

**IN THE UNITED STATES PATENT AND TRADEMARK OFFICE**

Inventor	: Jae Lark JUNG, et al.
Applicant	: FIRSTFACE CO., LTD.
App. No.	: Not Yet Assigned
Filed	: Herewith
For	: ACTIVATING DISPLAY AND PERFORMING USER AUTHENTICATION IN MOBILE TERMINAL WITH ONE-TIME USER INPUT
Examiner	: Not Yet Assigned
Art Unit	: Not Yet Assigned
Conf No.	: Not Yet Assigned

**TRANSMITTAL****Mail Stop PATENT APPLICATION**

Commissioner for Patents  
P.O. Box 1450  
Alexandria, VA 22313-1450

Dear Sir:

The following enclosures are transmitted herewith to be filed in the patent application:

- (X) Application Data Sheet in 7 pages.
- (X) Specification in 19 pages.
- (X) Drawings in 5 pages.
- (X) Request to Retrieve Electronic Priority Application in 2 pages.
- (X) Request for First Action Interview in 2 pages.
- (X) Declaration filed in Parent Application No. 14/058,761 in 1 page.
- (X) Power of Attorney by Applicant and its transmittal in 2 pages.
- (X) Certification & Request for Prioritized Examination under 37 CFR 1.102(e) in 1 page.
- (X) Rescission of Any Prior Disclaimers and Request to Revisit Art in 1 page.
- (X) Information Disclosure Statement and PTO/SB/08a in 9 pages.

**Application No.** : **Not Yet Assigned**  
**Filing Date** : **Herewith**

Respectfully submitted,

KNOBBE, MARTENS, OLSON & BEAR, LLP

Dated: September 8, 2015

By: /Mincheol Kim/

Mincheol Kim  
Registration No. 51,306  
Attorney of Record  
Customer No. 20995  
(949) 760-0404

21535546  
090815

Under the Paperwork Reduction Act of 1995, no persons are required to respond to a collection of information unless it contains a valid OMB control number.

<b>Application Data Sheet 37 CFR 1.76</b>		Attorney Docket Number	UNIS005.001C2
		Application Number	
Title of Invention	ACTIVATING DISPLAY AND PERFORMING USER AUTHENTICATION IN MOBILE TERMINAL WITH ONE-TIME USER INPUT		
<p>The application data sheet is part of the provisional or nonprovisional application for which it is being submitted. The following form contains the bibliographic data arranged in a format specified by the United States Patent and Trademark Office as outlined in 37 CFR 1.76.</p> <p>This document may be completed electronically and submitted to the Office in electronic format using the Electronic Filing System (EFS) or the document may be printed and included in a paper filed application.</p>			

**Secrecy Order 37 CFR 5.2**

<input type="checkbox"/>	Portions or all of the application associated with this Application Data Sheet may fall under a Secrecy Order pursuant to 37 CFR 5.2 (Paper filers only. Applications that fall under Secrecy Order may not be filed electronically.)
--------------------------	---

**Inventor Information:**

Inventor 1					Remove
Legal Name					
Prefix	Given Name	Middle Name	Family Name	Suffix	
	Jae Lark		JUNG		
Residence Information (Select One) <input type="radio"/> US Residency <input checked="" type="radio"/> Non US Residency <input type="radio"/> Active US Military Service					
City	Goyang-si	Country of Residence <sup>i</sup>	KR		
Mailing Address of Inventor:					
Address 1	1607-1604, Hugok Maeul Ilsan 3(sam)-dong, Ilsan-gu				
Address 2					
City	Goyang-si, Gyeonggi-do	State/Province			
Postal Code		Country i	KR		
Inventor 2					Remove
Legal Name					
Prefix	Given Name	Middle Name	Family Name	Suffix	
	Kyoung duck		BAE		
Residence Information (Select One) <input type="radio"/> US Residency <input checked="" type="radio"/> Non US Residency <input type="radio"/> Active US Military Service					
City	Seoul	Country of Residence <sup>i</sup>	KR		
Mailing Address of Inventor:					
Address 1	101-1709, Kukdong Green Apt.				
Address 2	Oksu-dong, Seongdong-gu				
City	Seoul	State/Province			
Postal Code		Country i	KR		
All Inventors Must Be Listed - Additional Inventor Information blocks may be generated within this form by selecting the Add button.					Add

**Correspondence Information:**

<b>Application Data Sheet 37 CFR 1.76</b>		Attorney Docket Number	UNIS005.001C2
		Application Number	
Title of Invention	ACTIVATING DISPLAY AND PERFORMING USER AUTHENTICATION IN MOBILE TERMINAL WITH ONE-TIME USER INPUT		

Enter either Customer Number or complete the Correspondence Information section below.  
For further information see 37 CFR 1.33(a).

An Address is being provided for the correspondence information of this application.

Customer Number	20995		
Email Address	efiling@knobbe.com	<input type="button" value="Add Email"/>	<input type="button" value="Remove Email"/>

### Application Information:

Title of the Invention	ACTIVATING DISPLAY AND PERFORMING USER AUTHENTICATION IN MOBILE TERMINAL WITH ONE-TIME USER INPUT		
Attorney Docket Number	UNIS005.001C2	Small Entity Status Claimed	<input checked="" type="checkbox"/>
Application Type	Nonprovisional		
Subject Matter	Utility		
Total Number of Drawing Sheets (if any)	5	Suggested Figure for Publication (if any)	1

### Filing By Reference :

Only complete this section when filing an application by reference under 35 U.S.C. 111(c) and 37 CFR 1.57(a). Do not complete this section if application papers including a specification and any drawings are being filed. Any domestic benefit or foreign priority information must be provided in the appropriate section(s) below (i.e., "Domestic Benefit/National Stage Information" and "Foreign Priority Information").

For the purposes of a filing date under 37 CFR 1.53(b), the description and any drawings of the present application are replaced by this reference to the previously filed application, subject to conditions and requirements of 37 CFR 1.57(a).

Application number of the previously filed application	Filing date (YYYY-MM-DD)	Intellectual Property Authority or Country <sup>i</sup>

### Publication Information:

Request Early Publication (Fee required at time of Request 37 CFR 1.219)

**Request Not to Publish.** I hereby request that the attached application not be published under 35 U.S.C. 122(b) and certify that the invention disclosed in the attached application **has not and will not** be the subject of an application filed in another country, or under a multilateral international agreement, that requires publication at eighteen months after filing.

### Representative Information:

Representative information should be provided for all practitioners having a power of attorney in the application. Providing this information in the Application Data Sheet does not constitute a power of attorney in the application (see 37 CFR 1.32). Either enter Customer Number or complete the Representative Name section below. If both sections are completed the customer number will be used for the Representative Information during processing.

Please Select One:	<input checked="" type="radio"/> Customer Number	<input type="radio"/> US Patent Practitioner	<input type="radio"/> Limited Recognition (37 CFR 11.9)
Customer Number	20995		

<b>Application Data Sheet 37 CFR 1.76</b>	Attorney Docket Number	UNIS005.001C2
	Application Number	
Title of Invention	ACTIVATING DISPLAY AND PERFORMING USER AUTHENTICATION IN MOBILE TERMINAL WITH ONE-TIME USER INPUT	

### Domestic Benefit/National Stage Information:

This section allows for the applicant to either claim benefit under 35 U.S.C. 119(e), 120, 121, 365(c), or 386(c) or indicate National Stage entry from a PCT application. Providing this information in the application data sheet constitutes the specific reference required by 35 U.S.C. 119(e) or 120, and 37 CFR 1.78.

When referring to the current application, please leave the application number blank.

Prior Application Status	Pending	<input type="button" value="Remove"/>			
Application Number	Continuity Type	Prior Application Number	Filing Date (YYYY-MM-DD)		
	Continuation of	14/538880	2014-11-12		
Prior Application Status	Patented	<input type="button" value="Remove"/>			
Application Number	Continuity Type	Prior Application Number	Filing Date (YYYY-MM-DD)	Patent Number	Issue Date (YYYY-MM-DD)
14/538880	Continuation of	14/058761	2013-10-21	8918074	2014-12-23
Prior Application Status	Patented	<input type="button" value="Remove"/>			
Application Number	Continuity Type	Prior Application Number	Filing Date (YYYY-MM-DD)	Patent Number	Issue Date (YYYY-MM-DD)
14/058761	Continuation of	13/590483	2012-08-21	8831557	2014-09-09
Additional Domestic Benefit/National Stage Data may be generated within this form by selecting the <b>Add</b> button.					<input type="button" value="Add"/>

### Foreign Priority Information:

This section allows for the applicant to claim priority to a foreign application. Providing this information in the application data sheet constitutes the claim for priority as required by 35 U.S.C. 119(b) and 37 CFR 1.55. When priority is claimed to a foreign application that is eligible for retrieval under the priority document exchange program (PDX) the information will be used by the Office to automatically attempt retrieval pursuant to 37 CFR 1.55(i)(1) and (2). Under the PDX program, applicant bears the ultimate responsibility for ensuring that a copy of the foreign application is received by the Office from the participating foreign intellectual property office, or a certified copy of the foreign priority application is filed, within the time period specified in 37 CFR 1.55(g)(1).

<input type="button" value="Remove"/>			
Application Number	Country <sup>i</sup>	Filing Date (YYYY-MM-DD)	Access Code <sup>j</sup> (if applicable)
10-2011-0106839	KR	2011-10-19	
Additional Foreign Priority Data may be generated within this form by selecting the <b>Add</b> button.			<input type="button" value="Add"/>

<b>Application Data Sheet 37 CFR 1.76</b>	Attorney Docket Number	UNIS005.001C2
	Application Number	
Title of Invention	ACTIVATING DISPLAY AND PERFORMING USER AUTHENTICATION IN MOBILE TERMINAL WITH ONE-TIME USER INPUT	

## Statement under 37 CFR 1.55 or 1.78 for AIA (First Inventor to File) Transition Applications

This application (1) claims priority to or the benefit of an application filed before March 16, 2013 and (2) also contains, or contained at any time, a claim to a claimed invention that has an effective filing date on or after March 16, 2013.

NOTE: By providing this statement under 37 CFR 1.55 or 1.78, this application, with a filing date on or after March 16, 2013, will be examined under the first inventor to file provisions of the AIA.

## Authorization to Permit Access:

Authorization to Permit Access to the Instant Application by the Participating Offices

If checked, the undersigned hereby grants the USPTO authority to provide the European Patent Office (EPO), the Japan Patent Office (JPO), the Korean Intellectual Property Office (KIPO), the World Intellectual Property Office (WIPO), and any other intellectual property offices in which a foreign application claiming priority to the instant patent application is filed access to the instant patent application. See 37 CFR 1.14(c) and (h). This box should not be checked if the applicant does not wish the EPO, JPO, KIPO, WIPO, or other intellectual property office in which a foreign application claiming priority to the instant patent application is filed to have access to the instant patent application.

In accordance with 37 CFR 1.14(h)(3), access will be provided to a copy of the instant patent application with respect to: 1) the instant patent application-as-filed; 2) any foreign application to which the instant patent application claims priority under 35 U.S.C. 119(a)-(d) if a copy of the foreign application that satisfies the certified copy requirement of 37 CFR 1.55 has been filed in the instant patent application; and 3) any U.S. application-as-filed from which benefit is sought in the instant patent application.

In accordance with 37 CFR 1.14(c), access may be provided to information concerning the date of filing this Authorization.

## Applicant Information:

Providing assignment information in this section does not substitute for compliance with any requirement of part 3 of Title 37 of CFR to have an assignment recorded by the Office.

<b>Application Data Sheet 37 CFR 1.76</b>	Attorney Docket Number	UNIS005.001C2
	Application Number	
Title of Invention	ACTIVATING DISPLAY AND PERFORMING USER AUTHENTICATION IN MOBILE TERMINAL WITH ONE-TIME USER INPUT	

<b>Applicant 1</b>		<input type="button" value="Remove"/>
<p>If the applicant is the inventor (or the remaining joint inventor or inventors under 37 CFR 1.45), this section should not be completed. The information to be provided in this section is the name and address of the legal representative who is the applicant under 37 CFR 1.43; or the name and address of the assignee, person to whom the inventor is under an obligation to assign the invention, or person who otherwise shows sufficient proprietary interest in the matter who is the applicant under 37 CFR 1.46. If the applicant is an applicant under 37 CFR 1.46 (assignee, person to whom the inventor is obligated to assign, or person who otherwise shows sufficient proprietary interest) together with one or more joint inventors, then the joint inventor or inventors who are also the applicant should be identified in this section.</p>		
<input type="button" value="Clear"/>		
<input checked="" type="radio"/> Assignee	<input type="radio"/> Legal Representative under 35 U.S.C. 117	<input type="radio"/> Joint Inventor
<input type="radio"/> Person to whom the inventor is obligated to assign.	<input type="radio"/> Person who shows sufficient proprietary interest	
If applicant is the legal representative, indicate the authority to file the patent application, the inventor is:		
Name of the Deceased or Legally Incapacitated Inventor : <input type="text"/>		
If the Applicant is an Organization check here. <input checked="" type="checkbox"/>		
Organization Name	FIRSTFACE CO., LTD.	
<b>Mailing Address Information For Applicant:</b>		
Address 1	10F., 97, Uisadang-daero, Yeongdeungpo-gu	
Address 2		
City	Seoul	State/Province
Country   KR	Postal Code	150-737
Phone Number	Fax Number	
Email Address		
Additional Applicant Data may be generated within this form by selecting the Add button. <input type="button" value="Add"/>		

## Assignee Information including Non-Applicant Assignee Information:

<p>Providing assignment information in this section does not substitute for compliance with any requirement of part 3 of Title 37 of CFR to have an assignment recorded by the Office.</p>	
<b>Assignee 1</b>	
<p>Complete this section if assignee information, including non-applicant assignee information, is desired to be included on the patent application publication. An assignee-applicant identified in the "Applicant Information" section will appear on the patent application publication as an applicant. For an assignee-applicant, complete this section only if identification as an assignee is also desired on the patent application publication.</p>	
<input type="button" value="Remove"/>	
If the Assignee or Non-Applicant Assignee is an Organization check here. <input type="checkbox"/>	

Under the Paperwork Reduction Act of 1995, no persons are required to respond to a collection of information unless it contains a valid OMB control number.

<b>Application Data Sheet 37 CFR 1.76</b>	Attorney Docket Number	UNIS005.001C2
	Application Number	
Title of Invention	ACTIVATING DISPLAY AND PERFORMING USER AUTHENTICATION IN MOBILE TERMINAL WITH ONE-TIME USER INPUT	

Prefix	Given Name	Middle Name	Family Name	Suffix

**Mailing Address Information For Assignee including Non-Applicant Assignee:**

Address 1				
Address 2				
City		State/Province		
Country i	Postal Code			
Phone Number		Fax Number		
Email Address				

Additional Assignee or Non-Applicant Assignee Data may be generated within this form by selecting the Add button.

**Signature:**


NOTE: This form must be signed in accordance with 37 CFR 1.33. See 37 CFR 1.4 for signature requirements and certifications.					
Signature	/Mincheol Kim/			Date (YYYY-MM-DD)	2015-09-08
First Name	Mincheol	Last Name	Kim	Registration Number	51306
Additional Signature may be generated within this form by selecting the Add button.					<input type="button" value="Add"/>

This collection of information is required by 37 CFR 1.76. The information is required to obtain or retain a benefit by the public which is to file (and by the USPTO to process) an application. Confidentiality is governed by 35 U.S.C. 122 and 37 CFR 1.14. This collection is estimated to take 23 minutes to complete, including gathering, preparing, and submitting the completed application data sheet form to the USPTO. Time will vary depending upon the individual case. Any comments on the amount of time you require to complete this form and/or suggestions for reducing this burden, should be sent to the Chief Information Officer, U.S. Patent and Trademark Office, U.S. Department of Commerce, P.O. Box 1450, Alexandria, VA 22313-1450. DO NOT SEND FEES OR COMPLETED FORMS TO THIS ADDRESS. **SEND TO: Commissioner for Patents, P.O. Box 1450, Alexandria, VA 22313-1450.**



## Privacy Act Statement

The Privacy Act of 1974 (P.L. 93-579) requires that you be given certain information in connection with your submission of the attached form related to a patent application or patent. Accordingly, pursuant to the requirements of the Act, please be advised that: (1) the general authority for the collection of this information is 35 U.S.C. 2(b)(2); (2) furnishing of the information solicited is voluntary; and (3) the principal purpose for which the information is used by the U.S. Patent and Trademark Office is to process and/or examine your submission related to a patent application or patent. If you do not furnish the requested information, the U.S. Patent and Trademark Office may not be able to process and/or examine your submission, which may result in termination of proceedings or abandonment of the application or expiration of the patent.

The information provided by you in this form will be subject to the following routine uses:

1. The information on this form will be treated confidentially to the extent allowed under the Freedom of Information Act (5 U.S.C. 552) and the Privacy Act (5 U.S.C. 552a). Records from this system of records may be disclosed to the Department of Justice to determine whether the Freedom of Information Act requires disclosure of these records.
2. A record from this system of records may be disclosed, as a routine use, in the course of presenting evidence to a court, magistrate, or administrative tribunal, including disclosures to opposing counsel in the course of settlement negotiations.
3. A record in this system of records may be disclosed, as a routine use, to a Member of Congress submitting a request involving an individual, to whom the record pertains, when the individual has requested assistance from the Member with respect to the subject matter of the record.
4. A record in this system of records may be disclosed, as a routine use, to a contractor of the Agency having need for the information in order to perform a contract. Recipients of information shall be required to comply with the requirements of the Privacy Act of 1974, as amended, pursuant to 5 U.S.C. 552a(m).
5. A record related to an International Application filed under the Patent Cooperation Treaty in this system of records may be disclosed, as a routine use, to the International Bureau of the World Intellectual Property Organization, pursuant to the Patent Cooperation Treaty.
6. A record in this system of records may be disclosed, as a routine use, to another federal agency for purposes of National Security review (35 U.S.C. 181) and for review pursuant to the Atomic Energy Act (42 U.S.C. 218(c)).
7. A record from this system of records may be disclosed, as a routine use, to the Administrator, General Services, or his/her designee, during an inspection of records conducted by GSA as part of that agency's responsibility to recommend improvements in records management practices and programs, under authority of 44 U.S.C. 2904 and 2906. Such disclosure shall be made in accordance with the GSA regulations governing inspection of records for this purpose, and any other relevant (i.e., GSA or Commerce) directive. Such disclosure shall not be used to make determinations about individuals.
8. A record from this system of records may be disclosed, as a routine use, to the public after either publication of the application pursuant to 35 U.S.C. 122(b) or issuance of a patent pursuant to 35 U.S.C. 151. Further, a record may be disclosed, subject to the limitations of 37 CFR 1.14, as a routine use, to the public if the record was filed in an application which became abandoned or in which the proceedings were terminated and which application is referenced by either a published application, an application open to public inspections or an issued patent.
9. A record from this system of records may be disclosed, as a routine use, to a Federal, State, or local law enforcement agency, if the USPTO becomes aware of a violation or potential violation of law or regulation.

**ACTIVATING DISPLAY AND PERFORMING USER AUTHENTICATION  
IN MOBILE TERMINAL WITH ONE-TIME USER INPUT**

**INCORPORATION BY REFERENCE TO ANY PRIORITY APPLICATIONS**

Any and all applications for which a foreign or domestic priority claim is identified in the Application Data Sheet as filed with the present application are hereby incorporated by reference under 37 CFR 1.57.

**BACKGROUND**

Field

**[0001]** The disclosure relates to a method and mobile communication terminal for performing a specific function when a mobile communication terminal is activated, and more particularly to a method and mobile communication terminal for performing various functions according to the number of presses or a press time of a button for switching from an inactive state to an active state.

Description of the Related Art

**[0002]** Recently, various terminals, for example, such as smart phones, mobile phones, personal digital assistants (PDAs), and web pads, having not only communication functions but also various other functions have come into wide use. These terminals have rapidly been generalized because not only can an environment identical or similar to a desktop computer be implemented anytime and anywhere on the above-described terminals, but they also include a telephone function.

**[0003]** At present, in order to operate a corresponding function among various functions included in a terminal such as those described above, a certain operation should be performed in a state in which the terminal is in an active state, that is, in a state in which a display is turned on. In addition, in order to add a certain function, an interface or button for performing the function should be added to the terminal. For example, it is possible to transmit a rescue signal indicating an emergency or urgent situation by pressing an emergency button only when the emergency button for the urgent situation is separately added.

**[0004]** On the other hand, users of the terminals described above perform operations of habitually taking out and activating the terminals on the move or in a standby state while carrying the terminals.

## SUMMARY

**[0005]** According to an embodiment, there is provided a mobile communication terminal comprising: a display unit including a touch screen capable of receiving user's input through the touch screen for controlling the mobile communication terminal; a memory unit; a communication unit; and an activation sensing unit, wherein the activation sensing unit detects a change from an inactive state of the mobile communication terminal to an active state of the mobile communication terminal, wherein the inactive state is defined that the display unit being turned off while the mobile communication terminal being communicable and the active state is defined that the display unit being turned on while the mobile communication terminal being communicable, wherein the mobile communication terminal performs a predetermined operation by an application of the mobile communication terminal when the activation sensing unit detects the change from the inactive state to the active state.

**[0006]** According to an another embodiment, there is provided a method for performing a specific function when a mobile communication terminal is activated, the method comprising: sensing a change from an inactive state of the mobile communication terminal to an active state of the mobile communication terminal, wherein the inactive state is defined that a display unit being turned off while the mobile communication terminal being communicable, wherein the active state is defined that a display unit being turned on while the mobile communication terminal being communicable; and performing a predetermined operation by an application of the mobile communication terminal when the mobile communication terminal changes from the inactive state to the active state.

## BRIEF DESCRIPTION OF THE DRAWINGS

**[0007]** Embodiments are described in further detail below with reference to the accompanying drawings. It should be understood that various aspects of the drawings may have been exaggerated for clarity:

**[0008]** FIG. 1 is a diagram illustrating an external appearance of a mobile communication terminal according to an embodiment of the present invention;

**[0009]** FIG. 2 is a diagram illustrating an example of an operation of the mobile communication terminal when an activation button has been pressed according to an embodiment of the present invention;

**[0010]** FIGS. 3A and 3B are block diagrams illustrating the operation of the mobile

communication terminal according to an embodiment of the present invention;

**[0011]** FIGS. 4A and 4B are block diagrams illustrating the operation of the mobile communication terminal according to another embodiment of the present invention;

**[0012]** FIG. 5 is a block diagram illustrating the operation of the mobile communication terminal according to still another embodiment of the present invention; and

**[0013]** FIG. 6 is a diagram illustrating a configuration of a service providing system (server) for enabling a specific function to be operated when the mobile communication terminal is activated according to an embodiment of the present invention.

### **DETAILED DESCRIPTION**

**[0014]** In the following detailed description, reference is made to the accompanying drawings that show, by way of illustration, specific embodiments in which the invention may be practiced. These embodiments are described in sufficient detail to enable those skilled in the art to practice the invention. It is to be understood that the various embodiments of the invention, although different, are not necessarily mutually exclusive. For example, a particular feature, structure, or characteristic described herein in connection with one embodiment may be implemented within other embodiments without departing from the spirit and scope of the present invention. Also, it is to be understood that the positions or arrangements of individual elements in the embodiment may be changed without separating the spirit and scope of the present invention. The following detailed description is, therefore, not to be taken in a limiting sense, and the scope of the present invention is defined only by the appended claims that should be appropriately interpreted along with the full range of equivalents to which the claims are entitled. In the drawings, like reference numerals identify like or similar elements or functions through the several views.

**[0015]** Hereinafter, embodiments of the present invention will be explained in detail with reference to the accompanying drawing so that those skilled in the art can easily practice the invention.

#### Terms

**[0016]** The term “mobile communication terminal” used herein refers to a digital device that includes a memory means and a microprocessor with computing capability as in a mobile phone, a navigation system, a web pad, a PDA, a workstation, a personal computer (for example, a

notebook computer or the like) as a digital device including wired/wireless communication functions or other functions. Although an example of the mobile communication terminal (for example, a mobile phone) will be described in part of this specification, the present invention is not limited thereto.

**[0017]** The term “inactive state” used herein refers to a state in which the mobile communication terminal is communicable but a display screen is turned off. Even when the display screen is turned off, a predetermined function (for example, a music play function or the like) is operable. As described above, the term “inactive state” used herein refers to a concept encompassing states in which the display screen is turned off, regardless of whether or not the mobile communication terminal performs a predetermined operation. However, a state in which the mobile communication terminal is completely turned off is excluded.

**[0018]** The term “active state” used herein refers to a state in which the display screen of the mobile communication terminal is turned on. Switching from the “inactive state” to the “active state” refers to switching of the display screen from the OFF state to the ON state, regardless of information displayed on the display screen in the ON state. For example, the mobile communication terminal can be determined to be in the “active state” even when only a lock screen is displayed.

#### Mobile Communication Terminal

**[0019]** FIG. 1 is a diagram illustrating an external appearance of the mobile communication terminal according to an embodiment of the present invention.

**[0020]** Referring to FIG. 1, the mobile communication terminal 100 according to this embodiment can include a display unit 110 and an activation button 120. The mobile communication terminal 100 can further include a camera 130.

**[0021]** Although the display unit 110 is provided on the front side of a frame constituting the mobile communication terminal 100, the activation button 120 is provided on a lower part of the display unit 110, and the camera 130 is provided on an upper part of the display unit 110 as illustrated in FIG. 1, other forms may be configured. For example, the display unit 110 need not necessarily be formed on the entire surface of the mobile communication terminal 100. That is, the display unit 110 is only required to be formed on at least part of the mobile communication terminal 100, and the activation button 120 is only required to be formed on a part different from that of the display unit 110. In addition, the camera 130 can be formed on the other side on

which the display unit 110 is not provided in the mobile communication terminal 100.

**[0022]** The display unit 110 displays various information regarding operation states of the mobile communication terminal 100, and also displays an interface for a user's input if the mobile communication terminal 100 drives a touch screen. In general, if a state in which the user's operation on the mobile communication terminal 100 is absent continues for a predetermined period of time, the mobile communication terminal 100 is in the inactive state. The user's operation refers to an input through the interface displayed on the display unit 110, an operation through the button 120, or an operation through a function key (for example, a volume control key or the like). A condition in which the inactive state is reached can be set by the user. For example, the condition can be set using a setting menu through the interface displayed on the display unit 110. On the other hand, the state can be switched to the inactive state by pressing another button (for example, an ON/OFF button) provided on the mobile communication terminal 100. For example, the mobile communication terminal 100 can be completely turned off if the ON/OFF button is pressed for a long time when the mobile communication terminal 100 is in the active state, but the mobile communication terminal 100 can be in the inactive state as a communicable state in which a phone call can be received if the ON/OFF button is pressed for a short time.

**[0023]** The activation button 120 is means for switching the mobile communication terminal 100 from the inactive state to the active state. That is, if the user presses the activation button 120 when the mobile communication terminal 100 is in the inactive state, switching to the active state is performed. FIG. 1 illustrates a state in which a lock screen is displayed on the display unit 110 after pressing the activation button 120 when the mobile communication terminal 100 is in the inactive state. However, the activation button 120 can function as means for another operation (for example, means for moving to a standby screen while a certain operation state is displayed on the display unit 110 or means for displaying a list of programs currently being operated).

**[0024]** According to an embodiment of the present invention, if the user presses the activation button 120 when the mobile communication terminal 100 is in the inactive state, the mobile communication terminal 100 performs a predetermined operation in addition to switching to the active state. For example, image information is displayed on a lock screen of the display unit 110 when the predetermined operation is being performed. The image information is displayed on a lock screen of the display unit when the predetermined operation is being performed. The lock screen is configured to be displayed when the mobile communication

terminal 100 changes from the inactive state to the active state. The display unit 110 can provide an unlock means on a part of the display unit 110 when the predetermined operation is being performed.

**[0025]** When the mobile communication terminal 100 is in the inactive state, the user can set an operation to be performed by pressing the activation button 120. For example, an operation of the mobile communication terminal 100 connected to the activation button 120 can be set using a setting menu through the interface displayed on the display unit 110. In addition, according to an embodiment of the present invention, an operation which differs according to the number of presses or a press time of the activation button 120 can be performed when the mobile communication terminal 100 is in the inactive state. For example, a first operation can be set to be performed if the activation button 120 is pressed once, and a second operation can be set to be performed if the activation button 120 is continuously pressed three times. In addition, as another example, the first operation can be set to be performed if the activation button 120 is pressed once for a short time, and the second operation can be set to be performed if the activation button 120 is pressed once for a long time. The mobile communication terminal 120 can include a predetermined clock circuit or timer to calculate the cumulative number of continuous presses of the activation button 120 and measure a period of time for which the activation button 120 is pressed. For example, the number of presses is determined to be two if the activation button 120 is re-pressed within a threshold time after one press. If the activation button 120 is pressed for the threshold time or more, a long press of the activation button 120 can be determined. Operations capable of being performed by pressing the activation button 120 in the inactive state will be described later.

**[0026]** According to an embodiment of the present invention, a sub-display unit 121 can be provided on the activation button 120. Information regarding an operation to be performed by pressing the activation button 120 can be displayed on the sub-display unit 121. Various types such as a shape, a character, a graphic, and color can be displayed. When the display type is the shape, a circle, a triangle, a rectangle, a hexagon, or the like can be displayed. For example, the circle can be displayed on the sub-display unit 121 when the first operation is set to be performed by pressing the activation button 120, and the triangle can be displayed on the sub-display unit 121 when the second operation is set to be performed by pressing the activation button 120, and vice versa. A display type of the sub-display unit 121 and a correspondence relationship between operations and displays can also be set by the user. For example, the user can select the first

operation as the operation to be performed by pressing the activation button 120 from a setting menu and select the triangle as the display type of the sub-display unit 121 of the activation button 120. Accordingly, the user can recognize that the first operation is performed when the user has pressed the activation button 120 because the triangle is displayed on the sub-display unit 121 even when the mobile communication terminal 100 is in the inactive state.

[0027] Although the sub-display unit 121 can be implemented by a general display such as liquid crystal, a liquid crystal display (LCD), or a light emitting diode (LED), the present invention is not limited thereto.

[0028] An operation of controlling driving of the display unit 110 and the sub-display unit 121 can be performed in the same processor and the same method or in different processors and different methods.

[0029] Hereinafter, various embodiments for operations of the mobile communication terminal 100 capable of being performed by pressing the activation button 120 will be described.

#### Operations through Activation Button

[0030] Operations to be described below can be performed by pressing the activation button 120 when the mobile communication terminal 100 is in the inactive state, and set by the user. The operations described below are only examples. Of course, other operations can be performed by pressing the activation button 120.

##### 1. Camera Activation Function

[0031] When the mobile communication terminal 100 is in the inactive state, the camera 130 provided in the mobile communication terminal 100 can be activated by pressing the activation button 120, and a screen currently imaged by the camera 130 can be displayed on the display unit 110.

[0032] FIG. 2 is a diagram illustrating an example in which the camera 130 is activated after the activation button 120 is pressed and an imaged scene is displayed on the display unit 110.

##### 2. Health Sensing and Health Information Transmission Functions

[0033] When the mobile communication terminal 100 is in the inactive state, the health sensing function can be driven, so that sensed health information can be transmitted to a medical authority such as a doctor or a protector.

[0034] FIGS. 3A and 3B are block diagrams of the mobile communication terminal 100 illustrating the above-described functions. FIGS. 3A and 3B illustrate functional block diagrams



illustrating the above-described functions of the mobile communication terminal 100.

**[0035]** Referring to FIG. 3A, the mobile communication terminal 100 can include an activation sensing unit 310, a health sensing unit 320, and a health information transmission unit 330.

**[0036]** When the mobile communication terminal 100 is in the inactive state, the activation sensing unit 310 senses whether or not the user has pressed the activation button 120.

**[0037]** The health sensing unit 320 is operated when the activation sensing unit 310 has sensed that the activation button 120 has been pressed, and senses a health state of the user in various methods.

**[0038]** FIG. 3B is a block diagram illustrating an example of the health sensing unit 320. Referring to FIG. 3B, the health sensing unit 320 can include a camera activation element 321, an eyeball detection element 322, and a health information acquisition element 323.

**[0039]** The camera activation element 321 activates the camera 130 provided in the mobile communication terminal 100. According to the activation of the camera 130, a video currently captured by the camera 130 is displayed on the display unit 110. If an eye or face of the user is imaged by the camera 130, the eyeball detection element 322 performs a function of recognizing and extracting an eyeball of the user. A general eyeball detection algorithm can be used for eyeball detection. The health information acquisition element 323 acquires various health information through the eyeball detected through the eyeball detection element 322. It is possible to recognize a stress index, a diabetes index, or retinal diseases of the user through a color or health state of the eyeball. A well-known algorithm in the related art can be used as an algorithm for detecting health information from characteristics of the detected eyeball.

**[0040]** The health information acquired as described above can be transmitted by the health information transmission unit 330 to the mobile communication terminal of a protector, a medical authority such as a doctor or the like, or a predetermined server. Information regarding the protector (for example, a phone number or an e-mail address) can be stored in advance. The acquired health information can be displayed on the display unit 110 so that the user can check the acquired health information.

**[0041]** The above-described operations, that is, the eyeball detection function and the health sensing function based on information regarding the detected eyeball, can be performed by installing a predetermined application. That is, the application includes an eyeball detection algorithm and a health sensing algorithm, so that the operations as described above can be

performed by installing the application in the mobile communication terminal 100. The user can download this application and install the downloaded application in the mobile communication terminal 100. In addition, although an example of only health sensing through eyeball detection has been described above, it is possible to install an application, for example, for health sensing through face detection, and connect the application to the activation button 120. The user can use the functions as described above by setting the application to be operated immediately when the activation button 120 is pressed through the setting menu in the inactive state of the mobile communication terminal 100.

**[0042]** In general, aged persons may not use the health sensing function due to a difficult operation even when the health sensing function is provided in the mobile communication terminal 100. However, according to the above-described embodiment of the present invention, the health sensing function is operated only by pressing the activation button 120 without a special operation. Accordingly, it is possible to easily check health information and transmit the health information to a protector or a doctor.

### 3. User Identification Function

**[0043]** When the mobile communication terminal 100 is in the inactive state, a user authentication process can be performed for security by pressing the activation button 120.

**[0044]** FIGS. 4A and 4B illustrate block diagrams of the mobile communication terminal 100 illustrating the above-described functions. Referring to FIG. 4A, the mobile communication terminal 100 can include an activation sensing unit 410 and a user identification unit 420.

**[0045]** When the mobile communication terminal 100 is in the inactive state, the activation sensing unit 410 senses whether or not the user has pressed the activation button 120.

**[0046]** If the activation sensing unit 410 senses that the activation button 120 has been pressed, the user identification unit 420 operates the user identification function in various methods.

**[0047]** FIG. 4B is a block diagram illustrating an example of the user identification unit 420. Referring to FIG. 4B, the user identification unit 420 can include a camera activation element 421, an iris detection element 422, and a user identification element 423.

**[0048]** The camera activation element 421 activates the camera 130 provided in the mobile communication terminal 100. According to the activation of the camera 130, a video currently captured by the camera 130 is displayed on the display unit 110. If an eye or face of the user is imaged by the camera 130, the iris detection element 422 performs a function of recognizing and

extracting an iris from an eyeball of the user. A general iris detection algorithm can be used for iris recognition. The user identification element 423 performs a function of comparing the iris detected by the iris detection element 422 to pre-stored iris information of the user, and authenticating the current user as a true user if the two match. For this, the user identification element 423 can use iris information of the user pre-stored in a database (not illustrated). The iris information of the user can be stored by registering information regarding the iris detected by the iris detection element 422 using a video of the true user first captured by the camera 130.

Predetermined identification information (for example, an identifier (ID), a password, a social security number, or the like) should be input to change the registered iris information of the true user. If the user identification element 423 authenticates the current user as the true user, the lock state of the mobile communication terminal 100 is released and all functions are available. If the current *user is not authenticated* as the true user, the lock state continues along with a display of an alarm message.

**[0049]** The above-described operations, that is, the iris detection function, the user identification function, and the user authentication function, can be performed by installing a predetermined application. That is, the application includes the iris detection algorithm and the authentication algorithm based on an iris comparison, so that the operations as described above can be performed by installing the application in the mobile communication terminal 100. The user can download this application and install the downloaded application in the mobile communication terminal 100. The user can use the functions as described above by setting the application to be operated immediately when the activation button 120 is pressed through the setting menu in the inactive state of the mobile communication terminal 100.

**[0050]** Accordingly, it is possible to efficiently reduce security risks by setting the user authentication process to be performed through a separate setting, that is, by pressing the activation button 120, when the mobile communication terminal 100 is used in a region vulnerable to the security risks.

**[0051]** Although an example of an authentication method through iris recognition has been described above, other authentication methods, for example, an authentication key matching method, a password matching method, a face recognition method, a fingerprint recognition method, and the like, can be used. That is, one or more authentication methods can be performed by pressing the activation button 120.

#### 4. Location Information Transmission Function

**[0052]** When the mobile communication terminal 100 is in the inactive state, collected location information can be transmitted to a protector or a protection authority (a police station or a fire station) by pressing the activation button 120.

**[0053]** FIG. 5 illustrates a block diagram of the mobile communication terminal 100 illustrating the above-described function. Referring to FIG. 5, the mobile communication terminal 100 can include an activation sensing unit 510, a location information collection unit 520, and a location information transmission unit 530.

**[0054]** When the mobile communication terminal 100 is in the inactive state, the activation sensing unit 510 senses whether or not the user has pressed the activation button 120.

**[0055]** When the activation sensing unit 510 senses that the activation button 120 has been pressed, the location information collection unit 520 collects a current location using a global positioning system (GPS) sensor or other location sensors.

**[0056]** The location information transmission unit 530 performs a function of transmitting location information collected by the location information collection unit 520 to a protector or a protection authority. In an urgent situation, a message indicating the urgent situation can be transmitted along with the location information. The location information and the urgent message can be optionally transmitted. On the other hand, this operation may differ according to the number of presses or a press time of the activation button 120. For example, it is possible to set an operation of transmitting the urgent message to a police station along with the location information when the activation button 120 is pressed for a short time, and set an operation of transmitting only the location information to the protector when the activation button 120 is pressed for a long time. In addition, as another example, it is possible to set an operation of transmitting the location information to the police station along with the urgent message when the activation button 120 is pressed once and set an operation of transmitting the location information to a fire station along with the urgent message when the activation button 120 is pressed three times.

**[0057]** The above-described operations can be performed by installing a predetermined application. That is, the application includes an algorithm for collecting location information and transmitting the collected located information along with an urgent message, so that the operations as described above can be performed by installing the application in the mobile communication terminal 100. The user can download this application and install the downloaded

application in the mobile communication terminal 100. The user can use the functions as described above by setting the application to be operated immediately when the activation button 120 is pressed through the setting menu in the inactive state of the mobile communication terminal 100.

**[0058]** Accordingly, it is possible to efficiently escape a dangerous situation because the user can report the dangerous situation to a protector or a protection authority along with his/her location information with only a simple operation.

#### 5. File Transmission Function

**[0059]** When the mobile communication terminal 100 is in the inactive state, a function of uploading content (for example, contact information, a photo, a moving image, or an application) included in the mobile communication terminal 100 to another mobile communication terminal 100 or a media space (for example, a personal media space such as Twitter, Facebook, or a blog or a community media space such as a café or club community) can be operated.

#### 6. Mode Change During Drive

**[0060]** When the mobile communication terminal 100 is in the inactive state, the mobile communication terminal 100 can be switched to a hands-free function or some communication functions (a voice communication function, a short message service (SMS) function, and an Internet function) of the mobile communication terminal 100 can be interrupted by pressing the activation button 120.

**[0061]** Accordingly, it is possible to significantly reduce traffic accident risks by switching the mode of the mobile communication terminal 100 or interrupting the communication function with only a simple operation of pressing the activation button 120 during driving.

#### 7. Advertisement Display Operation

**[0062]** When the mobile communication terminal 100 is in the inactive state, the activation button 120 is pressed so that an advertisement can be displayed on at least a part of the display unit 110. The advertisement display can be implemented by displaying an advertisement provided from an external server in real time, and driven by an advertisement-related application previously installed within the mobile communication terminal 100.

**[0063]** This application for enabling the advertisement to be displayed may be received in advance from an advertisement distribution server, an advertiser server, or a server for providing a service according to an embodiment of the present invention, that is, a service for driving a predetermined application according to a button input that switches the mobile communication

terminal 100 from the inactive state to the active state.

**[0064]** An advertisement display method can be implemented by a method of randomly displaying advertisements of advertisers joining this service, a customized advertisement display method based on user information, and an advertisement display method based on a current location.

**[0065]** The user information can be pre-stored in a corresponding application and pre-transmitted to a server that provides an advertising service. On the other hand, location information collection necessary for the advertisement display method based on the current location can be used in conjunction with 4. Location Information Function described above. That is, current location information is collected simultaneously with the activation of the mobile communication terminal 100 and transmitted to an advertising-service providing server. Based on the current location information, advertisements related to the current location are distributed to the mobile communication terminal 100.

#### 8. Other Application Operations

**[0066]** If a predetermined operation is performed in addition to switching to a simple active state by pressing the activation button 120 when the mobile communication terminal 100 is in the inactive state, this belongs to the scope of the present invention.

**[0067]** For example, an entertainment operation (for example, an operation of a music or video player, execution of a game application, or news reception) can be performed by pressing the activation button 120.

#### Operation Standby of Application

**[0068]** According to an embodiment of the present invention, the above-described predetermined applications are driven when the mobile communication terminal 100 is switched from the inactive state to the active state.

**[0069]** For this, when the mobile communication terminal 100 is in the inactive state, the applications should be maintained in an operation standby state. When the mobile communication terminal 100 is switched from the active state to the inactive state, the above-described applications can be in the operation standby state. That is, a selected application to be driven when the mobile communication terminal 100 is switched to the active state can be in the operation standby state when the mobile communication terminal 100 is switched to the inactive state.

**[0070]** However, a predetermined application operable when the mobile communication terminal 100 is switched from the inactive state to the active state regardless of the operation standby state or an operation disable state of the application belongs to the present invention.

### Service Providing Server

**[0071]** Hereinafter, the service providing server according to an embodiment will be described.

**[0072]** FIG. 6 is a diagram illustrating a configuration of a service providing system (server) for enabling a specific function to be operated when the mobile communication terminal is activated according to an embodiment of the present invention.

**[0073]** Referring to FIG. 6, the service providing server 200 can include an application providing unit 210, an activation sensing unit 220, an application driving unit 230, a communication unit 240, and a control unit 250. According to an embodiment of the present invention, the application providing unit 210, the activation sensing unit 220, the application driving unit 230, the communication unit 240, and the control unit 250 of the service providing server 200 can be program modules or hardware communicable with an external apparatus. The program modules or hardware can be included in the service providing server 200 or another apparatus communicable with the service providing server 200 in the form of an operation system, an application program module, and other program modules, and physically stored in various known storage apparatuses. On the other hand, these program modules or hardware include a routine, a sub routine, a program, an object, a component, and a data structure, each of which executes a specific task to be described later or specific abstract data, but the present invention is not limited thereto.

**[0074]** The application providing unit 210 enables the predetermined application described above to be transmitted to the mobile communication terminal 100. The user can receive a desired application by accessing the service providing server 200 through the mobile communication terminal 100, and install the received application within the mobile communication terminal 100. The application can include a control function of controlling a predetermined operation to be performed when the mobile communication terminal 100 is activated, and can independently perform the predetermined operation. For example, the application transmitted from the application providing unit 210 can be an application for enabling an advertisement to be displayed on the display unit 110 when the mobile

communication terminal 100 is switched from the inactive state to the active state.

**[0075]** The activation sensing unit 220 according to an embodiment can sense the switching of the mobile communication terminal 100 from the inactive state to the active state. The user can transmit a signal indicating the activation of the mobile communication terminal 100 to the service providing server 200 by pressing the activation button of the mobile communication terminal 100.

**[0076]** The application driving unit 230 according to an embodiment enables a predetermined operation to be performed in the mobile communication terminal 100 when the activation of the mobile communication terminal 100 is sensed. That is, the application driving unit 230 drives a predetermined application within the mobile communication terminal 100 and enables a related screen to be displayed on the display unit 110. For example, if the activation of the mobile communication terminal 100 is sensed, an advertisement-related application can be executed. The application driving unit 230 can perform an additional operation related to driving of a corresponding application. For example, an application for enabling an advertisement to be displayed is driven to receive current location information and control advertisement information related to a corresponding location to be displayed on the display unit 110 of the mobile communication terminal 100. In addition, it is possible to collect user information (for example, a sex, an age, a region of residence, a matter of interest, and the like) and control advertisement information customized for a corresponding user to be displayed. Necessary advertisement information (for example, advertisement information to be transmitted to the mobile communication terminal 100 based on location information or user information) can be transmitted from an advertiser server or an advertisement distribution server. As described above, the application driving unit 230 can drive a predetermined application simultaneously with the activation within the mobile communication terminal 100 and perform an additional operation for optimally driving the application.

**[0077]** The communication unit 240 according to an embodiment makes information communication between the service providing server 200, the mobile communication terminal 100, and another apparatus possible. That is, the communication unit 240 can transmit an application to the mobile communication terminal 100 and receive an activation signal and information for driving the application from the mobile communication terminal 100.

**[0078]** The control unit 250 according to an embodiment can perform a function of controlling data flows between the application providing unit 210, the activation sensing unit 220,



the application driving unit 230, and the communication unit 240. That is, the control unit 250 according to the embodiment can control the application providing unit 210, the activation sensing unit 220, the application driving unit 230, and the communication unit 240 to perform unique functions.

**[0079]** According to embodiments of the present invention, it is possible to enable an advantageous function to be utilized and improve an interest of a terminal user because various operations can be performed only by pressing an activation button when a terminal is in an inactive state.

**[0080]** According to embodiments of the present invention, it is possible to enable health check of an aged person to be performed with a simple operation and enable information regarding the health check to be transmitted to a protector or a medical authority.

**[0081]** According to embodiments of the present invention, it is possible to enable a user authentication process of which the security is enhanced to be operable with only a simple procedure.

**[0082]** According to embodiments of the present invention, it is possible to enable an urgent message to be transmitted along with location information with only a simple operation in an urgent situation.

**[0083]** The embodiments according to the present invention described above may be implemented in the form of program instructions that may be executed through various computer components and recorded on a computer-readable medium. The computer-readable medium may include program instructions, data files, data structures, and the like individually or in combination. The program instructions recorded on the medium may be specifically designed for the present invention or may be well known to one of ordinary skill in the art of software. Examples of the computer-readable recording medium include a magnetic medium such as a hard disk, a floppy disk, or a magnetic tape, an optical medium such as a compact disc-read only memory (CD-ROM) or a digital versatile disc (DVD), a magneto-optical medium such as a floptical disk, and a hardware device such as ROM, a random access memory (RAM), or a flash memory that is specially designed to store and execute program instructions. Examples of the program instructions include not only machine code generated by a compiler or the like but also high-level language codes that may be executed by a computer using an interpreter or the like. The hardware device described above may be constructed so as to operate as one or more software modules for performing the operations of the embodiments of the present invention, and

vice versa.

**[0084]** Although the present invention has been described with reference to the specific embodiments and drawings together with specific details such as detailed components, the above description is provided only for better understanding of the present invention and it will be apparent to those skilled in the art that various modifications and variations may be made from the above description.

**[0085]** While embodiments have been disclosed herein, it should be understood that other variations may be possible. Such variations are not to be regarded as a departure from the spirit and scope of embodiments of the present application, and all such modifications as would be obvious to one skilled in the art are intended to be included within the scope of the following claims.

What is Claimed is:

1. A mobile communication terminal comprising:  
a touch screen display,  
a power button configured to turn on and off the terminal by pressing; and  
an activation button separate from the power button and configured for pressing to turn on the touch screen display.

**ACTIVATING DISPLAY AND PERFORMING USER AUTHENTICATION  
IN MOBILE TERMINAL WITH ONE-TIME USER INPUT**

**ABSTRACT**

Disclosed is a mobile terminal including a touch screen display, a power button and an activation button for turning on the touch screen display. Upon detection of one-time pressing of the activation button while the touch screen display is turned off, the terminal is configured to turn on the touch screen display and perform a fingerprint authentication function in addition to turning on the touch screen display. The touch screen display displays a lock screen thereon as it is turned on in response to the detection of one-time pressing, and the lock screen is displayed on the touch screen display when the fingerprint authentication function is being performed. A lock state of the terminal continues when the fingerprint authentication function fails to authenticate a user, and the lock state is released for enabling other functions of the terminal when the fingerprint authentication function authenticates a user

21526066  
090415

FIG. 1

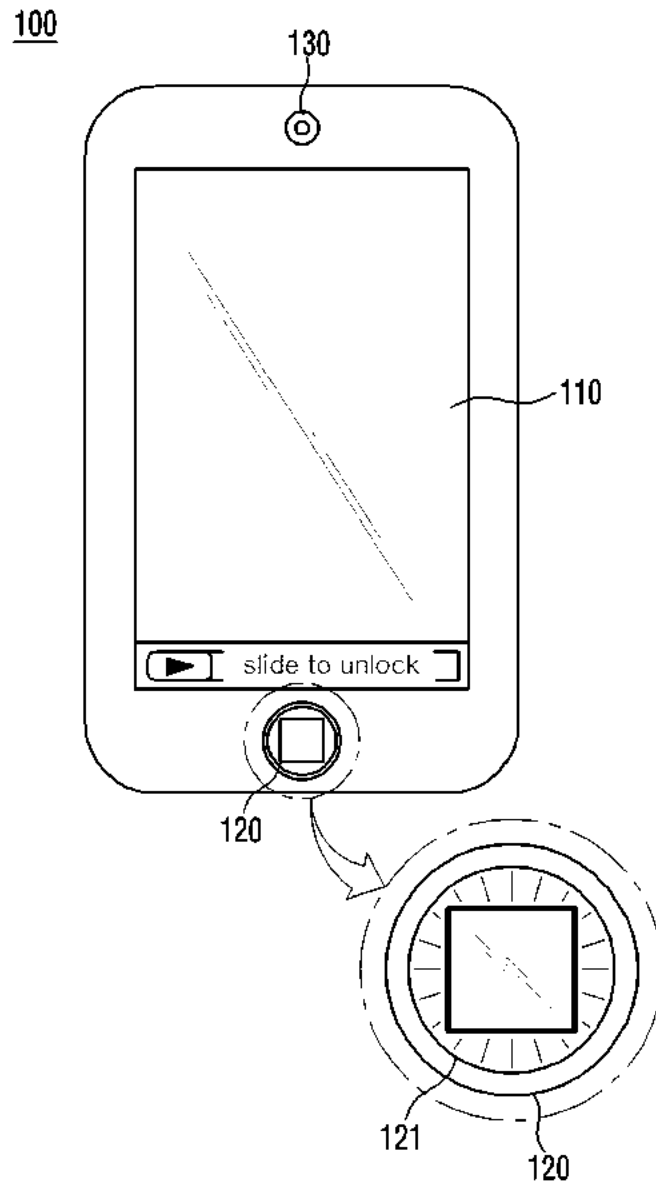


FIG. 2

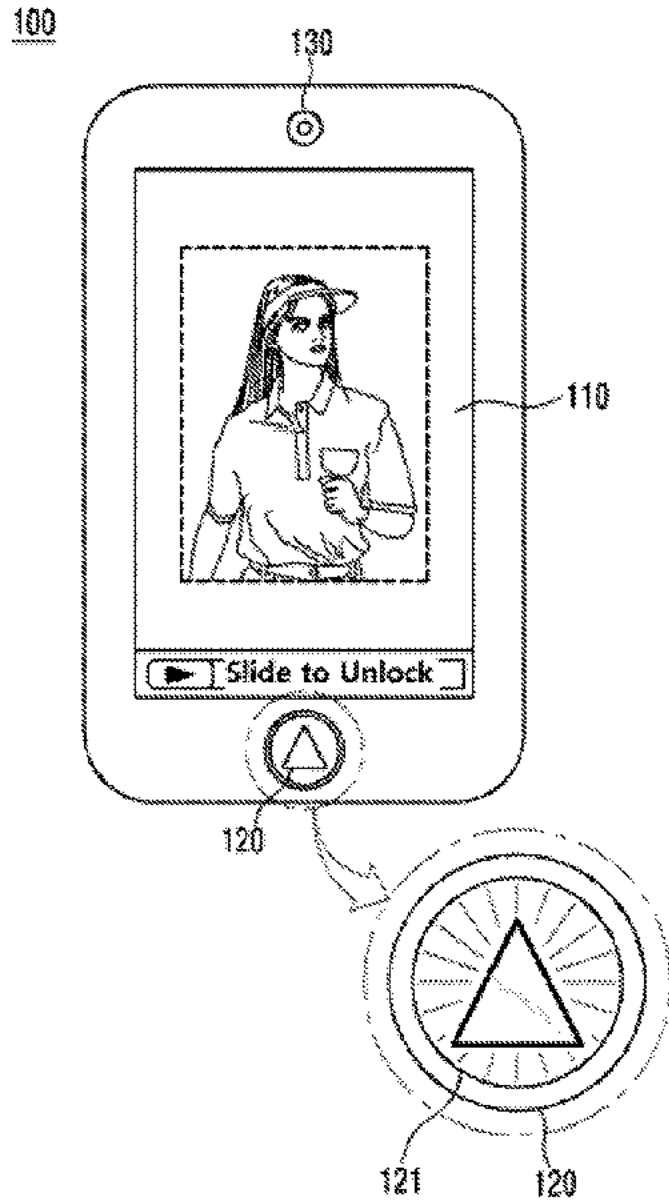


FIG. 3A

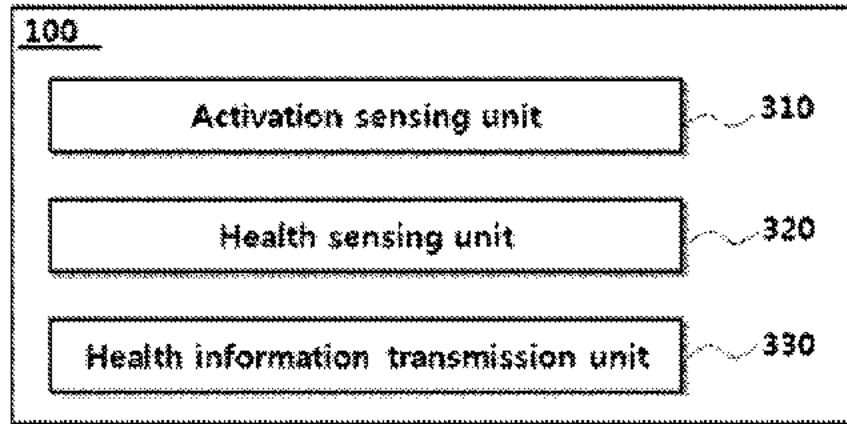


FIG. 3B

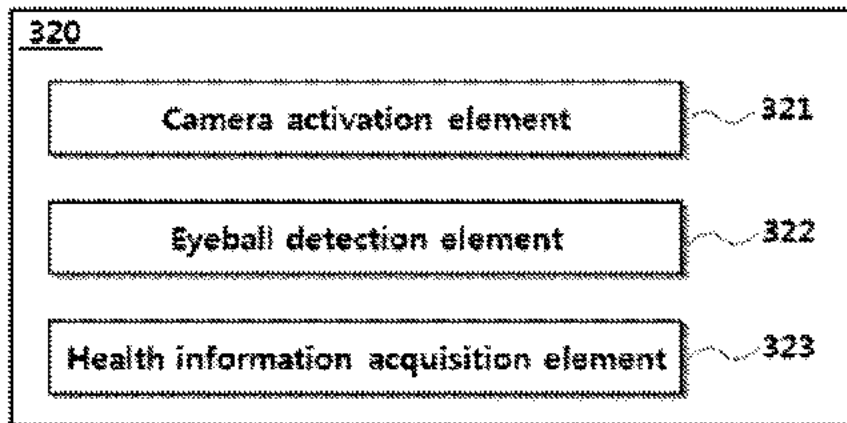


FIG. 4A

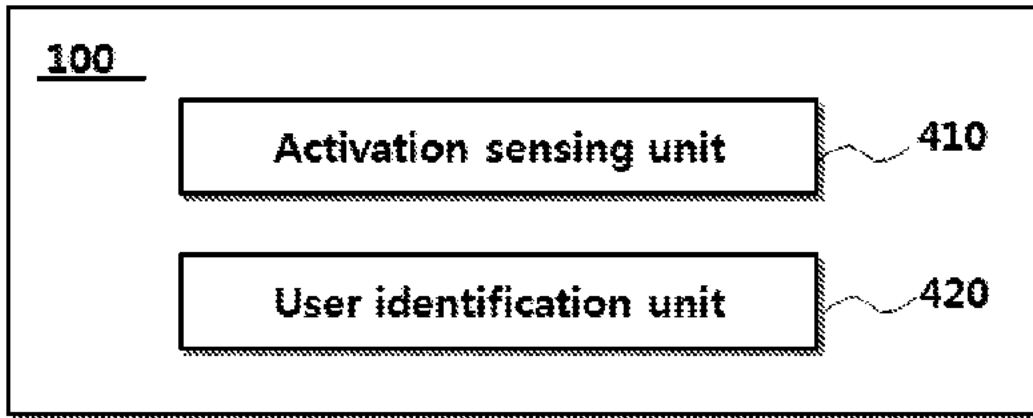


FIG. 4B

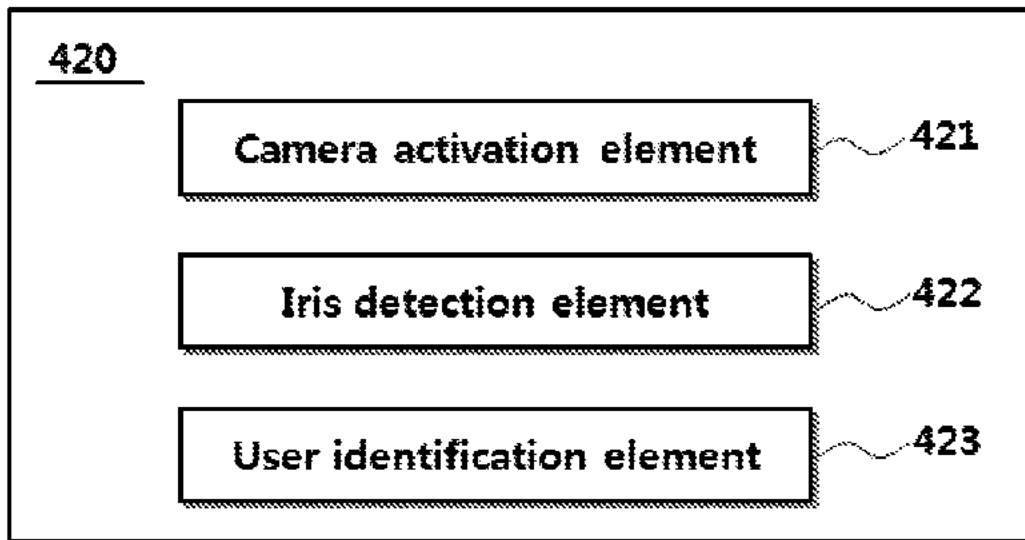




FIG. 5

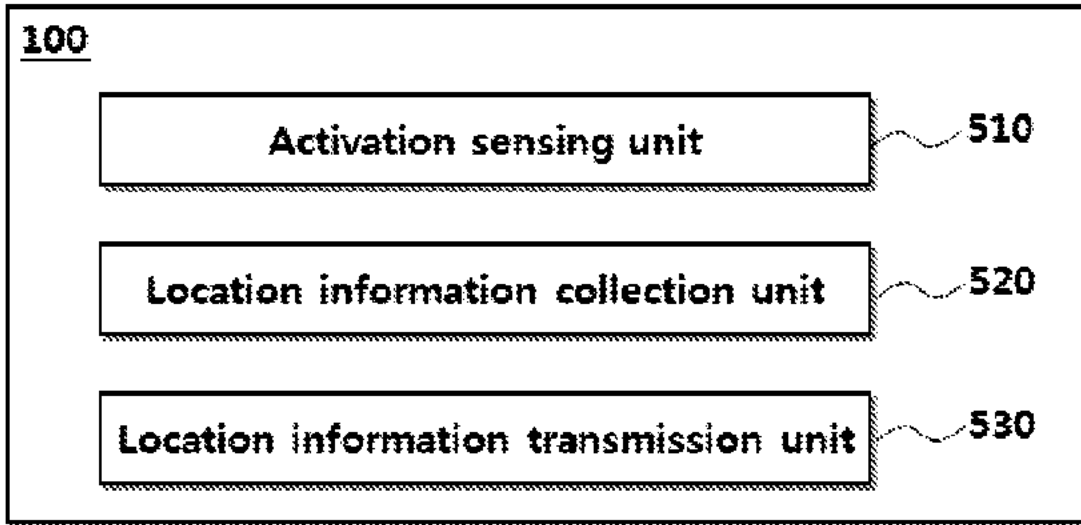
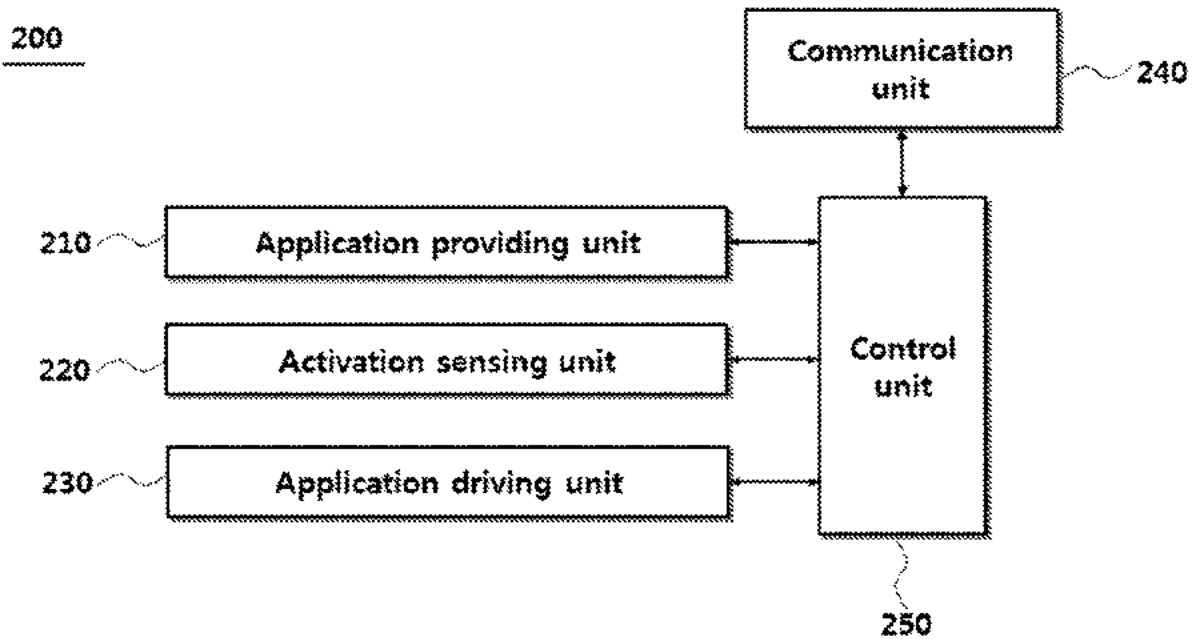


FIG. 6



Under the Paperwork Reduction Act of 1995, no persons are required to respond to a collection of information unless it displays a valid OMB control number.

### Request to Retrieve Electronic Priority Application(s)

Send completed form to: Commissioner for Patents  
P.O. Box 1450, Alexandria, VA 22313-1450

COMPLETE IF KNOWN	
Application Number	Not Yet Assigned
Filing Date	Herewith
First Named Inventor	Jae Lark JUNG
Art Unit	Not Yet Assigned
Examiner Name	Not Yet Assigned
Attorney Docket Number	UNIS005 001C2

Pursuant to 37 CFR 1.55(h), the undersigned hereby requests that the USPTO retrieve an electronic copy of each of the following foreign applications for which priority has been claimed under 35 U.S.C. 119(a)-(d) from a foreign intellectual property office participating with the USPTO in a bilateral or multilateral priority document exchange agreement. This Request must be submitted:

- within the later of sixteen months from the filing date of the prior foreign application or four months from the actual filing date of an application under 35 U.S.C. 111(a),
- within four months from the later of the date of commencement (37 CFR 1.491(a)) or the date of the initial submission under 35 U.S.C. 371 of an application entering the national stage under 35 U.S.C. 371, or
- with a petition under 37 CFR 1.55(e).

**OPTION A**

Please retrieve the priority application identified in Column C, a certified copy of which is contained in the EP or JP application identified in Columns A and B:

A	B		C	
Code for Participating Office (EP or JP only)	Application containing the non-participating priority application		Non-participating priority application to be retrieved	
	App. No.	Filing Date	Country Code	App. No.
1				

**OPTION B**

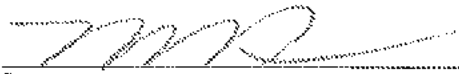
This Request may be used for the infrequent circumstance when a claim for priority to an application filed in a participating foreign intellectual property office was made prior to that foreign intellectual property office becoming a participating foreign intellectual property office.

Please retrieve the priority application identified in Columns A and B:

A	B		
Code for Participating Office (e.g., EP, JP, KR, CN) or WIPO DAS Depositing Office (e.g., AU, DK, ES, FI, GB, IB, SE)	App. No.	Filing Date	Access Code (for WIPO DAS Depositing Office)
1 KR	10-2011-0106839	October 19, 2011	
2			

The USPTO will not attempt to retrieve the identified priority application(s) unless an identical claim for foreign priority to the application identified above is made pursuant to 37 CFR 1.55(d) or a petition is granted under 37 CFR 1.55(e). Applicants are advised to consult Private PAIR (accessed through [www.uspto.gov](http://www.uspto.gov)) to assure that the retrieval has been successful. The applicant bears the ultimate responsibility for ensuring that a copy of the foreign application is received by the Office from the participating foreign intellectual property office, or a certified copy of the foreign priority application is filed, within the time period set forth in 37 CFR 1.55(g)(1).

I hereby declare that I have the authority to grant access to the above-identified foreign application(s).

  
 Signature  
 Mincheol Kim  
 Printed or Typed Name  
 Attorney of Record  
 Title

2015-09-08  
 Date  
 949-760-0404  
 Telephone Number  
 51,306  
 Registration Number, if applicable

This collection of information is required by 37 CFR 1.55(d). The information is required to obtain or retain a benefit by the public which is to file (and by the USPTO to process) an application. Confidentiality is governed by 35 U.S.C. 122 and 37 CFR 1.11 and 1.14. This collection is estimated to take 8 minutes to complete, including gathering, preparing, and submitting the completed application form to the USPTO. Time will vary depending upon the individual case. Any comments on the amount of time you require to complete this form and/or suggestions for reducing this burden, should be sent to the Chief Information Officer, U.S. Patent and Trademark Office, U.S. Department of Commerce, P.O. Box 1450, Alexandria, VA 22313-1450. DO NOT SEND FEES OR COMPLETED FORMS TO THIS ADDRESS. SEND TO: Commissioner for Patents, P.O. Box 1450, Alexandria, VA 22313-1450.

If you need assistance in completing the form, call 1-800-PTO-9199 and select option 2.

## Privacy Act Statement

The Privacy Act of 1974 (P.L. 93-579) requires that you be given certain information in connection with your submission of the attached form related to a patent application or patent. Accordingly, pursuant to the requirements of the Act, please be advised that: (1) the general authority for the collection of this information is 35 U.S.C. 2(b)(2); (2) furnishing of the information solicited is voluntary; and (3) the principal purpose for which the information is used by the U.S. Patent and Trademark Office is to process and/or examine your submission related to a patent application or patent. If you do not furnish the requested information, the U.S. Patent and Trademark Office may not be able to process and/or examine your submission, which may result in termination of proceedings or abandonment of the application or expiration of the patent.

The information provided by you in this form will be subject to the following routine uses:

1. The information on this form will be treated confidentially to the extent allowed under the Freedom of Information Act (5 U.S.C. 552) and the Privacy Act (5 U.S.C. 552a). Records from this system of records may be disclosed to the Department of Justice to determine whether the Freedom of Information Act requires disclosure of these records.
2. A record from this system of records may be disclosed, as a routine use, in the course of presenting evidence to a court, magistrate, or administrative tribunal, including disclosures to opposing counsel in the course of settlement negotiations.
3. A record in this system of records may be disclosed, as a routine use, to a Member of Congress submitting a request involving an individual, to whom the record pertains, when the individual has requested assistance from the Member with respect to the subject matter of the record.
4. A record in this system of records may be disclosed, as a routine use, to a contractor of the Agency having need for the information in order to perform a contract. Recipients of information shall be required to comply with the requirements of the Privacy Act of 1974, as amended, pursuant to 5 U.S.C. 552a(m).
5. A record related to an International Application filed under the Patent Cooperation Treaty in this system of records may be disclosed, as a routine use, to the International Bureau of the World Intellectual Property Organization, pursuant to the Patent Cooperation Treaty.
6. A record in this system of records may be disclosed, as a routine use, to another federal agency for purposes of National Security review (35 U.S.C. 181) and for review pursuant to the Atomic Energy Act (42 U.S.C. 218(c)).
7. A record from this system of records may be disclosed, as a routine use, to the Administrator, General Services, or his/her designee, during an inspection of records conducted by GSA as part of that agency's responsibility to recommend improvements in records management practices and programs, under authority of 44 U.S.C. 2904 and 2906. Such disclosure shall be made in accordance with the GSA regulations governing inspection of records for this purpose, and any other relevant (i.e., GSA or Commerce) directive. Such disclosure shall not be used to make determinations about individuals.
8. A record from this system of records may be disclosed, as a routine use, to the public after either publication of the application pursuant to 35 U.S.C. 122(b) or issuance of a patent pursuant to 35 U.S.C. 151. Further, a record may be disclosed, subject to the limitations of 37 CFR 1.14, as a routine use, to the public if the record was filed in an application which became abandoned or in which the proceedings were terminated and which application is referenced by either a published application, an application open to public inspections or an issued patent.
9. A record from this system of records may be disclosed, as a routine use, to a Federal, State, or local law enforcement agency, if the USPTO becomes aware of a violation or potential violation of law or regulation.

Under the Paperwork Reduction Act of 1995, no persons are required to respond to a collection of information unless it displays a valid OMB control number.

## TRANSMITTAL FOR POWER OF ATTORNEY TO ONE OR MORE REGISTERED PRACTITIONERS

**NOTE:** This form is to be submitted with the Power of Attorney by Applicant form (PTO/AIA/82B) to identify the application to which the Power of Attorney is directed, in accordance with 37 CFR 1.5, unless the application number and filing date are identified in the Power of Attorney by Applicant form. If neither form PTO/AIA/82A nor form PTO/AIA82B identifies the application to which the Power of Attorney is directed, the Power of Attorney will not be recognized in the application.

Application Number	Not Yet Assigned
Filing Date	Herewith
First Named Inventor	Jae Lark JUNG
Title	ACTIVATING DISPLAY AND PERFORMING USER AUTHENTICATION IN MOBILE TERMINAL WITH ONE-TIME USER INPUT
Art Unit	Not Yet Assigned
Examiner Name	Not Yet Assigned
Attorney Docket Number	UNIS005.001C2

### SIGNATURE of Applicant or Patent Practitioner

Signature	/Mincheol Kim/	Date (Optional)	2015-09-08
Name	MINCHEOL KIM	Registration Number	51,306
Title (if Applicant is a juristic entity)	Attorney for Applicant		
Applicant Name (if Applicant is a juristic entity)	<b>FIRSTFACE CO., LTD.</b>		

**NOTE:** This form must be signed in accordance with 37 CFR 1.33. See 37 CFR 1.4(d) for signature requirements and certifications. If more than one applicant, use multiple forms.

\*Total of 1 forms are submitted.

This collection of information is required by 37 CFR 1.131, 1.32, and 1.33. The information is required to obtain or retain a benefit by the public which is to file (and by the USPTO to process) an application. Confidentiality is governed by 35 U.S.C. 122 and 37 CFR 1.11 and 1.14. This collection is estimated to take 3 minutes to complete, including gathering, preparing, and submitting the completed application form to the USPTO. Time will vary depending upon the individual case. Any comments on the amount of time you require to complete this form and/or suggestions for reducing this burden, should be sent to the Chief Information Officer, U.S. Patent and Trademark Office, U.S. Department of Commerce, P.O. Box 1450, Alexandria, VA 22313-1450. **DO NOT SEND FEES OR COMPLETED FORMS TO THIS ADDRESS. SEND TO: Commissioner for Patents, P.O. Box 1450, Alexandria, VA 22313-1450.**

*If you need assistance in completing the form, call 1-800-PTO-9199 and select option 2.*

## POWER OF ATTORNEY BY APPLICANT

I hereby revoke all previous powers of attorney given in the application identified in either the attached transmittal letter or the boxes below.

Application Number	Filing Date

(Note: The boxes above may be left blank if information is provided on form PTO/AIA/82A.)

- I hereby appoint the Patent Practitioner(s) associated with the following Customer Number as my/our attorney(s) or agent(s), and to transact all business in the United States Patent and Trademark Office connected therewith for the application referenced in the attached transmittal letter (form PTO/AIA/82A) or identified above: 20995
- OR
- I hereby appoint Practitioner(s) named in the attached list (form PTO/AIA/82C) as my/our attorney(s) or agent(s), and to transact all business in the United States Patent and Trademark Office connected therewith for the patent application referenced in the attached transmittal letter (form PTO/AIA/82A) or identified above. (Note: Complete form PTO/AIA/82C.)

**Please recognize or change the correspondence address for the application identified in the attached transmittal letter or the boxes above to:**

- The address associated with the above-mentioned Customer Number
- OR
- The address associated with Customer Number
- OR

Firm or Individual Name			
Address			
City	State	Zip	
Country			
Telephone	Email		

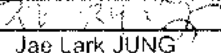
I am the Applicant (if the Applicant is a juristic entity, list the Applicant name in the box)

**FIRSTFACE CO., LTD.**

- Inventor or Joint Inventor (title not required below)
- Legal Representative of a Deceased or Legally Incapacitated Inventor (title not required below)
- Assignee or Person to Whom the Inventor is Under an Obligation to Assign (provide signer's title if applicant is a juristic entity)
- Person Who Otherwise Shows Sufficient Proprietary Interest (e.g., a petition under 37 CFR 1.46(b)(2) was granted in the application or is concurrently being filed with this document) (provide signer's title if applicant is a juristic entity)

**SIGNATURE of Applicant for Patent**

The undersigned (whose title is supplied below) is authorized to act on behalf of the applicant (e.g., where the applicant is a juristic entity).

Signature		Date (Optional)	August 07, 2015
Name	Jae Lark JUNG		
Title	CEO & President		

**NOTE:** Signature - This form must be signed by the applicant in accordance with 37 CFR 1.33. See 37 CFR 1.4 for signature requirements and certifications. If more than one applicant, use multiple forms.

Total of 1 forms are submitted.

This collection of information is required by 37 CFR 1.131, 1.32, and 1.33. The information is required to obtain or retain a benefit by the public which is to file (and by the USPTO to process) an application. Confidentiality is governed by 35 U.S.C. 122 and 37 CFR 1.11 and 1.14. This collection is estimated to take 3 minutes to complete, including gathering, preparing, and submitting the completed application form to the USPTO. Time will vary depending upon the individual case. Any comments on the amount of time you require to complete this form and/or suggestions for reducing this burden, should be sent to the Chief Information Officer, U.S. Patent and Trademark Office, U.S. Department of Commerce, P.O. Box 1450, Alexandria, VA 22313-1450. DO NOT SEND FEES OR COMPLETED FORMS TO THIS ADDRESS. SEND TO: Commissioner for Patents, P.O. Box 1450, Alexandria, VA 22313-1450.

*If you need assistance in completing the form, call 1-800-PTO-9199 and select option 2.*

**CERTIFICATION AND REQUEST FOR PRIORITIZED EXAMINATION  
 UNDER 37 CFR 1.102(e) (Page 1 of 1)**

First Named Inventor:	Jae Lark JUNG	Nonprovisional Application Number (if known):	
Title of Invention:	ACTIVATING DISPLAY AND PERFORMING USER AUTHENTICATION IN MOBILE TERMINAL WITH ONE-TIME USER INPUT		

**APPLICANT HEREBY CERTIFIES THE FOLLOWING AND REQUESTS PRIORITIZED EXAMINATION FOR THE ABOVE-IDENTIFIED APPLICATION.**

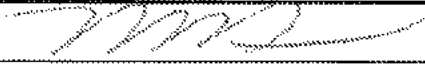
1. The processing fee set forth in 37 CFR 1.17(i)(1) and the prioritized examination fee set forth in 37 CFR 1.17(c) have been filed with the request. The publication fee requirement is met because that fee, set forth in 37 CFR 1.18(d), is currently \$0. The basic filing fee, search fee, and examination fee are filed with the request or have been already been paid. I understand that any required excess claims fees or application size fee must be paid for the application.
2. I understand that the application may not contain, or be amended to contain, more than four independent claims, more than thirty total claims, or any multiple dependent claims, and that any request for an extension of time will cause an outstanding Track 1 request to be dismissed.
3. The applicable box is checked below:

**I.  Original Application (Track One) - Prioritized Examination under § 1.102(e)(1)**

- i. (a) The application is an original nonprovisional utility application filed under 35 U.S.C. 111(a). This certification and request is being filed with the utility application via EFS-Web.  
 --OR--  
 (b) The application is an original nonprovisional plant application filed under 35 U.S.C. 111(a). This certification and request is being filed with the plant application in paper.
- ii. An executed inventor's oath or declaration under 37 CFR 1.63 or 37 CFR 1.64 for each inventor, or the application data sheet meeting the conditions specified in 37 CFR 1.53(f)(3)(i) is filed with the application.

**II.  Request for Continued Examination - Prioritized Examination under § 1.102(e)(2)**

- i. A request for continued examination has been filed with, or prior to, this form.
- ii. If the application is a utility application, this certification and request is being filed via EFS-Web.
- iii. The application is an original nonprovisional utility application filed under 35 U.S.C. 111(a), or is a national stage entry under 35 U.S.C. 371.
- iv. This certification and request is being filed prior to the mailing of a first Office action responsive to the request for continued examination.
- v. No prior request for continued examination has been granted prioritized examination status under 37 CFR 1.102(e)(2).

Signature 	Date 2015-09-08
Name (Print/Typed) <b>Mincheol Kim</b>	Practitioner Registration Number <b>51,306</b>

**Note:** This form must be signed in accordance with 37 CFR 1.33. See 37 CFR 1.4(d) for signature requirements and certifications. Submit multiple forms if more than one signature is required.\*

\*Total of 1 forms are submitted.

Please Direct All Correspondence to Customer Number 20995

**RESCISSION OF ANY PRIOR DISCLAIMERS AND REQUEST TO REVISIT ART**

Applicant	:	Jae Lark JUNG, et al.
App. No	:	Unknown
Filed	:	Herewith
For	:	ACTIVATING DISPLAY AND PERFORMING USER AUTHENTICATION IN MOBILE TERMINAL WITH ONE-TIME USER INPUT
Examiner	:	Unknown
Art Unit	:	Unknown
Conf #	:	Unknown

Commissioner for Patents  
P.O. Box 1450  
Alexandria, VA 22313-1450

Dear Sir:

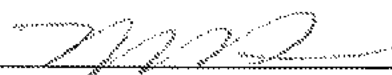
The claims of the present application are different and possibly broader in scope than the claims pursued in the parent application(s). To the extent any prior amendments or characterizations of the scope of any claim or referenced art could be construed as a disclaimer of any subject matter supported by the present disclosure, Applicant hereby rescinds and retracts such disclaimer. Accordingly, the references previously considered in the parent application(s) may need to be re-visited.

Please charge any additional fees, including any fees for additional extension of time, or credit overpayment to Deposit Account No. 11-1410.

Respectfully submitted,

KNOBBE, MARTENS, OLSON & BEAR, LLP

Dated: 2015-09-08

By:   
Mincheol Kim  
Registration No. 51,306  
Attorney of Record  
Customer No. 20995  
(949) 760-0404

Doc Code: FAI.REQ

Document Description: Request First Action Interview

PTO/SB/413C (05-11)

Approved for use through 01/31/2013, OMB 0651-0031

U.S. Patent and Trademark Office, U. S. DEPARTMENT OF COMMERCE

Under the Paperwork Reduction Act of 1995, no persons are required to respond to a collection of information unless it displays a valid OMB control number.

### REQUEST FOR FIRST ACTION INTERVIEW (FULL PILOT PROGRAM)

Attorney Docket Number: <b>UNIS005.001C2</b>	Application Number (if known):	Filing date: <b>HEREWITH</b>
First Named Inventor: <b>Jae Lark JUNG</b>	Title: <b>ACTIVATING DISPLAY AND PERFORMING USER AUTHENTICATION IN MOBILE TERMINAL WITH ONE-TIME USER INPUT</b>	

**APPLICANT HEREBY REQUESTS A FIRST ACTION INTERVIEW IN THE ABOVE-IDENTIFIED APPLICATION. See Instruction Sheet on page 2.**

- The application must contain three (3) or fewer independent claims and twenty (20) or fewer total claims.
- The application must not contain any multiple dependent claims.
- By filing this request:

Applicant is agreeing to make an election without traverse if the Office determines that the claims are not obviously directed to a single invention; and

Applicant is agreeing not to request for a refund of the search fee and any excess claims fee paid in the application after the mailing or notification of the pre-interview communication prepared by the examiner.

- Other attachments: \_\_\_\_\_

Signature 	Date: <b>2015-09-08</b>
Name (Print/Typed) <b>Mincheol Kim</b>	Registration Number <b>51,306</b>

**Note:** This form must be signed in accordance with 37 CFR 1.33. See 37 CFR 1.4(d) for signature requirements and certifications. Submit multiple forms if more than one signature is required, see below.

Total of 1 forms are submitted.

The information is required to obtain or retain a benefit by the public which is to file (and by the USPTO to process) an application. Confidentiality is governed by 35 U.S.C. 122 and 37 CFR 1.11 and 1.14. This collection is estimated to take 12 hours to complete, including gathering, preparing, and submitting the completed application form to the USPTO. Time will vary depending upon the individual case. Any comments on the amount of time you require to complete this form and/or suggestions for reducing this burden, should be sent to the Chief Information Officer, U.S. Patent and Trademark Office, U.S. Department of Commerce, P.O. Box 1450, Alexandria, VA 22313-1450. DO NOT SEND FEES OR COMPLETED FORMS TO THIS ADDRESS. SEND TO: Commissioner for Patents, P.O. Box 1450, Alexandria, VA 22313-1450.

If you need assistance in completing the form, call 1-800-PTO-9199 and select option 2.



## Privacy Act Statement

The **Privacy Act of 1974 (P.L. 93-579)** requires that you be given certain information in connection with your submission of the attached form related to a patent application or patent. Accordingly, pursuant to the requirements of the Act, please be advised that: (1) the general authority for the collection of this information is 35 U.S.C. 2(b)(2); (2) furnishing of the information solicited is voluntary; and (3) the principal purpose for which the information is used by the U.S. Patent and Trademark Office is to process and/or examine your submission related to a patent application or patent. If you do not furnish the requested information, the U.S. Patent and Trademark Office may not be able to process and/or examine your submission, which may result in termination of proceedings or abandonment of the application or expiration of the patent.

The information provided by you in this form will be subject to the following routine uses:

1. The information on this form will be treated confidentially to the extent allowed under the Freedom of Information Act (5 U.S.C. 552) and the Privacy Act (5 U.S.C. 552a). Records from this system of records may be disclosed to the Department of Justice to determine whether disclosure of these records is required by the Freedom of Information Act.
2. A record from this system of records may be disclosed, as a routine use, in the course of presenting evidence to a court, magistrate, or administrative tribunal, including disclosures to opposing counsel in the course of settlement negotiations.
3. A record in this system of records may be disclosed, as a routine use, to a Member of Congress submitting a request involving an individual, to whom the record pertains, when the individual has requested assistance from the Member with respect to the subject matter of the record.
4. A record in this system of records may be disclosed, as a routine use, to a contractor of the Agency having need for the information in order to perform a contract. Recipients of information shall be required to comply with the requirements of the Privacy Act of 1974, as amended, pursuant to 5 U.S.C. 552a(m).
5. A record related to an International Application filed under the Patent Cooperation Treaty in this system of records may be disclosed, as a routine use, to the International Bureau of the World Intellectual Property Organization, pursuant to the Patent Cooperation Treaty.
6. A record in this system of records may be disclosed, as a routine use, to another federal agency for purposes of National Security review (35 U.S.C. 181) and for review pursuant to the Atomic Energy Act (42 U.S.C. 218(c)).
7. A record from this system of records may be disclosed, as a routine use, to the Administrator, General Services, or his/her designee, during an inspection of records conducted by GSA as part of that agency's responsibility to recommend improvements in records management practices and programs, under authority of 44 U.S.C. 2904 and 2906. Such disclosure shall be made in accordance with the GSA regulations governing inspection of records for this purpose, and any other relevant (i.e., GSA or Commerce) directive. Such disclosure shall not be used to make determinations about individuals.
8. A record from this system of records may be disclosed, as a routine use, to the public after either publication of the application pursuant to 35 U.S.C. 122(b) or issuance of a patent pursuant to 35 U.S.C. 151. Further, a record may be disclosed, subject to the limitations of 37 CFR 1.14, as a routine use, to the public if the record was filed in an application which became abandoned or in which the proceedings were terminated and which application is referenced by either a published application, an application open to public inspection or an issued patent.
9. A record from this system of records may be disclosed, as a routine use, to a Federal, State, or local law enforcement agency, if the USPTO becomes aware of a violation or potential violation of law or regulation.

Doc Code: FAI.REQ

Document Description: Request First Action Interview

PTO/SB/413C (05-11)

Approved for use through 01/31/2013, OMB 0651-0031

U.S. Patent and Trademark Office, U. S. DEPARTMENT OF COMMERCE

Under the Paperwork Reduction Act of 1995, no persons are required to respond to a collection of information unless it displays a valid OMB control number.

### REQUEST FOR FIRST ACTION INTERVIEW (FULL PILOT PROGRAM)

Attorney Docket Number: <b>UNIS005.001C2</b>	Application Number (if known):	Filing date: <b>HEREWITH</b>
First Named Inventor: <b>Jae Lark JUNG</b>	Title: <b>ACTIVATING DISPLAY AND PERFORMING USER AUTHENTICATION IN MOBILE TERMINAL WITH ONE-TIME USER INPUT</b>	

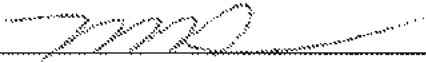
**APPLICANT HEREBY REQUESTS A FIRST ACTION INTERVIEW IN THE ABOVE-IDENTIFIED APPLICATION. See Instruction Sheet on page 2.**

- The application must contain three (3) or fewer independent claims and twenty (20) or fewer total claims.
- The application must not contain any multiple dependent claims.
- By filing this request:

Applicant is agreeing to make an election without traverse if the Office determines that the claims are not obviously directed to a single invention; and

Applicant is agreeing not to request for a refund of the search fee and any excess claims fee paid in the application after the mailing or notification of the pre-interview communication prepared by the examiner.

- Other attachments: \_\_\_\_\_

Signature 	Date: <b>2015-09-08</b>
Name (Print/Typed) <b>Mincheol Kim</b>	Registration Number <b>51,306</b>

**Note:** This form must be signed in accordance with 37 CFR 1.33. See 37 CFR 1.4(d) for signature requirements and certifications. Submit multiple forms if more than one signature is required, see below.

Total of 1 forms are submitted.

The information is required to obtain or retain a benefit by the public which is to file (and by the USPTO to process) an application. Confidentiality is governed by 35 U.S.C. 122 and 37 CFR 1.11 and 1.14. This collection is estimated to take 12 hours to complete, including gathering, preparing, and submitting the completed application form to the USPTO. Time will vary depending upon the individual case. Any comments on the amount of time you require to complete this form and/or suggestions for reducing this burden, should be sent to the Chief Information Officer, U.S. Patent and Trademark Office, U.S. Department of Commerce, P.O. Box 1450, Alexandria, VA 22313-1450. DO NOT SEND FEES OR COMPLETED FORMS TO THIS ADDRESS. SEND TO: Commissioner for Patents, P.O. Box 1450, Alexandria, VA 22313-1450.

If you need assistance in completing the form, call 1-800-PTO-9199 and select option 2.

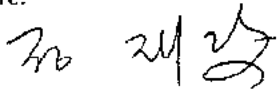
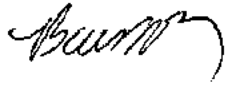
## Privacy Act Statement

The **Privacy Act of 1974 (P.L. 93-579)** requires that you be given certain information in connection with your submission of the attached form related to a patent application or patent. Accordingly, pursuant to the requirements of the Act, please be advised that: (1) the general authority for the collection of this information is 35 U.S.C. 2(b)(2); (2) furnishing of the information solicited is voluntary; and (3) the principal purpose for which the information is used by the U.S. Patent and Trademark Office is to process and/or examine your submission related to a patent application or patent. If you do not furnish the requested information, the U.S. Patent and Trademark Office may not be able to process and/or examine your submission, which may result in termination of proceedings or abandonment of the application or expiration of the patent.

The information provided by you in this form will be subject to the following routine uses:

1. The information on this form will be treated confidentially to the extent allowed under the Freedom of Information Act (5 U.S.C. 552) and the Privacy Act (5 U.S.C. 552a). Records from this system of records may be disclosed to the Department of Justice to determine whether disclosure of these records is required by the Freedom of Information Act.
2. A record from this system of records may be disclosed, as a routine use, in the course of presenting evidence to a court, magistrate, or administrative tribunal, including disclosures to opposing counsel in the course of settlement negotiations.
3. A record in this system of records may be disclosed, as a routine use, to a Member of Congress submitting a request involving an individual, to whom the record pertains, when the individual has requested assistance from the Member with respect to the subject matter of the record.
4. A record in this system of records may be disclosed, as a routine use, to a contractor of the Agency having need for the information in order to perform a contract. Recipients of information shall be required to comply with the requirements of the Privacy Act of 1974, as amended, pursuant to 5 U.S.C. 552a(m).
5. A record related to an International Application filed under the Patent Cooperation Treaty in this system of records may be disclosed, as a routine use, to the International Bureau of the World Intellectual Property Organization, pursuant to the Patent Cooperation Treaty.
6. A record in this system of records may be disclosed, as a routine use, to another federal agency for purposes of National Security review (35 U.S.C. 181) and for review pursuant to the Atomic Energy Act (42 U.S.C. 218(c)).
7. A record from this system of records may be disclosed, as a routine use, to the Administrator, General Services, or his/her designee, during an inspection of records conducted by GSA as part of that agency's responsibility to recommend improvements in records management practices and programs, under authority of 44 U.S.C. 2904 and 2906. Such disclosure shall be made in accordance with the GSA regulations governing inspection of records for this purpose, and any other relevant (i.e., GSA or Commerce) directive. Such disclosure shall not be used to make determinations about individuals.
8. A record from this system of records may be disclosed, as a routine use, to the public after either publication of the application pursuant to 35 U.S.C. 122(b) or issuance of a patent pursuant to 35 U.S.C. 151. Further, a record may be disclosed, subject to the limitations of 37 CFR 1.14, as a routine use, to the public if the record was filed in an application which became abandoned or in which the proceedings were terminated and which application is referenced by either a published application, an application open to public inspection or an issued patent.
9. A record from this system of records may be disclosed, as a routine use, to a Federal, State, or local law enforcement agency, if the USPTO becomes aware of a violation or potential violation of law or regulation.

**DECLARATION (37 CFR 1.63) FOR UTILITY OR DESIGN PATENT APPLICATION  
USING AN APPLICATION DATA SHEET (37 CFR 1.76)**

<b>Title of Invention:</b>	Method, mobile communication terminal and computer-readable recording medium for performing specific function when mobile recording medium for performing specific function when mobile communication terminal is activated	
<p>As the below named inventor, I hereby declare that:                  This declaration is directed to  <input type="checkbox"/> the attached application, or  <input checked="" type="checkbox"/> United States application No. 14/058,761 filed on 10/21/2013.</p> <p>The above-identified application was made or authorized to be made by me.</p> <p>I believe that I am the original inventor or an original joint inventor of a claimed invention in the application.</p> <p>I hereby acknowledge that any willful false statement made in this declaration is punishable under 18 U.S.C. 1001 by fine or imprisonment of not more than five (5) years, or both The above-identified application was made or authorized to be made by me.</p>		
<b>Legal Name of First Inventor: JUNG, Jae lark</b>		
Inventor's Signature:		Date: 2014.9.23
<b>Legal Name of Additional Inventor: BAE, Kyoung duck</b>		
Inventor's Signature:		Date: 2014.9.23

<b>INFORMATION DISCLOSURE STATEMENT BY APPLICANT</b> ( Not for submission under 37 CFR 1.99)	Application Number		
	Filing Date		
	First Named Inventor	JAE LARK JUNG	
	Art Unit		
	Examiner Name		
	Attorney Docket Number	UNIS005.001C2	

U.S.PATENTS						Remove
Examiner Initial*	Cite No	Patent Number	Kind Code <sup>1</sup>	Issue Date	Name of Patentee or Applicant of cited Document	Pages,Columns,Lines where Relevant Passages or Relevant Figures Appear
	1	6636732	B1	2003-10-21	Boling et al.	
	2	7613446	B2	2009-11-03	Engstrom et al.	
	3	7623847	B2	2009-11-24	Yamashita et al.	
	4	7668829	B2	2010-02-23	Chu et al.	
	5	7738916	B2	2010-06-15	Fukuda	
	6	8265607	B2	2012-09-11	Wormald et al.	
	7	8311514	B2	2012-11-13	Bandyopadhyay et al.	
	8	8538370	B2	2013-09-17	Ray et al.	

**INFORMATION DISCLOSURE  
STATEMENT BY APPLICANT**  
( Not for submission under 37 CFR 1.99)

Application Number		
Filing Date		
First Named Inventor	JAE LARK JUNG	
Art Unit		
Examiner Name		
Attorney Docket Number	UNIS005.001C2	

9	8660545	B1	2014-02-25	Redford et al.	
10	8782775	B2	2014-07-15	Fadell et al.	
11	8850365	B2	2014-09-30	Cumming	

If you wish to add additional U.S. Patent citation information please click the Add button.

[Add](#)

**U.S.PATENT APPLICATION PUBLICATIONS**

[Remove](#)

Examiner Initial*	Cite No	Publication Number	Kind Code <sup>1</sup>	Publication Date	Name of Patentee or Applicant of cited Document	Pages, Columns, Lines where Relevant Passages or Relevant Figures Appear
	1	20030018395	A1	2003-01-23	Crnkovich et al.	
	2	20050039135	A1	2005-02-17	Othmer et al.	
	3	20060142071	A1	2006-06-29	Stephens	
	4	20070060114	A1	2007-03-15	Ramer et al.	
	5	20070100981	A1	2007-05-03	Adamczyk et al.	
	6	20070136761	A1	2007-06-14	Basmajian, II et al.	

**INFORMATION DISCLOSURE  
STATEMENT BY APPLICANT**  
( Not for submission under 37 CFR 1.99)

Application Number		
Filing Date		
First Named Inventor	JAE LARK JUNG	
Art Unit		
Examiner Name		
Attorney Docket Number	UNIS005.001C2	

7	20070249330	A1	2007-10-25	Cortegiano et al.	
8	20070294725	A1	2007-12-20	Cohen et al.	
9	20080027813	A1	2008-01-31	Kogure et al.	
10	20080066610	A1	2008-03-20	Chu et al.	
11	20080070622	A1	2008-03-20	Lee	
12	20080133336	A1	2008-06-05	Altman et al.	
13	20080214150	A1	2008-09-04	Ramer et al.	
14	20090012704	A1	2009-01-08	Franco et al.	
15	20100020020	A1	2010-01-28	Chen	
16	20100102939	A1	2010-04-29	Stewart	
17	20100312643	A1	2010-12-09	Gil	

**INFORMATION DISCLOSURE  
STATEMENT BY APPLICANT**  
( Not for submission under 37 CFR 1.99)

Application Number		
Filing Date		
First Named Inventor	JAE LARK JUNG	
Art Unit		
Examiner Name		
Attorney Docket Number	UNIS005.001C2	

18	20110004678	A1	2011-01-06	Rothrock	
19	20110080260	A1	2011-04-07	Wang et al.	
20	20120052836	A1	2012-03-01	Buratti et al.	
21	20120302200	A1	2012-11-29	Esbensen	
22	20130057385	A1	2013-03-07	Murakami et al.	
23	20130102273	A1	2013-04-25	Jung et al.	
24	20130102363	A1	2013-04-25	Jung et al.	

If you wish to add additional U.S. Published Application citation information please click the Add button. [Add](#)

**FOREIGN PATENT DOCUMENTS**

[Remove](#)

Examiner Initial*	Cite No	Foreign Document Number <sup>3</sup>	Country Code <sup>2</sup> i	Kind Code <sup>4</sup>	Publication Date	Name of Patentee or Applicant of cited Document	Pages, Columns, Lines where Relevant Passages or Relevant Figures Appear	T <sup>5</sup>
	1	2076000	EP	A2	2009-07-01	LG ELECTRONICS INC		<input type="checkbox"/>
	2	10-1998-085647	KR	A	1998-12-05	LG INFORMATION & COMMUNICATIONS LTD.		<input checked="" type="checkbox"/>



**INFORMATION DISCLOSURE  
STATEMENT BY APPLICANT**  
( Not for submission under 37 CFR 1.99)

Application Number		
Filing Date		
First Named Inventor	JAE LARK JUNG	
Art Unit		
Examiner Name		
Attorney Docket Number	UNIS005.001C2	

3	10-2001-0026243	KR	A	2001-04-06	SAMSUNG ELECTRONICS CO., LTD.	<input checked="" type="checkbox"/>
4	10-2005-0079475	KR	A	2005-08-10	PANTECH CO.,LTD.	<input checked="" type="checkbox"/>
5	10-2006-0033664	KR	A	2006-04-19	PANTECH CO.,LTD.	<input checked="" type="checkbox"/>
6	10-2008-0086757	KR	A	2008-09-26	LG UPLUS CORP	<input checked="" type="checkbox"/>
7	10-2010-0027855	KR	A	2010-03-11	LG UPLUS CORP	<input checked="" type="checkbox"/>
8	10-2010-0049986	KR	A	2010-05-13	LG ELECTRONICS INC.	<input checked="" type="checkbox"/>
9	2007/033358	WO	A2	2007-03-22	JUMP TAP, INC.	<input type="checkbox"/>
10	2008/081420	WO	A2	2008-07-10	CELLTICK TECHNOLOGIES LTD	<input type="checkbox"/>
11	2010/126504	WO	A1	2010-11-04	HEWLETT-PACKARD DEVELOPMENT COMPANY, L.P.	<input type="checkbox"/>

If you wish to add additional Foreign Patent Document citation information please click the Add button [Add](#)

**NON-PATENT LITERATURE DOCUMENTS**

[Remove](#)

Examiner Initials*	Cite No	Include name of the author (in CAPITAL LETTERS), title of the article (when appropriate), title of the item (book, magazine, journal, serial, symposium, catalog, etc), date, pages(s), volume-issue number(s), publisher, city and/or country where published.	T <sup>5</sup>
--------------------	---------	---	----------------

**INFORMATION DISCLOSURE  
STATEMENT BY APPLICANT**  
( Not for submission under 37 CFR 1.99)

Application Number		
Filing Date		
First Named Inventor	JAE LARK JUNG	
Art Unit		
Examiner Name		
Attorney Docket Number	UNIS005.001C2	

1	International Search Report dated March 20, 2013 of corresponding PCT Application PCT/KR2012/008470 (WO/2013/058533)	<input type="checkbox"/>
2	EP Search Report of corresponding European Patent Application No. 20120842666	<input type="checkbox"/>
3	Think Vantage Fingerprint Software, International Business Machines Corporation, First Edition, November 2005 "http://download.lenovo.com/ibmdl/pub/pc/pccbbs/thinkvantage_en/tfs56ug_en.pdf"	<input type="checkbox"/>
4	Concept iPhone 5 with Fingerprint Scanner "http://gadgets.in.com/concept-iphone-5-with-fingerprint-scanner.htm"	<input type="checkbox"/>
5	Acer Tempo M900 "http://www.theregister.co.uk/2009/07/15review_phone_acer_tempo_m900/"	<input type="checkbox"/>
6	iPhone User Guide (For iOS 4.2 and 4.3 Software) (Apple Inc.) 2011.03.09 Chapter 1	<input type="checkbox"/>

If you wish to add additional non-patent literature document citation information please click the Add button **Add**

**EXAMINER SIGNATURE**

Examiner Signature		Date Considered	
--------------------	--	-----------------	--

\*EXAMINER: Initial if reference considered, whether or not citation is in conformance with MPEP 609. Draw line through a citation if not in conformance and not considered. Include copy of this form with next communication to applicant.

<sup>1</sup> See Kind Codes of USPTO Patent Documents at [www.USPTO.GOV](http://www.USPTO.GOV) or MPEP 901.04. <sup>2</sup> Enter office that issued the document, by the two-letter code (WIPO Standard ST.3). <sup>3</sup> For Japanese patent documents, the indication of the year of the reign of the Emperor must precede the serial number of the patent document. <sup>4</sup> Kind of document by the appropriate symbols as indicated on the document under WIPO Standard ST.16 if possible. <sup>5</sup> Applicant is to place a check mark here if English language translation is attached.

**INFORMATION DISCLOSURE  
STATEMENT BY APPLICANT**  
( Not for submission under 37 CFR 1.99)

Application Number		
Filing Date		
First Named Inventor	JAE LARK JUNG	
Art Unit		
Examiner Name		
Attorney Docket Number	UNIS005.001C2	

**CERTIFICATION STATEMENT**

Please see 37 CFR 1.97 and 1.98 to make the appropriate selection(s):

That each item of information contained in the information disclosure statement was first cited in any communication from a foreign patent office in a counterpart foreign application not more than three months prior to the filing of the information disclosure statement. See 37 CFR 1.97(e)(1).

**OR**

That no item of information contained in the information disclosure statement was cited in a communication from a foreign patent office in a counterpart foreign application, and, to the knowledge of the person signing the certification after making reasonable inquiry, no item of information contained in the information disclosure statement was known to any individual designated in 37 CFR 1.56(c) more than three months prior to the filing of the information disclosure statement. See 37 CFR 1.97(e)(2).

- See attached certification statement.
- The fee set forth in 37 CFR 1.17 (p) has been submitted herewith.
- A certification statement is not submitted herewith.

**SIGNATURE**

A signature of the applicant or representative is required in accordance with CFR 1.33, 10.18. Please see CFR 1.4(d) for the form of the signature.

Signature	/Mincheol Kim/	Date (YYYY-MM-DD)	2015-09-08
Name/Print	Mincheol Kim	Registration Number	51306

This collection of information is required by 37 CFR 1.97 and 1.98. The information is required to obtain or retain a benefit by the public which is to file (and by the USPTO to process) an application. Confidentiality is governed by 35 U.S.C. 122 and 37 CFR 1.14. This collection is estimated to take 1 hour to complete, including gathering, preparing and submitting the completed application form to the USPTO. Time will vary depending upon the individual case. Any comments on the amount of time you require to complete this form and/or suggestions for reducing this burden, should be sent to the Chief Information Officer, U.S. Patent and Trademark Office, U.S. Department of Commerce, P.O. Box 1450, Alexandria, VA 22313-1450. **DO NOT SEND FEES OR COMPLETED FORMS TO THIS ADDRESS. SEND TO: Commissioner for Patents, P.O. Box 1450, Alexandria, VA 22313-1450.**

## Privacy Act Statement

The Privacy Act of 1974 (P.L. 93-579) requires that you be given certain information in connection with your submission of the attached form related to a patent application or patent. Accordingly, pursuant to the requirements of the Act, please be advised that: (1) the general authority for the collection of this information is 35 U.S.C. 2(b)(2); (2) furnishing of the information solicited is voluntary; and (3) the principal purpose for which the information is used by the U.S. Patent and Trademark Office is to process and/or examine your submission related to a patent application or patent. If you do not furnish the requested information, the U.S. Patent and Trademark Office may not be able to process and/or examine your submission, which may result in termination of proceedings or abandonment of the application or expiration of the patent.

The information provided by you in this form will be subject to the following routine uses:

1. The information on this form will be treated confidentially to the extent allowed under the Freedom of Information Act (5 U.S.C. 552) and the Privacy Act (5 U.S.C. 552a). Records from this system of records may be disclosed to the Department of Justice to determine whether the Freedom of Information Act requires disclosure of these records.
2. A record from this system of records may be disclosed, as a routine use, in the course of presenting evidence to a court, magistrate, or administrative tribunal, including disclosures to opposing counsel in the course of settlement negotiations.
3. A record in this system of records may be disclosed, as a routine use, to a Member of Congress submitting a request involving an individual, to whom the record pertains, when the individual has requested assistance from the Member with respect to the subject matter of the record.
4. A record in this system of records may be disclosed, as a routine use, to a contractor of the Agency having need for the information in order to perform a contract. Recipients of information shall be required to comply with the requirements of the Privacy Act of 1974, as amended, pursuant to 5 U.S.C. 552a(m).
5. A record related to an International Application filed under the Patent Cooperation Treaty in this system of records may be disclosed, as a routine use, to the International Bureau of the World Intellectual Property Organization, pursuant to the Patent Cooperation Treaty.
6. A record in this system of records may be disclosed, as a routine use, to another federal agency for purposes of National Security review (35 U.S.C. 181) and for review pursuant to the Atomic Energy Act (42 U.S.C. 218(c)).
7. A record from this system of records may be disclosed, as a routine use, to the Administrator, General Services, or his/her designee, during an inspection of records conducted by GSA as part of that agency's responsibility to recommend improvements in records management practices and programs, under authority of 44 U.S.C. 2904 and 2906. Such disclosure shall be made in accordance with the GSA regulations governing inspection of records for this purpose, and any other relevant (i.e., GSA or Commerce) directive. Such disclosure shall not be used to make determinations about individuals.
8. A record from this system of records may be disclosed, as a routine use, to the public after either publication of the application pursuant to 35 U.S.C. 122(b) or issuance of a patent pursuant to 35 U.S.C. 151. Further, a record may be disclosed, subject to the limitations of 37 CFR 1.14, as a routine use, to the public if the record was filed in an application which became abandoned or in which the proceedings were terminated and which application is referenced by either a published application, an application open to public inspections or an issued patent.
9. A record from this system of records may be disclosed, as a routine use, to a Federal, State, or local law enforcement agency, if the USPTO becomes aware of a violation or potential violation of law or regulation.

IN THE UNITED STATES PATENT AND TRADEMARK OFFICE

Inventor : Jae Lark JUNG, et al.  
 Applicant : FIRSTFACE CO., LTD.  
 App. No : Unknown  
 Filed : Herewith  
 For : ACTIVATING DISPLAY AND PERFORMING USER AUTHENTICATION  
 IN MOBILE TERMINAL WITH ONE-TIME USER INPUT  
 Examiner : Unknown  
 Art Unit : Unknown  
 Conf. No. : Unknown

INFORMATION DISCLOSURE STATEMENT

Commissioner for Patents  
 P.O. Box 1450  
 Alexandria, VA 22313-1450

Dear Sir:

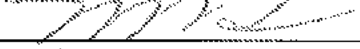
Enclosed is a PTO/SB/08a Form listing references including those that were previously disclosed to or cited by the Patent and Trademark Office in the prosecution of U.S. Patent Application Nos. 13/590,483 (now US 8,831,557), 14/058,761 (now US 8,918,074) and 14/538,880, which are the parents of the application being filed herewith. Copies of the foreign patent documents and non-patent literature documents, which were previously disclosed to or cited by the PTO, are not submitted pursuant to 37 C.F.R. §1.98(d).

This Information Disclosure Statement is being filed within three months of the filing date of this application, and thus no fee is required in accordance with 37 C.F.R. §1.97(b)(1).

Respectfully submitted.

KNOBBE, MARTENS, OLSON & BEAR, LLP

Dated: 2015-09-08

By:   
 Mincheol Kim  
 Registration No. 51,306  
 Attorney of Record  
 Customer No. 20995  
 (949) 760-0404

## Electronic Patent Application Fee Transmittal

<b>Application Number:</b>	
<b>Filing Date:</b>	
<b>Title of Invention:</b>	ACTIVATING DISPLAY AND PERFORMING USER AUTHENTICATION IN MOBILE TERMINAL WITH ONE-TIME USER INPUT
<b>First Named Inventor/Applicant Name:</b>	Jae Lark JUNG
<b>Filer:</b>	Mincheol Kim/kim skoff
<b>Attorney Docket Number:</b>	UNIS005.001C2

Filed as Small Entity

### Filing Fees for Track I Prioritized Examination - Nonprovisional Application under 35 USC 111(a)

Description	Fee Code	Quantity	Amount	Sub-Total in USD(\$)
<b>Basic Filing:</b>				
Utility filing Fee (Electronic filing)	4011	1	70	70
Utility Search Fee	2111	1	300	300
Utility Examination Fee	2311	1	360	360
Request for Prioritized Examination	2817	1	2000	2000

**Pages:**

**Claims:**

**Miscellaneous-Filing:**

Description	Fee Code	Quantity	Amount	Sub-Total in USD(\$)
Publ. Fee- Early, Voluntary, or Normal	1504	1	0	0
PROCESSING FEE, EXCEPT PROV. APPLS.	2830	1	70	70
<b>Petition:</b>				
<b>Patent-Appeals-and-Interference:</b>				
<b>Post-Allowance-and-Post-Issuance:</b>				
<b>Extension-of-Time:</b>				
<b>Miscellaneous:</b>				
<b>Total in USD (\$)</b>				<b>2800</b>

## Electronic Acknowledgement Receipt

<b>EFS ID:</b>	23432367
<b>Application Number:</b>	14848191
<b>International Application Number:</b>	
<b>Confirmation Number:</b>	9599
<b>Title of Invention:</b>	ACTIVATING DISPLAY AND PERFORMING USER AUTHENTICATION IN MOBILE TERMINAL WITH ONE-TIME USER INPUT
<b>First Named Inventor/Applicant Name:</b>	Jae Lark JUNG
<b>Customer Number:</b>	20995
<b>Filer:</b>	Mincheol Kim/Gustavo Lopez
<b>Filer Authorized By:</b>	Mincheol Kim
<b>Attorney Docket Number:</b>	UNIS005.001C2
<b>Receipt Date:</b>	08-SEP-2015
<b>Filing Date:</b>	
<b>Time Stamp:</b>	20:22:15
<b>Application Type:</b>	Utility under 35 USC 111(a)

### Payment information:

Submitted with Payment	yes
Payment Type	Credit Card
Payment was successfully received in RAM	\$2800
RAM confirmation Number	8081
Deposit Account	111410
Authorized User	KNOBBE MARTENS OLSON AND BEAR

The Director of the USPTO is hereby authorized to charge indicated fees and credit any overpayment as follows:

Charge any Additional Fees required under 37 C.F.R. Section 1.16 (National application filing, search, and examination fees)

Charge any Additional Fees required under 37 C.F.R. Section 1.17 (Patent application and reexamination processing fees)



<b>File Listing:</b>					
<b>Document Number</b>	<b>Document Description</b>	<b>File Name</b>	<b>File Size(Bytes)/ Message Digest</b>	<b>Multi Part /.zip</b>	<b>Pages (if appl.)</b>
1	Transmittal of New Application	Transmittal.pdf	38878 1f562ee0e458bdff84719e56067280ab4a04528d	no	2
<b>Warnings:</b>					
<b>Information:</b>					
2	Application Data Sheet	ADS.pdf	1819769 dcfa1a7b4aaae9e9309101c33ef1bc6a9f0b7c2	no	7
<b>Warnings:</b>					
<b>Information:</b>					
3		Specification.pdf	371091 7c17e523b3e968f80f539a36ead78975b17a916	yes	19
	<b>Multipart Description/PDF files in .zip description</b>				
	<b>Document Description</b>		<b>Start</b>	<b>End</b>	
	Specification		1	17	
	Claims		18	18	
Abstract		19	19		
<b>Warnings:</b>					
<b>Information:</b>					
4	Drawings-only black and white line drawings	Drawings.pdf	281108 ca15acb31829e800c244a5c69d3a11bb4a9a46435	no	5
<b>Warnings:</b>					
<b>Information:</b>					
5	Request for USPTO to retrieve priority docs	SB38.pdf	1015891 6ca69ae55743b3f6be5a3293a5b5ede270aa406	no	2
<b>Warnings:</b>					
<b>Information:</b>					
6	First Action Interview - Enrollment Request	FAI-REQUEST.pdf	829762 09ee6e0779a4c4f26574333b0769fc1f8d82c7f5	no	2

<b>Warnings:</b>					
<b>Information:</b>					
7	Oath or Declaration filed	Declaration.pdf	41195 c31d47544367b7218f2467d467beb46174c692a	no	1
<b>Warnings:</b>					
<b>Information:</b>					
8	Power of Attorney	POA.pdf	335058 1f3f3879f31ada89b24bd4707c8ba057c1fb25549	no	2
<b>Warnings:</b>					
<b>Information:</b>					
9	TrackOne Request	Track1.pdf	490727 51b0a64b0e2ea188e9de03733b01bb040f3c22d	no	1
<b>Warnings:</b>					
<b>Information:</b>					
10	Miscellaneous Incoming Letter	Rescission.pdf	290487 9524309edfa706e6ca52fb35d652059638bb0276	no	1
<b>Warnings:</b>					
<b>Information:</b>					
11	Information Disclosure Statement (IDS) Form (SB08)	IDS.pdf	614363 31652d11315ff498e270f94fe6cbebd11af64c7	no	8
<b>Warnings:</b>					
<b>Information:</b>					
12	Miscellaneous Incoming Letter	IDS_Statement.pdf	282599 4b6ef3d7e448d4aec33a763318ee5bb061e24ea8	no	1
<b>Warnings:</b>					
<b>Information:</b>					
13	Fee Worksheet (SB06)	fee-info.pdf	40796 7532e06dff0813b59003ff06445c6537bee7503d	no	2
<b>Warnings:</b>					
<b>Information:</b>					
<b>Total Files Size (in bytes):</b>			6451724		

**This Acknowledgement Receipt evidences receipt on the noted date by the USPTO of the indicated documents, characterized by the applicant, and including page counts, where applicable. It serves as evidence of receipt similar to a Post Card, as described in MPEP 503.**

**New Applications Under 35 U.S.C. 111**

**If a new application is being filed and the application includes the necessary components for a filing date (see 37 CFR 1.53(b)-(d) and MPEP 506), a Filing Receipt (37 CFR 1.54) will be issued in due course and the date shown on this Acknowledgement Receipt will establish the filing date of the application.**

**National Stage of an International Application under 35 U.S.C. 371**

**If a timely submission to enter the national stage of an international application is compliant with the conditions of 35 U.S.C. 371 and other applicable requirements a Form PCT/DO/EO/903 indicating acceptance of the application as a national stage submission under 35 U.S.C. 371 will be issued in addition to the Filing Receipt, in due course.**

**New International Application Filed with the USPTO as a Receiving Office**

**If a new international application is being filed and the international application includes the necessary components for an international filing date (see PCT Article 11 and MPEP 1810), a Notification of the International Application Number and of the International Filing Date (Form PCT/RO/105) will be issued in due course, subject to prescriptions concerning national security, and the date shown on this Acknowledgement Receipt will establish the international filing date of the application.**

**IN THE UNITED STATES PATENT AND TRADEMARK OFFICE**

Inventor : Jae Lark JUNG, et al.  
Applicant : FIRSTFACE CO., LTD.  
App. No. : 14/848,191  
Filed : September 8, 2015  
For : ACTIVATING DISPLAY AND PERFORMING USER  
AUTHENTICATION IN MOBILE TERMINAL WITH ONE-TIME  
USER INPUT  
Examiner : Not Yet Assigned  
Art Unit : Not Yet Assigned  
Conf. No. : 9599

PRELIMINARY AMENDMENT

**Mail Stop Amendment**

Commissioner for Patents  
P.O. Box 1450  
Alexandra, VA 22313-1450

Dear Sir:

Prior to examination of the above-identified application on the merits, please amend the application as follows:

**Amendments to the Claims** begin on page 2 of this paper.

**Remarks** begin on page 7 of this paper.

Application No. : 14/848,191  
Filing Date : September 8, 2015

### AMENDMENTS TO THE CLAIMS

The following listing of claims will replace all prior versions of claims in the application.

1. (Currently Amended) A mobile communication terminal comprising:  
a touch screen display;  
a camera;  
a power button configured to turn on and off the terminal by pressing; and  
an activation button separate from the power button and configured for pressing to turn on the touch screen display and to initiate one or more additional functions of the terminal,;

wherein the terminal has a first function and a second function to perform in response to user input and is configured to provide user settings for configuring at least one of the first and second functions such that the at least one of the first and second functions is set to be performed in addition to turning on the touch screen display upon detection of pressing of the activation button while the touch screen display is turned off, wherein the first and second functions are different from each other and selected from the group consisting of fingerprint authentication, activating the camera, and an operation that involves playing a sound.

wherein upon detection of one-time pressing of the activation button while the touch screen display is turned off, the terminal is configured to turn on the touch screen display and further perform the at least one of the first and second functions in addition to turning on the touch screen display such that:

the touch screen display displays a lock screen thereon as the terminal turns on the touch screen in response to the detection of one-time pressing.

the lock screen is displayed on the touch screen display when the at least one of the first and second functions is being performed.

the first function is performed when the detected one-time pressing is for short time shorter than a reference time period, and

the second function is performed when the detected one-time pressing is for long time longer than the reference time period.

**Application No.** : 14/848,191  
**Filing Date** : September 8, 2015

2. (New) The terminal of Claim 1, wherein upon detection of one-time pressing of the activation button for short time while the touch screen display is turned off, the terminal is configured to turn on the touch screen display for displaying the lock screen and further configured to display the lock screen when the first function is being performed.

3. (New) The terminal of Claim 2, wherein upon detection of one-time pressing of the activation button for long time while the touch screen display is turned off, the terminal is configured to turn on the touch screen display for displaying the lock screen and further configured to display the lock screen when the second function is being performed.

4. (New) The terminal of Claim 1, wherein one of the first and second functions comprises the fingerprint authentication, wherein the terminal is configured to turn on the touch screen display for displaying the lock screen and further configured to display the lock screen when the fingerprint authentication is being performed in response to detection of one-time pressing of the activation button while the touch screen display is turned off.

5. (New) The terminal of Claim 4, wherein the terminal is configured to continue its lock state when the fingerprint authentication fails to authenticate a user, whereas the terminal is configured to release the lock state and make its other functions available when the fingerprint authentication authenticates a user.

6. (New) The terminal of Claim 5, wherein the terminal is configured to display an alarm message on the touch screen display when the lock state continues due to failure of user authentication by the fingerprint authentication.

7. (New) The terminal of Claim 1, wherein the at least one of the first and second functions is associated with software downloadable by the terminal.

8. (New) The terminal of Claim 1, wherein the at least one of the first and second functions is associated with initiating a hands-free operation of the terminal.

**Application No.** : **14/848,191**  
**Filing Date** : **September 8, 2015**

9. (New) The terminal of Claim 1, wherein the terminal is configured to have a mobile application stay in a standby state when the touch screen display is turned off while the mobile application is running, wherein in response to the detection of one-time pressing of the activation button while the touch screen display is turned off, the terminal is configured to perform the at least one of the first and second functions regardless of whether the at least one of the first and second functions is in its standby state or an operation disable state.

10. (New) The terminal of Claim 1, wherein upon detection of repeated pressing of the activation button while the touch screen display is turned off, the terminal is configured to turn on the touch screen display and further perform a third function other than the first and second functions in addition to turning on the touch screen display.

11. (New) The terminal of Claim 1, wherein the terminal comprises a smartphone which comprises an activation sensor configured to detect pressing of the activation button and a user identification module configured to perform the fingerprint authentication.

12. (New) A method of operating a mobile computing terminal, the method comprises:

providing a mobile computing terminal which comprises a touch screen display, a camera, a power button for pressing to turn on/off the terminal, and an activation button for pressing to turn on the touch screen display, the terminal having a first function and a second function that are different from each other and selected from the group consisting of fingerprint authentication, activating the camera, and an operation that involves playing a sound;

detecting one-time pressing of the activation button while the terminal is in an inactive state in which the touch screen display is turned off;

in response to detection of the one-time pressing, changing the terminal from the inactive state to an active state in which the touch screen display is turned on; and

in addition to changing to the active state, further performing at least one of the first and second functions without additional user input;

**Application No.** : 14/848,191  
**Filing Date** : September 8, 2015

wherein in changing to the active state and performing the at least one of the first and second functions, the terminal operates such that:

the touch screen display displays a lock screen thereon as the terminal changes to the active state in response to the detection of one-time pressing,

the lock screen is displayed on the touch screen display when the at least one of the first and second functions is being performed,

the first function is performed when the detected one-time pressing is for short time shorter than a reference time period, and

the second function is performed when the detected one-time pressing is for long time longer than the reference time period.

13. (New) The method of Claim 12, further comprising:  
receiving user input on a setting menu of the terminal; and  
configuring, based on the user input, settings of the terminal such that the at least one of the first and second functions is set to be performed in addition to changing to the active state upon detection of one-time pressing of the activation button while the terminal is in its inactive state.

14. (New) The method of Claim 12, wherein the at least one of the first and second functions comprises the fingerprint authentication, in which the lock screen is displayed on the touch screen display when the fingerprint authentication is being performed, wherein in performing the fingerprint authentication, the terminal operates such that;

a lock state of the terminal continues when the fingerprint authentication fails to authenticate a user, and

the lock state is released for enabling other functions of the terminal when the fingerprint authentication authenticates a user.

15. (New) The method of Claim 14, wherein the touch screen display displays an alarm message thereon when the lock state continues due to failure of user authentication by the fingerprint authentication.



**Application No.** : 14/848,191  
**Filing Date** : September 8, 2015

16. (New) The method of Claim 12, wherein the at least one of the first and second functions is associated with software downloadable by the terminal.

17. (New) The method of Claim 12, wherein the at least one of the first and second functions is associated with initiating a hands-free operation of the terminal.

18. (New) The method of Claim 12, wherein the terminal is configured to have a mobile application stay in a standby state when the touch screen display is turned off while the mobile application is running, wherein in response to the detection of one-time pressing of the activation button while the terminal is in its inactive state, the terminal performs the at least one of the first and second functions regardless of whether the at least one of the first and second functions is in its standby state or an operation disable state.

19. (New) The method of Claim 12, further comprising:

detecting repeated pressing of the activation button while the terminal is in its inactive state;

in response to detection of the repeated pressing, changing the terminal from the inactive state to the active state; and

in addition to changing to the active state, further performing a third function other than the first and second functions without additional user input;

wherein in changing to the active state and performing the at least one of the first and second functions, the terminal operates such that:

the touch screen display displays the lock screen thereon as the terminal changes to the active state in response to the detection of repeated pressing,

the lock screen is displayed on the touch screen display when the third function is being performed.

20. (New) The method of Claim 12, wherein the terminal comprises a smartphone which comprises an activation sensor configured to detect pressing of the activation button and a user identification module configured to perform the fingerprint authentication.

Application No. : 14/848,191  
Filing Date : September 8, 2015

**REMARKS**

Applicant has amended Claim 1 and added new Claims 2-20. Support for the amendments of Claims 1-20 can be found in the specification originally filed. No new matter is added by the amendments.

No Disclaimers or Disavowals

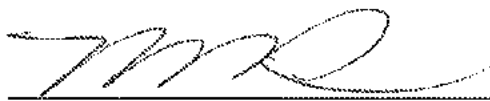
Although the present communication may include alterations to the application or claims, or characterizations of claim scope or referenced art, Applicant is not conceding in this application that previously pending claims are not patentable over the cited references. Rather, any alterations or characterizations are being made to facilitate expeditious prosecution of this application. Applicant reserves the right to pursue at a later date any previously pending or other broader or narrower claims that capture any subject matter supported by the present disclosure, including subject matter found to be specifically disclaimed herein or by any prior prosecution. Accordingly, reviewers of this or any parent, child or related prosecution history shall not reasonably infer that Applicant has made any disclaimers or disavowals of any subject matter supported by the present application.

Please charge any additional fees, including any fees for additional extension of time, or credit overpayment to Deposit Account No. 11-1410.

Respectfully submitted,

KNOBBE, MARTENS, OLSON & BEAR, LLP

Dated: 2015-09-09

By:   
Mincheol Kim  
Registration No. 51,306  
Attorney of Record  
Customer No. 20,995  
(949) 760-0404

21540786  
090815

## Electronic Acknowledgement Receipt

<b>EFS ID:</b>	23437515
<b>Application Number:</b>	14848191
<b>International Application Number:</b>	
<b>Confirmation Number:</b>	9599
<b>Title of Invention:</b>	ACTIVATING DISPLAY AND PERFORMING USER AUTHENTICATION IN MOBILE TERMINAL WITH ONE-TIME USER INPUT
<b>First Named Inventor/Applicant Name:</b>	Jae Lark JUNG
<b>Customer Number:</b>	20995
<b>Filer:</b>	Mincheol Kim/ThuyQuyen Nguyen
<b>Filer Authorized By:</b>	Mincheol Kim
<b>Attorney Docket Number:</b>	UNIS005.001C2
<b>Receipt Date:</b>	09-SEP-2015
<b>Filing Date:</b>	
<b>Time Stamp:</b>	12:43:21
<b>Application Type:</b>	Utility under 35 USC 111(a)

### Payment information:

Submitted with Payment	no
------------------------	----

### File Listing:

Document Number	Document Description	File Name	File Size(Bytes)/ Message Digest	Multi Part /.zip	Pages (if appl.)
1		Preliminary-Amendment.pdf	2101450 <small>94f67e0327cd58d449edfce8acb76cb4f63e9688</small>	yes	7

<b>Multipart Description/PDF files in .zip description</b>			
<b>Document Description</b>		<b>Start</b>	<b>End</b>
Preliminary Amendment		1	1
Claims		2	6
Applicant Arguments/Remarks Made in an Amendment		7	7

**Warnings:**

**Information:**

<b>Total Files Size (in bytes):</b>	2101450
-------------------------------------	---------

**This Acknowledgement Receipt evidences receipt on the noted date by the USPTO of the indicated documents, characterized by the applicant, and including page counts, where applicable. It serves as evidence of receipt similar to a Post Card, as described in MPEP 503.**

**New Applications Under 35 U.S.C. 111**

**If a new application is being filed and the application includes the necessary components for a filing date (see 37 CFR 1.53(b)-(d) and MPEP 506), a Filing Receipt (37 CFR 1.54) will be issued in due course and the date shown on this Acknowledgement Receipt will establish the filing date of the application.**

**National Stage of an International Application under 35 U.S.C. 371**

**If a timely submission to enter the national stage of an international application is compliant with the conditions of 35 U.S.C. 371 and other applicable requirements a Form PCT/DO/EO/903 indicating acceptance of the application as a national stage submission under 35 U.S.C. 371 will be issued in addition to the Filing Receipt, in due course.**

**New International Application Filed with the USPTO as a Receiving Office**

**If a new international application is being filed and the international application includes the necessary components for an international filing date (see PCT Article 11 and MPEP 1810), a Notification of the International Application Number and of the International Filing Date (Form PCT/RO/105) will be issued in due course, subject to prescriptions concerning national security, and the date shown on this Acknowledgement Receipt will establish the international filing date of the application.**

Under the Paperwork Reduction Act of 1995, no persons are required to respond to a collection of information unless it displays a valid OMB control number.

<b>PATENT APPLICATION FEE DETERMINATION RECORD</b> Substitute for Form PTO-875	Application or Docket Number <b>14/848,191</b>	Filing Date <b>09/08/2015</b>	<input type="checkbox"/> To be Mailed
---	---	----------------------------------	---------------------------------------

ENTITY:  LARGE  SMALL  MICRO

**APPLICATION AS FILED – PART I**

FOR	NUMBER FILED	NUMBER EXTRA	RATE (\$)	FEE (\$)
<input type="checkbox"/> BASIC FEE (37 CFR 1.16(a), (b), or (c))	N/A	N/A	N/A	
<input type="checkbox"/> SEARCH FEE (37 CFR 1.16(k), (l), or (m))	N/A	N/A	N/A	
<input type="checkbox"/> EXAMINATION FEE (37 CFR 1.16(o), (p), or (q))	N/A	N/A	N/A	
TOTAL CLAIMS (37 CFR 1.16(j))	minus 20 = *		X \$ =	
INDEPENDENT CLAIMS (37 CFR 1.16(h))	minus 3 = *		X \$ =	
<input type="checkbox"/> APPLICATION SIZE FEE (37 CFR 1.16(s))	If the specification and drawings exceed 100 sheets of paper, the application size fee due is \$310 (\$155 for small entity) for each additional 50 sheets or fraction thereof. See 35 U.S.C. 41(a)(1)(G) and 37 CFR 1.16(s).			
<input type="checkbox"/> MULTIPLE DEPENDENT CLAIM PRESENT (37 CFR 1.16(j))				
* If the difference in column 1 is less than zero, enter "0" in column 2.			<b>TOTAL</b>	

**APPLICATION AS AMENDED – PART II**

	(Column 1)	(Column 2)	(Column 3)	PRESENT EXTRA	RATE (\$)	ADDITIONAL FEE (\$)
<b>AMENDMENT</b>	<b>09/09/2015</b>	CLAIMS REMAINING AFTER AMENDMENT	HIGHEST NUMBER PREVIOUSLY PAID FOR			
	Total (37 CFR 1.16(i))	* 20	Minus ** 20	= 0	X \$40 =	0
	Independent (37 CFR 1.16(h))	* 2	Minus *** 3	= 0	X \$210 =	0
	<input type="checkbox"/> Application Size Fee (37 CFR 1.16(s))					
<input type="checkbox"/> FIRST PRESENTATION OF MULTIPLE DEPENDENT CLAIM (37 CFR 1.16(j))						
					<b>TOTAL ADD'L FEE</b>	<b>0</b>

	(Column 1)	(Column 2)	(Column 3)	PRESENT EXTRA	RATE (\$)	ADDITIONAL FEE (\$)
<b>AMENDMENT</b>		CLAIMS REMAINING AFTER AMENDMENT	HIGHEST NUMBER PREVIOUSLY PAID FOR			
	Total (37 CFR 1.16(i))	-	Minus **	=	X \$ =	
	Independent (37 CFR 1.16(h))	*	Minus ***	=	X \$ =	
	<input type="checkbox"/> Application Size Fee (37 CFR 1.16(s))					
<input type="checkbox"/> FIRST PRESENTATION OF MULTIPLE DEPENDENT CLAIM (37 CFR 1.16(j))						
					<b>TOTAL ADD'L FEE</b>	

\* If the entry in column 1 is less than the entry in column 2, write "0" in column 3.  
 \*\* If the "Highest Number Previously Paid For" IN THIS SPACE is less than 20, enter "20".  
 \*\*\* If the "Highest Number Previously Paid For" IN THIS SPACE is less than 3, enter "3".

The "Highest Number Previously Paid For" (Total or Independent) is the highest number found in the appropriate box in column 1.

LIE  
/JUDY SWAYNE/

This collection of information is required by 37 CFR 1.16. The information is required to obtain or retain a benefit by the public which is to file (and by the USPTO to process) an application. Confidentiality is governed by 35 U.S.C. 122 and 37 CFR 1.14. This collection is estimated to take 12 minutes to complete, including gathering, preparing, and submitting the completed application form to the USPTO. Time will vary depending upon the individual case. Any comments on the amount of time you require to complete this form and/or suggestions for reducing this burden, should be sent to the Chief Information Officer, U.S. Patent and Trademark Office, U.S. Department of Commerce, P.O. Box 1450, Alexandria, VA 22313-1450. DO NOT SEND FEES OR COMPLETED FORMS TO THIS ADDRESS. **SEND TO: Commissioner for Patents, P.O. Box 1450, Alexandria, VA 22313-1450.**

If you need assistance in completing the form, call 1-800-PTO-9199 and select option 2.

**IN THE UNITED STATES PATENT AND TRADEMARK OFFICE**

Inventor	: Jae Lark JUNG, et al.
Applicant	: FIRSTFACE CO., LTD.
App. No.	: 14/848,191
Filed	: September 8, 2015
For	: ACTIVATING DISPLAY AND PERFORMING USER AUTHENTICATION IN MOBILE TERMINAL WITH ONE-TIME USER INPUT
Examiner	: Not Yet Assigned
Art Unit	: 2642
Conf. No.	: 9599

**REQUEST TO NOT ENTER THE SEPTEMBER 9, 2015 PRELIMINARY AMENDMENT  
AND  
PRELIMINARY AMENDMENT**

**Mail Stop Amendment**  
 Commissioner for Patents  
 P.O. Box 1450  
 Alexandria, VA 22313-1450

Dear Sir:

Prior to examination of the above-identified application on the merits, please amend the application as follows:

**Request to Not Enter the September 9, 2015 Preliminary Amendment** begins on page 2 of this paper.

**Amendments to the Claims** begin on page 3 of this paper.

**Remarks** begin on page 8 of this paper.

**Application No.** : **14/848,191**  
**Filing Date** : **September 8, 2015**

**REQUEST TO NOT ENTER THE SEPTEMBER 9, 2015 PRELIMINARY AMENDMENT**

On September 9, 2015, Applicant filed a Preliminary Amendment amending Claim 1 and adding Claims 2-20 in this application. Applicant has found that errors were included in the Preliminary Amendment. Applicant notes that the original recitation of Claim 1 appearing at page 2 of the Preliminary Amendment is not consistent with Claim 1 appearing at page 18 of the original specification filed on September 8, 2015. Specifically, “a camera” at line 3 and “and to initiate one or more additional functions of the terminal” at lines 6-7 are added by mistake in Claim 1 of the Preliminary Amendment while no such language was included in the original specification. In fact, Applicant notes that the amendments presented in the Preliminary Amendment are those for the concurrently-filed related application, Application No. 14/848,156.

In order to correct the errors and also to avoid duplicate prosecution of the same claims in two separate applications, Applicant submits a new set of claims in this paper. In view of the errors and further in view of the new set of claims, Applicant requests that the PTO enter the amendments included in this paper and not enter the September 9, 2015 Preliminary Amendment.

Application No. : 14/848,191  
Filing Date : September 8, 2015

### AMENDMENTS TO THE CLAIMS

The following listing of claims will replace all prior versions of claims in the application.

1. (Currently Amended) A mobile communication terminal comprising:  
a touch screen display;  
a power button configured to turn on and off the terminal by pressing; and  
an activation button separate from the power button and configured for pressing to turn on the touch screen display, -

wherein upon detection of one-time pressing of the activation button while the touch screen display is turned off, the terminal is configured to turn on the touch screen display and perform a fingerprint authentication function in addition to turning on the touch screen display such that:

the touch screen display displays a lock screen thereon as it is turned on in response to the detection of one-time pressing,

the lock screen is displayed on the touch screen display when the fingerprint authentication function is being performed,

a lock state of the terminal continues when the fingerprint authentication function fails to authenticate a user, and

the lock state is released for enabling other functions of the terminal when the fingerprint authentication function authenticates a user.

2. (New) The terminal of Claim 1, wherein the terminal is configured to perform the fingerprint authentication function in addition to turning on the touch screen display when the detected one-time pressing is for short time shorter than a reference time period.

3. (New) The terminal of Claim 2, wherein the terminal is further configured to perform at least one function other than the fingerprint authentication function in addition to turning on the touch screen display in response to the detection of one-time pressing during the terminal's inactive state when the detected one-time pressing is for long time longer than a reference time



**Application No.** : **14/848,191**  
**Filing Date** : **September 8, 2015**

period, wherein the at least one functions is selected from the group consisting of activating the camera, and an operation that involves playing a sound.

4. (New) The terminal of Claim 3, wherein the touch screen display displays a lock screen thereon as it is turned on in response to the detection of one-time pressing for long time, wherein the lock screen is displayed on the touch screen display when the at least one function is being initiated.

5. (New) The terminal of Claim 3, wherein the touch screen display displays a lock screen thereon as it is turned on in response to the detection of one-time pressing for long time, wherein the at least one function is associated with initiating a hands-free operation of the terminal.

6. (New) The terminal of Claim 3, wherein the terminal is configured to have a mobile application stay in a standby state when the touch screen display is turned off while the mobile application is running, wherein in response to the detection of one-time pressing of the activation button while the touch screen display is turned off, the terminal is configured to perform the at least one function regardless of whether the at least one function is in its standby state or an operation disable state.

7. (New) The terminal of Claim 1, wherein the terminal is configured to display an alarm message on the touch screen display when the lock state continues due to failure of fingerprint authentication by the fingerprint authentication function.

8. (New) The terminal of Claim 1, wherein the at least one function is associated with software downloadable by the terminal.

9. (New) The terminal of Claim 1, wherein upon detection of repeated pressing of the activation button while the touch screen display is turned off, the terminal is configured to turn on the touch screen display and further perform at least one function other than the fingerprint authentication function in addition to turning on the touch screen display.

**Application No.** : **14/848,191**  
**Filing Date** : **September 8, 2015**

10. (New) The terminal of Claim 1, wherein the terminal comprises a smartphone which comprises an activation sensor configured to detect pressing of the activation button and a user identification module configured to perform the fingerprint authentication function.

11. (New) A method of operating a mobile computing terminal, the method comprising:  
providing a mobile computing terminal which comprises a touch screen display, a camera, a power button for pressing to turn on/off the terminal, and an activation button for pressing to turn on the touch screen display;

detecting one-time pressing of the activation button while the terminal is in an inactive state in which the touch screen display is turned off;

in response to detection of the one-time pressing, changing the terminal from the inactive state to an active state in which the touch screen display is turned on; and

in addition to changing to the active state, further performing a fingerprint authentication function using fingerprint recognition without additional user input,

wherein in changing to the active state and performing the fingerprint authentication function, the terminal operates such that:

the touch screen display displays a lock screen thereon as the terminal changes to the active state in response to the detection of one-time pressing,

the lock screen is displayed on the touch screen display when the fingerprint authentication function is being performed,

a lock state of the terminal continues when the fingerprint authentication function fails to authenticate a user, and

the lock state is released for enabling other functions of the terminal when the fingerprint authentication function authenticates a user.

12. (New) The method of Claim 11, wherein performing the fingerprint authentication function in addition to changing to the active state occurs when the detected one-time pressing is for short time shorter than a reference time period.

13. (New) The method of Claim 12, wherein the method further comprises performing at least one function other than the fingerprint authentication function in addition to changing to the

**Application No.** : 14/848,191  
**Filing Date** : September 8, 2015

active state in response to the detection of one-time pressing during the terminal's inactive state when the detected one-time pressing is for long time longer than the reference time period, wherein the at least one function is selected from the group consisting of activating the camera, a hands-free operation and an operation that involves playing a sound.

14. (New) The method of Claim 13, wherein the touch screen display displays a lock screen thereon as the terminal changes to its active state in response to the detection of one-time pressing for long time, wherein the lock screen is displayed on the touch screen display when the at least one function is being initiated.

15. (New) The method of Claim 13, wherein the touch screen display displays a lock screen thereon as the terminal changes to its active state in response to the detection of one-time pressing for long time, wherein the at least one function is associated with initiating a hands-free operation of the terminal a hands-free operation.

16. (New) The method of Claim 13, wherein the terminal is configured to have a mobile application stay in a standby state when the touch screen display is turned off while the mobile application is running, wherein in response to the detection of one-time pressing of the activation button while the terminal is in its inactive state, the terminal performs the at least one function regardless of whether the at least one function is in its standby state or an operation disable state.

17. (New) The method of Claim 13, wherein the touch screen display displays an alarm message thereon when the lock state continues due to failure of fingerprint authentication by the fingerprint authentication function.

18. (New) The method of Claim 13, further comprising:  
receiving user input on a setting menu of the terminal; and  
configuring, based on the user input, settings of the terminal such that the at least one function is set to be performed in addition to changing to the active state upon detection of one-time pressing of the activation button while the terminal is in its inactive state.

**Application No.** : **14/848,191**  
**Filing Date** : **September 8, 2015**

19. (New) The method of Claim 11, wherein the at least one function is associated with software downloadable by the terminal.

20. (New) The method of Claim 11, further comprising:

detecting repeated pressing of the activation button while the terminal is in its inactive state;

in response to detection of the repeated pressing, changing the terminal from the inactive state to the active state; and

in addition to changing to the active state, further performing at least one function other than the fingerprint authentication function without additional user input,

wherein in changing to the active state and performing the at least one function, the terminal operates such that:

the touch screen display displays the lock screen thereon as the terminal changes to the active state in response to the detection of repeated pressing,

the lock screen is displayed on the touch screen display when the at least one function is being performed.

Application No. : 14/848,191  
Filing Date : September 8, 2015

**REMARKS**

Applicant has amended Claim 1 and added new Claims 2-20. Support for the amendments of Claims 1-20 can be found in the specification originally filed. No new matter is added by the amendments.

No Disclaimers or Disavowals

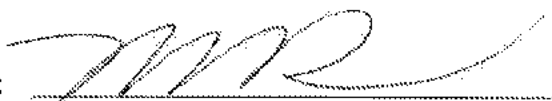
Although the present communication may include alterations to the application or claims, or characterizations of claim scope or referenced art, Applicant is not conceding in this application that previously pending claims are not patentable over the cited references. Rather, any alterations or characterizations are being made to facilitate expeditious prosecution of this application. Applicant reserves the right to pursue at a later date any previously pending or other broader or narrower claims that capture any subject matter supported by the present disclosure, including subject matter found to be specifically disclaimed herein or by any prior prosecution. Accordingly, reviewers of this or any parent, child or related prosecution history shall not reasonably infer that Applicant has made any disclaimers or disavowals of any subject matter supported by the present application.

Please charge any additional fees, including any fees for additional extension of time, or credit overpayment to Deposit Account No. 11-1410.

Respectfully submitted,

KNOBBE, MARTENS, OLSON & BEAR, LLP

Dated: 2015-09-16

By:   
Mincheol Kim  
Registration No. 51,306  
Attorney of Record  
Customer No. 20,995  
(949) 760-0404

21598318  
091615

## Electronic Acknowledgement Receipt

<b>EFS ID:</b>	23514002
<b>Application Number:</b>	14848191
<b>International Application Number:</b>	
<b>Confirmation Number:</b>	9599
<b>Title of Invention:</b>	ACTIVATING DISPLAY AND PERFORMING USER AUTHENTICATION IN MOBILE TERMINAL WITH ONE-TIME USER INPUT
<b>First Named Inventor/Applicant Name:</b>	Jae Lark JUNG
<b>Customer Number:</b>	20995
<b>Filer:</b>	Mincheol Kim/Jennifer Neat
<b>Filer Authorized By:</b>	Mincheol Kim
<b>Attorney Docket Number:</b>	UNIS005.001C2
<b>Receipt Date:</b>	16-SEP-2015
<b>Filing Date:</b>	
<b>Time Stamp:</b>	17:53:40
<b>Application Type:</b>	Utility under 35 USC 111(a)

### Payment information:

Submitted with Payment	no
------------------------	----

### File Listing:

Document Number	Document Description	File Name	File Size(Bytes)/ Message Digest	Multi Part /.zip	Pages (if appl.)
1		PrelimAmendment-UNIS005_001 C2.pdf	627372 <small>931231c0e3e0aa76280a5f0f7209e8ea7cfd2526</small>	yes	8

<b>Multipart Description/PDF files in .zip description</b>			
<b>Document Description</b>		<b>Start</b>	<b>End</b>
Preliminary Amendment		1	2
Claims		3	7
Applicant Arguments/Remarks Made in an Amendment		8	8

**Warnings:**

**Information:**

<b>Total Files Size (in bytes):</b>	627372
-------------------------------------	--------

**This Acknowledgement Receipt evidences receipt on the noted date by the USPTO of the indicated documents, characterized by the applicant, and including page counts, where applicable. It serves as evidence of receipt similar to a Post Card, as described in MPEP 503.**

**New Applications Under 35 U.S.C. 111**

**If a new application is being filed and the application includes the necessary components for a filing date (see 37 CFR 1.53(b)-(d) and MPEP 506), a Filing Receipt (37 CFR 1.54) will be issued in due course and the date shown on this Acknowledgement Receipt will establish the filing date of the application.**

**National Stage of an International Application under 35 U.S.C. 371**

**If a timely submission to enter the national stage of an international application is compliant with the conditions of 35 U.S.C. 371 and other applicable requirements a Form PCT/DO/EO/903 indicating acceptance of the application as a national stage submission under 35 U.S.C. 371 will be issued in addition to the Filing Receipt, in due course.**

**New International Application Filed with the USPTO as a Receiving Office**

**If a new international application is being filed and the international application includes the necessary components for an international filing date (see PCT Article 11 and MPEP 1810), a Notification of the International Application Number and of the International Filing Date (Form PCT/RO/105) will be issued in due course, subject to prescriptions concerning national security, and the date shown on this Acknowledgement Receipt will establish the international filing date of the application.**

Under the Paperwork Reduction Act of 1995, no persons are required to respond to a collection of information unless it displays a valid OMB control number.

<b>PATENT APPLICATION FEE DETERMINATION RECORD</b> Substitute for Form PTO-875	Application or Docket Number <b>14/848,191</b>	Filing Date <b>09/08/2015</b>	<input type="checkbox"/> To be Mailed
---	---	----------------------------------	---------------------------------------

ENTITY:  LARGE  SMALL  MICRO

**APPLICATION AS FILED – PART I**

FOR	NUMBER FILED	NUMBER EXTRA	RATE (\$)	FEE (\$)
<input type="checkbox"/> BASIC FEE (37 CFR 1.16(a), (b), or (c))	N/A	N/A	N/A	
<input type="checkbox"/> SEARCH FEE (37 CFR 1.16(k), (l), or (m))	N/A	N/A	N/A	
<input type="checkbox"/> EXAMINATION FEE (37 CFR 1.16(o), (p), or (q))	N/A	N/A	N/A	
TOTAL CLAIMS (37 CFR 1.16(i))	minus 20 = *		X \$ =	
INDEPENDENT CLAIMS (37 CFR 1.16(h))	minus 3 = *		X \$ =	
<input type="checkbox"/> APPLICATION SIZE FEE (37 CFR 1.16(s))	If the specification and drawings exceed 100 sheets of paper, the application size fee due is \$310 (\$155 for small entity) for each additional 50 sheets or fraction thereof. See 35 U.S.C. 41(a)(1)(G) and 37 CFR 1.16(s).			
<input type="checkbox"/> MULTIPLE DEPENDENT CLAIM PRESENT (37 CFR 1.16(j))				
* If the difference in column 1 is less than zero, enter "0" in column 2.			TOTAL	

**APPLICATION AS AMENDED – PART II**

	(Column 1)	(Column 2)	(Column 3)	PRESENT EXTRA	RATE (\$)	ADDITIONAL FEE (\$)
<b>AMENDMENT</b>	<b>09/16/2015</b>	CLAIMS REMAINING AFTER AMENDMENT	HIGHEST NUMBER PREVIOUSLY PAID FOR			
	Total (37 CFR 1.16(i))	- 20	Minus	** 20	= 0	X \$40 = 0
	Independent (37 CFR 1.16(h))	- 2	Minus	***3	= 0	X \$210 = 0
	<input type="checkbox"/> Application Size Fee (37 CFR 1.16(s)) <input type="checkbox"/> FIRST PRESENTATION OF MULTIPLE DEPENDENT CLAIM (37 CFR 1.16(j))					
					TOTAL ADD'L FEE	<b>0</b>

	(Column 1)	(Column 2)	(Column 3)	PRESENT EXTRA	RATE (\$)	ADDITIONAL FEE (\$)
<b>AMENDMENT</b>		CLAIMS REMAINING AFTER AMENDMENT	HIGHEST NUMBER PREVIOUSLY PAID FOR			
	Total (37 CFR 1.16(i))	-	Minus	**	=	X \$ =
	Independent (37 CFR 1.16(h))	*	Minus	***	=	X \$ =
	<input type="checkbox"/> Application Size Fee (37 CFR 1.16(s)) <input type="checkbox"/> FIRST PRESENTATION OF MULTIPLE DEPENDENT CLAIM (37 CFR 1.16(j))					
					TOTAL ADD'L FEE	

\* If the entry in column 1 is less than the entry in column 2, write "0" in column 3.  
 \*\* If the "Highest Number Previously Paid For" IN THIS SPACE is less than 20, enter "20".  
 \*\*\* If the "Highest Number Previously Paid For" IN THIS SPACE is less than 3, enter "3".  
 The "Highest Number Previously Paid For" (Total or Independent) is the highest number found in the appropriate box in column 1.

LIE  
/JUDY SWAYNE/

This collection of information is required by 37 CFR 1.16. The information is required to obtain or retain a benefit by the public which is to file (and by the USPTO to process) an application. Confidentiality is governed by 35 U.S.C. 122 and 37 CFR 1.14. This collection is estimated to take 12 minutes to complete, including gathering, preparing, and submitting the completed application form to the USPTO. Time will vary depending upon the individual case. Any comments on the amount of time you require to complete this form and/or suggestions for reducing this burden, should be sent to the Chief Information Officer, U.S. Patent and Trademark Office, U.S. Department of Commerce, P.O. Box 1450, Alexandria, VA 22313-1450. DO NOT SEND FEES OR COMPLETED FORMS TO THIS ADDRESS. **SEND TO: Commissioner for Patents, P.O. Box 1450, Alexandria, VA 22313-1450.**

If you need assistance in completing the form, call 1-800-PTO-9199 and select option 2.



**PATENT APPLICATION FEE DETERMINATION RECORD**

Substitute for Form PTO-875

Application or Docket Number  
14/848,191

**APPLICATION AS FILED - PART I**

	(Column 1)	(Column 2)
FOR	NUMBER FILED	NUMBER EXTRA
BASIC FEE (37 CFR 1.16(a), (b), or (c))	N/A	N/A
SEARCH FEE (37 CFR 1.16(k), (l), or (m))	N/A	N/A
EXAMINATION FEE (37 CFR 1.16(e), (p), or (q))	N/A	N/A
TOTAL CLAIMS (37 CFR 1.16(i))	20 minus 20 =	*
INDEPENDENT CLAIMS (37 CFR 1.16(h))	2 minus 3 =	*
APPLICATION SIZE FEE (37 CFR 1.16(s))	If the specification and drawings exceed 100 sheets of paper, the application size fee due is \$310 (\$155 for small entity) for each additional 50 sheets or fraction thereof. See 35 U.S.C. 41(a)(1)(G) and 37 CFR 1.16(s).	
MULTIPLE DEPENDENT CLAIM PRESENT (37 CFR 1.16(j))		

\* If the difference in column 1 is less than zero, enter "0" in column 2.

SMALL ENTITY	
RATE(\$)	FEE(\$)
N/A	70
N/A	300
N/A	360
x 40 =	0.00
x 210 =	0.00
	0.00
	0.00
<b>TOTAL</b>	<b>730</b>

OTHER THAN SMALL ENTITY	
RATE(\$)	FEE(\$)
N/A	
N/A	
N/A	
<b>TOTAL</b>	

**APPLICATION AS AMENDED - PART II**

AMENDMENT A	(Column 1)	(Column 2)	(Column 3)
	CLAIMS REMAINING AFTER AMENDMENT	HIGHEST NUMBER PREVIOUSLY PAID FOR	PRESENT EXTRA
Total (37 CFR 1.16(i))	*	Minus **	=
Independent (37 CFR 1.16(h))	*	Minus ***	=
Application Size Fee (37 CFR 1.16(s))			
FIRST PRESENTATION OF MULTIPLE DEPENDENT CLAIM (37 CFR 1.16(j))			

SMALL ENTITY	
RATE(\$)	ADDITIONAL FEE(\$)
x =	
x =	
<b>TOTAL ADD'L FEE</b>	

OTHER THAN SMALL ENTITY	
RATE(\$)	ADDITIONAL FEE(\$)
x =	
x =	
<b>TOTAL ADD'L FEE</b>	

AMENDMENT B	(Column 1)	(Column 2)	(Column 3)
	CLAIMS REMAINING AFTER AMENDMENT	HIGHEST NUMBER PREVIOUSLY PAID FOR	PRESENT EXTRA
Total (37 CFR 1.16(i))	*	Minus **	=
Independent (37 CFR 1.16(h))	*	Minus ***	=
Application Size Fee (37 CFR 1.16(s))			
FIRST PRESENTATION OF MULTIPLE DEPENDENT CLAIM (37 CFR 1.16(j))			

SMALL ENTITY	
RATE(\$)	ADDITIONAL FEE(\$)
x =	
x =	
<b>TOTAL ADD'L FEE</b>	

OTHER THAN SMALL ENTITY	
RATE(\$)	ADDITIONAL FEE(\$)
x =	
x =	
<b>TOTAL ADD'L FEE</b>	

\* If the entry in column 1 is less than the entry in column 2, write "0" in column 3.  
 \*\* If the "Highest Number Previously Paid For" IN THIS SPACE is less than 20, enter "20".  
 \*\*\* If the "Highest Number Previously Paid For" IN THIS SPACE is less than 3, enter "3".  
 The "Highest Number Previously Paid For" (Total or Independent) is the highest found in the appropriate box in column 1.



UNITED STATES PATENT AND TRADEMARK OFFICE

UNITED STATES DEPARTMENT OF COMMERCE
United States Patent and Trademark Office
Address: COMMISSIONER FOR PATENTS
P.O. Box 1450
Alexandria, Virginia 22313-1450
www.uspto.gov

Table with 7 columns: APPLICATION NUMBER, FILING or 371(c) DATE, GRP ART UNIT, FIL. FEE REC'D, ATTY. DOCKET NO, TOT. CLAIMS, IND. CLAIMS. Row 1: 14/848,191, 09/08/2015, 2642, 730, UNIS005.001C2, 20, 2

CONFIRMATION NO. 9599

FILING RECEIPT

20995
KNOBBE MARTENS OLSON & BEAR LLP
2040 MAIN STREET
FOURTEENTH FLOOR
IRVINE, CA 92614



Date Mailed: 09/24/2015

Receipt is acknowledged of this non-provisional patent application. The application will be taken up for examination in due course. Applicant will be notified as to the results of the examination. Any correspondence concerning the application must include the following identification information: the U.S. APPLICATION NUMBER, FILING DATE, NAME OF APPLICANT, and TITLE OF INVENTION. Fees transmitted by check or draft are subject to collection. Please verify the accuracy of the data presented on this receipt. If an error is noted on this Filing Receipt, please submit a written request for a Filing Receipt Correction. Please provide a copy of this Filing Receipt with the changes noted thereon. If you received a "Notice to File Missing Parts" for this application, please submit any corrections to this Filing Receipt with your reply to the Notice. When the USPTO processes the reply to the Notice, the USPTO will generate another Filing Receipt incorporating the requested corrections

Inventor(s)

Jae Lark JUNG, Goyang-si, KOREA, REPUBLIC OF;
Kyoung duck BAE, Seoul, KOREA, REPUBLIC OF;

Applicant(s)

FIRSTFACE CO., LTD., Seoul, KOREA, REPUBLIC OF;

Power of Attorney: The patent practitioners associated with Customer Number 20995

Domestic Priority data as claimed by applicant

This application is a CON of 14/538,880 11/12/2014
which is a CON of 14/058,761 10/21/2013 PAT 8918074
which is a CON of 13/590,483 08/21/2012 PAT 8831557

Foreign Applications (You may be eligible to benefit from the Patent Prosecution Highway program at the USPTO. Please see http://www.uspto.gov for more information.)
REPUBLIC OF KOREA 10-2011-0106839 10/19/2011

Permission to Access - A proper Authorization to Permit Access to Application by Participating Offices (PTO/SB/39 or its equivalent) has been received by the USPTO.

Request to Retrieve - This application either claims priority to one or more applications filed in an intellectual property Office that participates in the Priority Document Exchange (PDX) program or contains a proper Request to Retrieve Electronic Priority Application(s) (PTO/SB/38 or its equivalent). Consequently, the USPTO will attempt to electronically retrieve these priority documents.

If Required, Foreign Filing License Granted: 09/21/2015

The country code and number of your priority application, to be used for filing abroad under the Paris Convention, is **US 14/848,191**

**Projected Publication Date:** 12/31/2015

**Non-Publication Request:** No

**Early Publication Request:** No

**\*\* SMALL ENTITY \*\***

**Title**

ACTIVATING DISPLAY AND PERFORMING USER AUTHENTICATION IN MOBILE TERMINAL WITH ONE-TIME USER INPUT

**Preliminary Class**

455

**Statement under 37 CFR 1.55 or 1.78 for AIA (First Inventor to File) Transition Applications:** No

### **PROTECTING YOUR INVENTION OUTSIDE THE UNITED STATES**

Since the rights granted by a U.S. patent extend only throughout the territory of the United States and have no effect in a foreign country, an inventor who wishes patent protection in another country must apply for a patent in a specific country or in regional patent offices. Applicants may wish to consider the filing of an international application under the Patent Cooperation Treaty (PCT). An international (PCT) application generally has the same effect as a regular national patent application in each PCT-member country. The PCT process **simplifies** the filing of patent applications on the same invention in member countries, but **does not result** in a grant of "an international patent" and does not eliminate the need of applicants to file additional documents and fees in countries where patent protection is desired.

Almost every country has its own patent law, and a person desiring a patent in a particular country must make an application for patent in that country in accordance with its particular laws. Since the laws of many countries differ in various respects from the patent law of the United States, applicants are advised to seek guidance from specific foreign countries to ensure that patent rights are not lost prematurely.

Applicants also are advised that in the case of inventions made in the United States, the Director of the USPTO must issue a license before applicants can apply for a patent in a foreign country. The filing of a U.S. patent application serves as a request for a foreign filing license. The application's filing receipt contains further information and guidance as to the status of applicant's license for foreign filing.

Applicants may wish to consult the USPTO booklet, "General Information Concerning Patents" (specifically, the section entitled "Treaties and Foreign Patents") for more information on timeframes and deadlines for filing foreign patent applications. The guide is available either by contacting the USPTO Contact Center at 800-786-9199, or it can be viewed on the USPTO website at <http://www.uspto.gov/web/offices/pac/doc/general/index.html>.

For information on preventing theft of your intellectual property (patents, trademarks and copyrights), you may wish to consult the U.S. Government website, <http://www.stopfakes.gov>. Part of a Department of Commerce initiative, this website includes self-help "toolkits" giving innovators guidance on how to protect intellectual property in specific countries such as China, Korea and Mexico. For questions regarding patent enforcement issues, applicants may call the U.S. Government hotline at 1-866-999-HALT (1-866-999-4258).

**LICENSE FOR FOREIGN FILING UNDER**  
**Title 35, United States Code, Section 184**  
**Title 37, Code of Federal Regulations, 5.11 & 5.15**

**GRANTED**

The applicant has been granted a license under 35 U.S.C. 184, if the phrase "IF REQUIRED, FOREIGN FILING LICENSE GRANTED" followed by a date appears on this form. Such licenses are issued in all applications where the conditions for issuance of a license have been met, regardless of whether or not a license may be required as set forth in 37 CFR 5.15. The scope and limitations of this license are set forth in 37 CFR 5.15(a) unless an earlier license has been issued under 37 CFR 5.15(b). The license is subject to revocation upon written notification. The date indicated is the effective date of the license, unless an earlier license of similar scope has been granted under 37 CFR 5.13 or 5.14.

This license is to be retained by the licensee and may be used at any time on or after the effective date thereof unless it is revoked. This license is automatically transferred to any related applications(s) filed under 37 CFR 1.53(d). This license is not retroactive.

The grant of a license does not in any way lessen the responsibility of a licensee for the security of the subject matter as imposed by any Government contract or the provisions of existing laws relating to espionage and the national security or the export of technical data. Licensees should apprise themselves of current regulations especially with respect to certain countries, of other agencies, particularly the Office of Defense Trade Controls, Department of State (with respect to Arms, Munitions and Implements of War (22 CFR 121-128)); the Bureau of Industry and Security, Department of Commerce (15 CFR parts 730-774); the Office of Foreign Assets Control, Department of Treasury (31 CFR Parts 500+) and the Department of Energy.

**NOT GRANTED**

No license under 35 U.S.C. 184 has been granted at this time, if the phrase "IF REQUIRED, FOREIGN FILING LICENSE GRANTED" DOES NOT appear on this form. Applicant may still petition for a license under 37 CFR 5.12, if a license is desired before the expiration of 6 months from the filing date of the application. If 6 months has lapsed from the filing date of this application and the licensee has not received any indication of a secrecy order under 35 U.S.C. 181, the licensee may foreign file the application pursuant to 37 CFR 5.15(b).

---

***SelectUSA***

The United States represents the largest, most dynamic marketplace in the world and is an unparalleled location for business investment, innovation, and commercialization of new technologies. The U.S. offers tremendous resources and advantages for those who invest and manufacture goods here. Through SelectUSA, our nation works to promote and facilitate business investment. SelectUSA provides information assistance to the international investor community; serves as an ombudsman for existing and potential investors; advocates on behalf of U.S. cities, states, and regions competing for global investment; and counsels U.S. economic development organizations on investment attraction best practices. To learn more about why the United States is the best country in the world to develop technology, manufacture products, deliver services, and grow your business, visit <http://www.SelectUSA.gov> or call +1-202-482-6800.



별첨 사본은 아래 출원의 원본과 동일함을 증명함.

This is to certify that the following application annexed hereto  
is a true copy from the records of the Korean Intellectual  
Property Office

출 원 번 호 : 10-2011-0106839

Application Number

출 원 년 월 일 : 2011년 10월 19일

Filing Date OCT. 19, 2011

출 원 인 : 정재락 외 1명

Applicant(s) JUNG JAELARK, et al.

2015년 11월 02일

특 허 청

COMMISSIONER



**【서지사항】**

**【서류명】** 특허출원서  
**【출원구분】** 특허출원  
**【출원인】**  
**【성명】** 정재락  
**【출원인코드】** 4-2011-047499-7  
**【출원인】**  
**【성명】** 배경덕  
**【출원인코드】** 4-2011-047771-6  
**【대리인】**  
**【성명】** 김성호  
**【대리인코드】** 9-1998-000633-4  
**【포괄위임등록번호】** 2011-079413-6  
**【포괄위임등록번호】** 2011-079999-4  
**【발명의 국문명칭】** 이동 통신 단말기의 활성화 시에 특정 동작이 수행되도록 하기 위한 방법, 이동 통신 단말기 및 컴퓨터 판독 가능 기록 매체  
**【발명의 영문명칭】** METHOD, MOBILE COMMUNICATION TERMINAL AND COMPUTER-READABLE RECORDING MEDIUM FOR OPERATING SPECIFIC FUNCTION WHEN ACTIVAING OF MOBILE COMMUNICATION TERMINAL  
**【발명자】**  
**【성명】** 정재락  
**【출원인코드】** 4-2011-047499-7  
**【발명자】**  
**【성명】** 배경덕

제출 일자 : 2011-10-19

**【출원인코드】** 4-2011-047771-6  
**【심사청구】** 청구  
**【취지】** 위와 같이 특허청장에게 제출합니다.

대리인 김성호 (서명 또는 인)

**【수수료】**

<b>【출원료】</b>	0 면	38,000 원
<b>【가산출원료】</b>	32 면	0 원
<b>【우선권주장료】</b>	0 건	0 원
<b>【심사청구료】</b>	24 항	1,090,000 원
<b>【합계】</b>		1,128,000 원
<b>【감면사유】</b>	개인(70%감면)	
<b>【감면후 수수료】</b>		338,400 원

**【명세서】**

**【발명의 명칭】**

이동 통신 단말기의 활성화 시에 특정 동작이 수행되도록 하기 위한 방법,  
이동 통신 단말기 및 컴퓨터 판독 가능 기록 매체(METHOD, MOBILE COMMUNICATION  
TERMINAL AND COMPUTER-READABLE RECORDING MEDIUM FOR OPERATING SPECIFIC  
FUNCTION WHEN ACTIVATING OF MOBILE COMMUNICATION TERMINAL)

**【기술분야】**

<1> 본 발명은 이동 통신 단말기의 활성화 시에 특정 동작이 수행되도록 하기 위  
한 방법, 이동 통신 단말기 및 컴퓨터 판독 가능 기록 매체에 관한 것으로서, 보다  
상세하게는, 비활성화 상태를 활성화 상태로 전환시키는 버튼의 눌러는 횟수, 시간  
에 따라 다양한 기능이 실행될 수 있도록 하기 위한 방법, 이동 통신 단말기 및 컴  
퓨터 판독 가능 기록 매체에 관한 것이다.

**【배경기술】**

<2> 최근 통신 기능뿐만 아니라 다른 여러가지 기능을 포함하는 각종 단말기, 예  
를 들면, 스마트폰, 핸드폰, PDA, 웹 패드 등의 단말기가 많이 보급되고 있다. 이  
러한 단말기는 언제 어니에시나 데스크톱과 동일 또는 유사한 환경 구현을 가능하  
게 할 뿐만 아니라, 전화 기능 또한 포함하고 있어, 급속히 보편화되고 있는 실정  
이다.

<3> 이러한 단말기에는 각종 기능이 포함되어 있는데, 현재는 해당 기능을 실행



제출 일자 : 2011-10-19

시기기 위해서는 단말기가 활성화 상태, 즉, 디스플레이가 켜진 상태에서 어떠한 조작용 가하여야만 했었다. 또한, 어떠한 기능을 추가하기 위해서는 단말기에 해당 기능 수행을 위한 인터페이스 또는 버튼을 더 추가하였어야 했다. 예를 들어, 긴급 상황에 대처하기 위한 비상 버튼을 별도로 추가하여야만 해당 버튼을 누름으로써 비상 상황을 알리고 구조 신호를 전송할 수 있었다.

<4> 한편, 상기와 같은 단말기의 사용자들은 단말기를 휴대하다가, 이동시 또는 대기시에 습관적으로 자신의 단말기를 꺼내 단말기를 활성화시키는 조작용 수행한다.

**【선행기술문헌】**

**【특허문헌】**

<5> (특허분원 0001) 한국특허공개공보 제10-2008-0036974호 (공개일: 2008.04.29.)

**【발명의 내용】**

**【해결하려는 과제】**

<6> 본 발명의 목적은 단말기에 구비된 활성화 버튼에 다양한 동작을 접목시켜, 습관적으로 누르게 되는 활성화 버튼을 누르는 간단한 조작만으로도 유익한 기능을 활용할 수 있도록 하는 것이다.

<7> 본 발명의 다른 목적은 노인들이 간단한 조작만으로도 건강 체크를 할 수 있

고, 해당 정보가 보호자 또는 의료 기관에 전달될 수 있도록 하는 것이다.

<8> 본 발명의 또 다른 목적은 간단한 절차만으로도 보안이 강화된 사용자 인증 프로세스가 동작할 수 있도록 하는 것이다.

<9> 본 발명의 또 다른 목적은 긴급 상황에서 간단한 조작만으로도 위치 정보와 함께 긴급 메시지가 필요한 곳에 전달될 수 있도록 하는 것이다.

**【과제의 해결 수단】**

<10> 본 발명의 일 실시예에 따르면, 디스플레이부; 및 상기 디스플레이부가 오프 상태인 비활성화 상태를 상기 디스플레이부가 온 상태인 활성화 상태로 전환시키는 활성화 버튼을 포함하고, 상기 활성화 버튼이 눌러짐으로써 상기 활성화 상태로 전환됨과 동시에 소정의 동작이 수행되는 이동 통신 단말기가 제공된다.

<11> 상기 동작은 이동 통신 단말기의 카메라를 활성화시키고, 현재 카메라로 촬영되는 영상을 상기 디스플레이부에 표시하는 동작일 수 있다.

<12> 상기 이동 통신 단말기는, 상기 비활성화 상태에서 상기 활성화 버튼이 눌러짐이 감지되면, 상기 이동 통신 단말기에 구비된 카메라를 통해 수집된 영상으로부터 사용자의 얼굴 또는 안구를 검출하여, 사용자의 건강 상태 정보를 획득하고, 획득된 건강 정보를 전송할 수 있다.

<13> 상기 이동 통신 단말기는, 상기 비활성화 상태에서 상기 활성화 버튼이 눌러짐이 감지되면, 상기 이동 통신 단말기에 구비된 카메라를 통해 수집된 영상으로부터 사용자의 홍채를 검출하고, 기 저장된 진정한 사용자의 홍채 정보와 비교하여,

해당 사용자에게 대한 인증을 수행할 수 있다.

<14> 상기 이동 통신 단말기는, 상기 비활성화 상태에서 상기 활성화 버튼이 눌러짐이 감지되면, 상기 이동 통신 단말기에 구비된 센서에 의해 수집된 위치 정보 또는 긴급 메시지를 보호자 또는 보호 기관에 전송할 수 있다.

<15> 상기 이동 통신 단말기는, 상기 비활성화 상태에서 상기 활성화 버튼이 눌러짐이 감지되면, 상기 이동 통신 단말기의 콘텐츠를 다른 단말기 또는 소정 미디어 공간에 전송할 수 있다.

<16> 상기 이동 통신 단말기는, 상기 비활성화 상태에서 상기 활성화 버튼이 눌러짐이 감지되면, 상기 이동 통신 단말기를 핸드프리 모드로 전환하거나, 통신 기능 중 일부를 차단할 수 있다.

<17> 상기 비활성화 상태에서 상기 활성화 버튼이 눌러짐이 감지되면, 특정 애플리케이션이 동작할 수 있다.

<18> 본 발명의 다른 실시예에 따르면, 이동 통신 단말기의 활성화 시에 특정 동작을 수행하도록 하기 위한 방법으로, 디스플레이부가 오프 상태인 비활성화 상태를 상기 디스플레이부가 온 상태인 활성화 상태로 전환시키는 활성화 버튼이 눌러짐을 감지하는 단계; 및 상기 비활성화 상태에서 상기 활성화 버튼이 눌러짐이 감지되면, 상기 활성화 상태로 전환함과 동시에 소정의 동작을 수행하는 단계를 포함하는 방법이 제공된다.

<19> 또한, 본 발명의 또 다른 실시예에 따르면, 비활성화 상태에서 활성화 상태

로 전환하는 활성화 버튼이 눌러짐이 감지되면, 소정의 동작 또는 소정의 애플리케이션이 동작될 수 있도록 하는 다른 방법 및 이러한 방법을 실행하기 위한 컴퓨터 프로그램을 기록하는 컴퓨터 판독 가능한 기록 매체가 제공된다.

**【발명의 효과】**

- <20> 본 발명에 따르면, 단말기가 비활성 상태에 있을 때 활성화 버튼을 누르는 것만으로도 다양한 동작이 이루어지도록 할 수 있기 때문에, 단말기를 보다 유익하게 활용할 수 있고, 단말기 사용의 흥미도 또한 향상시킬 수 있다.
- <21> 본 발명에 따르면, 노인들이 간단한 조작만으로도 건강 체크를 할 수 있고, 해당 정보가 보호자 또는 의료 기관에 전달될 수 있다.
- <22> 본 발명에 따르면, 간단한 절차만으로도 보안이 강화된 사용자 인증 프로세스가 동작될 수 있다.
- <23> 본 발명의 따르면, 긴급 상황에서 간단한 조작만으로도 위치 정보와 함께 긴급 메시지가 필요한 곳에 전달될 수 있다.

**【도면의 간단한 설명】**

- <24> 도 1은 본 발명의 일 실시예에 따른 이동 통신 단말기의 외형을 나타내는 도면이다.  
도 2는 본 발명의 일 실시예에 따라 활성화 버튼이 눌러졌을 때 이동 통신 단말기의 일 동작예를 나타내는 도면이다.  
도 3a 및 도 3b는 본 발명의 일 실시예에 따른 이동 통신 단말기의 동작을

설명하기 위한 블록도이다.

도 4a 및 도 4b는 본 발명의 다른 실시예에 따른 이동 통신 단말기의 동작을 설명하기 위한 블록도이다.

도 5는 본 발명의 또 다른 실시예에 따른 이동 통신 단말기의 동작을 설명하기 위한 블록도이다.

**【발명을 실시하기 위한 구체적인 내용】**

<25> 후술하는 본 발명에 대한 상세한 설명은, 본 발명이 실시될 수 있는 특정 실시예를 예시로서 도시하는 첨부 도면을 참조한다. 이들 실시예는 당업자가 본 발명을 실시할 수 있기에 충분하도록 상세히 설명된다. 본 발명의 다양한 실시예는 서로 다르지만 상호 배타적일 필요는 없음이 이해되어야 한다. 예를 들어, 여기에 기재되어 있는 특정 형상, 구조 및 특성은 일 실시예에 관련하여 본 발명의 정신 및 범위를 벗어나지 않으면서 다른 실시예로 구현될 수 있다. 또한, 각각의 개시된 실시예 내의 개별 구성요소의 위치 또는 배치는 본 발명의 정신 및 범위를 벗어나지 않으면서 변경될 수 있음이 이해되어야 한다. 따라서, 후술하는 상세한 설명은 한정적인 의미로서 취하려는 것이 아니며, 본 발명의 범위는, 적절하게 설명된다면, 그 청구항들이 주장하는 것과 균등한 모든 범위와 더불어 첨부된 청구항에 의해서만 한정된다. 도면에서 유사한 참조부호는 여러 측면에 걸쳐서 동일하거나 유사한 기능을 지칭한다.

<26> 이하에서는, 본 발명이 속하는 기술분야에서 통상의 지식을 가진 자가 본 발

명을 용이하게 실시할 수 있도록 하기 위하여, 본 발명의 바람직한 실시예들에 관하여 첨부된 도면을 참조하여 상세히 설명하기로 한다.

<27> [본 발명의 바람직한 실시예]

<28> 본 명세서에서 "이동 통신 단말기"라 함은 유무선 통신 기능 또는 이와는 다른 기능을 포함하는 디지털 기기로서, 이동 전화기, 네비게이션, 웹 페드, PDA, 위크스태이션, 개인용 컴퓨터(예를 들어, 노트북 컴퓨터 등) 등과 같이 메모리 수단을 구비하고 마이크로 프로세서를 탑재하여 연산 능력을 갖춘 디지털 기기를 일컫는 용어로서, 본 명세서의 일부분에서는 이동 통신 단말기(예를 들면, 핸드폰 등)를 예로서 상정하여 설명할 것이지만, 반드시 이에 한정되는 것은 아니다.

<29> 본 명세서에서 "비활성 상태"라 함은 이동 통신 단말기가 통신 가능한 상태이기는 하나, 디스플레이 화면이 오프(off)인 상태를 의미한다. 디스플레이 화면이 오프인 상태이더라도, 소정의 기능(예를 들면, 음악 재생 기능 등)은 동작하고 있을 수 있다. 이처럼, 본 명세서에서 "비활성 상태"라는 용어는 이동 통신 단말기가 소정의 동작을 하고 있는지 여부를 불문하고, 디스플레이 화면이 오프인 상태를 포괄하는 개념이다. 그러나, 이동 통신 단말기가 완전히 꺼진 상태를 제외한다.

<30> 본 명세서에서 "활성 상태"라 함은 이동 통신 단말기의 디스플레이 화면이 온(on) 상태인 경우를 의미한다. "비활성 상태"에서 "활성 상태"로의 전환이라는 것은 디스플레이 화면이 오프인 상태에서 디스플레이 화면을 온 상태로 전환시키는 것을 의미하는 것으로, 온 상태인 디스플레이 화면에 어떠한 정보가 디스플레이되

는지는 불문한다. 예를 들면, 단지 잠금 화면만이 디스플레이되는 경우라 할지라도, 이는 이동 통신 단말기의 "활성 상태"라고 할 수 있다.

<31>            이동 통신 단말기의 구성

<32>            도 1은 본 발명에 따른 이동 통신 단말기의 외관을 나타내는 도면이다.

<33>            도 1을 참조하면, 본 발명의 이동 통신 단말기(100)는 디스플레이부(110), 활성화 버튼(120)을 포함할 수 있다. 또한, 카메라(130)가 더 포함될 수도 있다.

<34>            도 1에는 이동 통신 단말기(100)를 이루는 프레임 전면에 디스플레이부(110)가 구비되고, 디스플레이부(110) 하부에 활성화 버튼(120)이 구비되며, 디스플레이부(110) 상부에 카메라(130)가 구비되는 것으로 예시되었으나, 이와는 다른 형태로 형성될 수도 있다. 예를 들면, 디스플레이부(110)가 이동 통신 단말기(100)의 전제면에 걸쳐 형성되지 않아도 족하다. 즉, 이동 통신 단말기(100)의 적어도 일부에 형성되면 족하며, 활성화 버튼(120)은 디스플레이부(110)와 다른 부분에 형성되면 족하다. 또한, 카메라(130)는 이동 통신 단말기(100)에 있어서 디스플레이부(110)가 구비되지 않은 타면에 형성될 수도 있다.

<35>            디스플레이부(110)는 이동 통신 단말기(100)의 동작 상태에 대한 각종 정보를 표시하며, 이동 통신 단말기(100)가 터치스크린 구동 방식인 경우에는 사용자 입력을 위한 인터페이스 또한 표시한다. 통상적으로, 이동 통신 단말기(100)에 대한 사용자 조작이 없는 상태가 일정 시간 동안 지속되면, 이동 통신 단말기(100)는 비활성 상태가 된다. 사용자 조작이라는 것은, 디스플레이부(110)에 표시되는 인

터페이스를 통한 입력, 버튼(120)을 통한 조작 또는 이와는 다른 기능기(예를 들면, 볼륨 조절 키 등)를 통한 조작 등을 의미한다. 비활성 상태가 되는 조건은 사용자에게 의해 설정될 수 있다. 예를 들면, 디스플레이부(110)에 표시되는 인터페이스를 통해 설정 메뉴로 들어가 설정할 수 있다. 한편, 이동 통신 단말기(100)에 구비되는 다른 버튼(예를 들면, 온/오프 버튼)을 누름으로써 비활성 상태로 전환될 수도 있다. 예를 들면, 이동 통신 단말기(100)가 활성 상태에 있을 때, 온/오프 버튼을 길게 누르면 이동 통신 단말기(100)가 완전히 꺼질 수 있지만, 온/오프 버튼을 짧게 누르면, 전화가 수신될 시 받을 수 있는 통신 가능한 상태로 비활성 상태가 될 수 있다.

<36>           활성화 버튼(120)은 이동 통신 단말기(100)의 비활성 상태를 활성 상태로 전환되게 하는 수단이다. 즉, 이동 통신 단말기(100)가 비활성 상태일 때, 사용자가 활성화 버튼(120)을 누르면 활성 상태로 전환된다. 도 1은 이동 통신 단말기(100)가 비활성 상태일 때, 활성화 버튼(120)을 누름으로써 디스플레이부(110)에 잠금 화면이 표시되는 상태를 예시한다. 그러나, 활성화 버튼(120)은 이와는 다른 동작을 위한 수단(예를 들면, 디스플레이부(110)에 어떠한 동작 상태가 표시되는 중 대기 화면으로 이동하기 위한 수단, 현재 동작 중인 프로그램 목록을 표시하는 수단)으로서 기능할 수도 있다.

<37>           본 발명의 일 실시예에 따르면, 이동 통신 단말기(100)가 비활성 상태일 때, 사용자가 활성화 버튼(120)을 누르게 되면, 단순히 이동 통신 단말기(100)가 활성 상태로 전환되는 것이 아니라, 소정의 동작을 수행하게 된다. 이동 통신 단말기



(100)가 미활성 상태에 있을 때 활성화 버튼(120)을 누름으로써 수행되는 동작에 대한 설정은 사용자에게 의해 가능하다. 예를 들면, 디스플레이부(110)에 표시되는 인터페이스를 통해 설정 메뉴로 들어가 활성화 버튼(120)과 연계되는 이동 통신 단말기(100)의 동작에 대한 설정을 할 수 있다. 또한, 본 발명의 일 실시예에 따르면, 이동 통신 단말기(100)가 미활성 상태에 있을 때, 활성화 버튼(120)이 눌러지는 횟수 또는 눌러지는 시간에 따라 서로 다른 동작이 수행될 수도 있다. 예를 들면, 활성화 버튼(120)이 1회 눌러지는 경우에는 제1 동작이 수행되고, 3회 연속하여 눌러지는 경우에는 제2 동작이 수행되도록 설정될 수 있다. 또한, 다른 예로서, 활성화 버튼(120)이 짧게 1회 눌러지는 경우에는 제1 동작이 수행되고, 길게 1회 눌러지는 경우에는 제2 동작이 수행되도록 설정될 수 있다. 활성화 버튼(120)이 연속해서 눌러지는 횟수의 누산 및 활성화 버튼(120)이 눌러지는 시간 측정을 위해 이동 통신 단말기(120)는 소정의 클럭 회로 또는 타이머를 포함하고 있을 수 있다. 예를 들어, 활성화 버튼(120)이 눌러지고 임계 시간 내에 제차 눌러지는 경우에는 2회 눌러진 것으로 판단하고, 임계 시간 이상 눌러지는 경우에는 활성화 버튼(120)이 길게 눌러지는 경우로서 판단할 수 있다. 미활성화 상태에서 활성화 버튼(120)을 누름으로써 수행될 수 있는 동작들에 대해서는 후술하기로 한다.

<38> 본 발명의 일 실시예에 따르면, 활성화 버튼(120)에는 서브 디스플레이부(121)가 구비될 수 있다. 서브 디스플레이부(121)에는 활성화 버튼(120)을 누름으로써 수행되는 동작에 대한 정보가 표시될 수 있다. 표시 형태는 도형, 텍스트, 문자, 그림, 색상 등 다양한 형태일 수 있다. 표시 형태가 도형일 경우에는 원,

삼각형, 사각형, 육각형 등이 표시될 수 있다. 예를 들어, 활성화 버튼(120)을 누름으로써 제1 동작이 수행되는 것으로 설정된 경우에는 서브 디스플레이부(121)에 원이 표시되고, 활성화 버튼(120)을 누름으로써 제2 동작이 수행되는 것으로 설정된 경우에는 서브 디스플레이부(121)에 삼각형이 표시될 수 있으며, 그 역으로 구현될 수도 있다. 서브 디스플레이부(121)에 표시되는 형태 및 각 동작과 각 표시의 대응 관계에 대해서 또한 사용자에게 의해 설정될 수 있다. 예를 들면, 사용자는 설정 메뉴에서 활성화 버튼(120)을 누름으로써 수행되는 동작으로써 제1 동작을 선택하고, 활성화 버튼(120)의 서브 디스플레이부(121)에 표시되는 형태로서 삼각형을 선택할 수 있다. 이에 따르면, 이동 통신 단말기(100)가 비활성 상태인 경우일지라도, 서브 디스플레이부(121)에는 삼각형이 표시되므로, 사용자는 이를 통해 활성화 버튼(120)을 눌렀을 때 제1 동작이 수행된다는 것을 파악할 수 있다.

<39> 서브 디스플레이부(121)는 액정, LCD, LED 등의 통상적인 디스플레이로 구현될 수도 있으나, 이에 제한되는 것은 아니다.

<40> 디스플레이부(110)와 서브 디스플레이부(121)에 대한 구동 제어는 동일한 프로세서에 의해 동일한 방식으로 이루어질 수 있으나, 그렇지 않을 수도 있다.

<41> 이하에서는, 활성화 버튼(120)을 누름으로써 수행될 수 있는 이동 통신 단말기(100)의 동작들에 대한 다양한 실시예를 설명하기로 한다.

<42> 활성화 버튼을 통한 동작

<43> 이하에서 설명되는 각 동작들은 이동 통신 단말기(100)가 비활성 상태일 때

활성화 버튼(120)을 누름으로써 수행될 수 있는 동작들이며, 각 동작들이 수행될 수 있도록 하는 설정은 사용자에게 의해 이루어질 수 있다. 이하에 설명되는 각 동작들은 하나의 예에 불과하며, 이와는 다른 다양한 동작들이 활성화 버튼(120)이 눌러짐으로써 수행될 수도 있음은 물론이다.

<44> 1. 카메라 활성화 기능

<45> 이동 통신 단말기(100)가 비활성 상태에 있을 때, 활성화 버튼(120)을 누름으로써, 이동 통신 단말기(100)에 구비되는 카메라(130)가 활성화될 수 있으며, 현재 카메라(130)에 의해 미뤄지는 화면이 디스플레이부(110)에 표시될 수 있다.

<46> 도 2는 활성화 버튼(120)이 눌러진 후, 카메라(130)가 활성화되고, 디스플레이부(110)에 촬영 장면이 표시되는 일례를 나타내는 도면이다.

<47> 2. 건강 감지 및 건강 정보 전송 기능

<48> 이동 통신 단말기(100)가 비활성 상태에 있을 때, 활성화 버튼(120)을 누름으로써, 건강 감지 기능이 구동되고 감지된 건강 정보가 주치의 등의 의료 기관 또는 보호자 등에 전송될 수 있다.

<49> 도 3a 및 도 3b는 이러한 기능을 설명하기 위한 이동 통신 단말기(100)의 블록도를 나타낸다. 도 3a 및 도 3b는 이동 통신 단말기(100)의 이러한 기능을 설명하기 위한 블록도를 기능적으로 나타낸 것이다.

<50> 도 3a를 참조하면, 이동 통신 단말기(100)는 활성화 감지부(310), 건강 감지부(320), 건강 정보 전송부(330)를 포함할 수 있다.

- <51>           활성화 감지부(310)는 이동 통신 단말기(100)가 비활성 상태에 있을 때, 활성화 버튼(120)이 사용자에게 의해 눌러지는지 여부를 감지한다.
  
- <52>           건강 감지부(320)는 활성화 감지부(310)에 의해 활성화 버튼(120)이 눌러지는 것으로 감지된 경우에 동작을 하며, 다양한 방법으로 사용자의 건강 상태를 감지한다.
  
- <53>           도 3b는 건강 감지부(320)의 일례를 나타내는 블록도이다. 도 3b를 참조하면, 건강 감지부(320)는 카메라 활성화부(321), 안구 검출부(322), 건강 정보 획득부(323)를 포함할 수 있다.
  
- <54>           카메라 활성화부(321)는 이동 통신 단말기(100)에 구비되는 카메라(130)를 활성화시킨다. 카메라(130) 활성화에 의해 디스플레이부(110)에는 카메라(130)에 의해 현재 비춰지는 영상이 표시된다. 사용자가 자신의 눈 또는 얼굴을 카메라(130)에 비추면, 안구 검출부(322)는 사용자의 안구를 인식하고, 이를 추출해내는 기능을 수행한다. 안구 검출을 위해서는 통상적인 안구 검출 알고리즘을 사용할 수 있다. 건강 정보 획득부(323)는 안구 검출부(322)를 통해 검출된 안구를 통해 여러가지 건강 정보를 획득한다. 안구의 색상 또는 운동 상대 등을 통해, 사용자의 스트레스 지수, 당뇨병 지수, 망막 질환 등을 파악할 수 있다. 검출된 안구의 특성을 통해 건강 정보를 검출해내는 알고리즘 또한 당업계에 널리 알려진 알고리즘을 사용할 수 있다.
  
- <55>           이렇게 획득된 건강 정보는 건강 정보 전송부(330)에 의해 보호자의 이동 통

신 단말기에 전송되거나, 주치의 등의 의료기관에 전송될 수 있으며, 소정의 서버에 전송될 수도 있다. 보호자에 대한 정보(예를 들면, 전화 번호 또는 이메일 주소 등)는 기 저장되어 있을 수 있다. 또한, 획득된 건강 정보를 사용자가 확인할 수 있도록 디스플레이부(110)에 표시할 수도 있다.

<56>        상기 설명한 동작들, 즉, 안구 검출 및 검출된 안구의 정보를 통한 건강 감지 기능은 소정의 애플리케이션 설치에 의해 가능해질 수 있다. 즉, 해당 애플리케이션에는 안구 검출 알고리즘, 건강 감지 알고리즘 등이 포함되어 있어서, 이동통신 단말기(100)에 설치됨으로써 상기와 같은 동작을 할 수 있다. 이러한 애플리케이션은 사용자에 의해 다운로드된 후 이동통신 단말기(100)에 설치될 수 있다. 또한, 상기 설명에서는 안구 검출을 통한 건강 감지에 대해서만 예시하였으나, 이와는 다른 방식, 예를 들면, 얼굴 검출을 통한 건강 감지 등을 위한 애플리케이션의 설치 및 활성화 버튼(120)과의 연계가 가능함은 물론이다. 사용자는 설정 메뉴를 통해 활성화 버튼(120)이 이동통신 단말기(100)의 비활성 상태에서 눌러지는 경우, 해당 애플리케이션이 바로 동작되도록 설정함으로써 상기와 같은 기능을 제공받을 수 있다.

<57>        통상적으로 노인들은 이동통신 단말기(100)에 건강 감지 기능이 있더라도, 그 조작이 어려워 무용지물이 되는 경우가 많은데, 본 발명에 따르면, 별도의 동작 없이, 활성화 버튼(120)을 누르는 것만으로 해당 동작이 수행됨으로써 아주 손쉽게 건강 정보를 확인하고 이를 보호자 또는 주치의에게 전송할 수 있게 된다.

<58>        3. 사용자 식별 기능

- <59> 이동 통신 단말기(100)가 비활성 상태에 있을 때 활성화 버튼(120)을 누름으로써 보안을 위한 사용자 인증 프로세스가 진행될 수도 있다.
- <60> 도 4a 및 도 4b는 이러한 기능을 설명하기 위한 이동 통신 단말기(100)의 블록도를 나타낸다. 도 4a를 참조하면, 활성화 감지부(410), 사용자 식별부(420)를 포함할 수 있다.
- <61> 활성화 감지부(410)는 이동 통신 단말기(100)가 비활성 상태에 있을 때, 활성화 버튼(120)이 사용자에게 의해 눌러지는지 여부를 감지한다.
- <62> 사용자 식별부(420)는 활성화 감지부(410)에 의해 활성화 버튼(120)이 눌러지는 것으로 감지된 경우에 동작을 하며, 다양한 방법으로 사용자를 식별하는 기능을 수행한다.
- <63> 도 4b는 사용자 식별부(420)의 일례를 나타내는 블록도이다. 도 4b를 참조하면, 사용자 식별부(420)는 카메라 활성화부(421), 홍채 검출부(422), 사용자 식별부(423)를 포함할 수 있다.
- <64> 카메라 활성화부(421)는 이동 통신 단말기(100)에 구비되는 카메라(130)를 활성화시킨다. 카메라(130) 활성화에 의해 디스플레이부(110)에는 카메라(130)에 의해 현재 비춰지는 영상이 표시된다. 사용자가 자신의 눈 또는 얼굴을 카메라(130)에 비추면, 홍채 검출부(422)는 사용자의 안구 중에서 홍채를 인식하고, 이를 추출해내는 기능을 수행한다. 홍채 인식을 위해서는 통상적인 홍채 검출 알고리즘을 사용할 수 있다. 사용자 식별부(423)는 홍채 검출부(422)를 통해 검출된 홍채와

기 저장된 사용자의 홍채 정보를 비교하여, 매칭되는 경우 현재 사용자를 진정한 사용자로서 인증하는 기능을 수행한다. 이를 위해 사용자 식별부(423)는 데이터베이스(미도시됨)에 저장된 사용자의 홍채 정보를 이용할 수 있다. 사용자의 홍채 정보는 최초로 카메라(130)를 이용하여 촬영한 진정한 사용자의 영상을 이용하여 홍채 검출부(422)에 의해 검출되는 홍채에 대한 정보 등록에 의해 저장될 수 있다. 등록된 진정 사용자의 홍채 정보 변경을 위해서는 소정의 식별 정보(예를 들면, ID, 비밀번호, 주민등록번호 등)가 입력되어야 할 것이다. 사용자 식별부(423)에 의해 진정 사용자로서 인증되면, 이동 통신 단말기(100)의 잠금 상태가 해제되어 모든 기능을 사용할 수 있는 상태가 될 수 있고, 진정 사용자로서 인증되지 않으면, 경고 메시지 표시와 함께 잠금 상태가 지속될 수 있다.

<65>           상기 설명한 동작들, 즉, 홍채 검출 및 사용자 식별, 인증 등의 기능은 소정의 애플리케이션 설치에 의해 가능해질 수 있다. 즉, 해당 애플리케이션에는 홍채 검출 알고리즘, 홍채 비교를 통한 인증 알고리즘 등이 포함되어 있어서, 이동 통신 단말기(100)에 설치됨으로써 상기와 같은 동작을 할 수 있다. 이러한 애플리케이션은 사용자에게 의해 다운로드된 후 이동 통신 단말기(100)에 설치될 수 있다. 사용자는 설정 메뉴를 통해 활성화 버튼(120)이 이동 통신 단말기(100)의 비활성 상태에서 눌러지는 경우, 해당 애플리케이션이 바로 동작되도록 설정함으로써 상기와 같은 기능을 제공받을 수 있다.

<66>           이에 따르면, 보안에 취약한 지역에서 이동 통신 단말기(100)를 사용할 시에는 별도의 설정, 즉, 활성화 버튼(120)을 누름으로써 상기 사용자 인증 프로세스가

진행되도록 하는 설정을 함으로써, 효율적으로 보안 위험성을 낮출 수 있다.

<67>           상기 설명에서는 홍채 인식을 통한 인증 방법에 대해 예로서 설명하였지만, 이와는 다른 방식의 인증 방법, 예를 들면, 인증키 매칭 방법, 비밀번호 매칭 방법, 안면 인식 방법, 지문 인식 방법 등이 이용될 수도 있다. 즉, 활성화 버튼(120)을 누름으로써, 다양한 사용자 인증 방법 중 어느 하나, 또는 복수의 인증 방법 중 임의의 방법이 수행되도록 할 수 있다.

<68>           4. 위치 정보 전송 기능

<69>           이동 통신 단말기(100)가 비활성 상태에 있을 때 활성화 버튼(120)을 누름으로써 수집된 위치 정보가 보호자 또는 보호 기관(경찰서 또는 소방서 등)에 전송될 수 있다.

<70>           도 5는 이러한 기능을 설명하기 위한 이동 통신 단말기(100)의 블록도를 나타낸다. 도 5를 참조하면, 활성화 감지부(510), 위치 정보 수집부(520), 위치 정보 전송부(530)를 포함할 수 있다.

<71>           활성화 감지부(510)는 이동 통신 단말기(100)가 비활성 상태에 있을 때, 활성화 버튼(120)이 사용자에게 의해 눌러지는지 여부를 감지한다.

<72>           위치 정보 수집부(520)는 활성화 감지부(510)에 의해 활성화 버튼(120)이 눌러지는 것으로 감지된 경우에 GPS 센서 또는 이와는 다른 위치 감지 센서를 이용하여 현재 위치를 수집한다.

<73>           위치 정보 전송부(530)는 위치 정보 수집부(520)에 의해 수집된 위치 정보를



보호자 또는 보호 기관 등에 전송하는 기능을 수행한다. 긴급 상황인 경우에는 긴급 상황을 알리는 메시지가 함께 전송될 수 있다. 위치 정보와 긴급 메시지는 선택적으로 전송될 수도 있다. 한편, 이러한 동작은 활성화 버튼(120)이 눌러지는 횟수 또는 눌러지는 시간에 따라 달리 동작할 수 있다. 예를 들어, 활성화 버튼(120)이 짧게 눌러지는 경우에는 경찰서에 긴급 메시지와 함께 위치 정보를 전송하는 동작이 행해지도록 설정될 수 있고, 활성화 버튼(120)이 길게 눌러지는 경우에는 보호자에게 위치 정보만을 전송하는 동작이 행해지도록 설정될 수 있다. 또한, 다른 예로서, 활성화 버튼(120)이 1회 눌러지는 경우에는 경찰서에 긴급 메시지와 함께 위치 정보를 전송하는 동작이 행해지도록 설정될 수 있고, 활성화 버튼(120)이 3회 눌러지는 경우에는 소방서에 긴급 메시지와 함께 위치 정보를 전송하는 동작이 행해지도록 설정될 수 있다.

<74>           상기 설명한 동작들 또한 소정의 어플리케이션 설치에 의해 가능해질 수 있다. 즉, 해당 어플리케이션에는 위치 정보 수집, 긴급 메시지와 함께 전송을 위한 알고리즘 등이 포함되어 있어서, 이동 통신 단말기(100)에 설치됨으로써 상기와 같은 동작을 할 수 있다. 이러한 어플리케이션은 사용자에 의해 다운로드된 후 이동 통신 단말기(100)에 설치될 수 있다. 사용자는 설정 메뉴를 통해 활성화 버튼(120)이 이동 통신 단말기(100)의 비활성 상태에서 눌러지는 경우, 해당 어플리케이션이 바로 동작되도록 설정함으로써 상기와 같은 기능을 제공받을 수 있다.

<75>           이에 따르면, 긴급 상황에서 간단한 조작만으로 자신의 위험을 보호자 또는 보호 기관에 알릴 수 있으며, 자신의 위치 정보 또한 알릴 수 있기 때문에, 위험

상황에 대한 대처가 효율적으로 가능해질 수 있다.

<76> 5. 파일 전송 기능

<77> 이동 통신 단말기(100)가 비활성 상태에 있을 때, 활성화 버튼(120)을 누름으로써, 이동 통신 단말기(100)에 포함된 콘텐츠(예를 들면, 연락처 정보, 사진, 동영상, 애플리케이션 등의 콘텐츠)가 다른 이동 통신 단말기(100) 또는 여타의 미디어 공간(예를 들면, 트위터, 페이스북, 블로그 등의 1인 미디어 공간 또는 카페, 커뮤니티, 블로그 등의 다인 미디어 공간 등)에 업로드되는 기능이 동작할 수도 있다.

<78> 6. 운전 중의 모드 변경 등

<79> 이동 통신 단말기(100)가 비활성 상태에 있을 때, 활성화 버튼(120)을 누름으로써, 이동 통신 단말기(100)가 핸즈프리 기능으로 전환되거나, 이동 통신 단말기(100)의 통신 기능(음성 통화 기능, 문자 메시지 기능, 인터넷 기능 등) 중 일부가 차단될 수도 있다.

<80> 이에 따르면, 운전 중 활성화 버튼(120)을 누르는 간단한 조작만으로 이동 통신 단말기(100)의 모드를 핸즈프리 모드로 전환하거나, 통신 기능을 차단시킴으로써 교통 사고의 위험을 현저히 줄일 수 있다.

<81> 7. 이와는 다른 애플리케이션의 동작

<82> 이동 통신 단말기(100)가 비활성 상태에 있을 때, 활성화 버튼(120)을 누름으로써 단순히 활성 상태로 전환되는 것이 아니라, 소정 동작이 수행되기만

한다면, 본 발명의 권리범위에 속한다.

<83> 예를 들면, 활성화 버튼(120)이 눌러짐으로써 엔터테인먼트 등의 동작(예를 들면, 음악 또는 동영상 플레이어의 동작, 게임 애플리케이션 실행, 뉴스 수신 등)이 행해질 수 있다.

<84> 이상 설명된 본 발명에 따른 실시예들은 다양한 컴퓨터 구성요소를 통하여 수행될 수 있는 프로그램 명령어의 형태로 구현되어 컴퓨터 판독 가능한 기록 매체에 기록될 수 있다. 상기 컴퓨터 판독 가능한 기록 매체는 프로그램 명령어, 데이터 파일, 데이터 구조 등을 단독으로 또는 조합하여 포함할 수 있다. 상기 컴퓨터 판독 가능한 기록 매체에 기록되는 프로그램 명령어는 본 발명을 위하여 특별히 설계되고 구성된 것들이거나 컴퓨터 소프트웨어 분야의 당업자에게 공지되어 사용 가능한 것일 수도 있다. 컴퓨터 판독 가능한 기록 매체의 예에는, 하드 디스크, 플로피 디스크 및 자기 테이프와 같은 자기 매체, CD-ROM, DVD와 같은 광기록 매체, 플롭티컬 디스크(floptical disk)와 같은 자기-광 매체(magneto-optical media), 및 ROM, RAM, 플래시 메모리 등과 같은 프로그램 명령어를 저장하고 수행하도록 특별히 구성된 하드웨어 장치가 포함된다. 프로그램 명령어의 예에는, 컴파일러에 의해 만들어지는 것과 같은 기계어 코드뿐만 아니라 인터프리터 등을 사용해서 컴퓨터에 의해서 실행될 수 있는 고급 언어 코드도 포함된다. 상기 하드웨어 장치는 본 발명에 따른 처리를 수행하기 위해 하나 이상의 소프트웨어 모듈로서 작동하도록 구성될 수 있으며, 그 역도 마찬가지이다.

<85> 이상에서 본 발명이 구체적인 구성요소 등과 같은 특정 사항들과 한정된 실

시예 및 도면에 의해 설명되었으나, 이는 본 발명의 보다 전반적인 이해를 돕기 위해서 제공된 것일 뿐, 본 발명이 상기 실시예들에 한정되는 것은 아니며, 본 발명이 속하는 기술분야에서 통상적인 지식을 가진 자라면 이러한 기재로부터 다양한 수정 및 변형을 꾀할 수 있다.

<86> 따라서, 본 발명의 사상은 상기 설명된 실시예에 국한되어 정해져서는 아니 되며, 후술하는 특허청구범위뿐만 아니라 이 특허청구범위와 균등하게 또는 등가적으로 변형된 모든 것들은 본 발명의 사상의 범주에 속한다고 할 것이다.

**【부호의 설명】**

- <87> 110: 속도 감지부
- 120: 통신 기능 차단부
- 130: 음성 변환부
- 140: 애플리케이션 제어부
- 141: 제어 명령 수신부
- 142: 권한 인증부
- 143: 애플리케이션 설치/삭제/실정부
- 150: 애플리케이션 구동부
- 160: 데이터베이스

**【특허청구범위】**

**【청구항 1】**

디스플레이부; 및

상기 디스플레이부가 오프 상태인 비활성화 상태를 상기 디스플레이부가 온 상태인 활성화 상태로 전환시키는 활성화 버튼을 포함하고,

상기 활성화 버튼이 눌러짐으로써 상기 활성화 상태로 전환됨과 동시에 소정의 동작이 수행되는 이동 통신 단말기.

**【청구항 2】**

제1항에 있어서,

상기 활성화 버튼은 그 내부에 서브 디스플레이부를 포함하는 이동 통신 단말기.

**【청구항 3】**

제2항에 있어서,

상기 서브 디스플레이부에는 상기 활성화 버튼이 눌러짐으로써 수행되는 동작에 따라 상이한 표시가 디스플레이되는 이동 통신 단말기.

**【청구항 4】**

제3항에 있어서,

상기 표시는 도형, 텍스트, 문자, 그림 또는 색상 중 적어도 하나인 이동 통신 단말기.

**【청구항 5】**

제1항에 있어서,

상기 활성화 버튼이 눌러지는 횟수 또는 눌러지는 시간에 따라 상이한 동작이 수행되는 이동 통신 단말기.

**【청구항 6】**

제1항 내지 제5항 중 어느 한 항에 있어서,

카메라를 더 포함하고,

상기 동작은 상기 카메라를 활성화시키고, 현재 카메라로 촬영되는 영상을 상기 디스플레이부에 표시하는 동작인 이동 통신 단말기.

**【청구항 7】**

제1항 내지 제5항 중 어느 한 항에 있어서,

상기 비활성화 상태에서 상기 활성화 버튼이 눌러짐이 감지되면, 상기 이동 통신 단말기에 구비된 카메라를 통해 수집된 영상으로부터 사용자의 얼굴 또는 안구를 검출하여, 사용자의 건강 상태 정보를 획득하고, 획득된 건강 정보를 전송하는 이동 통신 단말기.

**【청구항 8】**

제1항 내지 제5항 중 어느 한 항에 있어서,

상기 비활성화 상태에서 상기 활성화 버튼이 눌러짐이 감지되면, 상기 이동 통신 단말기에 구비된 카메라를 통해 수집된 영상으로부터 사용자의 홍채를 검출하

고, 기 저장된 진정한 사용자의 홍채 정보와 비교하여, 해당 사용자에 대한 인증을 수행하는 이동 통신 단말기.

**【청구항 9】**

제1항 내지 제5항 중 어느 한 항에 있어서,

상기 비활성화 상태에서 상기 활성화 버튼이 눌러짐이 감지되면, 상기 이동 통신 단말기에 구비된 센서에 의해 수집된 위치 정보 또는 긴급 메시지를 보호자 또는 보호 기관에 전송하는 이동 통신 단말기.

**【청구항 10】**

제9항에 있어서,

상기 활성화 버튼이 눌러지는 횟수 또는 눌러지는 시간에 따라 상이한 대상으로 위치 정보 또는 긴급 메시지가 전송되는 이동 통신 단말기.

**【청구항 11】**

제1항 내지 제5항 중 어느 한 항에 있어서,

상기 비활성화 상태에서 상기 활성화 버튼이 눌러짐이 감지되면, 상기 이동 통신 단말기의 콘텐츠가 다른 단말기 또는 소정 미디어 공간에 전송되는 이동 통신 단말기.

**【청구항 12】**

제1항 내지 제5항 중 어느 한 항에 있어서,

상기 비활성화 상태에서 상기 활성화 버튼이 눌러짐이 감지되면, 상기 이동

통신 단말기를 핸드프리 모드로 전환하거나, 통신 기능 중 일부를 차단하는 이동 통신 단말기.

**【청구항 13】**

제1항 내지 제5항 중 어느 한 항에 있어서,

상기 비활성화 상태에서 상기 활성화 버튼이 눌러짐이 감지되면, 특정 애플리케이션이 동작하는 이동 통신 단말기.

**【청구항 14】**

이동 통신 단말기의 활성화 시에 특정 동작을 수행되도록 하기 위한 방법으로서,

디스플레이부가 오프 상태인 비활성화 상태를 상기 디스플레이부가 온 상태인 활성화 상태로 전환시키는 활성화 버튼이 눌러짐을 감지하는 단계; 및

상기 비활성화 상태에서 상기 활성화 버튼이 눌러짐이 감지되면, 상기 활성화 상태로 전환함과 동시에 소정의 동작을 수행하는 단계를 포함하는 방법.

**【청구항 15】**

제14항에 있어서,

상기 동작 수행 단계는,

상기 이동 통신 단말기의 카메라를 활성화시키고, 현재 카메라로 촬영되는 영상을 상기 디스플레이부에 표시하는 단계를 포함하는 방법.



**【청구항 16】**

제14항에 있어서,

상기 동작 수행 단계는,

상기 이동 통신 단말기에 구비된 카메라를 통해 수집된 영상으로부터 사용자의 얼굴 또는 안구를 검출하여, 사용자의 건강 상태 정보를 획득하고, 획득된 건강 정보를 전송하는 단계를 포함하는 방법.

**【청구항 17】**

제14항에 있어서,

상기 동작 수행 단계는,

상기 이동 통신 단말기에 구비된 카메라를 통해 수집된 영상으로부터 사용자의 홍채를 검출하고, 기 저장된 진정한 사용자의 홍채 정보와 비교하여, 해당 사용자에 대한 인증을 수행하는 단계를 포함하는 방법.

**【청구항 18】**

제14항에 있어서,

상기 동작 수행 단계는,

상기 이동 통신 단말기에 구비된 센서에 의해 수집된 위치 정보 또는 긴급 메시지를 보호자 또는 보호 기관에 전송하는 단계를 포함하는 방법.

**【청구항 19】**

제18항에 있어서,

상기 동작 수행 단계는,

상기 활성화 버튼이 눌러지는 횟수 또는 눌러지는 시간에 따라 상이한 대상으로 위치 정보 또는 긴급 메시지를 전송하는 단계들 더 포함하는 방법.

**【청구항 20】**

제14항에 있어서,

상기 동작 수행 단계는,

상기 이동 통신 단말기의 콘텐츠가 다른 단말기 또는 소정 미디어 공간에 전송하는 단계를 포함하는 방법.

**【청구항 21】**

제14항에 있어서,

상기 동작 수행 단계는,

상기 이동 통신 단말기를 핸드프리 모드로 전환하거나, 통신 기능 중 일부를 차단하는 단계를 포함하는 방법.

**【청구항 22】**

제14항에 있어서,

상기 동작 수행 단계는,

특정 애플리케이션을 동작시키는 단계를 포함하는 방법.

**【청구항 23】**

제14항에 있어서,

상기 동작 수행 단계는,

상기 활성화 버튼이 눌러지는 횟수 또는 눌러지는 시간에 따라 상이한 동작을 수행하는 단계들 포함하는 방법.

**【청구항 24】**

제14항 내지 제23항 중 어느 한 항에 따른 방법을 수행하기 위한 컴퓨터 프로그램이 기록된 컴퓨터 판독 가능한 기록 매체.

**【요약서】**

**【요약】**

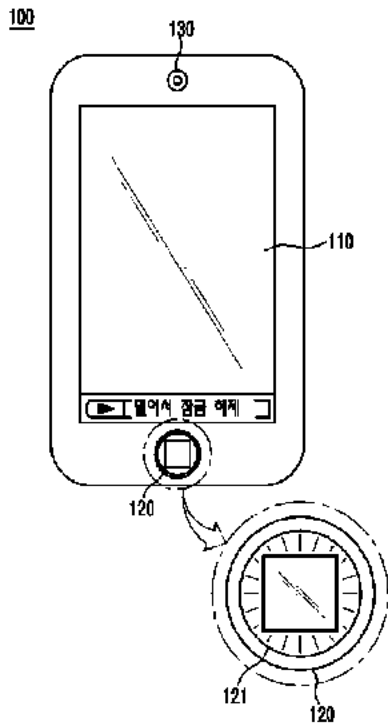
본 발명의 일 실시예에 따르면, 디스플레이부; 및 상기 디스플레이부가 오프 상태인 비활성화 상태를 상기 디스플레이부가 온 상태인 활성화 상태로 전환시키는 활성화 버튼을 포함하고, 상기 활성화 버튼이 눌러짐으로써 상기 활성화 상태로 전환됨과 동시에 소정의 동작이 수행되는 이동 통신 단말기가 제공된다.

**【대표도】**

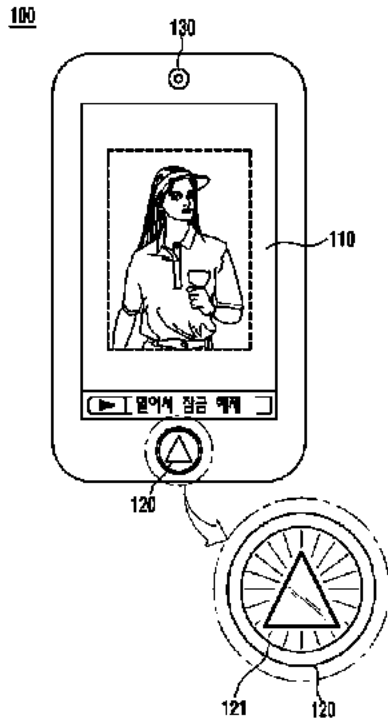
도 1

【도면】

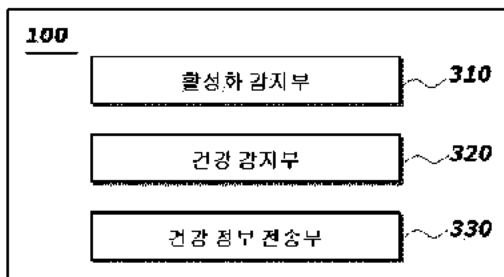
【도 1】



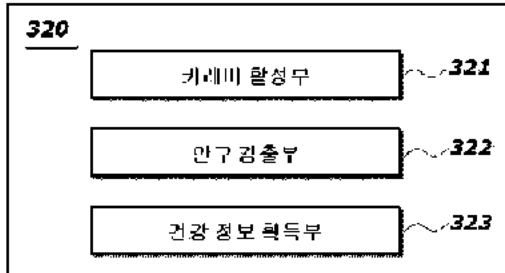
【도 2】



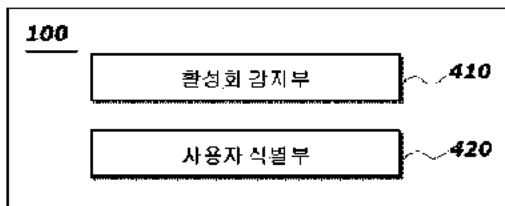
【도 3a】



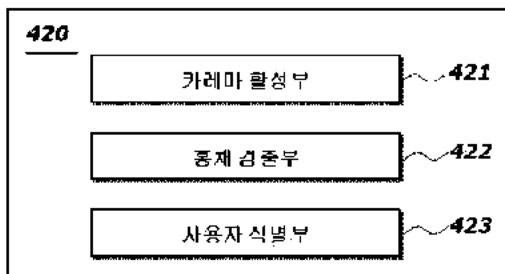
【도 3b】



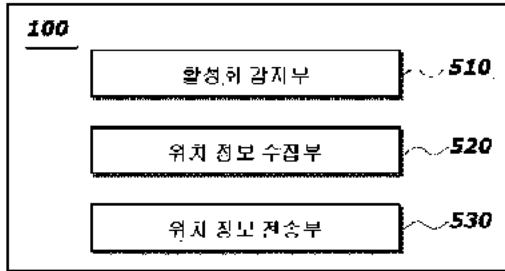
【도 4a】



【도 4b】



【도 5】





<b>INFORMATION DISCLOSURE STATEMENT BY APPLICANT</b> ( Not for submission under 37 CFR 1.99)	Application Number		14848191	
	Filing Date		2015-09-08	
	First Named Inventor	Jae Lark Jung		
	Art Unit		2143	
	Examiner Name	Jennifer N. To		
	Attorney Docket Number		UNIS005.001C2	

U.S.PATENTS						Remove
Examiner Initial*	Cite No	Patent Number	Kind Code <sup>1</sup>	Issue Date	Name of Patentee or Applicant of cited Document	Pages,Columns,Lines where Relevant Passages or Relevant Figures Appear
	1	6476797	B1	2002-11-05	Kurihara et al.	
	2	8811948	B2	2014-08-19	Bandyopadhyay et al.	
	3	9082235	B2	2015-07-14	Lau et al.	

If you wish to add additional U.S. Patent citation information please click the Add button.

Add

U.S.PATENT APPLICATION PUBLICATIONS						Remove
Examiner Initial*	Cite No	Publication Number	Kind Code <sup>1</sup>	Publication Date	Name of Patentee or Applicant of cited Document	Pages,Columns,Lines where Relevant Passages or Relevant Figures Appear
	1	20020083329	A1	2002-06-27	Kiyomoto	
	2	20020188855	A1	2002-12-12	Nakayama et al.	
	3	20090017871	A1	2009-01-15	Brieskom	

**INFORMATION DISCLOSURE  
STATEMENT BY APPLICANT**  
( Not for submission under 37 CFR 1.99)

Application Number	14848191
Filing Date	2015-09-08
First Named Inventor	Jae Lark Jung
Art Unit	2143
Examiner Name	Jennifer N. To
Attorney Docket Number	UNIS005.001C2

4	20090083850	A1	2009-03-26	Fadell et al.	
5	20090239591	A1	2009-09-24	Alameh et al.	
6	20100079380	A1	2010-04-01	Numi	
7	20100079508	A1	2010-04-01	Hodge et al.	
8	20110069940	A1	2011-03-24	Shimy et al.	
9	20120069042	A1	2012-03-22	Ogita et al.	
10	20120146898	A1	2012-06-14	Lin	
11	20150133086	A1	2015-05-14	Pratt et al.	

If you wish to add additional U.S. Published Application citation information please click the Add button. [Add](#)

**FOREIGN PATENT DOCUMENTS**

[Remove](#)

Examiner Initial*	Cite No	Foreign Document Number <sup>3</sup>	Country Code <sup>2</sup> j	Kind Code <sup>4</sup>	Publication Date	Name of Patentee or Applicant of cited Document	Pages, Columns, Lines where Relevant Passages or Relevant Figures Appear	T <sup>5</sup>
	1	1990734	EP	A1	2008-11-12	Menstecnica S.R.L.		<input type="checkbox"/>

**INFORMATION DISCLOSURE  
STATEMENT BY APPLICANT**  
( Not for submission under 37 CFR 1.99)

Application Number	14848191
Filing Date	2015-09-08
First Named Inventor	Jae Lark Jung
Art Unit	2143
Examiner Name	Jennifer N. To
Attorney Docket Number	UNIS005.001C2

2	10-2007-0076317	KR	A	2007-07-24	LG Electronics Inc.	<input checked="" type="checkbox"/>
3	2007-179343	JP	A	2007-07-12	Casio Hitachi Mobile Communications Co Ltd.	<input checked="" type="checkbox"/>
4	H11-328362	JP	A	1999-11-30	Toshiba Corp.	<input checked="" type="checkbox"/>

If you wish to add additional Foreign Patent Document citation information please click the Add button **Add**

**NON-PATENT LITERATURE DOCUMENTS**

**Remove**

Examiner Initials*	Cite No	Include name of the author (in CAPITAL LETTERS), title of the article (when appropriate), title of the item (book, magazine, journal, serial, symposium, catalog, etc), date, pages(s), volume-issue number(s), publisher, city and/or country where published.	T <sup>5</sup>
	1		<input type="checkbox"/>

If you wish to add additional non-patent literature document citation information please click the Add button **Add**

**EXAMINER SIGNATURE**

Examiner Signature	Date Considered
--------------------	-----------------

\*EXAMINER: Initial if reference considered, whether or not citation is in conformance with MPEP 609. Draw line through a citation if not in conformance and not considered. Include copy of this form with next communication to applicant.

<sup>1</sup> See Kind Codes of USPTO Patent Documents at [www.USPTO.GOV](http://www.USPTO.GOV) or MPEP 901.04. <sup>2</sup> Enter office that issued the document, by the two-letter code (WIPO Standard ST.3). <sup>3</sup> For Japanese patent documents, the indication of the year of the reign of the Emperor must precede the serial number of the patent document. <sup>4</sup> Kind of document by the appropriate symbols as indicated on the document under WIPO Standard ST.16 if possible. <sup>5</sup> Applicant is to place a check mark here if English language translation is attached.

**INFORMATION DISCLOSURE  
STATEMENT BY APPLICANT**  
( Not for submission under 37 CFR 1.99)

Application Number	14848191
Filing Date	2015-09-08
First Named Inventor	Jae Lark Jung
Art Unit	2143
Examiner Name	Jennifer N. To
Attorney Docket Number	UNIS005.001C2

**CERTIFICATION STATEMENT**

Please see 37 CFR 1.97 and 1.98 to make the appropriate selection(s):

That each item of information contained in the information disclosure statement was first cited in any communication from a foreign patent office in a counterpart foreign application not more than three months prior to the filing of the information disclosure statement. See 37 CFR 1.97(e)(1).

**OR**

That no item of information contained in the information disclosure statement was cited in a communication from a foreign patent office in a counterpart foreign application, and, to the knowledge of the person signing the certification after making reasonable inquiry, no item of information contained in the information disclosure statement was known to any individual designated in 37 CFR 1.56(c) more than three months prior to the filing of the information disclosure statement. See 37 CFR 1.97(e)(2).

- See attached certification statement.
- The fee set forth in 37 CFR 1.17 (p) has been submitted herewith.
- A certification statement is not submitted herewith.

**SIGNATURE**

A signature of the applicant or representative is required in accordance with CFR 1.33, 10.18. Please see CFR 1.4(d) for the form of the signature.

Signature	/Mincheol Kim/	Date (YYYY-MM-DD)	2015-11-20
Name/Print	Mincheol Kim	Registration Number	51306

This collection of information is required by 37 CFR 1.97 and 1.98. The information is required to obtain or retain a benefit by the public which is to file (and by the USPTO to process) an application. Confidentiality is governed by 35 U.S.C. 122 and 37 CFR 1.14. This collection is estimated to take 1 hour to complete, including gathering, preparing and submitting the completed application form to the USPTO. Time will vary depending upon the individual case. Any comments on the amount of time you require to complete this form and/or suggestions for reducing this burden, should be sent to the Chief Information Officer, U.S. Patent and Trademark Office, U.S. Department of Commerce, P.O. Box 1450, Alexandria, VA 22313-1450. **DO NOT SEND FEES OR COMPLETED FORMS TO THIS ADDRESS. SEND TO: Commissioner for Patents, P.O. Box 1450, Alexandria, VA 22313-1450.**

## Privacy Act Statement

The Privacy Act of 1974 (P.L. 93-579) requires that you be given certain information in connection with your submission of the attached form related to a patent application or patent. Accordingly, pursuant to the requirements of the Act, please be advised that: (1) the general authority for the collection of this information is 35 U.S.C. 2(b)(2); (2) furnishing of the information solicited is voluntary; and (3) the principal purpose for which the information is used by the U.S. Patent and Trademark Office is to process and/or examine your submission related to a patent application or patent. If you do not furnish the requested information, the U.S. Patent and Trademark Office may not be able to process and/or examine your submission, which may result in termination of proceedings or abandonment of the application or expiration of the patent.

The information provided by you in this form will be subject to the following routine uses:

1. The information on this form will be treated confidentially to the extent allowed under the Freedom of Information Act (5 U.S.C. 552) and the Privacy Act (5 U.S.C. 552a). Records from this system of records may be disclosed to the Department of Justice to determine whether the Freedom of Information Act requires disclosure of these records.
2. A record from this system of records may be disclosed, as a routine use, in the course of presenting evidence to a court, magistrate, or administrative tribunal, including disclosures to opposing counsel in the course of settlement negotiations.
3. A record in this system of records may be disclosed, as a routine use, to a Member of Congress submitting a request involving an individual, to whom the record pertains, when the individual has requested assistance from the Member with respect to the subject matter of the record.
4. A record in this system of records may be disclosed, as a routine use, to a contractor of the Agency having need for the information in order to perform a contract. Recipients of information shall be required to comply with the requirements of the Privacy Act of 1974, as amended, pursuant to 5 U.S.C. 552a(m).
5. A record related to an International Application filed under the Patent Cooperation Treaty in this system of records may be disclosed, as a routine use, to the International Bureau of the World Intellectual Property Organization, pursuant to the Patent Cooperation Treaty.
6. A record in this system of records may be disclosed, as a routine use, to another federal agency for purposes of National Security review (35 U.S.C. 181) and for review pursuant to the Atomic Energy Act (42 U.S.C. 218(c)).
7. A record from this system of records may be disclosed, as a routine use, to the Administrator, General Services, or his/her designee, during an inspection of records conducted by GSA as part of that agency's responsibility to recommend improvements in records management practices and programs, under authority of 44 U.S.C. 2904 and 2906. Such disclosure shall be made in accordance with the GSA regulations governing inspection of records for this purpose, and any other relevant (i.e., GSA or Commerce) directive. Such disclosure shall not be used to make determinations about individuals.
8. A record from this system of records may be disclosed, as a routine use, to the public after either publication of the application pursuant to 35 U.S.C. 122(b) or issuance of a patent pursuant to 35 U.S.C. 151. Further, a record may be disclosed, subject to the limitations of 37 CFR 1.14, as a routine use, to the public if the record was filed in an application which became abandoned or in which the proceedings were terminated and which application is referenced by either a published application, an application open to public inspections or an issued patent.
9. A record from this system of records may be disclosed, as a routine use, to a Federal, State, or local law enforcement agency, if the USPTO becomes aware of a violation or potential violation of law or regulation.

## Electronic Acknowledgement Receipt

<b>EFS ID:</b>	24150229
<b>Application Number:</b>	14848191
<b>International Application Number:</b>	
<b>Confirmation Number:</b>	9599
<b>Title of Invention:</b>	ACTIVATING DISPLAY AND PERFORMING USER AUTHENTICATION IN MOBILE TERMINAL WITH ONE-TIME USER INPUT
<b>First Named Inventor/Applicant Name:</b>	Jae Lark JUNG
<b>Customer Number:</b>	20995
<b>Filer:</b>	Mincheol Kim/KIM SKOFF
<b>Filer Authorized By:</b>	Mincheol Kim
<b>Attorney Docket Number:</b>	UNIS005.001C2
<b>Receipt Date:</b>	20-NOV-2015
<b>Filing Date:</b>	08-SEP-2015
<b>Time Stamp:</b>	16:14:04
<b>Application Type:</b>	Utility under 35 USC 111(a)

### Payment information:

Submitted with Payment	no
------------------------	----

### File Listing:

Document Number	Document Description	File Name	File Size(Bytes)/ Message Digest	Multi Part /.zip	Pages (if appl.)
1	Foreign Reference	EP1990734A1.PDF	202623 <small>02f503544164d00a523d8e76a45b493b031d f85c</small>	no	12

### Warnings:

### Information:

2	Foreign Reference	KR102007007631.PDF	512730 5005798e911d4da7d3ad2dea8f7fa70e06d f719	no	9
<b>Warnings:</b>					
<b>Information:</b>					
3	Foreign Reference	JP2007179343.PDF	872886 9c42f105e842c29b4d5a3fba647c027ad6ef cc15	no	15
<b>Warnings:</b>					
<b>Information:</b>					
4	Foreign Reference	JPH11328362.PDF	851162 1fab01dc8f1f7315fc997480e11894b324a7c a2c	no	12
<b>Warnings:</b>					
<b>Information:</b>					
5	Information Disclosure Statement (IDS) Form (SB08)	IDS.pdf	613092 ebf591aeds79ca826c80ea2a120be9890d8 8c486	no	5
<b>Warnings:</b>					
<b>Information:</b>					
<b>Total Files Size (in bytes):</b>				3052493	

**This Acknowledgement Receipt evidences receipt on the noted date by the USPTO of the indicated documents, characterized by the applicant, and including page counts, where applicable. It serves as evidence of receipt similar to a Post Card, as described in MPEP 503.**

**New Applications Under 35 U.S.C. 111**

**If a new application is being filed and the application includes the necessary components for a filing date (see 37 CFR 1.53(b)-(d) and MPEP 506), a Filing Receipt (37 CFR 1.54) will be issued in due course and the date shown on this Acknowledgement Receipt will establish the filing date of the application.**

**National Stage of an International Application under 35 U.S.C. 371**

**If a timely submission to enter the national stage of an international application is compliant with the conditions of 35 U.S.C. 371 and other applicable requirements a Form PCT/DO/EO/903 indicating acceptance of the application as a national stage submission under 35 U.S.C. 371 will be issued in addition to the Filing Receipt, in due course.**

**New International Application Filed with the USPTO as a Receiving Office**

**If a new international application is being filed and the international application includes the necessary components for an international filing date (see PCT Article 11 and MPEP 1810), a Notification of the International Application Number and of the International Filing Date (Form PCT/RO/105) will be issued in due course, subject to prescriptions concerning national security, and the date shown on this Acknowledgement Receipt will establish the international filing date of the application.**



(11) **EP 1 990 734 A1**

(12) **EUROPEAN PATENT APPLICATION**

(43) Date of publication:  
12.11.2008 Bulletin 2008/46

(51) Int Cl.:  
**G06F 15/02** (2006.01) **G06F 21/00** (2006.01)  
**G07C 9/00** (2006.01)

(21) Application number: **08006930.5**

(22) Date of filing: **07.04.2008**

(84) Designated Contracting States:  
**AT BE BG CH CY CZ DE DK EE ES FI FR GB GR HR HU IE IS IT LI LT LU LV MC MT NL NO PL PT RO SE SI SK TR**  
Designated Extension States:  
**AL BA MK RS**

(71) Applicant: **Menstecnica S.R.L.**  
**85038 Senise (PZ) (IT)**

- (72) Inventors:
- **Bellusci, Domenica**  
**85038 Senise (PZ) (IT)**
  - **Cantisani, Carmen**  
**00146 Roma (RM) (IT)**
  - **Fachechi, Luca**  
**73017 Sannicola (LE) (IT)**

(30) Priority: **09.05.2007 IT RM20070260**

(54) **Portable and independent system for storage and display of passwords and pins**

(57) Apparatus and method for a portable and autonomous system fitted to store and display passwords, PINs and other sensitive information. The system does not require the use of a personal computer, even if it can be optionally attached to it. The system is composed of a microcontroller, a non - volatile memory, a display, a biometric authentication system and an integrated device for the elaboration of biometric data.

The biometric sensor acts also by pointing device and allows the insertion and the management of data through a virtual keyboard visualized on the display.

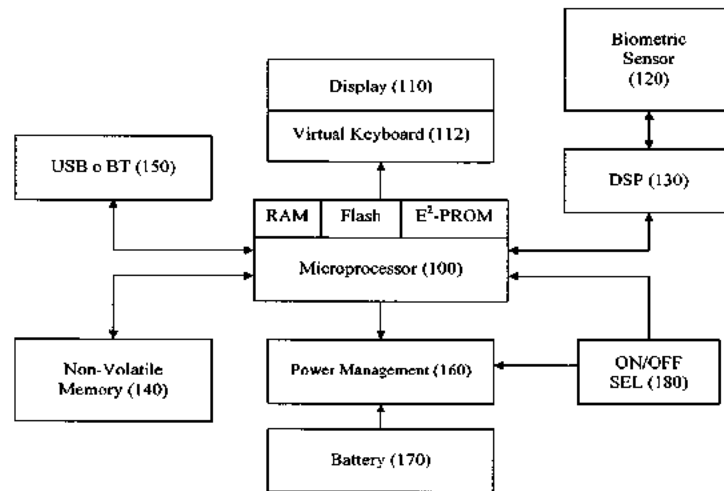
The system, with feeding on battery and with the size of a keychain, can be brought with himself and used in

case of need to see the passwords and PIN codes needed to access websites, to make operations cash dispenser or otherwise.

The data, passwords, PINs, etc. are stored in non-volatile memory in ciphered form. The system of encryption extracts the key using the data provided by the biometric sensor.

The non-volatile memory ensures the protection of data also with a flat battery.

The encryption of data guarantees the secrecy of the same if the device is lost or stolen. Compared with previous systems the object of this invention has the advantage of being autonomous, failing need to be connected to personal computers.



**Drawing 1 : Block diagram of the device**

**EP 1 990 734 A1**



**Description****FIELD OF TECHNIQUE** ( *to which the invention refers*).

**[0001]** The field of technique of the invention is the electronics.

**INVENTION** (*Brief description of the invention*).

**[0002]** Apparatus and method for a portable and autonomous system fitted to store and display passwords, PINs (Personal Identification Number) and other sensitive information. The system does not require the use of a personal computer, even if it can be optionally attached to it. The system is composed of a microcontroller, a non-volatile memory, a display, a biometric authentication system and an integrated device for the elaboration of biometric data.

**[0003]** The biometric sensor acts also by pointing device and allows the insertion and the management of data through a virtual keyboard visualized on the display.

**[0004]** The system, with feeding on battery and with the size of a keychain, can be brought with himself and used in case of need to see the passwords and PIN codes needed to access websites, to make operations cash dispenser or otherwise.

**[0005]** The data, passwords, PINs, etc. are stored in non-volatile memory in ciphered form. The system of encryption extracts the key using the data provided by the biometric sensor.

**[0006]** The non-volatile memory ensures the protection of data also with a flat battery.

**[0007]** The encryption of data guarantees the secrecy of the same if the device is lost or stolen. Compared with previous systems the object of this invention has the advantage of being autonomous, failing need to be connected to personal computers.

**STATE OF KNOWLEDGE:** (*Outline to what is already known or present on the market*).

**[0008]** Systems of storage of the passwords with authentication by biometric sensor are already present on the market. They still have two disadvantages: or are integrated into systems more complex, cumbersome or expensive as notebook or handhelds, or require to be connected to personal computers, for example through USB (Universal Serial Bus) ports.

**[0009]** In the first case, their use requires the purchase of the integrated system and the knowledge, from the user, of the host operating system. In the second case these systems aren't autonomous and therefore don't allow to access to information in they contained in any place and at any time.

**[0010]** To go towards these requirements, the device object of this invention is a portable and autonomous device that presents a user interface simple and immediate and that really requires a minimal effort of learning.

**PROBLEM:**(*Description of the problem that is solved with the new invention*).

**[0011]** The problem that it intends to solve with this invention is that of the safely and independently storage of sensitive data.

**[0012]** The memorization of codes and passwords is an theme that becomes increasingly important. The current information tools, while on the one hand permit to simplify many aspects of the work and of the life in generally, on the other hand often put to the difficult test the mnemonic capacity of user through the demand for access codes.

**[0013]** In particular, thinking of the numerous activities that each of us make using a card and the relative code (credit cards, ATM - Automatic Teller Machines - card, cards for purchases, codes for unblock equipment such as mobile phones, etc..) or a password (for the computers in the office, for that at the home, for the links and for the transactions on the Internet as the e-mail, the operation banking, the fiscal and tributary transactions, etc..).

**[0014]** For reasons of security it is almost always required that these passwords are at least a certain length, containing at the same numbers and lowercase and uppercase characters or special symbols, in other words that are not easily stored. Also for some of these systems, such as the computer of the office, it is required to periodically change the password.

**[0015]** The spread of these systems, closely linked to the spread of the information and telematics system in all areas of the professional and personal life, is only the beginning. Therefore will become increasingly pressing two needs strongly linked to the spread of these identification systems: 1) the possibility to consult, whenever it is serve, quickly and easily a code or a password; 2) the necessity that such information are protected and that their reading are done in complete safety for the owner.

**[0016]** Each of us has developed a system for transcribing, ciphered or store the codes, with the frequent risk of forgetting where they were annotated, of losing tickets and agendas with these information or becoming unable to decipher the strange notes written. The same method of authentication through the password of protection, it is not uniquely associated to the user, in the sense that if a person, different from the owner, comes into possession of the password, he can enter into the data in the same way of the owner.

**SOLUTIONS OF THE TECHNICAL PROBLEM:** (*Illustration of the optimal solution that is designed to give to the problem described in the preceding paragraph*).

**[0017]** The system in object allows the user, and only he, to store and display in way completely secure a series of codes, passwords and other identifiers.

**[0018]** The owner of the device has to store his biometric data (in particular his fingerprints), once before

including the codes and passwords.

**[0019]** From that moment on, both the memory and the display will activate themselves only to the recognition of fingerprint of the owner, ensuring the protection of stored data.

**[0020]** As form of personal authentication, and uniquely associated to the owner, this invention preferably using a biometric system for the recognition of fingerprints.

**[0021]** The market of the chips for the survey of the fingerprints is varied and today offers a wide range of sensors, relatively shape, size and technology of survey (optical, thermic, capacitive, RF, etc..).

**[0022]** To a limited extent to this invention we can classify these chips into two classes: the first class consists of the chip type Area / Flatbed, and the other consists of the chip type Line / swipe. The chip of the first class are generally larger and with form rectangular. They are constitute by an matrix of sensors and the image is acquired all in one go just putting the finger on the surface of the chip.

**[0023]** The chip of the second class are generally smaller and with form elongated. They consist of a few lines of sensors and the image of the impression is acquired by sliding the finger on the surface of the chip.

**[0024]** One additional characteristic of some of these chips, which for this invention is a particularly important role, is the implementation of a function of survey of the movements of finger on the sensor (without being read the fingerprint). In this way the sensor can be used as a pointing device, as if it were a small touch-pad.

**[0025]** In fact, the present invention uses preferably a chip of type line / swipe with survey of motion of finger on the sensor. This allows to implement and to manage a system of navigation based on menu and on virtual keyboard, designed on the display, and to avoid the use of keys of navigation.

**[0026]** The recognition of impression is a complex task and highly demanding in terms of computing power and, until very recently, required the presence of a computer to which the chip would be connected. Recently some manufacturers of chips have developed some integrated devices, particularly the DSP (Digital Signal Processor) that, through optimized algorithms, supplied together with the DSP, can to carry out operations of storage, acquisition and recognition of fingerprints in autonomous way.

**[0027]** The DSP united to the chips for the survey of the fingerprints allow storage in situ of a small number of fingerprints, and are therefore suitable for applications of unique recognition (that is the mark of the person who is trying to authenticate is compared with the stored imprint previously by the same person).

**[0028]** These DSP provide the result of the comparison with a margin of error very low and in a very short time, in the order of fractions of a second.

**[0029]** The result of the comparison, which consists of a series of 100-200 bytes, is the starting basis for the generation of the key of the encryption used by the sys-

tem for storage of confidential data. Essential characteristic of these DSP is the low consumption of energy, which makes them suitable for portable applications with battery feeding.

#### **FUNCTIONING AND DESCRIPTION OF DRAWINGS:** ***(Description of the working of the invention and relative drawings).***

**[0030]** The drawings attached to this description illustrate the principle of operation of the invention and its possible implementation, in particular:

- the Drawing 1 shows the block diagram of the device;
- the Drawing 2 shows the flowchart of the phase of initialization of the device;
- the Drawing 3 shows the flowchart of the phase of normal use of the device;
- the Drawing 4 shows a possible implementation of the device;
- the Drawing 5 shows the exploded of the possible configuration of the device.

**[0031]** The system (Drawing 1) is constituted essentially by the following functional blocks: a microcontroller, a system of visualization and navigation, a system of biometric identification, a memory, a system of management of the feeding, a interface of communication with the outside.

**[0032]** The microcontroller (100) monitors and manages the functioning of the other blocks. It includes, internally or externally, a RAM - Random Access Memory - , a flash memory and a memory E2-PROM. The firmware is stored in the internal flash memory. Once that the firmware is written in the flash memory, the access in reading from the outside of the microcontroller is disabled. The subsystem composed by the biometric sensor (120) and by the DSP (Digital Signal Processor) (130) constitutes the authentication system. The DSP, connected directly to the biometric sensor, is responsible for the real-time processing of biometric data and provides the interface between the microcontroller and the biometric sensor.

**[0033]** Before it can use, the device must be initialized. The initialization (Drawing 2) consists in to store inside the device a series of digital signatures associated to biometric data, preferably a series of fingerprint of the owner. The phase of initialization is activated at the first starting of the device, or after a hardware reset of itself.

**[0034]** The initialization deletes irrecoverable possible data and stored signatures previously, in order to safeguard the secrecy of the data. During the initializing the device requires to the user the inclusion of the one or more sets of biometric data, preferably one or more fingerprints. From each set of biometric data DSP extracts a digital signature that is sent to the microcontroller.

**[0035]** The microcontroller, through a proper algorithm, generates beginning from the digital signature an

key of encryption, associated with the digital signature. It is possible associate the same key of encryption to multiple digital signatures. For example more fingerprints by the same owner may be associated with the same key of encryption.

**[0036]** The key of encryption and the associated signatures can be encrypted, through a random and unique key for each device, and stored in a protected area of the flash memory or of the internal eeprom memory. The access to protected of the flash or of the eeprom memory is excluded from outside of the microcontroller, therefore the digital signatures and the keys are inaccessible.

**[0037]** The keys associated with digital signatures are used during the normal use to encrypt / decrypt data of the user.

**[0038]** Once that the system was correctly initialized it can be used to enter and read data. At this stage of normal use the flowchart of reference can be found in Drawing 3.

**[0039]** At the starting of the device is required to the user to authenticate, that's to say to provide one of the sets of the biometric data used during the phase of the initialization. The DSP derived from this set of data the digital signature that is sent to the microcontroller. The microcontroller codes the signature and compares it with the encrypted signatures stored in protected memory. If any of the signatures match is granted the permission to proceed and is visualized on the display a operating menu.

**[0040]** Using the menu it's possible to choose whether to insert new data or read existing ones. In both cases, the user can insert data or move between them thanks to the virtual keyboard (112) displayed on the display (110) and to the navigation system composed of biometric sensor (120) and button of selection (180).

**[0041]** The inserted data are encrypted with algorithm recognized secure, preferably of type AES (Advanced Encryption Standard), using the key of encryption associated with the digital signature of the user and then stored in the external no volatile memory (140), of type flash or eeprom . During the reading the data are read from external non-volatile memory, are decrypted and then visualized on the display. To increase the security of the device the display disabled itself after a interval of time of a few seconds.

**[0042]** In the phase of inserting or reading of the data the biometric sensor is used as a pointing system, like a touch-pad, while the button of starting is used as a device of selection. This allows to insert in the easy way any kind of data and at the same time to maintain limited the size of the device.

**[0043]** Another choice of the user, once authenticated, may be that to allow the connection with a personal computer. In this case through a specific software the user can easily manage the data in the easy way. In any case, the use of the computer is only optional, because the device is completely autonomous.

**[0044]** The device is fed through a common button battery or, alternatively, through a rechargeable battery

(170). The management of battery is entrusted to a system implemented partially in hardware and partially in the firmware (160), that will disable the components of the device that are not used in a given operating phase and thereby will reduce the consumption and increase the independence. In particular, the system provides to shut down the entire device after a given interval of time of no use.

**[0045]** The shut off at time of the device is an additional measure of security, because prevents the access to the confidential data from unauthorized persons if the device remains unattended. The device, in its possible deployment, is fully contained in a plastic container with the size of a keychain. The container (Drawing 4 and Drawing 5) is composed of two parts, one upper and one lower closed together through a series of joints.

**[0046]** In the superior part there is the opening for the display and for the biometric sensor. The display may or may not be protected by a thin slab of plastic. The opening for biometric sensor, in this implementation composed of a sensor for the reading of the fingerprints, also serves as a guide for the finger that must slide on it. Still on the superior part is set the on / off button and the button of selection.

**[0047]** In the lower part of the container is practised a slot for one or two button batteries, or for a rechargeable battery. An appropriate door allows to access to the batteries.

**[0048]** A further opening in the lateral part of the container can contain a possible connector for the USB connection of the device to the personal computer. If the link is kind of wireless, for example Bluetooth, this opening is absent.

#### ***ADVANTAGES: (Illustration of the advantages offered by the new invention).***

##### **[0049]**

- high degree of miniaturization required to obtain an instrument with a extremely compact size;
- implementation of the system of control of the biometric sensor to be used also as a pointing device;
- minimisation of consumption to prolong the autonomy of the battery;
- implementation of specific (*ad hoc*) security protocols to guarantee the confidentiality of data;

##### **Claims**

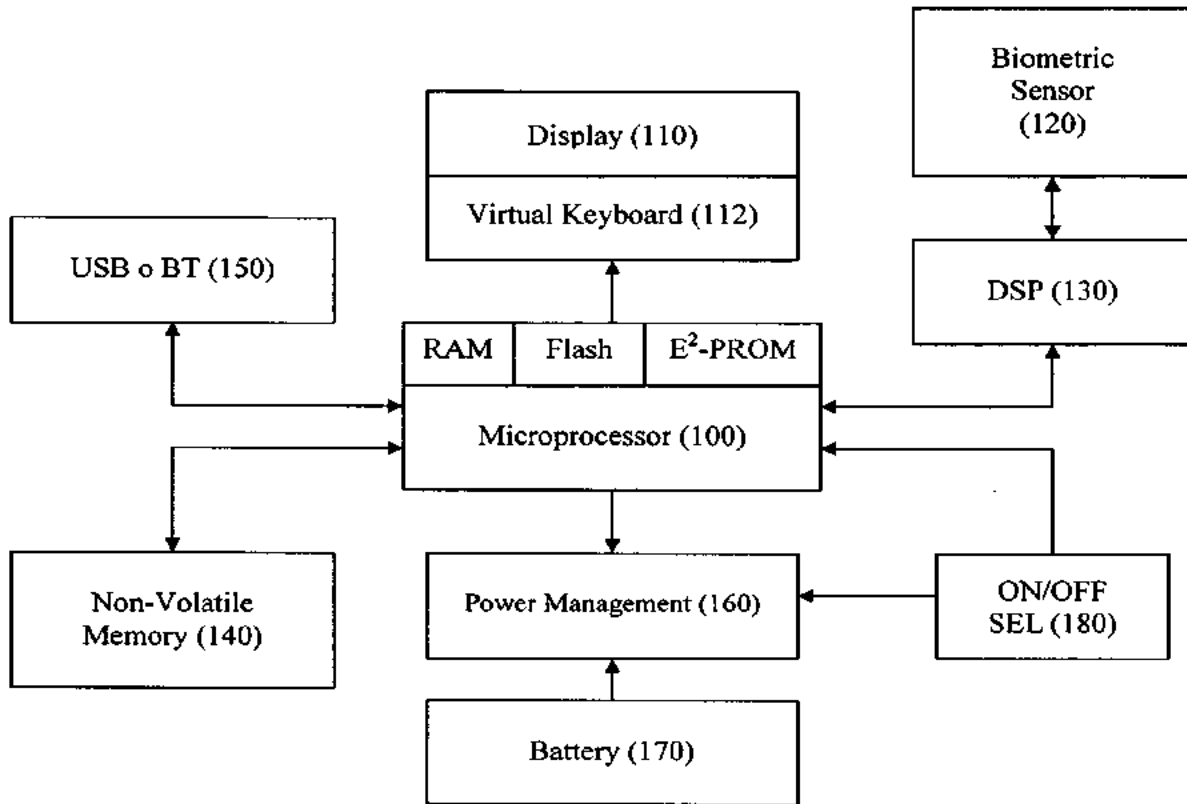
1. Claim 1: Portable and autonomous system to storage and to display of the confidential information, such as passwords, PINs, numbers of bank account, etc.. composed of microcontroller, display, non-volatile memory, biometric sensor, integrated device for biometric data processing, battery.

- 2. System as claimed in claim 1 in which the device integrated of processing of biometric data is a DSP, a microcontroller, an ASIC, or a programmable logic properly programmed. 5
- 3. System as claimed in the preceding claims points in which the non-volatile memory is type eeprom or flash. 10
- 4. System as claimed in the preceding claims in which the data are stored in ciphered form in the non-volatile memory. 15
- 5. System as claimed in the preceding claims in which the input and the reading of the data is done through a virtual keyboard projected on the display and through the biometric sensor used as a pointing device (touchpad). 20
- 6. System as claimed in the preceding claims in which the access to the stored data is granted only after that the user has been authenticated by a biometric sensor. 25
- 7. System as claimed in the preceding claims in which the system requires to the user to authenticate himself at the first starting of the device, or after a reset of the same, to store signatures associated with himself biometric data and to create encryption keys of the data. 30
- 8. System as claimed in the preceding claims in which is previewed a system of bypass of the biometric sensor for the recovery of the data, in the case is not possible to use the biometric sensor. 35
- 9. System as claimed in the preceding claims in which is inserted a circuit for recharge the battery 40
- 10. System as claimed in the preceding claims in which is inserted a interface of communication, of seriale type, usb, bluetooth, zig-bee, wifi, infrared or intranet, for the connection to a personal computer. 45

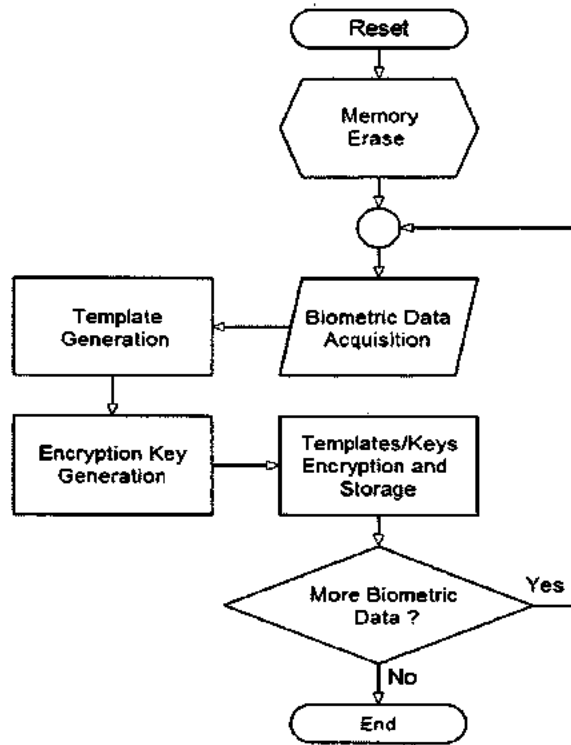
50

55

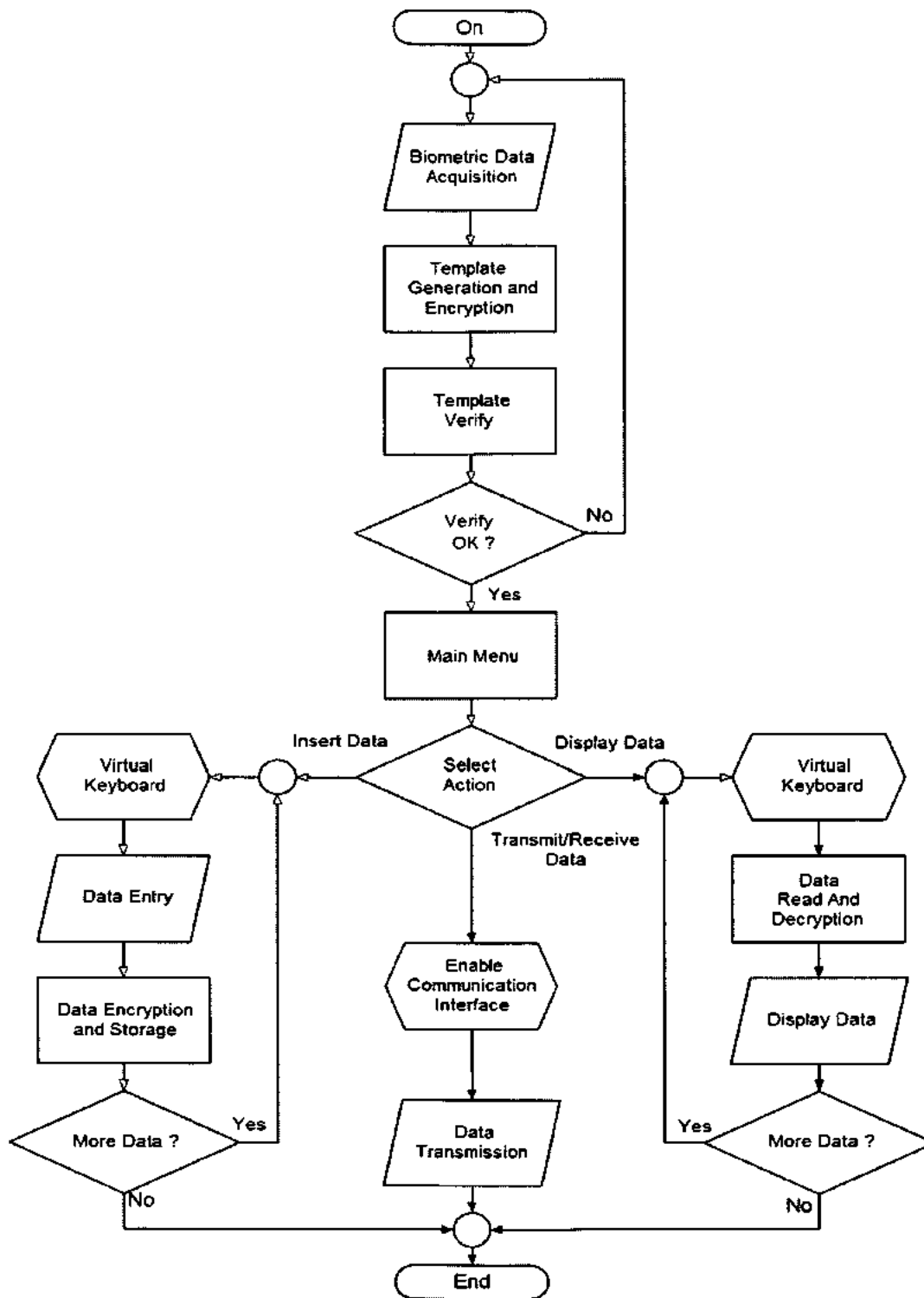
5



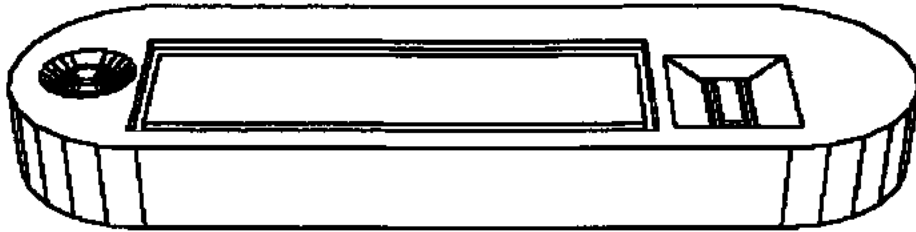
**Drawing 1 : Block diagram of the device**



**Drawing 2 : Flowchart of the initialization phase**

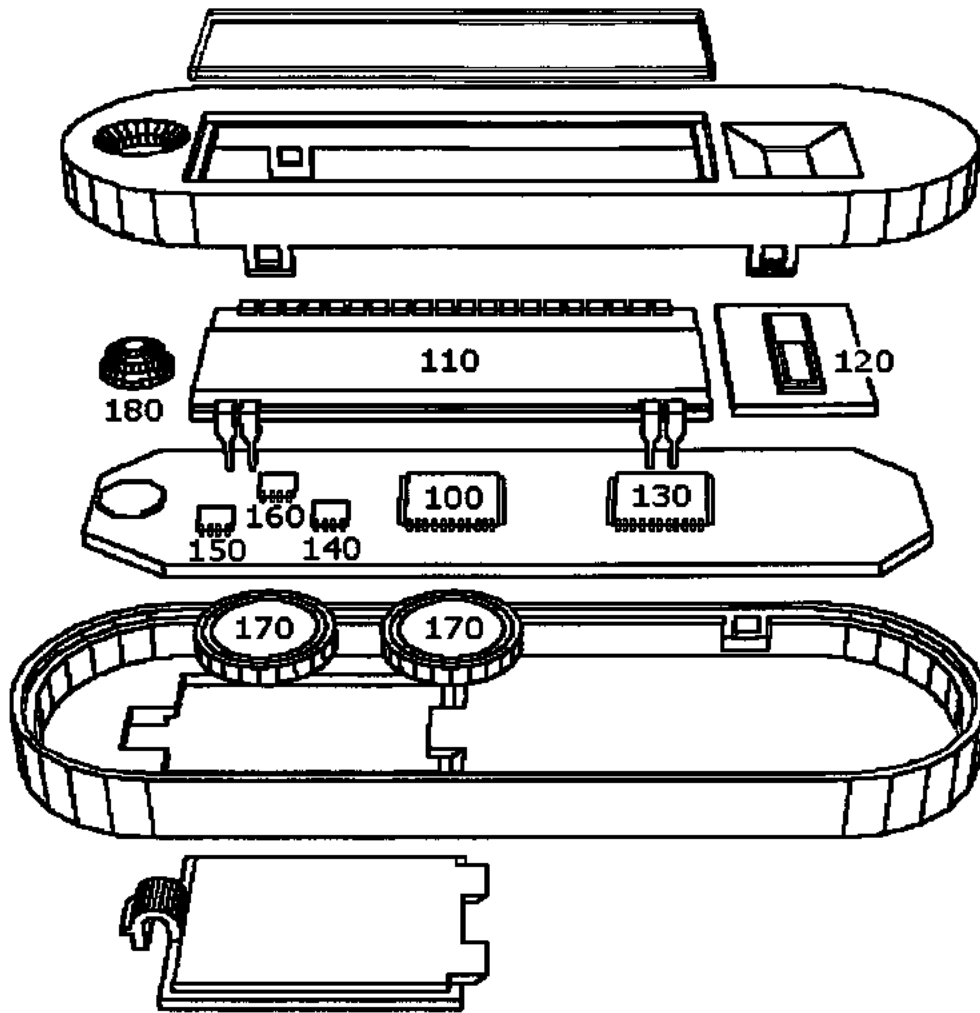


**Drawing 3 : Flowchart of the normal use phase**



**Drawing 4 : A possible configuration of the device**





**Drawing 5 : Drawing exploded of a possible configuration of the device**



DOCUMENTS CONSIDERED TO BE RELEVANT			
Category	Citation of document with indication, where appropriate, of relevant passages	Relevant to claim	CLASSIFICATION OF THE APPLICATION (IPC)
X	US 2006/013446 A1 (STEPHENS DEBRA K [US]) 19 January 2006 (2006-01-19) * abstract * * paragraph [0004] - paragraph [0005] * * paragraph [0017] - paragraph [0021] * * paragraph [0025] - paragraph [0032] * * paragraph [0034] - paragraph [0039] * * claims 1-39; figures 1-11 * -----	1-10	INV. G06F15/02  ADD. G06F21/00 G07C9/00
X	US 2005/039027 A1 (SHAPIRO MICHAEL F [US]) 17 February 2005 (2005-02-17) * abstract * * paragraph [0005] - paragraph [0008] * * paragraph [0015] - paragraph [0019] * * paragraph [0021] - paragraph [0032] * * claims 1-23; figures 1-6 * -----	1-10	
X	US 2006/205497 A1 (WELLS WILLIAM R [US] ET AL) 14 September 2006 (2006-09-14) * abstract * * paragraph [0004] - paragraph [0006] * * paragraph [0011] - paragraph [0016] * * paragraph [0018] - paragraph [0022] * * claims 21-23; figures 1-3 * -----	1-10	TECHNICAL FIELDS SEARCHED (IPC)  G06G G07C G06F G06K
X	US 2006/236119 A1 (BOBBITT JOSEPH M [US]) 19 October 2006 (2006-10-19) * abstract * * paragraph [0008] * * paragraph [0010] - paragraph [0015] * * paragraph [0017] * * paragraph [0020] * * paragraph [0023] - paragraph [0034] * * claims 1-24; figures 1-8 * -----	1-10	
The present search report has been drawn up for all claims			
Place of search <b>Munich</b>		Date of completion of the search <b>22 August 2008</b>	Examiner <b>Eftimescu, Nicolae</b>
CATEGORY OF CITED DOCUMENTS		T : theory or principle underlying the invention E : earlier patent document, but published on, or after the filing date D : document cited in the application L : document cited for other reasons ----- & : member of the same patent family, corresponding document	
X : particularly relevant if taken alone Y : particularly relevant if combined with another document of the same category A : technological background O : non-written disclosure P : intermediate document			

1  
EPC/FORM 1503 (01.02.2004)

**ANNEX TO THE EUROPEAN SEARCH REPORT  
ON EUROPEAN PATENT APPLICATION NO.**

EP 08 00 6930

This annex lists the patent family members relating to the patent documents cited in the above-mentioned European search report. The members are as contained in the European Patent Office EDP file on The European Patent Office is in no way liable for these particulars which are merely given for the purpose of information.

22-08-2008

Patent document cited in search report	Publication date	Patent family member(s)	Publication date
US 2006013446 A1	19-01-2006	WD 2006019396 A1	23-02-2006
US 2005039027 A1	17-02-2005	US 2008148059 A1	19-06-2008
US 2006205497 A1	14-09-2006	NONE	
US 2006236119 A1	19-10-2006	NONE	

EPO FORM P0458

For more details about this annex : see Official Journal of the European Patent Office, No. 12/82

컴퓨터의 전원 인가 및 사용 인승 장치와 인승 방법

Apparatus and method for arresting use of computer

(6) Int. Cl. G06F 1/00(2006.01) G06F 1/26(2006.01)

(A) Class No.

(7) Application No.(Date) 102007-0005214 (2007.07.19)

(7) Applicant (SAMSUNG ELECTRONICS CO., LTD.)

(11) Registration No. (Date)

(66) Unexam. Pub. No.(Date) KR2007-00178211 (2007.07.27)

(1) Publication No.(Date)

(86) Int. Application No.(Date)

(87) Int. Unexam. Pub. No.(Date)

(90) Priority info

(Country / No. / Date)

Legal Status: **SELECTED**

Final Status of Examination: **NO. 2011-01-01-0001 (Completed)**

Freezing

Inst. info

Kind/Right of Org. Application

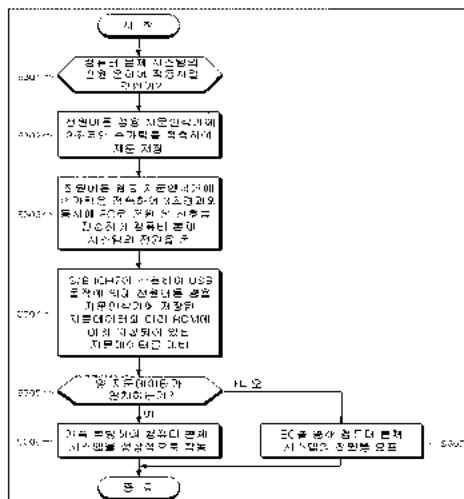
Right of Org. Applicant No. (Date)

Rejected Application No.

Issued text for an examination (Date) 11

Number of examination claims 11

Zoom







(19)대한민국특허청(KR)  
(12) 공개특허공보(A)

(51) Int. Cl.

G06F 1/00 (2006.01)

G06F 1/26 (2006.01)

(11) 공개번호 10-2007-0076317

(43) 공개일자 2007년07월24일

(21) 출원번호 10-2006-0005534

(22) 출원일자 2006년01월18일

심사청구일자 없음

(71) 출원인 엘지전자 주식회사  
서울특별시 영등포구 여의도동 20번지

(72) 발명자 이규호  
경기 안양시 동안구 부흥동 은하수청구 APT 107동 1503호

(74) 대리인 특허법인우린

전체 청구항 수 : 총 10 항

**(54) 컴퓨터의 전원 인가 및 사용 인증 장치와 인증 방법**

(57) 요약

이 발명은 컴퓨터를 켜기 위해서는 전원 버튼을 손가락으로 접촉하여야 한다는 것과 컴퓨터를 사용하기 위해 지문 인증을 수행하기 위해서는 지문인식 센서에 손가락을 접촉시켜야 한다는 것을 하나의 과정으로 실행하게 하여 사용자가 컴퓨터를 사용하기 위해 전원을 인가할 때 이와 동시에 지문 인식을 통한 사용자 인증도 함께 이루어져 사용자의 편의성과 보안을 도모하는 컴퓨터의 전원 인가 및 사용 인증 장치와 인증 방법의 제공을 그 목적으로 한다.

상기의 목적을 달성하기 위해 이 발명은, 손가락을 접촉하면 전원 온 신호가 발생되면서 내부에 지문이 저장되는 전원버튼 겸용 지문인식기(100)와, 상기 전원버튼 겸용 지문인식기(100)에서 발생하는 전원 온 신호에 의해 컴퓨터 본체 시스템(200)에 전원을 인가하는 EC(210) 및, 상기 EC(210)에서 인가된 전원에 의해 작동하여 상기 전원버튼 겸용 지문인식기(200)와 USB 인터페이스로 연결된 상태를 유지하면서, 상기 전원버튼 겸용 지문인식기(100)에 저장된 지문데이터와 내부의 ROM(230)에 미리 저장되어 있는 지문 데이터를 대비하여 사용자 인증을 수행하는 S/B ICH7(220)로 이루어진다.

내표도

도 3

특허청구의 범위

청구항 1.

손가락을 접촉하면 전원 온 신호가 발생되면서 내부에 지문이 저장되는 전원버튼 겸용 지문인식기와;

상기 전원버튼 겸용 지문인식기에서 발생하는 전원 온 신호에 의해 컴퓨터 본체 시스템에 전원을 인가하는 전원 인가부; 및,

상기 전원 인가부에서 인가된 전원에 의해 작동하여 상기 전원버튼 겸용 지문인식기와 연결된 상태를 유지하면서, 상기 전원버튼 겸용 지문인식기에 저장된 지문데이터와 내부에 미리 저장되어 있는 지문 데이터를 대비하여 사용자 인증을 수행하는 지문 데이터 대비 인증부;로 이루어진 것을 특징으로 하는 컴퓨터의 전원 인가 및 사용 인증 장치.

## 청구항 2.

제 1항에 있어서,

상기 전원버튼 겸용 지문인식기는, 손가락을 접촉하여 일정 시간 경과 후에 전원 온 신호가 발생되면서 그 사이에 지문이 내부에 저장되는 것을 특징으로 하는 컴퓨터의 전원 인가 및 사용 인증 장치.

## 청구항 3.

제 2항에 있어서,

상기 전원버튼 겸용 지문인식기는, 손가락이 접촉되어 전원 온 신호가 발생되기까지의 일정 시간을 2~4초로 설정한 것을 특징으로 하는 컴퓨터의 전원 인가 및 사용 인증 장치.

## 청구항 4.

제 2항에 있어서,

상기 전원버튼 겸용 지문인식기는, 손가락을 접촉하여 지문이 내부에 저장이 완료되면 알람 또는 발광 등의 저장 완료 표시를 하는 것을 특징으로 하는 컴퓨터의 전원 인가 및 사용 인증 장치.

## 청구항 5.

제 1항에 있어서,

상기 전원버튼 겸용 지문인식기는, 상기 지문 데이터 대비 인증부와 USB 인터페이스로 연결된 것을 특징으로 하는 컴퓨터의 전원 인가 및 사용 인증 장치.

## 청구항 6.

전원버튼 겸용 지문인식기에 손가락을 접촉하면 전원 온 신호가 발생되면서 내부에 지문이 저장되는 단계와;

상기 단계에서 발생하는 전원 온 신호에 의해 컴퓨터 본체 시스템에 전원을 인가하는 단계; 및,

상기 단계에서 인가된 전원에 의해 작동하여 상기 전원버튼 겸용 지문인식기와 연결된 상태를 유지하면서, 상기 전원버튼 겸용 지문인식기에 저장된 지문데이터와 상기 컴퓨터 본체 시스템 내부에 미리 저장되어 있는 지문 데이터를 대비하여 사용자 인증을 수행하는 단계;로 이루어진 것을 특징으로 하는 컴퓨터의 전원 인가 및 사용 인증 방법.

## 청구항 7.

제 6항에 있어서,

상기 지문 데이터를 대비하여 사용자 인증을 수행하는 단계에서 양 지문 데이터가 일치하면, 사용자 인증을 하여 컴퓨터 본체 시스템을 정상적으로 작동하게 계속 부팅시키는 것을 특징으로 하는 컴퓨터의 사용 인증 방법.

### 청구항 8.

제 6항에 있어서,

상기 전원 온 신호가 발생되면서 내부에 지문이 저장되는 단계는, 상기 전원버튼 겸용 지문인식기에 손가락을 접촉하여 일정 시간 경과 후에 전원 온 신호가 발생되면서 그 사이에 지문이 내부에 저장되는 것을 특징으로 하는 컴퓨터의 전원 인가 및 사용 인증 방법.

### 청구항 9.

제 8항에 있어서,

상기 전원 온 신호가 발생되면서 내부에 지문이 저장되는 단계는, 상기 전원버튼 겸용 지문인식기에 손가락이 접촉되어 전원 온 신호가 발생되기까지의 일정 시간을 2~4초로 설정한 것을 특징으로 하는 컴퓨터의 전원 인가 및 사용 인증 방법.

### 청구항 10.

제 8항에 있어서,

상기 전원 온 신호가 발생되면서 내부에 지문이 저장되는 단계는, 상기 전원버튼 겸용 지문인식기에 손가락을 접촉하여 지문이 내부에 저장이 완료되면 알람 또는 발광 등의 저장 완료 표시를 하는 것을 특징으로 하는 컴퓨터의 전원 인가 및 사용 인증 방법.

명세서

## 발명의 상세한 설명

### 발명의 목적

발명이 속하는 기술 및 그 분야의 종래기술

이 발명은 컴퓨터의 전원 인가 및 사용 인증 장치와 인증 방법에 관한 것으로서, 보다 상세하게는 사용자가 컴퓨터를 사용하기 위해 전원을 인가할 때 이와 동시에 지문 인식을 통한 사용자 인증도 함께 이루어져 사용자의 편의성을 도모하는 컴퓨터의 전원 인가 및 사용 인증 장치와 인증 방법에 관한 것이다.

가정 또는 회사에서 정보처리장치인 데스크탑 컴퓨터 및 노트북 컴퓨터의 사용이 보편화되면서, 자신의 정보 및 기밀문서 등을 잘 관리 보관하여야 한다. 이와 같이 컴퓨터에 저장된 중요한 정보들이 무단으로 접속한 다인에 의해 도용하거나 훼손되는 것을 방지하기 위해 인증된 사용자만 접속할 수 있도록 컴퓨터의 사용을 제한하는 보안기술이 개발되고 있다.

그 기술 중에 하나가 지문인식기술이다. 컴퓨터에 접속된 지문인식기를 통해 사용자의 지문정보를 입력하면, 입력된 지문 정보와 저장된 지문정보가 일치하는 지를 확인하고, 일치하면 로그인(Log In) 한다.

도 1은 종래의 기술에 따른 컴퓨터의 전원 인가 및 사용 인증 장치를 도시한 블록도이다.



도 1에 도시된 바와 같이, 사용자가 컴퓨터 본체 시스템(20)에 연결 접속된 전원버튼(10)을 누르면, 상기 전원버튼(10)에서 발생된 신호가 EC(Embedded Controller)(21)로 입력되면서, 전원이 컴퓨터 본체 시스템(20)의 S/B ICH7(Input Output Controller Hub7)(22)에 인가된다.

이와 같이 전원이 상기 S/B ICH7(22)에 인가되면, 지문인식기(30)와 USB 인터페이스를 통해 연결된 상태를 유지하여, 사용자가 지문인식기(30)에 사용자의 지문을 인식시키면, 상기 지문인식기(30)는 사용자의 지문을 스캔한 후 접속된 USB 인터페이스를 통해 지문 데이터를 상기 S/B ICH7(22)에 전송한다.

상기 S/B ICH7(22)에서는, ROM(23)에 미리 저장된 지문 데이터와 상기 지문인식기(30)로부터 전송된 지문 데이터를 비교하여 일치하는 지를 확인하는 인증단계를 거치게 되는데, 이때 일치하면 로그인(Log In) 하고, 사용자는 컴퓨터를 사용한다. 하지만, 불일치할 경우에는 로그 아웃(Log Out) 상태를 유지한다.

이와 같이 종래 컴퓨터를 사용하기 위해서는 사용자가 일단 전원버튼을 눌러 전원을 인가한 후에 지문인식기를 통해 로그인 하여 컴퓨터의 사용을 인증 받는다.

따라서, 사용자가 전원버튼을 눌러 전원을 인가한 후부터 로그인하여 컴퓨터를 사용하기까지의 시간이 길어지며, 전원버튼과 지문인식기를 별도의 구성요소로 갖춰야 한다는 문제점이 있다.

또한, 사용자는 컴퓨터를 작동시키기 위해 번거롭게 전원버튼을 누르고, 지문을 인식시켜야 한다는 불편함도 있게 된다.

#### 발명이 이루고자 하는 기술적 과제

이 발명은 앞서 설명한 바와 같은 종래 기술의 문제점을 해결하기 위한 것으로서, 컴퓨터를 켜기 위해서는 전원 버튼을 손가락으로 접촉하여야 한다는 것과 컴퓨터를 사용하기 위해 지문 인증을 수행하기 위해서는 지문인식 센서에 손가락을 접촉시켜야 한다는 것을 하나의 과정으로 실행하게 하여 사용자가 컴퓨터를 사용하기 위해 전원을 인가할 때 이와 동시에 지문 인식을 통한 사용자 인증도 함께 이루어져 사용자의 편의성과 보안을 도모하는 컴퓨터의 전원 인가 및 사용 인증 장치와 인증 방법의 제공을 그 목적으로 한다.

#### 발명의 구성

상기의 목적을 달성하기 위해 이 발명은, 손가락을 접촉하면 전원 온 신호가 발생되면서 내부에 지문이 저장되는 전원버튼 겸용 지문인식기와; 상기 전원버튼 겸용 지문인식기에서 발생하는 전원 온 신호에 의해 컴퓨터 본체 시스템에 전원을 인가하는 전원 인가부; 및, 상기 전원 인가부에서 인가된 전원에 의해 작동하여 상기 전원버튼 겸용 지문인식기와 연결된 상태를 유지하면서, 상기 전원버튼 겸용 지문인식기에 저장된 지문데이터와 내부에 미리 저장되어 있는 지문 데이터를 대비하여 사용자 인증을 수행하는 지문 데이터 대비 인증부;로 이루어진 것을 특징으로 하는 컴퓨터의 전원 인가 및 사용 인증 장치를 제공한다.

바람직하게는, 상기 전원버튼 겸용 지문인식기는, 손가락을 접촉하여 일정 시간 경과 후에 전원 온 신호가 발생되면서 그 사이에 지문이 내부에 저장되는 것이어도 좋다.

바람직하게는, 상기 전원버튼 겸용 지문인식기는, 손가락이 접촉되어 전원 온 신호가 발생되기까지의 일정 시간을 2~4초로 설정한 것이어도 좋다.

바람직하게는, 상기 전원버튼 겸용 지문인식기는, 손가락을 접촉하여 지문이 내부에 저장이 완료되면 알람 또는 발광 등의 저장 완료 표시를 하는 것이어도 좋다.

바람직하게는, 상기 전원버튼 겸용 지문인식기는, 상기 지문 데이터 대비 인증부와 USB 인터페이스로 연결된 것이어도 좋다.

또한, 상기의 목적을 달성하기 위해 이 발명은, 전원버튼 겸용 지문인식기에 손가락을 접촉하면 전원 온 신호가 발생되면서 내부에 지문이 저장되는 단계와; 상기 단계에서 발생하는 전원 온 신호에 의해 컴퓨터 본체 시스템에 전원을 인가하는

단계; 및, 상기 단계에서 인가된 전원에 의해 작동하여 상기 전원버튼 겸용 지문인식기와 연결된 상태를 유지하면서, 상기 전원버튼 겸용 지문인식기에 저장된 지문데이터와 상기 컴퓨터 본체 시스템 내부에 미리 저장되어 있는 지문 데이터를 대비하여 사용자 인증을 수행하는 단계;로 이루어진 것을 특징으로 하는 컴퓨터의 전원 인가 및 사용 인증 방법을 제공한다.

바람직하게는, 상기 지문 데이터를 대비하여 사용자 인증을 수행하는 단계에서 양 지문 데이터가 일치하면, 사용자 인증을 하여 컴퓨터 본체 시스템을 정상적으로 작동하게 계속 부팅시키도록 할 수 있다.

바람직하게는, 상기 전원 온 신호가 발생되면서 내부에 지문이 저장되는 단계는, 상기 전원버튼 겸용 지문인식기에 손가락을 접촉하여 일정 시간 경과 후에 전원 온 신호가 발생되면서 그 사이에 지문이 내부에 저장되는 것이어도 좋다.

바람직하게는, 상기 전원 온 신호가 발생되면서 내부에 지문이 저장되는 단계는, 상기 전원버튼 겸용 지문인식기에 손가락이 접촉되어 전원 온 신호가 발생되기까지의 일정 시간을 2~4초로 설정한 것이어도 좋다.

바람직하게는, 상기 전원 온 신호가 발생되면서 내부에 지문이 저장되는 단계는, 상기 전원버튼 겸용 지문인식기에 손가락을 접촉하여 지문이 내부에 저장이 완료되면 알람 또는 발광 등의 저장 완료 표시를 하는 것이어도 좋다.

이하에서는, 이 발명의 실시 예에 따른 컴퓨터의 전원 인가 및 사용 인증 장치를 첨부하는 도 2를 참조하여 상세하게 설명한다.

도 2에 도시되어 있는 바와 같이, 이 발명의 실시 예에 따른 컴퓨터의 전원 인가 및 사용 인증 장치는, 손가락을 접촉하면 전원 온 신호가 발생되면서 내부에 지문이 저장되는 전원버튼 겸용 지문인식기(100)와, 상기 전원버튼 겸용 지문인식기(100)에서 발생하는 전원 온 신호에 의해 컴퓨터 본체 시스템(200)에 전원을 인가하는 EC(210) 및, 상기 EC(210)에서 인가된 전원에 의해 작동하여 상기 전원버튼 겸용 지문인식기(200)와 USB 인터페이스로 연결된 상태를 유지하면서, 상기 전원버튼 겸용 지문인식기(100)에 저장된 지문데이터와 내부의 ROM(230)에 미리 저장되어 있는 지문 데이터를 대비하여 사용자 인증을 수행하는 S/B ICH7(220)로 이루어진다.

상기 전원버튼 겸용 지문인식기(100)는, 손가락을 접촉하여 일정 시간 경과 후에 전원 온 신호가 발생되면서 그 사이에 지문이 내부에 저장되는데, 손가락이 접촉되어 전원 온 신호가 발생되기까지의 일정 시간을 2~4초로 설정할 수 있고, 바람직하게는 3초로 설정하여 오작동 발생을 동작 시간의 지연으로 방지한다.

또한, 상기 전원버튼 겸용 지문인식기(100)는, 손가락을 접촉하여 지문이 내부에 저장이 완료되면 알람 또는 발광 등의 저장 완료 표시를 하게 하여 손가락의 접촉 상태를 해제시키는 한편으로 지문이 내부에 제대로 저장된 것을 확인할 수 있도록 한다.

상기와 같은 구성을 갖는 이 발명의 실시 예에 따른 컴퓨터의 전원 인가 및 사용 인증 장치에 대해 첨부하는 도 3을 참조하여 작동 과정을 설명한다.

먼저, 컴퓨터의 사용을 위해 전원을 온할 것인지를 판단하여(S301), 사용하고자 하는 경우에는 컴퓨터 본체 시스템(200)의 사용을 위해 전원을 온하기 위해 전원버튼 겸용 지문인식기(100)에 3초 동안 접촉시키면, 상기 전원버튼 겸용 지문인식기(100)의 센서에서 손가락을 인식하고, 사용자의 지문을 스캔하여 지문 데이터를 자체 메모리에 저장한다.(S302)

그리고 전원버튼 겸용 지문인식기(100)에 손가락을 접촉하여 3초 경과와 동시에 상기 EC(210)로 전원 온 신호를 전송하여 컴퓨터 본체 시스템(200)의 전원을 인가한다.(S303)

다음으로, S/H ICH7(220)이 작동하여 USB인터페이스 동작에 의해 전원버튼 겸용 지문인식기(100)에 저장된 지문 데이터와 ROM(230)에 미리 저장된 지문 데이터를 대비하여 인증된 사용자인지를 확인한다.(S304)

이때 양 지문 데이터가 일치하는 지를 판단하고(S305), 일치하면 계속 부팅하여 컴퓨터 본체 시스템(200)을 정상적으로 작동시킨다.(S306)

만일 양 지문 데이터가 일치하지 않을 경우에는 상기 EC(210)를 통해 컴퓨터 본체 시스템(200)에 인가되었던 전원을 차단한다.(S307)

이 발명은 상기의 실시 예에 한정되지 않으며, 특허청구범위에 기재되는 발명의 범위 내에서 다양한 변형이 가능하고, 이러한 변형도 이 발명의 범위 내에 포함된다.

발명의 효과

이상에서 상세하게 설명한 바와 같이, 이 발명의 컴퓨터의 전원 인가 및 사용 인증 장치와 인증 방법에 의하면, 사용자가 컴퓨터의 사용을 위해 전원 버튼을 자신의 손가락을 접촉시키면 전원 공급 및 인증 작업이 함께 이루어짐에 따라 사용자가 종래와 같이 전원 버튼을 켜고 지문을 인식시키는 두 번의 작업을 한 번의 작업으로 줄일 수 있고, 더불어 컴퓨터에 접속하기까지의 시간을 단축할 수 있다는 장점이 있다.

도면의 간단한 설명

도 1은 종래의 기술에 따른 컴퓨터의 전원 인가 및 사용 인증 장치를 도시한 블록도이고,

도 2는 이 발명의 실시 예에 따른 컴퓨터의 전원 인가 및 사용 인증 장치를 도시한 블록도이며,

도 3은 도 2에 도시된 컴퓨터의 전원 인가 및 사용 인증 장치의 작동 과정을 도시한 흐름도이다.

<도면의 주요 부분에 대한 부호의 설명>

10 : 전원버튼

20, 200 : 컴퓨터 본체 시스템

30 : 지문인식기

100 : 전원버튼 겸용 지문인식기

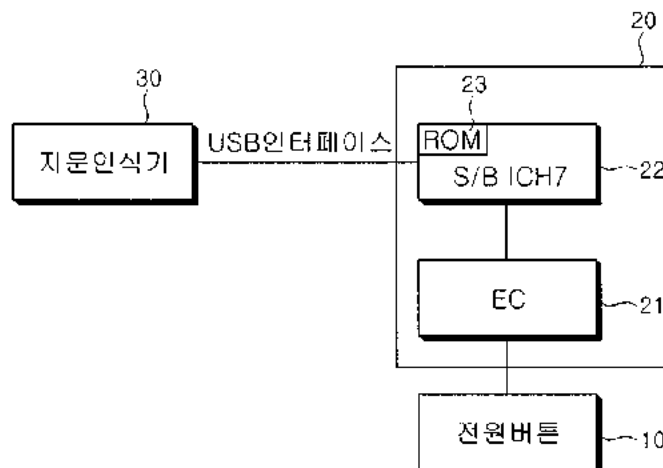
21, 210 : EC(Embedded Controller)

22, 220 : S/B ICH7

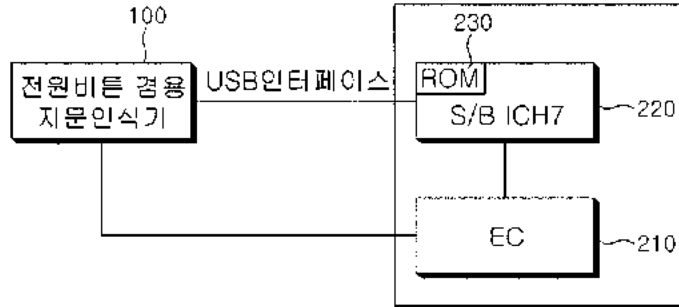
23, 230 : ROM

도면

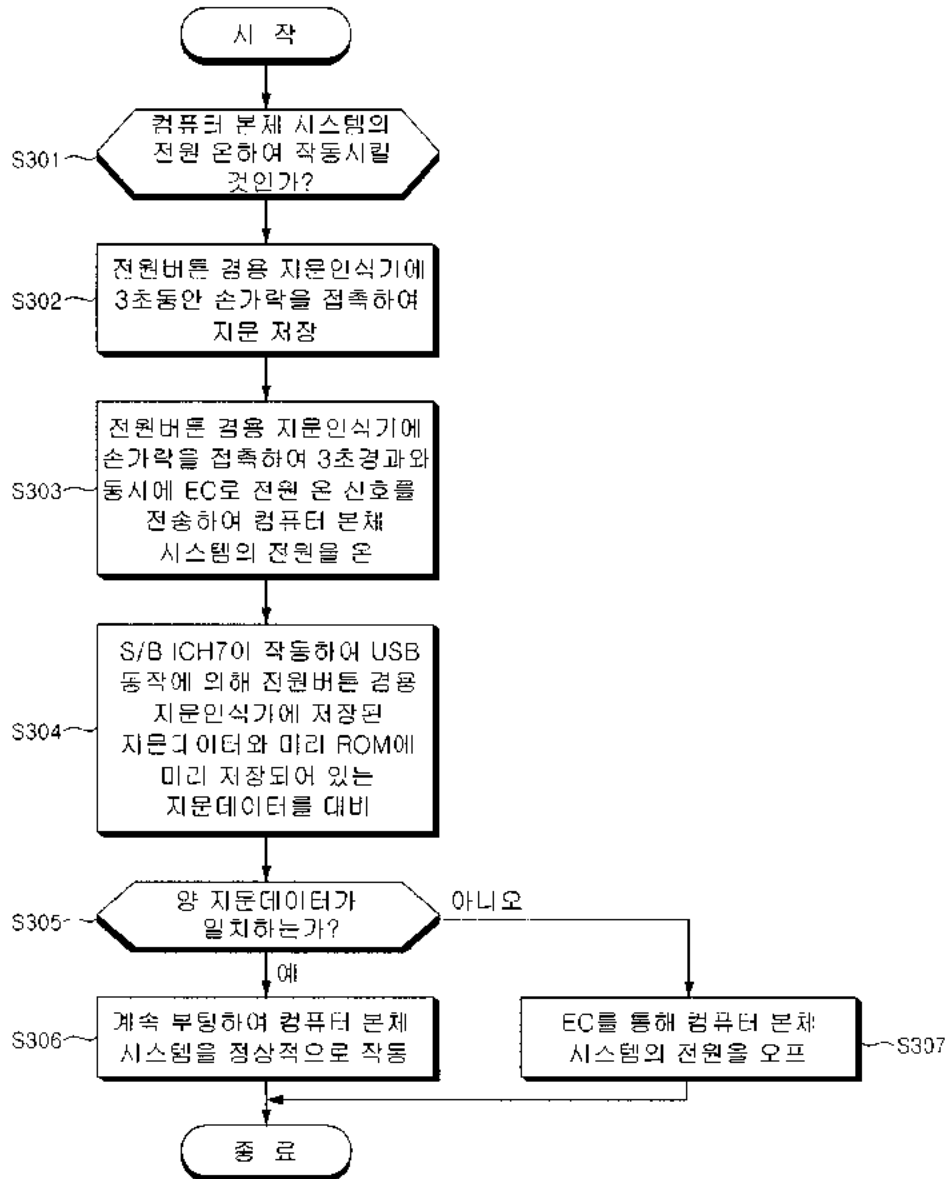
도면1



도면2



도면3





Espacenet

Bibliographic data: JP2007179343 (A) — 2007-07-12

## INFORMATION PROCESSOR WITH SECURITY FUNCTION AND PROGRAM

**Inventor(s):** NISHIO TOYOICHI ± (NISHIO TOYOICHI)

**Applicant(s):** CASIO HITACHI MOBILE COMM CO ± (CASIO HITACHI MOBILE COMMUNICATIONS CO LTD)

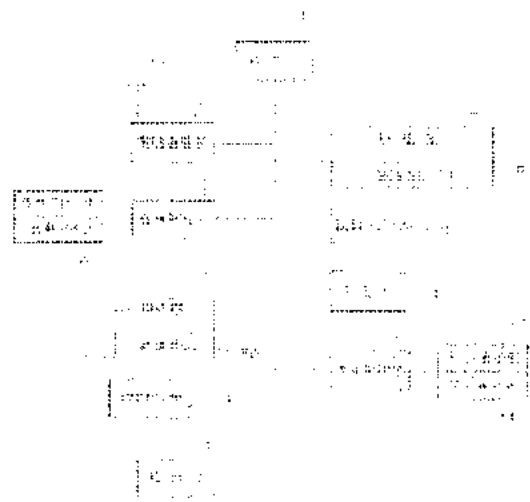
**Classification:** - **international:** G06F21/32; G06F21/62; H04L9/32; H04M1/2745; H04W88/02  
- **cooperative:**

**Application number:** JP20050377547 20051228

**Priority number (s):** JP20050377547 20051228

## Abstract of JP2007179343 (A)

PROBLEM TO BE SOLVED: To output information so as to prevent a third party from knowing even the presence of concealed information even if restricting the output of the concealed information according to whether a user is an authorized user or the third party. ;SOLUTION: A CPU 1 determines whether the person is an authorized user (oneself) or not by comparing a fingerprint pattern of an operator detected in power ON operation by operating a power button PW with a fingerprint sensor FS and a previously registered fingerprint pattern when actual information is stored and managed inside a storage part 2 as the concealed information correspondingly to each management function of an address book, a schedule book, a mail folder, a transmission history, a receipt history or the like, and that dummy information thereof is stored and managed, displays the actual information corresponding to a processing function when the user is authorized, and display the dummy information associated to the processing function when the user is the third party. ;COPYRIGHT: (C) 2007, JPO&INPIT



(51) Int. Cl.	F I	テーマコード (参考)
G06F 21/20 (2006.01)	G06F 15/00 330F	5B017
G06F 21/24 (2006.01)	G06F 12/14 530A	5B285
H04L 9/32 (2006.01)	H04L 9/00 673D	5J104
H04Q 7/38 (2006.01)	H04B 7/26 109R	5K036
H04M 1/2745 (2006.01)	H04M 1/2745	5K067

審査請求 未請求 請求項の数 8 O L (全 13 頁)

(21) 出願番号 特願2005-377547 (P2005-377547)  
 (22) 出願日 平成17年12月28日 (2005.12.28)

(71) 出願人 504149100  
 株式会社カシオ日立モバイルコミュニケー  
 ションズ  
 東京都東大和市桜が丘2-229番地の1  
 (74) 代理人 100090619  
 弁理士 長南 満輝男  
 (72) 発明者 西尾 豊一  
 東京都東大和市桜が丘2丁目229番地の  
 1 株式会社  
 カシオ日立モバイルコミュニケーショ  
 ンズ  
 内  
 Fターム(参考) 5B017 AA07 BA05  
 5B285 AA04 BA07 CB15 CB63 CB74  
 CB83 CB89

最終頁に続く

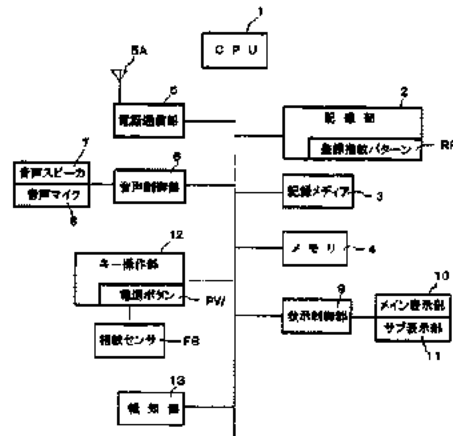
(54) 【発明の名称】 セキュリティ機能付き情報処理装置及びプログラム

(57) 【要約】

【課題】 正規なユーザか第三者かに応じて秘匿情報の出力を制限したとしても、秘匿情報が存在することすら第三者に分からないような状態で情報を出力できるようにする。

【解決手段】 CPU 1は、アドレス帳・スケジュール帳・メールフォルダ・発信履歴・着信履歴などの各管理機能に対応して、記憶部2内にその実情報が秘匿情報として記憶管理されていると共にそのダミー情報が記憶管理されている状態において、指紋センサFS付きの電源ボタンPWが操作されることによって電源ON操作時に検出された操作者の指紋パターンと予め登録されている指紋パターンとを比較することによって正規なユーザ(本人)か否かを判別し、ユーザ本人であれば、当該処理機能対応の実情報を表示出力させ、第三者であれば、当該処理機能に対応付けられているダミー情報を表示出力させる。

【選択図】 図1



**【特許請求の範囲】****【請求項1】**

秘匿情報の出力を制限するセキュリティ機能付き情報処理装置であって、  
所定の処理機能に対応してその実情報を秘匿情報として記憶管理すると共にそのダミー情報を記憶管理する情報記憶手段と、

入力されたユーザ情報と予め登録されているユーザ情報とを比較することによって正規なユーザか否かを判別する判別手段と、

前記処理機能が選択された場合に、前記判別結果を参照し、正規なユーザであれば、当該処理機能対応の実情報を出力させ、正規ユーザ以外の第三者であれば、当該処理機能対応のダミー情報を出力させる出力制御手段と、

を具備したことを特徴とするセキュリティ機能付き情報処理装置。

**【請求項2】**

前記出力制御手段は、前記実情報あるいはダミー情報を表示出力させる際に、同一あるいは類似の表示形態で出力する、

ようにしたことを特徴とする請求項1記載のセキュリティ機能付き情報処理装置。

**【請求項3】**

前記処理機能の選択に回答して前記ダミー情報が出力されている状態において、この処理機能の動作に応じて当該ダミー情報を処理する、

ようにしたことを特徴とする請求項1記載のセキュリティ機能付き情報処理装置。

**【請求項4】**

前記ダミー情報は、正規なユーザによって任意に入力作成された情報、予め固定的に用意されていた標準的な情報、ランダム生成された情報、前記実情報を加工することによって生成された情報、更新以前の実情報のうち、少なくともその何れかの情報である、ことを特徴とする請求項1記載のセキュリティ機能付き情報処理装置。

**【請求項5】**

前記所定の処理機能は、電話帳情報、スケジュール情報、データフォルダ情報、発信履歴情報、着信履歴情報のうち、少なくともその何れかの情報を管理するデータ管理機能である、ことを特徴とする請求項1記載のセキュリティ機能付き情報処理装置。

**【請求項6】**

前記判別手段によって正規なユーザであると判別された場合に、そのことをどのような方法で報知するかを示す報知方法を任意に設定可能とした、ことを特徴とする請求項1記載のセキュリティ機能付き情報処理装置。

**【請求項7】**

前記入力されたユーザ情報は、入力電源オン操作時あるいは所定時間毎に自動検出された生体情報である、ことを特徴とする請求項1記載のセキュリティ機能付き情報処理装置。

**【請求項8】**

コンピュータに対して、

所定の処理機能に対応してその実情報を秘匿情報として記憶管理すると共にそのダミー情報を記憶管理する機能と、

入力されたユーザ情報と予め登録されているユーザ情報とを比較することによって正規なユーザか否かを判別する機能と、

前記処理機能が選択された場合に、前記判別結果を参照し、正規なユーザであれば、当該処理機能対応の実情報を出力し、正規ユーザ以外の第三者であれば、当該処理機能対応のダミー情報を出力する機能と、

を実現させるためのプログラム。

**【発明の詳細な説明】****【技術分野】****【0001】**

この発明は、秘匿情報の出力を制限するセキュリティ機能付き情報処理装置及びプログ



ラムに関する。

【背景技術】

【0002】

従来、パスワード入力、指紋検知などによってユーザ認証を行い、その認証結果に応じて情報表示を制限するセキュリティ機能付きの情報処理装置としては、例えば、指紋照合の結果、指紋不一致時にはシークレット情報を非表示とする通常モードで起動し、指紋一致時にはシークレット情報を含めた全情報を表示するシークレットモードで起動するようにした電子機器が知られている（特許文献1参照）。

【特許文献1】特開平7-105142号公報

【発明の開示】

【発明が解決しようとする課題】

【0003】

このようなセキュリティ機能を備えることで、シークレットエリア内のデータを不正アクセスから保護することができるが、不正者はシークレットエリア内のデータを見ることができないことから、アクセス制限がかかっている自分が排除（拒絶）されていることを知り得るようになる。この場合、例えば、ハッカーなどと呼ばれているコンピュータ技術に詳しい人であれば、その技術を駆使してセキュリティを破ることは決して不可能なことではなく、不正者にアクセス制限が知られた時点でそのデータは危険にさらされることになり、如何なるセキュリティ技術であっても万全とは言い難かった。

【0004】

この発明の課題は、正規なユーザか第三者かに応じて秘匿情報の出力を制限したとしても、秘匿情報が存在していることすら第三者に分からないような状態で情報を出力できるようにすることである。

【課題を解決するための手段】

【0005】

請求項1記載の発明は、秘匿情報の出力を制限するセキュリティ機能付き情報処理装置であって、所定の処理機能に対応してその実情報を秘匿情報として記憶管理すると共にそのダミー情報を記憶管理する情報記憶手段と、入力されたユーザ情報と予め登録されているユーザ情報とを比較することによって正規なユーザか否かを判別する判別手段と、前記処理機能が選択された場合に、前記判別結果を参照し、正規なユーザであれば、当該処理機能対応の実情報を出力させ、正規ユーザ以外の第三者であれば、当該処理機能対応のダミー情報を出力させる出力制御手段とを具備したことを特徴とする。

更に、コンピュータに対して、上述した請求項1記載の発明に示した主要機能を実現させるためのプログラムを提供する（請求項8記載の発明）。

ここで、「ダミー情報」とは、第三者（不正アクセス者）を欺くために実情報の身代わりとなる情報であり、架空の情報以外にも実情報の更新前の情報（デフォルト値など）であってもよく、実情報を推測不能なものであればよい（以下、同様）。

【0006】

なお、上述した請求項1記載の発明は次のようなものであってもよい。

前記出力制御手段は、前記実情報あるいはダミー情報を表示出力させる際に、同一あるいは類似の表示形態で出力する（請求項2記載の発明）。

【0007】

前記処理機能の選択にตอบสนองして前記ダミー情報が出力されている状態において、この処理機能の動作に応じて当該ダミー情報を処理する（請求項3記載の発明）。

【0008】

前記ダミー情報は、正規なユーザによって任意に入力作成された情報、予め固定的に用意されていた標準的な情報、ランダム生成された情報、前記実情報を加工することによって生成された情報、更新以前の実情報のうち、少なくともその何れかの情報である（請求項4記載の発明）。

【0009】

前記所定の処理機能は、電話帳情報、スケジュール情報、データフォルダ情報、発信履歴情報、着信履歴情報のうち、少なくともその何れかの情報を管理するデータ管理機能である（請求項5記載の発明）。

【0010】

前記判別手段によって正規なユーザであると判別された場合に、そのことをどのような方法で報知するかを示す報知方法を任意に設定可能とする（請求項6記載の発明）。

【0011】

前記入力されたユーザ情報は、入力電源オン操作時あるいは所定時間毎に自動検出された生体情報である（請求項7記載の発明）。

【発明の効果】

【0012】

請求項1記載の発明によれば、所定の処理機能に対応してその実情報を秘匿情報として記憶管理すると共にそのダミー情報を記憶管理している状態において、入力されたユーザ情報と予め登録されているユーザ情報とを比較することによって正規なユーザか否かを判別し、正規なユーザであれば、当該処理機能対応の実情報を出力させ、正規ユーザ以外の第三者であれば、当該処理機能対応のダミー情報を出力させるようにしたから、正規なユーザか第三者かに応じて秘匿情報の出力を制限したとしても、秘匿情報が存在していることすら第三者に分からないような状態で情報を出力することができ、逆説的に不正者を欺くことによって不正アクセス者によるセキュリティ破りを未然に防止することが可能となる。

【0013】

請求項2記載の発明によれば、上述した請求項1記載の発明と同様の効果を有するほか、実情報あるいはダミー情報を表示出力させる際に、同一あるいは類似の表示形態で出力するようにしたから、実情報とダミー情報との区別がつかないように表示させることができ、安全性を高めることが可能となる。この場合、実情報が複数桁の数値列データあるいは文字列データであれば、ダミー情報も同一桁の数値列あるいは文字列データを使用したり、同一フォームを使用して表示するにすればよい。

【0014】

請求項3記載の発明によれば、上述した請求項1記載の発明と同様の効果を有するほか、処理機能の選択にตอบสนองしてダミー情報が出力されている状態において、この処理機能の動作に応じて当該ダミー情報を処理するようにしたから、処理の実行中、実行後であっても安全性を高めることが可能となる。

【0015】

請求項4記載の発明によれば、上述した請求項1記載の発明と同様の効果を有するほか、ダミー情報は、正規なユーザによって任意に入力作成された情報、予め固定的に用意されていた標準的な情報、ランダム生成された情報、実情報を加工することによって生成された情報、更新以前の実情報のうち、少なくともその何れかの情報であるから、不正アクセス者を欺くことが可能な情報としては適切なものとなる。

【0016】

請求項5記載の発明によれば、上述した請求項1記載の発明と同様の効果を有するほか、所定の処理機能は、電話帳情報、スケジュール情報、データフォルダ情報、発信履歴情報、着信履歴情報のうち、少なくともその何れかの情報を管理するデータ管理機能であるから、セキュリティ対策を必要とするデータ管理機能に活用することができ、プライバシーを保護するうえで有効なものとなる。

【0017】

請求項6記載の発明によれば、上述した請求項1記載の発明と同様の効果を有するほか、正規なユーザであると判別された場合に、そのことをどのような方法で報知するかを示す報知方法を任意に設定可能としたから、例えば、アイコン表示、パイプレーション報知など、秘匿情報のアクセスが許可されたことをユーザの好みに合った方法で知ることができる。

## 【0018】

請求項7記載の発明によれば、上述した請求項1記載の発明と同様の効果を有するほか、入力電源オン操作時あるいは所定時間毎に自動検出された生体情報をユーザ情報として取り込むようにしたから、ユーザに意識させることなく、生体情報を自動取得してユーザ認証を行うことが可能となる。

## 【発明を実施するための最良の形態】

## 【0019】

以下、図1～図7を参照して本発明の実施例を説明する。

この実施例は、秘匿情報の出力を制限するセキュリティ機能付き情報処理装置として携帯電話装置に適用した場合を例示したもので、図1は、セキュリティ機能付き携帯電話装置の基本的な構成要素を示したブロック図である。

この携帯電話装置は、例えば、2つの筐体（上部筐体、下部筐体）が開閉可能に取り付けられた折り畳み自在なもので、通話機能、メール機能、インターネット接続機能などが備えられている。この場合、電話帳（アドレス帳）情報、スケジュール帳情報、メールフォルダ情報、発信履歴情報、着信履歴情報などを管理するデータ管理機能も備えられている。

## 【0020】

CPU1は、記憶部2内の各種のプログラムに応じてこの携帯電話装置の全体動作を制御する中核的な中央演算処理装置であり、このメインCPU1のほか、この携帯電話装置には、例えば、映像、音声データの受送信機能などの機能別に複数のサブCPU（図示せず）を有する構成となっている。記憶部2は、不揮発性メモリ（内部メモリ）であり、例えば、フラッシュメモリなどによって構成され、プログラム領域とデータ領域とを有し、このプログラム領域には、後述する図5～図7に示す動作手順に応じて本実施例を実現するためのプログラムが格納されている。記録メディア3は、着脱自在な可搬型メモリで、各種のデータ、プログラムを外部供給するもので、例えば、スマートメディア、ICカードなどによって構成されている。メモリ4は、ワーク領域を有する内部メモリで、例えば、DRAM（Direct Random Access Memory）、SDRAM（Synchronous DRAM）などによって構成されている。

## 【0021】

電話通信部5は、無線部、ベースバンド部、多重分離部などを備え、アンテナ5Aに接続された送受信デュプレクサの受信側から信号を取り込んで受信ベースバンド信号に復調したのちに、音声制御部6を介して音声スピーカ7から音声出力させる。また、電話通信部5は、音声マイク8から入力された音声データを音声制御部6から取り込み、送信ベースバンド信号に符号化したのちに送受信デュプレクサの送信側に与えられてアンテナ5Aから発信出力させる。一方、電子メール機能、インターネット接続機能によって電話通信部5を介して受信取得した表示データは、表示制御部9を介してLCD（液晶表示装置）などを備えたメイン表示部10に与えられて表示出力される。

## 【0022】

メイン表示部10は、文字情報、画像、各種のメッセージなどを高品位に表示し、サブ表示部11は現在日時、簡易なメッセージ、アイコンなどを表示する。キー操作部12は、ダイヤル入力、文字入力、コマンド入力などを行うもので、CPU1は、キー操作部12からのキー入力信号に応じた処理を実行する。報知部13は、着信報知などの報知用のスピーカ、LED（発光ダイオード）、振動モータを備え、電話・メール着信時に駆動されて着信報知を行うほか、アラーム報知時にも駆動される。

## 【0023】

図2は、折り畳み式の装置本体を開いた状態を示した図であり、キー操作部12には、指紋センサFS付きの電源ボタンPWが設けられている。

すなわち、電源ボタンPWのキートップ部分には指紋センサFSが接着固定されており、電源ON操作時にその操作者の親指の指紋パターンを自動検出するようにしている。この場合、CPU1は、入力された指紋パターンと予め記憶部2に登録されている正規ユー

ザの指紋パターンとを比較することによってユーザ認証(本人確認)を行い、本人(正規なユーザ)であれば、実情報(秘匿情報)のアクセスを許可し、この実情報を読み出してメイン表示部10に表示出力させる。その際、実情報のアクセスが許可されたことをユーザ本人に報知するようにしている。この本人報知の方法は予め当該ユーザが任意に選択設定した方法で行われるが、図2の例では、任意の図形(例えば、ハート型図形)のアイコン表示で本人報知が行われた状態を示している。

#### 【0024】

ここで、図3は、記憶部2にセットされる本人フラグFG、本人報知の設定内容PSを示した図である。

この本人フラグFGは、電源ON操作時に実行されるユーザ認証の結果、正規なユーザ(本人)であることを確認した場合にセットされるもので、電源OFF操作時にリセットされる。本人報知の設定内容PSは、ユーザ本人が予め任意に選択設定した本人報知時の報知方法であり、上述のようなアイコン表示のほか、振動モータの駆動によるバイブレーション報知、単一音を複数回発生させる断続音による報知などの中から任意に選択された報知方法が設定される。

#### 【0025】

図4は、アドレス帳・スケジュール帳・メールフォルダ・発信履歴・着信履歴などの各管理機能に対応して、その実情報が秘匿情報として記憶管理されている共にそのダミー情報が記憶管理されている状態において、電源ON時のユーザ認証の結果、第三者による操作の場合に、実情報(秘匿情報)に代わってそのダミー情報を表示出力させることを示した図である。

すなわち、記憶部2のデータ領域には、所定の処理機能の実情報として、電話帳(アドレス帳)情報、スケジュール帳情報、発信履歴情報、着信履歴情報、メールフォルダ情報(送信メール情報、受信メール情報)が記憶管理され、また、これらのダミー情報として、ダミーアドレス帳情報、ダミースケジュール帳情報、……、ダミー受信メール情報が記憶管理されている。

#### 【0026】

ダミー情報は、正規なユーザによって任意に入力作成された情報、予め固定的に用意されていた標準的な情報、ランダム生成された情報、実情報を加工することによって生成された情報のうち、その何れかの情報であり、例えば、実情報が複数桁の数値列データ、文字列データであれば、ダミー情報も同一桁の数値列データ、文字列データによって構成され、実存しそうな氏名、得意先名、電話番号、メール番号、住所などをダミー情報としたり、本当らしい出張先名、会議名、日時などをダミー情報としている。CPU1は、このダミー情報表示時に実情報とダミー情報との区別がつかないように実情報の表示フォーマットを使用して表示させるようにしている。

#### 【0027】

次に、この実施例における携帯電話装置の動作概念を図5～図7に示すフローチャートを参照して説明する。ここで、これらのフローチャートに記述されている各機能は、読み取り可能なプログラムコードの形態で格納されており、このプログラムコードにしたがった動作が逐次実行される。また、伝送媒体を介して伝送されてきた上述のプログラムコードに従った動作を逐次実行することもできる。すなわち、記録媒体のほか、伝送媒体を介して外部供給されたプログラム/データを利用してこの実施例特有の動作を実行することもできる。

#### 【0028】

図5～図7は、電源投入に伴って実行開始される携帯電話装置の全体動作を示したフローチャートである。

まず、CPU1は、指紋センサFS付き電源ボタンPWによる電源ON操作に応答してユーザ認証を行う。すなわち、この指紋センサFSによって自動検出された操作者の親指の指紋パターンを取得し(図5のステップS1)、この指紋パターンと予め記憶部2に登録されている正規ユーザの指紋パターンとを比較することによってユーザ認証(本人確認

）を行い（ステップS2）、両指紋パターンの一致を検出した際には（ステップS3でYES）、つまり、正規なユーザによる操作であると判別した際には、本人フラグFGをセットしておく（ステップS4）。

【0029】

そして、CPU1は、本人報知の設定内容PSを参照してその設定有無を調べ（ステップS5）、本人報知の方法が設定されていれば、この設定内容にしたがった方法で本人報知を行ったのち（ステップS6）、所定の待受画像を表示出力させる待ち受け状態となる（ステップS7）。一方、上述のユーザ認証の結果、本人以外の第三者による電源ON操作を検出した場合（ステップS3でNO）あるいは本人報知方法が未設定の場合には（ステップS5でNO）、そのままステップS7に移って待ち受け状態となる。

この待ち受け状態において、CPU1は、電話（通話）あるいはメールの発信・着信の有無をチェックしたり（ステップS8）、キー操作の有無をチェックする（ステップS11）。ここで、電話あるいはメールの発信・着信を検出すると、発信・着信処理を実行したのち（ステップS9）、今回の発信履歴情報あるいは着信履歴情報を記録する処理を実行するが（ステップS10）、何らかのキー操作を検出すると（ステップS11でYES）、図6あるいは図7のフローに移り、操作キーに応じた処理の実行に移る。

【0030】

まず、CPU1は、任意の情報の設定を指示する設定操作が行われたかをチェックし（図6のステップS12）、この設定操作が行われた場合には、本人フラグFGの有無を調べる（ステップS13）。いま、電源ON操作時のユーザ認証の結果、その操作者が正規なユーザ（本人）であれば、本人フラグFGがセットされているので、ステップS14に移り、上述した本人報知方法を設定するための本人報知メニューを含む全ての設定メニューを読み出して一覧表示させる（ステップS14）。

【0031】

このメニュー画面の中から任意にメニュー項目が選択指定されると（ステップS15）、この選択メニューが「本人報知設定メニュー」であれば（ステップS16でYES）、本人報知方法を選択設定する処理に移る（ステップS17）。この場合、本人報知の設定内容PSには、アイコン表示による報知、振動モータの駆動によるバイブレーション報知、単一音を複数回発生させる断続音による報知などの中から任意に選択された報知方法が設定される。また、「本人報知設定メニュー」以外のメニューが選択された場合には（ステップS16でNO）、選択メニュー対応の設定処理の実行に移る（ステップS18）。ここでは、例えば、アドレス帳あるいはスケジュール帳などにその実情報を入力して新規設定したり、電話帳、スケジュール帳、メールフォルダ、発信履歴、着信履歴などに対応してユーザ本人が任意に入力した情報などをダミー情報として設定する処理が行われるが、その際、実情報あるいはダミー情報の設定は、同一の設定フォーマットを使用して行うようにしている。

【0032】

また、本人フラグFGがリセットされている場合（ステップS13でNO）、つまり、電源ON操作時のユーザ認証の結果、その操作者が本人以外の第三者である場合には、上述の本人報知メニューを含まない設定メニューを読み出して一覧表示させたのち（ステップS19）、このメニュー画面から任意のメニュー項目が選択されると（ステップS20）、この選択メニュー対応の設定処理を実行する処理に移るが、その際、電話帳、スケジュール帳、メールフォルダ、発信履歴、着信履歴などの選択メニューに対応して予め設定されているダミー用設定データを表示出力させた状態で（ステップS21）、その設定処理が行われる（ステップS22）。このようにユーザ本人と基本的には同様の設定処理を第三者に対しても許可するが、ダミーを使用する点がユーザ本人の場合と異なる。

【0033】

一方、アドレス帳の呼び出しがユーザ操作によって指示された際には（ステップS23でYES）、本人フラグFGの有無を調べる（ステップS24）。ここで、ユーザ本人が電源ON操作を行った場合には（ステップS24でYES）、正規なアドレス帳データ（

実情報)を読み出して表示出力させたのち(ステップS25)、操作待ち状態となる(ステップS27)。ここで、何らかの操作が行われたときには、アドレス帳編集が指示されたかを調べ(ステップS28でYES)、編集指示を受けたときには、本人フラグFGがセットされていることを条件に(ステップS29でYES)、正規なアドレス帳データ(実情報)に対する編集処理が行われる(ステップS30)。

**【0034】**

また、ユーザ操作によって編集以外の処理が指示されると(ステップS28でNO)、CPU1は、アドレス帳処理の終了を指示する終了操作が行われたかを調べ(ステップS32)、通信相手先の電話番号/メール番号の呼び出しなどの指示操作であれば、この操作対応の処理の実行に移る(ステップS33)。ここで、アドレス帳処理を終了させるために終了操作が行われると(ステップS32でYES)、図5のステップS7に戻り、待ち受け状態となる。

**【0035】**

一方、第三者によるアドレス帳の呼び出しを受けたときには(ステップS24でNO)、ダミーアドレス帳データ(ダミー情報)を読み出して表示出力させたのち(ステップS26)、操作待ち状態となる(ステップS27)。ここで、アドレス帳編集が指示されると(ステップS28でYES)、上述と同様にステップS29に進むが、この場合、本人フラグFGはリセットされているので、ダミーアドレス帳データ(ダミー情報)に対する編集処理が行われる(ステップS31)。また、編集以外の処理が指示されたときには(ステップS28でNO)、ダミー情報に応じて操作対応処理が実行される(ステップS33)。このように第三者に対しては、ユーザ本人と基本的には同様のアドレス帳処理が許可されるが、ダミーを使用する点がユーザ本人の場合と異なる。

**【0036】**

他方、発信履歴情報あるいは着信履歴情報の呼び出しがユーザ操作によって指示された場合には(図7のステップS34)、本人フラグFGの有無を調べ(ステップS35)、電源ON時の操作者がユーザ本人であれば、正規な発信履歴あるいは着信履歴データ(実情報)を読み出して表示出力させたのち(ステップS36)、操作待ち状態となる(ステップS37)。ここで、ユーザ操作が行われると、履歴呼び出しの終了を指示する終了操作かを調べ(ステップS38)、スクロール表示指示、次ページ切り替え指示などを受けた場合には(ステップS38でNO)、この操作対応処理の実行に移るが(ステップS39)、終了指示を受けた場合には、図5のステップS7に戻り、待ち受け状態となる。

**【0037】**

また、第三者による発信履歴/着信履歴情報の呼び出しの場合(ステップS35でNO)、CPU1は、ダミー発信履歴あるいは着信履歴データ(ダミー情報)を読み出して表示出力させたのち(ステップS40)、操作待ち状態となる(ステップS37)。ここで、上述の場合と同様に、操作対応処理が実行可能となるが(ステップS39)、第三者の場合には、ダミー情報を用いた処理となる。

**【0038】**

メールフォルダ情報の呼び出しがユーザ操作によって指示されたときには(図7のステップS41でYES)、呼び出し対象として送信メールが指定されたのか、受信メールが指定されたのかを調べ(ステップS42)、送信メールが指定されたときには、本人フラグFGの有無を調べ(ステップS43)、その結果、電源ON時の操作者がユーザ本人であれば、正規な送信メールデータ(実情報)を読み出して表示出力させるが(ステップS44)、第三者であれば、ダミー送信メールデータ(ダミー情報)を読み出して表示出力させる(ステップS45)。同様に、受信メールが指定されたときには(ステップS42でNO)、本人フラグFGの有無を調べ(ステップS46)、ユーザ本人であれば、正規な受信メールデータ(実情報)を読み出して表示出力させるが(ステップS47)、第三者であれば、ダミー受信メールデータ(ダミー情報)を読み出して表示出力させる(ステップS48)。

**【0039】**

以下、操作待ち状態となり（ステップS49）、何らかの操作が行われたときには、メールフォルダ情報の呼び出し終了を指示する終了操作が行われたかを調べる（ステップS50）。この結果、終了以外の操作が行われた場合、例えば、印刷処理、編集処理、分類処理などを指定する操作であれば、この操作に対応する処理が実行される（ステップS51）。この際、操作者が第三者であれば、ダミー情報に応じて操作対応処理が実行される。以下、終了指示を受けた場合には、図5のステップS7に戻り、待ち受け状態となる。

なお、上述のステップS41でNOと判断された場合には、その他の処理としてスケジュール情報の呼び出し指示などの実行に移るが（ステップS52）、この場合にも、ユーザ本人か第三者かに応じて実情報あるいはダミー情報に応じてスケジュール処理などが実行される。

#### 【0040】

以上のように、この実施例においてCPU1は、アドレス帳・スケジュール帳・メールフォルダ・発信履歴・着信履歴などの各管理機能に対応して、記憶部2内にその実情報が秘匿情報として記憶管理されていると共にそのダミー情報が記憶管理されている状態において、指紋センサFS付きの電源ボタンPWが操作されると、この電源ON操作時に検出された操作者の指紋パターンと予め登録されている指紋パターンとを比較することによって正規なユーザ（本人）か否かを判別し、ユーザ本人であれば、当該処理機能対応の実情報を表示出力させ、第三者であれば、当該処理機能対応のダミー情報を表示出力させるようにしたから、ユーザ本人か第三者かに応じて秘匿情報の表示出力を制限したとしても、秘匿情報が存在していることすら第三者に分からないような状態で情報を表示出力することができ、逆説的に不正者を欺くことによって不正アクセス者によるセキュリティ破りを未然に防止することが可能となる。

#### 【0041】

CPU1は、実情報あるいはダミー情報を表示出力させる際に、同一のフォーマットで表示出力するようにしたから、実情報とダミー情報との区別がつかないように表示させることができ、安全性を高めることが可能となる。この場合、実情報が複数桁の数値列データあるいは文字列データであれば、ダミー情報も同一桁の数値列あるいは文字列データで表示すればよい。

#### 【0042】

この場合、セキュリティ対策を必要とするアドレス帳・スケジュール帳・メールフォルダ・発信履歴・着信履歴などの各データ管理機能に活用することができ、プライベートを保護するうえで有効なものとなる。また、CPU1は、処理機能の選択に応答してダミー情報が出力されている状態において、この処理機能の動作に応じて当該ダミー情報を処理するようにしたから、処理の実行中、実行後であっても安全性を高めることが可能となる。

#### 【0043】

実情報のアクセスが許可されたことをユーザ本人に報知するための本人報知の方法をその本人が任意に設定可能としたから、例えば、アイコン表示、バイブレーション報知など、秘匿情報のアクセスが許可されたことをユーザの好みに合った方法で知ることができる。

また、入力電源ON操作時に検出された指紋パターンをユーザ情報として取り込むようにしたから、ユーザに意識させることなくユーザ認証を行うことが可能となる。

#### 【0044】

なお、上述した実施例においては、ユーザ本人が任意に入力作成した情報をダミー情報としたが、これに限らず、例えば、予め固定的に用意されている標準的な情報あるいはランダムに生成された情報であってもよく、また、実情報を加工することによって生成された情報、更新以前の実情報（例えば、デフォルト値など）であってもよい。つまり、不正アクセス者を欺くことが可能な情報であればどのような情報であってもよい。

上述した実施例においては、操作者が第三者の場合のメニュー画面内には、本人報知メニューを除くようにしたが、この本人報知メニューに代わってダミーの本人報知メニュー

を表示するようにしてもよい。

【0045】

上述した実施例においては、指紋パターンを検出することによってユーザ認証を行うようにしたが、ユーザの顔画像を撮影可能なカメラを備えた携帯電話装置にあっては、カメラ撮影したユーザの顔画像と予め登録されている顔画像とを比較することによってユーザ認証を行うようにしてもよい。更に、ユーザの眼球部分の撮影画像に基づいて虹彩認識を行うことによって本人確認を行うようにしてもよい。更に、指の静脈認識によって本人確認を行うようにしてもよい。

【0046】

上述した実施例においては、電源ON時にユーザ認証を行うようにしたが、電源ON時から所定時間が経過するごとに操作者をカメラ撮影したり、装置本体を把持している接触部分の指紋あるいは掌を検出するなど、所定時間毎にユーザ認証を繰り返して実行し、装置本体からユーザ本人が離れた場合（例えば、置き忘れた場合）に、実情報表示からダミー情報表示に切り替えるようにしてもよい。

【0047】

上述した実施例においては、実情報、ダミー情報を表示する場合を例示したが、勿論、実情報、ダミー情報を音声出力、印刷出力、送信出力する場合でも同様であり、また、処理機能としては、アドレス帳情報、スケジュール帳情報、メールフォルダ情報、発信履歴情報、着信履歴情報を管理するデータ管理機能を例示したが、売り上げ管理機能などの処理機能であっても同様に適用可能である。その他、携帯電話装置に限らず、例えば、PDA、電子カメラ、電子腕時計、音楽再生機などの携帯端末装置、パーソナルコンピュータなどにも同様に適用可能である。

【図面の簡単な説明】

【0048】

【図1】セキュリティ機能付き情報処理装置として適用した携帯電話装置の基本的な構成要素を示したブロック図。

【図2】折り畳み式の装置本体を開いた状態を示した概略斜視図。

【図3】図3は、記憶部2にセットされる本人フラグFG、本人報知の設定内容PSを示した図。

【図4】アドレス帳・スケジュール帳・メールフォルダ・発信履歴・着信履歴などの各管理機能に対応して、その実情報が秘匿情報として記憶管理されている共にそのダミー情報が記憶管理されている状態において、電源ON時のユーザ認証の結果、第三者による操作の場合に、実情報（秘匿情報）に代わってそのダミー情報を表示出力させることを示した図。

【図5】電源投入に伴って実行開始される携帯電話装置の全体動作を示したフローチャート。

【図6】図5に続く、フローチャート。

【図7】図6に続く、フローチャート。

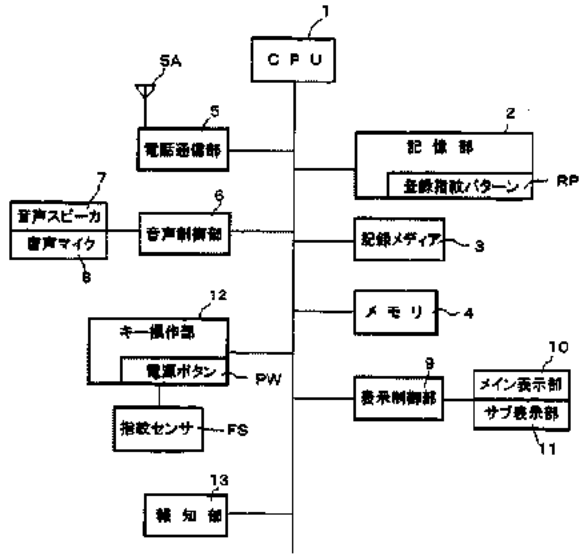
【符号の説明】

【0049】

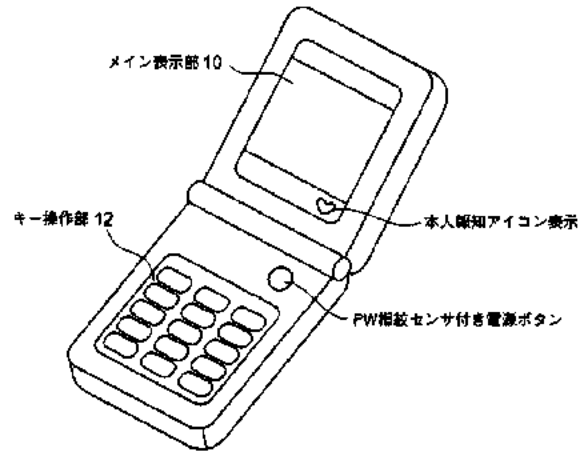
- 1 CPU
- 2 記憶部
- 5 電話通信部
- 10 メイン表示部
- 12 キー操作部
- 13 報知部
- FS 指紋センサ
- PW 電源ボタン
- FG 本人フラグ
- PS 本人報知の設定内容



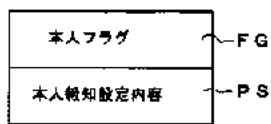
【図1】



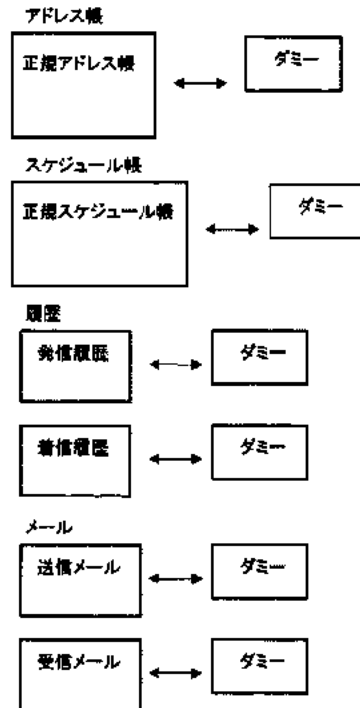
【図2】



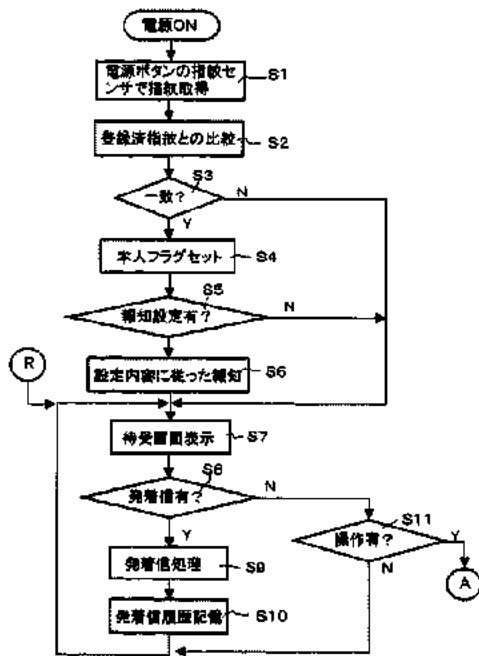
【図3】



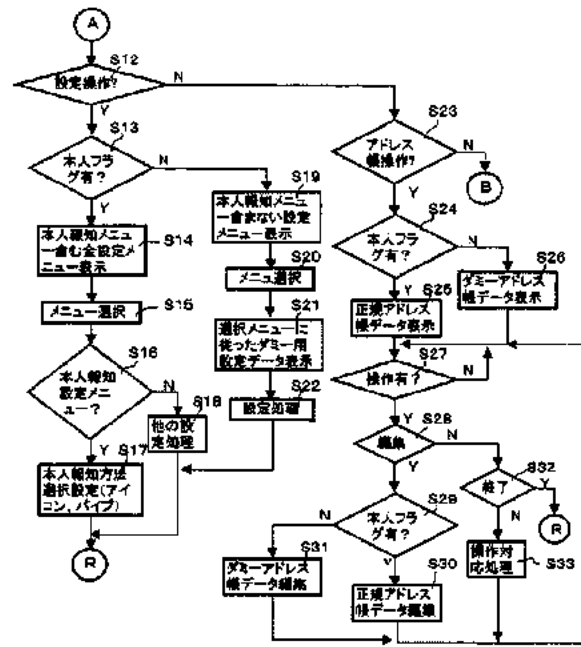
【図4】



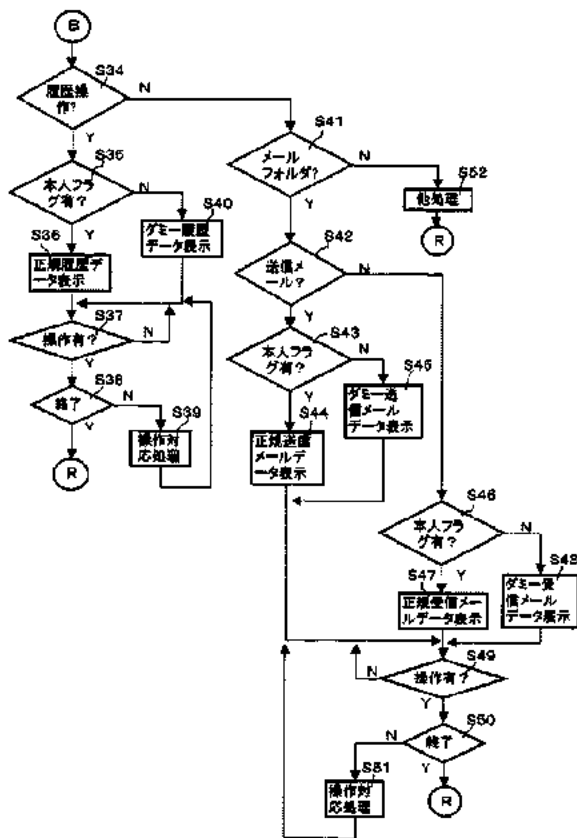
【図5】



【図6】



【図7】



Fターム(参考) 5J104 AA07 KA01 KA04 KA16 NA05 NA07 NA27 NA38  
5K036 AA07 BB18 JJ12 KK09  
5K067 AA30 BB04 EE02 FF02 FF05 FF06 FF07 HH22 HH23



Espacenet

Bibliographic data: JPH11328362 (A) — 1999-11-30

**INFORMATION PROCESSOR WITH INDIVIDUAL AUTHENTICATING FUNCTION  
AND DISPLAY DEVICE USED FOR SAME INFORMATION PROCESSOR**

**Inventor(s):** ITO TAKAFUMI ± (ITO TAKAFUMI)

**Applicant(s):** TOSHIBA CORP ± (TOSHIBA CORP)

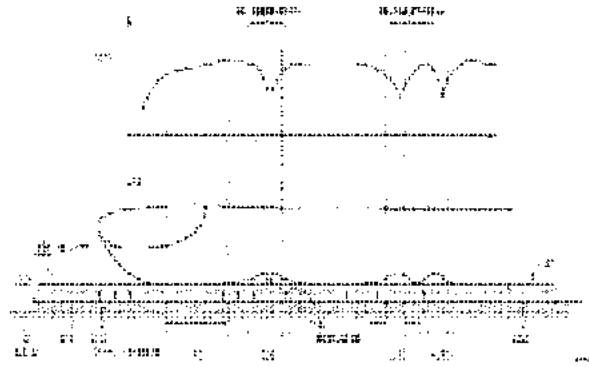
**Classification:** - **international:** G06F15/00; G06F21/20; G06T1/00;  
(IPC1-7): G06F15/00; G06T1/00  
- **cooperative:**

**Application number:** JP19980128883 19980512

**Priority number (s):** JP19980128883 19980512

**Abstract of JPH11328362 (A)**

**PROBLEM TO BE SOLVED:** To reduce the influence of an electric field produced by a display device and to keep authentication precision high by arranging a sensor for finger authentication on the display device while making the sensor transparent, making a direct guide display at the position where a finger of an authenticated person is placed, and providing a transparent shield electrode between the display screen of the display device and the sensor. **SOLUTION:** On the display screen of the display device 13 provided to a device main body, the sensor 19 for finger authentication which is made of a transparent material so as to detect a finger pattern of the authenticated person at a specific position is installed and an authenticating process is performed according to the output signal of the sensor 19. Specially, at the time of authentication, guide information indicating the mount position of the finger 30 is displayed at the installation position of the sensor 19. The shield electrode 33 made of the transparent material so as to cut off the electric field led to the sensor 19 from the display screen is provided between the display screen of the display device 13 and the sensor 19, or the sensor 19 is placed in detecting operation while the display device 13 makes no display.



(5)Int.Cl. <sup>6</sup>	識別記号	F I	
G 0 6 T 1/00		G 0 6 F 15/64	C
G 0 6 F 15/00	3 3 0	15/00	3 3 0 F

審査請求 未請求 請求項の数9 O L (全 10 頁)

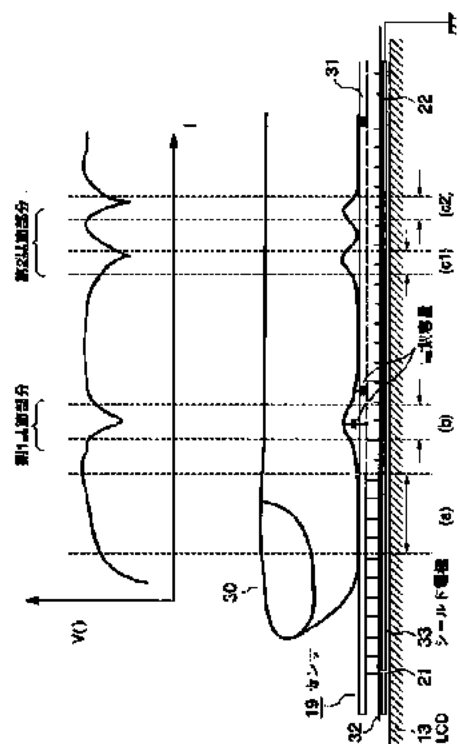
(21)出願番号	特願平10-128883	(71)出願人	000003078 株式会社東芝 神奈川県川崎市幸区堀川町72番地
(22)出願日	平成10年(1998)5月12日	(72)発明者	伊藤 隆文 東京都青梅市末広町2丁目9番地 株式会 社東芝青梅工場内
		(74)代理人	弁理士 鈴江 武彦 (外6名)

(54)【発明の名称】 個人認証機能付き情報処理装置及びこの情報処理装置に用いられる表示装置

(57)【要約】

【課題】個人の指の特徴情報を用いた個人認証方式において、そのセンサ部を透明化して表示装置上に配置した場合での有効な活用方法を提供すると共に、表示装置から生じる電界の影響を低減し、認証精度を高く確保する。

【解決手段】透明化されたセンサ19をLCD13の表示画面上に配置した場合に、被認証者の指30を置く位置に直接ガイド表示を行う。また、LCD13の表示画面とセンサ19との間に透明な材質で形成されたシールド電極33を設け、LCD13から生じる電界の影響を低減する。これにより、より正確な指認証動作が可能となる。



## 【特許請求の範囲】

【請求項1】 装置本体に設けられた表示装置と、この表示装置の表示画面上に設置され、所定の位置で被認証者の指パターンを検出するための透明な材質で形成された指認証用のセンサと、

このセンサの出力信号に基づいて認証処理を行う制御手段とを具備し、

上記表示装置は、認証時に指の載置位置を示すガイド情報を上記センサの設置位置に表示することを特徴とする個人認証機能付き情報処理装置。

【請求項2】 上記表示装置の表示画面と上記センサとの間に、上記表示画面から上記センサへ誘導される電界をシールドするための透明な材質で形成されたシールド電極が設けられていることを特徴とする請求項1記載の個人認証機能付き情報処理装置。

【請求項3】 上記表示装置の非表示期間中に上記センサの検出動作を実行するセンサ制御手段を具備したことを特徴とする請求項1記載の個人認証機能付き情報処理装置。

【請求項4】 装置本体に設けられた表示装置と、この表示装置の表示画面上に設置され、それぞれ所定の位置で指パターンの検出を行うための透明な材質で形成された指認証用の複数のセンサと、

これらのセンサの検出位置と複数の異なる項目とを割付け、指パターンを検出したセンサの出力信号に基づいて認証処理とその検出位置に応じた項目選択処理を行う制御手段とを具備したことを特徴とする個人認証機能付き情報処理装置。

【請求項5】 上記各センサを共通の駆動回路で駆動し、それらの出力信号を時分割で処理するセンサ制御手段を具備したことを特徴とする請求項4記載の個人認証機能付き情報処理装置。

【請求項6】 装置本体に設けられ、表示動作のための複数の電極を有し、これらの電極が被認証者の指パターンを検出するためのセンサ電極として用いられる表示装置と、認証時にこの表示装置の上記各電極を駆動する電極駆動手段とを具備したことを特徴とする個人認証機能付き情報処理装置。

【請求項7】 上記電極駆動手段は、上記表示装置の表示動作のための電極駆動と指認証のための電極駆動を時分割で行うことを特徴とする請求項6記載の個人認証機能付き情報処理装置。

【請求項8】 表示画面上に所定の位置で被認証者の指パターンを検出するための透明な材質で形成された指認証用のセンサが設置され、認証時に指の載置位置を示すガイド情報を上記センサの設置位置に表示することを特徴とする表示装置。

【請求項9】 上記表示画面と上記センサとの間に、上記表示画面から上記センサへ誘導される電界をシールド

するための透明な材質で形成されたシールド電極が設けられていることを特徴とする請求項8記載の表示装置。

## 【発明の詳細な説明】

【0001】

【発明の属する技術分野】本発明は、個人の指の凹凸パターンを特徴情報として検出し、その指の凹凸パターンに基づいて個人認証を行う個人認証機能付き情報処理装置と、この情報処理装置に用いられる表示装置に関する。

【0002】

【従来技術】近年のパーソナルコンピュータ（以下、PCと称す）の普及により、各個人が自分のPCを使用して各種の業務を行うようになってきた。これに伴い、例えばPCに住所録やスケジュールなどの個人情報を記録するようになり、そのためPC本体に対するセキュリティの確保も製品を提供する上で重要な課題となっている。

【0003】PC本体にセキュリティを施す手段としては、PC本体に個人認証の仕組みを設けるものももっとも多い。現状では、パスワードなどのソフトウェアによるセキュリティを用いるのが一般的ではあるが、パスワードを忘れてしまうなどの事故も少なくない。このため、個人の指の特徴情報を用いた個人認証方式が注目されている。

【0004】個人の指の特徴情報を用いた個人認証方式としては、例えば特願平7-168930号公報（以下、文献1と称す）や特願平9-068550号公報（以下、文献2と称す）などに開示されているように、平行に設置された複数の線状電極によって、人間の指（間接部分を含む）の凹凸パターンを読み取り、予め登録された複数のパターンと照合することで、その指を持つ人間を識別し、機密保持などに応用するものがある。

【0005】文献1では、電極と指とが接触したときに生じる電極間の電気抵抗値を利用して、指の凹凸パターンを読み取る技術が開示されている。文献2では、指と電極の間の電気容量を利用して、指の凹凸パターンを読み取る技術が開示されている。

【0006】上記文献1において、センサ部は指の方向と直角の方向に、複数の細い線状電極が多数設置されている。電極と指とは直接接触し、隣り合う電極間の抵抗値がサンプリングされて、指のパターンの入力データとなる。この場合、指の凹凸によって電極と指との接触圧が異なるため、それぞれの隣り合う電極間の抵抗値が異なり、そのサンプリングデータのパターンが個人毎の指特徴を示すデータとなる。

【0007】また、予め各ユーザの指パターンを登録しておき、入力された指パターンと登録パターンとを照合し、入力パターンに近いものが登録パターンの中にあれば、その登録した人の指であると判定する。

【0008】上記文献2において、センサ部は指の方向

と直角の方向に、複数の細い線状電極が多数設置されている。電極の上には絶縁シートが設置されており、それぞれの電極と指との間の電気容量がサンプリングされて、指のパターンの入力データとなる。以後の照合方法は上記文献1と同様である。

【0009】

【発明が解決しようとする課題】上記したような個人の指の特徴情報を用いた個人認証方式では、センサ部は線状電極で形成されているので、製造が簡単で、安価であるなどの利点がある。また、電極をITO（透明高導電性薄膜）などの透明材料で形成することで、センサ自体を透明化することも容易である。

【0010】ここで、上記文献1には、センサ部を透明化することで、小型機器（ICカード）の表示装置上にも設置できるようになり、センサ部の配置自由度が大きくなることが開示されている。しかしながら、実際にセンサ部を透明化して表示装置上に配置した場合での具体的な活用方法、特にパーソナルコンピュータ等の情報処理装置に用いられる表示装置上に実装した場合での有効的な活用方法について何ら言及されていない。

【0011】また、センサ部を表示装置上に配置した場合に、表示装置から生じる電界の影響を受けて、認証動作が正しく行われない問題があった。本発明は上記の課題を解決するためになされたもので、個人の指の特徴情報を用いた個人認証方式において、そのセンサ部を透明化して表示装置上に配置した場合での有効な活用方法を提供すると共に、表示装置から生じる電界の影響を低減し、認証精度を高く確保することのできる個人認証機能付き情報処理装置及びこの情報処理装置に用いられる表示装置を提供することを目的とする。

【0012】

【課題を解決するための手段】（1）本発明の情報処理装置は、装置本体に設けられた表示装置の表示画面上に、所定の位置で被認証者の指パターンを検出するための透明な材質で形成された指認証用のセンサを設置し、このセンサの出力信号に基づいて認証処理を行うものであり、特に認証時に指の載置位置を示すガイド情報を上記センサの設置位置に表示することを特徴とする（請求項1）。

【0013】このような構成によれば、透明化されたセンサを表示装置の表示画面上に配置した場合に、被認証者の指を置く位置に直接ガイド表示を行うことで、より正確な指データの検出処理を行うことができる。

【0014】また、表示装置から生じる電界の影響を低減するため、本発明は、上記表示装置の表示画面と上記センサとの間に上記表示画面から上記センサへ誘導される電界をシールドするための透明な材質で形成されたシールド電極を設けるか（請求項2）、あるいは、上記表示装置の非表示期間中に上記センサの検出動作を実行することを特徴とする（請求項3）。

【0015】このような構成によれば、表示装置が稼働中であっても、その表示装置から発生する電界に影響されずに、センサによって指パターンを検出することができ、正常な認証動作を行うことができる。

【0016】（2）本発明の情報処理装置は、装置本体に設けられた表示装置の表示画面上に、それぞれ所定の位置で指パターンの検出を行うための透明な材質で形成された指認証用の複数のセンサを設置し、これらのセンサの検出位置と複数の異なる項目とを割付け、指パターンを検出したセンサの出力信号に基づいて認証処理とその検出位置に応じた項目選択処理を行うことを特徴とする（請求項4）。

【0017】このような構成によれば、複数のセンサのそれぞれで認証処理を行い、あるセンサの信号で本人と判定できたら、そのときのセンサの検出位置に応じた項目を選択したものと判断して以後の処理を行うことで、認証処理と項目選択の同時処理が可能となる。

【0018】また、上記各センサを共通の駆動回路で駆動し、それらの出力信号を時分割で処理することで（請求項5）、複数のセンサを設置した場合でのコストの低減化が可能となる。

【0019】（3）本発明の情報処理装置は、装置本体に設けられ、表示動作のための複数の電極を有し、これらの電極が被認証者の指パターンを検出するためのセンサ電極として用いられる表示装置を備え、認証時にこの表示装置の上記各電極を駆動するようにしたものである（請求項6）。

【0020】このような構成によれば、表示装置の電極を指パターン検出電極として利用することで、特別なセンサを必要とせず、個人認証を行うことができる。また、上記表示装置の表示動作のための電極駆動と指認証のための電極駆動を時分割で行うことで（請求項7）、表示動作と認証動作を同時に行うことができる。

【0021】

【発明の実施の形態】以下、図面を参照して本発明の一実施形態を説明する。図1は本発明の一実施形態に係る個人認証機能付き情報処理装置のシステム構成を示すブロック図である。なお、本装置は、例えば磁気ディスク等の記録媒体に記録されたプログラムを読み込み、このプログラムによって動作が制御されるコンピュータによって実現される。

【0022】図1において、CPU11はプログラムの起動により動作し、本装置全体の制御を行うものである。このCPU11には、システムバス10を介してメモリ等の各種のデバイスが接続されている。DRAM12は、主メモリとして使用されるリード/ライト可能なメモリであり、プログラムなど、本装置の動作に必要な各種の情報が格納される。

【0023】LCD（液晶ディスプレイ）13は、本装置の表示装置として設けられているものであり、データ



の表示を行う。LCDコントローラ14は、VRAM15の内容をLCD13に表示するための表示制御を行う。VRAM15は、LCD13に表示する内容を保持するためのメモリである。

【0024】キーボード16およびマウス17は、本装置の入力装置として設けられているものであり、データの入力やファンクションの指示を行う。HDD（ハードディスク装置）18は、本装置の補助記憶装置として用いられるものであり、アプリケーションプログラムやファイルなど、各種の情報を保持している。

【0025】以上は、一般的なPCの構成と同様であり、その詳細な構成については説明を省略する。ここで、本装置は、指の凹凸パターンを個人の特徴情報として検出し、その凹凸パターンに基づいて個人認証を行う機能を備えている。センサ19は、この指認証を行うためのものであり、シート状で透明な材料で形成され、LCD13の表示画面上に重ねて配置されている。センサ制御回路20は、センサ19の駆動制御と信号処理を行う。

【0026】図2および図3にセンサ19とセンサ制御回路20の具体的な構成を示す。図2はセンサ19とセンサ制御回路20の概略構成を示すブロック図、図3はセンサ19に指を置いたときの側面図とそのときに得られる投影信号の波形図である。

【0027】センサ19は、被認証者の指30の長手方向に沿って所定間隔で配設された複数の出力電極21と、被認証者の指30の長手方向に沿った端部に配設された単一の入力電極22とからなる。出力電極21と入力電極22は、ITOなどの透明な材質で形成されている。

【0028】センサ制御回路20は、スイッチ回路23、発振器24、タイミングパルス発生器25、検波回路26、A/D変換器27、終端抵抗28によって構成されている。

【0029】スイッチ回路23は、出力電極21と発振器24との間に介在されており、タイミングパルス発生器25から出力されるタイミングパルス信号によってオン/オフ動作し、各出力電極21を順次切り替える。発振器24は、出力電極21に印加する交流信号を発生する。

【0030】タイミングパルス発生器25は、システムバス10を介して入力される制御信号に基づいてスイッチ回路23の切り替えと、A/D変換器27の標準化タイミングを制御するためのパルス信号を発生する。この場合、例えばパルス信号の立ち下がりスイッチ回路23の切り替えが行われ、立ち上がりでA/D変換器27のA/D変換が行われるものとする。

【0031】検波回路26は、入力電極22に接続されており、この入力電極22で検出された信号を増幅する増幅回路とその信号から必要な信号成分を取り出すフィ

ルタ回路からなる。A/D変換器27は、タイミングパルス発生器25から発生されるパルス信号に基づいて、検波回路26によって得られたアナログの信号をデジタル信号に変換してシステムバス10に出力する。

【0032】また、入力電極22は終端抵抗28を介して接地されており、この終端抵抗28は入力電極22に生じる信号を電圧に変換する。ここで、本実施形態において、図3に示すように、センサ19はLCD13の表示画面上の一部または全面に重ねて設置されている。この場合、センサ19は透明な材質（ITO）で形成されているため、下のLCD13の視認性に問題はない。

【0033】センサ19を構成する出力電極21および入力電極22は電氣的絶縁体としての絶縁体薄膜31、32で被覆されている。この絶縁体薄膜31、32も透明な材質（ITO）で形成されており、これで出力電極21および入力電極22を被覆することで、出力電極21および入力電極22と指30とは静電結合によるみ接続されることになり、接触抵抗が無限大となる。したがって、発汗などの指30の表面の状態変化に影響されずに、より安定した投影信号V(i)を得ることができる。

【0034】また、LCD13の表示画面とセンサ19との間には、シールド電極33が設けられている。このシールド電極33は、LCD13からセンサ19へ誘導される電界をシールドするためのものであり、透明な材質（ITO）で形成され、LCD13の全面、あるいは、少なくともセンサ19が設置される部分に配設されている。

【0035】図2および図3の動作原理を以下に説明する。図中の出力電極21は細い線状の電極アレイで、電極間隔は1/10mm~1/3mm程度とする。出力電極21の数、すなわち、線状電極アレイの指30の長手方向の長さは、指30の先端から第2間接を完全に含む長さとする。入力電極22はやや広い帯状の電極であり、指30の長手方向の長さが出力電極21よりも長く形成されている。

【0036】このような構成において、出力電極21および入力電極22に指30を電極配列方向に対して直交方向に押し付ける。このとき、スイッチ回路23を指先から指元方向へ順次切り替えて、発振器24の信号を出力電極21に印加する。出力電極21に印加された信号は、出力電極21と指30との間の電気容量を通して指30に伝わる。指30は電氣的には比較的抵抗値の小さい抵抗体と見なされるので、指30に伝わった信号は指30と入力電極22との容量を通して入力電極22に伝わる。

【0037】この入力電極22に伝わった信号を終端抵抗28で電圧に変換し、検波回路26のバンドパスフィルタで必要な信号成分（元の信号の周波数成分）を取り出し、A/D変換器27にてデジタル信号に変換する。

【0038】この場合、出力電極21と指30との間の容量の大きさは出力電極21と指30との間隔によって異なり、間隔が大きいほど、容量が小さくなって出力電極21から指30に伝わる信号が小さくなり、A/D変換器27が出力するデジタル値も小さくなる。

【0039】スイッチ回路23による出力電極21の走査に従ったタイミングでA/D変換器27の出力するデジタル値を取り込めば、図3の上部に示すような、出力電極21と指30との間隔に応じてレベルが変化する信号V(i)が得られる。この信号V(i)は、被認証者の指30の凹凸パターンに応じて変化する信号パターンであり、各個人で異なったパターンを示すため、個人認証データとして利用することができる。

【0040】このようなセンサ19を用いた個人認証処理を以下に説明する。

(a) 登録時

図4は登録時の個人認証処理を示すフローチャートである。

【0041】登録モードが開始されると、LCD13上の指を置くべき位置(センサ19が設置されている部分)に、図6に示すような指の載置位置を示すガイド41が表示される(ステップA11)。このガイド41は、指の形状をなし、その中に例えば「ここに指を置いてください」といったようなメッセージが書かれている。被認証者は、このガイド41に従って指を置くことができる。

【0042】続いて、センサ19による信号検出が行われ(ステップA12)、上記のようにして取り込まれた被認証者の指の特徴を表す信号V(i)が登録パターンとしてHDD18に格納される(ステップA13)。

【0043】(b) 照合時

図5は照合時の個人認証処理を示すフローチャートである。照合モードが開始されると、上記登録時と同様に、LCD13上の指を置くべき位置に、図6に示すような指の載置位置を示すガイド41が表示される(ステップB11)。

【0044】続いて、センサ19による信号検出が行われ(ステップB12)、新たに取り込まれた被認証者の指の特徴を表す信号V(i)がHDD18に格納された登録パターンと照合される(ステップB13)。その結果、登録パターンとの差が一定の基準値より小さければ(ステップB14のYes)、本人であると判定する(ステップB15)。登録パターンとの差が一定の基準値以上であれば(ステップB14のNo)、本人でないと判定する(ステップB16)。

【0045】なお、入力パターンと辞書パターンとの差の計算方法については公知であるため、ここでは具体的な説明を省略する。このように、透明化されたセンサ19をLCD13上に配置することで、被認証者の指を置く位置に直接ガイド表示を行うことができ、より正確な

指データの検出処理を行うことができる。この場合、LCD13として、PCに標準装備されている表示装置を使用しているため、ガイド表示のための付加的な構成要素を必要としないといった利点がある。

【0046】次に、表示装置上にセンサを重ねた場合の検出信号の劣化防止方法について説明する。表示装置にガイド情報などを表示しつつ、センサで凹凸パターンの検出を行う場合、表示装置は稼働中であるため、表示装置からはかなり強力な電界が発生している。LCDの場合、画像を駆動する電極から発生する。

【0047】指の凹凸パターンを検出するための信号は通常微弱であるため、表示装置からの電界の輻射によって、その信号が埋もれてしまい、認証動作を正常に行うことができなくなることがある。このような問題を防ぐため、本実施形態では、以下のような対策を施している。

【0048】(1) 図3に示すように、LCD13の表示画面とセンサ19との間に透明なシート状のシールド電極33を設ける。このシールド電極33により、LCD13が稼働中であっても、そのLCD13から発生する電界に影響されずに、指の凹凸パターンを検出することができ、正常な認証動作を行うことができる。

【0049】なお、このようなシールド電極33はLCD13の全面に限らず、少なくともLCD13上のセンサ19の部分に配置すれば、シールド効果を期待することができる。

【0050】(2) LCD13の表示動作とセンサ19の検出動作を時分割で行う。すなわち、図7に示すように、LCD13の1フレーム分の表示期間と1フレーム分の表示期間との間に所定の非表示期間(帰線期間)を設定し、その非表示期間をセンス期間として利用する。

【0051】このように、LCD13の非表示期間にセンサ19の検出動作を行えば、LCD13が稼働中であっても、そのLCD13から発生する電界に影響されずに、指の凹凸パターンを検出することができ、正確な認証動作を行うことができるようになる。

【0052】なお、上記非表示期間をあまり長く取ると、LCD13の表示精度は悪くなるため(画面がちらつく)、表示にそれ程影響を与えない範囲で非表示期間を設定し、その期間でセンサ動作を行う必要がある。

【0053】次に、他の実施形態として、2つのセンサを用いて認証処理と項目選択を同時に行う場合について説明する。図8に示すように、LCD13上に2つのセンサ19aおよびセンサ19bを配置し、それぞれのセンサ位置に指の載置位置と項目内容を示すガイド41aおよびガイド41bを表示する。なお、センサ19aおよびセンサ19bは、図2および図3で説明したような構成を有し、それぞれに対応するセンサ制御回路20によって駆動されるものとする。

【0054】図8の例では、ガイド41aは項目Aの選択と指認証、ガイド41bは項目Bの選択と指認証のた

めのガイド情報として表示されている。項目Aと項目Bは、例えば「通常処理」と「ネットワークの接続処理」や、「データベースAの検索処理」と「データベースBの検索処理」といったように、PCが持つ各種の処理項目である。

【0055】このような構成において、被認証者の指の凹凸パターンの登録動作は上記図4と同様であるので、ここでは照合動作について、図9を参照して以下に説明する。

【0056】図9は2つのセンサを用いた場合での照合時の個人認証処理を示すフローチャートである。照合モードが開始されると、LCD13上の指を置くべき位置に、図8に示すような指の載置位置と項目内容を示すガイド41aおよびガイド41bが表示される(ステップC11)。

【0057】続いて、2つのセンサ19aとセンサ19bの信号検出が行われる。例えば被認証者がガイド41a上に指を載せたとすると、センサ19aから被認証者の指の特徴(凹凸パターン)を示す信号V(i)が出力される(ステップC12)。したがって、このセンサ19aからの信号V(i)がHDD18に格納された登録パターンと照合され(ステップC13)、登録パターンとの差が一定の基準値より小さければ(ステップC14のYes)、本人であると判定すると共に項目Aの選択があったものとして処理する(ステップC15)。

【0058】一方、被認証者がガイド41b上に指を載せたとすると、センサ19bから被認証者の指の特徴(凹凸パターン)を示す信号V(i)が出力される(ステップC16)。したがって、このセンサ19bからの信号V(i)がHDD18に格納された登録パターンと照合され(ステップC17)、登録パターンとの差が一定の基準値より小さければ(ステップC18のYes)、本人であると判定すると共に項目Bの選択があったものとして処理する(ステップC19)。

【0059】また、センサ19aまたはセンサ19bからの信号V(i)が登録パターンと一致しない場合には(ステップC18のNo)、本人でないとして判定する(ステップC20)。

【0060】このように、2つのセンサ19aとセンサ19bのそれぞれで認証処理を行い、どちらか一方の信号で本人と判定できたら、そのときのセンサの検出位置に応じた項目を選択したものと判断し、以後の処理を行う。これにより、認証処理と項目選択を同時に行うことができ、使用者の操作上の負担が軽減する。

【0061】また、認証時に指の載置位置および項目内容を示すガイド情報を各センサ19a、19bの設置位置にそれぞれ表示することで、どのセンサでどのような項目を選択できるのかが一目で判断できるため、操作性が向上する。

【0062】なお、上記の説明では、2つのセンサを設

ける場合を想定して説明したが、例えば1つのセンサを用いて、そのセンサ領域を2つに分けて信号処理を行うことも可能である。

【0063】さらに、センサ駆動回路として、発振器24、タイミングパルス発生器25、入力電極22、終端抵抗28、検波回路26、A/D変換器27を共通化し、各センサの出力信号を時分割で処理することで、複数のセンサを設置した場合でのコストの低減化が可能となる。

【0064】次に、他の実施形態として、LCDの画素駆動電極を指パターンの検出電極として利用する場合について説明する。図10および図11にその具体的な構成を示す。

【0065】図10はLCD13の画素駆動電極を指パターン検出電極として利用する場合の概略構成を示すブロック図、図11はLCD13の画素駆動電極に指を置いたときの側面図である。

【0066】LCD13は、マトリックス状に張られた横電極51と縦電極52とで画素53を駆動することで表示を行っている。この画素駆動用の横電極51の一部を指パターンの検出電極54として使用する。なお、図11において、55は絶縁体であり、ガラスなどで形成されている。

【0067】表示動作時は、ドライバ制御回路63が表示データに基づいて横電極51用のドライバ回路61と縦電極52用のドライバ回路62を駆動制御する。これは、通常のLCDの表示動作と同様である。この表示動作時に上記図6で説明したようなガイド表示を行う。

【0068】ここで、指パターンの検出を行う場合には、ドライバ制御回路63が発振器64の信号に基づいてドライバ回路61を制御する。これにより、ドライバ回路61によって横電極51に信号が順次印加される。横電極51に印加された信号は、横電極51と指30との間の電気容量を通して指30に伝えられ、さらに検出電極54に伝えられる。

【0069】この検出電極54に伝わった信号を抵抗器65で電圧に変換し、検波回路66のバンドパスフィルタで必要な信号成分(元の信号の周波数成分)を取り出し、A/D変換器67にてデジタル信号に変換する。このA/D変換器67の出力が被認証者の指の特徴(凹凸パターン)を示す信号V(i)となる。以後の登録動作や照合動作については、図4および図5で説明した方法と同様である。

【0070】このように、LCD13の画素駆動電極を指パターン検出電極として利用することでも、被認証者の指の特徴を示す信号V(i)を得ることができ、その信号V(i)に基づいて個人認証を行うことができる。

【0071】なお、表示動作を行っていない場合(画面オフ)において、認証動作のみを行うことも可能であるが(ただし、このときにガイド表示はできない)、上記

図7で説明したような時分割処理を利用すれば、表示動作と認証動作を同時に行うこともできる。

【0072】さらに、時分割処理を利用すれば、上記図8および図9で説明したような2つのセンサを用いて認証処理と項目選択を同時に行うような構成も可能である。また、上記実施形態では、指と電極との容量結合を用いる指パターン検出方式を想定して説明したが、センサ部の透明化が可能な他の方式、例えば接触抵抗を用いる方式でも本発明の手法を適用可能である。ただし、接触抵抗を用いる方式では、電界の影響は関係ないので、図3に示すようなシールド電極33は不要である。

【0073】また、上記実施形態では、LCD上にセンサを設置するものとして説明したが、表示装置としてはLCDに必ずしも限定されるものではない。ただし、図10の構成を実現するためには、LCDのようにマトリクス状の電極を有する表示装置である必要がある。また、本発明はPC以外にも、例えば金融端末などの他の情報処理装置にも適用することができる。

【0074】

【発明の効果】以上詳記したように本発明によれば、指認証用のセンサを透明化して表示装置上に配置し、被認証者の指を置く位置に直接ガイド表示を行うようにしたため、より正確な指データの検出処理を行うことができる。

【0075】また、表示装置の表示画面とセンサとの間に透明なシールド電極を設けるか、あるいは、表示装置の非表示期間中にセンサの検出動作を実行するようにしたため、表示装置が稼働中であっても、その表示装置から発生する電界に影響されずに、センサによって指パターンを検出することができ、正常な認証動作を行うことができる。

【0076】また、表示装置の表示画面上に指認証用の複数のセンサを設置し、これらのセンサの検出位置と複数の異なる項目とを割付け、指パターンを検出したセンサの出力信号に基づいて認証処理とその検出位置に応じた項目選択処理を同時に行うことにより、認証処理と項目選択の同時処理が可能となる。

【0077】また、各センサを共通の駆動回路で駆動し、それらの出力信号を時分割で処理することで、複数のセンサを設置した場合でのコストの低減化が可能となる。また、表示装置が持つ複数の電極をセンサ電極として用い、認証時にこれらの電極を駆動するようにしたた

め、特別なセンサを必要とせずに、個人認証を行うことができる。また、表示装置の表示動作のための電極駆動と指認証のための電極駆動を時分割で行うことで、表示動作と認証動作を同時に行うことができる。

【図面の簡単な説明】

【図1】本発明の一実施形態に係る個人認証機能付き情報処理装置のシステム構成を示すブロック図。

【図2】センサとセンサ制御回路の概略構成を示すブロック図。

【図3】センサに指を置いたときの側面図とそのときに得られる投影信号の波形図。

【図4】登録時の個人認証処理を示すフローチャート。

【図5】照合時の個人認証処理を示すフローチャート。

【図6】認証時のガイド表示を示す図。

【図7】LCD表示期間とセンス期間との関係を示す図。

【図8】2つのセンサを用いて認証処理と項目選択を同時に行う場合でのガイド表示を示す図。

【図9】2つのセンサを用いた場合での照合時の個人認証処理を示すフローチャート。

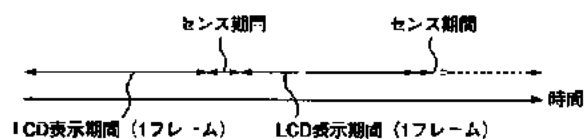
【図10】LCDの画素駆動電極を指パターン検出電極として利用する場合の概略構成を示すブロック図。

【図11】LCDの画素駆動電極に指を置いたときの側面図。

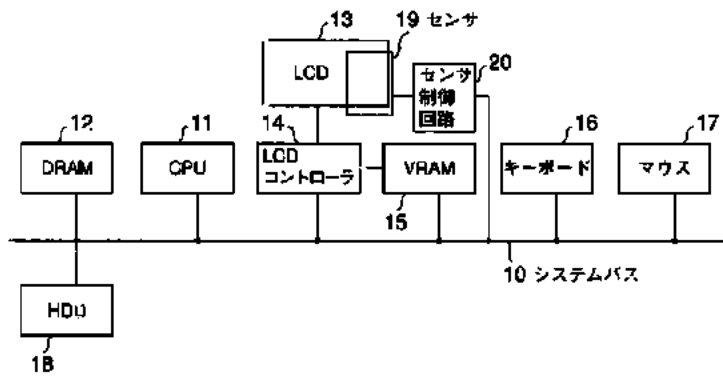
【符号の説明】

- 11…CPU
- 13…LCD
- 19…センサ
- 20…センサ制御回路
- 21…出力電極
- 22…入力電極
- 23…スイッチ回路
- 24…発振器
- 25…タイミングパルス発生器
- 26…検波回路
- 27…A/D変換器
- 28…終端抵抗
- 31…絶縁体薄膜
- 32…絶縁体薄膜
- 33…シールド電極
- 41…ガイド

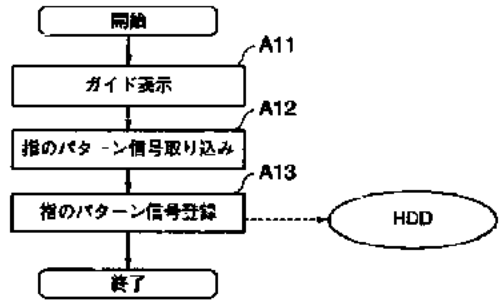
【図7】



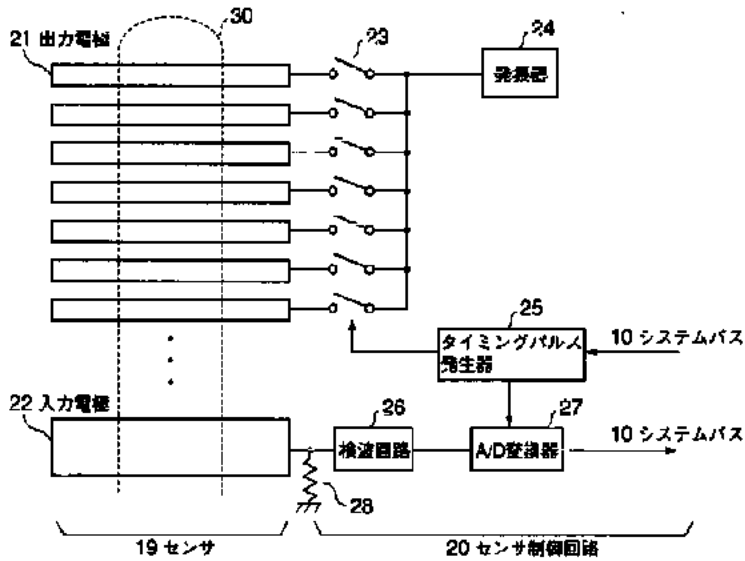
【図1】



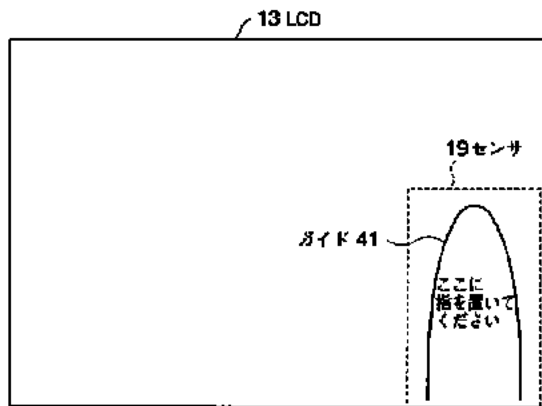
【図4】



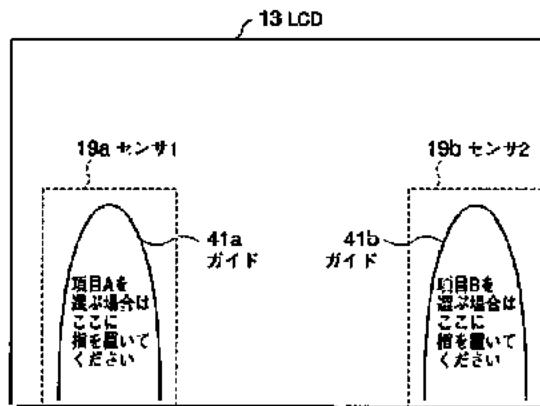
【図2】



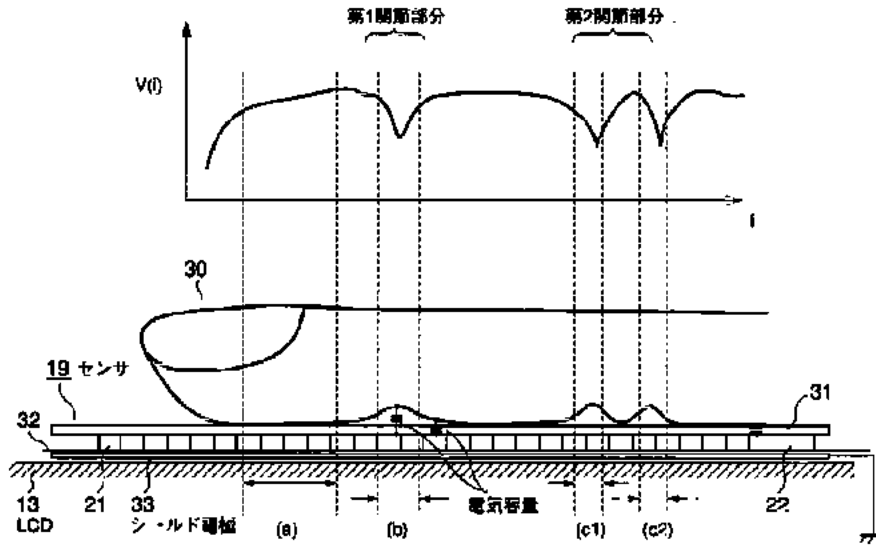
【図6】



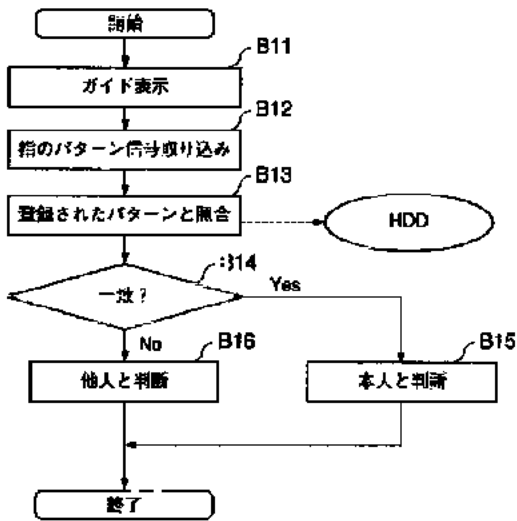
【図8】



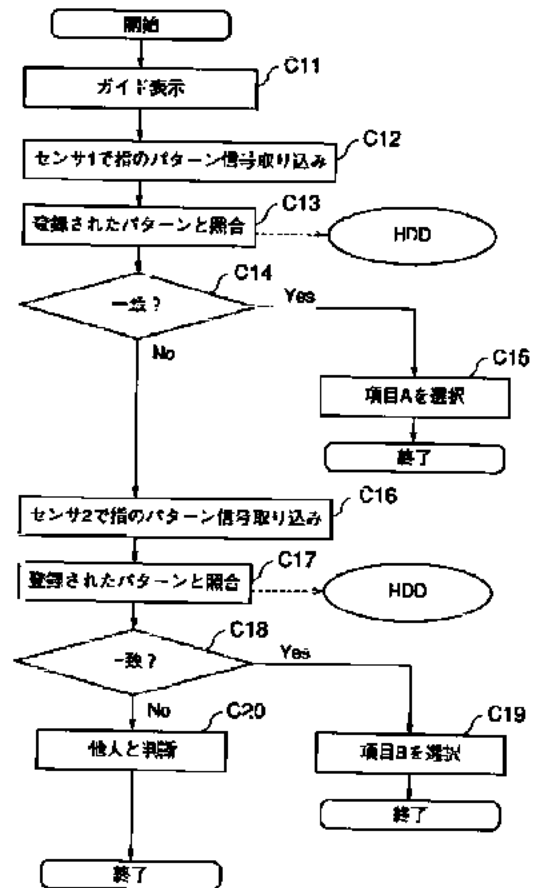
【図3】



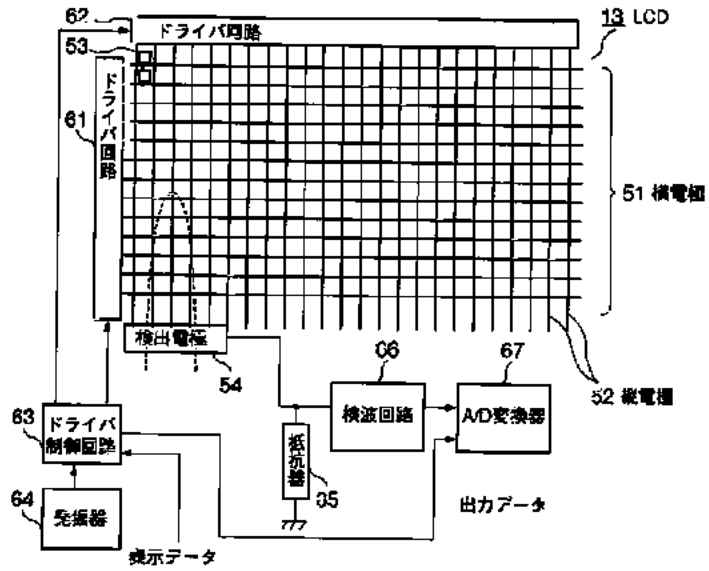
【図5】



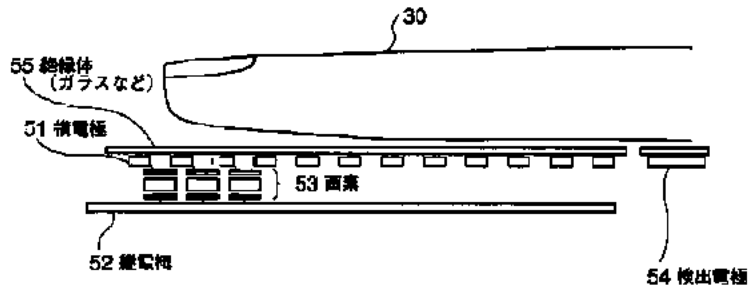
【図9】



【図10】



【図11】





UNITED STATES PATENT AND TRADEMARK OFFICE

UNITED STATES DEPARTMENT OF COMMERCE
United States Patent and Trademark Office
Address: COMMISSIONER FOR PATENTS
P.O. Box 1450
Alexandria, Virginia 22313-1450
www.uspto.gov

Table with 4 columns: APPLICATION NUMBER (14/848,191), FILING OR 371(C) DATE (09/08/2015), FIRST NAMED APPLICANT (Jae Lark JUNG), ATTY. DOCKET NO./TITLE (UNIS005.001C2)

CONFIRMATION NO. 9599

PUBLICATION NOTICE

20995
KNOBBE MARTENS OLSON & BEAR LLP
2040 MAIN STREET
FOURTEENTH FLOOR
IRVINE, CA 92614



Title:ACTIVATING DISPLAY AND PERFORMING USER AUTHENTICATION IN MOBILE TERMINAL WITH ONE-TIME USER INPUT

Publication No.US-2015-0378595-A1

Publication Date:12/31/2015

NOTICE OF PUBLICATION OF APPLICATION

The above-identified application will be electronically published as a patent application publication pursuant to 37 CFR 1.211, et seq. The patent application publication number and publication date are set forth above.

The publication may be accessed through the USPTO's publically available Searchable Databases via the Internet at www.uspto.gov. The direct link to access the publication is currently http://www.uspto.gov/patft/.

The publication process established by the Office does not provide for mailing a copy of the publication to applicant. A copy of the publication may be obtained from the Office upon payment of the appropriate fee set forth in 37 CFR 1.19(a)(1). Orders for copies of patent application publications are handled by the USPTO's Office of Public Records. The Office of Public Records can be reached by telephone at (703) 308-9726 or (800) 972-6382, by facsimile at (703) 305-8759, by mail addressed to the United States Patent and Trademark Office, Office of Public Records, Alexandria, VA 22313-1450 or via the Internet.

In addition, information on the status of the application, including the mailing date of Office actions and the dates of receipt of correspondence filed in the Office, may also be accessed via the Internet through the Patent Electronic Business Center at www.uspto.gov using the public side of the Patent Application Information and Retrieval (PAIR) system. The direct link to access this status information is currently http://pair.uspto.gov/. Prior to publication, such status information is confidential and may only be obtained by applicant using the private side of PAIR.

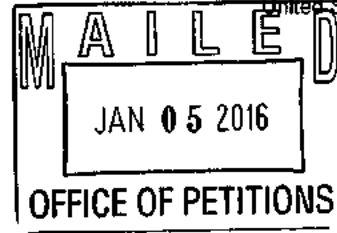
Further assistance in electronically accessing the publication, or about PAIR, is available by calling the Patent Electronic Business Center at 1-866-217-9197.

Office of Data Management, Application Assistance Unit (571) 272-4000, or (571) 272-4200, or 1-888-786-0101





**KNOBBE MARTENS OLSON & BEAR LLP**  
2040 MAIN STREET  
FOURTEENTH FLOOR  
IRVINE CA 92614



Doc Code: TRACK1.GRANT

<p><b>Decision Granting Request for Prioritized Examination (Track I or After RCE)</b></p>	<p>Application No.: 14/848191</p>
<p>1. THE REQUEST FILED <u>September 8, 2015</u> IS <b>GRANTED</b>.</p> <p>The above-identified application has met the requirements for prioritized examination</p> <p>A. <input checked="" type="checkbox"/> for an original nonprovisional application (Track I). <input type="checkbox"/> for an application undergoing continued examination (RCE).</p> <p>2. <b>The above-identified application will undergo prioritized examination.</b> The application will be accorded special status throughout its entire course of prosecution until one of the following occurs:</p> <p>A. filing a <b><u>petition for extension of time</u></b> to extend the time period for filing a reply;</p> <p>B. filing an <b><u>amendment to amend the application to contain more than four independent claims, more than thirty total claims</u></b>, or a multiple dependent claim;</p> <p>C. filing a <b><u>request for continued examination</u></b>;</p> <p>D. filing a notice of appeal;</p> <p>E. filing a request for suspension of action;</p> <p>F. mailing of a notice of allowance;</p> <p>G. mailing of a final Office action;</p> <p>H. completion of examination as defined in 37 CFR 41.102; or</p> <p>I. abandonment of the application.</p> <p>Telephone inquiries with regard to this decision should be directed to Jose' G. Dees at 571-272-1569.</p> <p>/Jose' G. Dees/ [Signature]</p> <p>Petitions Examiner, Office of Petitions (Title)</p>	



UNITED STATES PATENT AND TRADEMARK OFFICE

UNITED STATES DEPARTMENT OF COMMERCE  
United States Patent and Trademark Office  
Address: COMMISSIONER FOR PATENTS  
P O Box 1450  
Alexandria, Virginia 22313-1450  
www.uspto.gov

APPLICATION NO.	FILING DATE	FIRST NAMED INVENTOR	ATTORNEY DOCKET NO.	CONFIRMATION NO.
14/848,191	09/08/2015	Jae Lark JUNG	UNIS005.001C2	9599

20995 7590 02/02/2016  
KNOBBE MARTENS OLSON & BEAR LLP  
2040 MAIN STREET  
FOURTEENTH FLOOR  
IRVINE, CA 92614

EXAMINER
----------

SHEDRICK, CHARLES TERRELL

ART UNIT	PAPER NUMBER
----------	--------------

2646

NOTIFICATION DATE	DELIVERY MODE
-------------------	---------------

02/02/2016

ELECTRONIC

**Please find below and/or attached an Office communication concerning this application or proceeding.**

The time period for reply, if any, is set in the attached communication.

Notice of the Office communication was sent electronically on above-indicated "Notification Date" to the following e-mail address(es):

jayna.cartee@knobbe.com  
efiling@knobbe.com

<b>Notice of References Cited</b>	Application/Control No. 14/848,191	Applicant(s)/Patent Under Reexamination JUNG ET AL.	
	Examiner CHARLES SHEDRICK	Art Unit 2646	Page 1 of 1

**U.S. PATENT DOCUMENTS**

*		Document Number Country Code-Number-Kind Code	Date MM-YYYY	Name	CPC Classification	US Classification
*	A	US-2006/0258289 A1	11-2006	Dua; Robin	G06F17/30058	455/41.3
*	B	US-2010/0102939 A1	04-2010	STEWART; Arthur Leslie	G10H1/34	340/384.1
*	C	US-2010/0159898 A1	06-2010	Krzyzanowski; Paul	G06F9/4445	455/414.1
*	D	US-2010/0304731 A1	12-2010	Bratton; R. Alex	H04N5/232	455/420
*	E	US-2012/0009896 A1	01-2012	Bandyopadhyay; Shamik	G06F1/1643	455/411
*	F	US-2012/0052836 A1	03-2012	Buratti; Richard Michael	H04M1/72541	455/404.2
*	G	US-8,311,514 B2	11-2012	Bandyopadhyay; Shamik	G06F1/1643	455/410
*	H	US-2013/0104187 A1	04-2013	Weidner; Klaus Helmut	G06F21/31	726/1
*	I	US-2014/0162598 A1	06-2014	Villa-Real; Antony-Euclid C.	H04M1/66	455/411
*	J	US-8,782,775 B2	07-2014	Fadell; Anthony	G06F21/316	726/16
	K	US-				
	L	US-				
	M	US-				

**FOREIGN PATENT DOCUMENTS**

*		Document Number Country Code-Number-Kind Code	Date MM-YYYY	Country	Name	CPC Classification
	N					
	O					
	P					
	Q					
	R					
	S					
	T					

**NON-PATENT DOCUMENTS**

*		Include as applicable: Author, Title Date, Publisher, Edition or Volume, Pertinent Pages)
	U	
	V	
	W	
	X	

\*A copy of this reference is not being furnished with this Office action. (See MPEP § 707.05(a).)  
Dates in MM-YYYY format are publication dates. Classifications may be US or foreign.

<b>First Action Interview Pilot Program Pre-Interview Communication</b>	<b>Application No.</b> 14/848,191	<b>Applicant(s)</b> JUNG ET AL.	
	<b>Examiner</b> CHARLES SHEDRICK	<b>Art Unit</b> 2646	<b>AIA (First Inventor to File) Status</b> No

**-The MAILING OR NOTIFICATION DATE of this communication appears on the cover sheet with the correspondence address - THE SHORTENED STATUTORY PERIOD FOR REPLY IS SET TO EXPIRE **ONE MONTH OR THIRTY (30) DAYS**, WHICHEVER IS LONGER, FROM THE MAILING OR NOTIFICATION DATE OF THIS COMMUNICATION.**

**This time period for reply is extendable under 37 CFR 1.136(a) for only ONE additional MONTH.**

**This communication constitutes notice under 37 CFR 1.136(a)(1)(i).**

Applicant must, within the time period for reply, file: (1) A letter requesting not to have a first action interview; (2) A reply under 37 CFR 1.111 waiving the first action interview and First Action Interview Office Action; or (3) An Applicant Initiated Interview Request Form (PTOL-413A) electronically via EFS-Web, accompanied by a proposed amendment or arguments, and schedule the interview within 2 months from the filing of the request. A failure to respond to this communication will be treated as a request not to have an interview. If applicant waives the First Action Interview Office Action, the instant Pre-Interview Communication is deemed the first Office Action on the Merits. The next subsequent Office action may be made final if appropriate. See MPEP 706.07(a).

**Status**

- 1)  Responsive to communication(s) filed on 9/8/15.  
 A declaration(s)/affidavit(s) under **37 CFR 1.130(b)** was/were filed on \_\_\_\_\_.

**Disposition of Claims**

- 2)  Claim(s) 1-20 is/are pending in the application.  
2a) Of the above claim(s) \_\_\_\_\_ is/are withdrawn from consideration.  
3)  Claim(s) \_\_\_\_\_ is/are allowed.  
4)  Claim(s) 1-20 is/are rejected.  
5)  Claim(s) \_\_\_\_\_ is/are objected to.  
6)  Claim(s) \_\_\_\_\_ are subject to restriction and/or election requirement.

**Application Papers**

- 7)  The specification is objected to by the Examiner.  
8)  The drawing(s) filed on 9/8/15 is/are: a)  accepted or b)  objected to by the Examiner.  
Applicant may not request that any objection to the drawing(s) be held in abeyance. See 37 CFR 1.85(a).  
Replacement drawing sheet(s) including the correction is required if the drawing(s) is objected to. See 37 CFR 1.121(d).

**Priority under 35 U.S.C. § 119**

- 9)  Acknowledgment is made of a claim for foreign priority under 35 U.S.C. § 119(a)-(d) or (f).  
a)  All   b)  Some \*   c)  None of:  
1.  Certified copies of the priority documents have been received.  
2.  Certified copies of the priority documents have been received in Application No. \_\_\_\_\_.  
3.  Copies of the certified copies of the priority documents have been received in this National Stage application from the International Bureau (PCT Rule 17.2(a)).

\*See the attached detailed Office action for a list of the certified copies not received.

**Contact Information**

Examiner's Telephone Number: (571)272-8621  
Examiner's Typical Work Schedule: Monday thru Friday 8:00AM-4:30PM  
  
Supervisor's Name: Lester Kincaid    Supervisor's Telephone Number:

<b>Attachment(s)</b> 1) <input checked="" type="checkbox"/> Notice of References Cited (PTO-892) 2) <input checked="" type="checkbox"/> Information Disclosure Statement(s) (PTO/SB/08) Paper No(s)/Mail Date _____.	3) <input type="checkbox"/> Interview Summary (PTO-413) Paper No(s)/Mail Date _____. 4) <input type="checkbox"/> Other: _____.
---	--

<b>First Action Interview Pilot Program Pre-Interview Communication</b>	<b>Application No.</b> 14/848,191		<b>Applicant(s)</b> JUNG ET AL.	
	<b>Examiner</b> CHARLES SHEDRICK		<b>Art Unit</b> 2646	<b>AIA (First Inventor to File) Status</b> No

**Notification of Rejection(s) and/or Objection(s)**

#	Claim(s)	Reference(s) (if applicable)	Rejection Statutory Basis	Brief Explanation of Rejection
1	1-20	N/A	35 USC 101	Claims 1-20 are rejected on the ground of nonstatutory double patenting as being unpatentable over claims of U.S. Patent No. 9179298, 8918074, 8831557
2	1-6,9-15 and 18-20	E	35 USC 102	Abstract, 0004-0005, 0012, 0077-0080-0087, 0101-0106. figures 5 and 6
3	1-20	E and G and/or B and K	35 USC 103	Assuming arguendo that a single reference does not provide adequate teachings the Examiner submits it still would have been obvious to combine the teaching of the prior art to arrive at the claimed invention which provides essentially a manner of authenticati
4	1 and 12	B	35 USC 102	Abstract, 0006, 0009,0019, 0021
5	1 and 12	J	35 USC 102	Abstract, figures 4, 6,8 and 1. col. 1 line 54-col. 2 lines 50,

**Expanded Discussion/Commentary**

3	Via an activation button based on a locked screen. G teaches in the abstract that The application allows wake-up and unlock operations to occur using a single event, such as a single keystroke. In process block 730, in response to the determination that the received input is from a human touch, the mobile device simultaneously activates the touch screen and unlocks the device via fingerprint
1	Claims 1-20 of copending Application 14848156 are identical to the claims of the instant application and therefore cannot be overcome with a Terminal disclaimer

**DATE:**  
26 January, 2016

/CHARLES SHEDRICK/  
Primary Examiner, Art Unit 2646

<b>Notice of References Cited</b>	Application/Control No. 14/848,191	Applicant(s)/Patent Under Reexamination JUNG ET AL.	
	Examiner CHARLES SHEDRICK	Art Unit 2646	Page 1 of 1

**U.S. PATENT DOCUMENTS**

*		Document Number Country Code-Number-Kind Code	Date MM-YYYY	Name	CPC Classification	US Classification
*	A	US-2006/0258289 A1	11-2006	Dua; Robin	G06F17/30058	455/41.3
*	B	US-2010/0102939 A1	04-2010	STEWART; Arthur Leslie	G10H1/34	340/384.1
*	C	US-2010/0159898 A1	06-2010	Krzyzanowski; Paul	G06F9/4445	455/414.1
*	D	US-2010/0304731 A1	12-2010	Bratton; R. Alex	H04N5/232	455/420
*	E	US-2012/0009896 A1	01-2012	Bandyopadhyay; Shamik	G06F1/1643	455/411
*	F	US-2012/0052836 A1	03-2012	Buratti; Richard Michael	H04M1/72541	455/404.2
*	G	US-8,311,514 B2	11-2012	Bandyopadhyay; Shamik	G06F1/1643	455/410
*	H	US-2013/0104187 A1	04-2013	Weidner; Klaus Helmut	G06F21/31	726/1
*	I	US-2014/0162598 A1	06-2014	Villa-Real; Antony-Euclid C.	H04M1/66	455/411
*	J	US-8,782,775 B2	07-2014	Fadell; Anthony	G06F21/316	726/16
	K	US-				
	L	US-				
	M	US-				

**FOREIGN PATENT DOCUMENTS**

*		Document Number Country Code-Number-Kind Code	Date MM-YYYY	Country	Name	CPC Classification
	N					
	O					
	P					
	Q					
	R					
	S					
	T					

**NON-PATENT DOCUMENTS**

*		Include as applicable: Author, Title Date, Publisher, Edition or Volume, Pertinent Pages)
	U	
	V	
	W	
	X	

\*A copy of this reference is not being furnished with this Office action. (See MPEP § 707.05(a).)  
Dates in MM-YYYY format are publication dates. Classifications may be US or foreign.


**UNITED STATES PATENT AND TRADEMARK OFFICE**

UNITED STATES DEPARTMENT OF COMMERCE  
**United States Patent and Trademark Office**  
 Address: COMMISSIONER FOR PATENTS  
 P.O. Box 1450  
 Alexandria, Virginia 22313-1450  
 www.uspto.gov

**BIB DATA SHEET**
**CONFIRMATION NO. 9599**

SERIAL NUMBER	FILING or 371(c) DATE	CLASS	GROUP ART UNIT	ATTORNEY DOCKET NO.		
14/848,191	09/08/2015	455	2646	UNIS005.001C2		
<b>APPLICANTS</b> FIRSTFACE CO., LTD., Seoul, KOREA, REPUBLIC OF; <b>INVENTORS</b> Jae Lark JUNG, Goyang-si, KOREA, REPUBLIC OF; Kyoung duck BAE, Seoul, KOREA, REPUBLIC OF; <b>** CONTINUING DATA *****</b> This application is a CON of 14/538,880 11/12/2014 PAT 9179298 which is a CON of 14/058,761 10/21/2013 PAT 8918074 which is a CON of 13/590,483 08/21/2012 PAT 8831557 <b>** FOREIGN APPLICATIONS *****</b> REPUBLIC OF KOREA 10-2011-0106839 10/19/2011 <b>** IF REQUIRED, FOREIGN FILING LICENSE GRANTED ** ** SMALL ENTITY **</b> 09/21/2015						
Foreign Priority claimed <input checked="" type="checkbox"/> Yes <input type="checkbox"/> No	35 USC 119(a-d) conditions met <input checked="" type="checkbox"/> Yes <input type="checkbox"/> No	<input type="checkbox"/> Met after Allowance cs	<b>STATE OR COUNTRY</b> KOREA, REPUBLIC OF	<b>SHEETS DRAWINGS</b> 5	<b>TOTAL CLAIMS</b> 20	<b>INDEPENDENT CLAIMS</b> 2
Verified and /CHARLES TERRELL SHEDRICK Acknowledged Examiner's Signature	Initials					
<b>ADDRESS</b> KNOBBE MARTENS OLSON & BEAR LLP 2040 MAIN STREET FOURTEENTH FLOOR IRVINE, CA 92614 UNITED STATES						
<b>TITLE</b> ACTIVATING DISPLAY AND PERFORMING USER AUTHENTICATION IN MOBILE TERMINAL WITH ONE-TIME USER INPUT						
<b>FILING FEE RECEIVED</b> 730	FEES: Authority has been given in Paper No. _____ to charge/credit DEPOSIT ACCOUNT No. _____ for following:			<input type="checkbox"/> All Fees <input type="checkbox"/> 1.16 Fees (Filing) <input type="checkbox"/> 1.17 Fees (Processing Ext. of time) <input type="checkbox"/> 1.18 Fees (Issue) <input type="checkbox"/> Other _____ <input type="checkbox"/> Credit		

<b>INFORMATION DISCLOSURE STATEMENT BY APPLICANT</b> ( Not for submission under 37 CFR 1.99)	Application Number		14848191 - GAU: 2646
	Filing Date		Receipt date: 09/08/2015
	First Named Inventor	JAE LARK JUNG	
	Art Unit		
	Examiner Name		
	Attorney Docket Number		UNIS005.001C2

U.S.PATENTS						Remove
Examiner Initial*	Cite No	Patent Number	Kind Code <sup>1</sup>	Issue Date	Name of Patentee or Applicant of cited Document	Pages,Columns,Lines where Relevant Passages or Relevant Figures Appear
	1	6636732	B1	2003-10-21	Boling et al.	
	2	7613446	B2	2009-11-03	Engstrom et al.	
	3	7623847	B2	2009-11-24	Yamashita et al.	
	4	7668829	B2	2010-02-23	Chu et al.	
	5	7738916	B2	2010-06-15	Fukuda	
	6	8265607	B2	2012-09-11	Wormald et al.	
	7	8311514	B2	2012-11-13	Bandyopadhyay et al.	
	8	8538370	B2	2013-09-17	Ray et al.	

ALL REFERENCES CONSIDERED EXCEPT WHERE LINED THROUGH. /C.S./



**INFORMATION DISCLOSURE  
STATEMENT BY APPLICANT**  
( Not for submission under 37 CFR 1.99)

Application Number		14848191 - GAU: 2646
Filing Date		
First Named Inventor	JAE LARK JUNG	
Art Unit		
Examiner Name	Receipt date: 09/08/2015	
Attorney Docket Number	UNIS005.001C2	

9	8660545	B1	2014-02-25	Redford et al.	
10	8782775	B2	2014-07-15	Fadell et al.	
11	8850365	B2	2014-09-30	Cumming	

If you wish to add additional U.S. Patent citation information please click the Add button.

[Add](#)

**U.S.PATENT APPLICATION PUBLICATIONS**

[Remove](#)

Examiner Initial*	Cite No	Publication Number	Kind Code <sup>1</sup>	Publication Date	Name of Patentee or Applicant of cited Document	Pages, Columns, Lines where Relevant Passages or Relevant Figures Appear
	1	20030018395	A1	2003-01-23	Ornkovich et al.	
	2	20050039135	A1	2005-02-17	Othmer et al.	
	3	20060142071	A1	2006-06-29	Stephens	
	4	20070060114	A1	2007-03-15	Ramer et al.	
	5	20070100981	A1	2007-05-03	Adamczyk et al.	
	6	20070136761	A1	2007-06-14	Basmajian, II et al.	

**INFORMATION DISCLOSURE  
STATEMENT BY APPLICANT**  
( Not for submission under 37 CFR 1.99)

Application Number		14848191 - GAU: 2646
Filing Date		
First Named Inventor	JAE LARK JUNG	
Art Unit		
Examiner Name	Receipt date: 09/08/2015	
Attorney Docket Number	UNIS005.001C2	

7	20070249330	A1	2007-10-25	Cortegiano et al.	
8	20070294725	A1	2007-12-20	Cohen et al.	
9	20080027813	A1	2008-01-31	Kogure et al.	
10	20080066610	A1	2008-03-20	Chu et al.	
11	20080070622	A1	2008-03-20	Lee	
12	20080133336	A1	2008-06-05	Altman et al.	
13	20080214150	A1	2008-09-04	Ramer et al.	
14	20090012704	A1	2009-01-08	Franco et al.	
15	20100020020	A1	2010-01-28	Chen	
16	20100102939	A1	2010-04-29	Stewart	
17	20100312643	A1	2010-12-09	Gil	

**INFORMATION DISCLOSURE  
STATEMENT BY APPLICANT**  
( Not for submission under 37 CFR 1.99)

Application Number		14848191 - GAU: 2646
Filing Date		
First Named Inventor	JAE LARK JUNG	
Art Unit		
Examiner Name	Receipt date: 09/08/2015	
Attorney Docket Number	UNIS005.001C2	

18	20110004678	A1	2011-01-06	Rothrock	
19	20110080260	A1	2011-04-07	Wang et al.	
20	20120052836	A1	2012-03-01	Buratti et al.	
21	20120302200	A1	2012-11-29	Esbensen	
22	20130057385	A1	2013-03-07	Murakami et al.	
23	20130102273	A1	2013-04-25	Jung et al.	
24	20130102363	A1	2013-04-25	Jung et al.	

If you wish to add additional U.S. Published Application citation information please click the Add button. [Add](#)

**FOREIGN PATENT DOCUMENTS**

[Remove](#)

Examiner Initial*	Cite No	Foreign Document Number <sup>3</sup>	Country Code <sup>2</sup> i	Kind Code <sup>4</sup>	Publication Date	Name of Patentee or Applicant of cited Document	Pages, Columns, Lines where Relevant Passages or Relevant Figures Appear	T <sup>5</sup>
	1	2076000	EP	A2	2009-07-01	LG ELECTRONICS INC		<input type="checkbox"/>
	2	10-1998-085647	KR	A	1998-12-05	LG INFORMATION & COMMUNICATIONS LTD.		<input checked="" type="checkbox"/>

ALL REFERENCES CONSIDERED EXCEPT WHERE LINED THROUGH. /C.S./

**INFORMATION DISCLOSURE  
STATEMENT BY APPLICANT**  
( Not for submission under 37 CFR 1.99)

Application Number		14848191 - GAU: 2646
Filing Date		
First Named Inventor	JAE LARK JUNG	
Art Unit		
Examiner Name	Receipt date: 09/08/2015	
Attorney Docket Number	UNIS005.001C2	

3	10-2001-0026243	KR	A	2001-04-06	SAMSUNG ELECTRONICS CO., LTD.	<input checked="" type="checkbox"/>
4	10-2005-0079475	KR	A	2005-08-10	PANTECH CO.,LTD.	<input checked="" type="checkbox"/>
5	10-2006-0033664	KR	A	2006-04-19	PANTECH CO.,LTD.	<input checked="" type="checkbox"/>
6	10-2008-0086757	KR	A	2008-09-26	LG UPLUS CORP	<input checked="" type="checkbox"/>
7	10-2010-0027855	KR	A	2010-03-11	LG UPLUS CORP	<input checked="" type="checkbox"/>
8	10-2010-0049986	KR	A	2010-05-13	LG ELECTRONICS INC.	<input checked="" type="checkbox"/>
9	2007/033358	WO	A2	2007-03-22	JUMP TAP, INC.	<input type="checkbox"/>
10	2008/081420	WO	A2	2008-07-10	CELLTICK TECHNOLOGIES LTD	<input type="checkbox"/>
11	2010/126504	WO	A1	2010-11-04	HEWLETT-PACKARD DEVELOPMENT COMPANY, L.P.	<input type="checkbox"/>

If you wish to add additional Foreign Patent Document citation information please click the Add button **Add**

**NON-PATENT LITERATURE DOCUMENTS**

**Remove**

Examiner Initials*	Cite No	Include name of the author (in CAPITAL LETTERS), title of the article (when appropriate), title of the item (book, magazine, journal, serial, symposium, catalog, etc), date, pages(s), volume-issue number(s), publisher, city and/or country where published.	T <sup>5</sup>
--------------------	---------	---	----------------

<b>INFORMATION DISCLOSURE STATEMENT BY APPLICANT</b> ( Not for submission under 37 CFR 1.99)	Application Number	14848191 - GAU: 2646
	Filing Date	
	First Named Inventor	JAE LARK JUNG
	Art Unit	
	Examiner Name	Receipt date: 09/08/2015
	Attorney Docket Number	UNIS005.001C2

1	International Search Report dated March 20, 2013 of corresponding PCT Application PCT/KR2012/008470 (WO/2013/058533)	<input type="checkbox"/>
2	EP Search Report of corresponding European Patent Application No. 20120842666	<input type="checkbox"/>
3	Think Vantage Fingerprint Software, International Business Machines Corporation, First Edition, November 2005 "http://download.lenovo.com/ibmdl/pub/pc/pccbbs/thinkvantage_en/dfs56ug_en.pdf"	<input type="checkbox"/>
4	Concept iPhone 5 with Fingerprint Scanner "http://gadgets.in.com/concept-iphone-5-with-fingerprint-scanner.htm"	<input type="checkbox"/>
5	Acer Tempo M900 "http://www.theregister.co.uk/2009/07/15/review_phone_acer_tempo_m900/"	<input type="checkbox"/>
6	iPhone User Guide (For iOS 4.2 and 4.3 Software) (Apple Inc.) 2011.03.09 Chapter 1	<input type="checkbox"/>

If you wish to add additional non-patent literature document citation information please click the Add button **Add**


**EXAMINER SIGNATURE**

Examiner Signature	/Charles Shedrick/	Date Considered	01/26/2016
--------------------	--------------------	-----------------	------------

\*EXAMINER: Initial if reference considered, whether or not citation is in conformance with MPEP 609. Draw line through a citation if not in conformance and not considered. Include copy of this form with next communication to applicant.

<sup>1</sup> See Kind Codes of USPTO Patent Documents at [www.USPTO.GOV](http://www.USPTO.GOV) or MPEP 901.04. <sup>2</sup> Enter office that issued the document, by the two-letter code (WIPO Standard ST.3). <sup>3</sup> For Japanese patent documents, the indication of the year of the reign of the Emperor must precede the serial number of the patent document. <sup>4</sup> Kind of document by the appropriate symbols as indicated on the document under WIPO Standard ST.16 if possible. <sup>5</sup> Applicant is to place a check mark here if English language translation is attached.

ALL REFERENCES CONSIDERED EXCEPT WHERE LINED THROUGH. /G.S./

<b>Search Notes</b>  	<b>Application/Control No.</b>  14848191	<b>Applicant(s)/Patent Under Reexamination</b>  JUNG ET AL.
	<b>Examiner</b>  CHARLES SHEDRICK	<b>Art Unit</b>  2646

CPC- SEARCHED		
Symbol	Date	Examiner
H04W 4/02 ; H04W 12/08 ; H04M 1/67 ; H04M 1/7258 ; H04M 2250/52 ; H04M 1/72519 ; H04W 8/22; H04W 52/027 ; G06F 21/32 ; H04W 12/06 ; H04M 22	1/26/2016	cs

CPC COMBINATION SETS - SEARCHED		
Symbol	Date	Examiner

US CLASSIFICATION SEARCHED			
Class	Subclass	Date	Examiner
455	411,414.1, 420,404.2, 410	1/26/2016	cs
726	1,16	1/26/2016	cs

SEARCH NOTES		
Search Notes	Date	Examiner
EAST text search, CPC search, Inventor search	1/19/2016	cs

INTERFERENCE SEARCH			
US Class/ CPC Symbol	US Subclass / CPC Group	Date	Examiner

	/CHARLES SHEDRICK/ Primary Examiner.Art Unit 2646
--	--

<b>INFORMATION DISCLOSURE STATEMENT BY APPLICANT</b> ( Not for submission under 37 CFR 1.99)	Application Number		14848191	
	Filing Date		2015-09-08	
	First Named Inventor	Jae Lark Jung		
	Art Unit	2143		
	Examiner Name	Jennifer N. To		
	Attorney Docket Number	UNIS005.001C2		

U.S.PATENTS						Remove
Examiner Initial*	Cite No	Patent Number	Kind Code <sup>1</sup>	Issue Date	Name of Patentee or Applicant of cited Document	Pages,Columns,Lines where Relevant Passages or Relevant Figures Appear
	1	6476797	B1	2002-11-05	Kurihara et al.	
	2	8811948	B2	2014-08-19	Bandyopadhyay et al.	
	3	9082235	B2	2015-07-14	Lau et al.	

If you wish to add additional U.S. Patent citation information please click the Add button.

Add

U.S.PATENT APPLICATION PUBLICATIONS						Remove
Examiner Initial*	Cite No	Publication Number	Kind Code <sup>1</sup>	Publication Date	Name of Patentee or Applicant of cited Document	Pages,Columns,Lines where Relevant Passages or Relevant Figures Appear
	1	20020083329	A1	2002-06-27	Kiyomoto	
	2	20020188855	A1	2002-12-12	Nakayama et al.	
	3	20090017871	A1	2009-01-15	Brieskorn	

ALL REFERENCES CONSIDERED EXCEPT WHERE LINED THROUGH. /C.S./

**INFORMATION DISCLOSURE  
STATEMENT BY APPLICANT**  
( Not for submission under 37 CFR 1.99)

Application Number		14848191
Filing Date		2015-09-08
First Named Inventor	Jae Lark Jung	
Art Unit		2143
Examiner Name	Jennifer N. To	
Attorney Docket Number	UNIS005.001C2	

4	20090083850	A1	2009-03-26	Fadell et al.	
5	20090239591	A1	2009-09-24	Alameh et al.	
6	20100079380	A1	2010-04-01	Numi	
7	20100079508	A1	2010-04-01	Hodge et al.	
8	20110069940	A1	2011-03-24	Shimy et al.	
9	20120069042	A1	2012-03-22	Ogita et al.	
10	20120146898	A1	2012-06-14	Lin	
11	20150133086	A1	2015-05-14	Pratt et al.	

If you wish to add additional U.S. Published Application citation information please click the Add button. [Add](#)

**FOREIGN PATENT DOCUMENTS**

[Remove](#)

Examiner Initial*	Cite No	Foreign Document Number <sup>3</sup>	Country Code <sup>2</sup> i	Kind Code <sup>4</sup>	Publication Date	Name of Patentee or Applicant of cited Document	Pages, Columns, Lines where Relevant Passages or Relevant Figures Appear	T <sup>5</sup>
	1	1990734	EP	A1	2008-11-12	Menstecnica S.R.L.		<input type="checkbox"/>

ALL REFERENCES CONSIDERED EXCEPT WHERE LINED THROUGH. /C.S./



**INFORMATION DISCLOSURE  
STATEMENT BY APPLICANT**  
( Not for submission under 37 CFR 1.99)

Application Number		14848191
Filing Date		2015-09-08
First Named Inventor	Jae Lark Jung	
Art Unit	2143	
Examiner Name	Jennifer N. To	
Attorney Docket Number	UNIS005.001C2	

2	10-2007-0076317	KR	A	2007-07-24	LG Electronics Inc.	<input checked="" type="checkbox"/>
3	2007-179343	JP	A	2007-07-12	Casio Hitachi Mobile Communications Co Ltd.	<input checked="" type="checkbox"/>
4	H11-328362	JP	A	1999-11-30	Toshiba Corp.	<input checked="" type="checkbox"/>

If you wish to add additional Foreign Patent Document citation information please click the Add button **Add**

**NON-PATENT LITERATURE DOCUMENTS**

**Remove**

Examiner Initials*	Cite No	Include name of the author (in CAPITAL LETTERS), title of the article (when appropriate), title of the item (book, magazine, journal, serial, symposium, catalog, etc), date, pages(s), volume-issue number(s), publisher, city and/or country where published.	T <sup>5</sup>
	1		<input type="checkbox"/>

If you wish to add additional non-patent literature document citation information please click the Add button **Add**

**EXAMINER SIGNATURE**

Examiner Signature	/Charles Shedrick/	Date Considered	/Charles Shedrick/
--------------------	--------------------	-----------------	--------------------

\*EXAMINER: Initial if reference considered, whether or not citation is in conformance with MPEP 609. Draw line through a citation if not in conformance and not considered. Include copy of this form with next communication to applicant.

<sup>1</sup> See Kind Codes of USPTO Patent Documents at [www.USPTO.GOV](http://www.USPTO.GOV) or MPEP 901.04. <sup>2</sup> Enter office that issued the document, by the two-letter code (WIPO Standard ST.3). <sup>3</sup> For Japanese patent documents, the indication of the year of the reign of the Emperor must precede the serial number of the patent document. <sup>4</sup> Kind of document by the appropriate symbols as indicated on the document under WIPO Standard ST.16 if possible. <sup>5</sup> Applicant is to place a check mark here if English language translation is attached.

ALL REFERENCES CONSIDERED EXCEPT WHERE LINED THROUGH. /C.S./

**Applicant Initiated Interview Request Form**

Application No.: 14/848,191 First Named Applicant: Jae Lark Jung  
 Examiner: Charles Terrell Shedrick Art Unit: 2646 Status of Application: PENDING

**Tentative Participants:**

- (1) Examiner Shedrick (2) Mincheol Kim; Reg. 51,306  
 (3) Hochan Song; Reg. 67,824 (4) \_\_\_\_\_

Proposed Date of Interview: April 11, 2016 Proposed Time: 2:00 PM ET (AM/PM)

**Type of Interview Requested:**

- (1)  Telephonic (2)  Personal (3)  Video Conference

Exhibit To Be Shown or Demonstrated:  YES  NO

If yes, provide brief description: \_\_\_\_\_

**Issues To Be Discussed**

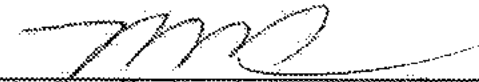
Issues (Rej., Obj., etc)	Claims/ Fig. #s	Prior Art	Discussed	Agreed	Not Agreed
(1) <u>Rej. 101</u>	<u>Claim 1</u>	<u>N/A</u>	<input type="checkbox"/>	<input type="checkbox"/>	<input type="checkbox"/>
(2) <u>Rej. 102</u>	<u>Claims 1 &amp; 11</u>	_____	<input type="checkbox"/>	<input type="checkbox"/>	<input type="checkbox"/>
(3) _____	_____	_____	<input type="checkbox"/>	<input type="checkbox"/>	<input type="checkbox"/>
(4) <u>Rej. 103</u>	<u>Claims 1 &amp; 11</u>	_____	<input type="checkbox"/>	<input type="checkbox"/>	<input type="checkbox"/>

Continuation Sheet Attached  Proposed Amendment or Arguments Attached

Brief Description of Arguments to be Presented: PROPOSED AMENDMENTS PROVIDED PRIOR TO INTERVIEW

An interview was conducted on the above-identified application on \_\_\_\_\_

**NOTE:** This form should be completed and filed by applicant in advance of the interview (see MPEP § 713.01). If this form is signed by a registered practitioner not of record, the Office will accept this as an indication that he or she is authorized to conduct an interview on behalf of the principal (37 CFR 1.32(a)(3)) pursuant to 37 CFR 1.34. This is not a power of attorney to any above named practitioner. See the Instruction Sheet for this form, which is incorporated by reference. By signing this form, applicant or practitioner is certifying that he or she has read the Instruction Sheet. After the interview is conducted, applicant is advised to file a statement of the substance of this interview (37 CFR 1.133(b)) as soon as possible. This application will not be delayed from issue because of applicant's failure to submit a written record of this interview.



Applicant/Applicant's Representative Signature

Mincheol Kim

Typed/Printed Name of Applicant or Representative

51,306

Registration Number, if applicable

Examiner/SPE Signature

This collection of information is required by 37 CFR 1.133. The information is required to obtain or retain a benefit by the public which is to file (and by the USPTO to process) an application. Confidentiality is governed by 35 U.S.C. 122 and 37 CFR 1.11 and 1.14. This collection is estimated to take 24 minutes to complete, including gathering, preparing, and submitting the completed application form to the USPTO. Time will vary depending upon the individual case. Any comments on the amount of time you require to complete this form and/or suggestions for reducing this burden, should be sent to the Chief Information Officer, U.S. Patent and Trademark Office, U.S. Department of Commerce, P.O. Box 1450, Alexandria, VA 22313-1450. DO NOT SEND FEES OR COMPLETED FORMS TO THIS ADDRESS. SEND TO: Commissioner for Patents, P.O. Box 1450, Alexandria, VA 22313-1450.

If you need assistance in completing the form, call 1-800-PTO-9199 and select option 2.

## Electronic Acknowledgement Receipt

<b>EFS ID:</b>	25070633
<b>Application Number:</b>	14848191
<b>International Application Number:</b>	
<b>Confirmation Number:</b>	9599
<b>Title of Invention:</b>	ACTIVATING DISPLAY AND PERFORMING USER AUTHENTICATION IN MOBILE TERMINAL WITH ONE-TIME USER INPUT
<b>First Named Inventor/Applicant Name:</b>	Jae Lark JUNG
<b>Customer Number:</b>	20995
<b>Filer:</b>	Mincheol Kim/Sandra Autry
<b>Filer Authorized By:</b>	Mincheol Kim
<b>Attorney Docket Number:</b>	UNIS005.001C2
<b>Receipt Date:</b>	01-MAR-2016
<b>Filing Date:</b>	08-SEP-2015
<b>Time Stamp:</b>	19:56:26
<b>Application Type:</b>	Utility under 35 USC 111(a)

### Payment information:

Submitted with Payment	no
------------------------	----

### File Listing:

Document Number	Document Description	File Name	File Size(Bytes)/ Message Digest	Multi Part /.zip	Pages (if appl.)
1	First Action Interview - Schedule Interview request	FAI_InterviewRequest-UNIS005_001C2.pdf	123104 <small>2f4012ec701b003434f533e0abd85957bc1Ba5b4</small>	no	1

### Warnings:

### Information:

**This Acknowledgement Receipt evidences receipt on the noted date by the USPTO of the indicated documents, characterized by the applicant, and including page counts, where applicable. It serves as evidence of receipt similar to a Post Card, as described in MPEP 503.**

**New Applications Under 35 U.S.C. 111**

**If a new application is being filed and the application includes the necessary components for a filing date (see 37 CFR 1.53(b)-(d) and MPEP 506), a Filing Receipt (37 CFR 1.54) will be issued in due course and the date shown on this Acknowledgement Receipt will establish the filing date of the application.**

**National Stage of an International Application under 35 U.S.C. 371**

**If a timely submission to enter the national stage of an international application is compliant with the conditions of 35 U.S.C. 371 and other applicable requirements a Form PCT/DO/EO/903 indicating acceptance of the application as a national stage submission under 35 U.S.C. 371 will be issued in addition to the Filing Receipt, in due course.**

**New International Application Filed with the USPTO as a Receiving Office**

**If a new international application is being filed and the international application includes the necessary components for an international filing date (see PCT Article 11 and MPEP 1810), a Notification of the International Application Number and of the International Filing Date (Form PCT/RO/105) will be issued in due course, subject to prescriptions concerning national security, and the date shown on this Acknowledgement Receipt will establish the international filing date of the application.**



UNITED STATES PATENT AND TRADEMARK OFFICE

UNITED STATES DEPARTMENT OF COMMERCE
United States Patent and Trademark Office
Address: COMMISSIONER FOR PATENTS
P O Box 1450
Alexandria, Virginia 22313-1450
www.uspto.gov

Table with 5 columns: APPLICATION NO., FILING DATE, FIRST NAMED INVENTOR, ATTORNEY DOCKET NO., CONFIRMATION NO.
14/848,191 09/08/2015 Jae Lark JUNG UNIS005.001C2 9599

20995 7590 04/15/2016
KNOBBE MARTENS OLSON & BEAR LLP
2040 MAIN STREET
FOURTEENTH FLOOR
IRVINE, CA 92614

EXAMINER

SHEDRICK, CHARLES TERRELL

ART UNIT PAPER NUMBER

2646

NOTIFICATION DATE DELIVERY MODE

04/15/2016

ELECTRONIC

Please find below and/or attached an Office communication concerning this application or proceeding.

The time period for reply, if any, is set in the attached communication.

Notice of the Office communication was sent electronically on above-indicated "Notification Date" to the following e-mail address(es):

jayna.cartee@knobbe.com
efiling@knobbe.com

<b>Applicant-Initiated Interview Summary</b>	<b>Application No.</b> 14/848,191	<b>Applicant(s)</b> JUNG ET AL.	
	<b>Examiner</b> CHARLES SHEDRICK	<b>Art Unit</b> 2646	

All participants (applicant, applicant's representative, PTO personnel):

- (1) CHARLES SHEDRICK. (3) Hochan Song; 67,824.  
(2) Mincheol Kim, Req. 51,306. (4) \_\_\_\_\_.

Date of Interview: 4/12/16.

Type:  Telephonic  Video Conference  
 Personal [copy given to:  applicant  applicant's representative]

Exhibit shown or demonstration conducted:  Yes  No.  
If Yes, brief description: \_\_\_\_\_.

Issues Discussed 101 112 102 103 Others  
(For each of the checked box(es) above, please describe below the issue and detailed description of the discussion)

Claim(s) discussed: 1.

Identification of prior art discussed: Bandyopadhyay et al., US 2012/0009896 A1, Fadell et al. US Patent Pub. No.: 2009/0083850.

**Substance of Interview**

(For each issue discussed, provide a detailed description and indicate if agreement was reached. Some topics may include: identification or clarification of a reference or a portion thereof, claim interpretation, proposed amendments, arguments of any applied references etc...)

Examiner discussed that Amendments overcome 102 rejection. However, the case appears to still present USC 103 issues. Examiner suggested combining dependent claim subject matter to potentially overcome obviousness 103 rejection.

**Applicant recordation instructions:** The formal written reply to the last Office action must include the substance of the interview. (See MPEP section 713.04). If a reply to the last Office action has already been filed, applicant is given a non-extendable period of the longer of one month or thirty days from this interview date, or the mailing date of this interview summary form, whichever is later, to file a statement of the substance of the interview

**Examiner recordation instructions:** Examiners must summarize the substance of any interview of record. A complete and proper recordation of the substance of an interview should include the items listed in MPEP 713.04 for complete and proper recordation including the identification of the general thrust of each argument or issue discussed, a general indication of any other pertinent matters discussed regarding patentability and the general results or outcome of the interview, to include an indication as to whether or not agreement was reached on the issues raised.

Attachment

/CHARLES SHEDRICK/  
Primary Examiner, Art Unit 2646

## Summary of Record of Interview Requirements

### Manual of Patent Examining Procedure (MPEP), Section 713.04, Substance of Interview Must be Made of Record

A complete written statement as to the substance of any face-to-face, video conference, or telephone interview with regard to an application must be made of record in the application whether or not an agreement with the examiner was reached at the interview.

### Title 37 Code of Federal Regulations (CFR) § 1.133 Interviews Paragraph (b)

In every instance where reconsideration is requested in view of an interview with an examiner, a complete written statement of the reasons presented at the interview as warranting favorable action must be filed by the applicant. An interview does not remove the necessity for reply to Office action as specified in §§ 1.111, 1.135. (35 U.S.C. 132)

#### 37 CFR §1.2 Business to be transacted in writing.

All business with the Patent or Trademark Office should be transacted in writing. The personal attendance of applicants or their attorneys or agents at the Patent and Trademark Office is unnecessary. The action of the Patent and Trademark Office will be based exclusively on the written record in the Office. No attention will be paid to any alleged oral promise, stipulation, or understanding in relation to which there is disagreement or doubt.

The action of the Patent and Trademark Office cannot be based exclusively on the written record in the Office if that record is itself incomplete through the failure to record the substance of interviews.

It is the responsibility of the applicant or the attorney or agent to make the substance of an interview of record in the application file, unless the examiner indicates he or she will do so. It is the examiner's responsibility to see that such a record is made and to correct material inaccuracies which bear directly on the question of patentability.

Examiners must complete an Interview Summary Form for each interview held where a matter of substance has been discussed during the interview by checking the appropriate boxes and filling in the blanks. Discussions regarding only procedural matters, directed solely to restriction requirements for which interview recordation is otherwise provided for in Section 812.01 of the Manual of Patent Examining Procedure, or pointing out typographical errors or unreadable script in Office actions or the like, are excluded from the interview recordation procedures below. Where the substance of an interview is completely recorded in an Examiners Amendment, no separate Interview Summary Record is required.

The Interview Summary Form shall be given an appropriate Paper No., placed in the right hand portion of the file, and listed on the "Contents" section of the file wrapper. In a personal interview, a duplicate of the Form is given to the applicant (or attorney or agent) at the conclusion of the interview. In the case of a telephone or video-conference interview, the copy is mailed to the applicant's correspondence address either with or prior to the next official communication. If additional correspondence from the examiner is not likely before an allowance or if other circumstances dictate, the Form should be mailed promptly after the interview rather than with the next official communication.

The Form provides for recordation of the following information:

- Application Number (Series Code and Serial Number)
- Name of applicant
- Name of examiner
- Date of interview
- Type of interview (telephonic, video-conference, or personal)
- Name of participant(s) (applicant, attorney or agent, examiner, other PTO personnel, etc.)
- An indication whether or not an exhibit was shown or a demonstration conducted
- An identification of the specific prior art discussed
- An indication whether an agreement was reached and if so, a description of the general nature of the agreement (may be by attachment of a copy of amendments or claims agreed as being allowable). Note: Agreement as to allowability is tentative and does not restrict further action by the examiner to the contrary.
- The signature of the examiner who conducted the interview (if Form is not an attachment to a signed Office action)

It is desirable that the examiner orally remind the applicant of his or her obligation to record the substance of the interview of each case. It should be noted, however, that the Interview Summary Form will not normally be considered a complete and proper recordation of the interview unless it includes, or is supplemented by the applicant or the examiner to include, all of the applicable items required below concerning the substance of the interview.

A complete and proper recordation of the substance of any interview should include at least the following applicable items:

- 1) A brief description of the nature of any exhibit shown or any demonstration conducted,
- 2) an identification of the claims discussed,
- 3) an identification of the specific prior art discussed,
- 4) an identification of the principal proposed amendments of a substantive nature discussed, unless these are already described on the Interview Summary Form completed by the Examiner,
- 5) a brief identification of the general thrust of the principal arguments presented to the examiner.  
(The identification of arguments need not be lengthy or elaborate. A verbatim or highly detailed description of the arguments is not required. The identification of the arguments is sufficient if the general nature or thrust of the principal arguments made to the examiner can be understood in the context of the application file. Of course, the applicant may desire to emphasize and fully describe those arguments which he or she feels were or might be persuasive to the examiner.)
- 6) a general indication of any other pertinent matters discussed, and
- 7) if appropriate, the general results or outcome of the interview unless already described in the Interview Summary Form completed by the examiner.

Examiners are expected to carefully review the applicant's record of the substance of an interview. If the record is not complete and accurate, the examiner will give the applicant an extendable one month time period to correct the record.

### Examiner to Check for Accuracy

If the claims are allowable for other reasons of record, the examiner should send a letter setting forth the examiner's version of the statement attributed to him or her. If the record is complete and accurate, the examiner should place the indication, "Interview Record OK" on the paper recording the substance of the interview along with the date and the examiner's initials.

Electronic Petition Request	<b>TERMINAL DISCLAIMER TO OBIVIATE A DOUBLE PATENTING REJECTION OVER A "PRIOR" PATENT</b>
Application Number	14848191
Filing Date	08-Sep-2015
First Named Inventor	Jae Lark JUNG
Attorney Docket Number	UNIS005.001C2
Title of Invention	ACTIVATING DISPLAY AND PERFORMING USER AUTHENTICATION IN MOBILE TERMINAL WITH ONE-TIME USER INPUT

- Filing of terminal disclaimer does not obviate requirement for response under 37 CFR 1.111 to outstanding Office Action
- This electronic Terminal Disclaimer is not being used for a Joint Research Agreement.

Owner	Percent Interest
FIRSTFACE CO., LTD.	100%

The owner(s) with percent interest listed above in the instant application hereby disclaims, except as provided below, the terminal part of the statutory term of any patent granted on the instant application which would extend beyond the expiration date of the full statutory term of prior patent number(s)

9179298  
8918074  
8831557

as the term of said prior patent is presently shortened by any terminal disclaimer. The owner hereby agrees that any patent so granted on the instant application shall be enforceable only for and during such period that it and the prior patent are commonly owned. This agreement runs with any patent granted on the instant application and is binding upon the grantee, its successors or assigns.

In making the above disclaimer, the owner does not disclaim the terminal part of the term of any patent granted on the instant application that would extend to the expiration date of the full statutory term of the prior patent, "as the term of said prior patent is presently shortened by any terminal disclaimer," in the event that said prior patent later:

- expires for failure to pay a maintenance fee;
- is held unenforceable;
- is found invalid by a court of competent jurisdiction;
- is statutorily disclaimed in whole or terminally disclaimed under 37 CFR 1.321;
- has all claims canceled by a reexamination certificate;
- is reissued; or
- is in any manner terminated prior to the expiration of its full statutory term as presently shortened by any terminal disclaimer.



Terminal disclaimer fee under 37 CFR 1.20(d) is included with Electronic Terminal Disclaimer request.

I certify, in accordance with 37 CFR 1.4(d)(4), that the terminal disclaimer fee under 37 CFR 1.20(d) required for this terminal disclaimer has already been paid in the above-identified application.

Applicant claims the following fee status:

Small Entity

Micro Entity

Regular Undiscounted

I hereby declare that all statements made herein of my own knowledge are true and that all statements made on information and belief are believed to be true; and further that these statements were made with the knowledge that willful false statements and the like so made are punishable by fine or imprisonment, or both, under Section 1001 of Title 18 of the United States Code and that such willful false statements may jeopardize the validity of the application or any patent issued thereon.

THIS PORTION MUST BE COMPLETED BY THE SIGNATORY OR SIGNATORIES

I certify, in accordance with 37 CFR 1.4(d)(4) that I am:

An attorney or agent registered to practice before the Patent and Trademark Office who is of record in this application

Registration Number 51306

A sole inventor

A joint inventor; I certify that I am authorized to sign this submission on behalf of all of the inventors as evidenced by the power of attorney in the application

A joint inventor; all of whom are signing this request

Signature	/Mincheol Kim/
Name	MINCHEOL KIM

\*Statement under 37 CFR 3.73(b) is required if terminal disclaimer is signed by the assignee (owner).  
Form PTO/SB/96 may be used for making this certification. See MPEP § 324.

## Electronic Patent Application Fee Transmittal

<b>Application Number:</b>	14848191
<b>Filing Date:</b>	08-Sep-2015
<b>Title of Invention:</b>	ACTIVATING DISPLAY AND PERFORMING USER AUTHENTICATION IN MOBILE TERMINAL WITH ONE-TIME USER INPUT
<b>First Named Inventor/Applicant Name:</b>	Jae Lark JUNG
<b>Filer:</b>	Mincheol Kim/Christina Graul
<b>Attorney Docket Number:</b>	UNIS005.001C2

Filed as Small Entity

**Filing Fees for Utility under 35 USC 111(a)**

Description	Fee Code	Quantity	Amount	Sub-Total in USD(\$)
<b>Basic Filing:</b>				
Statutory or Terminal Disclaimer	2814	1	160	160

**Pages:**

**Claims:**

**Miscellaneous-Filing:**

**Petition:**

**Patent-Appeals-and-Interference:**

**Post-Allowance-and-Post-Issuance:**

Description	Fee Code	Quantity	Amount	Sub-Total in USD(\$)
<b>Extension-of-Time:</b>				
<b>Miscellaneous:</b>				
<b>Total in USD (\$)</b>				<b>160</b>

Doc Code: DISQ.E.FILE

Document Description: Electronic Terminal Disclaimer – Approved

Application No.: 14848191

Filing Date: 08-Sep-2015

Applicant/Patent under Reexamination: JUNG et al.

Electronic Terminal Disclaimer filed on May 13, 2016

APPROVED

**This patent is subject to a terminal disclaimer**

DISAPPROVED

Approved/Disapproved by: Electronic Terminal Disclaimer automatically approved by EFS-Web

U.S. Patent and Trademark Office

## Electronic Acknowledgement Receipt

<b>EFS ID:</b>	25773923
<b>Application Number:</b>	14848191
<b>International Application Number:</b>	
<b>Confirmation Number:</b>	9599
<b>Title of Invention:</b>	ACTIVATING DISPLAY AND PERFORMING USER AUTHENTICATION IN MOBILE TERMINAL WITH ONE-TIME USER INPUT
<b>First Named Inventor/Applicant Name:</b>	Jae Lark JUNG
<b>Customer Number:</b>	20995
<b>Filer:</b>	Mincheol Kim/Christina Graul
<b>Filer Authorized By:</b>	Mincheol Kim
<b>Attorney Docket Number:</b>	UNIS005.001C2
<b>Receipt Date:</b>	13-MAY-2016
<b>Filing Date:</b>	08-SEP-2015
<b>Time Stamp:</b>	16:25:48
<b>Application Type:</b>	Utility under 35 USC 111(a)

### Payment information:

Submitted with Payment	yes
Payment Type	Credit Card
Payment was successfully received in RAM	\$160
RAM confirmation Number	2982
Deposit Account	111410
Authorized User	KNOBBE MARTENS OLSON AND BEAR

The Director of the USPTO is hereby authorized to charge indicated fees and credit any overpayment as follows:

Charge any Additional Fees required under 37 CFR 1.16 (National application filing, search, and examination fees)

Charge any Additional Fees required under 37 CFR 1.17 (Patent application and reexamination processing fees)

--	--	--	--	--	--

**File Listing:**

Document Number	Document Description	File Name	File Size(Bytes)/ Message Digest	Multi Part /.zip	Pages (if appl.)
1	Electronic Terminal Disclaimer-Filed	eTerminal-Disclaimer.pdf	34014 f73a1c5b0f3aa91a87f0a9000f689a4ed6485d91	no	2

**Warnings:**

**Information:**

2	Fee Worksheet (SB06)	fee-info.pdf	30704 7371a0241e3418393f1494e0e7b3095e6bb8218e	no	2
---	----------------------	--------------	---	----	---

**Warnings:**

**Information:**

<b>Total Files Size (in bytes):</b>			64718		
-------------------------------------	--	--	-------	--	--

**This Acknowledgement Receipt evidences receipt on the noted date by the USPTO of the indicated documents, characterized by the applicant, and including page counts, where applicable. It serves as evidence of receipt similar to a Post Card, as described in MPEP 503.**

**New Applications Under 35 U.S.C. 111**

**If a new application is being filed and the application includes the necessary components for a filing date (see 37 CFR 1.53(b)-(d) and MPEP 506), a Filing Receipt (37 CFR 1.54) will be issued in due course and the date shown on this Acknowledgement Receipt will establish the filing date of the application.**

**National Stage of an International Application under 35 U.S.C. 371**

**If a timely submission to enter the national stage of an international application is compliant with the conditions of 35 U.S.C. 371 and other applicable requirements a Form PCT/DO/EO/903 indicating acceptance of the application as a national stage submission under 35 U.S.C. 371 will be issued in addition to the Filing Receipt, in due course.**

**New International Application Filed with the USPTO as a Receiving Office**

**If a new international application is being filed and the international application includes the necessary components for an international filing date (see PCT Article 11 and MPEP 1810), a Notification of the International Application Number and of the International Filing Date (Form PCT/RO/105) will be issued in due course, subject to prescriptions concerning national security, and the date shown on this Acknowledgement Receipt will establish the international filing date of the application.**

<b>INFORMATION DISCLOSURE STATEMENT BY APPLICANT</b> ( Not for submission under 37 CFR 1.99)	Application Number	14848191
	Filing Date	2015-09-08
	First Named Inventor	Jae Lark Jung
	Art Unit	2646
	Examiner Name	Shedrick, Charles Terrell
	Attorney Docket Number	UNIS005.001C2

U.S.PATENTS						Remove
Examiner Initial*	Cite No	Patent Number	Kind Code <sup>1</sup>	Issue Date	Name of Patentee or Applicant of cited Document	Pages,Columns,Lines where Relevant Passages or Relevant Figures Appear
	1	6532298	B1	2003-03-11	Cambier et al.	

If you wish to add additional U.S. Patent citation information please click the Add button.

Add

U.S.PATENT APPLICATION PUBLICATIONS						Remove
Examiner Initial*	Cite No	Publication Number	Kind Code <sup>1</sup>	Publication Date	Name of Patentee or Applicant of cited Document	Pages,Columns,Lines where Relevant Passages or Relevant Figures Appear
	1	20060258289	A1	2006-11-06	Dua	
	2	20100159898	A1	2010-06-24	Krzyzanowski et al.	
	3	20100304731	A1	2010-12-02	Bratton et al.	
	4	20120009896	A1	2012-01-12	Bandyopadhyay et al.	
	5	20130104187	A1	2013-04-25	Weidner	

**INFORMATION DISCLOSURE  
STATEMENT BY APPLICANT**  
( Not for submission under 37 CFR 1.99)

Application Number	14848191
Filing Date	2015-09-08
First Named Inventor	Jae Lark Jung
Art Unit	2646
Examiner Name	Shedrick, Charles Terrell
Attorney Docket Number	UNIS005.001C2

6	20140162598	A1	2014-06-12	Villa-Real
7	20050113071	A1	2005-05-26	Nagata
8	20060156028	A1	2006-07-13	Aoyama et al.
9	20060288234	A1	2006-12-21	Azar et al.
10	20070259685	A1	2007-11-08	Engblom et al.
11	20090258667	A1	2009-10-15	Suzuki et al.
12	20120098639	A1	2012-04-26	Jias
13	20120235790	A1	2012-09-20	Zhao et al.
14	20120303476	A1	2012-11-29	Krzyzanowski et al.
15	20130031619	A1	2013-01-31	Waltermann et al.
16	20130063611	A1	2013-03-14	Papakipos et al.



**INFORMATION DISCLOSURE  
STATEMENT BY APPLICANT**  
( Not for submission under 37 CFR 1.99)

Application Number	14848191
Filing Date	2015-09-08
First Named Inventor	Jae Lark Jung
Art Unit	2646
Examiner Name	Shedrick, Charles Terrell
Attorney Docket Number	UNIS005.001C2

17	20150051913	A1	2015-02-19	Choi
18	20100159995	A1	2010-06-24	Stallings et al.

If you wish to add additional U.S. Published Application citation information please click the Add button

**FOREIGN PATENT DOCUMENTS**

Examiner Initial*	Cite No	Foreign Document Number <sup>3</sup>	Country Code <sup>2j</sup>	Kind Code <sup>4</sup>	Publication Date	Name of Patentee or Applicant of cited Document	Pages, Columns, Lines where Relevant Passages or Relevant Figures Appear	T <sup>5</sup>
	1	2770643	EP	A2	2014-08-27	FIRSTFACE CO LTD		
	2	10-2013-0104682	KR	A	2013-09-25	CHOI, SANG GIL		×
	3	10-2010-0057461	KR	A	2010-05-31	NHN BUSINESS PLATFORM CORP		☒
	4	2 288 126	EP	A1	2011-02-23	LG ELECTONICS INC.		<input type="checkbox"/>
	5	2013/177173	WO	A1	2013-11-28	BRANDINTELX, INC.		<input type="checkbox"/>
	6	2013/060940	WO	A2	2013-05-02	NOKIA CORPORATION		<input type="checkbox"/>
	7	2014/022347	WO	A1	2014-02-06	CUSACK, Elijah		<input type="checkbox"/>

If you wish to add additional Foreign Patent Document citation information please click the Add button

<b>INFORMATION DISCLOSURE STATEMENT BY APPLICANT</b> ( Not for submission under 37 CFR 1.99)	Application Number	14848191
	Filing Date	2015-09-08
	First Named Inventor	Jae Lark Jung
	Art Unit	2646
	Examiner Name	Shedrick, Charles Terrell
	Attorney Docket Number	UNIS005.001C2

NON-PATENT LITERATURE DOCUMENTS			Remove
Examiner Initials*	Cite No	Include name of the author (in CAPITAL LETTERS), title of the article (when appropriate), title of the item (book, magazine, journal, serial, symposium, catalog, etc), date, pages(s), volume-issue number(s), publisher, city and/or country where published.	T <sup>5</sup>
	1	European Search Report dated March 10, 2016 of corresponding European Patent Application No. 15195436.9 in 11 pages.	

If you wish to add additional non-patent literature document citation information please click the Add button

#### EXAMINER SIGNATURE

Examiner Signature		Date Considered	
--------------------	--	-----------------	--

\*EXAMINER: Initial if reference considered, whether or not citation is in conformance with MPEP 609. Draw line through a citation if not in conformance and not considered. Include copy of this form with next communication to applicant.

<sup>1</sup> See Kind Codes of USPTO Patent Documents at [www.USPTO.GOV](http://www.USPTO.GOV) or MPEP 901.04. <sup>2</sup> Enter office that issued the document, by the two-letter code (WIPO Standard ST.3). <sup>3</sup> For Japanese patent documents, the indication of the year of the reign of the Emperor must precede the serial number of the patent document. <sup>4</sup> Kind of document by the appropriate symbols as indicated on the document under WIPO Standard ST.16 if possible. <sup>5</sup> Applicant is to place a check mark here if English language translation is attached.

**INFORMATION DISCLOSURE  
STATEMENT BY APPLICANT**  
( Not for submission under 37 CFR 1.99)

Application Number	14848191
Filing Date	2015-09-08
First Named Inventor	Jae Lark Jung
Art Unit	2646
Examiner Name	Shedrick, Charles Terrell
Attorney Docket Number	UNIS005.001C2

**CERTIFICATION STATEMENT**

Please see 37 CFR 1.97 and 1.98 to make the appropriate selection(s):

That each item of information contained in the information disclosure statement was first cited in any communication from a foreign patent office in a counterpart foreign application not more than three months prior to the filing of the information disclosure statement. See 37 CFR 1.97(e)(1).

**OR**

That no item of information contained in the information disclosure statement was cited in a communication from a foreign patent office in a counterpart foreign application, and, to the knowledge of the person signing the certification after making reasonable inquiry, no item of information contained in the information disclosure statement was known to any individual designated in 37 CFR 1.56(c) more than three months prior to the filing of the information disclosure statement. See 37 CFR 1.97(e)(2).

See attached certification statement.

The fee set forth in 37 CFR 1.17 (p) has been submitted herewith.

A certification statement is not submitted herewith.

**SIGNATURE**

A signature of the applicant or representative is required in accordance with CFR 1.33, 10.18. Please see CFR 1.4(d) for the form of the signature.

Signature	/Mincheol Kim/	Date (YYYY-MM-DD)	2016-05-13
Name/Print	Mincheol Kim	Registration Number	51306

This collection of information is required by 37 CFR 1.97 and 1.98. The information is required to obtain or retain a benefit by the public which is to file (and by the USPTO to process) an application. Confidentiality is governed by 35 U.S.C. 122 and 37 CFR 1.14. This collection is estimated to take 1 hour to complete, including gathering, preparing and submitting the completed application form to the USPTO. Time will vary depending upon the individual case. Any comments on the amount of time you require to complete this form and/or suggestions for reducing this burden, should be sent to the Chief Information Officer, U.S. Patent and Trademark Office, U.S. Department of Commerce, P.O. Box 1450, Alexandria, VA 22313-1450. **DO NOT SEND FEES OR COMPLETED FORMS TO THIS ADDRESS. SEND TO: Commissioner for Patents, P.O. Box 1450, Alexandria, VA 22313-1450.**

## Privacy Act Statement

The Privacy Act of 1974 (P.L. 93-579) requires that you be given certain information in connection with your submission of the attached form related to a patent application or patent. Accordingly, pursuant to the requirements of the Act, please be advised that: (1) the general authority for the collection of this information is 35 U.S.C. 2(b)(2); (2) furnishing of the information solicited is voluntary; and (3) the principal purpose for which the information is used by the U.S. Patent and Trademark Office is to process and/or examine your submission related to a patent application or patent. If you do not furnish the requested information, the U.S. Patent and Trademark Office may not be able to process and/or examine your submission, which may result in termination of proceedings or abandonment of the application or expiration of the patent.

The information provided by you in this form will be subject to the following routine uses:

1. The information on this form will be treated confidentially to the extent allowed under the Freedom of Information Act (5 U.S.C. 552) and the Privacy Act (5 U.S.C. 552a). Records from this system of records may be disclosed to the Department of Justice to determine whether the Freedom of Information Act requires disclosure of these records.
2. A record from this system of records may be disclosed, as a routine use, in the course of presenting evidence to a court, magistrate, or administrative tribunal, including disclosures to opposing counsel in the course of settlement negotiations.
3. A record in this system of records may be disclosed, as a routine use, to a Member of Congress submitting a request involving an individual, to whom the record pertains, when the individual has requested assistance from the Member with respect to the subject matter of the record.
4. A record in this system of records may be disclosed, as a routine use, to a contractor of the Agency having need for the information in order to perform a contract. Recipients of information shall be required to comply with the requirements of the Privacy Act of 1974, as amended, pursuant to 5 U.S.C. 552a(m).
5. A record related to an International Application filed under the Patent Cooperation Treaty in this system of records may be disclosed, as a routine use, to the International Bureau of the World Intellectual Property Organization, pursuant to the Patent Cooperation Treaty.
6. A record in this system of records may be disclosed, as a routine use, to another federal agency for purposes of National Security review (35 U.S.C. 181) and for review pursuant to the Atomic Energy Act (42 U.S.C. 218(c)).
7. A record from this system of records may be disclosed, as a routine use, to the Administrator, General Services, or his/her designee, during an inspection of records conducted by GSA as part of that agency's responsibility to recommend improvements in records management practices and programs, under authority of 44 U.S.C. 2904 and 2906. Such disclosure shall be made in accordance with the GSA regulations governing inspection of records for this purpose, and any other relevant (i.e., GSA or Commerce) directive. Such disclosure shall not be used to make determinations about individuals.
8. A record from this system of records may be disclosed, as a routine use, to the public after either publication of the application pursuant to 35 U.S.C. 122(b) or issuance of a patent pursuant to 35 U.S.C. 151. Further, a record may be disclosed, subject to the limitations of 37 CFR 1.14, as a routine use, to the public if the record was filed in an application which became abandoned or in which the proceedings were terminated and which application is referenced by either a published application, an application open to public inspections or an issued patent.
9. A record from this system of records may be disclosed, as a routine use, to a Federal, State, or local law enforcement agency, if the USPTO becomes aware of a violation or potential violation of law or regulation.

**IN THE UNITED STATES PATENT AND TRADEMARK OFFICE**

First Named Inventor	: Jae Lark JUNG
Applicant	: FIRSTFACE CO., LTD.
App. No.	: 14/848,191
Filed	: September 8, 2015
Examiner	: Shedrick, Charles Terrell
Art Unit	: 2646
Conf. No.	: 9599

**AMENDMENT IN RESPONSE TO INTERVIEW  
AND PRE-INTERVIEW COMMUNICATION**

Mail Stop Amendment  
Commissioner for Patents  
P.O. Box 1450  
Alexandria, VA 22313-1450

Dear Sir:

This is in accordance with the discussions during the telephonic interview of April 12, 2016 and in response to the Pre-Interview Communication of February 2, 2016 and the Interview Summary of April 15, 2016 in the above-identified application. Applicant submits the following items for consideration in connection with the application.

**Amendments to the Claims** are reflected in the listing of claims which begins on page 2 of this paper.

**Remarks** begin on page 8 of this paper.

### AMENDMENTS TO THE CLAIMS

The listing of claims will replace all prior versions and listings of claims in the application.

1. (Currently Amended) A mobile communication terminal comprising:
  - a touch screen display;
  - a power button configured to turn on and off the terminal by pressing; and
  - an activation button separate from the power button and located outside the touch screen display, the activation button configured for pressing to turn on the touch screen display,

wherein upon ~~detection of~~ one-time pressing of the activation button while the touch screen display is turned off, the terminal is configured to turn on the touch screen display and perform a fingerprint authentication function in addition to turning on the touch screen display such that:

  - the touch screen display displays a lock screen thereon as the touch screen display it is turned on in response to the detection of one-time pressing of the activation button while the touch screen display being turned off,
  - in addition to turning on the touch screen display and displaying the lock screen, the one-time pressing while the touch screen display being turned off initiates the fingerprint authentication function,
  - the lock screen is displayed on the touch screen display when the fingerprint authentication function initiated by the one-time pressing is being performed,
  - a lock state of the terminal continues when the fingerprint authentication function fails to authenticate a user, and
  - the lock state is released for enabling other functions of the terminal when the fingerprint authentication function authenticates a user in response to the one-time pressing of the activation button while the touch screen display being turned off.
2. (Currently Amended) The terminal of Claim 1, wherein the terminal is configured to perform at least one additional function in addition to the fingerprint authentication function after in addition to turning on the touch screen display for displaying the lock screen when the detected one-time pressing is for short time shorter than a reference time period of the activation

button is detected while the touch screen display is turned off.

3. (Currently Amended) The terminal of Claim ~~2~~1, wherein the terminal is further configured to perform at least one function other than the fingerprint authentication function in addition to turning on the touch screen display for displaying the lock screen in response to the ~~detection of one-time pressing of the activation button during the terminal's inactive state~~ when the detected one-time pressing is for long time longer than a reference time period, wherein the at least one functions is selected from the group consisting of activating the camera, and an operation that involves playing a sound.

4. (Currently Amended) The terminal of Claim 3, wherein the touch screen display displays a lock screen thereon as it is turned on in response to the ~~detection of one-time pressing for long time~~, wherein the lock screen is displayed on the touch screen display when the at least one function is being initiated.

5. (Currently Amended) The terminal of Claim 3, wherein the touch screen display displays a lock screen thereon as it is turned on in response to the ~~detection of one-time pressing for long time~~, wherein the at least one function is associated with initiating a hands-free operation of the terminal.

6. (Currently Amended) The terminal of Claim 3, wherein the terminal is configured to have a mobile application stay in a standby state when the touch screen display is turned off while the mobile application is running, wherein in response to the ~~detection of one-time pressing of the activation button while the touch screen display is turned off~~, the terminal is configured to perform the at least one function regardless of whether the at least one function is in its standby state or an operation disable state.

7. (Currently Amended) The terminal of Claim 1, wherein the terminal is configured to display ~~an alarm~~ a message on the touch screen display when the lock state continues due to failure of fingerprint authentication by the fingerprint authentication function.

8. (Previously Presented) The terminal of Claim 1, wherein the at least one

function is associated with software downloadable by the terminal.

9. (Currently Amended) The terminal of Claim 1, wherein upon ~~detection of~~ repeated pressing of the activation button while the touch screen display is turned off, the terminal is configured to turn on the touch screen display and further perform at least one function other than the fingerprint authentication function in addition to turning on the touch screen display.

10. (Previously Presented) The terminal of Claim 1, wherein the terminal comprises a smartphone which comprises an activation sensor configured to detect pressing of the activation button and a user identification module configured to perform the fingerprint authentication function.

11. (Currently Amended) A method of operating a mobile computing terminal, the method comprising:

providing a mobile computing terminal which comprises a touch screen display, a camera, a power button for pressing to turn on/off the terminal, and an activation button for pressing to turn on the touch screen display, the activation button located outside the touch screen display;

detecting one-time pressing of the activation button while the terminal is in an inactive state in which the touch screen display is turned off,

in response to ~~detection of the~~ one-time pressing, changing the terminal from the inactive state to an active state in which the touch screen display is turned on; and

in addition to changing to the active state, further performing a fingerprint authentication function using fingerprint recognition without additional user input,

wherein in changing to the active state and performing the fingerprint authentication function, the terminal operates such that:

the touch screen display displays a lock screen thereon as the terminal changes to the active state in response to the detection of one-time pressing of the activation button while the terminal being in the inactive state,

in addition to changing the terminal to the active state, the one-time pressing while the terminal being in the inactive state initiates the fingerprint authentication function,



the lock screen is displayed on the touch screen display when the fingerprint authentication function initiated by the one-time pressing is being performed,

a lock state of the terminal continues when the fingerprint authentication function fails to authenticate a user, and

the lock state is released for enabling other functions of the terminal when the fingerprint authentication function authenticates a user in response to the one-time pressing of the activation button while the terminal being in the inactive state.

12. (Currently Amended) The method of Claim 11, wherein performing at least one function in addition to the fingerprint authentication function after ~~in addition to~~ changing to the active state for displaying the lock screen ~~occurs when the detected one-time pressing is detected while the terminal being in the inactive state.~~ ~~for short time shorter than a reference time period.~~

13. (Currently Amended) The method of Claim ~~12~~ 11, wherein the method further comprises performing at least one function other than the fingerprint authentication function in addition to changing to the active state in response to the ~~detection of one-time~~ pressing during the terminal's inactive state when the detected one-time pressing is for long time longer than the reference time period, wherein the at least one function is selected from the group consisting of activating the camera, a hands-free operation and an operation that involves playing a sound.

14. (Currently Amended) The method of Claim 13, wherein the touch screen display displays a lock screen thereon as the terminal changes to its active state in response to the ~~detection of one-time~~ pressing for long time, wherein the lock screen is displayed on the touch screen display when the at least one function is being initiated.

15. (Currently Amended) The method of Claim 13, wherein the touch screen display displays a lock screen thereon as the terminal changes to its active state in response to the ~~detection of one-time~~ pressing for long time, wherein the at least one function is associated with initiating a hands-free operation of the terminal a hands-free operation.

16. (Currently Amended) The method of Claim 13, wherein the terminal is configured to have a mobile application stay in a standby state when the touch screen display is turned off

while the mobile application is running, wherein in response to the ~~detection of one-time~~ pressing of the activation button while the terminal is in its inactive state, the terminal performs the at least one function regardless of whether the at least one function is in its standby state or an operation disable state.

17. (Currently Amended) The method of Claim 13, wherein the touch screen display displays ~~an alarm~~ a message thereon when the lock state continues due to failure of fingerprint authentication by the fingerprint authentication function.

18. (Currently Amended) The method of Claim 13, further comprising:  
receiving user input on a setting menu of the terminal; and  
configuring, based on the user input, settings of the terminal such that the at least one function is set to be performed in addition to changing to the active state in response to ~~upon detection of one-time~~ pressing of the activation button while the terminal is in its inactive state.

19. (Previously Presented) The method of Claim 11, wherein the at least one function is associated with software downloadable by the terminal.

20. (Currently Amended) The method of Claim 11, further comprising:  
detecting repeated pressing of the activation button while the terminal is in its inactive state;  
in response to ~~detection of the~~ repeated pressing, changing the terminal from the inactive state to the active state; and  
in addition to changing to the active state, further performing at least one function other than the fingerprint authentication function without additional user input,  
wherein in changing to the active state and performing the at least one function, the terminal operates such that:  
the touch screen display displays the lock screen thereon as the terminal changes to the active state in response to the ~~detection of repeated~~ pressing,  
the lock screen is displayed on the touch screen display when the at least one

**Application No.:** 14/848,191  
**Filed:** September 8, 2015

function is being performed.

**Application No.:** 14/848,191  
**Filed:** September 8, 2015

## **REMARKS**

In response to the Pre-Interview Communication of February 2, 2016 and the Interview Summary of April 15, 2016, Applicant has amended the application as set forth above. Specifically, Claims 1-7, 9, 11-18 and 20 are amended. No new matter is added by the amendments. Upon entry of the amendments, Claims 1-20 are pending in the application. Applicant respectfully requests the entry of the amendments and reconsideration of the application in view of the foregoing amendments and the following remarks.

### Telephonic Interview

Applicant thanks Examiner Charles Terrell Shedrick for the April 12, 2016 telephonic interview granted to Applicant's Representatives, Mincheol Kim, Reg. No. 51,306, and Hochan Song, Reg. No. 67,824, in the captioned application. During the interview, the Examiner and Applicant's Representatives discussed the rejections under 35 U.S.C. § 102 and 103, and the features of the proposed claim amendments.

### Double Patenting Rejection under 35 U.S.C. §101

Claims 1-20 were rejected under 35 U.S.C. §101 as identical to the claims of the co-pending application, Application No. 14/848,156. Applicant respectfully disagrees. The claims of the present application were not and are not identical to the claims of the co-pending application. Applicant respectfully request withdrawal of the rejection.

### Double Patenting Rejection

Claims 1-20 were rejected on the ground of nonstatutory double patenting as being unpatentable over claims of U.S. Patent Nos. 9,179,298, 8,918,074 and 8,831,557. Applicant respectfully disagrees. The claims of the present application are significantly different from the claims of the cited patents. Although some claims of the present application and the cited patents may have common or similar features, Applicant respectfully submits that the double patenting rejection should be made on a claim-by-claim basis. For this reason, Applicant respectfully traverses the rejection.

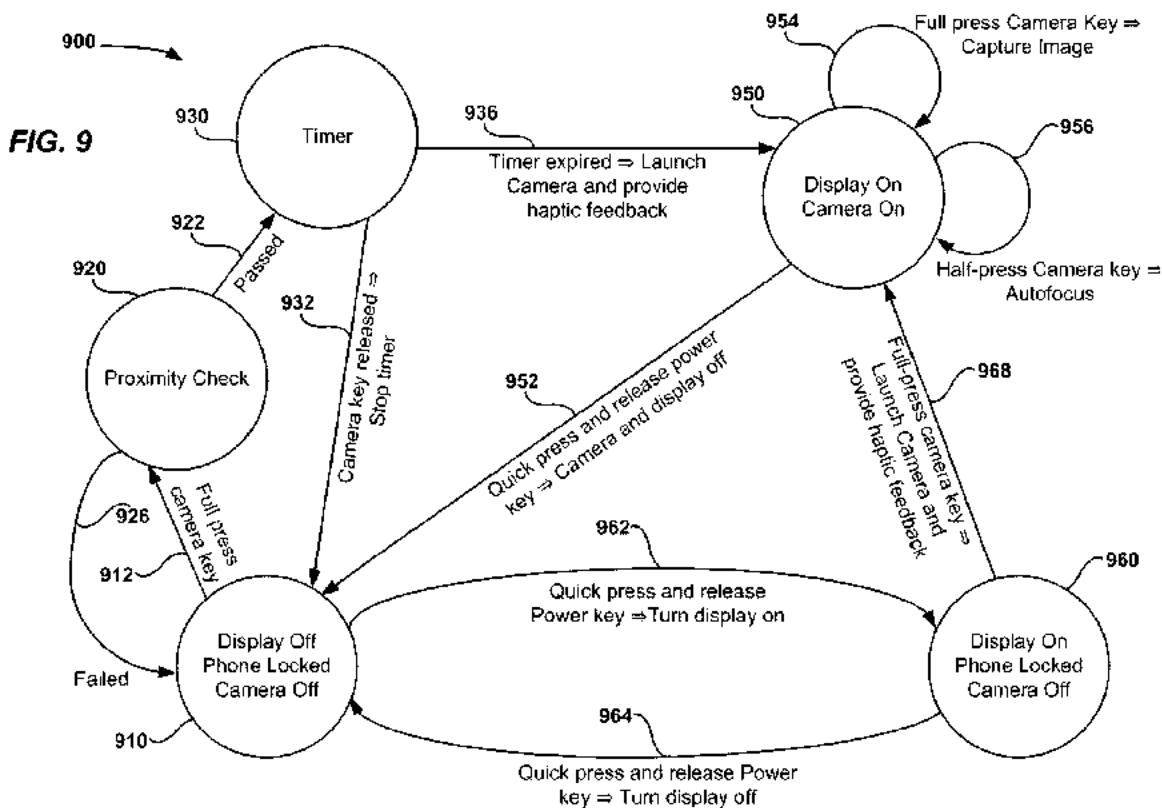
Nonetheless, Applicant herewith files a Terminal Disclaimer in compliance with 37 C.F.R.

§ 1.321. This application and the cited patents are owned by FirstFace Co., Ltd. The chain of title is established in the assignment recorded in U.S. Patent No. 9,179,298 at Reel/Frame Nos. 035060/0627 and 035060/0847; U.S. Patent No. 8,918,074 at Reel/Frame Nos. 035060/0627, 035060/0792 and 033963/0130; and U.S. Patent No. 8,831,557 at Reel/Frame Nos. 028864/0537, 029762/0633, 035060/0627 and 035060/0761. The withdrawal of the double patenting rejection is respectfully requested.

Rejection under 35 U.S.C. § 102 Based on Bandyopadhyay '896

Claims 1-6, 9-15 and 18-20 were rejected under 35 U.S.C. § 102 as being anticipated by Bandyopadhyay et al. (US2012/0009896, hereinafter "Bandyopadhyay '896"). Applicant respectfully disagrees.

Bandyopadhyay '896 relates to a camera function of a smartphone. Bandyopadhyay '896 teaches activating the camera function from when the smartphone's screen is turned off (display-off state). For the Examiner's reference, Figure 9 of Bandyopadhyay '896 is reproduced below.



Bandyopadhyay '896 discloses turning on its display screen from its turned-off state (from

state 910 to state 950). However, no teaching of a lock screen during the transition from the state 910 to state 950. Applicant notes that Bandyopadhyay '896 discloses a lock screen in its Figure 5A, but it is silent about how the lock screen of Figure 5A is displayed. In view of this, Bandyopadhyay '896 fails to teach at least the following limitations of Claims 1 and 11:

Claim 1

- the touch screen display displays a lock screen thereon as the touch screen display is turned on in response to the one-time pressing of the activation button while the touch screen display being turned off.

Claim 11

- the touch screen display displays a lock screen thereon as the terminal changes to the active state in response to the one-time pressing of the activation button while the terminal being in the inactive state.

Bandyopadhyay '896 mentions fingerprint authentication as an alternative of a pin pad authentication (Figure 5B) for accessing data stored in the smartphone while performing the camera function. Because the pin pad authentication is initiated while performing the camera function, i.e., display on, however, even if fingerprint authentication is used in replacement of the pin pad authentication of Figure 5B, such would not be while the touch screen display is turned off. Further, Bandyopadhyay '896 does not provide any detail about how the fingerprint authentication is performed, i.e., no teaching of "in response to one-time pressing of a button." Thus, Bandyopadhyay '896 fails to teach at least the following limitations of Claims 1 and 11:

Claim 1

- in addition to turning on the touch screen display and displaying the lock screen, the one-time pressing while the touch screen display being turned off initiates the fingerprint authentication function; and
- the lock screen is displayed on the touch screen display when the fingerprint authentication function initiated by the one-time pressing is being performed.

Claim 11

- in addition to changing the terminal to the active state, the one-time pressing while the terminal being in the inactive state initiates the fingerprint authentication function; and
- the lock screen is displayed on the touch screen display when the fingerprint authentication function initiated by the one-time pressing is being performed.

Bandyopadhyay '896 fails to anticipate Claim 1, 11 or their dependent claims.

Rejection under 35 U.S.C. § 102 Based on Fadell

Claims 1 and 12 were further rejected under 35 U.S.C. § 102 as being anticipated Fadell et al. (US8782775). Applicant respectfully disagrees. Claim 12 depends from independent Claim 11. Thus, Applicant now discusses Claim 11.

Fadell discloses an electronic device with an embedded authentication sensor that can capture a user's authentication information, such as fingerprint, even when the user is not attempting to input the authentication information. To accomplish this, Fadell provides a fingerprint sensor at a location where the user typically places her finger when using the device. In the context of a portable media player or cellular telephone, Fadell teaches that such a sensor may be placed behind a home button. *See* Fadell at Col. 11, ln. 60-62.

However, Fadell does not teach displaying a lock screen as the display is turned on in response to one-time pressing of a button while the display being turned off. Fadell does not teach that (in addition to turning on and displaying the lock screen) the same one-time pressing while the display being turned off causes fingerprint authentication. Further, Fadell does not teach that displaying the lock screen when the fingerprint authentication initiated by the same one-time pressing is being performed. Thus, Fadell fails to teach at least the following features of Claims 1 and 11:

Claim 1

- the touch screen display displays a lock screen thereon as the touch screen display is turned on in response to the one-time pressing of the activation button while the touch screen display being turned off;
- in addition to turning on the touch screen display and displaying the lock screen, the one-time pressing while the touch screen display being turned off initiates the fingerprint authentication function; and
- the lock screen is displayed on the touch screen display when the fingerprint authentication function initiated by the one-time pressing is being performed.

Claim 11

- the touch screen display displays a lock screen thereon as the terminal changes to the active state in response to the one-time pressing of the activation button while the terminal being in the inactive state;
- in addition to changing the terminal to the active state, the one-time pressing while the terminal being in the inactive state initiates the fingerprint

- authentication function; and
- the lock screen is displayed on the touch screen display when the fingerprint authentication function initiated by the one-time pressing is being performed.

Rejection under 35 U.S.C. § 102 Based on Stewart

Claims 1 and 12 were further rejected under 35 U.S.C. § 102 as being anticipated by Stewart et al. (US2010/0102939). Applicant respectfully disagrees. Claim 12 depends from independent Claim 11. Thus, we will discuss the patentability of Claim 12.

Stewart discloses a finger biometric sensor for an electronic device. Specifically, Stewart discloses a slide biometric finger sensor for detecting finger movement to control changing tones of music playing on the electronic device. However, Stewart does not disclose at least the following features of Claims 1 and 11:

Claim 1

- the touch screen display displays a lock screen thereon as the touch screen display is turned on in response to the one-time pressing of the activation button while the touch screen display being turned off;
- in addition to turning on the touch screen display and displaying the lock screen, the one-time pressing while the touch screen display being turned off initiates the fingerprint authentication function; and
- the lock screen is displayed on the touch screen display when the fingerprint authentication function initiated by the one-time pressing is being performed.

Claim 11

- the touch screen display displays a lock screen thereon as the terminal changes to the active state in response to the one-time pressing of the activation button while the terminal being in the inactive state;
- in addition to changing the terminal to the active state, the one-time pressing while the terminal being in the inactive state initiates the fingerprint authentication function; and
- the lock screen is displayed on the touch screen display when the fingerprint authentication function initiated by the one-time pressing is being performed.

Rejection under 35 U.S.C. § 103

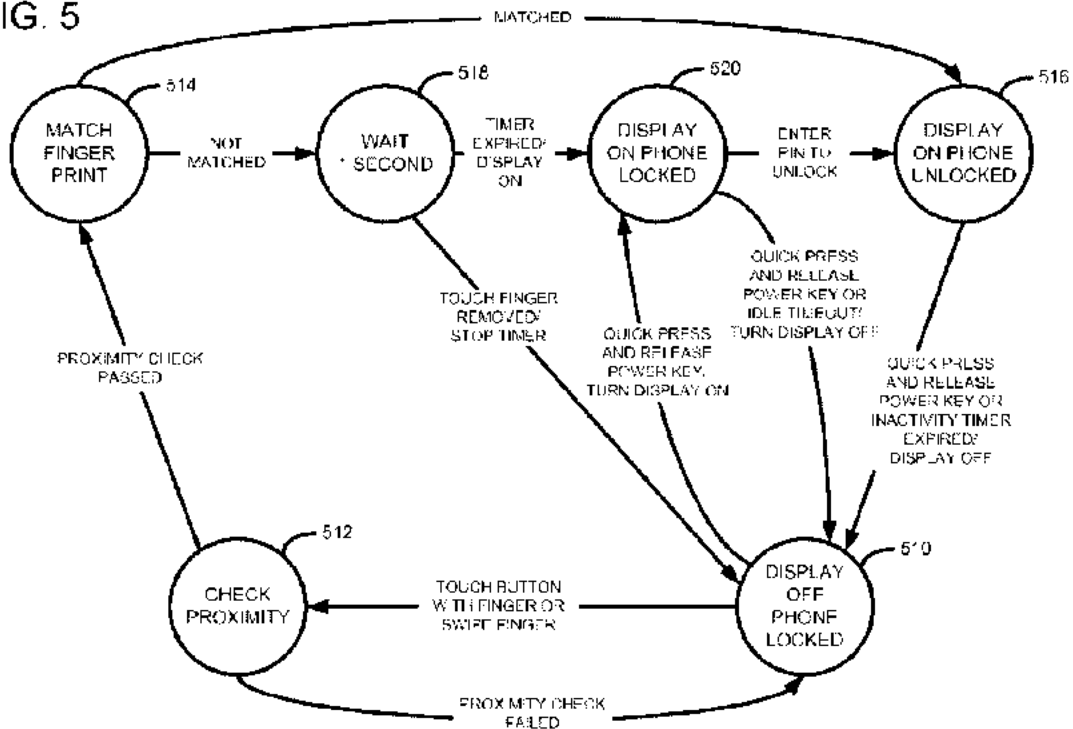
Claims 1-20 were rejected under 35 U.S.C. § 103 as being unpatentable over Bandyopadhyay '896 and Bandyopadhyay et al. (US8311514, hereinafter "Bandyopadhyay '514") and/or Fadell and Stewart. Applicant respectfully disagrees.

Bandyopadhyay '514 relates to wake-up and unlock operations of a smart phone in



response to a single event, such as a single keystroke. For the Examiner's reference, Figure 5 of Bandyopadhyay '514 is reproduced below.

FIG. 5



Bandyopadhyay '514 discloses turning on its display to the phone's locked state (from state 510 to state 520) by quick press and release of the power key. Bandyopadhyay '514 also discloses the transition from state 510 (display off) to state 520 (display on phone locked) via proximity check (state 512), fingerprint match (state 514) and wait 1 second (state 518). In the states 512, 514 and 518, the display is not yet turned on. Bandyopadhyay '514 also discloses turning on its display to the phone's unlocked state in the transition from the state 520 (display on phone locked) to the state 516 (display on phone unlocked) by entering pin to unlock. Further, Bandyopadhyay '514 discloses the direct transition from state 514 (fingerprint match) to state 516 (display on phone unlocked). However, in any of these transitions from state 510 (display off phone locked) to state 516 (display on phone unlocked) or from state 510 (display off phone locked) to state 520 (display on phone locked), the display is not turned on prior to the state 520 or 516. Particularly, when fingerprint matching is performed at state 514, the display is off.

In any transitions, Bandyopadhyay '514 fails to disclose the following claim features:

Claim 1

- the touch screen display displays a lock screen thereon as the touch screen

display is turned on in response to the one-time pressing of the activation button while the touch screen display is turned off;

- in addition to turning on the touch screen display and displaying the lock screen, the one-time pressing while the touch screen display being turned off initiates the fingerprint authentication function; and
- the lock screen is displayed on the touch screen display when the fingerprint authentication function initiated by the one-time pressing is being performed.

#### Claim 11

- the touch screen display displays a lock screen thereon as the terminal changes to the active state in response to the one-time pressing of the activation button while the terminal being in the inactive state;
- in addition to changing the terminal to the active state, the one-time pressing while the terminal being in the inactive state initiates the fingerprint authentication function; and
- the lock screen is displayed on the touch screen display when the fingerprint authentication function initiated by the one-time pressing is being performed.

As discussed above in connection with the 102 rejections, none of Bandyopadhyay '896, Fadell and Stetwart teaches the foregoing features of Claims 1 and 11 that Bandyopadhyay '514 fails to teach. Accordingly, however the combinations might be, the prior art references cited in the Pre-Interview Communication do not teach every feature of Claim 1 or every feature of Claim 11. At least for this reason, no *prima facie* obviousness has been established with regard to all pending claims. Withdrawal of the rejection is respectfully requested.

#### Dependent Claims

Although Applicant has not addressed all the issues of the dependent claims, Applicant respectfully submits that Applicant does not necessarily agree with the characterization and assessments of the dependent claims made by the Examiner, and Applicant believes that each claim is patentable on its own merits. Applicant respectfully submits that the dependent claims incorporate by reference all the limitations of the claim to which they refer and include their own patentable features, and are therefore in condition for allowance. Therefore, Applicant respectfully requests the withdrawal of all claim rejections and prompts allowance of the claims.

#### No Disclaimers or Disavowals

Although the present communication may include alterations to the application or claims,

**Application No.:** 14/848,191  
**Filed:** September 8, 2015

or characterizations of claim scope or referenced art, Applicant is not conceding in this application that previously pending claims are not patentable over the cited references. Rather, any alterations or characterizations are being made to facilitate expeditious prosecution of this application. Applicant reserves the right to pursue at a later date any previously pending or other broader or narrower claims that capture any subject matter supported by the present disclosure, including subject matter found to be specifically disclaimed herein or by any prior prosecution. Accordingly, reviewers of this or any parent, child or related prosecution history shall not reasonably infer that Applicant has made any disclaimers or disavowals of any subject matter supported by the present application.

### CONCLUSION

Applicant has endeavored to address all of the Examiner's concerns as expressed in the Pre-Interview Communication and during the interview. Accordingly, arguments in support of the patentability of the pending claim set are presented above.

In light of the above remarks, reconsideration and withdrawal of the outstanding rejections is respectfully requested. If the Examiner has any questions which may be answered by telephone, he is invited to call the undersigned directly.

Please charge any additional fees, including any fees for additional extension of time, or credit overpayment to Deposit Account No. 11-1410.

Respectfully submitted,

KNOBBE, MARTENS, OLSON & BEAR, LLP

Dated: May 13, 2016

By: /Mincheol Kim/  
Mincheol Kim  
Registration No. 51,306  
Attorney of Record  
Customer No. 20,995  
(949) 760-0404

**IN THE UNITED STATES PATENT AND TRADEMARK OFFICE**

First Named Inventor	:	Jae Lark JUNG
Applicant	:	FIRSTFACE CO., LTD.
App. No.	:	14/848,191
Filed	:	September 8, 2015
Examiner	:	Shedrick, Charles Terrell
Art Unit	:	2646
Conf. No.	:	9599

TRANSMITTAL

Mail Stop Amendment  
 Commissioner for Patents  
 P.O. Box 1450  
 Alexandria, VA 22313-1450

Dear Sir:

The following enclosures are transmitted herewith:


- (X) Amendment in Response to Interview & Pre-Interview Communication in 15 pages.
- (X) Information Disclosure Statement in 6 pages and a copy of 8 references.
- (X) Terminal Disclaimers (3) (USP Nos. 8,831,557, 8,918,074 and 9,179,298) filed concurrently herewith.

The Commissioner is hereby authorized to charge any additional fees which may be required, or credit any overpayment to Deposit Account No. 11-1410.

Respectfully submitted,

KNOBBE, MARTENS, OLSON & BEAR, LLP

Dated: 5/13/16

By:   
 Mincheol Kim  
 Registration No. 51,306  
 Attorney of Record  
 Customer No. 20995  
 (949) 760-0404

## Electronic Patent Application Fee Transmittal

<b>Application Number:</b>	14848191
<b>Filing Date:</b>	08-Sep-2015
<b>Title of Invention:</b>	ACTIVATING DISPLAY AND PERFORMING USER AUTHENTICATION IN MOBILE TERMINAL WITH ONE-TIME USER INPUT
<b>First Named Inventor/Applicant Name:</b>	Jae Lark JUNG
<b>Filer:</b>	Mincheol Kim/kim skoff
<b>Attorney Docket Number:</b>	UNIS005.001C2

Filed as Small Entity

**Filing Fees for Utility under 35 USC 111(a)**

Description	Fee Code	Quantity	Amount	Sub-Total in USD(\$)
<b>Basic Filing:</b>				
<b>Pages:</b>				
<b>Claims:</b>				
<b>Miscellaneous-Filing:</b>				
<b>Petition:</b>				
<b>Patent-Appeals-and-Interference:</b>				
<b>Post-Allowance-and-Post-Issuance:</b>				
<b>Extension-of-Time:</b>				

Description	Fee Code	Quantity	Amount	Sub-Total in USD(\$)
<b>Miscellaneous:</b>				
Submission- Information Disclosure Stmt	2806	1	90	90
<b>Total in USD (\$)</b>				<b>90</b>

## Electronic Acknowledgement Receipt

<b>EFS ID:</b>	25774299
<b>Application Number:</b>	14848191
<b>International Application Number:</b>	
<b>Confirmation Number:</b>	9599
<b>Title of Invention:</b>	ACTIVATING DISPLAY AND PERFORMING USER AUTHENTICATION IN MOBILE TERMINAL WITH ONE-TIME USER INPUT
<b>First Named Inventor/Applicant Name:</b>	Jae Lark JUNG
<b>Customer Number:</b>	20995
<b>Filer:</b>	Mincheol Kim/ThuyQuyen Nguyen
<b>Filer Authorized By:</b>	Mincheol Kim
<b>Attorney Docket Number:</b>	UNIS005.001C2
<b>Receipt Date:</b>	13-MAY-2016
<b>Filing Date:</b>	08-SEP-2015
<b>Time Stamp:</b>	16:57:06
<b>Application Type:</b>	Utility under 35 USC 111(a)

### Payment information:

Submitted with Payment	yes
Payment Type	Credit Card
Payment was successfully received in RAM	\$90
RAM confirmation Number	3590
Deposit Account	111410
Authorized User	KNOBBE MARTENS OLSON AND BEAR

The Director of the USPTO is hereby authorized to charge indicated fees and credit any overpayment as follows:

Charge any Additional Fees required under 37 CFR 1.16 (National application filing, search, and examination fees)

Charge any Additional Fees required under 37 CFR 1.17 (Patent application and reexamination processing fees)

<b>File Listing:</b>					
<b>Document Number</b>	<b>Document Description</b>	<b>File Name</b>	<b>File Size(Bytes)/ Message Digest</b>	<b>Multi Part /.zip</b>	<b>Pages (if appl.)</b>
1	Foreign Reference	EP2770643A2.PDF	1589603	no	22
			689389afa59452b55f24e4248a5cd99f701d c160		
<b>Warnings:</b>					
<b>Information:</b>					
2	Foreign Reference	KR1020130104682wAbst.PDF	1397111	no	9
			58f70ba3d72488f7b5242b08466f2c7b6de 08335		
<b>Warnings:</b>					
<b>Information:</b>					
3	Foreign Reference	KR1020100057461wAbst.PDF	1618617	no	15
			556e719c08a035252d5e8b7833ea2c92d12 cb79e		
<b>Warnings:</b>					
<b>Information:</b>					
4	Foreign Reference	EP2288126.PDF	2328321	no	26
			199c024e312fd85ad6c85115f516477b34b0 55f6		
<b>Warnings:</b>					
<b>Information:</b>					
5	Foreign Reference	WO2013177173.PDF	9548946	no	79
			1112b459ff62999f52131fb77b35d99c7532 b1f0		
<b>Warnings:</b>					
<b>Information:</b>					
6	Foreign Reference	WO2013060940.PDF	4554966	no	42
			0b622f537ef1aff0645fa08bc5a75c7c7e37f6 5a		
<b>Warnings:</b>					
<b>Information:</b>					
7	Foreign Reference	WO2014022347.PDF	2373644	no	23
			625c2e77ba1784db155063d5be53d8619a c6da5d		
<b>Warnings:</b>					
<b>Information:</b>					



8	Non Patent Literature	EPsr.PDF	625493 a9aff38cda1bcf584031f187d108876006612b	no	11
<b>Warnings:</b>					
<b>Information:</b>					
9	Information Disclosure Statement (IDS) Form (SB08)	IDS.pdf	613232 5c6f30b18a67ac11331e5bb6119e0455d160635f	no	6
<b>Warnings:</b>					
<b>Information:</b>					
10		Response.pdf	661389 26cc3cf6d9b7c3a4021d04547686e53a2a3dcafe	yes	15
	<b>Multipart Description/PDF files in .zip description</b>				
	<b>Document Description</b>		<b>Start</b>	<b>End</b>	
	Reply under 1.111 to Pre-Interview Communication		1	1	
	Claims		2	7	
	Applicant Arguments/Remarks Made in an Amendment		8	15	
<b>Warnings:</b>					
<b>Information:</b>					
11	Transmittal Letter	Transmittal.pdf	68452 be13d833deaa6724e7b7ea8bbec936f35ec8e2b	no	1
<b>Warnings:</b>					
<b>Information:</b>					
12	Fee Worksheet (SB06)	fee-info.pdf	30864 08f1dd9a2642514ccab999da6f9995c3ae85c69f	no	2
<b>Warnings:</b>					
<b>Information:</b>					
<b>Total Files Size (in bytes):</b>				25410638	

**This Acknowledgement Receipt evidences receipt on the noted date by the USPTO of the indicated documents, characterized by the applicant, and including page counts, where applicable. It serves as evidence of receipt similar to a Post Card, as described in MPEP 503.**

**New Applications Under 35 U.S.C. 111**

**If a new application is being filed and the application includes the necessary components for a filing date (see 37 CFR 1.53(b)-(d) and MPEP 506), a Filing Receipt (37 CFR 1.54) will be issued in due course and the date shown on this Acknowledgement Receipt will establish the filing date of the application.**

**National Stage of an International Application under 35 U.S.C. 371**

**If a timely submission to enter the national stage of an international application is compliant with the conditions of 35 U.S.C. 371 and other applicable requirements a Form PCT/DO/EO/903 indicating acceptance of the application as a national stage submission under 35 U.S.C. 371 will be issued in addition to the Filing Receipt, in due course.**

**New International Application Filed with the USPTO as a Receiving Office**

**If a new international application is being filed and the international application includes the necessary components for an international filing date (see PCT Article 11 and MPEP 1810), a Notification of the International Application Number and of the International Filing Date (Form PCT/RO/105) will be issued in due course, subject to prescriptions concerning national security, and the date shown on this Acknowledgement Receipt will establish the international filing date of the application.**



(11) **EP 2 770 643 A2**

(12) **EUROPEAN PATENT APPLICATION**  
published in accordance with Art. 153(4) EPC

(43) Date of publication: **27.08.2014 Bulletin 2014/35**

(51) Int Cl: **H04B 1/40 (2006.01) H04W 4/22 (2009.01)**  
**H04W 4/02 (2009.01)**

(21) Application number: **12842666.5**

(86) International application number: **PCT/KR2012/008470**

(22) Date of filing: **17.10.2012**

(87) International publication number: **WO 2013/058533 (25.04.2013 Gazette 2013/17)**

(84) Designated Contracting States:  
**AL AT BE BG CH CY CZ DE DK EE ES FI FR GB GR HR HU IE IS IT LI LT LU LV MC MK MT NL NO PL PT RO RS SE SI SK SM TR**

(30) Priority: **19.10.2011 KR 20110106839**

(71) Applicant: **Jung, Jae Lark**  
**Goyang-si, Gyeonggi-do 411-737 (KR)**

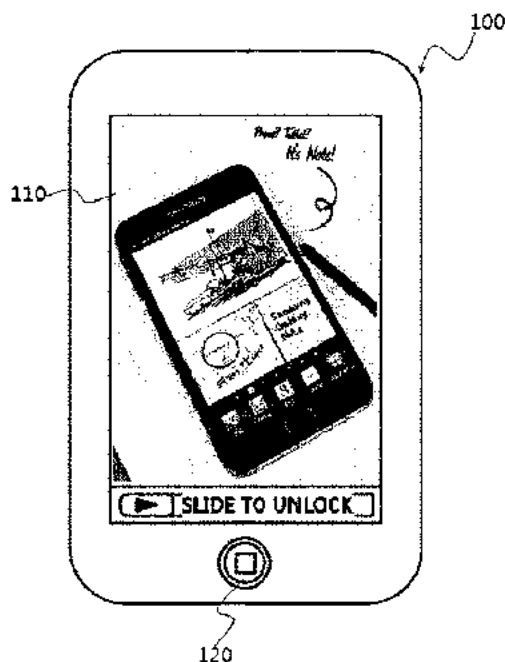
(72) Inventor: **BAE, Kyoung Duck**  
**Seoul 133-759 (KR)**

(74) Representative: **Zardi, Marco**  
**M. Zardi & Co. SA**  
**Via Ploda 6**  
**6900 Lugano (CH)**

(54) **METHOD, SYSTEM AND MOBILE COMMUNICATION TERMINAL FOR CAUSING A PREDETERMINED OPERATION TO BE EXECUTED IN THE ACTIVATION OF THE MOBILE COMMUNICATION TERMINAL**

(57) Provided is a mobile communication terminal including a display unit and an activation button configured to switch an inactive state in which the display unit is off to an active state in which the display is on, in which, when the activation button is pressed, the inactive state is switched to the active state and simultaneously a pre-determined operation is performed.

Fig. 7



**EP 2 770 643 A2**

## Description

### BACKGROUND

#### 1. Field of the Invention

**[0001]** The present invention relates to a method, a system, and a mobile communication terminal for performing a specific function when the mobile communication terminal is activated, and more particularly, to a method, a system, and a mobile communication terminal for performing various functions depending on the number of times or duration of time a button for switching from an inactive state to an active state is pressed.

#### 2. Discussion of Related Art

**[0002]** Recently, all kinds of terminals, for example, such as smartphones, mobile phones, personal digital assistants (PDAs), and web pads, having not only communication functions but also various other functions have come into wide use. These terminals have rapidly been generalized because not only can an environment identical or similar to a desktop computer be implemented anytime and anywhere on the above-described terminals, but they also include a telephone function.

**[0003]** At present, in order to operate a corresponding function among various functions included in a terminal such as those described above, a certain operation should be performed in a state in which the terminal is in an active state, that is, in a state in which a display is turned on. In addition, in order to add a certain function, an interface or button for performing the function should be added to the terminal. For example, it is possible to transmit a rescue signal indicating an emergency or urgent situation by pressing an emergency button only when the emergency button for the urgent situation is separately added.

**[0004]** Meanwhile, users of the terminals described above perform operations of habitually taking out and activating the terminals on the move or in a standby state while carrying the terminals.

**[0005]** Specifically, the terminals generally have the button for switching from an inactive state in which a display is off to an active state in which the display is on, and at present, many users may press the activation switch button several times intentionally or unintentionally. Typical terminals show only brief information, such as a current time, on their wallpaper set by the users when the activation switch button is pressed. Accordingly, the users cannot get any beneficial information and interest when pressing the activation switch button, and then the terminals are switched from the active state to the inactive state.

### SUMMARY OF THE INVENTION

**[0006]** The present invention is directed to technology

for enabling an advantageous function to be utilized with only a simple operation of pressing an activation button, which is habitually pressed, by connecting various operations to the activation button provided in a terminal.

**[0007]** The present invention is also directed to technology for enabling aged persons to check their health with only a simple operation and enabling information regarding the health check to be transmitted to a guardian or medical authority.

**[0008]** The present invention is also directed to technology for enabling a security-enhanced user authentication process to be operated with only a simple procedure.

**[0009]** The present invention is also directed to technology for enabling an urgent message to be transmitted to a necessary recipient along with location information with only a simple operation in an urgent situation.

**[0010]** The present invention is also directed to technology for enabling an advertising revenue and an efficient advertising effect to be generated by displaying an advertisement on the terminal when the activation button is habitually pressed by a user, by connecting an advertising display function to the activation button provided in the terminal.

**[0011]** According to an aspect of the present invention, there is provided a mobile communication terminal including: a display unit; and an activation button configured to switch an inactive state in which the display unit is off to an active state in which the display is on, in which, when the activation button is pressed, the inactive state is switched to the active state and simultaneously a predetermined operation is performed.

**[0012]** According to another aspect of the present invention, there is provided a method of performing a specific function when a mobile communication terminal is activated, the method including: sensing whether an activation button is pressed to switch from an inactive state, which is an OFF state of a display unit, to an active state, which is an ON state of the display unit; and performing a predetermined operation within the mobile communication terminal simultaneously with switching to the active state if the pressing of the activation button is sensed the inactive state.

**[0013]** According to still another aspect of the present invention, there is a system for providing a service for performing a specific operation when a mobile communication terminal is activated, the system including: an activation sensing unit configured to receive a sensing signal indicating that the mobile communication terminal is switched from an inactive state, which is an OFF state of a display unit, to an active state, which is an ON state of the display unit, from the mobile communication terminal; and an application driving unit configured to control a predetermined operation to be performed within the mobile communication terminal according to the switching to the active state.

## BRIEF DESCRIPTION OF THE DRAWINGS

**[0014]** The above and other objects, features, and advantages of the present invention will become more apparent to those of ordinary skill in the art by describing in detail exemplary embodiments thereof with reference to the accompanying drawings, in which:

FIG. 1 is a view illustrating an external appearance of a mobile communication terminal according to an embodiment of the present invention;

FIG. 2 is a view illustrating an example operation of the mobile communication terminal when an activation button is pressed according to an embodiment of the present invention;

FIGS. 3A and 3B are block diagrams illustrating the operations of the mobile communication terminal according to an embodiment of the present invention;

FIGS. 4A and 4B are block diagrams illustrating the operations of the mobile communication terminal according to another embodiment of the present invention;

FIG. 5 is a block diagram illustrating the operation of the mobile communication terminal according to still another embodiment of the present invention;

FIG. 6 is a view schematically illustrating an overall configuration of a system for displaying an advertisement when the mobile communication terminal is activated, according to an embodiment of the present invention;

FIG. 7 is a view illustrating an example in which an advertisement is displayed on a display unit when the mobile communication terminal is switched from an inactive state to an active state according to an embodiment of the present invention;

FIG. 8 is a view illustrating a process of using some of advertising revenue as a donation according to an embodiment of the present invention;

FIG. 9 is a view illustrating a configuration of an advertisement providing system according to an embodiment of the present invention; and

FIG. 10 is a block diagram illustrating a configuration of a system for providing a predetermined operation to the mobile communication terminal according to an embodiment of the present invention.

## DETAILED DESCRIPTION OF EXEMPLARY EMBODIMENTS

**[0015]** In the following detailed description, reference is made to the accompanying drawings that show, by way of illustration, specific embodiments in which the present invention may be practiced. These embodiments are described in sufficient detail to enable those skilled in the art to practice the present invention. It is to be understood that the various embodiments of the present invention, although different, are not necessarily mutually exclusive. For example, a particular feature, structure, or characteristic described herein in connection with one embodiment may be implemented within other embodiments without departing from the spirit and scope of the present invention. In addition, it is to be understood that the location or arrangement of individual elements within each disclosed embodiment may be modified without departing from the spirit and scope of the present invention. The following detailed description is, therefore, not to be taken in a limiting sense, and the scope of the present invention is defined only by the appended claims, appropriately interpreted, along with the full range of equivalents to which the claims are entitled. In the drawings, like numerals refer to the same or similar elements throughout several views.

**[0016]** Hereinafter, various preferred embodiments of the present invention will be described in more detail with reference to the accompanying drawings so that a person skilled in the art can easily practice the invention.

[Preferred embodiments of the present invention]

**[0017]** The term "mobile communication terminal" used herein refers to a digital device that includes a memory means and a microprocessor with computing capability as in a mobile phone, a navigation system, a web pad, a PDA, a workstation, a personal computer (for example, a notebook computer or the like) as a digital device including wired/wireless communication functions or other functions. Although an example of the mobile communication terminal (for example, a mobile phone) will be described in part of this specification, the present invention is not limited thereto.

**[0018]** The term "inactive state" used herein refers to a state in which the mobile communication terminal is communicable but a display screen is turned off. Even when the display screen is turned off, a predetermined function (for example, a music play function or the like) is operable. As described above, the term "inactive state" used herein refers to a concept encompassing states in which the display screen is turned off, regardless of whether or not the mobile communication terminal performs a predetermined operation. However, a state in which the mobile communication terminal is completely turned off is excluded.

**[0019]** The term "active state" used herein refers to a state in which the display screen of the mobile commu-

nication terminal is turned on. Switching from the "inactive state" to the "active state" refers to switching of the display screen from the OFF state to the ON state, regardless of information displayed on the display screen in the ON state. For example, the mobile communication terminal can be determined to be in the "active state" even when only a lock screen is displayed.

#### Configuration of mobile communication terminal

**[0020]** FIG. 1 is a view illustrating an external appearance of a mobile communication terminal according to an embodiment of the present invention.

**[0021]** Referring to FIG. 1, the mobile communication terminal 100 according to this embodiment may include a display unit 110 and an activation button 120. The mobile communication terminal 100 may further include a camera 130.

**[0022]** Although the display unit 110 is provided on an entire surface of a frame constituting the mobile communication terminal 100, the activation button 120 may be provided on a lower portion of the display unit 110, and the camera 130 is provided on an upper portion of the display unit 110 as illustrated in FIG. 1, the present invention may be configured in a variety of different ways. For example, the display unit 110 is not necessarily formed on the entire surface of the mobile communication terminal 100. That is, the display unit 110 may be formed on at least a portion of the mobile communication terminal 100 and the activation button 120 may be formed on a part different from that of the display unit 110. In addition, the camera 130 may be formed on the other side of the mobile communication terminal 100 where the display unit 110 is not provided.

**[0023]** The display unit 110 displays a variety of information about operation states of the mobile communication terminal 100, and also displays an interface for a user's input when the mobile communication terminal 100 is a touchscreen-driven terminal. In general, if a state in which the user's operation on the mobile communication terminal 100 is absent continues for a predetermined period of time, the mobile communication terminal 100 is switched to the inactive state. The user's operation refers to an input through the interface displayed on the display unit 110, an operation through the activation button 120, or an operation through a function key (for example, a volume control key or the like). A condition for switching to the inactive state may be set by a user. For example, the condition may be set in a setting menu through the interface displayed on the display unit 110. Meanwhile, the mobile communication terminal 100 may be switched to the inactive state by pressing another button (for example, an on/off button) provided thereon. For example, the mobile communication terminal 100 may be completely powered off if the on/off button is pressed for a long time when the mobile communication terminal 100 is in the active state. However, the mobile communication terminal 100 may be inactivated to be in a com-

municable state in which a phone call can be received if the on/off button is pressed for a short time.

**[0024]** The activation button 120 is a means for switching the mobile communication terminal 100 from the inactive state to the active state. That is, if the user presses the activation button 120 when the mobile communication terminal 100 is in the inactive state, the mobile communication terminal 100 is switched to the active state. FIG. 1 illustrates a state in which a lock screen is displayed on the display unit 110 by pressing the activation button 120 when the mobile communication terminal 100 is in the inactive state. However, the activation button 120 may function as a means for another operation (for example, a means for moving to a standby screen while a certain operation state is displayed on the display unit 110 or a means for displaying a list of programs being currently executed).

**[0025]** According to an embodiment of the present invention, if the user presses the activation button 120 when the mobile communication terminal 100 is in the inactive state, the mobile communication terminal 100 performs a predetermined operation in addition to being switched to the active state. When the mobile communication terminal 100 is in the inactive state, the user can set an operation to be performed by pressing the activation button 120. For example, the operation of the mobile communication terminal 100 connected to the activation button 120 may be set in a setting menu through the interface displayed in the display unit 110. In addition, according to an embodiment of the present invention, when the mobile communication terminal 100 is in the inactive state, various operations may be performed depending on the number of times or duration of time the activation button 120 is pressed. For example, a first operation may be set to be performed when the activation button 120 is pressed once, and a second operation may be set to be performed when the activation button 120 is pressed three times consecutively. As another example, the first operation may be set to be performed when the activation button 120 is pressed once for a short time, and a second operation may be set to be performed when the activation button 120 is pressed once for a long time. In order to count the number of consecutive presses of the activation button 120 and measure a press time of the activation button 120, the mobile communication terminal 100 may include a certain clock circuit or timer. For example, if the activation button 120 is pressed and then repressed within a threshold time, it may be determined that the button is pressed twice. If the activation button 120 is pressed for more than a threshold period of time, it may be determined that the button is pressed for a long time. Operations capable of being performed by pressing the activation button 120 in the inactive state will be described later.

**[0026]** According to an embodiment of the present invention, a sub-display unit 121 may be provided on the activation button 120. Information about an operation to be performed by pressing the activation button 120 may

be displayed on the sub-display unit 121. Various types such as a shape, a text, a character, a graphic, and a color can be displayed. When the display type is the shape, a circle, a triangle, a rectangle, a hexagon, or the like may be displayed. For example, the circle may be displayed on the sub-display unit 121 when the first operation is set to be performed by pressing the activation button 120, and the triangle may be displayed on the sub-display unit 121 when the second operation is set to be performed by pressing the activation button 120, and vice versa. A display type of the sub-display unit 121 and a correspondence relation between operations and displays can also be set by the user. For example, the user may select the first operation as the operation to be performed by pressing the activation button 120 from a setting menu and select the triangle as the display type of the sub-display unit 121 of the activation button 120. Accordingly, the user can recognize that the first operation is performed when the user has pressed the activation button 120 because the triangle is displayed on the sub-display unit 121 even when the mobile communication terminal 100 is in the inactive state.

**[0027]** Although the sub-display unit 121 may be implemented by a general display device such as liquid crystal, a liquid crystal display (LCD), or a light emitting diode (LED), the present invention is not limited thereto.

**[0028]** An operation of controlling driving of the display unit 110 and the sub-display unit 121 may or may not be performed by the same processor and in the same method.

**[0029]** Hereinafter, various embodiments for operations of the mobile communication terminal 100 capable of being performed by pressing the activation button 120 will be described.

#### Operations through activation button

**[0030]** Operations to be described below may be performed by pressing the activation button 120 when the mobile communication terminal 100 is in the inactive state, which may be set by the user. The operations described below are only examples. Of course, other operations can be performed by pressing the activation button 120.

##### 1. Camera activation function

**[0031]** When the mobile communication terminal 100 is in the inactive state, the camera 130 provided in the mobile communication terminal 100 can be activated by pressing the activation button 120, and a screen currently imaged by the camera 130 can be displayed on the display unit 110.

**[0032]** FIG. 2 is a diagram illustrating an example in which the camera 130 is activated after the activation button 120 is pressed and an image is displayed on the display unit 110.

##### 2. Health sensing and health information transmission functions

**[0033]** When the mobile communication terminal 100 is in the inactive state, a health sensing function can be driven by pressing the activation button 120, so that sensed health information can be transmitted to a medical authority such as a doctor, or a guardian.

**[0034]** FIGS. 3A and 3B are block diagrams illustrating the operations of the mobile communication terminal 100 according to an embodiment of the present invention. FIGS. 3A and 3B illustrate functional block diagrams illustrating the above-described functions of the mobile communication terminal 100.

**[0035]** Referring to FIG. 3A, the mobile communication terminal 100 may include an activation sensing unit 310, a health sensing unit 320, and a health information transmission unit 330.

**[0036]** When the mobile communication terminal 100 is in the inactive state, the activation sensing unit 310 senses whether the activation button 120 is pressed by the user.

**[0037]** The health sensing unit 320 is operated when the activation sensing unit 310 senses that the activation button 120 is pressed, and senses a health state of the user in various methods.

**[0038]** FIG. 3B is a block diagram illustrating an example of the health sensing unit 320. Referring to FIG. 3B, the health sensing unit 320 may include a camera activation element 321, an eyeball detection element 322, and a health information acquisition element 323.

**[0039]** The camera activation element 321 activates the camera 130 provided in the mobile communication terminal 100. According to the activation of the camera 130, a video currently captured by the camera 130 is displayed on the display unit 110. If an eye or face of the user is imaged by the camera 130, the eyeball detection element 322 performs a function of recognizing and extracting an eyeball of the user. A general eyeball detection algorithm may be used for eyeball detection. The health information acquisition element 323 acquires various health information from the eyeball detected by the eyeball detection element 322. It is possible to recognize a stress index, a diabetes index, or retinal diseases of the user from a color or health state of the eyeball. A well-known algorithm in the related art can be used as an algorithm for detecting health information from characteristics of the detected eyeball.

**[0040]** The health information acquired as described above can be transmitted by the health information transmission unit 330 to the mobile communication terminal of a guardian, a medical authority such as a doctor or the like, or a predetermined server. Information regarding the guardian (for example, a phone number or an e-mail address) can be stored in advance. The acquired health information can be displayed on the display unit 110 so that the user can check the acquired health information.

**[0041]** The above-described operations, that is, the

eyeball detection function and the health sensing function based on information regarding the detected eyeball, can be performed by installing a predetermined application. That is, the application includes an eyeball detection algorithm and a health sensing algorithm, so that the operations as described above can be performed by installing the application in the mobile communication terminal 100. The user may download this application and install the downloaded application in the mobile communication terminal 100. In addition, although only an example of health sensing through eyeball detection has been described above, it is also possible, for example, to install an application for health sensing through face detection and connect the application to the activation button 120. The user can use the functions as described above by setting the application through the setting menu to be operated immediately when the activation button 120 is pressed in the inactive state of the mobile communication terminal 100.

**[0042]** In general, aged persons may not use the health sensing function due to a difficult operation even when the health sensing function is provided in the mobile communication terminal 100. However, according to the above-described embodiment of the present invention, the health sensing function is operated only by pressing the activation button 120 without a special operation. Accordingly, it is possible to easily check health information and transmit the health information to a guardian or a doctor.

### 3. User identification function

**[0043]** When the mobile communication terminal 100 is in the inactive state, a user authentication process can be performed for security by pressing the activation button 120.

**[0044]** FIGS. 4A and 4B illustrate block diagrams of the mobile communication terminal 100 illustrating the above-described functions. Referring to FIG. 4A, the mobile communication terminal 100 may include an activation sensing unit 410 and a user identification unit 420.

**[0045]** When the mobile communication terminal 100 is in the inactive state, the activation sensing unit 410 senses whether the activation button 120 is pressed by the user.

**[0046]** When it is sensed by the activation sensing unit 410 that the activation button 120 is pressed, the user identification unit 420 operates the user identification function in various methods.

**[0047]** FIG. 4B is a block diagram illustrating an example of the user identification unit 420. Referring to FIG. 4B, the user identification unit 420 may include a camera activation element 421, an iris detection element 422, and a user identification element 423.

**[0048]** The camera activation element 421 activates the camera 130 provided in the mobile communication terminal 100. According to the activation of the camera 130, a video currently captured by the camera 130 is

displayed on the display unit 110. If an eye or face of the user is imaged by the camera 130, the iris detection element 422 performs a function of recognizing and extracting an iris from an eyeball of the user. A general iris detection algorithm can be used for iris recognition. The user identification element 423 performs a function of comparing the iris detected by the iris detection element 422 to pre-stored iris information of the user, and authenticating the current user as a true user if the two match. For this, the user identification element 423 can use iris information of the user pre-stored in a database (not illustrated). The iris information of the user can be stored by registering information regarding the iris detected by the iris detection element 422 using a video of the true user first captured by the camera 130. Predetermined identification information (for example, an identifier (ID), a password, a social security number, or the like) should be input to change the registered iris information of the true user. If the user identification element 423 authenticates the current user as the true user, the lock state of the mobile communication terminal 100 is released and all functions are available. If the current user is not authenticated as the true user, the lock state continues along with a display of an alarm message.

**[0049]** The above-described operations, that is, the iris detection function, the user identification function, and the user authentication function, can be performed by installing a predetermined application. That is, the application includes the iris detection algorithm and the authentication algorithm based on an iris comparison, so that the operations as described above can be performed by installing the application in the mobile communication terminal 100. The user can download this application and install the downloaded application in the mobile communication terminal 100. The user can use the functions as described above by setting the application through the setting menu to be operated immediately when the activation button 120 is pressed in the inactive state of the mobile communication terminal 100.

**[0050]** Accordingly, it is possible to efficiently reduce security risks by setting the user authentication process to be performed through a separate setting, that is, by pressing the activation button 120, when the mobile communication terminal 100 is used in a region vulnerable to the security risks.

**[0051]** Although an example of an authentication method through iris recognition has been described above, other authentication methods, for example, an authentication key matching method, a password matching method, a face recognition method, a fingerprint recognition method, and the like, can be used. That is, one or more authentication methods can be performed by pressing the activation button 120.

### 4. Location information transmission function

**[0052]** When the mobile communication terminal 100 is in the inactive state, collected location information can



be transmitted to a guardian or a protection authority (a police station or a fire station) by pressing the activation button 120.

**[0053]** FIG. 5 illustrates a block diagram of the mobile communication terminal 100 illustrating the above-described function. Referring to FIG. 5, the mobile communication terminal 100 may include an activation sensing unit 510, a location information collection unit 520, and a location information transmission unit 530.

**[0054]** When the mobile communication terminal 100 is in the inactive state, the activation sensing unit 510 senses whether the user has pressed the activation button 120.

**[0055]** When the activation sensing unit 510 senses that the activation button 120 has been pressed, the location information collection unit 520 collects a current location using a global positioning system (GPS) sensor or other location sensors.

**[0056]** The location information transmission unit 530 performs a function of transmitting location information collected by the location information collection unit 520 to a guardian or a protection authority. In an urgent situation, a message indicating the urgent situation can be transmitted along with the location information. The location information and the urgent message can be selectively transmitted. Meanwhile, this operation may differ according to the number of times or duration of time the activation button 120 is pressed. For example, it is possible to set an operation of transmitting the urgent message to a police station along with the location information when the activation button 120 is pressed once for a short time, and set an operation of transmitting only the location information to the guardian when the activation button 120 is pressed once for a long time. In addition, as another example, it is possible to set an operation of transmitting the location information to the police station along with the urgent message when the activation button 120 is pressed once and set an operation of transmitting the location information to a fire station along with the urgent message when the activation button 120 is pressed three times.

**[0057]** The above-described operations can be performed by installing a predetermined application. That is, the application includes an algorithm for collecting location information and transmitting the collected location information along with an urgent message, so that the operations as described above can be performed by installing the application in the mobile communication terminal 100. The user can download this application and install the downloaded application in the mobile communication terminal 100. The user can use the functions as described above by setting the application through the setting menu to be operated immediately when the activation button 120 is pressed in the inactive state of the mobile communication terminal 100.

**[0058]** Accordingly, it is possible to efficiently cope with a dangerous situation because the user can report the dangerous situation to a guardian or a protection author-

ity along with his/her location information with only a simple operation.

#### 5. File transmission function

**[0059]** When the mobile communication terminal 100 is in the inactive state, a function of uploading content (for example, contact information, a photo, a moving image, or an application) included in the mobile communication terminal 100 to another mobile communication terminal 100 or a media space (for example, a personal media space such as Twitter, Facebook, or a blog or a community media space such as a café or club community) can be operated.

#### 6. Mode change during drive

**[0060]** When the mobile communication terminal 100 is in the inactive state, the mobile communication terminal 100 can be switched to a hands-free function or some communication functions (a voice call function, a short message service (SMS) function, and an Internet function) of the mobile communication terminal 100 can be interrupted by pressing the activation button 120.

**[0061]** Accordingly, it is possible to significantly reduce traffic accident risks by switching the mobile communication terminal 100 to a hand-free mode or interrupting the communication function with only a simple operation of pressing the activation button 120 during driving.

#### 7. Advertisement display operation

**[0062]** FIG. 6 is a view schematically illustrating an overall configuration of a system for displaying an advertisement when the mobile communication terminal is activated, according to an embodiment of the present invention.

**[0063]** Referring to FIG. 6, the overall system according to an embodiment of the present invention may include a mobile communication terminal 100, an advertisement providing system 200, an advertiser server 300, and a service providing server 400.

**[0064]** According to an embodiment, the mobile communication terminal 100, the advertisement providing system 200, the advertiser server 300, and the service providing server 400 may communicate with each other over a communication network. The communication network may be wired or wireless, and examples of the communication network may include, but not limited to, a Local Area Network (LAN), a Metropolitan Area Network (MAN), and a Wide Area Network (WAN). Preferably, the communication network according to an embodiment of the present invention may be the World Wide Web (WWW).

**[0065]** According to an embodiment, the mobile communication terminal 100 may include a display unit 110 and an activation button 120.

**[0066]** Although the display unit 110 is provided on an

entire surface of a frame constituting the mobile communication terminal 100 and the activation button 120 may be provided on a lower portion of the display unit 110 as illustrated in FIG. 6, the present invention may be configured in a variety of different ways. For example, the display unit 110 is not necessarily formed on the entire surface of the mobile communication terminal 100. That is, the display unit 110 is only required to be formed on at least a portion of the mobile communication terminal 100 and the activation button 120 may be formed on a part different from that of the display unit 110.

**[0067]** The display unit 110 displays a variety of information about operation states of the mobile communication terminal 100, and also displays an interface for a user's input when the mobile communication terminal 100 is a touchscreen-driven terminal. In general, if a state in which the user's operation on the mobile communication terminal 100 is absent continues for a predetermined period of time, the mobile communication terminal 100 is switched to the inactive state. The user's operation refers to an input through the interface displayed on the display unit 110, an operation through the activation button 120, or an operation through a function key (for example, a volume control key or the like). A condition for switching to the inactive state may be set by a user. For example, the condition may be set in a setting menu through the interface displayed on the display unit 110. As an example, the mobile communication terminal 100 may be switched to the inactive state when there has been no user's input for a certain time. Meanwhile, the mobile communication terminal 100 may be switched to the inactive state by pressing another button (for example, an on/off button) provided thereon. For example, the mobile communication terminal 100 may be completely powered off if the on/off button is pressed for a long time when the mobile communication terminal 100 is in the active state. However, the mobile communication terminal 100 may be inactivated to be in a communicable state in which a phone call can be received if the on/off button is pressed for a short time.

**[0068]** The activation button 120 is a means for switching the mobile communication terminal 100 from the inactive state to the active state. That is, if the user presses the activation button 120 when the mobile communication terminal 100 is in the inactive state, the mobile communication terminal 100 is switched to the active state. FIG. 6 illustrates a state in which a lock screen is displayed on the display unit 110 by pressing the activation button 120 when the mobile communication terminal 100 is in the inactive state. However, the activation button 120 may function as a means for another operation (for example, a means for moving to a standby screen while a certain operation state is displayed on the display unit 110 or a means for displaying a list of programs being currently executed).

**[0069]** According to an embodiment of the present invention, if the user presses the activation button 120 when the mobile communication terminal 100 is in the

inactive state, the mobile communication terminal is not switched to the active state, but a predetermined advertisement is displayed on the display unit 110. FIG. 7 is a view illustrating an example in which an advertisement is displayed on the display unit 110 when the mobile communication terminal 100 is switched from the inactive state to the active state according to an embodiment of the present invention.

**[0070]** According to an embodiment of the present invention, the advertisement may be displayed by driving an application previously installed in the mobile communication terminal 100. That is, an application is driven for activating the mobile communication terminal 100 through the activation button 120 and simultaneously enabling the advertisement to be displayed, and thus the advertisement may be displayed on the display unit 110. This application may be previously transmitted from an external system such as the advertisement providing system 200 or the advertiser server 300 and then installed.

**[0071]** As another embodiment, when the mobile communication terminal 100 is activated, the advertisement provided by the advertisement providing server 200 may be displayed on the display unit 110. Advertisement information from the advertisement providing server 200 may be received before the mobile communication terminal 100 is activated (for example, when inactivated or at other times) or at the same time as the mobile communication terminal 100 is activated.

**[0072]** Advertisements may be randomly selected and displayed, or only advertisements selected under a predetermined condition may be displayed.

**[0073]** According to an embodiment of the present invention, only advertisements associated with the current position information of the mobile communication terminal 100 may be displayed (implemented in conjunction with "4. Location information transmission function" described above). Specifically, on the basis of the current location information of the mobile communication terminal 100, the advertisements for companies around the current position may be displayed. The location information of the mobile communication terminal 100 may be sensed upon activation or in real time.

**[0074]** According to another embodiment, customized advertisements may be displayed based on user information of the mobile communication terminal 100. For example, advertisements for associated companies may be displayed based on a gender, an age, a region of residence, an occupation, a matter of interest, and the like of a user. The user information may be input and stored by the user when the user subscribes to an advertisement providing service or installs an application for displaying an advertisement. The user information may be stored in the mobile communication terminal 100 or transmitted and stored to the advertisement providing server 200.

**[0075]** According to still another embodiment, different advertisements may be displayed on the display unit 110 by time of day. For example, advertisements for restau-

rant businesses may be displayed in a meal time, and advertisements for soap operas may be displayed in a soap opera time.

**[0076]** Elements for determining the displayed type of advertisements have been described above, but at least two of the elements may be combined with each other and used to determine the type of advertisements. For example, an advertisement may be displayed in consideration of both location information and user information. Moreover, the advertisement may include a brand advertisement, a program advertisement, a service advertisement, a promotion advertisement, and an event advertisement.

**[0077]** According to an embodiment of the present invention, if a user enters an additional input when an advertisement is displayed on the display unit 110, various operations may be achieved. For example, if the user clicks on the displayed advertisement, movement to a webpage associated with the advertisement is achieved. The webpage may provide information about a company or product associated with the advertisement, discount information, location information, and so on.

**[0078]** As another example, some of advertising revenue earned by an advertisement provider by clicking on the advertisement may be used as donation money. FIG. 8 is a view illustrating a process of using some of advertising revenue as a donation by clicking on the advertisement displayed on the display unit 110. Referring to FIG. 8, an interface for selecting whether to save donation money may be provided by clicking an advertisement, and if a user requests to save donation money, some of advertising revenue may be used as the donation money and an indication associated with this (for example, a social network page such as Angel Book) may be displayed.

**[0079]** According to an embodiment of the present invention, when the mobile communication terminal 100 is activated, a specific application may be executed, but an advertisement may be displayed only when there is no update of the information provided by the application to the user. For example, when the mobile communication terminal 100 is activated, a social network service provided by the service providing server is driven to display a corresponding page on the display unit 110. In this case, the advertisement may be displayed only when there is no new content in the corresponding page, which is not checked by the user.

**[0080]** An overall system for displaying an advertisement when the mobile communication terminal is activated according to an embodiment of the present invention will be described below.

**[0081]** FIG. 9 is a view illustrating a configuration of an advertisement providing system according to an embodiment of the present invention.

**[0082]** Referring to FIG. 9, the advertisement providing system 200 may include an application providing unit 210, an activation sensing unit 220, an advertisement providing unit 230, an additional function providing unit

240, a database 250, a communication unit 260, and a control unit 270. According to an embodiment of the present invention, each of the application providing unit 210, the activation sensing unit 220, the advertisement providing unit 230, the additional function providing unit 240, the database 250, the communication unit 260, and the control unit 270 may be a program module or a hardware component capable of communicating with an external apparatus. The program module or hardware component may be included, as an operating system, an application program module, or a program module, in the advertisement providing system 200 or another apparatus capable of communicating therewith and physically stored on various well-known memory devices. Examples of the program module or hardware component include, but not limited to, a routine, a sub-routine, a program, an object, a component, and a data structure for performing a specific task to be described later or executing a specific abstract data type.

**[0083]** When the mobile communication terminal 100 is switched to the active state, the application providing unit 210 provides an application for displaying an advertisement on the display unit 110. The user may access the advertisement providing system 200 through the mobile communication terminal 100 to receive and install the application. The application may include a function of transmitting location information, user information, or time information of the mobile communication terminal 100. However, if an advertisement is distributed to the display unit 110 when the mobile communication terminal 100 is switched to the active state without installation of the application, the application providing unit 210 may be omitted.

**[0084]** The activation sensing unit 220 according to an embodiment of the present invention may sense that the mobile communication terminal 100 is switched from the inactive state to the active state. The mobile communication terminal 100 may transmit a signal indicating occurrence of activation to the service providing server 200 by the user pressing the activation button 120 of the mobile communication terminal 100.

**[0085]** The advertisement providing unit 230 according to an embodiment of the present invention performs a function of displaying a predetermined advertisement on the display unit 110 of the mobile communication terminal 100 when it is sensed that the mobile communication terminal 100 is activated. The advertisement may be previously stored in the mobile communication terminal 100 or in the database 250 of the advertisement providing system 200. The advertisement providing system 200 may receive advertisement content from the advertiser server 300 and store the advertisement content to the database 250. The advertisement content may be categorized and stored according to a predetermined classification. For example, the advertisement content to be provided by location, user characteristic, and time may be classified and stored. The advertisement providing unit 230 may select advertisement content, which is re-

quired to be provided when the mobile communication terminal 100 is activated, from the database 250 under a predetermined condition to provide the selected advertisement content to the mobile communication terminal 100. In a case in which an application provided from the service providing server 400 is set to be driven when the mobile communication terminal 100 is switched to the active state, the advertisement may be provided when the application is driven or when the application has no new information to be provided to the user.

**[0086]** However, according to another embodiment of the present invention, since an application provided by the application providing unit 210 includes both advertisement content and condition information about advertisements to be displayed, the mobile communication terminal 100 may autonomously perform an advertisement display operation when the mobile communication terminal 100 is switched to the active state.

**[0087]** The additional function providing unit 240 according to an embodiment of the present invention performs an additional function according to a request of the user on the basis of an advertisement provided by the advertisement providing unit 230. For example, a function of displaying additional information of the advertisement, moving to a related webpage, providing information about an advertisement target product or service, or utilizing some of advertisement revenue as donation money may be provided corresponding to click on the advertisement by a user.

**[0088]** According to a modification of the present invention, the above-described functions of the advertisement providing system 200 may be autonomously performed in the mobile communication terminal 100. That is, the additional function may be driven through the display of the advertisement and the click on the advertisement by sensing the activation in the mobile communication terminal 100.

**[0089]** The communication unit 260 according to an embodiment of the present invention allows information to be communicated between the advertisement providing system 200 and each of the mobile communication terminal 100, the advertiser server 300, and the service providing server 400.

**[0090]** The control unit 270 according to an embodiment of the present invention may perform a function of controlling the flow of data among the application providing unit 210, the activation sensing unit 220, the advertisement providing unit 230, the additional function providing unit 240, the database 250, and the communication unit 260. That is, the control unit 270 according to an embodiment of the present invention may control the application providing unit 210, the activation sensing unit 220, the advertisement providing unit 230, the additional function providing unit 240, the database 250, and the communication unit 260 to perform their unique functions.

## 8. Other application operations

**[0091]** If a predetermined operation is performed in addition to simply switching to an active state by pressing the activation button 120 when the mobile communication terminal 100 is in the inactive state, this belongs to the scope of the present invention.

**[0092]** For example, an entertainment operation (for example, an operation of a music or video player, execution of a game application, or reception of news) can be performed by pressing the activation button 120.

### Operation standby of application

**[0093]** According to an embodiment of the present invention, the above-described predetermined applications are driven when the mobile communication terminal 100 is switched from the inactive state to the active state.

**[0094]** For this, when the mobile communication terminal 100 is in the inactive state, the applications should be maintained in an operation standby state. When the mobile communication terminal 100 is switched from the active state to the inactive state, the above-described applications can be in the operation standby state. That is, a selected application to be driven when the mobile communication terminal 100 is switched to the active state can be in the operation standby state when the mobile communication terminal 100 is switched to the inactive state.

**[0095]** However, a predetermined application operable when the mobile communication terminal 100 is switched from the inactive state to the active state regardless of the operation standby state or an operation disable state of the application belongs to the present invention.

### Service providing server

**[0096]** Hereinafter, the service providing server according to an embodiment of the present invention will be described.

**[0097]** FIG. 10 is a view illustrating a configuration of a service providing system (server) for enabling a specific function to be operated when the mobile communication terminal is activated according to an embodiment of the present invention.

**[0098]** In this embodiment, the description of the advertisement providing system for "7. Advertisement display operation" is the same as described above. That is, the description of the advertisement providing server may be applied to operations other than "7. Advertisement display operation."

**[0099]** Referring to FIG. 10, a service providing server 1000 may include an application providing unit 1100, an activation sensing unit 1200, an application driving unit 1300, a communication unit 1400, and a control unit 1500. According to an embodiment of the present invention, each of the application providing unit 1100, the ac-

tivation sensing unit 1200, the application driving unit 1300, the communication unit 1400, and the control unit 1500 of the service providing server 1000 may be a program module or hardware component capable of communicating with an external apparatus. The program module or hardware component may be included, as an operating system, an application program module, or a program module, in the mobile communication terminal 100 or another apparatus capable of communicating therewith and physically stored on various well-known memory devices. Examples of the program module or hardware component include, but not limited to, a routine, a sub-routine, a program, an object, a component, and a data structure for performing a specific task to be described later or executing a specific abstract data type.

**[0100]** The application providing unit 1100 enables the predetermined application described above to be transmitted to the mobile communication terminal 100. The user may access the service providing server 1000 through the mobile communication terminal 100 to receive and install a desired application in the mobile communication terminal 100. The application may include a control function of allowing a predetermined operation to be performed when the mobile communication terminal 100 is activated, and can independently perform the predetermined operation.

**[0101]** The activation sensing unit 1200 according to an embodiment of the present invention may sense that the mobile communication terminal 100 is switched from the inactive state to the active state. The mobile communication terminal 100 may transmit a signal for informing occurrence of activation to the service providing server 1000 by the user pressing the activation button 120 of the mobile communication terminal 100.

**[0102]** The application driving unit 1300 according to an embodiment of the present invention enables a predetermined operation to be performed in the mobile communication terminal 100 when the activation of the mobile communication terminal 100 is sensed. That is, the application driving unit 1300 drives a predetermined application within the mobile communication terminal 100 and enables a related screen to be displayed on the display unit 110. The application driving unit 1300 can perform an additional operation associated with driving of a corresponding application. As described above, the application driving unit 1300 can drive the predetermined application simultaneously with the activation within the mobile communication terminal 100 and perform an additional operation for optimally driving the application.

**[0103]** The communication unit 1400 according to an embodiment of the present invention may allow information to be communicated between the service providing server 1000, and the mobile communication terminal 100 and another apparatus. That is, the communication unit 1400 can transmit an application to the mobile communication terminal 100, receive an activation signal from the mobile communication terminal 100, and receive information for driving the application.

**[0104]** The control unit 1500 according to an embodiment of the present invention may perform a function of controlling the data flows between the application providing unit 1100, the activation sensing unit 1200, the application driving unit 1300, the communication unit 1400, and the control unit 1500. That is, the control unit 1500 according to an embodiment of the present invention may control the application providing unit 1100, the activation sensing unit 1200, the application driving unit 1300, the communication unit 1400, and the control unit 1500 to perform their unique functions.

**[0105]** The embodiments according to the present invention described above may be implemented in the form of program instructions that may be executed through various computer components and recorded on a computer-readable medium. The computer-readable recording medium may include program instructions, data files, data structures, and the like individually or in combination. The program instructions recorded on the medium may be specifically designed for the present invention or may be well known to one of ordinary skill in the art of software. Examples of the computer-readable recording medium include a magnetic medium such as a hard disk, a floppy disk, or a magnetic tape, an optical medium such as a compact disc-read only memory (CD-ROM) or a digital versatile disc (DVD), a magneto-optical medium such as a floptical disk, and a hardware device such as a ROM, a random access memory (RAM), or a flash memory that is specially designed to store and execute program instructions. Examples of the program instructions include not only machine language codes generated by a compiler or the like but also high-level language codes that may be executed by a computer using an interpreter or the like. The hardware device described above may be constructed so as to operate as one or more software modules for performing the operations of the embodiments of the present invention, and vice versa.

**[0106]** According to the present invention, it is possible to beneficially utilize a terminal and also enhance an interest in using the terminal because various operations may be performed only by pressing an activation button when the terminal is in an inactive state.

**[0107]** According to the present invention, it is also possible to perform health check of an aged person with only a simple operation and transmit information regarding the health check to a guardian or medical authority.

**[0108]** According to the present invention, it is also possible to operate a security-enhanced user authentication process with only a simple procedure.

**[0109]** According to the present invention, it is also possible to transmit an urgent message in addition to location information to a necessary recipient with only a simple operation in an urgent situation.

**[0110]** According to the present invention, it is also possible to generate an advertising revenue and an efficient advertising effect by displaying an advertisement on the terminal when the activation button is habitually pressed

by a user, by connecting an advertising display function to the activation button provided in the terminal.

**[0111]** Although the present invention has been described with reference to the specific embodiments and drawings together with specific details such as detailed components, the above description is provided only for better understanding of the present invention and it will be apparent to those skilled in the art that various modifications and variations may be made from the above description.

**[0112]** While exemplary embodiments have been disclosed herein, it should be understood that other variations may be possible. Such variations are not to be regarded as a departure from the spirit and scope of exemplary embodiments of the present application, and all such modifications as would be obvious to one skilled in the art are intended to be included within the scope of the following claims.

### Claims

1. A mobile communication terminal comprising:
  - a display unit; and
  - an activation button configured to switch an inactive state in which the display unit is off to an active state in which the display is on, wherein, when the activation button is pressed, the inactive state is switched to the active state and simultaneously a predetermined operation is performed.
2. The mobile communication terminal of claim 1, wherein the activation button internally includes a sub-display unit.
3. The mobile communication terminal of claim 2, wherein an indication displayed on the sub-display unit differs depending on the operation performed by pressing the activation button.
4. The mobile communication terminal of claim 1, wherein the operation differs depending on the number of times or duration of time the activation button is pressed.
5. The mobile communication terminal of claim 1, wherein the operation is performed to display an advertisement on the display unit.
6. The mobile communication terminal of claim 1, wherein the displayed advertisement is determined based on at least one of location information of the mobile communication terminal, user characteristic information, and a current time.
7. The mobile communication terminal of claim 1, wherein a specific application is driven in the mobile communication terminal at the same time as the mobile communication terminal is switched to the active state, and the advertisement is displayed only when there is no new information that is not checked by a user among information provided by the application.
8. The mobile communication terminal of claim 1, wherein after the advertisement is displayed, at least one operation of displaying additional information or a webpage associated with the advertisement, displaying information about a product or service to be advertised, and utilizing some of advertising revenue as donation money is further performed.
9. The mobile communication terminal of claim 8, wherein the operation is performed when the advertisement is clicked on.
10. The mobile communication terminal of claim 1, further comprising a camera, wherein the operation is performed to activate the camera and display a video currently captured by the camera on the display unit.
11. The mobile communication terminal of claim 1, wherein, when the pressing of the activation button is sensed in the inactive state, a face or an eyeball of a user is detected from a video collected through a camera provided in the mobile communication terminal, health state information of the user is acquired, and the acquired health state information is transmitted.
12. The mobile communication terminal of claim 1, wherein, when the pressing of the activation button is sensed in the inactive state, an iris of a user is detected from a video collected through a camera provided in the mobile communication terminal, and the user is authenticated by comparing the detected iris to pre-stored iris information of the user.
13. The mobile communication terminal of claim 1, wherein, when the pressing of the activation button is sensed in the inactive state, an urgent message or location information collected by a sensor provided in the mobile communication terminal is transmitted to a guardian or a protection authority.
14. The mobile communication terminal of claim 1, wherein, when the pressing of the activation button is sensed in the inactive state, content of the mobile communication terminal is transmitted to another terminal or a predetermined media space.
15. The mobile communication terminal of claim 1, wherein, when the pressing of the activation button

is sensed in the inactive state, the mobile communication terminal is switched to a hands-free mode or some communication functions are interrupted.

16. The mobile communication terminal of claim 1, wherein, when the pressing of the activation button is sensed in the inactive state, a specific application is operated.
17. A method of performing a predetermined operation when a mobile communication terminal is activated, the method comprising:
- sensing whether an activation button is pressed to switch from an inactive state, which is an OFF state of a display unit, to an active state, which is an ON state of the display unit; and performing a predetermined operation within the mobile communication terminal simultaneously with switching to the active state if the pressing of the activation button is sensed the inactive state.
18. The method of claim 17, wherein the performing of a predetermined operation comprises displaying an advertisement on the display unit of the mobile communication terminal.
19. The method of claim 18, wherein the displayed advertisement is determined based on at least one of location information of the mobile communication terminal, user characteristic information, and a current time.
20. The method of claim 18, wherein the displaying of an advertisement is performed only when there is no new information, which is not checked by a user, among information provided by an application that is driven at the same time as the mobile communication terminal is switched to the active state.
21. The method of claim 18, further comprising, after the displaying of an advertisement, performing at least one operation of displaying additional information or an webpage associated with the advertisement, displaying information about a product or service to be advertised, and utilizing some of advertising revenue as donation money.
22. The method of claim 21, wherein the operation is performed when the advertisement is clicked on.
23. A system for providing a service for performing a specific operation when a mobile communication terminal is activated, the system comprising:

an activation sensing unit configured to receive a sensing signal indicating that the mobile com-

munication terminal is switched from an inactive state, which is an OFF state of a display unit, to an active state, which is an ON state of the display unit, from the mobile communication terminal; and

an application driving unit configured to control a predetermined operation to be performed within the mobile communication terminal according to the switching to the active state.

24. The system of claim 23, wherein the operation is performed to display an advertisement on the display unit.
25. The system of claim 24, wherein the advertisement is provided based on at least one of location information of the mobile communication terminal, user information, and a current time.
26. The system of claim 23, further comprising an advertisement providing unit configured to allow an advertisement to be displayed only when there is no new information, which is not checked by a user, among information provided by an application that is driven at the same time as the mobile communication terminal is switched to the active state.
27. The system of claim 23, further comprising an additional function providing unit configured to perform at least one operation of displaying additional information or an webpage associated with the advertisement, displaying information about a product or service to be advertised, and utilizing some of advertising revenue as donation money after an advertisement is displayed.
28. The system of claim 27, wherein the additional function providing unit performs the operation when a signal indicating occurrence of a click on the advertisement by a user is received.
29. The system of claim 23, wherein the predetermined operation comprises at least one operation of activation of a camera of the mobile communication terminal, health information acquisition through detection of a user's face or eyeball from a video collected from the camera, user authentication through detection of the user's iris from the video collected from the camera, transmission of location information of the mobile communication terminal or an urgent message, transmission of content stored in the mobile communication terminal to another terminal or a predetermined media space, switching to a hands-free mode of the mobile communication terminal, interruption of some functions of the mobile communication terminal, and driving of a specific application within the mobile communication terminal.

30. The system of claim 23, further comprising: an application providing unit configured to provide the mobile communication terminal with an application for enabling the predetermined operation.

5

10

15

20

25

30

35

40

45

50

55



Fig. 1

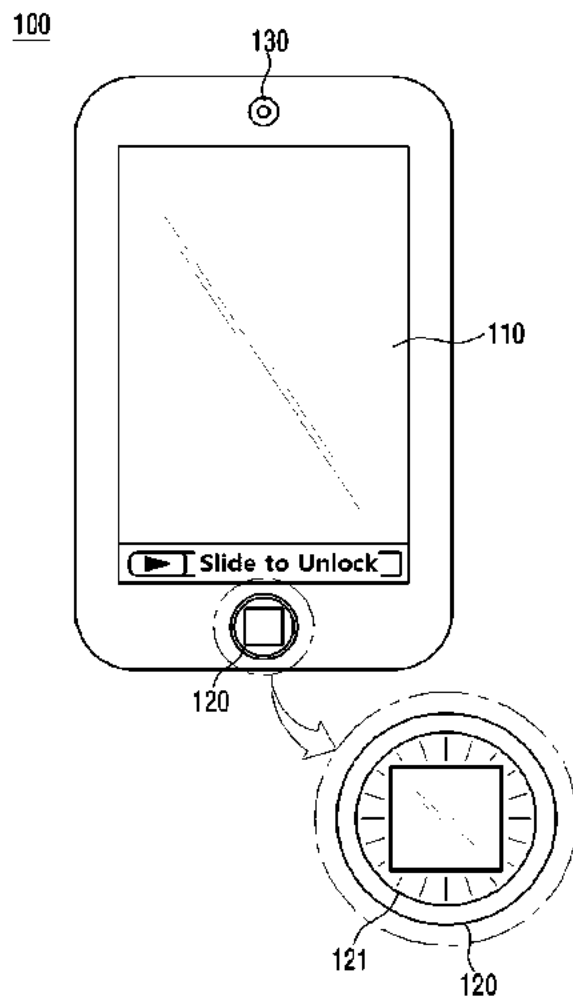


Fig. 2

100

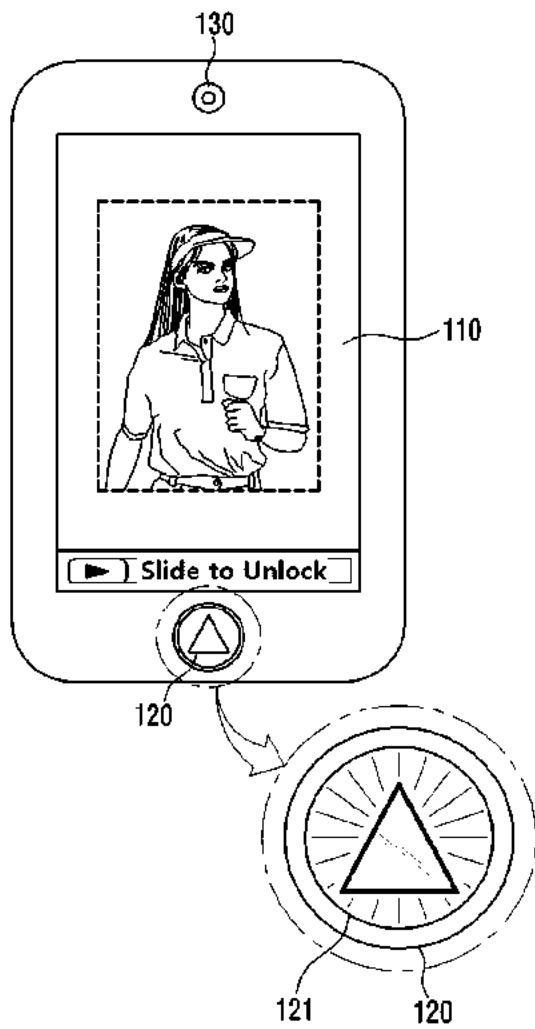


Fig. 3A

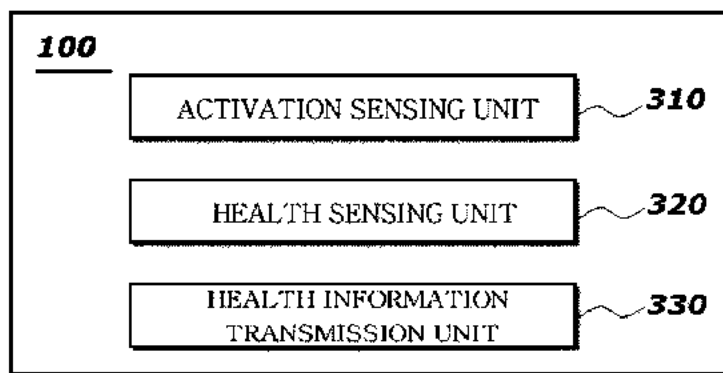


Fig. 3B

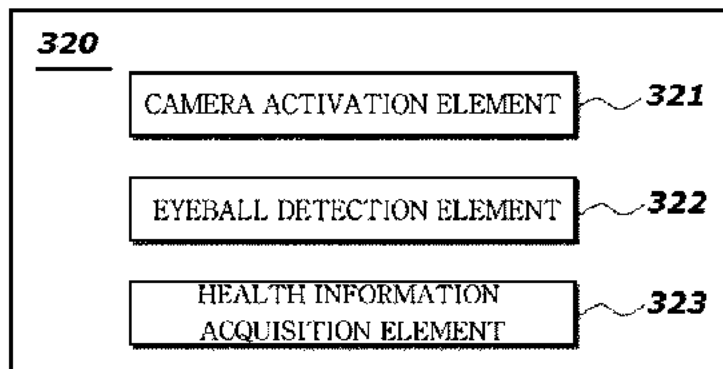


Fig. 4A

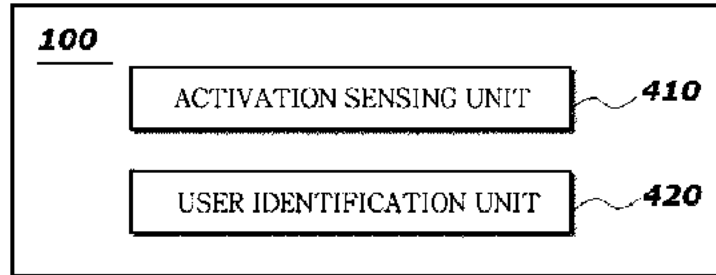


Fig. 4B

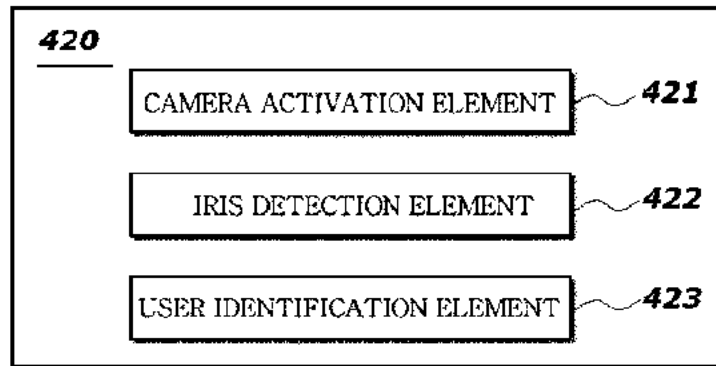


Fig. 5

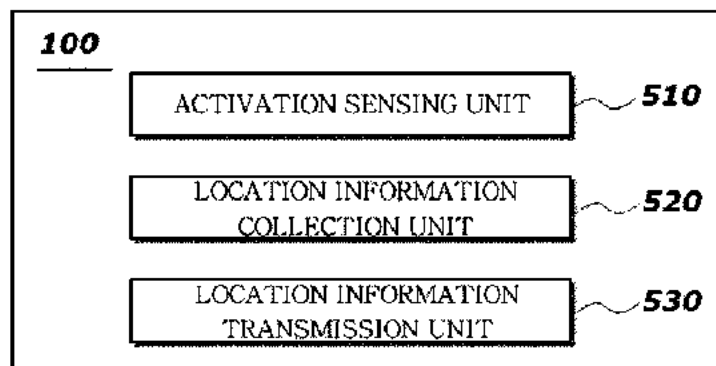


Fig. 6

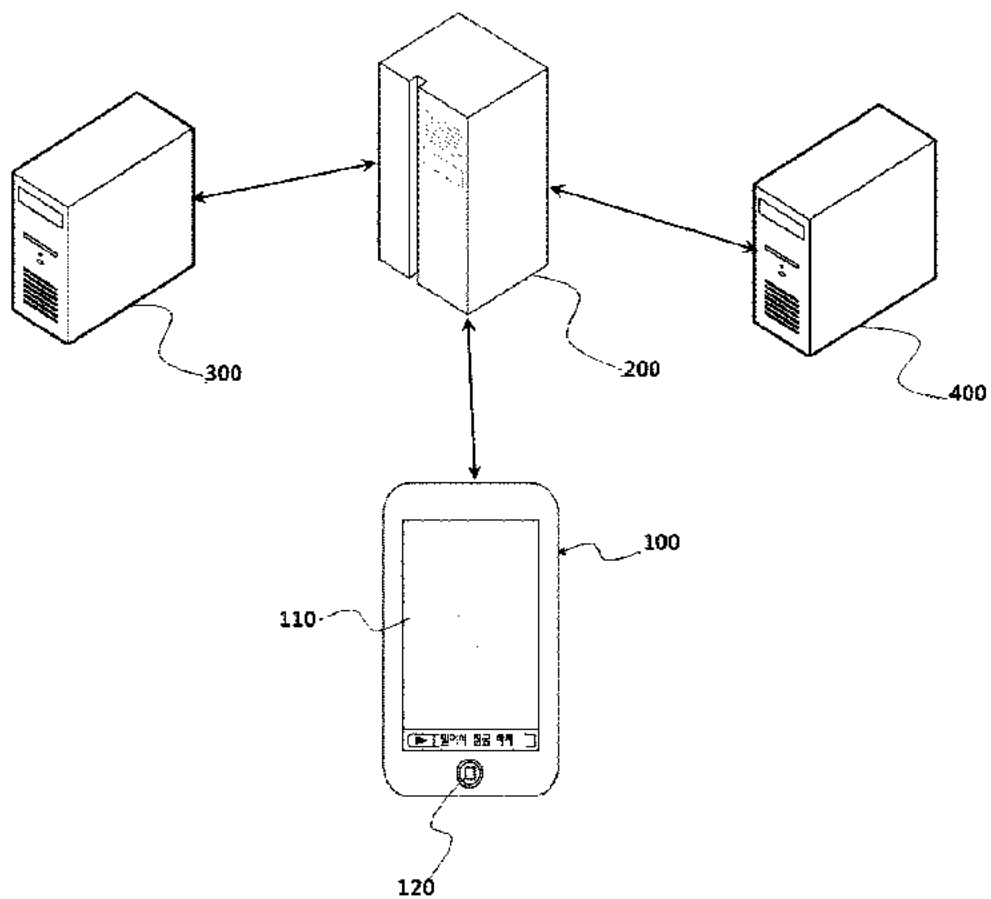


Fig. 7

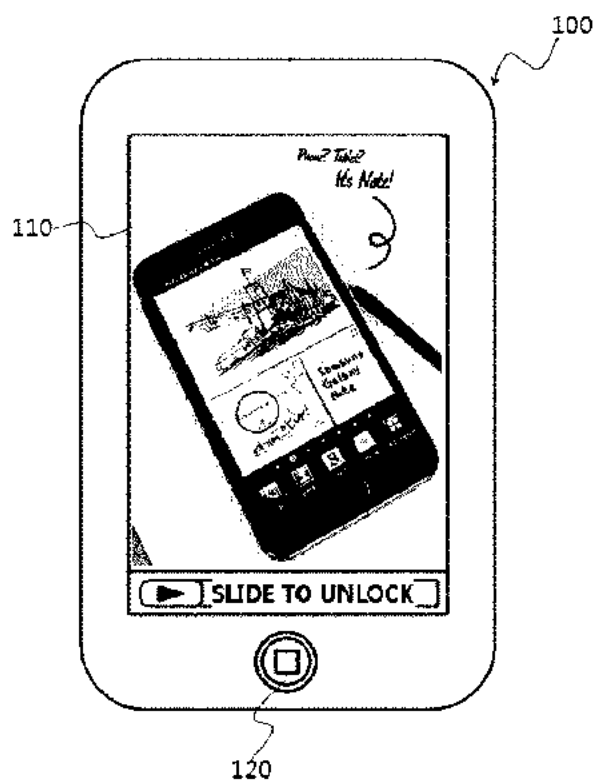


Fig. 8

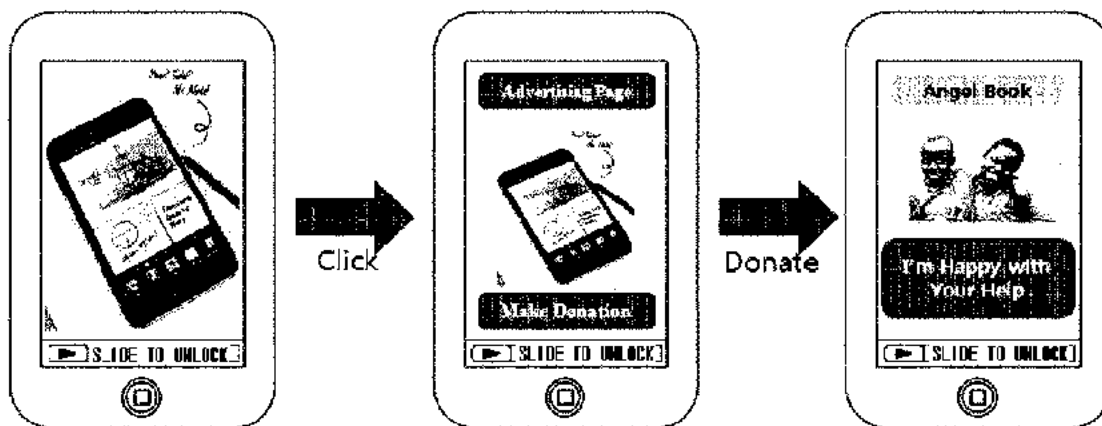


Fig. 9

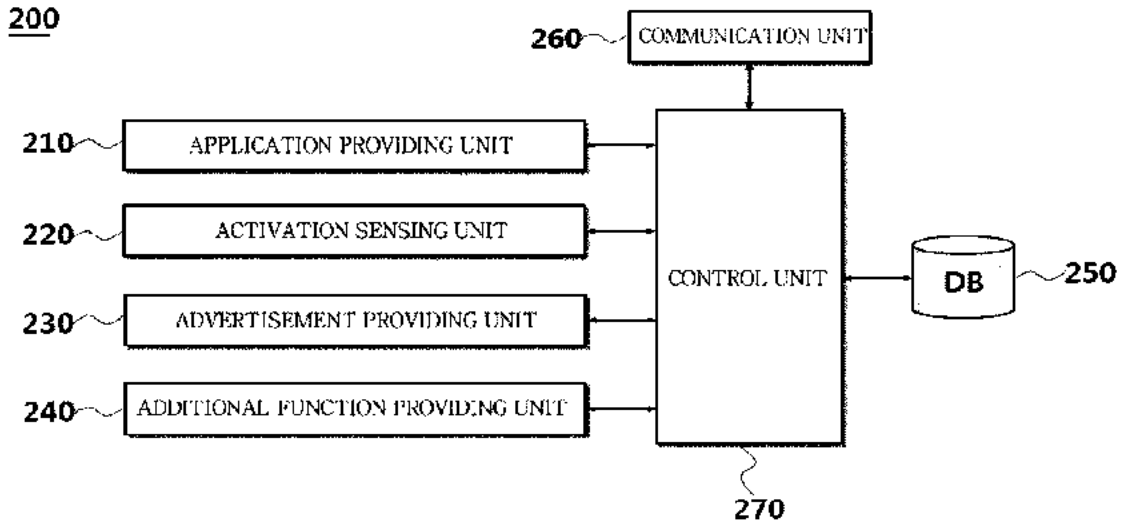
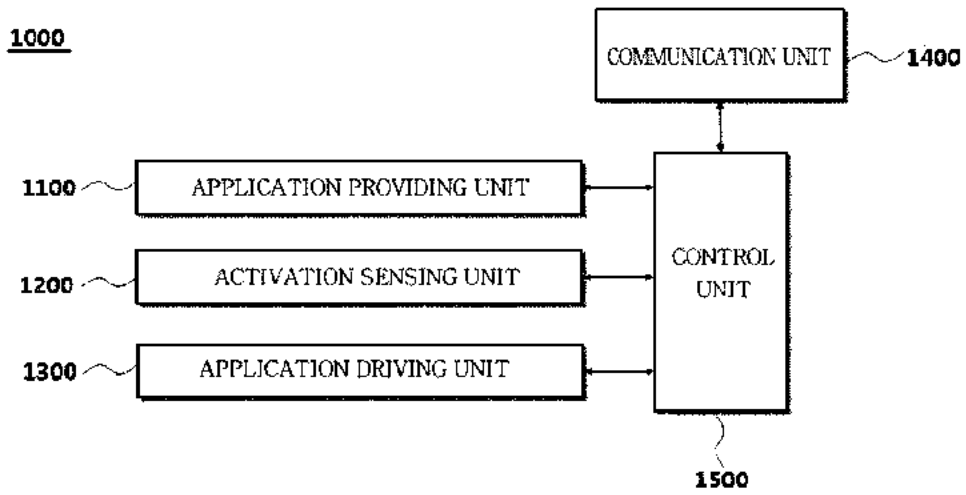


Fig. 10







Espacenet

**Bibliographic data: KR20130104682 (A) — 2013-09-25**

**APPARATUS AND METHOD FOR AUTOMATICALLY LOCKING DISPLAY AND TOUCH IN MOBILE PHONE**

**Inventor(s):** CHOI SANG GIL [KR] ± (CHOI, SANG GIL)

**Applicant(s):** CHOI SANG GIL [KR] ± (CHOI, SANG GIL)


**Classification:** - **international:** G06F3/041; G06K9/46; H04B1/40  
- **cooperative:** G06F21/32; G06F3/0412; G06F3/0416;  
G06K9/4619; H04B1/401more

**Application number:** KR20120026391 20120315

**Priority number (s):** KR20120026391 20120315

**Abstract of KR20130104682 (A)**

**PURPOSE:** An automatic lock apparatus for a display screen and a touch function of a mobile terminal and a method thereof are provided to lock and unlock a touch function based on face recognition data which is obtained through a camera lens by using a face recognition program. **CONSTITUTION:** An illuminance sensor (200) detects the intensity of ambient light. An InfraRed Emitting Diode (IRED) emits infrared radiation. A camera unit (500) photographs an outside image. A face recognition unit (600) detects a face image of a user and identifies the user. A main control unit (300) detects motions of a mobile terminal using a 3G sensor. The main control unit recognizes the intensity of ambient light using an illumination sensor. If the intensity of the ambient light is low, the main control unit turns on the IRED. Also, the main control unit outputs an operation control signal which turns on or off the camera unit to photograph. The main control unit outputs a lock or unlock control signal which turns on or off a display screen and a touch sensor based on the result of face recognition processed by the face recognition unit using an image photographed by the camera unit. [Reference numerals] (100) 3G sensor; (200) Illuminance sensor; (300) Main control unit; (400) IRED control unit; (500) Camera unit; (600) Face recognition unit; (610) Face detection unit; (620) Distance calculation unit (630) Identity authentication unit (700) LCD screen control unit; (800) Touch control unit

	(19) 대한민국특허청(KR)	(11) 공개번호	10-2013-0104682
	(12) 공개특허공보(A)	(43) 공개일자	2013년09월25일
(51) 국제특허분류(Int. Cl.)	(71) 출원인		
H04B 1/40 (2006.01) G06K 9/46 (2006.01)	최상길		
G06F 3/041 (2006.01)	경기도 용인시 처인구 양지면 양지로143번길		
(21) 출원번호	10-2012-0026391	18-3, 103호 (대성2차아파트)	
(22) 출원일자	2012년03월15일	(72) 발명자	
심사청구일자	2012년03월15일	최상길	
		경기도 용인시 처인구 양지면 양지로143번길	
		18-3, 103호 (대성2차아파트)	

전체 청구항 수 : 총 6 항

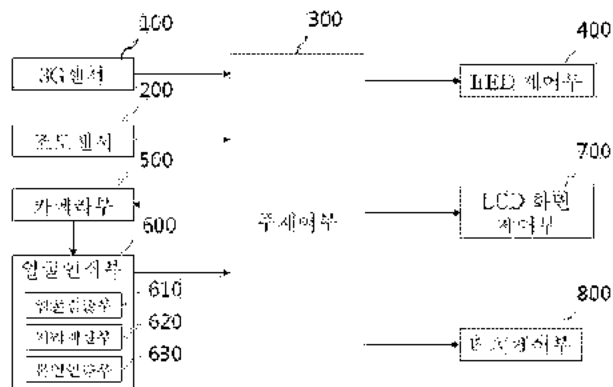
(54) 발명의 명칭 이동통신 단말기에서 디스플레이 화면 및 터치 자동 잠금 장치 및 그 방법

(57) 요약

본 발명은 이동통신단말기의 디스플레이 화면의 온, 오프와 터치스크린의 잠금 및 해제를, 사용자가 단말기를 사용하기 위하여 화면을 바라볼 때, 카메라 렌즈를 통해 들어오는 얼굴 이미지로부터 인식 알고리즘을 이용하여 자동으로 제어할 수 있도록 함으로써, 단말기를 사용하거나 사용을 중단하기 위하여 건넌 버튼을 누르는 불편함을 없애고 의도하지 않은 터치스크린의 활성화를 방지하여 사용자가 이동통신 단말기를 안전하게 보관 및 휴대할 수 있는 이동통신 단말기에서의 디스플레이 화면 및 터치 기능의 자동 잠금 장치 및 그 방법은 제공하기 위한 것으로서,

이동통신 단말기 전면부에 부착되어 외부 영상을 촬영하는 카메라부와, 상기 카메라부에서 촬영된 영상에서 사용자 얼굴 이미지를 검출하고, 이를 통해 이동통신 단말기와 사용자 얼굴과의 거리를 계산하고 부인을 입증하는 얼굴 인식부와, 카메라에 촬영된 얼굴 인식용 근거리 상기 디스플레이 화면을 온/오프하고 터치 기능을 해제 또는 잠금 제어신호를 출력하는 제어부를 포함하는바 있다.

도 1



*특허청구의 범위*

**청구항 1**

이동통신단말기의 움직인 변화를 센싱하는 3G 센서와,  
 주변부의 밝기를 센싱하는 조도센서와,  
 어두운 환경하에서 카메라 촬영을 하기 위하여 적외선을 조사하는 IrLED와,  
 이동통신 단말기 전면부에 부착되어 외부 영상을 촬영하는 카메라부와,  
 상기 카메라부에서 촬영된 영상에서 사용자 얼굴 이미지를 검출하고, 이를 통해 계산된 이동통신 단말기와 사용자 얼굴과의 거리를 계산하고 본인인증을 확인하는 얼굴 인식부와,  
 디스플레이 화면을 켜고 끄는 제어를 하는 LCD 화면 제어부와,  
 디스플레이 화면과 결합되어 있는 터치 센서의 작동을 잠금/해제하는 터치 제어부와,  
 이동통신 단말기의 움직임을 상기 3G센서로부터 감지하여 상기 조도센서로부터 주변환경의 밝기 강도를 인식하여 어두우면 상기 IrLED를 켜고 동시에 상기 카메라부의 촬영을 위한 온/오프를 지시하는 작동 제어신호를 출력하고, 상기 얼굴 인식부에서 카메라에 촬영된 이미지의 얼굴 인식 여부에 따라 상기 디스플레이 화면과 터치센서를 온/오프 시키는 해제 또는 잠금 제어신호를 출력하며 제어하는 주제어부를 포함하는 것을 특징으로 하는 이동통신 단말기에서 디스플레이 화면 및 터치 자동 잠금 장치.

**청구항 2**

제 1 항에 있어서, 상기 얼굴 인식부는  
 상기 줌 영역 변환부에서 확대된 이미지 파일로부터 얼굴 인식 프로그램을 이용한 얼굴 인식을 수행하여 얼굴영역을 검출하고, 이를 통해 얼굴정보를 생성하는 얼굴 검출부와,  
 상기 얼굴 검출부에서 생성한 얼굴정보를 기반으로 카메라부와 사용자 얼굴과의 거리를 계산하는 거리 계산부와,  
 상기 본인 인증부에서 보안 기능 작동 시 기준에 저장된 본인의 이미지와 비교하여 일치하는 지를 인증하는 것을 특징으로 하는 이동통신 단말기에서 디스플레이 화면 및 터치 자동 잠금 장치.

**청구항 3**

제 2 항에 있어서,  
 상기 얼굴정보는 얼굴의 크기, 얼굴의 방향, 얼굴의 위치, 눈의 위치 중 어느 하나를 포함하는 것을 특징으로 하는 이동통신 단말기에서 디스플레이 화면 및 터치 기능의 자동 잠금 장치.

**청구항 4**

제 1 항에 있어서,  
 상기 이동통신 단말기 전면부에 부착되어 저조도에서 상기 카메라부를 통해 외부 영상의 촬영이 가능하도록 적외광을 발광하는 적외선 발광 다이오드(IRED)를 더 포함하는 것을 특징으로 하는 이동통신 단말기에서 디스플레이 화면 및 터치 기능의 자동 잠금 장치.

**청구항 5**

제 1 항에 있어서,  
 상기 이동통신 단말기 전면부에 부착되어 영상통화용 카메라가 적외선을 받아들일 수 있도록 2 밴드필터로 구성되어 있거나 혹은 영상통화용 카메라와는 별도로 전용 카메라 모듈을 더 포함하는 것을 특징으로 하는 이동통신

단말기에서 디스플레이 화면 및 터치 기능의 자동 잠금 장치.

**청구항 6**

제 1 항에 있어서,

본인 인증에 한해서는 얼굴 외에 홍채인식 등 다른 방법을 더 포함하는 것을 특징으로 하는 이동통신 단말기에서 디스플레이 화면 및 터치 기능의 자동 잠금 장치.

*발명의 상세한 설명*

*기술 분야*

[0001] 본 발명은 디스플레이 화면을 갖는 이동식 단말기의 화면을 자동으로 온/오프하는 방법에 관한 것으로 기존의 버튼으로 디스플레이 화면을 온/오프하는 것을 카메라 렌즈를 통해 인식되는 사용자 얼굴 인식 데이터를 이용하여 보다 간편하고 정확하게 온/오프하는 것과 더불어 등록된 사용자에게만 허용되는 보안기능 및 터치스크린의 잠금 및 해제를 시킬 수 있는 방법에 관한 것이다.

*배경 기술*

[0002] 최근 이동통신단말기가 보편화되면서 일인 일단말기의 시대가 도래하고 있다. 더구나 스마트폰의 사용자가 크게 늘게 되어 전자상거래, 인터넷 서핑, 소셜네트워크 등을 이용하면서 손에서 뗄 수 없는 모바일 컴퓨터가 되었다.

[0003] 이러한 이동통신 단말기는 각종 정보를 디스플레이 하기 위한 LCD 혹은 AMOLED을 구비하고 스마트폰의 경우 터치스크린을 이용하여 디스플레이에 표시되어 있는 버튼을 손가락이나 터치펜으로 접촉하여 단말기의 기능을 제어하는 방식으로 사용하여 사용자가 보다 쉽고 간편하게 정보를 입력할 수 있도록 구성되어 있다.

[0004] 또한 모바일 컴퓨터화 되면서 단말기 내에 모든 개인 정보가 들어 있어 보안 강화가 요구 되어 비밀번호를 입력하거나 패턴을 입력하게 하여 보호를 하고 있다.

[0005] 위와 같이 이동통신단말기의 구조 및 특성상 여러 가지 불편한 점을 야기시키는데 먼저 화면을 온/오프시키기 위해서는 버튼을 반드시 눌러야 한다. 특히 터치스크린이 구비된 이동통신 단말기는 가방이나 사용자의 신체와 접촉되어 보관될 경우에, 특정한 불체나 인체와 직접 또는 간접적으로 접촉될 수 있는데, 이러한 불필요한 터치로 인해 이동통신 단말기는 터치 입력이 있다고 판단하여 단말기가 오작동하거나 다른 사람에게 통화 연결되어 곤란한 경우를 겪는 일이 종종 발생하기도 한다. 또한 보안 기능이 취약하여 배주자 혹은 주변인에게 쉽게 노출되어 개인의 프라이버시를 침해하는 경우가 빈번하다.

[0006] 터치기능을 가진 이동통신 단말기는 통화 시에 단말기를 얼굴에 대기 때문에 발생하는 오동작을 방지하기 위하여 근접센서를 추가하였다. 근접센서의 동작은 이동통신 단말기와 얼굴이 가까워지면 터치 기능을 강제 잠금하고, 이동통신 단말기와 얼굴이 멀어지면 터치 기능의 잠금을 해제되도록 제어하고 있다. 따라서 통화하기 위하여 단말기를 얼굴에 근접하게 되면 터치를 잠금으로 변환시키고 얼굴에서 떨어지게 하면 터치 잠금을 해제하게 되어 있으나 근접센서의 경우 밝기로 인식하기 되어 머리카락이나 이동통신 단말기를 잡고 있는 손이나 케이스 등으로 오동작이 가끔 발생하고 상기한 바와 같이 수머니나 가방 속에서 온/오프 버튼을 잘못 눌러 터치센서가 활성화되면 근접센서를 작동을 못하는 경우가 빈번하다.

*발명의 내용*

*해결하려는 과제*

[0007] 따라서 본 발명은 상기와 같은 문제점을 해결하기 위해 인출한 것으로서, 이동통신 단말기의 화면을 자동으로 온/오프하고 터치 기능의 잠금 및 해제를 얼굴 인식 프로그램을 이용하여 카메라 렌즈를 통해 인식되는 얼굴 인식 데이터를 통해 제어할 수 있도록 함으로써, 버튼을 사용하는 불편함을 없애고 의도하지 않은 터치스크린의 활성화를 방지하여 사용자가 이동통신 단말기를 안전하게 보관 및 휴대할 수 있는 이동통신 단말기에서 터치 기능의 자동 잠금 장치 및 그 방법을 제공하는데 그 목적이 있다.

[0008] 본 발명의 다른 목적은 이동통신 단말기에 부착되어 있는 카메라 렌즈를 통해 촬영되는 얼굴 이미지의 얼굴 인

식 데이터를 통해 분석할 경우 외부에 단말기내의 정보 유출을 방지하도록 이동통신 단말기에서 화면 및 터치 기능의 자동 잠금 장치 및 그 방법을 제공하는데 있다.

[0009] 본 발명의 다른 목적은 이동통신 단말기의 전원 절약을 위하여 기본적으로 일정 시간 후에는 LCD 화면이 꺼지도록 세팅하여 사용을 하는데 장시간 사용 시 화면 꺼짐을 방지하기 위하여 수시로 화면을 터치해야 하는 불편함을 감소하고 있다. 본 발명을 적용할 경우에는 얼굴이 인식되는 경우에는 화면 꺼짐이 없이 그대로 유지할 수가 있어 편리하게 사용할 수 있다.

*특정의 해결 수단*

[0010] 상기와 같은 목적을 달성하기 위한 본 발명에 따른 이동통신 단말기에서 터치 기능의 자동 잠금 장치의 특징은 이동통신 단말기 전면부에 부착되어 외부 영상을 촬영하는 카메라부와, 상기 카메라부에서 촬영된 영상에서 사용자 얼굴 이미지를 검출하고, 이를 통해 계산된 이동통신 단말기와 사용자 얼굴과의 거리를 포함하는 얼굴 인식 데이터를 생성하는 얼굴 인식부와, 보안을 강화하기 위해서는 인식된 얼굴이 본인인지를 확인하는 감식부, 어두운 환경에서 얼굴인식을 위한 적외선 발광소자부, 이동통신 단말기의 사용 또는 미사용인을 감지하기 위한 3G 센서로부터 움직임을 인식하고 조도센서로부터 조도상태를 인식하는 센서 인식부, 상기 카메라부의 촬영을 위한 온/오프를 지시하는 작동 제어신호를 출력하고, 상기 얼굴 인식부에서 출력되는 얼굴 인식 어부에 따라 상기 LCD화면 및 터치센서를 온/오프 시키는 해제 또는 잠금 제어신호를 출력하는 제어부를 포함하는데 있다.

[0011] 바람직하게는 상기 얼굴 인식부는 상기 카메라부에서 촬영되어 입력되는 디지털 변환된 RAW 데이터를 디스플레이 가능하도록 신호 처리하여 이미지 파일을 출력하는 영상 처리부와, 광학 줌 기능 또는 디지털 줌 기능을 통해 상기 영상 처리부에서 입력되는 이미지 파일을 확대하는 줌 영역 변환부와, 상기 줌 영역 변환부에서 확대된 이미지 파일로부터 얼굴 인식 프로그램을 이용한 얼굴 인식을 수행하여 얼굴영역을 검출하고, 이를 통해 얼굴정보를 생성하는 얼굴 검출부와, 상기 얼굴 검출부에서 생성한 얼굴정보를 기반으로 카메라부와 사용자 얼굴과의 거리를 계산하는 거리 계산부를 포함하는 것을 특징으로 한다.

[0012] 바람직하게는 상기 얼굴정보는 얼굴의 크기, 얼굴의 방향, 얼굴의 위치, 눈의 위치 중 어느 하나를 포함하는 것을 특징으로 한다.

[0013] 바람직하게는 상기 터치 기능 제어부는 얼굴 인식 데이터를 기반으로 카메라부와 사용자 얼굴과의 거리가 특정 거리 구간인 경우에는 상기 터치 센서로 해제, LCD 화면 온 제어신호를 출력하고, 그 외의 거리인 경우에는 상기 터치 센서로 잠금, LCD 화면 오프 제어신호를 출력하는 것을 특징으로 한다.

[0014] 바람직하게는 상기 이동통신 단말기 전면부에 부착되어 저조도에서 상기 카메라부를 통해 외부 영상의 촬영이 가능하도록 적외광을 발광하는 적외선 발광 다이오드(IRED)를 더 포함하는 것을 특징으로 한다. 적외선 발광 다이오드를 온/오프하기 위해서 조도센서로부터 조도값을 받아서 일정 조도 이하에서는 적외선 발광 다이오드를 온한다.

[0015] 바람직하게는 얼굴인식을 하기 위해서는 카메라와 인식장치가 계속 구동하고 있어야 하고 이는 전력소비가 과다하게 발생시키는 원인이 된다. 이를 개선하기 위해서 화면이 오픈된 상태에서는 카메라와 인식장치를 슬립모드로 전환하고 이동통신단말기를 움직일 경우 발생하는 3G 센서의 데이터 변화를 받아들여 카메라와 인식장치의 전원을 켜도록 한다.

[0016] 바람직하게는 얼굴인식에서 단순한 얼굴인식 단계와 얼굴인식은 물론 본인 인증까지 하는 단계로 구분 가능하다. 이는 본인여부와 관계없이 얼굴을 인식하여 화면을 온 시키고 보안이 요구되는 메뉴에 접근 시에만 본인 인증을 하는 방법과 처음 화면 온 작동부터 본인을 인증하는 방식으로 사용자 설정이 가능하다.

[0017] 상기와 같은 목적을 달성하기 위한 본 발명에 따른 이동통신 단말기에서 화면 및 터치 기능의 자동 잠금 방법의 특징은 (A) 카메라부에서 촬영되어 입력되는 디지털 변환된 RAW 데이터를 디스플레이 가능하도록 신호 처리하여 이미지 파일을 생성하고, 이미지 파일을 확대하는 단계와, (B) 상기 확대된 이미지 파일로부터 얼굴 인식 프로그램을 이용한 얼굴 인식을 수행하여 얼굴영역을 검출하고, 이를 통해 얼굴의 크기, 얼굴의 방향, 얼굴의 위치, 눈의 위치 중 적어도 하나를 포함하는 얼굴정보를 생성하는 단계와, (C) 상기 생성된 얼굴정보를 기반으로 카메라부와 사용자 얼굴과의 거리를 계산하고, 계산된 카메라부와 사용자 얼굴과의 거리를 포함하는 얼굴 인식 데이터는 생성하는 단계와, (D) 상기 얼굴 인식 데이터에 포함된 카메라부와 사용자 얼굴과의 거리가 일정 거리 구간인 경우 터치 센서로 해제 제어신호를 출력하여 이동통신 단말기의 터치 기능을 해제시키는 단계와, (E) 상기 얼굴 인식 데이터에 포함된 카메라부와 사용자 얼굴과의 거리가 일정 거리를 벗어나는 경우 터치 센서로 잠

금 제어신호를 출력하여 이동통신 단말기의 터치 기능을 잠금시키는 단계를 포함하는데 있다.

- [0018] 바람직하게 상기 (B) 단계에서의 얼굴정보 생성은 이미지 파일의 쉼리 및 에지록 기반으로 얼굴영역을 검출하는 단계와, 상기 검출된 얼굴영역의 건물 중심부와 미리 설정되어 있는 기준 중심부 사이의 거리를 이용하여 얼굴 위치를 계산하는 단계와, 상기 검출된 얼굴영역 및 얼굴위치로부터 눈과 입으로 구성된 삼각형 형태를 이용하여 얼굴 방향을 검출하는 단계를 포함하는 것을 특징으로 한다.
- [0019] 바람직하게 상기 (C) 단계는 (C1) 상기 이미지 파일을 확대한 비율 및 상기 검출된 얼굴영역의 크기를 기반으로 촬영된 사용자의 확대 전의 얼굴 크기를 산출하는 단계와, (C2) 상기 산출된 얼굴 크기를 미리 설정되어 있는 거리별 기준 얼굴 크기와의 비교를 통해 카메라부와 사용자 얼굴과의 거리를 계산하는 단계를 포함하는 것을 특징으로 한다.
- [0020] 바람직하게 상기 (C2) 단계에서 미리 설정되어 있는 거리별 기준 얼굴 크기는 거리별 얼굴 크기를 데이터베이스화하여 상기 산출된 얼굴 크기와 데이터베이스화되어 있는 기준 얼굴 크기를 비교하여 가장 얼굴 크기에 해당되는 거리를 검출하거나, 또는 거리별 얼굴 크기의 변화량을 설정하여 상기 산출된 얼굴 크기를 상기 설정된 변화량에 적용하여 거리를 산출하는 것을 특징으로 한다.

**발명의 효과**

- [0021] 이상에서 설명한 바와 같은 본 발명에 따른 이동통신 단말기에서 화면 및 터치 기능의 자동 잠금 장치 및 그 방법은 다음과 같은 효과가 있다.
- [0022] 첫째, 이동통신단말기의 전원 버튼을 누르지 않고 화면을 자동으로 온/오프할 수 있어 편리하다.
- [0023] 둘째, 사용하고 있는 중에는 전원선택모드에 의한 화면 꺼짐이 없어 화면을 켜진 상태로 유지하기 위한 터치가 필요 없어진다. 화면이 계속 켜져 있는 어플리케이션인 경우에는 잠시 화면을 바라보지 않을 때는 화면을 오프하여 배터리 소모를 줄일 수가 있다.
- [0024] 셋째, 단말기를 잃어버린 경우는 물론이고 가까운 가족에게도 단말기의 접근을 제한할 수 있다. 기존의 패턴이나 숫자 암호의 경우 가족에게 노출이 쉬워 단말기의 내용이 쉽게 노출될 수 있다. 하지만 본 발명은 본인의 얼굴을 인증하므로 본인 외에는 노출이 불가능하다.
- [0025] 넷째, 터치 오작동을 방지한다. 기존의 터치폰의 경우 주머니나 가방 속에 둔 단말기가 오작동 또는 경우가 빈번하지만 본 발명이 적용되는 경우 얼굴이 인식되지 않는 이상 오작동이 발생하지 않는 효과가 있다.

**도면의 간단한 설명**

- [0026] [도 1] 본 발명의 실시예에 따른 이동통신 단말기에서 화면 및 터치 기능의 자동 온-오프 장치의 구조를 나타낸 구성도
- [0027] [도 2] 도 2 는 본 발명의 실시예에 따른 이동통신 단말기에서 화면 및 터치 기능의 자동 온-오프 방법을 설명하기 위한 흐름도

**발명을 실시하기 위한 구체적인 내용**

- [0027] 본 발명의 다른 목적, 특징 및 이점들은 첨부한 도면을 참조한 실시예들의 상세한 설명을 통해 명백해질 것이다.
- [0028] 본 발명에 따른 이동통신 단말기에서 터치 기능의 자동 잠금 장치 및 그 방법의 바람직한 실시예에 대하여 첨부한 도면을 참조하여 설명하면 다음과 같다. 그러나 본 발명은 이하에서 개시되는 실시예에 한정되는 것이 아니라 서로 다른 다양한 형태로 구현될 수 있으며, 단지 본 실시예는 본 발명의 개시가 완전하도록 하며 통상의 지식을 가진 자에게 발명의 범주를 완전하게 알려주기 위해 제공되는 것이다. 따라서 본 명세서에 기재된 실시예와 도면에 도시된 구성은 본 발명의 가장 바람직한 일 실시예에 불과할 뿐이고 본 발명의 기술적 사상을 모두 대변하는 것은 아니므로, 본 출원시점에 있어서 이를 대체할 수 있는 다양한 균등물과 변형예들이 있을 수 있음을 이해하여야 한다.
- [0029] 도 1 은 본 발명의 실시예에 따른 이동통신 단말기에서 화면 및 터치 기능의 자동 잠금 장치의 구조를 나타낸 구성도이다.
- [0030] 도 1과 같이, 화면 및 터치 기능의 자동 잠금 장치는 3G 센서(100), 조도센서(200), 주 제어부(300), IrED 제어

부(400), 카메라부(500), 얼굴인식부(600), LCD 화면, 그리고 터치 제어부(800)를 포함한다.

- [0031] 상기 3G 센서(100)는 최근 스마트폰에 장착되고 있는 센서로 스마트폰의 x, y, z 축으로의 움직임을 데이터 값으로 출력한다. 본 발명에서는 카메라 및 얼굴인식부를 포함한 장치의 배터리 소모를 방지하기 위하여 움직임이 있을 경우에만 작동하게 한다.
- [0032] 상기 조도 센서(200)는 일반적으로 주변의 조도값을 출력하며 이 데이터를 근거로 하여 LCD 화면의 밝기를 제어하는 데 사용되고 있다. 본 발명에서는 어두운 환경에서 얼굴인식을 하기 위하여 적외선 LED(IrED)(400)를 작동시키기 위하여 사용된다.
- [0033] 상기 카메라부(500)는 이동통신 단말기 전면부에 부착된 기존의 전면부 카메라로서, 셔터, 렌즈부, 조리개 및 이미지센서 및 아날로그/디지털 변환기(ADC)를 포함하며, 외부 영상을 촬영한다. 기존의 전면 카메라, 즉 영상 통화용 카메라를 이용할 경우에는 일반적으로 사용되는 IR cut-off filter를 Dual band filter로 대체하여야 한다. IR cut-off filter는 적외선을 차단함으로써 인하여 최상의 화질을 구현하도록 되어 있다. 그러므로 저조도에서 적외선을 받아들일 수가 없다. 따라서 기시광과 특정 파장대의 적외선을 받아들일 수 있는 Dual band filter를 사용하여 저조도에서 적외광을 받아들여 이미지 촬영이 가능하다. 주간 환경에서 적외광이 들어옴에 따른 색 재현성 문제는 ISP 튜닝으로 해결이 가능하다. 이와 관련한 기술에 대해서는 "카메라 모듈 및 이를 구비한 휴대형 단말기"라는 제목으로 특허를 제출한 바가 있고 현재도 이를 적용한 이동통신단말기를 양산 중에 있다.
- [0034] 다른 방법으로는 가격 인상 요인은 있지만 파워 소모를 줄일 수 있는 장점을 고려한다면 저화소의 흑백 이미지 센서로 모듈을 만들어서 이미지센서 가격은 최소로 하고 IR cut-off 필터를 사용하지 않은 얼굴인식 전용으로 구현하는 것도 가능하다.
- [0035] 상기 얼굴 인식부(600)는 카메라부(500)에서 촬영된 영상에서 사용자 얼굴 이미지를 검출하고, 이를 통해 계산된 이동통신 단말기와 사용자 얼굴과의 거리를 포함하는 얼굴 인식 데이터를 생성하여 주제어부(300)로 출력한다.
- [0036] 상기 주제어부(300)는 이동통신 단말기의 사용 또는 미사용임을 감지하여 카메라부(400)의 촬영을 위한 온/오프를 지시하는 자동 제어신호를 생성하여 출력하고, 얼굴 인식부(500)에서 출력되는 얼굴 인식 데이터에 따라 LCD 화면(700)과 터치기능(800)을 온/오프 시키는 해제/잠금 제어신호를 생성 출력하며, 터치센서가 해제된 경우에 터치스크린의 접촉을 통해 사용자에게 의해 선택된 단말기의 기능을 제어하기 위한 터치 입력 데이터를 입력받아 해당 기능을 수행시킨다.
- [0037] 한편, 상기 얼굴 인식부(600)는 다시 얼굴 검출부(610)와, 거리 계산부(620), 그리고 본인 식별부(630)를 포함한다.
- [0038] 상기 얼굴 검출부(610)는 얼굴 인식 프로그램을 이용한 얼굴 인식을 수행하여 얼굴영역을 검출하고, 이를 통해 얼굴의 크기, 얼굴의 방향, 얼굴의 위치, 눈 등의 얼굴정보를 생성한다.
- [0039] 상기 거리 계산부(620)는 상기 얼굴 검출부(610)에서 생성한 얼굴정보를 기반으로 이동통신단말기와 사용자 얼굴 간의 거리를 계산한다. 상기 얼굴 검출부(610)에서 검출된 얼굴영역의 크기를 기반으로 미리 설정되어 있는 거리별 기준 얼굴 크기와의 비교를 통해 카메라부(500)와 사용자 얼굴과의 거리를 계산한다.
- [0040] 상기 본인 인증부(630)는 사용자가 보안 작동이 되도록 설정한 경우 동작을 할 수가 있으며 얼굴 검출부(610)에서 확보한 이미지와 기저장된 본인 이미지와 비교하여 본인 여부를 확인한다.
- [0041] 그리고 얼굴 인식부(600)는 상기 거리 계산부(620)에서 계산된 이동통신단말기와 사용자 얼굴 간의 거리를 포함하는 얼굴 인식 여부 그리고 본인 확인 결과 데이터를 주제어부(300)로 전송한다.
- [0042] 상기 주제어부(300)는 얼굴 인식부(500)에서 입력되는 얼굴 인식 데이터를 기반으로 사용자가 이동통신 단말기의 화면을 바라보면서 터치 기능을 사용할 가능성이 높은 것으로 판단하여, LCD 화면 제어부(700)를 통하여 LCD 화면을 켜고 터치 제어부(200)로 터치 잠금 해제 제어신호를 출력하고, 그 외의 거리인 경우에는 사용자가 이동통신 단말기의 화면을 바라보지 않는 것으로 터치 기능을 사용할 가능성이 낮은 것으로 판단하여, LCD 화면을 끄고 터치 센서로 잠금 제어신호를 출력한다.
- [0043] 이는 사용자가 터치 기능을 사용할 경우에는 반드시 일정 거리에서 화면을 응시하면서, 이후 이동통신 단말기의 터치 기능을 사용하게 되므로, 검출되는 이동통신단말기와 사용자 얼굴과의 거리를 통해서 터치 기능의 사용 여부를 판단할 수 있기 때문이다.

- [0044] 만약 테이블 위에 단말기를 놓고 약간 밀려서 사용하는 경우 등 특별한 상황에서는 메뉴를 사용하여 항상 화면을 켜 두게 세팅할 수 있다.
- [0045] 이와 같이 구성된 본 발명이 따른 이동통신 단말기에서 디스플레이 화면 및 터치 자동 잠금 장치의 동작을 첨부한 도면을 참조하여 상세히 설명하면 다음과 같다.
- [0046] 도 2 는 본 발명의 실시예에 따른 이동통신 단말기에서 디스플레이 화면 및 터치 자동 잠금 방법을 설명하기 위한 흐름도이다.
- [0047] 도 2를 참조하여 설명하면 먼저, 이동통신단말기가 꺼져 있는 상태에서 3G 센서(100)와 주제어부(300)는 계속 작동을 하면서 단말기를 사용하기 위하여 움직이는 순간을 데이터로부터 인식한다(S10). 이때 주머니나 가방에 넣고 이동함에 따른 단순 이동과 단말기를 사용하기 위해 x,y,z축 변위값이 복잡하게 변화하는 것을 구분하여야 한다. 그래야만 배터리 소모를 줄일 수가 있으며 화면이 꺼진 상태에서도 3G센서(100)와 주제어부(300)는 계속 작동을 해야 하므로 저전력형 반도체로 제작되는 것이 유리하다.
- [0048] 단말기를 사용하기 위한 움직임이과고 판단되면 조도센서(200)로부터 주변의 밝기값을 주제어부(300)에서 읽어 들인다(S20). 이때, 주변이 어둡다고 판단되면 IrED를 켜다.(S30) 물론 밝은 경우에는 이러한 작동은 배제하고 카메라부(500)및 얼굴 인식부(600)에 전원을 공급하고 작동을 시킨다.(S40)
- [0049] 그리고 얼굴 인식부(600)에서 검출된 얼굴이 일정 거리 내에 있는지 혹은 본인 얼굴로 인증되고 일정 거리에 있는 지를 판단한다.(S50) 이와 같은 조건에 만족하면 LCD 화면을 켜고 터치 잠금을 해제한다.(S60) 이 조건에 만족하지 않으면 LCD 화면을 끈 상태로 두고 터치도 잠금한 채로 유지한다.(S70)
- [0050] 위의 과정에서 LCD 화면을 켜든 꺼든지 간에 다시 맨 처음의 3G 센서(100) 데이터를 체크하는 과정으로 되돌아간다. 이 때 단말기의 움직임이 없으면 현재의 상태를 그대로 유지시킨다. 따라서 휴대폰을 보고 있는 상태에서는 화면이 꺼지는 경우가 없게 수시로 터치를 해야 하는 불편함을 개선할 수 있다. 또한 이러한 불편을 줄이기 위해서 특정 어플리케이션에서는 화면이 계속해서 켜진 상태로 두도록 되어 있는데 이 경우에는 배터리 소모가 걱정이 되어 잠시 쉬는 경우에는 화면을 꺼는 버튼을 눌러는 경우가 많다. 본 발명에서는 이러한 불편을 감소할 필요가 없다. 화면을 보고 있는 중에는 계속 켜져 있으며 모지 않는 경우에는 화면이 자동으로 꺼지게 되기 때문이다.
- [0051] 상기에서 설명한 본 발명의 기술적 사상은 바람직한 실시예에서 구체적으로 기술되었으나, 상기한 실시예는 그 설명을 위한 것이며 그 제한을 위한 것이 아님을 주의하여야 한다. 또한, 본 발명의 기술적 분야의 통상의 지식을 가진 자라면 본 발명의 기술적 사상의 범위 내에서 다양한 실시예가 가능함을 이해할 수 있을 것이다. 따라서 본 발명의 진정한 기술적 보호 범위는 첨부된 특허청구범위의 기술적 사상에 의해 정해져야 할 것이다.

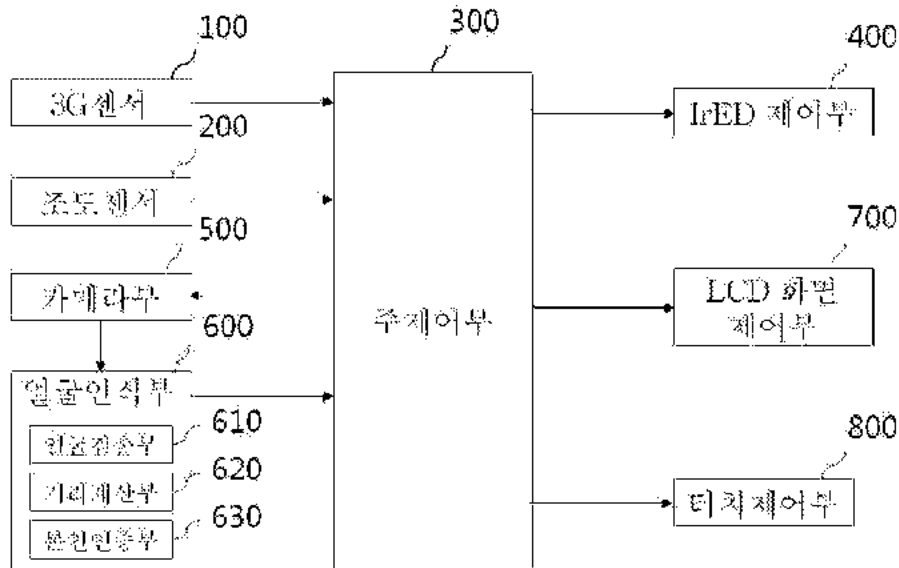
부호의 설명

- [0052] 100 : 3G 센서
- 200 : 조도 센서
- 300 : 주제어부
- 400 : IrED 제어부
- 500 : 카메라부
- 600 : 얼굴인식부
  - 610 : 얼굴검출부
  - 620 : 거리계산부
  - 650 : 본인인증부
- 700 : LCD 화면 제어부
- 800 : 터치 제어부

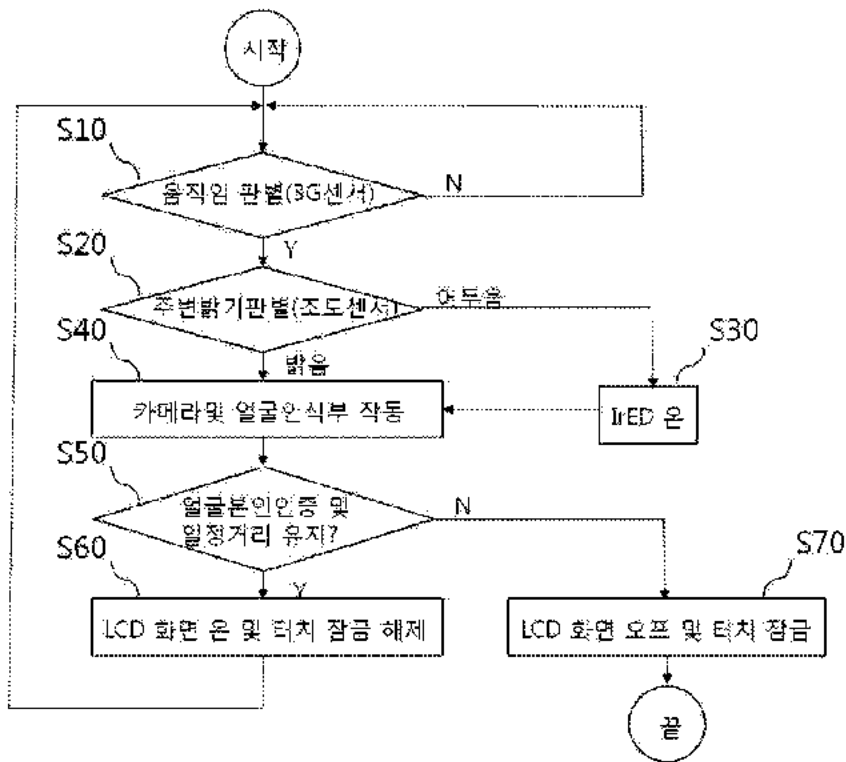


도면

도면1



도면2






Espacenet

**Bibliographic data: KR20100057461 (A) — 2010-05-31****METHOD, SYSTEM AND COMPUTER-READABLE RECORDING MEDIUM FOR PROVIDING DISPLAY ADVERTISEMENT ON LOCK SCREEN FOR PREVENTING WRONG INPUT TO USER TERMINAL.****Inventor(s):** NAM KYUNG BO [KR] ± (NAM, KYUNG BO)**Applicant(s):** NHN BUSINESS PLATFORM CORP [KR] ± (NHN BUSINESS PLATFORM CORP)**Classification:** - **international:** G06Q30/02  
- **cooperative:****Application number:** KR20080116513 20081121**Priority number (s):** KR20080116513 20081121**Also published as:** KR101102852 (B1)**Abstract of KR20100057461 (A)**

**PURPOSE:** A method for posting display advertisement on a lock screen for preventing wrong input about a user terminal is provided to increase advertisement effect by supplying display advertisement on the lock screen. **CONSTITUTION:** A user information manager(210) receives information about a user characteristic from a user terminal. An advertisement contents manager(220) selects one or more advertisement contents transmitted to the user terminal based on the information about the user characteristic. A web browser driver offers a landing page of the display advertisement if a selective request about the display advertisement is received.

	(19) 대한민국특허청(KR)	(11) 공개번호	10-2010-0057461
	(12) 공개특허공보(A)	(43) 공개일자	2010년05월31일

(51) Int. Cl. G06Q 30/00 (2006.01)	(71) 출원인 엔에이치엠비즈니스플랫폼 주식회사 경기 성남시 분당구 서현동 266-1 퍼스트타워 9층
(21) 출원번호 10-2008-0116513 (22) 출원일자 2008년11월21일 심사청구일자 2008년11월21일	(72) 발명자 남경보 서울 강남구 대치3동 우성2차아파트 205동 301호
	(74) 대리인 특허법인에이아이피

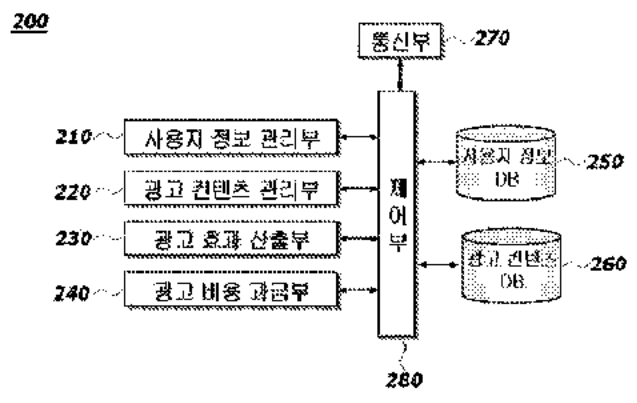
전체 청구항 수 : 총 18 항

(54) 사용자 단말 장치에 대한 오입력을 방지하기 위한 잠금 화면에 디스플레이 광고를 게재하기 위한 방법, 시스템 및 컴퓨터 판독 가능한 기록 매체

(57) 요약

사용자 단말 장치에 대한 오입력을 방지하기 위한 잠금 상태에서 디스플레이 되는 잠금 화면에 디스플레이 광고를 게재하기 위한 방법, 시스템 및 컴퓨터 판독 가능한 기록 매체가 개시된다. 본 발명에 따르면, 사용자 단말 장치에 디스플레이 광고를 게재하기 위한 방법으로서, 광고주로부터 수신된 적어도 하나의 광고 콘텐츠를 사용자 단말 장치에 전송하는 단계, 및 상기 사용자 단말 장치가 잠금 상태일 때의 화면에 상기 전송된 광고 콘텐츠 중 적어도 하나를 디스플레이 광고로서 노출하는 단계를 포함하는 방법이 제공된다. 본 발명에 따르면, 사용자는 자신이 자주 접하기 마련인 잠금 화면을 통해 디스플레이 광고에 빈번하게 노출되는바, 광고 효과가 향상될 수 있으며, 광고 서비스를 제공하는 측에서는 새로운 광고 플랫폼의 구현에 따라 추가적인 광고 수익을 도모할 수 있게 된다.

도 1은 도 3



**특허청구의 범위**

**청구항 1**

사용자 단말 장치에 디스플레이 광고를 게재하기 위한 방법으로서,

- (a) 적어도 하나의 광고 콘텐츠를 사용자 단말 장치에 전송하는 단계, 및
- (b) 상기 사용자 단말 장치가 잠금 상태일 때 잠금 화면에 상기 전송된 광고 콘텐츠 중 적어도 하나를 디스플레이 광고로서 게재하는 단계를 포함하는 방법.

**청구항 2**

제1항에 있어서,

상기 사용자 단말 장치로부터 사용자 특성에 관한 정보를 수신하는 단계를 더 포함하고,

상기 (a) 단계는,

상기 수신된 사용자 특성에 관한 정보를 기초로 하여 상기 사용자 단말 장치가 전송할 적어도 하나의 광고 콘텐츠를 선택하는 단계를 포함하는 것을 특징으로 하는 방법.

**청구항 3**

제2항에 있어서,

상기 사용자 특성에 관한 정보는 성별, 연령대, 단말 장치의 사용 장소, 생활 패턴 중 적어도 하나를 포함하는 것을 특징으로 하는 방법.

**청구항 4**

제1항에 있어서,

상기 (b) 단계는,

상기 광고 콘텐츠가 복수 개인 경우, 롤링 방식을 이용하여 노출하는 단계를 포함하는 것을 특징으로 하는 방법.

**청구항 5**

제1항에 있어서,

상기 노출된 디스플레이 광고에 대한 선택 요청이 수신되는 경우, 상기 디스플레이 광고의 랜딩페이지(Landing Page)를 상기 사용자 단말 장치에 제공하는 단계를 더 포함하는 것을 특징으로 하는 방법.

**청구항 6**

제5항에 있어서,

상기 선택 요청은 상기 사용자 단말 장치의 터치스크린이 터치되는 동작, 상기 터치스크린이 특정 모양 또는 방향으로 드래그되는 동작, 특정 버튼이 눌러지는 동작 또는 상기 사용자 단말 장치가 일정 방향으로 흔들리는 동작 중 적어도 하나의 방식에 의해 입력되는 것을 특징으로 하는 방법.

**청구항 7**

제1항에 있어서,

상기 사용자 단말 장치로부터 상기 디스플레이 광고의 효과를 산출하는 데에 필요한 정보를 수신하는 단계, 및 상기 산출된 광고 효과에 대응되는 광고 비용을 상기 디스플레이 광고를 제공한 광고주에게 과금하는 단계를 더 포함하는 것을 특징으로 하는 방법.

**청구항 8**

제7항에 있어서,

상기 정보는 상기 디스플레이 광고의 노출 시간, 노출 횟수 또는 CTR(click through rate) 중 적어도 하나를 포함하는 것을 특징으로 하는 방법.

**청구항 9**

제1항에 있어서,

상기 (a) 단계는,

상기 광고 콘텐츠를 상기 사용자 단말 장치의 사용 빈도가 낮은 시간대에 전송하는 것을 특징으로 하는 방법.

**청구항 10**

사용자 단말 장치에 디스플레이 광고를 게재하기 위한 시스템으로서,

적어도 하나의 광고 콘텐츠를 사용자 단말 장치에 전송하는 광고 제공 시스템, 및

장규 상태일 때 장규 화면에 상기 전송된 광고 콘텐츠 중 적어도 하나를 디스플레이 광고로서 게재하는 사용자 단말 장치

를 포함하는 시스템.

**청구항 11**

제10항에 있어서,

상기 광고 제공 시스템은,

상기 사용자 단말 장치로부터 사용자 특성에 관한 정보를 수신하는 사용자 정보 권리부, 및

상기 수신된 사용자 특성에 관한 정보를 기초로 하여 상기 사용자 단말 장치가 전송할 적어도 하나의 광고 콘텐츠를 선택하는 광고 콘텐츠 권리부를 포함하는 것을 특징으로 하는 시스템.

**청구항 12**

제11항에 있어서,

상기 사용자 특성에 관한 정보는 성별, 연령대, 단말 장치의 사용 장소, 생활 패턴 중 적어도 하나를 포함하는 것을 특징으로 하는 시스템.

**청구항 13**

제10항에 있어서,

상기 사용자 단말 장치는,

상기 광고 콘텐츠가 복수 개인 경우, 돌링 방식을 이용하여 노출하는 것을 특징으로 하는 시스템.

**청구항 14**

제10항에 있어서,

상기 사용자 단말 장치는,

상기 노출된 디스플레이 광고에 대한 선택 요청이 수신되는 경우, 웹 브라우저를 구동시켜 상기 디스플레이 광고의 랜딩페이지를 제공하는 웹 브라우저 구동부를 포함하는 것을 특징으로 하는 시스템.

**청구항 15**

제14항에 있어서,

상기 선택 요청은 상기 사용자 단말 장치의 터치스크린이 터치되는 동작, 상기 터치스크린이 특정 모양 또는 방

향으로 드래그되는 동작, 특정 버튼이 눌러지는 동작 또는 상기 사용자 단말 장치가 일정 방향으로 흔들리는 동작 중 적어도 하나의 방식에 의해 입력되는 것을 특징으로 하는 시스템

**청구항 16**

제10항에 있어서,

상기 광고 제공 시스템은,

상기 사용자 단말 장치로부터 상기 디스플레이 광고의 효과를 산출하는 데에 필요한 정보를 수신하는 광고 효과 산출부, 및

상기 산출된 광고 효과에 대응되는 광고 비용을 상기 디스플레이 광고를 제공한 광고주에게 과금하는 광고 비용 과금부를 더 포함하는 것을 특징으로 하는 시스템.

**청구항 17**

제10항에 있어서,

상기 광고 제공 시스템은, 상기 광고 콘텐츠를 상기 사용자 단말 장치의 사용 빈도가 낮은 시간대에 전송하는 것을 특징으로 하는 시스템.

**청구항 18**

제1항 내지 제9항 중 어느 한 항에 따른 방법을 실행하기 위한 컴퓨터 프로그램을 기록하기 위한 컴퓨터 판독 가능한 기록 매체.

**발명적 상세한 설명**

**기술 분야**

[0001] 사용자 단말 장치에 대한 오일력을 방지하기 위한 잠금 화면에 디스플레이 광고를 게재하기 위한 방법, 시스템 및 컴퓨터 판독 가능한 기록 매체에 관한 것으로서, 보다 상세하게는, 사용자 단말 장치가 잠금 상태일 때 잠금 화면에 디스플레이 광고를 지공함으로써, 광고주 측에서는 사용자가 자주 접하기 마련인 잠금 화면을 통해 광고 효과를 향상시킬 수 있고, 서비스 제공자 측에서는 새로운 광고 플랫폼 구현에 따른 추가적인 광고 수익을 포함할 수 있는 방법, 시스템 및 컴퓨터 판독 가능한 기록 매체에 관한 것이다.

**배경 기술**

[0002] 이동 단말기는 현대 생활에 없어서는 안 되는 필수품으로 자리 잡은 지 오래이며, 현대인들이 가장 빈번하게 접하는 기기이기도 하다. 이로 인해 이동 단말기를 통한 부가 콘텐츠 사업 및 광고 마케팅 기술에 대한 개발이 다각적으로 이루어지고 있는 추세이다.

[0003] 이에 따라 초기에는 문자와 음성에 국한되었던 이동 단말기용 서비스에 카메라 기능, MP3 기능, 신용카드기능, 교통카드기능, 위치추적기능, 내비게이션 기능, DMB 기능 등 다양한 기능이 추가되어 소비자들의 기호를 충족시켜주고 있으며, 여기에 더하여 홈네트워크(Home Network) 및 유비쿼터스(Ubiquitous)에 필요한 수많은 기능들이 추가되는 방향으로 나아가고 있다.

[0004] 이와 같은 추세 속에서 이동 단말기를 이용한 다음과 같은 광고 모델이 제안되어 왔다.

[0005] 가령, 단문메시지(SMS)나 멀티메시지(MMS)에 광고를 첨부하여 대상 이동 단말기에 전송하는 형식의 광고 모델이 제안된 적이 있으나, 이러한 형식의 광고는 사용자들에게 스팸 메시지도 취급받고 있으며, 그 광고 효과 또한 충분히 발휘되기 힘든 실정이나, 따라서, 광고주 입장에서 이러한 형식의 광고는 소요된 비용 만큼의 광고 효과를 거두기 힘든 문제점이 있었다. 또한, 현재 이루어지고 있는 모바일 광고는 사용자의 특성을 고려하지 않은 불특정 다수를 대상으로 하는 광고이기 때문에, 사용자는 자신의 관심사와는 상관없는 광고를 계속해서 접하기 마련이며, 이에 따라 광고에 대한 불쾌감이 증가하게 되는 문제가 있었다. 뿐만 아니라, 이러한 광고 코

별은 사용자가 단말기를 사용하는 도중에도 광고가 무작위로 제공되는 폐단이 있었는바, 광고 효과가 떨어진다 는 단점이 있었다.

**발명의 내용**

**해결하고자 하는 과제**

- [0006] 본 발명은 상술한 종래 기술의 문제점을 해결하는 것을 그 목적으로 한다.
- [0007] 또한, 본 발명의 다른 목적은 사용자 단말 장치의 오작동을 방지하기 위한 잠금 상태에서의 화면에 디스플레이 광고를 게재하면 사용자가 단말 장치를 사용하고자 할 때 상기 잠금 화면에 게재된 광고를 볼 수 밖에 없으므로 사용자가 보다 광고에 확실하게 노출될 수 있고, 사용자가 단말 장치를 사용하지 않는 때인 잠금 상태에서의 화면에 광고를 노출시킴으로써 사용자의 광고에 대한 거부감을 감소시켜 광고의 효과를 향상시키는 것이다.
- [0008] 한편, 본 발명의 또 다른 목적은 사용자 단말 장치의 잠금 화면을 이용하여 디스플레이 광고 서비스를 제공함으로써, 새로운 광고 플랫폼 호브에 다른 추가적인 광고 수익의 창출을 포함 수 있도록 하는 것이다.

**과제 해결 수단**

- [0009] 상기 목적을 달성하기 위한 본 발명의 대표적인 구성은 다음과 같다.
- [0010] 먼저, 본 발명의 일 실시예에 따르면, 사용자 단말 장치에 디스플레이 광고를 게재하기 위한 방법으로서, 적어도 하나의 광고 콘텐츠를 사용자 단말 장치에 전송하는 단계, 및 상기 사용자 단말 장치가 잠금 상태일 때 잠금 화면에 상기 전송된 광고 콘텐츠 중 적어도 하나를 디스플레이 광고로서 게재하는 단계를 포함하는 방법이 제공된다.
- [0011] 한편, 본 발명의 다른 실시예에 따르면, 사용자 단말 장치에 디스플레이 광고를 게재하기 위한 시스템으로서, 적어도 하나의 광고 콘텐츠를 사용자 단말 장치에 전송하는 광고 제공 시스템, 및 잠금 상태일 때 잠금 화면에 상기 전송된 광고 콘텐츠 중 적어도 하나를 디스플레이 광고로서 게재하는 사용자 단말 장치를 포함하는 시스템이 제공된다.
- [0012] 또한, 본 발명의 또 다른 실시예에 따르면, 사용자 단말 장치의 잠금 화면에 디스플레이 광고를 게재할 수 있도록 하는 다른 방법 및 이러한 방법을 실행하기 위한 컴퓨터 프로그램을 기록하는 컴퓨터 판독 가능한 기록 매체가 제공된다.

**효과**

- [0013] 본 발명에 의하면, 사용자 단말 장치에 대한 오입력을 방지하기 위한 잠금 상태에서의 화면에 디스플레이 광고가 게재되기 때문에, 사용자가 자신의 단말기를 사용하고자 할 때 볼 수 밖에 없는 잠금 화면을 통해 해당 디스플레이 광고를 빈번하게 접할 수 있게 되므로, 광고 효과를 향상시킬 수 있다.
- [0014] 또한, 본 발명에 의하면, 광고 서비스를 제공하는 측에서는 잠금 화면을 이용하는 새로운 광고 플랫폼을 구현할 수 있으므로, 추가적인 광고 수익을 창출할 수 있게 된다

**발명의 실시를 위한 구체적인 내용**

- [0015] 후술하는 본 발명에 대한 상세한 설명은, 본 발명이 실시될 수 있는 특정 실시예를 예시로서 도시하는 첨부 도면을 참조한다. 이들 실시예는 당업자가 본 발명을 실시할 수 있기에 충분하도록 상세히 설명된다. 본 발명의 다양한 실시예는 서로 다르지만 상호 배타적일 필요는 없음이 이해되어야 한다. 예를 들어, 여기에 기재되어 있는 특정 형상, 구조 및 특성은 일 실시예에 관련하여 본 발명의 정신 및 범위를 벗어나지 않으면서 다른 실시예로 구현될 수 있다. 또한, 각각의 개시된 실시예 내의 개별 구성요소의 위치 또는 배치는 본 발명의 정신 및 범위를 벗어나지 않으면서 변경될 수 있음이 이해되어야 한다. 따라서, 후술하는 상세한 설명은 한정적인 의미로서 취하려는 것이 아니며, 본 발명의 범위는, 적절하게 설명된다면, 그 청구항들이 주장하는 것과 균등한 모든 범위와 더불어 첨부된 청구항에 의해서만 한정된다. 도면에서 유사한 참조부호는 여러 측면에 걸쳐서 동일하거나 유사한 기능을 지칭한다.
- [0016] 이하에서는, 본 발명이 속하는 기술분야에서 통상의 지식을 가진 자가 본 발명을 용이하게 실시할 수 있도록 하

기 위하여, 본 발명의 바람직한 실시예들에 관하여 첨부된 도면을 참조하여 상세히 설명하기로 한다.

[0017] [본 발명의 바람직한 실시예]

[0018] 우선, 본 발명에 대한 상세한 설명을 하기 전에, 본 발명에 따른 서비스의 근간이 되는 소위 "잠금 화면"에 대해 설명한다.

[0019] 일반적으로, 현재 보급되고 있는 이동 단말기에는 잠금 상태를 설정할 수 있는 기능이 포함되어 있다. 예를 들어, 이동 단말기에 있어서는 사용자의 의사와는 상관없이 터치스크린이나 외부 입력 버튼 등이 터치되어 오작동될 우려가 있으므로, 터치스크린이나 외부 입력 버튼 등이 비활성화되도록 이동 단말기를 잠금 상태로 설정할 수 있다.

[0020] 도 1a 및 도 1b는 이동 단말기가 잠금 상태일 때 디스플레이되는 잠금 화면의 일례를 나타낸다.

[0021] 통상적으로 잠금 화면에는 사용자가 설정한 화면 또는 기본 배경 화면이 표시될 수 있다. 사용자는 자신이 가장 자주 사용하고 확인하는 매체인 이동 단말기를 통해 이러한 잠금 화면을 매우 빈번하게 접하게 되는데, 이러한 잠금 화면을 이용하여 모바일 광고 서비스를 제공한다면 자연스럽게 높은 광고 효과를 기대할 수 있을 것이다.

[0022] 전체 시스템의 구성

[0023] 도 2는 본 발명의 일 실시예에 따라 사용자 단말 장치의 잠금 화면에 디스플레이 광고를 게재하기 위한 전체 시스템의 구성을 개략적으로 나타내는 도면이다.

[0024] 도 2에 도시되어 있는 바와 같이, 본 발명의 전체 시스템은 통신망(100), 광고 제공 시스템(200), 사용자 단말 장치(300), 광고주 단말 장치(400)를 포함하여 구성될 수 있다.

[0025] 먼저, 통신망(100)은 유선 및 무선 등과 같은 그 통신 양태를 가리지 않고 구성될 수 있으며, 근거리 통신망(LAN: Local Area Network), 도시권 통신망(MAN: Metropolitan Area Network), 광역 통신망(WAN: Wide Area Network) 등 다양한 통신망으로 구성될 수 있다. 바람직하게는, 본 발명에서 말하는 통신망(100)은 공지의 월드와이드웹(WWW: World Wide Web)일 수 있다.

[0026] 본 발명의 일 실시예에 따른 광고 제공 시스템(200)은 사용자 단말 장치(300)에 광고 콘텐츠를 제공하여 사용자 단말 장치(300)가 잠금 상태일 때 해당 광고 콘텐츠가 디스플레이 광고로서 잠금 화면에 게재될 수 있도록 한다. 사용자 단말 장치(300)는 잠금에 대한 오입력을 막기 위한 잠금 기능을 포함할 수 있는데, 이러한 잠금 기능이 활성화될 때, 즉, 잠금 상태일 때, 상기 사용자 단말 장치(300)의 표시부(가령, 스크린 등의 화면)에 도 1a 및 도 1b에서와 같은 잠금 화면이 디스플레이될 수 있다. 광고 제공 시스템(200)은 이러한 잠금 화면에 디스플레이 광고로서 게재될 수 있는 광고 콘텐츠를 사용자 단말 장치(300)에 제공한다. 본 발명의 일 실시예에 따르면, 광고 콘텐츠의 제공은 사용자 단말 장치(300)가 사용자에 의해 사용되지 않는 시간대에 이루어질 수 있다. 예를 들면, 사용자 단말 장치(300)가 사용되지 않는 매일 새벽 5시경에 광고 콘텐츠들이 사용자 단말 장치(300)에 일괄적으로 전송되도록 할 수 있다. 이때, 광고 제공 시스템(200)은 잠금 화면을 통해 노출될 광고들의 게재 방식에 대한 정보도 전송되도록 할 수 있다. 예를 들면, 사용자 단말 장치(300)에 전송될 복수 개의 광고의 노출 순서, 노출 횟수, 노출 시간 등에 관한 정보가 함께 제공되도록 할 수 있다.

[0027] 한편, 이러한 광고 콘텐츠들이 사용자 단말 장치(300)가 잠금 상태일 때의 화면(즉, 잠금 화면)에 디스플레이 광고로서 노출될 때, 사용자는 소정의 액션을 통해 노출된 광고의 랜딩페이지(Landing Page)로 이동할 수 있다. 예를 들면, 사용자 단말 장치(300)가 터치스크린 기반일 때는 디스플레이된 광고를 터치하거나 특정 모양 또는 방향으로 드래그함으로써 해당 광고의 랜딩페이지로 이동할 수 있고, 사용자 단말 장치(300)가 가속도 센서(accelerometer)를 구비하고 있는 경우에는 해당 단말 장치를 특정 방향으로 흔들으로써 해당 광고의 랜딩페이지로 이동할 수 있다. 이때, 사용자 단말 장치(300)에는 해당 광고의 랜딩페이지를 표시하기 위한 웹 브라우저가 포함되어 있을 수 있다.

[0028] 또한, 본 발명의 일 실시예에 따른 광고 제공 시스템(200)은 사용자 단말 장치(300)의 사용자에게 맞춤형 광고를 제공할 수 있다. 즉, 사용자 단말 장치(300)로부터 사용자에 대한 개인 특성 정보를 수신하고, 이에 기초하여 맞춤형 광고 콘텐츠를 제공할 수 있다.

[0029] 한편, 본 발명의 일 실시예에 따른 광고 제공 시스템(200)은 광고 효과를 산출하여 상응하는 광고 비용을 광고주에게 과금할 수 있다. 이를 위해 광고 제공 시스템(200)은 사용자 단말 장치(300)로부터 광고 효과 및 상응



하는 광고 비용 산출에 필요한 정보를 수신할 수 있다.

- [0030] 본 발명의 일 실시예에 따른 사용자 단말 장치(300)는 사용자가 광고 제공 시스템(200)에 접속한 후 수신할 수 있도록 하는 기능을 함하는 디지털 기기로서, 개인용 컴퓨터(예를 들어, 데스크탑 컴퓨터, 노트북 컴퓨터 등), 워크스테이션, PDA, 웹 패드, 이동 전화기 등과 같이 메모리 수단을 구비하고 마이크로 프로세서를 탑재하여 연산 능력을 갖춘 디지털 기기라면 얼마든지 본 발명에 따른 사용자 단말 장치(300)로서 채택될 수 있다. 또한, 사용자 단말 장치(200)에는 사용자가 다른 웹 서버(미도시됨)에 접속하여 다양한 형태의 콘텐츠를 제공 받을 수 있도록 하는 웹 브라우저 프로그램이 더 포함되어 있을 수 있다.
- [0031] 한편, 본 발명의 일 실시예에 따른 광고주 단말 장치(400)는 광고 제공 시스템(200)에 광고 콘텐츠를 제공하는 기능을 수행한다. 광고주 단말 장치(400)의 광고주는 입찰 방식 등을 통해 광고 제공 시스템(200)이 제공하는 광고 서비스를 이용할 수 있고, 광고 제공 시스템(200)은 광고주 단말 장치(400)로부터 제공된 광고 콘텐츠를 사용자 단말 장치(300)에 제공한다. 한편, 진술한 바와 같이 광고 제공 시스템(200)은 소정 기준에 따라 책정된 광고 비용을 과급시키는데, 이를 위해 광고 제공 시스템(200)은 광고 비용의 책정 기준 및 책정된 금액 등에 관한 정보를 해당 광고주의 광고주 단말 장치(400)에 전송할 수 있다. 광고주는 광고주 단말 장치(400)에 전송된 상기 정보를 참조하여, 광고 비용을 선불 또는 후불로 결제할 수 있다.
- [0032] 한편, 광고주는 자신이 게재하고자 하는 광고 콘텐츠를 광고주 단말 장치(400)를 통해 광고 제공 시스템(200)에 전송하고 광고 제공 시스템(200)으로부터 광고 비용 결제에 필요한 정보를 수신할 수 있으며, 상기 광고주 단말 장치(400)는 이러한 기능을 수행하기 위한 메모리 수단을 구비하고 마이크로 프로세서를 탑재하여 연산 능력을 갖춘 디지털 기기라면, 얼마든지 본 발명에 따른 광고주 단말 장치(400)로서 채택될 수 있다.
- [0033] 광고 제공 시스템(200)의 구성
- [0034] 이하에서는, 본 발명의 구현을 위하여 중요한 기능을 수행하는 광고 제공 시스템(200)의 내부 구성 및 각 구성 요소의 기능에 대하여 살펴보기로 한다.
- [0035] 도 3은 본 발명의 일 실시예에 따른 광고 제공 시스템(200)의 내부 구성을 도시하는 도면이다. 도 3에 도시되는 바와 같이, 본 발명의 광고 제공 시스템(200)은 사용자 정보 관리부(210), 광고 콘텐츠 관리부(220), 광고 효과 산출부(230), 광고 비용 과급부(240), 사용자 정보 데이터베이스(250), 광고 콘텐츠 데이터베이스(260), 통신부(270) 및 제어부(280)를 포함하여 구성될 수 있다. 본 발명의 일 실시예에 따르면, 사용자 정보 관리부(210), 광고 콘텐츠 관리부(220), 광고 효과 산출부(230), 광고 비용 과급부(240), 사용자 정보 데이터베이스(250), 광고 콘텐츠 데이터베이스(260), 통신부(270) 및 제어부(280)는 그 중 적어도 일부가 사용자 단말 장치(300) 또는 광고주 단말 장치(400)와 통신하는 프로그램 모듈들일 수 있다. 이러한 프로그램 모듈들은 운영 시스템, 응용 프로그램 모듈 및 기타 프로그램 모듈의 형태로 광고 제공 시스템(200)에 포함될 수 있으며, 물리적으로는 여러 가지 장치의 기억 장치 상에 저장될 수 있다. 또한, 이러한 프로그램 모듈들은 광고 제공 시스템(200)과 통신 가능한 원격 기억 장치에 저장될 수도 있다. 한편, 이러한 프로그램 모듈들은 본 발명에 따라 후술할 특정 업무를 수행하거나 특정 추상 데이터 유형을 실행하는 루틴, 서브루틴, 프로그램, 오브젝트, 컴포넌트, 데이터 구조 등을 포함하지만, 이에 제한되지는 않는다.
- [0036] 먼저, 본 발명의 일 실시예에 따른 사용자 정보 관리부(210)는 일 이상의 사용자 단말 장치(300)로부터 사용자 정보를 수신하고 이를 사용자 정보 데이터베이스(250)에 저장하는 기능을 수행한다. 사용자 단말 장치(300)로부터 전송되는 사용자 정보는 사용자의 성별, 연령대, 단말 장치의 사용 장소, 평소의 통신과 관계된 생활 패턴, 월 이동 통신 이용 요금 등일 수 있으며, 이러한 정보는 사용자 정보 데이터베이스(250)에 각 사용자의 식별 정보와 함께 대응되어 저장될 수 있다. 상기 정보들은 사용자에게 맞춤형 광고 콘텐츠를 제공하는 데 사용될 수 있다.
- [0037] 또한, 사용자 정보 관리부(210)는 잠금 화면에 노출시키기 위한 광고 콘텐츠를 수신하는 시간, 즉, 사용자 단말 장치(300)에 광고 콘텐츠를 전송하기에 적합한 시각에 관한 정보를 사용자 단말 장치(300)로부터 수신할 수 있다. 이러한 수신 시각에 맞추어 사용자 단말 장치(300)는 광고 콘텐츠 관리부(220)로부터 광고 콘텐츠를 수신할 수 있으며, 이에 대해서는 후에 상세히 설명하기로 한다. 여기서, 상기 수신 시각은 반드시 사용자 단말 장치(300)에 의해 결정되는 것은 아니며, 경우에 따라 단말 장치(300)가 가장 사용되지 않는 시간대를 상기 사용자 정보 중 생활 패턴에 관한 정보 등으로부터 파악한 후 그러한 시간대를 이용하여 광고 콘텐츠를 사용자 단말 장치(300)에 전송할 수 있음은 물론이다.
- [0038] 한편, 사용자 정보 관리부(210)는 사용자 단말 장치(300)로부터 광고 효과 산출에 필요한 정보를 수신할 수도

있다. 광고 효과 산출에 필요한 정보는 사용자 단말 장치(300)의 화면을 통해 디스플레이된 광고들에 대한 식별 정보, 해당 광고의 노출 시간, 노출 횟수, CTR에 관한 정보 등을 포함할 수 있다. 이때, 사용자 단말 장치(300)가 이동식 단말 장치인 경우에는 광고 제공 시스템(200)과의 통신 속도가 느리기 때문에, 상기와 같은 정보들은 사용자 단말 장치(300)가 작동하지 않는 시간대에 전송되도록 할 수도 있다.

[0039] 다음으로, 본 발명의 일 실시예에 따른 광고 콘텐츠 관리부(220)는 일 이상의 광고주 단말 장치(400)로부터 입력된 광고 콘텐츠를 수신하고 이를 광고 콘텐츠 데이터베이스(260)에 저장하는 기능을 수행한다. 또한, 광고 콘텐츠 데이터베이스(260)에 저장되어 있는 광고 콘텐츠 중 삼급 화면에 노출되기 위한 광고 콘텐츠를 일 이상의 사용자 단말 장치(300)로 전송하는 기능을 수행한다. 광고 콘텐츠 관리부(220)는 사용자 단말 장치(300)에 맞춤형 광고 콘텐츠를 제공하기 위해 광고 콘텐츠를 일정 기준에 따라 분류하여 광고 콘텐츠 데이터베이스(260)에 저장할 수 있다. 예를 들면, 광고 콘텐츠를 사용자의 연령대별, 성별, 생활 패턴 등에 따라 카테고리별로 분류하여 저장할 수도 있다.

[0040] 한편, 광고 콘텐츠 관리부(220)는 사용자 정보 데이터베이스(250)에 저장된 사용자 정보를 참조하여 사용자 단말 장치(300)에 삼급 화면용 광고 콘텐츠를 전송할 시간을 특정할 수 있다.

[0041] 다음으로, 본 발명의 일 실시예에 따른 광고 효과 산출부(230)는 사용자 단말 장치(300)로부터 광고 효과 산출에 필요한 정보를 수신하고, 이에 기초하여 해당 광고에 대한 효과를 산출하는 기능을 수행한다. 광고 효과 산출에 필요한 정보에는 해당 사용자 단말 장치(300)에서 해당 광고가 노출된 시간, 횟수 또는 CTR 등 해당 광고가 사용자 단말 장치(300)의 사용자에게 의해 다양한 방법으로 선택된 횟수 또는 빈도 등이 포함될 수 있다.

[0042] 본 발명의 일 실시예에 따른 광고 비용 과금부(240)는 광고 효과 산출부(230)에 의해 산출된 광고 효과를 기초로 하여 광고 비용을 산출하고 광고주 단말 장치(400)로 광고 비용에 관한 정보를 전송함과 동시에 광고 비용의 결제를 위한 애플리케이션을 제공할 수 있다.

[0043] 본 발명의 일 실시예에 따른 통신부(270)는 광고 제공 시스템(200)이 사용자 단말 장치(300) 및 광고주 단말 장치(400) 등과 같은 외부 장치와 통신할 수 있도록 하는 기능을 수행할 수 있다.

[0044] 한편, 본 발명의 일 실시예에 따른 제어부(280)는 사용자 정보 관리부(210), 광고 콘텐츠 관리부(220), 광고 효과 산출부(230), 광고 비용 과금부(240), 사용자 정보 데이터베이스(250), 광고 콘텐츠 데이터베이스(260) 및 통신부(270) 간의 데이터의 흐름을 제어하는 기능을 수행할 수 있다. 즉, 본 발명에 따른 제어부(280)는 광고 제공 시스템(200)의 각 구성요소 간의 데이터의 흐름을 제어함으로써, 사용자 정보 관리부(210), 광고 콘텐츠 관리부(220), 광고 효과 산출부(230), 광고 비용 과금부(240), 사용자 정보 데이터베이스(250), 광고 콘텐츠 데이터베이스(260) 및 통신부(270)에서 각각 고유한 기능을 수행하도록 지시할 수 있다.

[0045] 사용자 단말 장치(300)의 구성

[0046] 이하에서는, 사용자 단말 장치(300)의 내부 구성 및 각 구성요소의 기능과 함께 본 발명의 구현예에 대해 살펴보기로 한다.

[0047] 도 4는 본 발명의 일 실시예에 따른 사용자 단말 장치(300)의 내부 구성을 도시하는 도면이다. 도 4에 도시되는 바와 같이, 본 발명의 사용자 단말 장치(300)는 잠금 상태 설정부(310), 디스플레이 광고 게재부(320), 웹 브라우저 구동부(330), 데이터베이스(340), 통신부(350) 및 제어부(360)를 포함하여 구성될 수 있다. 본 발명의 일 실시예에 따르면, 잠금 상태 설정부(310), 디스플레이 광고 게재부(320), 웹 브라우저 구동부(330), 데이터베이스(340), 통신부(350) 및 제어부(360)는 그 중 적어도 일부가 광고 제공 시스템(200)과 통신하는 프로그램 모듈들일 수 있다. 이러한 프로그램 모듈들은 운영 시스템, 응용 프로그램 모듈 및 기타 프로그램 모듈의 형태로 사용자 단말 장치(300)에 포함될 수 있으며, 물리적으로는 여러 가지 공지의 기억 장치 상에 저장될 수 있다. 또한, 이러한 프로그램 모듈들은 사용자 단말 장치(300)와 통신 가능한 원격 기억 장치에 저장될 수도 있다. 한편, 이러한 프로그램 모듈들은 본 발명에 따라 후술할 특정 업무를 수행하거나 특정 추상 데이터 유형을 실행하는 루틴, 서브루틴, 프로그램, 오브젝트, 컴포넌트, 데이터 구조 등을 포괄하지만, 이에 제한되지는 않는다.

[0048] 먼저, 본 발명의 일 실시예에 따른 잠금 상태 설정부(310)는 사용자 단말 장치(300)가 동작하지 않을 시에 오동작을 방지하기 위한 잠금 상태를 설정하는 기능을 수행한다. 선술한 바와 같이 사용자 단말 장치(300)는 터치스크린 기반일 수도 있고 외부 버튼을 포함할 수도 있다. 이때, 사용자의 의사와는 다르게 터치스크린 또는 외부 버튼이 눌러져 장치의 오동작이 일어날 수 있으므로, 잠금 상태 설정부(310)는 사용자 단말 장치(300)의 터치스크린 또는 외부 버튼이 사용자의 입력에 반응하지 않도록 하는 잠금 상태를 설정하는 기능을 수행할 수

있다. 잠금 상태는 사용자 단말 장치(300)가 소정 시간 이상 사용되지 않을 때 자동으로 설정될 수도 있으며, 사용자에 의해 수동으로 설정될 수도 있는 등 다양하게 설정 가능한 것이다.

[0049] 본 발명의 일 실시예에 따른 디스플레이 광고 게재부(320)는 잠금 상태로 설정되어 있는 사용자 단말 장치(300)의 표시부에 디스플레이 광고를 게재하는 기능을 수행한다. 구체적으로, 사용자 단말 장치(300)의 잠금 화면 상에는 사용자가 설정하거나 기타 다른 방법에 의해 결정된 정형화된 콘텐츠 또는 공백 영역이 디스플레이되는 대신에, 디스플레이 광고 게재부(320)가 데이터베이스(340)를 참조하여 선택한 특정 디스플레이 광고들 잠금 화면 상에 노출되도록 할 수 있다. 디스플레이 광고로서 게재되는 대상은 데이터베이스(340)에 저장되어 있는 광고 콘텐츠 중 하나 이상일 수 있으며, 이러한 광고 콘텐츠는 광고 제공 시스템(200)으로부터 미리 전송될 것일 수 있다. 여기서, 디스플레이 광고 게재부(320)가 잠금 화면에 광고 콘텐츠를 노출시키기 위해서는, 이동통신사나 단말기 업체와의 제휴를 통해 잠금 화면용 광고 콘텐츠를 소정의 데이터베이스(이도시)에 기록할 수 있도록 하거나, 소정의 어플리케이션을 다운로드하여 잠금 화면을 제어할 수 있도록 하는 등, 다양한 변형예를 적용하여 구현하는 경우를 상정해 볼 수 있을 것이다.

[0050] 도 5a 및 도 5b는 본 발명의 일 실시예에 따라 사용자 단말 장치(300)의 잠금 화면에 노출되는 디스플레이 광고의 일례를 나타내는 도면이다.

[0051] 도 5a 및 도 5b에 도시되는 바와 같이 디스플레이 광고 게재부(320)는 사용자 단말 장치(300)의 잠금 화면 상의 넓은 영역에 디스플레이 광고(510, 520)를 게재할 수 있다. 도 5c 및 도 5b에는 이미지 형태로 노출되는 디스플레이 광고가 제시되었으나, 디스플레이 광고가 동영상 또는 플래시 등의 형태로 노출될 수 있음은 물론이다. 한편, 데이터베이스(340)에는 광고 콘텐츠와 함께 해당 광고 콘텐츠가 디스플레이 광고로서 노출되는 방식(예를 들면, 노출되는 순서, 횟수 또는 빈도 등)이 함께 저장되어 있을 수 있고, 디스플레이 광고 게재부(320)는 이러한 정보들을 참조로 하여 데이터베이스(340)에 저장되어 있는 광고 콘텐츠를 디스플레이 광고로서 노출할 수 있다. 예를 들면, 복수 개의 디스플레이 광고가 일정 주기로 번갈아가면서 노출되는 롤링 방식이 이용될 수도 있으며, 롤링 과정 중에서는 특정 광고의 노출 빈도가 상대적으로 높을 수도 있다.

[0052] 다음으로, 본 발명의 일 실시예에 따른 웹 브라우저 구동부(330)는 사용자가 단말 장치(300)에 노출된 디스플레이 광고들 소정 액션으로 선택할 때, 웹 브라우저를 구동하여 해당 광고의 랜딩페이지가 디스플레이될 수 있도록 하는 기능을 수행한다. 사용자는 해당 디스플레이 광고를 터치하거나 특정 모양 또는 방향으로 드래그함으로써 해당 광고를 선택할 수 있고, 소정의 버튼 입력을 통해 해당 광고를 선택할 수도 있으며, 가속도 센서가 구비된 사용자 단말 장치(300)인 경우에는 해당 단말 장치(300)를 일정 방향으로 흔들으로써 해당 광고를 선택할 수 있다. 웹 브라우저 구동부(330)는 이러한 사용자의 광고 선택 동작이 수행되는 경우, 웹 브라우저를 구동하고 해당 광고의 랜딩페이지를 표시하는 기능을 수행한다. 사용자는 해당 랜딩페이지에서 추가적인 정보를 얻을 수도 있으며, 해당 광고 대상 상품 또는 서비스를 구매할 수도 있다.

[0053] 본 발명의 일 실시예에 따른 통신부(350)는 사용자 단말 장치(300)가 광고 제공 시스템(200) 등과 같은 외부 장치와 통신할 수 있도록 하는 기능을 수행할 수 있다.

[0054] 한편, 본 발명의 일 실시예에 따른 제어부(360)는 잠금 상태 설정부(310), 디스플레이 광고 게재부(320), 웹 브라우저 구동부(330), 데이터베이스(340) 및 통신부(350) 간의 데이터의 흐름을 제어하는 기능을 수행할 수 있다. 즉, 본 발명에 따른 제어부(360)는 사용자 단말 장치(300)의 각 구성요소 간의 데이터의 흐름을 제어함으로써, 잠금 상태 설정부(310), 디스플레이 광고 게재부(320), 웹 브라우저 구동부(330), 데이터베이스(340) 및 통신부(350)에서 각각 고유한 기능을 수행하도록 제어할 수 있다.

[0055] 이상 설명된 본 발명에 따른 실시예들은 다양한 컴퓨터 구성요소를 통하여 수행될 수 있는 프로그램 명령어의 형태로 구현되어 컴퓨터 판독 가능한 기록 매체에 기록될 수 있다. 상기 컴퓨터 판독 가능한 기록 매체는 프로그램 명령어, 데이터 파일, 데이터 구조 등을 단독으로 또는 조합하여 포함할 수 있다. 상기 컴퓨터 판독 가능한 기록 매체에 기록되는 프로그램 명령어는 본 발명을 위하여 특별히 설계되고 구성된 것들이거나 컴퓨터 소프트웨어 분야의 당업자에게 공지되어 사용 가능한 것일 수도 있다. 컴퓨터 판독 가능한 기록 매체의 예에는, 하드 디스크, 플로피 디스크 및 자기 테이프와 같은 자기 매체, CD-ROM, DVD와 같은 광기록 매체, 플롭티컬 디스크(floptical disk)와 같은 자기-광 매체(magneto-optical media), 및 ROM, RAM, 플래시 메모리 등과 같은 프로그램 명령어를 저장하고 수행하도록 특별히 구성된 하드웨어 장치가 포함된다. 프로그램 명령어의 예에는, 컴파일러에 의해 만들어지는 것과 같은 기계어 코드뿐만 아니라 인터프리터 등을 사용해서 컴퓨터에 의해서 실행될 수 있는 고급 언어 코드도 포함된다. 상기 하드웨어 장치는 본 발명에 따른 처리를 수행하기 위해 하나 이상의 소프트웨어 모듈로서 작동하도록 구성될 수 있으며, 그 역도 마찬가지이다.

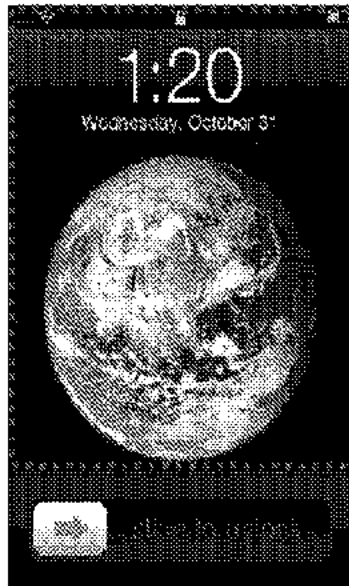
- [0056] 이상에서 본 발명이 구체적인 구성요소 등과 같은 특정 사항들과 한정된 실시예 및 도면에 의해 설명되었으나, 이는 본 발명의 보다 전반적인 이해를 돕기 위해서 제공된 것일 뿐, 본 발명이 상기 실시예들에 한정되는 것은 아니며, 본 발명이 속하는 기술분야에서 통상적인 지식을 가진 자라면 이러한 기재로부터 다양한 수정 및 변형을 꾀할 수 있다.
- [0057] 따라서, 본 발명의 사상은 상기 설명된 실시예에 국한되어 정해져서는 아니되며, 후술하는 특허청구범위뿐만 아니라 이 특허청구범위와 균등하게 또는 능가적으로 변형된 모든 것들은 본 발명의 사상의 범주에 속한다고 할 것이다.

*도면의 간단한 설명*

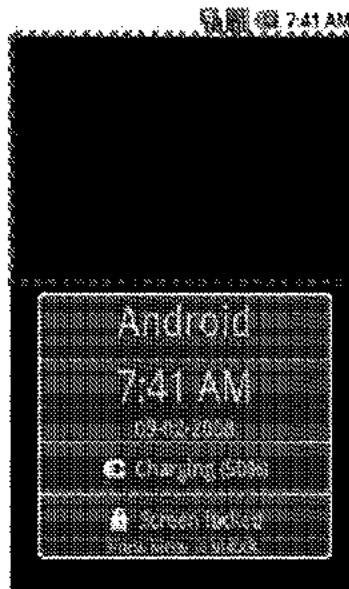
- [0058] 도 1a 및 도 1b는 이동 단말기에서 잠금 상태가 선정된 경우의 화면의 예를 나타낸 도면이다.
- [0059] 도 2는 본 발명의 일 실시예에 따라 사용자 단말 장치의 잠금 화면에 디스플레이 광고를 노출하기 위한 전체 시스템의 구성을 개략적으로 나타낸 도면이다.
- [0060] 도 3은 본 발명의 일 실시예에 따른 광고 제공 시스템(200)의 내부 구성을 상세하게 도시한 도면이다.
- [0061] 도 4는 본 발명의 일 실시예에 따른 사용자 단말 장치(300)의 내부 구성을 상세하게 도시한 도면이다.
- [0062] 도 5a 및 도 5b는 본 발명의 일 실시예에 따라 사용자 단말 장치(300)의 잠금 화면에 디스플레이 광고가 노출되는 예를 나타낸 도면이다.
- [0063] <주요 도면부호에 대한 간단한 설명>
- [0064] 100: 통신망
- [0065] 200: 광고 제공 시스템
- [0066] 300: 사용자 단말 장치
- [0067] 400: 광고주 단말 장치
- [0068] 210: 사용자 정보 관리부
- [0069] 220: 광고 콘텐츠 관리부
- [0070] 230: 광고 효과 산출부
- [0071] 240: 광고 비용 과금부
- [0072] 250: 사용자 정보 데이터베이스
- [0073] 260: 광고 콘텐츠 데이터베이스
- [0074] 310: 잠금 상태 설정부
- [0075] 320: 디스플레이 광고 게재부
- [0076] 330: 웹 브라우저 구동부
- [0077] 340: 데이터베이스

도면

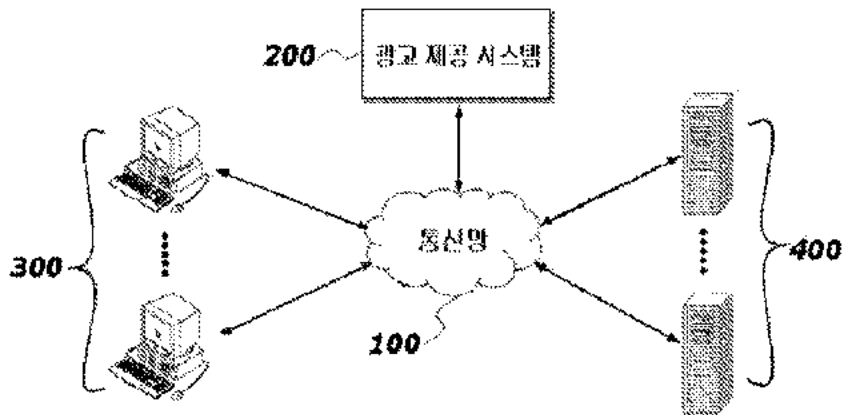
도면1a



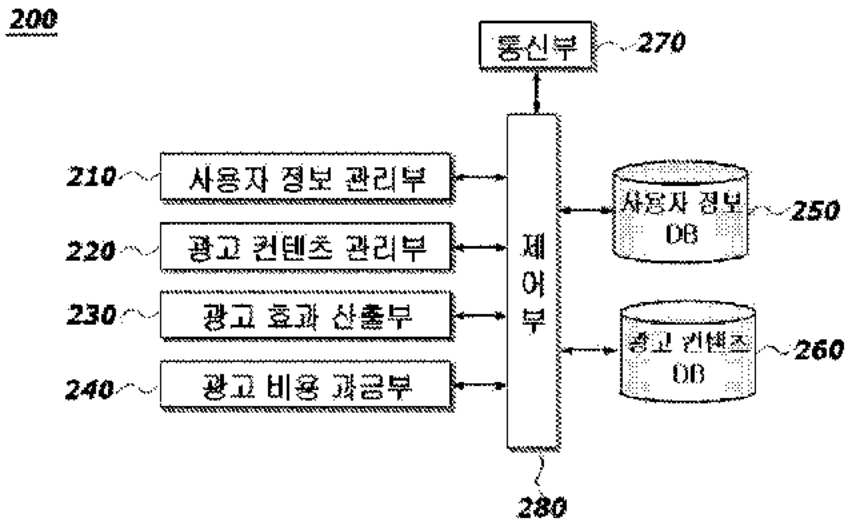
도면1b



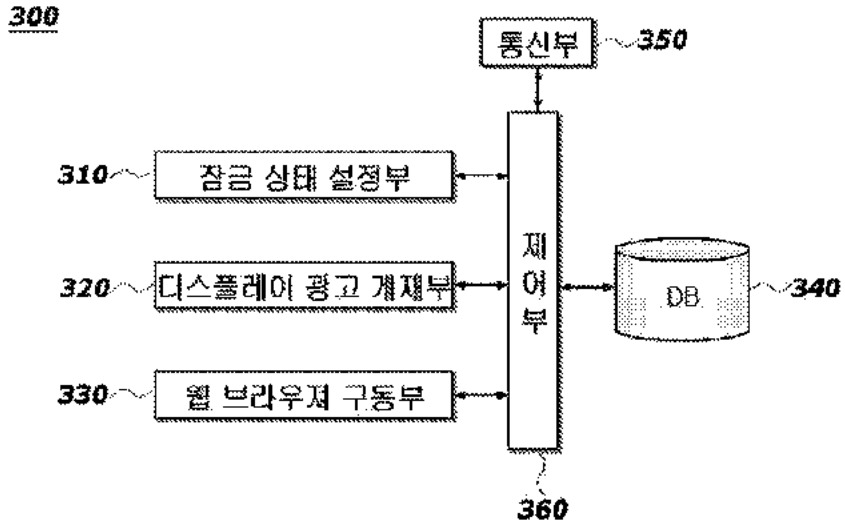
도면2



도면3



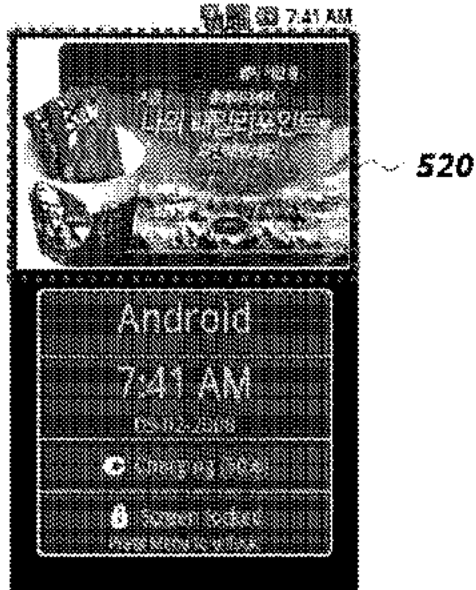
도면4



도면5a



도면55







(11) **EP 2 288 126 A1**

(12) **EUROPEAN PATENT APPLICATION**

(43) Date of publication:  
**23.02.2011 Bulletin 2011/08**

(51) Int Cl.:  
**H04M 1/725<sup>(2006.01)</sup> H04M 19/04<sup>(2006.01)</sup>**  
**H04M 1/67<sup>(2006.01)</sup>**

(21) Application number: **10161337.0**

(22) Date of filing: **28.04.2010**

(84) Designated Contracting States:  
**AT BE BG CH CY CZ DE DK EE ES FI FR GB GR  
HR HU IE IS IT LI LT LU LV MC MK MT NL NO PL  
PT RO SE SI SK SM TR**  
Designated Extension States:  
**AL BA ME RS**

(71) Applicant: **LG ELECTRONICS INC.**  
**Yeongdeungpo-gu**  
**Seoul 150-721 (KR)**

(72) Inventor: **Choi, Jung Eun**  
**153-801, Seoul (KR)**

(30) Priority: **19.08.2009 KR 20090076644**

(74) Representative: **Cabinet Plasseraud et al**  
**52, rue de la Victoire**  
**75440 Paris Cedex 09 (FR)**

(54) **Mobile terminal and controlling method thereof**

(57) A mobile terminal including a wireless communication unit (110) configured to wirelessly communicate with at least one other terminal, a display unit (151) configured to display information, a user input unit (130) including a hardware input unit having a light emitting device, and a controller (180) configured to control the light emitting device of the hardware input unit to emit light in

a predetermined pattern or color to inform a user of the mobile terminal about an unidentified received communication event that has not yet been checked by the user, and to display information about the unidentified communication event on the display unit when the user manipulates the hardware input unit.

**EP 2 288 126 A1**

**Description****Field of the invention**

[0001] The present invention relates to a mobile terminal and corresponding method for informing a user of an unidentified communication event in various ways and making it easier for the user to check the unidentified communication event.

**Background of the invention**

[0002] Generally, terminals can be classified into mobile/portable terminals and stationary terminals. Mobile terminals can also be classified into handheld terminals and vehicle mount terminals. Users can also play games, watch videos, listen to music, receive and send text messages, take pictures, etc. using their mobile terminal. Thus, mobile terminals function as multimedia players.

[0003] However, because the mobile terminals provide so many functions, it is often difficult for the user to keep track of events that have occurred on their mobile terminal.

**Summary of the invention**

[0004] Accordingly, one object of the present invention is to address the above-noted and other problems of the related art.

[0005] Another object of the present invention is to provide a mobile terminal and corresponding method for informing a user about an occurrence of previous events on their mobile terminal.

[0006] Yet another object of the present invention is to provide a mobile terminal and corresponding method for informing a user about a type of an occurrence of previous events on their mobile terminal.

[0007] Still another object of the present invention is to provide a mobile terminal and corresponding method for making it easy for a user to conveniently check previous events that have occurred on their terminal and have not yet been reviewed by the user.

[0008] It will be appreciated by persons skilled in the art that the objects that could be achieved with the present invention are not limited to what has been particularly described hereinabove and the above and other objects that the present invention could achieve will be more clearly understood from the following detailed description taken in conjunction with the accompanying drawings.

[0009] To achieve these objects and other advantages and in accordance with the purpose of the invention, as embodied and broadly described herein, the present invention provides in one aspect a mobile terminal including a wireless communication unit configured to wirelessly communicate with at least one other terminal, a display unit configured to display information, a user input unit including a hardware input unit having a light emitting

device, and a controller configured to control the light emitting device of the hardware input unit to emit light in a predetermined pattern or color to inform a user of the mobile terminal about an unidentified received communication event that has not yet been checked by the user, and to display information about the unidentified communication event on the display unit when the user manipulates the hardware input unit. The present invention also provides a corresponding method of controlling the mobile terminal.

[0010] In another aspect, the present invention provides a mobile terminal including a display unit including one of a liquid crystal display (LCD) and a plurality of light emitting diodes (LEDs) configured to emit light, a wireless communication unit configured to wirelessly communicate with at least one other terminal, a user input unit including a hardware input unit, and a controller configured to control the one of the LCD and the plurality of LEDs to emit light in a predetermined pattern or color to inform a user of the mobile terminal about an unidentified received communication event that has not yet been checked by the user, and to display information about the unidentified communication event on the display unit when the user manipulates the hardware input unit. The present invention also provides a corresponding method of controlling the mobile terminal.

[0011] Accordingly, embodiments of the present invention provide several advantages. First, the mobile terminal informs the user of an unidentified event occurrence more effectively. Secondly, the user can be informed of a type of an unidentified event using at least one of a color and light-emitting pattern of a light emitting device provided to a key button. Thirdly, the user can easily check an unidentified event more conveniently.

[0012] In addition, the above-described methods can be implemented in a program recorded medium as computer-readable codes. The computer-readable media include all kinds of recording devices in which data readable by a computer system are stored such as ROM, RAM, CD-ROM, magnetic tapes, floppy discs, optical data storage devices, and the like.

[0013] It is to be understood that the advantages that can be obtained by the present invention are not limited to the aforementioned advantages and other advantages which are not mentioned will be apparent from the following description to the person with an ordinary skill in the art to which the present invention pertains.

**Brief description of the drawings**

[0014] The accompanying drawings, which are included to provide a further understanding of the invention and are incorporated in and constitute a part of this application, illustrate embodiment(s) of the invention and together with the description serve to explain the principle of the invention. In the drawings:

[0015] FIG. 1 is a block diagram of a mobile terminal according to one embodiment of the present invention;

[0016] FIG. 2A is a front perspective diagram of a mobile terminal according to one embodiment of the present invention;

[0017] FIG. 2B is a rear perspective diagram of a mobile terminal according to one embodiment of the present invention;

[0018] FIG. 3 is a front diagram of a mobile terminal for explaining one operational state of the mobile terminal according to one embodiment of the present invention;

[0019] FIG. 4 is a flowchart illustrating a method of indicating and checking an unidentified communication event of a mobile terminal according to one embodiment of the present invention;

[0020] FIG. 5 includes overviews of display screens illustrating an example of an operation related to an unidentified communication event of a mobile terminal according to one embodiment of the present invention;

[0021] FIG. 6 includes diagrams of light emitting patterns of a light emitting device provided to a vector pad according to one embodiment of the present invention;

[0022] FIG. 7 includes overviews of display screens illustrating an example of a user checking an unidentified communication event on a mobile terminal according to one embodiment of the present invention;

[0023] FIG. 8 is a diagram of a backlight unit using a direct-drop type light emitting diode according to an embodiment of the present invention; and

[0024] FIG. 9 includes diagrams illustrating an example of a light emitting pattern per type of an unidentified communication event using a backlight unit including light emitting diodes according to an embodiment of the present invention.

### Detailed description of the invention

[0025] In the following detailed description, reference is made to the accompanying drawing figures which form a part hereof, and which show by way of illustration specific embodiments of the invention. It is to be understood by those of ordinary skill in this technological field that other embodiments may be utilized, and structural, electrical, as well as procedural changes may be made without departing from the scope of the present invention. Wherever possible, the same reference numbers will be used throughout the drawings to refer to the same or similar parts.

[0026] The present invention can be applicable to a various types of terminals. Examples of such terminals include mobile as well as stationary terminals, such as mobile phones, user equipment, smart phones, DTV, computers, digital broadcast terminals, personal digital assistants, portable multimedia players (PMP) and navigators. However, by way of non-limiting example only, further description will be with regard to a mobile terminal 100, and it should be noted that such teachings may apply equally to other types of terminals.

[0027] FIG. 1 is a block diagram of a mobile terminal 100 according to an embodiment of the present invention.

As shown, the mobile terminal 100 includes a radio communication unit 110, an audio/video (A/V) input unit 120, a user input unit 130, a sensing unit 140, an output unit 150, a memory 160, an interface 170, a controller 180, and a power supply 190. Not all of the components shown in FIG. 1 are essential parts and the number of components included in the mobile terminal can be varied.

[0028] In addition, the radio communication unit 110 includes at least one module that enables radio communication between the mobile terminal 100 and a radio communication system or between the mobile terminal 100 and a network in which the mobile terminal 100 is located. For example, in FIG. 1, the radio communication unit 110 includes a broadcasting receiving module 111, a mobile communication module 112, a wireless Internet module 113, a short-range communication module 114 and a position information module 115.

[0029] The broadcasting receiving module 111 receives broadcasting signals and/or broadcasting related information from an external broadcasting management server through a broadcasting channel. Further, the broadcasting channel can include a satellite channel and a terrestrial channel. Also, the broadcasting management server can be a server that generates and transmits broadcasting signals and/or broadcasting related information or a server that receives previously created broadcasting signals and/or broadcasting related information and transmits the broadcasting signals and/or broadcasting related information to a terminal. The broadcasting signals can include not only TV broadcasting signals, radio broadcasting signals and data broadcasting signals, but also signals in the form of a combination of a TV broadcasting signal and a radio broadcasting signal.

[0030] In addition, the broadcasting related information can be information on a broadcasting channel, a broadcasting program or a broadcasting service provider. The broadcasting related information can be provided even through a mobile communication network. In this instance, the broadcasting related information can be received by the mobile communication module 112. The broadcasting related information can also exist in various forms. For example, the broadcasting related information can exist in the form of an electronic program guide (EPG) of the digital multimedia broadcasting (DMB) system or in the form of an electronic service guide (ESG) of the digital video broadcast-handheld (DVB-H) system.

[0031] In addition, the broadcasting receiving module 111 receives broadcasting signals using various broadcasting systems. In particular, the broadcasting receiving module 111 can receive digital broadcasting signals using digital broadcasting systems such as the digital multimedia broadcasting-terrestrial (DMB-T) system, the digital multimedia broadcasting-satellite (DMB-S) system, the media forward link only (MediaFLO) system, and the DVB-H and integrated services digital broadcast-terrestrial (ISDB-T) system. The broadcasting receiving module 111 can also be constructed to be suited to broad-

casting systems providing broadcasting signals other than the above-described digital broadcasting systems. The broadcasting signals and/or broadcasting related information received through the broadcasting receiving module 111 can also be stored in the memory 160.

[0032] Further, the mobile communication module 112 transmits/receives a radio signal to/from at least one of a base station, an external terminal, and a server on a mobile communication network. The radio signal can include a voice call signal, a video telephony call signal or data in various forms according to transmission and receiving of text/multimedia messages. The wireless Internet module 113 corresponds to a module for wireless Internet access and can be included in the mobile terminal 100 or externally attached to the mobile terminal 100. Wireless LAN (WLAN) (Wi-Fi), wireless broadband (WiBro), world interoperability for microwave access (Wimax), high speed downlink packet access (HSDPA) and so on can be used as a wireless Internet technique. The short-range communication module 114 corresponds to a module for local area communication. Bluetooth, radio frequency identification (RFID), infrared data association (IrDA), ultra wideband (UWB) and ZigBee can be used as a local area communication technique.

[0033] In addition, the position information module 115 confirms or obtains the position of the mobile terminal 100. A global positioning system (GPS) module is a representative example of the position information module 115. Further, the GPS module 115 can calculate information on distances between one point (object) and at least three satellites and information on the time when the distance information is measured and apply trigonometry to the obtained distance information to obtain three-dimensional position information on the point (object) according to latitude, longitude and altitude coordinates at a predetermined time. Furthermore, a method of calculating position and time information using three satellites and correcting the calculated position and time information using another satellite is also used. In addition, the GPS module 115 continuously calculates the current position in real time and calculates velocity information using the position information.

[0034] Referring to FIG. 1, the A/V input unit 120 is used to input an audio signal or a video signal and includes a camera 121 and a microphone 122. The camera 121 processes image frames of still images or moving images obtained by an image sensor in a video telephony mode or a photographing mode. The processed image frames can be displayed on a display 151 included in the output unit 150. In addition, the image frames processed by the camera 121 can be stored in the memory 160 or transmitted to an external device through the radio communication unit 110. The mobile terminal 100 can also include at least two cameras according to constitution of the terminal.

[0035] Further, the microphone 122 receives an external audio signal in a call mode, a recording mode or a speed recognition mode and processes the received au-

dio signal into electric audio data. The audio data can also be converted into a form that can be transmitted to a mobile communication base station through the mobile communication module 112 and output in the call mode.

5 The microphone 122 can employ various noise removal algorithms for removing noise generated when the external audio signal is received.

[0036] In addition, the user input unit 130 receives input data for controlling the operation of the terminal from a user. The user input unit 130 can include a keypad, a dome switch, a touch pad (constant voltage/capacitance), jog wheel, jog switch and so on. The sensing unit 140 senses the current state of the mobile terminal 100, such as an open/close state of the mobile terminal 100, the position of the mobile terminal 100, whether a user touches the mobile terminal 100, the direction of the mobile terminal 100 and acceleration/deceleration of the mobile terminal 100 and generates a detection signal for controlling the operation of the mobile terminal 100. For example, the sensing unit 140 can sense whether a slide phone is opened or closed when the mobile terminal 100 is the slide phone. Furthermore, the sensing unit 140 can sense whether the power supply 190 supplies power and whether the interface 170 is connected to an external device. The sensing unit 140 can also include a proximity sensor 141.

[0037] In addition, the output unit 150 generates visual, auditory or tactile output and in Fig. 1 includes the display 151, an audio output module 152, an alarm 153, a haptic module 154, and a projector module 155. The display 151 displays information processed by the mobile terminal 100. For example, the display 151 displays a UI or graphic user interface (GUI) related to a telephone call when the mobile terminal is in the call mode. The display 151 also displays a captured or/and received image, UI or GUI when the mobile terminal 100 is in the video telephony mode or the photographing mode.

[0038] The display 151 can also include at least one of a liquid crystal display, a thin film transistor liquid crystal display, an organic light-emitting diode display, a flexible display and a three-dimensional display. Some of these displays can be of a transparent type or a light transmission type, which is referred to as a transparent display. The transparent display also includes a transparent liquid crystal display. The rear structure of the display unit 151 can also be of the light transmission type. According to this structure, a user can see an object located behind the body of the mobile terminal 100 through an area of the body of the mobile terminal 100, which is occupied by the display 151.

[0039] Further, the mobile terminal 100 can include at least two displays 151 according to constitution of the terminal. For example, the mobile terminal 100 can include a plurality of displays that are arranged on a single face at a predetermined distance or integrated. Otherwise, the plurality of displays can be arranged on different sides. In addition, when the display 151 and a sensor sensing touch (referred to as a touch sensor hereinafter)

form a layered structure, which is referred to as a touch screen hereinafter, the display 151 can be used as an input device in addition to an output device. The touch sensor can be in the form of a touch film, a touch sheet and a touch pad, for example.

[0040] Also, the touch sensor can be constructed such that it converts a variation in pressure applied to a specific portion of the display 151 or a variation in capacitance generated at a specific portion of the display 151 into an electric input signal. The touch sensor can also be constructed such that it can sense pressure of touch as well as the position and area of touch. When touch input is applied to the touch sensor, a signal corresponding to the touch input is transmitted to a touch controller. The touch controller then processes the signal and transmits data corresponding to the processed signal to the controller 180. Accordingly, the controller 180 can detect a touched portion of the display 151.

[0041] Referring to FIG. 1, the proximity sensor 141 can be located in an internal region of the mobile terminal 100, surrounded by the touch screen, or near the touch screen. The proximity sensor 141 senses an object approaching a predetermined sensing face or an object located near the proximity sensor 141 using an electromagnetic force or infrared rays without having mechanical contact. Further, the proximity sensor 141 has a lifetime longer than that of a contact sensor and has wide application. The proximity sensor 141 also includes a transmission type photo-electric sensor, a direct reflection type photo-electric sensor, a mirror reflection type photo-electric sensor, a high-frequency oscillating proximity sensor, a capacitive proximity sensor, a magnetic proximity sensor, an infrared proximity sensor, etc.

[0042] In addition, a capacitive touch screen is constructed such that a proximity of a pointer is detected through a variation in an electric field according to the proximity of the pointer. In this instance, the touch screen (touch sensor) can be classified as a proximity sensor. For convenience of explanation, an action of approaching the pointer to the touch screen while the pointer is not in contact with the touch screen such that the location of the pointer on the touch screen is recognized is referred to as a "proximity touch" and an action of bringing the pointer into contact with the touch screen is referred to as a "contact touch" in the following description. Also, a proximity touch point of the pointer on the touch screen means a point of the touch screen to which the pointer corresponds perpendicularly to the touch screen when the pointer proximity-touches the touch screen.

[0043] Further, the proximity sensor 141 senses a proximity touch and a proximity touch pattern (for example, a proximity touch distance, a proximity touch direction, a proximity touch velocity, a proximity touch time, a proximity touch position, a proximity touch moving state, etc.). Information corresponding to the sensed proximity touch action and proximity touch pattern can also be displayed on the touch screen.

[0044] Also, the audio output module 152 can output

audio data received from the radio communication unit 110 or stored in the memory 160 in a call signal receiving mode, a telephone call mode or a recording mode, a speech recognition mode and a broadcasting receiving mode. The audio output module 152 also outputs audio signals related to functions (for example, a call signal incoming tone, a message incoming tone, etc.) performed in the mobile terminal 100. The audio output module 152 can include a receiver, a speaker, a buzzer, etc.

[0045] The alarm 153 outputs a signal for indicating a generation of an event of the mobile terminal 100. Examples of events generated in the mobile terminal 100 include receiving a call signal, receiving a message, inputting a key signal, inputting touch, etc. The alarm 153 can also output signals in forms different from video signals or audio signals, for example, a signal for indicating a generation of an event through vibration. The video signals or the audio signals can also be output through the display unit 151 or the audio output module 152.

[0046] In addition, the haptic module 154 generates various haptic effects that the user can feel. A representative example of the haptic effects is vibration. The intensity and pattern of vibration generated by the haptic module 154 can also be controlled. For example, different vibrations can be combined and output or sequentially output. The haptic module 154 can also generate a variety of haptic effects including an effect of stimulus according to an arrangement of pins vertically moving for a contact skin face, an effect of stimulus according to a jet force or sucking force of air through a jet hole or a sucking hole, an effect of stimulus of rubbing the skin, an effect of stimulus according to contact of an electrode, an effect of stimulus using an electrostatic force and an effect according to reproduction of cold and warmth using an element capable of absorbing or radiating heat in addition to vibrations. Further, the haptic module 154 can not only transmit haptic effects through direct contact but also allow the user to feel haptic effects through kinesthetic sense of his or her fingers or arms. The mobile terminal 100 can also include at least two or more haptic modules 154 according to constitution of the mobile terminal.

[0047] The projector module 155 is an element for performing an image projector function using the mobile terminal 100. That is, the projector module 155 can display an image, which is identical to or partially different at least from the image displayed on the display 151, on an external surface such as a wall or screen according to a control signal of the controller 180. In particular, the projector module 155 includes a light source generating light (e.g., laser) for projecting an image, an image producing unit for producing an image to be projected using the light generated from the light source, and a lens for enlarging the image to be projected in a predetermined focus distance. In addition, the projector module 155 can include an adjustment device for adjusting an image projected direction by mechanically moving the lens or the whole module.

[0048] Further, the projector module 155 can be classified into a CRT (cathode ray tube) module, an LCD (liquid crystal display) module, a DLP (digital light processing) module or the like according to a device type of a display mechanism. In particular, the DLP module is operated by the mechanism of enabling the light generated from the light source to reflect on a DMD (digital micro-mirror device) chip and can be advantageous for the downsizing of the projector module 151. Preferably, the projector module 155 can be provided in a length direction of a lateral, front or backside direction of the mobile terminal 100. The projector module 155 can also be provided to any portion of the mobile terminal 100.

[0049] In addition, the memory 160 stores a program for the operation of the controller 180 and temporarily stores input/output data (for example, phone book, messages, still images, moving images, etc.). The memory 160 can also store data about vibrations and sounds in various patterns, which are output when a touch input is applied to the touch screen. The memory 160 can include at least one of a flash memory, a hard disk type memory, a multimedia card micro type memory, a card type memory (for example, SD or XD memory), a random access memory (RAM), a static RAM (SRAM), a read-only memory (ROM), an electrically erasable programmable ROM (EEPROM), a programmable ROM (PROM) magnetic memory, a magnetic disk and an optical disk. The mobile terminal 100 can also operate in relation to a web storage performing the storing function of the memory 160 on the Internet.

[0050] Further, the interface 170 serves as a path to all external devices connected to the mobile terminal 100. The interface 170 receives data or power from the external devices and transmits the data or power to the internal components of the mobile terminal 100 or transmits data of the mobile terminal 100 to the external devices. The interface 170 can also include a wired/wireless headset port, an external charger port, a wired/wireless data port, a memory card port, a port for connecting a device having a user identification module, an audio I/O port, a video I/O port, an earphone port, etc., for example.

[0051] In addition, an identification module is a chip that stores information for authenticating the authority to use the mobile terminal 100 and can include a user identify module (UIM), a subscriber identify module (SIM) and a universal subscriber identify module (USIM). A device (referred to as an identification device hereinafter) including the identification module can be manufactured in the form of a smart card. Accordingly, the identification device can be connected to the mobile terminal 100 through a port.

[0052] Also, the interface 170 can serve as a path through which power from an external cradle is provided to the mobile terminal 100 when the mobile terminal 100 is connected to the external cradle or a path through which various command signals input by the user through the cradle to the mobile terminal 100. The various command signals or power input from the cradle can be used

as a signal for confirming whether the mobile terminal 100 is correctly set in the cradle.

[0053] The controller 180 controls the overall operation of the mobile terminal. For example, the controller 180 performs control and processing for voice communication, data communication and video telephony. In FIG. 1, the controller 180 includes a multimedia module 181 for playing multimedia. The multimedia module 181 can be included in the controller 180 or separated from the controller 180. Further, the controller 180 can perform a pattern recognition process capable of recognizing handwriting input or picture-drawing input applied to the touch screen as characters or images. In addition, the power supply 190 receives external power and internal power and provides power required for the operations of the components of the mobile terminal under the control of the controller 180.

[0054] Further, various embodiments of the present invention can be implemented in a computer or similar device readable recording medium using software, hardware or a combination thereof, for example. According to a hardware implementation, the embodiments of the present invention can be implemented using at least one of application specific integrated circuits (ASICs), digital signal processors (DSPs), digital signal processing devices (DSPDs), programmable logic devices (PLDs), field programmable gate arrays (FPGAs), processors, controllers, micro-controllers, microprocessors, electrical units for executing functions. The embodiments can also be implemented by the controller 180.

[0055] According to a software implementation, embodiments such as procedures or functions can be implemented with a separate software module executing at least one function or operation. Software codes can be implemented according to a software application written in an appropriate software language. Furthermore, the software codes can be stored in the memory 160 and executed by the controller 180.

[0056] Next, FIG. 2A is a front perspective view of a mobile terminal or a handheld terminal 100 according to an embodiment of the present invention. As shown, the mobile terminal 100 is a bar type terminal body. However, the present invention is not limited to a bar type terminal and can be applied to terminals of various types including a slide type, folder type, swing type and swivel type terminals having at least two bodies that are relatively movably combined.

[0057] In addition, the terminal body includes a case (a casing, a housing, a cover, etc.) forming the exterior of the terminal 100. In the present embodiment, the case is divided into a front case 101 and a rear case 102. Various electronic components are also arranged in the space formed between the front case 101 and the rear case 102. At least one middle case can be additionally arranged between the front case 101 and the rear case 102. The cases can also be formed of plastics through injection molding or be made of a metal material such as stainless steel (STS) or titanium (Ti).

[0058] In addition, the display 151, the audio output unit 152, the camera 121, user input units 131 and 132 of the user input unit 130 (FIG. 1), the microphone 122 and the interface 170 are arranged in the terminal body, specifically, in the front case 101. Also, the display 151 occupies most part of the main face of the front case 101. The audio output unit 152 and the camera 121 are arranged in a region in proximity to one of both ends of the display 151 and the user input unit 131 and the microphone 122 are located in a region in proximity to the other end of the display 151. In addition, the user input unit 132 and the interface 170 are arranged on the sides of the front case 101 and the rear case 102.

[0059] Further, the user input unit 130 is operated to receive commands for controlling the operation of the handheld terminal 100 and can include the operating units 131 and 132. The operating units 131 and 132 can be referred to as manipulating portions and employ any tactile manner in which a user operates the operating units 131 and 132 while having tactile feeling. The operating units 131 and 132 can also receive various inputs. For example, the operating unit 131 receives commands such as start, end and scroll, and the second operating unit 132 receives commands such as control of the volume of sound output from the audio output unit 152 or conversion of the display 151 to a touch recognition mode. A broadcast antenna 116 can also be included in the mobile terminal 100.

[0060] Next, FIG. 2B is a rear perspective view of the mobile terminal 100 shown in FIG. 2A according to an embodiment of the present invention. Referring to FIG. 2B, a camera 121' is additionally attached to the rear side of the terminal body, that is, the rear case 102. The camera 121' has a photographing direction opposite to that of the camera 121 shown in FIG. 2A and can have pixels different from those of the camera 121 shown in FIG. 2A. For example, it is preferable that the camera 121 has low pixels such that it can capture an image of the face of a user and transmit the image to a receiving part for video telephony, while the camera 121' has high pixels because it captures an image of a general object and does not immediately transmit the image in many instances. The cameras 121 and 121' can also be attached to the terminal body such that they can be rotated or pop-up.

[0061] A flash bulb 123 and a mirror 124 are also arranged in proximity to the camera 121'. The flash bulb 123 lights an object when the camera 121' takes a picture of the object, and the mirror 124 is used for the user to look at his/her face in the mirror when the user wants to self-photograph himself/herself using the camera 121'. An audio output unit 152' is also provided on the rear side of the terminal body. The audio output unit 152' can thus achieve a stereo function with the audio output unit 152 shown in FIG. 2A and be used for a speaker phone mode when the terminal is used for a telephone call.

[0062] A broadcasting signal receiving antenna 124 is also attached to the side of the terminal body in addition to an antenna for telephone calls. The antenna 124 can

structing a part of the broadcasting receiving module 111 shown in FIG. 1 can be set in the terminal body such that the antenna 124 can be retracted from the terminal body. Further, the power supply 190 for providing power to the handheld terminal 100 is set in the terminal body. The power supply 190 can be included in the terminal body or detachably attached to the terminal body.

[0063] A touch pad 135 for sensing touch is also attached to the rear case 102. The touch pad 135 can be of a light transmission type as the display 151. In this instance, if the display 151 outputs visual information through both sides thereof, the visual information can be recognized through the touch pad 135. The information output through both sides of the display 151 can also be controlled by the touch pad 135. Otherwise, a display is additionally attached to the touch pad 135 such that a touch screen can be arranged even in the rear case 102.

[0064] The touch pad 135 also operates in connection with the display 151 of the front case 101. The touch pad 135 can be located in parallel with the display 151 behind the display 151, and can be identical to or smaller than the display 151 in size.

[0065] A third manipulating unit 136 in FIG. 2A includes a first button 137 provided to a center of the third manipulating unit and a second key button 138 enclosing the first button 137. Further, the first button 137 can include a general push button, a touch pad or a track pad configured to recognize a touch. When the first button 137 is the push button, the first button 137 includes at least one rotational shaft to receive an input of a scroll command. A small display device such as a small LCD, a plurality of small-scale LEDs having a prescribed arrangement and the like is also provided to the first button 137 to display a simple symbol, sign, a figure and/or the like thereon.

[0066] In order to perform functions of a navigation key, the second button 138 can distinctively recognize a pressure change, a light intensity change or an electrostatic capacity change according to at least 4-directional contact (up, down, left and right). In addition, the second button 138 can simultaneously recognize at least two directions. In other words, the second button 138 can operate as a pressure-sensitive type, which responds to a pressure applied in a random direction. Alternatively, the second button 138 can operate as a photosensitive type, which responds to an intensity of light reaching at least one portion of the second button by a shadow according to a proximity of such a pointer as a finger, a stylus pen and the like or a change of a light applied pattern. Alternatively, the second button can be implemented as a general button of an electrostatic capacity type.

[0067] For instance, when a cursor displayed on the display unit 151 is manipulated, if an upper portion of the second button 138 and a right portion of the second button 138 are simultaneously touched, the cursor diagonally moves in a right upper direction. The second button 138 can also recognize a pressure applied in each direction or a contact size by discriminating it by at least two

steps. In particular, if a user applies a first pressure in one direction on manipulating a cursor, the cursor moves at a first speed. If a second pressure greater than the first pressure is applied, the cursor moves at a second speed higher than the first speed. Hence, a user can move a cursor or select a menu by controlling a direction and pressure when pressing the second button 138 more conveniently than using a general navigation key. Optionally, the second button 138 can be formed of a light-transmissive material and provided with a light emitting device loaded therein, thereby bringing about various visual effects. The light emitting device can also include at least one light emitting diode (LED) or a plurality of light emitting diodes differing from one another in color, which can emit lights in a plurality of colors or a flickering pattern under the control of the controller 180. In the following description, the third manipulating unit 136 including the first button 137 and the second button 138 are named a 'vector pad' for clarity and convenience.

**[0068]** An interconnected operational mechanism between the display 151 and the touchpad 135 will now be explained with reference to FIG. 3, which illustrates a front view of the mobile terminal 100 according to an embodiment of the present invention.

**[0069]** As shown in FIG. 3, various types of visual information such as characters, numerals, symbols, graphics, icons, etc. can be displayed on the display 151. The characters, numerals, symbols, graphics and icons are also provided in a single predetermined array to form a keypad. The keypad formation can also be called 'soft keys'.

**[0070]** The display 151 is also operable through an entire area or can be divided into a plurality of regions, which interoperate with each other. In FIG. 3, the display 151 includes an output window 151a and an input window 151b. The input window 151b also includes a soft key 151c' representing a digit for inputting a phone number or the like. Thus, if the user touches the soft key 151c', the controller 180 displays the digit corresponding to the touched soft key on the output window 151a. The user can then manipulate the first manipulating unit 131 to call the phone number displayed on the output window 151a.

**[0071]** In addition, information displayed on the display 151 or the touchpad 135 can be scrolled by shifting a cursor or pointer located at an entity (e.g., icon or the like). Furthermore, when the user shifts or drags their finger on the display 151 or the touchpad 135, the controller 180 can display a path of the shifted finger on the display 151. This may be useful when the user is editing an image displayed on the display 151, for example.

**[0072]** Also, when both of the display 151 and the touchpad 135 are touched together within a predetermined time range, the controller 180 can execute a particular function of the terminal. For example, the user can clasp or clamp the terminal body using their thumb and first finger to execute a predetermined function such as activating or deactivating the display 151 and/or the touchpad 135.

**[0073]** Further, a 'pointer' or 'cursor' is often displayed as an arrow on the display unit. Thus, to discriminate between the terms 'pointer' and 'cursor', the term 'cursor' will be defined as an element or figure that is displayed on the display unit to indicate a specific position, and the term 'pointer' will be defined as the user's finger, a stylus pen, etc., which is used to physically apply a contact touch or a proximity touch to a specific point of a touchscreen.

**[0074]** FIG. 3 also illustrates the mobile terminal including the vector pad 136 having the first and second buttons 137 and 138. These buttons are used in various ways to inform the user about a previous event that has occurred on their terminal (e.g., missed incoming call). The vector pad 136 will be described in more detail throughout the description of the present application.

**[0075]** Next, FIG. 4 is a flowchart illustrating a method of indicating and checking an unidentified communication event of a mobile terminal according to one embodiment of the present invention. As shown, the mobile terminal 100 receives a signal indicating an unidentified communication event has occurred on the terminal (S401).

**[0076]** In addition, the unidentified communication event includes a communication event that the user has not acknowledged such as a short text message (SMS) received via the wireless communication unit 100, a multimedia message (MMS), a voice mail, an email, a voice call, a video call and the like. That is, the unidentified communication event includes the user not checking a received short text message (SMS), a received multimedia message (MMS), a received voice mail, a received email or the like. The unidentified event also includes bidirectional communication that has not been established because the user has not responded to an incoming voice or video call.

**[0077]** Then, when an unidentified event has occurred, the controller 180 drives a light emitting device provided to the vector pad 136 to emit light in different patterns or colors to visually inform the user of a presence of the unidentified communication event (S402). Further, the controller 180 drives the light emitting device to emit light in a different color or pattern according to the type of the unidentified communication event.

**[0078]** For instance, when the unidentified communication event is a text message, the controller 180 drives the light emitting device to emit blue light, and when the unidentified communication event is a voice call, the controller 180 drives the light emitting device to emit red light. In another example, when the unidentified communication event is a text message, the controller 180 drives the light emitting device to periodically flicker, and when the unidentified communication event is a voice call, the controller 180 drives the light emitting device to constantly emit light. The user can also set what color is to be emitted for what event using the appropriate menu options provided on the mobile terminal of the present invention.



[0079] In addition, if at least two types of unidentified communication events simultaneously exist, the controller 180 drives the light emitting device to alternately provide a color or light emitting pattern corresponding to each event or provide a third color or light emitting pattern. Then, as shown in FIG. 4, when the light emitting device is activated, and the user inputs a specific button through the user input unit 130 (Yes in S403), the controller 180 displays the unidentified communication event on the display unit 151 (S404).

[0080] Further, if a plurality of different unidentified communication events exist, the controller 180 can display the unidentified communication events in order of occurrence irrespective of the types, according to a user-set priority per type of the unidentified communication event or per originator of the unidentified communication event. Also, when the user identifies one of the displayed unidentified communication events, the controller 180 can automatically display an event having a next highest or lowest priority. In addition, the list displaying order or checking order is just an example and a priority can be set according to various references or by a group unit.

[0081] Meanwhile, after the user has checked the unidentified communication event, the controller 180 determines whether there is a remaining unidentified communication event (S405). When all remaining unidentified communication events have not been checked (No in S405), the controller 180 drives the light emitting device of the vector pad 136 to emit light in a predetermined color or light emitting pattern corresponding to the remaining unidentified communication event. That is, in one embodiment of the present invention, the controller 180 informs the user about the unidentified event using the first and second buttons 137 and 138 of the vector pad 136. These features will be explained in more detail later.

[0082] Further, when the mobile terminal 100 includes a touchscreen, the controller 180 can lock the touchscreen to prevent recognition of any unintended touch input on the touchscreen. For example, if the user does not touch the touchscreen for a predetermined duration or a predetermined time passes after occurrence of an unidentified communication event, the controller 180 locks the touchscreen. The user can then unlock the touchscreen by manipulating a hardware key (e.g., a hold key, a touch unlock button, etc.).

[0083] The controller 180 can also unlock the touchscreen when the user checks a displayed unidentified communication event, and again lock the touchscreen after the user has checked the unidentified communication event. Thus, the user does not have to perform cumbersome operations for locking and unlocking the touchscreen when checking the unidentified communication event.

[0084] The user can also use only the vector pad 136 to check an unidentified communication event when the touchscreen is locked. In particular, after the controller 180 displays an unidentified communication event ac-

ording to the user's input via the vector pad 136, and if the user makes an input (e.g., contact, push, scroll, etc.) via the vector pad again 136, the controller 180 can sequentially display unidentified communication events. Thus, because the user does not manipulate the touchscreen to check the unidentified communication event, the continuous locking and unlocking of the touchscreen can be avoided. Further, the methods of unlocking the touchscreen lock and checking the unidentified communication event using the vector pad are usable by being combined together.

[0085] A method of indicating and checking the unidentified communication event in the mobile terminal will now be explained with reference to FIGs. 5 to 7. In particular, FIG. 5 includes overviews of display screens illustrating an example of an operation related to unidentified communication events occurring on the mobile terminal according to one embodiment of the present invention.

[0086] As shown in FIG. 5(a), when an incoming voice call is received via the wireless communication unit 110, the controller 180 displays information 510 identifying the caller on a portion of the display 151. The controller 180 can also display a phone-shape icon 520 indicating an incoming voice call has been received and a mail letter-shape icon 530 indicating a presence of an unidentified text message on an indicator area provided to a top side of the display 151.

[0087] As shown in FIG. 5(b), when the user does not answer the incoming voice call, the voice call session is not established and the controller 180 changes the icon 520 into an icon 521 indicating that there is a missed call. Moreover, the controller 180 dims the display 151 to save power. Also, if the user does not perform an input operation while the display 151 is dim or getting dimmer, the controller 180 turns off the display 151 as shown in FIG. 5(c). The controller 180 also drives a light emitting device of the second button 138 of the vector pad 136 to emit light and thereby inform the user that a missed call exists. Further, to prevent a malfunction, the controller 180 can lock the touchscreen as discussed above.

[0088] Next, FIG. 6 includes diagrams illustrating different light emitting patterns of a light emitting device for the vector pad 136 according to one embodiment of the present invention. As shown in FIG. 6(a), the light emitting device is arranged along a shape of the second button 138 and includes a light-transmittive material. The controller 180 also drives the light emitting device to emit light in a shape rotating in one direction. Further, as shown in FIG. 6(b), the controller 180 can drive the light emitting device to emit light in a fade-in & fade-out pattern (e.g., the emitted light gets brighter and then gradually dimmer).

[0089] FIG. 6(c) illustrates the first button 137 including a plurality of small LEDs. Thus, the controller 180 can display a simple figure indicating a type of an unidentified communication event by driving particular LEDs to emit light. In particular, FIG. 6(c) illustrates the controller 180

driving the LEDs to make a shape of a phone and a mail message. When the first button 137 includes an LCD, the controller 180 can drive the LCD to make the shapes shown in FIG. 6(d), for example. The figure display of the first button 137 can be used together with the light emitting patterns of the second button 138 shown in FIG. 6, for example.

[0090] Next, FIG. 7 includes overviews of display screens illustrating an example of a user checking an unidentified communication event on a mobile terminal according to one embodiment of the present invention. FIG. 7 also illustrates a state of the mobile terminal 100 the state shown in FIG. 5(c). FIG. 7 also illustrates an unanswered voice call (i.e., a missed call) and a text message that have not been acknowledged by the user. Thus, the controller 180 drives the light emitting device of the vector pad 136 and/or a small display device of the first button 137 to emit light in colors or patterns corresponding to the missed call and the text message, respectively. Further, the controller 180 has touch-locked the touchscreen.

[0091] In addition, if the user touches or manipulates the user input unit 130 different from the vector pad 136, i.e., either a touchscreen or a hardware button is manipulated, the controller 180 displays an icon indicating the touch lock mode is set and how to unlock the touch lock mode. FIG. 7(a) illustrates one example of informing the user about the touch lock mode. Further, until the user unlocks the touch lock mode by one of methods displayed on the display 151, the controller 180 deactivates other functions.

[0092] However, if the user touches the first button 137 of the vector pad 136 as shown in FIG. 7(a), the controller 180 displays the unidentified communication events on the display unit 151 as shown in FIG. 7(b). That is, even though the touch lock mode is not unlocked, the controller 180 does not apply the touch lock mode to the functions related to the unidentified communication events. Hence, the user can easily check unidentified communication events using the vector pad 136 without having to separately unlock the touch lock mode.

[0093] In addition, while the unidentified communication events are displayed on the display 151, the controller 180 can recognize other inputs (e.g., touch, push, scroll, etc.) from the user via the vector pad 136. Thus, the user can use only the vector pad 136 for checking and reading missed events. For example, the controller 180 can display a cursor on the display unit 151 that moves in response to user touching or manipulating the second button 138. Thus, when the controller 180 is displaying a plurality of unidentified communication events on the display 151, the user can move the cursor to a specific unidentified communication event and then select the corresponding unidentified communication event through an input made via the first button 137.

[0094] Moreover, when the controller 180 does not display a separate cursor, the user can check an unidentified communication event by manipulating the first button

137. For instance, if there is only an unidentified communication event of one type, the user can check the unidentified communication event by manipulating the first button 137 once. If there are multiple types of unidentified communication events, the unidentified communication events can be sequentially displayed in order determined according to a prescribed reference each time the first button 137 is manipulated once. Also, a wheel function can be provided to the first button 137 so the user can check an unidentified communication event in a forward or backward direction according to a scroll direction of a wheel.

[0095] The user can also check an unidentified communication event by pressing the first button 137 for a long time (i.e., a long-touch input). For instance, if the user wants to check a different type of unidentified communication event when they are checking another unidentified communication event, the user can check the different type of unidentified communication event by applying a long-touch input to the first button 137 or by pressing the first button 137 over a prescribed duration. In another example, if the user applies a long touch to the first button 137 when checking a random unidentified communication event, the controller 180 can directly execute a function of entering the unidentified communication event of a preset type.

[0096] Thus, because the user does not manipulate a touchscreen to check an unidentified communication event, the controller 180 or user do not have to continually lock and unlock the display 151. In addition, the above-explained methods of unlocking the touchscreen and checking the unidentified communication event using the vector pad can be combined together.

[0097] Again, with reference to FIG. 7(b), the user can also touches the missed call displayed item 710, and the controller 180 unlocks the touchscreen and displays a history of unidentified voice calls as shown in FIG. 7(c). The controller 180 can also interrupt the light emission of the light emitting device provided to the vector pad 136 and/or the figure display of the small display device when the user is checking the unidentified events. Then, as shown in FIG. 7(d), when the user completes the checking the history of the unidentified voice calls, the controller 180 removes the indicator 521. However, because a text message remains unchecked, the controller 180 continues to display the indicator 530 indicating the presence of the unidentified text message.

[0098] Thereafter, if the user does not perform any input operation for a predetermined period of time, the controller 180 turns off the display 151 and then enables the light emitting device of the vector pad 136 to emit light in the color or pattern corresponding to the unidentified text message again as shown in FIG. 7(d). The controller 180 can also set the touch lock mode.

[0099] Next, a method of informing the user of an unidentified communication event using LEDs of the display 151 instead of a light emitting device of the vector pad 136 according to another embodiment of the present in-

vention will be described.

**[0100]** The display 151 includes a liquid crystal display (LCD). The LCD is a non-light-emitting electronic display device (i.e., does not emit light by itself) and thus uses a backlight unit (BLU) as the light source. The BLU is generally a complex structure including a light source, a power circuit for driving the light source and a series of parts for generating planar light.

**[0101]** In addition, the BLU can be categorized into a direct type or an edge type according to how it is arranged in association with an LCD panel. The direct type BLU is located at a back position of the LCD panel for directly applying light from the backside of the LCD panel and include a backlight lamp as a light source, a reflector for reflecting light of the backlight lamp and a diffusing plate for diffusing the reflected light evenly.

**[0102]** The edge type BLU is located at a lateral side of an LCD panel, and light generated from the light source located at the lateral side is applied as planar light to the LCD panel via a light guide plate for guiding the light. The edge type is slimmer than the direct type. In addition, a Cold Cathode Fluorescent Lamp (CCFL) has mainly been used as the backlight lamp of the BLU. The CCFL includes a glass tube having its inner side coated with a fluorescent material, electrodes attached to both ends of the glass tube, high-pressure mixed gas and Hg of constant quantity enclosed within the glass tube.

**[0103]** When power is applied to the CCFL, electrons from the electrode collide with Hg to generate UV ray, and the generated UV ray reacts with the fluorescent material to generate visible rays. In this embodiment of the present invention, the CCFL is not used as the BLU, but rather a plurality of LEDs are used. Further, the BLU using LEDs has lower power consumption, higher color reproducibility and excellent response speed compared to the CCFL. Further, this embodiment of the present invention informs a user of a presence of an unidentified communication event in various ways using the LED BLU.

**[0104]** In particular, the present embodiment is similar to embodiments described with reference to FIGs. 2-7, but uses the LED BLU instead of the light emitting device of the vector pad. Further, the user can check an unidentified event by manipulating a random hardware input unit instead of the vector pad. A structure of the LED BLU applicable to the mobile terminal 100 according to the present embodiment will now be explained with reference to FIG. 8.

**[0105]** In particular, FIG. 8 is a diagram illustrating a backlight unit using a direct-drop type light emitting diode according to an embodiment of the present invention. Referring to FIG. 8, LEDs 800 are arranged in a check shape to construct a direct type BLU. Further, the controller 180 can control the brightness or flickering of each LED 180 individually to bring about a prescribed visual effect. An example of one visual effect will now be explained with reference to FIG. 9.

**[0106]** As shown in FIG. 9(a), when an unidentified

communication event is a voice call, the controller 180 controls the BLU to emit light in a phone shape. Similarly, as shown in FIG. 9(b), when the unidentified communication event is a text message, the controller 180 controls the BLU to emit light in a letter shape, and as shown in FIG. 9(c), when the unidentified communication event is an email, the controller 180 controls the BLU to emit light in a shape of an alphabet 'e'.

**[0107]** Further, FIG. 9 is one example for describing an alternative embodiment of the present invention and can be modified into various shapes. Moreover, a cycle, intensity and pattern of light emission of the BLU can be variously adjusted in consideration of power consumption. In addition, the vector pad 136 is one example including the first and second buttons 137 and 138. However, various types of vector pads are applicable to the present invention.

**[0108]** For instance, the vector pad 136 can have only one button having functions of the first and second buttons 137 and 138 combined together. In particular, a light emitting device and can be provided within one button (single button) and/or a small display device can be provided on a top of the one button (single button), whereby the above-described light-emitting and figure displaying functions can be implemented. Then, if the user presses a center of the vector pad of the single button type downwardly, a same effect of pressing the first button can take place, and if the user presses an edge portion of this vector pad, a same effect of pressing the second button can take place.

**[0109]** The above descriptions refer checking an occurrence of an unidentified event. However, the present invention is not limited to communication events and can also be applied to notification and/or checking method for various kinds of events. For instance, if a point of time or an anniversary preset by a user has come, the controller 180 can inform the user of the advent of the preset time point by using either one of above described methods. For another instance, if a time point of a schedule preset by a user has come, the controller 180 can inform the user of the advent of the predetermined schedule by using either one of above described methods. Namely, various visual effects can be provided to the user according to a type of the alarm/notification event via the vector pad.

**[0110]** Moreover, the user can conveniently check various kinds of events by manipulating the vector pad in such a way as similarly applying the above described methods for checking unidentified communication events. Also, because the user does not have to manipulate the touchscreen to check the various kinds of events, the touchscreen does not have to be locked and unlocked continuously. Moreover, when a plurality of events have occurred, the above described methods for sequentially displaying and checking the events according to a preset priority can be applied similarly.

**[0111]** It will be apparent to those skilled in the art that various modifications and variations can be made in the

present invention without departing from the scope of the inventions. Thus, it is intended that the present invention covers the modifications and variations of this invention provided they come within the scope of the appended claims and their equivalents.

#### Claims

1. A mobile terminal, comprising:
  - a wireless communication unit (110) configured to wirelessly communicate with at least one other terminal;
  - a display unit (151) configured to display information;
  - a user input unit (130) including a hardware input unit having a light emitting device; and
  - a controller (180) configured to control the light emitting device of the hardware input unit to emit light in a predetermined pattern or color to inform a user of the mobile terminal about an unidentified received communication event that has not yet been checked by the user, and to display information about the unidentified communication event on the display unit when the user manipulates the hardware input unit.
2. The mobile terminal of claim 1, wherein the predetermined pattern includes continuously emitted light.
3. The mobile terminal of claim 1 or 2, wherein the unidentified communication event comprises at least one of a short text message (SMS), a multimedia message (MMS), a voice mail, an email, a voice call and a video call.
4. The mobile terminal of any one of claims 1 to 3, wherein the light emitting device comprising a plurality of light emitting diode (LEDs) configured to emit a plurality of different colors, and wherein the controller is further configured to control the light emitting device to emit light in one of the plurality of the different colors differing according to a type of the unidentified communication event.
5. The mobile terminal of any one of claims 1 to 4, wherein the hardware input unit includes a navigation key configured to recognize at least four directions including up, down, left and right directions input by the user using the navigation key.
6. The mobile terminal of claim 5, wherein the navigation key includes a pressure sensor configured to recognize the four directions input by the user pressing the navigation key.
7. The mobile terminal of any one of claims 1 to 6,
  - wherein the display unit includes a touchscreen configured to recognize a touch input from the user, and
  - wherein the controller is further configured to lock the touchscreen so touch input is not recognized if a user input via the user input unit or the touchscreen is not made or a prescribed time has passed from an occurrence of the unidentified communication event.
8. The mobile terminal of claim 7, wherein the controller is further configured to unlock the touchscreen only if the touch input is related to checking the unidentified communication event is displayed on the touchscreen.
9. The mobile terminal of claim 7, wherein the unidentified event includes a plurality of unidentified events, and wherein the controller is further configured to display information about each unidentified communication event as the user consecutively manipulates the hardware input unit when a list of the plurality of unidentified communication events is displayed on the touchscreen.
10. The mobile terminal of claim 9, wherein the controller is further configured to display the information about each unidentified communication event in a consecutive order according to an occurrence order of the unidentified communication event, a priority granted per type of the unidentified communication event and a priority granted per originator of the unidentified communication event.
11. The mobile terminal of any one of claims 1 to 10, wherein the hardware input unit further includes a display device, and wherein the controller is further configured to control the display device to display a figure of a different shape according to a type of the unidentified communication event.
12. The mobile terminal of any one of claims 1 to 11, wherein the controller is further configured to activate the light emitting device of the hardware input unit after a prescribed time expires from an occurrence of the unidentified communication event and when the display unit is turned off.
13. A method of controlling a mobile terminal, the method comprising:
  - allowing, via a wireless communication unit, wireless communication with at least one other terminal;
  - receiving, via a user input unit including a hardware input unit having a light emitting device, input from a user; and
  - controlling (S402), via a controller, the light emit-

ting device of the hardware input unit to emit light in a predetermined pattern or color to inform a user of the mobile terminal about an unidentified received communication event that has not yet been checked by the user; and displaying (S404), via a display unit, information about the unidentified communication event when the user manipulates the hardware input unit.

5

10

14. The method of claim 13, wherein the unidentified communication event comprises at least one of a short text message (SMS), a multimedia message (MMS), a voice mail, an email, a voice call and a video call.

15

15. The method of claim 13 or 14, wherein the unidentified event includes a plurality of unidentified events, and wherein the method further comprises displaying information about each unidentified communication event on the display unit as the user consecutively manipulates the hardware input unit when a list of the plurality of unidentified communication events is displayed on the display unit.

20

25

30

35

40

45

50

55

FIG. 1

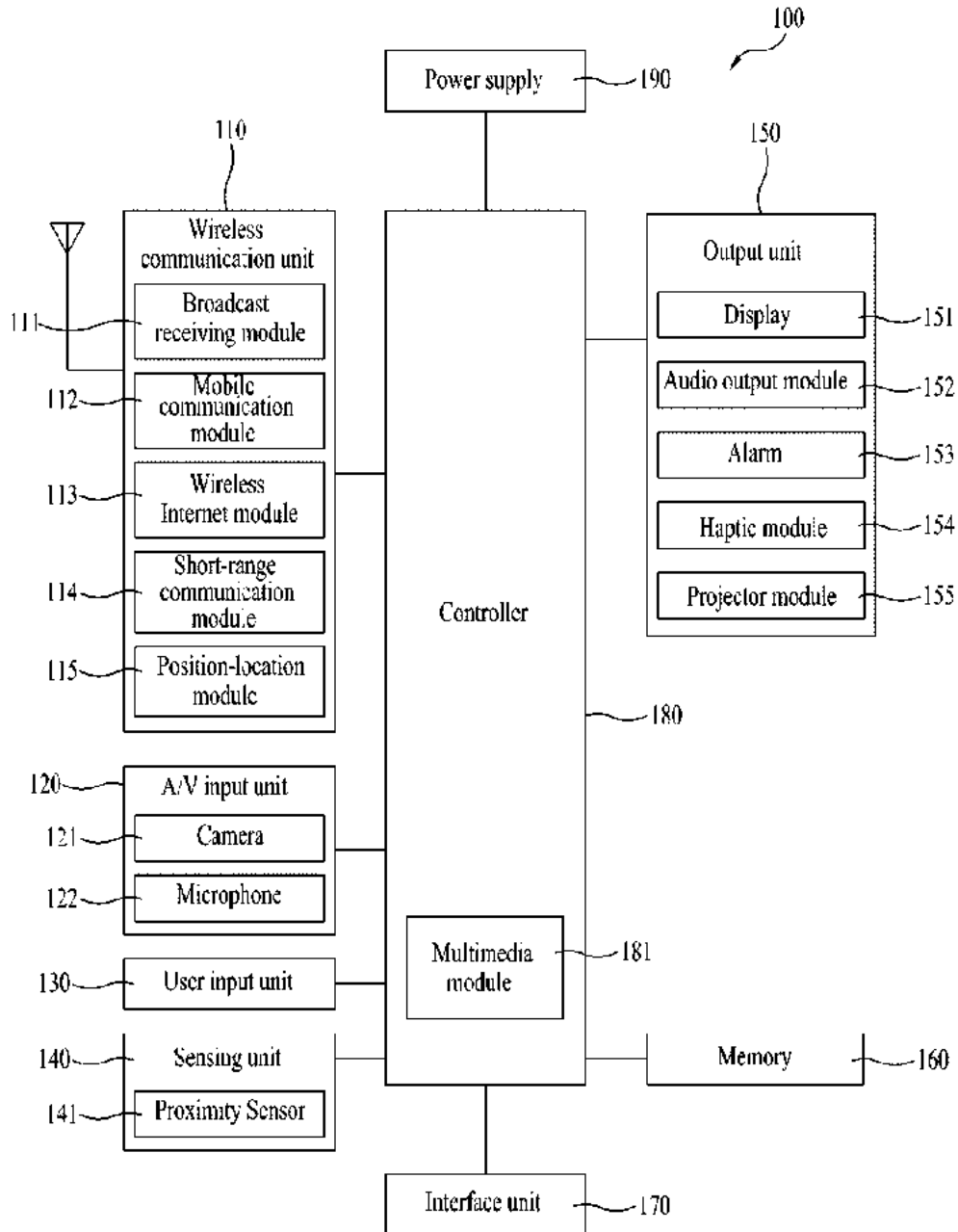


FIG. 2A

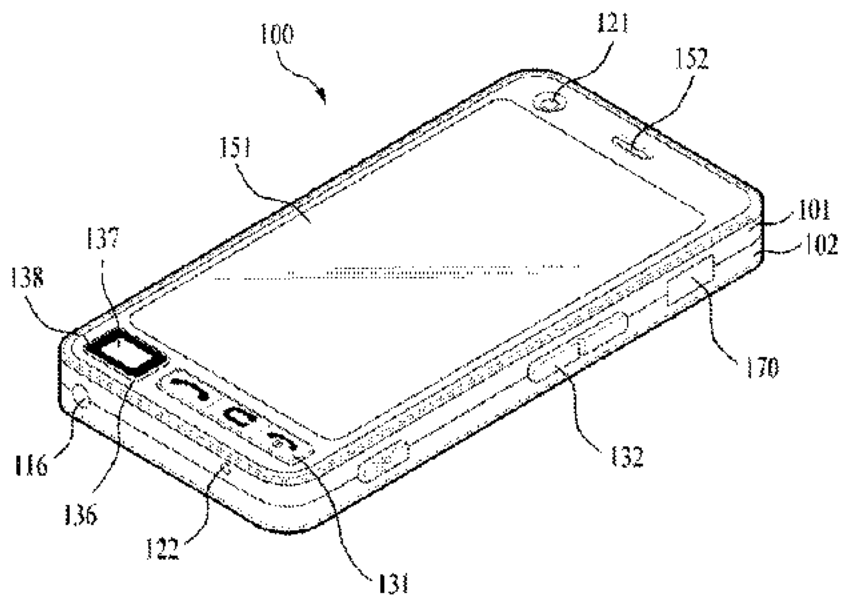


FIG. 2B

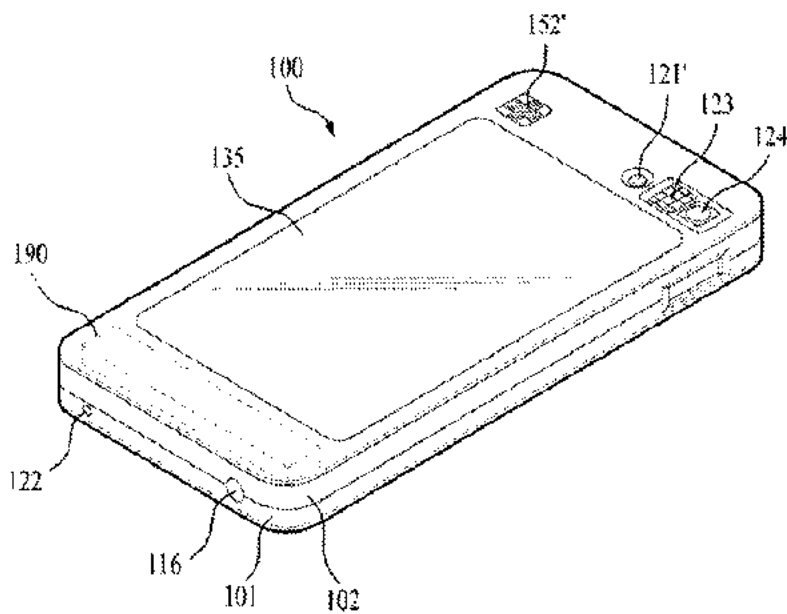


FIG. 3

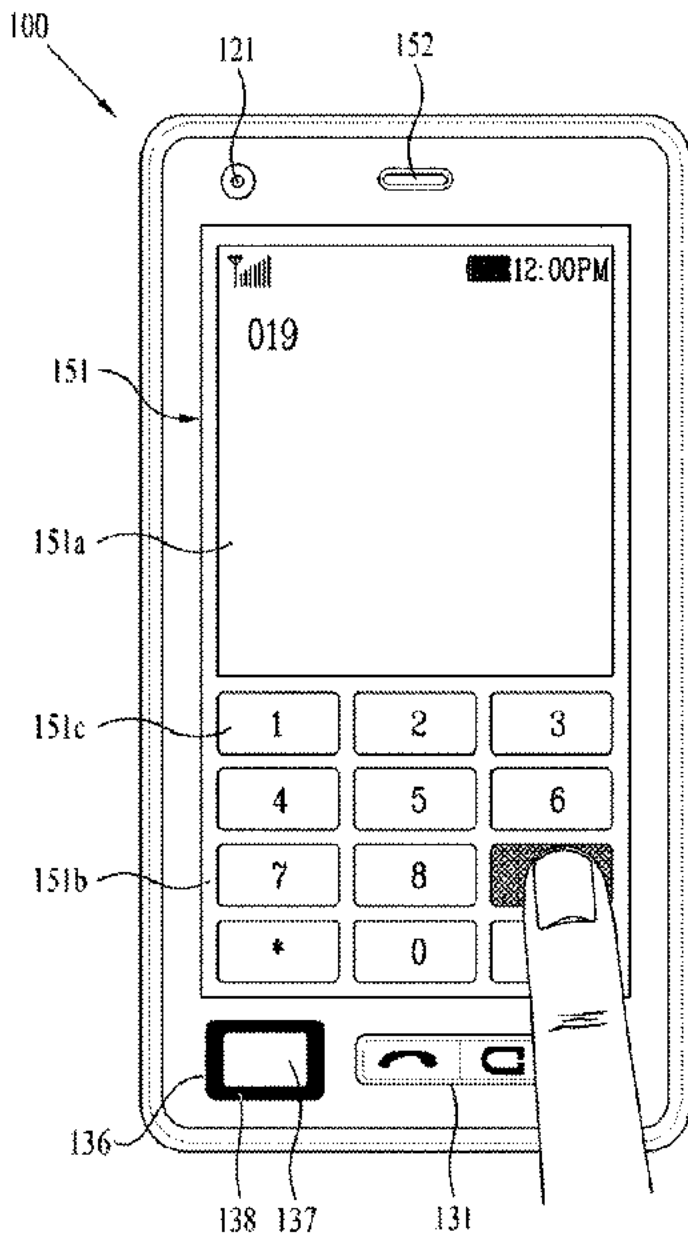




FIG. 4

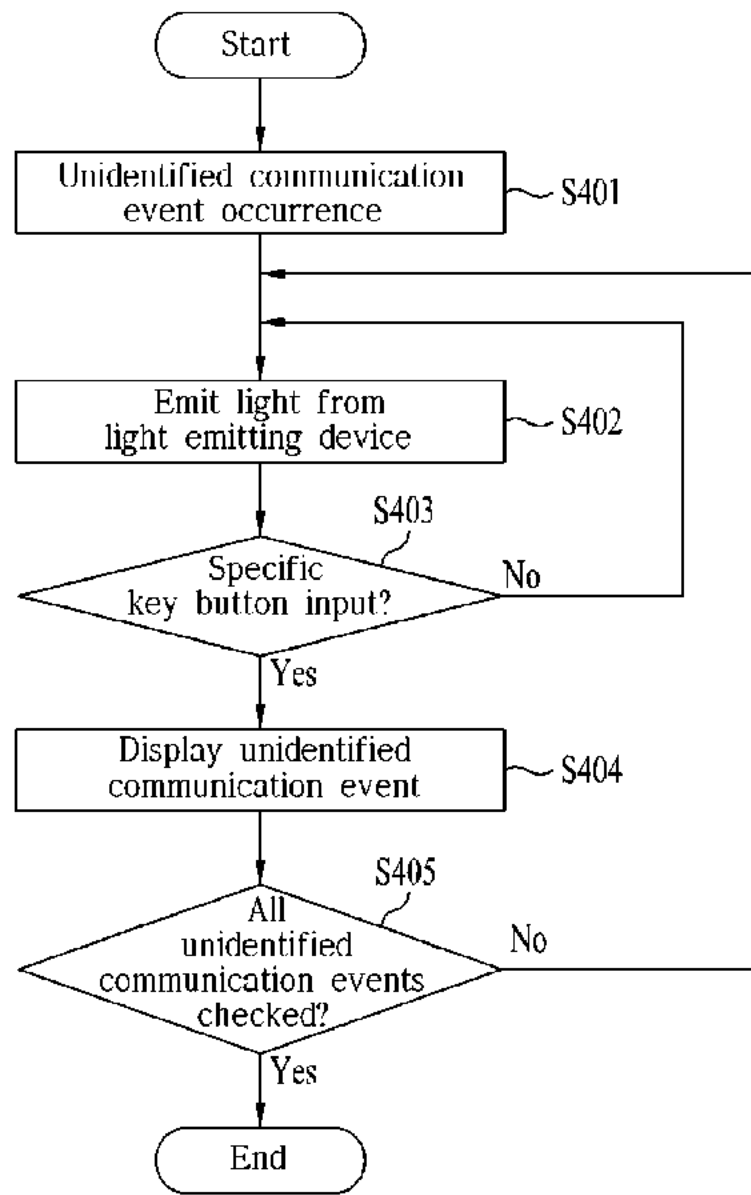


FIG. 5

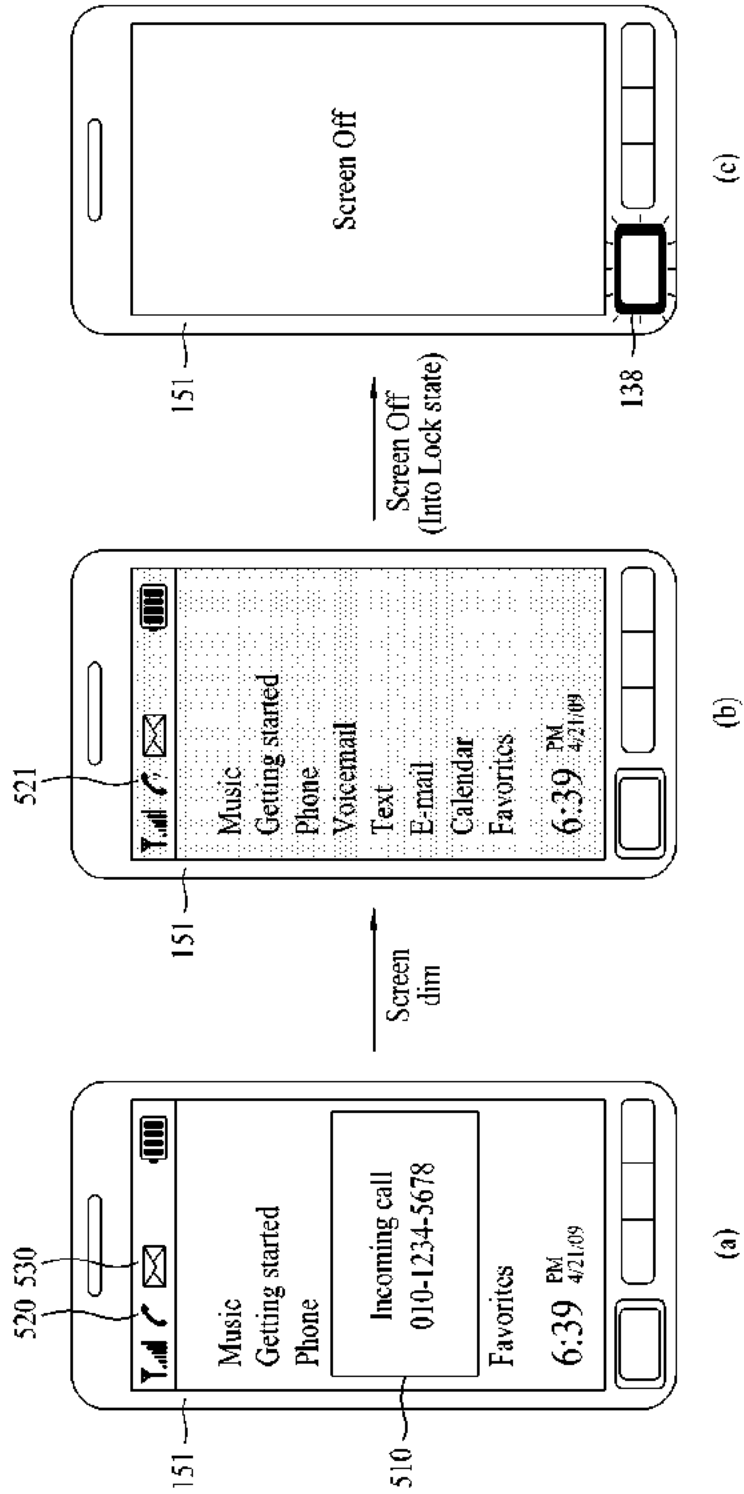
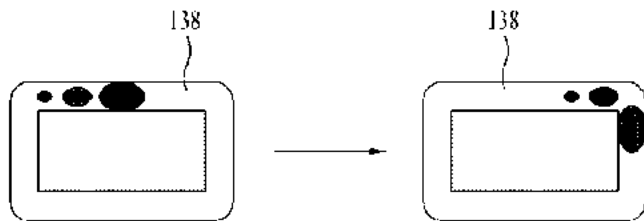
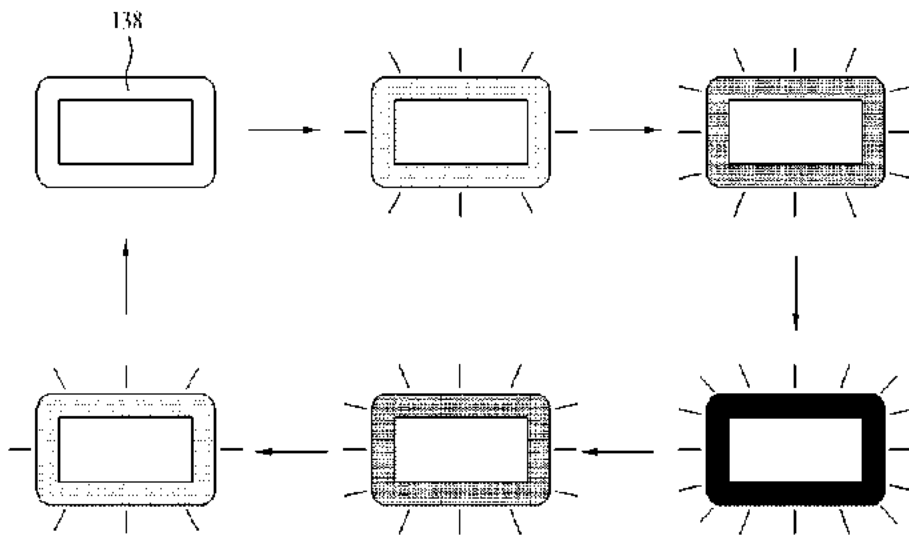


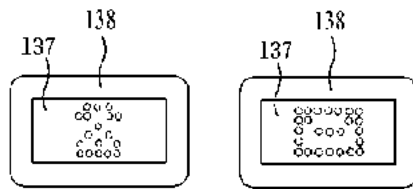
FIG. 6



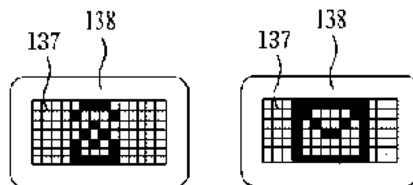
(a)



(b)



(c)



(d)

FIG. 7

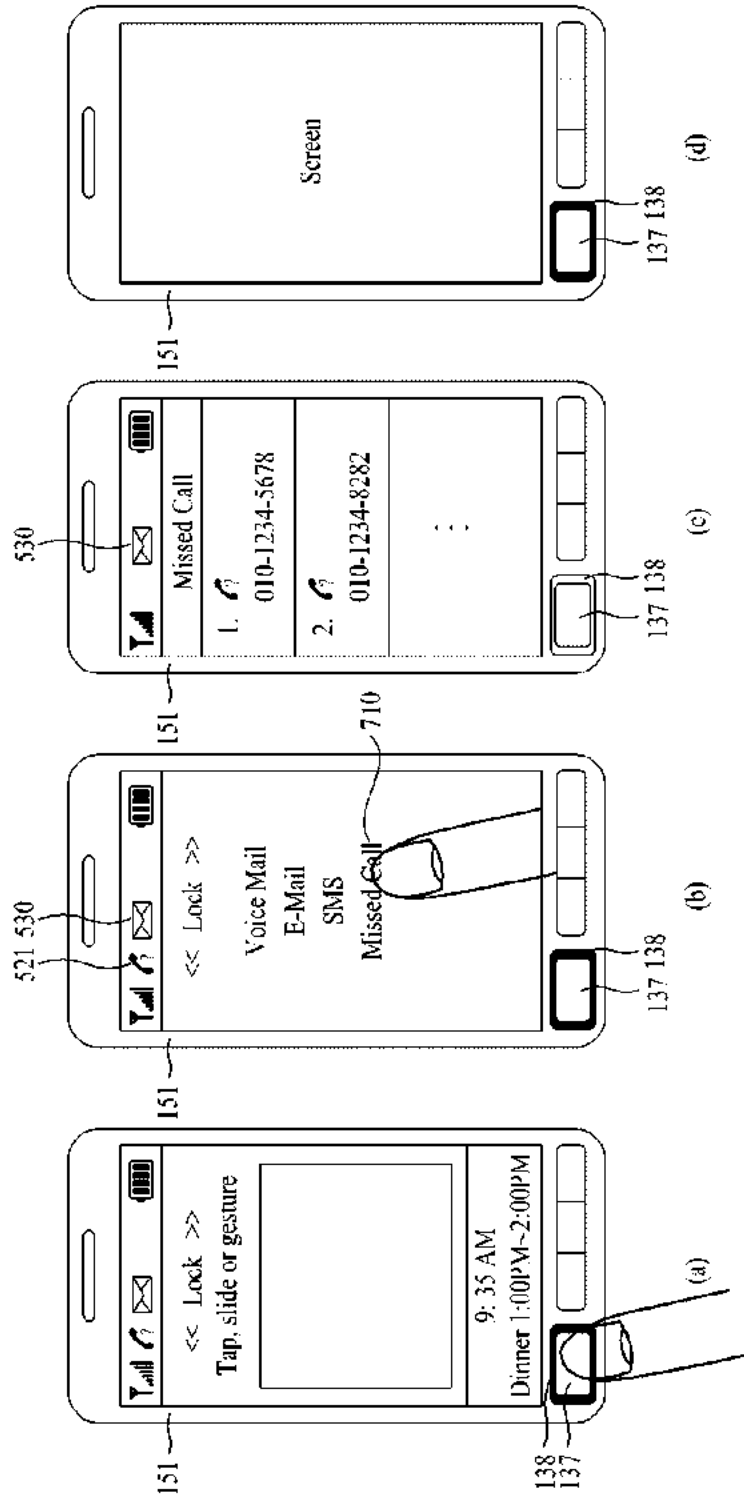


FIG. 8

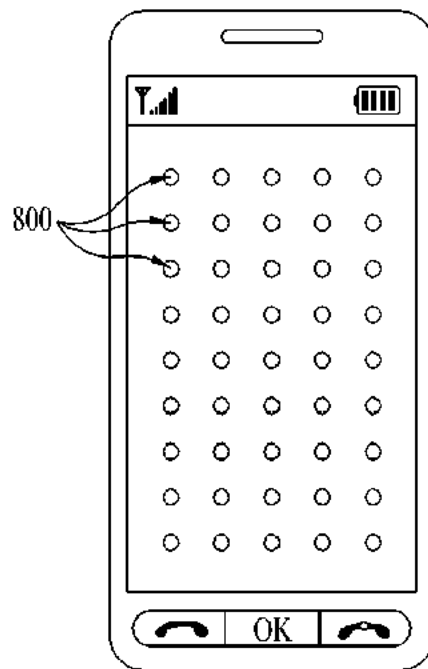
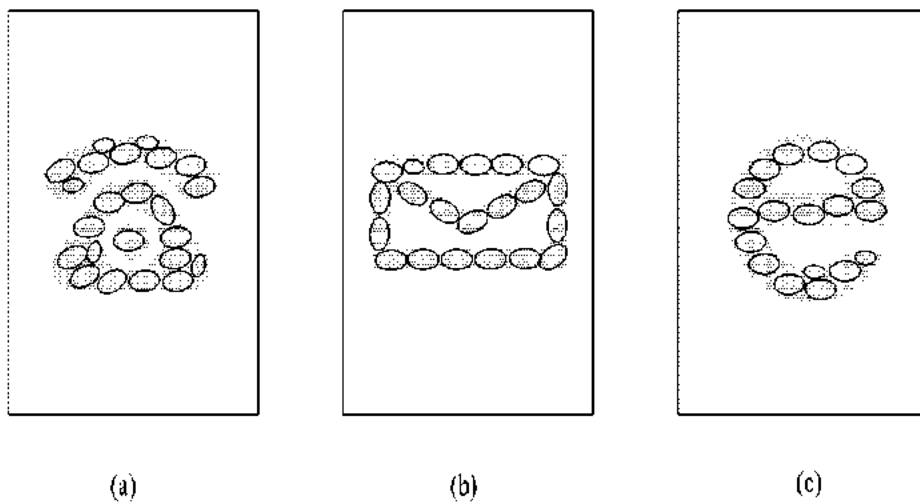


FIG. 9





EUROPEAN SEARCH REPORT

Application Number  
EP 10 16 1337

DOCUMENTS CONSIDERED TO BE RELEVANT			
Category	Citation of document with indication, where appropriate, of relevant passages	Relevant to claim	CLASSIFICATION OF THE APPLICATION (IPC)
X	US 2003/034878 A1 (HULL ERIC J [US] ET AL) 20 February 2003 (2003-02-20)	1-6, 13-15	INV. H04M1/725 H04M19/04 H04M1/67
Y	* paragraphs [0002], [0005], [0021] - [0038], [0058] - [0062] *	7-12	
Y	US 2008/220752 A1 (FORSTALL SCOTT [US] ET AL) 11 September 2008 (2008-09-11)	7-10	
Y	* paragraph [0092] - paragraph [0175]; figures 5a,5b,5c,5d,5e,5f,8b *	11,12	
A	EP 1 758 345 A1 (LG ELECTRONICS INC [KR]) 28 February 2007 (2007-02-28)	1-15	
A	US 2005/190196 A1 (O'NEIL DANIEL G [US] ET AL) 1 September 2005 (2005-09-01)	1-6, 13-15	
A	EP 1 887 766 A1 (LG ELECTRONICS INC [KR]) 13 February 2008 (2008-02-13)	1-6, 13-15	TECHNICAL FIELDS SEARCHED (IPC) H04M
The present search report has been drawn up for all claims			
Place of search The Hague		Date of completion of the search 14 January 2011	Examiner Sorrentino, Andrea
CATEGORY OF CITED DOCUMENTS X : particularly relevant if taken alone Y : particularly relevant if combined with another document of the same category A : technological background O : non-written disclosure P : intermediate document		T : theory or principle underlying the invention E : earlier patent document, but published on, or after the filing date D : document cited in the application L : document cited for other reasons & : member of the same patent family, corresponding document	

4  
EP 0 101 114 1 (publication)



Application Number

EP 10 16 1337

**CLAIMS INCURRING FEES**

The present European patent application comprised at the time of filing claims for which payment was due.

- Only part of the claims have been paid within the prescribed time limit. The present European search report has been drawn up for those claims for which no payment was due and for those claims for which claims fees have been paid, namely claim(s):
- No claims fees have been paid within the prescribed time limit. The present European search report has been drawn up for those claims for which no payment was due.

**LACK OF UNITY OF INVENTION**

The Search Division considers that the present European patent application does not comply with the requirements of unity of invention and relates to several inventions or groups of inventions, namely:

see sheet B

- All further search fees have been paid within the fixed time limit. The present European search report has been drawn up for all claims.
- As all searchable claims could be searched without effort justifying an additional fee, the Search Division did not invite payment of any additional fee.
- Only part of the further search fees have been paid within the fixed time limit. The present European search report has been drawn up for those parts of the European patent application which relate to the inventions in respect of which search fees have been paid, namely claims:
- None of the further search fees have been paid within the fixed time limit. The present European search report has been drawn up for those parts of the European patent application which relate to the invention first mentioned in the claims, namely claims:
- The present supplementary European search report has been drawn up for those parts of the European patent application which relate to the invention first mentioned in the claims (Rule 164 (1) EPC).





**LACK OF UNITY OF INVENTION  
SHEET B**

Application Number  
EP 10 16 1337

The Search Division considers that the present European patent application does not comply with the requirements of unity of invention and relates to several inventions or groups of inventions, namely:

1. claims: 1-6, 13-15

Mobile terminal comprising wireless communication unit, display unit, user input unit including hardware input having a light emitting device and a controller configured to control the light emitting device of the hardware input unit to inform a user about an unidentified received communication event, said light emitting device configured to emit a plurality of different colors to identify type of event

---

2. claims: 1, 7-10

Mobile terminal comprising wireless communication unit, display unit, user input unit including hardware input having a light emitting device and a controller configured to control the light emitting device of the hardware input unit to inform a user about an unidentified received communication event, display unit including a touchscreen that is locked if a prescribed time has passed from the occurrence of the unidentified event.

---

3. claims: 1, 11, 12

Mobile terminal comprising wireless communication unit, display unit, user input unit including hardware input having a light emitting device and a controller configured to control the light emitting device of the hardware input unit to inform a user about an unidentified received communication event, said hardware input unit further including a display device to display a figure of a different shape according to the type of the unidentified communication event.

---

ANNEX TO THE EUROPEAN SEARCH REPORT  
ON EUROPEAN PATENT APPLICATION NO.

EP 10 16 1337

This annex lists the patent family members relating to the patent documents cited in the above-mentioned European search report. The members are as contained in the European Patent Office EDP file on the European Patent Office is in no way liable for these particulars which are merely given for the purpose of information.

14-01-2011

Patent document cited in search report	Publication date	Patent family member(s)	Publication date
US 2003034878 A1	20-02-2003	AU 2002331596 A1 EP 1518428 A2 WO 03017624 A2 US 2004224670 A1	03-03-2003 30-03-2005 27-02-2003 11-11-2004
US 2008220752 A1	11-09-2008	NONE	
US 2008125178 A1	29-05-2008	KR 100815522 B1	20-03-2008
EP 1758345 A1	28-02-2007	JP 2007074716 A US 2007049358 A1 US 2008070648 A1	22-03-2007 01-03-2007 20-03-2008
US 2005190196 A1	01-09-2005	CN 1661591 A EP 1615115 A2 JP 2005267629 A KR 20060043249 A	31-08-2005 11-01-2006 29-09-2005 15-05-2006
EP 1887766 A1	13-02-2008	CN 101123771 A KR 20080013588 A US 2008036575 A1	13-02-2008 13-02-2008 14-02-2008

EPO FORM P/066

For more details about this annex : see Official Journal of the European Patent Office, No. 12/82



- (51) **International Patent Classification:**  
G06Q 50/30 (2012.01) G06Q 30/02 (2012.01)
- (21) **International Application Number:**  
PCT/US2013/042042
- (22) **International Filing Date:**  
21 May 2013 (21.05.2013)
- (25) **Filing Language:** English
- (26) **Publication Language:** English
- (30) **Priority Data:**

61/649,718	21 May 2012 (21.05.2012)	US
13/800,638	13 March 2013 (13.03.2013)	US
13/800,832	13 March 2013 (13.03.2013)	US
13/801,246	13 March 2013 (13.03.2013)	US
13/801,343	13 March 2013 (13.03.2013)	US
- (63) **Related by continuation (CON) or continuation-in-part (CIP) to earlier application:**

US	13/800,638 (CIP)
Filed on	13 March 2013 (13.03.2013)
- (71) **Applicant: BRANDINTEIX, INC.** [US/US]; 130 Fenwick Lane, Suite 105, Silver Spring, Maryland 20910 (US).
- (72) **Inventors; and**
- (71) **Applicants : WARD, Sterling A.** [US/US]; 6814 Eighth St., NW, Washington, District of Columbia 20012 (US).  
**WARD, James Bud** [US/US]; 7020 Wyndale St., NW, Washington, District of Columbia 20015 (US).

CASTEEL, Charles E., Sr. [US/US]; 119 Quiet Pine Circle, Pooler, Georgia 31322 (US).

(74) **Agents: KRATZ, Rudy** et al.; Fitch, Even, Tabin & Flannery, 120 S. LaSalle Street, Suite 1600, Chicago, Illinois 60603 (US).

(81) **Designated States** (unless otherwise indicated, for every kind of national protection available): AE, AG, AL, AM, AO, AT, AU, AZ, BA, BB, BG, BH, BN, BR, BW, BY, BZ, CA, CH, CL, CN, CO, CR, CU, CZ, DE, DK, DM, DO, DZ, EC, EE, EG, ES, FI, GB, GD, GE, GH, GM, GT, HN, HR, HU, ID, IL, IN, IS, JP, KE, KG, KM, KN, KP, KR, KZ, LA, LC, LK, LR, LS, LT, LU, LY, MA, MD, ME, MG, MK, MN, MW, MX, MY, MZ, NA, NG, NI, NO, NZ, OM, PA, PE, PG, PH, PL, PT, QA, RO, RS, RU, RW, SC, SD, SE, SG, SK, SL, SM, ST, SV, SY, TH, TJ, TM, TN, TR, TT, TZ, UA, UG, US, UZ, VC, VN, ZA, ZM, ZW.

(84) **Designated States** (unless otherwise indicated, for every kind of regional protection available): ARIPO (BW, GH, GM, KE, LR, LS, MW, MZ, NA, RW, SD, SI, SZ, TZ, UG, ZM, ZW), Eurasian (AM, AZ, BY, KG, KZ, RU, TJ, TM), European (AL, AT, BE, BG, CH, CY, CZ, DE, DK, EE, ES, FI, FR, GB, GR, HR, HU, IE, IS, IT, LT, LU, LV, MC, MK, MT, NL, NO, PL, PT, RO, RS, SE, SI, SK, SM, TR), OAPI (BF, BJ, CF, CG, CI, CM, GA, GN, GQ, GW, ML, MR, NE, SN, TD, TG).

[Continued on next page]

(54) **Title: MOBILE MESSAGING ECOSYSTEM**

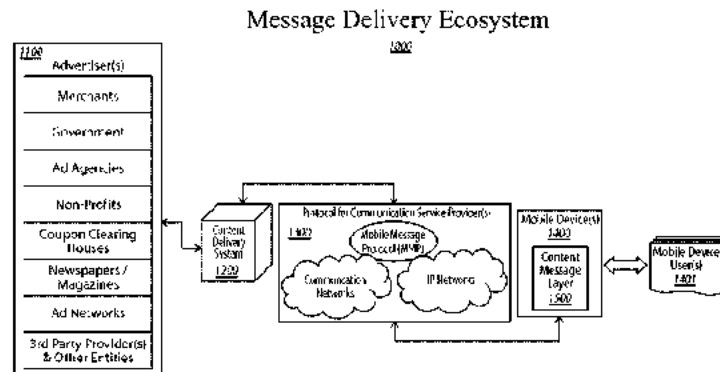


FIG. 1

(57) **Abstract:** This disclosure relates to the use of a content message layer or a mobile device edge technology to render and measure interactive impression messages to a mobile device during a specified time and place and with discretionary control. Furthermore, the disclosure describes a new mobile message delivery and measurement channel that joins the message sender and recipient in a closed-loop progressive conversation and where messages can be rolled over in time.

**Published:**

— *with international search report (Art. 21(3))*

**MOBILE MESSAGING ECOSYSTEM  
RELATED APPLICATION(S)**

**[001]** This application is a continuation-in-part of and claims benefit of U.S. Application Number 13/800,638 titled Mobile Messaging Ecosystem – Closed Loop and filed March 13, 2013, and claims benefit of U.S. Application Number 13/800,832 titled Mobile Messaging Ecosystem – Content Message Layer and filed March 13, 2013, U.S. Application Number 13/801,246 titled Mobile Messaging Ecosystem – Rendered Message and filed March 13, 2013, U.S. Application Number 13/801,343 titled Mobile Messaging Ecosystem – Rollover Message and filed March 13, 2013, each of which claims the benefit of U.S. Application Number 61/649,718 filed May 21, 2012, all of which are incorporated by reference herein in their entireties.

**TECHNICAL FIELD**

**[002]** This disclosure relates to the use of a content message layer or a mobile device edge technology to render and measure interactive impression messages to a mobile device during a specified time and place and with discretionary control and to a new mobile message delivery and measurement channel that joins the message sender and recipient in a closed-loop progressive conversation and where messages can be rolled over in time.

**BACKGROUND**

**[003]** Display impression advertisements (ads) on mobile devices are primarily recycled internet ads, simply down sized to fit the smaller screen of mobile devices. Some impression ads are provided through mobile internet websites and others are provided through thin-clients embedded into mobile content products (applications). Both methods of providing the impression ads are widely distributed through ad networks. There are a fast growing number of content providers enabling these thin-clients to serve pictures, banners, or small video clips into the pre- or post-loading screens of mobile games, videos, music tracks, and upper, middle, and lower sections of mobile application displays. By recycling these internet-based ads, coupled with the ad network's ubiquitous reach, it makes this advertising distribution channel a very inexpensive and technically efficient method to send ads to large audiences.

**[004]** There are at least three drawbacks or limitations to today's mobile display impression ads:

- 1) Annoyance Factor – impression ads are displayed while users are actively using their mobile device, and the line between valuable advertising content and spam is never going to move in favor of the advertiser. The frequency and ubiquity of such ads can quickly reach a point of diminishing return for the advertiser and/or publisher if poorly executed;
- 2) Underutilized Technology – because impression ads are displayed while the device is in use, the industry’s best practices, as outlined by the Mobile Marketing Association (MMA), discourage the use of most of the native capabilities of the device (such as the speakers, LED flash, vibrator, and the like), all to minimize the annoyance factor as witnessed by internet advertising; and
- 3) Undeveloped Measurement – impressions served, click-thru rates, page views, duration, and conversion are today’s standard for ascertaining effectiveness of mobile device impression ads; while each of these are measurable from a technology perspective, they provide very limited actionable insight to the advertisers that inform their decision on how to maintain or strengthen their market position.

[004] In the current mobile advertising environment, there are more mobile devices than there are TVs and internet-connected PCs. Moreover, mobile devices (especially mobile phones) are typically with an individual, especially at the point of purchase. Therefore, the potential to reach large audiences and influence their purchasing decisions when the mobile device is close to a retail outlet is commanding broad enthusiasm.

[005] Based on lessons learned from the Dot-Com era of internet advertising and coupled with the fact that in conventional ad delivery methods, mobile display advertising is delivered while the device is in active use, the MMA has developed best practices to guard against crossing the line in the consumer’s perception of what is valuable ad content and what would be considered spam or junk. The intent is to avoid the internet-like annoyance factor from happening in mobile. Furthermore, additional heightened concern centers on the personal and private nature of mobile devices and the inherent sense of privacy expected from individuals while using their devices.

[006] Using internet advertising as a framework, along with the goal of not annoying the consumer, the MMA’s best practices have established standards for: opt-in to an ad; opt-out of an ad; ad size and format; when and where ads are displayed; and guidelines for how ads are displayed. The net result of the MMA’s best practices has been an evolution to a wholesale

reuse of the internet business model, scaled down to fit the smaller screen size of mobile; thus, adopting a low-profile approach to display impression ads so as not to draw too much attention away from the user's intended use of the device: to make and receive calls, read books, view videos, listen to music, play games, browse the internet, and the like.

[007] In a world of 3,000 ad messages a day and technology and behavior that facilitates unprecedented ad skipping, the "impression" ad is less and less able to sway purchase habits. The measuring of eyeball impressions is no longer good enough for many forms of marketing. The shifting from commodity-oriented benchmarks of input measures such as cost per thousand impressions (CPMs) (or cost per 1,000 viewers) to more output-oriented measures such as cost per hand-raiser and cost per lead represents the next evolutionary step in measuring and predicting the effectiveness of advertising campaigns.

[008] In the world of advertising that includes TV, radio, print, online, and mobile, the distribution model for those 3,000 ad messages that are created every day is often one-to-many, where the advertiser sends one ad to many individuals (also known as the shotgun approach). Consumers are merely on the receiving end of those ad messages with little opportunity to have a direct conversation or relationship with advertisers about the advertisements they individually received. Focus groups, sample surveys, completed questionnaires, and the like are used to provide linkage between the advertiser and the consumer, namely, to provide consumer segmentation data to categorize people for targeting purposes and to provide feedback on already executed ad campaigns.

[009] Advertising is a mature, yet evolving business model, but the newer measures for ad effectiveness -- hand-raisers, leads, and increase in sales -- are rarely connected from the ad to the individual consumer and back to the advertiser, and none are done on a large scale.

[0010] Tremendous amounts of capital and intellectual resources are expended in delivering and measuring advertising to mobile devices today by companies worldwide of all sizes seeking to capture the next great entrepreneurial event. Each is competing in an environment that was not designed to deliver or measure advertising messages.

[0011] The current wireless infrastructure has three principle participants (wireless carriers, device manufacturers, and software operating system developers). Each tends to innovate in a different direction, and neither participant has a vested interest in making advertising on mobile devices work effectively. Thus, the current state of the wireless infrastructure is synonymous to

creating a square peg and trying to fit it into a round hole created by advertisers' need to deliver and measure mass advertising to targeted audiences.

[0012] In the conventional wireless infrastructure, the challenges that limit advertising's potential are caused by the fact that there are numerous handsets manufactured with non-standard operating systems (OS) that are each connected on different wireless carriers' networks. Collectively, these three different components fracture and constrain the scalability of a mass advertising delivery system. There are too many different devices with too many different OSs to deploy an effective ad delivery system that reaches large audiences. Therefore, to thrive in this fractured environment, advertisers have identified and latched onto low common denominator ad delivery methods (for example, text messages, tiny banner ads, and mobile search results) to reach their targeted audiences. Unfortunately, these ad delivery methods tended to create separate stovepiped customer acquisition requirements that further inhibit scalability and as a result create even more fragmentation.

[0013] Additional challenges to reaching mobile advertising's long-term potential are the lack of standards and verifiable methods for reliably measuring whether an advertising message was displayed to the intended audience on the mobile device and for ascertaining the mobile device user's responses to and engagement with the displayed advertisement.

[0014] There are many methods currently deployed for displaying and measuring advertising to mobile devices. For instance, it is known to display an advertising message on a lock screen display of a mobile device. What is missing is a unifying element that can bridge devices, OS's, and wireless carriers and that enables a single scalable solution. As a result, compared to TV, radio, print, and online, mobile advertising continues to be constrained as a distribution channel in the global world of direct advertising.

#### SUMMARY

[0015] Generally speaking, according to various embodiments, the disclosed edge technology addresses the above-noted annoyance factor of impression ads by creating a unique time, place and discretionary control of the mobile impression ad. Components of this edge technology can enable one or more of: rendering of an ad when the device is in a locked state (time) never while the device is unlocked and in active use; rendering of an ad only on the lock screen display (place); and full user control of the ad duration (discretion) to never force the user to watch any minimum rendering length. The disclosed edge technology enables the presentation of



impression ads in a different manner than presently done by any prior art. As described hereinafter, non-intrusive ad delivery is described.

[0016] To explain further, by one aspect, an ad is never rendered to a user while the user is actively using the mobile device. In this case, ads are only rendered on the lock screen display during the period between wake up of the mobile device and unlocking of the device. In another aspect, ads are rendered only when the user initiates use of the device and not when the user responds to the device (in other words ads are not rendered upon notification of an incoming call, text, or message alert). Many devices display a picture from the user's address book or a wallpaper image during an incoming call, and this practice could continue. Although no ads are rendered while actively using the mobile device, whether on a call, using the Internet, texting someone, or any other user activity, the mobile device user can still opt-in to any prior art, ad supported campaign or program that is not in accordance with these disclosures.

[0017] Consequently, in various aspects, the disclosed edge technology enables the creation of a consistent, predictable, and user controllable line between advertising content and annoyance upon which both users and advertisers can rely.

[0018] The MMA's best practices are satisfied by uniquely addressing the ad annoyance factor. In keeping with this element, the subject matter of this disclosure can fully leverage virtually every technology present on mobile devices -- today and in the future -- to create a new class of eye-catching and engaging impression ads. This is achieved by manufacturing, integrating, bundling, configuring, modifying, installing, or otherwise designing the edge technology directly onto selected mobile devices and creating a distinct time, place and user discretionary control of the impression ad.

[0019] So configured, the disclosed subject matter creates a new technology driven impression ad that does not exist today. One implementation includes a Content Message Layer (CML) manufactured, integrated, bundled, configured, modified, installed, or otherwise designed into the operating system of the mobile device (such as a fat client). This approach is considered to be edge technology because it sits at the farthest edge of the wireless carrier's network, inside the mobile device, and in the end-user's hand. The CML effects one or more of the following attributes:

- a) Enables the non-intrusive ad rendering;

- b) Enables the impression ad to instantly start without server or communication related delays;
- c) Enables full use of hardware, software, and operating system elements native to the mobile device to create uniquely mobile impression ads;
- d) Contains a physics engine to create additional uniquely mobile impression ads;
- e) Enables the user to select how he/she wants to respond and/or to share an ad;
- f) Accurately captures and measures ad delivery, rendering and user's direct and indirect ad responses;
- g) Leverages time and location based ad delivery and rendering;
- h) Addressable and linked to a content server to establish anonymity and two-way communication;
- i) Facilitates transparency functionality and substantial privacy and security safeguards;
- j) Contains a set of application programming interfaces (APIs) for third-party innovation and independent audience measurement; and
- k) Facilitates a new robust alert messaging system for foreign or domestic national, state, county, and local government entities (and their foreign equivalents), and wireless carriers.

[0020] The edge technology by one approach facilitates a new framework for creating lock screen display impression ads by unleashing the innovative forces of third-party software developers to create new, exciting, and eye-catching ads. Using a software developer's kit (SDK), developers and advertisers are only limited by their imaginations to create new impression ads uniquely for rendering on a mobile device. The SDK is an ad creation toolkit that enables the developer to leverage the edge technology on the mobile device. A broader array of design elements for impression ad creation is possible because access can be provided to a physics engine and to all the native capabilities of the device (for example, microphone, accelerometer, gyroscope, compass, vibrator, GPS, LED flash, proximity sensor, Near Field Communication (NFC), and the like). These native device capabilities are used in both impression ad rendering (the first thing you see or experience), as well as the user interaction (how the user engages and plays/interacts with the ad).

[0021] The following three examples illustrate the distinctiveness of the new impression ads using the noted edge technology -- both how they are rendered and how the user interacts with them.

[0022] Example Ad 1

[0023] The instant the wake button is depressed on a mobile device - Animated mercury balls quickly roll and collide with each other onto the screen from all directions; simultaneously, the device correspondingly vibrates and makes a rumbling sound; with each collision a sucking sound is heard as the balls congeal together; eventually (for instance, three seconds later) the congealed mercury forms an accurate representation of a particular brand of pick-up truck, and then to a quiet background a gruff voice says "this is one tough truck." The user could then:

- 1) shake the device in response to which the mercury balls will scatter off the screen, then the sequence would start all over again;
- 2) further delay the unlocking process, and after five seconds the screen would go black and the sequence would start over again, but with every iteration the action would slow down by 25%, and after the fifth iteration it would freeze with the pick-up truck staying on the screen;
- 3) long-touch the screen if the user was interested in learning more about the pick-up truck (with such a long-touch, the screen would react as if a finger was inserted into water and ripples would start from the user's touch point and ripple out to the screen's edges, and when the user lifts the finger from the long-touch, the water and pick-up truck would explode off the screen accompanied by a corresponding sound and vibration, and then the screen would go black); or
- 4) at anytime -- beginning, middle or end -- of the ad rendering process, the user without delay, can unlock the mobile device.

[0024] Example Ad 2

[0025] The instant the wake button is depressed -- A liter diet cola bottle, full, sits in the middle of the screen with its top on; after one second a popping sound is heard, the bottle top flies off the bottle and the screen, and the foam from the soda first begins to shoot up out of the bottle and then it falls back down onto the ground, all while the bottle rotates clockwise; concurrently, the mobile device's vibrator mimics a rumbling feeling while the speakers emit a fizzing, spraying sound; and while the spraying continues, uninterrupted, a text message scrolls on the bottom of the screen saying 'Touch Now for 10% Off'. The execution of this ad is predicated on the user

being within a geo-fence designation of a participating grocery store; if the user is not, a different ad would render. Thereafter:

- 1) the user could shake the mobile device up and down, and the fluid inside the bottle would correspondingly jostle up and down; this would also cause the spraying from the bottle to accelerate higher and higher; and concurrent to it all, the rumbling feeling and fizzing sound would equally correspond to the shaking of the bottle;
- 2) the user could touch the bottle to stop its clockwise rotation; or flick gesture, left or right, to make the bottle spin faster in a clockwise or counter clockwise rotation;
- 3) the user could lean the mobile device to the left or right; this would alter the direction of the spraying animation, and the spraying liquid would first tilt in the direction of the leaning and then to the ground in accordance with the laws of physics;
- 4) if the user was interested in learning more about the diet cola offer, the user could long-touch the screen; the spraying animation would all reverse back into the bottle, the bottle cap would re-fasten to the bottle top, and then large lettered font would appear in the center of the screen saying 'Thank You'; or
- 5) at anytime – beginning, middle or end of the ad rendering process, the user, without delay, can unlock the mobile device.

**[0026]** Example Ad 3

**[0027]** The instant the wake button is depressed -- A woman appears on the screen, dressed in a fashionable business suit from a local department store. The woman stands with one hand on her hip and the other extended outwardly with her palm up. The department store's logo is in the bottom left corner and after the first two seconds the image of the woman slowly rotates clockwise, while at the same time, little square pieces of paper fall from the top of the screen with different lettering written on them -- some say 5% off, some 10% off, and others say 15% off. The little squares fall over the woman and eventually to the ground, but one lands on the woman's outwardly extended hand -- it reads 10% off. All of this takes five seconds. As with the prior two examples, user interaction can occur by:

- 1) blowing air into the mobile device's microphone and causing all of the pieces of paper on the ground and in the woman's hand to blow upwardly to the top of the screen. If the user continues to blow, all the papers will also continue to blow upwardly and swirl at the top of the screen. When the user stops blowing, the paper will re-float back down again, and based

- on randomness, the same or a different discount percent amount could land in the woman's hand. This could be repeated until the 15% off paper lands in the woman's hand;
- 2) the user long-touching the 15% off square paper in the woman's hand if the user is interested in learning more about the department store's discount offer. The department store's logo on the bottom left of the screen would move and take over the entire screen, and then the whole screen would fade to white; or
  - 3) at anytime -- beginning, middle or end -- of the ad rendering and user interaction process, the user without delay, can unlock the mobile device.

**[0028]** The three examples demonstrate the innovation and ad engagement possibilities from the disclosed edge technology. Generally speaking, impression ads with instant start, use of native device capabilities to interact with the ad, rendered objects responding to the laws of physics, and dynamic interaction with the ad were not previously possible with conventional display impression ads on the lock screen display. The disclosed subject matter enables these possibilities because of the time and place where the impression ads are rendered. By anyone's standards, mercury balls rolling on the screen to advertise a pickup truck while reading your email, playing a game, or browsing the internet would definitely be annoying. But such an ad that you know will render on the lock screen display, and, if you so desire, can interact with and control the amount of time that the ad is rendered, makes such advertising manageable.

**[0029]** Moreover, the disclosed subject matter can create new actionable insights for the advertiser that better inform its decision on how to maintain or strengthen its market position that does not exist today. For instance, the disclosed edge technology effects an ad effectiveness measurement. Once the user acknowledges the rendered ad to learn more about the product, service, or offer, an additional feature of the edge technology broadens and standardizes the user's responses to a given ad, essentially providing the user with consistent and predictable ad response choices. In contrast, today's ad responses are pre-selected by the advertiser, a single call-to-action, and the majority of advertisers choose for the user to launch a web browser. While the web browser provides the advertiser a wide selection of potential ad responses for the user; due to technology limitations, business rules, and/or enabling user simplicity, the advertiser usually provides only a single ad response. In addition to launching a web browser, other conventional pre-selected ad responses include: click to call, email, text, or to launch a mobile application. Furthermore, from a user's perspective, every advertiser's website is slightly

different. There is no consistency of what and where the product or service information is presented, and there is no standard way across the different advertiser's other digital assets to know how to navigate to learn more about the product or service to help the user get to a buying decision.

**[0030]** In one such approach, the advertiser is provided with a standard framework for organizing and presenting their website information and other digital assets about their product or service. This framework also provides the user with multiple and consistent ad response choices to learn more about a product, service, or offer. Furthermore, this framework provides the user with predictable navigation paths, across all advertisers and all product and service categories, for the user to know how to find out more about the advertisements on his or her mobile device. This framework is referred to as Learn More Attributes, which encompasses actionable insight in one or more of the four phases of the following sales purchase funnel, plus a social component.

- Awareness:
  - Print Media
  - Video Media
  - Audio Media
  - Website
- Interest:
  - Map/Location
  - Product Reviews
  - Price Comparison
  - Survey/Polling
  - Call
  - eMail/Text
  - Product Search
- Desire:
  - Shopping List
  - Wish/Gift List
  - Shopping Cart for Purchase
- Action:

- Mobile Ahead Reservation/Purchase
- Redeem Coupon
- Buy In Store/Online
- Purchase History
- Other:
  - Social

[0031] From reading press releases and product reviews to adding an item to a shopping cart or sharing an ad with a friend, the Learn More Attributes framework provides consistent choice, immediacy, and transparency to the user's experience. By empowering users to easily navigate and engage in multiple ways with the advertiser – in the time and manner of their choice – it fits within a common-sense belief that when people get more personally involved in the marketing behind the advertisement, they are likely to develop a more favorable impression of an advertiser's brand. Thus, learning something important about the advertised product or service often facilitates the user getting to a buying decision.

[0032] In another aspect, based on which Learn More Attribute the consumer engages, the framework is also able to quantify each attribute and assign it a numeric value. For example, if the user's engagement is in the higher end of the purchase funnel (such as awareness and interest), a lower value is given; whereas, if the user's engagement is in the lower end (such as desire and action), a higher value is given. Accordingly, based on each Learn More Attribute the consumer engages for any ad, the disclosed technology is able to determine an ad effectiveness measurement based on a numeric value.

[0033] So configured, the disclosed ad delivery channel is a disruptive change to the evolving world of advertising that offers an authentic one-to-one relationship between the advertiser and the individual consumer – on a mass scale. In contrast to the prevailing one-to-many model, the disclosed subject matter provides a scalable one-to-one model where advertisers use a rifle, and not a shotgun, to reach their targeted audiences.

[0034] By connecting the disclosed innovative impression ad directly to the consumer and advertiser, this enables closed-loop ad campaigns that can be repetitious, episodic, progressive, or build to a crescendo or an event. All are highly effective communication tactics for product or services branding initiatives at every phase of the sales purchase funnel.

[0035] The consumers are the most important element in the advertising delivery channel. Their acceptance and active participation is the life blood of the delivery channel. To partially gain and nurture their willingness to participate in the advertising delivery channel, strong privacy and security safeguards have been developed to provide them with transparency and control of their data and an assurance of anonymity.

[0036] An understanding of how advertisers have the ability to have closed-loop, progressive conversations with individual consumers begins with understanding how the consumer engages the Learn More Attributes, and how that engagement is tied directly to a known profile (such as the anonymous user's).

[0037] By one example, the consumer completes a two-part profile (for instance, a consumer oriented profile as well as a trade or professional oriented profile). The former profile is geared towards business to consumer (B2C) advertising, and the latter profile is geared towards business to business (B2B). Next, an overlay of the consumer's explicit response/no response to every ad received as well as other related implicit advertising activity is provided.

[0038] In one aspect, at any time and frequency, the consumer can see what information/data is tracked about him or her, and the consumer can subsequently delete, modify, or elevate any tracked item. Thus, users are provided transparency and user control of their data.

[0039] Using the consumer's self-identified profile, combined with the explicit and implicit tracking data, consumer segmentation information will serve as a rollup of liked-profiled individuals (i.e., real people), one-by-one, into a database. Unlike the prevailing practice of using focus groups or sample surveys to define publishers and distribution channels, consumer segmentations in accordance with this approach involve real people. The ability to access profiles of real people for targeted advertisement, at scale, instead of sample profiles and focus group data, will have an enormous impact on, and will lead to profound change to, all advertising, and not just mobile.

[0040] Display advertising via TV, radio, print, online, or mobile does not have scalable models for having a closed-loop progressive conversation between an advertiser and the consumer. The sector that best performs such a closed-loop progressive conversation is direct selling. The very nature of direct sells affords the opportunity to prospect, discuss features and benefits to overcome the prospect's objections, and come to a sale/closure. Direct selling is regarded as the most effective selling tool, but it is also the most expensive.



[0041] By sending an ad directly to the consumer and then sending the consumer's response/no response directly back to the advertiser, in a closed-loop conversation, the disclosed subject matter will be able to achieve many of the attributes of direct selling, but at a much lower cost.

[0042] In one example, when an advertiser selects from the database of self-identified consumers, the advertiser initiates the closed-looped conversation. The next steps include: the advertiser creates a new impression ad with the SDK; the advertiser populates the Learn More Attributes ad responses; the advertiser selects a time and/or geographical location for ad delivery; and the advertiser completes the impression ad acquisition process. Then, based on a match between the user's profile information and the advertiser's target audience, the intended ad message is delivered to addressable individuals.

[0043] The power of the noted closed-loop progressive conversation can be seen in the following example of an outdoor camping advertiser executing an ad campaign for an end-of-summer clearance sale.

[0044] To start, assume there are one million users nationwide with mobile devices operating in accordance with various aspects of the disclosed subject matter. The outdoor camping advertiser first selects, for example, the geographical area of metropolitan Washington DC, and the Message Manager reveals there are 10,000 users in the area. Next, the advertiser selects "enjoys outdoor activities" consumer segmentation, and the Message Manager reveals 1,000 self-identified outdoor users. For privacy concerns, the user's name, mobile number, address, or any other identifiable attributes are never disclosed to the advertiser unless authorized by the user; however, the advertiser does know definitively that there are 1,000 real people in the Washington area who like outdoor activities (which comprises the advertiser's target audience for the end-of-summer clearance sale).

[0045] For sake of simplicity, it is assumed that all 1,000 users received the end-of-summer advertisement. Out of those 1,000, only 100 users engaged in selected Learn More Attributes and converted the ad to a digital coupon, and then, ultimately bought a tent. Through a process on the device, this example is able to track those purchases. A second group of 200 users received the ad and engaged in selected Learn More Attributes, but did not buy anything. And finally, the third group of 700 users unlocked the device without any delay, and was merely exposed to the ad.

[0046] With three weeks left to the end of the sale, the advertiser decides to send out a second ad. With the ability to have a progressive conversation, the advertiser does not send the same ad to the same 1,000 users. Instead, the advertiser crafts three separate follow up ads, each relevant and cognizant of the user's place in the purchase funnel. To the first group that purchased a tent, a follow-up ad is sent thanking them and incenting them to buy tent accessories. To the second group that engaged the ad but did not buy anything, a follow-up ad is sent that includes more information about features and benefits. And to the last group that ignored the ad, a follow-up ad is sent that is a little more innovative and eye-catching in hopes of getting their attention.

[0047] This progressive conversation, mindful of the user's previous response, could continue, with several iterations, until the conclusion of the tent sale.

[0048] The disclosed closed-looped conversation, similar to direct selling, provides advertisers with actionable insights to inform them about what to say and/or do next in their ad campaign in reply to the user's previous response/no response.

[0049] Another compelling aspect of the closed-looped progressive conversation is the unparalleled measurement information captured. The database collects data into three primary buckets (advertisement, advertiser, and consumer). Each ad and response contains unique identifiers that correspond to this database structure. All explicit data collected from the consumer's engagement with the ad and implicit data collected from other advertiser related interaction are similarly identified. This data is compiled and organized to create numerous views for analysis; and three such views are the Ad Centric View, Advertiser Centric View, and Consumer Centric View.

[0050] In the Ad Centric View, essentially every ad sent to every consumer by every advertiser creates the first view. Using the ad effectiveness measurement ascertained from the Learn More Attributes, the effectiveness of every ad can be ranked in the database. This data can then be parsed by: industry; sector; geography; product group; individual product; advertiser; online; brick and mortar; consumer segment; and more. Thus, this view creates a quantitative way to rank overall ad effectiveness across all advertisements in the database.

[0051] In the Advertiser Centric View, essentially every ad sent to every consumer by each advertiser creates the second view. Using the same ad effectiveness, every ad sent by each advertiser to every consumer segment can be ranked. Likewise, the disclosed approach then can parse the data by: industry; sector; geography; product group; individual product; online; brick

and mortar; consumer segment; and more. This view makes it easier for the advertiser to determine which ad campaigns were effective and which were not. Additionally, a meaningful overall brand ranking of all the advertisers is readily available.

[0052] In the Consumer Centric View, essentially every ad sent by every advertiser to each consumer segment creates the third view. Using the same ad effectiveness, every ad sent by every advertiser to each consumer segment can be similarly ranked. Likewise, the disclosed subject matter is then able to parse the data by: industry; sector; geography; product group; individual product; online; brick and mortar; and more. This view makes it easier to determine the ads to which the consumers best respond, what products and services they are most interested in, and which advertisers they may view favorably.

[0053] In various approaches, the disclosed subject matter creates new actionable insights for the advertiser that better inform decisions on how to maintain or strengthen their market position that does not exist today. These three views possible with various implementations of the disclosed technology provide credible ways to evaluate the return on the advertiser's dollar spent. Using this intelligence illuminates the consumers' unique interests and needs and allows the advertisers to ascertain actionable insight to discover what matters and what is relevant to the consumers. Such options were generally not possible using impressions served, click-thru rates, page views, duration, and conversion -- all today's standard for ascertaining effectiveness of mobile device impression ads. So configured, the disclosed technology provides advertisers unprecedented tools for both finding prospects to fill their purchase funnel and for moving them down the funnel to become long-term loyal customers. Ultimately, when compared to other ad delivery channels, the disclosed technology gives advertisers more marketing control over how to spend their advertising dollars.

#### BRIEF DESCRIPTION OF THE DRAWINGS

[0054] FIG. 1 is a block diagram of five elements of an example Message Delivery Ecosystem;

[0055] FIG. 2 is a block diagram illustrating the major sub-components of an example Content Delivery System and the connection of those sub-components to the remainder of the Message Delivery Ecosystem of FIG. 1;

[0056] FIG. 3 is a block diagram illustrating an example protocol for the Communication Service Provider and an example interconnection of the Communication Service Provider to other elements in the Message Delivery Ecosystem of FIG. 1; and

[0057] FIGS. 4A and 4B are a block diagram illustrating details of an example Content Message Layer in the Mobile Device element and the interconnection of the Content Message Layer to other elements in the Message Delivery Ecosystem of FIG. 1.

[0058] Those skilled in the art will recognize and understand that the illustrated systems may be comprised of a plurality of physically distinct elements as is suggested by the illustrations. It is also possible, however, to view these illustrations as comprising a logical view, in which case one or more of these elements can be enabled and realized via a shared platform. It will also be understood that such a shared platform may comprise a wholly or at least partially programmable platform as are known in the art.

#### GLOSSARY OF TERMS AND DEFINITIONS

[0059] For the purpose of clarity, the terms set forth hereinafter are specifically defined for use herein:

[0060] The term “Message Delivery Ecosystem” or “MDE” refers to the methods and apparatus(es) that deliver addressable advertisement and alert messages to a mobile device using a communication protocol produced by a message creator. The mobile device receives the addressed advertisement and alert messages in background, stores them, and then, based on defined triggering events, instantly renders the message content deploying/using device capabilities native to the mobile device. Modern mobile devices contain a locking mechanism to prevent accidental use. These advertisement and alert messages are rendered while the mobile device is in the locked state and are not rendered after the mobile device is unlocked. While in the locked state, the mobile device enables the addressed mobile device user to interact with the message using the device capabilities native to the mobile device. Using a communication protocol, the mobile device sends delivery, rendering confirmation, and other measurable information back to the initiator of the message for analysis to ascertain message effectiveness and determination of potential next action.

[0061] The term “mobile device” refers to any device deploying any operating system that has been manufactured, installed, modified, bundled, integrated, configured, or otherwise designed with the Content Message Layer and communicating on any voice and/or data network.

[0062] The term “mobile device user” or “anonymous mobile device user” or “user” refers to the registered owner of the mobile device, and can also be referred to as the consumer or targeted consumer segment.

[0063] The term “mobile device capabilities” refers to the mobile device’s hardware, firmware, software, and operating system native components for rendering and interaction purposes.

[0064] The term “advertiser” or “government” or “third party providers,” collectively referred to as “advertiser(s),” refers to the initiator and evaluator of the addressable advertisement and alert messages; these include, but are not limited to: merchants, brands, entrepreneurs, groups, individuals, schools, newspaper publishers, magazines, ad networks, ad servers, ad agencies, coupon clearing houses, non-profit organizations, other third party entities; and foreign or domestic national, state, county, and local government entities (and their foreign equivalents); and wireless carriers, and the like. It is possible that the initiator and evaluator can be different entities.

[0065] The term “lock screen display” refers to the screen display seen upon waking up a mobile device from sleep mode by engaging a logical or physical input key. The lock screen display is only seen during the period between wake-up of the mobile device and unlocking of the mobile device.

[0066] The term “render” refers to compose, draw, express, build, present visually or non-visually, animate, or otherwise portray artistically.

[0067] The term “Content Delivery System” refers to the system components where advertisement or alert messages are created, stored, and formatted prior to transmission to the communication service provider for delivery to an addressable mobile device user and where the response to the message sent is measured and analyzed.

[0068] The terms “advertisement”, “ad”, “message”, “ad message”, “alert message”, “message template”, or “message content” each refer to a pre-packaged, three-part message (Parts A, B, and C) created, customized, modified, or enhanced by software developers via the software development kit and by advertisers via a web portal to create advertisement or alert messages that are rendered using the mobile device’s capabilities.

[0069] The term “Part A” is a package of software code and associated files as created by a software developer via the software development kit, which package provides the Content Message Layer instructions on how to render an advertisement or alert message utilizing the mobile device’s capabilities.

[0070] The term “Part B” is a package of software code, metadata, and associated files, as created, modified, or enhanced by a software developer via the software development kit, and as

customized by the advertiser via a web portal, which package provides the Content Message Layer instructions on what to render as an advertisement or alert message utilizing the mobile device's capabilities.

[0071] The term "Part C" refers to digital elements pre-stored in the Content Message Layer that are tools, objects, rich media, data, audio files, and/or other digitized elements to be used to render an advertisement or alert message utilizing the mobile device's capabilities.

[0072] The term "Learn More " or "Learn More Attributes " refers to attributes defined by the advertiser that provide a means for the mobile device user to interact and engage with the advertiser and/or other mobile device users, to become informed about the advertisements or alert messages, and to actually purchase their product or service.

[0073] The term "Explicit Manager" refers to computer executable language manufactured, installed, modified, integrated, bundled, configured, or otherwise designed into the operating system that enables the rendering of the advertisement or alert message and the mobile device user's interaction with the rendering message. The "Explicit Manager" is a module of the Content Message Layer that captures and stores the mobile device user's engagement with advertisements or alert messages, including the Learn More attributes.

[0074] The term "Implicit Manager" refers to a module of the Content Message Layer that is a computer executable language manufactured, installed, modified, integrated, bundled, configured, or otherwise designed into the operating system that captures and stores any device collectable data indirectly linked to advertisers.

[0075] The term "Mobile Message Protocol" ("MMP") refers to a formatted data package to transport messages to and from mobile devices using existing communication service provider's network and protocols.

[0076] The term "Companion Page" or "Offer Page" refers to an attribute of the learn more attributes, a sub-set of the message template; where the advertiser presents the essence of the ad message, and its definition is crafted by the advertiser.

[0077] The term "Digital Resource Center" or "DRC" refers to a component of the Content Message Layer that stores tools, objects, rich media, data, audio files, elements of Part C, and/or other digitized elements to be used by other elements of the Content Message Layer.

[0078] The term "User Profile Cookie" refers to a specialized internet cookie manifested and controlled by the mobile device user and with permission is dispensed to affiliated internet web sites.

[0079] The term "first triggering event" refers to an event that causes the mobile device to wake from the sleep mode.

[0080] The term "second triggering event" refers to an event that is a representation of the mobile device user going to the next step in the advertiser's message and/or rendering process.

[0081] The term "Inbound Message" refers to messages that are transmitted to the mobile device.

[0082] The term "Outbound Message" refers to messages that are transmitted from the mobile device to affiliated content servers.

#### DETAILED DESCRIPTION

[0083] Referring now to the figures, an example system including the components of the Message Delivery Ecosystem (MDE) 1000: the Content Delivery System (CDS) 1200; the Mobile Message Protocol (MMP) (a protocol for communication service provider (PCSP)) 1300; and the Content Message Layer (CML) 1500 on the mobile device 1400 will be described.

[0084] Message Delivery Ecosystem - Figure 1 illustrates the functionality and methods of the example MDE 1000 and each of its three components. The MDE 1000 effects the ability to create, transport, store, render, capture, and measure addressable messages from one group 1100 (the advertisers) to another group 1401 (the mobile device users), on a mass scale. The CDS 1200 are system components where ad messages or alert messages are created, stored, and formatted prior to transmission through the communication service provider for delivery to an addressable mobile device user 1401 via one or more mobile devices 1400; and where the sent message responses are measured and analyzed by the initiator 1100 (advertiser). The PCSP 1300 is a formatted data package to transport messages to and from mobile devices 1400 using existing communication service provider's network and protocols. The CML 1500 is an apparatus manufactured, integrated, bundled, configured, modified, installed, or otherwise designed into the operating system of the mobile device 1400. Once manufactured, integrated, bundled, configured, modified, installed, or otherwise designed, the mobile device 1400 can receive, store, render, capture and retransmit trackable responses to ad messages or alert messages back to the CDS 1200 using the PCSP 1300.

**[0085]** Content Delivery System -- Referring to Figure 2, this figure illustrates an example embodiment of the CDS 1200. The CDS 1200 consists of web portals, file servers, relational databases, software developers 1220, advertisers 1100, PCSP 1300, mobile devices 1400, and mobile device users 1401. The web portals are: Consumer Profile 1261, Advertiser Profile 1241, Mobile Device Registry 1262, Message Manager 1240 (and related functionality), and Software Development Kit (SDK) 1221. The file servers include: Content System Interface 1210, MMP Message Handler 1280, Communication Gateway 1290, API Interface 1270, and Message Confirmation Server 1250. The CDS 1200 also consists of several large databases: Message Inventory 1230, Behavior Tracking 1263, and Consumer Analytics 1260.

**[0086]** Collectively, Figure 2 illustrates the CDS 1200 as one complex system with many logical and physical attributes. The content system interface 1210 merely represents the interaction within the CDS 1200 and provides a simplified view of how all logical and physical connections and interaction among and between the sub-elements of the CDS 1200 communicate.

**[0087]** The CDS 1200 has many embodiments and some are detailed herein; there are five preferred embodiments: the first is the software developer's 1220 view; the second is the advertiser's 1100 view (all advertisers 1101, government 1102, but excluding third-party providers 1103); the third is the government's 1102 view (additional functionality for government and wireless carriers only); the fourth is the view from using APIs 1270 (third-party providers 1103); and the fifth is the mobile device user's 1401 view. These views are presented to illustrate the different perspectives of the CDS 1200 and how the various sub-elements are deployed and how they subsequently interface with the PCSP 1300 and the CML 1500.

**[0088]** Content Delivery System 1200 (Software Developer's 1220 View) -- Sub-elements of Figure 2 illustrates the viewpoint from software developer 1220. Software Developer Kit (SDK) 1221 is a web based tool to create ad messages and alert system messages in the form of message templates to be stored in the message inventory 1230. Another embodiment of the SDK 1221 is a downloaded tool that can be used directly on a software developer's 1220 computer and then the finished message template can be uploaded into the message inventory 1230. The SDK 1221 provides a method to create messages that take advantage of the mobile device's 1400 capabilities for rendering and interaction purposes. Once the message template has been created, the SDK 1221 will automatically parse and format elements of the message template into three packages: Part A 1230A, Part B 1230B and Part C. Part A 1230A is a package of software code



and associated files which provide the CML 1500 instructions on how to render and enable the mobile device user 1401 to interact with an ad message or alert message utilizing the mobile device's 1400 capabilities. Part B 1230B is a package of software code, metadata, and associated files which provide the CML 1500 instructions on what to render as an ad message or alert message utilizing the mobile device's 1400 capabilities. Part C are digital elements pre-stored in the CML 1500 that are tools, objects, rich media, data, audio files, physics engine elements, and other digitized elements for rendering purposes. Part A 1230A is larger in size than Part B 1230B and is transmitted separately from Part B 1230B, usually during non-peak, lower network volume periods for the communication service provider 1310. Part B 1230B is a smaller data packet and can be transmitted closer to the advertiser's 1100 selected time for execution. The CML 1500 receives both parts and stores them separately for subsequent rendering.

**[0089]** In this illustration of the SDK, the SDK 1221 compares rendering components in Part A's 1230A message template against the mobile devices 1400 registered in the mobile device registry 1262. The mobile device registry 1262 contains mobile device's 1400 capabilities native to each registered mobile device 1400. This comparison will provide the software developer 1220 information about the compatible mobile devices 1400 that are fully able to render their messages. This comparison ultimately determines the reach of their message template; thus quantifying what percentage of the mobile devices 1400 that can render their message. Based on this comparison, the software developer 1220 could then modify their message template to increase the percentage of compatible mobile devices 1400.

**[0090]** Content Delivery System 1200 (Advertiser's 1100 View) - Sub-elements of Figure 2 illustrate the viewpoint from the advertiser 1100 - all advertisers 1101, government 1102, but excluding third-party providers 1103 (see View Used by APIs). The message templates used by the advertiser 1100, called ad messages, are illustrated in this embodiment. In this embodiment, the advertiser profile 1241 contains account billing information about the advertiser 1100, general company information, detailed product and service information, and metadata used to populate select learn more attributes 1243 for ad messages.

**[0091]** The message manager 1240 provides the advertiser 1100 access and control of their ad message inventory 1230; to which consumer segment 1264 the message is addressed and sent; delivery elements of time and location 1242 of when and where the message is rendered;

definition of each learn more attributes 1243 responses the advertiser 1100 wants the mobile device user 1401 to know, experience, or learn (exposure); and quantifiable measurement factors as to whether the ad message was actually delivered (message confirmation 1250) to the addressed mobile device 1400 and the overall message effectiveness 1265, as enumerated by which and how many learn more attributes 1243 responses the mobile device user 1401 actually engaged.

[0092] The advertiser 1100 can either create their own ad message using internal or external software developers 1220, or they can acquire ad message created by third-party software developers 1220 or acquire standard, pre-made ad messages. All ad messages are stored in the message inventory 1230 and are managed and acquired by the message acquisition 1231.

[0093] The advertiser 1100 uses the consumer segmentation 1264 to view the consumer analytics 1260, to select and refine targeted consumer group(s) to satisfy their business need, or to fulfill the needs of an ad campaign. Even though none of the mobile device user's 1401 personally identifiable information is accessible to the advertiser 1100; the advertiser 1100 uses the consumer analytics 1260 to ascertain desirable consumer segments for targeting purposes. The consumer analytics 1260 is a compilation of self-reported consumer profile 1261 information obtained directly from the mobile device user 1401 and that is then married with explicit and implicit behavior tracking 1263 information; derived directly and indirectly from the mobile device user's 1401 exposure and interaction with advertisers 1100 and the ad messages addressed, sent and received by the CML 1500.

[0094] Once the desired targeted consumer group is selected, the advertiser 1100 identifies the time and location 1242 considerations for sending the ad message to the mobile device 1400. The CML 1500 receives and stores the addressed ad message and does not render it until time and/or location considerations are satisfied. If the time and/or location considerations are not satisfied, the CML 1500 sends this disposition to the message confirmation 1250, and subsequently this disposition is presented to the advertiser 1100 in the message effectiveness 1265. Likewise, if the time and/or location considerations are satisfied, and the ad message is rendered, the CML 1500 also sends this disposition to the message confirmation 1250, and subsequently this affirmative disposition is presented to the advertiser 1100 in the message effectiveness 1265.

[0095] Still using the message manager 1240, the advertiser 1100 authorizes the acquired ad message to be sent, based on time and location 1242 considerations, to the targeted consumer segmentation 1264, and then ultimately arriving at the addressed mobile device 1400 associated with the mobile device user 1401 within the consumer segmentation group. The linking methodology to achieve this starts by assigning the advertiser 1100 a unique identification number (ID) in the advertiser profile 1241; assigning the mobile device user 1401 an identification number in the consumer profile 1261; assigning the mobile device 1400 a unique identification number in the mobile device registry 1262; and then assigning the ad message to be sent its unique identification number in the message inventory 1230. Accordingly, the mobile device registry 1262 also ties the registered mobile device 1400 directly to an affiliated communication service provider. Consequently, when the advertiser 1100 authorizes the ad message to be sent, the message manager 1240 uses the appropriate identifiers as a method to send specific ad messages to specific mobile devices 1400; this is first processed through the MMP message handler 1280 and then through the communication gateway 1290 for a specific communication service provider to transport to the mobile device 1400, then ultimately on to the assigned mobile device user 1401.

[0096] The MMP message handler 1280 formats, packages, and encrypts the ad message, message ID, mobile device 1400 ID, mobile device user 1401 ID, and the advertiser ID; according to the PCSP 1300. The communication gateway 1290 is configured for each separate communication service provider. The mobile device 1400 ID designates which communication service provider is affiliated to each mobile device 1400 and the communication gateway 1290 uses this ID to process the ad message to the appropriate communication service provider. This aforementioned method explains the process that the message manager 1240 uses to determine which ad message is sent through to a specific communication service provider, and to be subsequently delivered to a specific mobile device 1400. The CML 1500 has an authentication methodology for accepting or rejecting ad messages that do not match the mobile device 1400 ID and the mobile device user 1401 ID against those same defaulted values in the CML 1500.

[0097] All CDS 1200 outbound and inbound transmissions from the content system interface 1210 are processed through both MMP message handler 1280 and the communication gateway 1290.

[0098] One additional composition variable of the ad message is for the advertiser 1100 to define the elements of the learn more attributes 1243 that are associated with the ad message. These learn more attributes 1243 provide a means for the mobile device user 1401 to interact and engage with the advertiser 1100 and/or other mobile device users 1401, to learn more about the ad message sent, share, as well as, to actually purchase their product or service. The first learn more attribute 1243 is the companion page and this page or section of the lock screen display, is rendered immediately after a second triggering event. The companion page is also referred to as the offer page; where the advertiser 1100 presents the essence of the ad message; its definition is crafted by the advertiser 1100 in the learn more attribute 1243. Additional learn more attributes 1243 are also defined by the advertiser 1100 and are comprised of web links and other means to convey and share information which are tailored to a specific ad message, provides additional information to the mobile device user 1401 about the subject of the ad message, the product, service or brand. Examples of additional information are, but not limited to: a video, press release, an audio file, a website, map or location, survey questions, product reviews, price comparison, call the merchant, email, text, search for related products, add to a shopping list, add to a gift or wish list, mobile ahead purchases or restaurant reservations, convert to a redeemable coupon, or share through a social venue. Many of these learn more attributes 1243 could be the same across the advertiser's 1100 products and services, as found in the advertiser profile 1241, and are appended and managed using the learn more attributes 1243 and then are subsequently linked to an ad message using the message ID. Once defined and linked to a message ID, the learn more attributes 1243 become a subset of the Part B 1230B ad message, and the CML 1500 subsequently processes each attribute using consistent methodologies.

[0099] The advertisers 1100 use the message effective 1265 functionality to assess and evaluate the successfulness of their current advertisement; a key element provided is the message confirmation 1250 that the ad message was delivered and rendered. This information along with other information provided, aids the advertiser 1100 in determining what could be their next action step in running their ad campaigns.

[00100] Collectively, this embodiment of the CDS 1200 provides methods for the advertisers 1100 to have a closed-loop conversation with each anonymous addressed mobile device user 1401. This embodiment is illustrated by linking the advertiser's 1100 unique ID to the ad message ID and to the mobile device user 1401 ID, and then creating closed-loop

transactions to and from the CML 1500. Consequently, as each ad message is sent, interacted with, or shared by the addressed mobile device user 1401, all three unique IDs are tracked at every step of the CDS 1200 process. Subsequently, the consumer analytics 1260 collects data from the CML 1500 into three buckets: ad messages, advertisers 1100, and mobile device user 1401 (each anonymous mobile device user 1401 is aggregated with like profiles and behavior to constitute organically formed, unique consumer segments). Each ad message sent (inbound to the CML 1500) and ad message response (outbound from the CML 1500) contains these unique identifiers and ultimately correspond to one embodiment of the consumer analytics 1260 structure.

**[00101]** All explicit 1263A and implicit 1263B behavior data collected by the CML 1500 are similarly identified with these same identifiers. The consumer analytics 1260 compiles and organizes this data to create multiple views for analysis by the advertisers 1100. There are numerous embodiments of this data; the following are just three:

**[00102]** Ad Message Centric View – Every ad message sent to every mobile device user 1401 by every advertiser 1100 creates the first view. Using the ad message effectiveness 1265 measurement ascertained from mobile device users 1401 engaging in the various learn more attributes, the consumer analytics 1260 is able to rank the effectiveness of every ad message sent in the database. This data is then parsed by: industry, sector, geography, product group, individual product, advertiser 1100, online, brick and mortar, consumer segmentation 1264, and more. This view creates a method to rank overall ad message effectiveness across all ad messages in the database.

**[00103]** Advertiser 1100 Centric View – Every ad message sent to every mobile device user 1401 by each advertiser 1100 creates the second view. Using the same ad message effectiveness 1265, the consumer analytics 1260 is able to similarly rank every ad message sent by each advertiser 1100 to every consumer segment 1264. Likewise, the consumer analytics 1260 is then able to parse the data by: industry, sector, geography, product group, individual product, online, brick and mortar, consumer segment 1264, and more. This view is a method for the advertiser 1100 to determine which ad campaigns were effective and which were not. Additionally, a method for overall brand ranking of all the advertisers 1100 is readily available.

**[00104]** Consumer Centric View – Every ad message sent by every advertiser 1100 to each consumer segment 1264 creates the third view. Using the same ad message effectiveness

1265, the consumer analytics 1260 is able to similarly rank every ad message sent by every advertiser 1100 to each consumer segment 1264. Likewise, the consumer analytics 1260 is then able to parse the data by: industry, sector, geography, product group, individual product, online, brick and mortar, and more. This view is a method for determining which ad messages the mobile device user 1401 best responds, what products and services they are most interested in, and which advertisers 1100 they view in high or low regard.

**[00105]** These views provide multiple methods to assess and evaluate the return of the advertiser's 1100 dollar spent. Advertisers 1100 using these multiple methods can illuminate the targeted consumer's unique interests and needs, which then provide the advertiser 1100 actionable insight to further discover what matters and what is relevant to the mobile device user 1401. Also, these methods provide tools for the advertiser 1100 to find new prospects for their products and services. Once the new prospects have been identified, the advertiser 1100 can use the closed-loop conversation method to help nurture the relationship from being new prospects to become long-term loyal customers. Ultimately, the CDS 1200 gives the advertiser 1100 more data and methods for assessing market opportunity while also giving them new methods for creating long-term value, through delivering more relevant and responsive ad messages.

**[00106]** The following paragraphs provide an illustration of a closed-loop conversation between an advertiser 1100 and a targeted consumer segment 1264; and how a method for using the consumer analytics 1260 can assist the advertiser 1100 in moving new prospects into becoming long-term loyal customers. This illustration is of an outdoor camping advertiser 1100 executing an ad campaign for an end-of-summer clearance sale.

**[00107]** To start, let's assume there are one million mobile device users 1401 nation-wide with mobile devices 1400. The outdoor camping advertiser 1100 first selects the geographical area of metropolitan Washington DC; the message manager 1240 presents there are 10,000 mobile device users 1401 in the area. Next the advertiser 1100 selects 'enjoys outdoor activities' consumer segmentation 1264, the message manager 1240 presents 1,000 profiled mobile device users 1401 that enjoy outdoor activities. For privacy concerns, the mobile device user's 1401 name, mobile number, address, or any other identifiable attributes are never disclosed to the advertiser 1100; however, the advertiser 1100 does know definitively – there are 1,000 real people in the Washington area who enjoy outdoor activities – the advertiser's 1100 target audience for their end-of-summer clearance sale.

[00108] For simplicity sake, let's assume that all 1,000 mobile device users 1401 received the end-of-summer ad message. Out of those 1,000, only 100 mobile device users 1401 engaged the ad message and converted the ad message into a digital coupon (a choice of the learn more attributes 1243) and then ultimately bought a tent. Through a function of the learn more attributes 1243, the CML 1500 is able to track those purchases using the digital coupon. A second group of mobile device users 1401, 200 of them, received the ad message, engaged in a variety of learn more attributes 1243 – however, did not buy anything. And finally, the third group, 700 users, were merely exposed to the ad message and did not engage in any learn more attributes 1243.

[00109] With three weeks left to the end of the sale, the advertiser 1100 decides to send out a second ad message. Using the specific knowledge of each group's responses from the consumer analytics 1260, the advertiser 1100 is able to have a distinctive progressive conversation; thus the advertiser 1100 does not send the same ad message to the same 1,000 mobile device users 1401. Instead, the advertiser 1100 crafts three separate follow up second ad messages, each relevant and responsive to the mobile device user's 1401 previous ad message response and interaction. To the first group, who bought a tent, an ad message thanking them and incenting them to buy tent accessories. To the second group, engaged but didn't buy anything, an ad message that included more information about features and benefits. And to the last group, the ones that did not respond to the ad message, an ad that is a little more innovative about getting their attention. This progressive conversation, mindful of the mobile device user's 1401 previous response, could continue, with several iterations, until the tent sale has concluded.

[00110] This illustration of the CDS 1200 closed-loop conversation, similar to direct selling, provides the advertiser 1100 with actionable insights (methods) to inform the advertiser 1100 of what to say and/or do next in their ad campaign. These methods assist the advertiser 1100 to evolve their ad messages to help move the mobile device user 1401 to become a long-term loyal customer and to ultimately strengthen the market position.

[00111] Content Delivery System 1200 (Government's 1102 View) - Sub-elements of Figure 2 illustrate the viewpoint from the government 1102 (foreign or domestic national, state, county, and local government entities (and their foreign equivalents), and wireless carriers). This view has two embodiments: first as a regular advertiser 1100 and second as a government 1102 entity. Within the first, as a regular advertiser 1100, they deploy the same systems, methods and

apparatus as discussed in paragraphs [0090] to [00110] above. The second embodiment addresses the government's 1102 role as part of the Emergency Alert System and/or other alert messaging requirements.

[00112] The Emergency Alert System (EAS) is a U.S. national public warning system that requires broadcasters, cable television systems, wireless cable systems, satellite digital audio radio service (SDARS) providers, and direct broadcast satellite (DBS) providers to provide the communications capability to the President of the United States to address the American public during a national emergency. The system also may be used by state and local authorities to deliver important emergency information, such as AMBER alerts and weather information targeted to specific areas. This embodiment addresses the foreign or domestic national, state, county, and local government entities (and their foreign equivalents), and wireless carriers as a collective entity and it illustrates how the CDS 1200 provides a new communication method for delivering important alert information.

[00113] The same systems, methods and apparatus as discussed above for all advertisers 1100, also are deployed in this embodiment, plus four additional distinctions that are unique to the EAS: first, alert message used only by the government 1102; second, the ability to prioritize the alert message delivery to supersede all other messages; third, the ability to render the alert message without a first triggering event; and fourth, a specialized API interface with the CML 1500 for establishing two-way communication.

[00114] The message templates used only by the government 1102, called alert messages, are illustrated in this embodiment. These alert messages are standardized and preinstalled into the CML 1500 at manufacture or via firmware upgrade or at the device fulfillment vendor premises or through other system updates. The preinstalled alert messages are only Part A 1230A of the two part alert message; Part B 1230B will be transported as dictated by government 1102 requirements. The CML 1500 contains segregated storage for these alert messages; and new messages or existing messages can be added, modified or deleted at any time by the government 1102 using the message manager 1240 and SDK 1221. Additionally, the U.S. Government 1102 has established a Common Alert Protocol (CAP) for disseminating alert messages across multiple channels. The API interface 1270 will process these messages automatically, without human intervention.



[00115] The ability to prioritize the message delivery to supersede all other messages is functionality available only to government 1102 entities, and is illustrated in this embodiment. Among the government 1102 entities is a pre-determined hierarchy for which entity has message priority over another, e.g., the President over a local authority; and this hierarchy structure is stored in the advertiser profile 1241 and then processed by the message manager 1240. The message manager 1240 or the API interface 1270 processes the message priority status onto designated alert messages, transmits through the PCSP 1300 to the CML 1500 within the mobile device 1400 and then subsequently, the alert message is rendered based on this designation. Consequently, based on message priority designation, alert messages may be scheduled to be rendered before any other message in the message queue in the CML 1500; or scheduled to be rendered at a specific time, regardless of the other messages in the message queue; or scheduled to be rendered based on a specific location, regardless of the other messages in the message queue; or scheduled to be rendered at a specific time and location 1242, regardless of the other messages in the message queue.

[00116] The ability to render the message without a first triggering event is illustrated in this embodiment. This enables the government 1102 to transmit alert messages and have those messages rendered without a first triggering event. Other messages generally require a first triggering event before any message is rendered. Only the government's 1102 alert message can be rendered without a first triggering event. The designation of which alert messages can be rendered without a first triggering event is also included in the message priority in Part B 1230B of the alert message. The establishing, processing and rendering of this designation uses the same methods as described in the previous paragraph.

[00117] A specialized API interface within the CML 1500 for establishing two-way communication is illustrated in this embodiment. This enables the government 1102, via the API interface 1270, to communicate with the API interface within the CML 1500 of the mobile device 1400 to engage the mobile device's 1400 capabilities to establish two-way communication between the mobile device 1400 and the government 1102 entity.

[00118] Content Delivery System 1200 (View Using APIs) Sub-elements of Figure 2 illustrate the view using APIs. In this embodiment, an application programming interface (API) is a source code-based specification intended to be used as an interface by software components to communicate with each other. An API may include specifications for routines, data structures,

object classes, and variables. The API interface 1270 provides a software component for the CML 1500 to communicate with the content system interface 1210 and back, as well as, for outside entities to communicate with the content system interface 1210. There are multiple embodiments to the API interface 1270, but only four are illustrated herein: first, third-party applications installed on the mobile device 1400 requesting ad messages 1230 to be sent to the mobile device 1400 for independent rendering by third-party applications; second, third-party applications installed on the mobile device 1400 requesting consumer segmentation 1264 or consumer analytics 1260 data to be sent to the mobile device 1400 for consumption by the third-party application; third, third-party providers 1103 repurposing their digital advertising content to send select ad messages from the message inventory 1230 to the mobile device 1400; and fourth, the government 1102 to send CAP alert messages to the mobile device 1400.

**[00119]** The APIs for third-party applications installed on the mobile device 1400 to request an ad message from the message inventory 1230 to be sent to the mobile device 1400 for independent rendering is illustrated in this embodiment. The code-based interface starts when the third-party application using a unique API identifier assigned to the application, utilizes the CML 1500 to send a request to the API interface 1270, via the PCSP 1300. The request is for a specific ad message ID to be retrieved from the message inventory 1230. Upon retrieval, the API interface 1270 using the API identifier and other identifiers subsequently sends the requested ad message back through the PCSP 1300 to the CML 1500, where the third-party application independently renders the ad message. The CML 1500 separately tracks the mobile device user's 1401 response and interaction to the rendered ad message; this explicit behavior is linked to the same API identifier in the CML 1500. The stored explicit behavior is subsequently transmitted back through the PCSP 1300 to the behavior tracking 1263A.

**[00120]** The APIs for third-party applications installed on the mobile device 1400 requesting consumer segmentation 1264 or consumer analytics 1260 data to be sent to the mobile device 1400 for consumption by the third-party application is illustrated in this embodiment. The code-based interface starts when third-party application using a unique API identifier assigned to the application, utilizes the CML 1500 to send a request to the API interface 1270, via the PCSP 1300. The request is for specific consumer segmentation 1264 or consumer analytics 1260 data. Upon retrieval, the API interface 1270 using the API identifier subsequently sends the requested consumer segmentation 1264 or consumer analytics 1260 data back through

the PCSP 1300 to the CML 1500, where the third-party application independently processes the information sent. The CML 1500 separately tracks the mobile device user's 1401 response and interaction to the rendered ad message; this explicit behavior is linked to the same API identifier in the CML 1500. The stored explicit behavior is subsequently transmitted back through the PCSP 1300 to the behavior tracking 1263A.

**[00121]** The APIs for third-party providers 1103 (including select advertisers 1101 and government 1102 with automated interfaces) to repurpose their digital advertising content to send select ad messages 1230 to the mobile device user 1401 is illustrated in this embodiment. The code-based interface enables third-party providers 1103 to send preformatted digital advertising content to the API interface 1270 for packaging and processing. The API interface 1270 utilizes default ad messages from the message inventory 1230 and sends the ad message to predetermined consumer segmentation 1264 groups. Both time and location 1242 delivery elements are limited by the API interface 1270, consequently the CML 1500 schedules these messages for delivery to the mobile device user 1401 after other advertisers 1100 do not have a message scheduled to be rendered; these third-party provider's 1103 digital advertising content ad messages are rendered to fill unused time blocks and remnant inventory. Other than the exceptions noted above, the third-party providers 1103, deploy the same systems, methods and apparatus as discussed in paragraphs [0090] to [00110] above.

**[00122]** The APIs for the government 1102 (excluding all other advertisers 1101 and third-party providers 1103) to send CAP alert messages to the mobile device user 1401 is illustrated in this embodiment. The code-based interface enables government 1102 to send preformatted alert messages to the API interface 1270 for packaging and processing. The API interface 1270 utilizes default ad messages from the message inventory 1230 and sends the ad message to predetermined consumer segmentation 1264 groups. Other than the exceptions noted above, the government 1102 deploys the same systems, methods and apparatus as discussed in paragraphs [0090] to [00110] above.

**[00123]** Content Delivery System 1200 (Mobile Device User 1401 View) -- Sub-elements of Figure 2 illustrate the viewpoint from the mobile device user 1401. In this embodiment, the mobile device user 1401 administers his or her consumer profile 1261, the content and privacy aspects of their explicit 1263A and implicit 1263B tracked behavior in the behavior tracking 1263, the content and authorization of their personalized internet cookie, and the loyalty aspects

of their consumer profile information. Also in this embodiment, the consumer profile 1261 and the mobile device registry 1262 create an identity authentication method in the CML 1500.

**[00124]** In this embodiment, the consumer segmentation 1264 is derived from direct input information from individual mobile device users 1401 through a web portal to the consumer profile 1261 and from the explicit 1263A and implicit 1263B tracked behavior captured by the CML 1500 on their mobile devices 1400. Together, the consumer segmentation 1264 information is a rollup of anonymous liked-profiled and tracked individuals – real people, organically aggregated, one-by-one into a database.

**[00125]** The authenticity and accuracy of the consumer segmentation 1264 information is illustrated by providing transparency and control of the individual's consumer profile 1261 to author and originator of the information – the mobile device user 1401. This is further illustrated by the mobile device user 1401 accessing his or her individual consumer profile 1261 through a web portal and enabling the mobile device user 1401 to enter in new profile information, modify existing information and/or delete any aspect of the profile information, at any frequency. This is even further illustrated by providing the mobile device user 1401 a transparent view of the tracked explicit 1263A and implicit 1263B items in the behavior tracking 1263. In this embodiment, the consumer profile 1261 presents to the mobile device user 1401 how the behavior tracking 1263 views him or her. The behavior tracking 1263 provides a method for the mobile device user 1401 to use his/her recent behaviors to act as a navigation tool and show how those behaviors contribute to his/her profile. Each attribute reflects an inferred interest according to their recent behavior. The mobile device user 1401 can either change the behavior tracking 1263 to 'track it' and elevate the inferred segment or topic into a declared interest, or to 'delete it' and eliminate the item from the behavior tracking 1263. Alternatively, the mobile device user 1401 just leaves the tracking results as they were.

**[00126]** Collectively, these embodiments provide methods for the mobile device user 1401 to control the content of what resides in the behavior tracking 1263 about them and the ability to delete or modify any item they deem private or do not want tracked or used for targeted advertising purposes. Furthermore, these embodiments illustrate methods for the mobile device user 1401 to be the catalyst for organically self-defined and naturally generated consumer segments 1264 to be created, which are all derived, maintained and controlled by individual mobile device users 1401. This embodiment of the consumer segmentation 1264 provides the

advertisers 1100 a method to identify real but anonymous people (mobile device users 1401) via the self-defined consumer segmentation 1264, to address and send contextually relevant ad messages based on this self definition, subsequently assess the individual and collective responses to those messages using the behavior tracking 1263, and then send reiterative ad messages based on the mobile device users 1401 previous message responses. This embodiment is another illustration of having a closed-loop progressive conversation using responsive ad messages.

**[00127]** In this embodiment, the mobile device user 1401 uses the consumer profile 1261 to administer a personalized internet cookie that they define and control. Conventionally, internet cookies are used to remember the information about the internet user who has visited a website in order to show relevant content in the future. Often, the relevant content is in the form of display advertisement on the web pages subsequently visited by the internet user. In this embodiment, a personalized internet cookie is manifested and authorized by the mobile device user 1401 to be used by the mobile device's 1400 internet browser to facilitate personalized display advertisement on the web pages visited by the mobile device user 1401 from his or her mobile device 1400. In this illustration, using the consumer profile 1261, the mobile device user 1401 has a collective view of his or her profile information combined with his or her tracked explicit 1263A and implicit 1263B behavior information. This collective view is a representation of the mobile device user's 1401 personalized internet cookie. Using the consumer profile 1261 as illustrated in paragraphs [00125] to [00126] to define and maintain his or her individual profiles and tracked behavior information, the mobile device user 1401 effects the manifestation and control over his or her personalized internet cookie. As a further illustration, using the consumer profile 1261 the mobile device user 1401 may elect authorization of his or her personalized internet cookie. If authorized, the consumer profile 1261 processes the mobile device user's 1401 personalized internet cookie through the PCSP 1300 to the CML 1500 for use by the mobile device user 1401.

**[00128]** In this embodiment, loyalty aspects of the mobile device user's 1401 profile information and tracked behavior are made transparent and can be administered. Generally, loyalty programs are structured marketing efforts that reward, and therefore encourage, loyal buying and other behavior – behavior which is potentially beneficial to the advertiser. In this illustration the consumer profile 1261 provides the mobile device user 1401 a transparent view of

which advertisers 1100 are associated with each aspect of their profile information and their explicit 1263A and implicit 1263B tracked behavior; and provides the mobile device user 1401 the ability to delete existing associations or to create new associations with advertisers 1100. This associated linkage is derived from the advertiser's 1100 identification number entered into each ad message sent to the mobile device user 1401 and to the advertiser's 1100 identification number captured and tracked in the mobile device user's 1401 subsequent explicit 1263A and implicit 1263B behavior. In this illustration, the name of the advertiser 1100 will be presented when an attribute of the mobile device user's 1401 profile information is associated with an advertiser's 1100 identification number. Also, in this illustration, the name of the advertiser 1100 will be presented when an attribute of the mobile device user's 1401 explicit 1263A and implicit 1263B behavior is associated with an advertiser's 1100 identification number. Using the consumer profile 1261, the mobile device user 1401 can administer the loyalty aspects of their profile information by: viewing the loyalty program elements associated with an advertiser 1100 linked to each attribute, and then deleting an existing association with an advertiser 1100, or creating a new association with an advertiser 1100.

**[00129]** In this embodiment, an additional privacy safeguard is created by issuing the mobile device user 1401 a unique identification number. This mobile user ID is assigned by the consumer profile 1261 upon initiation and is used throughout the CDS 1200 when addressing the mobile device user 1401. The unique identification number is for keeping the mobile device user 1401 anonymous.

**[00130]** In this embodiment, the mobile device user 1401 administers his or her mobile device registry 1262. The mobile device registry 1262 is derived from direct input information from mobile device users 1401 through a web portal assigning their mobile device's 1400 affiliation with the CDS 1200. The mobile device user 1401 may affiliate one or more mobile devices 1400 to the CDS 1200 and each device is assigned a unique mobile device 1400 identification number. These mobile devices' 1400 IDs are portable and can be transferred to and from mobile device users 1401. Through the consumer profile 1261 the mobile device user 1401 administers this linkage between mobile device(s) 1400 and himself or herself, as well as, the linkage between the mobile device(s) 1400 and their affiliated communication service provider. This embodiment illustrates the method used to link one or more mobile devices 1400 to a single mobile device user's 1401 consumer profile 1261 and to link each mobile device 1400

to a communication service provider. This further illustrates the method to collect behavior tracking information 1263 from multiple mobile devices 1400, each tied to a single consumer profile 1261 and mobile device user 1401. Additionally, this illustrates the method used for determining which communication service provider to address the ad message for transmission to reach the mobile device user 1401.

**[00131]** In this embodiment, the consumer profile 1261 and the mobile device registry 1262 create an identity authentication method in the CML 1500. After the mobile device 1400 identification number has been established in the mobile device registry 1262, this mobile device 1400 ID and corresponding mobile device user 1401 identification number is transmitted through the PCSP 1300 to the CML 1500 on the registered mobile device 1400. Both of these identification numbers are stored in the CML 1500 and are used to authenticate future content system interface 1210 transmissions addressed to the mobile device 1400. Each subsequent ad message, alert message or API message transmission sent from the content system interface 1210 through the PCSP 1300 contains both the mobile device 1400 and the mobile device user's 1401 identification numbers. Upon receipt of each transmission, the CML 1500 uses the store identification numbers to validate against the received transmission. If the authentication fails, the transmission is rejected and if the authentication is satisfied, the transmission is accepted and processed.

**[00132]** Protocol for Communication Service Provider (PCSP) 1300 – Referring to Figure 3, this figure illustrates the embodiment of the PCSP 1300. The PCSP 1300 is a formatted data package to transport messages to and from mobile devices 1400 using existing communication service provider's network and protocols; and it serves to optimize the CDS 1200 and CML 1500 communication relationship. A communications service provider 1310 is a service provider that transports information electronically. The term encompasses public and private companies in the telecom (landline and wireless), Internet, cable, satellite, and managed services businesses. A communications protocol is a system of digital message formats and rules for exchanging those messages in or between computing systems and in telecommunications. The PCSP 1300 consists of Mobile Message Protocol (MMP) 1320 with two digital message formats: the first for MMP inbound messages 1321 and the second for MMP outbound messages 1322. This embodiment illustrates the digital message formats used to transmit messages to and from the CDS 1200 and

the CML 1500 on the mobile device 1400. MMP inbound messages 1321 are transmitted to the CML 1500 and MMP outbound messages 1322 are transmitted from the CML 1500.

**[00133]** MMP 1320 represents a specialized top application layer, Layer 7 of the OSI Telecommunication Stack. Open Systems Interconnection (OSI) model is a product of the Open Systems Interconnection effort at the International Organization for Standardization. It is a prescription of characterizing and standardizing the functions of a communications system in terms of abstraction layers. Similar communication functions are grouped into logical layers. A layer serves the layer above it and is served by the layer below it. The top application layer in the OSI model facilitates interaction between familiar entities. The MMP 1320 protocol is a specialized top application layer that facilitates interaction between the CDS 1200 and the CML 1500 on the mobile device 1400.

**[00134]** In this embodiment, the in and out bound message formats (1321 and 1322) are illustrated in detail and are further illustrated in context to the interaction between the CDS 1200 and the CML 1500 on the mobile device 1400.

**[00135]** The MMP inbound message 1321 traverses from the CDS 1200 through the communication service providers 1310 to the CML 1500 on the mobile device 1400. In this embodiment, the MMP inbound message 1321 format is composed of six major components: the MMP inbound message header 1381, message type 1334, delivery information 1331, message content 1330, administration data 1311, and API content server response 1372. The message header 1381 refers to supplemental data placed at the beginning of a block of data being stored or transmitted. The encryption 1382 is illustrated as a subcomponent to the MMP inbound message header 1381 and it refers to the security protocol of the MMP inbound message 1321. The message type 1334 illustrates the four types of messages transmitted from the CDS 1200 to the mobile device 1400 for CML 1500 processing. The four message types are: ad message 1335, alert messages 1336, API messages 1337, and administrative messages 1310. The delivery information 1331 illustrates the five unique identifiers directly linked to each message type 1334 transmitted from the CDS 1200 to the mobile device 1400 for CML 1500 processing, plus a delivery priority flag that is used to alert messages 1336 for further processing. The five delivery information 1331 identifiers are: mobile device user (1401) ID 1361, mobile device (1400) ID 1362, advertiser (1100) ID 1340, message ID 1332, and API ID 1370; and the delivery priority flag is message priority 1333. The message content 1330 illustrates two parts of the ad message



and alert message transmitted from the CDS 1200 to the mobile device 1400 for CML 1500 processing. The two parts of the message content are the same two parts of the message template: Part A 1330A and Part B 1330B. The administration data 1311 illustrates the various administrative elements transmitted from the CDS 1200 to the mobile device 1400 for CML 1500 processing; to include but not limited to: Part C data, user profile cookie data, digital resource center data, software and system updates. The API content server response 1372 illustrates the various API related data responses transmitted from the CDS 1200 to the mobile device 1400 for CML 1500 processing. The broadcast support 1390 illustrates utilizing a given radio layer protocol for broadcast capabilities to facilitate updates to the CML 1500.

[00136] The MMP outbound message 1322 traverses from the CML 1500 on the mobile device 1400 through the communication service providers 1310 to the CDS 1200. In this embodiment, the MMP outbound message 1322 format is composed of seven major components: the MMP outbound message header 1383, message type 1334, delivery information 1331, message delivery status 1350, administration data 1313, behavior tracking data 1363, and API content server request 1371. The message header 1383 refers to supplemental data placed at the beginning of a block of data being stored or transmitted. The encryption 1384 is illustrated as a subcomponent to the MMP outbound message header 1383 and it refers to the security protocol of the MMP outbound message 1322. The message type 1334 illustrates the four types of messages transmitted from CML 1500 on the mobile device 1400 to the CDS 1200 for processing. The four message types are: ad message 1335, alert messages 1336, API messages 1337, and administrative messages 1312. The delivery information 1331 illustrates the five unique identifiers directly linked to each message type 1334 transmitted from CML 1500 on the mobile device 1400 to the CDS 1200 for processing. The five delivery information 1331 identifiers are: mobile device user (1401) ID 1361, mobile device (1400) ID 1362, advertiser (1100) ID 1340, message ID 1332, and API ID 1370. The message delivery status 1350 illustrates the three delivery confirmation statuses of whether both parts (1330A and 1330B) of the message content 1330 were received 1351 by the CML 1500 and whether the message content 1330 was rendered 1352 or not rendered 1353; this message delivery status 1350 is subsequently transmitted from CML 1500 on the mobile device 1400 to the CDS 1200 for processing. The administration data 1313 illustrates the various administrative elements transmitted from the CML 1500 on the mobile device 1400 to the CDS 1200 for processing. The

behavior tracking 1363 illustrates the two types of the mobile device user's 1401 behavior information captured, tracked and transmitted from the CML 1500 on the mobile device 1400 to the CDS 1200 for processing. The two types of behavior tracking information are: explicit 1363A and implicit 1363B data. The API content server request 1371 illustrates the various API related requests for content server information transmitted from the CML 1500 on the mobile device 1400 to the CDS 1200 for processing. The broadcast support 1390 illustrates utilizing a given radio layer protocol for broadcast capabilities to facilitate updates to the CML 1500.

**[00137]** Content Message Layer (CML) 1500 – Referring to Figure 4, this figure illustrates the embodiment of the CML 1500. The CML 1500 is an apparatus within the operating system 1402 of the mobile device 1400. The CML 1500 is a stored executable code that interfaces and manipulates the mobile device operating system 1402, the mobile device storage 1403, and the mobile device capabilities 1404 to receive, store and render messages sent by the CDS 1200 via the PCSP 1300; to capture, store, and transmit the mobile device user's 1401 direct and indirect responses to the messages back to the CDS 1200 via the PCSP 1300; and to execute a set of APIs to request and obtain addressable mobile device user's 1401 profile information and selected ad messages from the CDS 1200 via the PCSP 1300 and have the requested profile information and ad messages sent back to the CML 1500 via the PCSP 1300. Additionally, the mobile device user 1401 is able to affect changes to their profile information in the CDS 1200 that influences attributes in the CML 1500 that in turn influences the kind, nature and frequency of messages addressed to them from the CDS 1200. The CML's 1500 stored executable code uses the mobile device's 1400 capabilities to execute its functionality. In this embodiment the CML's 1500 functional components consist of the MMP message agent 1501, MMP security agent 1502, MMP message processor 1503, explicit manager 1563A, implicit manager 1563B, and the APIs applications and services agent 1570.

**[00138]** The CML 1500 has at least five preferred embodiments detailed herein: 1) the software developer's 1220 view; 2) the advertiser's 1100 view (all advertisers 1101; the government 1102, and third-party providers 1103); 3) the government's 1102 view; 4) the view from using APIs; and 5) the mobile device user's 1401 view. These views are presented to illustrate the different embodiments of the CML 1500 and how the various functional components are deployed on the mobile device 1400 and how they interface with the PCSP 1300 and the CDS 1200.

[00139] Content Message Layer 1500 (Software Developer's 1220 View) -- Sub-elements of Figure 4 illustrate the view point from the software developer 1220. In this embodiment, the message template as created by the software developer 1220 and as acquired by the advertiser 1100 is transmitted from the CDS 1200 using the PCSP 1300 to the CML 1500 on the mobile device 1400 for processing.

[00140] The initial steps of the process include: the inbound message assembler 1581 within the MMP message agent 1501 to assemble the received transmission; the inbound authentication 1582 within the MMP security agent 1502 applies data and identity security policies; and then depending on the type of message received, the MMP message processor 1503 using the ad message 1535-1, the alert message 1536-1, the API 1537-1 elements, first stores the message in the message folder 1530, as part of the mobile device storage 1403, in their respective folders, ad message 1535-2, alert message 1536-2, and API 1537-2, and then passes the advertiser 1100 defined delivery sub-elements of the message for the ad message 1535-1 and alert message 1536-1 to the scheduling manager 1563A-1 for further processing.

[00141] The transmitted ad message and alert message consists of two parts and can be transmitted together or separately; when both parts have been stored in the respective message folder (1535-2, 1536-2, or 1537-2) and paired by the respective MMP message processor (1535-1, 1536-1, or 1537-1) into the respective message Part A (1535A, 1536A, or 1537A) and respective message Part B (1535B, 1536B, or 1537B) storage, the respective MMP message processor (1535-1, 1536-1, or 1537-1) executes the message delivery 1550 sub-element of the explicit manager 1563A and a message delivery confirmation is created. Subsequently, the respective MMP message processor (1535-1, 1536-1, or 1537-1) processes the outbound message delivery 1550 status to the MAP security agent 1502 for outbound encryption 1584, and then to the MAP message agent 1501 for outbound dissembler 1583 for transmission to the CDS 1200 using the PCSP 1300.

[00142] Next, based on the advertiser's 1100 defined event(s), the scheduling manager 1563A-1 will queue the ad message for immediate rendering on the mobile device 1400.

[00143] When creating the message template in the CDS 1200, the software developer 1220 selects elements of the mobile device's capabilities 1404 to create a message template for rendering purposes. Based on what the software developer 1220 has created, there are numerous embodiments of what a message template could render on a mobile device 1400, with and

without input from the mobile device user 1401. Once the scheduling manager 1563A-1 queues the message template for immediate rendering and after a first triggering event occurs, the rendering manager 1563A-2 actuates the message template rendering instructions, as created by the software developer 1220, and executes the functionality of mobile device capabilities 1404 and the pre-stored elements of Part C in the Digital Resource Center (DRC) 1571 and/or the physics engine 1563A-3 (see paragraph [0088]); for message template rendering. There are two primary illustrations of the message template rendering: without input or interaction from the mobile device user 1401 and with input or interaction from the mobile device user 1401. In the former illustration, there are numerous embodiments and the rendering starts immediately after a first triggering event occurs and continues rendering until a second trigger event occurs or until the display times out or the mobile device 1400 is unlocked. In the latter illustration, there are also numerous embodiments and the rendering, after it is started, can be altered, changed, or otherwise impacted by input or interaction from the mobile device user 1401. One example of the latter illustration is:

**[00144]** Immediately after the first triggering event – a character of a woman appears, dressed in a fashionable business suit from a local department store. The woman stands with one hand on her hip and the other extended outwardly with her palm up. The local department store's logo is in the bottom left corner and after the first two seconds the image of the woman slowly rotates clockwise, while at the same time, little square pieces of paper fall from the top of the screen with different lettering written on them – some say 5% off, some 10% off and others say 15% off. The little squares fall over the woman and eventually to the ground, but one lands on the woman's outwardly extended hand – it reads 10% off. All of this takes five seconds. The mobile device user 1401 could blow air into the mobile device's 1400 microphone and cause all of the pieces of paper on the ground and in the woman's hand to blow upwardly to the top of the screen. If the mobile device user 1401 continues to blow, all the papers will also continue to blow upwardly and swirl at the top of the screen. When mobile device user 1401 stops blowing, the paper will re-float back down again, and based on randomness, the same or a different discount percent amount could land in the woman's hand. This could be repeated until the 15% off paper lands in the hand.

**[00145]** In this example, the software developer 1220 created a message template that utilized the physics engine 1563A-3 and elements of the mobile device capabilities 1404 for

rendering purposes. The little pieces of paper floating down from the top of the screen depicted the gravity properties of the physics engine 1563A-3; and the microphone (listed as other) as an element of the mobile device capabilities 1404 captured the blowing sound from the mobile device user 1401 to change and alter what was being rendered and to actuate the little pieces of paper being blown upward into the air off the ground.

[00146] Once rendered, regardless of the rendering duration, the scheduling manager 1563A-1 executes the message delivery 1550 and a message rendered delivery confirmation is created. Subsequently, the MMP respective message processor (1535-1, 1536-1, or 1537-1) processes the outbound message delivery 1550 status to the MMP security agent 1502 for outbound encryption 1584, then to the MMP message agent 1501 for outbound dissembler 1583 for transmission to the CDS 1200 using the PCSP 1300.

[00147] Collectively, this embodiment illustrates the method for rendering messages for the at least five preferred views herein.

[00148] Content Message Layer 1500 (Advertiser's 1100 View) – Sub-elements of Figure 4 illustrate the view point from the advertiser 1100 – all advertisers 1101, government 1102, and third-party providers 1103. In this embodiment, in CDS 1200, the advertisers 1100 define the delivery elements of time block and location of when and where their messages are rendered; in the CML 1500, these defined delivery elements are sub-elements of the ad message Part B 1535B; which upon receipt, the ad message 1535-1 of the MMP message processor 1503 passes these delivery elements to the scheduling manager 1563A-1 for processing. The scheduling manager 1563A-1 uses the clock, calendar, global positioning system (GPS), frequency radio, Wi-Fi, and other elements of the mobile device capabilities 1404 to create a queue of sequenced ad messages scheduled for immediate rendering based the delivery elements.

[00149] In this embodiment, the time block delivery element is a representation of time as determined by the clock and calendar components of the mobile device capabilities 1404. Time is illustrated by a block of time that when all the time blocks are added together they represent a single twenty-four hour day; a single day is a subset of the calendar. In the CDS 1200, the advertiser 1100 defines the day(s) and time block(s) for when the ad message is scheduled for rendering; additionally, in the CDS 1200 the advertiser 1100 can also define rollover block(s) of time, rollover is a method to keep the ad message in the scheduling manager 1563A-1 queue for multiple time blocks across multiple days; this rollover method enables the scheduling manager

1563A-1 to retain the ad message in the queue long enough to be rendered by a first triggering event, or until the blocks of time expire, after which the ad message is removed from the queue.

[00150] Once any ad message is not rendered and has been removed from the queue, the scheduling manager 1563A-1 executes the message delivery 1550 and a message not rendered delivery confirmation is created. Subsequently, the ad message 1535-1 of the MMP message processor 1503 processes the outbound message delivery 1550 status to the MMP security agent 1502 for outbound encryption 1584, then to the MMP message agent 1501 for outbound dissembler 1583 for transmission to the CDS 1200 using the PCSP 1300 for further processing.

[00151] In this embodiment, the location delivery element is a representation of geographical location as determined by the GPS, frequency radio, Wi-Fi, and/or other components of the mobile device capabilities 1404. GPS refers to a space-based satellite navigation system that provides location anywhere on the earth, including terrestrial repeaters or augmentation signals to the space-based satellite system. Frequency radio refers to the attaining of the current position of a mobile device 1400, stationary or moving via multilateration of radio signals between (several) radio towers of the cellular network and the mobile device 1400. Wi-Fi refers to technology that allows the mobile device 1400 to exchange data wirelessly (using radio waves) over a computer network, including high-speed Internet connections. In the CDS 1200, the advertiser 1100 defines the location and/or representation for where the mobile device 1400 should be geographically for when the ad message is scheduled to be rendered.

[00152] Whenever a first triggering event occurs, the scheduling manager 1563A-1 deploys the rendering manager 1563A-2 to immediately render the first ad message in the queue. See paragraphs [00143] to [00146] for the method to render an ad message. After the first triggering event the scheduling manager 1563A-1 advances the next scheduled ad message for immediate rendering. If there is no second triggering event and the mobile device 1400 is unlocked, the scheduling manager 1563A-1 holds in the queue the next scheduled ad message for the next first triggering event. Any time after there is no second triggering event and the mobile device 1400 was unlocked and a new first triggering event occurs, the scheduling manager 1563A-1 deploys the rendering manager 1563A-2 to immediately render the next ad message in the queue. This reiterative queuing and rendering by the scheduling manager 1563A-1 continues dynamically, within and across time blocks and geographical locations. When time and location based ad messages are exhausted in the queue, within a time block and/or location, the

scheduling manager 1563A-1 begins queuing for rendering ad messages that do not have defined delivery elements, those from third-party providers 1103 (see paragraph [00121]).

**[00153]** Whenever a second triggering event occurs, the rendering manager 1563A-2 immediately transitions to the learn more 1563A-5 attributes; the first such attribute is the companion page of the ad message. The companion page is also referred to as the offer page; where the advertiser 1100 presents the essence of the ad message; its definition is crafted by the advertiser 1100 in the CDS 1200, see paragraph [0098]. After the learn more 1563A-5 presents the companion page, the mobile device user 1401 either navigates away or he/she navigates to the remaining learn more 1563A-5 attributes presented. These remaining attributes are also defined by the advertiser 1100 and are comprised of web links and other means to convey information, which, when tailored to a specific ad message, provides additional information to the mobile device user 1401 about the subject and essence of the ad message, the product, service or brand. All attributes are consistently organized regardless of the product, service, or brand category and are also standardized in how the mobile device user 1401 navigates to each. Additionally, each attribute provides trackable elements that are captured and stored.

**[00154]** The behavior tracking 1563A-4 captures the trackable elements of the mobile device user 1401 interaction with the learn more 1563A-5 attributes; and each captured element is stored in the behavior tracking folder 1563 in the explicit data 1563A-8. Each captured element may additionally contain a mobile device user(s) 1401 identifier, which is stored in mobile user ID 1563A-8-61; an advertiser(s) 1100 identifier, which is stored in advertiser ID 1563A-8-40, and a message identifier, which is stored in message ID 1563A-8-30. Periodically, the behavior tracking 1563A-4 deploys the ad message 1535-1 of the MMP message processor 1503 to outbound transmit the explicit data 1563A-8 to CDS 1200 for further processing (see paragraphs [00101] to [00105]), via the MMP security agent 1502 and the MMP message agent 1501.

**[00155]** Collectively, these embodiments illustrate methods for how, when and where ad messages are rendered and how the mobile device user's 1401 message responses are captured, stored and transmitted to the CDS 1200 for further processing.

**[00156]** Content Message Layer 1500 (Government's 1102 View) – Sub-elements of Figure 4 illustrate the view point from the government 1102 (foreign or domestic national, state, county, and local government entities (and their foreign equivalents), and wireless carriers). This

view has two embodiments: as a regular advertiser 1100 and as a government 1102 entity. As the former, a regular advertiser 1100, they may deploy the same systems, methods and apparatus as discussed in paragraphs [00148] to [00155] above. The latter embodiment addresses the government's 1102 role as part of the Emergency Alert System and/or other alert messaging requirements.

**[00157]** In the CDS 1200, four distinct methods unique to the government 1102 were illustrated: first, alert messages used only by the government 1102; second, the ability to prioritize the message delivery to supersede all other messages; third, the ability to render the message without a first triggering event; and fourth, a specialized API interface with the CML 1500 for establishing two-way communication. In this embodiment, these same corresponding four distinct aspects of the government 1102 are illustrated in the CML 1500 apparatus.

**[00158]** In this embodiment, Part A of the message template of the alert messages has been preinstalled (stored) in the message Part A 1536A of the alert message 1536-2 folder in the message folder 1530; or later created or modified in the CDS 1200, subsequently transmitted through the PCSP 1300, processed by the MMP message agent 1501, MMP security agent 1502, the alert message 1536-1 of the MMP message processor 1503, and then consequently stored in the message Part A 1536A of the alert message 1536-2 folder in the message folder 1530. Part B of the alert message is created in the CDS 1200 or through an interface with the Common Alert Protocol (CAP) and is subsequently transmitted through the PCSP 1300, processed by the MMP message agent 1501, MMP security agent 1502, the alert message 1536-1 of the MMP message processor 1503, and then consequently stored in the message Part B 1536B of the alert message 1536-2 folder in the message folder 1530. When both parts have been stored in the message folder 1530 and paired by the alert message 1536-1 into the message Part A 1536A and message Part B 1536B storage, the alert message 1536-1 executes the message delivery 1550 sub-element of the explicit manager 1563A and a message delivery confirmation is created. Subsequently, the alert message 1536-1 processes the outbound message delivery 1550 status to the MMP security agent 1502 for outbound encryption 1584, and then to the MMP message agent 1501 for outbound dissembler 1583 for transmission to the CDS 1200 using the PCSP 1300.

**[00159]** In this embodiment, when the alert message 1536-1 receives and processes for storage the alert message Part B 1536B, this transmission may also contain a message priority element defined by the government 1102; when received, the alert message 1536-1 passes the



message priority element to the scheduling manager 1563A-1 for further processing. This message priority element may be defined by the government 1102 to supersede all other messages in the scheduling manager 1563A-1 queue. The scheduling manager 1563A-1 consequently sequences the alert message in the message delivery queue based on this prioritization.

**[00160]** In this embodiment, the message priority element defined by the government 1102 may be defined to render the alert message without a first triggering event. In this illustration, without waiting on a first triggering event, the scheduling manager 1563A-1 either renders the alert message immediately or renders it based on the government 1102 defined delivery elements that are sub-elements of the alert message Part B 1536B.

**[00161]** In this embodiment, specialized APIs Applications and Services Agent (AASA) 1570 enable the government 1102 to establish two-way communication between the mobile device 1400 and the government 1102; in this illustration, the AASA 1570 interfaces with the mobile device capabilities 1404 to establish two-way communication.

**[00162]** Content Message Layer 1500 (View Using APIs) – Sub-elements of Figure 4 illustrate the view using APIs. There are multiple embodiments to the AASA 1570, but only two are illustrated herein: third-party applications installed on the mobile device 1400 requesting ad messages from the CDS 1200 to be sent to the mobile device 1400 for independent rendering by third-party applications; and third-party applications installed on the mobile device 1400 requesting consumer segmentation or consumer analytics data from the CDS 1200 to be sent to the mobile device 1400 for consumption by the third-party application.

**[00163]** Third-party applications installed on the mobile device 1400 requesting ad messages from the CDS 1200 to be sent to the mobile device 1400 for independent rendering by third-party applications is illustrated in this embodiment. Each third-party application that utilizes the AASA 1570 has a unique identifier, the API identifier. Through an authentication process, the third-party application accesses the AASA 1570 to request a specific ad message to be sent from the CDS 1200; this API content server request is processed by the AASA 1570, through to the API message 1537-1 of the MMP message processor 1503, the MMP security agent 1502, the MMP message agent 1501, and then through the PCSP 1300 to the CDS 1200 for processing. Subsequently, the CDS 1200 sends the API message content (Part A and B) back through the PCSP 1300 through to the MMP message agent 1501, the MMP security agent 1502,

the API message 1537-1, and then the API message 1537-2 for storage and to the third-party application agent 1563A-6 for processing. When both parts have been stored in the message folder 1530 and paired by the API message 1537-1 into the API message 1537-2, message Part A 1537A and message Part B 1537B storage, the API message 1537-1 executes the message delivery 1550 sub-element of the explicit manager 1563A and a message delivery confirmation is created. Subsequently, the API message 1537-1 processes the outbound message delivery 1550 status to the MMP security agent 1502 for outbound encryption 1584, and then to the MMP message agent 1501 for outbound dissembler 1583 for transmission to the CDS 1200 using the PCSP 1300.

**[00164]** Different than all other advertiser's 1100 ad messages, the API initiated ad messages are not processed nor sequenced for rendering by the scheduling manager 1563A-1. The third-party application, using the third-party application agent 1563A-6, controls the method of when and where the API initiated ad messages are rendered. The third-party application agent 1563A-6 supplants the first triggering event for initiating the rendering process with a third-party application created event. Once the third-party application agent 1563A-6 initiates the API initiated ad message to render, the rendering manager 1563A-2 actuates the API initiated ad message rendering instructions, as created by the software developer 1220, and executes the functionality of mobile device capabilities 1404 and the pre-stored elements of Part C in the Digital Resource Center (DRC) 1571 and/or the physics engine 1563A-3 (see paragraph [0088]) for message template rendering. There are two primary illustrations of the API initiated ad message rendering: without input or interaction from the mobile device user 1401 and with input or interaction from the mobile device user 1401. In the former illustration, there are numerous embodiments and the rendering starts immediately when the third-party application agent 1563A-6 initiates the API initiated ad message to render and continues rendering until a second trigger event occurs or until the display times out. In the latter illustration, there are also numerous embodiments and the rendering, after it is started, can be altered, changed, or otherwise impacted by input or interaction from the mobile device user 1401.

**[00165]** Whenever a second triggering event occurs, the rendering manager 1563A-2 immediately transitions to the learn more 1563A-5 attributes; the first such attribute is the companion page of the API initiated ad message. After the learn more 1563A-5 presents the companion page, the mobile device user 1401 either navigates away or he/she navigates to the

remaining learn more 1563A-5 attributes presented; each attribute provides trackable elements that are captured and stored.

**[00166]** The behavior tracking 1563A-4 captures the trackable elements of the mobile device user 1401 interaction with the learn more 1563A-5 attributes; and each captured element is stored in the behavior tracking folder 1563 in the explicit data 1563A-8. Each captured element contains the API identifier, which is stored in API ID 1563A-8-70; and may additionally contain a mobile device user(s) 1401 identifier, which is stored in mobile user ID 1563A-8-61; an advertiser(s) 1100 identifier, which is stored in advertiser ID 1563A-8-40, and a message identifier, which is stored in message ID 1563A-8-30. Periodically, the behavior tracking 1563A-4 deploys the API message 1537-1 to outbound transmit the explicit data 1563A-8 to CDS 1200 for further processing, via the MMP security agent 1502 and the MMP message agent 1501.

**[00167]** Third-party applications installed on the mobile device 1400 requesting consumer segmentation or consumer analytics data from the CDS 1200 to be sent to the mobile device 1400 for consumption by the third-party application is illustrated in this embodiment. Through an authentication process, the third-party application accesses the AASA 1570 to request consumer segmentation or consumer analytics data to be sent from the CDS 1200; this API content server request is processed by the AASA 1570, through to the API message 1537-1, the MMP security agent 1502, the MMP message agent 1501, and then through the PCSP 1300 to the CDS 1200 for processing. Subsequently, the CDS 1200 sends an API content server response back through the PCSP 1300 through to the MMP message agent 1501, the MMP security agent 1502, the API message 1537-1, and then the DRC 1571 for storage and to the third-party application agent 1563A-6 for processing.

**[00168]** There are numerous embodiments of what third-party applications can do with the consumer segmentation or consumer analytics data received from CDS 1200 and stored in the DRC 1571. This consumer segmentation or consumer analytics data include one or more trackable elements of the mobile device user's 1401 interaction with the consumer segmentation or consumer analytics data; each captured element is stored in the behavior tracking folder 1563 in the explicit data 1563A-8. Each captured element contains the API identifier, which is stored in API ID 1563A-8-70; and may additionally contain a mobile device user(s) 1401 identifier, which is stored in mobile user ID 1563A-8-61; an advertiser(s) 1100 identifier, which is stored in

advertiser ID 1563A-8-40, and a message identifier, which is stored in message ID 1563A-8-30. Periodically, the behavior tracking 1563A-4 deploys the MMP message processor 1503 to outbound transmit the explicit data 1563A-8 to CDS 1200 for further processing, via the MMP security agent 1502 and the MMP message agent 1501.

**[00169]** Content Message Layer (Mobile Device User 1401 View) – Sub-elements of Figure 4 illustrate the mobile device user 1401. In this embodiment, rendered messages from advertisers 1100 are accessible to the mobile device user 1401; and the subsequent direct and indirect mobile device user's 1401 exposure and interaction with messages initiated by the advertiser 1100 are captured, stored and transmitted.

**[00170]** In this embodiment, many modern mobile devices 1400 deploy a logical or physical locking mechanism to prevent accidental or unintended use of the device; once unlocked the mobile device user 1401 gains full access to the mobile device 1400; while the device is locked, the mobile device user 1401 has limited access. The term "lock-screen display" refers to the screen display seen upon waking up a mobile device 1400 from sleep mode by engaging a logical or physical input key. The lock-screen display is only seen during the period between wake-up of the mobile device 1400 and unlocking of the mobile device 1400. The lock-screen display has both an active state and a passive state; in the active state, the mobile device 1400 is turned on and the display is actively engaged; and in the passive state, the mobile device 1400 is turned on but it is asleep and nothing is displayed. In the former, the lock-screen display can convey a large variety of things, from internal to the mobile device 1400 driven events like alarm clocks, calendar alerts, and status of what music is being played, to external to the mobile device 1400 driven events like email notifications, incoming phone calls, and stock alerts. The commonality across all active state events is that each event wakes the mobile device 1400 from the sleep mode and actively engages the lock-screen display. In the latter, the lock-screen display is absent of any active engagement and the mobile device 1400 is asleep, and the mobile device 1400 continues in this sleep or passive state until a triggering event occurs to wake it from sleep or the battery dies. A triggering event to wake the mobile device 1400 from sleep mode can be a logical or physical input, and after the triggering event, many modern mobile devices 1400 will display a lock-screen wallpaper, a clock, or another representation of being temporarily awake and active on the lock-screen display. This temporary wake state persists

until either the mobile device user 1401 deploys a logical or physical unlocking mechanism or the lock-screen display times-out and the mobile device 1400 goes back to sleep.

[00171] In this illustration, the triggering event that causes the mobile device 1400 to wake temporarily from the sleep mode is herein referred to as the “first triggering event”. In the place of a lock-screen wallpaper, a clock, or another representation of being temporarily awake, the rendering manager 1563A-2 will render the next scheduled advertiser’s 1100 message. The advertiser’s 1100 message will persist rendering until the lock-screen display times-out, the mobile device user 1401 deploys a logical or physical unlocking mechanism, or mobile device user 1401 deploys a logical or physical second triggering event. In this embodiment, the second triggering event is a representation of the mobile device user 1401 going to the next step in the advertiser’s 1100 message and/or rendering process.

[00172] Between the first and second triggering events, the mobile device user 1401 engages, interacts, or otherwise plays with the advertiser’s 1100 message using the mobile device capabilities 1404. There are numerous embodiments of this interaction, and the following is one example:

[00173] The instant following the first triggering event - animated mercury balls quickly roll and collide with each other onto the lock-screen display from all directions: simultaneously the mobile device 1400 correspondingly vibrates and makes a rumbling sound; with each collision a sucking sound is heard as the balls congeal together; eventually (three seconds later) the congealed mercury forms an accurate representation of a name brand pickup truck, and then to a quiet background, where a gruff voice says ‘Pickup Truck Tough’. The mobile device user 1401 could shake the mobile device 1400 and the mercury balls will scatter off the lock-screen display, then the sequence would start all over again. The mobile device user 1401 could further delay the unlocking process and after five seconds the screen would go black and the sequence would start over again, but with every iteration, the action would slow down by 25%, and after the fifth iteration it would freeze with the representation of the pickup truck staying on the screen. If the mobile device user 1401 was interested in learning more about the name brand pickup truck, the mobile device user 1401 could long-touch the lock- screen display (an illustration of a second triggering event) , when doing so the lock-screen display would react as if a finger was inserted into water and ripples would start from the mobile device user’s 1401 touch point and ripple out to the lock-screen display’s edges; when the mobile device user 1401

lifts his or her finger from the long-touch, the water and pickup truck would explode off the screen accompanied by a corresponding sound and vibration, and then the screen would go black. At anytime beginning, middle or end of the ad rendering process, the mobile device user 1401, without delay, can unlock his or her mobile device 1400 by moving the logical or physical input.

[00174] In this illustrated embodiment, the government 1102 defines a message priority causing the scheduling manager 1563A-1 to render an alert message without a first triggering event. There are many illustrations of this embodiment and the following represents two: while the mobile device 1400 is in the sleep and locked state, and while the mobile device 1400 is in the active and unlocked state.

[00175] The first illustrative embodiment is while the mobile device 1400 is in the sleep and locked state. In the CDS 1200 or through an interface with the Common Alert Protocol, the government 1102 defines a message priority delivery to supersede all other messages in the scheduling manager 1563A-1 queue and to render while the mobile device 1400 is in the sleep and locked state. Based on delivery elements and message priority of the received and processed alert message, if the mobile device 1400 is asleep and locked, the rendering manager 1563A-2 engages the necessary mobile device capabilities 1404 to wake the mobile device 1400 from the sleep state, and then renders the alert message. Based on delivery elements and message priority of the received and processed alert message, if the mobile device 1400 is unlocked and in an active state, the rendering manager 1563A-2 waits for the mobile device 1400 to return to a sleep and locked state, and then the rendering manager 1563A-2 engages the necessary mobile device capabilities 1404 to wake the mobile device 1400 from the sleep state to render the alert message.

[00176] The second illustrative embodiment is while the mobile device 1400 is active and unlocked. In the CDS 1200 or through an interface with the Common Alert Protocol, the government 1102 defines a message priority delivery to supersede all other messages in the scheduling manager 1563A-1 queue and to render while the mobile device 1400 is active and in an unlocked state. Based on delivery elements and message priority of the received and processed alert message, the rendering manager 1563A-2 engages the mobile device capabilities 1404 to interrupt the necessary mobile device 1400 activities and then renders the alert message.

[00177] Third-party applications acquired independently by the mobile device user 1401, through means outside the MDE 1000 that are used on their mobile device 1400, which contain specific APIs that interface with the CDS 1200 or the AASA 1570 are illustrated in this embodiment. These APIs provide a method for third-party application developers to leverage the information entered, captured and tracked about the mobile device user 1401, and to create innovative commerce, social, or other focused applications. There are numerous embodiments of how third-party application developers could use mobile device user's 1401 profile information to create games, services, product demonstrations, social interaction, user generated content, contextual search, user lifestyle enablers, and other unnamed applications. Common to each embodiment is the API identifier and the use of the mobile device user's 1401 profile information to innovate to provide a service, utility, entertainment or value to the mobile device user 1401.

[00178] In this embodiment, capturing, storing and transmitting the mobile device user's 1401 explicit behavior is illustrated. Explicit behavior is information derived directly from the mobile device user's 1401 exposure and interaction with messages initiated by the advertiser 1100. The behavior tracking 1563A-4 captures every exposure and interaction the mobile device user 1401 has with each message, excluding message delivery 1550 items (see paragraph [00146]). All captured explicit behavior is stored and encrypted (1585) in the explicit data 1563A-8 in the behavior tracking folder 1563. Periodically, the behavior tracking 1563A-4 deploys the respective message (ad message 1535-1, alert message 1536-1, or API message 1537-1) processor of the MMP message processor 1503 to outbound transmit the explicit data 1563A-8 to CDS 1200 for further processing, via the MMP security agent 1502 and the MMP message agent 1501.

[00179] There are numerous embodiments of this illustration, the common method among them is a message identifier that is captured and stored in the message ID 1563A-8-30: with each mobile device user's 1401 exposure and interaction to each message (rendering and learn more 1563A-5 attributes), the behavior tracking 1563A-4 captures and stores the associated message identifier along with the trackable elements of the exposure and interaction into their respective folders, message ID 1563A-8-30 and explicit data 1563A-8. In this embodiment, from a mobile device user's 1401 perspective, the message has two elements: rendering and the learn more 1563A-5 attributes.

[00180] Rendering — immediately following a first triggering event and simultaneous to the message delivery 1550 process that advises the CDS 1200 that a message has been rendered; the behavior tracking 1563A-4 captures the message rendering duration, mobile device user 1401 interaction with the rendering message, and the event that ended the rendering; and then subsequently stores the captured information into the explicit data 1563A-8. The rendering duration is the time between the first triggering event and one of the following: the lock screen display times-out; the mobile device user 1401 deploys a logical or physical unlocking mechanism; or mobile device user 1401 deploys a logical or physical second triggering event. The mobile device user's 1401 interaction with the rendering message has numerous variables, as defined by the software developer 1220 author of the ad message. Each variable may have trackable elements. Subsequently, as each trackable element is engaged by the mobile device user 1401, the behavior tracking 1563A-4 captures and stores the captured trackable element into the explicit data 1563A-8. The event that ended the rendering is one of the following: the lock screen display times-out; the mobile device user 1401 deploys a logical or physical unlocking mechanism; or mobile device user 1401 deploys a logical or physical second triggering event. The behavior tracking 1563A-4 captures and stores the ending event into the explicit data 1563A-8. Additionally, if the first triggering event occurs and the event that ended the rendering was the lock screen display timing-out, the scheduling manager 1563A-1 keeps the current ad message at the top of the queue for re-rendering; the scheduling manager 1563A-1 maintains the current ad message at the top of the queue for re-rendering until the mobile device user 1401 deploys a logical or physical unlocking mechanism, mobile device user 1401 deploys a logical or physical second triggering event, or until the time block has expired and the scheduling manager 1563A-1 places a different ad message at the top of the queue. Consequently, each re-rendering causes the behavior tracking 1563A-4 to capture the message rendering duration, mobile device user 1401 interaction with the rendering message, and the event that ended the rendering; and then subsequently stores the captured information into the explicit data 1563A-8. Concurrently with each re-rendering, the message delivery 1550 processes a new confirmation that advises the CDS 1200 that a message has been rendered.

[00181] Immediately following a second triggering event, the rendering manager 1563A-2 transitions to the learn more 1563A-5 attributes of the ad message. The learn more 1563A-5 attributes have two components: the externally derived, Part B (1535-2, 1536-2, or 1537-2) of



the ad message, the advertiser 1100 specific information that supplements the rendered message, and the internally derived framework to standardize and organize the mobile device user 1401 user experience for presentation and navigation of the Part B (1535-2, 1536-2, or 1537-2) component. The Part B (1535-2, 1536-2, or 1537-2) component is defined by the advertiser 1100 in the CDS 1200 and has the following attributes: 1) the companion page; 2) product, service or brand awareness illustrations: print media, video media, audio media, website, other; 3) product, service or brand interest illustrations: map or location, product, service or brand reviews, price comparison, survey or questionnaire, calling, emailing, texting, product, service or brand search, other; 4) product, service or brand desire illustrations: shopping list, wish list, gift list, shopping cart, other; 5) product, service or brand action illustrations: mobile ahead transactions, redeem coupon, in-store purchase, online purchase, review purchase history, other; 6) product, service or brand social illustrations: share, post, comment, update, visit, rank, influence, other; each aforementioned attribute provides trackable elements. The internal component of the learn more 1563A-5 contains a framework that standardizes the way each attribute is organized and how the mobile device user 1401 navigates, thus creating a consistent look and feel to the mobile device user 1401 for engaging each attribute across all product, service or brand categories. The learn more 1563A-5 draws resources from the DRC 1571 to support this illustration. Subsequently, the behavior tracking 1563A-4 captures each trackable element of each attribute and stores them in the explicit data 1563A-8.

[00182] In this embodiment, capturing, storing and transmitting the mobile device user's 1401 implicit behavior is illustrated. Implicit behavior is information derived indirectly from the mobile device user's 1401 exposure and interaction with advertisers 1100, which is not directly linked to a message. The behavior tracking 1563B-1 in the implicit manager 1563B captures the exposure and interaction of the mobile device user 1401 by monitoring transactions, activities, or data points that potentially could be linked to an advertiser's 1100 unique identifier or to a third-party application developer's (API) unique identifier (collectively referred to as implicit behavior).

[00183] All the implicit behavior captured by the behavior tracking 1563B-1 is stored and encrypted (1586) in the implicit data 1563B-8 in the behavior tracking folder 1563. Periodically, the behavior tracking 1563B-1 deploys the admin message 1510 processor of the MMP message

processor 1503 to outbound transmit the implicit data 1563B-8 to CDS 1200 for further processing, via the MMP security agent 1502 and the MMP message agent 1501.

**[00184]** In this embodiment, the behavior tracking 1563B-1 captures implicit behavior of the mobile device user 1401; the mobile wallet interface 1563B-2 captures transactional information; the third-party audience measurement interface 1563B-3; and other context 1563B-4 captures other integrated services transitions. User profile cookie 1561 controls and captures transactions related to distributing the mobile device user's 1401 authorized personalized internet cookie.

**[00185]** The behavior tracking 1563B-1 capturing implicit behavior of the mobile device user 1401 is illustrated in this embodiment. The CML 1500 is manufactured into the mobile device operating system 1402, and with permission, has access to core functionality of the mobile device operating system 1402 to enable monitoring, and when programmed, captures designated transactions, activities, or data points performed by the mobile device user 1401; the behavior tracking 1563B-1 is the active element within the CML that performs this function. All captured implicit behavior is stored and encrypted (1586) in the implicit data 1563B-8 in the behavior tracking folder 1563; and if any unique identifiers for mobile device users 1401, advertisers 1100, messages, or third-party developers (API) are captured and can be associated with any of the implicit behavior, these items are also stored in the respective folders: 1563B-8-61, 1563B-8-40, 1563B-8-30, 1563B-8-70 with a linkage to the implicit data 1563B-8 stored.

**[00186]** The mobile wallet interface 1563B-2 capturing transactional information is illustrated in this embodiment. Mobile wallet is an alternative payment method; instead of paying with cash, check or credit cards, a mobile device user 1401 can use their mobile device 1400 to pay for a wide range of services and digital or hard goods; there are four primary models for mobile payments: premium SMS-based transactional payments, direct mobile billing, mobile web payments (WAP), contactless NFC (Near Field Communication). The mobile wallet interface 1563B-2 is manufactured into the mobile device operating system 1402 and with permission, has access to core functionality of the mobile device's 1400 mobile wallet to enable monitoring, and when programmed, captures designated transactional information performed by the mobile device user 1401 using his or her mobile wallet. All captured transactional information is stored and encrypted (1586) in the implicit data 1563B-8 in the behavior tracking folder 1563; and if any unique identifiers for mobile device users 1401, advertisers 1100,

messages, or third-party developers (API) are captured and can be associated with any of the transactional information, these items are also stored in the respective folders: 1563B-8-61, 1563B-8-40, 1563B-8-30, 1563B-8-70 with a linkage to the implicit data 1563B-8 stored.

**[00187]** The third-party audience measurement interface 1563B-3 capturing third-party transactions and activities are illustrated in this embodiment. Third-party transactions and activities are viewing, listening, reading, browsing, social and other transactions and activities that are provided by third-party entities for the benefit of the mobile device user 1401 on his or her mobile device 1400; either executed by native mobile device 1400 applications or by non-native, remotely connected functionality. There are numerous embodiments of third-party transactions and activities that capture the exposure and interaction of the mobile device user 1401 by monitoring viewing, listening, reading, browsing, social and other transactions, activities, or data points that potentially could be linked to an advertiser's 1100 unique identifier or to a third-party application developer's (API) unique identifier. The third-party audience measurement interface 1563B-3 is manufactured into the mobile device operating system 1402 and with permission, has access to core functionality of the mobile device's 1400 viewing, listening, reading, browsing, social and other integrated services transactions to enable monitoring or receipt, and when programmed, captures or receives designated viewing, listening, reading, browsing, social and other integrated services transactions performed by the mobile device user 1401. All captured or received viewing, listening, reading, browsing, social and other integrated services transactions are stored and encrypted (1586) in the implicit data 1563B-8 in the behavior tracking folder 1563; and if any unique identifiers for mobile device users 1401, advertisers 1100, messages, or third-party developers (API) are captured or received and can be associated with any of the viewing, listening, reading, browsing, social and other integrated services transactions, these items are also stored in the respective folders: 1563B-8-61, 1563B-8-40, 1563B-8-30, 1563B-8-70 with a linkage to the implicit data 1563B-8 stored.

**[00188]** The other context 1563B-4 capturing other integrated services transactions is illustrated in this embodiment. There are numerous embodiments of other integrated services transactions that capture the exposure and interaction of the mobile device user 1401 by monitoring other transactions, activities, or data points that potentially could be linked to an advertiser's 1100 unique identifier or to a third-party application developer's (API) unique identifier. The other context 1563B-4 is manufactured into the mobile device operating system

1402 and with permission, has access to core functionality of the mobile device's 1400 other integrated services transactions to enable monitoring, and when programmed, captures designated other integrated services transactions performed by the mobile device user 1401. All captured other integrated services transactions are stored and encrypted (1586) in the implicit data 1563B-8 in the behavior tracking folder 1563; and if any unique identifiers for mobile device users 1401, advertisers 1100, messages, or third-party developers (API) are captured and can be associated with any of the other integrated services transactions, these items are also stored in the respective folders: 1563B-8-61, 1563B-8-40, 1563B-8-30, 1563B-8-70 with a linkage to the implicit data 1563B-8 stored.

[00189] The user profile cookie 1561 controlling and capturing transactions related to distribution of the mobile device user's 1401 authorized personalized internet cookie is illustrated in this embodiment. The mobile device user 1401 defines and administers his or her profile information in the CDS 1200, and with permission, authorizes the distribution of his or her personalized internet cookie representing his or her profile information (see paragraph [00127]). The user profile cookie 1561 is manufactured into the mobile device operating system 1402, and with permission, has access to core functionality of the mobile device's 1400 web browser to distribute the mobile device user's 1401 authorized personalized internet cookie and to enable monitoring, and when programmed, captures designated transactions performed by the mobile device user 1401 using his or her web browser. All captured personalized internet cookie distribution and subsequent captured transactions are stored and encrypted (1585) in the implicit data 1563B-8 in the behavior tracking folder 1563; and if any unique identifiers for mobile device users 1401, advertisers 1100, messages, or third-party developers (API) are captured and can be associated with any of the personalized internet cookie distribution and subsequent transactions, these items are also stored in the respective folders: 1563B-8-61, 1563B-8-40, 1563B-8-30, 1563B-8-70 with a linkage to the implicit data 1563B-8 stored.

[00190] Those skilled in the art will appreciate that the above-described processes are readily enabled using any of a wide variety of available and/or readily configured platforms, including partially or wholly programmable platforms as are known in the art or dedicated purpose platforms as may be desired for some applications. In an additional alternative embodiment, the functionality or logic described in the figures may be embodied in the form of code that may be executed in a separate processor circuit. If embodied in software, each block

may represent a module, segment, or portion of code that comprises program instructions to implement the specified logical function(s). The program instructions may be embodied in the form of source code that comprises human-readable statements written in a programming language or machine code that comprises numerical instructions recognizable by a suitable execution system such as a processor in a computer system or other system. The machine code may be converted from the source code, etc. If embodied in hardware, each block may represent a circuit or a number of interconnected circuits to implement the specified logical function(s).

**[00191]** Those skilled in the art will recognize that a wide variety of modifications, alterations, and combinations can be made with respect to the above described embodiments without departing from the scope of the invention, and that such modifications, alterations, and combinations are to be viewed as being within the ambit of the inventive concept.

What is claimed is:

- 1) An apparatus comprising: a mobile device having a processing device and memory device, the mobile device configured to repurpose the lock screen display of the mobile device to use the firmware, hardware, software, and related operating system components of the mobile device to render an advertisement or alert message on the lock screen display during the period between wake-up of the mobile device and unlocking of the mobile device, and that allows a user of the mobile device to interact with the advertisement or alert message using the firmware, hardware, software, and related operating system of the mobile device.
- 2) The apparatus of claim 1 wherein the mobile device receives and stores an advertisement or alert message.
- 3) The apparatus of claim 1 wherein the mobile device user can cause the advertisement or alert message being rendered on the lock screen display to be accompanied by vibration of the mobile device.
- 4) The apparatus of claim 1 wherein the mobile device user can cause the advertisement or alert message already rendered on the lock screen display to be accompanied by vibration of the mobile device.
- 5) The apparatus of claim 1 wherein the mobile device user can cause the advertisement or alert message being rendered on the lock screen display to rotate with the mobile device.
- 6) The apparatus of claim 1 wherein the mobile device user can cause the advertisement or alert message already rendered on the lock screen display to rotate with the mobile device.
- 7) The apparatus of claim 1 wherein the mobile device user can cause the advertisement or alert message being rendered on the lock screen display to be accompanied by audio.
- 8) The apparatus of claim 1 wherein the mobile device user can cause the advertisement or alert message already rendered on the lock screen display to be accompanied by audio.
- 9) The apparatus of claim 1 wherein the mobile device user can cause the advertisement or alert message being rendered on the lock screen display to move with the motion or otherwise be affected by the motion of the mobile device.
- 10) The apparatus of claim 1 wherein the mobile device user can cause the advertisement or alert message already rendered on the lock screen display to move with the motion or otherwise be affected by the motion of the mobile device.
- 11) The apparatus of claim 1 wherein the mobile device user can cause the advertisement or

alert message being rendered on the lock screen display to be accompanied by plain text on the lock screen display.

12) The apparatus of claim 1 wherein the mobile device user can cause the advertisement or alert message already rendered on the lock screen display to be accompanied by plain text on the lock screen display.

13) The apparatus of claim 1 wherein the mobile device user can cause the advertisement or alert message being rendered on the lock screen display to be accompanied by at least one picture taken from at least one of the front and rear facing cameras of the mobile device.

14) The apparatus of claim 1 wherein the mobile device user can cause the advertisement or alert message already rendered on the lock screen display to be accompanied by at least one picture taken from at least one of the front and rear facing cameras of the mobile device.

15) The apparatus of claim 1 wherein the mobile device user can cause the advertisement or alert message being rendered on the lock screen display to be accompanied or changed by sound input from the immediate area around the mobile device.

16) The apparatus of claim 1 wherein the mobile device user can cause the advertisement or alert message already rendered on the lock screen display to be accompanied or changed by sound input from the immediate area around the mobile device.

17) The apparatus of claim 1 wherein the mobile device user can cause the advertisement or alert message being rendered on the lock screen display to apply a time context to the rendering advertisement or alert message on the lock screen.

18) The apparatus of claim 1 wherein the mobile device user can cause the advertisement or alert message already rendered on the lock screen display to apply a time context to the rendered advertisement or alert message on the lock screen.

19) The apparatus of claim 1 wherein the mobile device user can cause the advertisement or alert message being rendered on the lock screen display to apply a directional context of north, south, east, west, or any points between to the rendering advertisement or alert message on the lock screen display.

20) The apparatus of claim 1 wherein the mobile device user can cause the advertisement or alert message already rendered on the lock screen display to apply a directional context of north, south, east, west, or any points between to the rendered advertisement or alert message on the lock screen display.

- 21) The apparatus of claim 1 wherein the mobile device user can cause the advertisement or alert message being rendered on the lock screen display to apply a location-specific context to the rendering advertisement or alert message on the lock screen display.
- 22) The apparatus of claim 1 wherein the mobile device user can cause the advertisement or alert message already rendered on the lock screen display to apply a location-specific context to the rendered advertisement or alert message on the lock screen display.
- 23) The apparatus of claim 1 wherein the mobile device user can cause the advertisement or alert message being rendered on the lock screen display to be accompanied by flashing or steady light.
- 24) The apparatus of claim 1 wherein the mobile device user can cause the advertisement or alert message already rendered on the lock screen display to be accompanied by flashing or steady light.
- 25) The apparatus of claim 1 wherein the mobile device user can cause the advertisement or alert message being rendered on the lock screen display to change in response to being close to the mobile user's face.
- 26) The apparatus of claim 1 wherein the mobile device user can cause the advertisement or alert message already rendered on the lock screen display to change in response to being close to the mobile user's face.
- 27) The apparatus of claim 1 wherein the mobile device user can cause the advertisement or alert message being rendered on the lock screen display to change the amount of illumination on the lock screen display.
- 28) The apparatus of claim 1 wherein the mobile device user can cause the advertisement or alert message already rendered on the lock screen display to change the amount of illumination on the lock screen display.
- 29) The apparatus of claim 1 wherein the mobile device user can cause the advertisement or alert message being rendered on the lock screen display to change in response to interaction with physical or logical input keys/elements on the mobile device.
- 30) The apparatus of claim 1 wherein the mobile device user can cause the advertisement or alert message already rendered on the lock screen display to change in response to interaction with physical or logical input keys/elements on the mobile device.
- 31) The apparatus of claim 1 wherein the mobile device user can cause the advertisement or



alert message being rendered on the lock screen display to change in response to a remote connection to a third-party device.

32) The apparatus of claim 1 wherein the mobile device user can cause the advertisement or alert message already rendered on the lock screen display to change in response to a remote connection to a third-party device.

33) The apparatus of claim 1 wherein the mobile device user can cause the advertisement or alert message being rendered on the lock screen display to change in response to additional hardware, firmware, software, and related operating system installed components in or attached to the mobile device.

34) The apparatus of claim 1 wherein the mobile device user can cause the advertisement or alert message already rendered on the lock screen display to change in response to additional hardware, firmware, software, and related operating system installed components in or attached to the mobile device.

35) The apparatus of claim 1 wherein the firmware, hardware, software, and related operating system include at least one of the following:

- a) vibrator;
- b) three-axis gyroscope;
- c) speaker(s) or headphone;
- d) accelerometer;
- e) plain text capability;
- f) front or rear facing cameras;
- g) microphone(s);
- h) digital clock;
- i) digital compass;
- j) GPS;
- k) LED flash;
- l) proximity sensor;
- m) ambient light sensor;
- n) display;
- o) physical or logical device input keys/elements;
- p) NFC, RFID, Wi-Fi, Bluetooth, physical interface connection, or other physical or logical

remote connection;

- q) Device touch screen display or keypad or any other button on the device; and
  - r) additional hardware, firmware, software and related operating system installed components in or attached to the mobile device.
- 36) The apparatus of claim 1 wherein the mobile device can track, store and transmit the mobile device user's direct and indirect interactions with the advertisement or alert message.
- 37) The apparatus of claim 1 wherein the mobile device is manufactured to make the firmware, hardware, software, and related operating system components of the mobile device available to the user during said condition.
- 38) The apparatus of claim 1 wherein the mobile device operating system is installed to make the firmware, hardware, software, and related operating system components of the mobile device available to the mobile device during said condition.
- 39) The apparatus of claim 1 wherein the mobile device is modified to make the firmware, hardware, software, and related operating system components of the mobile device available to the user during said condition.
- 40) The apparatus of claim 1 wherein the function of rendering the message during said condition is bundled into the operating system of the mobile device.
- 41) The apparatus of claim 1 wherein the function of rendering the message during said condition is integrated into the operating system of the mobile device.
- 42) A method of rendering a user-interactive message on the lock screen display of a device during the period between wake-up of the device and unlocking of the device.
- 43) The method according to claim 42 wherein the lock screen display is made interactive using the firmware, hardware, software, and related operating systems of the device.
- 44) A computer-readable media for causing a device to render a user-interactive message on the device during the period between wake-up of the device and unlocking of the device.
- 45) A method of rendering a user-interactive message on the lock screen display of a device during the period between wake-up of the device and unlocking of the device by bypassing or replacing the lock screen functionality while preserving access and control to the device and user information.
- 46) A method of rendering a user-interactive message on the lock screen display of a device during the period between wake-up of the device and unlocking of the device by bypassing or

replacing the lock screen functionality while preserving access and control to the device and user information; said method redirecting the user back to the lock screen environment after the termination of the user-interactive message.

47) A method of rendering a user-interactive message on the lock screen display of a device during the period between wake-up of the device and unlocking of the device while preserving the existing user's experience with respect to telephony and other handset functionality.

48) An apparatus comprising: a mobile device having a processing device and memory device, the mobile device configured to store a message downloaded to the mobile device, and to render the downloaded message at a preselected time on the mobile device if the mobile device is in a first state; and if the stored message cannot be rendered because the mobile device is not in the first state, the mobile device is configured to roll over the stored message to a first subsequent preselected time or times on a same day or other days.

49) The apparatus of claim 48 wherein the mobile device is configured to be in the first state when the mobile device is in a condition between wake-up of the mobile device and unlocking of the mobile device.

50) The apparatus of claim 48 wherein the mobile device is configured to roll over the message to a second subsequent predetermined time or times on the same day or on yet other days if the mobile device is not in the first state at the first subsequent preselected time or times or the same day or other days.

51) The apparatus of claim 50 wherein the mobile device is configured to rollover the message for a preselected subsequent number of times or days.

52) The apparatus of claim 48 wherein the mobile device is configured to store the downloaded message in a scheduling queue that makes the message available for rendering by the mobile device at a preselected time block over multiple days.

53) The apparatus of claim 52 wherein the mobile device is configured to deliver the message for rendering in response to detection of the preselected time and the mobile device being in a condition between wake-up of the mobile device and unlocking of the mobile device.

54) The apparatus of claim 52 wherein the mobile device is configured to use a scheduling manager to keep the message in the scheduling queue until it is rendered a specified number of times or until a specified time period for rendering the message has expired.

55) The apparatus of claim 53 wherein the mobile device is configured to use the scheduling

queue to retain the message for a future rendering if a rendering of the message is interrupted by the mobile device being placed in a condition other than the condition between wake-up of the mobile device and unlocking of the mobile device.

56) The apparatus of claim 48 wherein the mobile device is configured to roll over the message for rendering at a subsequent preselected time or times on the same day or other days if the mobile device is not in a specified geographic location.

57) The apparatus of claim 48 wherein the mobile device operating system is installed to make the native technology available to the mobile device during said condition.

58) The apparatus of claim 48 wherein the mobile device is modified to make the native technology available to the user during said condition.

59) The apparatus of claim 48 wherein the function of rendering the message during said condition is bundled into the operating system of the mobile device.

60) The apparatus of claim 48 wherein the function of rendering the message during said condition is integrated into the operating system of the mobile device.

61) The apparatus of claim 48 wherein the mobile device is manufactured to make the native technology available to the user during said condition.

62) A method comprising:

rendering a message on a lock screen display of a mobile device if a scheduled time for rendering the message occurs during a period between wake-up of the mobile device and unlocking of the mobile device.

63) The method of claim 62 further comprising storing a message to be rendered on the lock screen display of the mobile device until the occurrence of the scheduled time for rendering.

64) The method of claim 62 further comprising rolling over the material to be rendered on the lock screen display of the mobile device in storage for rendering at a subsequent scheduled time on a same day or another day if the material cannot be rendered at a first scheduled time.

65) The method of claim 62 further comprising retaining the message to be rendered in storage until it is rendered a scheduled number of times or until a specified time period for rendering the message has expired.

66) The method of claim 62 further comprising rolling over the message to be rendered at the scheduled time in storage for rendering at a subsequent scheduled time on the same day or another day if the mobile device is not at a specified geographical location when the mobile

device is between wake-up of the mobile device and unlocking of the mobile device.

67) A computer-readable medium in a mobile device storing instructions configured or otherwise designed to cause a computing device in the mobile device to perform operations comprising rolling over in storage any message that cannot be rendered by the mobile device at a specified time.

68) A computer-readable medium in a mobile device storing instructions configured or otherwise designed to cause a computing device in the mobile device to perform operations comprising rolling over in storage any message that cannot be rendered by the mobile device at a specified time and a specified location.

69) The computer-readable medium of claim 68 wherein the instructions are further configured to cause the computing device in the mobile device to perform operations comprising rendering the rolled over message at a subsequent scheduled time on a same day or another day.

70) The computer-readable medium of claim 68 wherein the instructions are further configured to cause the computing device in the mobile device to perform operations comprising rendering the rolled over message at a subsequent scheduled time on the same day or another day if the mobile device is at the specified location.

71) An apparatus comprising: a mobile device having a processing device and memory device, the mobile device configured to effect a closed-loop progressive conversation with an interactive impression message addressed to the mobile device and rendered on the mobile device.

72) The apparatus of claim 71 wherein the mobile device is configured to return a user's response to the interactive impression message to a computing device associated with an originator of the interactive impression message.

73) The apparatus of claim 72 wherein the responses from other mobile devices to the interactive impression message are received by the originator of the interactive impression message.

74) The apparatus of claim 73 wherein the mobile device is configured to receive subsequent responses that are effected by the computing device associated with the originator of the interactive impression message.

75) The apparatus of claim 71 wherein the mobile device is configured to render the interactive impression message when the mobile device is in a condition between wake-up of the

mobile device and unlocking of the mobile device.

76) The apparatus of claim 75 wherein the mobile device is configured to render the interactive impression message as an advertisement with which the mobile device user can interact using at least one of firmware, hardware, software, or other features of the mobile device.

77) The apparatus of claim 76 wherein the firmware, hardware, software, and other features of the operating system of the operating system of the mobile device include at least one of the following:

- a) vibrator;
- b) three-axis gyroscope;
- c) speaker(s) or headphone;
- d) accelerometer;
- e) plain text capability;
- f) front or rear facing cameras;
- g) microphone(s);
- h) digital clock;
- i) digital compass;
- j) GPS;
- k) LED flash;
- l) proximity sensors;
- m) ambient light sensor;
- n) display;
- o) physical or logical device input keys/elements;
- p) NFC, RFID, Wi-Fi, Bluetooth, physical interface connection, or other physical or logical remote connection;
- q) device touch screen display or keypad or any other button on the device; or
- r) additional hardware, firmware, software and related operating system installed components in or attached to the mobile device.

78) The apparatus of claim 76 wherein the mobile device is configured to render the interactive impression message as repetitious, episodic, or building to a crescendo or an event.

79) The apparatus of claim 76 wherein the mobile device is configured to provide

information about the interactive impression message from an originator of the interactive impression message.

80) The apparatus of claim 76 wherein the mobile device is configured to segment responses to the interactive impression message into different categories.

81) The apparatus of claim 76 wherein the mobile device is configured to store the user's responses to the interactive impression message.

82) The apparatus of claim 76 wherein the mobile device is configured to receive future interactive impression message based upon the user's previous response or responses to the interactive impression message.

83) The apparatus of claim 71 wherein the mobile device is manufactured to make the native technology available to the user during said condition.

84) The apparatus of claim 71 wherein the mobile device operating system is installed to make the native technology available to the mobile device during said condition.

85) The apparatus of claim 71 wherein the mobile device is modified to make the native technology available to the user during said condition.

86) The apparatus of claim 71 wherein the function of rendering the message during said condition is bundled into the operating system of the mobile device.

87) The apparatus of claim 71 wherein the function of rendering the message during said condition is integrated into the operating system of the mobile device.

88) A method comprising:

rendering an interactive impression advertisement on the lock screen display of a mobile device if a scheduled time for rendering the advertisement occurs during the period between wake-up of the mobile device and unlocking of the mobile device;

receiving through the mobile device feedback from a user in response to the interactive impression advertisement to participate in a closed-loop progressive conversation with a computing device associated with an originator of the advertisement.

89) A computer-readable medium in a mobile device storing instructions configured or otherwise designed to cause the mobile device to perform operations comprising permitting the mobile device user to participate in a closed-loop progressive conversation with the originator of an interactive impression advertisement if a scheduled time for the advertisement occurs during the period between wake-up of the mobile device and unlocking of the mobile device.

- 90) An apparatus comprising: a mobile device having a processing device and memory device, the mobile device configured to make available to a user use of technology native to the mobile device to perform functions independently of other system components during interaction with a received message rendered on the mobile device as a rendered message when the mobile device is in a condition between wake-up of the mobile device and unlocking of the mobile device.
- 91) The apparatus of claim 90 wherein the mobile device is configured to provide a user of the mobile device independent control as to time and location in which to interact with the rendered message.
- 92) The apparatus of claim 91 wherein the mobile device is configured to provide the user tools to allow instant response to the rendered message because the message was previously received and placed in a queue.
- 93) The apparatus of claim 92 wherein the mobile device is configured to locally capture user responses and interactions with the rendered message.
- 94) The apparatus of claim 90 wherein the technology native to the mobile device that permits user interaction and response includes at least one of the following:
- a) vibrator;
  - b) three-axis gyroscope;
  - c) speaker(s) or headphone;
  - d) accelerometer;
  - e) plain text capability;
  - f) front or rear facing camera;
  - g) microphone(s);
  - h) digital clock;
  - i) digital compass;
  - j) GPS;
  - k) LED flash;
  - l) proximity sensors;
  - m) ambient light sensor;
  - n) display;
  - o) physical or logical device input keys/elements;

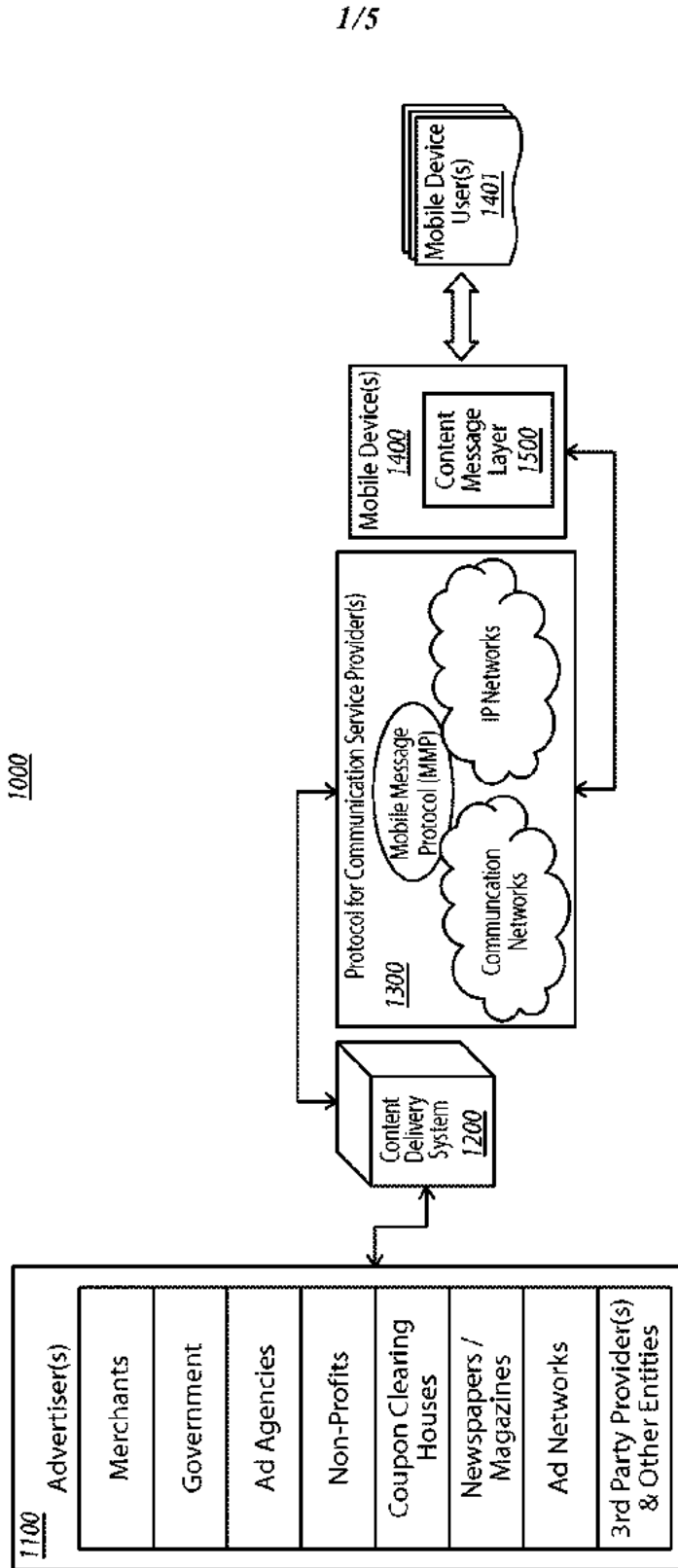


- p) NFC, RFID, Wi-Fi, Bluetooth, physical interface connections, or other physical or logical remote connections;
  - q) device touch screen display or keypad or any other button on the device; or
  - r) additional hardware, firmware, software and related operating system installed components in or attached to the mobile device.
- 95) The apparatus of claim 90 wherein mobile device tools, objects, rich media, data, and audio files are configured to render the message using the technology native to the mobile device.
- 96) The apparatus of claim 90 wherein the mobile device is configured to allow the user to create additional modes of interacting and responding to the rendered message.
- 97) The apparatus of claim 90 wherein the mobile device is configured to allow the rendered message to appear to respond to laws of physics.
- 98) The apparatus of claim 90 wherein the message is an advertisement.
- 99) The apparatus of claim 90 wherein the mobile device is configured to use a scheduling manager that uses the technology native to the mobile device to create a queued sequence of messages that are scheduled for immediate rendering at a specified time, location, or other triggering event when the mobile device is in the condition between wake-up of the mobile device and unlocking of the mobile device.
- 100) The apparatus of claim 90 wherein the mobile device is configured to track and record user response to the rendered message.
- 101) The apparatus of claim 90 wherein the mobile device is manufactured to make the native technology available to the user during said condition.
- 102) The apparatus of claim 90 wherein the mobile device operating system is installed to make the native technology available to the mobile device during said condition.
- 103) The apparatus of claim 90 wherein the mobile device is modified to make the native technology available to the user during said condition.
- 104) The apparatus of claim 90 wherein the function of rendering the message during said condition is bundled into the operating system of the mobile device.
- 105) The apparatus of claim 90 wherein the function of rendering the message during said condition is integrated into the operating system of the mobile device.
- 106) A method comprising rendering and interacting with a received message using only technology native to a mobile device when the mobile device is in a condition between wake-up

of the mobile device and unlocking of the mobile device.

107) A computer-readable medium in a mobile device storing instructions configured or otherwise designed to cause a mobile device to perform operations comprising using only technology native to the mobile device to render and interact with a received message when the mobile device is in a condition between wake-up of the mobile device and unlocking of the mobile device.

# Message Delivery Ecosystem



1/5

FIG. 1

# Content Delivery System

1200

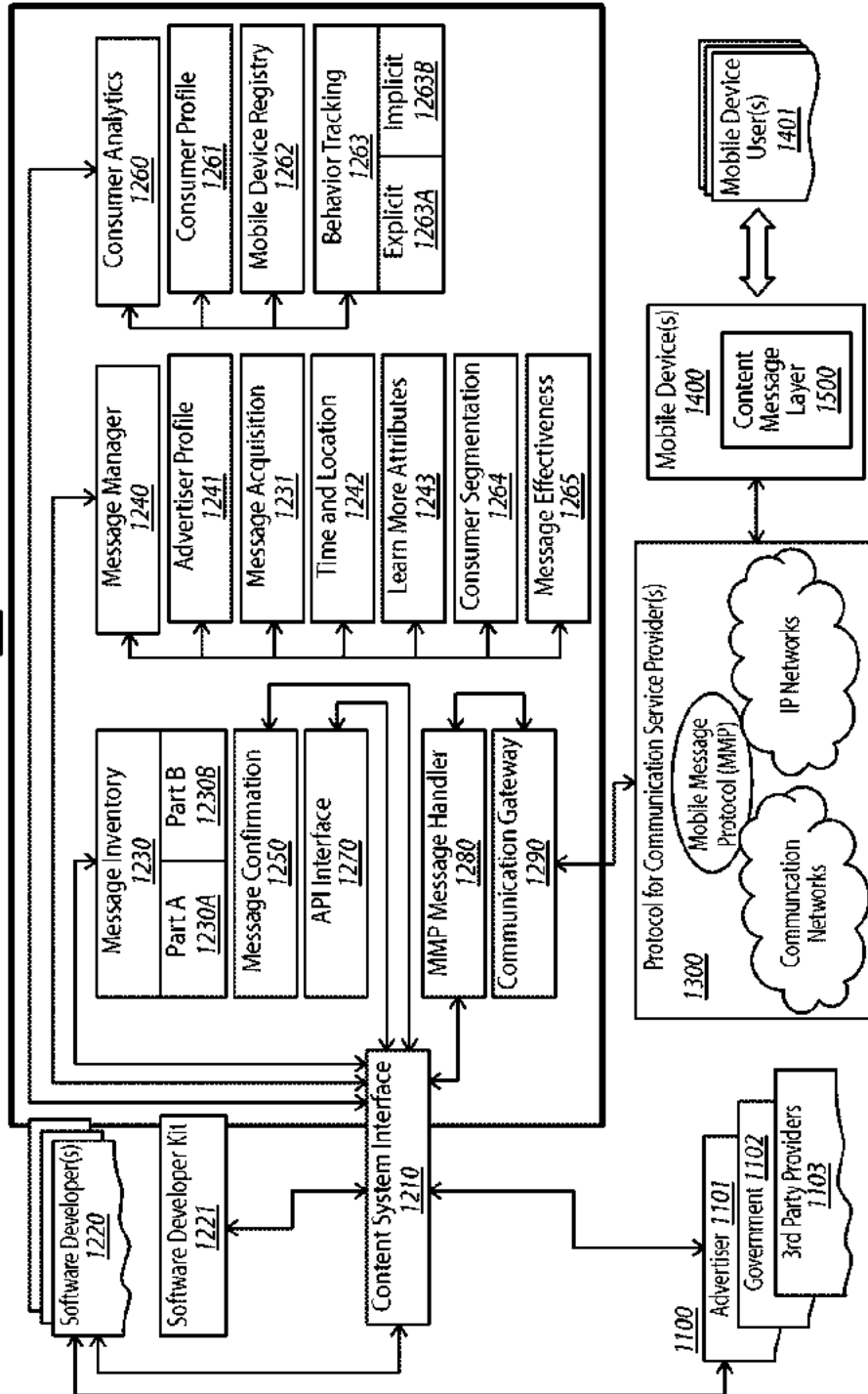


FIG. 2

# Protocol for Communication Service Provider

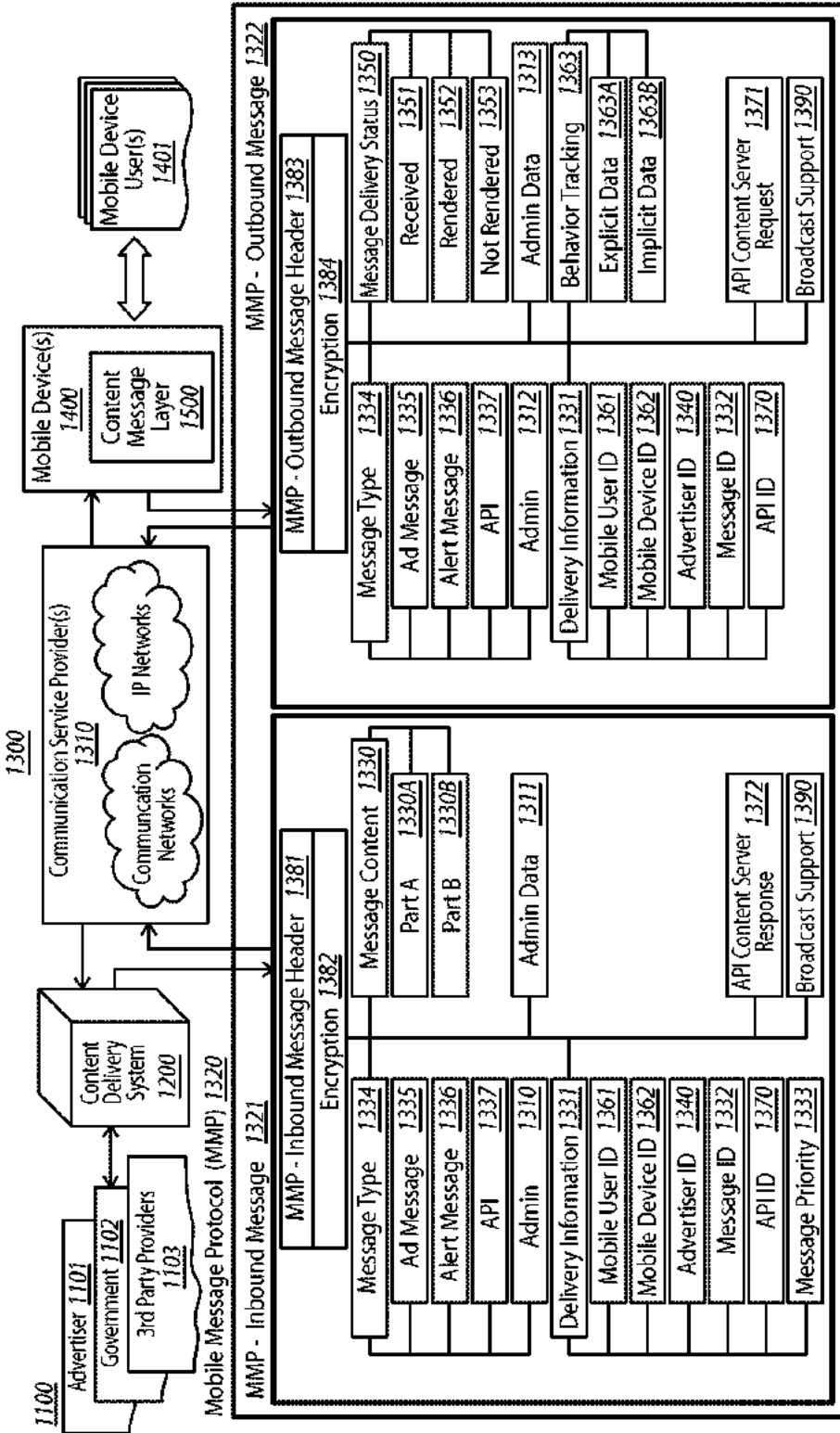


FIG. 3

# Content Message Layer

1500

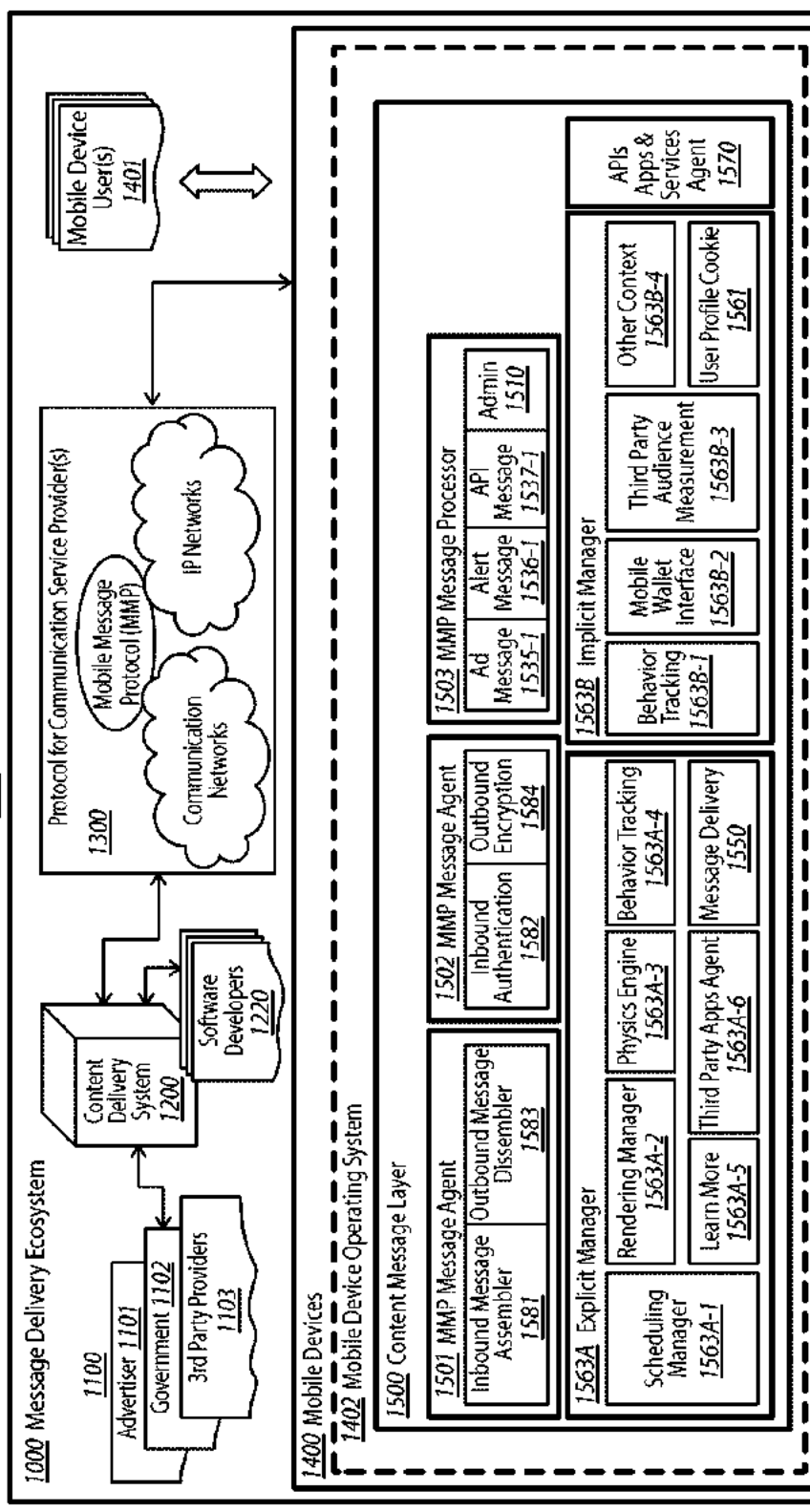


FIG. 4A

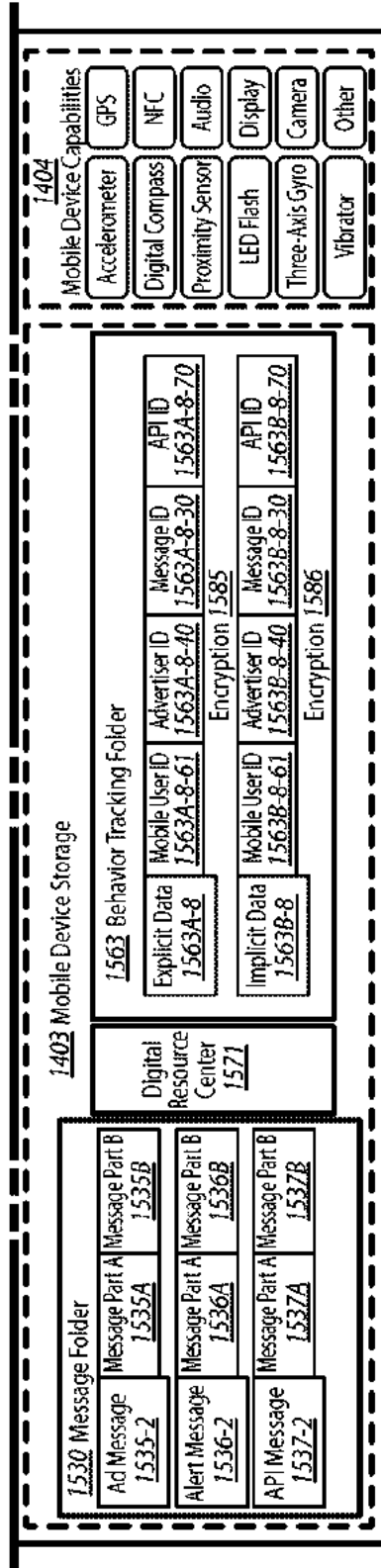


FIG. 4B

**A. CLASSIFICATION OF SUBJECT MATTER****G06Q 50/30(2012.01)i, G06Q 30/02(2012.01)i**

According to International Patent Classification (IPC) or to both national classification and IPC

**B. FIELDS SEARCHED**

Minimum documentation searched (classification system followed by classification symbols)

G06Q 50/30; H04W 4/12; G06Q 30/02; G06Q 30/00; H04W 4/16; H04Q 7/20; H04W 4/00; G06Q 50/00

Documentation searched other than minimum documentation to the extent that such documents are included in the fields searched

Korean utility models and applications for utility models

Japanese utility models and applications for utility models

Electronic data base consulted during the international search (name of data base and, where practicable, search terms used)

eKOMPASS(KIPO internal) &amp; Keywords: mobile, advertisement, lock screen, unlock

**C. DOCUMENTS CONSIDERED TO BE RELEVANT**

Category*	Citation of document, with indication, where appropriate, of the relevant passages	Relevant to claim No.
Y	KR 10-2002-0041805 A (LG ELECTRONICS INC.) 03 June 2002 See abstract, claims 1-9, and figure 1.	1-107
Y	KR 10-2010-0057461 A (NHN BUSINESS PLATFORM CORP.) 31 May 2010 See abstract, paragraphs [0048],[0051], claims 1-18, and figures 5a-5b.	1-107
A	WO 2012-015230 A2 (SEO, JANG WON et al.) 02 February 2012 See abstract, claim 1, and figures 2-5.	1-107
A	US 2010-0312643 A1 (AMIT GIL) 09 December 2010 See abstract, claims 1-38, and figure 1.	1-107
A	US 2009-0112708 A1 (WILLIAM J. BARHYDT et al.) 30 April 2009 See abstract, claims 1-35, and figure 1.	1-107

 Further documents are listed in the continuation of Box C. See patent family annex.

\* Special categories of cited documents:

"A" document defining the general state of the art which is not considered to be of particular relevance

"E" earlier application or patent but published on or after the international filing date

"L" document which may throw doubts on priority claim(s) or which is cited to establish the publication date of citation or other special reason (as specified)

"O" document referring to an oral disclosure, use, exhibition or other means

"P" document published prior to the international filing date but later than the priority date claimed

"T" later document published after the international filing date or priority date and not in conflict with the application but cited to understand the principle or theory underlying the invention

"X" document of particular relevance; the claimed invention cannot be considered novel or cannot be considered to involve an inventive step when the document is taken alone

"Y" document of particular relevance; the claimed invention cannot be considered to involve an inventive step when the document is combined with one or more other such documents, such combination being obvious to a person skilled in the art

"&amp;" document member of the same patent family

Date of the actual completion of the international search

16 August 2013 (16.08.2013)

Date of mailing of the international search report

**19 August 2013 (19.08.2013)**

Name and mailing address of the ISA/KR

Korean Intellectual Property Office  
189 Cheongsu-ro, Seo-gu, Daejeon Metropolitan City,  
302-701, Republic of Korea

Facsimile No. +82-42-472-7140

Authorized officer

OH Eung Gie

Telephone No. +82-42-481-8744





**INTERNATIONAL SEARCH REPORT**  
Information on patent family members

International application No.  
**PCT/US2013/042042**

Patent document cited in search report	Publication date	Patent family member(s)	Publication date
KR 10-2002-0011695 A	03/06/2002	None	
KR 10-2010-0057461 A	31/05/2010	None	
WO 2012-015239 A2	02/02/2012	CN 102656602 A EP 2498216 A2 JP 2013-513853 A KR 10-1039197 B1 US 2012-0278174 A1 WO 2012-015239 A3	05/09/2012 12/09/2012 22/04/2013 03/06/2011 01/11/2012 03/05/2012
US 2010-0312643 A1	09/12/2010	EP 1974559 A2 EP 1974559 A4 IL 180542 D0 IL 198917 D0 IL 224283 A US 2012-0258695 A1 US 8219153 B2 US 8285337 B1 WO 2008-081420 A2 WO 2008-081420 A3	01/10/2008 02/02/2011 04/07/2007 17/02/2010 30/05/2013 11/10/2012 10/07/2012 09/10/2012 10/07/2008 09/04/2009
US 2009-0112708 A1	30/04/2009	None	



- (51) International Patent Classification: Not classified
- (21) International Application Number: PCT/FI2012/051029
- (22) International Filing Date: 26 October 2012 (26.10.2012)
- (25) Filing Language: English
- (26) Publication Language: English
- (30) Priority Data: 13/284,451 28 October 2011 (28.10.2011) US
- (71) Applicant: NOKIA CORPORATION [FI/FI]; Keilalahdentie 4, FI-02150 Espoo (FI).
- (72) Inventor: BERUS, Bernard; Grünberger Str. 63a, 10245 Berlin (DE).
- (74) Agents: NOKIA CORPORATION et al.; IPR Department, Jussi Jaatinen, Keilalahdentie 4, FI-02150 Espoo (FI).
- (81) Designated States (unless otherwise indicated, for every kind of national protection available): AE, AG, AL, AM, AO, AT, AU, AZ, BA, BB, BG, BH, BN, BR, BW, BY,

BZ, CA, CH, CL, CN, CO, CR, CU, CZ, DE, DK, DM, DO, DZ, EC, EE, EG, ES, FI, GB, GD, GE, GH, GM, GT, HN, HR, HU, ID, IL, IN, IS, JP, KE, KG, KM, KN, KR, KZ, LA, LC, LK, LR, LS, LT, LU, LY, MA, MD, ME, MG, MK, MN, MW, MX, MY, MZ, NA, NG, NI, NO, NZ, OM, PA, PE, PG, PH, PL, PT, QA, RO, RS, RU, RW, SC, SD, SE, SG, SK, SL, SM, ST, SV, SY, TH, TJ, TM, TN, TR, TT, TZ, UA, UG, US, UZ, VC, VN, ZA, ZM, ZW.

- (84) Designated States (unless otherwise indicated, for every kind of regional protection available): ARIPO (BW, GH, GM, KE, LR, LS, MW, MZ, NA, RW, SD, SL, SZ, TZ, UG, ZM, ZW), Eurasian (AM, AZ, BY, KG, KZ, RU, TJ, TM), European (AL, AT, BE, BG, CH, CY, CZ, DE, DK, EE, ES, FI, FR, GB, GR, HR, HU, IE, IS, IT, LT, LU, LV, MC, MK, MT, NL, NO, PL, PT, RO, RS, SE, SI, SK, SM, TR), OAPI (BF, BJ, CF, CG, CI, CM, GA, GN, GQ, GW, ML, MR, NE, SN, TD, TG).

**Published:**

- without international search report and to be republished upon receipt of that report (Rule 48.2(g))



WO 2013/060940 A2

(54) Title: METHOD AND APPARATUS FOR INCREASING THE FUNCTIONALITY OF A USER DEVICE IN A LOCKED STATE

(57) Abstract: In an example embodiment, an approach is provided for increasing the functionality of a user device when the device is in an, at least in part, locked state. The approach involves presentation of a first user interface and rendering of at least a portion of a second user interface associated with the first user interface while the user device is in an, at least in part, locked state wherein the second user interface is associated with one or more applications and/or one or more services. Further, one or more interactions with the first user interface and/or with the at least a portion of the second user interface are detected and processed for at least changing the device to an, at least in part, unlocked state.

METHOD AND APPARATUS FOR  
INCREASING THE FUNCTIONALITY OF A  
USER DEVICE IN A LOCKED STATE

5 BACKGROUND

Service providers and device manufacturers (e.g., wireless, cellular, etc.) are continually challenged to deliver value and convenience to consumers by, for example, providing compelling network services. On a daily basis, users utilize different user devices (e.g., mobile phones, PDAs, computers,  
10 etc.) to perform various tasks (e.g., make phone calls, check emails, chat, log onto an internet service, etc.) User devices, such as those with touch screens and/or keypads, have a locking feature to avoid any accidental functioning and/or unauthorized use of the user device. The lock screen, however, requires additional time to unlock before accessing and using an application and/or a service that is run on the user device. There is a need, therefore, to increase the functionality of the  
15 user device while it is in an, at least in part, locked state.

SOME EXAMPLE EMBODIMENTS

Therefore, there is a need for an approach for increasing utility of a process for unlocking a user  
20 device while the device is in an, at least in part, locked state.

According to one embodiment, a method comprises causing, at least in part, a presentation of a first user interface associated with an, at least in part, locked state of a device. The method further comprises causing, at least in part, a rendering of at least a portion of a second user interface  
25 associated with the first user interface, wherein the second user interface is associated with one or more applications, one or more services, or a combination thereof. The method also comprises processing and/or facilitating a processing of one or more interactions with the first user interface, the at least a portion of the second user interface, or a combination thereof to cause, at least in part, a change of the device to an, at least in part, unlocked state.

30 According to another embodiment, an apparatus comprises at least one processor, and at least one memory including computer program code, the at least one memory and the computer program code configured to, with the at least one processor, cause, at least in part, the apparatus to cause, at least in part, a presentation of a first user interface associated with an, at least in part, locked state of a  
35 device. The apparatus is further caused to cause, at least in part, a rendering of at least a portion of a second user interface associated with the first user interface, wherein the second user interface is associated with one or more applications, one or more services, or a combination thereof. The apparatus is also caused to process and/or facilitate a processing of one or more interactions with the first user interface, the at least a portion of the second user interface, or a combination thereof to  
40 cause, at least in part, a change of the device to an, at least in part, unlocked state.

According to another embodiment, a computer-readable storage medium carries one or more sequences of one or more instructions which, when executed by one or more processors, cause, at least in part, an apparatus to cause, at least in part, a presentation of a first user interface associated with an, at least in part, locked state of a device. The apparatus is further caused to cause, at least in part, a rendering of at least a portion of a second user interface associated with the first user interface, wherein the second user interface is associated with one or more applications, one or more services, or a combination thereof. The apparatus is also caused to process and/or facilitate a processing of one or more interactions with the first user interface, the at least a portion of the second user interface, or a combination thereof to cause, at least in part, a change of the device to an, at least in part, unlocked state.

According to another embodiment, an apparatus comprises means for causing, at least in part, a presentation of a first user interface associated with an, at least in part, locked state of a device. The apparatus also comprises means for causing, at least in part, a rendering of at least a portion of a second user interface associated with the first user interface, wherein the second user interface is associated with one or more applications, one or more services, or a combination thereof. The apparatus further comprises means for causing to process and/or facilitate a processing of one or more interactions with the first user interface, the at least a portion of the second user interface, or a combination thereof to cause, at least in part, a change of the device to an, at least in part, unlocked state.

In addition, for various example embodiments of the invention, the following is applicable: a method comprising facilitating a processing of and/or processing (1) data and/or (2) information and/or (3) at least one signal, the (1) data and/or (2) information and/or (3) at least one signal based, at least in part, on (including derived at least in part from) any one or any combination of methods (or processes) disclosed in this application as relevant to any embodiment of the invention.

For various example embodiments of the invention, the following is also applicable: a method comprising facilitating access to at least one interface configured to allow access to at least one service, the at least one service configured to perform any one or any combination of network or service provider methods (or processes) disclosed in this application.

For various example embodiments of the invention, the following is also applicable: a method comprising facilitating creating and/or facilitating modifying (1) at least one device user interface element and/or (2) at least one device user interface functionality, the (1) at least one device user interface element and/or (2) at least one device user interface functionality based, at least in part, on data and/or information resulting from one or any combination of methods or processes disclosed in this application as relevant to any embodiment of the invention, and/or at least one signal resulting from one or any combination of methods (or processes) disclosed in this application as relevant to any embodiment of the invention.

For various example embodiments of the invention, the following is also applicable: a method comprising creating and/or modifying (1) at least one device user interface element and/or (2) at least one device user interface functionality, the (1) at least one device user interface element and/or (2) at least one device user interface functionality based at least in part on data and/or information  
5 resulting from one or any combination of methods (or processes) disclosed in this application as relevant to any embodiment of the invention, and/or at least one signal resulting from one or any combination of methods (or processes) disclosed in this application as relevant to any embodiment of the invention.

10 In various example embodiments, the methods (or processes) can be accomplished on the service provider side or on the mobile device side or in any shared way between service provider and mobile device with actions being performed on both sides.

For various example embodiments, the following is applicable: An apparatus comprising means for  
15 performing the method of any of originally filed claims 1-10, 21-30, and 46-48.

Still other aspects, features, and advantages of the invention are readily apparent from the following detailed description, simply by illustrating a number of particular embodiments and implementations, including the best mode contemplated for carrying out the invention. The invention is also capable  
20 of other and different embodiments, and its several details can be modified in various obvious respects, all without departing from the spirit and scope of the invention. Accordingly, the drawings and description are to be regarded as illustrative in nature, and not as restrictive.

#### BRIEF DESCRIPTION OF THE DRAWINGS

25

The embodiments of the invention are illustrated by way of example, and not by way of limitation, in the figures of the accompanying drawings:

FIG. 1 is a diagram of a system capable of increasing utility of a process for unlocking a user device while the device is in an, at least in part, locked state, according to one embodiment;

30 FIG. 2 is a diagram of components of a user equipment capable of an application processing platform, according to one embodiment;

FIG. 3 is a flowchart of a process for presenting a first and a second user interface associated with an, at least in part, locked state of a user device, according to one embodiment;

35 FIG. 4 is a flowchart of a process for processing user interactions and determining one or more applications, according to one embodiment;

FIGs. 5A-5F are diagrams of user interfaces utilized in the processes of FIGs. 3 and 4, according to various embodiments;

FIG. 6 is a diagram of hardware that can be used to implement an embodiment of the invention;

FIG. 7 is a diagram of a chip set that can be used to implement an embodiment of the invention; and

40 FIG. 8 is a diagram of a mobile terminal (e.g., handset) that can be used to implement an embodiment of the invention.

## DESCRIPTION OF SOME EMBODIMENTS

Examples of a method, apparatus, and computer program for increasing utility of a process for unlocking a user device while the device is in an, at least in part, locked state are disclosed. In the following description, for the purposes of explanation, numerous specific details are set forth in order to provide a thorough understanding of the embodiments of the invention. It is apparent, however, to one skilled in the art that the embodiments of the invention may be practiced without these specific details or with an equivalent arrangement. In other instances, well-known structures and devices are shown in block diagram form in order to avoid unnecessarily obscuring the embodiments of the invention.

FIG. 1 is a diagram of a system capable of increasing utility of a process for unlocking a user device while the device is in an, at least in part, locked state, according to one embodiment. Users utilize one or more user devices throughout the day for accomplishing tasks, communicating with others, entertainment, infotainment, education and the like. Further, the user devices, such as those with touch screens, have a lock screen feature to avoid any accidental functioning of the user device and/or to prevent unauthorized use of the user device. As a result, a user typically has to interact with the user device (e.g., enter a password/passcode) several times per day (unlocking times) to unlock it before utilizing it. The unlocking procedure may occur in any situation, for example, the user may have some available time (e.g., travelling on a train, waiting for a bus, waiting at an airport, etc.) and may wish to further interact with the user device during the unlocking of the user device. As such, one or more applications on the user device and/or a service provider can present one or more tasks, challenges, questions and the like to the unlocking process wherein one or more services (e.g., informational, educational, entraining, advertising, value added services, location-based, user defined, service-provider defined, etc.) can be presented to the user. For example, it is lunch-time and a user is walking by a restaurant while attempting to unlock his user device for utilization. Further, a service provider causes a challenge-question and a discount coupon for the nearby restaurant to be presented to the user when the user attempts to unlock the user device and upon answering the question and unlocking the user device, the discount coupon is presented to the user. Under the approach of the various embodiments described herein, the user would then have the option to unlock the device using a normal procedure, or to unlock the device by interacting with or responding to the challenge-question to unlock the device.

Accordingly, a system 100 of FIG. 1 introduces the capability to combine functionality of particular applications with an unlocking process at a user device (e.g., when the user device is locked) and to efficiently present one or more beneficial services to the user. For example, when a user wants to unlock a device (e.g., indicated by the user activating the screen of an, at least in part, locked device), the system 100 can display the normal unlocking user interface with additional user interface elements from a second or unrelated application or user interface. In one embodiment, The second application or user interface can (1) present information (e.g., advertising information); (2) display a competition question, poll, or etc; (3) request any interaction with another application presented in

the lock screen; and the like. Then, depending on how the user chooses to interact with the lock screen (e.g., unlock the screen normally, answer a challenge or poll question, interact with the other application, etc.), the system 100 can unlock the device and provide additional functionality based on the nature of the interactions and the applications supporting the interactions.

5

In other words, the system 100 enables one or more applications to determine when a user device is in an, at least in part, locked state, determine when a user attempts to unlock the user device and determine to combine functionalities of one or more applications with the unlocking process for presenting one or more services, contents and/or applications to the user.

10

For example, steps of combining one or more applications with unlocking process of a user device such as that discussed above may be as follows: get the user device from the user's pocket, press a key on a keypad or press the power button, an application on the user device indicates that the user device is in an, at least in part, locked state, presents a first user interface prompting the user to enter a user password, present a second user interface prompting the user to interact with the second user interface wherein upon receiving correct entries in both the first and second user interfaces, the user device is unlocked and one or more applications, services and/or contents are presented to the user either preceding or succeeding the unlocking of the user device. In this example, the application or a sub-process of the application for presenting the second user interface in an, at least in part, locked state can be running and accessible without having to unlock the phone, search for the application, access the application and run the application. Such an implementation may be based on close integration between a device's software and an application processing manager because lock screen content and behavior is usually controlled by the device's resident operating system. In one embodiment, the integration may be enabled by an operating system provided application programming interface to access lock screen rendering and functionality.

15

20

25

In various embodiments, a user device may be locked by a user and/or may have one or more predefined and/or configurable configurations for automatically locking the user device wherein portions of a touch screen area and/or a keypad area of the user device would be locked in order to prevent accidental operation and/or unauthorized use of the device. Further, a user may initiate an unlocking process by interacting with the user device via one or more keys on a keypad, a power button, a touch on one or more portions of a touch screen, audio (e.g., voice input), video (e.g., facial gestures), hand gestures and movements, or a combination thereof wherein the user may enter/submit one or more user passwords/passcodes for unlocking the user device for utilization.

30

35

As shown in FIG. 1, the system 100 comprises a user equipment (UE) 101 having connectivity to an application processing platform 103, content providers 113a-113n (collectively referred to as content provider 113), and a service platform 115 via a communication network 105. In one embodiment, the UE 101 has sensors 107 the detect context information about the location of the UE 101 and/or orientation information about the UE 101. The UE 101 may be in an, at least in part, locked state, and once a display is activated, the UE 101 displays one or more applications 111 such

40

as a user interface, a map, a media player, a web browser, a messaging application, that may be one of many applications functioning in the locked state. The UE 101 may switch between applications 111 and/or alternative views based on a movement of and/or an attempt to utilize the UE 101, which may be detected by the sensors 107, application processing manager 109 and/or one or more applications 111. The application processing platform 103 may be resident within the UE 101 or external to the UE 101 and/or the functionality of the application processing platform 103 may be replaced or shared by an application processing manager 109 that is resident within the UE 101. For simplicity, the application processing manager 109 will be described in the context of the application processing platform 103, herein. The application processing platform 103 may determine whether a switch or a button of the UE 101 has been actuated, whether a standard power mode or a low power mode should be activated on the UE 101 for running an application in the locked state, and process any context information that the processing platform 103 may receive by way of the sensors 107, for example. In one embodiment, the UE 101 includes a data collection module 117 for collecting information such as user profile information, use history, user preferences, location information and the like. In certain embodiments, one or more GPS satellites 119 may be utilized in determining the location of the UE 101 in connection with one or more spatiotemporal or GPS transceivers of the data collection module 117.

Further, one or more information items presented/submitted by a user during an unlocking process may be presented for evaluation to the service platform 115, the content provider 113 and/or the application processing platform 103 via a communication network 105.

Furthermore, one or more content items include one or more identifiers, metadata, access addresses (e.g., network address such as a Uniform Resource Locator (URL) or an Internet Protocol (IP) address; or a local address such as a file or storage location in a memory of the UE 101, description, or the like associated with the content. In one embodiment, content includes live media (e.g., streaming broadcasts), stored media (e.g., stored on a network or locally), metadata associated with media, text information or a combination thereof. Also, the content may be provided by the service platform 115 which (e.g., music service, mapping service, video service, social networking service, content broadcasting service, etc.), the content provider 113 (e.g., online content retailers, public databases, etc.) and/or other content sources available or accessible via the communication network 105.

By way of example, the UE 101 may execute the applications 111 to receive content and/or mapping information from the content provider 113 or other components of the communication network 105. As mentioned above, the UE 101 may utilize GPS satellites 119 and/or assisted GPS (A-GPS) to determine the location of the UE 101 to utilize one or more contents and/or one or more location-based services provided by the service platform 115.

In certain embodiments, the UE 101 may be in an, at least in part, locked state and when a user attempts to unlock the user device, the application processing manager 109 may cause, at least in



part, a combining of one or more applications with a password application for unlocking the user device. For example, a UE 101 is in an, at least in part, locked state and a user attempts to unlock the UE 101. The application processing manager 109 presents a password application and substantially concurrently one or more other applications (e.g., a media item, a map, a text box, etc.)  
5 on the user interface of the UE 101.

In one embodiment, a first user interface (UI) associated with an, at least in part, locked state of a user device is presented to a user. For example, the UI prompts the user to enter a password wherein the password may include one or more entries of textual, numerical, graphical, biometric, and the like parameters. For example, a user has setup a password including text, special and numerical characters, for example, "football-is-number-1". In another example, the password is an audio capture of the user's voice uttering a predefined number of words (e.g., "I love soccer").  
10

In various embodiments, one or more portions of a second user interface are presented associated with the first user interface, wherein the second user interface is associated with one or more applications and/or one or more services, wherein the one or more applications and/or the one or more services relate, at least in part, to an advertising service, a polling service, a competition service, a testing service and the like. For example, a user is presented with a question/challenge and a prompt (e.g., a second UI) for entering/selecting an answer to the question wherein the prompt may be combined and/or integrated with the first UI. In another embodiment, one or more interactions with the first user interface and/or with the one or more portions of the second user interface are determined and/or are processed to cause, at least in part, a change of the device to an, at least in part, unlocked state. For example, (1) a user attempts to unlock a user device, (2) is prompted in a first prompt (e.g., in a first UI) to enter his predefined password (e.g., a numeric code), (3) is prompted in a second prompt (e.g., a second UI) to enter/select (e.g., second entry) between a list of burger restaurants.  
15  
20  
25

In other embodiments, the one or more applications, the one or more services and/or the one or more interactions are determined, at least in part, by the device, a service provider, a content provider and the like. In one embodiment, the application processing manager 109 on the user device determines the one or more interactions between the user and the user device, for example, whether the user correctly answered a question presented in the second prompt. In another embodiment, the one or more interactions are processed by a service provider to ascertain validity of the user response. For example, the service provider may have presented a question (e.g., what is the cost of a burger?) related to a certain vendor (e.g., Joe's Burgers), wherein one or more incentives (e.g., a coupon for Joe's Burgers) can be presented to the user upon receiving a correct response from the user.  
30  
35

In various embodiments, the user has a choice to ignore the second prompt and proceed to present the password for evaluation by an application (e.g., a password application) for unlocking the device, or the user can respond to the second prompt wherein the first entry (e.g., the password  
40

entry) and the second entry (e.g., a selection of a burger restaurant) are presented to one or more applications for evaluation and for unlocking the device, and wherein one or more applications, one or more services or a combination thereof may be presented on a UI preceding or succeeding an unlocking of the user device.

5

In another embodiment, one or more interactions by the user with the user device are processed in order to determine whether one or more functions of one or more applications and/or one or more services are to be initiated. For example, if the user elects to interact with the second prompt (e.g., answers a questions presented in the second UI portion), then one or more applications and/or services (e.g., an application to present a coupon) may be initiated. In another example, if the user decides not to interact with the second prompt (e.g., ignore, cancel, etc.) then the password entered by the user in the first prompt is evaluated and if valid, the user device is unlocked.

10

In another embodiment, one or more content items may be cached at the user device (e.g., stored at the storage device in the user device). For example, a service provider can send (e.g., via a wireless service, via internet, etc.) to the user device one or more contents (e.g., applications, widgets, contents, services and the like) so that the user device may store the one or more contents at the user device and utilize them as needed. In a user case scenario, a service provider sends several coupons (e.g., related to one or more services and/or products) to a user device and the user device stores the coupons at a local storage. Further, the user device can monitor user activity (e.g., user is near a shopping mall) and can utilize one or more of the contents to present to the user, if the user attempts to unlock the user device while near the shopping mall. In another embodiment, the user device may contact a service provider and/or a content provider to request for one or more contents, for example, while the user device is idle, or there are no more locally stored contents, or free and/or low cost connection is available, or remaining locally stored content does not match user preferences and the like.

15

20

25

In another embodiment, one or more interactions by the user with the user device can cause, at least in part, a generation of the one or more content items. For example, the application processing manager 109 may determine that the last interaction by the user with the user device before the user device was locked (e.g., by the user or automatically) was that the user was consuming a media item (e.g., listening to a musical album by an artist) wherein the application processing manager 109, the service platform 115 and/or the content provider 113 can cause to generate one or more content items related to the media item (e.g., short segment of a new song by the artist) and present it (e.g., play it) to the user during the next unlocking process if the user chooses to accept the content.

30

35

In another embodiment, one or more interactions by the user with the user device are processed to determine one or more applications, one or more services, or a combination thereof. For example, a user may be utilizing an application on the user device to study/learn a language; further the application processing manager 109 can determine to combine with the unlocking process a presentation of a language skills task (e.g., translation of a word into a different language). In

40

another embodiment, the user can predefine that anytime the user attempts to unlock the user device, the application processing manager 109 should cause one or more applications to present a predefined task for the user (e.g., translate a word into a target language) wherein the application processing manager 109 can cause the one or more applications and/or the one or more services from a local storage, from a service provider and/or a content provider. In another example, the user may be touring a museum and attempts to unlock his user device wherein the application processing manager 109 can combine with the unlocking process a presentation of an image of a painting being exhibited in the museum and further can present a question related to the painting.

10 In another embodiment, one or more interaction histories are generated based, at least in part, on one or more interactions by the user with the user device. For example, the application processing manager 109 can generate an interaction history indicating that a user has elected to interact more frequently with one or more particular applications and/or services than other applications and/or services. In various embodiments, the service platform 115 and/or the content provider 113 may collect the user interaction information and generate one or more interaction histories.

In another embodiment, by processing the interaction history, the application processing manager 109, the service platform 115 and/or the content provider 113 can determine one or more applications and/or one or more services to be rendered/presented to the user during an unlocking process. For example, a user interaction history may indicate that the user favors interaction with certain types of applications and/or service. For example, an interaction history may indicate that a user more frequently interacts with sports related applications and/or services. In another example, a user may be interacting with applications and/or services only during certain time of the day (e.g., during lunch time, after office hours, etc.).

25 In one embodiment, the application processing manager 109, the service platform 115 and/or the content provider 113 can cause, at least in part, an initiation of one or more applications and/or one or more services based, at least in part, on a change of the user device to an, at least in part, unlocked state. For example, if a user elects to interact with a second prompt during an unlocking process of the user device, then once the user device is in the unlocked state, one or more applications and/or one or more services can be initiated and presented to the user. In another example, if during the unlocking process the user interacted with a second prompt related to a service (e.g., music download), then once the user device is unlocked, one or more applications and/or one or more services are initiated and presented to the user in a UI wherein the user may further interact with the one or more applications and/or one or more services (e.g., follow a link to a music website.) In another embodiment, one or more applications and/or one or more services initiated in the locked state may continue on to the unlocked state of the user device. For example, if during an unlocking process of a user device a user interacted with one or more applications and/or one or more services (e.g., music download), then the one or more applications and/or the one or more services may continue on and initiate one or more applications and/or one or more

services (e.g., launch an application, connect to a website, play a musical selection identified in the second prompt in the unlocking process and/or download the musical selection.).

5 In certain embodiments, the UE 101 may be running an application in an, at least in part, locked state and wherein the application may have multiple views or user interfaces available. The user, in this embodiment, may switch between views, user interfaces, or applications by actuating a switch (e.g., physical or virtual) that is part of the UE 101. For example, the user may hit a power button on the UE 101 to activate a display, and may then hit the power button again, or a volume button to change the view.

10 By way of example, the communication network 105 of system 100 includes one or more networks such as a data network (not shown), a wireless network (not shown), a telephony network (not shown), or any combination thereof. It is contemplated that the data network may be any local area network (LAN), metropolitan area network (MAN), wide area network (WAN), a public data  
15 network (e.g., the Internet), short range wireless network, or any other suitable packet-switched network, such as a commercially owned, proprietary packet-switched network, e.g., a proprietary cable or fiber-optic network, and the like, or any combination thereof. In addition, the wireless network may be, for example, a cellular network and may employ various technologies including enhanced data rates for global evolution (EDGE), general packet radio service (GPRS), global  
20 system for mobile communications (GSM), Internet protocol multimedia subsystem (IMS), universal mobile telecommunications system (UMTS), etc., as well as any other suitable wireless medium, e.g., worldwide interoperability for microwave access (WiMAX), Long Term Evolution (LTE) networks, code division multiple access (CDMA), wideband code division multiple access (WCDMA), wireless fidelity (WiFi), wireless LAN (WLAN), Bluetooth®, Internet Protocol (IP)  
25 data casting, satellite, mobile ad-hoc network (MANET), and the like, or any combination thereof.

The UE 101 is any type of mobile terminal, fixed terminal, or portable terminal including a mobile  
30 handset, station, unit, device, multimedia computer, multimedia tablet, Internet node, communicator, desktop computer, laptop computer, notebook computer, netbook computer, tablet computer, personal communication system (PCS) device, personal navigation device, personal digital assistants (PDAs), audio/video player, digital camera/camcorder, positioning device, television receiver, radio broadcast receiver, electronic book device, game device, or any combination thereof, including the accessories and peripherals of these devices, or any combination thereof. It is also contemplated that the UE 101 can support any type of interface to the user (such as “wearable” circuitry, etc.).

35 By way of example, the sensors 107 may be any of a camera, an orientation sensor, a movement sensor, a location sensor, a proximity sensor, a light sensor and the like.

40 By way of example, the UE 101, the application processing platform 103, the content provider 113; and service platform 115 communicate with each other and other components of the communication network 105 using well known, new or still developing protocols. In this context, a protocol

includes a set of rules defining how the network nodes within the communication network 105 interact with each other based on information sent over the communication links. The protocols are effective at different layers of operation within each node, from generating and receiving physical signals of various types, to selecting a link for transferring those signals, to the format of information indicated by those signals, to identifying which software application executing on a computer system sends or receives the information. The conceptually different layers of protocols for exchanging information over a network are described in the Open Systems Interconnection (OSI) Reference Model.

Communications between the network nodes are typically effected by exchanging discrete packets of data. Each packet typically comprises (1) header information associated with a particular protocol, and (2) payload information that follows the header information and contains information that may be processed independently of that particular protocol. In some protocols, the packet includes (3) trailer information following the payload and indicating the end of the payload information. The header includes information such as the source of the packet, its destination, the length of the payload, and other properties used by the protocol. Often, the data in the payload for the particular protocol includes a header and payload for a different protocol associated with a different, higher layer of the OSI Reference Model. The header for a particular protocol typically indicates a type for the next protocol contained in its payload. The higher layer protocol is said to be encapsulated in the lower layer protocol. The headers included in a packet traversing multiple heterogeneous networks, such as the Internet, typically include a physical (layer 1) header, a data-link (layer 2) header, an internetwork (layer 3) header and a transport (layer 4) header, and various application (layer 5, layer 6 and layer 7) headers as defined by the OSI Reference Model.

FIG. 2 is a diagram of the components of the UE 101 capable of associating one or more applications with an, at least in part, locked state of the UE 101, according to one embodiment. By way of example, the UE 101 includes one or more components for increasing the functionality of a user device while the device is in an, at least in part, locked state. It is contemplated that the functions of these components may be combined in one or more components or performed by other components of equivalent functionality. In this embodiment, the UE 101 includes a data collection module 117 that may include one or more location modules 201, context modules 203, and display modules 205. The UE 101 can also include a runtime module 207 to coordinate use of other components of the UE 101, a user interface 209, a communication interface 211, an actuation determination module 213, and memory 215. An application 111 (e.g., a location-based services application) of the UE 101 can execute on the runtime module 207 utilizing the components of the UE 101.

As mentioned previously, the location module 201 can determine a user's location, which can be determined by a triangulation system such as GPS, assisted GPs (A-GPS), Cell of Origin, or other location extrapolation technologies. Standard GPS and A-GPS systems can use GPS satellites 119 to pinpoint the location of a UE 101. The location module 201 may also utilize multiple

technologies to detect the location of the UE 101, for example, a Cell-of-Origin system can be used to determine the cellular tower that a cellular UE 101 is synchronized with. This information provides a coarse location of the UE 101 because the cellular tower can have a unique cellular identifier (cell-ID) that can be geographically mapped. Location coordinates (e.g., GPS coordinates) can give finer detail as to the location of the UE 101 when one or more location-based services are utilized and synchronized with the communication network 105.

The context module 203 receives context information by way of the communication module 211 about the UE 101 that may be detected by the sensors 107. A user profile may also be resident on the UE 101 or receivable from another network entity that communicates with the application processing platform 103. The context information that is received may be processed by the context module 203 to determine locations of interest to a user of the UE 101 such as landmarks, restaurants, bars, transportation information, hotels, etc. The display module 205 determines what information is to be displayed, and based on the determination made by the actuation determination module 213, determines which user interface or view of the application or other applications is to be displayed.

In one embodiment, the communication module 211 can be used to communicate with a service platform 115 or other UEs 101. Certain communications can be via methods such as an internet protocol, messaging (e.g., SMS, MMS, etc.), or any other communication method (e.g., via the communication network 105). In some examples, the UE 101 can send a request to the content provider 113 and/or to the service platform 115 via the communication module 211. The content provider 113 and/or the service platform 115 may then send a response back via the communication module 211. In certain embodiments, location and/or orientation information is used to generate a request for content and/or services.

The user interface 209 can include various methods of communication. For example, the user interface 209 can have outputs including a visual component (e.g., a screen), an audio component, a physical component (e.g., vibrations), and other methods of communication. User inputs can include a touch-screen interface, a scroll-and-click interface, a button interface, a microphone, etc. Moreover, the user interface 209 may be used to display maps, navigation information, camera images and streams, augmented reality application information, POIs, virtual reality map images, panoramic images and the like from the memory 215 and/or received via the communication module 211. Input can be via one or more methods such as voice input, textual input, typed input, typed touch-screen input, other touch-enabled input, etc. Further, the user interface 209 can additionally be utilized to add content, interact with content, manipulate content, or the like. Further, the user interface 209 may be utilized to filter content from a presentation and/or select criteria. Moreover, the user interface may be used to manipulate objects, cause presentation of images or a combination thereof.

40

FIG. 3 is a flowchart of a process for presenting a first and a second user interface associated with an, at least in part, locked state of a user device, according to one embodiment. In one embodiment, the application processing manager 109 performs the process 300 and is implemented in, for instance, a chip set including a processor and a memory as shown in FIG. 7. As such, the application processing manager 109 and/or runtime module 207 can provide means for accomplishing various parts of the process 300 as well as means for accomplishing other processes in conjunction with other components of the UE 101 and/or service platform 115.

In step 301, the application processing manager 109 causes, at least in part, a presentation of a first user interface associated with an, at least in part, locked state of a device. In one embodiment, one or more portions of one or more user interfaces (e.g., a touch screen, a keypad, etc.) on UE 101 are locked. In one embodiment, one or more sensors on the UE 101 (e.g., a power button, a key on a keypad, an accelerometer, etc.) detect one or more interactions (e.g., a touch on the screen, a key press, a movement of the UE 101, etc.) Further, upon detection of the one or more interactions, the application processing manager 109 present a UI wherein a user may enter/submit one or more passwords (e.g., textual, numerical, audio, biometrical, a combination thereof, etc.) for evaluation.

In step 303, the application processing manager 109 causes, at least in part, a rendering of at least a portion of a second user interface associated with the first user interface, wherein the second user interface is associated with one or more applications, one or more services, or a combination thereof. In one embodiment, a second prompt is presented whereby the user may interact with the second prompt for accomplishing one or more tasks. For example, the second prompt may present a question (e.g., "what is a latest game available for game console X") and ask the user to select an answer from a list of available answers. In another example, the user may be asked to pronounce one or more words at the UE 101 wherein one or more applications at the UE 101 and/or at a service provider can process the pronounced one or more words for further utilization by one or more applications (e.g., a password application). In various embodiments, the one or more applications, the one or more services and/or one or more content items relate, at least in part, to an advertising service, a polling service, a competition service, a testing service, or a combination thereof. In other embodiments, the one or more applications, the one or more services and/or the one or more interactions are determined, at least in part, by the device, a service provider, a content provider and the like. In one embodiment, the application processing manager 109 on the user device determines the one or more interactions between the user and the user device, for example, whether the user elected to participate in a community challenge question. In another embodiment, the one or more interactions are processed by a service provider to ascertain validity of the user response. For example, the service provider may quiz the user about a last walking-marathon that the user attended.

In step 305, the application processing manager 109 processes and/or facilitates a processing of one or more interactions with the first user interface, the at least a portion of the second user interface, or a combination thereof to cause, at least in part, a change of the device to an, at least in part,

unlocked state. In one embodiment, a password by a user comprising, for example, text, numbers, biometric parameters, audio, and the like is detected and/or processed. In another embodiment, a password by a user and a user interaction comprising, for example, an entry (e.g., textual, numerical, graphical, an audio capture, a gesture, etc.) into a second portion of a user interface and/or a user action are detected. For example a user enters a user password and enters/selects an answer to a question presented at the UE 101.

In step 307, the application processing manager 109 processes and/or facilitates a processing of the one or more interactions to determine whether to cause, at least in part, an initiation of one or more functions of the one or more applications, the one or more services, or a combination thereof. In various embodiments, a user may choose to interact, ignore, cancel, postpone, etc. interaction with a second prompt wherein one or more applications and/or services may be initiated based, at least in part, on the user interaction. For example, if user chooses to interact with the second prompt, one or more applications can be initiated on the UE 101.

In step 309, the application processing manager 109 processes and/or facilitates a processing of the one or more interactions to cause, at least in part, a generation of the one or more content items. In one embodiment, user chooses to interact with a second prompt (e.g., advertising) which causes one or more applications and/or a service provider to initiate further functionalities of one or more applications and/or services. In another embodiment, a user elects not to interact with the second prompt and instead proceed to cause an unlocking of the UE 101. In another embodiment, the user chooses to postpone interacting with the second prompt (e.g., interact with a language skills prompt after the UE 101 is unlocked).

FIG. 4 is a flowchart of a process for processing user interactions and determining one or more applications, according to one embodiment. In one embodiment, the application processing manager 109 performs the process 400 and is implemented in, for instance, a chip set including a processor and a memory as shown in FIG. 7. As such, the application processing manager 109 and/or runtime module 207 can provide means for accomplishing various parts of the process 400 as well as means for accomplishing other processes in conjunction with other components of the UE 101 and/or service platform 115.

In step 401, the application processing manager 109 causes, at least in part, a caching of the one or more content items at the device. In one embodiment, one or more content items are cached at the user device (e.g., stored at the storage device of UE 101). For example, a service provider can send (e.g., via a wireless service, via internet, etc.) to the user device one or more contents so that the user device may store the one or more contents at the user device and utilize them as needed. For example, a service provider sends several words to be used in language learning skills in a language defined by the user. In another example, a service provider sends one or more questions related to an on-line game application so that the UE 101 can save them at a UE 101 local storage. In various embodiments, the user device can request for one or more contents for local storage, for example,



when content availability at a local storage is low, the user has changed user's preferences, user's content consumption has changed and the like.

5 In step 403, the application processing manager 109 processes and/or facilitates a processing of the one or more interactions to determine the one or more applications, the one or more services, or a combination thereof. In one embodiment, one or more applications, service providers and/or content providers can determine a user interacting with a second prompt and/or other prompts in order to determine what application, service and/or content to present to the user. For example, a user may choose to partake in a survey related to a local gym wherein one or more coupons for one or more services (e.g., nutritional evaluation) can be presented to the user which may follow by a quiz related to calories in a certain food item. Further, a link to an online nutrition evaluation site is provided wherein, further, an application for accessing the online site is launched.

15 In step 405, the application processing manager 109 causes, at least in part, a generation of an interaction history based, at least in part, on the one or more interactions. In one embodiment, one or more applications on the user device UE 101 generates/creates one or more logs comprising user interactions with one or more applications and/or one or more services during one or more user device unlocking processes. For example, a user history may indicate that a user has been interacting with certain types of applications and/or services and has consumed certain types of contents during the last four weekends.

25 In step 407, the application processing manager 109 processes and/or facilitates a processing of the interaction history to determine the one or more applications, the one or more services, or a combination thereof. In various embodiments, a user interaction history may be processed, analyzed, evaluated, examined and the like in order to present one or more applications, one or more services and/or one or more contents to the user during an unlocking process of a user device.

30 In step 409, the application processing manager 109 causes, at least in part, an initiation of the one or more application, the one or more services, or a combination thereof based, at least in part, on the change of the device to the unlocked state. In one embodiment, the application processing manager 109, the service platform 115 and/or the content provider 113 can cause, at least in part, an initiation of one or more applications and/or one or more services based, at least in part, on a change of the user device to an, at least in part, unlocked state. For example, if a user elects to interact with a second prompt during an unlocking process of the user device, then once the user device is in the unlocked state, one or more applications and/or one or more services can be initiated for presentation to the user. For example, if during the unlocking process the user interacted with a second prompt related to a content (e.g., a food item), then once the user device is unlocked, one or more applications and/or one or more services are initiated and presented to the user in a UI wherein the user may obtain additional information related to the content. In another embodiment, one or more applications and/or one or more services initiated in the locked state may continue on to the unlocked state of the user device.

FIGs. 5A-5F are diagrams of user interfaces utilized in the processes of FIGs. 3 and 4, according to various embodiments. Each of the user interfaces illustrated in Figs. 4A and 4B have functionality of particular applications when a device is locked. FIG. 5A shows user interface 500 on a user device 501 (e.g., UE 101) which is in an, at least in part, locked state indicated by 503. In one embodiment, one or more sensors 107 detect an interaction, for example, with power button 505 and/or a key on keypad 507 wherein application processing manager 109 causes a presentation of first user interface 509 for the user entry of a user password. Further, the application processing manager 109 causes a presentation of a second portion of a user interface 511 wherein a one or more information items can be presented. For example, a coupon quiz is by a vendor "Joe's Burger Spot", a question/challenge (e.g., "How much does a burger cost at JOE's Burger Spot) and one or more answer selections 513 are presented to the user. Further, FIG. 5B shows user interface 520 wherein the user device still is in an, at least in part, locked state 525. At this point, the user may enter a user password (e.g., "myPassword") and additionally enter answer "A" (e.g., \$2.00) from the list of answers presented presenting an aggregated password of "myPassword\$2.00" at 523. Furthermore, FIG. 5C illustrates user interface 540 wherein upon validation of the aggregated password the user device is unlocked 543 and one or more content items 541 (e.g., a coupon "FREE BURGER at JOE's Burger Spot"), one or more applications and/or or services are presented to the user. In another embodiment, the user does not wish to partake in the quiz and only present a user password (e.g., "myPassword") for unlocking the user device wherein the user does not receive additional content (e.g., no coupon). In another embodiment, the user presents an incorrect answer (e.g., answer selection "'B") from the list 521 and therefore does not receive a coupon. In another embodiment, whether the user presents answer choice "A" or "B", preceding or succeeding the unlocking of the user device, the user is presented with a link and/or is routed to an online internet site for "JOE's Burger Spot".

FIG. 5D shows user interface 560 wherein the user device is in an, at least in part, locked state 561 and wherein during an unlocking process of the UE 101 an educational quiz/challenge is presented to the user of UE 101. In this example, the user is presented with a language skills quiz 563 (e.g., "What is the Spanish word for color BLUE?" and answer selections 565 wherein the user may enter an aggregated password of "myPasswordAZUL" at 567 or "myPasswordB" as a correct answer.

FIG. 5E shows user interface 580 wherein the user device is in an, at least in part, locked state 581. In one embodiment, during an unlocking process of the UE 101 a challenge and an offer 583 are presented to the user wherein the user is asked to complete a puzzle 585 in order to receive a 20% discount coupon valid at the "BIG" shopping mall whereby the user may present the user password "myPassword" at 587 and complete the puzzle in order to receive the coupon. In another embodiment, a user may store (e.g., at a local device or at a service provider) one or more coupons, offers, points, challenges, questions and the like presented during and/or after an unlocking process for future consideration.

In various embodiments, a user, one or more service providers and/or one or more content providers can configure presentation of one or more contents, services and/or applications during an unlocking process of a user device.

5 FIG. 5F shows user interface 590 wherein the user device is in an, at least in part, locked state 591. In one embodiment, during an unlocking process of the UE 101, an offer and a task 593 are presented to the user wherein the user is asked to “read aloud the following phrase for a free music download coupon from mymusic.com: “I LOVE MYMUSIC.COM””. Further, sensors 107 and/or applications 111 capture/record/process the voice of the user at 595 and a user password at 597 for  
10 further evaluation at the user device, at a service provider and/or at a content provider.

The processes described herein for increasing utility of a process for unlocking a user device while the device is in an, at least in part, locked state may be advantageously implemented via software, hardware, firmware or a combination of software and/or firmware and/or hardware. For example,  
15 the processes described herein, may be advantageously implemented via processor(s), Digital Signal Processing (DSP) chip, an Application Specific Integrated Circuit (ASIC), Field Programmable Gate Arrays (FPGAs), etc. Such exemplary hardware for performing the described functions is detailed below.

20 FIG. 6 illustrates a computer system 600 upon which an embodiment of the invention may be implemented. Although computer system 600 is depicted with respect to a particular device or equipment, it is contemplated that other devices or equipment (e.g., network elements, servers, etc.) within FIG. 6 can deploy the illustrated hardware and components of system 600. Computer system 600 is programmed (e.g., via computer program code or instructions) to increase the functionality of  
25 a user device while the device is in an, at least in part, locked state as described herein and includes a communication mechanism such as a bus 610 for passing information between other internal and external components of the computer system 600. Information (also called data) is represented as a physical expression of a measurable phenomenon, typically electric voltages, but including, in other embodiments, such phenomena as magnetic, electromagnetic, pressure, chemical, biological,  
30 molecular, atomic, sub-atomic and quantum interactions. For example, north and south magnetic fields, or a zero and non-zero electric voltage, represent two states (0, 1) of a binary digit (bit). Other phenomena can represent digits of a higher base. A superposition of multiple simultaneous quantum states before measurement represents a quantum bit (qubit). A sequence of one or more digits constitutes digital data that is used to represent a number or code for a character. In some  
35 embodiments, information called analog data is represented by a near continuum of measurable values within a particular range. Computer system 600, or a portion thereof, constitutes a means for performing one or more steps of increasing the functionality of a user device while the device is in an, at least in part, locked state.

A bus 610 includes one or more parallel conductors of information so that information is transferred quickly among devices coupled to the bus 610. One or more processors 602 for processing information are coupled with the bus 610.

5 A processor (or multiple processors) 602 performs a set of operations on information as specified by computer program code related to increase the functionality of a user device while the device is in an, at least in part, locked state. The computer program code is a set of instructions or statements providing instructions for the operation of the processor and/or the computer system to perform specified functions. The code, for example, may be written in a computer programming language  
10 that is compiled into a native instruction set of the processor. The code may also be written directly using the native instruction set (e.g., machine language). The set of operations include bringing information in from the bus 610 and placing information on the bus 610. The set of operations also typically include comparing two or more units of information, shifting positions of units of information, and combining two or more units of information, such as by addition or multiplication  
15 or logical operations like OR, exclusive OR (XOR), and AND. Each operation of the set of operations that can be performed by the processor is represented to the processor by information called instructions, such as an operation code of one or more digits. A sequence of operations to be executed by the processor 602, such as a sequence of operation codes, constitute processor instructions, also called computer system instructions or, simply, computer instructions. Processors  
20 may be implemented as mechanical, electrical, magnetic, optical, chemical or quantum components, among others, alone or in combination.

Computer system 600 also includes a memory 604 coupled to bus 610. The memory 604, such as a random access memory (RAM) or any other dynamic storage device, stores information including  
25 processor instructions for increasing the functionality of a user device while the device is in an, at least in part, locked state. Dynamic memory allows information stored therein to be changed by the computer system 600. RAM allows a unit of information stored at a location called a memory address to be stored and retrieved independently of information at neighboring addresses. The memory 604 is also used by the processor 602 to store temporary values during execution of  
30 processor instructions. The computer system 600 also includes a read only memory (ROM) 606 or any other static storage device coupled to the bus 610 for storing static information, including instructions, that is not changed by the computer system 600. Some memory is composed of volatile storage that loses the information stored thereon when power is lost. Also coupled to bus 610 is a non-volatile (persistent) storage device 608, such as a magnetic disk, optical disk or flash card, for  
35 storing information, including instructions, that persists even when the computer system 600 is turned off or otherwise loses power.

Information, including instructions for increasing the functionality of a user device while the device is in an, at least in part, locked state is provided to the bus 610 for use by the processor from an  
40 external input device 612, such as a keyboard containing alphanumeric keys operated by a human user, or a sensor. A sensor detects conditions in its vicinity and transforms those detections into

physical expression compatible with the measurable phenomenon used to represent information in computer system 600. Other external devices coupled to bus 610, used primarily for interacting with humans, include a display device 614, such as a cathode ray tube (CRT), a liquid crystal display (LCD), a light emitting diode (LED) display, an organic LED (OLED) display, a plasma screen, or a printer for presenting text or images, and a pointing device 616, such as a mouse, a trackball, cursor direction keys, or a motion sensor, for controlling a position of a small cursor image presented on the display 614 and issuing commands associated with graphical elements presented on the display 614. In some embodiments, for example, in embodiments in which the computer system 600 performs all functions automatically without human input, one or more of external input device 612, display device 614 and pointing device 616 is omitted.

In the illustrated embodiment, special purpose hardware, such as an application specific integrated circuit (ASIC) 620, is coupled to bus 610. The special purpose hardware is configured to perform operations not performed by processor 602 quickly enough for special purposes. Examples of ASICs include graphics accelerator cards for generating images for display 614, cryptographic boards for encrypting and decrypting messages sent over a network, speech recognition, and interfaces to special external devices, such as robotic arms and medical scanning equipment that repeatedly perform some complex sequence of operations that are more efficiently implemented in hardware.

Computer system 600 also includes one or more instances of a communications interface 670 coupled to bus 610. Communication interface 670 provides a one-way or two-way communication coupling to a variety of external devices that operate with their own processors, such as printers, scanners and external disks. In general the coupling is with a network link 678 that is connected to a local network 680 to which a variety of external devices with their own processors are connected. For example, communication interface 670 may be a parallel port or a serial port or a universal serial bus (USB) port on a personal computer. In some embodiments, communications interface 670 is an integrated services digital network (ISDN) card or a digital subscriber line (DSL) card or a telephone modem that provides an information communication connection to a corresponding type of telephone line. In some embodiments, a communication interface 670 is a cable modem that converts signals on bus 610 into signals for a communication connection over a coaxial cable or into optical signals for a communication connection over a fiber optic cable. As another example, communications interface 670 may be a local area network (LAN) card to provide a data communication connection to a compatible LAN, such as Ethernet. Wireless links may also be implemented. For wireless links, the communications interface 670 sends or receives or both sends and receives electrical, acoustic or electromagnetic signals, including infrared and optical signals that carry information streams, such as digital data. For example, in wireless handheld devices, such as mobile telephones like cell phones, the communications interface 670 includes a radio band electromagnetic transmitter and receiver called a radio transceiver. In certain embodiments, the communications interface 670 enables connection to the communication network 105 for increasing

the functionality of a user device while the device is in an, at least in part, locked state to the UE 101.

5 The term “computer-readable medium” as used herein refers to any medium that participates in providing information to processor 602, including instructions for execution. Such a medium may take many forms, including, but not limited to computer-readable storage medium (e.g., non-volatile media, volatile media), and transmission media. Non-transitory media, such as non-volatile media, include, for example, optical or magnetic disks, such as storage device 608. Volatile media include, for example, dynamic memory 604. Transmission media include, for example, twisted pair cables, 10 coaxial cables, copper wire, fiber optic cables, and carrier waves that travel through space without wires or cables, such as acoustic waves and electromagnetic waves, including radio, optical and infrared waves. Signals include man-made transient variations in amplitude, frequency, phase, polarization or other physical properties transmitted through the transmission media. Common forms of computer-readable media include, for example, a floppy disk, a flexible disk, hard disk, 15 magnetic tape, any other magnetic medium, a CD-ROM, CDRW, DVD, any other optical medium, punch cards, paper tape, optical mark sheets, any other physical medium with patterns of holes or other optically recognizable indicia, a RAM, a PROM, an EPROM, a FLASH-EPROM, an EEPROM, a flash memory, any other memory chip or cartridge, a carrier wave, or any other medium from which a computer can read. The term computer-readable storage medium is used 20 herein to refer to any computer-readable medium except transmission media.

Logic encoded in one or more tangible media includes one or both of processor instructions on a computer-readable storage media and special purpose hardware, such as ASIC 620.

25 Network link 678 typically provides information communication using transmission media through one or more networks to other devices that use or process the information. For example, network link 678 may provide a connection through local network 680 to a host computer 682 or to equipment 684 operated by an Internet Service Provider (ISP). ISP equipment 684 in turn provides data communication services through the public, world-wide packet-switching communication 30 network of networks now commonly referred to as the Internet 690.

A computer called a server host 692 connected to the Internet hosts a process that provides a service in response to information received over the Internet. For example, server host 692 hosts a process that provides information representing video data for presentation at display 614. It is 35 contemplated that the components of system 600 can be deployed in various configurations within other computer systems, e.g., host 682 and server 692.

At least some embodiments of the invention are related to the use of computer system 600 for implementing some or all of the techniques described herein. According to one embodiment of the invention, those techniques are performed by computer system 600 in response to processor 602 40 executing one or more sequences of one or more processor instructions contained in memory 604.

Such instructions, also called computer instructions, software and program code, may be read into memory 604 from another computer-readable medium such as storage device 608 or network link 678. Execution of the sequences of instructions contained in memory 604 causes processor 602 to perform one or more of the method steps described herein. In alternative embodiments, hardware, such as ASIC 620, may be used in place of or in combination with software to implement the invention. Thus, embodiments of the invention are not limited to any specific combination of hardware and software, unless otherwise explicitly stated herein.

The signals transmitted over network link 678 and other networks through communications interface 670, carry information to and from computer system 600. Computer system 600 can send and receive information, including program code, through the networks 680, 690 among others, through network link 678 and communications interface 670. In an example using the Internet 690, a server host 692 transmits program code for a particular application, requested by a message sent from computer 600, through Internet 690, ISP equipment 684, local network 680 and communications interface 670. The received code may be executed by processor 602 as it is received, or may be stored in memory 604 or in storage device 608 or any other non-volatile storage for later execution, or both. In this manner, computer system 600 may obtain application program code in the form of signals on a carrier wave.

Various forms of computer readable media may be involved in carrying one or more sequence of instructions or data or both to processor 602 for execution. For example, instructions and data may initially be carried on a magnetic disk of a remote computer such as host 682. The remote computer loads the instructions and data into its dynamic memory and sends the instructions and data over a telephone line using a modem. A modem local to the computer system 600 receives the instructions and data on a telephone line and uses an infra-red transmitter to convert the instructions and data to a signal on an infra-red carrier wave serving as the network link 678. An infrared detector serving as communications interface 670 receives the instructions and data carried in the infrared signal and places information representing the instructions and data onto bus 610. Bus 610 carries the information to memory 604 from which processor 602 retrieves and executes the instructions using some of the data sent with the instructions. The instructions and data received in memory 604 may optionally be stored on storage device 608, either before or after execution by the processor 602.

FIG. 7 illustrates a chip set or chip 700 upon which an embodiment of the invention may be implemented. Chip set 700 is programmed to increase the functionality of a user device while the device is in an, at least in part, locked state as described herein and includes, for instance, the processor and memory components described with respect to FIG. 6 incorporated in one or more physical packages (e.g., chips). By way of example, a physical package includes an arrangement of one or more materials, components, and/or wires on a structural assembly (e.g., a baseboard) to provide one or more characteristics such as physical strength, conservation of size, and/or limitation of electrical interaction. It is contemplated that in certain embodiments the chip set 700 can be implemented in a single chip. It is further contemplated that in certain embodiments the chip set or

chip 700 can be implemented as a single “system on a chip.” It is further contemplated that in certain embodiments a separate ASIC would not be used, for example, and that all relevant functions as disclosed herein would be performed by a processor or processors. Chip set or chip 700, or a portion thereof, constitutes a means for performing one or more steps of providing user interface navigation information associated with the availability of functions. Chip set or chip 700, or a portion thereof, constitutes a means for performing one or more steps of increasing the functionality of a user device while the device is in an, at least in part, locked state.

In one embodiment, the chip set or chip 700 includes a communication mechanism such as a bus 701 for passing information among the components of the chip set 700. A processor 703 has connectivity to the bus 701 to execute instructions and process information stored in, for example, a memory 705. The processor 703 may include one or more processing cores with each core configured to perform independently. A multi-core processor enables multiprocessing within a single physical package. Examples of a multi-core processor include two, four, eight, or greater numbers of processing cores. Alternatively or in addition, the processor 703 may include one or more microprocessors configured in tandem via the bus 701 to enable independent execution of instructions, pipelining, and multithreading. The processor 703 may also be accompanied with one or more specialized components to perform certain processing functions and tasks such as one or more digital signal processors (DSP) 707, or one or more application-specific integrated circuits (ASIC) 709. A DSP 707 typically is configured to process real-world signals (e.g., sound) in real time independently of the processor 703. Similarly, an ASIC 709 can be configured to performed specialized functions not easily performed by a more general purpose processor. Other specialized components to aid in performing the inventive functions described herein may include one or more field programmable gate arrays (FPGA) (not shown), one or more controllers (not shown), or one or more other special-purpose computer chips.

In one embodiment, the chip set or chip 700 includes merely one or more processors and some software and/or firmware supporting and/or relating to and/or for the one or more processors.

The processor 703 and accompanying components have connectivity to the memory 705 via the bus 701. The memory 705 includes both dynamic memory (e.g., RAM, magnetic disk, writable optical disk, etc.) and static memory (e.g., ROM, CD-ROM, etc.) for storing executable instructions that when executed perform the inventive steps described herein to increase the functionality of a user device while the device is in an, at least in part, locked state. The memory 705 also stores the data associated with or generated by the execution of the inventive steps.

FIG. 8 is a diagram of exemplary components of a mobile terminal (e.g., handset) for communications, which is capable of operating in the system of FIG. 1, according to one embodiment. In some embodiments, mobile terminal 801, or a portion thereof, constitutes a means for performing one or more steps of increasing the functionality of a user device while the device is in an, at least in part, locked state. Generally, a radio receiver is often defined in terms of front-end



and back-end characteristics. The front-end of the receiver encompasses all of the Radio Frequency (RF) circuitry whereas the back-end encompasses all of the base-band processing circuitry. As used in this application, the term "circuitry" refers to both: (1) hardware-only implementations (such as implementations in only analog and/or digital circuitry), and (2) to combinations of circuitry and software (and/or firmware) (such as, if applicable to the particular context, to a combination of processor(s), including digital signal processor(s), software, and memory(ies) that work together to cause an apparatus, such as a mobile phone or server, to perform various functions). This definition of "circuitry" applies to all uses of this term in this application, including in any claims. As a further example, as used in this application and if applicable to the particular context, the term "circuitry" would also cover an implementation of merely a processor (or multiple processors) and its (or their) accompanying software/or firmware. The term "circuitry" would also cover if applicable to the particular context, for example, a baseband integrated circuit or applications processor integrated circuit in a mobile phone or a similar integrated circuit in a cellular network device or other network devices.

15

Pertinent internal components of the telephone include a Main Control Unit (MCU) 803, a Digital Signal Processor (DSP) 805, and a receiver/transmitter unit including a microphone gain control unit and a speaker gain control unit. A main display unit 807 provides a display to the user in support of various applications and mobile terminal functions that perform or support the steps of increasing the functionality of a user device while the device is in an, at least in part, locked state. The display 807 includes display circuitry configured to display at least a portion of a user interface of the mobile terminal (e.g., mobile telephone). Additionally, the display 807 and display circuitry are configured to facilitate user control of at least some functions of the mobile terminal. An audio function circuitry 809 includes a microphone 811 and microphone amplifier that amplifies the speech signal output from the microphone 811. The amplified speech signal output from the microphone 811 is fed to a coder/decoder (CODEC) 813.

A radio section 815 amplifies power and converts frequency in order to communicate with a base station, which is included in a mobile communication system, via antenna 817. The power amplifier (PA) 819 and the transmitter/modulation circuitry are operationally responsive to the MCU 803, with an output from the PA 819 coupled to the duplexer 821 or circulator or antenna switch, as known in the art. The PA 819 also couples to a battery interface and power control unit 820.

In use, a user of mobile terminal 801 speaks into the microphone 811 and his or her voice along with any detected background noise is converted into an analog voltage. The analog voltage is then converted into a digital signal through the Analog to Digital Converter (ADC) 823. The control unit 803 routes the digital signal into the DSP 805 for processing therein, such as speech encoding, channel encoding, encrypting, and interleaving. In one embodiment, the processed voice signals are encoded, by units not separately shown, using a cellular transmission protocol such as enhanced data rates for global evolution (EDGE), general packet radio service (GPRS), global system for mobile communications (GSM), Internet protocol multimedia subsystem (IMS), universal mobile

40

telecommunications system (UMTS), etc., as well as any other suitable wireless medium, e.g., microwave access (WiMAX), Long Term Evolution (LTE) networks, code division multiple access (CDMA), wideband code division multiple access (WCDMA), wireless fidelity (WiFi), satellite, and the like, or any combination thereof.

5

The encoded signals are then routed to an equalizer 825 for compensation of any frequency-dependent impairments that occur during transmission through the air such as phase and amplitude distortion. After equalizing the bit stream, the modulator 827 combines the signal with a RF signal generated in the RF interface 829. The modulator 827 generates a sine wave by way of frequency or phase modulation. In order to prepare the signal for transmission, an up-converter 831 combines the sine wave output from the modulator 827 with another sine wave generated by a synthesizer 833 to achieve the desired frequency of transmission. The signal is then sent through a PA 819 to increase the signal to an appropriate power level. In practical systems, the PA 819 acts as a variable gain amplifier whose gain is controlled by the DSP 805 from information received from a network base station. The signal is then filtered within the duplexer 821 and optionally sent to an antenna coupler 835 to match impedances to provide maximum power transfer. Finally, the signal is transmitted via antenna 817 to a local base station. An automatic gain control (AGC) can be supplied to control the gain of the final stages of the receiver. The signals may be forwarded from there to a remote telephone which may be another cellular telephone, any other mobile phone or a land-line connected to a Public Switched Telephone Network (PSTN), or other telephony networks.

10

15

20

Voice signals transmitted to the mobile terminal 801 are received via antenna 817 and immediately amplified by a low noise amplifier (LNA) 837. A down-converter 839 lowers the carrier frequency while the demodulator 841 strips away the RF leaving only a digital bit stream. The signal then goes through the equalizer 825 and is processed by the DSP 805. A Digital to Analog Converter (DAC) 843 converts the signal and the resulting output is transmitted to the user through the speaker 845, all under control of a Main Control Unit (MCU) 803 which can be implemented as a Central Processing Unit (CPU) (not shown).

25

30

35

40

The MCU 803 receives various signals including input signals from the keyboard 847. The keyboard 847 and/or the MCU 803 in combination with other user input components (e.g., the microphone 811) comprise a user interface circuitry for managing user input. The MCU 803 runs a user interface software to facilitate user control of at least some functions of the mobile terminal 801 to increase the functionality of a user device while the device is in an, at least in part, locked state. The MCU 803 also delivers a display command and a switch command to the display 807 and to the speech output switching controller, respectively. Further, the MCU 803 exchanges information with the DSP 805 and can access an optionally incorporated SIM card 849 and a memory 851. In addition, the MCU 803 executes various control functions required of the terminal. The DSP 805 may, depending upon the implementation, perform any of a variety of conventional digital processing functions on the voice signals. Additionally, DSP 805 determines the background noise level of the

local environment from the signals detected by microphone 811 and sets the gain of microphone 811 to a level selected to compensate for the natural tendency of the user of the mobile terminal 801.

5 The CODEC 813 includes the ADC 823 and DAC 843. The memory 851 stores various data including call incoming tone data and is capable of storing other data including music data received via, e.g., the global Internet. The software module could reside in RAM memory, flash memory, registers, or any other form of writable storage medium known in the art. The memory device 851 may be, but not limited to, a single memory, CD, DVD, ROM, RAM, EEPROM, optical storage, magnetic disk storage, flash memory storage, or any other non-volatile storage medium capable of  
10 storing digital data.

An optionally incorporated SIM card 849 carries, for instance, important information, such as the cellular phone number, the carrier supplying service, subscription details, and security information. The SIM card 849 serves primarily to identify the mobile terminal 801 on a radio network. The card  
15 849 also contains a memory for storing a personal telephone number registry, text messages, and user specific mobile terminal settings.

While the invention has been described in connection with a number of embodiments and implementations, the invention is not so limited but covers various obvious modifications and equivalent arrangements, which fall within the purview of the appended claims. Although features of  
20 the invention are expressed in certain combinations among the claims, it is contemplated that these features can be arranged in any combination and order.

## CLAIMS

## WHAT IS CLAIMED IS:

1. A method of comprising:  
causing, at least in part, a presentation of a first user interface associated with an, at least in part,  
5 locked state of a device;  
causing, at least in part, a rendering of at least a portion of a second user interface associated  
with the first user interface, wherein the second user interface is associated with one or more  
applications, one or more services, or a combination thereof; and  
processing and/or facilitating a processing of one or more interactions with the first user  
10 interface, the at least a portion of the second user interface, or a combination thereof to  
cause, at least in part, a change of the device to an, at least in part, unlocked state.
2. A method of claim 1, further comprising:  
processing and/or facilitating a processing of the one or more interactions to determine whether  
15 to cause, at least in part, an initiation of one or more functions of the one or more  
applications, the one or more services, or a combination thereof.
3. A method of claim 2, wherein the one or more functions include, at least in part, a  
20 presentation of one or more content items.
4. A method of claim 3, further comprising:  
causing, at least in part, a caching of the one or more content items at the device.
5. A method according to any of claims 3-4, further comprising:  
25 processing and/or facilitating a processing of the one or more interactions to cause, at least in  
part, a generation of the one or more content items.
6. A method according to any of claims 1-5, further comprising:  
processing and/or facilitating a processing of the one or more interactions to determine the one  
30 or more applications, the one or more services, or a combination thereof.
7. A method according to any of claims 1-6, further comprising:  
causing, at least in part, a generation of an interaction history based, at least in part, on the one  
or more interactions; and  
35 processing and/or facilitating a processing of the interaction history to determine the one or more  
applications, the one or more services, or a combination thereof.
8. A method according to any of claims 1-7, further comprising:

causing, at least in part, an initiation of the one or more applications, the one or more services, or a combination thereof based, at least in part, on the change of the device to the unlocked state.

5 9. A method according to any of claims 1-8, wherein the one or more applications, the one or more services, or a combination thereof relate, at least in part, to an advertising service, a polling service, a competition service, a testing service, or a combination thereof.

10 10. A method according to any of claims 1-9, wherein the one or more applications, the one or more services, the one or more interactions are determined, at least in part, by the device, a service provider, a content provider, or a combination thereof.

11. An apparatus comprising:  
at least one processor; and  
15 at least one memory including computer program code for one or more programs,  
the at least one memory and the computer program code configured to, with the at least one processor, cause the apparatus to perform at least the following,  
cause, at least in part, a presentation of a first user interface associated with an, at least in part, locked state of a device;  
20 cause, at least in part, a rendering of at least a portion of a second user interface associated with the first user interface, wherein the second user interface is associated with one or more applications, one or more services, or a combination thereof; and  
process and/or facilitate a processing of one or more interactions with the first user interface, the at least a portion of the second user interface, or a combination thereof to cause, at least in  
25 part, a change of the device to an, at least in part, unlocked state.

12. An apparatus of claim 11, wherein the apparatus is further caused to:  
process and/or facilitate a processing of the one or more interactions to determine whether to  
cause, at least in part, an initiation of one or more functions of the one or more applications,  
30 the one or more services, or a combination thereof.

13. An apparatus of claim 12, wherein the one or more functions include, at least in part, a presentation of one or more content items.

35 14. An apparatus of claim 13, wherein the apparatus is further caused to:  
cause, at least in part, a caching of the one or more content items at the device.

15. An apparatus according to any of claims 13-14, wherein the apparatus is further caused to:  
process and/or facilitate a processing of the one or more interactions to cause, at least in part, a  
40 generation of the one or more content items.

- 5 16. An apparatus according to any of claims 11-15, wherein the apparatus is further caused to process and/or facilitate a processing of the one or more interactions to determine the one or more applications, the one or more services, or a combination thereof.
- 10 17. An apparatus according to any of claims 11-16, wherein the apparatus is further caused to cause, at least in part, a generation of an interaction history based, at least in part, on the one or more interactions; and process and/or facilitate a processing of the interaction history to determine the one or more applications, the one or more services, or a combination thereof.
- 15 18. An apparatus according to any of claims 11-17, wherein the apparatus is further caused to cause, at least in part, an initiation of the one or more applications, the one or more services, or a combination thereof based, at least in part, on the change of the device to the unlocked state.
- 20 19. An apparatus according to any of claims 11-18, wherein the one or more applications, the one or more services, or a combination thereof relate, at least in part, to an advertising service, a polling service, a competition service, a testing service, or a combination thereof.
- 20 20. An apparatus according to any of claims 11-19, wherein the one or more applications, the one or more services, the one or more interactions are determined, at least in part, by the device, a service provider, a content provider, or a combination thereof.
- 25 21. An apparatus according to any of claims 11-20, wherein the apparatus is a mobile phone further comprising:  
user interface circuitry and user interface software configured to facilitate user control of at least some functions of the mobile phone through use of a display and configured to respond to user input; and  
30 a display and display circuitry configured to display at least a portion of a user interface of the mobile phone, the display and display circuitry configured to facilitate user control of at least some functions of the mobile phone.
- 35 22. A computer-readable storage medium carrying one or more sequences of one or more instructions which, when executed by one or more processors, cause an apparatus to perform at least a method of at least one of claims 1-10.
23. An apparatus comprising means for performing a method of at least one of claims 1-10.
24. An apparatus of claim 23, wherein the apparatus is a mobile phone further comprising:

user interface circuitry and user interface software configured to facilitate user control of at least some functions of the mobile phone through use of a display and configured to respond to user input; and  
5 a display and display circuitry configured to display at least a portion of a user interface of the mobile phone, the display and display circuitry configured to facilitate user control of at least some functions of the mobile phone.

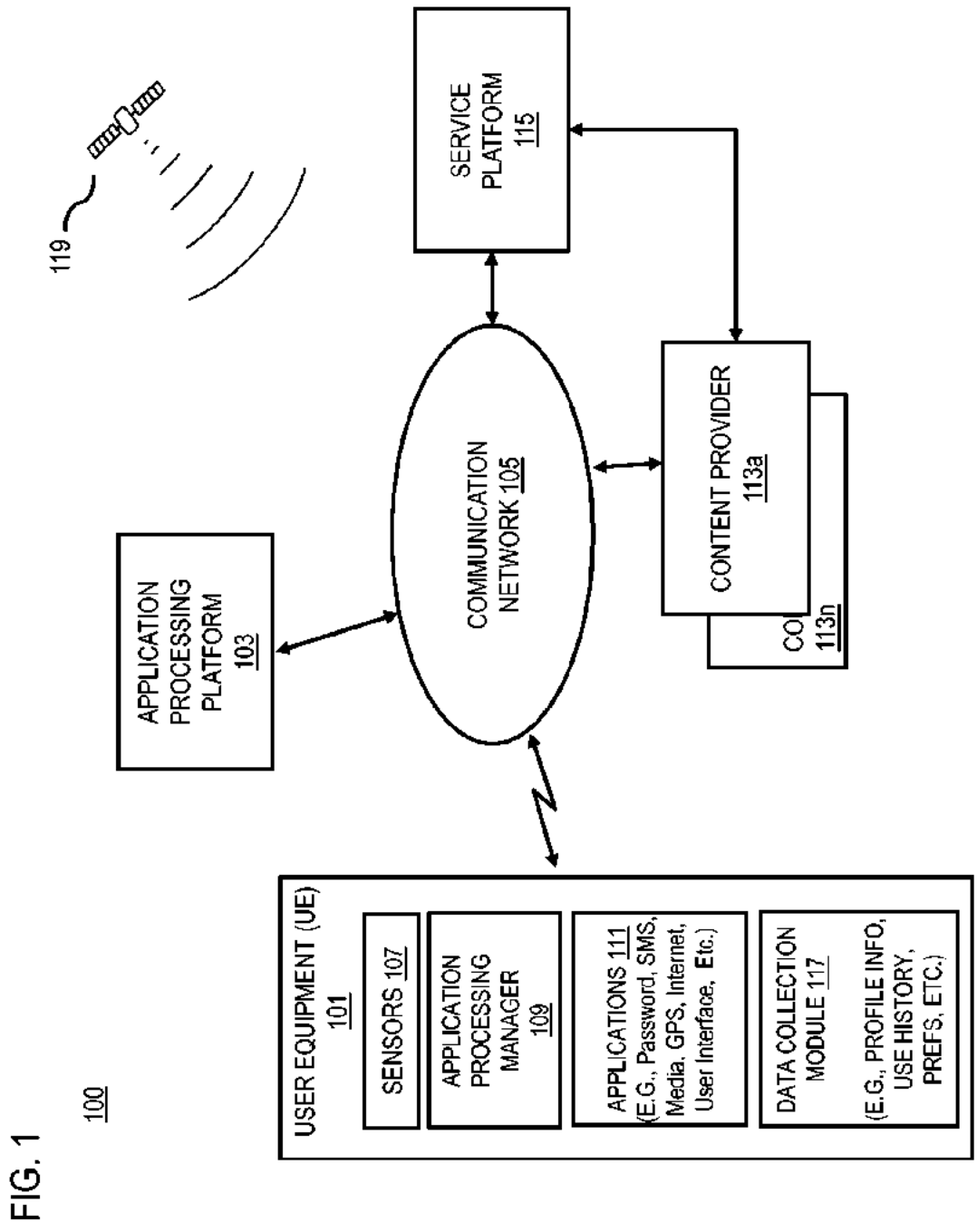
25. A computer program product including one or more sequences of one or more instructions which, when executed by one or more processors, cause an apparatus to at least perform the steps of  
10 a method of at least one of claims 1-10.

26. A method comprising facilitating access to at least one interface configured to allow access to at least one service, the at least one service configured to perform a method of at least one of  
15 claims 1-10.

27. A method comprising facilitating a processing of and/or processing (1) data and/or (2) information and/or (3) at least one signal, the (1) data and/or (2) information and/or (3) at least one  
signal based, at least in part, on the method of any of claims 1-10.

20 28. A method comprising facilitating creating and/or facilitating modifying (1) at least one device user interface element and/or (2) at least one device user interface functionality, the (1) at least one device user interface element and/or (2) at least one device user interface functionality based, at least in part, on the method of any of claims 1-10.

25





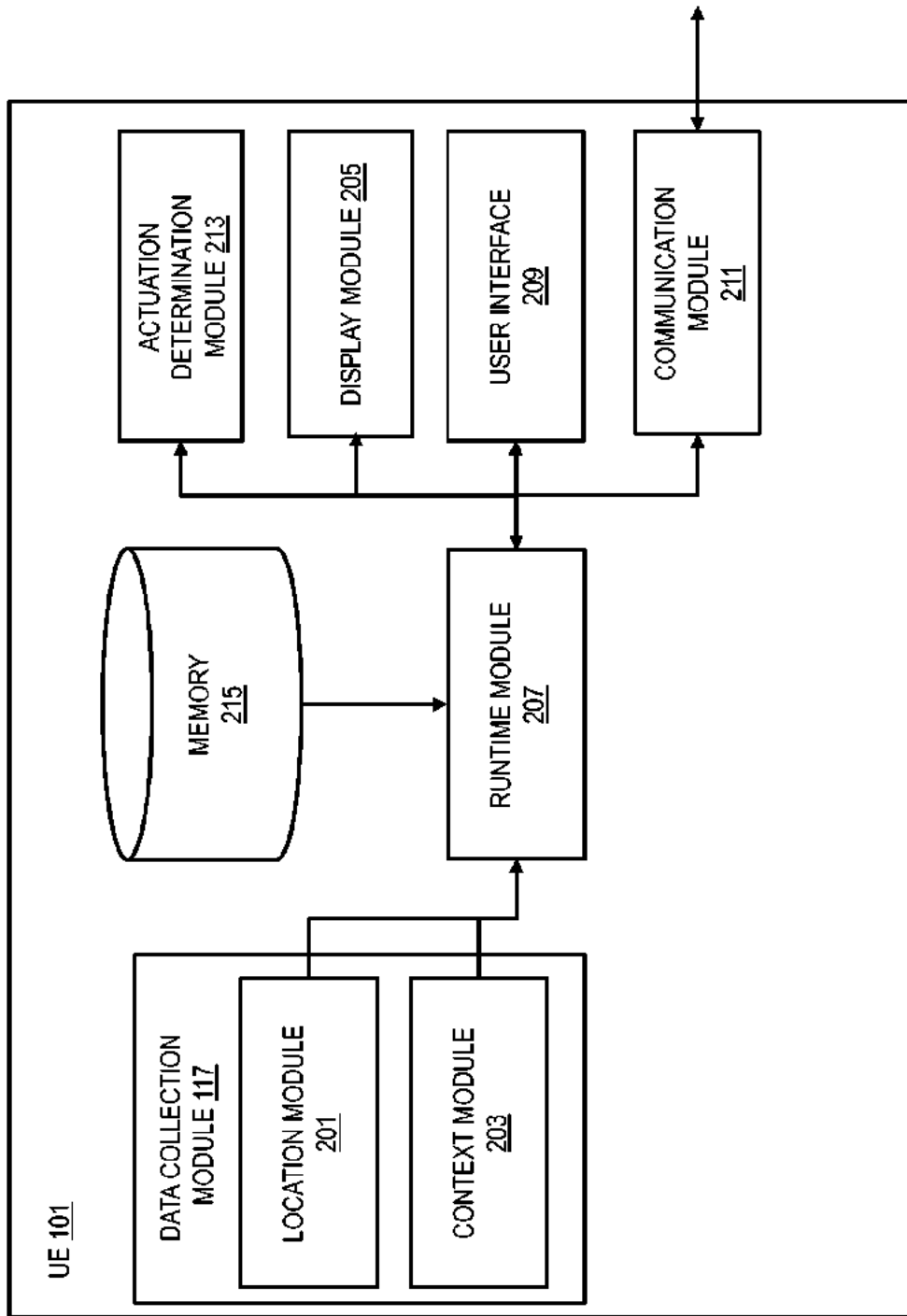


FIG. 2

FIG. 3

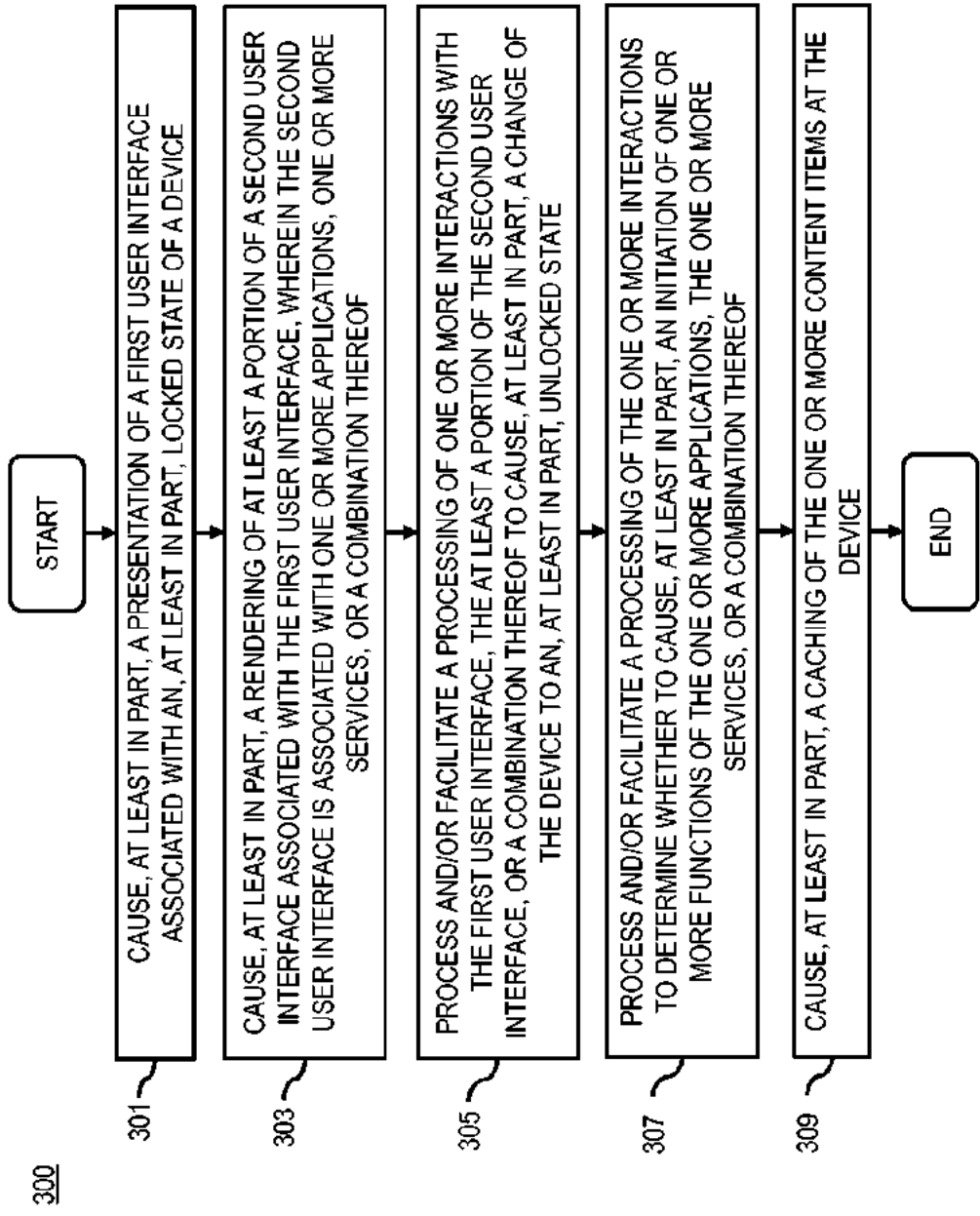


FIG. 4

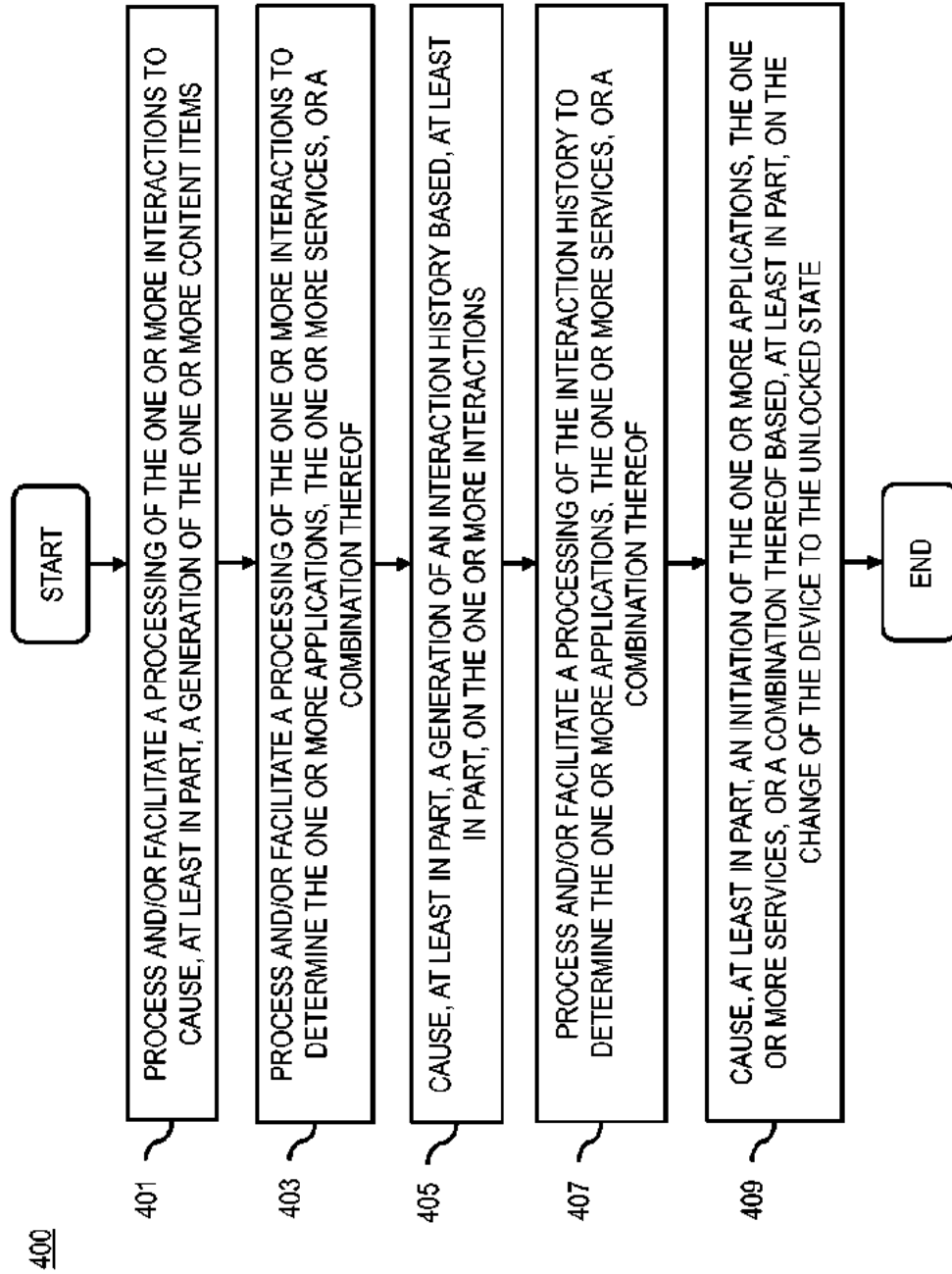


FIG. 5A

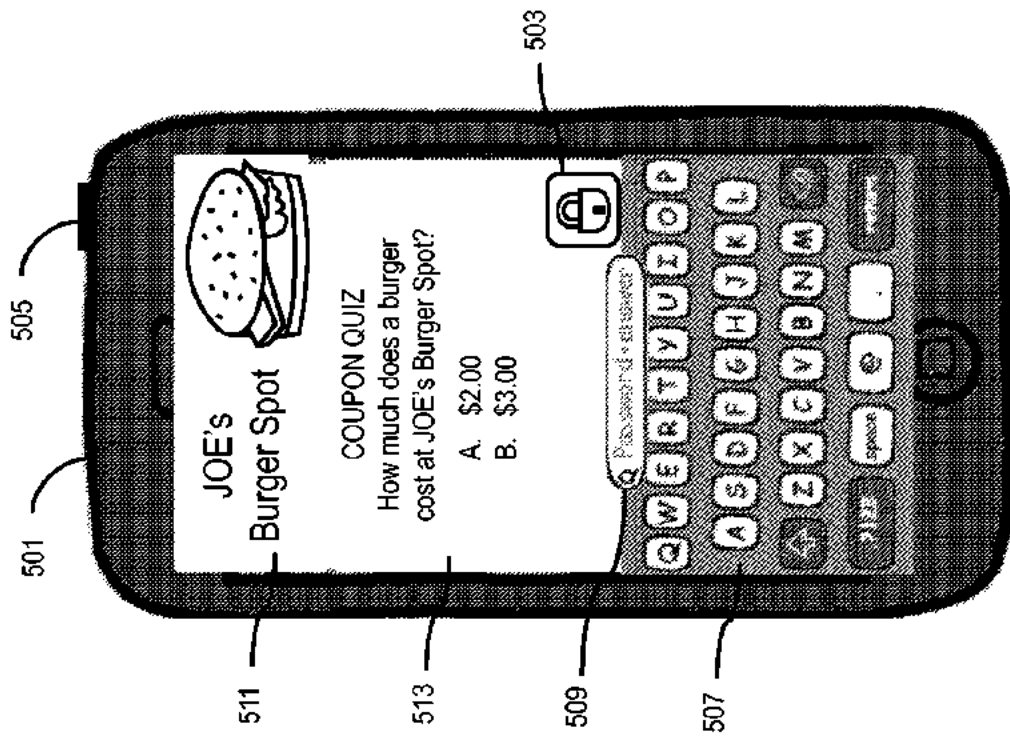


FIG. 5C

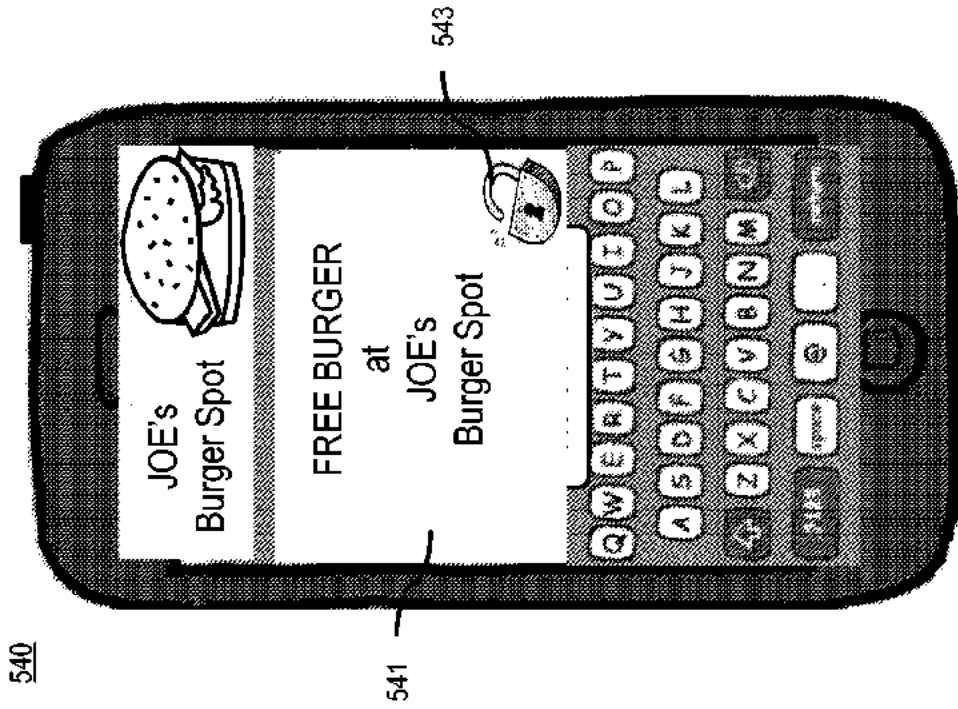


FIG. 5B

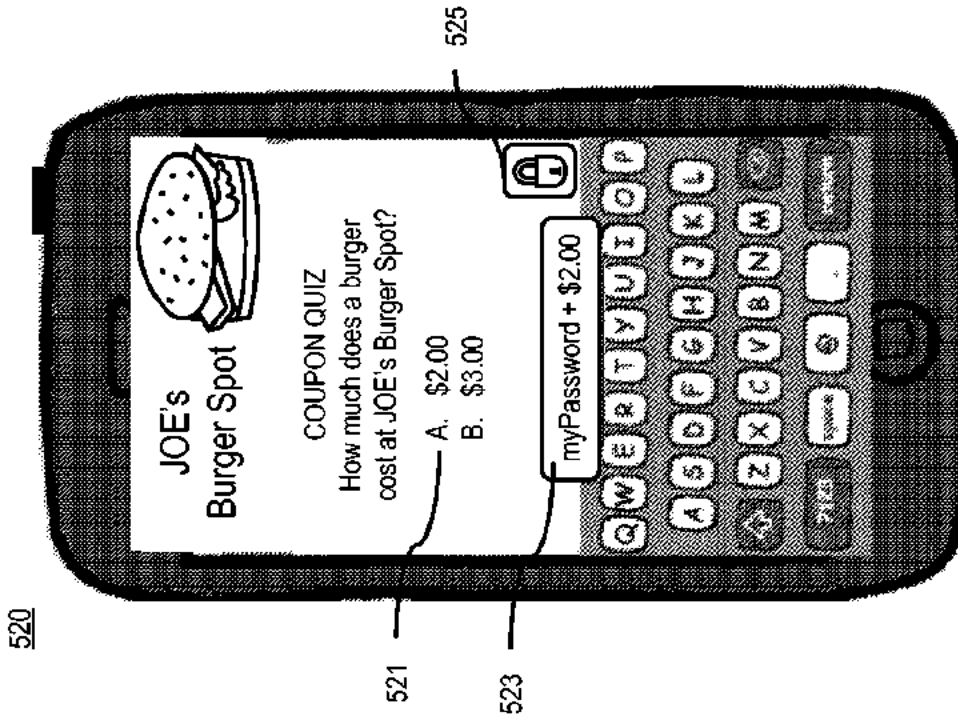


FIG. 5D

560

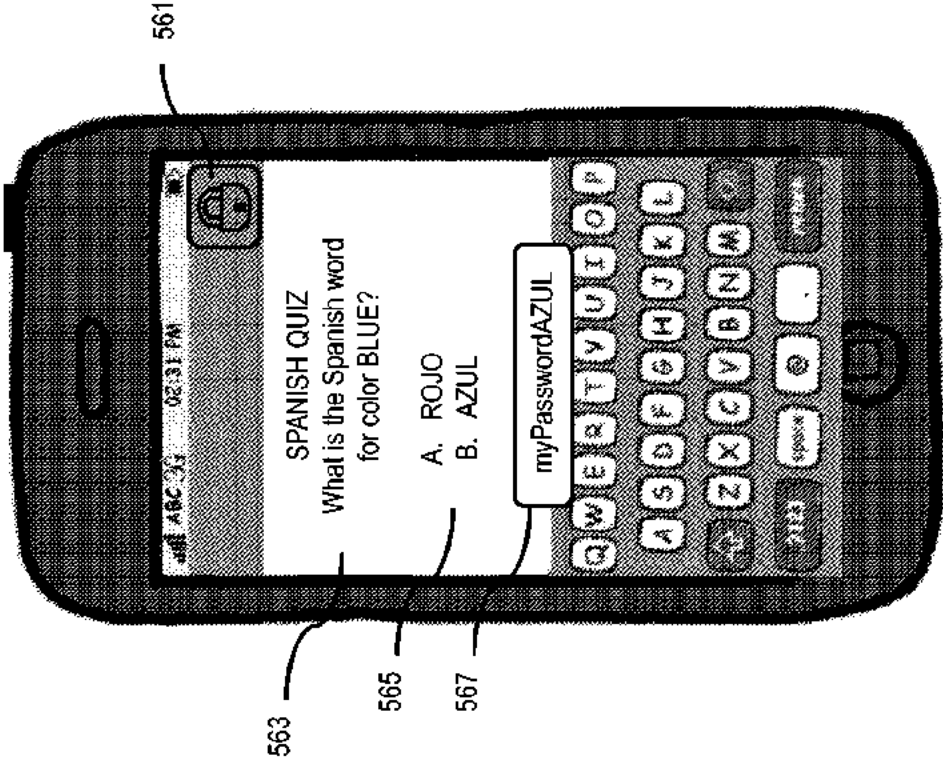
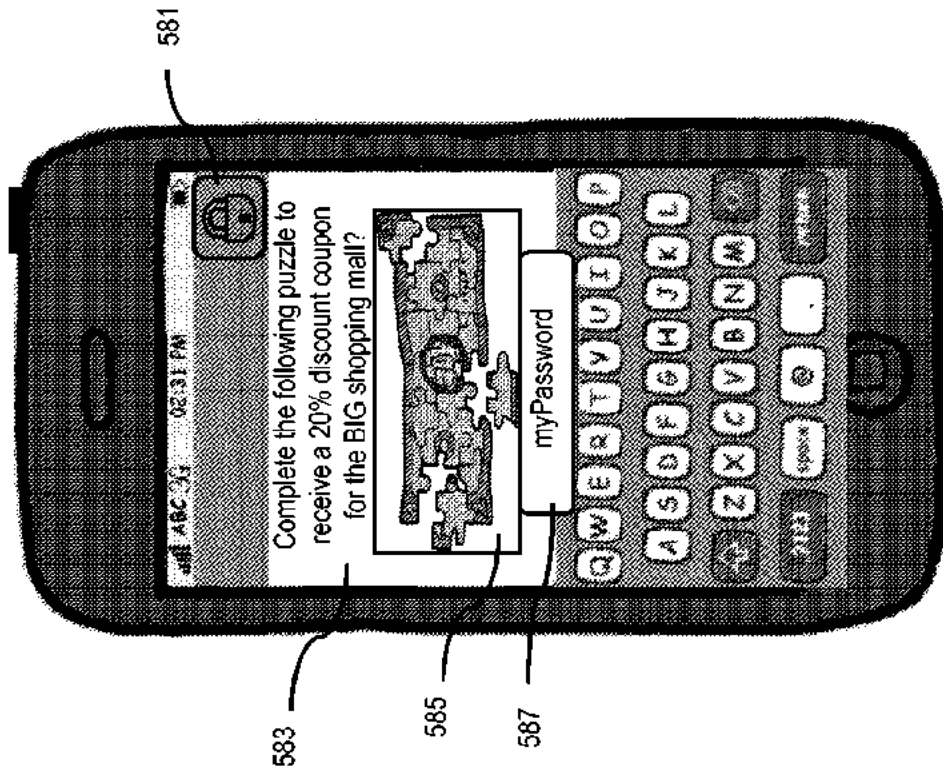


FIG. 5E



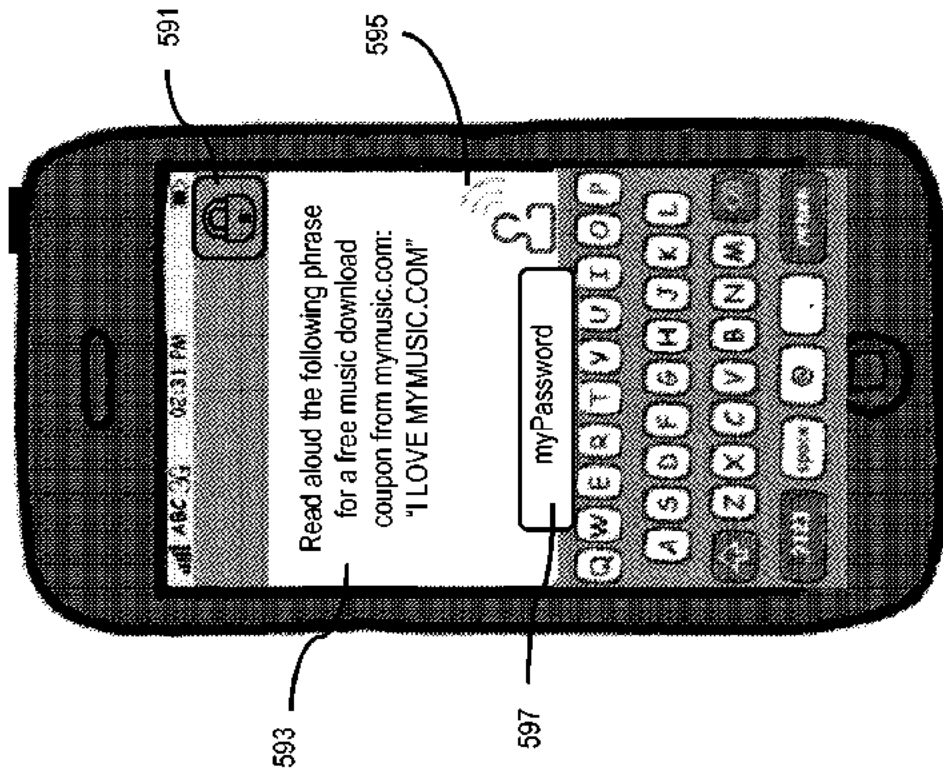


FIG. 5F

590



FIG. 6

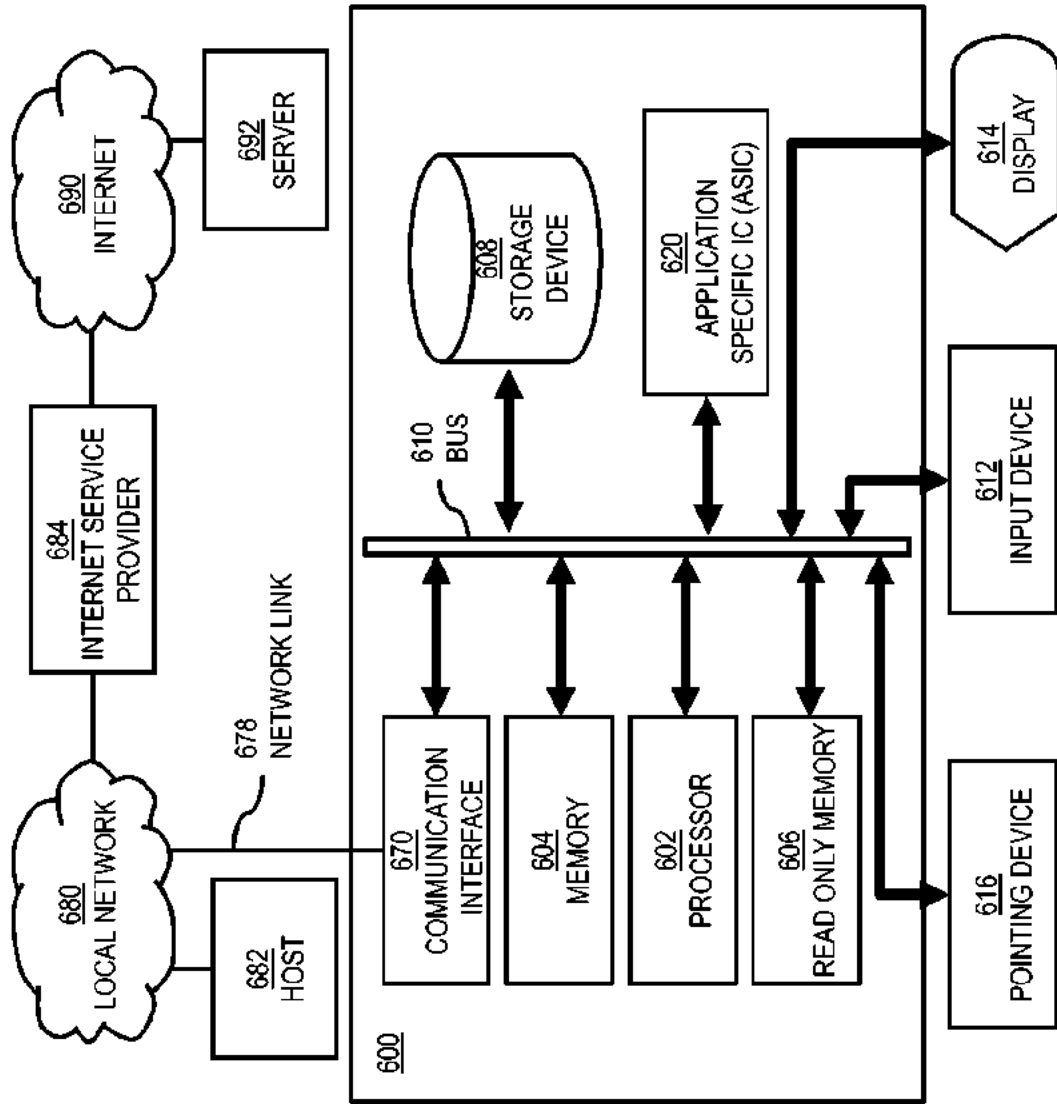


FIG. 7

700

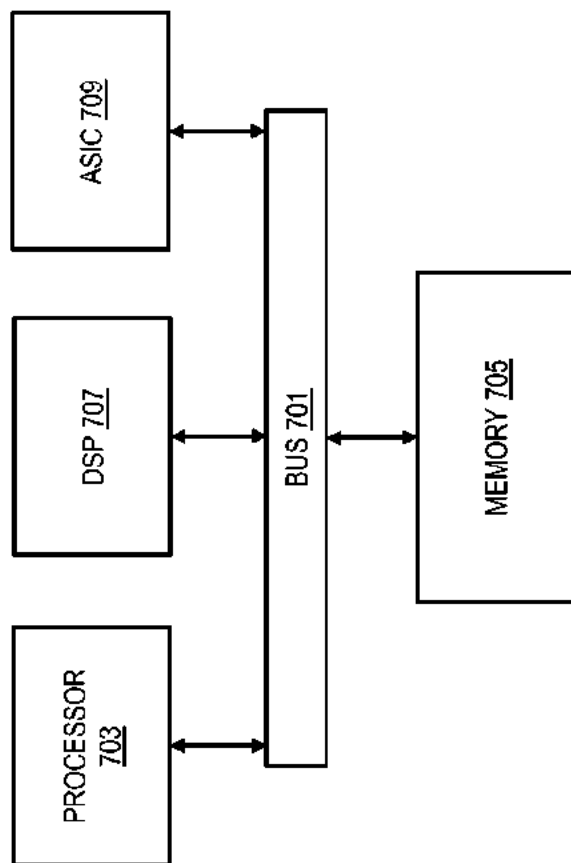
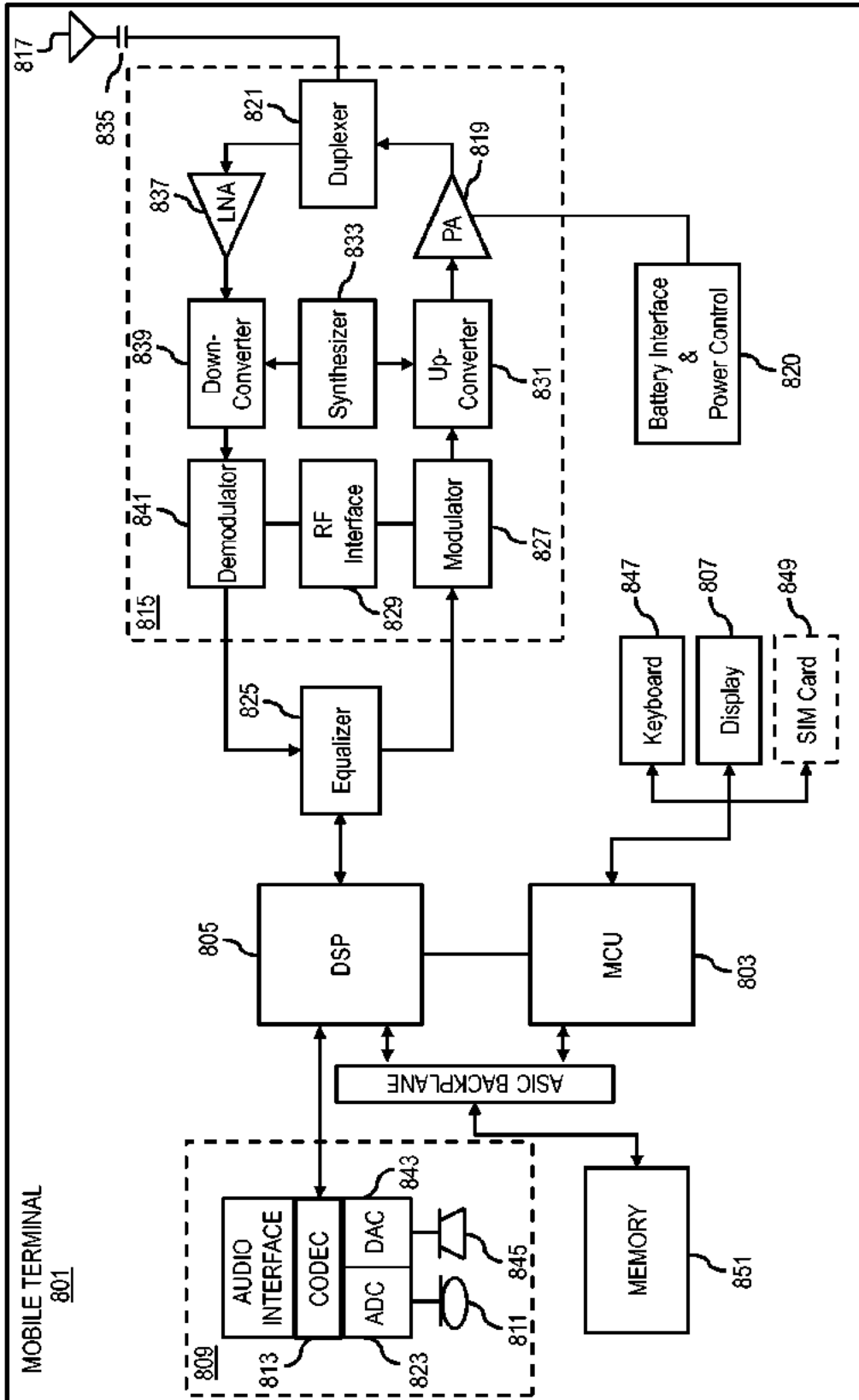


FIG. 8





- (51) **International Patent Classification:**  
G06Q 30/02 (2012.01) H04H 60/33 (2008.01)
- (21) **International Application Number:**  
PCT/US2013/052648
- (22) **International Filing Date:**  
30 July 2013 (30.07.2013)
- (25) **Filing Language:** English
- (26) **Publication Language:** English
- (30) **Priority Data:**  
13/566,523 3 August 2012 (03.08.2012) US
- (72) **Inventor; and**
- (71) **Applicant :** CUSACK, Elijah [NZ/US]; 2743 Pinewood Ave, Henderson, NV 89074 (US).
- (81) **Designated States** (unless otherwise indicated, for every kind of national protection available): AE, AG, AL, AM, AO, AT, AU, AZ, BA, BB, BG, BH, BN, BR, BW, BY, BZ, CA, CH, CL, CN, CO, CR, CU, CZ, DE, DK, DM, DO, DZ, EC, EE, EG, ES, FI, GB, GD, GE, GI, GM, GT, HN, HR, HU, ID, IL, IN, IS, JP, KE, KG, KN, KP, KR, KZ, LA, LC, LK, LR, LS, LT, LU, LY, MA, MD, ME, MG, MK, MN, MW, MX, MY, MZ, NA, NG, NI, NO, NZ,

OM, PA, PE, PG, PH, PL, PT, QA, RO, RS, RU, RW, SC, SD, SE, SG, SK, SL, SM, ST, SV, SY, TH, TJ, TM, TN, TR, TT, TZ, UA, UG, US, UZ, VC, VN, ZA, ZM, ZW.

(84) **Designated States** (unless otherwise indicated, for every kind of regional protection available): ARIPO (BW, GH, GM, KE, LR, LS, MW, MZ, NA, RW, SD, SL, SZ, TZ, UG, ZM, ZW), Eurasian (AM, AZ, BY, KG, KZ, RU, TJ, TM), European (AL, AT, BE, BG, CH, CY, CZ, DE, DK, EE, ES, FI, FR, GB, GR, HR, HU, IE, IS, IT, LT, LU, LV, MC, MK, MT, NL, NO, PL, PT, RO, RS, SE, SI, SK, SM, TR), OAPI (BF, BJ, CF, CG, CI, CM, GA, GN, GQ, GW, KM, ML, MR, NE, SN, TD, TG).

**Declarations under Rule 4.17:**

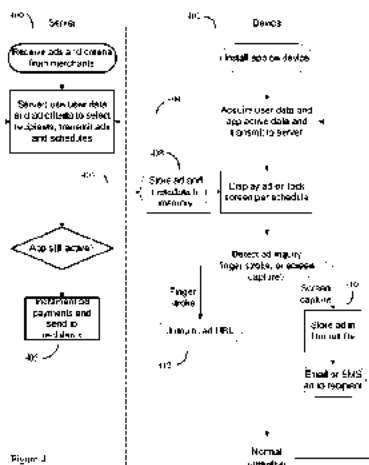
- as to the identity of the inventor (Rule 4.17(i))
- as to applicant's entitlement to apply for and be granted a patent (Rule 4.17(ii))
- as to the applicant's entitlement to claim the priority of the earlier application (Rule 4.17(iii))

**Published:**

- with international search report (Art. 21(3))



(54) **Title:** METHOD AND SYSTEM OF USING SMARTPHONE LOCKSCREENS AS PERSONAL ADVERTISING BILLBOARDS



(57) **Abstract:** Method, system, and software for displaying advertising media on the lockscreens of handheld computerized devices, such as smartphones. The invention comprises an advertising software app, and corresponding advertising internet server software. Merchants and other advertisers can transmit ads, along with corresponding ad display schedule information, and target ad recipient demographic information, to the server. The smartphone app software can collect user data, forward it to the server, and obtain from the server corresponding ad images that are displayed on the smartphone's lockscreen. The system may optionally keep track of usage and compensate smartphone users accordingly. Smartphone users, on seeing an ad of interest, can either use the ad image directly, transmit the ad image to a recipient, or jump to a web address corresponding to an ad associated URL. The method essentially allows a smartphone user to rent out his smartphone lockscreen as if it was a personal billboard.

METHOD AND SYSTEM OF USING SMARTPHONE LOCKSCREENS AS PERSONAL  
ADVERTISING BILLBOARDS

BACKGROUND OF THE INVENTION

- 5 This application is a continuation of, and claims the priority benefit of, US patent application 13/566,523 entitled "METHOD AND SYSTEM OF USING SMARTPHONE LOCKSCREENS AS PERSONAL ADVERTISING BILLBOARDS", inventor Elijah Cusack, filed August 3, 2012.

10 FIELD OF THE INVENTION

This invention is in the field of electronic, internet-based, advertising technology for smartphones and other handheld computerized devices.

DESCRIPTION OF THE RELATED ART

- 15 The use of various computerized devices for delivering advertising, in particular handheld computerized devices with wireless connections to the internet via WiFi and cellular telephone links, has exploded in recent years.

Such handheld computerized devices, exemplified by laptop computers, tablet computers, and smartphones, often run iOS, Android, Windows, or other operating systems on one or  
20 more microprocessors. Numerous types of software, such as web browsers or applications software, are available that can configure these devices to receive advertisements (ads) from various sources, usually over the internet.

As an example, it is now common to install a freeware app on a smartphone (such as an Apple iPhone, Android Smartphone, Windows Smartphone, and the like) that will display ads  
25 at various times during the app operation, such as an app startup splash screen, in a section of the app screen while other app software is also being displayed, or periodically as various advertising "nag" screens. By paying for the freeware, these ads may be permanently disabled.

Additionally, certain tablet computerized devices, exemplified by the Amazon Kindle Touch,  
30 are also available. The Amazon Kindle Touch, for example, is often sold at a reduced price

through Amazon's "special offers" program. In this special offers program, a Kindle Touch that might normally sell for \$139 is instead sold at a reduced price of \$99. A Kindle Touch with special offers will show an advertising screen when the device is switched off and is otherwise in an inoperative state. This "advertising screen while off" mode is possible  
5 because the device's electronic ink display continues to show an image even when the device is otherwise powered down.

When touch sensitive smartphones, such as the Apple iPhone, were originally developed, the designers noted that such devices had some specific user interface problems. The designers determined that the smartphone devices had to remain continually powered on in order to  
10 receive phone calls. However the designers also found that it was impractical to design the systems so that users had to first activate the smartphone's touch screen sensor by pressing a non-screen located power button; and then further control the smartphone by pressing virtual buttons on the device's touch screen. The designers also found that it was impractical to keep the smartphone's touch screen on and continually responsive to all touch input, because such  
15 devices are often stored in the user's pocket or purse. In the pocket or purse environment, such touch screens are constantly exposed to accidental contact with other objects.

In order to overcome this problem, the designers employed various types of "lockscreen" concepts. In lockscreen mode, a device's touch sensitive display remains touch sensitive, even if the device is nominally conserving energy by not powering on the device's display  
20 screen or display screen backlight (if any). Upon detecting a touch on the touch screen, the device may in turn power on the display screen and show an image (a lockscreen image), but in order to fully activate the device, the user will be required to initiate a specific touch action, such as moving a representation of a slider by touch, that would otherwise be very unlikely to occur by random contact with objects in the user's pocket or purse. This method  
25 of unlocking a device by performing gestures on an unlock image is described in US patent 7,657,849 by Chaudhri et. al., the contents of which are incorporated herein by reference.

Alternative methods of using gestures on unlock images (lockscreen images) have also been proposed. These include US patent 8,136,053 by Miller and Trivi, incorporated herein by  
reference, which use other types of specific user gestures on lockscreen images to unlock  
30 smartphones and other types of mobile computerized devices with touch sensitive display screens.

## BRIEF SUMMARY OF THE INVENTION

The invention is based, in part, on the insight that the lockscreen image presented by smartphones and other types of touch sensitive mobile computerized devices represents a presently untapped resource for showing ads. This is a remarkable omission, because  
5 lockscreens represent an excellent vehicle for displaying ads. This is because a typical smartphone user will often look at his or her device's lockscreen many times a day; generally whenever the user receives a telephone call, initiates a telephone call, or otherwise tries to use the device for almost any activity.

The invention is also based, in part, on the insight that in order to persuade users to in effect  
10 rent out their device's lockscreen images as a personal billboard for advertising purposes, some sort of commercial inducement will be required. Although standard advertising inducements such as electronic coupons with various price reductions, and the like, may be used, this may not always be sufficient. Thus in some embodiments of the invention, users are further incentivized to allow advertisements to be displayed on their device's lockscreens  
15 through a money payment system. Here for example, users may receive nominal money payments for simply keeping their device's lockscreen advertising software active, and for viewing the lockscreen ads (such as by unlocking the device) according to an established reimbursement schedule. Although this money for viewing lockscreen ads tradeoff will increase advertising costs to some extent, advertisers may justify this added expense because  
20 in addition to direct ad viewing by demographically targeted users, the user of the lockscreen ad equipped device may also access the product for sale directly from the lockscreen with an active button as well as show or relay various lockscreen ads to friends and associates by using screen capture. This helps generate some additional and valuable word-of-mouth advertising.

25 The invention is also based, in part, on the insight that in order to manage such a lockscreen ad system (e.g. personal billboard system) effectively, the system would require at least a first computerized device software component (e.g. a smartphone app), an a second internet server software based component. The first computerized device software component would intercept ad media (e.g. ad images) from the internet, and assign the ad media to the device's  
30 lockscreen image according to a schedule. The second internet server based software component would direct one or more internet servers to dispense the ads to various participating computerized devices. This second internet server based software component would ideally have both a merchant interface by which to receive ads and ad display criteria

(e.g. various target ad recipient demographic criteria) from various merchants. The second internet server based software component would also have database software capable of receiving user demographic data from the various computerized device users, appropriately matching the user data with the merchant ad display criteria, and then further dispense those ads (ad media, ad image) to the appropriate user devices.

Thus in some embodiments, the invention may be a method of displaying advertising media on the lockscreens of a plurality of wireless network connected handheld computerized devices. Here, the users (or alternatively the manufacturers) of the various computerized devices, such as smartphones, will typically install an advertising display software app (or alternatively embed this software as part of the device's operating system) on at least one such computerized devices, and typically a large number of different computerized devices. This advertising display software app, which will be installed on a per-device basis, will typically be configured to receive user data pertaining to the user of said device. This data can often be demographic data such as the user's age, sex, location, income bracket (geographic, by zip code, or by other method), and personal interests.

The advertising display software app will typically be configured to wirelessly transmit at least some of this user data to (at least one) network server, as well as wirelessly receive advertising data from this network server. The software app will further display this advertising media (e.g. often a plurality of different ad images) on the device's lockscreen according to an advertising display schedule.

In use, merchants, or other individuals or organizations interested in advertising, will usually upload their particular advertising media to the network server, along with a description of a target recipient population for the ads. Thus for example, the merchant may state that a given ad for pizza should be targeted to college age students in one or more zip codes near one or more colleges.

The server will then use the user data previously obtained from the software apps running on the various computerized devices, and the merchant's description of a target recipient population, to determine which of the various devices should receive which advertising media. The server will then upload the advertising media the appropriate devices. These devices in turn will then use the software app to then display the appropriate advertising media on the device's lockscreen, often according to a particular merchant, server, or user selected advertising display schedule.



## BRIEF DESCRIPTION OF THE DRAWINGS

Figure 1 shows an example of a smartphone lockscreen showing an 1800's era advertisement for "Parker's Ginger Tonic".

5 Figure 2 shows an overview of how the invention's server software interacts with both data from merchants/advertisers, and data from software running on various client computerized devices, to distribute ads to be shown on the lockscreens of these various computerized devices.

10 Figure 3 shows how the database component of the invention's server software may receive various types of user data from various computerized devices, match this data up with advertising data describing the intended target recipient population (obtained from various merchants), and when the user data matches up with the target data, transmit the appropriate advertising media (e.g. lockscreen images) to the appropriate handheld computerized devices (e.g. smartphones).

15 Figure 4 shows a software flow chart showing some of the key steps on both the server software and the client software that may be used to implement the present invention.

Figure 5 shows how a device user may capture a screenshot of a lockscreen ad of interest, and forward this ad (here the ad is also being used as a coupon) to an appropriate recipient.

## DETAILED DESCRIPTION OF THE INVENTION

20 As previously discussed, in some embodiments, the invention may be a method, system, or software product that enables advertising media, typically graphic images, to be displayed on the lockscreens of various computerized devices. These computerized devices will typically be handheld computerized devices with touch sensitive screens, which are configured to go from a locked configuration that is generally non-responsive to touch input, to an unlocked  
25 configuration that is generally responsive to touch input, upon receiving an unlocking touch gesture, such as a finger swipe on a particular location of the screen, or other statistically unlikely touch input generally indicative of a human desire to activate the device.

30 Figure 1 shows an example of a smartphone lockscreen type advertisement (100), here based on an 1800's era advertisement for "Parker's Ginger Tonic" to avoid copyright issues with present day advertisers. Here this advertisement is shown as an Apple iPhone 4 type lockscreen. In this configuration, by pressing what Apple describes as the iPhone 4's

“on/off” button (but which is better described as an “attention button”), the iPhone device changes from a lower power mode where, the device’s transmitter and receiver(s) are active, but the display is generally off, to a higher power mode where the display is illuminated, the touch sensor is on, but in which the system otherwise has a restricted sensitivity to touch  
5 input.

Upon sensing a finger swipe on the “slide to unlock section” (102), the iPhone device will then unlock and allow access to other icons and other touch sensitive functions. Note that in this Apple iOS 5.1 example, upon detecting a finger swipe on another area of the touch screen (104) distinct from the slide to unlock section, here shown as a camera icon, the  
10 iPhone 4 device is also capable of taking photos from the lockscreen mode as well. This is a useful secondary function, and in an alternative embodiment of the invention, an alternative type lockscreen finger swipe motion on a secondary part of the lockscreen may also be used to record the user’s interest in the advertisement, as well as to direct the system to, for example, jump to a corresponding advertising website.

15 Although such computerized devices, such as smartphones, may often be configured to operate in a lower power mode prior to touch activation, such computerized devices will nonetheless remain powered on and capable of receiving wireless signals, such as WiFi or Cellular telephone signals, prior to touch activation. In this respect the computerized devices which are the subject matter of the present invention are more closely related to devices such  
20 as the popular Apple iPhone/iPod touch/iPad series of devices, or to various Android series smartphones and tablets. By contrast, devices such as the Amazon Kindle touch, which are typically configured to be in an unpowered “off” stage when not in use, which do not receive wireless input in their inactive state, and which require a button push to activate rather than touch screen input to activate, are generally not covered by the present invention.

25 According to the method, the users or owners of the various computerized devices (often referred to in the alternative here as a smartphone for brevity) will usually install software, such as an advertising software app, onto their various respective machines. Alternatively this advertising software may be preloaded by the device manufacturer, or even configured as to be part of the handheld computerized device’s operating system.

30 Often, at least as a part of the initial installation process, and optionally on an ongoing basis, this advertising software app will usually be configured to receive user data pertaining to the user of the particular device that the software is installed upon. For example, as part of the

installation process, the software app may query the user as to the user's age, sex, location (or request access to the device's GPS location data), user's interests, and other user demographic data. The software app will usually then transmit some or all of this data, usually by wireless communications methods, to the invention's internet server.

- 5 Figure 2 shows an overview of how the invention's internet server (200) and database (202) interacts, over the internet (204) and various wireless network connections, with merchant/advertiser devices (206) and app software running on various the client computerized devices (208, 210, 212, 214), to distribute ads to be shown on the lockscreens of these various computerized devices.
- 10 The software apps running on the various computerized devices (208, 210, 212, 214) will, in turn receive, again usually over a wireless internet network connection (204), advertising data (e.g. lockscreen ad images) from the network server (200), and display this advertising media on the lockscreen (100) of the various handheld computerized devices according to an advertising ad display schedule. This display schedule, may, for example, call for specific
- 15 downloaded ads to be displayed on the lockscreen at various times, such as when the advertiser believes that the ad will be most effective. Thus for example, an ad for breakfast cereal may be preferentially displayed during the morning hours, while an ad for pizza may be preferentially displayed during the afternoon or evening hours.

In some embodiments, the device software app may be further programmed to periodically

20 report the device's location and/or lockscreen usage pattern to the server. Using this information, the server in turn may, for example, preferentially decide to display "rent a car" lockscreen ads or "hotel" lockscreen ads if the server determines that the device is being used while the user is traveling.

Merchants or other advertisers (206) desiring to use the system can then upload advertising

25 data, and a description of the desired characteristics of the target recipient population for these ads, to the network server (200). The invention's server software running on the network server (200) can then use this user data, along with a description of the target recipient population, to determine which of the various devices (208, 210, 212, 214) should receive which advertising media. The server software can then direct the network server

30 (200) to upload the relevant advertising media (e.g. ad images) to the appropriate devices (208, 210, 212, 214). Once this advertising media had been received by the device (e.g.

smartphone), the invention's software app can, as previously described, then display this advertising media on the device's lockscreen according to the advertising display schedule.

To allow merchants and other advertisers to upload this relevant advertising media, usually the network server (200) and database (202), in addition to the standard features such as at least one processor, memory, operating system software (e.g. Linux, Windows, Unix, etc.), web server software (e.g. Apache) support software (e.g. database software, script interpreter software, and the like) will also comprise advertising front end software. This advertising front end software will often be configured so that the merchant, often using the merchant's own internet connected computerized device (206), can use the front end software running on server (200) to upload advertising media and a description of a target recipient population from the merchant computerized device (206). Often a plurality of different merchants and advertisers will use the system. Indeed the system may be configured so as to make it extremely easy for nearly any advertiser of legal products and services to use the system.

Figure 3 shows how the invention's server (200) database (202) software may receive various types of user data (300), (302) from various computerized devices (e.g. 210, 212), match this user data up with advertising data (304), such as data from merchant or advertiser (206) (or other merchants and advertisers) that describes the intended target recipient population on the server (202, 204). When the user data (300, 302) matches up with the advertiser's description of the target recipient population (304), the server (200) can then transmit (306, 308) the appropriate advertising media (e.g. lockscreen images) to the appropriate handheld computerized devices (e.g. smartphones, such as 210, 212).

As previously discussed, this matching process will often be done by computer database software (200), (202), running on the network server and database. This database software may be configured to match the merchant's or advertiser's description of a target recipient population (304) with user data (300), (302). As a result of this matching process, the invention can determine which of the various devices (e.g. 208, 210, 212, 214) should receive which advertising media (306), (308).

In some embodiments, the network server software will further comprise ad scheduling software. This ad scheduling software can be used to determine a time schedule by which the various ads will be displayed on the lockscreens of the various devices (e.g. 208, 210, 212, 214), and may optionally transmit various ad display time schedules to the various advertising display software apps running on the various devices (e.g. 208, 210, 212, 214).

This schedule data can be used to control the times and durations in which the various advertising lockscreen ads are displayed.

Figure 4 shows a software flow chart showing some of the key steps on both the server and the client software that may be used to implement the present invention. The server software section on the left (400) shows some of the various software operations that are generally intended to run on the server (200) and server database (202), while the device software section on the right (402) shows the various software applications that are generally intended to run on the handheld computerized devices such as smartphones (208, 210, 212, and 214). The diagram also shows some areas where the invention's server software located on server (200) and the advertising display software app located on the various devices (208, 210, 212, and 214) exchange information over the network (204) (e.g. internet).

As one example, the software app (402) running on any of the devices (208, 210, 212, and 214) may periodically check to be sure that the app is still active (i.e. that the user has not removed or inactivated the app), and assuming that the app is still active may, along with the user data, also transmit that app active status information (404) to the server software (400) running on the server (200). The server software may in turn record this fact. Depending on how the device user rewards system is set up, the server software may, for example credit the user's account a certain amount of money (e.g. 1-10 cents a day) for every day that the app is active. The server can, as scheduled, further periodically transfer money to the device user's account, either directly (e.g. electronic transfer), or through one or more intermediate financial services (e.g. PayPal). This is shown as (405)

The server (200) and server software (400) will also, as previously described, take ad graphics file and other metadata (e.g. URL's associated with the ad, ad display schedule information, and the like) and transmit it to the various handheld devices (406), (208, 210, 212, 214) where this information will usually be stored in a memory buffer (408) onboard the handheld device.

When a user sees an ad of interest on the device lockscreen, the user can then use various methods to flag this ad for future use, or for referral to others. One of the simplest ways to capture a lockscreen ad of interest is to use the handheld device's own built-in screen capture software to capture the ad image. Here, using the Apple iPhone 4 with iOS software version 5.1 as a particular example, the operating system software is set up so that when the user simultaneously presses the "on/off" button and the "home" button, iPhone 4's operating

system's built-in screen capture software captures an image of even an unactivated lockscreen, and automatically places the lockscreen image in the iPhone devices photo's camera roll file (410). From this camera roll file, or the equivalent data file or database in other operating systems, the user may then use standard operating system functions, such as image storage and retrieval, or standard email or SMS operating software, to send image by email or SMS functions to those recipients as determined by the user.

Figure 5 shows an example of how an iPhone device user may capture a screenshot of a lockscreen ad of interest, and forward this ad (here the ad is also being used as a coupon), using the iPhone's standard operating system email software or SMS software (text messaging), to an appropriate recipient.

Alternative methods of handling an ad of interest are also possible. In an alternative embodiment, shown in Figure 4 (412), the advertising media data transmitted by the various merchants or advertisers (206) can, in addition to one or more advertising images and advertising display schedule information, also contain at least one web universal resource locator (URL) address.

In order to use these URL addresses, the handheld device software may be further configured so that, for example, movement of a secondary lockscreen touch sensitive area, such as movement on a camera icon Figure 1 (104) or equivalent, may cause the device software to use the system's web browser, or other internet browser or app, to jump to the URL address associated with the ad. Thus the user can go directly from a lockscreen image of an ad of interest to a web browser showing the ad's webpage.

Put alternatively, in this embodiment, advertising media can further comprise at least one web URL address, and the device advertising software app can be configured to further presents a button or active link on the lockscreen. This button or active link on the lockscreen can be further configured with the ad URL address, so that when a user presses or swipes on this lockscreen button or active link, the device opens up a web browser or equivalent corresponding to this ad URL, which will typically be an ad associated web address.

## Claims

1. A method of displaying advertising media on the lockscreens of a plurality of wireless network connected handheld computerized devices, said method comprising:
- 5 installing advertising display software app on at least one of said devices, said advertising display software app configured to receive user data pertaining to said user of said device, said advertising display software app further configured to wirelessly transmit at least some of said user data to a network server, wirelessly receive advertising data from said network server, and display said advertising media on said lockscreen according to an
- 10 advertising display schedule;
- uploading advertising media to said network server, along with a description of a target recipient population;
- using said user data, and said description of a target recipient population, to determine which of said devices should receive said advertising media, and using said network server to
- 15 upload said advertising media to said at least one device;
- and using said software app to display said advertising media on said lockscreen according to said advertising display schedule.
2. The method of claim 1, wherein said software app further reports its activation status to
- 20 said network server, and said network server transmits rewards to the users of said devices according to at least said activation status.
3. The method of claim 2, wherein said rewards comprise electronic transmission of money either directly from said network server to said users of said devices or through one or more
- 25 intermediate financial services to said users of said devices.
4. The method of claim 1, wherein said device further comprises device operating system software with a screen capture function, further using said screen capture function to capture advertising media displayed on said lockscreen and store said advertising media in a database
- 30 or file in said device for future use.
5. The method of claim 4, wherein said device further comprises device operating system software with an email or text function, further using a record of said advertising media

stored in said database or file to transmit said advertising media to another recipient using said email or text function.

6. The method of claim 1, wherein said network server comprises front end software, further using said front end software to upload advertising media and a description of a target recipient population from a merchant computerized device.

7. The method of claim 6, wherein said network server further comprises database software, further using said database software to match said description of a target recipient population with said user data, thereby determining which of said devices should receive said advertising media.

8. The method of claim 1, wherein said network server further comprises scheduling software, further using said scheduling software to determine a time schedule by which at least one advertising media will be displayed on said lockscreen of said device, and further transmitting said time schedule to said advertising display software app on said device to use as said advertising display schedule.

9. The method of claim 1, wherein said computerized device comprises a handheld Smartphone or a tablet computer with at least one processor, touch sensitive display screen, memory, and a wireless connection to a WiFi network and/or a Cellular network.

10. The method of claim 1, wherein said advertising media comprises advertising images, advertising images showing coupons, or advertising images showing at least one optical bar code or advertising alphanumeric serial number or phrase.

11. The method of claim 1, wherein said advertising media further comprises at least one web URL address, and wherein said software app further presents a button or active link on said lockscreen;

said button or active link on said lockscreen further configured with said at least one web URL address, and wherein said software app is further capable of detecting a user press or swipe on said button or active link on said lockscreen;

wherein after detecting said user press or swipe on said button or active link on said lockscreen, said software app, either before or after said device is unlocked, further activates



a web browser interface on said device that is directed towards said at least one web URL address.

12. A method of displaying advertising media on the lockscreens of a plurality of wireless network connected handheld computerized devices, said method comprising:
- 5 installing advertising display software app on at least one of said devices, said advertising display software app configured to receive user data pertaining to said user of said device, said advertising display software app further configured to wirelessly transmit at least some of said user data to a network server, wirelessly receive advertising data from said network server, and display said advertising media on said lockscreen according to an advertising display schedule;
- 10 uploading advertising media to said network server, along with a description of a target recipient population;
- using said user data, and said description of a target recipient population, to determine which of said devices should receive said advertising media, and using said network server to upload said advertising media to said at least one device;
- 15 and using said software app to display said advertising media on said lockscreen according to said advertising display schedule;
- wherein said software app further reports its activation status to said network server, and said network server transmits rewards to the users of said devices according to at least said activation status; and
- 20 wherein said rewards comprise electronic transmission of money either directly from said network server to said users of said devices or through one or more intermediate financial services to said users of said devices.

25

13. The method of claim 11, wherein said device further comprises device operating system software with a screen capture function, further using said screen capture function to capture advertising media displayed on said lockscreen and store said advertising media in a database or file in said device for future use;

- 30 wherein said device further comprises device operating system software with an email or text function, further using a record of said advertising media stored in said database or file to transmit said advertising media to another recipient using said email or text function.

14. The method of claim 12, wherein said network server comprises front end software, further using said front end software to upload advertising media and a description of a target recipient population from a merchant computerized device;

5 wherein said network server further comprises database software, further using said database software to match said description of a target recipient population with said user data, thereby determining which of said devices should receive said advertising media;

10 wherein said network server further comprises scheduling software, further using said scheduling software to determine a time schedule by which at least one advertising media will be displayed on said lockscreen of said device, and further transmitting said time schedule to said advertising display software app on said device to use as said advertising display schedule.

15 15. The method of claim 12, wherein said computerized device comprises a handheld Smartphone or a tablet computer with at least one processor, touch sensitive display screen, memory, and a wireless connection to a WiFi network and/or a Cellular network.

20 16. The method of claim 12, wherein said advertising media comprises advertising images, advertising images showing coupons, or advertising images showing at least one optical bar code or advertising alphanumeric serial number or phrase.

17. The method of claim 12, wherein said advertising media further comprises at least one web URL address, and wherein said software app further presents a button or active link on said lockscreen;

25 said button or active link on said lockscreen further configured with said at least one web URL address, and wherein said software app is further capable of detecting a user press or swipe on said button or active link on said lockscreen;

30 wherein after detecting said user press or swipe on said button or active link on said lockscreen, said software app, either before or after said device is unlocked, further activates a web browser interface on said device that is directed towards said at least one web URL address.

18. A method of displaying advertising media on the lockscreens of a plurality of wireless network connected handheld computerized devices, said method comprising:

installing advertising display software app on at least one of said devices, said advertising display software app configured to receive user data pertaining to said user of said device, said advertising display software app further configured to wirelessly transmit at least some of said user data to a network server, wirelessly receive advertising data from said  
5 network server, and display said advertising media on said lockscreen according to an advertising display schedule;

uploading advertising media to said network server, along with a description of a target recipient population;

using said user data, and said description of a target recipient population, to determine  
10 which of said devices should receive said advertising media, and using said network server to upload said advertising media to said at least one device;

and using said software app to display said advertising media on said lockscreen according to said advertising display schedule;

wherein said advertising media further comprises at least one web URL address, and  
15 wherein said software app further presents a button or active link on said lockscreen;

said button or active link on said lockscreen further configured with said at least one web URL address, and wherein said software app is further capable of detecting a user press or swipe on said button or active link on said lockscreen;

wherein after detecting said user press or swipe on said button or active link on said  
20 lockscreen, said software app, either before or after said device is unlocked, further activates a web browser interface on said device that is directed towards said at least one web URL address;

wherein said software app further reports its activation status to said network server, and said network server transmits rewards to the users of said devices according to at least  
25 said activation status; and

wherein said rewards comprise electronic transmission of money either directly from said network server to said users of said devices or through one or more intermediate financial services to said users of said devices;

wherein said network server comprises front end software, further using said front end  
30 software to upload advertising media and a description of a target recipient population from a merchant computerized device;

wherein said network server further comprises database software, further using said database software to match said description of a target recipient population with said user data, thereby determining which of said devices should receive said advertising media;

- wherein said network server further comprises scheduling software, further using said scheduling software to determine a time schedule by which at least one advertising media will be displayed on said lockscreen of said device, and further transmitting said time schedule to said advertising display software app on said device to use as said advertising display schedule; and
- 5 wherein said computerized device comprises a handheld Smartphone or a tablet computer with at least one processor, touch sensitive display screen, memory, and a wireless connection to a WiFi network and/or a Cellular network.
- 10 19. The method of claim 18, wherein said device further comprises device operating system software with a screen capture function, further using said screen capture function to capture advertising media displayed on said lockscreen and store said advertising media in a database or file in said device for future use;
- 15 wherein said device further comprises device operating system software with an email or text function, further using a record of said advertising media stored in said database or file to transmit said advertising media to another recipient using said email or text function.
- 20 20. The method of claim 18, wherein said advertising media comprises advertising images, advertising images showing coupons, or advertising images showing at least one optical bar code or advertising alphanumeric serial number or phrase.

Figure 1

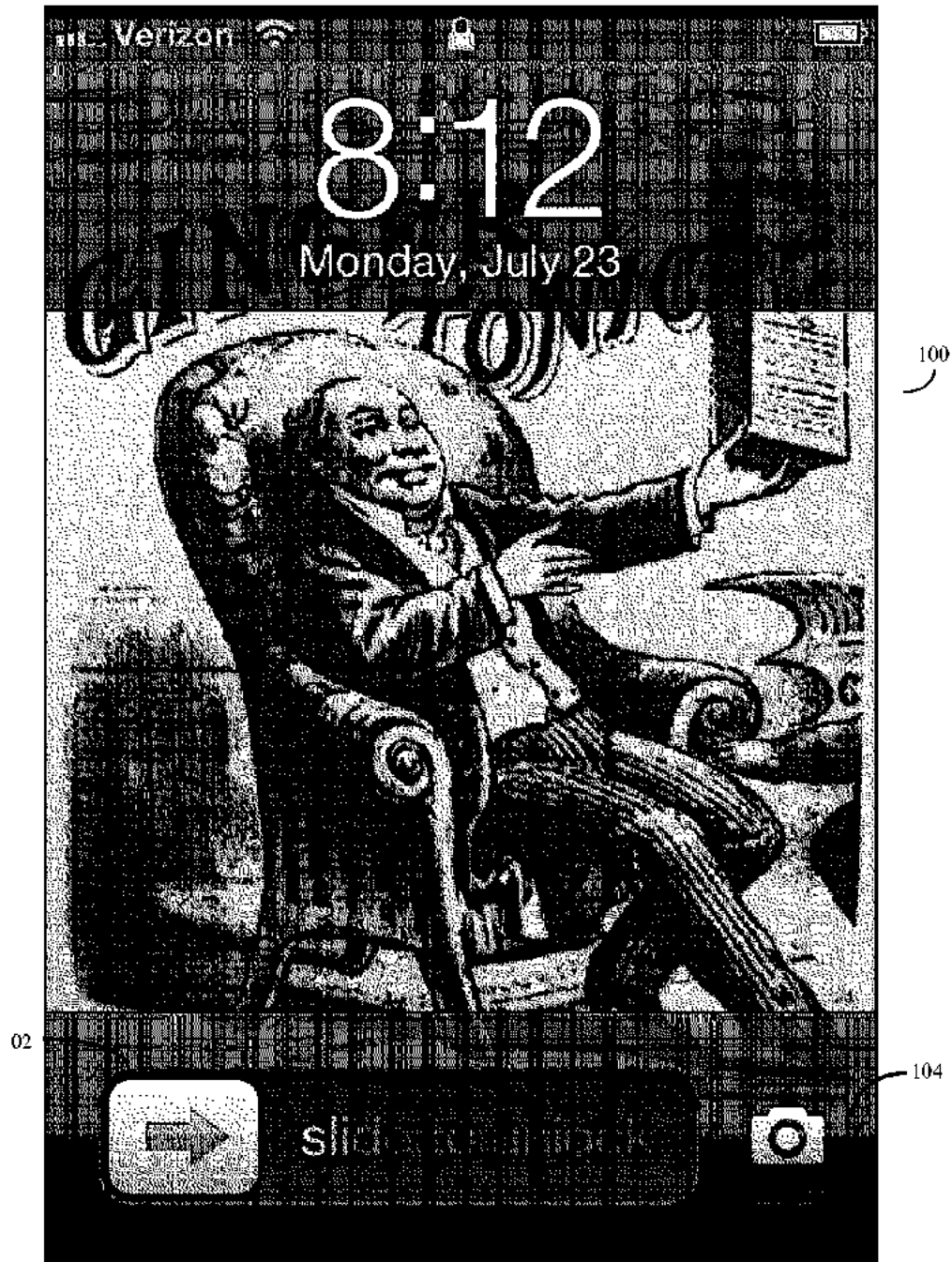


Figure 2

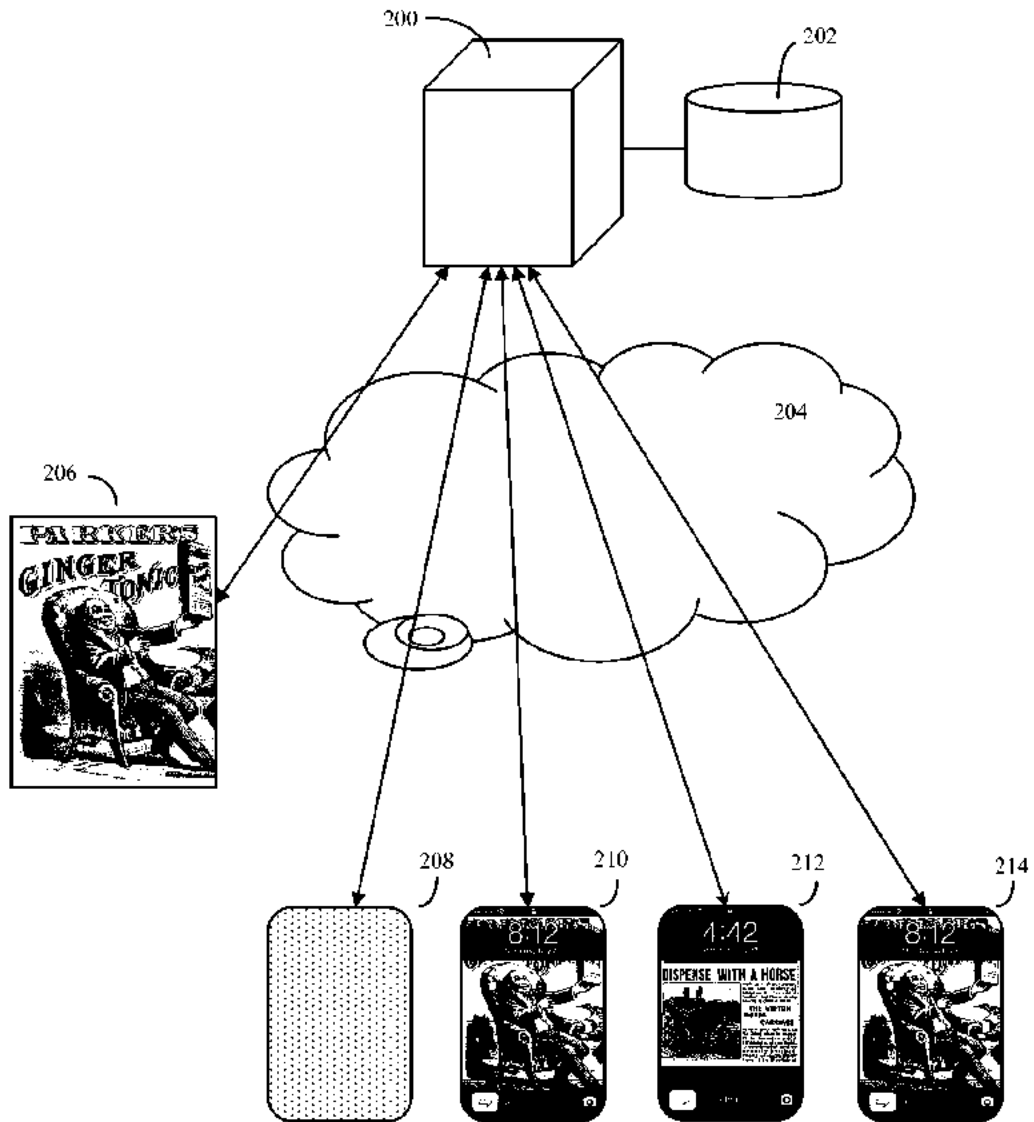


Figure 3

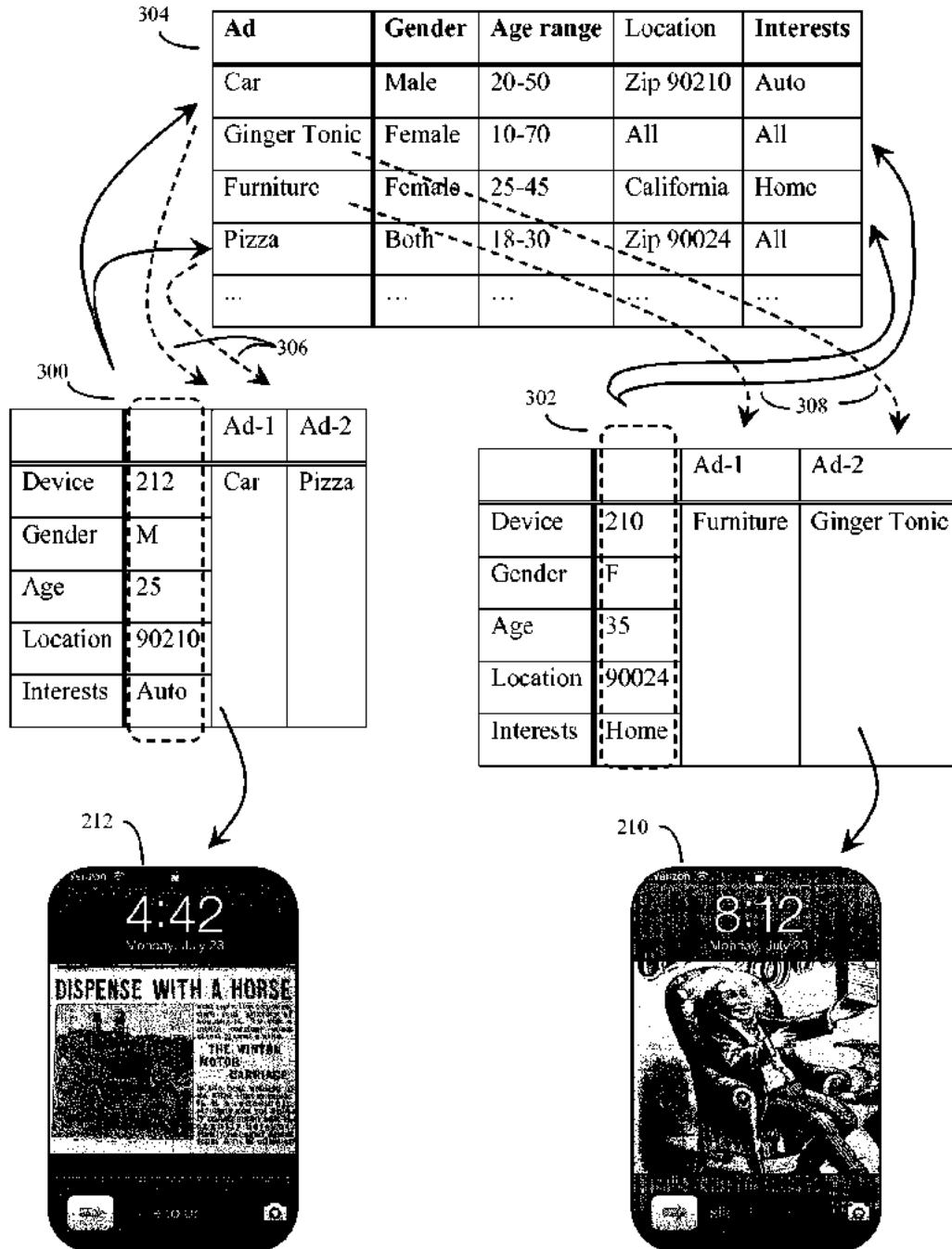


Figure 4

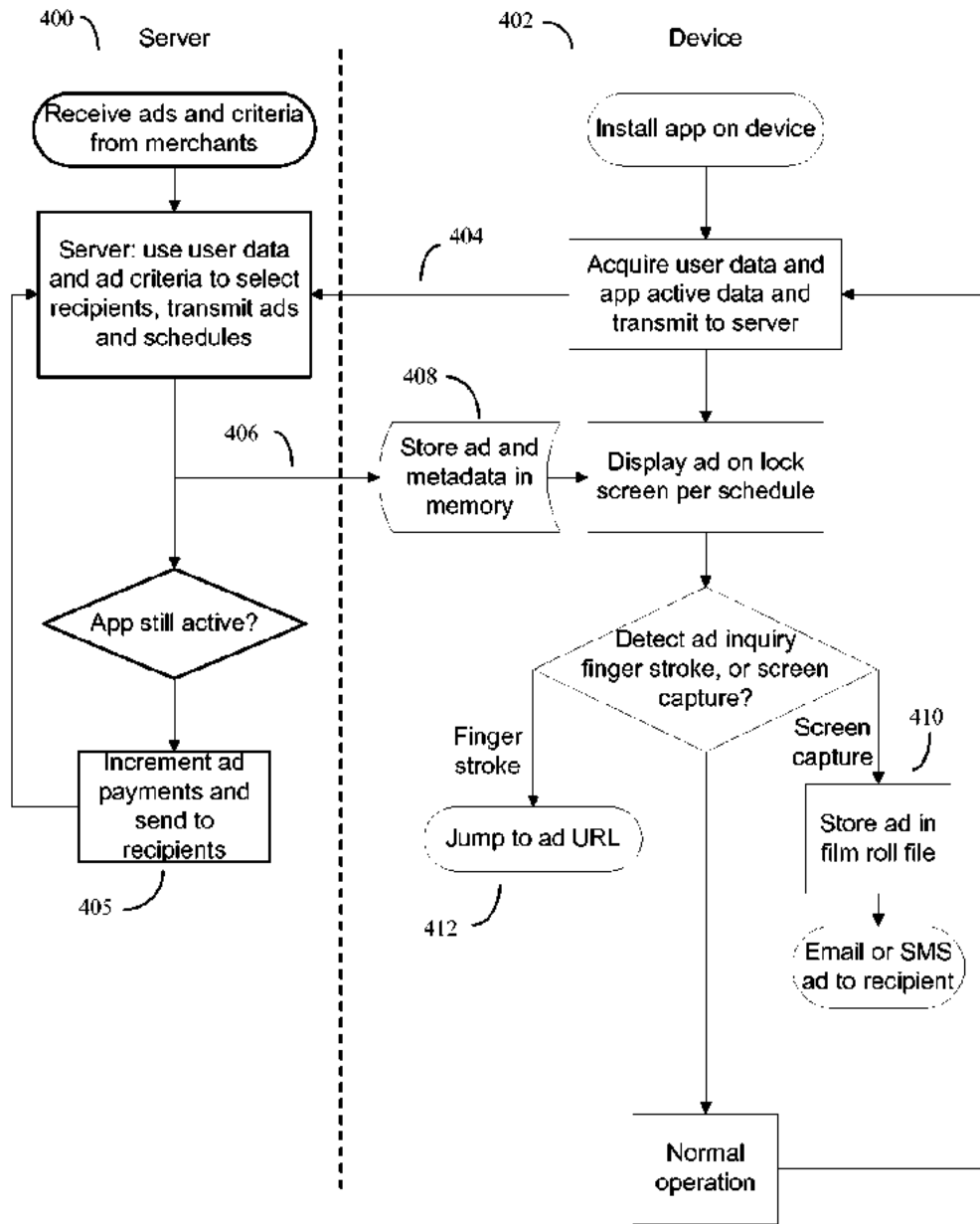
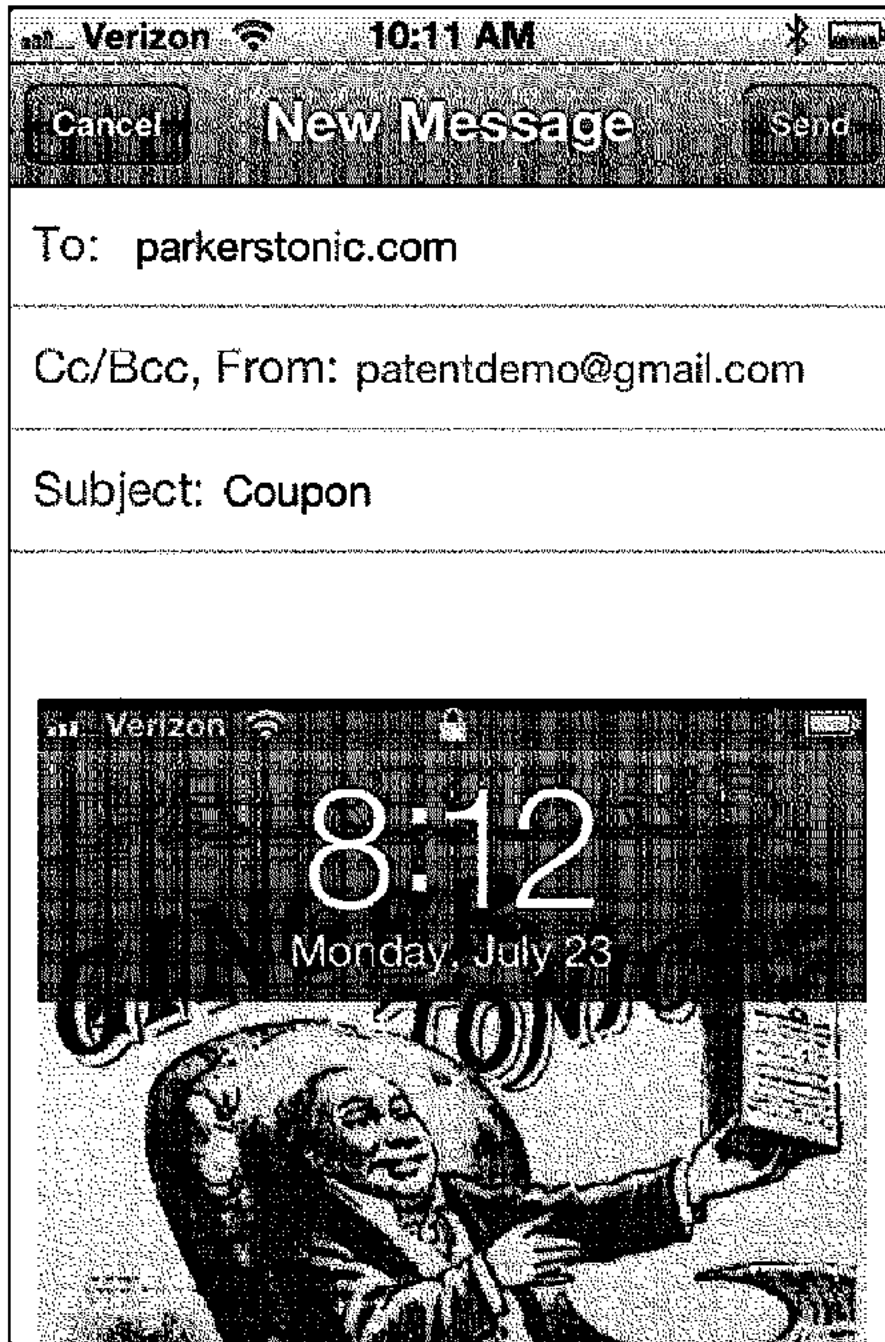




Figure 5



**INTERNATIONAL SEARCH REPORT**

International application No.

PCT/US 2013/052648

**A. CLASSIFICATION OF SUBJECT MATTER**

*G06Q 30/02 (2012.01)*  
*H04H 60/33 (2008.01)*

According to International Patent Classification (IPC) or to both national classification and IPC

**B. FIELDS SEARCHED**

Minimum documentation searched (classification system followed by classification symbols)

H04M 3/00, G06Q 30/00-30/02, G05B 21/00-21/02, G06T 15/00, H04H 20/00-20/71, 60/00-60/33

Documentation searched other than minimum documentation to the extent that such documents are included in the fields searched

Electronic data base consulted during the international search (name of data base and, where practicable, search terms used)

PatSearch (RUPTO internal), USPTO, PAJ, Esp@cenet, Information Retrieval System of FIPS

**C. DOCUMENTS CONSIDERED TO BE RELEVANT**

Category*	Citation of document, with indication, where appropriate, of the relevant passages	Relevant to claim No.
X	US 2010/0222046 A1 (RESEARCH IN MOTION LIMITED) 02.09.2010, [0014], [0019]-[0024], [0088]-[0101], [0104]-[0109], [0113]-[0119]	1-3, 6-9, 12, 14, 15
Y		4, 5, 10, 11, 13, 16-20
Y	US 2011/0093320 A1 (CONEXUS LLC) 21.04.2011, [0031], [0069], [0074], [0081]	10, 11, 13, 16-20
Y	US 2011/0184536 A1 (SYSMEX CORPORATION) 28.07.2011, [0066]	4, 5, 13, 19

Further documents are listed in the continuation of Box C.

See patent family annex.

* Special categories of cited documents:	"I" later document published after the international filing date or priority date and not in conflict with the application but cited to understand the principle or theory underlying the invention
"A" document defining the general state of the art which is not considered to be of particular relevance	"X" document of particular relevance; the claimed invention cannot be considered novel or cannot be considered to involve an inventive step when the document is taken alone
"E" earlier document but published on or after the international filing date	"Y" document of particular relevance; the claimed invention cannot be considered to involve an inventive step when the document is combined with one or more other such documents, such combination being obvious to a person skilled in the art
"L" document which may throw doubts on priority claim(s) or which is cited to establish the publication date of another citation or other special reason (as specified)	"&" document member of the same patent family
"O" document referring to an oral disclosure, use, exhibition or other means	
"P" document published prior to the international filing date but later than the priority date claimed	

Date of the actual completion of the international search

15 November 2013 (15.11.2013)

Date of mailing of the international search report

21 November 2013 (21.11.2013)

Name and mailing address of the ISA: FIPS  
Russia, 123995, Moscow, G-59, GSP-5,  
Berezhkovskaya nab., 30-1

Authorized officer

A. Tokarev

Facsimile No. +7 (499) 243-33-37

Telephone No. (499) 240-25-91

Under the Paperwork Reduction Act of 1995, no persons are required to respond to a collection of information unless it displays a valid OMB control number.

<b>PATENT APPLICATION FEE DETERMINATION RECORD</b> Substitute for Form PTO-875	Application or Docket Number <b>14/848,191</b>	Filing Date <b>09/08/2015</b>	<input checked="" type="checkbox"/> To be Mailed
---	---	----------------------------------	--

ENTITY:  LARGE  SMALL  MICRO

**APPLICATION AS FILED – PART I**

FOR	NUMBER FILED	NUMBER EXTRA	RATE (\$)	FEE (\$)
<input type="checkbox"/> BASIC FEE (37 CFR 1.16(a), (b), or (c))	N/A	N/A	N/A	
<input type="checkbox"/> SEARCH FEE (37 CFR 1.16(k), (l), or (m))	N/A	N/A	N/A	
<input type="checkbox"/> EXAMINATION FEE (37 CFR 1.16(o), (p), or (q))	N/A	N/A	N/A	
TOTAL CLAIMS (37 CFR 1.16(j))	minus 20 = *		X \$ =	
INDEPENDENT CLAIMS (37 CFR 1.16(h))	minus 3 = *		X \$ =	
<input type="checkbox"/> APPLICATION SIZE FEE (37 CFR 1.16(s))	If the specification and drawings exceed 100 sheets of paper, the application size fee due is \$310 (\$155 for small entity) for each additional 50 sheets or fraction thereof. See 35 U.S.C. 41(a)(1)(G) and 37 CFR 1.16(s).			
<input type="checkbox"/> MULTIPLE DEPENDENT CLAIM PRESENT (37 CFR 1.16(j))				
* If the difference in column 1 is less than zero, enter "0" in column 2.			TOTAL	

**APPLICATION AS AMENDED – PART II**

	(Column 1)	(Column 2)	(Column 3)	PRESENT EXTRA	RATE (\$)	ADDITIONAL FEE (\$)
<b>AMENDMENT</b>	<b>05/13/2016</b>	CLAIMS REMAINING AFTER AMENDMENT	HIGHEST NUMBER PREVIOUSLY PAID FOR			
	Total (37 CFR 1.16(i))	* 20	Minus ** 20	= 0	X \$40 =	0
	Independent (37 CFR 1.16(h))	* 2	Minus *** 3	= 0	X \$210 =	0
	<input type="checkbox"/> Application Size Fee (37 CFR 1.16(s)) <input type="checkbox"/> FIRST PRESENTATION OF MULTIPLE DEPENDENT CLAIM (37 CFR 1.16(j))					
					TOTAL ADD'L FEE	<b>0</b>

	(Column 1)	(Column 2)	(Column 3)	PRESENT EXTRA	RATE (\$)	ADDITIONAL FEE (\$)
<b>AMENDMENT</b>		CLAIMS REMAINING AFTER AMENDMENT	HIGHEST NUMBER PREVIOUSLY PAID FOR			
	Total (37 CFR 1.16(i))	-	Minus **	=	X \$ =	
	Independent (37 CFR 1.16(h))	*	Minus ***	=	X \$ =	
	<input type="checkbox"/> Application Size Fee (37 CFR 1.16(s)) <input type="checkbox"/> FIRST PRESENTATION OF MULTIPLE DEPENDENT CLAIM (37 CFR 1.16(j))					
					TOTAL ADD'L FEE	

SLIE  
/NICHELE PETERSON/

\* If the entry in column 1 is less than the entry in column 2, write "0" in column 3.  
 \*\* If the "Highest Number Previously Paid For" IN THIS SPACE is less than 20, enter "20".  
 \*\*\* If the "Highest Number Previously Paid For" IN THIS SPACE is less than 3, enter "3".

The "Highest Number Previously Paid For" (Total or Independent) is the highest number found in the appropriate box in column 1.

This collection of information is required by 37 CFR 1.16. The information is required to obtain or retain a benefit by the public which is to file (and by the USPTO to process) an application. Confidentiality is governed by 35 U.S.C. 122 and 37 CFR 1.14. This collection is estimated to take 12 minutes to complete, including gathering, preparing, and submitting the completed application form to the USPTO. Time will vary depending upon the individual case. Any comments on the amount of time you require to complete this form and/or suggestions for reducing this burden, should be sent to the Chief Information Officer, U.S. Patent and Trademark Office, U.S. Department of Commerce, P.O. Box 1450, Alexandria, VA 22313-1450. DO NOT SEND FEES OR COMPLETED FORMS TO THIS ADDRESS. **SEND TO: Commissioner for Patents, P.O. Box 1450, Alexandria, VA 22313-1450.**

If you need assistance in completing the form, call 1-800-PTO-9199 and select option 2.



UNITED STATES PATENT AND TRADEMARK OFFICE

UNITED STATES DEPARTMENT OF COMMERCE
United States Patent and Trademark Office
Address: COMMISSIONER FOR PATENTS
P O Box 1450
Alexandria, Virginia 22313-1450
www.uspto.gov

Table with 5 columns: APPLICATION NO., FILING DATE, FIRST NAMED INVENTOR, ATTORNEY DOCKET NO., CONFIRMATION NO.
14/848,191 09/08/2015 Jae Lark JUNG UNIS005.001C2 9599

20995 7590 05/17/2016
KNOBBE MARTENS OLSON & BEAR LLP
2040 MAIN STREET
FOURTEENTH FLOOR
IRVINE, CA 92614

EXAMINER

SHEDRICK, CHARLES TERRELL

ART UNIT PAPER NUMBER

2646

NOTIFICATION DATE DELIVERY MODE

05/17/2016

ELECTRONIC

Please find below and/or attached an Office communication concerning this application or proceeding.

The time period for reply, if any, is set in the attached communication.

Notice of the Office communication was sent electronically on above-indicated "Notification Date" to the following e-mail address(es):

jayna.cartee@knobbe.com
efiling@knobbe.com

<b>Notice of References Cited</b>	Application/Control No. 14/848,191	Applicant(s)/Patent Under Reexamination JUNG ET AL.	
	Examiner CHARLES SHEDRICK	Art Unit 2646	Page 1 of 1

**U.S. PATENT DOCUMENTS**

*		Document Number Country Code-Number-Kind Code	Date MM-YYYY	Name	CPC Classification	US Classification
*	A	US-2006/0258289 A1	11-2006	Dua; Robin	G06F17/30058	455/41.3
*	B	US-2010/0102939 A1	04-2010	STEWART; Arthur Leslie	G10H1/34	340/384.1
*	C	US-2010/0159898 A1	06-2010	Krzyzanowski; Paul	G06F9/4445	455/414.1
*	D	US-2010/0304731 A1	12-2010	Bratton; R. Alex	H04N5/232	455/420
*	E	US-2012/0009896 A1	01-2012	Bandyopadhyay; Shamik	G06F1/1643	455/411
*	F	US-2012/0052836 A1	03-2012	Buratti; Richard Michael	H04M1/72541	455/404.2
*	G	US-8,311,514 B2	11-2012	Bandyopadhyay; Shamik	G06F1/1643	455/410
*	H	US-2013/0104187 A1	04-2013	Weidner; Klaus Helmut	G06F21/31	726/1
*	I	US-2014/0162598 A1	06-2014	Villa-Real; Antony-Euclid C.	H04M1/66	455/411
*	J	US-8,782,775 B2	07-2014	Fadell; Anthony	G06F21/316	726/16
	K	US-				
	L	US-				
	M	US-				

**FOREIGN PATENT DOCUMENTS**

*		Document Number Country Code-Number-Kind Code	Date MM-YYYY	Country	Name	CPC Classification
	N					
	O					
	P					
	Q					
	R					
	S					
	T					

**NON-PATENT DOCUMENTS**

*		Include as applicable: Author, Title Date, Publisher, Edition or Volume, Pertinent Pages)
	U	
	V	
	W	
	X	

\*A copy of this reference is not being furnished with this Office action. (See MPEP § 707.05(a).)  
Dates in MM-YYYY format are publication dates. Classifications may be US or foreign.

<b>First Action Interview Office Action Summary</b>	<b>Application No.</b> 14/848,191	<b>Applicant(s)</b> JUNG ET AL.	
	<b>Examiner</b> CHARLES SHEDRICK	<b>Art Unit</b> 2646	<b>AIA (First Inventor to File) Status</b> No

*The MAILING OR NOTIFICATION DATE of this communication appears on the cover sheet with the correspondence address.*

THE SHORTENED STATUTORY PERIOD FOR REPLY IS SET TO EXPIRE **TWO MONTHS** FROM THE MAILING OR NOTIFICATION DATE OF THIS COMMUNICATION.

**This time period for reply is extendable under 37 CFR 1.136(a) for only TWO additional MONTHS.**

Applicant's request to not have a first-action interview is acknowledged (or the time period for reply set forth in the Pre-Interview Communication has expired and the Office did not receive any reply).

**Status**

- 1)  Responsive to communication(s) filed on 9/8/15 and interview conducted on \_\_\_\_\_.  
 A declaration(s)/affidavit(s) under **37 CFR 1.130(b)** was/were filed on \_\_\_\_\_.
- 2)  Since this application is in condition for allowance except for formal matters, prosecution as to the merits is closed in accordance with the practice under *Ex parte Quayle*, 1935 C.D. 11, 453 O.G. 213.

**Disposition of Claims**

- 3)  Claim(s) 1-20 is/are pending in the application.  
3a) Of the above claim(s) \_\_\_\_\_ is/are withdrawn from consideration.
- 4)  Claim(s) \_\_\_\_\_ is/are allowed.
- 5)  Claim(s) 1-20 is/are rejected.
- 6)  Claim(s) \_\_\_\_\_ is/are objected to.
- 7)  Claim(s) \_\_\_\_\_ are subject to restriction and/or election requirement.

**Application Papers**

- 8)  The specification is objected to by the Examiner.
- 9)  The drawing(s) filed on 9/8/15 is/are: a)  accepted or b)  objected to by the Examiner.  
Applicant may not request that any objection to the drawing(s) be held in abeyance. See 37 CFR 1.85(a).  
Replacement drawing sheet(s) including the correction is required if the drawing(s) is objected to. See 37 CFR 1.121(d).

**Priority under 35 U.S.C. § 119**

- 10)  Acknowledgment is made of a claim for foreign priority under 35 U.S.C. § 119(a)-(d) or (f).  
a)  All    b)  Some \*    c)  None of:  
1.  Certified copies of the priority documents have been received.  
2.  Certified copies of the priority documents have been received in Application No. \_\_\_\_\_.  
3.  Copies of the certified copies of the priority documents have been received in this National Stage application from the International Bureau (PCT Rule 17.2(a)).

\*See the attached detailed Office action for a list of the certified copies not received.

**Contact Information**

Examiner's Telephone Number: (571)272-8621

Examiner's Typical Work Schedule: Monday thru Friday 8:00AM-4:30PM

Supervisor's Name: Lester Kincaid

Supervisor's Telephone Number:

**Attachment(s)**

- 1)  Notice of References Cited (PTO-892)
- 2)  Information Disclosure Statement(s) (PTO/SB/08a and/or PTO/SB/08b)  
Paper No(s)/Mail Date \_\_\_\_\_.
- 3)  Interview Summary (PTO-413)  
Paper No(s)/Mail Date. \_\_\_\_\_.
- 4)  Other: \_\_\_\_\_.

<b>First Action Interview Office Action Summary</b>		<b>Application No.</b> 14/848,191		<b>Applicant(s)</b> JUNG ET AL.	
		<b>Examiner</b> CHARLES SHEDRICK		<b>Art Unit</b> 2646	<b>AIA (First Inventor to File) Status</b> No

**Notification of Rejection(s) and/or Objection(s)**

#	Claim(s)	Reference(s) (if applicable)	Rejection Statutory Basis	Brief Explanation of Rejection
1	1-20	n/a	35 USC 101	Claims 1-20 are rejected on the ground of nonstatutory double patenting as being unpatentable over claims of U.S. Patent No. 9179298, 8918074, 8831557
2	1-6,9-15, and 18-20	E	35 USC 102	Abstract, 0004-0005, 0012, 0077-0080-0087, 0101-0106. figures 5 and 6
3	1-20	E and G and /or B	35 USC 103	Assuming arguendo that a single reference does not provide adequate teachings the Examiner submits it still would have been obvious to combine the teaching of the prior art to arrive at the claimed invention
4	1 and 12	B	35 USC 102	Abstract. 0006, 0009,0019, 0021
5	1 and 12	J	35 USC 102	Abstract. figures 4, 6,8 and 1. col. 1 line 54-col. 2 lines 50.

**Expanded Discussion/Commentary**

1	Via an activation button based on a locked screen. G teaches in the abstract that The application allows wake-up and unlock operations to occur using a single event, such as a single keystroke. In process block 730, in response to the determination that the received input is from a human touch, the mobile device simultaneously activates the touch screen and unlocks the device via fingerprint			
3	Claims 1-20 of copending Application 14848156 are identical to the claims of the instant application and therefore cannot be overcome with a Terminal disclaimer			
	Note: As noted during the interview - Applicant is reminded to carefully (1) Examine the references in their entirety. The cited sections are indicated to merely assist the Applicant in understanding the Examiner's position and should not be used as substitute for reading the entire reference for other relevant details. (2) Carefully review the references cited on the PTO 892 when considering a response to avoid previously presented references on the 892 being applied in subsequent office actions			
	Examiner has cited particular columns and line numbers in the references applied to the claims above for the convenience of the applicant. Although the specified citations are representative of the teachings of the art and are applied to specific limitations within the individual claim, other passages and figures may apply as well.			
	It is respectfully requested from the applicant in preparing responses, to fully consider the references in entirety as potentially teaching all or part of the claimed invention, as well as the context of the passage as taught by the prior art or disclosed by the Examiner			
<table border="1" style="width: 100%;"> <tr> <td style="width: 30%;"><b>DATE:</b> 12 May, 2016</td> <td style="width: 40%;">/CHARLES SHEDRICK/ Primary Examiner. Art Unit 2646</td> <td style="width: 30%;"></td> </tr> </table>		<b>DATE:</b> 12 May, 2016	/CHARLES SHEDRICK/ Primary Examiner. Art Unit 2646	
<b>DATE:</b> 12 May, 2016	/CHARLES SHEDRICK/ Primary Examiner. Art Unit 2646			

<b>Notice of References Cited</b>	Application/Control No. 14/848,191	Applicant(s)/Patent Under Reexamination JUNG ET AL.	
	Examiner CHARLES SHEDRICK	Art Unit 2646	Page 1 of 1

**U.S. PATENT DOCUMENTS**

*		Document Number Country Code-Number-Kind Code	Date MM-YYYY	Name	CPC Classification	US Classification
*	A	US-2006/0258289 A1	11-2006	Dua; Robin	G06F17/30058	455/41.3
*	B	US-2010/0102939 A1	04-2010	STEWART; Arthur Leslie	G10H1/34	340/384.1
*	C	US-2010/0159898 A1	06-2010	Krzyzanowski; Paul	G06F9/4445	455/414.1
*	D	US-2010/0304731 A1	12-2010	Bratton; R. Alex	H04N5/232	455/420
*	E	US-2012/0009896 A1	01-2012	Bandyopadhyay; Shamik	G06F1/1643	455/411
*	F	US-2012/0052836 A1	03-2012	Buratti; Richard Michael	H04M1/72541	455/404.2
*	G	US-8,311,514 B2	11-2012	Bandyopadhyay; Shamik	G06F1/1643	455/410
*	H	US-2013/0104187 A1	04-2013	Weidner; Klaus Helmut	G06F21/31	726/1
*	I	US-2014/0162598 A1	06-2014	Villa-Real; Antony-Euclid C.	H04M1/66	455/411
*	J	US-8,782,775 B2	07-2014	Fadell; Anthony	G06F21/316	726/16
	K	US-				
	L	US-				
	M	US-				

**FOREIGN PATENT DOCUMENTS**

*		Document Number Country Code-Number-Kind Code	Date MM-YYYY	Country	Name	CPC Classification
	N					
	O					
	P					
	Q					
	R					
	S					
	T					

**NON-PATENT DOCUMENTS**

*		Include as applicable: Author, Title Date, Publisher, Edition or Volume, Pertinent Pages)
	U	
	V	
	W	
	X	

\*A copy of this reference is not being furnished with this Office action. (See MPEP § 707.05(a).)  
Dates in MM-YYYY format are publication dates. Classifications may be US or foreign.



**IN THE UNITED STATES PATENT AND TRADEMARK OFFICE**

First Named Inventor	: Jae Lark JUNG
Applicant	: FIRSTFACE CO., LTD.
App. No.	: 14/848,191
Filed	: September 8, 2015
Examiner	: Shedrick, Charles Terrell
Art Unit	: 2646
Conf. No.	: 9599

RESPONSETO THE MAY 17, 2016 FIRST ACTION INTERVIEW OFFICE ACTION

Mail Stop Amendment  
 Commissioner for Patents  
 P.O. Box 1450  
 Alexandria, VA 22313-1450

Dear Sir:

This paper is in response to the First Action Interview (FAI) Office Action dated May 17, 2016. On May 13, 2016, Applicant electronically filed AMENDMENT IN RESPONSE TO INTERVIEW AND PRE-INTERVIEW COMMUNICATION ("May 13, 2016 Amendment) in response to the FAI Pre-Interview Communication of February 2, 2016 and the Examiner's Interview Summary of April 15, 2016.

Applicant notes that the Examiner's substantive comments made in the May 17, 2016 FAI Office Action are identical to those in the February 2, 2016 FAI Pre-Interview Communication. Applicant's May 13, 2016 Amendment addresses the Examiner's concerns and comments made in the February 2, 2016 FAI Pre-Interview Communication and accordingly also responds to the May 17, 2016 FAI Office Action. On May 19, 2016, the undersigned Applicant's Representative spoke with Examiner Shedrick about the crossing of Applicant's filing of the May 13, 2016 Amendment and the issuance of the May 17, 2016 FAI Office Action. The Examiner confirmed that he would review the May 13, 2016 Amendment as Applicant's response to the May 17, 2016 FAI Office Action.

Application No.: 14/848,191  
Filed: September 8, 2015

Applicant notes that in the May 17, 2016 FAI Office Action, the Examiner made additional comments that the cited references should be considered in their entirety, not just the sections referenced by the Examiner. Applicant respectfully submits that in preparing the May 13, 2016 Amendment, Applicant considered the cited reference fully in their entirety.

Applicant respectfully requests reconsideration of the application in view of the amendments and remarks included in the May 13, 2016 Amendment. If the Examiner has any questions which may be answered by telephone, he is invited to call the undersigned directly.

No fee is believed to be due. However, please charge any fees, including any fees for additional extension of time, or credit overpayment to Deposit Account No. 11-1410.

Respectfully submitted,

KNOBBE, MARTENS, OLSON & BEAR, LLP

Dated: May 19, 2016

By: /Mincheol Kim/  
Mincheol Kim  
Registration No. 51,306  
Attorney of Record  
Customer No. 20,995  
(949) 760-0404

23372099  
031916

## Electronic Acknowledgement Receipt

<b>EFS ID:</b>	25832046
<b>Application Number:</b>	14848191
<b>International Application Number:</b>	
<b>Confirmation Number:</b>	9599
<b>Title of Invention:</b>	ACTIVATING DISPLAY AND PERFORMING USER AUTHENTICATION IN MOBILE TERMINAL WITH ONE-TIME USER INPUT
<b>First Named Inventor/Applicant Name:</b>	Jae Lark JUNG
<b>Customer Number:</b>	20995
<b>Filer:</b>	Mincheol Kim/Tony Do
<b>Filer Authorized By:</b>	Mincheol Kim
<b>Attorney Docket Number:</b>	UNIS005.001C2
<b>Receipt Date:</b>	19-MAY-2016
<b>Filing Date:</b>	08-SEP-2015
<b>Time Stamp:</b>	18:07:47
<b>Application Type:</b>	Utility under 35 USC 111(a)

### Payment information:

Submitted with Payment	no
------------------------	----

### File Listing:

Document Number	Document Description	File Name	File Size(Bytes)/ Message Digest	Multi Part /.zip	Pages (if appl.)
1	Supplemental Response or Supplemental Amendment	Response-UNIS005_001C2.pdf	139836 <small>f7fedba3ac6e2a7d21db1060147ad978b145720</small>	no	2

### Warnings:

### Information:

**This Acknowledgement Receipt evidences receipt on the noted date by the USPTO of the indicated documents, characterized by the applicant, and including page counts, where applicable. It serves as evidence of receipt similar to a Post Card, as described in MPEP 503.**

**New Applications Under 35 U.S.C. 111**

**If a new application is being filed and the application includes the necessary components for a filing date (see 37 CFR 1.53(b)-(d) and MPEP 506), a Filing Receipt (37 CFR 1.54) will be issued in due course and the date shown on this Acknowledgement Receipt will establish the filing date of the application.**

**National Stage of an International Application under 35 U.S.C. 371**

**If a timely submission to enter the national stage of an international application is compliant with the conditions of 35 U.S.C. 371 and other applicable requirements a Form PCT/DO/EO/903 indicating acceptance of the application as a national stage submission under 35 U.S.C. 371 will be issued in addition to the Filing Receipt, in due course.**

**New International Application Filed with the USPTO as a Receiving Office**

**If a new international application is being filed and the international application includes the necessary components for an international filing date (see PCT Article 11 and MPEP 1810), a Notification of the International Application Number and of the International Filing Date (Form PCT/RO/105) will be issued in due course, subject to prescriptions concerning national security, and the date shown on this Acknowledgement Receipt will establish the international filing date of the application.**



UNITED STATES PATENT AND TRADEMARK OFFICE

UNITED STATES DEPARTMENT OF COMMERCE
United States Patent and Trademark Office
Address: COMMISSIONER FOR PATENTS
P O Box 1450
Alexandria, Virginia 22313-1450
www.uspto.gov

Table with 5 columns: APPLICATION NO., FILING DATE, FIRST NAMED INVENTOR, ATTORNEY DOCKET NO., CONFIRMATION NO.
14/848,191 09/08/2015 Jae Lark JUNG UNIS005.001C2 9599

20995 7590 08/26/2016
KNOBBE MARTENS OLSON & BEAR LLP
2040 MAIN STREET
FOURTEENTH FLOOR
IRVINE, CA 92614

EXAMINER

SHEDRICK, CHARLES TERRELL

ART UNIT PAPER NUMBER

2646

NOTIFICATION DATE DELIVERY MODE

08/26/2016

ELECTRONIC

Please find below and/or attached an Office communication concerning this application or proceeding.

The time period for reply, if any, is set in the attached communication.

Notice of the Office communication was sent electronically on above-indicated "Notification Date" to the following e-mail address(es):

jayna.cartee@knobbe.com
efiling@knobbe.com

**Office Action Summary****Application No.**  
14/848,191**Applicant(s)**  
JUNG ET AL.**Examiner**  
CHARLES SHEDRICK**Art Unit**  
2646**AIA (First Inventor to File)  
Status**  
No**-- The MAILING DATE of this communication appears on the cover sheet with the correspondence address --****Period for Reply**A SHORTENED STATUTORY PERIOD FOR REPLY IS SET TO EXPIRE 3 MONTHS FROM THE MAILING DATE OF THIS COMMUNICATION.

- Extensions of time may be available under the provisions of 37 CFR 1.136(a). In no event, however, may a reply be timely filed after SIX (6) MONTHS from the mailing date of this communication.
- If NO period for reply is specified above, the maximum statutory period will apply and will expire SIX (6) MONTHS from the mailing date of this communication.
- Failure to reply within the set or extended period for reply will, by statute, cause the application to become ABANDONED (35 U.S.C. § 133). Any reply received by the Office later than three months after the mailing date of this communication, even if timely filed, may reduce any earned patent term adjustment. See 37 CFR 1.704(b).

**Status**

- 1)  Responsive to communication(s) filed on 5/19/16.  
 A declaration(s)/affidavit(s) under **37 CFR 1.130(b)** was/were filed on \_\_\_\_\_.
- 2a)  This action is **FINAL**.                      2b)  This action is non-final.
- 3)  An election was made by the applicant in response to a restriction requirement set forth during the interview on \_\_\_\_\_; the restriction requirement and election have been incorporated into this action.
- 4)  Since this application is in condition for allowance except for formal matters, prosecution as to the merits is closed in accordance with the practice under *Ex parte Quayle*, 1935 C.D. 11, 453 O.G. 213.

**Disposition of Claims\***

- 5)  Claim(s) 1-20 is/are pending in the application.  
 5a) Of the above claim(s) \_\_\_\_\_ is/are withdrawn from consideration.
- 6)  Claim(s) \_\_\_\_\_ is/are allowed.
- 7)  Claim(s) 1-20 is/are rejected.
- 8)  Claim(s) \_\_\_\_\_ is/are objected to.
- 9)  Claim(s) \_\_\_\_\_ are subject to restriction and/or election requirement.

\* If any claims have been determined allowable, you may be eligible to benefit from the **Patent Prosecution Highway** program at a participating intellectual property office for the corresponding application. For more information, please see [http://www.uspto.gov/patents/init\\_events/pph/index.jsp](http://www.uspto.gov/patents/init_events/pph/index.jsp) or send an inquiry to [PPHfeedback@uspto.gov](mailto:PPHfeedback@uspto.gov).

**Application Papers**

- 10)  The specification is objected to by the Examiner.
- 11)  The drawing(s) filed on \_\_\_\_\_ is/are: a)  accepted or b)  objected to by the Examiner.  
 Applicant may not request that any objection to the drawing(s) be held in abeyance. See 37 CFR 1.85(a).  
 Replacement drawing sheet(s) including the correction is required if the drawing(s) is objected to. See 37 CFR 1.121(d).

**Priority under 35 U.S.C. § 119**

- 12)  Acknowledgment is made of a claim for foreign priority under 35 U.S.C. § 119(a)-(d) or (f).

**Certified copies:**

- a)  All    b)  Some\*\*    c)  None of the:
- Certified copies of the priority documents have been received.
  - Certified copies of the priority documents have been received in Application No. \_\_\_\_\_.
  - Copies of the certified copies of the priority documents have been received in this National Stage application from the International Bureau (PCT Rule 17.2(a)).

\*\* See the attached detailed Office action for a list of the certified copies not received.

**Attachment(s)**

- 1)  Notice of References Cited (PTO-892)
- 2)  Information Disclosure Statement(s) (PTO/SB/08a and/or PTO/SB/08b)  
 Paper No(s)/Mail Date \_\_\_\_\_
- 3)  Interview Summary (PTO-413)  
 Paper No(s)/Mail Date. \_\_\_\_\_
- 4)  Other: \_\_\_\_\_

Art Unit: 2646

1. The present application is being examined under the pre-AIA first to invent provisions.

### **DETAILED ACTION**

#### ***Response to Arguments***

2. Applicant's arguments filed 5/13/16 have been fully considered but they are not persuasive.

#### ***Double Patenting***

1. A rejection based on double patenting of the "same invention" type finds its support in the language of 35 U.S.C. 101 which states that "whoever invents or discovers any new and useful process... may obtain a patent therefor..." (Emphasis added). Thus, the term "same invention," in this context, means an invention drawn to identical subject matter. See *Miller v. Eagle Mfg. Co.*, 151 U.S. 186 (1894); *In re Vogel*, 422 F.2d 438, 164 USPQ 619 (CCPA 1970); *In re Ockert*, 245 F.2d 467, 114 USPQ 330 (CCPA 1957).

A statutory type (35 U.S.C. 101) double patenting rejection can be overcome by canceling or amending the claims that are directed to the same invention so they are no longer coextensive in scope. The filing of a terminal disclaimer cannot overcome a double patenting rejection based upon 35 U.S.C. 101.

2. Claims 1-20 are provisionally rejected under 35 U.S.C. 101 as claiming the same invention as that of claims 1-20 of copending Application No. 14/848,156 (reference application). This is a provisional statutory double patenting rejection since the claims directed to the same invention have not in fact been patented.
3. For Example: The Original disclosure indicates that

Art Unit: 2646

[0025] The term "**inactive state**" used herein refers to a state in which the mobile communication terminal is communicable but a display screen **is turned off**. Even when the display screen is turned off, a predetermined function (for example, a music play function or the like) is operable. As described above, the term "inactive state" used herein refers to a concept encompassing states in which the display screen is turned off, regardless of whether or not the mobile communication terminal performs a predetermined operation. However, a state in which the mobile communication terminal is completely turned off is excluded.

[0026] The term "**active state**" used herein refers to a state in which the display screen of the mobile communication terminal **is turned on**. Switching from the "inactive state" to the "active state" refers to switching of the display screen from the **OFF** state to the **ON** state, regardless of information displayed on the display screen in the ON state. For example, the mobile communication terminal can be determined to be in the "active state" even when only a lock screen is displayed.

#### *Claim Rejections - 35 USC § 103*

4. The following is a quotation of pre-AIA 35 U.S.C. 103(a) which forms the basis for all obviousness rejections set forth in this Office action:

(a) A patent may not be obtained though the invention is not identically disclosed or described as set forth in section 102, if the differences between the subject matter sought to be patented and the prior art are such that the subject matter as a whole would have been obvious at the time the invention was made to a person having ordinary skill in the art to which said subject matter pertains. Patentability shall not be negated by the manner in which the invention was made.

5. The factual inquiries set forth in *Graham v. John Deere Co.*, 383 U.S. 1, 148 USPQ 459 (1966), that are applied for establishing a background for determining obviousness under pre-AIA 35 U.S.C. 103(a) are summarized as follows:

1. Determining the scope and contents of the prior art.



Art Unit: 2646

2. Ascertaining the differences between the prior art and the claims at issue.
  3. Resolving the level of ordinary skill in the pertinent art.
  4. Considering objective evidence present in the application indicating obviousness or nonobviousness.
6. This application currently names joint inventors. In considering patentability of the claims under pre-AIA 35 U.S.C. 103(a), the examiner presumes that the subject matter of the various claims was commonly owned at the time any inventions covered therein were made absent any evidence to the contrary. Applicant is advised of the obligation under 37 CFR 1.56 to point out the inventor and invention dates of each claim that was not commonly owned at the time a later invention was made in order for the examiner to consider the applicability of pre-AIA 35 U.S.C. 103(c) and potential pre-AIA 35 U.S.C. 102(e), (f) or (g) prior art under pre-AIA 35 U.S.C. 103(a).
7. Claims **1-4, 6-7, 10-14, 15-18 and 20** is/are rejected under pre-AIA 35 U.S.C. 103(a) as being unpatentable over Bandyopadhyay et al. US Patent No.: 8,311,514 B2, hereinafter, 'Ref-514' in view of Bandyopadhyay et al. US Patent Pub. No.: 2012/0009896 A1, hereinafter, 'Ref-896'.

Consider **Claims 1-2 and 11-12**, Ref- 514 teaches a mobile communication terminal (e.g., **100 figure 1**) comprising: a touch screen display (e.g., **110 of figure 1**); and an activation button separate from the power button and located outside the touch screen display (e.g., see **wake-up/activation button 120 of figure 1**), the activation button configured for pressing to turn on the touch screen display (e.g., **the user can touch the wake-up area to both activate the mobile device from a sleep mode and unlock the mobile device with a**

Art Unit: 2646

**single touch as noted in at least col. 1 lines 39-45)** wherein upon one-time pressing of the activation button while the touch screen display is turned off (e.g., **510 the display is off** ), the terminal is configured to turn on the touch screen display and further perform a fingerprint authentication function in addition to turning on the touch screen display (e.g., **consider that if in state 514, a match is not made, then in state 518, a wait period for 1 second is made. If the user's finger is removed, a jump to state 510 is made and the display is deactivated and locked, otherwise, the display is activated in state 520, but the mobile device remains locked.**) (i.e., at 518 if the user press and holds the wake-up area the screen is on and display on the phone is locked- the screen is turned off by removing the touch finger /timer stop or quick press and release of the power key) such that: the touch screen display displays the lock screen thereon as the terminal turns on the touch screen display in response to the one-time pressing of the activation button while the touch screen display is turned off(**note: the ambiguity of this limitation- this implies that the lock screen is displayed prior to the display being turned on. The Examiner respectfully submits that the display must be on before anything is actually displayed. This applies to claim 11 also since the Applicant's original disclosure clearly indicates that in the active state the display is on**)(i.e., at 518 if the user press and holds the wake-up area the screen is on and display on the phone is locked- the screen is turned off by removing the touch finger /timer stop or quick press and release of the power key), in addition to turning on the touch screen display and displaying the lock screen(**touch button with finger**), the one-time pressing while the touch screen display being turned off initiates the fingerprint authentication function(**match finger print**) **in addition**, the lock screen is displayed on the touch screen display when the fingerprint

Art Unit: 2646

authentication function initiated by the one-time pressing is being performed(i.e., **at 518 if the user press and holds the wake-up area the screen is on and display on the phone is locked- the screen is turned off by removing the touch finger /timer stop or quick press and release of the power key – the first function includes the authentication – the claim is recited in a manner in which the sequence lines up figure 5 since the first function is included in addition to the displaying the lock screen. The lock screen display occurs in addition to the fingerprint authentication when the match fails**), a lock state of the terminal continues when the fingerprint authentication function fails to authenticate a user (i.e., **no match see figure 5**), and the lock state is released for enabling other functions of the terminal when the fingerprint authentication function authenticates a user in response to the one-time pressing of the activation button while the touch screen display being turned off (i.e., **phone lock see at least figure 5**

However, Ref-514 does not explicitly display a power button configured to turn on and off the terminal by pressing; Ref 514 does not explicitly indicate display the lock screen when the fingerprint authentication is being performed in response to detection of one-time pressing of the activation button while the touch screen display is turned off (i.e., it would appear obvious that at step 520 that while the display is on and the device could retry the fingerprint authentication. However, ref-514 is not explicit).

In analogous art, Ref 896 teaches displaying the lock screen when the fingerprint authentication is being performed (e.g., see at least 960 of figure 9), a camera (e.g., see **camera 234 of figure 2** );

Therefore, it would have been obvious to a person of ordinary skill in the art at the time the invention was made to include displaying the lock screen when the fingerprint authentication

Art Unit: 2646

is being performed to arrive at the predictable result of displaying the lock screen when the fingerprint authentication is being performed in response to detection of one-time pressing of the activation button while the touch screen display is turned off for the purpose of operating a camera or other phone features while the phone remains in the locked state as suggested by Ref-896.

Consider **Claims 3 and 13**, Ref-514 teaches the claimed invention except wherein the terminal is further configured to perform at least one function other than the fingerprint authentication function in addition to turning on the touch screen display for displaying the lock screen in response to the detection of one-time pressing of the activation button during the terminal's inactive state when the detected one-time pressing is for long time longer than a reference time period, wherein the at least one functions is selected from the group consisting of activating the camera, and an operation that involves playing a sound.

Ref -514 teaches wherein upon detection of one-time pressing of the activation button for long time while the touch screen display is turned off, the terminal is configured to turn on the touch screen display for displaying the lock screen (e.g., consider that if in state 514, a match is not made, then in state 518, a wait period for 1 second is made. If the user's finger is removed, a jump to state 510 is made and the display is deactivated and locked, otherwise, the display is activated in state 520, but the mobile device remains locked.) (i.e., at 518 if the user press and holds the wake-up area the screen is on and display on the phone is locked- the screen is turned off by removing the touch finger /timer stop or quick press and release of the power key) Ref-514 does not teach (i.e., not explicitly) the feature of being further configured to display the lock screen when the second function is being performed.

Art Unit: 2646

In analogous art, Ref – 896 teaches in at least figure 7 where the camera can operate while the screen is locked.

Therefore, it would have been obvious to a person of ordinary skill in the art at the time the invention was made to include the feature of being further configured to display the lock screen when the second function is being performed for the purpose of customizing functions of a mobile device based on locking access to other features as suggested by Ref 896.

Consider **Claims 4 and 14**, Ref-514 teaches wherein the touch screen display displays a lock screen thereon **as it is** turned on in response to the detection of one-time pressing for long time (**note: based on the original disclosure and at least common knowledge the screen must be on to display and therefore interpreted by the Examiner accordingly**), wherein the lock screen is displayed on the touch screen display when the at least one function is being initiated(**e.g., consider that if in state 514, a match is not made, then in state 518, a wait period for 1 second is made. If the user's finger is removed, a jump to state 510 is made and the display is deactivated and locked, otherwise, the display is activated in state 520, but the mobile device remains locked.**) (i.e., **at 518 if the user press and holds the wake-up area the screen is on and display on the phone is locked- the screen is turned off by removing the touch finger /timer stop or quick press and release of the power key**).

The Applicant argues that this feature is not taught by Ref-514 since figure 5 of ref-514 indicates that the display is off in 510 to 514 and apparently the phone does not display anything until 516. However, The Examiner disagrees with the Applicant's position since if in state 514, a match is not made, then in state 518, a wait period for 1 second is made. If the user's finger is removed, a jump to state 510 is made and the display is deactivated and locked, otherwise, the

Art Unit: 2646

display is activated in state 520, but the mobile device remains locked.) (i.e., at 518 if the user press and holds the wake-up area the screen is on and display on the phone is locked- the screen is turned off by removing the touch finger /timer stop or quick press and release of the power key). Figure 5 implies that although there's no finger print match at 514 the user would simply maintain the initial finger position and the display is on in the locked state at 520 (noting that "fingerprint authentication" is a multi-step background process that includes multiple steps to confirm or deny a match).

However, for the sake of arguendo and since the disclosure of Ref- 514 is not explicit in such teaching the Examiner submits that Ref- 896 teaches in at least figure 5 in which the lock screen is displayed on the touch screen display when the fingerprint authentication is being performed wherein in performing the fingerprint authentication, the terminal operates such that; a lock state of the terminal continues when the fingerprint authentication fails to authenticate a user, and the lock state is released for enabling other functions of the terminal when the fingerprint authentication authenticates a user.

Therefore, it would have been obvious to a person of ordinary skill in the art at the time the invention was made to include displaying the lock screen when the fingerprint authentication is being performed to arrive at the predictable result in which the lock screen is displayed on the touch screen display when the fingerprint authentication is being performed wherein in performing the fingerprint authentication, the terminal operates such that; a lock state of the terminal continues when the fingerprint authentication fails to authenticate a user, and the lock state is released for enabling other functions of the terminal when the fingerprint authentication authenticates a user

Art Unit: 2646

Consider at least **claims 6 and 16**, Ref-514 teaches wherein the terminal is configured to have a mobile application stay in a standby state when the touch screen display is turned off while the mobile application is running (**e.g., see at least figure 5 sleep and locked**), wherein in response to the detection of one-time pressing of the activation button while the touch screen display is turned off, the terminal is configured to perform the at least one of the first and second functions regardless of whether the at least one functions is in its standby state or an operation disable state(**e.g., see at least figure 5 sleep and locked – press wake-up area as noted in at least figure 5**).

Consider **Claims 7 and 17**, Ref 514 teaches the claimed invention except wherein the terminal is configured to display a message on the touch screen display when the lock state continues due to failure of user authentication by the fingerprint authentication (**i.e., Ref- 514 does not illustrate or disclose a message that displays the fact that the screen is actually locked**).

In analogous art, Ref -896 teaches wherein the terminal is configured to display a message on the touch screen display when the lock state continues due to failure of user authentication by the fingerprint authentication (**i.e., figure 2 and 5 illustrates a display with lock icon that is maintained due to the failure of user authentication – the lock screen display icon serves as an alert the user that the authentication has not succeeded**).

Therefore, it would have been obvious to a person of ordinary skill in the art at the time the invention was made to include wherein the terminal is configured to display a message on the touch screen display when the lock state continues due to failure of user authentication by the

Art Unit: 2646

fingerprint authentication for the purpose of bringing the user's attention to the fact that the authentication has not succeeded.

Consider at **Claims 10**, Ref- 514 teaches wherein the terminal comprises a smartphone which comprises an activation sensor configured to detect pressing of the activation button and a user identification module configured to perform the fingerprint authentication (**e.g., see at least figures 3 and 4**).

Consider **Claim 18**, Ref- 514 teaches the claimed invention except receiving user input on a setting menu of the terminal; and configuring, based on the user input, settings of the terminal such that the at least one of the first and second functions is set to be performed in addition to changing to the active state upon detection of one-time pressing of the activation button while the terminal is in its inactive state.

In analogous art, Ref- 896 teaches and suggest configuring the setting of the Mobile device that can be operated and accessed during the locked state in at least 0075.

Therefore, it would have been obvious to a person of ordinary skill in the art at the time the invention was made given the suggestions of Ref- 514 to simultaneously perform a function in addition to changing to the active state upon detection of one-time pressing of the activation button while the terminal is in its inactive state (i.e., locked) to include configuring the setting of the Mobile device that can be operated and accessed during the locked state in at least 0075 to arrive at the predictable result of receiving user input on a setting menu of the terminal; and configuring, based on the user input, settings of the terminal such that the at least one of the first and second functions is set to be performed in addition to changing to the active state upon detection of one-time pressing of the activation button while the terminal is in its inactive state.



Art Unit: 2646

6. Claims **5, 8, 15 and 19** is/are rejected under pre-AIA 35 U.S.C. 103(a) as being unpatentable over Bandyopadhyay et al. US Patent No.: 8,311,514 B2, hereinafter, 'Ref-514' in view of Bandyopadhyay et al. US Patent Pub. No.: 2012/0009896 A1, hereinafter, 'Ref- 896' and further in view of Well-Known Art.

Consider Claims **5, 8, 15 and 19**, Ref-514 and Ref 896 teaches the claimed invention except wherein the at least one of the first and second functions is associated with software downloadable by the terminal or wherein the at least one of the first and second functions is associated with initiating a hands-free operation of the terminal.

However, the Examiner respectfully submits that software downloading and Hands-Free operation are notoriously well-known features and therefore it would have been obvious to a person of ordinary skill in the art at the time the invention was made to simply substitute the camera and/or fingerprint functions of the prior art with a well-known phone feature for the purpose of controlling access to other particular phone features.

8. Claims **9 and 20** is/are rejected under pre-AIA 35 U.S.C. 103(a) as being unpatentable over Bandyopadhyay et al. US Patent No.: 8,311,514 B2, hereinafter, 'Ref-514' in view of Bandyopadhyay et al. US Patent Pub. No.: 2012/0009896 A1, hereinafter, 'Ref- 896' and further in view of Buratti et al. US Patent Pub. No.: 2012/0052836 A1.

Consider Claims **9 and 20**, Ref- 514 and Ref- 896 teaches the claimed invention except , further comprising: detecting repeated pressing of the activation button while the terminal is in its inactive state; in response to detection of the repeated pressing, changing the terminal from the inactive state to the active state; and in addition to changing to the active state, further performing a third function other than the first and second functions without additional user

Art Unit: 2646

input; wherein in changing to the active state and performing the at least one of the first and second functions, the terminal operates such that: the touch screen display displays the lock screen thereon as the terminal changes to the active state in response to the detection of repeated pressing, the lock screen is displayed on the touch screen display when the third function is being performed.

In analogous art, Buratti teaches in 0023 that PEB 220 may be a dedicated button or switch on mobile communication device 200 for initiating a PEB event or may be selectively configured from buttons or switches on mobile communication device 200 having functionality in addition to initiating a PEB event and which when activated for a designated duration or in a defined pattern will initiate a PEB event and in 0028 that activation may be detected when the PEB is continuously activated for three seconds. In other embodiments, activation may be detected when the PEB is continuously activated for more or less than three seconds. In further embodiments, activation of a PEB may be selectively configurable to a desired activation pattern of one or more buttons on the communications device for selectively configurable durations.

Therefore, it would have been obvious to a person of ordinary skill in the art at the time the invention was made to modify Ref- 514 in view Ref- 896 with the functionality of Buratti to arrive at the predictable result further comprising: detecting repeated pressing of the activation button while the terminal is in its inactive state; in response to detection of the repeated pressing, changing the terminal from the inactive state to the active state; and in addition to changing to the active state, further performing a third function other than the first and second functions without additional user input; wherein in changing to the active state and performing the at least one of the first and second functions, the terminal operates such that: the touch screen display

Art Unit: 2646

displays the lock screen thereon as the terminal changes to the active state in response to the detection of repeated pressing, the lock screen is displayed on the touch screen display when the third function is being performed for the purpose of emergency communication as suggested by Buratti.

### *Conclusion*

9. **THIS ACTION IS MADE FINAL.** Applicant is reminded of the extension of time policy as set forth in 37 CFR 1.136(a).

A shortened statutory period for reply to this final action is set to expire **THREE MONTHS** from the mailing date of this action. In the event a first reply is filed within **TWO MONTHS** of the mailing date of this final action and the advisory action is not mailed until after the end of the **THREE-MONTH** shortened statutory period, then the shortened statutory period will expire on the date the advisory action is mailed, and any extension fee pursuant to 37 CFR 1.136(a) will be calculated from the mailing date of the advisory action. In no event, however, will the statutory period for reply expire later than **SIX MONTHS** from the mailing date of this final action.

Any inquiry concerning this communication or earlier communications from the examiner should be directed to CHARLES SHEDRICK whose telephone number is (571)272-8621. The examiner can normally be reached on Monday thru Friday 8:00AM-4:30PM.

If attempts to reach the examiner by telephone are unsuccessful, the examiner's supervisor, Lester Kincaid can be reached on (571)-272-7922. The fax phone number for the organization where this application or proceeding is assigned is 571-273-8300.

Art Unit: 2646

Information regarding the status of an application may be obtained from the Patent Application Information Retrieval (PAIR) system. Status information for published applications may be obtained from either Private PAIR or Public PAIR. Status information for unpublished applications is available through Private PAIR only. For more information about the PAIR system, see <http://pair-direct.uspto.gov>. Should you have questions on access to the Private PAIR system, contact the Electronic Business Center (EBC) at 866-217-9197 (toll-free). If you would like assistance from a USPTO Customer Service Representative or access to the automated information system, call 800-786-9199 (IN USA OR CANADA) or 571-272-1000.

/CHARLES SHEDRICK/  
Primary Examiner, Art Unit 2646

<b>INFORMATION DISCLOSURE STATEMENT BY APPLICANT</b> ( Not for submission under 37 CFR 1.99)	Application Number	14848191
	Filing Date	2015-09-08
	First Named Inventor	Jae Lark Jung
	Art Unit	2646
	Examiner Name	Shedrick, Charles Terrell
	Attorney Docket Number	UNIS005.001C2

U.S.PATENTS						Remove
Examiner Initial*	Cite No	Patent Number	Kind Code <sup>1</sup>	Issue Date	Name of Patentee or Applicant of cited Document	Pages,Columns,Lines where Relevant Passages or Relevant Figures Appear
	1	6532298	B1	2003-03-11	Cambier et al.	

If you wish to add additional U.S. Patent citation information please click the Add button.

Add

U.S.PATENT APPLICATION PUBLICATIONS						Remove
Examiner Initial*	Cite No	Publication Number	Kind Code <sup>1</sup>	Publication Date	Name of Patentee or Applicant of cited Document	Pages,Columns,Lines where Relevant Passages or Relevant Figures Appear
	1	20060258289	A1	2006-11-06	Dua	
	2	20100159898	A1	2010-06-24	Krzyzanowski et al.	
	3	20100304731	A1	2010-12-02	Bratton et al.	
	4	20120009896	A1	2012-01-12	Bandyopadhyay et al.	
	5	20130104187	A1	2013-04-25	Weidner	

ALL REFERENCES CONSIDERED EXCEPT WHERE LINED THROUGH. /C.T.S/

**INFORMATION DISCLOSURE  
STATEMENT BY APPLICANT**  
( Not for submission under 37 CFR 1.99)

Application Number	14848191
Filing Date	2015-09-08
First Named Inventor	Jae Lark Jung
Art Unit	2646
Examiner Name	Shedrick, Charles Terrell
Attorney Docket Number	UNIS005.001C2

6	20140162598	A1	2014-06-12	Villa-Real
7	20050113071	A1	2005-05-26	Nagata
8	20060156028	A1	2006-07-13	Aoyama et al.
9	20060288234	A1	2006-12-21	Azar et al.
10	20070259685	A1	2007-11-08	Engblom et al.
11	20090258667	A1	2009-10-15	Suzuki et al.
12	20120098639	A1	2012-04-26	Jias
13	20120235790	A1	2012-09-20	Zhao et al.
14	20120303476	A1	2012-11-29	Krzyzanowski et al.
15	20130031619	A1	2013-01-31	Waltermann et al.
16	20130063611	A1	2013-03-14	Papakipos et al.

**INFORMATION DISCLOSURE  
STATEMENT BY APPLICANT**  
( Not for submission under 37 CFR 1.99)

Application Number	14848191
Filing Date	2015-09-08
First Named Inventor	Jae Lark Jung
Art Unit	2646
Examiner Name	Shedrick, Charles Terrell
Attorney Docket Number	UNIS005.001C2

17	20150051913	A1	2015-02-19	Choi
18	20100159995	A1	2010-06-24	Stallings et al.

If you wish to add additional U.S. Published Application citation information please click the Add button

**FOREIGN PATENT DOCUMENTS**

Examiner Initial*	Cite No	Foreign Document Number <sup>3</sup>	Country Code <sup>2;j</sup>	Kind Code <sup>4</sup>	Publication Date	Name of Patentee or Applicant of cited Document	Pages, Columns, Lines where Relevant Passages or Relevant Figures Appear	T <sup>5</sup>
	1	2770643	EP	A2	2014-08-27	FIRSTFACE CO LTD		
	2	10-2013-0104682	KR	A	2013-09-25	CHOI, SANG GIL		×
	3	10-2010-0057461	KR	A	2010-05-31	NHN BUSINESS PLATFORM CORP		☒
	4	2 288 126	EP	A1	2011-02-23	LG ELECTONICS INC.		<input type="checkbox"/>
	5	2013/177173	WO	A1	2013-11-28	BRANDINTELX, INC.		<input type="checkbox"/>
	6	2013/060940	WO	A2	2013-05-02	NOKIA CORPORATION		<input type="checkbox"/>
	7	2014/022347	WO	A1	2014-02-06	CUSACK, Elijah		<input type="checkbox"/>

If you wish to add additional Foreign Patent Document citation information please click the Add button

**INFORMATION DISCLOSURE  
STATEMENT BY APPLICANT**  
( Not for submission under 37 CFR 1.99)

Application Number	14848191
Filing Date	2015-09-08
First Named Inventor	Jae Lark Jung
Art Unit	2646
Examiner Name	Shedrick, Charles Terrell
Attorney Docket Number	UNIS005.001C2

**NON-PATENT LITERATURE DOCUMENTS**

Examiner Initials*	Cite No	Include name of the author (in CAPITAL LETTERS), title of the article (when appropriate), title of the item (book, magazine, journal, serial, symposium, catalog, etc), date, pages(s), volume-issue number(s), publisher, city and/or country where published.	T <sup>5</sup>
	1	European Search Report dated March 10, 2016 of corresponding European Patent Application No. 15195436.9 in 11 pages.	

If you wish to add additional non-patent literature document citation information please click the Add button

**EXAMINER SIGNATURE**

Examiner Signature	/CHARLES T SHEDRICK/	Date Considered	08/22/2016
--------------------	----------------------	-----------------	------------

\*EXAMINER: Initial if reference considered, whether or not citation is in conformance with MPEP 609. Draw line through a citation if not in conformance and not considered. Include copy of this form with next communication to applicant.

<sup>1</sup> See Kind Codes of USPTO Patent Documents at [www.USPTO.GOV](http://www.USPTO.GOV) or MPEP 901.04. <sup>2</sup> Enter office that issued the document, by the two-letter code (WIPO Standard ST.3). <sup>3</sup> For Japanese patent documents, the indication of the year of the reign of the Emperor must precede the serial number of the patent document. <sup>4</sup> Kind of document by the appropriate symbols as indicated on the document under WIPO Standard ST.16 if possible. <sup>5</sup> Applicant is to place a check mark here if English language translation is attached.

ALL REFERENCES CONSIDERED EXCEPT WHERE LINED THROUGH. /C.T.S/



**INFORMATION DISCLOSURE  
STATEMENT BY APPLICANT**  
( Not for submission under 37 CFR 1.99)

Application Number		14848191	
Filing Date		2015-09-08	
First Named Inventor	Jae Lark Jung		
Art Unit	2646		
Examiner Name	Shedrick, Charles Terrell		
Attorney Docket Number	UNIS005.001C2		

**CERTIFICATION STATEMENT**

Please see 37 CFR 1.97 and 1.98 to make the appropriate selection(s):

That each item of information contained in the information disclosure statement was first cited in any communication from a foreign patent office in a counterpart foreign application not more than three months prior to the filing of the information disclosure statement. See 37 CFR 1.97(e)(1).

**OR**

That no item of information contained in the information disclosure statement was cited in a communication from a foreign patent office in a counterpart foreign application, and, to the knowledge of the person signing the certification after making reasonable inquiry, no item of information contained in the information disclosure statement was known to any individual designated in 37 CFR 1.56(c) more than three months prior to the filing of the information disclosure statement. See 37 CFR 1.97(e)(2).

See attached certification statement.

The fee set forth in 37 CFR 1.17 (p) has been submitted herewith.

A certification statement is not submitted herewith.

**SIGNATURE**

A signature of the applicant or representative is required in accordance with CFR 1.33, 10.18. Please see CFR 1.4(d) for the form of the signature.

Signature	/Mincheol Kim/	Date (YYYY-MM-DD)	2016-05-13
Name/Print	Mincheol Kim	Registration Number	51306

This collection of information is required by 37 CFR 1.97 and 1.98. The information is required to obtain or retain a benefit by the public which is to file (and by the USPTO to process) an application. Confidentiality is governed by 35 U.S.C. 122 and 37 CFR 1.14. This collection is estimated to take 1 hour to complete, including gathering, preparing and submitting the completed application form to the USPTO. Time will vary depending upon the individual case. Any comments on the amount of time you require to complete this form and/or suggestions for reducing this burden, should be sent to the Chief Information Officer, U.S. Patent and Trademark Office, U.S. Department of Commerce, P.O. Box 1450, Alexandria, VA 22313-1450. **DO NOT SEND FEES OR COMPLETED FORMS TO THIS ADDRESS. SEND TO: Commissioner for Patents, P.O. Box 1450, Alexandria, VA 22313-1450.**

## Privacy Act Statement

The Privacy Act of 1974 (P.L. 93-579) requires that you be given certain information in connection with your submission of the attached form related to a patent application or patent. Accordingly, pursuant to the requirements of the Act, please be advised that: (1) the general authority for the collection of this information is 35 U.S.C. 2(b)(2); (2) furnishing of the information solicited is voluntary; and (3) the principal purpose for which the information is used by the U.S. Patent and Trademark Office is to process and/or examine your submission related to a patent application or patent. If you do not furnish the requested information, the U.S. Patent and Trademark Office may not be able to process and/or examine your submission, which may result in termination of proceedings or abandonment of the application or expiration of the patent.

The information provided by you in this form will be subject to the following routine uses:

1. The information on this form will be treated confidentially to the extent allowed under the Freedom of Information Act (5 U.S.C. 552) and the Privacy Act (5 U.S.C. 552a). Records from this system of records may be disclosed to the Department of Justice to determine whether the Freedom of Information Act requires disclosure of these records.
2. A record from this system of records may be disclosed, as a routine use, in the course of presenting evidence to a court, magistrate, or administrative tribunal, including disclosures to opposing counsel in the course of settlement negotiations.
3. A record in this system of records may be disclosed, as a routine use, to a Member of Congress submitting a request involving an individual, to whom the record pertains, when the individual has requested assistance from the Member with respect to the subject matter of the record.
4. A record in this system of records may be disclosed, as a routine use, to a contractor of the Agency having need for the information in order to perform a contract. Recipients of information shall be required to comply with the requirements of the Privacy Act of 1974, as amended, pursuant to 5 U.S.C. 552a(m).
5. A record related to an International Application filed under the Patent Cooperation Treaty in this system of records may be disclosed, as a routine use, to the International Bureau of the World Intellectual Property Organization, pursuant to the Patent Cooperation Treaty.
6. A record in this system of records may be disclosed, as a routine use, to another federal agency for purposes of National Security review (35 U.S.C. 181) and for review pursuant to the Atomic Energy Act (42 U.S.C. 218(c)).
7. A record from this system of records may be disclosed, as a routine use, to the Administrator, General Services, or his/her designee, during an inspection of records conducted by GSA as part of that agency's responsibility to recommend improvements in records management practices and programs, under authority of 44 U.S.C. 2904 and 2906. Such disclosure shall be made in accordance with the GSA regulations governing inspection of records for this purpose, and any other relevant (i.e., GSA or Commerce) directive. Such disclosure shall not be used to make determinations about individuals.
8. A record from this system of records may be disclosed, as a routine use, to the public after either publication of the application pursuant to 35 U.S.C. 122(b) or issuance of a patent pursuant to 35 U.S.C. 151. Further, a record may be disclosed, subject to the limitations of 37 CFR 1.14, as a routine use, to the public if the record was filed in an application which became abandoned or in which the proceedings were terminated and which application is referenced by either a published application, an application open to public inspections or an issued patent.
9. A record from this system of records may be disclosed, as a routine use, to a Federal, State, or local law enforcement agency, if the USPTO becomes aware of a violation or potential violation of law or regulation.

**CERTIFICATION AND REQUEST FOR PRIORITIZED EXAMINATION  
 UNDER 37 CFR 1.102(e) (Page 1 of 1)**

First Named Inventor:	Jae Lark JUNG	Nonprovisional Application Number (if known):	14/848,191
Title of Invention:	ACTIVATING DISPLAY AND PERFORMING USER AUTHENTICATION IN MOBILE TERMINAL WITH ONE-TIME USER INPUT		

**APPLICANT HEREBY CERTIFIES THE FOLLOWING AND REQUESTS PRIORITIZED EXAMINATION FOR THE ABOVE-IDENTIFIED APPLICATION.**

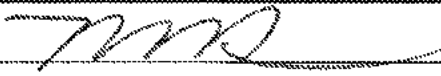
1. The processing fee set forth in 37 CFR 1.17(i)(1) and the prioritized examination fee set forth in 37 CFR 1.17(c) have been filed with the request. The publication fee requirement is met because that fee, set forth in 37 CFR 1.18(d), is currently \$0. The basic filing fee, search fee, and examination fee are filed with the request or have been already been paid. I understand that any required excess claims fees or application size fee must be paid for the application.
2. I understand that the application may not contain, or be amended to contain, more than four independent claims, more than thirty total claims, or any multiple dependent claims, and that any request for an extension of time will cause an outstanding Track I request to be dismissed.
3. The applicable box is checked below:

I.  **Original Application (Track One) - Prioritized Examination under § 1.102(e)(1)**

- i. (a) The application is an original nonprovisional utility application filed under 35 U.S.C. 111(a). This certification and request is being filed with the utility application via EFS-Web.  
 ---OR---  
 (b) The application is an original nonprovisional plant application filed under 35 U.S.C. 111(a). This certification and request is being filed with the plant application in paper.
- ii. An executed inventor's oath or declaration under 37 CFR 1.63 or 37 CFR 1.64 for each inventor, or the application data sheet meeting the conditions specified in 37 CFR 1.53(f)(3)(i) is filed with the application.

II.  **Request for Continued Examination - Prioritized Examination under § 1.102(e)(2)**

- i. A request for continued examination has been filed with, or prior to, this form.
- ii. If the application is a utility application, this certification and request is being filed via EFS-Web.
- iii. The application is an original nonprovisional utility application filed under 35 U.S.C. 111(a), or is a national stage entry under 35 U.S.C. 371.
- iv. This certification and request is being filed prior to the mailing of a first Office action responsive to the request for continued examination.
- v. No prior request for continued examination has been granted prioritized examination status under 37 CFR 1.102(e)(2).

Signature 	Date 2016-11-21
Name (Print/Typed) Mincheol Kim	Practitioner Registration Number 51,306

*Note: This form must be signed in accordance with 37 CFR 1.33. See 37 CFR 1.4(d) for signature requirements and certifications. Submit multiple forms if more than one signature is required.\**

\*Total of 1 forms are submitted.

## Privacy Act Statement

The **Privacy Act of 1974 (P.L. 93-579)** requires that you be given certain information in connection with your submission of the attached form related to a patent application or patent. Accordingly, pursuant to the requirements of the Act, please be advised that: (1) the general authority for the collection of this information is 35 U.S.C. 2(b)(2); (2) furnishing of the information solicited is voluntary; and (3) the principal purpose for which the information is used by the U.S. Patent and Trademark Office is to process and/or examine your submission related to a patent application or patent. If you do not furnish the requested information, the U.S. Patent and Trademark Office may not be able to process and/or examine your submission, which may result in termination of proceedings or abandonment of the application or expiration of the patent.

The information provided by you in this form will be subject to the following routine uses:

1. The information on this form will be treated confidentially to the extent allowed under the Freedom of Information Act (5 U.S.C. 552) and the Privacy Act (5 U.S.C. 552a). Records from this system of records may be disclosed to the Department of Justice to determine whether disclosure of these records is required by the Freedom of Information Act.
2. A record from this system of records may be disclosed, as a routine use, in the course of presenting evidence to a court, magistrate, or administrative tribunal, including disclosures to opposing counsel in the course of settlement negotiations.
3. A record in this system of records may be disclosed, as a routine use, to a Member of Congress submitting a request involving an individual, to whom the record pertains, when the individual has requested assistance from the Member with respect to the subject matter of the record.
4. A record in this system of records may be disclosed, as a routine use, to a contractor of the Agency having need for the information in order to perform a contract. Recipients of information shall be required to comply with the requirements of the Privacy Act of 1974, as amended, pursuant to 5 U.S.C. 552a(m).
5. A record related to an International Application filed under the Patent Cooperation Treaty in this system of records may be disclosed, as a routine use, to the International Bureau of the World Intellectual Property Organization, pursuant to the Patent Cooperation Treaty.
6. A record in this system of records may be disclosed, as a routine use, to another federal agency for purposes of National Security review (35 U.S.C. 181) and for review pursuant to the Atomic Energy Act (42 U.S.C. 218(c)).
7. A record from this system of records may be disclosed, as a routine use, to the Administrator, General Services, or his/her designee, during an inspection of records conducted by GSA as part of that agency's responsibility to recommend improvements in records management practices and programs, under authority of 44 U.S.C. 2904 and 2906. Such disclosure shall be made in accordance with the GSA regulations governing inspection of records for this purpose, and any other relevant (*i.e.*, GSA or Commerce) directive. Such disclosure shall not be used to make determinations about individuals.
8. A record from this system of records may be disclosed, as a routine use, to the public after either publication of the application pursuant to 35 U.S.C. 122(b) or issuance of a patent pursuant to 35 U.S.C. 151. Further, a record may be disclosed, subject to the limitations of 37 CFR 1.14, as a routine use, to the public if the record was filed in an application which became abandoned or in which the proceedings were terminated and which application is referenced by either a published application, an application open to public inspection or an issued patent.
9. A record from this system of records may be disclosed, as a routine use, to a Federal, State, or local law enforcement agency, if the USPTO becomes aware of a violation or potential violation of law or regulation.

**IN THE UNITED STATES PATENT AND TRADEMARK OFFICE**

First Named Inventor	:	Jae Lark Jung
Applicant	:	Firstface Co., Ltd.
App. No.	:	14/848,191
Filed	:	September 8, 2015
Examiner	:	Shedrick, Charles Terrell
Art Unit	:	2646
Conf. No.	:	9599

**TRANSMITTAL****Mail Stop AF**

Commissioner for Patents  
P.O. Box 1450  
Alexandria, VA 22313-1450

Dear Sir:

The following enclosures are transmitted herewith:

- (X) Amendment and Response to Final Office Action in 15 pages.
- (X) Request for Continued Examination in 3 pages.
- (X) Certification & Request for Prioritized Examination under 37 CFR 1.102(e) in 2 pages.
- (X) \$600 – Request for Continued Examination Fee will be paid via EFS Web.
- (X) \$2,070 – Request for Prioritized Examination/Processing Fee will be paid via EFS Web.

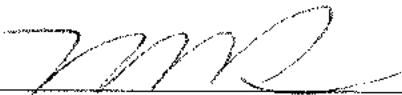
The Commissioner is hereby authorized to charge any additional fees which may be required, or credit any overpayment to Deposit Account No. 11-1410.

Application No.: 14/848,191  
Filing Date: September 8, 2015

Respectfully submitted,

KNOBBE, MARTENS, OLSON & BEAR, LLP

Dated: 2016-11-21

By:   
Mincheol Kim  
Registration No. 51,306  
Attorney of Record  
Customer No. 20995  
(949) 760-0404

24556694  
110216

**REQUEST FOR CONTINUED EXAMINATION(RCE)TRANSMITTAL  
(Submitted Only via EFS-Web)**

Application Number	14848191	Filing Date	2015-09-08	Docket Number (if applicable)	UNIS005.001C2	Art Unit	2646
First Named Inventor	Jae Lark Jung			Examiner Name	Shedrick, Charles Terrell		

**This is a Request for Continued Examination (RCE) under 37 CFR 1.114 of the above-identified application.** Request for Continued Examination (RCE) practice under 37 CFR 1.114 does not apply to any utility or plant application filed prior to June 8, 1995, to any international application that does not comply with the requirements of 35 U.S.C. 371, or to any design application. The Instruction Sheet for this form is located at WWW.USPTO.GOV.

**SUBMISSION REQUIRED UNDER 37 CFR 1.114**

Note: If the RCE is proper, any previously filed unentered amendments and amendments enclosed with the RCE will be entered in the order in which they were filed unless applicant instructs otherwise. If applicant does not wish to have any previously filed unentered amendment(s) entered, applicant must request non-entry of such amendment(s).

- Previously submitted. If a final Office action is outstanding, any amendments filed after the final Office action may be considered as a submission even if this box is not checked.
- Consider the arguments in the Appeal Brief or Reply Brief previously filed on \_\_\_\_\_
- Other \_\_\_\_\_
- Enclosed
- Amendment/Reply
- Information Disclosure Statement (IDS)
- Affidavit(s)/ Declaration(s)
- Other \_\_\_\_\_

**MISCELLANEOUS**

- Suspension of action on the above-identified application is requested under 37 CFR 1.103(c) for a period of months \_\_\_\_\_ (Period of suspension shall not exceed 3 months; Fee under 37 CFR 1.17(i) required)
- Other \_\_\_\_\_

**FEES**

- The RCE fee under 37 CFR 1.17(e) is required by 37 CFR 1.114 when the RCE is filed. The Director is hereby authorized to charge any underpayment of fees, or credit any overpayments, to Deposit Account No 111410

**SIGNATURE OF APPLICANT, ATTORNEY, OR AGENT REQUIRED**

<input checked="" type="checkbox"/> Patent Practitioner Signature <input type="checkbox"/> Applicant Signature
---

Signature of Registered U.S. Patent Practitioner			
Signature	Mincheol Kim/	Date (YYYY-MM-DD)	2016-11-21
Name	Mincheol Kim	Registration Number	51306

This collection of information is required by 37 CFR 1.114. The information is required to obtain or retain a benefit by the public which is to file (and by the USPTO to process) an application. Confidentiality is governed by 35 U.S.C. 122 and 37 CFR 1.11 and 1.14. This collection is estimated to take 12 minutes to complete, including gathering, preparing, and submitting the completed application form to the USPTO. Time will vary depending upon the individual case. Any comments on the amount of time you require to complete this form and/or suggestions for reducing this burden, should be sent to the Chief Information Officer, U.S. Patent and Trademark Office, U.S. Department of Commerce, P.O. Box 1450, Alexandria, VA 22313-1450.

*If you need assistance in completing the form, call 1-800-PTO-9199 and select option 2.*



## Privacy Act Statement

The Privacy Act of 1974 (P.L. 93-579) requires that you be given certain information in connection with your submission of the attached form related to a patent application or patent. Accordingly, pursuant to the requirements of the Act, please be advised that: (1) the general authority for the collection of this information is 35 U.S.C. 2(b)(2); (2) furnishing of the information solicited is voluntary; and (3) the principal purpose for which the information is used by the U.S. Patent and Trademark Office is to process and/or examine your submission related to a patent application or patent. If you do not furnish the requested information, the U.S. Patent and Trademark Office may not be able to process and/or examine your submission, which may result in termination of proceedings or abandonment of the application or expiration of the patent.

The information provided by you in this form will be subject to the following routine uses:

1. The information on this form will be treated confidentially to the extent allowed under the Freedom of Information Act (5 U.S.C. 552) and the Privacy Act (5 U.S.C. 552a). Records from this system of records may be disclosed to the Department of Justice to determine whether the Freedom of Information Act requires disclosure of these records.
2. A record from this system of records may be disclosed, as a routine use, in the course of presenting evidence to a court, magistrate, or administrative tribunal, including disclosures to opposing counsel in the course of settlement negotiations.
3. A record in this system of records may be disclosed, as a routine use, to a Member of Congress submitting a request involving an individual, to whom the record pertains, when the individual has requested assistance from the Member with respect to the subject matter of the record.
4. A record in this system of records may be disclosed, as a routine use, to a contractor of the Agency having need for the information in order to perform a contract. Recipients of information shall be required to comply with the requirements of the Privacy Act of 1974, as amended, pursuant to 5 U.S.C. 552a(m).
5. A record related to an International Application filed under the Patent Cooperation Treaty in this system of records may be disclosed, as a routine use, to the International Bureau of the World Intellectual Property Organization, pursuant to the Patent Cooperation Treaty.
6. A record in this system of records may be disclosed, as a routine use, to another federal agency for purposes of National Security review (35 U.S.C. 181) and for review pursuant to the Atomic Energy Act (42 U.S.C. 218(c)).
7. A record from this system of records may be disclosed, as a routine use, to the Administrator, General Services, or his/her designee, during an inspection of records conducted by GSA as part of that agency's responsibility to recommend improvements in records management practices and programs, under authority of 44 U.S.C. 2904 and 2906. Such disclosure shall be made in accordance with the GSA regulations governing inspection of records for this purpose, and any other relevant (i.e., GSA or Commerce) directive. Such disclosure shall not be used to make determinations about individuals.
8. A record from this system of records may be disclosed, as a routine use, to the public after either publication of the application pursuant to 35 U.S.C. 122(b) or issuance of a patent pursuant to 35 U.S.C. 151. Further, a record may be disclosed, subject to the limitations of 37 CFR 1.14, as a routine use, to the public if the record was filed in an application which became abandoned or in which the proceedings were terminated and which application is referenced by either a published application, an application open to public inspections or an issued patent.
9. A record from this system of records may be disclosed, as a routine use, to a Federal, State, or local law enforcement agency, if the USPTO becomes aware of a violation or potential violation of law or regulation.

## Electronic Patent Application Fee Transmittal

<b>Application Number:</b>	14848191
<b>Filing Date:</b>	08-Sep-2015
<b>Title of Invention:</b>	ACTIVATING DISPLAY AND PERFORMING USER AUTHENTICATION IN MOBILE TERMINAL WITH ONE-TIME USER INPUT
<b>First Named Inventor/Applicant Name:</b>	Jae Lark JUNG
<b>Filer:</b>	Mincheol Kim
<b>Attorney Docket Number:</b>	UNIS005.001C2

Filed as Small Entity

### Filing Fees for Utility under 35 USC 111(a)

Description	Fee Code	Quantity	Amount	Sub-Total in USD(\$)
<b>Basic Filing:</b>				
REQUEST FOR PRIORITIZED EXAMINATION	2817	1	2000	2000
<b>Pages:</b>				
<b>Claims:</b>				
<b>Miscellaneous-Filing:</b>				
PROCESSING FEE, EXCEPT PROV. APPLS.	2830	1	70	70

**Petition:**

**Patent-Appeals-and-Interference:**

Description	Fee Code	Quantity	Amount	Sub-Total in USD(\$)
<b>Post-Allowance-and-Post-Issuance:</b>				
<b>Extension-of-Time:</b>				
<b>Miscellaneous:</b>				
RCE- 1st Request	2801	1	600	600
<b>Total in USD (\$)</b>				<b>2670</b>

## Electronic Acknowledgement Receipt

<b>EFS ID:</b>	27580085
<b>Application Number:</b>	14848191
<b>International Application Number:</b>	
<b>Confirmation Number:</b>	9599
<b>Title of Invention:</b>	ACTIVATING DISPLAY AND PERFORMING USER AUTHENTICATION IN MOBILE TERMINAL WITH ONE-TIME USER INPUT
<b>First Named Inventor/Applicant Name:</b>	Jae Lark JUNG
<b>Customer Number:</b>	20995
<b>Filer:</b>	Mincheol Kim/Angel Zehnder
<b>Filer Authorized By:</b>	Mincheol Kim
<b>Attorney Docket Number:</b>	UNIS005.001C2
<b>Receipt Date:</b>	21-NOV-2016
<b>Filing Date:</b>	08-SEP-2015
<b>Time Stamp:</b>	20:35:54
<b>Application Type:</b>	Utility under 35 USC 111(a)

### Payment information:

Submitted with Payment	yes
Payment Type	CARD
Payment was successfully received in RAM	\$2670
RAM confirmation Number	112216INTEFSW20394900
Deposit Account	111410
Authorized User	Angel Zehnder

The Director of the USPTO is hereby authorized to charge indicated fees and credit any overpayment as follows:

37 CFR 1.16 (National application filing, search, and examination fees)

37 CFR 1.17 (Patent application and reexamination processing fees)

--	--	--	--	--	--

**File Listing:**

Document Number	Document Description	File Name	File Size(Bytes)/ Message Digest	Multi Part /.zip	Pages (if appl.)
1		Final_OA_Response.pdf	426522	yes	15
			674f3ba75ffc0f13c651bfff429c78ae780d53ed		

Multipart Description/PDF files in .zip description					
Document Description		Start	End		
Amendment Submitted/Entered with Filing of CPA/RCE		1	1		
Claims		2	7		
Applicant Arguments/Remarks Made in an Amendment		8	15		

**Warnings:**

**Information:**

2	TrackOne Request	Req_Track1.pdf	4489893	no	2
			44c08e1678a514bec4d7291ba5d59bfcfe05d09b		

**Warnings:**

**Information:**

3	Transmittal Letter	Transmittal.pdf	49725	no	2
			9d0831282298cbdaf655b8a327d590fe2b2810af		

**Warnings:**

**Information:**

4	Request for Continued Examination (RCE)	RCE.pdf	1349917	no	3
			60a350f135a2b758e159ace737b91c03d773887		

**Warnings:**

**Information:**

5	Fee Worksheet (SB06)	fee-info.pdf	34430	no	2
			713c9078487023159f41c0b57065d0042bd80e4		

<b>Warnings:</b>	
<b>Information:</b>	
<b>Total Files Size (in bytes):</b>	6350487
<p><b>This Acknowledgement Receipt evidences receipt on the noted date by the USPTO of the indicated documents, characterized by the applicant, and including page counts, where applicable. It serves as evidence of receipt similar to a Post Card, as described in MPEP 503.</b></p> <p><b><u>New Applications Under 35 U.S.C. 111</u></b>  <b>If a new application is being filed and the application includes the necessary components for a filing date (see 37 CFR 1.53(b)-(d) and MPEP 506), a Filing Receipt (37 CFR 1.54) will be issued in due course and the date shown on this Acknowledgement Receipt will establish the filing date of the application.</b></p> <p><b><u>National Stage of an International Application under 35 U.S.C. 371</u></b>  <b>If a timely submission to enter the national stage of an international application is compliant with the conditions of 35 U.S.C. 371 and other applicable requirements a Form PCT/DO/EO/903 indicating acceptance of the application as a national stage submission under 35 U.S.C. 371 will be issued in addition to the Filing Receipt, in due course.</b></p> <p><b><u>New International Application Filed with the USPTO as a Receiving Office</u></b>  <b>If a new international application is being filed and the international application includes the necessary components for an international filing date (see PCT Article 11 and MPEP 1810), a Notification of the International Application Number and of the International Filing Date (Form PCT/RO/105) will be issued in due course, subject to prescriptions concerning national security, and the date shown on this Acknowledgement Receipt will establish the international filing date of the application.</b></p>	

**IN THE UNITED STATES PATENT AND TRADEMARK OFFICE**

First Named Inventor	:	Jae Lark Jung
Applicant	:	Firstface Co., Ltd.
App. No.	:	14/848,191
Filed	:	September 8, 2015
Examiner	:	Shedrick, Charles Terrell
Art Unit	:	2646
Conf No.	:	9599

**AMENDMENT AND RESPONSE TO FINAL OFFICE ACTION**

**Mail Stop AF**  
P.O. Box 1450  
Alexandria, VA 22313-1450

Dear Sir:

This is in response to the Final Office Action mailed August 26, 2016 in the above-identified application. Applicant submits the following items for consideration in connection with the application.

**Amendments to the Claims** begin on page 2 of this paper.

**Remarks/Arguments** begin on page 8 of this paper.

## AMENDMENTS TO THE CLAIMS

1. (Currently Amended) A mobile communication terminal comprising:  
a touch screen display;  
a power button configured to turn on and off the terminal by pressing; and  
an activation button separate from the power button and located outside the touch screen display, the activation button configured for pressing to turn on the touch screen display,

wherein upon one-time pressing of the activation button while the touch screen display is turned off, the terminal is configured to turn on the touch screen display and perform a fingerprint authentication function in addition to turning on the touch screen display such that:

~~the touch screen display displays~~ a lock screen is displayed on the touch screen display upon turning on thereon as the touch screen display is turned on in response to the one-time pressing of the activation button while the touch screen display being turned off.

in addition to turning on the touch screen display and displaying the lock screen, the one-time pressing while the touch screen display being turned off initiates the fingerprint authentication function,

the lock screen is displayed on the touch screen display when the fingerprint authentication function initiated by the one-time pressing is being performed,

a lock state of the terminal continues when the fingerprint authentication function fails to authenticate a user, and

the lock state is released for enabling other functions of the terminal when the fingerprint authentication function authenticates a user in response to the one-time pressing of the activation button while the touch screen display being turned off.

2. (Previously Presented) The terminal of Claim 1, wherein the terminal is configured to perform at least one additional function in addition to the fingerprint authentication



function after turning on the touch screen display for displaying the lock screen when the one-time pressing of the activation button is detected while the touch screen display is turned off.

3. (Currently Amended) The terminal of Claim 1, wherein the terminal is further configured to perform at least one function other than the fingerprint authentication function in addition to turning on the touch screen display for displaying the lock screen in response to the one-time pressing of the activation button when the ~~detected~~ one-time pressing is for long time longer than a reference time period, wherein the at least one function ~~functions~~ is selected from the group consisting of activating the camera, and an operation that involves playing a sound.

4. (Previously Presented) The terminal of Claim 3, wherein the touch screen display displays a lock screen thereon as it is turned on in response to the one-time pressing for long time, wherein the lock screen is displayed on the touch screen display when the at least one function is being initiated.

5. (Previously Presented) The terminal of Claim 3, wherein the touch screen display displays a lock screen thereon as it is turned on in response to the one-time pressing for long time, wherein the at least one function is associated with initiating a hands-free operation of the terminal.

6. (Previously Presented) The terminal of Claim 3, wherein the terminal is configured to have a mobile application stay in a standby state when the touch screen display is turned off while the mobile application is running, wherein in response to the one-time pressing of the activation button while the touch screen display is turned off, the terminal is configured to perform the at least one function regardless of whether the at least one function is in its standby state or an operation disable state.

7. (Previously Presented) The terminal of Claim 1, wherein the terminal is configured to display a message on the touch screen display when the lock state continues due to failure of fingerprint authentication by the fingerprint authentication function.

8. (Currently Amended) The terminal of Claim 1, wherein the terminal is further configured to perform at least one function other than the fingerprint authentication function in addition to turning on the touch screen display for displaying the lock screen in response to the one-time pressing of the activation button when the one-time pressing is for long time longer than a reference time period, wherein the at least one function is associated with software downloadable by the terminal.

9. (Previously Presented) The terminal of Claim 1, wherein upon repeated pressing of the activation button while the touch screen display is turned off, the terminal is configured to turn on the touch screen display and further perform at least one function other than the fingerprint authentication function in addition to turning on the touch screen display.

10. (Previously Presented) The terminal of Claim 1, wherein the terminal comprises a smartphone which comprises an activation sensor configured to detect pressing of the activation button and a user identification module configured to perform the fingerprint authentication function.

11. (Currently Amended) A method of operating a mobile computing terminal, the method comprising:

providing a mobile computing terminal which comprises a touch screen display, a camera, a power button for pressing to turn on/off the terminal, and an activation button for pressing to turn on the touch screen display, the activation button located outside the touch screen display;

detecting one-time pressing of the activation button while the terminal is in an inactive state in which the touch screen display is turned off;

in response to the one-time pressing, changing the terminal from the inactive state to an active state in which the touch screen display is turned on; and

in addition to changing to the active state, further performing a fingerprint authentication function using fingerprint recognition without additional user input,

wherein in changing to the active state and performing the fingerprint authentication function, the terminal operates such that:

~~the touch screen display displays a lock screen~~ is displayed on the touch screen display upon changing the terminal from the inactive state thereon as the terminal changes to the active state in response to the one-time pressing of the activation button while the terminal being in the inactive state,

in addition to changing the terminal to the active state, the one-time pressing while the terminal being in the inactive state initiates the fingerprint authentication function,

the lock screen is displayed on the touch screen display when the fingerprint authentication function initiated by the one-time pressing is being performed,

a lock state of the terminal continues when the fingerprint authentication function fails to authenticate a user, and

the lock state is released for enabling other functions of the terminal when the fingerprint authentication function authenticates a user in response to the one-time pressing of the activation button while the terminal being in the inactive state.

12. (Previously Presented) The method of Claim 11, wherein performing at least one function in addition to the fingerprint authentication function after changing to the active state for displaying the lock screen when the one-time pressing is detected while the terminal being in the inactive state.

13. (Currently Amended) The method of Claim 11, wherein the method further comprises performing at least one function other than the fingerprint authentication function in addition to changing to the active state in response to the one-time pressing during the terminal's inactive state when the ~~detected~~ one-time pressing is for long time longer than the reference time period, wherein the at least one function is selected from the group consisting of activating the camera, a hands-free operation and an operation that involves playing a sound.

14. (Previously Presented) The method of Claim 13, wherein the touch screen display displays a lock screen thereon as the terminal changes to its active state in response to the one-

time pressing for long time, wherein the lock screen is displayed on the touch screen display when the at least one function is being initiated.

15. (Previously Presented) The method of Claim 13, wherein the touch screen display displays a lock screen thereon as the terminal changes to its active state in response to the one-time pressing for long time, wherein the at least one function is associated with initiating a hands-free operation of the terminal a hands-free operation.

16. (Previously Presented) The method of Claim 13, wherein the terminal is configured to have a mobile application stay in a standby state when the touch screen display is turned off while the mobile application is running, wherein in response to the one-time pressing of the activation button while the terminal is in its inactive state, the terminal performs the at least one function regardless of whether the at least one function is in its standby state or an operation disable state.

17. (Previously Presented) The method of Claim 13, wherein the touch screen display displays a message thereon when the lock state continues due to failure of fingerprint authentication by the fingerprint authentication function.

18. (Previously Presented) The method of Claim 13, further comprising:  
receiving user input on a setting menu of the terminal; and  
configuring, based on the user input, settings of the terminal such that the at least one function is set to be performed in addition to changing to the active state in response to one-time pressing of the activation button while the terminal is in its inactive state.

19. (Currently Amended) The method of Claim 11, wherein the method further comprises performing at least one function other than the fingerprint authentication function in addition to changing to the active state in response to the one-time pressing during the terminal's inactive state when the one-time pressing is for long time longer than the reference time period, wherein the at least one function is associated with software downloadable by the terminal.

20. (Previously Presented) The method of Claim 11, further comprising:

detecting repeated pressing of the activation button while the terminal is in its inactive state;

in response to the repeated pressing, changing the terminal from the inactive state to the active state; and

in addition to changing to the active state, further performing at least one function other than the fingerprint authentication function without additional user input,

wherein in changing to the active state and performing the at least one function, the terminal operates such that:

the touch screen display displays the lock screen thereon as the terminal changes to the active state in response to the repeated pressing,

the lock screen is displayed on the touch screen display when the at least one function is being performed.

Application No.: 14/848,191  
Filing Date: September 8, 2015

## REMARKS

This paper is in response to the final Office Action dated August 26, 2016. Applicant has amended the application as set forth above. Specifically, Claims 1, 3, 8, 11, 13 and 19 have been amended. No new matter is added by the amendments. Upon the entry of the amendments, Claims 1-20 remain pending in this application. Applicant respectfully requests entry of the amendments and reconsideration of the application in view of the above amendments and the following remarks.

### Double Patenting Rejection under 35 U.S.C. §101

Claims 1-20 were rejected under 35 U.S.C. §101 as identical to the claims of the co-pending application, Application No. 14/848,156 (cited application). Applicant respectfully disagrees.

M.P.E.P. 804 states the following regarding a statutory double patenting rejection:

In determining whether a statutory basis for a double patenting rejection exists, the question to be asked is: Is the same invention being claimed twice? 35 U.S.C. 101 prevents two patents from issuing on the same invention. "Same invention" means identical subject matter. *Miller v. Eagle Mfg. Co.*, 151 U.S. 186 (1984); *In re Vogel*, 422 F.2d 438, 164 USPQ 619 (CCPA 1970); *In re Ockert*, 245 F.2d 467, 114 USPQ 330 (CCPA 1957).

A reliable test for double patenting under 35 U.S.C. 101 is whether a claim in the application could be literally infringed without literally infringing a corresponding claim in the patent. *In re Vogel*, 422 F.2d 438, 164 USPQ 619 (CCPA 1970). Is there an embodiment of the invention that falls within the scope of one claim, but not the other? If there is such an embodiment, then identical subject matter is not defined by both claims and statutory double patenting would not exist.

In view of the foregoing, if there is a product that literally infringes the rejected claims of but could not literally infringe the cited claims, no statutory double patenting issue should exist between the two applications or patents. Solely for the purpose of addressing this issue, Applicant would like to consider an imaginary mobile terminal that has a camera but does not have a fingerprint authentication function. The imaginary product could literally infringe some claims of the cited application because the independent claims 1 and 12 of the cited application do not necessarily require the fingerprint authentication function although the fingerprint authentication is recited in these claims. On the other hand, however, the same imaginary product could not possibly infringe any claims of the cited application because the independent claims 1 and 11 of the present application require the fingerprint authentication function. In view of the foregoing, Applicant respectfully request withdrawal of the rejection.

For the Examiner's reference, Applicant provides Claims 1 and 12 of the cited application that do not necessarily require the fingerprint authentication function.

Claim 1 of Cited Application

A mobile communication terminal comprising:  
a touch screen display;  
a camera;  
a power button configured to turn on and off the terminal by pressing; and  
an activation button separate from the power button and located outside the touch screen display, the activation button configured for pressing to turn on the touch screen display and to initiate one or more additional functions of the terminal,

wherein the terminal has a first function and a second function to perform in response to user input via the activation button and is configured to provide user settings for configuring at least one of the first and second functions such that at least one of the first and second functions is set to be performed in addition to turning on the touch screen display upon pressing of the activation button while the touch screen display is turned off, wherein the first and second functions are different from each other and selected from the group consisting of fingerprint authentication, activating the camera, and an operation that involves playing a sound,

wherein upon one-time pressing of the activation button while the touch screen display is turned off, the terminal is configured to turn on the touch screen display and further perform at least one of the first and second functions in addition to turning on the touch screen display such that:

the lock screen is displayed on the touch screen display upon turning on the touch screen display in response to the one-time pressing of the activation button while the touch screen display is turned off,

in response to the one-time pressing of the activation button, the first function is performed in addition to turning on the touch screen display for displaying the lock screen thereon, and

the second function is performed when the one-time pressing is for long time longer than a reference time period,

wherein at least one of the first and second functions is performed subsequent to turning on the touch screen display and displaying the lock screen in response to the one-time pressing of the activation button,

wherein the touch screen display displays the lock screen when at least one of the first and second functions is being performed.

Claim 12 of Cited Application

A method of operating a mobile computing terminal, the method comprises:  
providing a mobile computing terminal which comprises a touch screen display, a camera, a power button for pressing to turn on/off the terminal, and an activation button for pressing to turn on the touch screen display, the activation button located outside the touch screen display, the terminal having a first function and a second function that are different from each other and selected from the group consisting of fingerprint

authentication, activating the camera, and an operation that involves playing a sound;  
detecting one-time pressing of the activation button while the terminal is in an inactive state in which the touch screen display is turned off;  
in response to the one-time pressing, changing the terminal from the inactive state to an active state in which the touch screen display is turned on; and  
in addition to changing to the active state, further performing at least one of the first and second functions without additional user input other than the one-time pressing;  
wherein in changing to the active state and performing at least one of the first and second functions, the terminal operates such that:  
a lock screen is displayed on the touch screen display upon changing from the inactive state to the active state in response to the one-time pressing of the activation button while the touch screen display is turned off,  
in response to the one-time pressing of the activation button, the first function is performed in addition to changing to the active state for displaying the lock screen, and  
the second function is performed when the one-time pressing is for long time longer than a reference time period,  
wherein at least one of the first and second functions is initiated subsequent to changing to the active state and displaying the lock screen in response to the one-time pressing of the activation button,  
wherein the touch screen display displays the lock screen when at least one of the first and second functions is being performed.

In view of the foregoing, Applicant respectfully request withdrawal of the rejection.

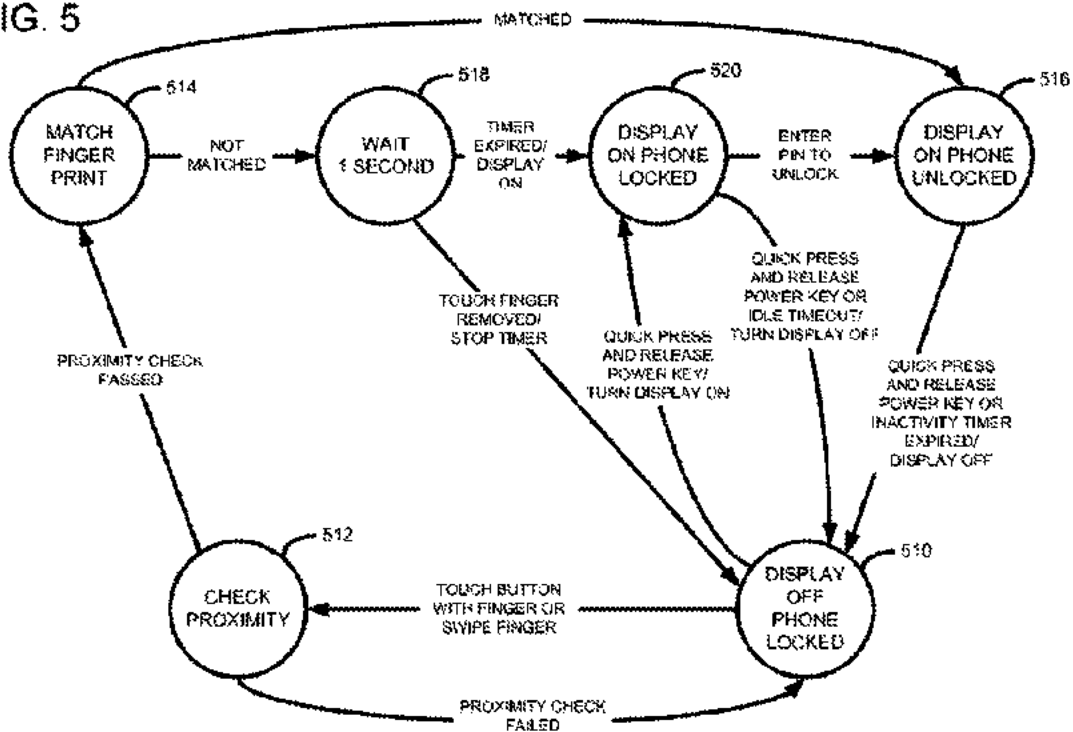
Rejection under 35 U.S.C. § 103

Claims 1-4, 6-7, 10-14, 15-18 and 20 were rejected under 35 U.S.C. § 103 (a) as being unpatentable over Bandyopadhyay et al. (US8311514, hereinafter “Bandyopadhyay ‘514”) in view of Bandyopadhyay et al. (US2012/0009896, hereinafter “Bandyopadhyay ‘896”).

**Bandyopadhyay ‘514** relates to wake-up and unlock operations of a smart phone using a single event, such as a single keystroke or pressing a button. For the Examiner’s reference, Figure 5 of Bandyopadhyay ‘514 is reproduced below.

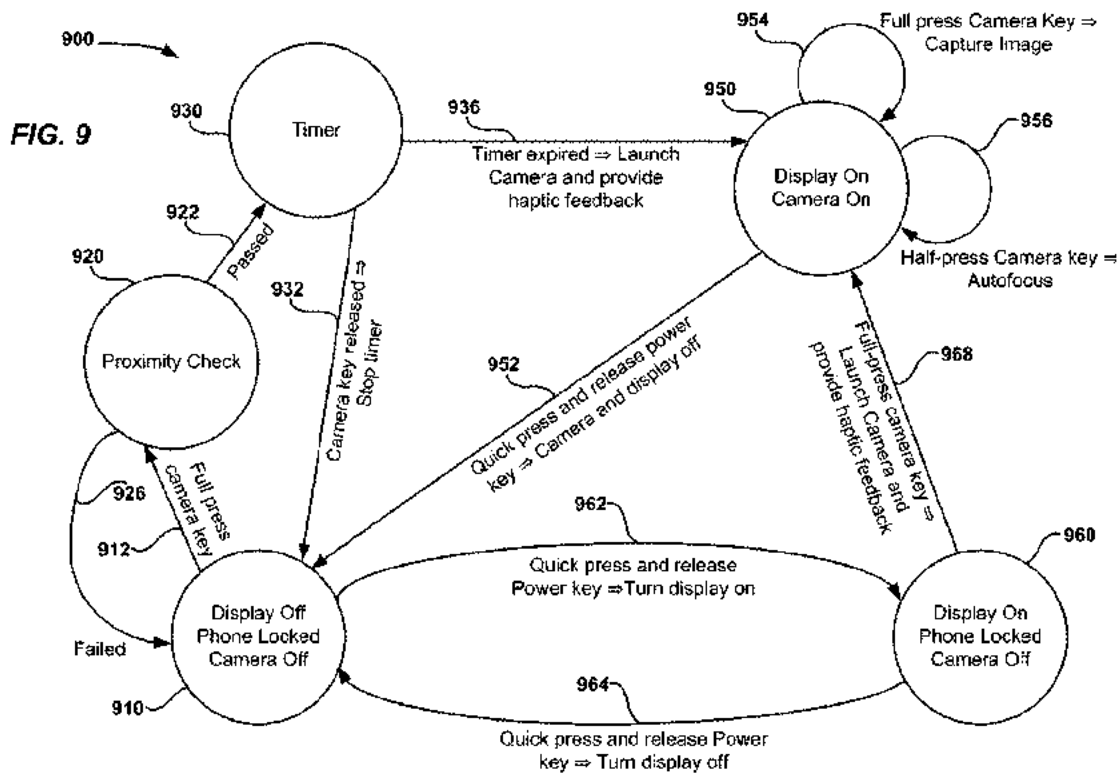


FIG. 5



Bandyopadhyay '514 discloses the transition from state 510 to state 520 which involves proximity check at 512, fingerprint match at 514 and wait 1 second at 518. Figure 5 illustrates that the display is not yet turned on at the 512, 514 and 518 during the transition. Accordingly, the fingerprint match at 514 is performed while the display is turned off. Also, Bandyopadhyay '514 discloses turning on its display to the phone's locked state from state 510 to state 520 by a quick press of the power key. Bandyopadhyay '514 discloses the transition from the state 520 (display on phone locked) to state 516 (display on phone unlock). These transitions do not involve the fingerprint match function. Thus, Bandyopadhyay '514 fails to disclose the feature that "the lock screen is displayed on the touch screen display when the fingerprint authentication function initiated by the one-time pressing is being performed" recited in Claims 1 and 11.

**Bandyopadhyay '896** relates to a smartphone having a camera. Bandyopadhyay '896 teaches activating the camera function from when the smartphone's screen is turned off (display-off state). For the Examiner's reference, Figure 9 of Bandyopadhyay '896 is reproduced below.



Bandyopadhyay '896 discloses turning on its display screen from its turned-off state by a quick press of the power key in the transition 962 from state 910 to state 960. Also, Bandyopadhyay '896 discloses turning on its display screen from its turned-off state by a full press of a camera key in the transition 912 from state 910 to state 950, which involves proximity check at 920 and waiting at 930. Figure 9 illustrates that turning on the display and activating the camera function at 950 occur after the functions of proximity check at 920 and waiting at 930. However, Figure 9 is silent about fingerprint authentication or lock screen.

Applicant notes that Bandyopadhyay '896 discloses a lock screen in its Figure 5A (not reproduced here) but is silent about how the lock screen of Figure 5A is displayed. Also, Applicant notes that Bandyopadhyay '896 mentions fingerprint authentication as an alternative to a pin pad authentication of Figure 5B (not reproduced here) for accessing data stored in the smartphone while performing the camera function. However, these do not amount to the feature that "the lock screen is displayed on the touch screen display when the fingerprint authentication function initiated by the one-time pressing is being performed" as recited in Claims 1 and 11.

**Application No.:** 14/848,191  
**Filing Date:** September 8, 2015

In view of the foregoing, Bandyopadhyay '896 does not remedy the deficiencies of Bandyopadhyay '514. Accordingly, Bandyopadhyay '514 and '896 do not establish *prima facie* obviousness against Claim 1 or 11. Withdrawal of the rejection is respectfully requested.

Examiner's Contention of Ambiguity of Language in Claims 1 and 11

In the Office Action at page 6, the Examiner contended Claims 1 and 11 include ambiguous claim limitations. Applicant respectfully disagrees with the contention. However, Applicant has amended Claims 1 and 11 to address the Examiner's concern.

Discussion of Rejection of Claims 5, 8, 9, 15, 19 and 20 under 35 U.S.C. § 103

The Office Action rejected Claims 5, 8, 15 and 19 under 35 U.S.C. § 103 (a) as being unpatentable over Bandyopadhyay '514 in view of Bandyopadhyay '896 and further in view of alleged Well-Known Art. The Office Action rejected Claims 9 and 20 under 35 U.S.C. § 103 (a) as being unpatentable over Bandyopadhyay '514 in view of Bandyopadhyay '896 and further in view of Buratti et al. (US 2012/0052836).

Claims 5, 8 and 9 depend from Claim 1, and Claims 15, 19 and 20 depend from Claim 11. If Claims 1 and 11 are patentable over the cited references, Claims 5, 8, 9, 15, 19 and 20 would also be patentable over the same references. Applicant now discusses the patentability of Claims 1 and 11. As discussed above, Bandyopadhyay '514 and Bandyopadhyay '896 fail to disclose every feature of Claim 1 and 11. In rejecting Claims 5, 8, 9, 15, 19 and 20, the Office Action relied on alleged Well-Known Art and Buratti to provide the features recited in these claims. While not acquiescing to the Office Action's assertion that the alleged Well-Known Art and Buratti disclose the Office Action's alleged features, Applicant submits that alleged Well-Known Art and Buratti do not disclose and are not concerned with what Bandyopadhyay '514 and Bandyopadhyay '896 fail to disclose. As such, the cited references in combination do not provide every feature of Claim 1 or 11. For this reason alone, no *prima facie* case of obviousness has been established against Claim 1 or 11. Therefore, Claims 1 and 11 their dependent claims including Claims 5, 8, 9, 15, 19 and 20 are patentable over the combination of the cited references.

**Application No.:** 14/848,191  
**Filing Date:** September 8, 2015

### Dependent Claims

Although Applicant has not addressed all the issues of the dependent claims, Applicant respectfully submits that Applicant does not necessarily agree with the characterization and assessments of the dependent claims made by the Examiner, and Applicant believes that each claim is patentable on its own merits. Applicant respectfully submits that the dependent claims incorporate by reference all the limitations of the claim to which they refer and include their own patentable features, and are therefore in condition for allowance. Therefore, Applicant respectfully requests the withdrawal of all claim rejections and prompts allowance of the claims.

### No Disclaimers or Disavowals

Although the present communication may include alterations to the application or claims, or characterizations of claim scope or referenced art, Applicant is not conceding in this application that previously pending claims are not patentable over the cited references. Rather, any alterations or characterizations are being made to facilitate expeditious prosecution of this application. Applicant reserves the right to pursue at a later date any previously pending or other broader or narrower claims that capture any subject matter supported by the present disclosure, including subject matter found to be specifically disclaimed herein or by any prior prosecution. Accordingly, reviewers of this or any parent, child or related prosecution history shall not reasonably infer that Applicant has made any disclaimers or disavowals of any subject matter supported by the present application.

**Application No.:** 14/848,191  
**Filing Date:** September 8, 2015

### CONCLUSION

Applicant has endeavored to address all of the Examiner's concerns as expressed in the outstanding Office Action. Accordingly, arguments in support of the patentability of the pending claim set are presented above.

In light of the above remarks, reconsideration and withdrawal of the outstanding rejections is respectfully requested. If the Examiner has any questions which may be answered by telephone, he is invited to call the undersigned directly.

Please charge any additional fees, including any fees for additional extension of time, or credit overpayment to Deposit Account No. 11-1410.

Respectfully submitted,

KNOBBE, MARTENS, OLSON & BEAR, LLP

Dated: November 21, 2016

By: /Mincheol Kim/  
Mincheol Kim  
Registration No. 51,306  
Attorney of Record  
Customer No. 20,995  
(949) 760-0404

24556624  
112116

Under the Paperwork Reduction Act of 1995, no persons are required to respond to a collection of information unless it displays a valid OMB control number.

<b>PATENT APPLICATION FEE DETERMINATION RECORD</b> Substitute for Form PTO-875	Application or Docket Number <b>14/848,191</b>	Filing Date <b>09/08/2015</b>	<input type="checkbox"/> To be Mailed
---	---	----------------------------------	---------------------------------------

ENTITY:  LARGE  SMALL  MICRO

**APPLICATION AS FILED – PART I**

FOR	NUMBER FILED	NUMBER EXTRA	RATE (\$)	FEE (\$)
<input type="checkbox"/> BASIC FEE (37 CFR 1.16(a), (b), or (c))	N/A	N/A	N/A	
<input type="checkbox"/> SEARCH FEE (37 CFR 1.16(k), (l), or (m))	N/A	N/A	N/A	
<input type="checkbox"/> EXAMINATION FEE (37 CFR 1.16(o), (p), or (q))	N/A	N/A	N/A	
TOTAL CLAIMS (37 CFR 1.16(i))	minus 20 =	*	X \$ =	
INDEPENDENT CLAIMS (37 CFR 1.16(h))	minus 3 =	*	X \$ =	
<input type="checkbox"/> APPLICATION SIZE FEE (37 CFR 1.16(s))	If the specification and drawings exceed 100 sheets of paper, the application size fee due is \$310 (\$155 for small entity) for each additional 50 sheets or fraction thereof. See 35 U.S.C. 41(a)(1)(G) and 37 CFR 1.16(s).			
<input type="checkbox"/> MULTIPLE DEPENDENT CLAIM PRESENT (37 CFR 1.16(j))				
* If the difference in column 1 is less than zero, enter "0" in column 2.			TOTAL	

**APPLICATION AS AMENDED – PART II**

	(Column 1)	(Column 2)	(Column 3)	PRESENT EXTRA	RATE (\$)	ADDITIONAL FEE (\$)
<b>AMENDMENT</b>	<b>11/21/2016</b>	CLAIMS REMAINING AFTER AMENDMENT		HIGHEST NUMBER PREVIOUSLY PAID FOR		
	Total (37 CFR 1.16(i))	- 20	Minus	** 20	= 0	X \$40 = 0
	Independent (37 CFR 1.16(h))	- 2	Minus	*** 3	= 0	X \$210 = 0
	<input type="checkbox"/> Application Size Fee (37 CFR 1.16(s))					
	<input type="checkbox"/> FIRST PRESENTATION OF MULTIPLE DEPENDENT CLAIM (37 CFR 1.16(j))					
					TOTAL ADD'L FEE	<b>0</b>

	(Column 1)	(Column 2)	(Column 3)	PRESENT EXTRA	RATE (\$)	ADDITIONAL FEE (\$)
<b>AMENDMENT</b>		CLAIMS REMAINING AFTER AMENDMENT		HIGHEST NUMBER PREVIOUSLY PAID FOR		
	Total (37 CFR 1.16(i))	-	Minus	**	=	X \$ =
	Independent (37 CFR 1.16(h))	*	Minus	***	=	X \$ =
	<input type="checkbox"/> Application Size Fee (37 CFR 1.16(s))					
	<input type="checkbox"/> FIRST PRESENTATION OF MULTIPLE DEPENDENT CLAIM (37 CFR 1.16(j))					
					TOTAL ADD'L FEE	

\* If the entry in column 1 is less than the entry in column 2, write "0" in column 3.  
 \*\* If the "Highest Number Previously Paid For" IN THIS SPACE is less than 20, enter "20".  
 \*\*\* If the "Highest Number Previously Paid For" IN THIS SPACE is less than 3, enter "3".

The "Highest Number Previously Paid For" (Total or Independent) is the highest number found in the appropriate box in column 1.

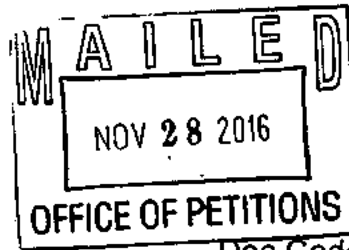
LIE  
DIANE JOHNSON

This collection of information is required by 37 CFR 1.16. The information is required to obtain or retain a benefit by the public which is to file (and by the USPTO to process) an application. Confidentiality is governed by 35 U.S.C. 122 and 37 CFR 1.14. This collection is estimated to take 12 minutes to complete, including gathering, preparing, and submitting the completed application form to the USPTO. Time will vary depending upon the individual case. Any comments on the amount of time you require to complete this form and/or suggestions for reducing this burden, should be sent to the Chief Information Officer, U.S. Patent and Trademark Office, U.S. Department of Commerce, P.O. Box 1450, Alexandria, VA 22313-1450. DO NOT SEND FEES OR COMPLETED FORMS TO THIS ADDRESS. **SEND TO: Commissioner for Patents, P.O. Box 1450, Alexandria, VA 22313-1450.**

If you need assistance in completing the form, call 1-800-PTO-9199 and select option 2.



KNOBBE MARTENS OLSON & BEAR LLP  
2040 MAIN STREET  
FOURTEENTH FLOOR  
IRVINE CA 92614



Doc Code: TRACK1.GRANT

<b>Decision Granting Request for Prioritized Examination (Track I or After RCE)</b>	Application No.: 14/848,191
<p>1. THE REQUEST FILED <u>November 21, 2016</u> IS <b>GRANTED</b>.</p> <p>The above-identified application has met the requirements for prioritized examination</p> <p>A. <input type="checkbox"/> for an original nonprovisional application (Track I).</p> <p>B. <input checked="" type="checkbox"/> for an application undergoing continued examination (RCE).</p> <p>2. <b>The above-identified application will undergo prioritized examination.</b> The application will be accorded special status throughout its entire course of prosecution until one of the following occurs:</p> <p>A. filing a <b><u>petition for extension of time</u></b> to extend the time period for filing a reply;</p> <p>B. filing an <b><u>amendment to amend the application to contain more than four independent claims, more than thirty total claims,</u></b> or a multiple dependent claim;</p> <p>C. filing a <b><u>request for continued examination</u></b>;</p> <p>D. filing a notice of appeal;</p> <p>E. filing a request for suspension of action;</p> <p>F. mailing of a notice of allowance;</p> <p>G. mailing of a final Office action;</p> <p>H. completion of examination as defined in 37 CFR 41.102; or</p> <p>I. abandonment of the application.</p> <p>Telephone inquiries with regard to this decision should be directed to Brian W. Brown at 571-272-5338.</p> <p>/Brian W. Brown/ [Signature]</p> <p>Petitions Examiner, Office of Petitions (Title)</p>	



NOTICE OF ALLOWANCE AND FEE(S) DUE

20995 7590 12/02/2016  
KNOBBE MARTENS OLSON & BEAR LLP  
2040 MAIN STREET  
FOURTEENTH FLOOR  
IRVINE, CA 92614

EXAMINER	
SHEDRICK, CHARLES TERRELL	
ART UNIT	PAPER NUMBER

2646

DATE MAILED: 12/02/2016

APPLICATION NO.	FILING DATE	FIRST NAMED INVENTOR	ATTORNEY DOCKET NO.	CONFIRMATION NO.
-----------------	-------------	----------------------	---------------------	------------------

14/848,191 09/08/2015 Jae Lark JUNG UNIS005.001C2 9599

TITLE OF INVENTION: ACTIVATING DISPLAY AND PERFORMING USER AUTHENTICATION IN MOBILE TERMINAL WITH ONE-TIME USER INPUT

APPLN. TYPE	ENTITY STATUS	ISSUE FEE DUE	PUBLICATION FEE DUE	PREV. PAID ISSUE FEE	TOTAL FEE(S) DUE	DATE DUE
-------------	---------------	---------------	---------------------	----------------------	------------------	----------

nonprovisional SMALL \$480 \$0 \$0 \$480 03/02/2017

THE APPLICATION IDENTIFIED ABOVE HAS BEEN EXAMINED AND IS ALLOWED FOR ISSUANCE AS A PATENT. PROSECUTION ON THE MERITS IS CLOSED. THIS NOTICE OF ALLOWANCE IS NOT A GRANT OF PATENT RIGHTS. THIS APPLICATION IS SUBJECT TO WITHDRAWAL FROM ISSUE AT THE INITIATIVE OF THE OFFICE OR UPON PETITION BY THE APPLICANT. SEE 37 CFR 1.313 AND MPEP 1308.

THE ISSUE FEE AND PUBLICATION FEE (IF REQUIRED) MUST BE PAID WITHIN THREE MONTHS FROM THE MAILING DATE OF THIS NOTICE OR THIS APPLICATION SHALL BE REGARDED AS ABANDONED. THIS STATUTORY PERIOD CANNOT BE EXTENDED. SEE 35 U.S.C. 151. THE ISSUE FEE DUE INDICATED ABOVE DOES NOT REFLECT A CREDIT FOR ANY PREVIOUSLY PAID ISSUE FEE IN THIS APPLICATION. IF AN ISSUE FEE HAS PREVIOUSLY BEEN PAID IN THIS APPLICATION (AS SHOWN ABOVE), THE RETURN OF PART B OF THIS FORM WILL BE CONSIDERED A REQUEST TO REAPPLY THE PREVIOUSLY PAID ISSUE FEE TOWARD THE ISSUE FEE NOW DUE.

HOW TO REPLY TO THIS NOTICE:

I. Review the ENTITY STATUS shown above. If the ENTITY STATUS is shown as SMALL or MICRO, verify whether entitlement to that entity status still applies.

If the ENTITY STATUS is the same as shown above, pay the TOTAL FEE(S) DUE shown above.

If the ENTITY STATUS is changed from that shown above, on PART B - FEE(S) TRANSMITTAL, complete section number 5 titled "Change in Entity Status (from status indicated above)".

For purposes of this notice, small entity fees are 1/2 the amount of undiscounted fees, and micro entity fees are 1/2 the amount of small entity fees.

II. PART B - FEE(S) TRANSMITTAL, or its equivalent, must be completed and returned to the United States Patent and Trademark Office (USPTO) with your ISSUE FEE and PUBLICATION FEE (if required). If you are charging the fee(s) to your deposit account, section "4b" of Part B - Fee(s) Transmittal should be completed and an extra copy of the form should be submitted. If an equivalent of Part B is filed, a request to reapply a previously paid issue fee must be clearly made, and delays in processing may occur due to the difficulty in recognizing the paper as an equivalent of Part B.

III. All communications regarding this application must give the application number. Please direct all communications prior to issuance to Mail Stop ISSUE FEE unless advised to the contrary.

IMPORTANT REMINDER: Utility patents issuing on applications filed on or after Dec. 12, 1980 may require payment of maintenance fees. It is patentee's responsibility to ensure timely payment of maintenance fees when due.



**PART B - FEE(S) TRANSMITTAL**

**Complete and send this form, together with applicable fee(s), to: Mail Mail Stop ISSUE FEE  
 Commissioner for Patents  
 P.O. Box 1450  
 Alexandria, Virginia 22313-1450  
 or Fax (571)-273-2885**

**INSTRUCTIONS:** This form should be used for transmitting the ISSUE FEE and PUBLICATION FEE (if required). Blocks 1 through 5 should be completed where appropriate. All further correspondence including the Patent, advance orders and notification of maintenance fees will be mailed to the current correspondence address as indicated unless corrected below or directed otherwise in Block 1, by (a) specifying a new correspondence address; and/or (b) indicating a separate "FEE ADDRESS" for maintenance fee notifications.

CURRENT CORRESPONDENCE ADDRESS (Note: Use Block 1 for any change of address)

20995 7590 12/02/2016  
**Knobbe Martens Olson & Bear LLP**  
 2040 MAIN STREET  
 FOURTEENTH FLOOR  
 IRVINE, CA 92614

Note: A certificate of mailing can only be used for domestic mailings of the Fee(s) Transmittal. This certificate cannot be used for any other accompanying papers. Each additional paper, such as an assignment or formal drawing, must have its own certificate of mailing or transmission.

**Certificate of Mailing or Transmission**

I hereby certify that this Fee(s) Transmittal is being deposited with the United States Postal Service with sufficient postage for first class mail in an envelope addressed to the Mail Stop ISSUE FEE address above, or being facsimile transmitted to the USPTO (571) 273-2885, on the date indicated below.

(Depositor's name)
(Signature)
(Date)

APPLICATION NO.	FILING DATE	FIRST NAMED INVENTOR	ATTORNEY DOCKET NO.	CONFIRMATION NO.
14/848,191	09/08/2015	Jae Lark JUNG	UNIS005.001C2	9599

TITLE OF INVENTION: ACTIVATING DISPLAY AND PERFORMING USER AUTHENTICATION IN MOBILE TERMINAL WITH ONE-TIME USER INPUT

APPLN. TYPE	ENTITY STATUS	ISSUE FEE DUE	PUBLICATION FEE DUE	PREV. PAID ISSUE FEE	TOTAL FEE(S) DUE	DATE DUE
nonprovisional	SMALL	\$480	\$0	\$0	\$480	03/02/2017

EXAMINER	ART UNIT	CLASS-SUBCLASS
SHEDRICK, CHARLES TERRELL	2646	455-404200

<p>1. Change of correspondence address or indication of "Fee Address" (37 CFR 1.363).</p> <p><input type="checkbox"/> Change of correspondence address (or Change of Correspondence Address form PTO/SB/122) attached.</p> <p><input type="checkbox"/> "Fee Address" indication (or "Fee Address" Indication form PTO/SB/47; Rev 03-02 or more recent) attached. Use of a <b>Customer Number is required.</b></p>	<p>2. For printing on the patent front page, list</p> <p>(1) The names of up to 3 registered patent attorneys or agents OR, alternatively, 1 _____</p> <p>(2) The name of a single firm (having as a member a registered attorney or agent) and the names of up to 2 registered patent attorneys or agents. If no name is listed, no name will be printed. 2 _____</p> <p>3 _____</p>
---	---

3. ASSIGNEE NAME AND RESIDENCE DATA TO BE PRINTED ON THE PATENT (print or type)

PLEASE NOTE: Unless an assignee is identified below, no assignee data will appear on the patent. If an assignee is identified below, the document has been filed for recordation as set forth in 37 CFR 3.11. Completion of this form is NOT a substitute for filing an assignment.

(A) NAME OF ASSIGNEE \_\_\_\_\_ (B) RESIDENCE: (CITY and STATE OR COUNTRY) \_\_\_\_\_

Please check the appropriate assignee category or categories (will not be printed on the patent):  Individual  Corporation or other private group entity  Government

<p>4a. The following fee(s) are submitted:</p> <p><input type="checkbox"/> Issue Fee</p> <p><input type="checkbox"/> Publication Fee (No small entity discount permitted)</p> <p><input type="checkbox"/> Advance Order - # of Copies _____</p>	<p>4b. Payment of Fee(s): (Please first reapply any previously paid issue fee shown above)</p> <p><input type="checkbox"/> A check is enclosed.</p> <p><input type="checkbox"/> Payment by credit card. Form PTO-2038 is attached.</p> <p><input type="checkbox"/> The director is hereby authorized to charge the required fee(s), any deficiency, or credits any overpayment, to Deposit Account Number _____ (enclose an extra copy of this form).</p>
---	---

5. Change in Entity Status (from status indicated above)

Applicant certifying micro entity status. See 37 CFR 1.29

Applicant asserting small entity status. See 37 CFR 1.27

Applicant changing to regular undiscounted fee status.

NOTE: Absent a valid certification of Micro Entity Status (see forms PTO/SB/15A and 15B), issue fee payment in the micro entity amount will not be accepted at the risk of application abandonment.

NOTE: If the application was previously under micro entity status, checking this box will be taken to be a notification of loss of entitlement to micro entity status.

NOTE: Checking this box will be taken to be a notification of loss of entitlement to small or micro entity status, as applicable.

NOTE: This form must be signed in accordance with 37 CFR 1.31 and 1.33. See 37 CFR 1.4 for signature requirements and certifications.

Authorized Signature \_\_\_\_\_ Date \_\_\_\_\_

Typed or printed name \_\_\_\_\_ Registration No. \_\_\_\_\_



UNITED STATES PATENT AND TRADEMARK OFFICE

UNITED STATES DEPARTMENT OF COMMERCE
United States Patent and Trademark Office
Address: COMMISSIONER FOR PATENTS
P.O. Box 1450
Alexandria, Virginia 22313-1450
www.uspto.gov

Table with 5 columns: APPLICATION NO., FILING DATE, FIRST NAMED INVENTOR, ATTORNEY DOCKET NO., CONFIRMATION NO.
14/848,191 09/08/2015 Jae Lark JUNG UNIS005.001C2 9599

20995 7590 12/02/2016
KNOBBE MARTENS OLSON & BEAR LLP
2040 MAIN STREET
FOURTEENTH FLOOR
IRVINE, CA 92614

EXAMINER

SHEDRICK, CHARLES TERRELL

ART UNIT PAPER NUMBER

2646

DATE MAILED: 12/02/2016

Determination of Patent Term Adjustment under 35 U.S.C. 154 (b)

(Applications filed on or after May 29, 2000)

The Office has discontinued providing a Patent Term Adjustment (PTA) calculation with the Notice of Allowance.

Section 1(h)(2) of the AIA Technical Corrections Act amended 35 U.S.C. 154(b)(3)(B)(i) to eliminate the requirement that the Office provide a patent term adjustment determination with the notice of allowance. See Revisions to Patent Term Adjustment, 78 Fed. Reg. 19416, 19417 (Apr. 1, 2013). Therefore, the Office is no longer providing an initial patent term adjustment determination with the notice of allowance. The Office will continue to provide a patent term adjustment determination with the Issue Notification Letter that is mailed to applicant approximately three weeks prior to the issue date of the patent, and will include the patent term adjustment on the patent. Any request for reconsideration of the patent term adjustment determination (or reinstatement of patent term adjustment) should follow the process outlined in 37 CFR 1.705.

Any questions regarding the Patent Term Extension or Adjustment determination should be directed to the Office of Patent Legal Administration at (571)-272-7702. Questions relating to issue and publication fee payments should be directed to the Customer Service Center of the Office of Patent Publication at 1-(888)-786-0101 or (571)-272-4200.

## OMB Clearance and PRA Burden Statement for PTOL-85 Part B

The Paperwork Reduction Act (PRA) of 1995 requires Federal agencies to obtain Office of Management and Budget approval before requesting most types of information from the public. When OMB approves an agency request to collect information from the public, OMB (i) provides a valid OMB Control Number and expiration date for the agency to display on the instrument that will be used to collect the information and (ii) requires the agency to inform the public about the OMB Control Number's legal significance in accordance with 5 CFR 1320.5(b).

The information collected by PTOL-85 Part B is required by 37 CFR 1.311. The information is required to obtain or retain a benefit by the public which is to file (and by the USPTO to process) an application. Confidentiality is governed by 35 U.S.C. 122 and 37 CFR 1.14. This collection is estimated to take 12 minutes to complete, including gathering, preparing, and submitting the completed application form to the USPTO. Time will vary depending upon the individual case. Any comments on the amount of time you require to complete this form and/or suggestions for reducing this burden, should be sent to the Chief Information Officer, U.S. Patent and Trademark Office, U.S. Department of Commerce, P.O. Box 1450, Alexandria, Virginia 22313-1450. DO NOT SEND FEES OR COMPLETED FORMS TO THIS ADDRESS. SEND TO: Commissioner for Patents, P.O. Box 1450, Alexandria, Virginia 22313-1450. Under the Paperwork Reduction Act of 1995, no persons are required to respond to a collection of information unless it displays a valid OMB control number.

### Privacy Act Statement

**The Privacy Act of 1974 (P.L. 93-579)** requires that you be given certain information in connection with your submission of the attached form related to a patent application or patent. Accordingly, pursuant to the requirements of the Act, please be advised that: (1) the general authority for the collection of this information is 35 U.S.C. 2(b)(2); (2) furnishing of the information solicited is voluntary; and (3) the principal purpose for which the information is used by the U.S. Patent and Trademark Office is to process and/or examine your submission related to a patent application or patent. If you do not furnish the requested information, the U.S. Patent and Trademark Office may not be able to process and/or examine your submission, which may result in termination of proceedings or abandonment of the application or expiration of the patent.

The information provided by you in this form will be subject to the following routine uses:

1. The information on this form will be treated confidentially to the extent allowed under the Freedom of Information Act (5 U.S.C. 552) and the Privacy Act (5 U.S.C. 552a). Records from this system of records may be disclosed to the Department of Justice to determine whether disclosure of these records is required by the Freedom of Information Act.
2. A record from this system of records may be disclosed, as a routine use, in the course of presenting evidence to a court, magistrate, or administrative tribunal, including disclosures to opposing counsel in the course of settlement negotiations.
3. A record in this system of records may be disclosed, as a routine use, to a Member of Congress submitting a request involving an individual, to whom the record pertains, when the individual has requested assistance from the Member with respect to the subject matter of the record.
4. A record in this system of records may be disclosed, as a routine use, to a contractor of the Agency having need for the information in order to perform a contract. Recipients of information shall be required to comply with the requirements of the Privacy Act of 1974, as amended, pursuant to 5 U.S.C. 552a(m).
5. A record related to an International Application filed under the Patent Cooperation Treaty in this system of records may be disclosed, as a routine use, to the International Bureau of the World Intellectual Property Organization, pursuant to the Patent Cooperation Treaty.
6. A record in this system of records may be disclosed, as a routine use, to another federal agency for purposes of National Security review (35 U.S.C. 181) and for review pursuant to the Atomic Energy Act (42 U.S.C. 218(c)).
7. A record from this system of records may be disclosed, as a routine use, to the Administrator, General Services, or his/her designee, during an inspection of records conducted by GSA as part of that agency's responsibility to recommend improvements in records management practices and programs, under authority of 44 U.S.C. 2904 and 2906. Such disclosure shall be made in accordance with the GSA regulations governing inspection of records for this purpose, and any other relevant (i.e., GSA or Commerce) directive. Such disclosure shall not be used to make determinations about individuals.
8. A record from this system of records may be disclosed, as a routine use, to the public after either publication of the application pursuant to 35 U.S.C. 122(b) or issuance of a patent pursuant to 35 U.S.C. 151. Further, a record may be disclosed, subject to the limitations of 37 CFR 1.14, as a routine use, to the public if the record was filed in an application which became abandoned or in which the proceedings were terminated and which application is referenced by either a published application, an application open to public inspection or an issued patent.
9. A record from this system of records may be disclosed, as a routine use, to a Federal, State, or local law enforcement agency, if the USPTO becomes aware of a violation or potential violation of law or regulation.

<b>Notice of Allowability</b>	<b>Application No.</b> 14/848,191	<b>Applicant(s)</b> JUNG ET AL.	
	<b>Examiner</b> CHARLES SHEDRICK	<b>Art Unit</b> 2646	<b>AIA (First Inventor to File) Status</b> No

**-- The MAILING DATE of this communication appears on the cover sheet with the correspondence address--**

All claims being allowable, PROSECUTION ON THE MERITS IS (OR REMAINS) CLOSED in this application. If not included herewith (or previously mailed), a Notice of Allowance (PTOL-85) or other appropriate communication will be mailed in due course. **THIS NOTICE OF ALLOWABILITY IS NOT A GRANT OF PATENT RIGHTS.** This application is subject to withdrawal from issue at the initiative of the Office or upon petition by the applicant. See 37 CFR 1.313 and MPEP 1308.

1.  This communication is responsive to RCE dated 11/21/16.  
 A declaration(s)/affidavit(s) under 37 CFR 1.130(b) was/were filed on \_\_\_\_\_.
2.  An election was made by the applicant in response to a restriction requirement set forth during the interview on \_\_\_\_\_; the restriction requirement and election have been incorporated into this action.
3.  The allowed claim(s) is/are 1-20. As a result of the allowed claim(s), you may be eligible to benefit from the **Patent Prosecution Highway** program at a participating intellectual property office for the corresponding application. For more information, please see [http://www.uspto.gov/patents/init\\_events/pph/index.jsp](http://www.uspto.gov/patents/init_events/pph/index.jsp) or send an inquiry to PPHfeedback@uspto.gov.
4.  Acknowledgment is made of a claim for foreign priority under 35 U.S.C. § 119(a)-(d) or (f).

**Certified copies:**

- a)  All    b)  Some    \*c)  None of the:
    1.  Certified copies of the priority documents have been received.
    2.  Certified copies of the priority documents have been received in Application No. \_\_\_\_\_.
    3.  Copies of the certified copies of the priority documents have been received in this national stage application from the International Bureau (PCT Rule 17.2(a)).
- \* Certified copies not received: \_\_\_\_\_.


Applicant has **THREE MONTHS FROM THE "MAILING DATE"** of this communication to file a reply complying with the requirements noted below. Failure to timely comply will result in ABANDONMENT of this application.  
**THIS THREE-MONTH PERIOD IS NOT EXTENDABLE.**

5.  CORRECTED DRAWINGS ( as "replacement sheets") must be submitted.  
 including changes required by the attached Examiner's Amendment / Comment or in the Office action of Paper No./Mail Date \_\_\_\_\_.  
**Identifying indicia such as the application number (see 37 CFR 1.84(c)) should be written on the drawings in the front (not the back) of each sheet. Replacement sheet(s) should be labeled as such in the header according to 37 CFR 1.121(d).**
6.  DEPOSIT OF and/or INFORMATION about the deposit of BIOLOGICAL MATERIAL must be submitted. Note the attached Examiner's comment regarding REQUIREMENT FOR THE DEPOSIT OF BIOLOGICAL MATERIAL.

**Attachment(s)**

- |  |   |
|--|---|
| 1. <input type="checkbox"/> Notice of References Cited (PTO-892)   | 5. <input type="checkbox"/> Examiner's Amendment/Comment                  |
| 2. <input type="checkbox"/> Information Disclosure Statements (PTO/SB/08),<br>Paper No./Mail Date _____    | 6. <input type="checkbox"/> Examiner's Statement of Reasons for Allowance |
| 3. <input type="checkbox"/> Examiner's Comment Regarding Requirement for Deposit<br>of Biological Material | 7. <input type="checkbox"/> Other _____.                                  |
| 4. <input type="checkbox"/> Interview Summary (PTO-413),<br>Paper No./Mail Date _____.                     |   |

/CHARLES SHEDRICK/  
Primary Examiner, Art Unit 2646

<b>Search Notes</b>  	<b>Application/Control No.</b>  14848191	<b>Applicant(s)/Patent Under Reexamination</b>  JUNG ET AL.
	<b>Examiner</b>  CHARLES SHEDRICK	<b>Art Unit</b>  2646

CPC- SEARCHED		
Symbol	Date	Examiner
H04W 4/02 ; H04W 12/08 ; H04M 1/67 ; H04M 1/7258 ; H04M 2250/52 ; H04M 1/72519 ; H04W 8/22; H04W 52/027 ; G06F 21/32 ; H04W 12/06 ; H04M 22	1/26/2016	cs


CPC COMBINATION SETS - SEARCHED		
Symbol	Date	Examiner

US CLASSIFICATION SEARCHED			
Class	Subclass	Date	Examiner
455	411,414.1, 420,404.2, 410	1/26/2016	cs
726	1,16	1/26/2016	cs

SEARCH NOTES		
Search Notes	Date	Examiner
EAST text search, CPC search, Inventor search	1/19/2016	cs

INTERFERENCE SEARCH			
US Class/ CPC Symbol	US Subclass / CPC Group	Date	Examiner
see searched notes and searched classes		11/28/2016	CS


	/CHARLES SHEDRICK/ Primary Examiner.Art Unit 2646
--	--

<b>Issue Classification</b> 	<b>Application/Control No.</b> 14848191	<b>Applicant(s)/Patent Under Reexamination</b> JUNG ET AL.
	<b>Examiner</b> CHARLES SHEDRICK	<b>Art Unit</b> 2646

CPC							
Symbol						Type	Version
G06Q	30	/	0262			F	2013-01-01
H04W	4	/	02			I	2013-01-01
H04W	4	/	22			A	2013-01-01
H04M	1	/	67			I	2013-01-01
H04M	1	/	7258			I	2013-01-01
H04M	2250	/	52			A	2013-01-01
H04M	1	/	72519			I	2013-01-01
H04W	8	/	22			I	2013-01-01
G06F	21	/	32			I	2013-01-01
H04W	12	/	06			I	2013-01-01
H04M	2250	/	12			A	2013-01-01
H04W	52	/	027			I	2013-01-01
G06F	3	/	04883			I	2013-01-01
G06K	9	/	00087			I	2013-01-01
H04W	88	/	02			A	2013-01-01
G06K	9	/	00006			I	2013-01-01
G06K	9	/	00221			I	2013-01-01
G06K	9	/	00597			I	2013-01-01
H04L	63	/	0861			I	2013-01-01
H04W	12	/	08			I	2013-01-01
G06Q	30	/	0241			I	2013-01-01
G06F	21	/	36			I	2013-01-01
G06F	21	/	62			I	2013-01-01
G06Q	30	/	0261			I	2013-01-01
G06Q	30	/	0267			I	2013-01-01
G06Q	30	/	0269			I	2013-01-01


CPC Combination Sets								
Symbol					Type	Set	Ranking	Version
		/						

NONE		<b>Total Claims Allowed:</b>	
(Assistant Examiner)	(Date)	20	
/CHARLES SHEDRICK/ Primary Examiner.Art Unit 2646	11/28/2016	O.G. Print Claim(s)	O.G. Print Figure
(Primary Examiner)	(Date)	1	1

<b>Issue Classification</b> 	<b>Application/Control No.</b> 14848191	<b>Applicant(s)/Patent Under Reexamination</b> JUNG ET AL.	
	<b>Examiner</b> CHARLES SHEDRICK	<b>Art Unit</b> 2646	

--	--	--	--	--	--


NONE		<b>Total Claims Allowed:</b>	
(Assistant Examiner)	(Date)	20	
/CHARLES SHEDRICK/ Primary Examiner. Art Unit 2646	11/28/2016	O.G. Print Claim(s)	O.G. Print Figure
(Primary Examiner)	(Date)	1	1

<b>Issue Classification</b> 	<b>Application/Control No.</b> 14848191	<b>Applicant(s)/Patent Under Reexamination</b> JUNG ET AL.
	<b>Examiner</b> CHARLES SHEDRICK	<b>Art Unit</b> 2646

US ORIGINAL CLASSIFICATION				INTERNATIONAL CLASSIFICATION									
CLASS		SUBCLASS		CLAIMED				NON-CLAIMED					
455		411		H	0	4	M	1 / 00 (2006.01.01)					
<b>CROSS REFERENCE(S)</b>													
CLASS	SUBCLASS (ONE SUBCLASS PER BLOCK)												
455	414 1	420											
726	1	16											

NONE		<b>Total Claims Allowed:</b>	
(Assistant Examiner)	(Date)	20	
/CHARLES SHEDRICK/ Primary Examiner. Art Unit 2646	11/28/2016	O.G. Print Claim(s)	O.G. Print Figure
(Primary Examiner)	(Date)	1	1



<b>Issue Classification</b> 	<b>Application/Control No.</b> 14848191	<b>Applicant(s)/Patent Under Reexamination</b> JUNG ET AL.
	<b>Examiner</b> CHARLES SHEDRICK	<b>Art Unit</b> 2646

<input checked="" type="checkbox"/> <b>Claims renumbered in the same order as presented by applicant</b>																<input type="checkbox"/> <b>CPA</b>		<input type="checkbox"/> <b>T.D.</b>		<input type="checkbox"/> <b>R.1.47</b>	
Final	Original	Final	Original	Final	Original	Final	Original	Final	Original	Final	Original	Final	Original	Final	Original						

NONE			<b>Total Claims Allowed:</b>	
			20	
(Assistant Examiner)	(Date)		O.G. Print Claim(s)	O.G. Print Figure
/CHARLES SHEDRICK/ Primary Examiner. Art Unit 2646	11/28/2016		1	1
(Primary Examiner)	(Date)			

### REQUEST FOR CONTINUED EXAMINATION(RCE)TRANSMITTAL (Submitted Only via EFS-Web)

Application Number	14848191	Filing Date	2015-09-08	Docket Number (if applicable)	UNIS005.001C2	Art Unit	2646
First Named Inventor	Jae Lark Jung			Examiner Name	Shedrick, Charles Terrell		

**This is a Request for Continued Examination (RCE) under 37 CFR 1.114 of the above-identified application.** Request for Continued Examination (RCE) practice under 37 CFR 1.114 does not apply to any utility or plant application filed prior to June 8, 1995, to any international application that does not comply with the requirements of 35 U.S.C. 371, or to any design application. The Instruction Sheet for this form is located at WWW.USPTO.GOV.

#### SUBMISSION REQUIRED UNDER 37 CFR 1.114

Note: If the RCE is proper, any previously filed unentered amendments and amendments enclosed with the RCE will be entered in the order in which they were filed unless applicant instructs otherwise. If applicant does not wish to have any previously filed unentered amendment(s) entered, applicant must request non-entry of such amendment(s).

Previously submitted. If a final Office action is outstanding, any amendments filed after the final Office action may be considered as a submission even if this box is not checked.

Consider the arguments in the Appeal Brief or Reply Brief previously filed on \_\_\_\_\_

Other \_\_\_\_\_

Enclosed

Amendment/Reply

Information Disclosure Statement (IDS)

Affidavit(s)/ Declaration(s)

Other \_\_\_\_\_

#### MISCELLANEOUS

Suspension of action on the above-identified application is requested under 37 CFR 1.103(c) for a period of months \_\_\_\_\_ (Period of suspension shall not exceed 3 months; Fee under 37 CFR 1.17(i) required)

Other \_\_\_\_\_

#### FEES

**The RCE fee under 37 CFR 1.17(e) is required by 37 CFR 1.114 when the RCE is filed.**

The Director is hereby authorized to charge any underpayment of fees, or credit any overpayments, to Deposit Account No 111410

#### SIGNATURE OF APPLICANT, ATTORNEY, OR AGENT REQUIRED

<input checked="" type="checkbox"/> Patent Practitioner Signature <input type="checkbox"/> Applicant Signature	
---	--

Signature of Registered U.S. Patent Practitioner			
Signature	Mincheol Kim/	Date (YYYY-MM-DD)	2016-12-05
Name	Mincheol Kim	Registration Number	51306

This collection of information is required by 37 CFR 1.114. The information is required to obtain or retain a benefit by the public which is to file (and by the USPTO to process) an application. Confidentiality is governed by 35 U.S.C. 122 and 37 CFR 1.11 and 1.14. This collection is estimated to take 12 minutes to complete, including gathering, preparing, and submitting the completed application form to the USPTO. Time will vary depending upon the individual case. Any comments on the amount of time you require to complete this form and/or suggestions for reducing this burden, should be sent to the Chief Information Officer, U.S. Patent and Trademark Office, U.S. Department of Commerce, P.O. Box 1450, Alexandria, VA 22313-1450.

*If you need assistance in completing the form, call 1-800-PTO-9199 and select option 2.*

## Privacy Act Statement

The Privacy Act of 1974 (P.L. 93-579) requires that you be given certain information in connection with your submission of the attached form related to a patent application or patent. Accordingly, pursuant to the requirements of the Act, please be advised that: (1) the general authority for the collection of this information is 35 U.S.C. 2(b)(2); (2) furnishing of the information solicited is voluntary; and (3) the principal purpose for which the information is used by the U.S. Patent and Trademark Office is to process and/or examine your submission related to a patent application or patent. If you do not furnish the requested information, the U.S. Patent and Trademark Office may not be able to process and/or examine your submission, which may result in termination of proceedings or abandonment of the application or expiration of the patent.

The information provided by you in this form will be subject to the following routine uses:

1. The information on this form will be treated confidentially to the extent allowed under the Freedom of Information Act (5 U.S.C. 552) and the Privacy Act (5 U.S.C. 552a). Records from this system of records may be disclosed to the Department of Justice to determine whether the Freedom of Information Act requires disclosure of these records.
2. A record from this system of records may be disclosed, as a routine use, in the course of presenting evidence to a court, magistrate, or administrative tribunal, including disclosures to opposing counsel in the course of settlement negotiations.
3. A record in this system of records may be disclosed, as a routine use, to a Member of Congress submitting a request involving an individual, to whom the record pertains, when the individual has requested assistance from the Member with respect to the subject matter of the record.
4. A record in this system of records may be disclosed, as a routine use, to a contractor of the Agency having need for the information in order to perform a contract. Recipients of information shall be required to comply with the requirements of the Privacy Act of 1974, as amended, pursuant to 5 U.S.C. 552a(m).
5. A record related to an International Application filed under the Patent Cooperation Treaty in this system of records may be disclosed, as a routine use, to the International Bureau of the World Intellectual Property Organization, pursuant to the Patent Cooperation Treaty.
6. A record in this system of records may be disclosed, as a routine use, to another federal agency for purposes of National Security review (35 U.S.C. 181) and for review pursuant to the Atomic Energy Act (42 U.S.C. 218(c)).
7. A record from this system of records may be disclosed, as a routine use, to the Administrator, General Services, or his/her designee, during an inspection of records conducted by GSA as part of that agency's responsibility to recommend improvements in records management practices and programs, under authority of 44 U.S.C. 2904 and 2906. Such disclosure shall be made in accordance with the GSA regulations governing inspection of records for this purpose, and any other relevant (i.e., GSA or Commerce) directive. Such disclosure shall not be used to make determinations about individuals.
8. A record from this system of records may be disclosed, as a routine use, to the public after either publication of the application pursuant to 35 U.S.C. 122(b) or issuance of a patent pursuant to 35 U.S.C. 151. Further, a record may be disclosed, subject to the limitations of 37 CFR 1.14, as a routine use, to the public if the record was filed in an application which became abandoned or in which the proceedings were terminated and which application is referenced by either a published application, an application open to public inspections or an issued patent.
9. A record from this system of records may be disclosed, as a routine use, to a Federal, State, or local law enforcement agency, if the USPTO becomes aware of a violation or potential violation of law or regulation.

<b>INFORMATION DISCLOSURE STATEMENT BY APPLICANT</b> ( Not for submission under 37 CFR 1.99)	Application Number	14848191
	Filing Date	2015-09-08
	First Named Inventor	JAE LARK JUNG
	Art Unit	2646
	Examiner Name	SHEDRICK, CHARLES TERRELL
	Attorney Docket Number	UNIS005.001C2

U.S.PATENTS						Remove
Examiner Initial*	Cite No	Patent Number	Kind Code <sup>1</sup>	Issue Date	Name of Patentee or Applicant of cited Document	Pages, Columns, Lines where Relevant Passages or Relevant Figures Appear
	1	9307396	B2	2016-04-05	Jung et al.	
	2	7251478	B2	2007-07-31	Cortegiano	
	3	9338274	B2	2016-05-10	Gao et al.	
	4	8745490	B2	2014-06-03	Kim	
	5	8149089	B2	2012-04-03	Lin et al.	
	6	8810367	B2	2014-08-19	Mullins	
	7	9229489	B2	2016-01-05	Toksvig et al.	
	8	8604906	B1	2013-12-10	Halferty et al.	

**INFORMATION DISCLOSURE  
STATEMENT BY APPLICANT**  
( Not for submission under 37 CFR 1.99)

Application Number	14848191
Filing Date	2015-09-08
First Named Inventor	JAE LARK JUNG
Art Unit	2646
Examiner Name	SHEDRICK, CHARLES TERRELL
Attorney Docket Number	UNIS005.001C2

9	8548206	B2	2013-10-01	Sahin et al.
10	8627096	B2	2014-01-07	Azar et al.
11	8912877	B2	2014-12-16	Ling et al.
12	8299889	B2	2012-10-30	Kumar et al.
13	8165355	B2	2012-04-24	Benkley et al.
14	7725511	B2	2010-05-25	Kadi
15	8643771	B2	2014-02-04	You

If you wish to add additional U.S. Patent citation information please click the Add button.

Add

**U.S.PATENT APPLICATION PUBLICATIONS**

Remove

Examiner Initial*	Cite No	Publication Number	Kind Code <sup>1</sup>	Publication Date	Name of Patentee or Applicant of cited Document	Pages, Columns, Lines where Relevant Passages or Relevant Figures Appear
	1	20110081889	A1	2011-04-07	Gao et al.	
	2	20130157561	A1	2013-06-20	Tamai et al.	

**INFORMATION DISCLOSURE  
STATEMENT BY APPLICANT**  
( Not for submission under 37 CFR 1.99)

Application Number	14848191
Filing Date	2015-09-08
First Named Inventor	JAE LARK JUNG
Art Unit	2646
Examiner Name	SHEDRICK, CHARLES TERRELL
Attorney Docket Number	UNIS005.001C2

3	20080049980	A1	2008-02-28	Castaneda et al.
4	20130082974	A1	2013-04-04	Kerr et al.
5	20130069764	A1	2013-03-21	Wu
6	20120133484	A1	2012-05-31	Griffin

If you wish to add additional U.S. Published Application citation information please click the Add button

**FOREIGN PATENT DOCUMENTS**

Examiner Initial*	Cite No	Foreign Document Number <sup>3</sup>	Country Code <sup>2</sup> i	Kind Code <sup>4</sup>	Publication Date	Name of Patentee or Applicant of cited Document	Pages, Columns, Lines where Relevant Passages or Relevant Figures Appear	T <sup>5</sup>
	1	2009-212558	JP	A	2009-09-17	NEC COMMUNICATION SYST		×
	2	2002-24712	JP	A	2002-01-25	MEDIA LINK SYSTEM KK		☒
	3	2003-143290	JP	A	2003-05-16	SANYO ELECTRIC CO; SANYO TELECOMM CO LTD		☒
	4	2004-80080	JP	A	2004-03-11	MATSUSHITA ELECTRIC IND CO LTD		☒
	5	101452365	CN	A	2009-06-10	LG ELECTRONICS INC		☒

If you wish to add additional Foreign Patent Document citation information please click the Add button

<b>INFORMATION DISCLOSURE STATEMENT BY APPLICANT</b> ( Not for submission under 37 CFR 1.99)	Application Number	14848191
	Filing Date	2015-09-08
	First Named Inventor	JAE LARK JUNG
	Art Unit	2646
	Examiner Name	SHEDRICK, CHARLES TERRELL
	Attorney Docket Number	UNIS005.001C2

NON-PATENT LITERATURE DOCUMENTS			Remove
Examiner Initials*	Cite No	Include name of the author (in CAPITAL LETTERS), title of the article (when appropriate), title of the item (book, magazine, journal, serial, symposium, catalog, etc), date, pages(s), volume-issue number(s), publisher, city and/or country where published.	T <sup>5</sup>
	1	DIETZ, "AuthenTec Unveils the World's Smallest Navigation and Fingerprint Matching Device for Mobile Phones", Business Wire, 2010 - 2 pageses	
	2	POCOVNICU, "Biometric Security for Cell Phones", Informatica Economică, 2009, Vol. 13, No. 1, pages 57 - 63	
	3	MALYKHINA, "Fujitsu Adds Mobile Phone With Fingerprint Sensor", InformationWeek, retrieved from <a href="http://www.informationweek.com/fujitsu-adds-mobile-phone-with-fingerprint-sensor/d/d-id/1064540?">http://www.informationweek.com/fujitsu-adds-mobile-phone-with-fingerprint-sensor/d/d-id/1064540?</a> on October 12, 2016	
	4	"LG Unveils Impressive Line of Smart, Feature-Rich Products at International CES 2010", PR Newswire, retrieved from <a href="http://www.prnewswire.com/news-releases/lg-unveils-impressive-line-of-smart-feature-rich-products-at-international-ces-2010-80803492.html">http://www.prnewswire.com/news-releases/lg-unveils-impressive-line-of-smart-feature-rich-products-at-international-ces-2010-80803492.html</a> on October 12, 2016	
	5	ANGULO et al., "Exploring Touch-Screen Biometrics for User Identification on Smart Phones", Privacy and Identity 2011, pages 130 - 143	
	6	YUAN et al., "User Authentication on Mobile Devices with Dynamical Selection of Biometric Techniques for Optimal Performance", Presentation Material of International Conference on Robotics and Biomimetics, 2010, pages 333 - 338	
	7	"Motorola Atrix 4G review", engadget, retrieved from <a href="https://www.engadget.com/motorola/atrx-4g-review/">https://www.engadget.com/motorola/atrx-4g-review/</a> on November 1, 2016	
	8	Office Action dated October 20, 2016 of corresponding Japanese Patent Application No. 2014-536982 and its English translation - 8 pages	×
	9	Office Action dated September 26, 2016 of corresponding Japanese Patent Application No. 2014-147884 and its English translation - 7 pages	☒



**INFORMATION DISCLOSURE  
STATEMENT BY APPLICANT**  
( Not for submission under 37 CFR 1.99)

Application Number	14848191
Filing Date	2015-09-08
First Named Inventor	JAE LARK JUNG
Art Unit	2646
Examiner Name	SHEDRICK, CHARLES TERRELL
Attorney Docket Number	UNIS005.001C2

10	"iPhone 4 Perfect Guide mini", Ascii Mediaworks K.K., August 29, 2010, pages 6-10, 12, 21, 23, 36, 44, 45, 55, 107, 110	<input type="checkbox"/>
11	First Office Action dated October 8, 2016 of corresponding Chinese Patent Application No. 201410377402.3 - 15 pages	<input checked="" type="checkbox"/>

If you wish to add additional non-patent literature document citation information please click the Add button

**EXAMINER SIGNATURE**

Examiner Signature		Date Considered	
--------------------	--	-----------------	--

\*EXAMINER: Initial if reference considered, whether or not citation is in conformance with MPEP 609. Draw line through a citation if not in conformance and not considered. Include copy of this form with next communication to applicant.

<sup>1</sup> See Kind Codes of USPTO Patent Documents at [www.USPTO.GOV](http://www.USPTO.GOV) or MPEP 901.04. <sup>2</sup> Enter office that issued the document, by the two-letter code (WIPO Standard ST.3). <sup>3</sup> For Japanese patent documents, the indication of the year of the reign of the Emperor must precede the serial number of the patent document. <sup>4</sup> Kind of document by the appropriate symbols as indicated on the document under WIPO Standard ST.16 if possible. <sup>5</sup> Applicant is to place a check mark here if English language translation is attached.

**INFORMATION DISCLOSURE  
STATEMENT BY APPLICANT**  
( Not for submission under 37 CFR 1.99)

Application Number	14848191
Filing Date	2015-09-08
First Named Inventor	JAE LARK JUNG
Art Unit	2646
Examiner Name	SHEDRICK, CHARLES TERRELL
Attorney Docket Number	UNIS005.001C2

**CERTIFICATION STATEMENT**

Please see 37 CFR 1.97 and 1.98 to make the appropriate selection(s):

That each item of information contained in the information disclosure statement was first cited in any communication from a foreign patent office in a counterpart foreign application not more than three months prior to the filing of the information disclosure statement. See 37 CFR 1.97(e)(1).

**OR**

That no item of information contained in the information disclosure statement was cited in a communication from a foreign patent office in a counterpart foreign application, and, to the knowledge of the person signing the certification after making reasonable inquiry, no item of information contained in the information disclosure statement was known to any individual designated in 37 CFR 1.56(c) more than three months prior to the filing of the information disclosure statement. See 37 CFR 1.97(e)(2).

See attached certification statement.

The fee set forth in 37 CFR 1.17 (p) has been submitted herewith.

A certification statement is not submitted herewith.

**SIGNATURE**

A signature of the applicant or representative is required in accordance with CFR 1.33, 10.18. Please see CFR 1.4(d) for the form of the signature.

Signature	/Mincheol Kim/	Date (YYYY-MM-DD)	2016-12-05
Name/Print	Mincheol Kim	Registration Number	51,306

This collection of information is required by 37 CFR 1.97 and 1.98. The information is required to obtain or retain a benefit by the public which is to file (and by the USPTO to process) an application. Confidentiality is governed by 35 U.S.C. 122 and 37 CFR 1.14. This collection is estimated to take 1 hour to complete, including gathering, preparing and submitting the completed application form to the USPTO. Time will vary depending upon the individual case. Any comments on the amount of time you require to complete this form and/or suggestions for reducing this burden, should be sent to the Chief Information Officer, U.S. Patent and Trademark Office, U.S. Department of Commerce, P.O. Box 1450, Alexandria, VA 22313-1450. **DO NOT SEND FEES OR COMPLETED FORMS TO THIS ADDRESS. SEND TO: Commissioner for Patents, P.O. Box 1450, Alexandria, VA 22313-1450.**

## Privacy Act Statement

The Privacy Act of 1974 (P.L. 93-579) requires that you be given certain information in connection with your submission of the attached form related to a patent application or patent. Accordingly, pursuant to the requirements of the Act, please be advised that: (1) the general authority for the collection of this information is 35 U.S.C. 2(b)(2); (2) furnishing of the information solicited is voluntary; and (3) the principal purpose for which the information is used by the U.S. Patent and Trademark Office is to process and/or examine your submission related to a patent application or patent. If you do not furnish the requested information, the U.S. Patent and Trademark Office may not be able to process and/or examine your submission, which may result in termination of proceedings or abandonment of the application or expiration of the patent.

The information provided by you in this form will be subject to the following routine uses:

1. The information on this form will be treated confidentially to the extent allowed under the Freedom of Information Act (5 U.S.C. 552) and the Privacy Act (5 U.S.C. 552a). Records from this system of records may be disclosed to the Department of Justice to determine whether the Freedom of Information Act requires disclosure of these records.
2. A record from this system of records may be disclosed, as a routine use, in the course of presenting evidence to a court, magistrate, or administrative tribunal, including disclosures to opposing counsel in the course of settlement negotiations.
3. A record in this system of records may be disclosed, as a routine use, to a Member of Congress submitting a request involving an individual, to whom the record pertains, when the individual has requested assistance from the Member with respect to the subject matter of the record.
4. A record in this system of records may be disclosed, as a routine use, to a contractor of the Agency having need for the information in order to perform a contract. Recipients of information shall be required to comply with the requirements of the Privacy Act of 1974, as amended, pursuant to 5 U.S.C. 552a(m).
5. A record related to an International Application filed under the Patent Cooperation Treaty in this system of records may be disclosed, as a routine use, to the International Bureau of the World Intellectual Property Organization, pursuant to the Patent Cooperation Treaty.
6. A record in this system of records may be disclosed, as a routine use, to another federal agency for purposes of National Security review (35 U.S.C. 181) and for review pursuant to the Atomic Energy Act (42 U.S.C. 218(c)).
7. A record from this system of records may be disclosed, as a routine use, to the Administrator, General Services, or his/her designee, during an inspection of records conducted by GSA as part of that agency's responsibility to recommend improvements in records management practices and programs, under authority of 44 U.S.C. 2904 and 2906. Such disclosure shall be made in accordance with the GSA regulations governing inspection of records for this purpose, and any other relevant (i.e., GSA or Commerce) directive. Such disclosure shall not be used to make determinations about individuals.
8. A record from this system of records may be disclosed, as a routine use, to the public after either publication of the application pursuant to 35 U.S.C. 122(b) or issuance of a patent pursuant to 35 U.S.C. 151. Further, a record may be disclosed, subject to the limitations of 37 CFR 1.14, as a routine use, to the public if the record was filed in an application which became abandoned or in which the proceedings were terminated and which application is referenced by either a published application, an application open to public inspections or an issued patent.
9. A record from this system of records may be disclosed, as a routine use, to a Federal, State, or local law enforcement agency, if the USPTO becomes aware of a violation or potential violation of law or regulation.



Espacenet

**Bibliographic data: JP2009212558 (A) — 2009-09-17**

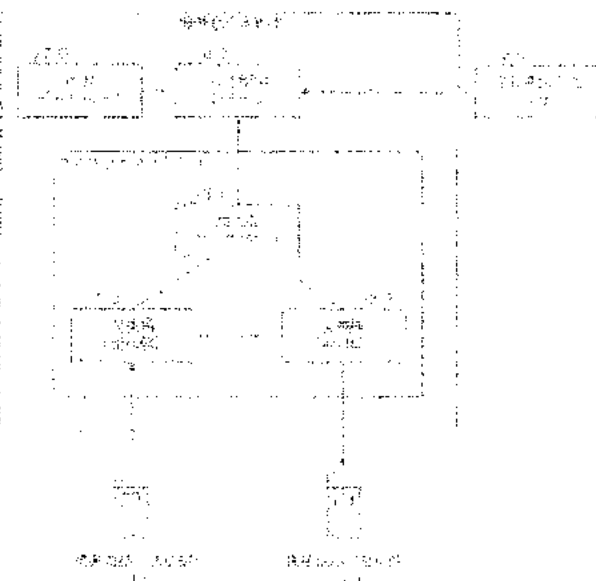
**VIDEO TELEPHONE ADVERTISEMENT SYSTEM, VIDEO TELEPHONE ADVERTISEMENT METHOD, EXCHANGE, AND PROGRAM FOR EXCHANGE**

**Inventor(s):** MATSUMORI TSUBASA ± (MATSUMORI TSUBASA)  
**Applicant(s):** NEC COMMUNICATION SYST ± (NEC COMMUN SYST LTD)  
**Classification:** - international: H04M11/00; H04N7/14; H04W4/02; H04W4/24  
 - cooperative:  
**Application number:** JP20080050509 20080229 [Global Dossier](#)  
**Priority number(s):** JP20080050509 20080229

**Abstract of JP2009212558 (A)**

**PROBLEM TO BE SOLVED:** To effectively utilize the signal sequence of existing call origination processing and to distribute advertisement information flexibly corresponding to the conditions of a call origination side and a call termination side, in a video telephone.

**SOLUTION:** A video telephone advertisement system comprises: a call origination telephone for transmitting a speech communication request including the telephone number of a call termination telephone and the identification information of the call origination telephone to a call origination exchange; the call origination exchange for acquiring advertisement contract information by retrieving a subscriber information storage means on the basis of the identification information, extracting advertisement information from an advertisement information storage means on the basis of the advertisement contract information, transmitting the speech communication request to a call termination exchange, and



transmitting the advertisement information to the call origination telephone including it in a calling start signal when the calling start signal is received from the call termination exchange; the call termination exchange for receiving the speech communication request, acquiring the advertisement contract information by retrieving the subscriber information storage means on the basis of the telephone number, extracting the corresponding advertisement information from the advertisement information storage means on the basis of the advertisement contract information, and transmitting the advertisement information to the call termination telephone including such information in the speech communication request; and the call termination telephone for transmitting calling start information to the call origination exchange when the speech communication request is received. ;COPYRIGHT: (C)2009, JPO&INPIT

(19) 日本国特許庁 (JP)

(12) 公開特許公報 (A)

(11) 特許出願公開番号

特開2009-212558

(P2009-212558A)

(43) 公開日 平成21年9月17日 (2009.9.17)

(51) Int. Cl.	F I	テーマコード (参考)
HO4M 11/00 (2006.01)	HO4M 11/00 302	5C164
HO4N 7/14 (2006.01)	HO4N 7/14	5K067
HO4W 4/02 (2009.01)	HO4Q 7/00 102	5K201
HO4W 4/24 (2009.01)	HO4Q 7/00 136	

審査請求 未請求 請求項の数 26 O L (全 18 頁)

(21) 出願番号 特願2008-50509 (P2008-50509)  
 (22) 出願日 平成20年2月29日 (2008.2.29)

(71) 出願人 000232254  
 日本電気通信システム株式会社  
 東京都港区三田1丁目4番28号  
 (74) 代理人 100086759  
 弁理士 渡辺 喜平  
 (72) 発明者 松森 翼  
 東京都港区三田一丁目4番28号 日本電  
 気通信システム株式会社内  
 Fターム (参考) 5C164 FA09 FA25 MA05P VA03P VA07P  
 VA21P VA36P  
 5K067 A441 B804 D017 D027 D029  
 D052 D053 D054 D057 EE02  
 EE10 EE16 EE23 FF03 FF05  
 FF23 FF25 FF27 JJ56

最終頁に続く

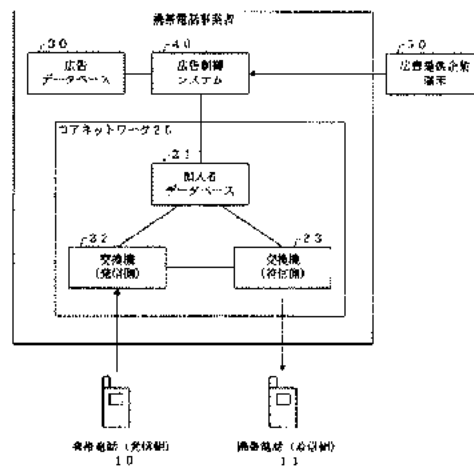
(54) 【発明の名称】 テレビ電話広告システム、テレビ電話広告方法、交換機、及び交換機用プログラム

(57) 【要約】

【課題】 テレビ電話において、既存の発信処理の信号シーケンスを有効に活用し、発信側及び着信側の条件に応じた柔軟な広告情報の配信を実現する。

【解決手段】 着信電話の電話番号と発信電話の識別情報を含む通話要求を発信交換機に送信する発信電話と、識別情報にもとづき加入者情報記憶手段を検索して広告契約情報を取得し、これにもとづき広告情報記憶手段から広告情報を抽出し、通話要求を着信交換機に送信し、着信交換機から呼び出し開始信号を受信すると広告情報を呼び出し開始信号に含め発信電話に送信する発信交換機と、通話要求を受信し、電話番号にもとづき加入者情報記憶手段を検索して広告契約情報を取得し、これにもとづき広告情報記憶手段から対応する広告情報を抽出し、これを通話要求に含めて着信電話に送信する着信交換機と、通話要求を受信すると、呼び出し開始情報を発信交換機に送信する着信電話を有するシステム。

【選択図】 図1



## 【特許請求の範囲】

## 【請求項1】

テレビ電話機能を備えた電話機に広告情報を配信するテレビ電話広告システムであって

加入者識別情報及び広告契約情報を含む加入者情報を格納する加入者情報記憶手段と、  
広告情報を格納する広告情報記憶手段と、

着信側電話機の電話番号と発信側電話機の加入者識別情報を含む通話確立要求信号を発信側交換機に送信する発信側電話機と、

前記発信側電話機の加入者識別情報にもとづき前記加入者情報記憶手段を検索して、対応する広告契約情報を取得し、この広告契約情報にもとづき前記広告情報記憶手段から対応する広告情報を抽出し、前記着信側電話機の電話番号を含む通話確立要求信号を着信側交換機に送信するとともに、前記着信側交換機から呼び出し開始信号を受信すると、前記抽出した広告情報を前記呼び出し開始信号に含めて前記発信側電話機に送信する発信側交換機と、

前記通話確立要求信号を受信すると、前記着信側電話機の電話番号にもとづき前記加入者情報記憶手段を検索して、対応する広告契約情報を取得し、この広告契約情報にもとづき広告情報記憶手段から対応する広告情報を抽出して、この広告情報を通話確立要求信号に含めて着信側電話機に送信する着信側交換機と、

前記広告情報を含む通話確立要求信号を受信すると、前記呼び出し開始情報を前記着信側交換機を介して前記発信側交換機に送信する着信側電話機と、を有する

ことを特徴とするテレビ電話広告システム。

## 【請求項2】

前記着信側電話機から通話開始信号が前記着信側交換機及び前記発信側交換機を介して前記発信側電話機に送信され、前記発信側電話機から通話開始信号に対する応答信号が前記発信側交換機及び前記着信側交換機を介して前記着信側電話機に送信されて、前記発信側電話機と前記着信側電話機との通話が確立したタイミングで、

前記着信側電話機が、前記着信側交換機から受信した前記通話確立要求信号に含まれる広告情報を出力し、

前記発信側電話機が、前記発信側交換機から受信した前記呼び出し開始信号に含まれる広告情報を出力する

ことを特徴とする請求項1記載のテレビ電話広告システム。

## 【請求項3】

前記着信側電話機が、前記着信側交換機から前記通話確立要求信号を受信したタイミングで、当該通話確立要求信号に含まれる広告情報を出力し、

前記発信側電話機が、前記発信側交換機から前記呼び出し開始信号を受信したタイミングで、当該呼び出し開始信号に含まれる広告情報を出力する

ことを特徴とする請求項1記載のテレビ電話広告システム。

## 【請求項4】

前記着信側交換機が、前記発信側交換機から前記着信側電話機の電話番号と発信側電話機の加入者識別情報を含む通話確立要求信号を受信し、前記着信側電話機の電話番号に代えて、前記発信側電話機の加入者識別情報にもとづき前記加入者情報記憶手段を検索して、対応する広告契約情報を取得し、この広告契約情報にもとづき前記広告情報記憶手段から対応する広告情報を抽出して、この広告情報を通話確立要求信号に含めて着信側電話機に送信する

ことを特徴とする請求項1～3のいずれかに記載のテレビ電話広告システム。

## 【請求項5】

前記発信側交換機が、前記発信側電話機の位置情報を取得して、この位置情報と、前記加入者情報記憶手段から取得した前記広告契約情報にもとづき前記広告情報記憶手段から対応する広告情報を抽出し、及び/又は、前記着信側交換機が、前記着信側電話機の位置

情報を取得して、この位置情報と、前記加入者情報記憶手段から取得した前記広告契約情報にもとづき前記広告情報記憶手段から対応する広告情報を抽出する

ことを特徴とする請求項1～4のいずれかに記載のテレビ電話広告システム。

【請求項6】

前記発信側電話機がGPS機能を備え、通話確立要求信号に当該発信側電話機の位置情報を含めて前記発信側交換機に送信し、

前記発信側交換機が、送信されてきた前記位置情報と、前記加入者情報記憶手段から取得した前記広告契約情報にもとづき前記広告情報記憶手段から対応する広告情報を抽出する

ことを特徴とする請求項1～4のいずれかに記載のテレビ電話広告システム。

【請求項7】

前記発信側交換機が、前記発信側電話機及び前記着信側電話機の通話時間、又は前記発信側電話機に広告情報を送信した時刻から通話が終了した時刻までの時間を広告再生時間として前記加入者情報記憶手段に登録する

ことを特徴とする請求項1～6のいずれかに記載のテレビ電話広告システム。

【請求項8】

前記発信側交換機及び前記着信側交換機による前記広告情報記憶手段からの広告情報の抽出が、一の広告制御手段により行われる

ことを特徴とする請求項1～7のいずれかに記載のテレビ電話広告システム。

【請求項9】

前記広告制御手段が、前記広告情報の抽出にあたり、前記広告契約情報に含まれる広告契約形態が企業指定を示す場合は、前記広告契約情報に含まれる広告提供企業を選択し、前記広告契約情報に含まれる広告契約形態が条件指定又は指定なしを示す場合は、前記広告情報記憶手段に登録されている候補企業の中からランダムに一の企業を選択し、この選択された企業に対応する広告情報のリストを前記広告情報記憶手段から取得し、最も優先順位が高い広告情報から順に配信条件が含まれるか否かを確認し、含まれる場合には、前記加入者情報が配信条件を満たすか否かを判定し、配信条件のない広告情報又は配信条件を満たす広告情報が検出された場合に、当該広告情報を抽出対象として決定する

ことを特徴とする請求項8記載のテレビ電話広告システム。

【請求項10】

前記着信側交換機が、前記発信側交換機から前記着信側電話機の電話番号を含む通話確立要求信号を受信したときに、前記着信側電話機の電話番号にもとづき前記加入者情報記憶手段を検索して、対応する広告契約情報に着信時の広告表示拒否情報が登録されているかどうかを判定し、登録されている場合は、前記広告情報記憶手段から対応する広告情報を抽出することなく、広告情報を含まない通話確立要求信号を着信側電話機に送信する

ことを特徴とする請求項1～9のいずれかに記載のテレビ電話広告システム。

【請求項11】

前記広告情報が文字広告情報であることを特徴とする請求項1～10のいずれかに記載のテレビ電話広告システム。

【請求項12】

テレビ電話機能を備えた電話機に広告情報を配信するテレビ電話広告方法であって、発信側電話機が、着信側電話機の電話番号と発信側電話機の加入者識別情報を含む通話確立要求信号を発信側交換機に送信し、

前記発信側交換機が、前記発信側電話機の加入者識別情報にもとづき加入者情報記憶手段を検索して、対応する広告契約情報を取得し、この広告契約情報にもとづき広告情報記憶手段から対応する広告情報を抽出し、前記着信側電話機の電話番号を含む通話確立要求信号を着信側交換機に送信し、

前記着信側交換機が、前記通話確立要求信号を受信すると、前記着信側電話機の電話番号にもとづき前記加入者情報記憶手段を検索して、対応する広告契約情報を取得し、この広告契約情報にもとづき広告情報記憶手段から対応する広告情報を抽出して、この広告情



報を前記通話確立要求信号に含めて着信側電話機に送信し、

前記着信側電話機が、前記通話確立要求信号を受信すると、前記呼び出し開始情報を、前記着信側交換機を介して前記発信側交換機に送信し、

前記発信側交換機が、前記呼び出し開始信号を受信すると、抽出した前記広告情報を前記呼び出し開始信号に含めて前記発信側電話機に送信する

ことを特徴とするテレビ電話広告方法。

【請求項13】

前記着信側電話機から通話開始信号が前記着信側交換機及び前記発信側交換機を介して前記発信側電話機に送信され、前記発信側電話機から通話開始信号に対する応答信号が前記発信側交換機及び前記着信側交換機を介して前記着信側電話機に送信されて、前記発信側電話機と前記着信側電話機との通話が確立したタイミングで、

前記着信側電話機が、前記着信側交換機から受信した前記通話確立要求信号に含まれる広告情報を出力し、

前記発信側電話機が、前記発信側交換機から受信した前記呼び出し開始信号に含まれる広告情報を出力する

ことを特徴とする請求項12記載のテレビ電話広告方法。

【請求項14】

前記着信側電話機が、前記着信側交換機から前記通話確立要求信号を受信したタイミングで、当該通話確立要求信号に含まれる広告情報を出力し、

前記発信側電話機が、前記発信側交換機から前記呼び出し開始信号を受信したタイミングで、当該呼び出し開始信号に含まれる広告情報を出力する

ことを特徴とする請求項12記載のテレビ電話広告方法。

【請求項15】

テレビ電話機能を備えた電話機に広告情報を配信するテレビ電話広告システムにおける発信側交換機であって、

発信側電話機から着信側電話機の電話番号と発信側電話機の加入者識別情報を含む通話確立要求信号を受信し、この加入者識別情報にもとづき加入者情報記憶手段を検索して、対応する広告契約情報を取得し、この広告契約情報にもとづき広告情報記憶手段から対応する広告情報を抽出し、前記着信側電話機の電話番号を含む通話確立要求信号を着信側交換機に送信するとともに、前記着信側交換機から呼び出し開始信号を受信すると、前記抽出した広告情報を前記呼び出し開始信号に含めて前記発信側電話機に送信する

ことを特徴とする発信側交換機。

【請求項16】

前記発信側電話機の位置情報を取得して、この位置情報と、前記加入者情報記憶手段から取得した前記広告契約情報にもとづき前記広告情報記憶手段から対応する広告情報を抽出する

ことを特徴とする請求項15記載の発信側交換機。

【請求項17】

テレビ電話機能を備えた電話機に広告情報を配信するテレビ電話広告システムにおける着信側交換機であって、

着信側電話機の電話番号を含む通話確立要求信号を発信側電話機から発信側交換機を介して受信すると、前記着信側電話機の電話番号にもとづき加入者情報記憶手段を検索して、対応する広告契約情報を取得し、この広告契約情報にもとづき広告情報記憶手段から対応する広告情報を抽出して、この広告情報を前記通話確立要求信号に含めて着信側電話機に送信する

ことを特徴とする着信側交換機。

【請求項18】

前記発信側交換機から前記着信側電話機の電話番号と発信側電話機の加入者識別情報を含む通話確立要求信号を受信すると、前記着信側電話機の電話番号に代えて、前記発信側電話機の加入者識別情報にもとづき前記加入者情報記憶手段を検索して、対応する広告契

約情報を取得し、この広告契約情報にもとづき広告情報記憶手段から対応する広告情報を抽出して、この広告情報を通話確立要求信号に含めて着信側電話機に送信する

ことを特徴とする請求項17記載の着信側交換機。

【請求項19】

前記着信側電話機の位置情報を取得して、この位置情報と、前記加入者情報記憶手段から取得した前記広告契約情報にもとづき前記広告情報記憶手段から対応する広告情報を抽出する

ことを特徴とする請求項17又は18記載の着信側交換機。

【請求項20】

前記発信側交換機から前記着信側電話機の電話番号を含む通話確立要求信号を受信すると、前記着信側電話機の電話番号にもとづき前記加入者情報記憶手段を検索して、対応する広告契約情報に着信時の広告表示拒否情報が登録されているかどうかを判定し、登録されている場合は、広告情報記憶手段から対応する広告情報を抽出することなく、広告情報を含まない通話確立要求信号を着信側電話機に送信する

ことを特徴とする請求項17～19のいずれかに記載の着信側交換機。

【請求項21】

テレビ電話機能を備えた電話機に広告情報を配信するテレビ電話広告システムにおける発信側交換機により実行される発信側交換機用プログラムであって、

前記発信側交換機に、

発信側電話機から着信側電話機の電話番号と発信側電話機の加入者識別情報を含む通話確立要求信号を受信させ、この加入者識別情報にもとづき加入者情報記憶手段を検索させて、対応する広告契約情報を取得させ、この広告契約情報にもとづき広告情報記憶手段から対応する広告情報を抽出させ、前記着信側電話機の電話番号を含む通話確立要求信号を着信側交換機に送信させるとともに、前記着信側交換機から呼び出し開始信号が送信されてくると、前記抽出させた広告情報を前記呼び出し開始信号に含めて前記発信側電話機へ送信させる

ことを実行させるための発信側交換機用プログラム。

【請求項22】

前記発信側交換機に、

前記発信側電話機の位置情報を取得させて、この位置情報と、前記加入者情報記憶手段から取得させた前記広告契約情報にもとづき前記広告情報記憶手段から対応する広告情報を抽出させる

ことを実行させるための請求項21記載の発信側交換機用プログラム。

【請求項23】

テレビ電話機能を備えた電話機に広告情報を配信するテレビ電話広告システムにおける着信側交換機により実行される着信側交換機用プログラムであって、

前記着信側交換機に、

着信側電話機の電話番号を含む通話確立要求信号が発信側電話機から発信側交換機を介して送信されてくると、前記着信側電話機の電話番号にもとづき加入者情報記憶手段を検索させて、対応する広告契約情報を取得させ、この広告契約情報にもとづき広告情報記憶手段から対応する広告情報を抽出させて、この広告情報を通話確立要求信号に含めて着信側電話機に送信させる

ことを実行させるための着信側交換機用プログラム。

【請求項24】

前記着信側交換機に、

前記発信側交換機から前記着信側電話機の電話番号と発信側電話機の加入者識別情報を含む通話確立要求信号が送信されてきたときに、前記着信側電話機の電話番号に代えて、前記発信側電話機の加入者識別情報にもとづき前記加入者情報記憶手段を検索させて、対応する広告契約情報を取得させ、この広告契約情報にもとづき広告情報記憶手段から対応する広告情報を抽出させて、着信側電話機に送信させる

ことを実行させるための請求項23記載の着信側交換機用プログラム。

【請求項25】

前記着信側交換機に、

前記着信側電話機の位置情報を取得させて、この位置情報と、前記加入者情報記憶手段から取得させた前記広告契約情報にもとづき前記広告情報記憶手段から対応する広告情報を抽出させる

ことを実行させるための請求項23又は24記載の着信側交換機用プログラム。

【請求項26】

前記着信側交換機に、

前記発信側交換機から前記着信側電話機の電話番号を含む通話確立要求信号が送信されてきたときに、前記着信側電話機の電話番号にもとづき前記加入者情報記憶手段を検索させて、対応する広告契約情報に着信時の広告表示拒否情報が登録されているかどうかを判定させ、登録されている場合は、広告情報記憶手段から対応する広告情報を抽出させることなく、広告情報を含まない通話確立要求信号を着信側電話機に送信させる

ことを実行させるための請求項23～25のいずれかに記載の着信側交換機用プログラ

【発明の詳細な説明】

【技術分野】

【0001】

本発明は、携帯電話機などにおけるテレビ電話機能を利用して、広告の配信を行うテレビ電話広告システム、テレビ電話広告方法、交換機、及び交換機用プログラムに関する。

【背景技術】

【0002】

近年、携帯電話機の多機能化が進展しており、テレビ電話機能を備えた携帯電話機も普及しつつある。

しかしながら、テレビ電話の通話料金は音声通話の料金と比較して高額であり、十分に使用されるには至っていないのが現状である。

【0003】

そこで、このような問題を解決すべく、従来から様々な提案が行われている。例えば、特許文献1には、電話の呼び出し中に、テレビ電話の映像表示部を利用して広告情報などを配信し、その表示頻度に応じて通話料金の割引を行う技術が記載されている。

【0004】

また、特許文献2にも、同様に、テレビ電話の発呼処理中に発信者側のテレビ電話に広告情報などを表示させる技術が記載されている。

さらに、特許文献3には、発信側のみならず、着信側のテレビ電話にも、発信側と同じ広告情報などを、相手側のTV画像と合成して表示させる技術が記載されている。

これらの技術を用いることで、テレビ電話での呼び出し中や通話中に、テレビ画面に広告情報を表示させ、その広告時間などに応じて、通話料金の割引を行うことが可能となっている。

【0005】

【特許文献1】特開2002-165008号公報

【特許文献2】特開2005-033442号公報

【特許文献3】特開2006-129394号公報

【発明の開示】

【発明が解決しようとする課題】

【0006】

しかしながら、これらの従来技術では、広告情報などをテレビ電話に表示させるために、広告情報をテレビ電話機に送信するための特別な処理が必要であり、既存のテレビ電話発信処理における信号シーケンスに与える影響が大きいという問題があった。

すなわち、このような従来技術によりテレビ電話に広告を表示させる場合は、既存のテレビ電話発信処理の手順を大きく変更しなければならないという問題があった。

## 【0007】

一方で、広告配信を行うにあたっては、発信側のみならず、着信側でも独自に広告配信を行えることが好ましく、その配信タイミングは最も効率的であることが望ましい。

さらに、利用者の位置や、そのときの状況に応じた柔軟な広告配信を行うことができれば、広告の利用効果が向上し、利用者の通話料金を低減できることに加え、一層の広告効果を期待することも可能となる。

## 【0008】

本発明は、上記の事情にかんがみなされたものであり、既存のテレビ電話発信処理における信号シーケンスに与える影響を最小限にとどめつつ効果的な広告配信を行うことで、テレビ電話の通話料金を低減させ、その利用率の向上を図ることの可能なテレビ電話広告システム、テレビ電話広告方法、交換機、及び交換機用プログラムの提供を目的とする。

## 【課題を解決するための手段】

## 【0009】

上記目的を達成するため、本発明のテレビ電話広告システムは、テレビ電話機能を備えた電話機に広告情報を配信するテレビ電話広告システムであって、加入者識別情報及び広告契約情報を含む加入者情報を格納する加入者情報記憶手段と、広告情報を格納する広告情報記憶手段と、着信側電話機の電話番号と発信側電話機の加入者識別情報を含む通話確立要求信号を発信側交換機に送信する発信側電話機と、発信側電話機の加入者識別情報にもとづき加入者情報記憶手段を検索して、対応する広告契約情報を取得し、この広告契約情報にもとづき広告情報記憶手段から対応する広告情報を抽出し、着信側電話機の電話番号を含む通話確立要求信号を着信側交換機に送信するとともに、着信側交換機から呼び出し開始信号を受信すると、抽出した広告情報を呼び出し開始信号に含めて発信側電話機に送信する発信側交換機と、通話確立要求信号を受信すると、着信側電話機の電話番号にもとづき加入者情報記憶手段を検索して、対応する広告契約情報を取得し、この広告契約情報にもとづき広告情報記憶手段から対応する広告情報を抽出して、この広告情報を通話確立要求信号に含めて着信側電話機に送信する着信側交換機と、広告情報を含む通話確立要求信号を受信すると、呼び出し開始情報を着信側交換機を介して発信側交換機に送信する着信側電話機とを有する構成としてある。

## 【0010】

また、本発明のテレビ電話広告方法は、テレビ電話機能を備えた電話機に広告情報を配信するテレビ電話広告方法であって、発信側電話機が、着信側電話機の電話番号と発信側電話機の加入者識別情報を含む通話確立要求信号を発信側交換機に送信し、発信側交換機が、発信側電話機の加入者識別情報にもとづき加入者情報記憶手段を検索して、対応する広告契約情報を取得し、この広告契約情報にもとづき広告情報記憶手段から対応する広告情報を抽出し、着信側電話機の電話番号を含む通話確立要求信号を着信側交換機に送信し、着信側交換機が、通話確立要求信号を受信すると、着信側電話機の電話番号にもとづき加入者情報記憶手段を検索して、対応する広告契約情報を取得し、この広告契約情報にもとづき広告情報記憶手段から対応する広告情報を抽出して、この広告情報を通話確立要求信号に含めて着信側電話機に送信し、着信側電話機が、通話確立要求信号を受信すると、呼び出し開始情報を、着信側交換機を介して発信側交換機に送信し、発信側交換機が、呼び出し開始信号を受信すると、抽出した広告情報を呼び出し開始信号に含めて発信側電話機に送信する方法としてある。

## 【0011】

また、本発明の発信側交換機は、テレビ電話機能を備えた電話機に広告情報を配信するテレビ電話広告システムにおける発信側交換機であって、発信側電話機から着信側電話機の電話番号と発信側電話機の加入者識別情報を含む通話確立要求信号を受信し、この加入者識別情報にもとづき加入者情報記憶手段を検索して、対応する広告契約情報を取得し、この広告契約情報にもとづき広告情報記憶手段から対応する広告情報を抽出し、着信側電話機の電話番号を含む通話確立要求信号を着信側交換機に送信するとともに、着信側交換機から呼び出し開始信号を受信すると、抽出した広告情報を呼び出し開始信号に含めて発

信側電話機に送信する構成としてある。

【0012】

また、本発明の着信側交換機は、テレビ電話機能を備えた電話機に広告情報を配信するテレビ電話広告システムにおける着信側交換機であって、着信側電話機の電話番号を含む通話確立要求信号を発信側電話機から発信側交換機を介して受信すると、着信側電話機の電話番号にもとづき加入者情報記憶手段を検索して、対応する広告契約情報を取得し、この広告契約情報にもとづき広告情報記憶手段から対応する広告情報を抽出して、この広告情報を通話確立要求信号に含めて着信側電話機に送信する構成としてある。

【0013】

また、本発明の発信側交換機用プログラムは、テレビ電話機能を備えた電話機に広告情報を配信するテレビ電話広告システムにおける発信側交換機により実行される発信側交換機用プログラムであって、発信側交換機に、発信側電話機から着信側電話機の電話番号と発信側電話機の加入者識別情報を含む通話確立要求信号を受信させ、この加入者識別情報にもとづき加入者情報記憶手段を検索させて、対応する広告契約情報を取得させ、この広告契約情報にもとづき広告情報記憶手段から対応する広告情報を抽出させ、着信側電話機の電話番号を含む通話確立要求信号を着信側交換機に送信させるとともに、着信側交換機から呼び出し開始信号が送信されてくると、抽出させた広告情報を呼び出し開始信号に含めて発信側電話機へ送信させる構成としてある。

【0014】

また、本発明の着信側交換機用プログラムは、テレビ電話機能を備えた電話機に広告情報を配信するテレビ電話広告システムにおける着信側交換機により実行される着信側交換機用プログラムであって、着信側交換機に、着信側電話機の電話番号を含む通話確立要求信号が発信側電話機から発信側交換機を介して送信されてくると、着信側電話機の電話番号にもとづき加入者情報記憶手段を検索させて、対応する広告契約情報を取得させ、この広告契約情報にもとづき広告情報記憶手段から対応する広告情報を抽出させて、この広告情報を通話確立要求信号に含めて着信側電話機に送信させる構成としてある。

【発明の効果】

【0015】

本発明によれば、既存のテレビ電話発信処理における信号シーケンスを利用して、広告配信を効率的なタイミングで行うことができ、発信側及び着信側の条件に応じた柔軟な広告情報の配信を行うことが可能である。

【発明を実施するための最良の形態】

【0016】

はじめに、本発明の概要について説明する。

本発明は、携帯電話の利用者が、広告提供企業と広告受信契約を締結し、テレビ電話の使用時に発信側と着信側双方の携帯電話の画面上に文字広告を表示させ、その対面として通話料金の一部を広告提供企業が負担することで、携帯電話の利用者の負担額の軽減を実現するものである。

【0017】

すなわち、広告契約を希望する携帯電話の利用者は、携帯電話のブラウザ機能を利用して、広告の提供を希望する企業とスポンサー契約を結ぶ、利用者がテレビ電話を使用すると、テレビ電話画面に文字広告がスクロール表示される。広告提供企業は広告費として、広告受信契約を締結した利用者の携帯電話使用料金の一部を負担する。負担金額は、広告表示時間、すなわちテレビ電話の通話時間にもとづき算出することができる。勿論、携帯電話事業者によるテレビ電話広告システムの運用に応じて、広告提供企業の負担金額を一定額や一定割合とすることも可能である。

【0018】

以下、本発明に係るテレビ電話広告システムの好ましい実施形態について、図面を参照しつつ説明する。

なお、以下の実施形態に示す本発明のテレビ電話広告システムは、プログラムに制御さ

れたコンピュータにより動作するようになっている。コンピュータのCPUは、プログラムにもとづいてコンピュータの各構成要素に指令を送り、交換機等の動作に必要となる所定の処理、例えば、広告契約確認処理、配信広告決定処理、広告表示拒否確認処理等を行わせる。このように、本発明のテレビ電話広告システムにおける各処理、動作は、プログラムとコンピュータとが協働した具体的手段により実現できるものである。

【0019】

プログラムは予めROM、RAM等の記録媒体に格納され、コンピュータに実装された記録媒体から当該コンピュータにプログラムを読み込ませて実行されるが、例えば通信回線を介してコンピュータに読み込ませることもできる。

また、プログラムを格納する記録媒体は、例えば半導体メモリ、磁気ディスク、光ディスク、その他任意のコンピュータで読取り可能な任意の記録手段により構成できる。

【0020】

まず、本発明の一実施形態の構成について、図1を参照して説明する。同図は、本実施形態のテレビ電話広告システムの構成を示すブロック図である。

図1に示すように、本実施形態のテレビ電話広告システムは、発信側携帯電話10、着信側携帯電話11、コアネットワーク20、加入者データベース21、発信側交換機22、着信側交換機23、広告データベース30、広告制御システム40、及び広告提供企業端末50を有している。

【0021】

発信側携帯電話10は、発信側の利用者が使用する携帯電話機であり、着信側携帯電話11は、着信側の利用者が使用する携帯電話機である。これらとしては、既存の一般的なテレビ電話機能を備えた携帯電話機を使用することができる。なお、これらの携帯電話として、テレビ電話機能を備えたPHSやモバイルコンピュータなどを用いることも可能である。

【0022】

コアネットワーク20とは、携帯電話事業者におけるテレビ電話システムにおける基本ネットワークであり、その内部に加入者データベース21と、発信側交換機22及び着信側交換機23を備えている。なお、図1では交換機として2台のみを示しているが、3台以上の交換機により構成することも可能である。

【0023】

加入者データベース21は、携帯電話事業者により提供される携帯電話サービスの加入者に関する情報を蓄積する。この情報としては、例えば電話番号などの加入者識別情報、加入者名、加入者の住所などの加入者の個人情報や、累積通話料金などの他、広告契約の有無、広告契約の形態、広告配信条件、広告提供企業などの広告契約に関する情報、着信時の広告表示拒否情報、累積広告表示時間等を格納する。

【0024】

発信側交換機22は、発信側の交換局における交換機であり、発信側携帯電話10から着信側携帯電話11宛のデータを受信して、これを着信側交換機23へ送信する。また、着信側交換機23から発信側携帯電話10宛のデータを受信して、これを発信側携帯電話10へ送信する。

また、これらの交換機は、加入者データベース21にアクセスして携帯電話に対応する広告契約情報を確認するとともに、広告制御システム40により、配信広告の決定や、広告データベース30からの広告情報の取得、携帯電話への配信等の処理を実行する。

【0025】

広告データベース30は、文字広告データなどの広告情報を蓄積する記憶装置である。この広告情報は、広告提供企業端末50により広告制御システム40に送信され、広告制御システム40により広告データベース30に登録することができる。本実施形態のテレビ電話広告システムにおいて、広告提供企業端末50を二以上保有させることも勿論可能である。

【0026】

広告情報としては、常時配信可能な広告（以下、一般広告と称する）のほか、地域や時間を限定して配信する広告（以下、条件付広告と称する）がある。これらは、広告データベース30にそれぞれ複数登録することが可能である。

複数の広告を登録する場合は、配信の優先順位も合わせて登録する。なお、配信条件を満たす条件付広告がない場合のために、広告提供企業端末50は少なくとも一の一般広告を登録することが好ましい。

【0027】

広告制御システム40は、広告提供企業端末50から送信されてきた広告情報を広告データベース30に登録する処理を行う。

また、広告制御システム40は、広告提供企業と携帯電話加入者との広告配信契約処理を扱う。具体的には、広告制御システム40は、広告契約の有無、広告契約の形態などの広告契約に関する情報を加入者データベース21に格納する。

さらに、着信時の広告表示拒否情報、累積広告表示時間等も加入者データベース21に格納することができる。

【0028】

広告提供企業端末50は、インターネットなどの通信回線を介して、広告制御システム40にアクセスし、この広告制御システム40により広告データベース30に対して、広告の登録や削除、広告内容の更新、配信条件の変更などを行う。

【0029】

次に、本実施形態のテレビ電話広告システムにおける広告契約時の処理手順について、図2を参照して説明する。

同図は、本実施形態のテレビ電話広告システムにおける広告契約時の処理手順を示すフローチャートである。

【0030】

まず、広告契約を希望する利用者の操作により、発信側携帯電話10は、コアネットワーク20を介して広告制御システム40にアクセスし、広告契約形態を選択するための画面を表示する。

そして、発信側携帯電話10は、利用者の操作により、広告契約形態を選択する（ステップS101）。本実施形態の広告契約形態には、図2に示すように、「条件指定」、「企業指定」、「指定なし」の3種類がある。

【0031】

広告契約形態として「条件指定」が選択された場合、発信側携帯電話10は、指定可能な広告配信条件のリストを取得し（ステップS102）、業種などの配信条件を選択する（ステップS103）。

広告契約形態として「企業指定」が選択された場合、発信側携帯電話10は、広告契約可能な企業のリストを取得し（ステップS104）、契約する企業を選択する（ステップS105）。

【0032】

このとき、広告制御システム40は、予めコアネットワーク20において登録されている広告配信条件リストや、契約可能企業リストを用いて上記の処理を実行する。また、ステップS102、S104において、広告制御システム40が広告データベース30からそれぞれ広告配信条件、広告提供企業の情報を抽出して、各々のリストを作成することもできる。

【0033】

ステップS103、ステップS105において選択処理が完了し、又はステップS101で「指定なし」が選択されると、これらの選択情報は発信側携帯電話10からコアネットワーク20を介して広告制御システム40へ送信され、広告契約処理が完了して、加入者データベース21内の加入者情報に当該広告契約情報が保存される。

【0034】

なお、広告制御システム40は、着信側携帯電話11についても、上述の発信側携帯電

話10と同様に広告契約処理を行うことができる。

また、着信側携帯電話11への広告の表示については、発信側携帯電話10の利用者及び着信側携帯電話11の利用者が広告配信契約をしている場合にのみ行うようにすることができる。

【0035】

さらに、発信側携帯電話10の利用者のみが広告配信契約している場合に、発信側携帯電話10及び着信側携帯電話11に広告を表示させることもできる。

勿論、発信側携帯電話10の利用者のみが広告配信契約している場合に、発信側携帯電話10にのみ広告を表示させることも可能である。

また、着信側携帯電話11の利用者のみが広告配信契約している場合に、着信側携帯電話11にのみ広告を表示させ、かつ、発信側携帯電話10の利用料金について、広告提供企業が広告表示に対応する料金を負担することも可能である。

【0036】

次に、図3を参照して、通話開始時及び通話中における各装置間の信号の流れについて説明する。同図は、本実施形態のテレビ電話広告システムにおける通話開始時及び通話中の信号シーケンス図である。

まず、発信側携帯電話10から着信側携帯電話11に対し、テレビ電話の発呼が行われる(ステップS201)。同図において、「SETUP」は、通話確立要求信号を示している。この通話確立要求信号には、着信側携帯電話11の電話番号のほか、例えば発信側携帯電話10の電話番号等などの発信側携帯電話10の利用者を識別可能な情報(加入者識別情報)が含まれる。

【0037】

発信側交換機22は、発信側携帯電話10から通話確立要求信号を受信すると、加入者識別情報にもとづき加入者データベース21を参照し、当該発信側携帯電話10に対応する広告契約情報を取得する(ステップS202)。

そして、取得した広告契約情報に、広告契約有りを示す広告契約情報が登録されている場合、発信側交換機22は、この広告契約情報を含む通話確立要求信号を着信側交換局23に送信する(ステップS203)。

【0038】

また、これと同時に、発信側交換機22は、広告制御システム40により広告データベース30から発信側携帯電話10に配信する広告情報を取得する(ステップS204)。このとき、広告制御システム40は、発信側携帯電話10の利用者に応じた広告情報を広告データベース30から取得する。この広告情報の取得方法については、図5を用いて後述する。

【0039】

着信側交換局23は、通話確立要求信号(S203のSETUP)を受信すると、着信側携帯電話11の電話番号等にもとづき加入者データベース21を参照し、着信側携帯電話11についての「着信時の広告表示拒否情報」が登録されていないかを確認する(ステップS205)。

【0040】

そして、加入者データベース21に、着信側携帯電話11に対応する「着信時の広告表示拒否情報」が登録されていない場合、着信側交換局23は、広告制御システム40により広告データベース30から着信側携帯電話11に配信するための広告情報を取得する(ステップS206)。

【0041】

このとき、広告制御システム40は、着信側携帯電話11の電話番号に対応する加入者情報にもとづき加入者データベース21を参照し、対応する広告契約に関する情報にもとづき広告データベース30から広告情報を取得して、着信側携帯電話11に配信することができる。

【0042】



また、広告制御システム40は、発信側携帯電話10の電話番号に対応する加入者情報にもとづき加入者データベース21を参照し、対応する広告契約に関する情報にもとづき広告データベース30から広告情報を取得して、着信側携帯電話11に配信することもできる。

このようにすれば、発信側携帯電話10に提供する広告情報と同一の広告情報を着信側携帯電話11に提供することが可能となる。

【0043】

さらに、広告制御システム40は、携帯電話の位置情報を考慮して、配信条件を満たす広告情報を決定することもできる。例えば、発信側携帯電話10がGPS (Global Positioning System) 機能を備え、ステップS201の通話確立要求信号の送信の際に、当該携帯電話の位置情報を取得して、これを合わせて発信側交換機22に送信することができる。

これにより、発信側交換機22は、広告制御システム40により発信側携帯電話10の位置情報を用いて、配信条件に合致する広告情報を決定することができる。

【0044】

また、広告制御システム40は、携帯電話機にGPS機能が備えられていない場合でも、数百m～1万m程度の大まかな範囲の位置情報であれば、セルベース測位方式などにより、取得することが可能である。

本実施形態において、この大まかな位置情報を用いて、配信条件に合致する広告情報を決定することも好ましい。

【0045】

この方法によれば、図3のステップS204において広告制御システム40は、発信側交換機22において特定された発信側携帯電話10の位置情報を受信し、又は、発信側交換機22からセル情報を受信して発信側携帯電話10の位置情報を算出し、この位置情報を用いて発信側に配信する広告を決定することができる。

【0046】

また、図3のステップS206において広告制御システム40は、着信側交換機23において特定された着信側携帯電話11の位置情報を受信し、又は、着信側交換機23からセル情報を受信して着信側携帯電話11の位置情報を算出し、この位置情報を用いて着信側に配信する広告を決定することができる。

【0047】

これにより、発信側携帯電話10及び着信側携帯電話11の双方の位置関係を考慮して、それぞれの中間にある店舗の広告情報を提供するなど、よりきめ細かな条件により広告配信を行うことが可能となる。

また、発信側携帯電話10又は着信側携帯電話11のいずれか一方のみについて、位置情報を取得し、これを用いて配信する広告を決定する構成とすることも勿論可能である。

【0048】

なお、加入者データベース21に、着信側携帯電話11に対応する「着信時の広告表示拒否情報」が登録されている場合は、着信側交換機23は、広告情報を取得することなく、着信側携帯電話11に対して通話確立要求信号を送信する。

【0049】

着信側交換機23は、広告情報を取得すると、この広告情報を含む通話確立要求信号を着信側携帯電話11に送信することにより、着信側携帯電話11を呼び出し、同時に取得した広告情報を着信側携帯電話11に配信する(ステップS207)。これにより、着信側携帯電話11において、呼び出し中に広告を表示することができる。

【0050】

このとき、例えば着信側携帯電話11の表面に設けられたサブディスプレイに広告を表示することができる。勿論、着信側携帯電話11のメインディスプレイに広告を表示して、利用者が通話ボタンを押下するまで視認可能にすることもできる。

【0051】

また、着信側交換機23は、着信側携帯電話11から呼び出し開始信号を受信して、呼び出しの開始を確認すると(ステップS208)、この呼び出し開始信号を発信側交換機22に送信する(ステップS209)。このとき、着信側携帯電話11に配信する広告情報を呼び出し開始信号に含めて発信側交換機22に送信することもできる。

【0052】

次に、発信側交換機22は、ステップS204で取得した広告情報を発信側携帯電話10に配信する。これにより、発信側携帯電話10において、広告を表示することができる。また、発信側携帯電話10において、着信側携帯電話11に配信している広告を表示することもできる。

これにより、着信側携帯電話11の呼び出しを適切に行えた場合に、発信側携帯電話10に広告を表示させることが可能となる。

【0053】

次に、着信側携帯電話11の利用者が着信に応答する操作をすると、着信側携帯電話11は、通話開始信号を、着信側交換機23と発信側交換機22を介して発信側携帯電話10に送信する(ステップS210)。

これに対して、発信側携帯電話10は、通話開始信号に対する応答信号を、発信側交換機22と着信側交換機23を介して着信側携帯電話11に送信する(ステップS211)。

【0054】

これにより、テレビ電話が通話中となるとともに、広告の表示が行われる(ステップS212)。

なお、上記の通り、ステップS207により着信側携帯電話11において広告の表示を行うことができ、ステップS209により発信側携帯電話10において広告の表示を行うことができるが、ステップ211により通話が確立してから、それぞれの携帯電話において広告の表示を開始することも勿論可能である。

図4は、このようにして携帯電話に表示された文字広告の例を示している。同図において、広告は、テレビ電話通話中に、画面の端にスクロール表示されている。

【0055】

次に、発信側携帯電話10において、通話終了の操作が行われると、通話終了信号が発信側交換機22と着信側交換機23を介して着信側携帯電話11に送信され、通話終了信号に対する応答信号が着信側携帯電話11から着信側交換機23と発信側交換機22を介して発信側携帯電話10に送信される。

発信側交換機22は、着信側携帯電話11からの通話終了信号に対する応答信号を受信すると、加入者データベース21に広告表示時間を記録する。

【0056】

このとき、発信側交換機22は、ステップS211により通話が確立してから、それぞれの携帯電話において広告の表示を開始する場合には、通話時間を広告表示時間として、加入者データベース21に記録することができる。

また、ステップS207により着信側携帯電話11において広告の表示を開始すると共に、ステップS209により発信側携帯電話10において広告の表示を開始する場合には、それぞれの広告表示時間を個別に加入者データベース21に記録することもできる。このようにすれば、通話開始前から携帯電話に広告を表示させる場合に、その表示時間を詳細に管理することが可能となる。

【0057】

このとき、ステップS208において、着信側携帯電話11は呼び出し開始信号に広告表示開始時刻を付加して発信側交換機22へ送信し、発信側交換機22は、この広告表示開始時刻と通話終了時刻とから着信側携帯電話11における広告表示時間を算出することができる。

【0058】

また、発信側交換機22は、ステップS209における発信側携帯電話10への広告配

信時刻と通話終了時刻とから発信側携帯電話10における広告表示時間を算出することができる。

このようにして算出された広告表示時間を累計することにより、携帯電話事業者は、広告費として広告提供企業が負担する金額を算出することが可能となる。

【0059】

次に、図5及び図6を参照して、本実施形態の広告制御システム40による配信広告の決定処理手順について説明する。図5は本実施形態のテレビ電話広告システムにおける広告選択時の処理手順を示すフローチャートである。図6は同システムにおける広告リストの例を示す図である。

【0060】

この広告制御システム40による配信広告の決定処理は、図3のステップS204及びステップS206において行われる。

まず、広告制御システム40は、発信側交換機22又は着信側交換機23から電話番号などの加入者識別情報を含む広告取得要求を受信すると、この加入者識別情報にもとづき加入者データベース21を検索して対応する携帯電話の加入者情報を取得し、広告提供企業を決定する(ステップS301)。

【0061】

このとき、取得した加入者情報における「広告契約形態」が「企業指定」であれば、広告制御システム40は、当該加入者情報における「広告提供企業」にもとづき広告提供企業を決定することができる。

また、「広告契約形態」が「条件指定」もしくは「指定なし」の場合、広告制御システム40は、広告データベース30に登録されている選択候補となる企業の中からランダムに1つの企業を選択することができる。

【0062】

次に、広告制御システム40は、決定した広告提供企業に対応する広告リストを、広告データベース30から取得し(ステップS302)、広告リストのうち最も優先順位が高い広告情報(図6ではリスト先頭)を参照する(ステップS303)。

また、広告制御システム40は、この取得した広告情報に配信条件が含まれるか否かを確認し(ステップS304)、含まれる場合には、加入者情報や現在時刻が配信条件を満たすか否かを判定する(ステップS305)。

【0063】

そして、加入者情報等が配信条件を満たさない場合、広告制御システム40は、広告リストにおける次候補の広告を参照して(ステップS306)、ステップS304、S305の判定を繰り返す。

配信条件のない広告情報(一般広告)又は配信条件を満たす広告情報(条件付広告)が検出された場合、広告制御システム40は、当該広告情報を配信広告として決定する(ステップS307)。

なお、発信側携帯電話10と着信側携帯電話11とでは、加入者情報等が異なるため、異なる広告が配信される場合がある。

【0064】

以上説明したように、本実施形態のテレビ電話広告システムによれば、着信先において呼び出しを開始した時点で発信元及び/又は着信先に文字広告情報を提供することができる。また、既存のテレビ電話発信処理における信号シーケンスを大きく変更することなく、現在すでに使用している信号を、広告情報等を載せられるように拡張することで、容易に実現することが可能である。

【0065】

また、広告情報が通話開始直前に取得される構成であるため、通話開始時点での最新の広告内容の配信することが可能である。例えば、在庫情報などの広告にはリアルタイムな情報が要求されるが、本実施形態によれば、企業側が広告内容をこまめに更新することで、正確な内容の広告を配信することが可能である。

また、カラオケや居酒屋などの広告の場合において、位置情報と関連付けて、最寄りの店舗の空席情報を配信することなども可能である。

【0066】

さらに、本実施形態によれば、発信側が契約している企業の広告を着信側にも提供することができる。

このため、着信メロディや呼び出し音などを広告媒体にしたシステムに比較して、より多くの利用者に対する広告閲覧を実現でき、広範囲に及ぶ広告効果を期待することが可能となる。

【0067】

また、本実施形態によれば、広告データベース30に配信条件を設定することができるため、位置情報や現在時刻に対応する広告情報の選択が可能である。

例えば、「○○電気××駅前店に新商品△△の在庫有り」「○○商店××町店、17時からタイムセール実施」などの、タイムリーな広告や局地的な広告を配信することが可能である。

【0068】

また、広告選択の際に加入者情報を参照できるため、例えば自動車メーカーの場合、20～30代の契約者にはスポーツカーの広告、40～50代の契約者には高級車の広告のように広告の配信先によって内容を変えることも可能である。

【0069】

本発明は、以上の実施形態に限定されるものではなく、本発明の範囲内において、種々の変更実施が可能であることは言うまでもない。

例えば、携帯電話ではなく、固定型のテレビ電話機に対する広告情報の配信に適用することが可能である。

【0070】

また、交換機に代えてメールサーバを使用することにより、広告情報をテレビ電話画面に付加するのではなく、携帯メールの末尾等に広告情報を付加する構成とすることも可能である。

さらに、テレビ電話において広告情報を表示させるのみならず、その携帯電話のメールアドレスに広告提供企業のクーポンや景品等を送信する構成とするなど適宜変更することが可能である。

【産業上の利用可能性】

【0071】

本発明は、既存の携帯電話のテレビ電話発信処理における信号シーケンスをできるだけ変更することなく、テレビ電話での広告配信を実現する場合に、好適に利用することが可能である。

【図面の簡単な説明】

【0072】

【図1】本発明の一実施形態のテレビ電話広告システムの構成を示すブロック図である。

【図2】本発明の一実施形態のテレビ電話広告システムにおける広告契約時の処理手順を示すフローチャートである。

【図3】本発明の一実施形態のテレビ電話広告システムにおける通話開始時及び通話中の信号シーケンス図である。

【図4】本発明の一実施形態のテレビ電話広告システムにおけるテレビ電話中の広告イメージを示す図である。

【図5】本発明の一実施形態のテレビ電話広告システムにおける広告選択時の処理手順を示すフローチャートである。

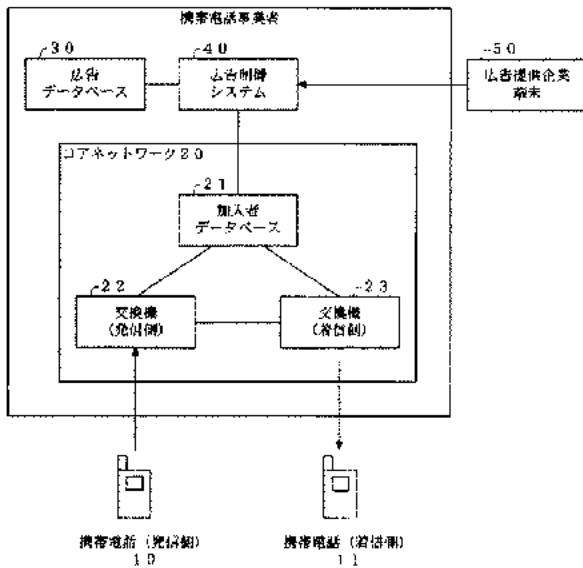
【図6】本発明の一実施形態のテレビ電話広告システムにおける広告リストの例を示す図である。

【符号の説明】

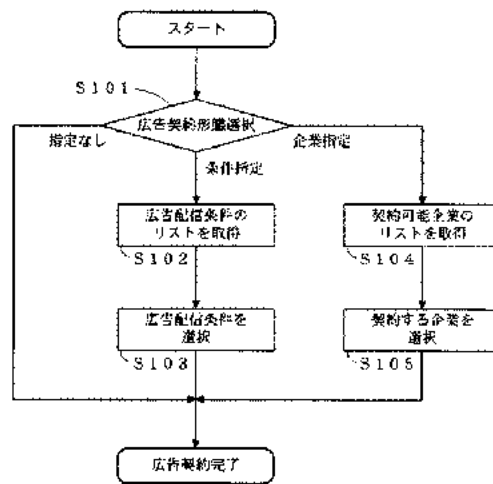
【0073】

- 10 発信側携帯電話
- 11 着信側携帯電話
- 20 コアネットワーク
- 21 加入者データベース
- 22 交換機 (発信側)
- 23 交換機 (着信側)
- 30 広告データベース
- 40 広告制御システム
- 50 広告提供企業端末

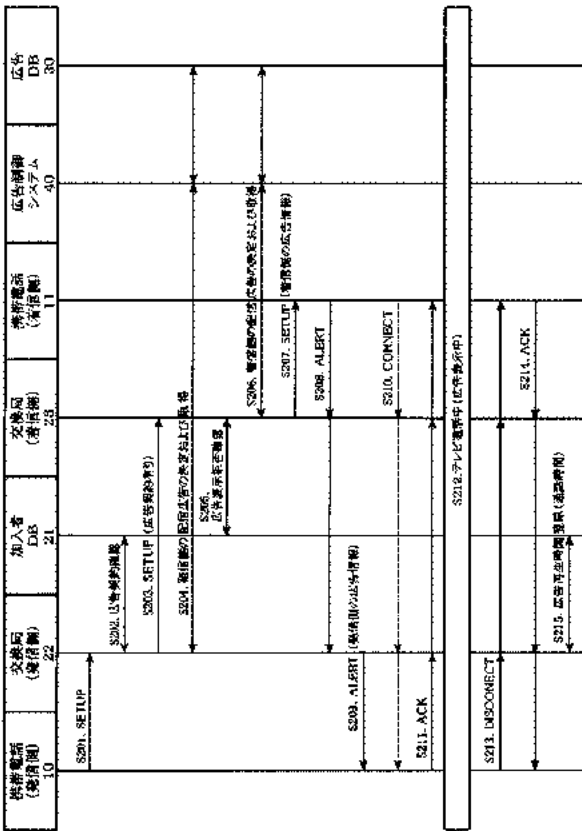
【図1】



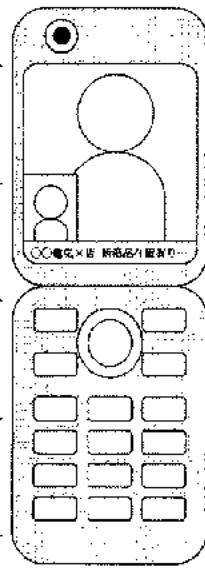
【図2】



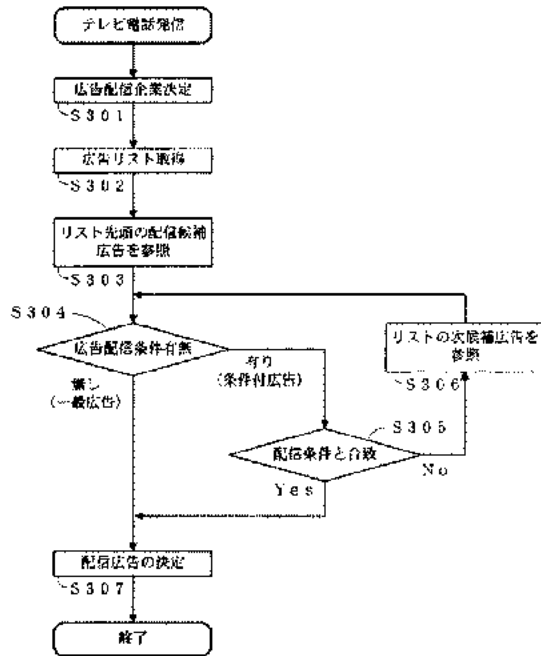
【図3】



【図4】



【図5】



【図6】

広告配信企業	優先順位	配信条件	広告内容
CCストア	1	配信時刻: 17:00~18:00 配信地域: A市内	A市にて19:00からタイムセール...
CCストア	2	配信地域: A市内	A店が新着商品...
CCストア	3	配信対象: 20~30代女性	食品への調味品販売...
...	...	...	...
CCストア	n	なし (一般広告)	全店一斉セール実施中...

Fターム(参考) 5K201 BA07 BC23 BC27 BD02 BD04 CA06 CB01 CB02 CB05 CB13  
CC01 CC04 DC03 EC02 ED05 EE08 EF10 FA07 FB01



Espacenet

**Bibliographic data: JP2002024712 (A) --- 2002-01-25****CONTRIBUTION SYSTEM**

**Inventor(s):** FUKUDA TORU ± (FUKUDA TORU)

**Applicant(s):** MEDIA LINK SYSTEM KK ± (MEDIA LINK SYSTEM:KK)

**Classification:** - **international:**G06Q10/00; G06Q30/02; G06Q30/06; G06Q50/00;  
G06Q50/26; (IPC1-7): G06F17/60  
- **cooperative:**

**Application number:** JP20000206301 20000707 Global Dossier

**Priority number (s):** JP20000206301 20000707

**Abstract of JP2002024712 (A)**

**PROBLEM TO BE SOLVED:** To provide a contribution system capable of reducing a cost for collecting a contribution by facilitating an endowment. **SOLUTION:** In this contribution system utilizing the Internet, a user clicks a banner on the homepage of a collecting body, and browses the homepage of a cosponsoring company. Thus, an advertisement expense is paid from the cosponsoring company to the collecting body.



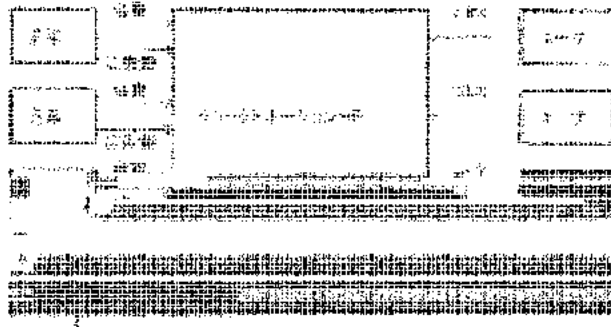


Figure 1

Figure 1 shows a schematic diagram of a system architecture. The diagram includes a central processing unit (CPU) connected to a memory unit (MEM) and a storage unit (STG). The CPU is also connected to a network interface (NET) and a user interface (UI). The system is powered by a power supply (PSU). The diagram is rendered in a high-contrast, black-and-white style with some noise.

Figure 2

Figure 2 shows a schematic diagram of a system architecture. The diagram includes a central processing unit (CPU) connected to a memory unit (MEM) and a storage unit (STG). The CPU is also connected to a network interface (NET) and a user interface (UI). The system is powered by a power supply (PSU). The diagram is rendered in a high-contrast, black-and-white style with some noise.

(19) 日本国特許庁 ( J P )

(12) 公開特許公報 ( A )

(11) 特許出願公開番号  
特開2002-24712  
( P2002-24712A )

(43) 公開日 平成14年1月25日 ( 2002. 1. 25 )

(51) Int.Cl.	識別記号	F I	テーマコード (参考)
G 0 6 F 17/60	3 3 8 1 5 4 3 2 6 5 0 2	C 0 6 F 17/60	3 3 8 1 5 4 3 2 6 5 0 2

審査請求 未請求 請求項の数 9 O L ( 全 5 頁 )

(21) 出願番号 特願2000-206301 ( P2000-206301 )

(71) 出願人 591013854

株式会社メディア・リンク・システム

東京都中央区東日本橋2-2-10 東日本橋オリモビル

(22) 出願日 平成12年7月7日 ( 2000. 7. 7 )

(72) 発明者 福田 徹

東京都中央区東日本橋2-1-6 東日本橋藤和ビル 株式会社メディア・リンク・システム内

(74) 代理人 100074538

弁理士 田辺 徹

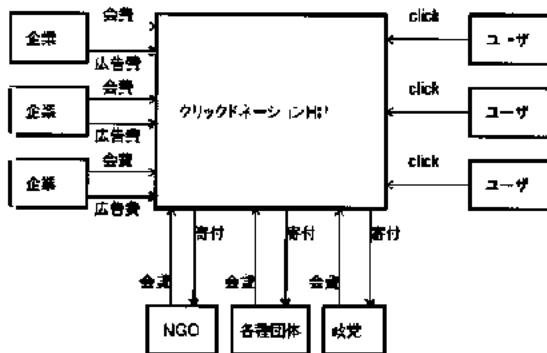
Fターム (参考) 5B049 AA06 BB49 DD01 FF01

(54) 【発明の名称】 寄付システム

(57) 【要約】

【課題】 寄付行為を簡単にし、寄付集めに要するコストを低減できる寄付システムを提供する。

【解決手段】 インターネットを利用した寄付システムにおいて、ユーザが募集团体のホームページ上のバナーをクリックして、協賛企業のホームページを閲覧し、それにより、広告費が協賛企業から募集团体に支払われるようにする。



【特許請求の範囲】

【請求項1】 インターネットを利用した寄付システムにおいて、ユーザが募集团体のホームページ上のバナーをクリックして、協賛企業のホームページを閲覧し、それにより、広告費が協賛企業から募集团体に寄付金として支払われることを特徴とする寄付システム。

【請求項2】 インターネットを利用した寄付システムにおいて、ユーザは協賛企業のホームページを見てホームページの中に配置された寄付マークをクリックし、それにより、広告費が協賛企業から募集团体に寄付金として支払われることを特徴とする寄付システム。

【請求項3】 1つの協賛企業が複数の募集团体へ寄付する形で協賛している場合、ユーザは特定の募集团体を選択する構成にした請求項2に記載の寄付システム。

【請求項4】 協賛企業は毎月の広告費の上限を決め、ユーザのクリック回数がある上限を超えた場合、ホームページから自動的に寄付マークが消滅する請求項2に記載の寄付システム。

【請求項5】 協賛企業は毎月の広告費の上限と記念品を決め、寄付マークにその内容を表示し、クリック回数が上限を超えた後、クリックしたユーザへ、上限をオーバーしたので寄付は行えないが、記念品の抽選対象にはなることを表示する請求項2に記載の寄付システム。

【請求項6】 協賛企業、募集团体、ユーザ名、クリック回数のデータベースを自動的に作成し、毎月、企業別、団体別、ユーザ別に自動集計する請求項1～5のいずれか1項に記載の寄付システム。

【請求項7】 寄付ネットワークのサーバーに募集团体のホームページを載せ、協賛企業の毎月の広告費の上限に応じて作成した広告契約データベースの内容から、企業のバナー広告を企業が希望する募集团体のホームページへ自動的に添付又は消去する請求項1～6のいずれか1項に記載の寄付システム。

【請求項8】 協賛企業のホームページと、寄付ネットワークのサーバ上の募集团体のホームページの内企業が協賛する団体との間に自動的にリンクを設定する請求項1～7のいずれか1項に記載の寄付システム。

【請求項9】 特定のユーザが同じ協賛企業のホームページを1日に複数回閲覧したとき寄付用の有効な閲覧回数を所定の回数に制限できる請求項1～8のいずれか1項に記載の寄付システム。

【発明の詳細な説明】

【0001】

【発明の属する技術分野】本発明は、インターネットを利用して、ユーザが協賛企業のホームページを見ることにより協賛企業から募集团体に広告費が寄付金として支払われる寄付システムに関する。

【0002】

【従来の技術】従来は、寄付募集团体からユーザへダイレクトメールで寄付振込用紙が送られ、ユーザは、その

用紙に希望する金額を記入し、最寄りの金融機関で振り込み手続きをして寄付していた。

【0003】また、米国のインターネットオンラインショッピング(i-give.com)では、ユーザが買い物をした金額に応じて、ホームページ上で寄付したい団体を選択して、寄付できるようになっている。

【0004】

【発明が解決しようとする課題】従来、寄付を行う場合、寄付する側は郵便による送金や金融機関での振込を行う必要があった。

【0005】また、寄付を募集する団体側でも、寄付者へその情報を伝える手段として、新聞や雑誌等のマスコミやダイレクトメールを利用している。そのため、寄付を集めるために多くの経費がかかっていた。

【0006】本発明の目的は、寄付行為を簡単にし、寄付集めに要するコストを低減できる寄付システムを提供することである。

【0007】

【課題を解決するための手段】インターネットを利用した寄付システムにおいて、ユーザが募集团体のホームページ上のバナーをクリックして、協賛企業のホームページを閲覧し、それにより、広告費が協賛企業から募集团体に支払われるようにする。

【0008】また、インターネットを利用した寄付システムにおいて、ユーザは協賛企業のホームページを見てホームページの中に配置された寄付マークをクリックし、それにより、広告費が協賛企業から募集团体に支払われるようにする。

【0009】好ましくは、1つの協賛企業が複数の募集团体へ寄付する形で協賛している場合、ユーザは特定の募集团体を選択して寄付する。

【0010】また、協賛企業は毎月の広告費の上限を決め、ユーザのクリック回数がある上限を超えた場合、ホームページから自動的に寄付マークが消滅するようにするのが好ましい。

【0011】協賛企業は毎月の広告費の上限と記念品を決め、寄付マークにその内容を表示し、クリック回数が上限を超えた後、クリックしたユーザへ、上限をオーバーしたので寄付は行えないが、記念品の抽選対象にはなることを表示することも可能である。

【0012】好ましくは、協賛企業、募集团体、ユーザ名、クリック回数のデータベースを自動的に作成し、毎月、企業別、団体別、ユーザ別に自動集計する。

【0013】また、寄付ネットワークのサーバーに募集团体のホームページを載せ、協賛企業の毎月の広告費の上限に応じて作成した広告契約データベースの内容から、企業のバナー広告を企業が希望する募集团体のホームページへ自動的に添付又は消去するのが好ましい。

【0014】協賛企業のホームページと、寄付ネットワークのサーバ上の募集团体のホームページの内企業が協

賛する団体との間に自動的にリンクを設定するのが好ましい。

【0015】特定のユーザが同じ協賛企業のホームページを1日に複数回閲覧したとき寄付用の有効な閲覧回数を所定の回数に制限できる。

【0016】

【発明の実施の形態】本発明は、インターネットにより寄付行為を簡単にするものである。さらに、寄付する側の財産の一部を募集团体へ送金するのではなく、あるいは、それに加えて、寄付側はインターネット広告を見て画面上でクリックするだけで寄付行為が行えるようにし、協賛企業が広告費を寄付金として提供するものである。

【0017】今日、多くの企業はインターネットのホームページを広告媒体と位置づけている。そのため、多くの企業は、自社のホームページを見て貰うために、ポータルサイト（ヤフー（登録商標）などのように、大勢の人が見に来るサイト）へ広告料を支払い、そのホームページなどへバナー広告を載せている。

【0018】本発明は、この広告ビジネスの仕組みを寄付ネットワークのサイトに応用し、ユーザは企業のホームページを見て広告費を獲得し、それを寄付金として利用することができる仕組みを提供するものである。

【0019】本発明においては、寄付ネットワークのサイトに協賛企業と募集团体のホームページが設けられる。これらのホームページには寄付マーク（バナー広告）が配置され、ユーザはこれらのホームページを閲覧し寄付マークをクリックするだけで、協賛企業からユーザへ広告料が支払われ、この広告料が募集团体へ寄付される。

【0020】本発明においては、以上の操作をネットワークパソコン上の画面をクリックするだけで簡単に行うことができる。

【0021】なお、本明細書では「寄付」や「寄付金」は広い意味で使用しており、「献金」を含むものである。

【0022】

【実施例】以下、本発明の実施例を説明する。

【0023】実施例1

インターネットに寄付ネットワークのサイト（click-donation.com）を設ける。このサイトには、寄付募集团体一覧リストと、寄付協賛企業一覧リストが配置される。これらのリストから各協賛企業や募集团体のホームページへリンクを張ることにより、ユーザは見たい協賛企業や募集团体のホームページを見ることができる。

【0024】協賛企業のホームページには寄付マークが配置される。ユーザはこの寄付マークをクリックして寄付したい募集团体を選択することにより、寄付行為を行うことができる。

【0025】寄付ネットワークのホームページには、寄付協賛企業リストと寄付募集团体リストを示す。

【0026】たとえば、協賛企業のホームページには、〇〇株式会社ホームページと表示し、そこに、会社概要、社名、所在地、新製品紹介、組織、募集などを記す。

【0027】ユーザは寄付マークをクリックし、寄付したい団体名を選択することにより、寄付行為を行うことができる。

【0028】募集团体のホームページには協賛企業のバナーが表示され、ユーザがこのバナーをクリックし、協賛企業のホームページを見ることにより、協賛企業からの広告料が自動的に寄付したい団体に寄付される。

【0029】募集团体のホームページの一例を説明すると、まず、〇〇保存会のホームページが示され、活動案内、ニュース、組織、会員募集などが記される。

【0030】ユーザはこの企業バナーをクリックし、その企業のホームページを閲覧することにより、寄付行為を行うことができる。

【0031】ユーザが寄付ネットワークへアクセスして、寄付行為が完了するまでの実際の流れの一例を以下に示す。

【0032】例①

寄付ネットワークへアクセス  
ユーザ登録（氏名、住所）  
寄付ネットワークホームページ表示  
協賛企業紹介リスト表示  
協賛企業ホームページ表示  
寄付したい募集团体を選択  
募集团体から寄付への謝辞表示  
自動的に団体へ寄付

例②

募集团体紹介リスト表示  
募集团体ホームページ表示  
バナー広告クリック  
協賛企業ホームページ表示  
募集团体から寄付への謝辞表示  
自動的に団体へ寄付

本発明の好ましい形態においては、寄付ネットワークのサーバの機能として、ユーザがどの企業のホームページを見てどの団体へ寄付をしたかを寄付データベースへ自動的に記録する。データベースの項目は、年・月・日、ユーザ名、住所、企業名、団体名その他とし、このデータベースから、毎月、ユーザ別の寄付リスト、企業の広告費集計、団体別の寄付金額集計など、の自動計算と印刷出力を行う。

【0033】実施例2

ユーザは、協賛企業の広告ページを見ることによって寄付する。振込等の手続きをしないうで、インターネットで画面をクリックするだけで寄付する。

【0034】たとえば、ユーザはクリックドネーション（寄付）のホームページ（click-donation.com）から企業広告を見て、CLICK-DONATIONのアイコンをクリックするだけで、支援する団体に寄付をすることができる。

【0035】寄付を集めたい募集团体（たとえば赤十字、野鳥の会、世界遺産、各種NGO、学校法人、政治団体等）と、寄付に賛同する協賛企業は、寄付ネットワークに会員登録する。

【0036】各協賛企業は、ホームページ（click-donation.com）に企業の広告ページを作成し、このページにCLICK DONATIONのアイコンをつける。

【0037】ユーザは賛同する募集团体のホームページから企業広告ページへアクセスして、CLICK-DONATIONのアイコンをクリックして寄付を行う。

【0038】図1は、そのような寄付ネットワークのシステムの一例を示す。

【0039】クリック操作によるドネーション（寄付）を行うためのホームページ（HP）を寄付ネットワークに設ける。寄付ネットワークに参加する企業は会費及び広告費を寄付ネットワークに納める。また、各種募集团体は会費を寄付ネットワークに納める。

【0040】寄付ネットワークでは、ユーザが企業の広告を見て、CLICK-DONATIONのアイコンをクリックすると、寄付行為をしたことになり、ユーザにかわり、各団体へ寄付が行なわれる。

【0041】ユーザの寄付回数はポイント化され、ホームページ上で公開される。また、ポイントに応じて感謝カードなどを発行しインセンティブを与える。

【0042】各団体は寄付の用途について毎月および／または毎年、ホームページ上で情報公開する。

【0043】寄付ネットワークの開設と運営の一例を説明する。

【0044】財団法人、NGOなど営利を目的としない団体で開設して運営する。

【0045】寄付を集めたい募集团体及び寄付協賛企業が会員となる。

【0046】寄付者（ユーザ）の一覧や寄付金額等、寄付情報の透明性を確保することが容易である。

【0047】集まった寄付の用途、その効果などの付帯情報をオープンにすることが容易である。

【0048】インターネットを利用するので、合理化がしやすい。人千のかからないバーチャル運営が可能である。

【0049】世界中に寄付ネットワークの活動を展開しやすい。

【0050】サーチエンジン（多言語）、自動ランキング等を行うことが容易である。

【0051】実施例3

次は、政治資金規制法に基づく寄付について説明する。

【0052】所属国会議員5人以上又は衆参いずれかの選挙における得票率が3%以上の政党において以下のような規制がある。

【0053】・政治家個人に対する寄付の禁止。

【0054】・企業等の団体献金は、政党又は政治資金団体（政治家1人につき1つの資金管理団体）に限り認める。

【0055】・寄付の公開基準は年間5万円超。

【0056】寄付ネットワークでは、ユーザが企業広告を見たことによる代償として、ユーザの名前で各団体へ寄付を行う。必要に応じて、政党への寄付が年間5万円を超えたユーザの名前はネット上で公開されるように設定できる。

【0057】実施例4

好ましい寄付ネットワークにおいては、インターネット上でクリックをして簡単に寄付（献金）をできるようにし、かつ、全てのサイトの運営及び管理を自動化する。

【0058】e-money（ユーザのインターネットバンクや電子マネー）で寄付をする。

【0059】寄付ネットワークがユーザのクリックに応じて会員企業から受け取った広告費を、募集团体へ寄付をする。

【0060】寄付ネットワークのホームページで買い物をするにより、売上の一部が寄付される。

【0061】寄付協会から各企業へは広告費の明細書、各ユーザ毎に各種団体への寄付明細書を自動的に作成する。

【0062】寄付ネットワークのシステムの一例を説明する。

【0063】寄付ネットワークの会員は以下の通りである。

【0064】支援側としては、企業、商店、銀行などがある。企業は、ホームページの閲覧数に応じて広告費を支払う。広告費の上限を設定できる。商店は、オンラインショップの売上の数%を支払う。銀行は、ユーザの振込金額を支払う。振込手数料は無料又は割引とする。

【0065】寄付募集側としては、各種団体、NGO、政党などがある。

【0066】ユーザは、住所・氏名を登録して寄付行為を行う。

【0067】寄付ネットワークでは、ユーザが企業のホームページを見て、CLICK-DONATIONのアイコンをクリックして、クリック数に応じて、企業が寄付ネットワークへ広告料を支払い、それをユーザ名で各団体へ寄付する。毎月の広告料の上限を設定する。

【0068】寄付ネットワークのショッピングサイトでは、ユーザは購入金額の数%を、ユーザが希望する団体へ寄付することができる。

【0069】ユーザが寄付ネットワークの協賛銀行（オ

ンラインバンク)に口座を持っている場合は、ユーザの希望する団体への寄付の送金が容易にできる。

【0070】ユーザの寄付回数・金額はポイント化され、ホームページ上で公開される。また、ポイント数に応じて感謝カードなどを発行し、寄付行為へのインセンティブを与える。

【0071】各団体は寄付の用途について毎月および／または毎年、ホームページ上で情報公開する。

【0072】図2は、寄付ネットワークのホームページの流れの一例を示す。

【0073】まず、ユーザは、寄付ネットワーク (click donation.com) のホームページへアクセスする。そして、ユーザ登録をする。

【0074】所定のメニューから寄付項目を選択する。たとえば、募集团体 (寄付したい団体) や協賛企業 (見たい企業のホームページ) を選択する。

【0075】また、ショッピングサイト、eBank、

e moneyなどを選択することも可能とする。

【0076】協賛企業のホームページを見て、Donationマークをクリックする。

【0077】最後に、寄付への御礼が表示される。寄付したい団体をクリックすると、寄付への御礼が表示される。

【0078】ショッピングの会計をするときは、購入金額の1%を寄付するように設定しておき、寄付したい団体を選択する。すると、寄付への御礼が表示される。

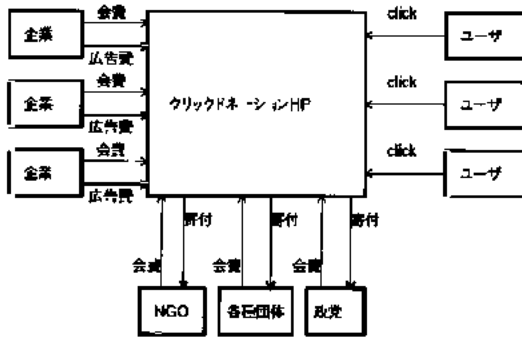
【0079】また、ID、暗証番号を入力して、寄付したい団体をクリックし、金額を入力して寄付をすると、寄付への御礼が表示される。

【図面の簡単な説明】

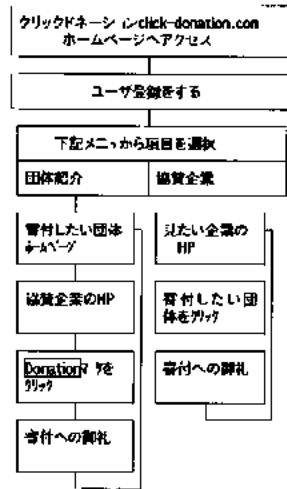
【図1】本発明の1つの実施例による寄付システムを示す。

【図2】本発明の1つの実施例によるホームページの流れを示す。

【図1】



【図2】





Espacenet

Bibliographic data: JP2003143290 (A) — 2003-05-16

## PORTABLE TELEPHONE SET

**Inventor(s):** OTSUKA SHUJI ± (OTSUKA SHUJI)

**Applicant(s):** SANYO ELECTRIC CO; SANYO TELECOMM CO LTD ± (SANYO ELECTRIC CO LTD, ; SANYO TELECOMMUNICATIONS CO LTD)

**Classification:** - **international:** *G06Q10/00; G06Q20/00; G06Q20/06; G06Q20/32; G06Q50/00; G07G1/12; H04M1/02; H04M1/21; H04M1/67; H04M1/725; H04W88/02;*  
(IPC1-7): G06F17/60; G07G1/12; H04M1/02; H04M1/21; H04M1/67; H04M1/725; H04Q7/38

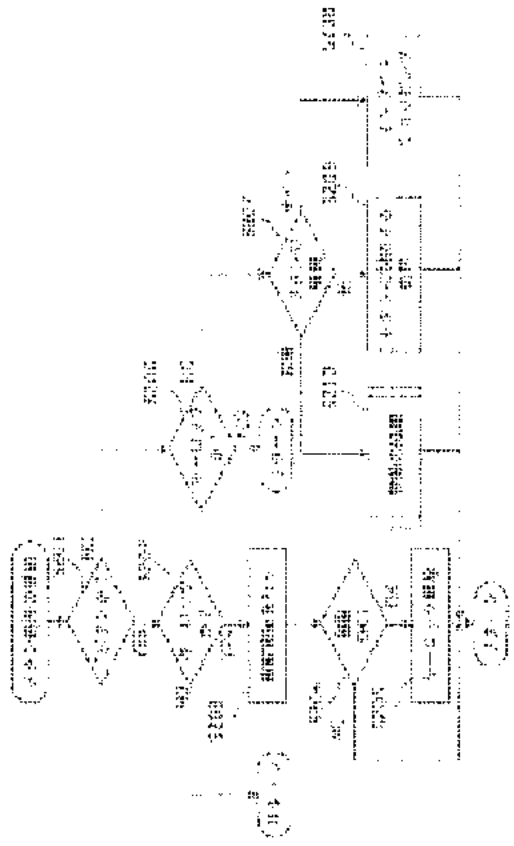
- **cooperative:**

**Application number:** JP20010333469 20011030      [Global Dossier](#)

**Priority number(s):** JP20010333469 20011030

## Abstract of JP2003143290 (A)

PROBLEM TO BE SOLVED: To provide a portable telephone set, in which the operation of a person except for a legal user is not accepted even while a lock function is turned off. SOLUTION: This portable telephone set has a fingerprint authenticating function and the legal user of the portable telephone set previously registers his/her own fingerprint. The portable telephone set recognizes whether an operator is the legal user or not by reading the fingerprint of the operator and collating the fingerprint of the operator with the registered fingerprint. The portable telephone set is in a key lock state in ordinary waiting and only when the fingerprint of the operator is matched with the registered fingerprint, the key lock state is canceled so that only the legal user can utilize the portable telephone set.







【特許請求の範囲】

【請求項1】 利用を禁止されている状態にある携帯電話機であって、

当該携帯電話機を操作した操作者の指紋を読み取り、読み取った指紋を示す指紋情報を用いて、前記操作者が当該携帯電話機の正当な利用者か否か認識する認識手段と、

正当な利用者と認識された場合のみ、当該携帯電話機の利用を許可する許可手段とを備えることを特徴とする携帯電話機。

【請求項2】 前記認識手段は、予め、前記正当な利用者の指紋を示す指紋情報を記憶している記憶部と、

前記操作者の指紋を読み取る読取部とを含み、前記記憶部が記憶している指紋情報と前記読取部が読み取る指紋を示す指紋情報とが一致するか否か判定することにより、正当な利用者か否か認識することを特徴とする請求項1に記載の携帯電話機。

【請求項3】 前記許可手段は、前記操作者が正当な利用者と認識されない場合、前記操作者の入力操作により生成された入力情報を破棄することを特徴とする請求項2に記載の携帯電話機。

【請求項4】 前記携帯電話機は、商品を販売する販売装置と接続されており、前記操作者は前記携帯電話機を用いて販売装置から商品を購入し、前記許可手段は、さらに、前記操作者が正当な利用者であると認識された場合に、前記操作者が購入する商品の代金の支払処理を行う支払手段を含むことを特徴とする請求項1に記載の携帯電話機。

【請求項5】 前記携帯電話機は、ネットワークを介して販売装置と接続されており、前記支払手段は、ネットワークを介したオンラインショッピングにおいて、前記販売装置に商品の購入を示す支払情報を送信することを特徴とする請求項4に記載の携帯電話機。

【請求項6】 前記携帯電話機は、貨幣と同等の価値を有する電子マネー情報を記憶しており、前記支払手段は、購入する商品の代金に等しい電子マネー情報を、前記販売装置に送信することを特徴とする請求項4に記載の携帯電話機。

【請求項7】 前記読取部は、操作者が読み取りの対象となる指を接触させる読取面を備え、前記読取面は、複数の機能を有するファンクションキーの表面に設けられていることを特徴とする請求項2に記載の携帯電話機。

【請求項8】 前記読取部は、操作者が読み取りの対象となる指を接触させる読取面を備え、前記読取面は、操作を受け付ける操作キーの表面に設けられていることを特徴とする請求項2に記載の携帯電話機。

【請求項9】 前記許可手段は、さらに、正当な利用者と認識された後、操作者から最後の操作を受け付けた直後からの時間を測定する測定手段と、

測定した時間が所定時間以上である場合は、当該携帯電話機の利用を禁止状態とする禁止手段とを含むことを特徴とする請求項1に記載の携帯電話機。

【請求項10】 前記許可手段は、着信があった場合、前記認識手段の認識結果に関わらず、通話、又は電子メール受信を許可することを特徴とする請求項1に記載の携帯電話機。

【請求項11】 前記許可手段は、さらに、予め1個の電話番号を記憶している記憶手段と、正当な利用者であると認識された場合に、前記電話番号を読み出す読出手段と、読み出した前記電話番号へ発呼する発呼手段とを含むことを特徴とする請求項1に記載の携帯電話機。

【発明の詳細な説明】

【0001】

【発明の属する技術分野】本発明は、指紋認証機能を有する携帯電話機に関する。

【0002】

【従来の技術】携帯電話機は、操作者が誤って操作することを防ぐ為に、ボタンの操作による入力を受け付けないロック機能を有する。前記ロック機能をオンに設定していない状態で携帯電話機を紛失すると、携帯電話機に記憶されている情報が漏洩するという問題がある。

【0003】この問題を改善する方法としては、特開平10-164219号公報に開示されている技術によると、利用者が携帯電話機を紛失した場合、携帯電話業者に紛失を届け出ると、携帯電話業者は、無線基地局から前記携帯電話機にロック指示データを発信する、前記携帯電話機は、前記ロック指示データを受信すると、ロック機能をオンに設定する。この様にして、携帯電話機を紛失した場合にも、他人に使用されることを防止することができる。

【0004】

【発明が解決しようとする課題】しかしながら、携帯電話機の所有者が、携帯電話機を紛失したことに気が付かなければ、無線基地局から前記ロック指示データを携帯電話機に送信することができず、所有者が携帯電話機の紛失に気が付き、ロック指示データを携帯電話機に送信し、携帯電話機のロック機能をオンに設定するまでの間に、情報が漏洩する危険性が高い。

【0005】上記問題点を解決するために、本発明は、携帯電話機のロック機能がオフの状態でも紛失した場合であっても、正当な利用者以外の人の操作を受け付けない携帯電話機を提供することを目的とする。

【0006】

【課題を解決するための手段】上記目的を達成する為に、本発明は、利用を禁止されている状態にある携帯電

話機であって、当該携帯電話機を操作した操作者の指紋を読み取り、読み取った指紋を示す指紋情報を用いて、前記操作者が当該携帯電話機の正当な利用者か否か認識し、正当な利用者と認識された場合のみ、当該携帯電話機の利用を許可する。

【0007】さらに、本発明は、予め、前記正当な利用者の指紋を示す指紋情報を記憶し、前記操作者の指紋を読み取り、記憶している指紋情報と読み取る指紋を示す指紋情報とが一致するか否か判定することにより、正当な利用者か否か認識する。さらに、本発明は、前記操作者が正当な利用者と認識されない場合、前記操作者の入力操作により生成された入力情報を破棄する。

【0008】さらに、本発明は、前記操作者が正当な利用者と認識された後、操作者から最後の操作を受け付けた直後からの時間を測定し、測定した時間が所定時間以上である場合は、当該携帯電話機の利用を禁止状態とする。

【0009】

【発明の実施の形態】本発明に係る実施の形態として、携帯電話機10について、図面を用いて説明する。

<構成>ここでは、携帯電話機10の構成について説明する。図1に示す様に、携帯電話機10は、送受信部101、制御部102、操作部103、指紋認証部104、表示部105、記憶部106、アンテナ107、スピーカー108及びマイク109から構成される。

【0010】携帯電話機10は、無線電波を用いて移動通信できる可搬型の電話機であり、具体的には、マイクロプロセッサ、ROM、RAM、液晶ディスプレイユニット、及びキー操作部などから構成されるコンピュータシステムである。

(1) 送受信部101

送受信部101は、通話の処理、電子メール送受信の処理、インターネットを介したオンラインショッピングの処理、及び電子マネー支払の処理において、アンテナ107を介して受信信号を受信し、受信した受信信号を受信データに変換し、変換した受信データを制御部102へ出力する。また、送受信部101は、制御部102から送信データを受け取り、受け取った送信データを送信信号に変換し、変換した送信信号をアンテナ107を介して送信する。

【0011】前記通話の処理において、送受信部101は、アンテナ107を介して無線基地局から着呼信号、呼設定信号、認証要求信号、応答確認信号及び音声信号を受信し、受信した信号をそれぞれ、着呼メッセージ、呼設定メッセージ、認証要求メッセージ、応答確認メッセージ及び音声データに変換し、制御部102へ出力する。

【0012】また、送受信部101は、制御部102から着呼応答メッセージ、呼設定受付メッセージ、秘匿鍵設定メッセージ、認証応答メッセージ、応答メッセージ

及び音声データを受け取り、受け取ったデータをそれぞれ、着呼応答信号、呼設定受付信号、秘匿鍵設定信号、認証応答信号、応答信号及び音声信号に変換し、アンテナ107を介して無線基地局へ送信する。各データについては後に説明する。

【0013】前記インターネットを介したオンラインショッピングの処理において、送受信部101は、アンテナ107、無線基地局及びインターネットを介して、オンラインショッピング業者が有する装置のWebサーバから、商品を紹介する画面、商品の購入を受け付ける画面、暗証番号の入力を受け付ける画面等の各画面を生成するために用いられる複数の画面制御情報を受信し、受信した複数の画面制御情報を制御部102へ出力する。また、送受信部101は、制御部102から暗証番号及び支払情報を受け取り、受け取った暗証番号及び支払情報を前記Webサイトに送信する。

【0014】ここで、暗証番号とは、携帯電話機10の正当な利用者を認証するために用いられる情報であり、予め前記利用者が操作部103を介して入力し、記憶部106が記憶している登録暗証番号と前記暗証番号とを照合することにより認証を行う。支払情報とは、利用者から代金支払の処理を要求する入力を受け付けたことを示す情報であり、送受信部101が、支払情報を前記Webサーバへ送信することにより、代金支払の処理が開始される。

【0015】前記電子マネー支払の処理において、送受信部101は、アンテナ107を介して、レジスター装置との間でデータを送受信し、送受信したデータを用いて、相互にチャレンジャーレスポンス型の認証を行う。携帯電話機10及び当該レジスター装置が共に認証に成功すると、送受信部101は、制御部102から電子マネー情報を受け取り、受け取った電子マネー情報をアンテナ107を介して当該レジスター装置に送信する。

【0016】ここで、電子マネー情報とは、貨幣と同等の価値を有する電子マネーを示す情報である。携帯電話機10は、記憶部106に電子マネー情報を記憶し、レジスター装置に、購入する商品の対価に等しい電子マネー情報を送信することにより、商品の決済を行うことが出来る。

(2) 制御部102

制御部102は、制御用コンピュータプログラムを記憶し、マイクロプロセッサが制御用コンピュータプログラムを実行することにより、携帯電話機10が有する通話、メール送受信、インターネット接続、電子マネーの支払及び指紋認証の機能を制御する。

【0017】制御部102は、指紋登録の処理において、指紋認証部104の受光部305から電気信号を受け取り、受け取った電気信号から指紋情報を生成する。更に、制御部102は、生成した指紋情報を登録指紋情報として、記憶部106に書き込む。制御部102は、

指紋認証の処理において、指紋認証部104の受光部305から電気信号を受け取り、受け取った電気信号から指紋情報を生成する。次に、制御部102は、記憶部106から登録指紋情報を読み出し、前記指紋情報と前記登録指紋情報とを比較する。前記指紋情報と前記登録指紋情報とが一致する場合、制御部102は、内部に記憶しているロックフラグを「オフ」に設定する。

【0018】なお、ここで言う、指紋情報の一致とは、前記指紋情報と前記登録指紋情報との誤差が所定値以下であることを示す。ここで、ロックフラグとは、操作部103を介した入力を受け付けないことを示す「オン」、及び操作部103を介した入力を受け付けることを示す「オフ」の何れかを示すフラグであり、具体的には、ロックフラグが「オン」の場合、制御部102は、操作部103を介して受け付ける入力により生成される入力情報を破棄し、ロックフラグが「オフ」の場合、制御部102は、操作部103を介して受け付ける入力により生成される入力情報に基づき処理を行う。

【0019】制御部102は、操作部103を介して入力を受け付けた最後の時刻からの時間を測定し、測定した時間が、予め設定した所定の時間以上になった時点で前記ロックフラグを「オン」に設定する。オンラインショッピングの処理において、制御部102は、送受信部101から受け取る複数の画面制御情報に基づき、各画面を生成し、生成した各画面を表示部105に出力する。制御部102は、表示部105が表示する各画面において、操作部103を介して受け付ける操作信号に応じた処理を行う。一例として、制御部102は、暗証番号の入力を受け付ける画面において暗証番号の入力を受け付け、記憶部106が記憶している登録暗証番号を読み出し、入力された前記暗証番号と登録暗証番号を照合する。

【0020】制御部102は、更に、前記暗証番号と登録暗証番号が一致することにより認証が成功すると、指紋認証部104を起動する指示を出力する。電子マネー支払の処理において、制御部102は、レジスタ装置との間でチャレンジレスポンス型の認証を行い、認証に成功すると、指紋認証部104を起動する指示を出力する。

【0021】通信の処理において、制御部102は、送受信部101を介して無線基地局から受信する各データに応じた処理を行う。一例として、制御部102は、呼設定メッセージを受信すると、内部に記憶しているロックフラグを読み、ロックフラグが「オフ」である場合は、呼設定受付メッセージを生成する。通信の処理における制御部102の機能の詳細は後述する。

【0022】更に、制御部102は、操作部103のキーロックが解除された状態において、操作部103が最後に操作入力を受け付けた時点からの時間を測定し、測定時間が、予め内部に記憶している所定の時間以上経過

すると、ロックフラグの設定を「オフ」から「オン」に替えて記憶する。

### (3) 操作部103

操作部103は、図2に示す様に、携帯電話機10の操作面に設けられたファンクションボタン（以下では「Fボタン」という）201と複数の操作ボタン202とを含む。

【0023】Fボタン201は、項目の選択、項目の決定、アイコンの選択、アイコンの決定及びカーソルの移動を行うボタンである。Fボタンは、光の透過性が高い材質から成り、表面には、指紋認証部104の一部である指紋読取面が設けられている。指紋認証部104については、次項に詳しく述べる。操作ボタン202は、「電源」、「0」、「1」、・・・、「9」等、Fボタン以外の全てのボタンを示す。

【0024】操作部103は、利用者から、電話番号の発信を受け付ける。操作部103は、また、表示部105が表示する各画面において、利用者から操作入力を受け付け、受け付けた操作入力に対応する操作信号を生成し、生成した操作信号を制御部102へ出力する。

### (4) 指紋認証部104

指紋認証については、特開2001-92960号公報、及び、特開2001-103046号公報に開示されているため、詳細な説明は省略し、ここでは、図3を用いて指紋認証部104の概略を説明する。

【0025】図3は、図2のA-A線における矢視断面の光の光路を示す概略図である。指紋認証部104は、制御部102からの指示を受けると、発光部303が光を照射する。照射された光は、光の光路に対し45度の角度をなすように位置するハーフミラー304を透過し、光路に対し垂直に設置された指紋読取面302に到達する。指紋読取面302に到達した光は、指紋読取面302上の指紋により反射する。指紋により反射した反射光は、更に、ハーフミラー304により光路を45度の角度で変化させ、反射光の光路に垂直に位置する受光部305へ到達する。

【0026】受光部305は、反射光を電気信号に変換し、変換した電気信号を制御部102へ出力する。

### (5) 表示部105

表示部105は、液晶ディスプレイを含み、制御部102が生成する複数の画面を液晶ディスプレイに表示する。表示部105は、更に、各画面において、操作部103を介して利用者から受け付ける操作入力に応じた内容を表示する。

【0027】具体例として、表示部105は、オンラインショッピングの処理において商品を紹介する画面、商品購入を申し込む画面、暗証番号の入力を受け付ける画面等を液晶ディスプレイ表示する。また、表示部105は、支払の処理において、携帯電話機10とレジスタ装置との間の認証が失敗すると、NGの処理として、

「電子マネー使用不可」というメッセージを液晶ディスプレイに表示する。

#### 【0028】(6) 記憶部106

記憶部106は、データを記憶する領域を有し、制御部102が書き込むデータを記憶する。具体例として、記憶部106は、制御部102が、操作部103を介して利用者から受け付ける登録暗証番号を記憶する。また、記憶部106は、制御部102が、指紋認証部104を介して利用者から受け付ける登録指紋を示す指紋情報を記憶する。

【0029】更に、記憶部106は、電子マネー情報を記憶している。電子マネー情報とは、商品購入の際に対価として用いることが出来る電子マネーを示す情報である。制御部102が商品の対価に等しい電子マネー情報を記憶部106から読み出し、読み出した電子マネー情報を、送受信部101及びアンテナ107を介して、レジスター装置に送信することにより、商品の決済を行うことが出来る。

【0030】<動作>ここでは、携帯電話機10の動作について、図4から図9に示すフローチャートを用いて、説明する。

#### (1) 全体の動作

携帯電話機10の全体の動作を、図4のフローチャートに示す。

【0031】制御部102は、操作部103を介して入力を受け付け(ステップS101)、受け付けた入力の種類を判断する(ステップS102)、受け付けた入力「ボタン」であるなら(ステップS102で「ボタン」)、携帯電話機10は、ボタンの処理を行う(ステップS103)。詳細は後述する。受け付けた入力「支払要求」であるなら(ステップS102で「支払要求」)、携帯電話機10は支払の処理を行う(ステップS104)。詳細は後述する。受け付けた入力「着信」であるなら(ステップS102で「着信」)、携帯電話機10は通信の処理を行う(ステップS105)。詳細は後述する。

#### 【0032】(2) ボタンの処理

ボタンの処理における携帯電話機10の処理について、図5に示すフローチャートを用いて説明する。なお、ここで説明する動作は、図4のフローチャートにおけるステップS103の詳細である。制御部102は、操作部103を介して入力を受け付けたボタンが、「Fボタン」であるか否か判断する(ステップS201)、受け付けたボタンが「Fボタン」であるなら(ステップS201でYES)、制御部102は、内部に記憶しているロックフラグを読み、操作部103がキーロック状態であるか否か判断する(ステップS202)。ロックフラグが「オフ」に設定され、操作部103がキーロック状態でないなら(ステップS202でNO)、ステップS101に戻り処理を続ける。ロックフラグが「オン」に

設定され、操作部103がキーロック状態であるなら(ステップS202でYES)、制御部102は、指紋認証部104を起動する指示を出力し、指紋認証部104は、当該利用者の指紋情報が登録指紋情報と一致するか否か判断することにより指紋認証を行う(ステップS203)。当該利用者の指紋情報が登録指紋情報と一致し、正当な利用者であることが認証されると(ステップS204でOK)、制御部102は、ロックフラグを「オフ」に設定することにより、キーロックを解除する(ステップS205)。その後、ステップS101に戻り処理を続ける。当該利用者の指紋情報が登録指紋情報と一致せず、正当な利用者でない判断されると(ステップS204でNG)、ステップS101に戻る。

【0033】操作部103を介して入力を受け付けたボタンが「Fボタン」でないなら(ステップS201でNO)、制御部102は、内部に記憶しているロックフラグを読み、操作部103がキーロック状態であるか否か判断し、ロックフラグが「オン」に設定され、操作部103がキーロック状態であるなら(ステップS206でYES)、ステップS101に戻り処理を続ける。ロックフラグが「オフ」に設定され、操作部103がキーロック状態でないなら(ステップS202でYES)、制御部102は、受け付けたボタンの種類を判断する(ステップS207)。

【0034】受け付けたボタンが「サイト接続」であるなら(ステップS207でサイト)、携帯電話機10は、オンラインショッピングの処理を行う(ステップS208)。詳細は後述する。受け付けたボタンが「その他」であるなら(ステップS207で他)、携帯電話機10は、ボタンに対応した処理を行う(ステップS209)。受け付けたボタンが「登録」であるなら(ステップS207で登録)、携帯電話機10は、指紋登録の処理を行う(ステップS210)。詳細は後述する。

【0035】(3) オンラインショッピングの処理  
オンラインショッピングの処理における携帯電話機10の動作について、図4に示すフローチャートを用いて説明する。なお、ここで説明する動作は、図5のフローチャートにおけるステップS208の詳細である。送受信部101は、アンテナ107及びインターネットを介してオンラインショッピング業者が有する装置のWebサーバに接続する(ステップS301)。表示部105は、商品を紹介する画面、及び、商品の購入を受け付ける画面を表示する。制御部102は、前記商品の購入を受け付ける画面において、操作部103を介して、利用者から購入する商品の入力を受け付ける(ステップS302)。

【0036】次に、表示部105は、暗証番号の入力を受け付ける画面を表示し、制御部102は、前記暗証番号の入力を受け付ける画面において、操作部103を介して、利用者から、暗証番号の入力を受け付ける(ステ

ップS303)。制御部102は、受け付けた暗証番号が、記憶部106に記憶されている登録暗証番号と一致するか否かを判断することにより、当該利用者が正当な利用者であるか認証を行う(ステップS304)。

【0037】受け付けた暗証番号が、記憶部106に記憶されている登録暗証番号と異なる場合は(ステップS304でNG)、ステップS303へ戻り処理を続ける。受け付けた暗証番号が、記憶部106に記憶されている登録暗証番号と一致する場合は(ステップS304でOK)、制御部102は、指紋認証部104を起動する指示を出力し、指紋認証部104は、利用者の指紋情報が登録指紋情報と一致するか否かを判断することにより当該利用者が正当な利用者であるか認証を行う(ステップS305)。当該利用者の指紋情報が、登録指紋情報と一致する場合は(ステップS306でOK)、送受信部101を介して支払情報を送信することにより購入の処理を行う(ステップS307)。

【0038】登録指紋情報と一致しない場合は(ステップS306でNG)、NGが3回目か否かを判断し(ステップS308)、NGが3回目なら(ステップS308でYES)、制御部102は、ロックフラグをオンに設定し、操作部103をキーロック状態にする(ステップS309)。NGが3回目でないなら(ステップS308でNO)、ステップS305に戻り、処理を続ける。

【0039】(4) 登録の処理  
登録の処理における携帯電話機10の処理について、図7に示すフローチャートを用いて説明する。なお、ここで説明する動作は、図5のフローチャートにおけるステップS210の詳細である。制御部102は、操作部103を介して指紋登録の入力を受け付けると、記憶部106に登録指紋情報が記憶されているか否かを判断する(ステップS601)。登録指紋情報が記憶されている場合(ステップS601でYES)、ステップS101に戻り処理を続ける。

【0040】登録指紋情報が記憶されていない場合(ステップS601でNO)、制御部102は、指紋認証部104を起動する指示を出力し、指紋認証部104が起動する(ステップS602)。指紋認証部104は、Fボタンに接触された指の指紋を読み取り(ステップS603)、読み取った指紋を電気信号に変換し(ステップS604)、電気信号を制御部102へ出力する。制御部102は、電気信号を受け取り、受け取った電気信号を登録指紋情報として記憶部106に書き込む(ステップS605)。

【0041】(5) 支払の処理  
支払の処理における携帯電話機10の動作について、図8に示すフローチャートを用いて説明する。なお、ここで説明する動作は、図4のフローチャートにおけるステップS104の詳細である。携帯電話機10は、貨幣と

同等の価値を有する電子マネーを示す電子マネー情報を記憶部106に記憶しており、商品購入時に携帯電話機10とレジスター装置とが無線通信により前記電子マネー情報の送受信を行うことで、利用者は、商品を購入する。

【0042】まず、携帯電話機10は、当該レジスター装置が正当なレジスター装置であるか否かを認証する(ステップS401)。ここでいう認証方法は、具体的には、チャレンジレスポンス型の認証である。当該レジスター装置が正当なレジスター装置でない場合は(ステップS402でNG)、携帯電話機10の制御部102は、表示部105に「電子マネー使用不可」というメッセージを表示し、送受信部101を介した無線通信を停止することにより、NGの処理を行う(ステップS403)。

【0043】当該レジスター装置が正当なレジスター装置である場合は(ステップS402でOK)、当該レジスター装置は、携帯電話機10が正当な携帯電話機であるか否かを認証する(ステップS404)。ここでいう認証方法は、具体的には、チャレンジレスポンス型の認証である。携帯電話機10が正当な携帯電話機でない場合は(ステップS405でNG)、ステップS403と同様にNGの処理を行う(ステップS406)。携帯電話機10が正当な携帯電話機である場合は(ステップS405でOK)、制御部102は、指紋認証部104を起動する指示を出力し、指紋認証部104は、当該利用者の指紋情報が、記憶部106に記憶されている登録指紋情報に一致するか否かを判断することにより、指紋認証を行う(ステップS407)。

【0044】当該利用者の指紋情報が登録指紋情報と一致する場合は(ステップS408でOK)、制御部102は、購入する商品の対面に等しい電子マネー情報を、送受信部101及びアンテナ107を介してレジスター装置に送信し、記憶部106が記憶している電子マネー情報から、送信した前記電子マネー情報を差し引く(ステップS409)。

【0045】当該利用者の指紋情報が登録指紋情報と一致しない場合は(ステップS408でNG)、NGが3回目か否かを判断し(ステップS410)、NGが3回目であるなら(ステップS410でYES)、制御部102は、ロックフラグを「オン」に設定し、操作部103をキーロック状態にする(ステップS411)、NGが3回目でない場合は(ステップS410でNO)、ステップS407に戻り、処理を続ける。

【0046】(6) 通信の処理  
通信の処理における携帯電話機10の動作について、図9に示すフローチャートを用いて説明する。なお、ここで説明する動作は、図4に示すフローチャートにおけるステップS105の詳細であり、携帯電話機10と無線基地局との間の信号の送受信を示している。まず、無線

基地局は、着呼メッセージを送信し、携帯電話機10の制御部102は、アンテナ107及び送受信部101を介して、前記着呼メッセージを受信する(ステップS501)。制御部102は、着呼応答メッセージを生成する(ステップS502)。制御部102は、生成した着呼応答メッセージを、送受信部101及びアンテナ107を介して無線基地局に送信し、無線基地局は、前記着呼応答メッセージを受信する(ステップS503)。

【0047】次に、無線基地局は、呼設定メッセージを生成する(ステップS504)。無線基地局は、生成した呼設定メッセージを、アンテナ107及び送受信部101を介して制御部102に送信し、送受信部101は前記呼設定メッセージを受信する(ステップS505)。制御部102は、前記呼設定メッセージを受信すると、内部に記憶しているロックフラグを読み、(ステップS506)、ロックフラグが「オン」に設定されている場合(ステップS506でYES)、ステップS101に戻り、処理を続ける。

【0048】ロックフラグが「オフ」に設定されている場合(ステップS506でNO)、制御部102は、呼設定受付メッセージを生成する(ステップS507)。制御部102は、送受信部101及びアンテナ107を介して、前記呼設定受付メッセージを無線基地局に送信し、無線基地局は前記呼設定受付メッセージを受信する(ステップS508)。

【0049】次に、制御部102は、認証に用いる秘鍵を生成し(ステップS509)、生成した秘鍵を含む秘鍵設定メッセージを、送受信部101及びアンテナ107を介して無線基地局に送信し、無線基地局は前記秘鍵設定メッセージを受信する(ステップS510)。無線基地局は、前記秘鍵設定メッセージを受信すると、認証乱数を生成する(ステップS511)。無線基地局は、生成した認証乱数を含む認証要求メッセージを、アンテナ107及び送受信部101を介して制御部102へ送信し、制御部102は前記認証要求メッセージを受信する(ステップS512)。前記認証要求メッセージを受信した制御部102は、受信した認証乱数と自身が持つ認証鍵を用いて演算を実行し(ステップS513)、演算結果を含む認証応答メッセージを、送受信部101及びアンテナ107を介して無線基地局へ送信し、無線基地局は、前記認証応答メッセージを受信する(ステップS514)。前記認証応答メッセージを受信した無線基地局は、同様に認証乱数と認証鍵とを用いて演算を実行し、演算結果が、前記認証応答メッセージに含まれる演算結果と一致するか否かを判断する(ステップS515)。

【0050】制御部102は、前記認証応答メッセージを送信すると、次に、応答メッセージを生成し(ステップS516)、生成した応答メッセージを無線基地局に送信することにより着信の受付を通知し、無線基地局は

前記応答メッセージを受信する(ステップS517)。前記応答メッセージを受信した無線基地局は、応答確認メッセージを生成し(ステップS518)、生成した前記応答確認メッセージを、アンテナ107及び送受信部101を介して制御部102へ送信し、制御部102は前記応答確認メッセージを受信する(ステップS519)。制御部102が前記応答確認メッセージを受信することにより、携帯電話機10は通話状態となる(ステップS520)。その後、携帯電話機10は、ステップS101に戻り処理を続ける。

【0051】<まとめ>以上説明したように、本発明によると、携帯電話機10は指紋認証機能を有する。携帯電話機10の正当なユーザが、予め自分の指紋を登録することにより、操作者の指紋を読み取り、操作者の指紋と登録済みの指紋を照合することにより、正当なユーザか他ユーザかを認識できる。

【0052】携帯電話機10は、通常の待ち受け時はキーロック状態である。操作者の指紋が登録指紋と一致する場合のみ、キーロック状態が解除され、操作者の指紋と登録指紋が一致しない場合はキーロックが継続される。そのため、正当なユーザのみが携帯電話機10を利用することができる。<その他の変形例>本発明を、上記実施の形態に基づき説明してきたが、本発明は、上記実施の形態に限定されず、以下の様な場合も、本発明に含まれる。

【0053】(1)上記実施の形態では、指紋認証部104の指紋読取面302はFボタンの表面に設けられているが、指紋読取面302の位置はFボタンの表面に限定されないのは勿論であり、Fボタン以外の複数の操作ボタンの内、何れか1個のボタンの表面、或いは複数のボタンの表面に設けられている場合も本発明に含まれる。更には、指紋読取面302が、表示部105の液晶ディスプレイの表面等、携帯電話機10の何れの位置に設けられている場合も本発明に含まれる。

【0054】(2)上記実施の形態における携帯電話機10は、キーロック状態では指紋認証により正当な利用者であると認証された場合に、着信を受け付ける構成としているが、キーロック状態であっても着信があったときは、指紋認証機能がオフになる構成としてもよい。また、キーロック状態であってもメール受信があったときは、指紋認証機能がオフになる構成としてもよい。

【0055】(3)上記実施の形態におけるオンラインショッピングの「商品」とは、着信メロディーのダウンロードを含み、更には、役務も含む概念とする。

(4)携帯電話機は、予め1個の電話番号を記憶し、通話ボタンを押して発呼状態であるときに指紋認証を行うと、前記電話番号を読み出し、前記電話番号へ発呼する構成としてもよい。

【0056】(5)携帯電話機は、例えば、3人からなる家族が共用するとしてもよい。携帯電話機は、前記3

人の3個の指紋情報をそれぞれ記憶する3個の記憶領域を備え、前記3人がそれぞれ個別に用いる3個の個別電話番号リストを備え、前記3人が共通に用いる1個の共用電話番号リストを備える。前記電話番号リストには、当該携帯電話機以外の電話機の電話番号などが記憶されている。

【0057】携帯電話機は、操作者の指紋を読み取り、読み取った指紋の指紋情報が前記記憶領域に記憶されているいずれかの指紋情報と一致するか否かを判断する。一致する指紋情報が存在しない場合には、上記の実施の形態と同様に、携帯電話機の利用は禁止される。いずれかの指紋情報と一致する場合には、携帯電話機は、一致する指紋情報と対応する個別電話番号リストの利用を前記操作者に対して許可する。他の個別電話番号リストの利用を前記操作者に対して禁止する。また、共用電話番号リストの利用を前記操作者に対して許可する。また、前記操作者に対して、電話番号の発信を許可する。また、前記操作者に対して、前記一致する指紋情報と対応する個別電話番号リストに記憶されている電話番号を発信者とする着信を許可する。

【0058】この様に、家族で1個の携帯電話機を共用する場合において、家族以外の他人には、携帯電話機の利用を禁止する。また、家族内においても、当人に割り当てられた個別電話番号リストの参照及び利用を許可し、家族内の他の人に割り当てられた個別電話番号リストの参照及び利用は、禁止する。また、共用電話番号リストは、家族の全員により参照及び利用が許可される。

【0059】(6)上記実施の形態において、制御部102は、予め所定の時間を記憶しており、操作部103が最後に操作入力を受け付けた時点からの測定時間が前記所定の時間を経過すると、ロックフラグを「オン」に設定する構成としているが、前記所定の時間は、携帯電話機10の利用者が設定できる構成としてもよい。

(7)上記実施の形態及び上記変形例をそれぞれ組み合わせる構成としてもよい。

【0060】

【発明の効果】以上説明した様に、本発明は、利用を禁止されている状態にある携帯電話機であって、当該携帯電話機を操作した操作者の指紋を読み取り、読み取った指紋を示す指紋情報を用いて、前記操作者が当該携帯電話機の正当な利用者か否か認識する認識手段と、正当な利用者と認識された場合のみ、当該携帯電話機の利用を許可する許可手段とを備えることを特徴とする携帯電話機である。

【0061】この構成によると、当該携帯電話機は、個人に特有の生体情報である指紋を用いて正当な利用者か否かを認識するため、確実に当該携帯電話機の正当な利用者を認識することが出来る。ここで、前記認識手段は、予め、前記正当な利用者の指紋を示す指紋情報を記憶している記憶部と、前記操作者の指紋を読み取る読取

部とを含み、前記記憶部が記憶している指紋情報と前記読取部が読み取る指紋を示す指紋情報とが一致するか否か判定することにより、正当な利用者か否か認識するように構成してもよい。

【0062】この構成によると、当該携帯電話機は、正当な利用者の指紋情報を記憶しているため、操作者の指紋情報と正当な利用者の指紋情報とを比較し、操作者が正当な利用者か否かを確実に認識することが出来る。ここで、前記許可手段は、前記操作者が正当な利用者と認識されない場合、前記操作者の入力操作により生成された入力情報を破棄するように構成してもよい。

【0063】この構成によると、操作者が正当な利用者でないとして認識された場合、操作者に当該携帯電話機を利用することを禁止することができる。ここで、前記携帯電話機は、商品を販売する販売装置と接続されており、前記操作者は前記携帯電話機を用いて販売装置から商品を購入し、前記許可手段は、さらに、前記操作者が正当な利用者であると認識された場合に、前記操作者が購入する商品の代金の支払処理を行う支払手段を含むように構成してもよい。

【0064】この構成によると、正当な利用者のみが購入代金を支払うことができる。ここで、前記携帯電話機は、ネットワークを介して販売装置と接続されており、前記支払手段は、ネットワークを介したオンラインショッピングにおいて、前記販売装置に商品の購入を示す支払情報を送信するように構成してもよい。この構成によると、ネットワークを介したオンラインショッピングにおいて、正当な利用者のみが購入代金を支払うことができる。

【0065】ここで、前記携帯電話機は、貨幣と同等の価値を有する電子マネー情報を記憶しており、前記支払手段は、購入する商品の代金に等しい電子マネー情報を、前記販売装置に送信するように構成してもよい。この構成によると、レジスター装置での支払いにおいて、正当な利用者のみが電子マネーを用いて購入代金を支払うことが出来る。

【0066】ここで、前記読取部は、操作者が読み取りの対象となる指を接触させる読取面を備え、前記読取面は、複数の機能を有するファンクションキーの表面に設けられている構成してもよい。この構成によると、ファンクションキーを用いて複数の機能の内、一つを選択すると同時に指紋認証を行うことが出来るので、操作手順が簡略化される。

【0067】ここで、前記読取部は、操作者が読み取りの対象となる指を接触させる読取面を備え、前記読取面は、操作を受け付ける操作キーの表面に設けられている構成してもよい。この構成によると、操作と同時に指紋認証を行うことが出来るので、操作手順が簡略化される。

【0068】ここで、前記許可手段は、さらに、正当な



利用者と認識された後、操作者から最後の操作を受け付けた直後からの時間を測定する測定手段と、測定した時間が所定時間以上である場合は、当該携帯電話機の利用を禁止状態とする禁止手段とを含むように構成してもよい。この構成によると、最後の操作を受け付けた後、所定時間が経過すると携帯電話機の利用が禁止されるので、利用者は改めて、禁止の操作をする必要がない。

【0069】ここで、前記許可手段は、着信があった場合、前記認識手段の認識結果に関わらず、通話、又は電子メール受信を許可するように構成してもよい。この構成によると、緊急の着信に素早く応答することが出来る。ここで、前記許可手段は、さらに、予め1個の電話番号を記憶している記憶手段と、正当な利用者であると認識された場合に、前記電話番号を読み出す読出手段と、読み出した前記電話番号へ発呼する発呼手段とを含むように構成してもよい。

【0070】この構成によると、指紋認証と同時に特定の電話番号に発信するので、発信操作が簡略化される。

【図面の簡単な説明】

【図1】携帯電話機10の構成を示すブロック図である。

【図2】携帯電話機10の操作部103の図である。

【図3】携帯電話機10の指紋認証部104の図である。

【図4】携帯電話機10の全体の動作を示すフローチャートである。

【図5】携帯電話機10のボタンの処理における動作を示すフローチャートであり、図4のフローチャートにおけるステップS103の詳細である。

【図6】携帯電話機10のオンラインショッピングの処

理における動作を示すフローチャートであり、図5のフローチャートにおけるステップS208の詳細である。

【図7】携帯電話機10の指紋登録の処理における動作を示すフローチャートであり、図5のフローチャートにおけるステップS210の詳細である。

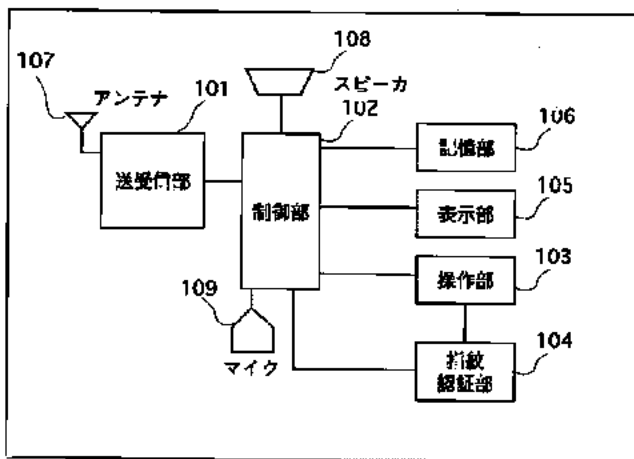
【図8】携帯電話機10の支払処理における動作を示すフローチャートであり、図4のフローチャートにおけるステップS104の詳細である。

【図9】携帯電話機10と無線基地局における通信の処理を示すフローチャートであり、図4のフローチャートにおけるステップS105の詳細である。

【符号の説明】

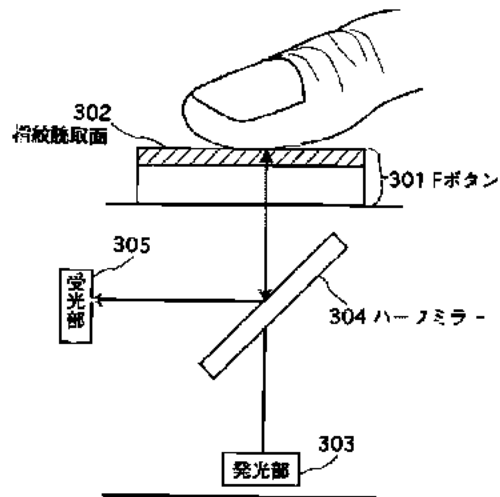
- 10 携帯電話機
- 101 送受信部
- 102 制御部
- 103 操作部
- 104 指紋認証部
- 105 表示部
- 106 記憶部
- 107 アンテナ
- 108 スピーカー
- 109 マイク
- 201 Fボタン
- 202 操作ボタン
- 301 Fボタン
- 302 指紋読取面
- 303 発光部
- 304 ハーフミラー
- 305 受光部

【図1】

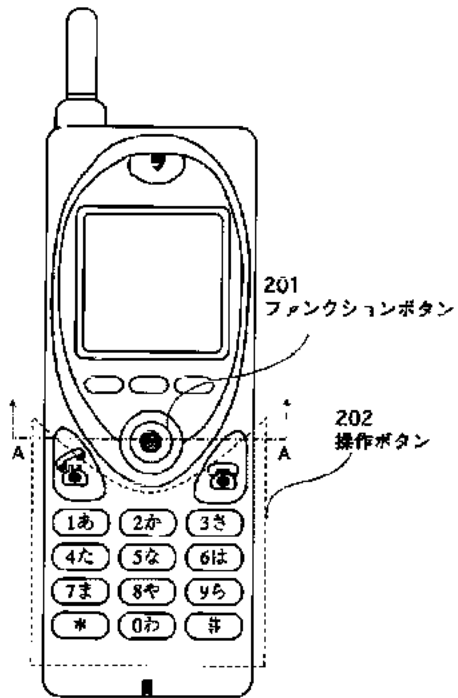


携帯電話機 10

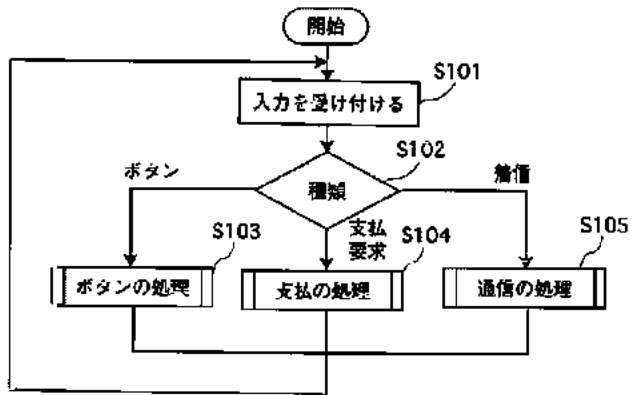
【図3】



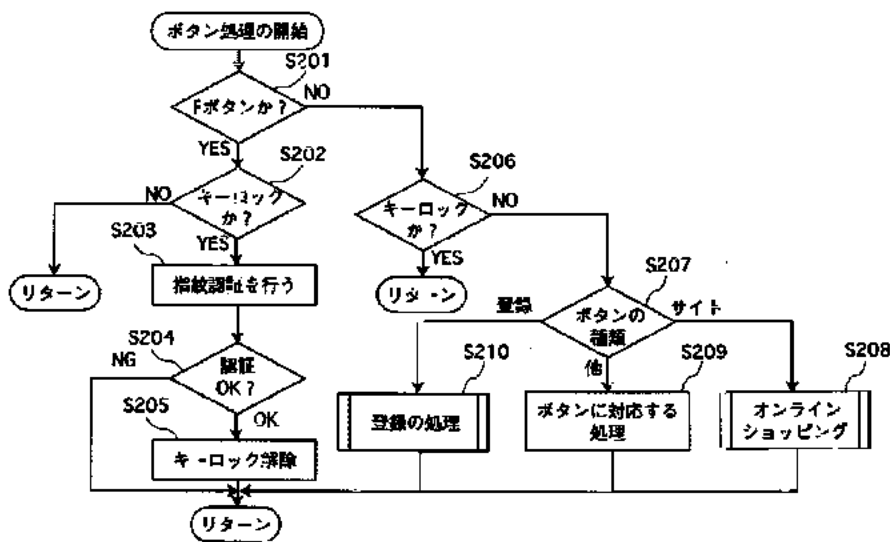
【図2】



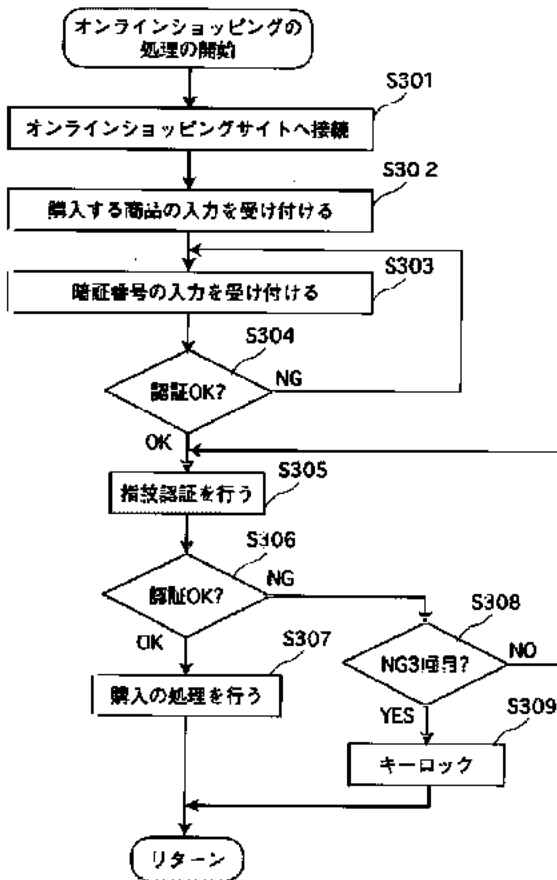
【図4】



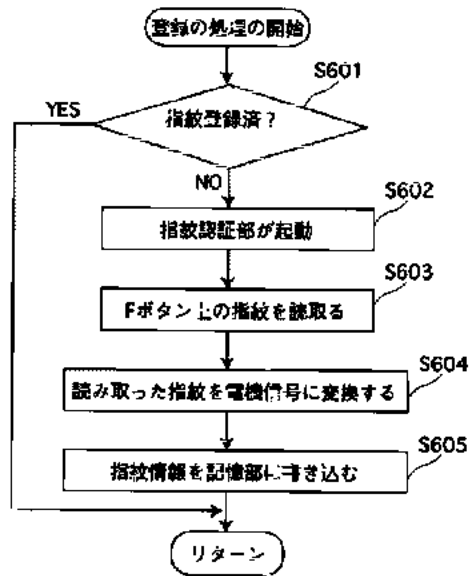
【図5】



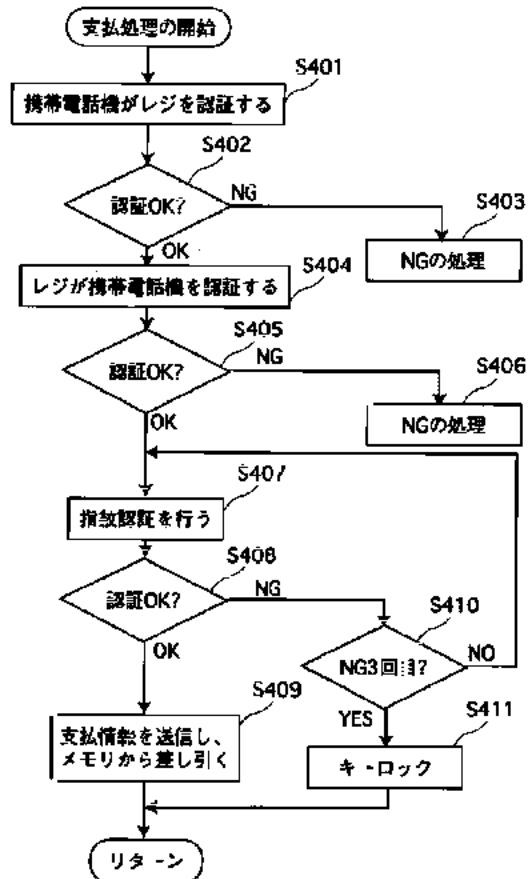
【図6】



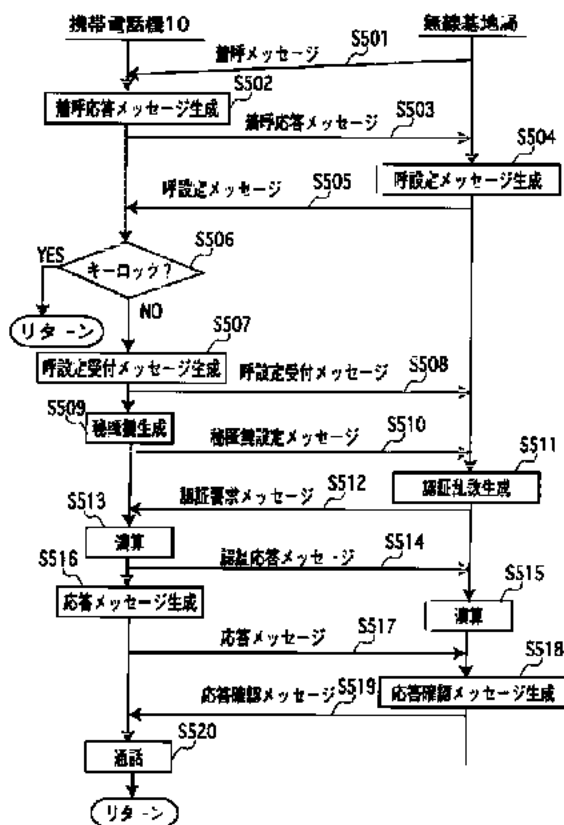
【図7】



【図8】



【 図 9 】



フロントページの続き

(51) Int. Cl. <sup>7</sup>	識別記号	F I	(参考)
H 0 4 M	1/21	H 0 4 M	1/21 Z
	1/725		1/725
H 0 4 Q	7/38	H 0 4 B	7/26 1 0 9 S

Fターム(参考) 3E042 C101  
 5K023 AA07 BB23 HH07 MM01 MM25  
 5K027 AA11 BB09 HH11 HH23 MM17  
 5K067 AA32 BB04 DD17 FF07 GG01  
 GG11 HH05 HH24



Espacenet

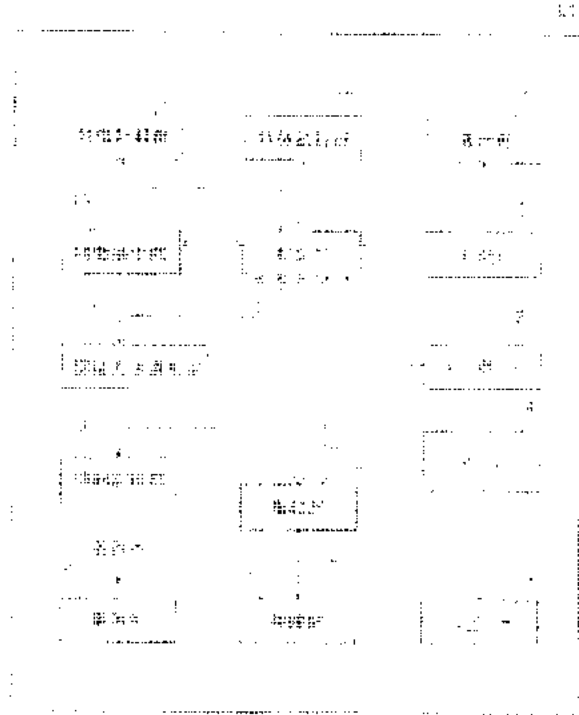
Bibliographic data: JP2004080080 (A) — 2004-03-11

## PORTABLE TELEPHONE WITH PERSONAL AUTHENTICATING FUNCTION SET

**Inventor(s):** KINOSHITA MASAFUMI ± (KINOSHITA MASAFUMI)**Applicant(s):** MATSUSHITA ELECTRIC IND CO LTD ± (MATSUSHITA ELECTRIC IND CO LTD)**Classification:** - **international:** G06F15/00; G06F21/31; G06F21/32; H04L9/14; H04L9/32; H04M1/667; H04W12/02; H04W12/08; (IPC1-7): G06F15/00; H04L9/14; H04L9/32; H04M1/667; H04Q7/38- **cooperative:****Application number:** JP20020233645 20020809 Global Dossier**Priority number (s):** JP20020233645 20020809

## Abstract of JP2004080080 (A)

PROBLEM TO BE SOLVED: To provide a portable telephone set with a personal authenticating function which can be set to a security level in response to a using mode. SOLUTION: A portable telephone 100 with the personal authenticating function includes an authenticating method selecting storage unit 13 for selecting at least one personal authenticating method from a plurality of personal authenticating methods and storing the selected authenticating method, an information storage unit 9 for storing input information used for the authenticating method stored in the storage unit 13, a feature extracting unit 10 for extracting the feature information from the input information stored in the storage unit 9 as authenticating information, a feature recorder 11 for previously recording the feature information of the user, and a feature authenticating unit 12 for personal authenticating the user by comparing the feature information previously recorded in recorder 11 with the authenticating information extracted by the extracting unit 10. :COPYRIGHT: (C)2004,JPO



(19) 日本国特許庁(JP)

(12) 公開特許公報(A)

(11) 特許出願公開番号

特開2004-80080

(P2004-80080A)

(13) 公開日 平成16年3月11日(2004.3.11)

(51) Int. Cl. <sup>7</sup>	F I	テーマコード (参考)
HO4M 1/667	HO4M 1/667	5B085
GO6F 15/00	GO6F 15/00 330B	5J104
HO4L 9/14	GO6F 15/00 330F	5K027
HO4L 9/32	HO4L 9/00 673D	5K067
HO4Q 7/38	HO4B 7/26 109R	

審査請求 未請求 請求項の数 4 O L (全 15 頁) 最終頁に続く

(21) 出願番号 特願2002-233645 (P2002-233645)  
 (22) 出願日 平成14年8月9日 (2002.8.9)

(71) 出願人 000005821  
 松下電器産業株式会社  
 大阪府門真市大字門真1006番地  
 (74) 代理人 100105647  
 弁理士 小栗 昌平  
 (74) 代理人 100105474  
 弁理士 本多 弘徳  
 (74) 代理人 100108589  
 弁理士 市川 利光  
 (74) 代理人 100115107  
 弁理士 高松 猛  
 (74) 代理人 100090343  
 弁理士 栗宇 百合子

最終頁に続く

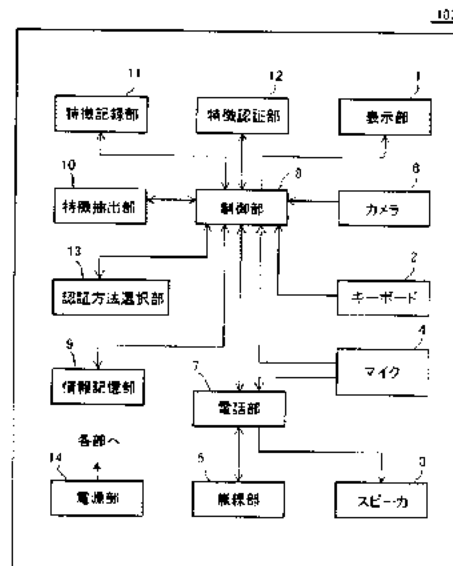
(54) 【発明の名称】 個人認証機能付き携帯電話機

(57) 【要約】

【課題】 使用形態に応じたセキュリティレベルの設定を行うことが可能な個人認証機能付き携帯電話機を提供する。

【解決手段】 個人認証機能付き携帯電話機100は、複数の個人認証方法から少なくとも一つの個人認証方法を選択し、当該選択された個人認証方法を記憶する認証方法選択記憶部13と、前記認証方法選択記憶部13に記憶された前記個人認証方法に用いられる入力情報を記憶する情報記憶部9と、前記情報記憶部9に記憶された前記入力情報から特徴情報を認証情報として抽出する特徴抽出部10と、予め使用者の特徴情報を記録する特徴記録部11と、前記特徴記録部11に予め記録された前記特徴情報と、前記特徴抽出部10により抽出された前記認証情報とを比較することにより使用者の個人認証を行う特徴認証部12と、を備えている。

【選択図】 図2



## 【特許請求の範囲】

## 【請求項 1】

複数の個人認証方法から少なくとも1つの個人認証方法を選択し、当該選択された個人認証方法を記憶する認証方法選択記憶部と、  
前記認証方法選択記憶部に記憶された前記個人認証方法に用いられる入力情報を記憶する情報記憶部と、  
前記情報記憶部に記憶された前記入力情報から特徴情報を認証情報として抽出する特徴抽出部と、  
予め使用者の特徴情報を記録する特徴記録部と、  
前記特徴記録部に予め記録された前記特徴情報と、前記特徴抽出部により抽出された前記認証情報とを比較することにより使用者の個人認証を行う特徴認証部と、  
を備えたことを特徴とする個人認証機能付き携帯電話機。

10

## 【請求項 2】

前記入力情報は画像情報であることを特徴とする請求項 1 に記載の個人認証機能付き携帯電話機。

## 【請求項 3】

前記入力情報は音声情報であることを特徴とする請求項 1 に記載の個人認証機能付き携帯電話機。

## 【請求項 4】

前記入力情報はキー入力情報であることを特徴とする請求項 1 に記載の個人認証機能付き携帯電話機。

20

## 【発明の詳細な説明】

## 【0001】

## 【発明の属する技術分野】

本発明は、携帯電話や PHS などの移動体通信システムに用いられる携帯電話機に関し、特に、個人認証により不正使用を防止する個人認証機能付き携帯電話機に関する。

## 【0002】

## 【従来の技術】

近年、その利便性から普及が著しい携帯電話機は、データ通信機能の搭載により、電子メールの送受信からインターネットショッピングまで、多機能化が進んでいる。物品購入や振込などの電子決済処理が携帯電話機から簡単な操作で行えるようになる一方で、他人の携帯電話機を使用して本来の所有者になりすます不正使用が社会的問題となっている。

30

## 【0003】

携帯電話機の使用者の認証方法として、従来は、キーボードから入力されたパスワードを照合する方法が一般的であった。以下に従来の個人認証機能付き携帯電話機の一例について説明する。

## 【0004】

図 14 は、従来の個人認証機能付き携帯電話機の一例の外観を示す斜視図である。携帯電話機 200 は、主に、電話番号などの各種文字情報を表示する表示部 21、電話番号やパスワードの入力などを行うキーボード 22、音声を出力するスピーカ 23、音声を入力するマイク 24、送受信および情報の送受信を無線で行う後述する無線部 25 のアンテナ 25a、で構成されている。

40

## 【0005】

図 15 は、図 14 に示した従来の個人認証機能付き携帯電話機の電氣的構成を示すブロック図である。表示部 21、キーボード 22、スピーカ 23、マイク 24、無線部 25 は、電話の発呼や着呼などの制御を行う電話部 26 と接続している。キーボード 22 から入力した内容や受信した情報などは表示部 21 に表示され、電話の受話や送話などはスピーカ 23 やマイク 24 を通じて行われる。また、電話部 26 は、無線部 25 を介してダイヤル情報や通信情報を無線信号で送受信する。電話部 26 は、電話番号やパスワード、音声などの情報を記憶する情報記憶部 27 とも接続している。電源部 28 は、上記の各部に電力

50



を供給する。

【0006】

次に、図16は、図14に示した従来の個人認証機能付き携帯電話機における個人認証動作の流れを示すフローチャートである。まず、使用者が携帯電話機200の電源を投入すると(ステップS701)、電源部28から各部へ電力が供給され、各部が動作を開始する。次に、パスワードの入力を促すメッセージが表示部21に表示されるので(ステップS702)、使用者がキーボード22からパスワードを入力すると(ステップS703)、入力されたパスワードが情報記憶部27に予め登録されているパスワードと比較、照合される(ステップS704)。次に、入力されたパスワードが情報記憶部27に予め登録されているパスワードと一致しているか否かの判定が行われる(ステップS705)。ステップS705で、入力されたパスワードが不一致ならばステップS702に戻って、使用者はパスワードを再度入力する。一方、入力されたパスワードが一致していれば正当な使用者と判定され、個人認証が終了して(ステップS706)、携帯電話機200の利用が可能となる(ステップS707)。

10

【0007】

【発明が解決しようとする課題】

上述したような従来の携帯電話機200における個人認証方法では、生年月日などの簡単な数字列をパスワードとして設定している場合や、入力時の操作を見られてしまった場合などには、悪意のある他人が簡単に不正使用でまってしまうという課題があった。例えば、パスワードの桁数を多くするという対策も考えられるが、パスワード忘れや入力誤りなどの問題が生じるため、根本的な解決にはなっていない。

20

【0008】

また、前述の通り携帯電話機が多機能化し、電子決済などが可能になると、これまでのパスワードによる認証だけでは不十分で、使用形態に応じたセキュリティレベルの設定が必要となっている。

【0009】

そこで、本発明は、このような実情に鑑みてなされたものであり、使用形態に応じたセキュリティレベルの設定を行うことができる個人認証機能付き携帯電話機を提供することを目的とする。

【0010】

【課題を解決するための手段】

請求項1に係る個人認証機能付き携帯電話機は、複数の個人認証方法から少なくとも1つの個人認証方法を選択し、当該選択された個人認証方法を記憶する認証方法選択記憶部と、前記認証方法選択記憶部に記憶された前記個人認証方法に用いられる入力情報を記憶する情報記憶部と、前記情報記憶部に記憶された前記入力情報から特徴情報を認証情報として抽出する特徴抽出部と、予め使用者の特徴情報を記録する特徴記録部と、前記特徴記録部に予め記録された前記特徴情報と、前記特徴抽出部により抽出された前記認証情報とを比較することにより使用者の個人認証を行う特徴認証部と、を備えたことを特徴とする。

30

【0011】

このように構成された個人認証機能付き携帯電話機によれば、個人認証のための複数の認証方法から選択された少なくとも1つの方法が記録され、個人認証が行われるようになっていので、使用者は認証方法を選択することにより使用形態に応じたセキュリティレベルの設定を行うことができる。

40

【0012】

また、請求項2に係る個人認証機能付き携帯電話機は、請求項1に記載の個人認証機能付き携帯電話機において、前記入力情報は画像情報であることを特徴とする。

【0013】

このように構成された個人認証機能付き携帯電話機によれば、画像情報に基づくセキュリティレベルの高い個人認証を行うことができる。

【0014】

50

また、請求項 3 に係る個人認証機能付き携帯電話機は、請求項 1 に記載の個人認証機能付き携帯電話機において、前記入力情報は音声情報であることを特徴とする。

【0015】

このように構成された個人認証機能付き携帯電話機によれば、音声情報に基づくセキュリティレベルの高い個人認証を行うことができる。

【0016】

また、請求項 4 に係る個人認証機能付き携帯電話機は、請求項 1 に記載の個人認証機能付き携帯電話機において、前記入力情報はキー入力情報であることを特徴とする。

【0017】

このように構成された個人認証機能付き携帯電話機によれば、キー入力情報に基づくセキュリティレベルの高い個人認証を行うことができる。 10

【0018】

【発明の実施の形態】

以下、本発明に係る個人認証機能付き携帯電話機の好ましい実施の形態について、図面を用いて詳細に説明する。なお、実施の形態を説明するものの全図において、同一機能を有する部位は同一符号を付し、説明は繰り返さないこととする。

【0019】

(実施の形態 1)

図 1 は、本発明の実施の形態 1 における個人認証機能付き携帯電話機の外観を示す斜視図である。個人認証機能付き携帯電話機 100 は、主に、電話番号などの各種文字情報や画像情報などを表示する表示部 1、電話番号やパスワードの入力などを行うキーボード 2、音声を出力するスピーカ 3、音声を入力するマイク 4、送受信および情報の送受信を無線で行う後述する無線部 5 のアンテナ 5a、画像を入力するカメラ 6、で構成されている。 20

【0020】

図 2 は、本発明の実施の形態 1 における個人認証機能付き携帯電話機の電氣的構成を示すブロック図である。表示部 1、キーボード 2、スピーカ 3、マイク 4、カメラ 6、および電話の発呼や着呼などの制御を行う電話部 7 は、携帯電話機 100 全体の制御を行う制御部 8 と接続している。キーボード 2 から入力した内容、カメラ 6 で取得した画像、受信した情報などは表示部 1 に表示され、電話の送受信および音声の記録などはスピーカ 3 やマイク 4 を通じて行われる。また、電話部 7 は、無線部 5 を介してダイヤル情報や通信情報 30 を無線信号で送受信する。制御部 8 は、個人認証のための複数の認証方法から選択された 1 つの方法を記録する認証方法選択部 13、前記 1 つの方法に用いられる入力情報を記憶する情報記憶部 9、情報記憶部 9 に記憶された入力情報から特徴情報を抽出する特徴抽出部 10、特徴抽出部 10 により抽出された特徴情報を認証情報として記録する特徴記録部 11、使用者による入力情報から特徴抽出部 10 により抽出された特徴情報を特徴記録部 11 に予め記録された認証情報と比較することにより使用者の個人認証を行う特徴認証部 12 とも接続しており、各部の動作を制御する。制御部 8 および認証方法選択部 13、情報記憶部 9、特徴抽出部 10、特徴記録部 11、特徴認証部 12 の各部は、例えば CPU とメモリから成るマイクロコンピュータで構成される。電源部 14 は、上記の各部に電力を供給する。 40

【0021】

図 3 は、本発明の実施の形態 1 における個人認証機能付き携帯電話機の、認証方法設定動作の流れを示すフローチャートである。まず、使用者がキーボード 2 を操作して、表示部 1 に表示されている操作メニューから「認証方法の選択」を選択すると（ステップ S101）、複数の認証方法が表示部 1 に表示される（ステップ S102）。本実施の形態 1 では、「パスワード入力」、「画像入力」、「音声入力」、「キー入力」の 4 種類の認証方法が表示される。次に、使用者がキーボード 2 を操作して、複数の認証方法から任意の 1 つの方法を選択すると（ステップ S103）、選択された認証方法が表示部 1 に表示される（ステップ S104）。次に、使用者が選択した認証方法でよいか否かを確認する（ステップ S105）。ステップ S105 で、認証方法を変更したい場合、ステップ S102 50

に戻り、使用者は認証方法を再度選択する。一方、そのままよい場合には、選択された認証方法が認証方法選択部 13 に記録され (ステップ S 106)、認証方法の設定が終了する。

#### 【0022】

次に、認証情報登録動作を、設定された認証方法ごとに図4から図7のフローチャートを用いて説明する。

#### 【0023】

図4は、「パスワード入力」を認証方法として設定した場合の、認証情報登録動作の流れを示すフローチャートである。まず、使用者がキーボード2を操作して、表示部1に表示されている操作メニューから「パスワード入力」を選択すると (ステップ S 201)、パスワードの入力を促すメッセージが表示部1に表示される (ステップ S 202)。次に、使用者がキーボード2からパスワードを入力すると (ステップ S 203)、入力されたパスワードが情報記憶部9に記憶される (ステップ S 204)。次に、使用者がキーボード2から確認用にパスワードを再入力すると (ステップ S 205)、再入力されたパスワードが情報記憶部9に記憶されているパスワードと一致しているか否かの判定が行われる (ステップ S 206)。ステップ S 206で、再入力されたパスワードが不一致ならばステップ S 202に戻り、使用者はパスワードを入力し直す。一方、再入力されたパスワードが一致していればそのパスワードが認証情報 (特徴情報) として特徴記録部 11 に記録される (ステップ S 207)。記録完了後、情報記憶部9に一時的に記憶されたパスワードが消去され (ステップ S 208)、パスワードの登録が終了する。

#### 【0024】

図5は、「画像入力」を認証方法として設定した場合の、認証情報登録動作の流れを示すフローチャートである。まず、使用者がキーボード2を操作して、表示部1に表示されている操作メニューから「画像入力」を選択する (ステップ S 211)。次に、使用者が認証に使用する対象 (例えば、自分の手のひら、顔など) を選択してカメラ6で撮影すると (ステップ S 212)、撮影された画像が情報記憶部9に記憶され (ステップ S 213)、表示部1に表示される (ステップ S 214)。次に、情報記憶部9に記憶された画像からの特徴情報 (例えば、指の長さ、目や鼻の位置など) の抽出が特徴抽出部 10 で行われ、抽出された特徴情報が認証情報として特徴記録部 11 に記録される (ステップ S 215)。特徴情報の抽出には、公知の画像認識および画像処理方法を用いることができる。次に、使用者が再度同じ画像を撮影すると、同様に特徴情報が抽出される (ステップ S 216)。次に、特徴認識部 12 で、再度撮影した画像から抽出された特徴情報が特徴記録部 11 に記録されている認証情報と比較され一致しているか否かの判定が行われる (ステップ S 217)。ステップ S 217で、再度撮影した画像から抽出された特徴情報が不一致ならばステップ S 212に戻り、使用者は画像を撮影し直す。一方、再度撮影した画像から抽出された特徴情報が一致していれば情報記憶部9に一時的に記憶された画像情報が消去され (ステップ S 218)、画像情報の登録が終了する。なお、認証用画像の対象は、手のひらや顔など、使用者固有の情報となるものが好ましい。

#### 【0025】

図6は、「音声入力」を認証方法として設定した場合の、認証情報登録動作の流れを示すフローチャートである。まず、使用者がキーボード2を操作して、表示部1に表示されている操作メニューから「音声入力」を選択する (ステップ S 221)。次に、使用者がマイク4から認証に使用する音声 (例えば、言葉、歌など) を入力すると (ステップ S 222)、入力された音声情報が情報記憶部9に記憶され (ステップ S 223)、スピーカ3から再生される (ステップ S 224)。次に、情報記憶部9に記憶された音声からの特徴情報 (例えば、声紋、イントネーションなど) の抽出が特徴抽出部 10 で行われ、抽出された特徴情報が認証情報として特徴記録部 11 に記録される (ステップ S 225)。特徴情報の抽出には、公知の音声認識および音声処理方法を用いることができる。次に、使用者が再度同じ音声を入力すると、同様に特徴情報が抽出される (ステップ S 226)。次に、特徴認識部 12 で、再度入力した音声から抽出された特徴情報が特徴記録部 11 に記録さ

れている認証情報と比較され一致しているか否かの判定が行われる（ステップS227）。ステップS227で、再度入力した音声から抽出された特徴情報が不一致ならばステップS222に戻り、使用者は音声を入力し直す。一方、再度入力した音声から抽出された特徴情報が一致していれば情報記憶部9に一時的に記憶された音声情報が消去され（ステップS228）、音声情報の登録が終了する。なお、認証用の音声は、使用者が発する声など、使用者固有の情報となるものであることが好ましい。

#### 【0026】

図7は、「キー入力」を認証方法として設定した場合の、認証情報登録動作の流れを示すフローチャートである。まず、使用者がキーボード2を操作して、表示部1に表示されている操作メニューから「キー入力」を選択する（ステップS231）。次に、使用者がキーボード2から認証に使用するキー入力（例えば、任意の数字列の入力など）を行うと（ステップS232）、キー入力情報が情報記憶部9に記憶される（ステップS233）。次に、情報記憶部9に記憶されたキー入力情報からの特徴情報（例えば、入力スピード、リズムなど）の抽出が特徴抽出部10で行われ、抽出された特徴情報が認証情報として特徴記録部11に記録される（ステップS234）。特徴情報の抽出には、公知の検知方法を用いることができる。次に、使用者が再度同じキー入力を行うと、同様に特徴情報が抽出される（ステップS235）。次に、特徴認証部12で、再度行ったキー入力から抽出された特徴情報が特徴記録部11に記録されている認証情報と比較され一致しているか否かの判定が行われる（ステップS236）。ステップS236で、再度行ったキー入力から抽出された特徴情報が不一致ならばステップS232に戻り、使用者がキー入力をやり直す。一方、再度行ったキー入力から抽出された特徴情報が一致していれば情報記憶部9に一時的に記憶されたキー入力情報が消去され（ステップS237）、キー入力情報の登録が終了する。

#### 【0027】

次に、図8は、本発明の実施の形態1における個人認証機能付き携帯電話機の、認証方法の設定と認証情報の登録が完了した後の使用開始時における個人認証動作の流れを示すフローチャートである。まず、使用者が携帯電話機100の電源を投入すると（ステップS301）、電源部14から各部へ電力が供給され、各部が動作を開始する。次に、認証方法選択部13に記録された認証方法が指定され（ステップS302）、指定された認証方法に対応する情報の入力を促すメッセージが表示部1に表示される（ステップS303）。次に、使用者が指定された認証方法に対応する情報を入力すると（ステップS304）、入力された情報からの特徴情報の抽出が特徴抽出部10で行われ（ステップS305）、特徴認証部12で、抽出された特徴情報が予め特徴記録部11に記録されている認証情報と比較、照合される（ステップS306）。次に、抽出された特徴情報が予め特徴記録部11に記録されている認証情報と一致しているか否かの判定が行われる（ステップS307）。ステップS307で、抽出された特徴情報が不一致ならばステップS303に戻り、使用者は情報を入力し直す。一方、抽出された特徴情報が一致していれば正当な使用者と判定され、個人認証が終了して（ステップS308）、携帯電話機100の使用が可能となる（ステップS309）。なお、ステップS307で所定の回数認証に失敗した場合、強制的に認証処理を終了して、携帯電話機100の電源を切断するような設定にすることが好ましい。

#### 【0028】

このような本実施の形態1の個人認証機能付き携帯電話機によれば、個人認証のための複数の認証方法から選択された1つの方法が記録され、個人認証が行われるようになっているので、使用者は認証方法を選択して、使用形態に応じたセキュリティレベルの設定を行うことができる。また、パスワードだけでなく、画像情報、音声情報、キー入力情報といった他人が模倣しにくい情報を認証情報として用いるので、セキュリティレベルの高い個人認証を行うことができる。

#### 【0029】

（実施の形態2）

次に、本発明の実施の形態 2 における個人認証機能付き携帯電話機について説明する。本実施の形態 2 の個人認証機能付き携帯電話機は、実施の形態 1 における認証方法選択部 13 を、複数の認証方法の組み合わせを記録する認証方法組み合わせ選択部 15 に置き換えたことを特徴とする。

#### 【0030】

本実施の形態 2 の個人認証機能付き携帯電話機の外観は、実施の形態 1 のそれと同じであるので図示および説明を省略する。

#### 【0031】

図 9 は、本実施の形態 2 の個人認証機能付き携帯電話機 100a の電氣的構成を示すブロック図である。前述の実施の形態 1 と比較すると、実施の形態 1 における認証方法選択部 13 が、認証方法組み合わせ選択部 15 に置き換わった構成となっている。認証方法組み合わせ選択部 15 は、個人認証のための複数の認証方法から選択された少なくとも 2 つの認証方法の組み合わせを記録するものである。それ以外の各部の構成は実施の形態 1 と同じであるので説明を省略する。

10

#### 【0032】

図 10 は、本実施の形態 2 の個人認証機能付き携帯電話機の、認証方法設定動作の流れを示すフローチャートである。まず、使用者がキーボード 2 を操作して、表示部 1 に表示されている操作メニューから「認証方法の組み合わせ選択」を選択すると（ステップ S401）、複数の認証方法が表示部 1 に表示される（ステップ S402）。本実施の形態 2 では、「パスワード入力」、「画像入力」、「音声入力」、「キー入力」の 4 種類の認証方法が表示される。次に、使用者がキーボード 2 を操作して、複数の認証方法から任意の 1 つの方法を選択すると（ステップ S403）、選択された認証方法が表示部 1 に表示される（ステップ S404）。次に、使用者が選択した認証方法で終了か否かを確認する（ステップ S405）。ステップ S405 で、2 番目の認証方法を選択する場合、ステップ S402 に戻り、使用者は 2 番目の認証方法を同様に選択する。ステップ S402 からステップ S405 までの手順を任意の回数繰り返して、複数の認証方法を選択し確定すると、選択された複数の認証方法が認証方法組み合わせ選択部 15 に記録され（ステップ S406）、認証方法の設定が終了する。

20

#### 【0033】

認証情報登録動作は、実施の形態 1（図 4 から図 7 のフローチャートを参照）と同じであるので説明を省略する。

30

#### 【0034】

次に、図 11 は、本実施の形態 2 の個人認証機能付き携帯電話機の、複数の認証方法の設定と認証情報の登録が完了した後の使用開始時における個人認証動作の流れを示すフローチャートである。まず、使用者が携帯電話機 100a の電源を投入すると（ステップ S501）、電源部 14 から各部へ電力が供給され、各部が動作を開始する。次に、認証方法組み合わせ選択部 15 に記録された認証方法が指定され（ステップ S502）、指定された認証方法に対応する情報の入力を促すメッセージが表示部 1 に表示される（ステップ S503）。次に、使用者が指定された認証方法に対応する情報を入力すると（ステップ S504）、入力された情報から特徴情報の抽出が特徴抽出部 10 で行われ（ステップ S505）、特徴認証部 12 で、抽出された特徴情報が予め特徴記録部 11 に記録されている特徴情報と比較、照合される（ステップ S506）。次に、抽出された特徴情報が予め特徴記録部 11 に記録されている特徴情報と一致しているか否かの判定が行われる（ステップ S507）。ステップ S507 で、抽出された特徴情報が不一致ならばステップ S503 に戻り、使用者は情報を入力し直す。一方、抽出された特徴情報が一致すれば 1 番目の認証方法において認証成功として判定され、記録された複数の認証方法のすべてについて認証が実行されたか否かの判定が行われる（ステップ S508）。ステップ S508 で、実行されていない認証方法がある場合はステップ S502 に戻り、使用者は 2 番目の認証方法に対応する情報を入力する。ステップ S502 からステップ S508 までの手順を、登録した認証方法の数だけ繰り返して、すべての認証方法において認証が成功すると、個人認

40

50

証が終了して（ステップS509）、携帯電話機100aの使用が可能となる（ステップS510）。なお、ステップS507で所定の回数認証に失敗した場合、強制的に認証処理を終了して、携帯電話機100aの電源を切断するような設定にすることが好ましい。

【0035】

このような本実施の形態2の個人認証機能付き携帯電話機によれば、個人認証のための複数の認証方法から選択された複数の方法が記録され、個人認証が行われるようになっているので、使用者は複数の認証方法を組み合わせて選択して、使用形態に応じたセキュリティレベルの設定を行うことができる。また、パスワードだけでなく、画像情報、音声情報、キー入力情報といった他人が模倣しにくい情報を認証情報として用いるので、更にセキュリティレベルの高い個人認証を行うことができる。

10

【0036】

（実施の形態3）

次に、本発明の実施の形態3における個人認証機能付き携帯電話機について説明する。本実施の形態3の個人認証機能付き携帯電話機は、決済情報や認証情報を送信する際に暗号化する暗号化部16を備えたことを特徴とする。

【0037】

本実施の形態3の個人認証機能付き携帯電話機の外観は、実施の形態1のそれと同じであるので図示および説明を省略する。

【0038】

図12は、本実施の形態3の個人認証機能付き携帯電話機100bの電氣的構成を示すブロック図である。前述の実施の形態2と比較すると、実施の形態2の構成に、制御部8と接続する暗号化部16が付加された構成となっている。暗号化部16は、電子決済の際に通信先での認証に用いられる認証情報や決済情報を暗号化するものである。暗号化は、公知の暗号化手法を用いることができる。それ以外の各部の構成は実施の形態2と同じであるので説明を省略する。

20

【0039】

図13は、本実施の形態3の個人認証機能付き携帯電話機の、電子決済の際の通信先での個人認証動作の流れを示すフローチャートである。まず、使用者が携帯電話機100bの電源を投入すると（ステップS601）、電源部14から各部へ電力が供給され、各部が動作を開始する。次に、使用者が決済に必要な内容や条件をキーボード2から入力し（ステップS602）、決済先へダイヤルすると、無線部5よりダイヤル情報が送信され通信が確立される（ステップS603）。次に、認証方法組み合わせ選択部15に記録されている認証方法から、決済に使用する認証方法が設定される（ステップS604）。次に、特徴記録部11に記録されている複数の認証情報から、設定された認証方法に対応する認証情報が読み出され、この認証情報や決済情報が暗号化部16で暗号化される（ステップS605）。次に、暗号化された情報が無線部5から決済先へ送信される（ステップS606）。

30

【0040】

決済先では、暗号化された情報が受信され（ステップS607）、復号化され元の情報に戻される（ステップS608）。次に、復号化の結果得られた認証情報が決済先に予め登録されている認証情報と比較、照合される（ステップS609）。次に、復号化の結果得られた認証情報が決済先に予め登録されている認証情報と一致しているか否かの判定が行われる（ステップS610）。ステップS610で、復号化の結果得られた認証情報が一致していれば、送信者が正当な使用者と判定され、決済処理が実行される（ステップS611）。一方、復号化の結果得られた認証情報が不一致ならば、送信者が不正使用者と判定され、決済処理が中止され（ステップS612）、認証に失敗した旨が携帯電話機100bに返信され（ステップS613）、処理が終了する。

40

【0041】

このような本実施の形態3の個人認証機能付き携帯電話機によれば、認証情報や決済情報が送信される際に暗号化されるので、無線信号の盗聴によるこれらの情報の漏洩を防止す

50

ることができ、

【0042】

【発明の効果】

上述した説明から明らかなように、本発明に係る個人認証機能付き携帯電話機によれば、個人認証のための複数の認証方法から選択された少なくとも1つの方法が記録され、個人認証が行われるようになっていて、使用者は認証方法を選択することにより使用形態に応じたセキュリティレベルの設定を行うことができる。

【図面の簡単な説明】

【図1】本発明の実施の形態1における個人認証機能付き携帯電話機の外観を示す斜視図である。

10

【図2】本発明の実施の形態1における個人認証機能付き携帯電話機の電氣的構成を示すブロック図である。

【図3】本発明の実施の形態1における個人認証機能付き携帯電話機の、認証方法設定動作の流れを示すフローチャートである。

【図4】「パスワード入力」を認証方法として設定した場合の、認証情報登録動作の流れを示すフローチャートである。

【図5】「画像入力」を認証方法として設定した場合の、認証情報登録動作の流れを示すフローチャートである。

【図6】「音声入力」を認証方法として設定した場合の、認証情報登録動作の流れを示すフローチャートである。

20

【図7】「キー入力」を認証方法として設定した場合の、認証情報登録動作の流れを示すフローチャートである。

【図8】認証方法の設定と認証情報の登録が完了した後の使用開始時における個人認証動作の流れを示すフローチャートである。

【図9】本発明の実施の形態2における個人認証機能付き携帯電話機の電氣的構成を示すブロック図である。

【図10】本発明の実施の形態2における個人認証機能付き携帯電話機の、認証方法設定動作の流れを示すフローチャートである。

【図11】複数の認証方法の設定と認証情報の登録が完了した後の使用開始時における個人認証動作の流れを示すフローチャートである。

30

【図12】本発明の実施の形態3における個人認証機能付き携帯電話機の電氣的構成を示すブロック図である。

【図13】本発明の実施の形態3における個人認証機能付き携帯電話機の、電子決済の際の通信先での個人認証動作の流れを示すフローチャートである。

【図14】従来の個人認証機能付き携帯電話機の一例の外観を示す斜視図である。

【図15】図14に示した従来の個人認証機能付き携帯電話機の電氣的構成を示すブロック図である。

【図16】図14に示した従来の個人認証機能付き携帯電話機における個人認証動作の流れを示すフローチャートである。

【符号の説明】

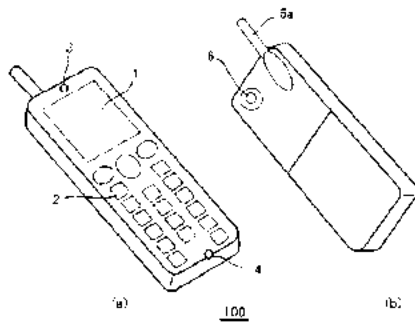
40

- 1 表示部
- 2 キーボード
- 3 スピーカ
- 4 マイク
- 5 無線部
- 6 カメラ
- 7 電話部
- 8 制御部
- 9 情報記憶部
- 10 特徴抽出部

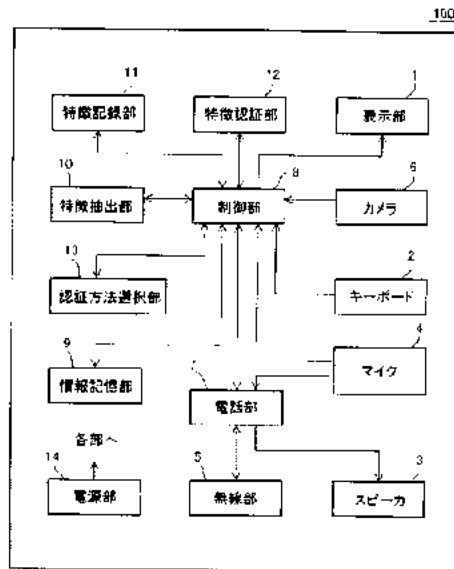
50

- 1 1 特徴記録部
- 1 2 特徴認証部
- 1 3 認証方法選択部
- 1 4 電源部
- 1 5 認証方法組み合わせ選択部
- 1 6 暗号化部
- 1 0 0、1 0 0 a、1 0 0 b 個人認証機能付き携帯電話機

【図 1】

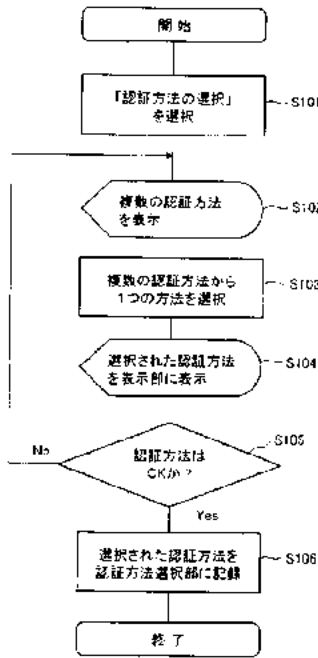


【図 2】

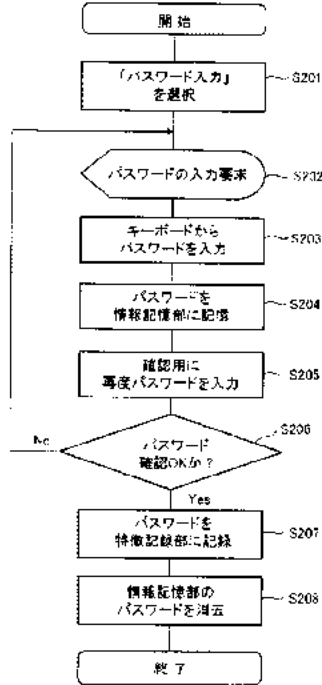




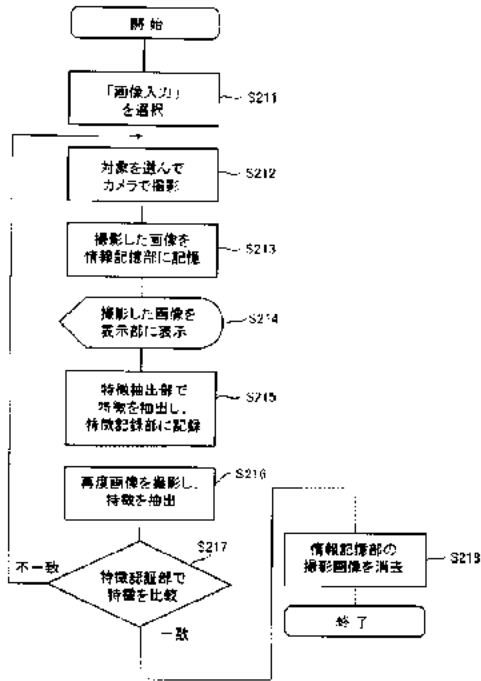
【図 3】



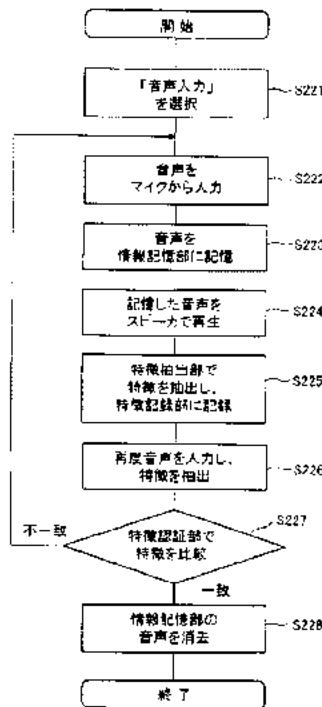
【図 4】



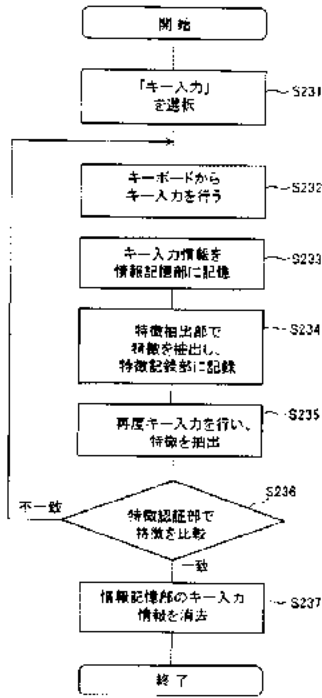
【図 5】



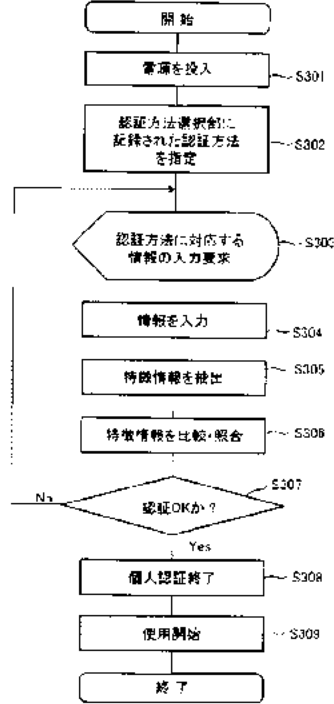
【図 6】



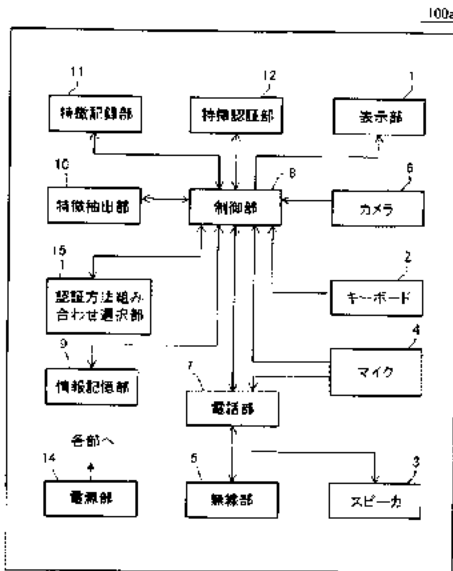
【図 7】



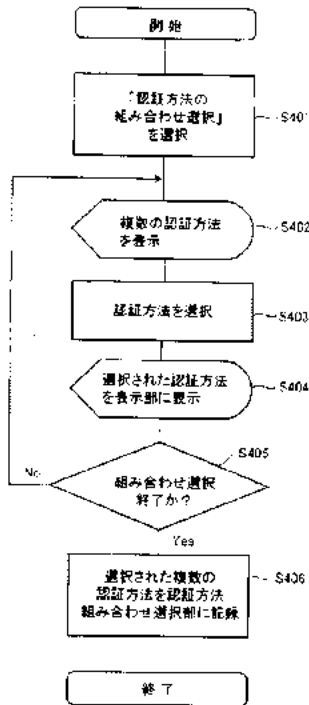
【図 8】



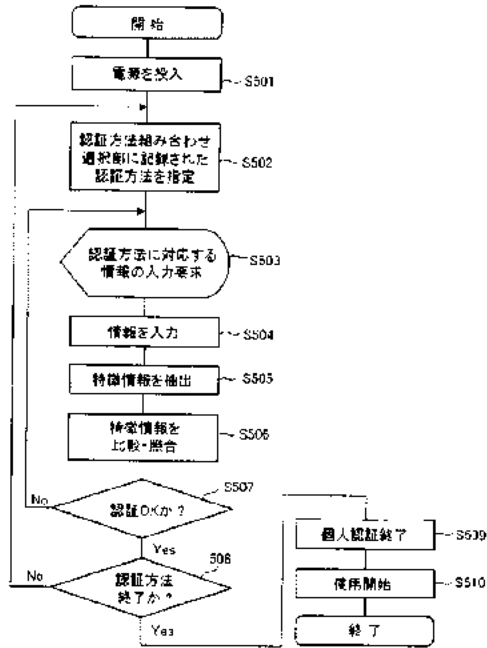
【図 9】



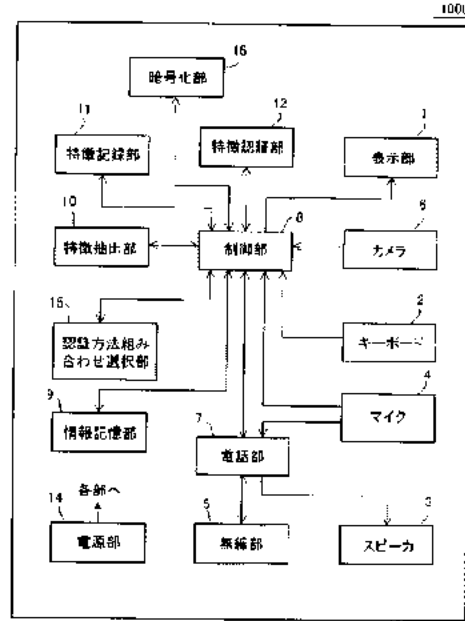
【図 10】



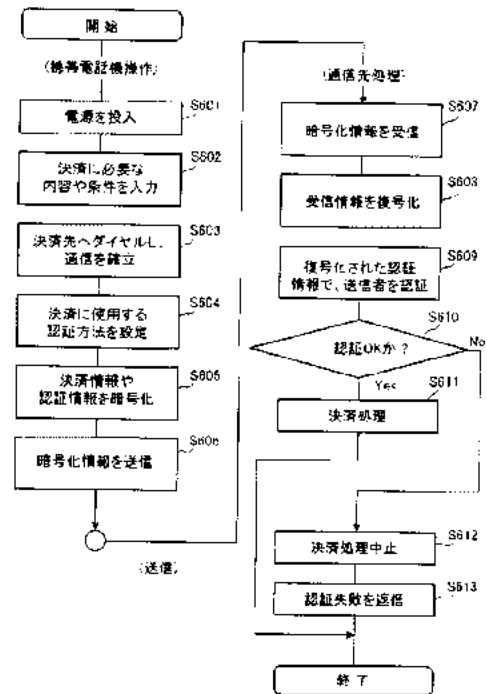
【図 1 1】



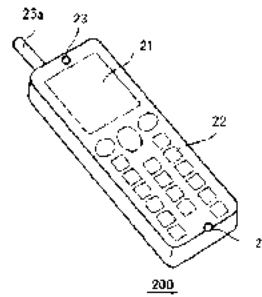
【図 1 2】



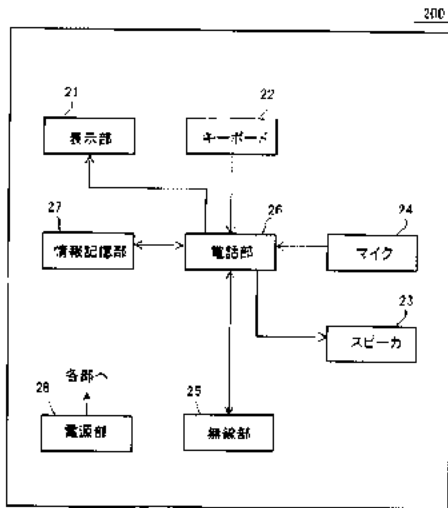
【図 1 3】



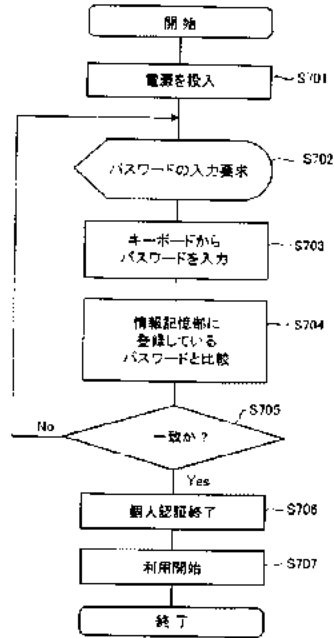
【図 1 4】



【図15】



【図16】



フロントページの続き

(51)Int. Cl.<sup>7</sup>

F I

テーマコード (参考)

H 0 4 L 9/00 6 4 1

(72)発明者 木下 雅文

神奈川県横浜市港北区綱島東四丁目 3 番 1 号 松下通信工業株式会社内

Fターム(参考) 5B085 AE01 AE15 AE23 AE25 BC01 BE01 BE04 BG02 BG07

5J104 AA07 KA01 KA16 NA05 PA02

5K027 AA11 BB09 HH00 HH20 HH23

5K067 AA32 BB04 DD52 FF23 HH22 HH23



Espacenet

Bibliographic data: CN101452365 (A) — 2009-06-10

Terminal and method of controlling the same

Inventor(s): JIN SEO [KR] ± (SEO JIN)

Applicant(s): LG ELECTRONICS INC [KR] ± (LG ELECTRONICS INC)

Classification: - international: G06F3/048; G06F3/0481; G06F3/0488  
 - cooperative: G06F3/04817; G06F3/04842; G06F3/04886;  
G06F3/04883; H04M1/72547; H04M1/72558;  
H04M2250/22; H04W52/027

Application number: CN2008192271 20080414

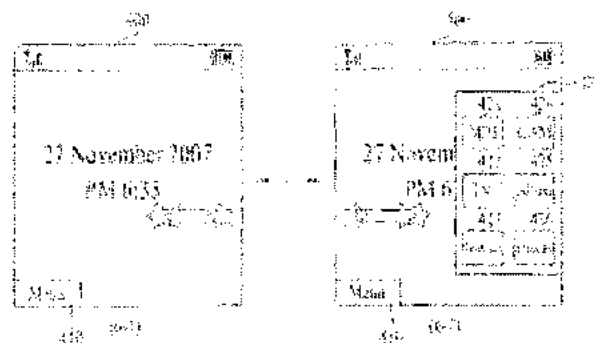
Priority number (s): KR20070126147 20071206

Also published as: CN101452365 (B) EP2076000 (A2) EP2076000 (A3)  
EP2076000 (B1) US2015277695 (A1) more

Abstract of CN101452365 (A)

According to an embodiment, a terminal and a method of displaying menu icons thereof are discussed, by which a terminal user is facilitated to input various commands. An embodiment of the present invention includes a touch screen and a control unit configured to control at least one touch-available icon to move between outer and inner areas of an image displayed on the touch screen in a direction of a touch-trag on the touch screen. Accordingly, the electric current for detecting a touch is supplied to the touch screen only if the touch available icon is displayed on the touch screen. Hence, the present invention minimizes power consumption in using the touch screen.

FIG. 6



[19] 中华人民共和国国家知识产权局

[51] Int. Cl.

G06F 3/048 (2006.01)

H04M 1/247 (2006.01)

H04M 1/725 (2006.01)



# [12] 发明专利申请公布说明书

[21] 申请号 200810092271.9

[43] 公开日 2009年6月10日

[11] 公开号 CN 101452365A

[22] 申请日 2008.4.14

[21] 申请号 200810092271.9

[30] 优先权

[32] 2007.12.6 [33] KR [31] 10-2007-0126147

[71] 申请人 LG 电子株式会社

地址 韩国首尔

[72] 发明人 李星哲 徐真 朴相贤

[74] 专利代理机构 上海专利商标事务所有限公司

代理人 李玲

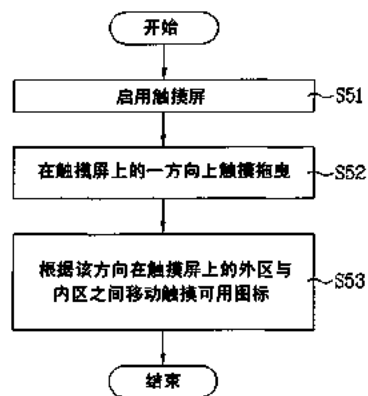
权利要求书 4 页 说明书 17 页 附图 11 页

[54] 发明名称

装置及其控制方法

[57] 摘要

根据一实施例，讨论了一种终端以及显示其菜单图标的方法，籍此有助于终端用户输入各种命令。本发明的实施例包括触摸屏、以及被配置成控制至少一个触摸可用图标在触摸屏上的触摸拖曳的方向上在触摸屏上所显示的图像的外区与内区之间移动的控制单元。相应地，用于检测触摸的电流仪在触摸可用图标被显示在触摸屏上时提供给该触摸屏。因此，本发明使得使用触摸屏的功耗最小化。



1. 一种终端，包括：  
触摸屏；以及  
控制单元，配置成控制至少一个触摸可用图标以在所述触摸屏上的触摸拖曳的方向上在所述触摸屏上所显示图像的外区与内区之间移动。
2. 如权利要求1所述的终端，其特征在于，还包括：  
用户输入单元，其具有配置成启用所述触摸屏的触摸屏启用键，  
其中当所述触摸屏被所述触摸屏启用键启用时所述控制单元控制所述至少一个触摸可用图标移动。
3. 如权利要求1所述的终端，其特征在于，有两个以上移动的触摸可用图标，  
其中所述控制单元控制根据所述触摸可用图标中每一个的类型被分类为多个组的所述触摸可用图标，  
其中所述控制单元控制属于所述多个组中每一组的触摸可用图标以对应所述触摸屏的至少一侧，以及  
其中所述控制单元通过将每一相应侧用作边界来控制属于所述多个组中每一组的触摸可用图标在所述外区与内区之间移动。
4. 如权利要求3所述的终端，其特征在于，如果所述触摸拖曳是在所述触摸屏上的指定方向上执行的，则所述控制单元使用与相反方向相对应的一侧作为边界来控制属于位于与所述相反方向相对应的一侧之外的所述外区中的那一组的触摸可用图标滑动地出现在所述内区中。
5. 如权利要求4所述的终端，其特征在于，如果所述触摸拖曳是在所述触摸屏上与所述指定方向相反的方向上执行的，则所述控制单元使用对应于所述相反方向的一侧作为所述边界来控制所述触摸屏上的所述触摸可用图标从所述内区滑动地消失在所述外区。
6. 如权利要求4所述的终端，其特征在于，如果属于所述组的所述触摸可用图标被分为第一子组触摸可用图标和第二子组触摸可用图标并且如果所述触摸拖曳是在所述触摸屏上的所述指定方向上执行的，则所述控制单元使用对应于所述相反方向的所述侧作为所述边界来控制所述第一子组触摸可用图标滑动地出现在所述内区中。



7. 如权利要求 6 所述的终端，其特征在于，如果所述触摸拖曳再一次在所述触摸屏上执行，则所述控制单元使用对应于所述相反方向的所述侧作为所述边界来控制所述第二子组触摸可用图标滑动地出现在所述内区中。

8. 如权利要求 7 所述的终端，其特征在于，如果所述触摸拖曳是在所述触摸屏上的相反方向上执行的，则所述控制单元使用对应于所述相反方向的所述侧作为所述边界来控制所述第二子组触摸可用图标从所述内区滑动地消失在所述外区。

9. 如权利要求 8 所述的终端，其特征在于，如果所述触摸拖曳再一次在所述触摸屏上的所述相反方向上执行，则所述控制单元使用对应于所述相反方向的所述侧作为所述边界来控制所述第一子组触摸可用图标从所述内区滑动地消失在所述外区。

10. 如权利要求 4 所述的终端，其特征在于，如果所述触摸拖曳是在所述触摸屏上的相反方向上执行的，则所述控制单元使用对应于所述相反方向的所述侧作为所述边界来控制所述触摸屏上的所述触摸可用图标从所述内区滑动地消失在所述外区，并且使用对应于所述指定方向的所述侧作为边界来控制属于位于与所述指定方向相对应的所述侧之外的外区中的那一组的所述触摸可用图标滑动地出现在所述内区中。

11. 如权利要求 3 所述的终端，其特征在于，所述控制单元控制属于与最接近所述触摸拖曳的起点的那一侧相对应的那一组的所述触摸可用图标以对所述触摸拖曳作出响应。

12. 如权利要求 1 所述的终端，其特征在于，还包括：

指示符，被配置成指示消息接收，

其中所述消息接收被指示，所述控制单元根据触摸拖曳的方向在所述触摸屏上滑动地显示消息窗口。

13. 如权利要求 12 所述的终端，其特征在于，所述消息窗口包括用于显示所述消息的触敏区、以及用于处理所述消息的至少一个触敏图标。

14. 一种用于在终端中显示菜单图标的方法，包括：

在所述终端的触摸屏上的指定方向上执行触摸拖曳；以及

在所述触摸拖曳的所述方向上在显示于所述触摸屏上的图像的外区与内区之间移动至少一个触摸可用图标。

15. 如权利要求 14 所述的方法，其特征在于，还包括：

使用触摸屏启用键选择性地启用所述触摸屏；以及

在所述触摸屏被启用之后在所述触摸屏上移动所述至少一个触摸可用图标。

16. 如权利要求 14 所述的方法，其特征在于，有两个以上移动的触摸可用图标，

其中所述触摸可用图标根据所述触摸可用图标中每一个的类型被分类为多个组，

其中属于所述多个组中每一组的所述触摸可用图标对应于所述触摸屏的至少一侧，以及

其中在所述移动步骤中，通过将每一相应侧用作边界，属于所述多个组中每一组的所述触摸可用图标在所述外区与内区之间移动。

17. 如权利要求 16 所述的方法，其特征在于，如果所述触摸拖曳是在所述触摸屏上的所述指定方向上执行的，则属于位于与相反方向相对应的一侧之外的外区中的那一组的所述触摸可用图标使用与所述相反方向相对应的一侧作为边界滑动地出现在所述内区中。

18. 如权利要求 17 所述的方法，其特征在于，如果所述触摸拖曳是在所述触摸屏上在与所述指定方向相反的方向上执行的，则所述触摸屏上的所述触摸可用图标使用对应于所述相反方向的一侧作为所述边界从所述内区滑动地消失在外区。

19. 如权利要求 17 所述的方法，其特征在于，如果属于所述组的所述触摸可用图标被分为第一子组触摸可用图标和第二子组触摸可用图标并且如果所述触摸拖曳是在所述触摸屏上的所述指定方向上执行的，则所述第一子组触摸可用图标使用对应于所述相反方向的所述侧作为所述边界滑动地出现在所述内区中。

20. 如权利要求 19 所述的方法，其特征在于，如果所述触摸拖曳再一次在所述触摸屏上执行，则所述第二子组触摸可用图标使用对应于所述相反方向的所述侧作为所述边界滑动地出现在所述内区中。

21. 如权利要求 20 所述的方法，其特征在于，如果所述触摸拖曳是在所述触摸屏上的相反方向上执行的，则所述第二子组触摸可用图标使用对应于所述相反方向的所述侧作为所述边界从所述内区滑动地消失在外区。

22. 如权利要求 21 所述的方法，其特征在于，如果所述触摸拖曳再一次在所述触摸屏上的所述相反方向上被执行，则所述第一子组触摸可用图标使用对应于所述相反方向的所述侧作为所述边界从所述内区滑动地消失在外区。

23. 如权利要求 17 所述的方法，其特征在于，如果所述触摸拖曳是在所述触

摸屏上的所述相反方向上执行的,则所述触摸屏上的所述触摸可用图标使用对应于所述相反方向的所述侧作为所述边界从所述内区滑动地消失在所述外区,并且属于位于与所述指定方向相对应的所述侧之外的所述外区中的那一组的所述触摸可用图标使用对应于所述指定方向的所述侧作为边界滑动地出现在所述内区中。

24. 如权利要求 16 所述的方法,其特征在于,属于与最接近所述触摸拖曳的起点的那一侧相对应的那一组的所述触摸可用图标被配置成对所述触摸拖曳作出响应。

25. 如权利要求 14 所述的方法,其特征在于,还包括:  
在所述触摸屏上显示指示消息接收的指示符;以及之后  
根据所述触摸屏上触摸拖曳的方向在所述触摸屏上滑动地显示消息窗口。

26. 如权利要求 25 所述的方法,其特征在于,所述消息窗口包括用于显示所述消息的触敏区、以及用于处理所述消息的至少一个触敏图标。

## 装置及其控制方法

本申请要求 2007 年 12 月 6 日提交的韩国专利申请 No. 10-2007-0126147 的优先权，该申请如在此充分阐述地通过引用包括于此。

### 技术领域

本发明涉及一种终端以及控制该终端的方法，尤其涉及一种终端及显示其菜单图标的方法。虽然本发明适用于较广范围的应用，但尤其适用于帮助用户向该终端输入各种命令。

### 背景技术

移动终端是一种可配置成执行各种功能的设备。这些功能的示例包括数据和语音通信、经由相机捕捉图像和视频、记录音频、经由扬声器系统播放音乐文件、以及在显示器上显示图像和视频。一些终端包括支持游戏的附加功能，而其它终端被配置成多媒体播放器。近来，移动终端已被配置成接收使得能够观看诸如视频和电视节目等内容的广播和多播信号。

现在正致力于支持和增加移动终端的功能性。这些努力包括软件和硬件改进，以及构成该移动终端的结构组件的变革和改进。

当一终端用作能够执行上述各种功能的多媒体设备时，如各种功能一样，各种菜单图标被显示在终端的显示屏上。然而，各种菜单图标妨碍了用户对终端操控的便利性并且可对用户造成困扰。所以，已经努力配置和布置各种菜单图标以有助于用户操控。

### 发明内容

相应地，本发明针对一种基本上避免了由于相关技术的局限和缺点所引起的一个或多个问题的终端及其控制方法。

本发明的目的是提供一种终端以及显示其菜单图标的方法，籍此有助于终端用户标识和选择显示在该终端的显示屏上的各种菜单图标中的特定一个。

本发明的其它优点、目的、和特征将部分在以下描述中阐述以及部分在基于对以下内容的研读基础之上将为本领域的技术人员所显见或可通过本发明的实践而获教。本发明的目标和其它优点可通过在书面描述及其权利要求以及附图中特别指出的结构来实现和获得。

为了实现这些目标和其它优点以及根据如在此体现和宽泛描述的本发明的用途，根据本发明的实施例的终端，包括：触摸屏；以及控制单元，配置成控制至少一个触摸可用图标以在触摸屏上的触摸拖曳的方向上在触摸屏上所显示的图像的外区与内区之间移动。

在本发明的另一方面，一种在终端中显示菜单图标的方法，包括：在终端的触摸屏上的指定方向上执行触摸拖曳；以及在该触摸拖曳的方向上在显示在触摸屏上的图像的外区与内区之间移动至少一个触摸可用图标。

应该理解的是，本发明的以上概述和以下详述仅是示例性和解释性的，并旨在提供对所要求保护的本发明的进一步解释。

#### 附图说明

被包括以提供对本发明的进一步理解并被包括在本申请中且构成其一部分的附图示出了本发明的实施例并与描述一道起解释本发明的原理的作用。在附图中：

图 1 是根据本发明的实施例的移动终端的框图；

图 2 是根据本发明的实施例的移动终端的一个示例的前侧的立体图；

图 3 是图 2 中所示移动终端的一个示例的后视图；

图 4 是与图 1 到 3 中的移动终端一起工作的 CDMA 无线通信系统的框图；

图 5 是根据本发明的显示菜单图标的方法的流程图；

图 6 是用以描述根据本发明的第一实施例的图像显示方法的移动终端的显示屏的示例的示图；

图 7 是用以描述根据本发明的第二实施例的图像显示方法的移动终端的显示屏的示例的示图；

图 8 是用以描述根据本发明的第三实施例的图像显示方法的移动终端的显示屏的示例的示图；

图 9 是用以描述根据本发明的第四实施例的图像显示方法的移动终端的显示屏的示例的示图；

图 10 是用以描述根据本发明的第五实施例的图像显示方法的移动终端的显示屏的示例的示图；

屏的示例的示图；

图 11 是用以描述根据本发明的第六实施例的图像显示方法的移动终端的显示屏的示例的示图。

### 具体实施例

现在将具体参照其示例在附图中示出的本发明的优选实施例。本领域普通技术人员应当理解，也可使用其它实施例，并且可在结构、电气以及程序上作出变化而不背离本发明的范围。在任何可能的地方，相同附图标记用于通篇指代相同或类似部分。

在以下描述中，要素的后缀“模块”、“单元”和“部分”被给出仅用以帮助对该公开的预备。所以，并未对这些后缀本身给予重要的意义或角色。因此，应该理解的是，“模块”、“单元”和“部分”可以一起或单独使用。

图 1 是根据本发明的实施例的移动终端 100 的框图。该移动终端可使用各种不同类型的终端来实现。这些终端的示例包括诸如移动电话、用户设备、智能电话、计算机、数字广播终端、个人数字助理、便携式多媒体播放器（PMP）和导航仪等移动及非移动终端。仅作为非限制性示例，进一步的描述将参照移动终端 100。然而，本发明的教义同样可应用于诸如非移动终端等其它类型的终端，并且本发明包括移动终端和非移动终端两者。图 1 示出了具有各种组件的移动终端 100，但是应当理解，实现所有所示组件并非必需。可替换性地实现更多或更少的组件。

图 1 示出了配置有若干通常实现的组件的无线通信单元 110。例如，无线通信单元 110 通常包括允许在移动终端 100 与该移动终端所处或正在访问的无线通信系统或网络之间的无线通信的一个或多个组件。

特别地，广播接收模块 111 经由广播频道从外部广播管理实体接收广播信号和/或与广播相关联的信息（例如，广播数据等）。广播频道可包括卫星频道和地面频道。广播管理实体通常指发射广播信号和/或与广播相关联的信息的系统。与广播相关联的信息的示例包括与广播频道、广播节目、广播服务供应商等相关联的信息。例如，与广播相关联的信息可包括数字多媒体广播（DMB）的电子节目指南（EPG）和/或手持数字视频广播（DVB-H）的电子服务指南（ESG）。

广播信号由其可实现为 TV 广播信号、无线电广播信号和/或数据广播信号等。如果需要，广播信号还可包括与 TV 或无线电广播信号相组合的广播信号。

广播接收模块 111 可被配置成接收从各种类型的广播系统发射的广播信号。

作为非限制性示例，这些广播系统包括但并不限于，地面数字多媒体广播（DMB-T）、卫星数字多媒体广播（DMB-S）、手持数字视频广播（DVB-H）、称为媒体单一前向链路（MediaFLO®）的数据广播系统和地面综合业务数字广播（ISDB-T）。由终端 200 接收多播信号也是可能的。如果需要，由广播接收模块 111 接收到的数据可被存储在诸如存储器 160 的适当设备中。

移动通信模块 112 向/从一个或多个网络实体（例如，基站、B 节点）发送/接收无线信号。这些信号可表示音频、视频、多媒体、控制信令和数据及其它。

无线因特网模块 113 支持移动终端 100 的因特网接入。该模块可内置式或外置式地耦合到该移动终端 100。用于无线因特网的合适技术包括但不限于：WLAN（无线 LAN）（Wi-Fi）、Wibro（无线宽带）、Wimax（全球微波接入互操作性）和 HSDPA（高速下行链路分组接入）。

短距离通信模块 114 有助于相对短距离的通信。短距离通信的合适技术包括但不限于例如：射频标识（RFID）、红外数据关联（IrDA）、超宽频带（UWB）以及通常称为蓝牙和 ZigBee 的联网技术。

定位模块 115 标识或者另外获得移动终端 100 的位置。如果需要，该模块 115 可使用与相关联的卫星、网络组件及其组合协作的全球定位系统（GPS）组件来实现。

音频/视频（A/V）输入单元 120 被配置成向移动终端 100 提供音频或视频信号输入。如该示例中所示，A/V 输入单元 120 包括相机 121 和话筒 122。相机 121 接收并处理静止画面或视频的图像帧。

当该便携式设备（例如，A/V 输入单元 120）处于诸如电话呼叫模式、记录模式和语音识别模式等特定模式时，话筒 122 接收外部音频信号。该音频信号被处理并转换成数字数据。便携式设备（例如，A/V 输入单元 120）可包括混合噪声（assorted noise）消除算法来消除在接收外部音频信号期间生成的噪声。由 A/V 输入单元 120 生成的数据可被存储在存储器 160 中、由输出单元 150 使用、或者经由通信单元 110 的一个或多个模块被发送。如果需要，可使用两个或多个话筒和/或相机。

响应于用户对相关联的一个或多个输入设备的操控，用户输入单元 130 生成输入数据。这些设备的示例包括小键盘、圆顶开关、触摸垫（例如，静压/电容式）、推轮和推摇开关（jog switch）。一具体示例是其中用户输入单元 130 被配置成与（将在以下更详细描述）触摸屏显示器协作的触摸垫。

感测单元 140 提供对终端 100 的各个方面的状态测量。例如，感测单元 140

可检测移动终端的开/关状态、移动终端的组件（例如显示器和小键盘）的相对定位、移动终端或移动终端的组件的位置改变、是否存在用户与移动终端的接触、移动终端的定向或加速/减速。作为示例，考虑移动终端 100 被配置为滑动型移动终端。在该配置中，感测单元 140 可感测移动终端的滑动部分是打开还是关闭。其它示例包括感测单元 140 感测电源 190 是否供电、以及接口单元 170 与外部设备之间是否存在耦合或其它连接。

接口单元 170 常常被实现成将移动终端 100 与外部设备耦合。典型的外部设备包括有线/无线听筒、外部充电器、电源、配置成存储数据（例如音频、视频、图片等）的存储设备、耳机、和话筒及其它。接口单元 170 可使用有线/无线数据端口、音频输入/输出端口、卡插槽（例如，用于耦合到存储卡、订户身份模块（SIM）卡、用户身份模块（UIM）卡、可移动用户身份模块（RUIM）卡）、音频输入/输出端口和视频输入/输出端口来配置。

输出单元 150 通常包括支持移动终端 100 的输出需求或要求的各种组件。显示器 151 通常被实现成视觉显示与移动终端 100 相关联的信息。例如，如果移动终端 100 工作在电话呼叫模式，则显示器 151 通常将提供包括与拨打、接通和结束电话呼叫相关联的信息的用户界面或图形用户界面。作为另一示例，如果移动终端 100 处于视频呼叫模式或拍摄模式，则显示器 151 将另外或替代地显示与这些模式相关联的图像。

显示器 151 的一个具体实现是将其设为与诸如触摸垫的输入设备（例如，输入单元 130）协作的触摸屏。该配置使显示器 151 能够用作输出设备和输入设备两者。

显示器 151 可使用公知的显示器技术来实现，包括例如液晶显示器（LCD）、薄膜晶体管液晶显示器（TFT-LCD）、有机发光二极管显示器（OLED）、柔性显示器和三维显示器。移动终端 100 可包括一个或多个此类显示器 151。双显示器实施例的一个示例是其中一个显示器 151 被配置成（当终端处于打开位置时可见的）内部显示器，而第二显示器被配置成（在打开和关闭位置都可见的）外部显示器。

输出单元 150 还包括支持移动终端 100 的音频输出需求或要求的音频输出模块 152。音频输出模块 152 使用一个或多个扬声器、蜂鸣器、其它音频产生设备及其组合来实现。音频输出模块 152 用在包括呼叫接收模式、呼叫拨打模式、记录模式、语音识别模式和广播接收模式等各种模式中。在操作期间，音频输出模块 152 输出与特定功能（例如收到呼叫、收到消息以及出错）相关的音频。



输出单元 150 还包括常被用来发信号通知或另外标识与移动终端相关联的特定事件的发生的报警器 153。典型事件包括收到呼叫、收到消息以及收到用户输入等。这些输出的示例包括向用户提供触觉（例如，振动）。例如，报警器 153 可被配置成响应于移动终端 100 收到呼叫或消息而振动。作为另一示例，响应于在移动终端 100 处接收到用户输入而由报警器 153 提供振动，由此提供触觉反馈机制。应当理解，由输出单元 150 的组件提供的各种信号可单独执行，或者这些输出可使用这些组件的任何组合来执行。

存储器 160 优选地用于存储各种类型的数据来支持移动终端 100 的处理、控制、存储需求或要求。这些数据的示例包括在移动终端上操作的应用的程序指令、联系人数据、电话簿数据、消息、图片、视频等。存储器 160 可使用任何类型（或组合）的合适的易失性和非易失性存储器或存储设备来实现，包括随机存取存储器（RAM）、静态随机存取存储器（SRAM）、电可擦可编程只读存储器（EEPROM）、可擦可编程只读存储器（EPROM）、可编程只读存储器（PROM）、只读存储器（ROM）、磁性存储器、闪存、磁盘或光盘存储器、卡式存储器或其它类似存储器或数据存储设备。

控制器 180 优选地控制移动终端 100 的总体操作。例如，控制器 180 执行与语音呼叫、数据通信、即时消息通信、视频呼叫、相机操作和记录/再现操作相关联的控制和处理。如果需要，控制器 180 可包括提供多媒体回放的多媒体模块 181。多媒体模块 181 可被配置成控制器 180 的一部分，或者实现为单独的组件。

电源 190 提供移动终端 100 的各种组件所需的功率。该功率可以是内部功率、外部功率或其组合。

本文所述的各个实施例可以在使用例如计算机软件、硬件或其某种组合的计算机可读介质中实现。对于硬件实现，可在一个或多个专用集成电路（ASIC）、数字信号处理器（DSP）、数字信号处理器件（DSPD）、可编程逻辑器件（PLD）、现场可编程门阵列（FPGA）、处理器、控制器、微控制器、微处理器、设计成执行本文所述功能的其它电子单元或其选择性组合中实现本文中所述的实施例。这些实施例也可通过控制器 180 来实现。

对于软件实现，本文所述的实施例可用诸如程序和功能的独立软件模块来实现，这些模块的每一个执行本文所述的功能和操作中的一个或多个。软件代码可通过以任何合适的编程语言编写的软件应用来实现，并且可被存储在存储器（例如，存储器 160）中，以及可由控制器或处理器（例如，控制器 180）来执行。

移动终端 100 可以各种不同配置来实现。这些配置的示例包括但并不限于，折叠型、滑动型、直板型、旋转型、回转型及其组合。为了清晰起见，进一步的公开将主要涉及滑动型移动终端。然而，本发明的这些示教可同等地应用于其它类型的终端。

图 2 是根据本发明的实施例的移动终端 100 的一个示例的前侧立体图。图 2 中的终端 100 包括图 1 中所示终端的全部或部分组件。

参照图 2，移动终端 100 被示为具有配置成与第二机身 205 可滑动地协作的第一机身 200。用户输入单元（图 1 中所述，例如，组件 130）可包括诸如触摸垫和功能键 210 的第一输入单元、诸如小键盘 215 的第二输入单元以及诸如侧键 245 的第三输入单元。功能键 210 与第一机身 200 相关联，而小键盘 215 与第二机身 205 相关联。小键盘 215 包括使得用户能够拨打呼叫、准备文本或多媒体消息以及另外操作移动终端的各种键（例如，数字、字符和符号）。

第一机身 200 相对于第二机身 205 在打开和关闭位置之间滑动。在关闭位置，第一机身以使得小键盘 215 基本或完全被第一机身 200 遮盖的方式定位于第二机身 205 之上。在打开位置，用户对小键盘 215 以及显示器 151 和功能键 210 的访问成为可能。功能键 210 便于用户输入诸如开始、停止和滚动等命令。

移动终端 100 可工作在待机模式（例如，能够接收呼叫或消息、接收网络控制信令并作出响应）或活动呼叫模式。通常，当处于关闭位置时移动终端 100 工作在待机模式，而处于打开位置时工作在活动模式。该模式配置可按要求或需要来改变。

第一机身 200 被示为由第一壳 220 和第二壳 225 构成，而第二机身 205 被示为由第一壳 230 和第二壳 235 构成。这些第一和第二壳通常由诸如注塑塑料的适当刚性材料制成，或者使用诸如不锈钢（STS）或钛（Ti）的金属材料制成。

如果需要，可在第一和第二机身 200、205 中的一者或两者的第一与第二壳之间设一个或多个中间壳。第一机身 200 和第二机身 205 的大小被设为容纳用于支持移动终端 100 的操作必需的电子组件。

第一机身 200 被示为具有相对于显示器 151 定位的相机 121 和被配置成扬声器的音频输出模块 152。如果需要，相机 121 可以以使其可相对于第一机身 200 选择性地定位的方式构造（例如，旋转、回转等）。

功能键 210 可定位成靠近显示器 151 的下侧。显示器 151 被示为实现成 LCD 或 OLED。回想显示器还可被配置成具有响应于用户与触摸屏的接触（例如，使用

手指、输入笔等)而生成信号的下层触摸垫的触摸屏。

第二机身 205 被示为具有定位成靠近小键盘 215 的话筒 122 以及沿着第二机身的侧面定位的、作为一类用户输入单元的侧键 245。较佳地,侧键 245 可被配置成热键,使得该侧键与移动终端的特定功能相关联。接口单元 170 被示为靠近侧键 245 定位,而电池形式的电源 190 位于第二机身 205 的下部。

图 3 是图 2 所示移动终端的后视图。图 3 示出了具有相机 221 以及相关联的闪光灯 250 和反光镜 255 的第二机身 205。闪光灯与第二机身 205 的相机 221 结合操作。反光镜 255 用于帮助用户在自拍模式中定位相机 221。第二机身的相机 221 面向与第一机身 200 (图 2) 的相机 121 所面向的方向相反的方向。第一和第二机身的相机 121 和 221 中的每一个可具有相同或不同的能力。

在一个实施例中,第一机身 200 的相机 121 以比第二机身 205 的相机 221 相对较低的分辨率进行操作。在例如反向链路带宽能力可能有限的视频会议期间,这种布置表现良好。第二机身 205 (图 3) 的相机 221 的相对较高的分辨率用于获得较高质量的图片以供以后使用或传送给他人。

第二机身 205 还包括位于第二机身的上侧并配置成扬声器的音频输出模块 252。第一和第二机身 200、205 的音频输出模块 152 和 252 可按需协作以提供立体声输出。此外,这些音频输出模块 152 和 252 中的任一者或两者可被配置成用作扬声器电话。图 3 中所示的第二机身 205 的所有组件是由控制器 180 控制并操作性地耦合在移动终端 100 中。

广播信号接收天线 260 被示为位于第二机身 205 的上端。天线 260 与广播接收模块 111 (图 1) 协同工作。根据需要,天线 260 可以是固定的或被配置成收缩到第二机身 205 中。第一机身 200 的后侧包括可与位于第二机身 205 的前侧的对应滑动模块滑动地耦合的滑动模块 265。

应当理解,第一和第二机身 200、205 的各个组件的例示布置可按要求或需要更改。一般而言,一个机身的某些或全部组件可选择性地在另一个机身上实现。另外,这些组件的位置和相对定位对于许多实施例并不关键,因此,这些组件可定位在与相应示图中所示的那些不同的位置。

图 1-3 的移动终端 100 可被配置成在包括无线和有线通信系统、以及基于卫星的通信系统等经由帧或分组来传送数据的通信系统内操作。这些通信系统使用不同的空中接口和/或物理层。

这些通信系统所使用的空中接口的示例包括但不限于,频分多址(FDMA)、

时分多址 (TDMA)、码分多址 (CDMA) 以及通用移动通信系统 (UMTS)、UMTS 的长期演进 (LTE) 和全球移动通信系统 (GSM)。仅作为非限制性示例, 进一步的描述将涉及 CDMA 通信系统, 但是这些教义同样可应用于其它系统类型。

现在参照图 4, CDMA 无线通信系统被示为具有多个移动终端 100、多个基站 270、基站控制器 (BSC) 275 和移动交换中心 (MSC) 280。MSC 280 被配置成与常规的公共交换电话网 (PSTN) 290 接口。MSC 280 还被配置成与 BSC 275 接口。BSC 275 经由回程线路耦合到基站 270。该回程线路可根据若干公知接口的任一种来配置, 例如 E1/T1、ATM、IP、PPP、帧中继、HDSL、ADSL、或 xDSL。应当理解, 系统可包括两个以上的 BSC 275。系统的所有组件被操作性地耦合和配置。

每个基站 270 可包括一个或多个扇区, 每个扇区具有全向天线或指向径向远离相应基站 270 的特定方向的天线。或者, 每个扇区可包括用于分集接收的两个天线。每个基站 270 可被配置成支持多个频率指派, 其中各个频率指派具有特定频谱 (例如, 1.25 MHz、5 MHz)。

扇区和频率指派的交集称为 CDMA 信道。基站 270 也可称为基站收发器子系统 (BTS)。在一些情形中, 术语“基站”可用于统指 BSC 275、以及一个或多个基站 270。基站 270 还可表示为“小区站点 (cell site)”。或者, 给定基站 270 的各个扇区可称为小区站点。

地面数字多媒体广播 (DMB) 发射机 295 (或其它类型的数字广播发射机) 被示为向工作在该系统中的便携式终端 100 广播。终端 100 的广播接收模块 111 (图 1) 优选地被配置成接收由 DMB 发射机 295 发射的广播信号。可为其它类型的广播和多播信令实现类似布置 (如上所述)。

图 4 还描绘了若干全球定位系统 (GPS) 卫星 300。这些卫星有助于定位部分或所有便携式终端 100 的位置。绘出了两个卫星, 但是应当理解, 可使用更多或更少的卫星来获得有用的定位信息。便携式终端 100 的定位模块 115 (图 1) 通常被配置成与卫星 300 协作以获得期望的位置信息。应当理解, 可替换性地实现其它类型的位置检测技术 (即, 可在 GPS 定位技术之外或作为其替代使用的定位技术)。根据需要, 部分或所有 GPS 卫星 300 可替换性地或附加地配置成提供卫星 DMB 发送。

在无线通信系统的操作期间, 基站 270 从各个移动终端 100 接收多组反向链路信号。移动终端 100 从事呼叫、消息接发以及其它通信。在该基站内处理由给定基站 270 接收到的每个反向链路信号。所得数据被转送到相关联的 BSC 275。BSC

275 提供呼叫资源分配以及包括基站 270 之间的软切换控制的移动性管理功能。BSC 275 还将收到的数据路由到 MSC 280, 由后者提供用于与 PSTN 290 接口的附加路由服务。类似地, PSTN 290 与 MSC 280 接口, MSC 280 与 BSC 275 接口, 后者又控制基站 270 向移动终端 100 发送多组前向链路信号。

在以下描述中, 参照诸如图 5-11 的附图说明在以上配置的移动终端中实现的菜单图标显示方法的各个实施例。换言之, 以下描述对包括触摸屏的显示模块 151 作出假设。触摸屏在以下描述中由附图标记 400 指示。然而, 以下实施例可实现于其它类型的通信终端中。

### 第一实施例

以下参照图 6 和 6 解释了根据本发明的第一实施例的菜单图标显示方法。

图 5 是用于解释根据本发明的显示菜单图标的方法的流程图, 而图 6 是用以描述根据本发明的第一实施例的图像显示方法的移动终端的显示屏的示例的示图。

首先, 本发明的多个菜单可主要被分类为两种类型, 即可由触摸屏上的触摸选择的菜单(以下称为“触摸可用菜单”)和不能由触摸选择的其它菜单(以下称为“触摸不可用菜单”)。将具体参照各种示例对其进行描述。

参照图 6 (6-1), 触摸屏 400 显示待机图像。并且, 待机图像中呈现‘菜单’图标 410。“菜单”图标 410 可通过诸如小键盘等用户输入单元 130 来选择。然而, ‘菜单’图标 410 不能通过触摸触摸屏 400 的指定部分来选择。所以‘菜单’图标 410 对应于触摸不可用图标。

对于本领域的技术人员显而易见的是, ‘菜单’图标 410 可通过用户输入单元 130 (例如, 软键) 来选择。所以, 为了描述的清晰和方便将在该公开中省略其细节。

最初, 如图 6 (6-1) 所示, 触摸屏 400 上并未显示任何触摸可用图标。因此此时无需启用触摸屏。由此用以检测由终端用户作出的触摸的电流源是不必要且可以节省的。

在该情形下, 终端用户按下提供给用户输入单元 130 的触摸屏启用键(未在图 6 中示出)。或者, 触摸屏启用键可用第三用户输入单元 245 的侧键来配置。如果这样, 触摸屏 400 被启用以检测终端用户所作的触摸[S51]。

随后, 在图 6 (6-1) 所示的触摸屏 400 (当前被启用以检测触摸) 上用箭头和星形显示的图像的指定点被用户(例如, 用户手指)触摸并随后从右向左拖曳(或在任何其它指定方向上) [52]。在以下描述中, 该动作被表示为触摸屏 400 的指定

点被从右向左拖曳这一表述。并且,应该理解的是,‘触摸拖曳’是包括‘轻拂(flick)’的概念。

然后,参照图6的(6-2),通过从触摸屏400的右端侧滑动进入触摸屏400,一组触摸可用图标420出现在触摸屏400的右侧上[53]。然而,触摸可用图标420可根据需要被配置成出现在触摸屏400的任何指定区域上。

因此,终端用户触摸以从显示在触摸屏400上的该组触摸可用图标420中选择一特定触摸可用图标,以执行对应于选定图标的功能。

为了描述的清晰性,介绍以下概念。

首先,触摸屏400优选地由4侧(即,右侧、左侧、上侧和下侧)构造而成。在以下描述中,被这4侧包围的内部(即,终端用户可见的真实部分)被命名为触摸屏400的‘内区’而这4侧之外的外部(即,终端用户不可见的虚拟部分)被命名为触摸屏的‘外区’(隐藏区)。

即,关于图6(6-2)通过从触摸屏400的右侧滑动进入触摸屏400出现该组触摸可用图标420的以上描述可被表示为位于右侧之外的外区中的一组触摸可用图标通过跨过外区与内区之间触摸屏400的右侧上的边界滑动进入内区。

一旦触摸可用图标420被显示在触摸屏400上,如图6(6-2)所示的触摸屏400的指定点就可从左向右触摸拖曳[S52]。如果这样,当前显示在触摸屏400上的该组触摸可用图标420滑动消失进入右侧。换言之,显示在内区上的该组触摸可用图标420滑动穿过右侧的边界并随后离开进入右侧之外的外区,由此触摸屏400上的触摸可用图标420对于用户不再可见[53]。

在另一示例中,为了使触摸可用图标消失,并不必要在与先前触摸可用图标籍其出现在触摸屏上的方向相反的方向上执行触摸拖曳。例如,在触摸可用图标滑动出现的方向上执行触摸拖曳的情形中,可以被配置成触摸可用图标420通过穿过触摸屏左侧上的边界滑动进入外区从而进入左侧。

任选地,即使触摸屏400的指定点未被触摸拖曳,也能够将触摸可用图标420配置成在通过操控触摸屏启用键禁用触摸屏时消失。

在以上描述中,已经根据本发明的实施例对用于在触摸屏被启用后触摸可用图标在显示单元的触摸屏上的出现/消失的机制进行了解释。本发明还适用于因触摸屏总是启用情形下省略触摸屏启用过程的配置。

在以上描述中,一组触摸可用图标(例如,对应于终端用户频繁使用的菜单的触摸可用图标)被配置成仅移过触摸屏400的一侧(例如,右侧)。任选地,本

发明可被配置成允许另一组触摸可用图标（例如，对应于终端设置相关菜单的触摸可用图标）还移过触摸屏 400 的另一侧。其它变形也是可能的。

## 第二实施例

在本发明的第一实施例的描述中，解释了触摸可用图标在触摸屏的内区与外区之间移动的过程。在以下本发明的第二实施例的描述中，解释了在触摸屏的内区上显示触摸可用图标时选择触摸可用图标中的至少一个的过程。

图 7 是用以描述根据本发明的第二实施例的图像显示方法的移动终端的显示屏的示例的示意图。

参照图 7 的 (7-1)，一组触摸可用图标 420 被显示在触摸屏 400 上。由于显示了触摸可用图标 420，所以显然触摸屏处于启用模式。

例如，假定从所显示的该组触摸可用图标 420 中选择了 ‘MP3’ 图标 421。

如果如此，如图 7 的 (7-2) 所示，用于播放 MP3 文件的窗口 430 被显示在触摸屏 400 上且移动终端 100 中的 MP3 文件播放功能被启用。这里，窗口 430 可显示用于选择特定 MP3 文件和/或控制 MP3 文件的回放操作的菜单，或者可预选一特定 MP3 文件。

随后，如图 7 的 (7-2) 所示，从左到右地触摸拖曳触摸屏 400 的指定点。

如果如此，一组不同的触摸可用图标 440 从触摸屏 400 的左侧滑动出现在触摸屏 400 中。换言之，存在于左侧之外的外区中的一组不同的触摸可用图标 440 移动穿过左侧上的边界（介于内区与外区之间）并随后在其滑动进入触摸屏的左侧时出现在触摸屏的左侧上。

属于不同组的触摸可用图标 440 可包括与 MP3 文件播放功能相关的图标。这里，终端用户能够通过从当前显示在触摸屏 400 上的该组触摸可用图标 440 中选择（例如，触摸）一特定图标来控制 MP3 文件播放功能。

参照图 7 的 (7-3)，触摸屏 400 的一指定点被从右向左地触摸拖曳。

然后，参照图 7 的 (7-4)，当前显示在触摸屏 400 的左侧上的该组不同的触摸可用图标 440 滑动进入触摸屏 400 的左侧并消失，由此在触摸屏 400 上触摸可用图标 440 不再可见。换言之，触摸屏 400 的内区（可见）上的触摸可用图标 440 移动和滑动穿过左方的边界从而消失在触摸屏 400 的左侧之外的外区中。

以下对中断 MP3 播放功能的情形进行了解释。

参照图 7 的 (7-4)，触摸屏 400 的一指定点被从右向左地触摸拖曳。然后参照图 4 的 (7-5)，一组触摸可用图标 420 越过触摸屏 400 的右侧滑动出现在触摸

屏 400 中。换言之，存在于右侧之外的外区（隐藏区）中的该组触摸可用图标 420 穿过右侧上的边界并随后滑动移进内区，由此触摸可用图标 420 滑动地出现在触摸屏 400 的右侧上。

在该情形中，‘MP3’图标 421 被该组触摸可用图标 420 当中的‘主页(Home)’图标 427 所代替。由于 MP3 文件播放功能正在进行中（例如，MP3 文件正在回放），此刻不需要‘MP3’图标 421，所以可以其它触摸可用图标出现另一图标。在另一示例中，可在触摸屏上出现触摸可用图标 420 的不同组合。此外，可按需由用户控制/选择触摸可用图标 420 的数目以及触摸可用图标 420 出现在触摸屏 400 上的方式。

作为示例，由终端用户选择“主页”图标 427。

然后，参照图 7 的（7-6），移动终端 100 中断 MP3 文件播放功能（例如，MP3 文件被停止）并在触摸屏 400 上显示待机图像。在其它示例中，用户可触摸选择所显示的触摸可用图标 420 中的任一个以执行所需功能。

### 第三实施例

虽然在本发明的第二实施例中描述的一特定功能（例如，MP3 文件播放功能）正在执行，但如果发生了诸如消息接收这样的事件，则如何处理该事件作为本发明参照图 8 的第三实施例如下进行解释。

图 8 是用以描述根据本发明的第三实施例的图像显示方法的移动终端的显示屏的示例的示图。

参照图 8 的（8-1），假定正在移动终端 100 中执行 MP3 文件播放功能。例如，当前正在移动终端 100 中播放一特定 MP3 文件（音频和/或视频）。

在此期间，假定移动终端 100 接收到一消息。

如果如此，则如图 8 的（8-2）所示，指示该消息接收的指示符 403 被显示在触摸屏 400 上。

如果触摸屏 400 不是处于触摸启用模式，则选择触摸屏启用键以启用该触摸屏从而使得可以检测到对触摸屏的触摸。

参照图 8 的（8-2），触摸屏 400 的一指定点被向上触摸拖曳。

然后参照图 8 的（8-3），用于该接收到的消息的窗口 450 越过触摸屏 400 的下侧滑动出现在触摸屏 400 中。换言之，存在于触摸屏 400 的下侧之外的外区（触摸屏 400 的隐藏区）上的窗口 450 穿过下侧上的边界并随后滑动移进触摸屏 400 的内区中。即，窗口 450 从触摸屏 400 的下侧滑动地出现在触摸屏 400 上。



终端用户通过触摸窗口 450 内的‘删除’图标 453 删除该接收到的消息或通过触摸窗口 450 内的‘回复’图标 455 响应于该接收到的消息作出回复。

随后参照图 8 的 (8-3)，触摸屏 400 的一指定点被向下触摸拖曳。

然后参照图 8 的 (8-4)，用于该接收到的消息的窗口 450 从触摸屏 400 的内区向下滑动消失在触摸屏 400 的下侧。换言之，存在于触摸屏的内区内的窗口 450 穿过下侧上的边界并随后往外滑动消失在触摸屏 400 的下侧之外的外区（隐藏区）中。结果，窗口 430 可以对用户可见。

#### 第四实施例

在以上描述中，当触摸屏一旦被触摸拖曳时，一组触摸可用图标就同时滑动地出现在触摸屏的内区上。或者，以下配置也是可能的。换言之，在该组触摸可用图标的部分已经滑动出现在触摸屏的内区上之后，如果该触摸屏被再一次触摸拖曳，则该组触摸可用图标的剩余部分滑动出现在触摸屏的内区上。该配置在以下作为本发明参照图 9 的第四实施例进行了解释。

图 9 是用以描述根据本发明的第四实施例的图像显示方法的移动终端的显示屏的示例的示图。

参照图 9 的 (9-1)，当触摸屏 400 处于启用模式（触摸模式）时，触摸屏 400 的一指定点被从右向左触摸拖曳。

如果如此，如图 9 的 (9-2) 所示，一组触摸可用图标 420 中存在于触摸屏 400 的右侧之外的外区中的部分（例如，图标 421、422 和 423）穿过右侧上的边界并随后滑动地出现在触摸屏 400 的右侧的内区上。

随后参照图 9 的 (9-2)，触摸屏 400 的一指定点被再一次从右向左触摸拖曳。

然后参照图 9 的 (9-3)，该组触摸可用图标 420 存在于触摸屏 400 的右侧之外的外区中的剩余部分（例如，图标 424、425 和 426）穿过右侧上的边界并随后滑动地出现在触摸屏 400 右侧的内区上。

因此，终端用户能够根据需要选择/触摸并操作所显示的触摸可用图标 420 中的特定一个。

同时，根据需要，如图 9 的 (9-3) 所示，触摸屏 400 的一指定点被从左向右触摸拖曳。

如果如此，如图 9 的 (9-4) 所示，该组触摸可用图标 420 最后显示在内区上的图标 424、425 和 426 穿过右侧上的边界并随后滑动地移进触摸屏 400 的右侧之外的外区中，由此这些图标 424、425 和 426 从触摸屏 400 消失。

然后参照图 9 的 (9-4)，触摸屏 400 的一指定点被再一次从左向右触摸拖曳。

如果如此，该组触摸可用图标 420 存在于内区内的部分（即，图标 412、422 和 423）穿过右侧上的边界并随后滑动地移进触摸屏 400 的右侧之外的外区中，由此所有图标 420 完全从触摸屏 400 消失并且可在触摸屏上出现待机图像。

在以上描述中，该组触摸可用图标的部分或全部根据触摸屏上触摸拖曳的计数（数目）向内滑动出现在触摸屏上。本发明还允许以下配置。即，该组触摸可用图标的部分或全部根据触摸屏上触摸拖曳的长度滑动出现在触摸屏上。这对于本领域的技术人员是显而易见的。所以，为了本公开的清晰起见在以下描述中省略其细节。

### 第五实施例

以下参照图 10 对根据本发明的第五实施例的显示菜单图标的方法进行了解释。

图 10 是用以描述根据本发明的第五实施例的图像显示方法的移动终端的显示屏的示例的示图。

参照图 10 的 (10-1)，假定移动终端 100 中正在执行 MP3 文件播放功能。

如果终端用户操控触摸屏启用键，则触摸屏 400 被启用进入触摸模式。

参照图 10 的 (10-2)，与 MP3 文件播放功能相关的一组触摸可用图标 440 被生成并显示在触摸屏 400 上。当触摸屏 400 被启用时，对该组触摸可用图标 440 出现的机制并不施加限制。例如，如先前描述中所提到的，能够将该组触摸可用图标 440 配置成从触摸屏 400 的左侧之外的外区滑动出现在内区中。

然后参照图 10 的 (10-2)，触摸屏 400 的一指定点被从右向左触摸拖曳。

然后参照图 10 的 (10-3)，该组触摸可用图标 440 从内区往外滑动消失在触摸屏 400 的左侧之外的外区中。同时，一组不同的触摸可用图标 420（例如，对应于终端用户频繁使用的菜单的触摸可用图标）从触摸屏 400 右侧的外区往内滑动出现在内区中。例如，图标 440 从触摸屏 400 滑动地消失并且同时、几乎同时、或以特定次序相继地滑动出现在触摸屏 400 上。

然后参照图 10 的 (10-3)，触摸屏 400 的一指定点被从左向右触摸拖曳。

如果如此，如图 10 的 (10-3) 所示，该组触摸可用图标 420 从内区滑动消失在触摸屏 400 的右侧之外的外区中。同时，该组触摸可用图标 440 以与图 10 的 (10-2) 相同的方式从触摸屏的左侧之外的外区滑动出现在内区中。

随后，终端用户通过操控触摸屏启用键禁用触摸屏 400。

如果如此，图 10 的 (10-2) 所示的该组触摸可用图标 440 如图 10 的 (10-1) 所示地从触摸屏 400 消失。当触摸屏 400 被禁用时，对该组触摸可用图标 440 消失的机制并不施加限制。例如，如先前描述所提到的，能够将该组触摸可用图标 440 配置成从内区往外滑动以消失在触摸屏 400 的左侧之外的外区中。

在以上描述中，当移动终端执行 MP3 文件播放功能时，触摸屏进入启用模式。所以，在触摸屏暗淡 (attenuation) 之后，一组与 MP3 文件播放功能相关的触摸可用图标被配置成显示在第一位置。并且，本发明还允许以下配置。即，当移动终端处于待机模式时，如果该触摸屏被启用，则能够配置成在该第一位置显示与终端用户频繁使用的菜单相对应的一组触摸可用图标 420。

### 第六实施例

以下参照图 11 对根据本发明的第六实施例显示菜单图标的方法进行了解释。

图 11 是用以描述根据本发明的第六实施例的图像显示方法的移动终端的显示屏的示例的示意图。

参照图 11 的 (11-1)，假定移动终端 100 中正在执行 MP3 文件播放功能。并且，还假定触摸屏 400 处于启用模式。

在该情形中，触摸屏 400 的内区被分割为多个区域。为了本实施例描述的清晰起见，假定内区被分为左区 I 和右区 II。左区和右区 I 和 II 分别与触摸屏 400 的左侧之外的触摸可用图标 440 的迁移和触摸屏 400 的右侧之外的触摸可用图标 420 的迁移相关联。这被具体解释如下。然而，本发明并不限于此且包括操作被划分为不同区域和/或不同方向 (例如，上区和下区) 的触摸屏。

如图 11 的 (11-1) 中所示，触摸屏 400 的左区 I 上的一指定点被从左向右触摸拖曳。

如果如此，存在于触摸屏 400 的左侧之外的外区中的一组触摸可用图标 440 如图 11 的 (11-2) 所示地穿过触摸屏 400 左侧上的边界并随后滑动进入内区中。例如，图标 440 滑动地出现在触摸屏 400 的左区 I 上。

参照图 11 的 (11-2)，触摸屏 400 的右区 II 上的一指定点被从右向左触摸拖曳。

如果如此，如图 11 的 (11-3) 中所示，存在于触摸屏 400 的右侧之外的外区中的一组不同的触摸可用图标 420 穿过触摸屏右侧上的边界并随后滑动出现在内区中。即，图标 420 滑动地出现在触摸屏 400 的右区 II 上。

然后参照图 11 的 (11-3)，触摸屏 400 的左区 I 上的一指定点被从右向左触

摸拖曳。

如果如此，如图 11 的 (11-4) 中所示，当前显示的该组触摸可用图标 440 从内区穿过左侧上的边界并随后滑动消失在触摸屏 400 的左侧之外的外区中。例如，所显示的图标 440 从左区 I 滑动地消失。

参照图 11 的 (11-4)，触摸屏 400 的右区 II 的一指定点被从左向右触摸拖曳。

如果如此，如图 11 的 (11-1) 所示，当前显示的该组不同的触摸可用图标 420 从内区穿过右侧上的边界并随后滑动消失在触摸屏的右侧之外的外区中。例如，图标 420 从触摸屏 400 的右区 II 滑动地消失。在以上示例中，结合具体方向（例如，从右向左、或从左向右）讨论了触摸拖曳操作。本发明并不限于以上给出的示例，而是完全包括其它方向的触摸拖曳操作。

相应地，本发明提供了以下效果和优点。

首先，根据本发明的一个实施例，用于检测触摸的电流仅在触摸可用图标被显示在触摸屏上时提供给该触摸屏。因此，本发明使得使用触摸屏的功耗最小化。

其次，根据本发明的一个实施例，便于终端用户经由触摸屏上的触摸拖曳显示触摸屏上的特定触摸可用图标。因此，本发明便于终端用户执行一特定菜单功能。

对于本领域的技术人员将显而易见的是，可在本发明中作出各种修改和变形而不会背离本发明的精神实质和范围。例如，上述方法可以在作为计算机可读代码在程序记录介质中实现。该计算机可读介质包括其中存储了可由计算机系统读取的数据的所有种类的记录设备。计算机可读介质例如包括 ROM、RAM、CD-ROM、磁带、软盘、光数据存储设备等且还包括载波型实现（例如，经由因特网传输）。并且，计算机可包括终端的控制器 180。因此，本发明旨在涵盖本发明的所有修改和变形，只要它们落在所附权利要求及其等效范围的范围内。

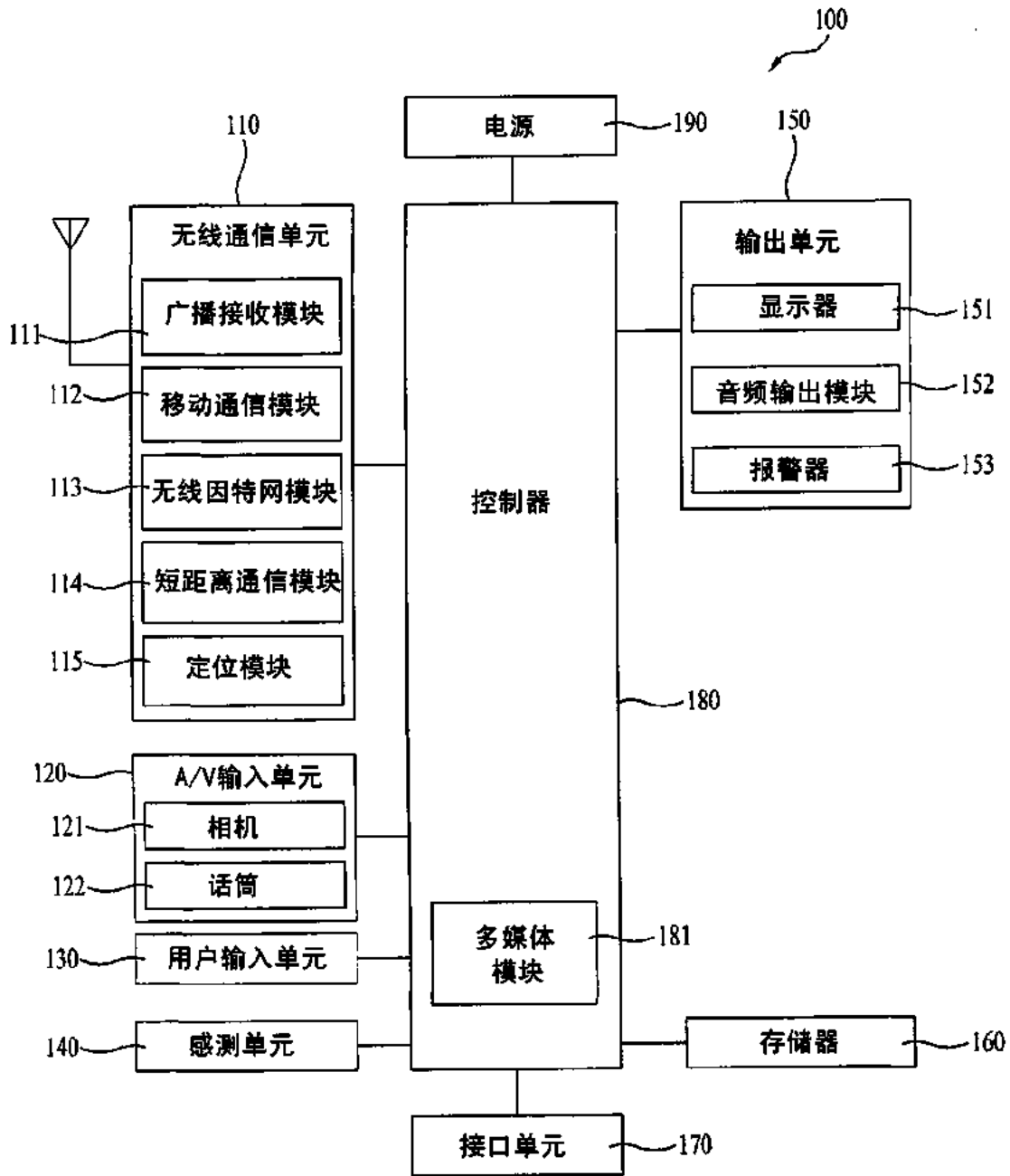


图 1

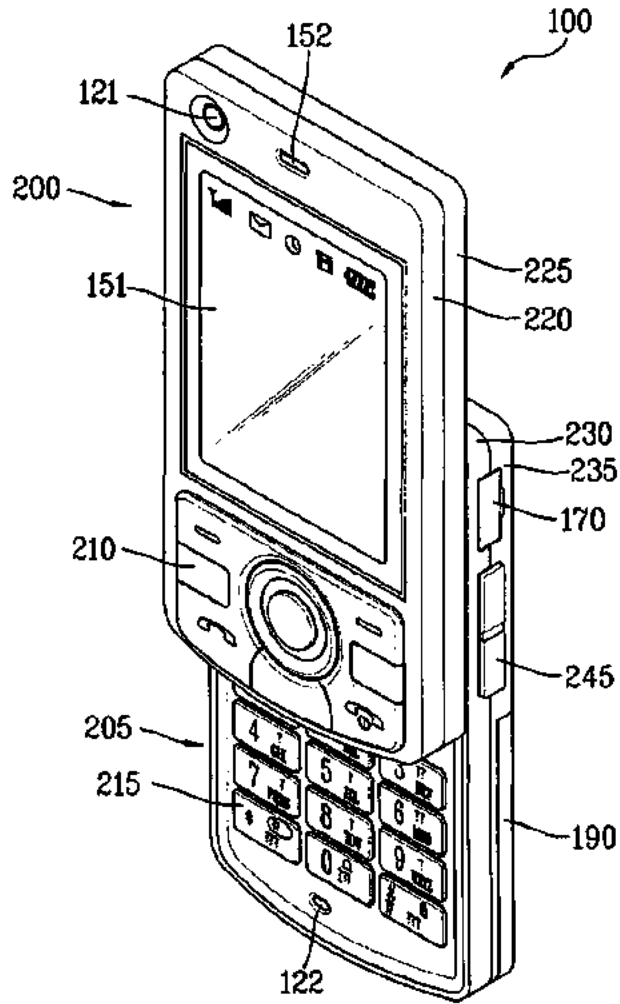


图 2

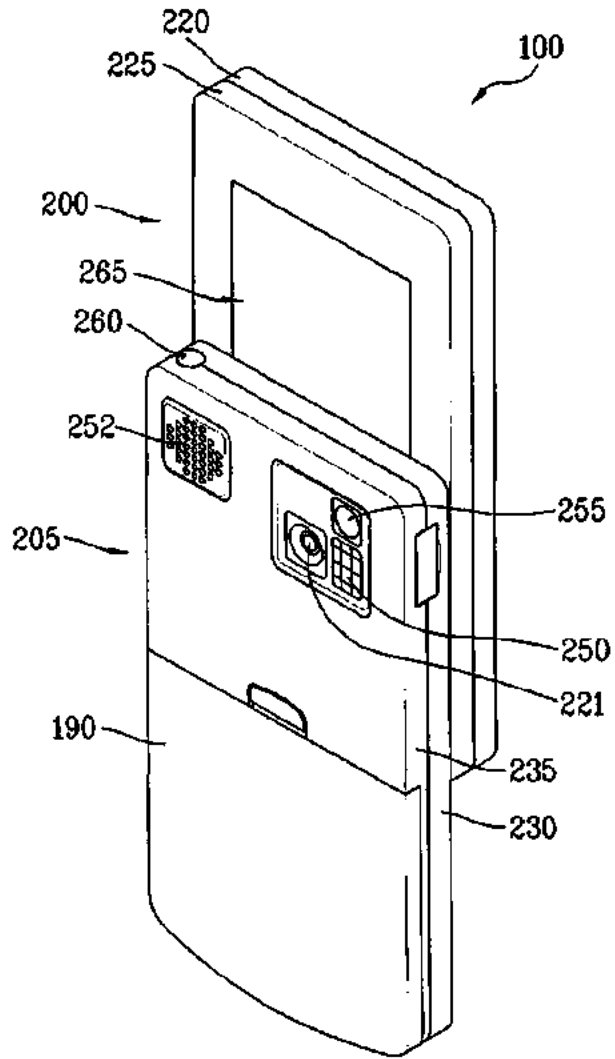


图 3

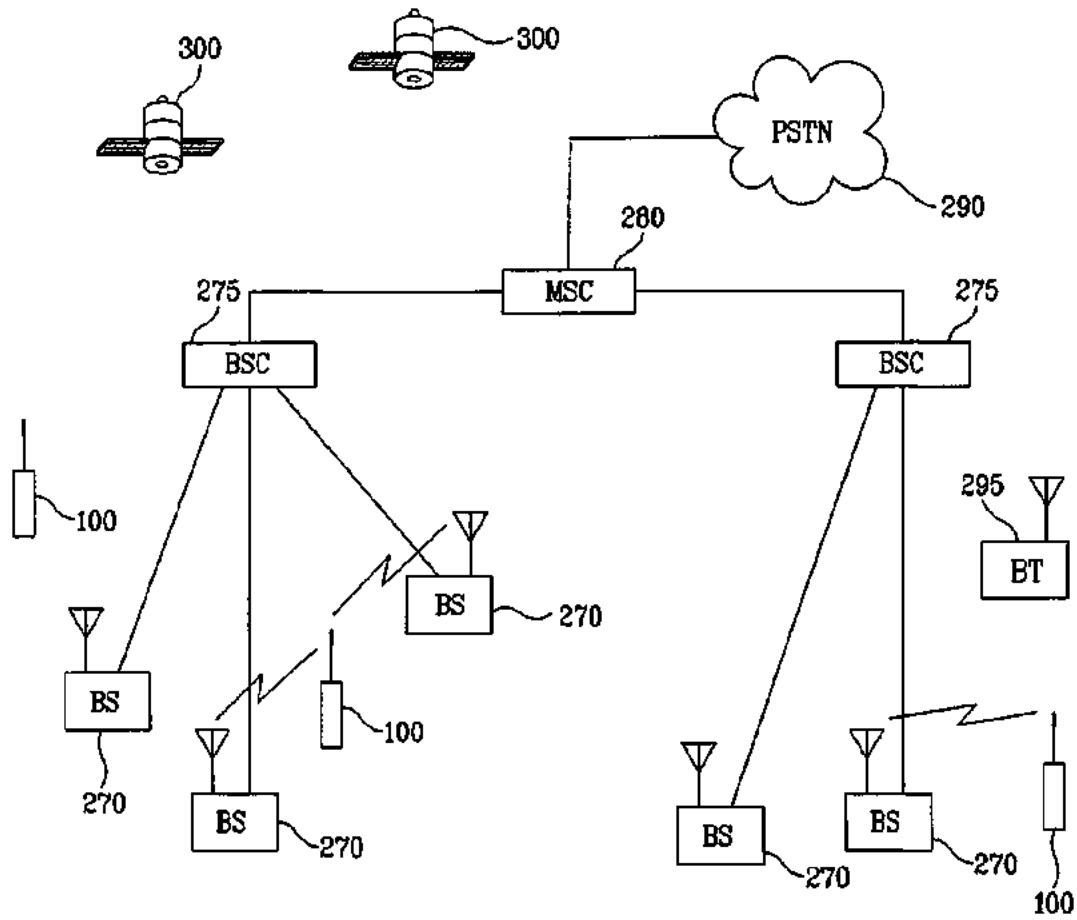


图 4



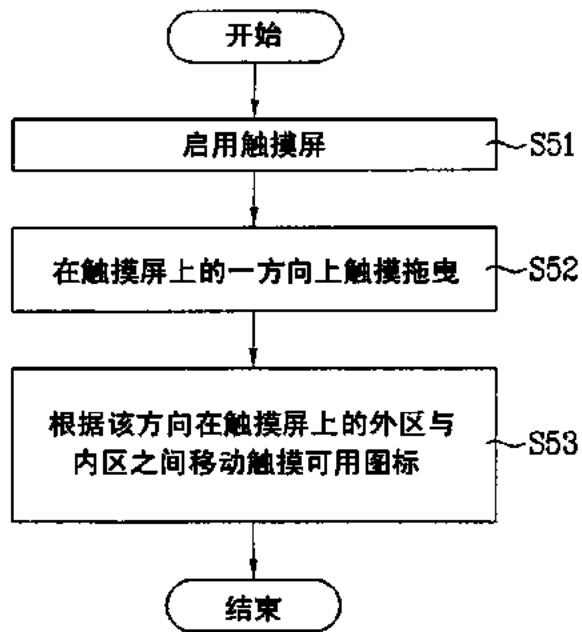


图 5

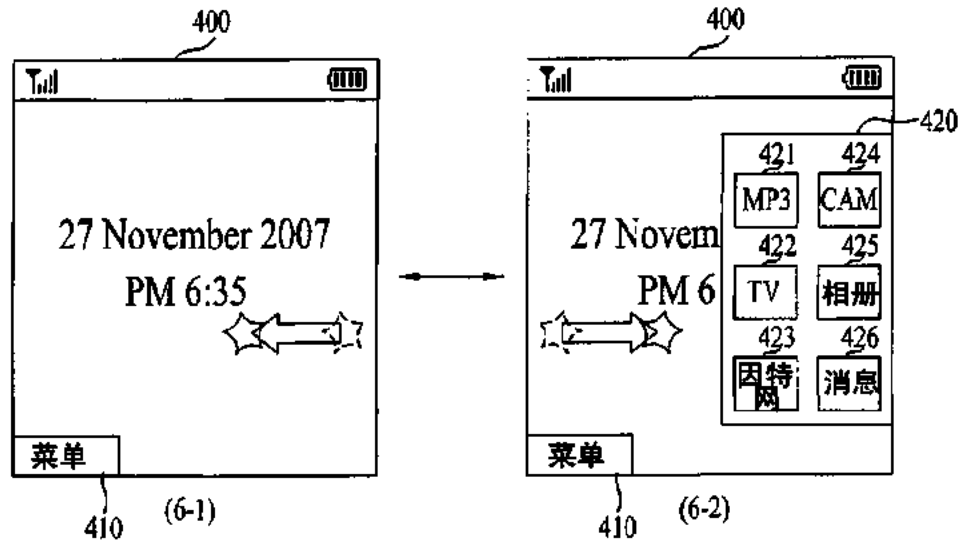


图 6

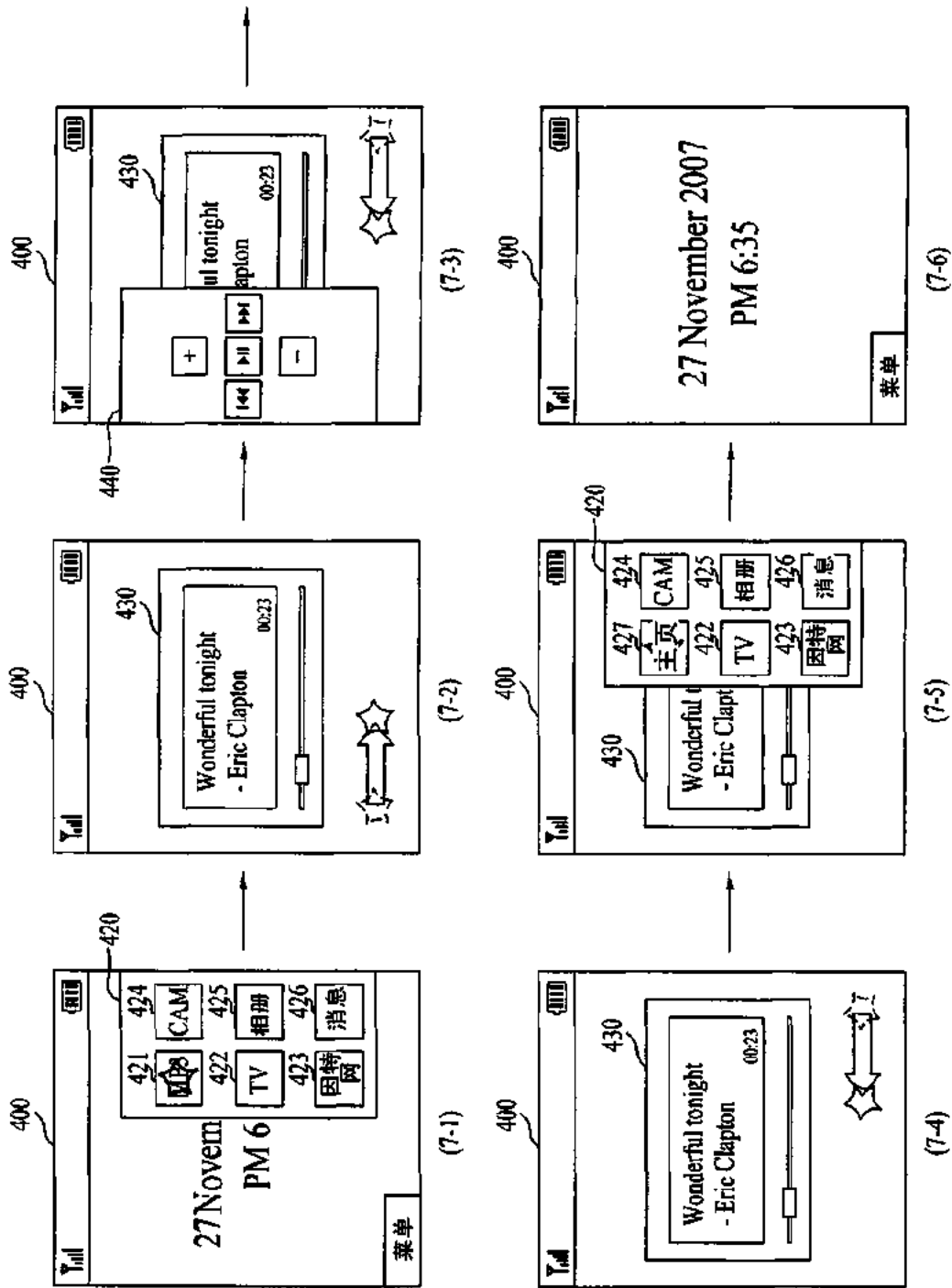


图 7

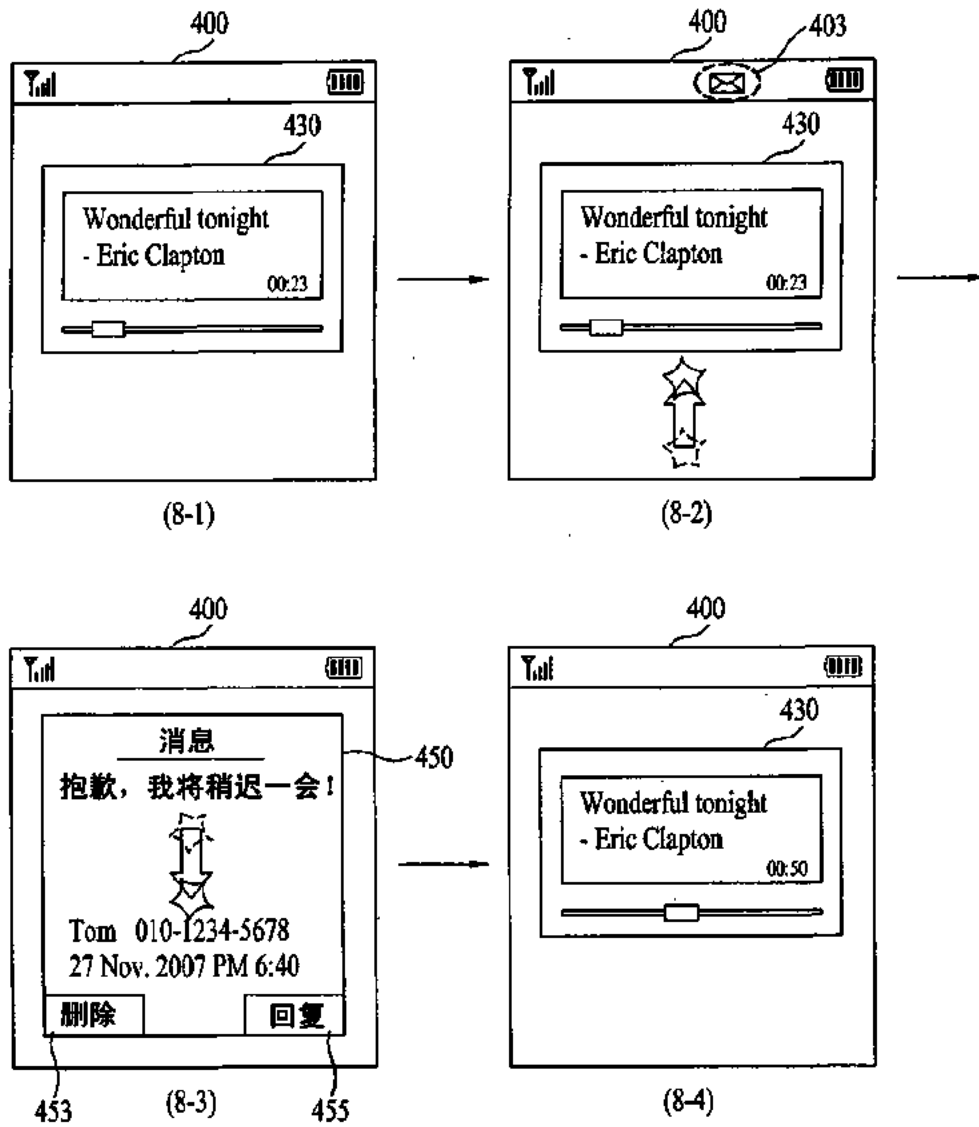


图 8

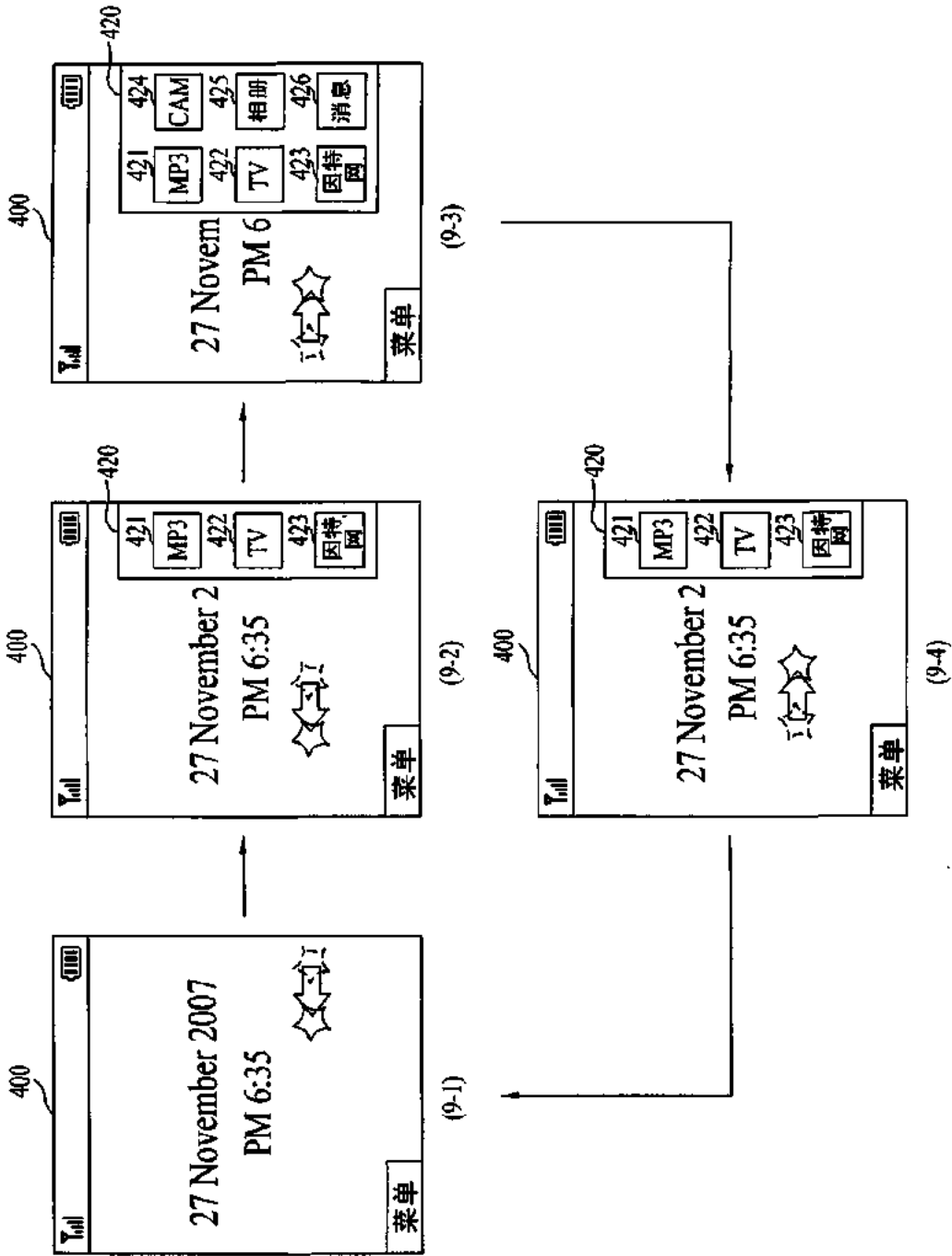


图 9

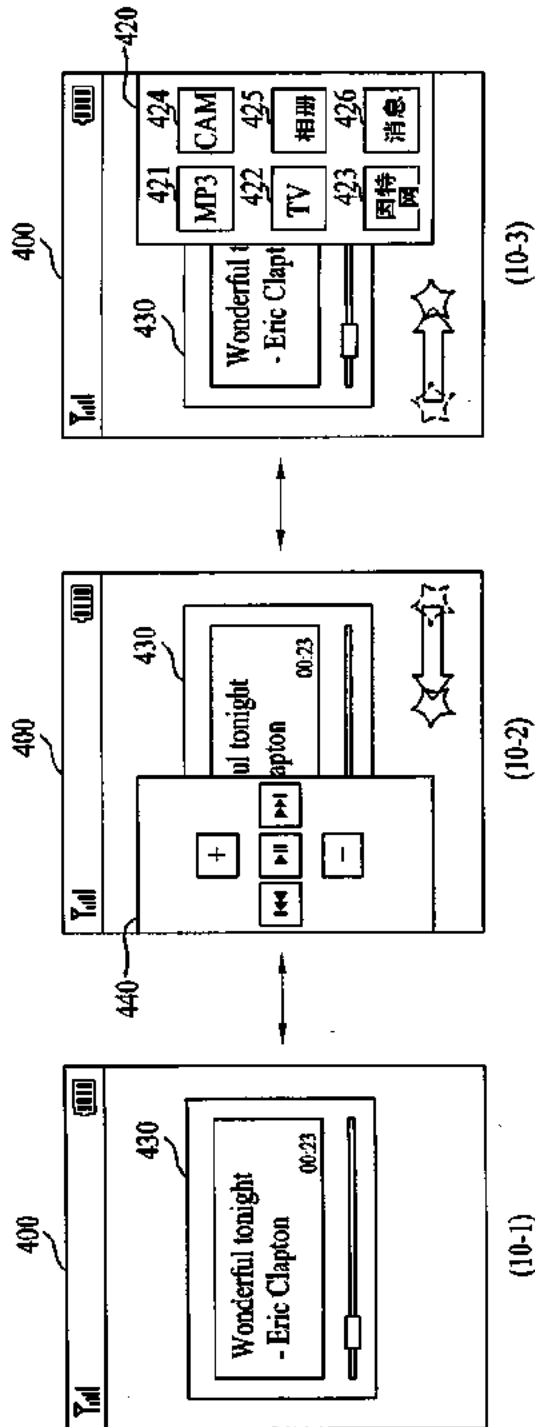


图 10

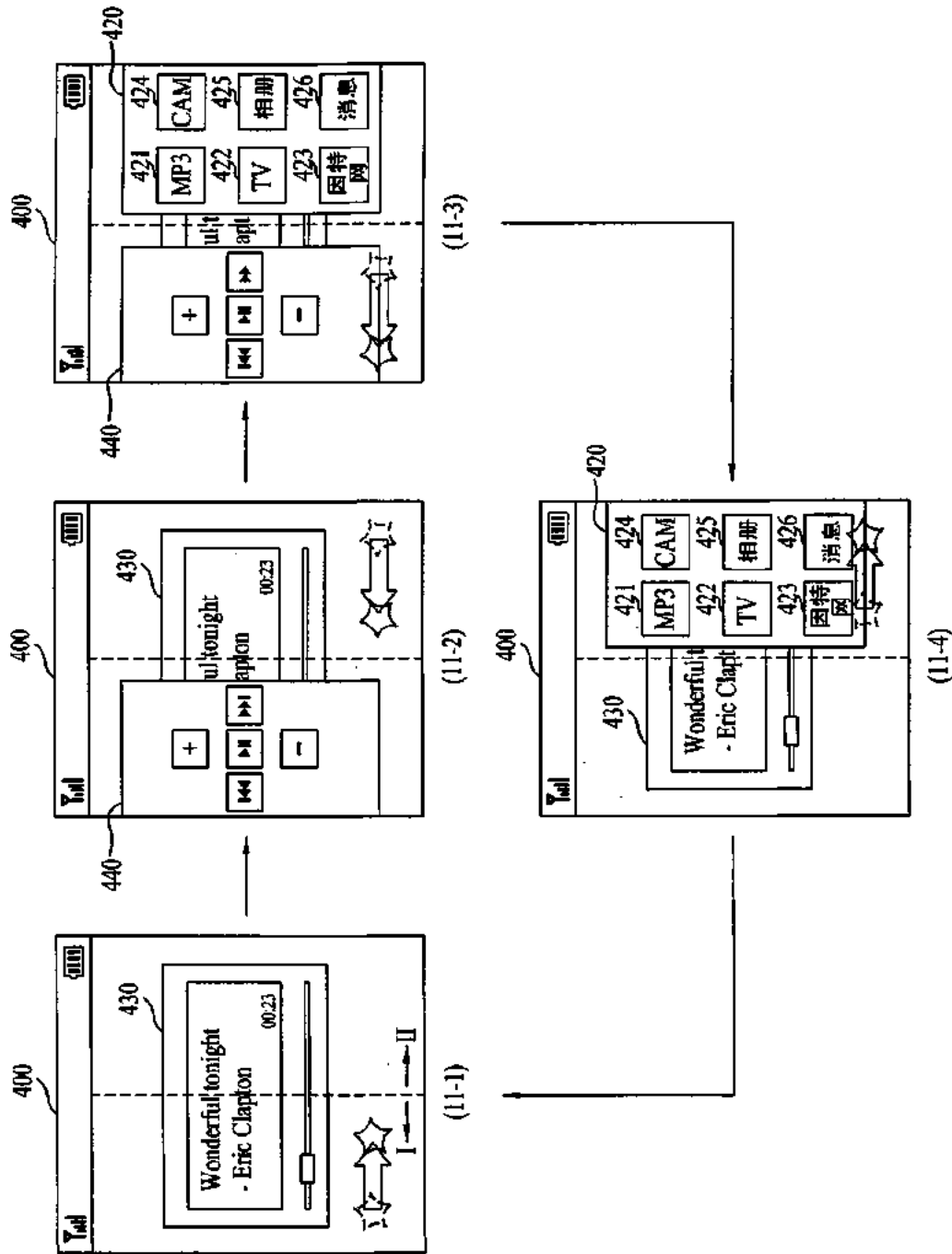


图 11



Espacenet

Bibliographic data: CN101452365 (A) --- 2009-06-10

Terminal and method of controlling the same

Inventor(s): JIN SEO [KR] ± (SEO JIN)

Applicant(s): LG ELECTRONICS INC [KR] ± (LG ELECTRONICS INC)

Classification: - international: G06F3/048; G06F3/0481; G06F3/0488  
 - cooperative: G06F3/04817; G06F3/04842; G06F3/0486;  
G06F3/04883; H04M1/72547; H04M1/72558;  
H04M2250/22; H04W52/027

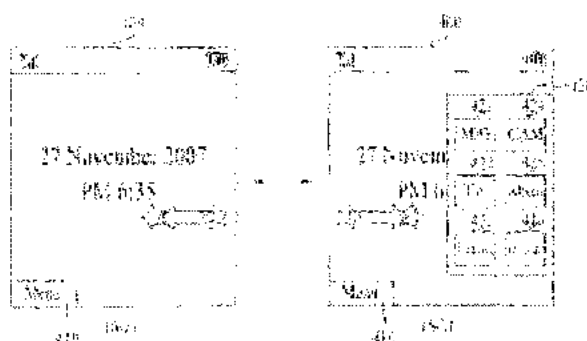
Application number: CN2008192271 20080414

Priority number(s): KR20070126147 20071206Also published as: CN101452365 (B) EP2076000 (A2) EP2076000 (A3)  
EP2076000 (B1) US2015277695 (A1) more

Abstract of CN101452365 (A)

According to an embodiment, a terminal and a method of displaying menu icons thereof are discussed, by which a terminal user is facilitated to input various commands. An embodiment of the present invention includes a touch screen and a control unit configured to control at least one touch-available icon to move between outer and inner areas of an image displayed on the touch screen in a direction of a touch-drag on the touch screen. Accordingly, the electric current for detecting a touch is supplied to the touch screen only if the touch-available icon is displayed on the touch screen. Hence, the present invention minimizes power consumption in using the touch screen.

FIG. 6





## Electronic Patent Application Fee Transmittal

<b>Application Number:</b>	14848191
<b>Filing Date:</b>	08-Sep-2015
<b>Title of Invention:</b>	ACTIVATING DISPLAY AND PERFORMING USER AUTHENTICATION IN MOBILE TERMINAL WITH ONE-TIME USER INPUT
<b>First Named Inventor/Applicant Name:</b>	Jae Lark JUNG
<b>Filer:</b>	Mincheol Kim/Jacquie O'Brien
<b>Attorney Docket Number:</b>	UNIS005.001C2

Filed as Small Entity

### Filing Fees for Utility under 35 USC 111(a)

Description	Fee Code	Quantity	Amount	Sub-Total in USD(\$)
<b>Basic Filing:</b>				
<b>Pages:</b>				
<b>Claims:</b>				
<b>Miscellaneous-Filing:</b>				
<b>Petition:</b>				
<b>Patent-Appeals-and-Interference:</b>				
<b>Post-Allowance-and-Post-Issuance:</b>				
<b>Extension-of-Time:</b>				

Description	Fee Code	Quantity	Amount	Sub-Total in USD(\$)
<b>Miscellaneous:</b>				
RCE- 2ND AND SUBSEQUENT REQUEST	2820	1	850	850
<b>Total in USD (\$)</b>				<b>850</b>

## Electronic Acknowledgement Receipt

<b>EFS ID:</b>	27692676
<b>Application Number:</b>	14848191
<b>International Application Number:</b>	
<b>Confirmation Number:</b>	9599
<b>Title of Invention:</b>	ACTIVATING DISPLAY AND PERFORMING USER AUTHENTICATION IN MOBILE TERMINAL WITH ONE-TIME USER INPUT
<b>First Named Inventor/Applicant Name:</b>	Jae Lark JUNG
<b>Customer Number:</b>	20995
<b>Filer:</b>	Mincheol Kim/Kevin Kraus
<b>Filer Authorized By:</b>	Mincheol Kim
<b>Attorney Docket Number:</b>	UNIS005.001C2
<b>Receipt Date:</b>	05-DEC-2016
<b>Filing Date:</b>	08-SEP-2015
<b>Time Stamp:</b>	18:25:12
<b>Application Type:</b>	Utility under 35 USC 111(a)

### Payment information:

Submitted with Payment	yes
Payment Type	CARD
Payment was successfully received in RAM	\$850
RAM confirmation Number	120616INTEFSW18254500
Deposit Account	111410
Authorized User	Kevin Kraus

The Director of the USPTO is hereby authorized to charge indicated fees and credit any overpayment as follows:

37 CFR 1.16 (National application filing, search, and examination fees)

37 CFR 1.17 (Patent application and reexamination processing fees)

<b>File Listing:</b>					
<b>Document Number</b>	<b>Document Description</b>	<b>File Name</b>	<b>File Size(Bytes)/ Message Digest</b>	<b>Multi Part /.zip</b>	<b>Pages (if appl.)</b>
1	Request for Continued Examination (RCE)	RCE-UNIS005_001C2.pdf	1349919	no	3
			7ae842bd6a5dc319bde135755a85948a1dc493d5		
<b>Warnings:</b>					
<b>Information:</b>					
2	Information Disclosure Statement (IDS) Form (SB08)	IDS-UNIS005_001C2.pdf	1037113	no	7
			5a548510b10c5249d394a563f42b27074655f61		
<b>Warnings:</b>					
<b>Information:</b>					
3	Foreign Reference	JP2009212558wAbst.PDF	2580737	no	20
			a10879dd07bbe7fc5618952ce4e8de527e700b6		
<b>Warnings:</b>					
<b>Information:</b>					
4	Foreign Reference	JP2002024712wAbst.PDF	1043415	no	7
			d763d4cad1d6a270e7426713be3735c588464c65		
<b>Warnings:</b>					
<b>Information:</b>					
5	Foreign Reference	JP2003143290-wAbst.PDF	2779082	no	14
			3cc6281a1d6b507a625e1b6563c27137952693ee		
<b>Warnings:</b>					
<b>Information:</b>					
6	Foreign Reference	JP2004080080-wAbst.PDF	2099304	no	17
			1b68b7a839efda1a78fd86e95f0bc786dfc50742		
<b>Warnings:</b>					
<b>Information:</b>					

7	Foreign Reference	CN101452365wAbst.PDF	3818321	no	35
			d72fcdca0974053b74fcc1f906c4094a59d c583		
<b>Warnings:</b>					
<b>Information:</b>					
8	Non Patent Literature	BRENT_DIETZ.PDF	253327	no	2
			646e3b36f338e90528ae39964f38fd7301b8 ee00		
<b>Warnings:</b>					
<b>Information:</b>					
9	Non Patent Literature	POCOVNICU.PDF	3451130	no	7
			37412522939d47ee30b20c74c357c2f778c ed0d9		
<b>Warnings:</b>					
<b>Information:</b>					
10	Non Patent Literature	ELENA_MALYKHINA.PDF	3348980	no	5
			fd8d1493bf51423a6f62fe511e8c20a238ce 3d4		
<b>Warnings:</b>					
<b>Information:</b>					
11	Non Patent Literature	LG.PDF	1168684	no	7
			3ff51f5da04a9e552eb086b2f52eb89a26ed 5031		
<b>Warnings:</b>					
<b>Information:</b>					
12	Non Patent Literature	ANGULO.PDF	2049989	no	14
			5f9b72d19fd2ca187e3d49138a64ba9f033 e6e9		
<b>Warnings:</b>					
<b>Information:</b>					
13	Non Patent Literature	YUAN.PDF	5975062	no	6
			567101dc57c8c08baad16d49db8a21c88ae b490c		
<b>Warnings:</b>					
<b>Information:</b>					

14	Non Patent Literature	ENGADGET_Motorola.pdf	12563210	no	9
			bbe3ef02dece93067968b5ab514808890957b18		
<b>Warnings:</b>					
<b>Information:</b>					
15	Non Patent Literature	JP_OA_2014536982.PDF	431692	no	8
			bd66faffee106e7c122983d6c92313480b9e7e3		
<b>Warnings:</b>					
<b>Information:</b>					
16	Non Patent Literature	JP_OA_2014147884.PDF	348771	no	7
			247ec2ad0e12c12e4b78694aa12b37aa92160d82		
<b>Warnings:</b>					
<b>Information:</b>					
17	Non Patent Literature	iPhone.PDF	4535740	no	16
			90dff0db410f6b72d2995379fa8cae13aabdd3509		
<b>Warnings:</b>					
<b>Information:</b>					
18	Non Patent Literature	CNOA.PDF	1270196	no	15
			faad2691952f09d71dd9f3f0e4d8c9e6476835ae		
<b>Warnings:</b>					
<b>Information:</b>					
19	Fee Worksheet (SB06)	fee-info.pdf	30832	no	2
			389af165f73402e64387253aca38f3241ce5b93f		
<b>Warnings:</b>					
<b>Information:</b>					
<b>Total Files Size (in bytes):</b>			50135504		

**This Acknowledgement Receipt evidences receipt on the noted date by the USPTO of the indicated documents, characterized by the applicant, and including page counts, where applicable. It serves as evidence of receipt similar to a Post Card, as described in MPEP 503.**

**New Applications Under 35 U.S.C. 111**

**If a new application is being filed and the application includes the necessary components for a filing date (see 37 CFR 1.53(b)-(d) and MPEP 506), a Filing Receipt (37 CFR 1.54) will be issued in due course and the date shown on this Acknowledgement Receipt will establish the filing date of the application.**

**National Stage of an International Application under 35 U.S.C. 371**

**If a timely submission to enter the national stage of an international application is compliant with the conditions of 35 U.S.C. 371 and other applicable requirements a Form PCT/DO/EO/903 indicating acceptance of the application as a national stage submission under 35 U.S.C. 371 will be issued in addition to the Filing Receipt, in due course.**

**New International Application Filed with the USPTO as a Receiving Office**

**If a new international application is being filed and the international application includes the necessary components for an international filing date (see PCT Article 11 and MPEP 1810), a Notification of the International Application Number and of the International Filing Date (Form PCT/RO/105) will be issued in due course, subject to prescriptions concerning national security, and the date shown on this Acknowledgement Receipt will establish the international filing date of the application.**



UNITED STATES PATENT AND TRADEMARK OFFICE

UNITED STATES DEPARTMENT OF COMMERCE
United States Patent and Trademark Office
Address: COMMISSIONER FOR PATENTS
P O Box 1450
Alexandria, Virginia 22313-1450
www.uspto.gov

Table with 5 columns: APPLICATION NO., FILING DATE, FIRST NAMED INVENTOR, ATTORNEY DOCKET NO., CONFIRMATION NO.
14/848,191 09/08/2015 Jae Lark JUNG UNIS005.001C2 9599

20995 7590 12/15/2016
KNOBBE MARTENS OLSON & BEAR LLP
2040 MAIN STREET
FOURTEENTH FLOOR
IRVINE, CA 92614

EXAMINER

SHEDRICK, CHARLES TERRELL

ART UNIT PAPER NUMBER

2646

NOTIFICATION DATE DELIVERY MODE

12/15/2016

ELECTRONIC

Please find below and/or attached an Office communication concerning this application or proceeding.

The time period for reply, if any, is set in the attached communication.

Notice of the Office communication was sent electronically on above-indicated "Notification Date" to the following e-mail address(es):

jayna.cartee@knobbe.com
efiling@knobbe.com





Art Unit: 2646

1. The present application is being examined under the pre-AIA first to invent provisions.

### **DETAILED ACTION**

#### ***Continued Examination Under 37 CFR 1.114***

2. A request for continued examination under 37 CFR 1.114, including the fee set forth in 37 CFR 1.17(e), was filed in this application after allowance or after an Office action under *Ex Parte Quayle*, 25 USPQ 74, 453 O.G. 213 (Comm'r Pat. 1935). Since this application is eligible for continued examination under 37 CFR 1.114, and the fee set forth in 37 CFR 1.17(e) has been timely paid, prosecution in this application has been reopened pursuant to 37 CFR 1.114.

Applicant's submission filed on 12/5/16 has been entered.

#### ***Claim Rejections - 35 USC § 103***

1. The following is a quotation of pre-AIA 35 U.S.C. 103(a) which forms the basis for all obviousness rejections set forth in this Office action:

(a) A patent may not be obtained though the invention is not identically disclosed or described as set forth in section 102, if the differences between the subject matter sought to be patented and the prior art are such that the subject matter as a whole would have been obvious at the time the invention was made to a person having ordinary skill in the art to which said subject matter pertains. Patentability shall not be negated by the manner in which the invention was made.

2. The factual inquiries set forth in *Graham v. John Deere Co.*, 383 U.S. 1, 148 USPQ 459 (1966), that are applied for establishing a background for determining obviousness under pre-AIA 35 U.S.C. 103(a) are summarized as follows:

1. Determining the scope and contents of the prior art.
2. Ascertaining the differences between the prior art and the claims at issue.
3. Resolving the level of ordinary skill in the pertinent art.
4. Considering objective evidence present in the application indicating obviousness or nonobviousness.

Art Unit: 2646

3. This application currently names joint inventors. In considering patentability of the claims under pre-AIA 35 U.S.C. 103(a), the examiner presumes that the subject matter of the various claims was commonly owned at the time any inventions covered therein were made absent any evidence to the contrary. Applicant is advised of the obligation under 37 CFR 1.56 to point out the inventor and invention dates of each claim that was not commonly owned at the time a later invention was made in order for the examiner to consider the applicability of pre-AIA 35 U.S.C. 103(c) and potential pre-AIA 35 U.S.C. 102(e), (f) or (g) prior art under pre-AIA 35 U.S.C. 103(a).

4. Claims **1-4, 6-7, 10-14, 15-18 and 20** is/are rejected under pre-AIA 35 U.S.C. 103(a) as being unpatentable over Bandyopadhyay et al. US Patent No.: 8,311,514 B2, hereinafter, '**Ref-514**' in view of Bandyopadhyay et al. US Patent Pub. No.: 2012/0009896 A1, hereinafter, '**Ref-896**' and further in view of DIETZ, "AuthenTec Unveils the World's Smallest Navigation and Fingerprint Matching Device for Mobile Phones", Business Wire, 2010 - 2 pages, hereinafter, '**Dietz**'

Consider **Claims 1-2 and 11-12**, Ref- 514 teaches a mobile communication terminal (e.g., **100 figure 1**) comprising: a touch screen display (e.g., **110 of figure 1**); and an activation button separate from the power button and located outside the touch screen display (e.g., see **wake-up/activation button 120 of figure 1**), the activation button configured for pressing to turn on the touch screen display (e.g., **the user can touch the wake-up area to both activate the mobile device from a sleep mode and unlock the mobile device with a single touch as noted in at least col. 1 lines 39-45**) wherein upon one-time pressing of the activation button while the touch screen display is turned off (e.g., **510 the display is off**), the

Art Unit: 2646

terminal is configured to turn on the touch screen display and further perform a fingerprint authentication function in addition to turning on the touch screen display (e.g., consider that if in state 514, a match is not made, then in state 518, a wait period for 1 second is made. If the user's finger is removed, a jump to state 510 is made and the display is deactivated and locked, otherwise, the display is activated in state 520, but the mobile device remains locked.) (i.e., at 518 if the user press and holds the wake-up area the screen is on and display on the phone is locked- the screen is turned off by removing the touch finger /timer stop or quick press and release of the power key) such that: the touch screen display displays the lock screen thereon as the terminal turns on the touch screen display in response to the one-time pressing of the activation button while the touch screen display is turned off(note: the ambiguity of this limitation- this implies that the lock screen is displayed prior to the display being turned on. The Examiner respectfully submits that the display must be on before anything is actually displayed. This applies to claim 11 also since the Applicant's original disclosure clearly indicates that in the active state the display is on) (i.e., at 518 if the user press and holds the wake-up area the screen is on and display on the phone is locked- the screen is turned off by removing the touch finger /timer stop or quick press and release of the power key), in addition to turning on the touch screen display and displaying the lock screen(touch button with finger), the one-time pressing while the touch screen display being turned off initiates the fingerprint authentication function(match finger print) in addition, the lock screen is displayed on the touch screen display when the fingerprint authentication function initiated by the one-time pressing is being performed(i.e., at 518 if the user press and holds the wake-up area the screen is on and display on the phone is locked-

Art Unit: 2646

**the screen is turned off by removing the touch finger /timer stop or quick press and release of the power key – the first function includes the authentication – the claim is recited in a manner in which the sequence lines up figure 5 since the first function is included in addition to the displaying the lock screen. The lock screen display occurs in addition to the fingerprint authentication when the match fails), a lock state of the terminal continues when the fingerprint authentication function fails to authenticate a user (i.e., no match see figure 5), and the lock state is released for enabling other functions of the terminal when the fingerprint authentication function authenticates a user in response to the one-time pressing of the activation button while the touch screen display being turned off (i.e., phone lock see at least figure 5**

However, Ref-514 does not explicitly display a power button configured to turn on and off the terminal by pressing; Ref 514 does not explicitly indicate display the lock screen when the fingerprint authentication is being performed in response to detection of one-time pressing of the activation button while the touch screen display is turned off (i.e., it would appear obvious that at step 520 that while the display is on and the device could retry the fingerprint authentication. However, ref-514 is not explicit).

In analogous art, Ref 896 teaches displaying the lock screen when the fingerprint authentication is being performed (e.g., see at least 960 of figure 9), a camera (e.g., see camera 234 of figure 2 );

Therefore, it would have been obvious to a person of ordinary skill in the art at the time the invention was made to include displaying the lock screen when the fingerprint authentication is being performed to arrive at the predictable result of displaying the lock screen when the fingerprint authentication is being performed in response to detection of one-time pressing of the

Art Unit: 2646

activation button while the touch screen display is turned off for the purpose of operating a camera or other phone features while the phone remains in the locked state as suggested by Ref-896.

However, although from the 896 and 514 it appears to obvious and perhaps could argued, it is not explicit that the touch screen display displays a lock screen thereon **as the touch screen display is turned on** in response to the one-time pressing of the activation button while the touch screen display being turned off or the touch screen display displays a lock screen thereon **as the terminal changes to the active state** in response to the one-time pressing of the activation button while the terminal being in the inactive state.

In analogous art, Dietz teaches “authenticate to wake” whereby the user can swipe the sensor when the phone is in standby mode and the phone's CPU will match a fingerprint image prior to powering up (see entire article).

Therefore, it would have been obvious to a person of ordinary skill in the art at the time the invention was made to include Dietz with the various features of locked screen display and fingerprint authentication to yield the result of pressing the activation button to wake up and display the lock screen or simultaneously authenticating to display upon one time pressing (i.e., authenticate to wake features) for the purpose of power conservation as suggested by Dietz. The combination of suggested features in the prior art would predictably yield and/or yield the obvious result of that the touch screen display displays a lock screen thereon as the touch screen display is turned on in response to the one-time pressing of the activation button while the touch screen display being turned off or the touch screen display displays a lock screen thereon as the

Art Unit: 2646

terminal changes to the active state in response to the one-time pressing of the activation button while the terminal being in the inactive state.

Consider **Claims 3 and 13**, Ref-514 teaches the claimed invention except wherein the terminal is further configured to perform at least one function other than the fingerprint authentication function in addition to turning on the touch screen display for displaying the lock screen in response to the detection of one-time pressing of the activation button during the terminal's inactive state when the detected one-time pressing is for long time longer than a reference time period, wherein the at least one functions is selected from the group consisting of activating the camera, and an operation that involves playing a sound.

Ref -514 teaches wherein upon detection of one-time pressing of the activation button for long time while the touch screen display is turned off, the terminal is configured to turn on the touch screen display for displaying the lock screen (e.g., consider that if in state 514, a match is not made, then in state 518, a wait period for 1 second is made. If the user's finger is removed, a jump to state 510 is made and the display is deactivated and locked, otherwise, the display is activated in state 520, but the mobile device remains locked.) (i.e., at 518 if the user press and holds the wake-up area the screen is on and display on the phone is locked- the screen is turned off by removing the touch finger /timer stop or quick press and release of the power key) Ref-514 does not teach (i.e., not explicitly) the feature of being further configured to display the lock screen when the second function is being performed.

In analogous art, Ref – 896 teaches in at least figure 7 where the camera can operate while the screen is locked.

Art Unit: 2646

Therefore, it would have been obvious to a person of ordinary skill in the art at the time the invention was made to include the feature of being further configured to display the lock screen when the second function is being performed for the purpose of customizing functions of a mobile device based on locking access to other features as suggested by Ref 896.

Consider **Claims 4 and 14**, Ref-514 teaches wherein the touch screen display displays a lock screen thereon **as it is** turned on in response to the detection of one-time pressing for long time (**note: based on the original disclosure and at least common knowledge the screen must be on to display and therefore interpreted by the Examiner accordingly**), wherein the lock screen is displayed on the touch screen display when the at least one function is being initiated(**e.g., consider that if in state 514, a match is not made, then in state 518, a wait period for 1 second is made. If the user's finger is removed, a jump to state 510 is made and the display is deactivated and locked, otherwise, the display is activated in state 520, but the mobile device remains locked.**) (i.e., at 518 if the user press and holds the wake-up area the screen is on and display on the phone is locked- the screen is turned off by removing the touch finger /timer stop or quick press and release of the power key).

The Applicant argues that this feature is not taught by Ref-514 since figure 5 of ref-514 indicates that the display is off in 510 to 514 and apparently the phone does not display anything until 516. However, The Examiner disagrees with the Applicant's position since if in state 514, a match is not made, then in state 518, a wait period for 1 second is made. If the user's finger is removed, a jump to state 510 is made and the display is deactivated and locked, otherwise, the display is activated in state 520, but the mobile device remains locked.) (i.e., at 518 if the user press and holds the wake-up area the screen is on and display on the phone is locked- the screen



Art Unit: 2646

is turned off by removing the touch finger /timer stop or quick press and release of the power key). Figure 5 implies that although there's no finger print match at 514 the user would simply maintain the initial finger position and the display is on in the locked state at 520 (noting that "fingerprint authentication" is a multi-step background process that includes multiple steps to confirm or deny a match).

However, for the sake of arguendo and since the disclosure of Ref- 514 is not explicit in such teaching the Examiner submits that Ref- 896 teaches in at least figure 5 in which the lock screen is displayed on the touch screen display when the fingerprint authentication is being performed wherein in performing the fingerprint authentication, the terminal operates such that; a lock state of the terminal continues when the fingerprint authentication fails to authenticate a user, and the lock state is released for enabling other functions of the terminal when the fingerprint authentication authenticates a user.

Therefore, it would have been obvious to a person of ordinary skill in the art at the time the invention was made to include displaying the lock screen when the fingerprint authentication is being performed to arrive at the predictable result in which the lock screen is displayed on the touch screen display when the fingerprint authentication is being performed wherein in performing the fingerprint authentication, the terminal operates such that; a lock state of the terminal continues when the fingerprint authentication fails to authenticate a user, and the lock state is released for enabling other functions of the terminal when the fingerprint authentication authenticates a user

Consider at least **claims 6 and 16**, Ref-514 teaches wherein the terminal is configured to have a mobile application stay in a standby state when the touch screen display is turned

Art Unit: 2646

off while the mobile application is running (**e.g., see at least figure 5 sleep and locked**), wherein in response to the detection of one-time pressing of the activation button while the touch screen display is turned off, the terminal is configured to perform the at least one of the first and second functions regardless of whether the at least one functions is in its standby state or an operation disable state(**e.g., see at least figure 5 sleep and locked – press wake-up area as noted in at least figure 5**).

Consider **Claims 7 and 17**, Ref 514 teaches the claimed invention except wherein the terminal is configured to display a message on the touch screen display when the lock state continues due to failure of user authentication by the fingerprint authentication (**i.e., Ref- 514 does not illustrate or disclose a message that displays the fact that the screen is actually locked**).

In analogous art, Ref -896 teaches wherein the terminal is configured to display a message on the touch screen display when the lock state continues due to failure of user authentication by the fingerprint authentication (**i.e., figure 2 and 5 illustrates a display with lock icon that is maintained due to the failure of user authentication – the lock screen display icon serves as an alert the user that the authentication has not succeeded**).

Therefore, it would have been obvious to a person of ordinary skill in the art at the time the invention was made to include wherein the terminal is configured to display a message on the touch screen display when the lock state continues due to failure of user authentication by the fingerprint authentication for the purpose of bringing the user's attention to the fact that the authentication has not succeeded.

Art Unit: 2646

Consider at **Claims 10**, Ref- 514 teaches wherein the terminal comprises a smartphone which comprises an activation sensor configured to detect pressing of the activation button and a user identification module configured to perform the fingerprint authentication (e.g., see at least **figures 3 and 4**).

Consider **Claim 18**, Ref- 514 teaches the claimed invention except receiving user input on a setting menu of the terminal; and configuring, based on the user input, settings of the terminal such that the at least one of the first and second functions is set to be performed in addition to changing to the active state upon detection of one-time pressing of the activation button while the terminal is in its inactive state.

In analogous art, Ref- 896 teaches and suggest configuring the setting of the Mobile device that can be operated and accessed during the locked state in at least 0075.

Therefore, it would have been obvious to a person of ordinary skill in the art at the time the invention was made given the suggestions of Ref- 514 to simultaneously perform a function in addition to changing to the active state upon detection of one-time pressing of the activation button while the terminal is in its inactive state (i.e., locked) to include configuring the setting of the Mobile device that can be operated and accessed during the locked state in at least 0075 to arrive at the predictable result of receiving user input on a setting menu of the terminal; and configuring, based on the user input, settings of the terminal such that the at least one of the first and second functions is set to be performed in addition to changing to the active state upon detection of one-time pressing of the activation button while the terminal is in its inactive state.

6. **Claims 5, 8, 15 and 19** is/are rejected under pre-AIA 35 U.S.C. 103(a) as being unpatentable over Bandyopadhyay et al. US Patent No.: 8,311,514 B2, hereinafter, 'Ref-514' in

Art Unit: 2646

view of Bandyopadhyay et al. US Patent Pub. No.: 2012/0009896 A1, hereinafter, 'Ref- 896' and further in view of Well-Known Art.

Consider **Claims 5, 8, 15 and 19**, Ref-514 and Ref 896 teaches the claimed invention except wherein the at least one of the first and second functions is associated with software downloadable by the terminal or wherein the at least one of the first and second functions is associated with initiating a hands-free operation of the terminal.

However, the Examiner respectfully submits that software downloading and Hands-Free operation are notoriously well-known features and therefore it would have been obvious to a person of ordinary skill in the art at the time the invention was made to simply substitute the camera and/or fingerprint functions of the prior art with a well-known phone feature for the purpose of controlling access to other particular phone features.

5. **Claims 9 and 20** is/are rejected under pre-AIA 35 U.S.C. 103(a) as being unpatentable over Bandyopadhyay et al. US Patent No.: 8,311,514 B2, hereinafter, 'Ref-514' in view of Bandyopadhyay et al. US Patent Pub. No.: 2012/0009896 A1, hereinafter, 'Ref- 896' and further in view of Buratti et al. US Patent Pub. No.: 2012/0052836 A1.

Consider **Claims 9 and 20**, Ref- 514 and Ref- 896 teaches the claimed invention except , further comprising: detecting repeated pressing of the activation button while the terminal is in its inactive state; in response to detection of the repeated pressing, changing the terminal from the inactive state to the active state; and in addition to changing to the active state, further performing a third function other than the first and second functions without additional user input; wherein in changing to the active state and performing the at least one of the first and second functions, the terminal operates such that: the touch screen display displays the lock

Art Unit: 2646

screen thereon as the terminal changes to the active state in response to the detection of repeated pressing, the lock screen is displayed on the touch screen display when the third function is being performed.

In analogous art, Buratti teaches in 0023 that PEB 220 may be a dedicated button or switch on mobile communication device 200 for initiating a PEB event or may be selectively configured from buttons or switches on mobile communication device 200 having functionality in addition to initiating a PEB event and which when activated for a designated duration or in a defined pattern will initiate a PEB event and in 0028 that activation may be detected when the PEB is continuously activated for three seconds. In other embodiments, activation may be detected when the PEB is continuously activated for more or less than three seconds. In further embodiments, activation of a PEB may be selectively configurable to a desired activation pattern of one or more buttons on the communications device for selectively configurable durations.

Therefore, it would have been obvious to a person of ordinary skill in the art at the time the invention was made to modify Ref- 514 in view Ref- 896 with the functionality of Buratti to arrive at the predictable result further comprising: detecting repeated pressing of the activation button while the terminal is in its inactive state; in response to detection of the repeated pressing, changing the terminal from the inactive state to the active state; and in addition to changing to the active state, further performing a third function other than the first and second functions without additional user input; wherein in changing to the active state and performing the at least one of the first and second functions, the terminal operates such that: the touch screen display displays the lock screen thereon as the terminal changes to the active state in response to the detection of repeated pressing, the lock screen is displayed on the touch screen display when the

Art Unit: 2646

third function is being performed for the purpose of emergency communication as suggested by Buratti.

*Conclusion*

Any inquiry concerning this communication or earlier communications from the examiner should be directed to CHARLES SHEDRICK whose telephone number is (571)272-8621. The examiner can normally be reached on Monday thru Friday 8:00AM-4:30PM.

If attempts to reach the examiner by telephone are unsuccessful, the examiner's supervisor, Lester Kincaid can be reached on (571)-272-7922. The fax phone number for the organization where this application or proceeding is assigned is 571-273-8300.

Information regarding the status of an application may be obtained from the Patent Application Information Retrieval (PAIR) system. Status information for published applications may be obtained from either Private PAIR or Public PAIR. Status information for unpublished applications is available through Private PAIR only. For more information about the PAIR system, see <http://pair-direct.uspto.gov>. Should you have questions on access to the Private PAIR system, contact the Electronic Business Center (EBC) at 866-217-9197 (toll-free). If you would like assistance from a USPTO Customer Service Representative or access to the automated information system, call 800-786-9199 (IN USA OR CANADA) or 571-272-1000.

/CHARLES SHEDRICK/  
Primary Examiner, Art Unit 2646

<b>INFORMATION DISCLOSURE STATEMENT BY APPLICANT</b> ( Not for submission under 37 CFR 1.99)	Application Number	14848191
	Filing Date	2015-09-08
	First Named Inventor	JAE LARK JUNG
	Art Unit	2646
	Examiner Name	SHEDRICK, CHARLES TERRELL
	Attorney Docket Number	UNIS005.001C2

U.S.PATENTS						Remove
Examiner Initial*	Cite No	Patent Number	Kind Code <sup>1</sup>	Issue Date	Name of Patentee or Applicant of cited Document	Pages, Columns, Lines where Relevant Passages or Relevant Figures Appear
	1	9307396	B2	2016-04-05	Jung et al.	
	2	7251478	B2	2007-07-31	Cortegiano	
	3	9338274	B2	2016-05-10	Gao et al.	
	4	8745490	B2	2014-06-03	Kim	
	5	8149089	B2	2012-04-03	Lin et al.	
	6	8810367	B2	2014-08-19	Mullins	
	7	9229489	B2	2016-01-05	Toksvig et al.	
	8	8604906	B1	2013-12-10	Hafferty et al.	

ALL REFERENCES CONSIDERED EXCEPT WHERE LINED THROUGH. /C.T.S/

**INFORMATION DISCLOSURE  
STATEMENT BY APPLICANT**  
( Not for submission under 37 CFR 1.99)

Application Number	14848191
Filing Date	2015-09-08
First Named Inventor	JAE LARK JUNG
Art Unit	2646
Examiner Name	SHEDRICK, CHARLES TERRELL
Attorney Docket Number	UNIS005.001C2

9	8548206	B2	2013-10-01	Sahin et al.
10	8627096	B2	2014-01-07	Azar et al.
11	8912877	B2	2014-12-16	Ling et al.
12	8299889	B2	2012-10-30	Kumar et al.
13	8165355	B2	2012-04-24	Benkley et al.
14	7725511	B2	2010-05-25	Kadi
15	8643771	B2	2014-02-04	You

If you wish to add additional U.S. Patent citation information please click the Add button.

Add

**U.S.PATENT APPLICATION PUBLICATIONS**

Remove

Examiner Initial*	Cite No	Publication Number	Kind Code <sup>1</sup>	Publication Date	Name of Patentee or Applicant of cited Document	Pages, Columns, Lines where Relevant Passages or Relevant Figures Appear
	1	20110081889	A1	2011-04-07	Gao et al.	
	2	20130157561	A1	2013-06-20	Tamai et al.	

ALL REFERENCES CONSIDERED EXCEPT WHERE LINED THROUGH. /C.T.S/



**INFORMATION DISCLOSURE  
STATEMENT BY APPLICANT**  
( Not for submission under 37 CFR 1.99)

Application Number	14848191
Filing Date	2015-09-08
First Named Inventor	JAE LARK JUNG
Art Unit	2646
Examiner Name	SHEDRICK, CHARLES TERRELL
Attorney Docket Number	UNIS005.001C2

3	20080049980	A1	2008-02-28	Castaneda et al.
4	20130082974	A1	2013-04-04	Kerr et al.
5	20130069764	A1	2013-03-21	Wu
6	20120133484	A1	2012-05-31	Griffin

If you wish to add additional U.S. Published Application citation information please click the Add button

**FOREIGN PATENT DOCUMENTS**

Examiner Initial*	Cite No	Foreign Document Number <sup>3</sup>	Country Code <sup>2;j</sup>	Kind Code <sup>4</sup>	Publication Date	Name of Patentee or Applicant of cited Document	Pages, Columns, Lines where Relevant Passages or Relevant Figures Appear	T <sup>5</sup>
	1	2009-212558	JP	A	2009-09-17	NEC COMMUNICATION SYST		×
	2	2002-24712	JP	A	2002-01-25	MEDIA LINK SYSTEM KK		☒
	3	2003-143290	JP	A	2003-05-16	SANYO ELECTRIC CO; SANYO TELECOMM CO LTD		☒
	4	2004-80080	JP	A	2004-03-11	MATSUSHITA ELECTRIC IND CO LTD		☒
	5	101452365	CN	A	2009-06-10	LG ELECTRONICS INC		☒

If you wish to add additional Foreign Patent Document citation information please click the Add button

**INFORMATION DISCLOSURE  
STATEMENT BY APPLICANT**  
( Not for submission under 37 CFR 1.99)

Application Number	14848191
Filing Date	2015-09-08
First Named Inventor	JAE LARK JUNG
Art Unit	2646
Examiner Name	SHEDRICK, CHARLES TERRELL
Attorney Docket Number	UNIS005.001C2

NON-PATENT LITERATURE DOCUMENTS		Remove	
Examiner Initials*	Cite No	Include name of the author (in CAPITAL LETTERS), title of the article (when appropriate), title of the item (book, magazine, journal, serial, symposium, catalog, etc), date, pages(s), volume-issue number(s), publisher, city and/or country where published.	T <sup>5</sup>
	1	DIETZ, "AuthenTec Unveils the World's Smallest Navigation and Fingerprint Matching Device for Mobile Phones", Business Wire, 2010 - 2 pageses	
	2	POCOVNICU, "Biometric Security for Cell Phones", Informatica Economică, 2009, Vol. 13, No. 1, pages 57 - 63	
	3	MALYKHINA, "Fujitsu Adds Mobile Phone With Fingerprint Sensor", InformationWeek, retrieved from <a href="http://www.informationweek.com/fujitsu-adds-mobile-phone-with-fingerprint-sensor/d/d-id/1064540?">http://www.informationweek.com/fujitsu-adds-mobile-phone-with-fingerprint-sensor/d/d-id/1064540?</a> on October 12, 2016	
	4	"LG Unveils Impressive Line of Smart, Feature-Rich Products at International CES 2010", PR Newswire, retrieved from <a href="http://www.pnewswire.com/news-releases/lg-unveils-impressive-line-of-smart-feature-rich-products-at-international-ces-2010-80803492.html">http://www.pnewswire.com/news-releases/lg-unveils-impressive-line-of-smart-feature-rich-products-at-international-ces-2010-80803492.html</a> on October 12, 2016	
	5	ANGULO et al., "Exploring Touch-Screen Biometrics for User Identification on Smart Phones", Privacy and Identity 2011, pages 130 - 143	
	6	YUAN et al., "User Authentication on Mobile Devices with Dynamical Selection of Biometric Techniques for Optimal Performance", Presentation Material of International Conference on Robotics and Biomimetics, 2010, pages 333 - 338	
	7	"Motorola Atrix 4G review", engadget, retrieved from <a href="https://www.engadget.com/motorola/atrx-4g-review/">https://www.engadget.com/motorola/atrx-4g-review/</a> on November 1, 2016	
	8	Office Action dated October 20, 2016 of corresponding Japanese Patent Application No. 2014-536982 and its English translation - 8 pages	×
	9	Office Action dated September 26, 2016 of corresponding Japanese Patent Application No. 2014-147884 and its English translation - 7 pages	☒

ALL REFERENCES CONSIDERED EXCEPT WHERE LINED THROUGH. /C.T.S/

<b>INFORMATION DISCLOSURE STATEMENT BY APPLICANT</b> ( Not for submission under 37 CFR 1.99)	Application Number	14848191
	Filing Date	2015-09-08
	First Named Inventor	JAE LARK JUNG
	Art Unit	2646
	Examiner Name	SHEDRICK, CHARLES TERRELL
	Attorney Docket Number	UNIS005.001C2

10	"iPhone 4 Perfect Guide mini", Ascii Mediaworks K.K., August 29, 2010, pages 6-10, 12, 21, 23, 36, 44, 45, 55, 107, 110	<input type="checkbox"/>
11	First Office Action dated October 8, 2016 of corresponding Chinese Patent Application No. 201410377402.3 - 15 pages	<input checked="" type="checkbox"/>

If you wish to add additional non-patent literature document citation information please click the Add button

**EXAMINER SIGNATURE**

Examiner Signature	/CHARLES T SHEDRICK/	Date Considered	12/11/2016
--------------------	----------------------	-----------------	------------

\*EXAMINER: Initial if reference considered, whether or not citation is in conformance with MPEP 609. Draw line through a citation if not in conformance and not considered. Include copy of this form with next communication to applicant.

<sup>1</sup> See Kind Codes of USPTO Patent Documents at [www.USPTO.GOV](http://www.USPTO.GOV) or MPEP 901.04. <sup>2</sup> Enter office that issued the document, by the two-letter code (WIPO Standard ST.3). <sup>3</sup> For Japanese patent documents, the indication of the year of the reign of the Emperor must precede the serial number of the patent document. <sup>4</sup> Kind of document by the appropriate symbols as indicated on the document under WIPO Standard ST.16 if possible. <sup>5</sup> Applicant is to place a check mark here if English language translation is attached.

ALL REFERENCES CONSIDERED EXCEPT WHERE LINED THROUGH. /C.T.S/

**INFORMATION DISCLOSURE  
STATEMENT BY APPLICANT**  
( Not for submission under 37 CFR 1.99)

Application Number	14848191
Filing Date	2015-09-08
First Named Inventor	JAE LARK JUNG
Art Unit	2646
Examiner Name	SHEDRICK, CHARLES TERRELL
Attorney Docket Number	UNIS005.001C2

**CERTIFICATION STATEMENT**

Please see 37 CFR 1.97 and 1.98 to make the appropriate selection(s):

That each item of information contained in the information disclosure statement was first cited in any communication from a foreign patent office in a counterpart foreign application not more than three months prior to the filing of the information disclosure statement. See 37 CFR 1.97(e)(1).

**OR**

That no item of information contained in the information disclosure statement was cited in a communication from a foreign patent office in a counterpart foreign application, and, to the knowledge of the person signing the certification after making reasonable inquiry, no item of information contained in the information disclosure statement was known to any individual designated in 37 CFR 1.56(c) more than three months prior to the filing of the information disclosure statement. See 37 CFR 1.97(e)(2).

See attached certification statement.

The fee set forth in 37 CFR 1.17 (p) has been submitted herewith.

A certification statement is not submitted herewith.

**SIGNATURE**

A signature of the applicant or representative is required in accordance with CFR 1.33, 10.18. Please see CFR 1.4(d) for the form of the signature.

Signature	/Mincheol Kim/	Date (YYYY-MM-DD)	2016-12-05
Name/Print	Mincheol Kim	Registration Number	51,306

This collection of information is required by 37 CFR 1.97 and 1.98. The information is required to obtain or retain a benefit by the public which is to file (and by the USPTO to process) an application. Confidentiality is governed by 35 U.S.C. 122 and 37 CFR 1.14. This collection is estimated to take 1 hour to complete, including gathering, preparing and submitting the completed application form to the USPTO. Time will vary depending upon the individual case. Any comments on the amount of time you require to complete this form and/or suggestions for reducing this burden, should be sent to the Chief Information Officer, U.S. Patent and Trademark Office, U.S. Department of Commerce, P.O. Box 1450, Alexandria, VA 22313-1450. **DO NOT SEND FEES OR COMPLETED FORMS TO THIS ADDRESS. SEND TO: Commissioner for Patents, P.O. Box 1450, Alexandria, VA 22313-1450.**

## Privacy Act Statement

The Privacy Act of 1974 (P.L. 93-579) requires that you be given certain information in connection with your submission of the attached form related to a patent application or patent. Accordingly, pursuant to the requirements of the Act, please be advised that: (1) the general authority for the collection of this information is 35 U.S.C. 2(b)(2); (2) furnishing of the information solicited is voluntary; and (3) the principal purpose for which the information is used by the U.S. Patent and Trademark Office is to process and/or examine your submission related to a patent application or patent. If you do not furnish the requested information, the U.S. Patent and Trademark Office may not be able to process and/or examine your submission, which may result in termination of proceedings or abandonment of the application or expiration of the patent.

The information provided by you in this form will be subject to the following routine uses:

1. The information on this form will be treated confidentially to the extent allowed under the Freedom of Information Act (5 U.S.C. 552) and the Privacy Act (5 U.S.C. 552a). Records from this system of records may be disclosed to the Department of Justice to determine whether the Freedom of Information Act requires disclosure of these records.
2. A record from this system of records may be disclosed, as a routine use, in the course of presenting evidence to a court, magistrate, or administrative tribunal, including disclosures to opposing counsel in the course of settlement negotiations.
3. A record in this system of records may be disclosed, as a routine use, to a Member of Congress submitting a request involving an individual, to whom the record pertains, when the individual has requested assistance from the Member with respect to the subject matter of the record.
4. A record in this system of records may be disclosed, as a routine use, to a contractor of the Agency having need for the information in order to perform a contract. Recipients of information shall be required to comply with the requirements of the Privacy Act of 1974, as amended, pursuant to 5 U.S.C. 552a(m).
5. A record related to an International Application filed under the Patent Cooperation Treaty in this system of records may be disclosed, as a routine use, to the International Bureau of the World Intellectual Property Organization, pursuant to the Patent Cooperation Treaty.
6. A record in this system of records may be disclosed, as a routine use, to another federal agency for purposes of National Security review (35 U.S.C. 181) and for review pursuant to the Atomic Energy Act (42 U.S.C. 218(c)).
7. A record from this system of records may be disclosed, as a routine use, to the Administrator, General Services, or his/her designee, during an inspection of records conducted by GSA as part of that agency's responsibility to recommend improvements in records management practices and programs, under authority of 44 U.S.C. 2904 and 2906. Such disclosure shall be made in accordance with the GSA regulations governing inspection of records for this purpose, and any other relevant (i.e., GSA or Commerce) directive. Such disclosure shall not be used to make determinations about individuals.
8. A record from this system of records may be disclosed, as a routine use, to the public after either publication of the application pursuant to 35 U.S.C. 122(b) or issuance of a patent pursuant to 35 U.S.C. 151. Further, a record may be disclosed, subject to the limitations of 37 CFR 1.14, as a routine use, to the public if the record was filed in an application which became abandoned or in which the proceedings were terminated and which application is referenced by either a published application, an application open to public inspections or an issued patent.
9. A record from this system of records may be disclosed, as a routine use, to a Federal, State, or local law enforcement agency, if the USPTO becomes aware of a violation or potential violation of law or regulation.

**IN THE UNITED STATES PATENT AND TRADEMARK OFFICE**

First Named Inventor	:	Jae Lark Jung
Applicant	:	Firstface Co., Ltd.
App. No.	:	14/848,191
Filed	:	September 8, 2015
Examiner	:	Shedrick, Charles Terrell
Art Unit	:	2646
Conf. No.	:	9599

**AMENDMENT AND RESPONSE TO OFFICE ACTION****Mail Stop Amendment**

P.O. Box 1450  
Alexandria, VA 22313-1450

Dear Sir:

This is in response to the Non-final Office Action mailed December 15, 2016 in the above-identified application. Applicant submits the following items for consideration in connection with the application.

**Amendments to the Claims** begin on page 2 of this paper.

**Remarks** begin on page 8 of this paper.

### **AMENDMENTS TO THE CLAIMS**

1. (Previously Presented) A mobile communication terminal comprising:  
a touch screen display;  
a power button configured to turn on and off the terminal by pressing; and  
an activation button separate from the power button and located outside the touch screen display, the activation button configured for pressing to turn on the touch screen display,

wherein upon one-time pressing of the activation button while the touch screen display is turned off, the terminal is configured to turn on the touch screen display and perform a fingerprint authentication function in addition to turning on the touch screen display such that:

a lock screen is displayed on the touch screen display upon turning on the touch screen display in response to the one-time pressing of the activation button while the touch screen display being turned off,

in addition to turning on the touch screen display and displaying the lock screen, the one-time pressing while the touch screen display being turned off initiates the fingerprint authentication function,

the lock screen is displayed on the touch screen display when the fingerprint authentication function initiated by the one-time pressing is being performed,

a lock state of the terminal continues when the fingerprint authentication function fails to authenticate a user, and

the lock state is released for enabling other functions of the terminal when the fingerprint authentication function authenticates a user in response to the one-time pressing of the activation button while the touch screen display being turned off.

2. (Previously Presented) The terminal of Claim 1, wherein the terminal is configured to perform at least one additional function in addition to the fingerprint authentication function after turning on the touch screen display for displaying the lock screen when the one-time pressing of the activation button is detected while the touch screen display is turned off.

3. (Currently Amended) The terminal of Claim 1, wherein the terminal is further configured to perform at least one function other than the fingerprint authentication function in addition to turning on the touch screen display for displaying the lock screen in response to the one-time pressing of the activation button when the one-time pressing is for long time longer than a reference time period, wherein the at least one function is selected from the group consisting of activating ~~the a~~ camera, and an operation that involves playing a sound.

4. (Currently Amended) The terminal of Claim 3, wherein the touch screen display displays ~~a the~~ lock screen thereon as it is turned on in response to the one-time pressing for long time, wherein the lock screen is displayed on the touch screen display when the at least one function is being initiated.

5. (Currently Amended) The terminal of Claim 1, wherein the terminal is further configured to perform at least one function other than the fingerprint authentication function in addition to turning on the touch screen display for displaying the lock screen in response to the one-time pressing of the activation button when the one-time pressing is for long time longer than a reference time period. ~~3, wherein the touch screen display displays a lock screen thereon as it is turned on in response to the one-time pressing for long time,~~ wherein the at least one function to perform in addition to turning on the touch screen display for displaying the lock screen in response to the one-time pressing for long time is associated with initiating a hands-free operation of the terminal.

6. (Previously Presented) The terminal of Claim 3, wherein the terminal is configured to have a mobile application stay in a standby state when the touch screen display is turned off while the mobile application is running, wherein in response to the one-time pressing of the activation button while the touch screen display is turned off, the terminal is configured to perform the at least one function regardless of whether the at least one function is in its standby state or an operation disable state.

7. (Previously Presented) The terminal of Claim 1, wherein the terminal is configured to display a message on the touch screen display when the lock state continues due to failure of fingerprint authentication by the fingerprint authentication function.



8. (Currently Amended) The terminal of Claim 1, wherein the terminal is further configured to perform at least one function other than the fingerprint authentication function in addition to turning on the touch screen display for displaying the lock screen in response to the one-time pressing of the activation button when the one-time pressing is for long time longer than a reference time period, ~~wherein the at least one function is associated with software downloadable by the terminal.~~

9. (Previously Presented) The terminal of Claim 1, wherein upon repeated pressing of the activation button while the touch screen display is turned off, the terminal is configured to turn on the touch screen display and further perform at least one function other than the fingerprint authentication function in addition to turning on the touch screen display.

10. (Previously Presented) The terminal of Claim 1, wherein the terminal comprises a smartphone which comprises an activation sensor configured to detect pressing of the activation button and a user identification module configured to perform the fingerprint authentication function.

11. (Previously Presented) A method of operating a mobile computing terminal, the method comprising:

providing a mobile computing terminal which comprises a touch screen display, a camera, a power button for pressing to turn on/off the terminal, and an activation button for pressing to turn on the touch screen display, the activation button located outside the touch screen display;

detecting one-time pressing of the activation button while the terminal is in an inactive state in which the touch screen display is turned off;

in response to the one-time pressing, changing the terminal from the inactive state to an active state in which the touch screen display is turned on; and

in addition to changing to the active state, further performing a fingerprint authentication function using fingerprint recognition without additional user input,

wherein in changing to the active state and performing the fingerprint authentication function, the terminal operates such that:

**Application No.:** 14/848,191  
**Filing Date:** September 8, 2015

a lock screen is displayed on the touch screen display upon changing the terminal from the inactive state to the active state in response to the one-time pressing of the activation button while the terminal being in the inactive state,

in addition to changing the terminal to the active state, the one-time pressing while the terminal being in the inactive state initiates the fingerprint authentication function,

the lock screen is displayed on the touch screen display when the fingerprint authentication function initiated by the one-time pressing is being performed,

a lock state of the terminal continues when the fingerprint authentication function fails to authenticate a user, and

the lock state is released for enabling other functions of the terminal when the fingerprint authentication function authenticates a user in response to the one-time pressing of the activation button while the terminal being in the inactive state.

12. (Previously Presented) The method of Claim 11, wherein performing at least one function in addition to the fingerprint authentication function after changing to the active state for displaying the lock screen when the one-time pressing is detected while the terminal being in the inactive state.

13. (Currently Amended) The method of Claim 11, wherein the method further comprises performing at least one function other than the fingerprint authentication function in addition to changing to the active state in response to the one-time pressing during the terminal's inactive state when the one-time pressing is for long time longer than ~~the~~a reference time period, wherein the at least one function is selected from the group consisting of activating the camera, a hands-free operation and an operation that involves playing a sound.

14. (Currently Amended) The method of Claim 13, wherein the touch screen display displays ~~a~~the lock screen thereon as the terminal changes to its active state in response to the one-time pressing for long time, wherein the lock screen is displayed on the touch screen display when the at least one function is being initiated.

15. (Currently Amended) The method of Claim 11, wherein the method further comprises performing at least one function other than the fingerprint authentication function in addition to changing to the active state in response to the one-time pressing during the terminal's inactive state when the one-time pressing is for long time longer than a reference time period, ~~13~~, wherein the touch screen display ~~displays a lock screen thereon as the terminal changes to its active state in response to the one-time pressing for long time~~, wherein the at least one function to perform in addition to turning on the touch screen display for displaying the lock screen in response to the one-time pressing for long time is associated with initiating a hands-free operation of the terminal ~~a hands-free operation~~.

16. (Previously Presented) The method of Claim 13, wherein the terminal is configured to have a mobile application stay in a standby state when the touch screen display is turned off while the mobile application is running, wherein in response to the one-time pressing of the activation button while the terminal is in its inactive state, the terminal performs the at least one function regardless of whether the at least one function is in its standby state or an operation disable state.

17. (Previously Presented) The method of Claim 13, wherein the touch screen display displays a message thereon when the lock state continues due to failure of fingerprint authentication by the fingerprint authentication function.

18. (Currently Amended) The method of Claim 13, further comprising:  
receiving user input on a setting menu of the terminal; and  
configuring, based on the user input, settings of the terminal such that the at least one function is set to be performed in addition to changing to the active state in response to the one-time pressing of the activation button while the terminal is in its inactive state.

19. (Currently Amended) The method of Claim 11, wherein the method further comprises performing at least one function other than the fingerprint authentication function in addition to changing to the active state in response to the one-time pressing during the terminal's inactive state when the one-time pressing is for long time longer than the reference time period; ~~wherein the at least one function is associated with software downloadable by the terminal.~~

**Application No.:** 14/848,191  
**Filing Date:** September 8, 2015

20. (Previously Presented) The method of Claim 11, further comprising:
- detecting repeated pressing of the activation button while the terminal is in its inactive state;
  - in response to the repeated pressing, changing the terminal from the inactive state to the active state; and
  - in addition to changing to the active state, further performing at least one function other than the fingerprint authentication function without additional user input,
- wherein in changing to the active state and performing the at least one function, the terminal operates such that:
- the touch screen display displays the lock screen thereon as the terminal changes to the active state in response to the repeated pressing,
  - the lock screen is displayed on the touch screen display when the at least one function is being performed.

### REMARKS

This paper is in response to the Office Action dated December 15, 2016. Applicant has amended the application as set forth above. No new matter is added by the amendments. Upon entry of the amendments, Claims 1-20 remain pending in this application. Applicant respectfully requests entry of the amendments and reconsideration of the application in view of the above amendments and the following remarks.

#### **Rejection under 35 U.S.C. § 103**

Claims 1-4, 6, 7, 10-14, 15-18 and 20 were rejected under 35 U.S.C. § 103 (a) as being unpatentable over Bandyopadhyay et al. (US8311514, hereinafter “Bandyopadhyay ‘514”) in view of Bandyopadhyay et al. (US2012/0009896, hereinafter “Bandyopadhyay ‘896”) and further in view of “AuthenTec Unveils the World’s Smallest Navigation and Fingerprint Matching Device for Mobile Phones”, Business Wire (2010) (hereinafter “Authentec”).

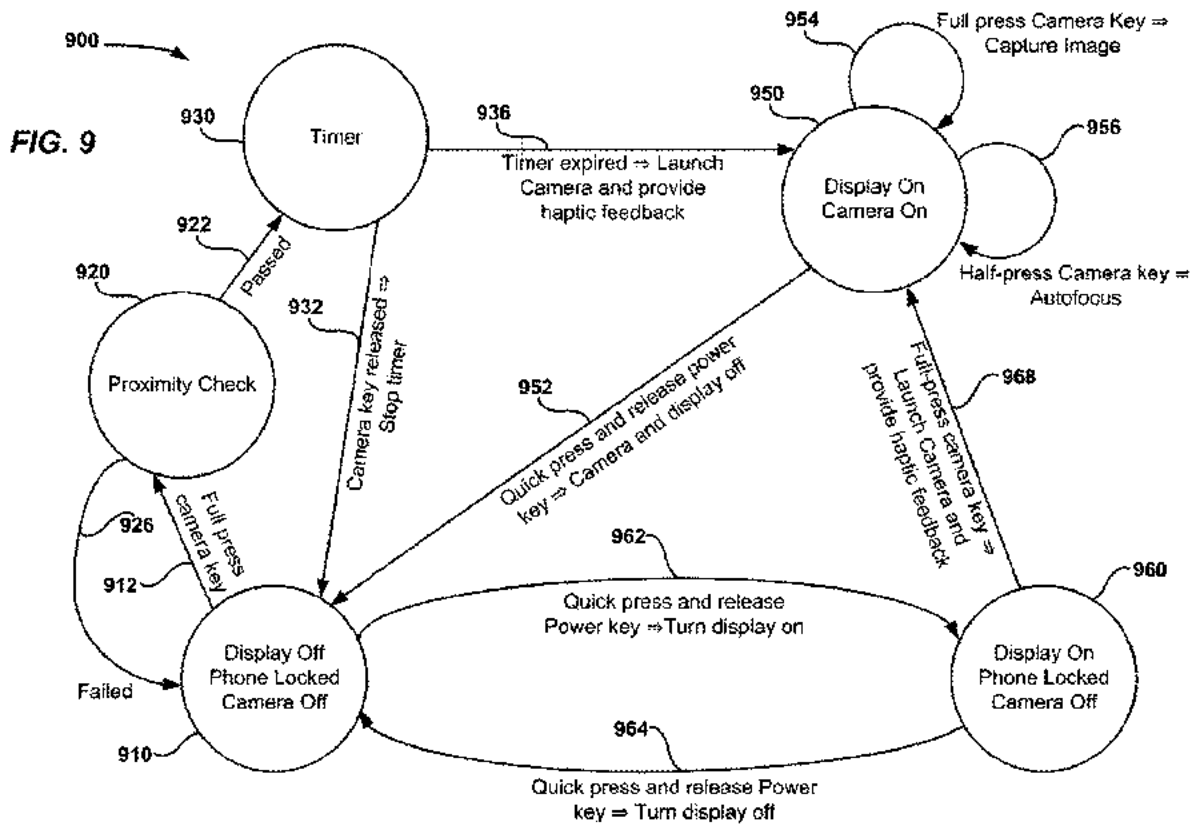
The Office Action asserted that Bandyopadhyay ‘514 discloses certain features of Claims 1 and 11. At page 5, however, the Office Action acknowledged that Bandyopadhyay ‘514 fails to disclose the feature of Claims 1 and 11 in that “the lock screen is displayed on the touch screen display when the fingerprint authentication function initiated by the one-time pressing is being performed.” Then, at page 5, the Office Action asserted that Bandyopadhyay ‘896 remedies the deficiency of Bandyopadhyay ‘514. Applicant respectfully disagrees and submits that Bandyopadhyay ‘896 does not disclose the subject feature as discussed below under the heading of “Bandyopadhyay ‘896 Fails to Teach Lock Screen When Fingerprint Authentication Is Being Performed.”

In making the same rejection, the Office Action acknowledged at page 6 that Bandyopadhyay ‘514 and ‘896 fail to disclose displaying a lock screen as the touch screen display is turned on in response to one-time pressing of the activation button while the touch screen display being turned off. Then, the Office Action asserted at page 6 that Authentec and the other references in combination would “yield the obvious result [] that the touch screen display displays a lock screen thereon as the touch screen display is turned on in response to the one-time pressing of the activation button while the touch screen display being turned off.” Applicant respectfully disagrees. Nonetheless, Applicant respectfully submits that Authentec fails to disclose what Bandyopadhyay ‘514 and ‘896 fail to disclose, as discussed below under

the heading of “Authentec Fails to Teach Lock Screen When Fingerprint Authentication Is Being Performed”

Bandyopadhyay ‘896 Fails to Teach Displaying Lock Screen  
When Fingerprint Authentication Is Being Performed

**Bandyopadhyay ‘896** relates to a smartphone having a camera. Bandyopadhyay ‘896 teaches activating the camera function from when the smartphone’s screen is turned off (display-off state). For the Examiner’s reference, Figure 9 of Bandyopadhyay ‘896 is reproduced below.



Bandyopadhyay ‘896 discloses turning on its display screen from its turned-off state 910 by a quick press of the power key (transition 962 from state 910 to state 960). Also, Bandyopadhyay ‘896 discloses turning on its display screen from its turned-off state 910 by a full press of a camera key (transition 912 from state 910 to state 950), which involves proximity check at 920 and waiting at 930. Figure 9 illustrates that turning on the display and activating the camera function at 950 occur after the functions of proximity check at 920 and waiting at 930. However, Figure 9 is silent about fingerprint authentication or lock screen.

Applicant notes that Bandyopadhyay ‘896 discloses a lock screen in its Figure 5A (not reproduced here) but is silent about how the lock screen of Figure 5A is displayed. Also,

**Application No.:** 14/848,191  
**Filing Date:** September 8, 2015

Applicant notes that Bandyopadhyay '896 mentions fingerprint authentication as an alternative to a pin pad authentication of Figure 5B (not reproduced here) for accessing data stored in the smartphone while performing the camera function. However, these do not amount to the feature that “the lock screen is displayed on the touch screen display when the fingerprint authentication function initiated by the one-time pressing is being performed” as recited in Claims 1 and 11.

Authentec Fails to Teach Displaying Lock Screen  
When Fingerprint Authentication Is Being Performed

As discussed above, Applicant notes that the Office Action asserted that Authentec in combination with the two Bandyopadhyay references would yield the result of displaying a lock screen as the touch screen display is turned on in response to one-time pressing the activation button. Applicant respectfully disagrees. Nonetheless, Authentec fails to disclose displaying a lock screen when fingerprint authentication is being performed.

**Authentec** is a press release of a fingerprint authentication sensor named “AES850” for installing in mobile phones. Authentec discloses AES850’s “authenticate to wake” feature. Applicant has reproduced the most relevant section of Authentec below.

The AES850 – formerly codenamed Saturn – combines fast, optical joystick and trackball-like cursor and menu navigation control with fingerprint authentication, adding convenient security and personalization features at a cost that is comparable to single purpose navigation devices such as optical joysticks or other mobile phone navigation trackpads. The AES850 is the first Authentec sensor to feature an ‘authenticate to wake’ feature whereby a user can swipe the sensor when the phone is in standby mode, and the phone’s CPU will match a fingerprint image prior to powering up. This helps conserve battery power and allows the AES850 to act as a power button that only works for a registered user. This newest addition to Authentec’s smart sensor portfolio complements the Company’s AES1750 smart sensor, which is tailored for easy integration in touchscreen-enabled smartphones.

Regarding the authenticate to wake feature, Authentec describes that “a user can swipe the sensor when the phone is in standby mode, and the phone’s CPU will match a fingerprint image prior to powering up.” It is not clear whether the term “standby mode” refers to the phone’s display being turned off or the phone’s display displaying a lock screen or another screen. Also, it is not clear whether the term “powering up” refers to turning on the phone’s display from its turned-off state or changing the content displayed on the phone’s display, e.g., from a lock screen to an unlock screen. Nonetheless, this statement of Authentec does not implicate that the phone’s lock screen is displayed when the fingerprint authentication is being performed by the phone’s CPU. Other than this, Authentec does not describe any relevant information. In view of this, Authentec fails to disclose the feature that “the lock screen is displayed on the touch screen display when the fingerprint authentication function initiated by the one-time pressing is being performed” as recited in Claims 1 and 11.

Application No.: 14/848,191  
Filing Date: September 8, 2015

No *Prima Facie* Obviousness Has Been Established

As discussed, none of Bandyopadhyay '514, Bandyopadhyay '896 and Authentec teaches at least the feature of Claims 1 and 11 that “the lock screen is displayed on the touch screen display when the fingerprint authentication function initiated by the one-time pressing is being performed.” In view of this alone, no *prima facie* obviousness has been established against Claims 1 and 11 and their dependent claims. Applicant respectfully request withdrawal of the rejection.

Discussion of Rejection of Claims 5, 8, 15 and 19 under 35 U.S.C. § 103

The Office Action rejected Claims 5, 8, 15 and 19 under 35 U.S.C. § 103 (a) as being unpatentable over Bandyopadhyay '514 in view of Bandyopadhyay '896 and further in view of the Examiner's alleged well-known art. Applicant respectfully traverses.

Claims 5 and 8 depend from Claim 1, and Claims 15 and 19 depend from Claim 11. If Claims 1 and 11 are patentable over the cited references, Claims 5, 8, 15 and 19 are also patentable over the same references. As discussed above, Bandyopadhyay '514 and Bandyopadhyay '896 fail to disclose “the lock screen is displayed on the touch screen display when the fingerprint authentication function initiated by the one-time pressing is being performed” as recited in Claims 1 and 11.

In rejecting Claims 5, 8, 15 and 19, the Office Action alleged that “software downloading and Hands-Free operation are notoriously well-known features”. However, the Examiner's alleged well-known features are not related to displaying a lock screen when fingerprint authentication is being performed. As such, Bandyopadhyay '514, Bandyopadhyay '896 and the Examiner's alleged well-known features in combination do not provide every feature of Claim 1 or 11. At least for this reason alone, no *prima facie* case of obviousness has been established against Claim 1 or 11 or their dependent Claims 5, 8, 15 and 19.

Moreover, the Examiner's alleged well-known features of “software downloading” and “Hands-Free operation” do not teach the features recited in Claims 5 and 15 either. While noting that “hands-free operation” could be found in the prior art, Applicant respectfully submits that the fact that “hands-free operation” is well-known itself does not amount to teaching that at least one function to perform in addition to turning on the touch screen display in response to one-time pressing for long time is associated with initiating a hands-free operation. To make it clear, Applicant has amended Claims 5 and 15 as above. At least for this reason, the “hands-free



**Application No.:** 14/848,191  
**Filing Date:** September 8, 2015

operation” in combination with the Bandyopadhyay references does not establish *prima facie* obviousness against Claim 5 or 15.

### **Rejection of Claims 9 and 20 under 35 U.S.C. § 103**

The Office Action rejected Claims 9 and 20 under 35 U.S.C. § 103 (a) as being unpatentable over Bandyopadhyay ‘514 in view of Bandyopadhyay ‘896 and further in view of Buratti et al. (US 2012/0052836). Applicant respectfully traverses.

Claim 9 depends from Claim 1, and Claim 20 depends from Claim 11. If Claims 1 and 11 are patentable over the cited references, Claims 9 and 20 would also be patentable over the same references. Applicant now discusses the patentability of Claims 1 and 11. As discussed above, Bandyopadhyay ‘514 and Bandyopadhyay ‘896 fail to disclose every feature of Claim 1 and 11. In rejecting Claims 9 and 20, the Office Action relied on Buratti to provide the features recited in these claims. While not acquiescing to the Office Action’s assertion on the disclosure of Buratti, Applicant respectfully submits that Buratti does not disclose and is not concerned with what Bandyopadhyay ‘514 and Bandyopadhyay ‘896 fail to disclose. As such, the cited references in combination do not provide every feature of Claim 1 or 11. For this reason alone, no *prima facie* case of obviousness has been established against Claim 1 or 11. Therefore, Claims 1 and 11 their dependent claims including Claims 9 and 20 are patentable over the combination of the cited references.

### **Dependent Claims**

Although Applicant has not addressed all the issues of the dependent claims, Applicant respectfully submits that Applicant does not necessarily agree with the characterization and assessments of the dependent claims made by the Examiner, and Applicant believes that each claim is patentable on its own merits. Applicant respectfully submits that the dependent claims incorporate by reference all the limitations of the claim to which they refer and include their own patentable features, and are therefore in condition for allowance. Therefore, Applicant respectfully requests the withdrawal of all claim rejections and prompts allowance of the claims.

### **No Disclaimers or Disavowals**

Although the present communication may include alterations to the application or claims, or characterizations of claim scope or referenced art, Applicant is not conceding in this

**Application No.:** 14/848,191  
**Filing Date:** September 8, 2015

application that previously pending claims are not patentable over the cited references. Rather, any alterations or characterizations are being made to facilitate expeditious prosecution of this application. Applicant reserves the right to pursue at a later date any previously pending or other broader or narrower claims that capture any subject matter supported by the present disclosure, including subject matter found to be specifically disclaimed herein or by any prior prosecution. Accordingly, reviewers of this or any parent, child or related prosecution history shall not reasonably infer that Applicant has made any disclaimers or disavowals of any subject matter supported by the present application.

### CONCLUSION

Applicant has endeavored to address all of the Examiner's concerns as expressed in the outstanding Office Action. Accordingly, arguments in support of the patentability of the pending claim set are presented above. In light of the above remarks, reconsideration and withdrawal of the outstanding rejections is respectfully requested. If the Examiner has any questions, the Examiner is invited to call the undersigned directly.

Please charge any additional fees, including any fees for additional extension of time, or credit overpayment to Deposit Account No. 11-1410.

Respectfully submitted,

KNOBBE, MARTENS, OLSON & BEAR, LLP

Dated: April 14, 2017

By: /Mincheol Kim/  
Mincheol Kim  
Registration No. 51,306  
Attorney of Record  
Customer No. 20,995  
(949) 760-0404

25703695  
041417

<b>INFORMATION DISCLOSURE STATEMENT BY APPLICANT</b> ( Not for submission under 37 CFR 1.99)	Application Number	14848191
	Filing Date	2015-09-08
	First Named Inventor	Jae Lark Jung
	Art Unit	2646
	Examiner Name	Shedrick, Charles Terrell
	Attorney Docket Number	UNIS005.001C2

U.S.PATENTS							Remove
Examiner Initial*	Cite No	Patent Number	Kind Code <sup>1</sup>	Issue Date	Name of Patentee or Applicant of cited Document	Pages,Columns,Lines where Relevant Passages or Relevant Figures Appear	
	1						

If you wish to add additional U.S. Patent citation information please click the Add button. Add

U.S.PATENT APPLICATION PUBLICATIONS							Remove
Examiner Initial*	Cite No	Publication Number	Kind Code <sup>1</sup>	Publication Date	Name of Patentee or Applicant of cited Document	Pages,Columns,Lines where Relevant Passages or Relevant Figures Appear	
	1	20100257490	A1	2010-10-07	Lyon et al.		

If you wish to add additional U.S. Published Application citation information please click the Add button. Add

FOREIGN PATENT DOCUMENTS								Remove
Examiner Initial*	Cite No	Foreign Document Number <sup>3</sup>	Country Code <sup>2</sup> i	Kind Code <sup>4</sup>	Publication Date	Name of Patentee or Applicant of cited Document	Pages,Columns,Lines where Relevant Passages or Relevant Figures Appear	T <sup>5</sup>
	1							

If you wish to add additional Foreign Patent Document citation information please click the Add button. Add

NON-PATENT LITERATURE DOCUMENTS								Remove
Examiner Initials*	Cite No	Include name of the author (in CAPITAL LETTERS), title of the article (when appropriate), title of the item (book, magazine, journal, serial, symposium, catalog, etc), date, pages(s), volume-issue number(s), publisher, city and/or country where published.						T <sup>5</sup>

<b>INFORMATION DISCLOSURE STATEMENT BY APPLICANT</b> ( Not for submission under 37 CFR 1.99)	Application Number	14848191
	Filing Date	2015-09-08
	First Named Inventor	Jae Lark Jung
	Art Unit	2646
	Examiner Name	Shedrick, Charles Terrell
	Attorney Docket Number	UNIS005.001C2

1	
---	--

If you wish to add additional non-patent literature document citation information please click the Add button

**EXAMINER SIGNATURE**

Examiner Signature		Date Considered	
--------------------	--	-----------------	--

\*EXAMINER: Initial if reference considered, whether or not citation is in conformance with MPEP 609. Draw line through a citation if not in conformance and not considered. Include copy of this form with next communication to applicant.

<sup>1</sup> See Kind Codes of USPTO Patent Documents at [www.USPTO.GOV](http://www.USPTO.GOV) or MPEP 901.04. <sup>2</sup> Enter office that issued the document, by the two-letter code (WIPO Standard ST.3). <sup>3</sup> For Japanese patent documents, the indication of the year of the reign of the Emperor must precede the serial number of the patent document. <sup>4</sup> Kind of document by the appropriate symbols as indicated on the document under WIPO Standard ST.16 if possible. <sup>5</sup> Applicant is to place a check mark here if English language translation is attached.

**INFORMATION DISCLOSURE  
STATEMENT BY APPLICANT**  
( Not for submission under 37 CFR 1.99)

Application Number	14848191
Filing Date	2015-09-08
First Named Inventor	Jae Lark Jung
Art Unit	2646
Examiner Name	Shedrick, Charles Terrell
Attorney Docket Number	UNIS005.001C2

**CERTIFICATION STATEMENT**

Please see 37 CFR 1.97 and 1.98 to make the appropriate selection(s):

That each item of information contained in the information disclosure statement was first cited in any communication from a foreign patent office in a counterpart foreign application not more than three months prior to the filing of the information disclosure statement. See 37 CFR 1.97(e)(1).

**OR**

That no item of information contained in the information disclosure statement was cited in a communication from a foreign patent office in a counterpart foreign application, and, to the knowledge of the person signing the certification after making reasonable inquiry, no item of information contained in the information disclosure statement was known to any individual designated in 37 CFR 1.56(c) more than three months prior to the filing of the information disclosure statement. See 37 CFR 1.97(e)(2).

See attached certification statement.

The fee set forth in 37 CFR 1.17 (p) has been submitted herewith.

A certification statement is not submitted herewith.

**SIGNATURE**

A signature of the applicant or representative is required in accordance with CFR 1.33, 10.18. Please see CFR 1.4(d) for the form of the signature.

Signature	/Mincheol Kim/	Date (YYYY-MM-DD)	2017-04-14
Name/Print	Mincheol Kim	Registration Number	51306

This collection of information is required by 37 CFR 1.97 and 1.98. The information is required to obtain or retain a benefit by the public which is to file (and by the USPTO to process) an application. Confidentiality is governed by 35 U.S.C. 122 and 37 CFR 1.14. This collection is estimated to take 1 hour to complete, including gathering, preparing and submitting the completed application form to the USPTO. Time will vary depending upon the individual case. Any comments on the amount of time you require to complete this form and/or suggestions for reducing this burden, should be sent to the Chief Information Officer, U.S. Patent and Trademark Office, U.S. Department of Commerce, P.O. Box 1450, Alexandria, VA 22313-1450. **DO NOT SEND FEES OR COMPLETED FORMS TO THIS ADDRESS. SEND TO: Commissioner for Patents, P.O. Box 1450, Alexandria, VA 22313-1450.**

## Privacy Act Statement

The Privacy Act of 1974 (P.L. 93-579) requires that you be given certain information in connection with your submission of the attached form related to a patent application or patent. Accordingly, pursuant to the requirements of the Act, please be advised that: (1) the general authority for the collection of this information is 35 U.S.C. 2(b)(2); (2) furnishing of the information solicited is voluntary; and (3) the principal purpose for which the information is used by the U.S. Patent and Trademark Office is to process and/or examine your submission related to a patent application or patent. If you do not furnish the requested information, the U.S. Patent and Trademark Office may not be able to process and/or examine your submission, which may result in termination of proceedings or abandonment of the application or expiration of the patent.

The information provided by you in this form will be subject to the following routine uses:

1. The information on this form will be treated confidentially to the extent allowed under the Freedom of Information Act (5 U.S.C. 552) and the Privacy Act (5 U.S.C. 552a). Records from this system of records may be disclosed to the Department of Justice to determine whether the Freedom of Information Act requires disclosure of these records.
2. A record from this system of records may be disclosed, as a routine use, in the course of presenting evidence to a court, magistrate, or administrative tribunal, including disclosures to opposing counsel in the course of settlement negotiations.
3. A record in this system of records may be disclosed, as a routine use, to a Member of Congress submitting a request involving an individual, to whom the record pertains, when the individual has requested assistance from the Member with respect to the subject matter of the record.
4. A record in this system of records may be disclosed, as a routine use, to a contractor of the Agency having need for the information in order to perform a contract. Recipients of information shall be required to comply with the requirements of the Privacy Act of 1974, as amended, pursuant to 5 U.S.C. 552a(m).
5. A record related to an International Application filed under the Patent Cooperation Treaty in this system of records may be disclosed, as a routine use, to the International Bureau of the World Intellectual Property Organization, pursuant to the Patent Cooperation Treaty.
6. A record in this system of records may be disclosed, as a routine use, to another federal agency for purposes of National Security review (35 U.S.C. 181) and for review pursuant to the Atomic Energy Act (42 U.S.C. 218(c)).
7. A record from this system of records may be disclosed, as a routine use, to the Administrator, General Services, or his/her designee, during an inspection of records conducted by GSA as part of that agency's responsibility to recommend improvements in records management practices and programs, under authority of 44 U.S.C. 2904 and 2906. Such disclosure shall be made in accordance with the GSA regulations governing inspection of records for this purpose, and any other relevant (i.e., GSA or Commerce) directive. Such disclosure shall not be used to make determinations about individuals.
8. A record from this system of records may be disclosed, as a routine use, to the public after either publication of the application pursuant to 35 U.S.C. 122(b) or issuance of a patent pursuant to 35 U.S.C. 151. Further, a record may be disclosed, subject to the limitations of 37 CFR 1.14, as a routine use, to the public if the record was filed in an application which became abandoned or in which the proceedings were terminated and which application is referenced by either a published application, an application open to public inspections or an issued patent.
9. A record from this system of records may be disclosed, as a routine use, to a Federal, State, or local law enforcement agency, if the USPTO becomes aware of a violation or potential violation of law or regulation.

## Electronic Patent Application Fee Transmittal

<b>Application Number:</b>	14848191
<b>Filing Date:</b>	08-Sep-2015
<b>Title of Invention:</b>	ACTIVATING DISPLAY AND PERFORMING USER AUTHENTICATION IN MOBILE TERMINAL WITH ONE-TIME USER INPUT
<b>First Named Inventor/Applicant Name:</b>	Jae Lark JUNG
<b>Filer:</b>	Mincheol Kim/kim skoff
<b>Attorney Docket Number:</b>	UNIS005.001C2

Filed as Small Entity

### Filing Fees for Utility under 35 USC 111(a)

Description	Fee Code	Quantity	Amount	Sub-Total in USD(\$)
<b>Basic Filing:</b>				
<b>Pages:</b>				
<b>Claims:</b>				
<b>Miscellaneous-Filing:</b>				
<b>Petition:</b>				
<b>Patent-Appeals-and-Interference:</b>				
<b>Post-Allowance-and-Post-Issuance:</b>				
<b>Extension-of-Time:</b>				

Description	Fee Code	Quantity	Amount	Sub-Total in USD(\$)
Extension - 1 month with \$0 paid	2251	1	100	100
<b>Miscellaneous:</b>				
SUBMISSION- INFORMATION DISCLOSURE STMT	2806	1	90	90
<b>Total in USD (\$)</b>				<b>190</b>



## Electronic Acknowledgement Receipt

<b>EFS ID:</b>	28935548
<b>Application Number:</b>	14848191
<b>International Application Number:</b>	
<b>Confirmation Number:</b>	9599
<b>Title of Invention:</b>	ACTIVATING DISPLAY AND PERFORMING USER AUTHENTICATION IN MOBILE TERMINAL WITH ONE-TIME USER INPUT
<b>First Named Inventor/Applicant Name:</b>	Jae Lark JUNG
<b>Customer Number:</b>	20995
<b>Filer:</b>	Mincheol Kim/Angel Zehnder
<b>Filer Authorized By:</b>	Mincheol Kim
<b>Attorney Docket Number:</b>	UNIS005.001C2
<b>Receipt Date:</b>	14-APR-2017
<b>Filing Date:</b>	08-SEP-2015
<b>Time Stamp:</b>	19:28:16
<b>Application Type:</b>	Utility under 35 USC 111(a)

### Payment information:

Submitted with Payment	yes
Payment Type	CARD
Payment was successfully received in RAM	\$190
RAM confirmation Number	041717INTEFSW19292600
Deposit Account	111410
Authorized User	Angel Zehnder

The Director of the USPTO is hereby authorized to charge indicated fees and credit any overpayment as follows:

37 CFR 1.16 (National application filing, search, and examination fees)

37 CFR 1.17 (Patent application and reexamination processing fees)

<b>File Listing:</b>					
<b>Document Number</b>	<b>Document Description</b>	<b>File Name</b>	<b>File Size(Bytes)/ Message Digest</b>	<b>Multi Part /.zip</b>	<b>Pages (if appl.)</b>
1		Response.pdf	703902	yes	13
			829f15fc2e4a92476ab712806dea6a59d796dead		
<b>Multipart Description/PDF files in .zip description</b>					
<b>Document Description</b>			<b>Start</b>	<b>End</b>	
Amendment/Req. Reconsideration-After Non-Final Reject			1	1	
Claims			2	7	
Applicant Arguments/Remarks Made in an Amendment			8	13	
<b>Warnings:</b>					
<b>Information:</b>					
2	Information Disclosure Statement (IDS) Form (SB08)	IDS1.pdf	611973	no	4
			7efaf109476f7474e28d5989791b5129012e7494e		
<b>Warnings:</b>					
<b>Information:</b>					
3	Fee Worksheet (SB06)	fee-info.pdf	32629	no	2
			7057132d9734c5e5c1cca789f7dea9e62d3557c		
<b>Warnings:</b>					
<b>Information:</b>					
<b>Total Files Size (in bytes):</b>			1348504		

**This Acknowledgement Receipt evidences receipt on the noted date by the USPTO of the indicated documents, characterized by the applicant, and including page counts, where applicable. It serves as evidence of receipt similar to a Post Card, as described in MPEP 503.**

**New Applications Under 35 U.S.C. 111**

**If a new application is being filed and the application includes the necessary components for a filing date (see 37 CFR 1.53(b)-(d) and MPEP 506), a Filing Receipt (37 CFR 1.54) will be issued in due course and the date shown on this Acknowledgement Receipt will establish the filing date of the application.**

**National Stage of an International Application under 35 U.S.C. 371**

**If a timely submission to enter the national stage of an international application is compliant with the conditions of 35 U.S.C. 371 and other applicable requirements a Form PCT/DO/EO/903 indicating acceptance of the application as a national stage submission under 35 U.S.C. 371 will be issued in addition to the Filing Receipt, in due course.**

**New International Application Filed with the USPTO as a Receiving Office**

**If a new international application is being filed and the international application includes the necessary components for an international filing date (see PCT Article 11 and MPEP 1810), a Notification of the International Application Number and of the International Filing Date (Form PCT/RO/105) will be issued in due course, subject to prescriptions concerning national security, and the date shown on this Acknowledgement Receipt will establish the international filing date of the application.**

Under the Paperwork Reduction Act of 1995, no persons are required to respond to a collection of information unless it displays a valid OMB control number.

<b>PATENT APPLICATION FEE DETERMINATION RECORD</b> Substitute for Form PTO-875	Application or Docket Number <b>14/848,191</b>	Filing Date <b>09/08/2015</b>	<input type="checkbox"/> To be Mailed
---	---	----------------------------------	---------------------------------------

ENTITY:  LARGE  SMALL  MICRO

**APPLICATION AS FILED – PART I**

FOR	NUMBER FILED	NUMBER EXTRA	RATE (\$)	FEE (\$)
<input type="checkbox"/> BASIC FEE (37 CFR 1.16(a), (b), or (c))	N/A	N/A	N/A	
<input type="checkbox"/> SEARCH FEE (37 CFR 1.16(k), (l), or (m))	N/A	N/A	N/A	
<input type="checkbox"/> EXAMINATION FEE (37 CFR 1.16(o), (p), or (q))	N/A	N/A	N/A	
TOTAL CLAIMS (37 CFR 1.16(j))	minus 20 = *		X \$ =	
INDEPENDENT CLAIMS (37 CFR 1.16(h))	minus 3 = *		X \$ =	
<input type="checkbox"/> APPLICATION SIZE FEE (37 CFR 1.16(s))	If the specification and drawings exceed 100 sheets of paper, the application size fee due is \$310 (\$155 for small entity) for each additional 50 sheets or fraction thereof. See 35 U.S.C. 41(a)(1)(G) and 37 CFR 1.16(s).			
<input type="checkbox"/> MULTIPLE DEPENDENT CLAIM PRESENT (37 CFR 1.16(j))				
* If the difference in column 1 is less than zero, enter "0" in column 2.			<b>TOTAL</b>	

**APPLICATION AS AMENDED – PART II**

	(Column 1)	(Column 2)	(Column 3)	PRESENT EXTRA	RATE (\$)	ADDITIONAL FEE (\$)
<b>AMENDMENT</b>	<b>04/14/2017</b>	CLAIMS REMAINING AFTER AMENDMENT	HIGHEST NUMBER PREVIOUSLY PAID FOR			
	Total (37 CFR 1.16(i))	* 20	Minus ** 20	= 0	X \$40 =	0
	Independent (37 CFR 1.16(h))	* 2	Minus *** 3	= 0	X \$210 =	0
	<input type="checkbox"/> Application Size Fee (37 CFR 1.16(s)) <input type="checkbox"/> FIRST PRESENTATION OF MULTIPLE DEPENDENT CLAIM (37 CFR 1.16(j))					
					<b>TOTAL ADD'L FEE</b>	<b>0</b>

	(Column 1)	(Column 2)	(Column 3)	PRESENT EXTRA	RATE (\$)	ADDITIONAL FEE (\$)
<b>AMENDMENT</b>		CLAIMS REMAINING AFTER AMENDMENT	HIGHEST NUMBER PREVIOUSLY PAID FOR			
	Total (37 CFR 1.16(i))	-	Minus **	=	X \$ =	
	Independent (37 CFR 1.16(h))	*	Minus ***	=	X \$ =	
	<input type="checkbox"/> Application Size Fee (37 CFR 1.16(s)) <input type="checkbox"/> FIRST PRESENTATION OF MULTIPLE DEPENDENT CLAIM (37 CFR 1.16(j))					
					<b>TOTAL ADD'L FEE</b>	

\* If the entry in column 1 is less than the entry in column 2, write "0" in column 3.  
 \*\* If the "Highest Number Previously Paid For" IN THIS SPACE is less than 20, enter "20".  
 \*\*\* If the "Highest Number Previously Paid For" IN THIS SPACE is less than 3, enter "3".

The "Highest Number Previously Paid For" (Total or Independent) is the highest number found in the appropriate box in column 1.

LIE  
RAMONA WILSON

This collection of information is required by 37 CFR 1.16. The information is required to obtain or retain a benefit by the public which is to file (and by the USPTO to process) an application. Confidentiality is governed by 35 U.S.C. 122 and 37 CFR 1.14. This collection is estimated to take 12 minutes to complete, including gathering, preparing, and submitting the completed application form to the USPTO. Time will vary depending upon the individual case. Any comments on the amount of time you require to complete this form and/or suggestions for reducing this burden, should be sent to the Chief Information Officer, U.S. Patent and Trademark Office, U.S. Department of Commerce, P.O. Box 1450, Alexandria, VA 22313-1450. DO NOT SEND FEES OR COMPLETED FORMS TO THIS ADDRESS. **SEND TO: Commissioner for Patents, P.O. Box 1450, Alexandria, VA 22313-1450.**

If you need assistance in completing the form, call 1-800-PTO-9199 and select option 2.

<b>INFORMATION DISCLOSURE STATEMENT BY APPLICANT</b> ( Not for submission under 37 CFR 1.99)	Application Number	14848191
	Filing Date	2015-09-08
	First Named Inventor	Jae Lark Jung
	Art Unit	2646
	Examiner Name	Shedrick, Charles Terrell
	Attorney Docket Number	UNIS005.001C2

U.S.PATENTS						Remove
Examiner Initial*	Cite No	Patent Number	Kind Code <sup>1</sup>	Issue Date	Name of Patentee or Applicant of cited Document	Pages,Columns,Lines where Relevant Passages or Relevant Figures Appear
	1	7647638	B2	2010-01-12	Furuyama	
	2	8138886	B1	2012-03-20	Chang	
	3	8638305	B2	2014-01-28	Inami	
	4	8965449	B2	2015-02-24	Alvarez Rivera et al.	
	5	9027117	B2	2015-05-05	Wilairat	
	6	8793786	B2	2017-07-29	Bhesania et al.	
	7	9076008	B1	2015-07-07	Moy	
If you wish to add additional U.S. Patent citation information please click the Add button.						Add
<b>U.S.PATENT APPLICATION PUBLICATIONS</b>						Remove

**INFORMATION DISCLOSURE  
STATEMENT BY APPLICANT**  
( Not for submission under 37 CFR 1.99)

Application Number	14848191
Filing Date	2015-09-08
First Named Inventor	Jae Lark Jung
Art Unit	2646
Examiner Name	Shedrick, Charles Terrell
Attorney Docket Number	UNIS005.001C2

Examiner Initial*	Cite No	Publication Number	Kind Code <sup>1</sup>	Publication Date	Name of Patentee or Applicant of cited Document	Pages, Columns, Lines where Relevant Passages or Relevant Figures Appear
	1	20080209547	A1	2008-08-28	Funahashi et al.	
	2	20090169070	A1	2009-07-02	Fadell et al.	
	3	20120071149	A1	2012-03-22	Bandyopadhyay et al.	Application Publication of US 8,311,514 B2
	4	20140310532	A1	2014-10-16	Ali et al.	

If you wish to add additional U.S. Published Application citation information please click the Add button.

**FOREIGN PATENT DOCUMENTS**

Examiner Initial*	Cite No	Foreign Document Number <sup>3</sup>	Country Code <sup>2j</sup>	Kind Code <sup>4</sup>	Publication Date	Name of Patentee or Applicant of cited Document	Pages, Columns, Lines where Relevant Passages or Relevant Figures Appear	T <sup>5</sup>
	1	2192519	EP	A1	2010-06-02	RESEARCH IN MOTION LTD		

If you wish to add additional Foreign Patent Document citation information please click the Add button.

**NON-PATENT LITERATURE DOCUMENTS**

Examiner Initials*	Cite No	Include name of the author (in CAPITAL LETTERS), title of the article (when appropriate), title of the item (book, magazine, journal, serial, symposium, catalog, etc), date, pages(s), volume-issue number(s), publisher, city and/or country where published.	T <sup>5</sup>
	1	WROBLEWSKI, "Apple's Overloaded iPhone Button", August 17, 2011, downloaded from <a href="https://www.lukew.com/ff/entry.asp?1382">https://www.lukew.com/ff/entry.asp?1382</a>	

**INFORMATION DISCLOSURE  
STATEMENT BY APPLICANT**  
( Not for submission under 37 CFR 1.99)

Application Number	14848191
Filing Date	2015-09-08
First Named Inventor	Jae Lark Jung
Art Unit	2646
Examiner Name	Shedrick, Charles Terrell
Attorney Docket Number	UNIS005.001C2

2	"WidgetLocker adds any widget to Android lock screen", Uploaded to YouTube on July 15, 2010, <a href="https://www.youtube.com/watch?v=cVXf1r6xd4E">https://www.youtube.com/watch?v=cVXf1r6xd4E</a>
3	GROBART, "16 Tips to Take Your iPhone to the Next Level", The New York Times, April 27, 2011 in 4 pages
4	"WidgetLocker Lockscreen Android App Review", Hemorrroidsnet, Uploaded to YouTube on July 26, 2010, <a href="https://www.youtube.com/watch?v=9lnD1QTy5IY">https://www.youtube.com/watch?v=9lnD1QTy5IY</a>
5	Office Action dated June 2, 2017 of related U.S. Application No. 15/013,951 (Attorney Docket No.: UNIS005.001C3) - 16 pages

If you wish to add additional non-patent literature document citation information please click the Add button

**EXAMINER SIGNATURE**

Examiner Signature		Date Considered	
--------------------	--	-----------------	--

\*EXAMINER: Initial if reference considered, whether or not citation is in conformance with MPEP 609. Draw line through a citation if not in conformance and not considered. Include copy of this form with next communication to applicant.

<sup>1</sup> See Kind Codes of USPTO Patent Documents at [www.USPTO.GOV](http://www.USPTO.GOV) or MPEP 901.04. <sup>2</sup> Enter office that issued the document, by the two-letter code (WIPO Standard ST.3). <sup>3</sup> For Japanese patent documents, the indication of the year of the reign of the Emperor must precede the serial number of the patent document. <sup>4</sup> Kind of document by the appropriate symbols as indicated on the document under WIPO Standard ST.16 if possible. <sup>5</sup> Applicant is to place a check mark here if English language translation is attached.

**INFORMATION DISCLOSURE  
STATEMENT BY APPLICANT**  
( Not for submission under 37 CFR 1.99)

Application Number	14848191
Filing Date	2015-09-08
First Named Inventor	Jae Lark Jung
Art Unit	2646
Examiner Name	Shedrick, Charles Terrell
Attorney Docket Number	UNIS005.001C2

**CERTIFICATION STATEMENT**

Please see 37 CFR 1.97 and 1.98 to make the appropriate selection(s):

That each item of information contained in the information disclosure statement was first cited in any communication from a foreign patent office in a counterpart foreign application not more than three months prior to the filing of the information disclosure statement. See 37 CFR 1.97(e)(1).

**OR**

That no item of information contained in the information disclosure statement was cited in a communication from a foreign patent office in a counterpart foreign application, and, to the knowledge of the person signing the certification after making reasonable inquiry, no item of information contained in the information disclosure statement was known to any individual designated in 37 CFR 1.56(c) more than three months prior to the filing of the information disclosure statement. See 37 CFR 1.97(e)(2).

See attached certification statement.

The fee set forth in 37 CFR 1.17 (p) has been submitted herewith.

A certification statement is not submitted herewith.

**SIGNATURE**

A signature of the applicant or representative is required in accordance with CFR 1.33, 10.18. Please see CFR 1.4(d) for the form of the signature.

Signature	/Mincheol Kim/	Date (YYYY-MM-DD)	2017-06-29
Name/Print	Mincheol Kim	Registration Number	51306

This collection of information is required by 37 CFR 1.97 and 1.98. The information is required to obtain or retain a benefit by the public which is to file (and by the USPTO to process) an application. Confidentiality is governed by 35 U.S.C. 122 and 37 CFR 1.14. This collection is estimated to take 1 hour to complete, including gathering, preparing and submitting the completed application form to the USPTO. Time will vary depending upon the individual case. Any comments on the amount of time you require to complete this form and/or suggestions for reducing this burden, should be sent to the Chief Information Officer, U.S. Patent and Trademark Office, U.S. Department of Commerce, P.O. Box 1450, Alexandria, VA 22313-1450. **DO NOT SEND FEES OR COMPLETED FORMS TO THIS ADDRESS. SEND TO: Commissioner for Patents, P.O. Box 1450, Alexandria, VA 22313-1450.**



## Privacy Act Statement

The Privacy Act of 1974 (P.L. 93-579) requires that you be given certain information in connection with your submission of the attached form related to a patent application or patent. Accordingly, pursuant to the requirements of the Act, please be advised that: (1) the general authority for the collection of this information is 35 U.S.C. 2(b)(2); (2) furnishing of the information solicited is voluntary; and (3) the principal purpose for which the information is used by the U.S. Patent and Trademark Office is to process and/or examine your submission related to a patent application or patent. If you do not furnish the requested information, the U.S. Patent and Trademark Office may not be able to process and/or examine your submission, which may result in termination of proceedings or abandonment of the application or expiration of the patent.

The information provided by you in this form will be subject to the following routine uses:

1. The information on this form will be treated confidentially to the extent allowed under the Freedom of Information Act (5 U.S.C. 552) and the Privacy Act (5 U.S.C. 552a). Records from this system of records may be disclosed to the Department of Justice to determine whether the Freedom of Information Act requires disclosure of these records.
2. A record from this system of records may be disclosed, as a routine use, in the course of presenting evidence to a court, magistrate, or administrative tribunal, including disclosures to opposing counsel in the course of settlement negotiations.
3. A record in this system of records may be disclosed, as a routine use, to a Member of Congress submitting a request involving an individual, to whom the record pertains, when the individual has requested assistance from the Member with respect to the subject matter of the record.
4. A record in this system of records may be disclosed, as a routine use, to a contractor of the Agency having need for the information in order to perform a contract. Recipients of information shall be required to comply with the requirements of the Privacy Act of 1974, as amended, pursuant to 5 U.S.C. 552a(m).
5. A record related to an International Application filed under the Patent Cooperation Treaty in this system of records may be disclosed, as a routine use, to the International Bureau of the World Intellectual Property Organization, pursuant to the Patent Cooperation Treaty.
6. A record in this system of records may be disclosed, as a routine use, to another federal agency for purposes of National Security review (35 U.S.C. 181) and for review pursuant to the Atomic Energy Act (42 U.S.C. 218(c)).
7. A record from this system of records may be disclosed, as a routine use, to the Administrator, General Services, or his/her designee, during an inspection of records conducted by GSA as part of that agency's responsibility to recommend improvements in records management practices and programs, under authority of 44 U.S.C. 2904 and 2906. Such disclosure shall be made in accordance with the GSA regulations governing inspection of records for this purpose, and any other relevant (i.e., GSA or Commerce) directive. Such disclosure shall not be used to make determinations about individuals.
8. A record from this system of records may be disclosed, as a routine use, to the public after either publication of the application pursuant to 35 U.S.C. 122(b) or issuance of a patent pursuant to 35 U.S.C. 151. Further, a record may be disclosed, subject to the limitations of 37 CFR 1.14, as a routine use, to the public if the record was filed in an application which became abandoned or in which the proceedings were terminated and which application is referenced by either a published application, an application open to public inspections or an issued patent.
9. A record from this system of records may be disclosed, as a routine use, to a Federal, State, or local law enforcement agency, if the USPTO becomes aware of a violation or potential violation of law or regulation.

## Electronic Patent Application Fee Transmittal

<b>Application Number:</b>	14848191
<b>Filing Date:</b>	08-Sep-2015
<b>Title of Invention:</b>	ACTIVATING DISPLAY AND PERFORMING USER AUTHENTICATION IN MOBILE TERMINAL WITH ONE-TIME USER INPUT
<b>First Named Inventor/Applicant Name:</b>	Jae Lark JUNG
<b>Filer:</b>	Mincheol Kim/kim skoff
<b>Attorney Docket Number:</b>	UNIS005.001C2

Filed as Small Entity

### Filing Fees for Utility under 35 USC 111(a)

Description	Fee Code	Quantity	Amount	Sub-Total in USD(\$)
<b>Basic Filing:</b>				
<b>Pages:</b>				
<b>Claims:</b>				
<b>Miscellaneous-Filing:</b>				
<b>Petition:</b>				
<b>Patent-Appeals-and-Interference:</b>				
<b>Post-Allowance-and-Post-Issuance:</b>				
<b>Extension-of-Time:</b>				

Description	Fee Code	Quantity	Amount	Sub-Total in USD(\$)
<b>Miscellaneous:</b>				
SUBMISSION- INFORMATION DISCLOSURE STMT	2806	1	90	90
<b>Total in USD (\$)</b>				<b>90</b>

## Electronic Acknowledgement Receipt

<b>EFS ID:</b>	29649750
<b>Application Number:</b>	14848191
<b>International Application Number:</b>	
<b>Confirmation Number:</b>	9599
<b>Title of Invention:</b>	ACTIVATING DISPLAY AND PERFORMING USER AUTHENTICATION IN MOBILE TERMINAL WITH ONE-TIME USER INPUT
<b>First Named Inventor/Applicant Name:</b>	Jae Lark JUNG
<b>Customer Number:</b>	20995
<b>Filer:</b>	Mincheol Kim/kim skoff
<b>Filer Authorized By:</b>	Mincheol Kim
<b>Attorney Docket Number:</b>	UNIS005.001C2
<b>Receipt Date:</b>	29-JUN-2017
<b>Filing Date:</b>	08-SEP-2015
<b>Time Stamp:</b>	17:54:36
<b>Application Type:</b>	Utility under 35 USC 111(a)

### Payment information:

Submitted with Payment	yes
Payment Type	CARD
Payment was successfully received in RAM	\$90
RAM confirmation Number	063017INTEFSW17560200
Deposit Account	
Authorized User	

The Director of the USPTO is hereby authorized to charge indicated fees and credit any overpayment as follows:

--	--	--	--	--	--

**File Listing:**

Document Number	Document Description	File Name	File Size(Bytes)/ Message Digest	Multi Part /.zip	Pages (if appl.)
1	Foreign Reference	EP2192519.PDF	951098	no	20
			3656361a8cabe301c397e2005267d7b8b9e a83d		

**Warnings:**

**Information:**

2	Non Patent Literature	NPL_Wroblewski.PDF	474512	no	2
			bfc0f985848dc8d22a2e210c1dc101392513 4901		

**Warnings:**

**Information:**

3	Non Patent Literature	NPL_Hemorroidsnet.PDF	526092	no	3
			52a55722486a4ea5c17doc2128774d1cd8b 1a82b		

**Warnings:**

**Information:**

4	Non Patent Literature	NPL_Grobart.PDF	1187727	no	4
			6855d6ed7f06567b77b142e4ce6d129283f1 58ah		

**Warnings:**

**Information:**

5	Non Patent Literature	NPL_androinica.PDF	422862	no	2
			b7bffa0b681fb46203765d1e371714a3a7fd 6aff		

**Warnings:**

**Information:**

6	Non Patent Literature	2017-06-02_FOA.pdf	4690708	no	16
			f24a16feb40b7de4633c03d33fc51c999269 f994		

**Warnings:**

**Information:**

7	Information Disclosure Statement (IDS) Form (SB08)	IDS.pdf	613115	no	5
			7dc2835bca0dca8d5ee2c0be65433d8c6948b42e		

**Warnings:**

**Information:**

8	Fee Worksheet (SB06)	fee-info.pdf	30699	no	2
			1e226269830cb083f4f2c43ac153f09f0765b824		

**Warnings:**

**Information:**

<b>Total Files Size (in bytes):</b>	8896813
-------------------------------------	---------

**This Acknowledgement Receipt evidences receipt on the noted date by the USPTO of the indicated documents, characterized by the applicant, and including page counts, where applicable. It serves as evidence of receipt similar to a Post Card, as described in MPEP 503.**

**New Applications Under 35 U.S.C. 111**

If a new application is being filed and the application includes the necessary components for a filing date (see 37 CFR 1.53(b)-(d) and MPEP 506), a Filing Receipt (37 CFR 1.54) will be issued in due course and the date shown on this Acknowledgement Receipt will establish the filing date of the application.

**National Stage of an International Application under 35 U.S.C. 371**

If a timely submission to enter the national stage of an international application is compliant with the conditions of 35 U.S.C. 371 and other applicable requirements a Form PCT/DO/EO/903 indicating acceptance of the application as a national stage submission under 35 U.S.C. 371 will be issued in addition to the Filing Receipt, in due course.

**New International Application Filed with the USPTO as a Receiving Office**

If a new international application is being filed and the international application includes the necessary components for an international filing date (see PCT Article 11 and MPEP 1810), a Notification of the International Application Number and of the International Filing Date (Form PCT/RO/105) will be issued in due course, subject to prescriptions concerning national security, and the date shown on this Acknowledgement Receipt will establish the international filing date of the application.



(12) **EUROPEAN PATENT APPLICATION**

(43) Date of publication:  
**02.06.2010 Bulletin 2010/22**

(51) Int Cl.:  
**G06F 21/20 (2006.01)**

(21) Application number: **08170378.7**

(22) Date of filing: **01.12.2008**

(84) Designated Contracting States:  
**AT BE BG CH CY CZ DE DK EE ES FI FR GB GR HR HU IE IS IT LI LT LU LV MC MT NL NO PL PT RO SE SI SK TR**  
Designated Extension States:  
**AL BA MK RS**

(72) Inventors:  
• **Davis, Dinah Lea Marie**  
**Waterloo Ontario N2L 5Z5 (CA)**  
• **Adams, Neil P.**  
**Waterloo Ontario N2L 5Z5 (CA)**

(71) Applicant: **Research In Motion Limited**  
**Waterloo, Ontario N2L 3W8 (CA)**

(74) Representative: **Patel, Binesh et al**  
**Barker Brettell LLP**  
**10-12 Priests Bridge**  
**London**  
**SW15 5JE (GB)**

(54) **System and method of providing biometric quick launch**

(57) By providing a biometric candidate to a biometric input device, a user may cause a computing device to be unlocked and cause a specific application to be launched on the computing device. The biometric input device may be on the computing device or on a peripheral

security device that is in communication with the computing device. Indeed, the specific application may be launched preloaded with certain data, selection of which data is controlled by the particular biometric provided to the biometric input device.

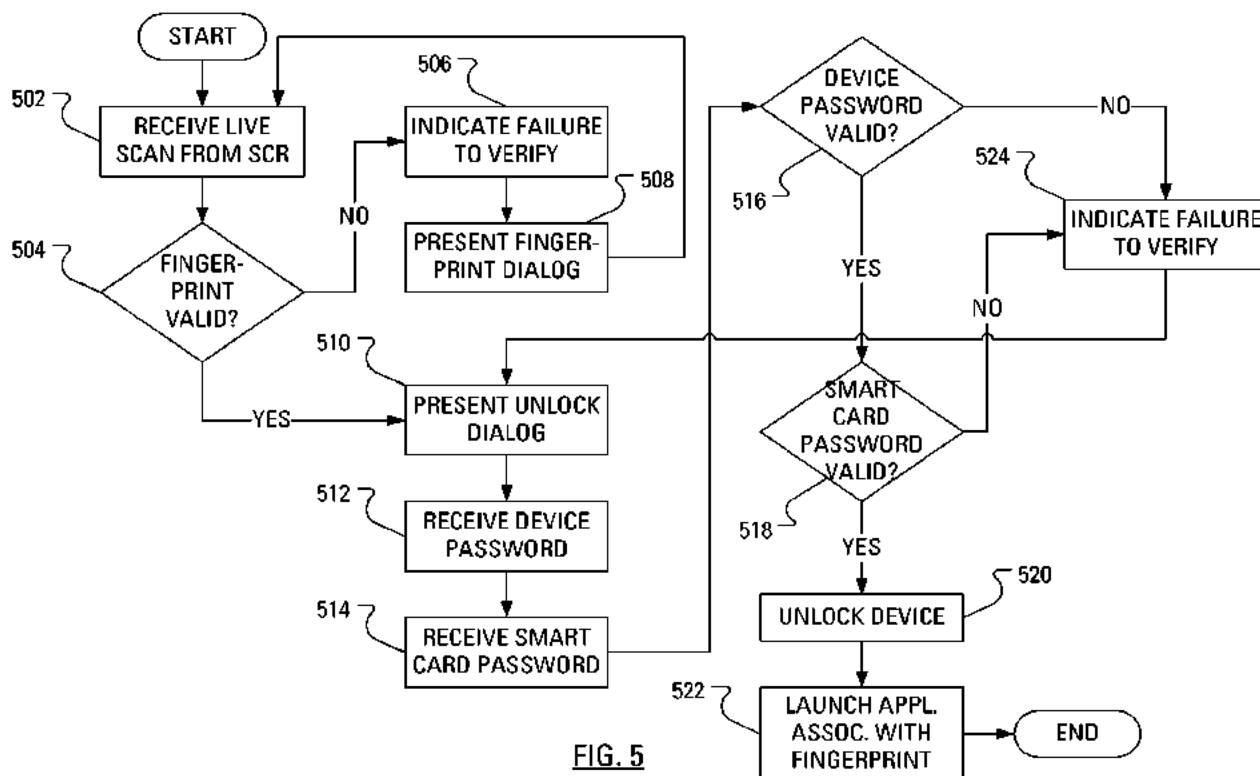


FIG. 5

## Description

**[0001]** The present application relates generally to launching applications on a device and, more particularly, to a system and method of launching applications, access to which is controlled, at least in part, by biometric authentication.

**[0002]** As an increasing volume of sensitive personal information is stored on computers, personal and otherwise, it is increasingly important that access to these computers is controlled. Even the most basic user of computers is familiar with a requirement to provide a password to gain access to a computer and execute various software application on the processor of the computer. Such a one-factor authentication scheme is based solely on what the user knows, i.e., the password. Should the password become known to those other than the user whose account access to which is controlled by the password, the others can use the password to gain access to the user's account.

**[0003]** To increase security, some computers have been configured to implement a two-factor authentication scheme. The user is provided with a smart card and a smart card reader that may connect to the computer of interest either by wired means or wireless means. The smart card may have an associated password previously revealed to the user. Now, to gain access to the computer of interest, the user provides a first password, which may be called a device password, and a second password, which may be called a smart card password. The user will only gain access to the computer of interest by submitting correct values for both the device password and the smart card password. The computer generally determines whether the provided smart card is a correct value by passing the provided smart card password to the smart card reader and receiving a yes or no answer. Such a two-factor authentication scheme is based on what the user knows, i.e., the device password and the smart card password, and what the user has, i.e., the smart card, since the computer of interest can not confirm the validity of the provided smart card password in the absence of the smart card.

**[0004]** To increase security even further, some computers have been configured to implement an additional authentication scheme. The additional factor is biometric information. Biometric information includes fingerprints, retinal scans, face geometry scans, hand geometry scans, voice or speech prints, etc. In one particular implementation, the smart card reader can also have a biometric input device. Now, to gain access to the computer of interest, the user provides a device password and a smart card password. If the passwords are determined to be valid, the user is prompted to provide biometric information. The user will only gain access to the computer of interest if the biometric information submitted responsive to the prompt properly matches a previously established and stored version of the biometric information. Incorporating the above-described factors, a three-

factor authentication scheme may be based on what the user knows, i.e., the device password and the smart card password, what the user has, i.e., the smart card, and something that is unique to the user, e.g., a fingerprint. Accordingly, even if the smart card falls into the hands of a nefarious person who also gains knowledge of the device password and the smart card password, the lack of the correct biometric data should keep the nefarious person from gaining access to the computer of interest.

## GENERAL

**[0005]** By providing a biometric candidate to a biometric input device, a user may cause a computing device to be unlocked and cause a specific application to be launched on the computing device. The biometric input device may be on the computing device or on a peripheral security device that is in communication with the computing device. Indeed, the specific application may be launched pre-loaded with certain data, selection of which data is controlled by the particular biometric provided to the biometric input device.

**[0006]** According to one aspect described herein, there may be provided a method of launching applications on a computing apparatus. The method may comprise receiving a biometric candidate, determining that the biometric candidate matches a stored biometric template and that the stored biometric template is associated with an application, determining that the stored biometric template is associated with unlocking the computing apparatus, unlocking said computing apparatus and launching execution of the application.

**[0007]** The biometric candidate may comprise a fingerprint candidate and wherein said stored biometric template comprises a stored fingerprint template.

**[0008]** The stored biometric template may be associated with data for loading into said application upon launching said application.

**[0009]** The application may comprise a web browsing application and said data may comprise a Uniform Resource Locator.

**[0010]** The application may comprise a telephone application and said data may comprise a directory number.

**[0011]** The application may comprise an electronic message composition application and said data comprises an e-mail address.

**[0012]** The application may comprise a Short Message Service message composition application and said data may comprise a directory number.

**[0013]** Receiving said biometric candidate may comprise receiving said biometric candidate from a peripheral device.

**[0014]** The peripheral device may comprise a smart card reader.

**[0015]** The method may further comprise: presenting an unlock dialog; receiving a candidate device password, wherein said device password is associated with said computing apparatus; and determining that said candi-



date device password matches a stored device password.

**[0016]** The method may further comprise only unlocking said computing apparatus subsequent to: receiving a candidate smart card password, wherein said smart card password is associated with a smart card communicably coupled to said peripheral device; and determining that said candidate smart card password matches a stored smart card password.

**[0017]** In other aspects of the present application, an apparatus may be provided for carrying out this method and a computer readable medium is provided for adapting a processor to carry out this method.

**[0018]** The computing apparatus may further comprise a short-range communication subsystem adapted to receive said biometric candidate from a peripheral device and pass said biometric candidate to said processor.

**[0019]** The peripheral device may comprise a smart card reader.

**[0020]** The computing apparatus may further comprise a biometric input device adapted to receive said biometric candidate and pass said biometric candidate to said processor.

**[0021]** The biometric input device may comprise a fingerprint sensor and wherein said stored biometric template comprises a stored fingerprint template.

**[0022]** Other aspects and features of the present invention will become apparent to those of ordinary skill in the art upon review of the following description of specific embodiments of the invention in conjunction with the accompanying figures.

#### BRIEF DESCRIPTION OF THE DRAWINGS

**[0023]** Reference will now be made to the drawings, which show by way of example, embodiments of the invention, and in which:

**[0024]** FIG. 1 shows in block diagram form a communication system suitable for a smart card reader and mobile communication device in accordance with one embodiment;

**[0025]** FIG. 2 shows an operational block representation of the mobile communication device of FIG. 1 according to one embodiment;

**[0026]** FIG. 3 shows an operational block representation of an embodiment of the smart card reader of FIG. 1;

**[0027]** FIG. 4 illustrates steps in an example method of maintaining secure access to the mobile communication device of FIG. 1;

**[0028]** FIG. 5 illustrates steps in an example method of launching execution of an application on the mobile communication device of FIG. 1 through the provision of biometric data and passwords according to an embodiment; and

**[0029]** FIG. 6 illustrates steps in an example method of launching execution of an application on the mobile communication device of FIG. 1 through the provision of biometric data according to another embodiment.

#### DESCRIPTION OF PREFERRED EMBODIMENTS

**[0030]** While three-factor authentication is secure, three-factor authentication may be considered time consuming to employ every time access to the computer of interest is desired. It is clear that any gains in efficiency in accomplishing the task for which access to the computer is desired would be welcome.

**[0031]** Reference is first made to FIG. 1, which shows an illustrative communication system 100 to which embodiments described herein can be applied. The system 100 includes one or more mobile communication devices 102 (only one of which is shown in FIG. 1) that are enabled to communicate with one or more wireless networks 104 (only one of which is shown in FIG. 1). In other embodiments, the mobile communication devices 102 may be replaced by or augmented with desktop personal computers, notebook computers, palmtop computers, etc. The wireless network 104 may be implemented as a packet-based cellular wide area wireless network that includes a number of base stations each providing wireless Radio Frequency (RF) coverage to a corresponding area or cell. In some embodiments, instead of, or in addition to, a wide area wireless network, the wireless network 104 may include a local wireless area network, such as for example a wireless local area network that conforms to Institute of Electrical and Electronics Engineers (IEEE) 802.11 standards such as 802.11b and/or 802.11g. In at least some example embodiments, the wireless network 104 is connected to one or more enterprise networks 106 (only one of which is shown in FIG. 1). The connection between the wireless network 104 and the enterprise network 106 may involve an intermediate communications link 108, which may pass through additional networks including, for example, the Internet. The enterprise network 106 may be associated with the illustrated mobile device 102, such that the mobile device 102 is enabled to exchange electronic messages and other information with the enterprise network 106. Optionally, the mobile device 102 may be associated with a secondary mobile device in the form of a smart card reader 110. Additionally, a user of the mobile device 102 and the smart card reader 110 is likely to have access to a personal computer 112 that is connected to the enterprise network 106 over a communications link 114. In one embodiment, the communications link 114 is a local area network or wide area network providing organizational connectivity with the enterprise network 106. The smart card reader 110 may also be used with the personal computer 112, through either a wired or wireless connection.

**[0032]** FIG. 2 illustrates the mobile communication device 102 as an example of a device that may be employed in the illustrative communication system 100 of FIG. 1. The mobile communication device 102 includes a housing, an input device (e.g., a keyboard 224 having a plurality of keys) and an output device (a display 226), which may be a full graphic, or full color, Liquid Crystal Display

(LCD). Other types of output devices may alternatively be utilized. A processing device (a microprocessor 228) is shown schematically in FIG. 2 as coupled between the keyboard 224 and the display 226. The microprocessor 228 controls the operation of the display 226, as well as the overall operation of the mobile communication device 102, in part, responsive to actuation of the keys on the keyboard 224 by a user. Notably, the keyboard 224 may comprise physical buttons (keys) or, where the display 226 is a touchscreen device, the keyboard 224 may be implemented, at least in part, as "soft keys". Actuation of a so-called soft key involves either touching the display 226 where the soft key is displayed or actuating a physical button in proximity to an indication, on the display 226, of a temporary action associated with the physical button.

**[0033]** The housing may be elongated vertically, or may take on other sizes and shapes (including clamshell housing structures). Where the keyboard 224 includes keys that are associated with at least one alphabetic character and at least one numeric character, the keyboard 224 may include a mode selection key, or other hardware or software, for switching between alphabetic entry and numeric entry.

**[0034]** In addition to the microprocessor 228, other parts of the mobile communication device 102 are shown schematically in FIG. 2. These include: a communications subsystem 202; a short-range communications subsystem 204; the keyboard 224 and the display 226, along with other input/output devices including a set of auxiliary I/O devices 206, a serial port 208, a speaker 210 and a microphone 212; as well as memory devices including a flash memory 216 and a Random Access Memory (RAM) 218; and various other device subsystems 220. The mobile communication device 102 may be a two-way radio frequency (RF) communication device having voice and data communication capabilities. In addition, the mobile communication device 102 may have the capability to communicate with other computer systems via the Internet.

**[0035]** Operating system software executed by the microprocessor 228 may be stored in a computer readable medium, such as the flash memory 216, but may be stored in other types of memory devices, such as a read only memory (ROM) or similar storage element. In addition, system software, specific device applications, or parts thereof, may be temporarily loaded into a volatile store, such as the RAM 218. Communication signals received by the mobile device may also be stored to the RAM 218.

**[0036]** The microprocessor 228, in addition to its operating system functions, enables execution of software applications on the mobile communication device 102. Executable code for a predetermined set of software applications that control basic device operations, such as a voice communications module 230A and a data communications module 230B, may be installed on the mobile communication device 102 during manufacture. A security module 230C may also be installed on the mobile

communication device 102 during manufacture, to implement aspects of the present application. As well, additional software modules, illustrated as an other software module 230N, which may be, for instance, a PIM application, may be installed during manufacture. The PIM application may be capable of organizing and managing data items, such as e-mail messages, calendar events, voice mail messages, appointments and task items. The PIM application may also be capable of sending and receiving data items via the wireless network 104 represented by a radio tower. The data items managed by the PIM application may be seamlessly integrated, synchronized and updated via the wireless network 104 with the device user's corresponding data items stored or associated with a host computer system.

**[0037]** Communication functions, including data and voice communications, are performed through the communication subsystem 202 and, possibly, through the short-range communications subsystem 204. The communication subsystem 202 includes a receiver 250, a transmitter 252 and one or more antennas, illustrated as a receive antenna 254 and a transmit antenna 256. In addition, the communication subsystem 202 also includes a processing module, such as a digital signal processor (DSP) 258, and local oscillators (LOs) 260. The specific design and implementation of the communication subsystem 202 is dependent upon the communication network in which the mobile communication device 102 is intended to operate. For example, the communication subsystem 202 of the mobile communication device 102 may be designed to operate with the Mobitex™, DataTAC™ or General Packet Radio Service (GPRS) mobile data communication networks and also designed to operate with any of a variety of voice communication networks, such as Advanced Mobile Phone Service (AMPS), Time Division Multiple Access (TDMA), Code Division Multiple Access (CDMA), Personal Communications Service (PCS), Global System for Mobile Communications (GSM), Enhanced Data rates for GSM Evolution (EDGE), Universal Mobile Telecommunications System (UMTS), Wideband Code Division Multiple Access (W-CDMA), etc. Other types of data and voice networks, both separate and integrated, may also be utilized with the mobile communication device 102.

**[0038]** Network access requirements vary depending upon the type of communication system. Typically, an identifier is associated with each mobile device that uniquely identifies the mobile device or subscriber to which the mobile device has been assigned. The identifier is unique within a specific network or network technology. For example, in Mobitex™ networks, mobile devices are registered on the network using a Mobitex Access Number (MAN) associated with each device and in DataTAC™ networks, mobile devices are registered on the network using a Logical Link Identifier (LLI) associated with each device. In GPRS networks, however, network access is associated with a subscriber or user of a device. A GPRS device therefore uses a subscriber iden-

tivity module, commonly referred to as a Subscriber Identity Module (SIM) card, in order to operate on a GPRS network. Despite identifying a subscriber by SIM, mobile devices within GSM/GPRS networks are uniquely identified using an International Mobile Equipment Identity (IMEI) number.

**[0039]** When required network registration or activation procedures have been completed, the mobile communication device 102 may send and receive communication signals over the wireless network 104. Signals received from the wireless network 104 by the receive antenna 254 are routed to the receiver 250, which provides for signal amplification, frequency down conversion, filtering, channel selection, etc., and may also provide analog to digital conversion. Analog-to-digital conversion of the received signal allows the DSP 258 to perform more complex communication functions, such as demodulation and decoding. In a similar manner, signals to be transmitted to the wireless network 104 are processed (e.g., modulated and encoded) by the DSP 258 and are then provided to the transmitter 252 for digital to analog conversion, frequency up conversion, filtering, amplification and transmission to the wireless network 104 (or networks) via the transmit antenna 256.

**[0040]** In addition to processing communication signals, the DSP 258 provides for control of the receiver 250 and the transmitter 252. For example, gains applied to communication signals in the receiver 250 and the transmitter 252 may be adaptively controlled through automatic gain control algorithms implemented in the DSP 258.

**[0041]** In a data communication mode, a received signal, such as a text message or web page download, is processed by the communication subsystem 202 and is input to the microprocessor 228. The received signal is then further processed by the microprocessor 228 for output to the display 226, or alternatively to some auxiliary I/O devices 206. A device user may also compose data items, such as e-mail messages, using the keyboard 224 and/or some other auxiliary I/O device 206, such as a touchpad, a rocker switch, a thumb-wheel, a trackball, a touchscreen, or some other type of input device. The composed data items may then be transmitted over the wireless network 104 via the communication subsystem 202.

**[0042]** In a voice communication mode, overall operation of the device is substantially similar to the data communication mode, except that received signals are output to a speaker 210, and signals for transmission are generated by a microphone 212. Alternative voice or audio I/O subsystems, such as a voice message recording subsystem, may also be implemented on the mobile communication device 102. In addition, the display 226 may also be utilized in voice communication mode, for example, to display the identity of a calling party, the duration of a voice call, or other voice call related information.

**[0043]** The short-range communications subsystem 204 enables communication between the mobile com-

munication device 102 and other proximate systems or devices, which need not necessarily be similar devices. For example, the short-range communications subsystem 204 may include an infrared device and associated circuits and components, or a Bluetooth™ communication module to provide for communication with similarly-enabled systems and devices. For example, the smart card reader 110 may be enabled to communicate with the mobile device 102 by way of the short-range communications subsystem 204.

**[0044]** Reference is next made to FIG. 3, which shows, in greater detail, an example embodiment of a secondary mobile device, namely the smart card reader 110. The smart card reader 110 includes a controller including at least one microprocessor 310, which is suitably programmed to control the overall operation and functions of the smart card reader 110, and an output device (e.g., a display module 312). The smart card reader 110 further includes peripheral devices or subsystems such as a flash memory 314, a random access memory (RAM) 316, a serial port 318 (e.g., a USB port), a short-range communications subsystem 320 (e.g., an infrared transceiver, wireless bus protocol such as a Bluetooth system or any other means of local communications), a storage component interface 322 (e.g., for a memory card or any other data storage device), a user input device 324 (e.g., a push button), and a biometric information input device 325 (e.g., a fingerprint sensor).

**[0045]** A fingerprint sensor generally comprises an electronic device used to capture a digital image of a fingerprint pattern. The captured digital image is called a live scan. As part of configuring a fingerprint access system, a live scan may be digitally processed to create a biometric template, which is stored and used for later matching. A future live scan may be similarly digitally processed to create a biometric candidate in a format that facilitates matching with the previously captured and stored biometric template. Some of the more commonly used fingerprint sensor technologies include: optical; ultrasonic; and capacitance.

**[0046]** One example fingerprint sensor has a bar shape. A silicon sensor constructs a fingerprint as a user swipes a finger across the bar. Another example fingerprint sensor has a pad shape. A sensor constructs a fingerprint as a user holds a finger on the pad, which is designed with a size to accommodate an entire fingerprint.

**[0047]** The microprocessor 310 operates under stored program control with code or firmware being stored in the flash memory 314 (or other type of non-volatile memory device or devices). As depicted in FIG. 3, the stored programs include an operating system program or code module 326 and other programs or software applications indicated generally by reference 328. The operating system 326 of the smart card reader 110 further includes a memory card driver component 330. The memory card driver 330 is responsible for coordinating communications between the smart card reader 110 and a memory

card 334 and/or between the smart card reader 110 and related drivers of a device to be used in conjunction with the smart card reader 110, such as the drivers 244 of the personal computer 112. The operating system code 326, code for specific software applications 328, code for the memory card driver 330, or code components thereof, may be temporarily loaded into a volatile storage medium such as the RAM 316. Received communication signals and other data with information may also be stored in the RAM 316. Additionally, the storage component interface 322 receives the removable memory card 334, providing additional storage space for the smart card reader 110. In one embodiment, the memory card 334 may be a smart card similar to the smart cards known to those skilled in the art. The memory card 334 may include fingerprint authentication data, password or pin code related data, or other security related data. While operation of the smart card reader 110 is described using a smart card, it will be understood by those skilled in the art that the smart card reader 110 may be designed using any suitable form of removable media without departing from the intended scope of the smart card reader 110.

**[0048]** The stored program control (e.g., operating system 326, software applications 328) for the microprocessor 310 also includes a predetermined set of applications or code components or software modules that control basic device operations, for example, management and security related control of the data of the smart card reader 110 and may be installed on the smart card reader 110 as a component of the software applications 328 during the manufacturing process. Further applications may also be loaded (i.e., downloaded) onto the smart card reader 110 through the operation of the serial port 318, the operation of the short-range communications subsystem 320 or from the smart card 334. The downloaded code module or components are then installed by the user (or automatically) in the non-volatile program memory (e.g., the flash memory 314) or the RAM 316.

**[0049]** The serial port 318 may comprise a USB-type interface port for interfacing or synchronizing with another device, such as the personal computer 112 or the mobile device 102. The serial port 318 is used to exchange data with a device such as the personal computer 112 to be stored on the smart card 334 that is plugged into the storage component interface 322 of the smart card reader 110. The serial port 318 is also used to extend the capabilities of the smart card reader 110 by providing for information or software downloads, including any user interface information, to the smart card reader 110.

**[0050]** In various example embodiments, the short-range communications subsystem 320 provides an interface for communication between the smart card reader 110 and the personal computer 112 or the mobile device 102. In one embodiment, the short-range communications subsystem 320 includes an infrared communication link or channel. In another embodiment, the subsystem 320 comprises a wireless RF bus protocol such as a Bluetooth™ communications subsystem. However, the short-

range communications subsystem 320 may comprise any suitable local wireless means of communication, so long as the short range communications subsystem 320 of the personal computer 112 is chosen to operate using the same protocol, which may for example facilitate wireless communication between the personal computer 112 and the smart card reader 110. Any suitable communications mechanism and/or protocol may be implemented for the short range communications subsystems 320 and 204.

**[0051]** In information technology, biometric authentication refers to technologies that measure and analyze human physical and behavioral characteristics for authentication purposes. Examples of physical characteristics include fingerprints, eye retinas and irises, facial patterns and hand measurements, while examples of mostly behavioral characteristics include signature, gait and typing patterns. Voice is considered a mix of both physical and behavioral characteristics. However, it can be argued that all biometric traits share physical and behavioral aspects.

**[0052]** The use of a biometric authentication system begins with the collection and storage of template biometrics from potential users of the biometric authentication system. At the time of desired authentication, the user inputs, to a device (or to a peripheral to the device), a "candidate" biometric. Matching algorithms are then used to compare previously stored template biometrics against the candidate biometric. In the case where the biometric is an image, an original image (template) may be directly compared with a candidate image. Alternatively, formation of the template involves identifying certain features of an original image. Once the features are identified, the template may be formed of location and orientation information for each of the features. Similarly, a candidate is formed by identifying certain features of a candidate image and, subsequently, the template is compared to the candidate.

**[0053]** In one application, biometric authentication may be used for authenticating the user of a mobile communication device.

**[0054]** In some enhanced security embodiments, in order for a user to use some or all of the functionality of the mobile device 102, the mobile device 102 must be in at least periodic communication with its associated smart card reader 110 through the mobile device short-range communications system 204 to receive authorization information stored on the memory card 334. The authorization information stored on the memory card 334 will typically include unique authentication information for a designated user of the mobile device 102, such as biometric templates and/or further authentication information such as passwords, etc. Such a configuration mitigates against unauthorized use when the mobile device 102 becomes separated (i.e., out of communications range) from the smart card reader 110 with which the mobile device 102 has been paired. According to example embodiments, in addition to providing enhanced se-

curity functionality, the smart card reader 110 is also used to backup data from the mobile device 100.

**[0055]** The auxiliary I/O devices 206 of the mobile device 102 may include "convenience keys". Such convenience keys may be positioned at specific locations about the housing of the mobile device 102. In operation, the convenience keys may each be mapped to a function. For instance, actuation of one convenience key may launch a web browsing application on the mobile device 102. Actuation of another convenience key may cause a menu to appear on the display 226, where the menu allows the user to select a notification profile different from the notification profile currently in use. As is known, a notification profile may be used to define a manner in which the mobile device 102 notifies the user of various events. The events may include an incoming telephone call, a recently received e-mail message, a recently received Short Messaging Service message, a recently received Instant Messaging message, an alert that an appointment time is imminent, a reminder of a due task, etc. One profile may be used in noisy environments and may be defined such that the user is alerted using a combination of loud noises and vibrations. Additionally, another profile may be used in quiet environments and may be defined such that a user is not alerted at all.

**[0056]** Through the use of convenience keys, execution of specific applications can be launched by a single action, e.g., a key press on a convenience key, rather than a series of actions, e.g., an actuation to bring up the display of a menu, an actuation to scroll through the menu to find a menu item associated with the desired application and a further actuation to select the desired application.

**[0057]** Many people opt for a holster to hold the handheld computing device in a manner that allows the handheld computing device and holster combination to be attached to a belt around the waist of the user or attached to the outside of a bag.

**[0058]** Typical components of a handheld computing device include an output device, such as a display screen, an input device, such as a keypad, and a battery, to allow operation away from fixed power sources. To minimize power use, many handheld computing devices have been designed to sense the suspension of user activity on the handheld computing device. Optionally, a handheld computing device may sense the presence of a corresponding holster and, responsive to sensing the close proximity of the holster, enter into a user-inactive mode. Entering the user-inactive mode may be defined to include disabling the display.

**[0059]** In one example, the holster is provided with a magnet. The corresponding handheld computing device is provided with a Hall Effect sensor in a position that corresponds, when the handheld computing device is in the holster, to the location of the magnet in the holster. When the handheld computing device is placed in the holster, the magnet is sensed by the Hall Effect sensor and the handheld computing device enters into the user-

inactive mode.

**[0060]** Furthermore, the device may enter into the user-inactive mode after a period of inactivity. In addition to the device automatically entering into the user-inactive mode, the user may specifically select a menu item on the device to enter into the user-inactive mode, i.e., to lock the device.

**[0061]** Upon retrieving the mobile device 102 from the holster and finding that the mobile device 102 is locked, the user will typically want to unlock the mobile device 102. Unlocking the mobile device 102 may be as straightforward as using one of the auxiliary I/O devices 206 to cause a dialog to be shown on the display 226. The user may then select an "unlock" menu item on the dialog. In the simplest case, the mobile device 102 simply unlocks responsive to receiving selection of the unlock menu item on the dialog. However, the user may prefer a degree of security and may configure the mobile device 102 to require a password before unlocking.

**[0062]** For an even higher degree of security, the user may configure the mobile device 102 to use the smart card reader 110. To unlock the mobile device 102, the user may have to provide a correct device password and a correct smart card password. Even further, biometric authentication may also be required to gain access to the mobile device 102. Steps in an example method of maintaining secure access to the mobile device 102 are illustrated in FIG. 4.

**[0063]** The microprocessor 228 of the mobile device 102 may initially receive (step 402) an "unlock" command, for instance, from the user selecting the unlock menu item from the dialog that is displayed on the mobile device 102 when locked. Responsive to receiving the unlock command, the microprocessor 228 arranges for the presentation of an unlock dialog (step 404) on the display 226 to prompt the user to enter authentication factors, such as a device password and/or a smart card password. Optionally, responsive to being presented with the unlock dialog, the user may enter a device password in a device password field of the unlock dialog and may enter a smart card password in a smart card field of the unlock dialog. The user may, for example, submit the entered information by, for example, actuating an "enter" key on the keyboard 224 or by actuating one of the auxiliary I/O devices 206 to cause a menu to appear on the display 226 and further indicating using the auxiliary I/O device 206 selection of a submit menu item.

**[0064]** Responsive to the submission of the passwords, the microprocessor 228 then receives (step 406) the device password and receives (step 408) the smart card password.

**[0065]** The microprocessor 228 verifies (step 410) the device password. That is, the microprocessor 228 compares the received device password to a stored device password. If a match is found between the two passwords, the microprocessor 228 verifies (step 412) the smart card password. That is, the microprocessor 228 compares the received smart card password to a stored

smart card password. If a match is found between the two passwords, the microprocessor 228 presents (step 416) a dialog on the display 226 to prompt the user to provide a fingerprint candidate. The term "fingerprint" is used hereinafter to refer to both the physical print on a finger and the digitally processed biometric candidate that is formed based on a digital image captured by the fingerprint sensor 325. As should be understood by a person of ordinary skill, the fingerprint is used herein as a non-limiting example of biometric data.

**[0066]** If no match is found between the received device password and the stored device password, the microprocessor 228 presents (step 414) a password verification failure dialog and returns to step 404 to present the unlock dialog. Similarly, if no match is found between the received smart card password and the stored smart card password, the microprocessor 228 presents (step 414) the password verification failure dialog and returns to step 404 to present the unlock dialog.

**[0067]** Responsive to being prompted (step 416) to provide a fingerprint, it is expected that the user will provide a fingerprint to the fingerprint sensor 325 (see FIG. 3) on the smart card reader 110. Once the fingerprint sensor 325 has formed a fingerprint candidate from the presented fingerprint, the smart card reader 110 transmits the fingerprint candidate to the mobile device 102 over the communication link between the devices. Notably, there may be security configurations for which smart card-based authentication is unnecessary and wherein a fingerprint sensor (or other biometric input device) is integral to the mobile device 102. Accordingly, responsive to being prompted (step 416) to provide a fingerprint, it would be expected that the user will provide a fingerprint to a fingerprint sensor on the mobile device 102 (configuration not shown).

**[0068]** Upon receiving (step 418) the fingerprint candidate from the smart card reader 110, the microprocessor 228 verifies (step 420) the fingerprint candidate. Notably, receiving (step 418) the fingerprint candidate from the smart card reader 110 may involve the short-range communication subsystem 204 receiving the fingerprint candidate from the smart card reader 110 and the microprocessor 228 receiving the fingerprint candidate from the short-range communication subsystem 204. Alternatively, in an embodiment that may not require the smart card 334 or the smart card reader 110, the microprocessor 228 may receive (step 418) the fingerprint candidate from a fingerprint sensor (not shown) on the mobile device 102. During the verification, if the fingerprint candidate matches a stored fingerprint template associated with unlocking the mobile device 102, the microprocessor 228 unlocks (step 422) the mobile device 102. However, if the fingerprint candidate does not match the stored fingerprint template associated with unlocking the mobile device 102, the microprocessor 228 presents (step 424) a fingerprint verification failure dialog and returns to step 416 to present the prompt to the user to provide a fingerprint.

**[0069]** In overview, a user may associate a specific application with a stored fingerprint template such that the specific application may be launched, if not already executing, on the mobile device 102 responsive to provision of fingerprint to the fingerprint sensor 325 on the smart card reader 110. Indeed, the specific application may be launched pre-loaded with certain data, selection of which data is controlled by the particular fingerprint provided to the fingerprint sensor 325.

**[0070]** In view of FIG. 5, consider that the mobile device 102 is in a locked state with a previously established pairing with the smart card reader 110. Initially, the user provides a fingerprint to the fingerprint sensor 325 on the smart card reader 110. Upon obtaining a live scan from the fingerprint sensor 325, the microprocessor 310 of the smart card reader 110 processes the live scan to produce a fingerprint candidate and arranges a transfer of the fingerprint candidate to the mobile device 102 using the short-range communication subsystem 320.

**[0071]** Upon receiving (step 502) the fingerprint candidate from the smart card reader 110, the microprocessor 228 verifies (step 504) the fingerprint candidate. Alternatively, in an embodiment that may not require the smart card 334 or the smart card reader 110, the microprocessor 228 may receive (step 502) the fingerprint candidate from a fingerprint sensor (not shown) on the mobile device 102. During the verification, the microprocessor 228 may determine that the fingerprint candidate matches a stored fingerprint template and that the stored fingerprint template is associated with initiating the unlocking of the mobile device 102. The microprocessor 228 may also determine that the fingerprint template is associated with an application. Responsive to determining that the stored fingerprint template is associated with initiating the unlocking of the mobile device 102, the microprocessor 228 arranges the presentation of an unlock dialog (step 510) on the display 226 to prompt the user to enter a device password and a smart card password.

**[0072]** However, if the fingerprint candidate does not match any stored fingerprint templates, the microprocessor 228 arranges (step 506) the presentation of a fingerprint verification failure dialog, arranges (step 508) the presentation of a dialog on the display 226 to prompt the user to provide a fingerprint and returns to step 502.

**[0073]** In one embodiment, responsive to being presented with the unlock dialog, the user will enter a device password in a device password field of the unlock dialog and/or enter a smart card password in a smart card field of the unlock dialog. The user may then submit the entered information by, for example, actuating an "enter" key on the keyboard 224 or by actuating one of the auxiliary I/O devices 206 to cause a menu to appear on the display 226 and further indicating using the auxiliary I/O device 206 selection of a submit menu item.

**[0074]** In an embodiment wherein both passwords are used as authentication factors, responsive to the submission of the passwords, the microprocessor 228 then receives (step 512) the device password and receives

(step 514) the smart card password.

**[0075]** Notably, the user may have a limited time (e.g., 30 seconds) to complete provision of the device password and the smart card password before the mobile device 102 reverts to a locked state.

**[0076]** The microprocessor 228 verifies (step 516) the device password. That is, the microprocessor 228 compares the received device password to a stored device password. If a match is found between the two passwords, the microprocessor 228 verifies (step 518) the smart card password. That is, the microprocessor 228 compares the received smart card password to a stored smart card password. If a match is found between the two passwords, the microprocessor 228 unlocks (step 520) the mobile device 102. Alternatively, the microprocessor 228 may transmit the received smart card password to the smart card reader 110 for authentication either by the smart card reader 110 or for authentication by the smart card 334.

**[0077]** Advantageously, it may be that the user has previously configured the mobile device 102 such that the particular fingerprint template associated with initiating the unlocking of the mobile device 102 is also associated with another action including, without limitation, launching an application. In such a case, subsequent to unlocking (step 520) the microprocessor 228 launches (step 522) the associated application.

**[0078]** If no match is found between the received device password and the stored device password, the microprocessor 228 arranges (step 524) the presentation of a password verification failure dialog and returns to step 510 to present the unlock dialog. Similarly, if no match is found between the received smart card password and the stored smart card password, the microprocessor 228 arranges (step 524) the presentation of the password verification failure dialog and returns to step 510 to present the unlock dialog.

**[0079]** It has been discussed hereinbefore that, through the use of convenience keys, execution of specific applications can be launched by a single action (e.g., a key press on the keyboard 224) rather than a series of actions. Similarly, initiating unlocking of the mobile device 102 and the execution of a specific application can be launched in step 522 by a single action, where that action is the provision of a fingerprint to the fingerprint sensor 325 on the smart card reader 110.

**[0080]** The variety available for the application to be associated with the fingerprint template and, accordingly, the application to be launched in step 522 is limited only by the applications resident on the mobile device 102. The fingerprint template formed from a live scan of the right index finger may, for example, be associated with an internet browsing application. Furthermore, the same user finger may produce distinct fingerprint templates based on the manner in which the finger is passed over the fingerprint sensor 325. That is, a top-to-bottom swipe across the fingerprint sensor 325, where the fingerprint sensor 325 is of the bar-shaped type, may produce a

fingerprint template distinct from a fingerprint template generated responsive to a bottom-to-top swipe across the fingerprint sensor 325 and may be associated with a distinct action. The pad type of fingerprint sensor 325 does not lend itself to such variation in fingerprint input strategies.

**[0081]** Beyond an association between a particular fingerprint template and a particular application, there may also be an association of specific data to be preloaded into the applications as the application launches. For instance, where the application is an internet browsing application, the application may be configured with specific data in the form of a Uniform Resource Locator (URL) of a particular page. For example, while the fingerprint template associated with the right index finger may be associated with the internet browsing application and an address of the user's home page, the fingerprint template associated with the right thumb print may be associated with the internet browsing application and an address of a weather forecasting page for the user's home city.

**[0082]** In operation, to, for example, obtain a weather forecast when the mobile device 102 is starting in the locked state, the user provides a right thumbprint to the fingerprint sensor 325 on the smart card reader 110 and provides the device password and smart card password when prompted. It is assumed in this example that the stored fingerprint template for right thumbprint is associated with both unlocking the device 102 and launching a browser application pre-loaded with a URL for a desired weather forecast.

**[0083]** Responsive to receiving (step 502) the fingerprint candidate, verifying (step 504) that the fingerprint candidate matches the fingerprint template associated with the right thumb, receiving (step 512) the device password, receiving (step 514) the smart card password, verifying (step 516) the device password and verifying (step 518) the smart card password, the microprocessor 228 unlocks (step 520) the mobile device 102 and launches (step 522) the browser application (see data communications module 230B, FIG. 2) preloaded with the URL for the desired weather forecast. The user need only to wait for the weather page to load and be shown on the display 226.

**[0084]** It should be understood that the right thumb print is only involved in unlocking the device if the fingerprint template associated with the right thumb has previously been associated with the unlock command. If the fingerprint template associated with the right thumb has not been associated with the unlock command and, instead, another fingerprint template has been associated with the unlock command, then the user would first swipe the "unlock" finger to unlock the mobile device 102. Accordingly, for this example, the order of operations would be, from the lock screen, user swipes right thumb, enters device password, enters smart card password and swipes unlock finger. Responsively, the mobile device 102 becomes unlocked and launches the browser application preloaded with the URL for the desired weather

forecast.

**[0085]** In a further embodiment, any of the fingers associated with launching an application may automatically be associated with unlocking the mobile device so that the user can just, for example, swipe the right thumb, enter the device password, enter the smart card password and watch as the desired application is automatically launched.

**[0086]** As should be clear to a person of ordinary skill in the art, the order in which various authentication factors are provided by the user should not be considered to be limited to the order in which the authentication factors are provided in the example embodiments presented herein. Indeed, many embodiments will only require a subset of the authentication factors discussed in this application.

**[0087]** Alternatively, where the mobile device 102 includes mobile telephone capabilities, specific fingerprint templates may be associated with the launch (in step 522) of a telephone application (see voice communications module 230A, FIG. 2). Again, specific data, this time, telephone directory numbers, may be associated with particular fingerprint templates. A fingerprint template associated with the user's left thumb may be associated with the telephone application and the user's home telephone directory number. In one embodiment, a particular fingerprint template may be associated with the most recently called directory number, whatever that directory number may be.

**[0088]** In operation, to, for example, place a call to the user's home telephone directory number when the mobile device 102 is starting in the locked state, the user provides a left thumbprint to the fingerprint sensor 325 on the smart card reader 110 and provides the device password and smart card password when prompted. It is assumed in this example that the stored fingerprint template for the left thumbprint is associated with both unlocking the device 102 and launching a telephone application pre-loaded with the user's home telephone directory number.

**[0089]** Responsive to receiving (step 502) the fingerprint candidate, verifying (step 504) that the fingerprint candidate matches a fingerprint template associated with the left thumb, receiving (step 512) the device password, receiving (step 514) the smart card password, verifying (step 516) the device password and verifying (step 518) the smart card password, the microprocessor 228 unlocks (step 520) the mobile device 102 and initiates (step 522) a telephone call to the user's home telephone directory number.

**[0090]** Further alternatively, where the mobile device 102 includes electronic messaging capabilities, specific fingerprints may be associated with the launch (in step 522) of, for one example, an e-mail message composition application or, for another example, a Short Messaging Service (SMS) message composition application. Again, specific data, this time, e-mail addresses or mobile telephone directory numbers, may be associated with par-

ticular fingerprint templates. A fingerprint template associated with the user's left ring finger may be associated with the e-mail message composition application and an e-mail address for the user's supervisor.

**[0091]** In operation, to, for example, send an e-mail message to the supervisor when the mobile device 102 is starting in the locked state, the user provides a left ring finger fingerprint to the fingerprint sensor 325 on the smart card reader 110 and provides the device password and smart card password when prompted. It is assumed in this example that the stored fingerprint template for the left ring finger is associated with both unlocking the device 102 and launching an e-mail application pre-loaded with the user's supervisor's e-mail address.

**[0092]** Responsive to receiving (step 502) the fingerprint candidate, verifying (step 504) that the fingerprint candidate matches a fingerprint template associated with the left ring finger, receiving (step 512) the device password, receiving (step 514) the smart card password, verifying (step 516) the device password and verifying (step 518) the smart card password, the microprocessor 228 unlocks (step 520) the mobile device 102 and launches (step 522) the e-mail message composition application, which application presents an e-mail composition screen on the display 226 with the e-mail address for the supervisor pre-loaded in the "To:" field. The user may then fill in the subject field and the body field and interact with the e-mail message composition application to initiate the transmission of the e-mail message.

**[0093]** Other example actions with corresponding applications that may be launched by way of embodiments of this application may include: the capturing of a digital photograph in a camera application; the determination and display of a current location in a mapping application; and the playing of an audio file or video file in a media player application.

**[0094]** There may be cases in which the mobile device 102 need not be unlocked to execute an application. In view of FIG. 6, consider that the mobile device 102 is in a locked state with a previously established pairing with the smart card reader 110. Initially, the user provides a fingerprint to the fingerprint sensor 325 on the smart card reader 110. Upon obtaining a live scan from the fingerprint sensor 325, the microprocessor 310 of the smart card reader 110 processes the live scan to form a fingerprint candidate and arranges a transfer of the fingerprint candidate to the mobile device 102 using the short-range communication subsystem 320.

**[0095]** Upon receiving (step 602) the fingerprint candidate from the smart card reader 110, the mobile device 102 verifies (step 604) the fingerprint candidate. During the verification, the microprocessor 228 may determine that the fingerprint candidate matches a fingerprint template and that the stored fingerprint template is associated with an application. Responsive to determining that the stored fingerprint template is associated with an application, the microprocessor 228 launches (step 610) the associated application.



**[0096]** However, if the fingerprint candidate does not match any fingerprint templates, the mobile device 102 presents (step 606) a fingerprint verification failure dialog, presents (step 608) a dialog on the display 226 to prompt the user to provide a fingerprint and returns to step 602.

**[0097]** In some embodiments, the applications selected for implementation using the method illustrated in FIG. 6 may be those that pose the lowest security risk to the mobile device 102. Indeed the mobile device 102 remains locked while executing the application. The telephone application is an example of a secure application that may be executed without verification of the device password and verification of the smart card password.

**[0098]** In operation, to place a call to the user's home telephone directory number when the mobile device 102 is starting in the locked state, the user provides a left thumbprint to the fingerprint sensor 325 on the smart card reader 110. Responsive to receiving (step 602) the fingerprint candidate and verifying (step 604) that the fingerprint candidate matches a fingerprint template associated with the left thumb, the mobile device 102 takes an action distinct from unlocking. The action may involve, without limitation, launching (step 610), if not already running, the telephone application and initiating a telephone call to the user's home telephone directory number.

**[0099]** Additionally, access to a notification profile change menu while the mobile device 102 is locked may be deemed not to be a security risk. To change the notification profile for the mobile device 102, then, the user provides a fingerprint to the fingerprint sensor 325 on the smart card reader 110 and, upon verification, the mobile device 102 provides the notification profile change menu on the display 226. Responsive to viewing the menu on the mobile device, the user may select one of the predetermined user profiles. It may further be that, in configuring the mobile device, the user has associated a particular fingerprint template with the most oft used notification profiles. For example, the fingerprint template associated with the right ring finger may be associated with a "Quiet" profile, for which no sounds or vibrations occur, and the fingerprint template associated with the right middle finger may be associated with a "Normal" profile.

**[0100]** In operation, the mobile device 102 may be in a locked state with a previously established pairing with the smart card reader 110. The user provides the fingerprint from the right ring finger. Responsive to receiving (step 602) the fingerprint candidate and verifying (step 604) that the fingerprint candidate matches the fingerprint template associated with the right ring finger, the mobile device 102 changes (step 610) the notification profile to the "Quiet" profile.

**[0101]** As will be clear to a person of ordinary skill in the art, while a fingerprint has been used as an example element of biometric data, other elements of biometric data may equally be used. However, there are downsides to for instance, using retinal scans instead of fingerprints. One disadvantage being that only two (one per eye) ap-

plications can be associated with retinal scans, where ten or more applications can be respectively associated with fingerprints.

**[0102]** Additionally, while the preceding has concentrated on implementation on a mobile communication device (mobile device 102), it should be clear to a person of ordinary skill that computing devices of other sizes and form factors also exist with security measures that involve a biometric input device. Accordingly, the subject matter described above could equally be applied to desktop computers and notebook computers, for example.

**[0103]** Furthermore, it should be clear to a person of ordinary skill that the biometric input device may be implemented in hardware on the device launching the applications. That is, the smart card reader 110 with integral biometric information input device 325 is optional if the mobile device 102 has a biometric information input device 325.

**[0104]** The above-described embodiments of the present application are intended to be examples only. Alterations, modifications and variations may be effected to the particular embodiments by those skilled in the art without departing from the scope of the application, which is defined by the claims appended hereto.

**Claims**

1. A method of launching applications on a computing apparatus (102), said method comprising:
  - receiving a biometric candidate;
  - determining that said biometric candidate matches a stored biometric template and that said stored biometric template is associated with an application;
  - determining that said stored biometric template is associated with unlocking said computing apparatus;
  - unlocking said computing apparatus; and
  - launching execution of said application.
2. The method of claim 1 wherein said biometric candidate comprises a fingerprint candidate and wherein said stored biometric template comprises a stored fingerprint template.
3. The method of claim 1 or claim 2 wherein said stored biometric template is associated with data for loading into said application upon launching said application.
4. The method of claim 3 wherein: said application comprises a web browsing application and said data comprises a Uniform Resource Locator; or said application comprises a telephone application and said data comprises a directory number; or said application comprises an electronic message composition application and said data comprises an e-mail ad-

dress; or said application comprises a Short Message Service message composition application and said data comprises a directory number.

5. The method of any one of claims 1 to 4 wherein said receiving said biometric candidate comprises receiving said biometric candidate from a peripheral device.

6. The method of claim 5 wherein said peripheral device comprises a smart card reader.

7. The method of claim 5 further comprising:

presenting an unlock dialog;  
receiving a candidate device password, wherein said device password is associated with said computing apparatus; and  
determining that said candidate device password matches a stored device password.

8. The method of claim 7 further comprising only unlocking said computing apparatus subsequent to:

receiving a candidate smart card password, wherein said smart card password is associated with a smart card communicably coupled to said peripheral device; and  
determining that said candidate smart card password matches a stored smart card password.

9. A computing apparatus (102) comprising:

a processor (228);  
a memory (216, 218) for storing:  
  
executable code for an application to be launched by said processor; and  
a biometric template;

said processor (228) being adapted to execute code for causing said computing apparatus (102) to implement the steps of the method of any one of claims 1 to 8.

10. The computing apparatus of claim 9 further comprising a short-range communication subsystem (204) adapted to receive said biometric candidate from a peripheral device (110) and pass said biometric candidate to said processor (228).

11. The computing apparatus of claim 10 wherein said peripheral device comprises a smart card reader (110).

12. The computing apparatus of claim 9 further compris-

ing a biometric input device (325) adapted to receive said biometric candidate and pass said biometric candidate to said processor (228).

13. The computing apparatus of claim 12 wherein said biometric input device comprises a fingerprint sensor (325) and wherein said stored biometric template comprises a stored fingerprint template.

14. A computer readable medium (216, 218) containing computer-executable instructions that, when performed by a processor (228), cause said processor to perform the steps of the method of any one of claims 1 to 8..

5  
10  
15  
20  
25  
30  
35  
40  
45  
50  
55

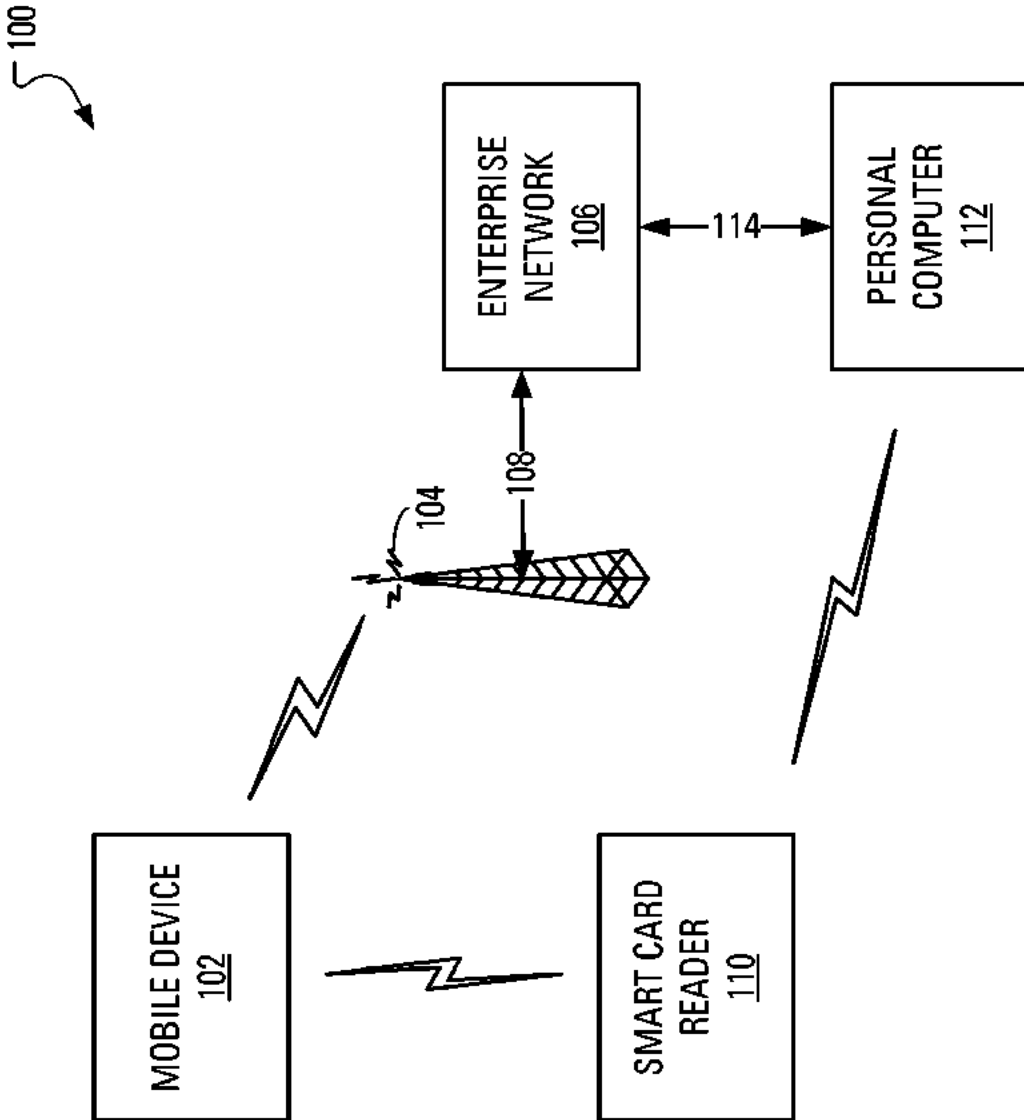


FIG. 1

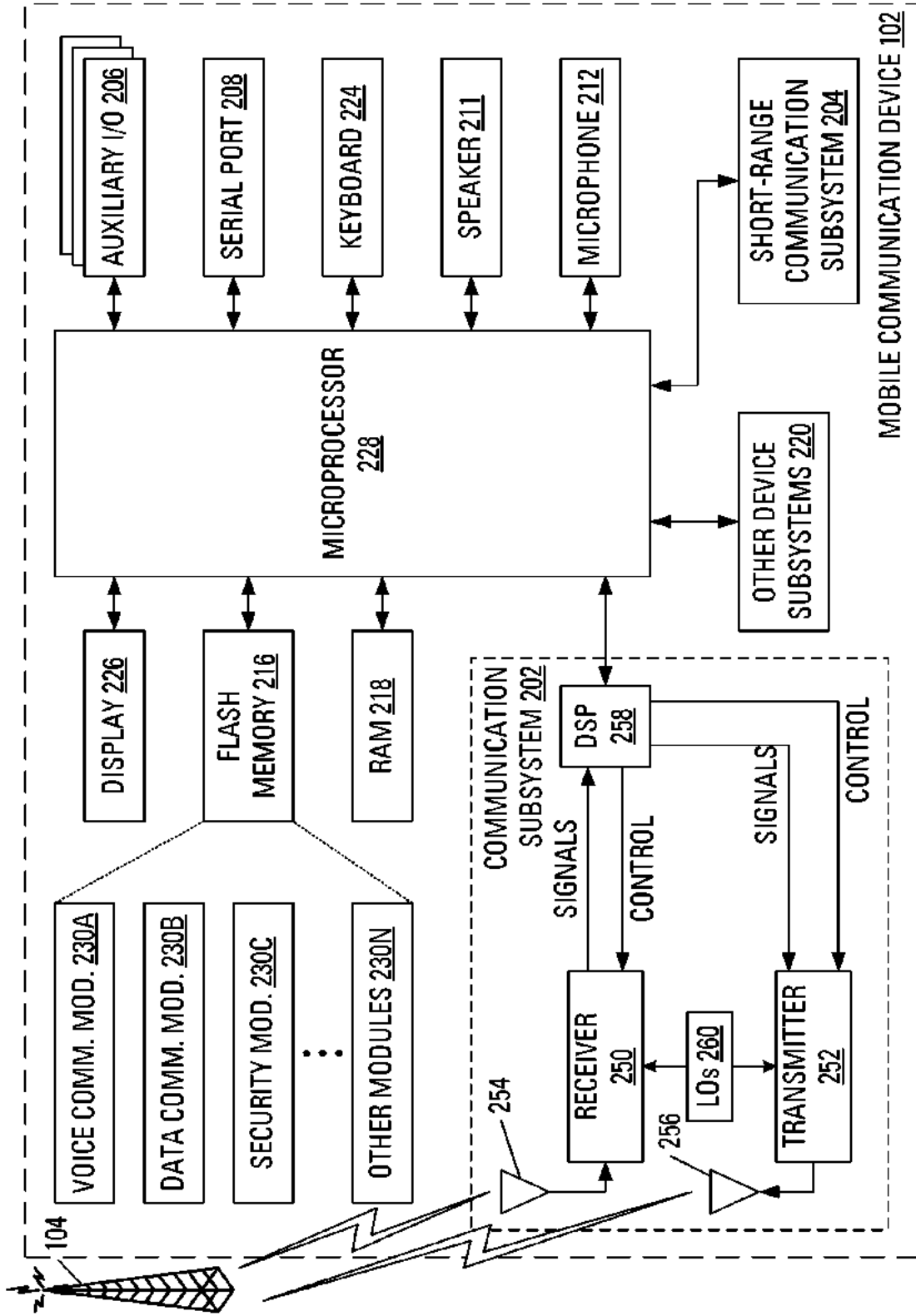


FIG. 2

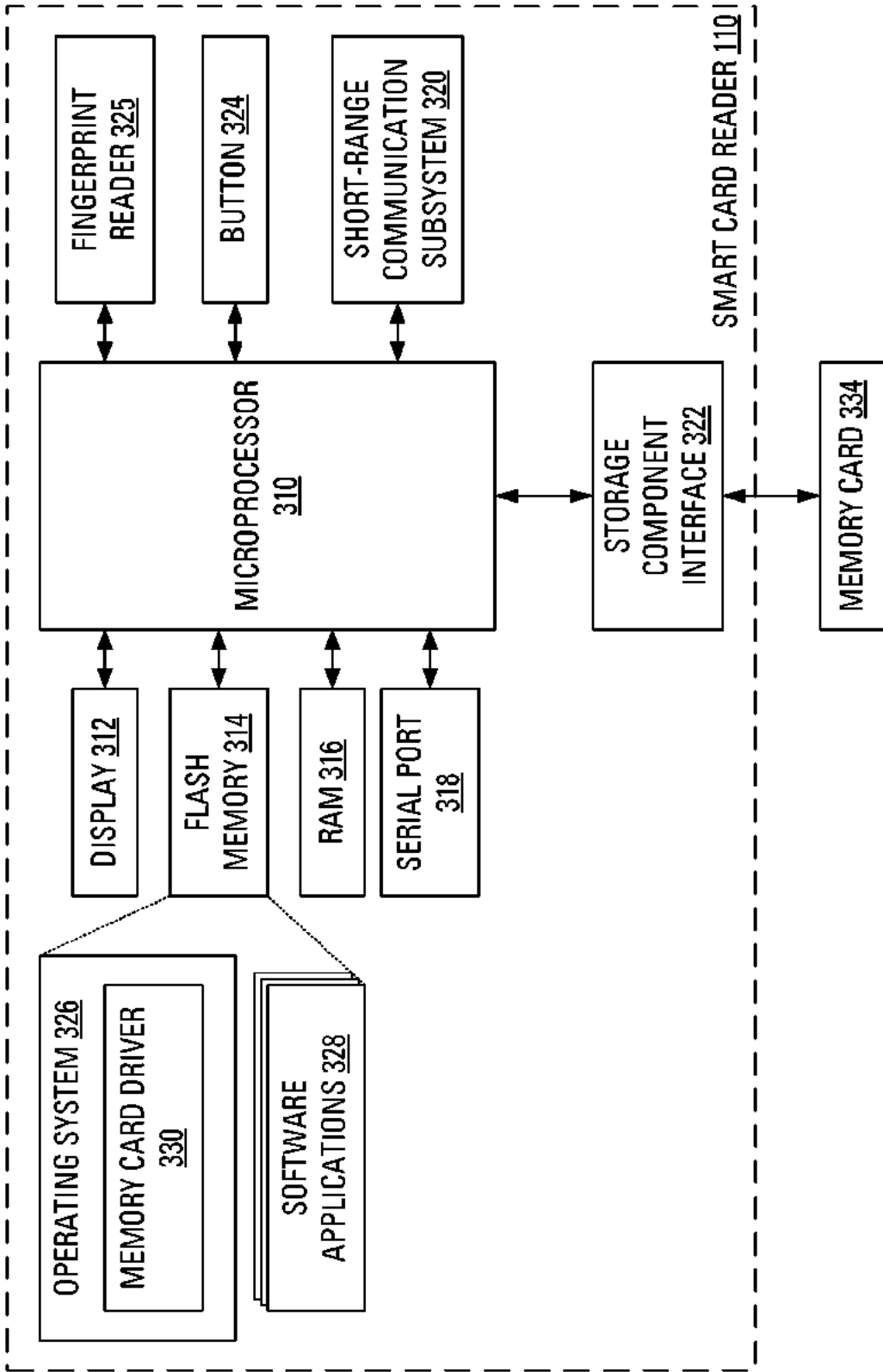


FIG. 3

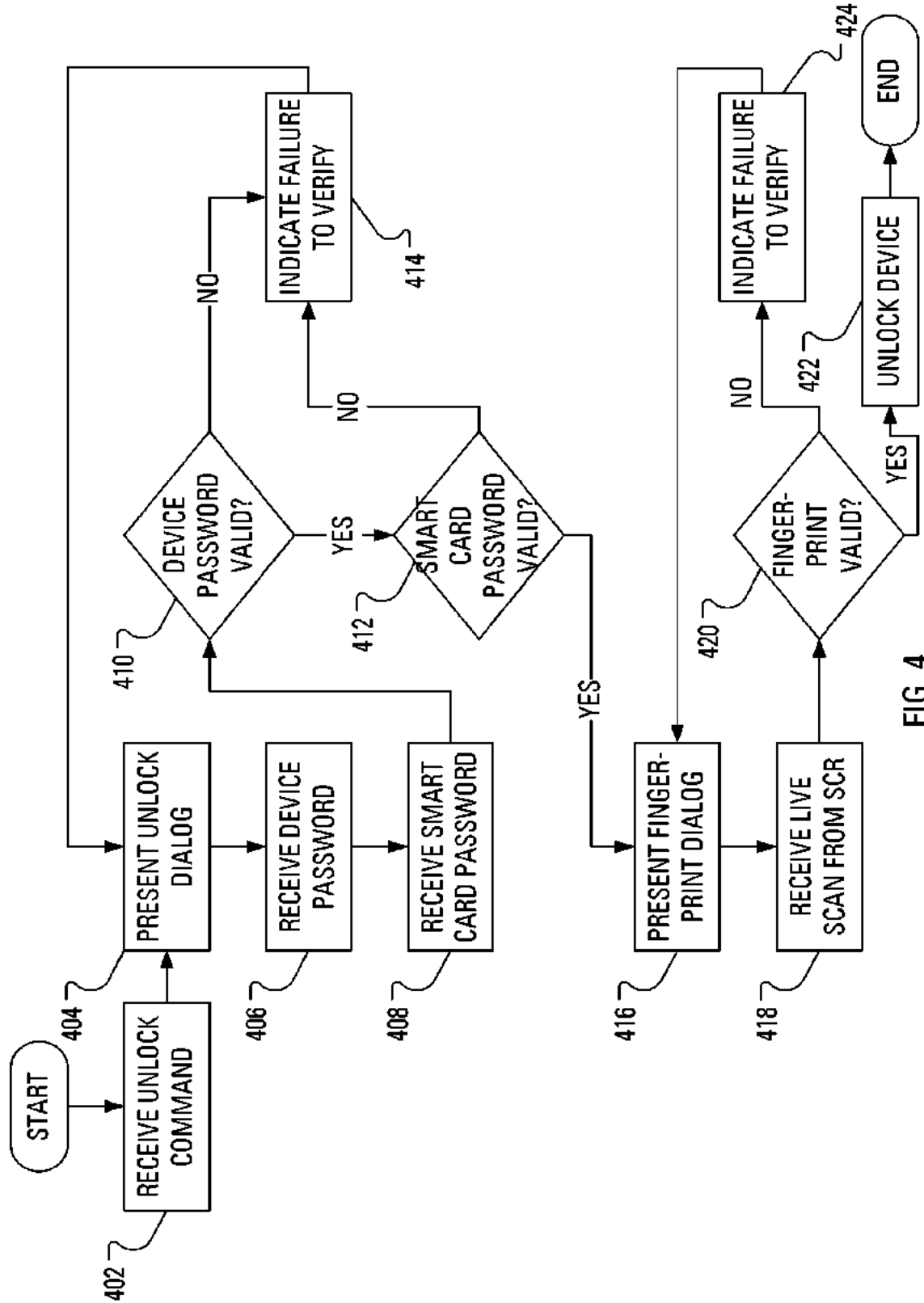


FIG. 4

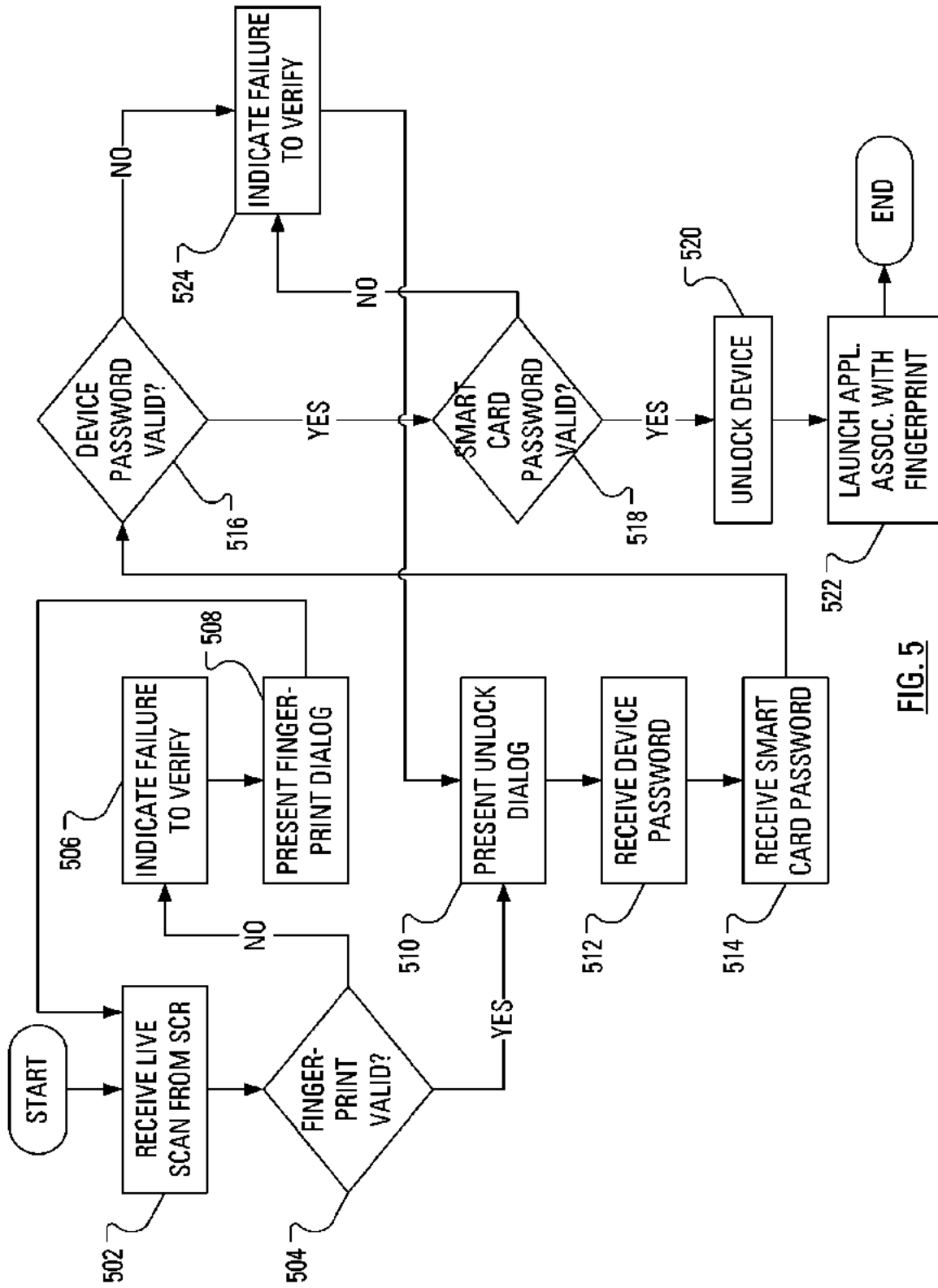


FIG. 5

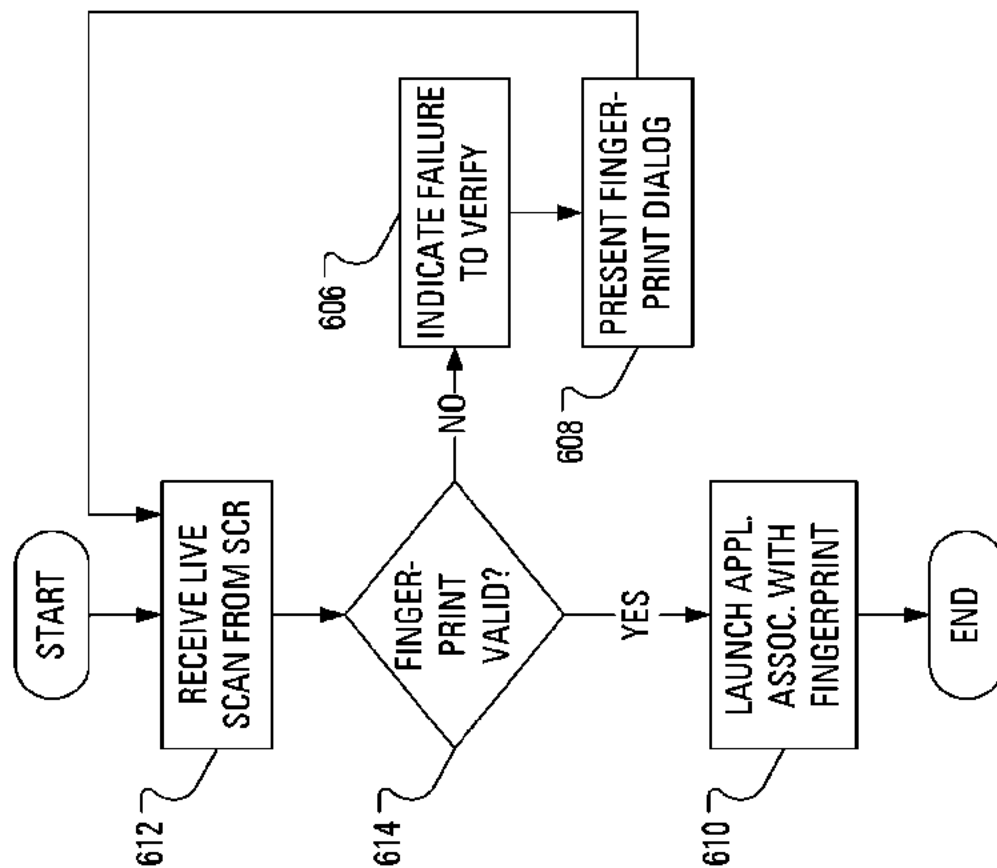


FIG. 6





EUROPEAN SEARCH REPORT

Application Number  
EP 08 17 0378

DOCUMENTS CONSIDERED TO BE RELEVANT				
Category	Citation of document with indication, where appropriate, of relevant passages	Relevant to claim	CLASSIFICATION OF THE APPLICATION (IPC)	
X	US 2005/039027 A1 (SHAPIRO MICHAEL F [US]) 17 February 2005 (2005-02-17) * paragraph [0015] - paragraph [0023]; figures 1,2,5 *	1-14	INV. G06F21/20	
X	US 2006/031289 A1 (EXPERTON BETTINA [US]) 9 February 2006 (2006-02-09) * paragraph [0009] - paragraph [0068]; figure 3 *	1-14		
X	US 2008/016371 A1 (JIANG YUAN-LIN [TW] ET AL) 17 January 2008 (2008-01-17) * abstract *	1-3,9, 10,14		
X	US 6 721 891 B1 (BORZA STEPHEN J [CA]) 13 April 2004 (2004-04-13) * column 5, line 35 - column 11, line 20; figure 5 *	1,2,5-7, 9-14		
X	US 2006/288182 A1 (CHOU BRUCE C S [TW] ET AL) 21 December 2006 (2006-12-21) * paragraph [0032] - paragraph [0076] *	1,2,5-7, 9-14		TECHNICAL FIELDS SEARCHED (IPC)
X	US 6 070 796 A (SIRBU CORNEL [FR]) 6 June 2000 (2000-06-06) * column 4, line 60 - column 8, line 45 *	1,2,5,6, 9-14		G06F
X	US 2007/195998 A1 (LE SAINT ERIC F [US] ET AL) 23 August 2007 (2007-08-23) * abstract *	1,2,5,6, 9-14		
The present search report has been drawn up for all claims				
Place of search <b>Munich</b>		Date of completion of the search <b>30 June 2009</b>	Examiner <b>Jascau, Adrian</b>	
<p>CATEGORY OF CITED DOCUMENTS</p> <p>X: particularly relevant if taken alone Y: particularly relevant if combined with another document of the same category A: technological background O: non-written disclosure F: intermediate document</p> <p>T: theory or principle underlying the invention E: earlier patent document, but published on, or after the filing date D: document cited in the application L: document cited for other reasons &amp;: member of the same patent family, corresponding document</p>				

EPC FORM 1506 (02.02.2004)

**ANNEX TO THE EUROPEAN SEARCH REPORT  
ON EUROPEAN PATENT APPLICATION NO.**

EP 08 17 0378

This annex lists the patent family members relating to the patent documents cited in the above-mentioned European search report. The members are as contained in the European Patent Office EDP file on  
The European Patent Office is in no way liable for these particulars which are merely given for the purpose of information.

30-06-2009

Patent document cited in search report	Publication date	Patent family member(s)	Publication date
US 2005039027 A1	17-02-2005	US 2008148059 A1	19-06-2008
US 2006031289 A1	09-02-2006	NONE	
US 2008016371 A1	17-01-2008	NONE	
US 6721891 B1	13-04-2004	NONE	
US 2006288182 A1	21-12-2006	JP 2006338670 A TW 265442 B	14-12-2006 01-11-2006
US 6070796 A	06-06-2000	AT 217103 T AU 720839 B2 AU 6824096 A BG 63764 B1 BG 102336 A BR 9610236 A CA 2230150 A1 CN 1194043 A CZ 9800408 A3 DE 69621042 D1 DE 69621042 T2 DK 870222 T3 EP 0870222 A2 ES 2176481 T3 WO 9707448 A2 HU 9900499 A2 JP 11511278 T JP 2007305144 A NO 980728 A NZ 503211 A PL 325164 A1 PT 870222 E RO 118910 B1 SK 22098 A3 TR 9800267 T2	15-05-2002 15-06-2000 12-03-1997 29-11-2002 30-12-1998 15-06-1999 27-02-1997 23-09-1998 16-12-1998 06-06-2002 22-05-2003 26-08-2002 14-10-1998 01-12-2002 27-02-1997 28-06-1999 28-09-1999 22-11-2007 20-04-1998 21-12-2001 06-07-1998 31-10-2002 30-12-2003 07-10-1998 21-07-1998
US 2007195998 A1	23-08-2007	NONE	

EPO/CPM/PMTS

For more details about this annex : see Official Journal of the European Patent Office, No. 12/82



NOTICE OF ALLOWANCE AND FEE(S) DUE

20995 7590 07/27/2017  
KNOBBE MARTENS OLSON & BEAR LLP  
2040 MAIN STREET  
FOURTEENTH FLOOR  
IRVINE, CA 92614

EXAMINER	
SHEDRICK, CHARLES TERRELL	
ART UNIT	PAPER NUMBER

2646

DATE MAILED: 07/27/2017

APPLICATION NO.	FILING DATE	FIRST NAMED INVENTOR	ATTORNEY DOCKET NO.	CONFIRMATION NO.
-----------------	-------------	----------------------	---------------------	------------------

14/848,191 09/08/2015 Jae Lark JUNG UNIS005.001C2 9599

TITLE OF INVENTION: ACTIVATING DISPLAY AND PERFORMING USER AUTHENTICATION IN MOBILE TERMINAL WITH ONE-TIME USER INPUT

APPLN. TYPE	ENTITY STATUS	ISSUE FEE DUE	PUBLICATION FEE DUE	PREV. PAID ISSUE FEE	TOTAL FEE(S) DUE	DATE DUE
-------------	---------------	---------------	---------------------	----------------------	------------------	----------

nonprovisional SMALL \$480 \$0 \$0 \$480 10/27/2017

THE APPLICATION IDENTIFIED ABOVE HAS BEEN EXAMINED AND IS ALLOWED FOR ISSUANCE AS A PATENT. PROSECUTION ON THE MERITS IS CLOSED. THIS NOTICE OF ALLOWANCE IS NOT A GRANT OF PATENT RIGHTS. THIS APPLICATION IS SUBJECT TO WITHDRAWAL FROM ISSUE AT THE INITIATIVE OF THE OFFICE OR UPON PETITION BY THE APPLICANT. SEE 37 CFR 1.313 AND MPEP 1308.

THE ISSUE FEE AND PUBLICATION FEE (IF REQUIRED) MUST BE PAID WITHIN THREE MONTHS FROM THE MAILING DATE OF THIS NOTICE OR THIS APPLICATION SHALL BE REGARDED AS ABANDONED. THIS STATUTORY PERIOD CANNOT BE EXTENDED. SEE 35 U.S.C. 151. THE ISSUE FEE DUE INDICATED ABOVE DOES NOT REFLECT A CREDIT FOR ANY PREVIOUSLY PAID ISSUE FEE IN THIS APPLICATION. IF AN ISSUE FEE HAS PREVIOUSLY BEEN PAID IN THIS APPLICATION (AS SHOWN ABOVE), THE RETURN OF PART B OF THIS FORM WILL BE CONSIDERED A REQUEST TO REAPPLY THE PREVIOUSLY PAID ISSUE FEE TOWARD THE ISSUE FEE NOW DUE.

HOW TO REPLY TO THIS NOTICE:

I. Review the ENTITY STATUS shown above. If the ENTITY STATUS is shown as SMALL or MICRO, verify whether entitlement to that entity status still applies.

If the ENTITY STATUS is the same as shown above, pay the TOTAL FEE(S) DUE shown above.

If the ENTITY STATUS is changed from that shown above, on PART B - FEE(S) TRANSMITTAL, complete section number 5 titled "Change in Entity Status (from status indicated above)".

For purposes of this notice, small entity fees are 1/2 the amount of undiscounted fees, and micro entity fees are 1/2 the amount of small entity fees.

II. PART B - FEE(S) TRANSMITTAL, or its equivalent, must be completed and returned to the United States Patent and Trademark Office (USPTO) with your ISSUE FEE and PUBLICATION FEE (if required). If you are charging the fee(s) to your deposit account, section "4b" of Part B - Fee(s) Transmittal should be completed and an extra copy of the form should be submitted. If an equivalent of Part B is filed, a request to reapply a previously paid issue fee must be clearly made, and delays in processing may occur due to the difficulty in recognizing the paper as an equivalent of Part B.

III. All communications regarding this application must give the application number. Please direct all communications prior to issuance to Mail Stop ISSUE FEE unless advised to the contrary.

IMPORTANT REMINDER: Utility patents issuing on applications filed on or after Dec. 12, 1980 may require payment of maintenance fees. It is patentee's responsibility to ensure timely payment of maintenance fees when due.

**PART B - FEE(S) TRANSMITTAL**

**Complete and send this form, together with applicable fee(s), to: Mail Mail Stop ISSUE FEE  
 Commissioner for Patents  
 P.O. Box 1450  
 Alexandria, Virginia 22313-1450  
 or Fax (571)-273-2885**

**INSTRUCTIONS:** This form should be used for transmitting the ISSUE FEE and PUBLICATION FEE (if required). Blocks 1 through 5 should be completed where appropriate. All further correspondence including the Patent, advance orders and notification of maintenance fees will be mailed to the current correspondence address as indicated unless corrected below or directed otherwise in Block 1, by (a) specifying a new correspondence address; and/or (b) indicating a separate "FEE ADDRESS" for maintenance fee notifications.

CURRENT CORRESPONDENCE ADDRESS (Note: Use Block 1 for any change of address)

20995 7590 07/27/2017  
**Knobbe Martens Olson & Bear LLP**  
 2040 MAIN STREET  
 FOURTEENTH FLOOR  
 IRVINE, CA 92614

Note: A certificate of mailing can only be used for domestic mailings of the Fee(s) Transmittal. This certificate cannot be used for any other accompanying papers. Each additional paper, such as an assignment or formal drawing, must have its own certificate of mailing or transmission.

**Certificate of Mailing or Transmission**

I hereby certify that this Fee(s) Transmittal is being deposited with the United States Postal Service with sufficient postage for first class mail in an envelope addressed to the Mail Stop ISSUE FEE address above, or being facsimile transmitted to the USPTO (571) 273-2885, on the date indicated below.

(Depositor's name)
(Signature)
(Date)

APPLICATION NO.	FILING DATE	FIRST NAMED INVENTOR	ATTORNEY DOCKET NO.	CONFIRMATION NO.
14/848,191	09/08/2015	Jae Lark JUNG	UNIS005.001C2	9599

TITLE OF INVENTION: ACTIVATING DISPLAY AND PERFORMING USER AUTHENTICATION IN MOBILE TERMINAL WITH ONE-TIME USER INPUT

APPLN. TYPE	ENTITY STATUS	ISSUE FEE DUE	PUBLICATION FEE DUE	PREV. PAID ISSUE FEE	TOTAL FEE(S) DUE	DATE DUE
nonprovisional	SMALL	\$480	\$0	\$0	\$480	10/27/2017

EXAMINER	ART UNIT	CLASS-SUBCLASS
SHEDRICK, CHARLES TERRELL	2646	455-411000

<p>1. Change of correspondence address or indication of "Fee Address" (37 CFR 1.363).</p> <p><input type="checkbox"/> Change of correspondence address (or Change of Correspondence Address form PTO/SB/122) attached.</p> <p><input type="checkbox"/> "Fee Address" indication (or "Fee Address" Indication form PTO/SB/47; Rev 03-02 or more recent) attached. Use of a <b>Customer Number is required.</b></p>	<p>2. For printing on the patent front page, list</p> <p>(1) The names of up to 3 registered patent attorneys or agents OR, alternatively, 1 _____</p> <p>(2) The name of a single firm (having as a member a registered attorney or agent) and the names of up to 2 registered patent attorneys or agents. If no name is listed, no name will be printed. 2 _____</p> <p>3 _____</p>
---	---

3. ASSIGNEE NAME AND RESIDENCE DATA TO BE PRINTED ON THE PATENT (print or type)

PLEASE NOTE: Unless an assignee is identified below, no assignee data will appear on the patent. If an assignee is identified below, the document has been filed for recordation as set forth in 37 CFR 3.11. Completion of this form is NOT a substitute for filing an assignment.

(A) NAME OF ASSIGNEE \_\_\_\_\_ (B) RESIDENCE: (CITY and STATE OR COUNTRY) \_\_\_\_\_

Please check the appropriate assignee category or categories (will not be printed on the patent):  Individual  Corporation or other private group entity  Government

<p>4a. The following fee(s) are submitted:</p> <p><input type="checkbox"/> Issue Fee</p> <p><input type="checkbox"/> Publication Fee (No small entity discount permitted)</p> <p><input type="checkbox"/> Advance Order - # of Copies _____</p>	<p>4b. Payment of Fee(s): (Please first reapply any previously paid issue fee shown above)</p> <p><input type="checkbox"/> A check is enclosed.</p> <p><input type="checkbox"/> Payment by credit card. Form PTO-2038 is attached.</p> <p><input type="checkbox"/> The director is hereby authorized to charge the required fee(s), any deficiency, or credits any overpayment, to Deposit Account Number _____ (enclose an extra copy of this form).</p>
---	---

5. Change in Entity Status (from status indicated above)

Applicant certifying micro entity status. See 37 CFR 1.29

Applicant asserting small entity status. See 37 CFR 1.27

Applicant changing to regular undiscounted fee status.

NOTE: Absent a valid certification of Micro Entity Status (see forms PTO/SB/15A and 15B), issue fee payment in the micro entity amount will not be accepted at the risk of application abandonment.

NOTE: If the application was previously under micro entity status, checking this box will be taken to be a notification of loss of entitlement to micro entity status.

NOTE: Checking this box will be taken to be a notification of loss of entitlement to small or micro entity status, as applicable.

NOTE: This form must be signed in accordance with 37 CFR 1.31 and 1.33. See 37 CFR 1.4 for signature requirements and certifications.

Authorized Signature \_\_\_\_\_ Date \_\_\_\_\_

Typed or printed name \_\_\_\_\_ Registration No. \_\_\_\_\_



UNITED STATES PATENT AND TRADEMARK OFFICE

UNITED STATES DEPARTMENT OF COMMERCE
United States Patent and Trademark Office
Address: COMMISSIONER FOR PATENTS
P.O. Box 1450
Alexandria, Virginia 22313-1450
www.uspto.gov

Table with 5 columns: APPLICATION NO., FILING DATE, FIRST NAMED INVENTOR, ATTORNEY DOCKET NO., CONFIRMATION NO.
Values: 14/848,191, 09/08/2015, Jae Lark JUNG, UNIS005.001C2, 9599

20995 7590 07/27/2017
KNOBBE MARTENS OLSON & BEAR LLP
2040 MAIN STREET
FOURTEENTH FLOOR
IRVINE, CA 92614

Table with 2 columns: EXAMINER, ART UNIT, PAPER NUMBER
Values: SHEDRICK, CHARLES TERRELL, 2646

DATE MAILED: 07/27/2017

Determination of Patent Term Adjustment under 35 U.S.C. 154 (b)
(Applications filed on or after May 29, 2000)

The Office has discontinued providing a Patent Term Adjustment (PTA) calculation with the Notice of Allowance.

Section 1(h)(2) of the AIA Technical Corrections Act amended 35 U.S.C. 154(b)(3)(B)(i) to eliminate the requirement that the Office provide a patent term adjustment determination with the notice of allowance. See Revisions to Patent Term Adjustment, 78 Fed. Reg. 19416, 19417 (Apr. 1, 2013). Therefore, the Office is no longer providing an initial patent term adjustment determination with the notice of allowance. The Office will continue to provide a patent term adjustment determination with the Issue Notification Letter that is mailed to applicant approximately three weeks prior to the issue date of the patent, and will include the patent term adjustment on the patent. Any request for reconsideration of the patent term adjustment determination (or reinstatement of patent term adjustment) should follow the process outlined in 37 CFR 1.705.

Any questions regarding the Patent Term Extension or Adjustment determination should be directed to the Office of Patent Legal Administration at (571)-272-7702. Questions relating to issue and publication fee payments should be directed to the Customer Service Center of the Office of Patent Publication at 1-(888)-786-0101 or (571)-272-4200.

## OMB Clearance and PRA Burden Statement for PTOL-85 Part B

The Paperwork Reduction Act (PRA) of 1995 requires Federal agencies to obtain Office of Management and Budget approval before requesting most types of information from the public. When OMB approves an agency request to collect information from the public, OMB (i) provides a valid OMB Control Number and expiration date for the agency to display on the instrument that will be used to collect the information and (ii) requires the agency to inform the public about the OMB Control Number's legal significance in accordance with 5 CFR 1320.5(b).

The information collected by PTOL-85 Part B is required by 37 CFR 1.311. The information is required to obtain or retain a benefit by the public which is to file (and by the USPTO to process) an application. Confidentiality is governed by 35 U.S.C. 122 and 37 CFR 1.14. This collection is estimated to take 12 minutes to complete, including gathering, preparing, and submitting the completed application form to the USPTO. Time will vary depending upon the individual case. Any comments on the amount of time you require to complete this form and/or suggestions for reducing this burden, should be sent to the Chief Information Officer, U.S. Patent and Trademark Office, U.S. Department of Commerce, P.O. Box 1450, Alexandria, Virginia 22313-1450. DO NOT SEND FEES OR COMPLETED FORMS TO THIS ADDRESS. SEND TO: Commissioner for Patents, P.O. Box 1450, Alexandria, Virginia 22313-1450. Under the Paperwork Reduction Act of 1995, no persons are required to respond to a collection of information unless it displays a valid OMB control number.

### Privacy Act Statement

**The Privacy Act of 1974 (P.L. 93-579)** requires that you be given certain information in connection with your submission of the attached form related to a patent application or patent. Accordingly, pursuant to the requirements of the Act, please be advised that: (1) the general authority for the collection of this information is 35 U.S.C. 2(b)(2); (2) furnishing of the information solicited is voluntary; and (3) the principal purpose for which the information is used by the U.S. Patent and Trademark Office is to process and/or examine your submission related to a patent application or patent. If you do not furnish the requested information, the U.S. Patent and Trademark Office may not be able to process and/or examine your submission, which may result in termination of proceedings or abandonment of the application or expiration of the patent.

The information provided by you in this form will be subject to the following routine uses:

1. The information on this form will be treated confidentially to the extent allowed under the Freedom of Information Act (5 U.S.C. 552) and the Privacy Act (5 U.S.C. 552a). Records from this system of records may be disclosed to the Department of Justice to determine whether disclosure of these records is required by the Freedom of Information Act.
2. A record from this system of records may be disclosed, as a routine use, in the course of presenting evidence to a court, magistrate, or administrative tribunal, including disclosures to opposing counsel in the course of settlement negotiations.
3. A record in this system of records may be disclosed, as a routine use, to a Member of Congress submitting a request involving an individual, to whom the record pertains, when the individual has requested assistance from the Member with respect to the subject matter of the record.
4. A record in this system of records may be disclosed, as a routine use, to a contractor of the Agency having need for the information in order to perform a contract. Recipients of information shall be required to comply with the requirements of the Privacy Act of 1974, as amended, pursuant to 5 U.S.C. 552a(m).
5. A record related to an International Application filed under the Patent Cooperation Treaty in this system of records may be disclosed, as a routine use, to the International Bureau of the World Intellectual Property Organization, pursuant to the Patent Cooperation Treaty.
6. A record in this system of records may be disclosed, as a routine use, to another federal agency for purposes of National Security review (35 U.S.C. 181) and for review pursuant to the Atomic Energy Act (42 U.S.C. 218(c)).
7. A record from this system of records may be disclosed, as a routine use, to the Administrator, General Services, or his/her designee, during an inspection of records conducted by GSA as part of that agency's responsibility to recommend improvements in records management practices and programs, under authority of 44 U.S.C. 2904 and 2906. Such disclosure shall be made in accordance with the GSA regulations governing inspection of records for this purpose, and any other relevant (i.e., GSA or Commerce) directive. Such disclosure shall not be used to make determinations about individuals.
8. A record from this system of records may be disclosed, as a routine use, to the public after either publication of the application pursuant to 35 U.S.C. 122(b) or issuance of a patent pursuant to 35 U.S.C. 151. Further, a record may be disclosed, subject to the limitations of 37 CFR 1.14, as a routine use, to the public if the record was filed in an application which became abandoned or in which the proceedings were terminated and which application is referenced by either a published application, an application open to public inspection or an issued patent.
9. A record from this system of records may be disclosed, as a routine use, to a Federal, State, or local law enforcement agency, if the USPTO becomes aware of a violation or potential violation of law or regulation.

<b>Examiner-Initiated Interview Summary</b>	<b>Application No.</b> 14/848,191	<b>Applicant(s)</b> JUNG ET AL.	
	<b>Examiner</b> CHARLES SHEDRICK	<b>Art Unit</b> 2646	

All participants (applicant, applicant's representative, PTO personnel):

- (1) CHARLES SHEDRICK. (3)\_\_\_\_\_.
- (2) Mincheol Kim 51,306. (4)\_\_\_\_\_.

Date of Interview: 14 July 2017.

Type:  Telephonic  Video Conference  
 Personal [copy given to:  applicant  applicant's representative]

Exhibit shown or demonstration conducted:  Yes  No.  
If Yes, brief description: \_\_\_\_\_.

Issues Discussed 101 112 102 103 Others  
(For each of the checked box(es) above, please describe below the issue and detailed description of the discussion)

Claim(s) discussed: independent.

Identification of prior art discussed: \_\_\_\_\_.

**Substance of Interview**

(For each issue discussed, provide a detailed description and indicate if agreement was reached. Some topics may include: identification or clarification of a reference or a portion thereof, claim interpretation, proposed amendments, arguments of any applied references etc...)

Applicant and Examiner discussed and agreed on claimed amendments to place the case in condition for allowance.

**Applicant recordation instructions:** It is not necessary for applicant to provide a separate record of the substance of interview.

**Examiner recordation instructions:** Examiners must summarize the substance of any interview of record. A complete and proper recordation of the substance of an interview should include the items listed in MPEP 713.04 for complete and proper recordation including the identification of the general thrust of each argument or issue discussed, a general indication of any other pertinent matters discussed regarding patentability and the general results or outcome of the interview, to include an indication as to whether or not agreement was reached on the issues raised.

Attachment

/CHARLES SHEDRICK/  
Primary Examiner, Art Unit 2646

<b>Notice of Allowability</b>	<b>Application No.</b> 14/848,191	<b>Applicant(s)</b> JUNG ET AL.	
	<b>Examiner</b> CHARLES SHEDRICK	<b>Art Unit</b> 2646	<b>AIA (First Inventor to File) Status</b> No

**-- The MAILING DATE of this communication appears on the cover sheet with the correspondence address--**  
All claims being allowable, PROSECUTION ON THE MERITS IS (OR REMAINS) CLOSED in this application. If not included herewith (or previously mailed), a Notice of Allowance (PTOL-85) or other appropriate communication will be mailed in due course. **THIS NOTICE OF ALLOWABILITY IS NOT A GRANT OF PATENT RIGHTS.** This application is subject to withdrawal from issue at the initiative of the Office or upon petition by the applicant. See 37 CFR 1.313 and MPEP 1308.

1.  This communication is responsive to response to arguments dated 4/14/17 and interview dated 7/14/17.  
 A declaration(s)/affidavit(s) under 37 CFR 1.130(b) was/were filed on \_\_\_\_\_.
2.  An election was made by the applicant in response to a restriction requirement set forth during the interview on \_\_\_\_\_; the restriction requirement and election have been incorporated into this action.
3.  The allowed claim(s) is/are 1-4,6-14 and 16-20 renumbered 1-18. As a result of the allowed claim(s), you may be eligible to benefit from the **Patent Prosecution Highway** program at a participating intellectual property office for the corresponding application. For more information, please see [http://www.uspto.gov/patents/init\\_events/pph/index.jsp](http://www.uspto.gov/patents/init_events/pph/index.jsp) or send an inquiry to PPHfeedback@uspto.gov.
4.  Acknowledgment is made of a claim for foreign priority under 35 U.S.C. § 119(a)-(d) or (f).

**Certified copies:**

- a)  All    b)  Some    \*c)  None of the:
  1.  Certified copies of the priority documents have been received.
  2.  Certified copies of the priority documents have been received in Application No. \_\_\_\_\_.
  3.  Copies of the certified copies of the priority documents have been received in this national stage application from the International Bureau (PCT Rule 17.2(a)).

\* Certified copies not received: \_\_\_\_\_.

Applicant has THREE MONTHS FROM THE "MAILING DATE" of this communication to file a reply complying with the requirements noted below. Failure to timely comply will result in ABANDONMENT of this application.

**THIS THREE-MONTH PERIOD IS NOT EXTENDABLE.**

5.  CORRECTED DRAWINGS ( as "replacement sheets") must be submitted.  
 including changes required by the attached Examiner's Amendment / Comment or in the Office action of Paper No./Mail Date \_\_\_\_\_.  
**Identifying indicia such as the application number (see 37 CFR 1.84(c)) should be written on the drawings in the front (not the back) of each sheet. Replacement sheet(s) should be labeled as such in the header according to 37 CFR 1.121(d).**
6.  DEPOSIT OF and/or INFORMATION about the deposit of BIOLOGICAL MATERIAL must be submitted. Note the attached Examiner's comment regarding REQUIREMENT FOR THE DEPOSIT OF BIOLOGICAL MATERIAL.

**Attachment(s)**

- |  |   |
|--|---|
| 1. <input type="checkbox"/> Notice of References Cited (PTO-892)   | 5. <input checked="" type="checkbox"/> Examiner's Amendment/Comment       |
| 2. <input checked="" type="checkbox"/> Information Disclosure Statements (PTO/SB/08),<br>Paper No./Mail Date _____ | 6. <input type="checkbox"/> Examiner's Statement of Reasons for Allowance |
| 3. <input type="checkbox"/> Examiner's Comment Regarding Requirement for Deposit<br>of Biological Material         | 7. <input type="checkbox"/> Other _____.                                  |
| 4. <input checked="" type="checkbox"/> Interview Summary (PTO-413),<br>Paper No./Mail Date _____.                  |   |

/CHARLES SHEDRICK/  
Primary Examiner, Art Unit 2646



Art Unit: 2646

1. The present application is being examined under the pre-AIA first to invent provisions.

### EXAMINER'S AMENDMENT

2. An examiner's amendment to the record appears below. Should the changes and/or additions be unacceptable to applicant, an amendment may be filed as provided by 37 CFR 1.312. To ensure consideration of such an amendment, it MUST be submitted no later than the payment of the issue fee.

Authorization for this examiner's amendment was given in an interview with Mincheol Kim Reg. No.: 51, 306 on 7/14/17.

The application has been amended as follows:

1. (Currently Amended) A mobile communication terminal comprising: a touch screen display;  
a power button configured to turn on and off the terminal by pressing; and an activation button separate from the power button and located outside the touch screen display, the activation button configured for pressing to turn on the touch screen display,  
wherein upon one-time pressing of the activation button while the touch screen display is turned off, the terminal is configured to turn on the touch screen display and perform a fingerprint authentication function in addition to turning on the touch screen display such that:  
a lock screen is displayed on the touch screen display upon turning on the touch screen display in response to the one-time pressing of the activation button while the touch screen display being turned off, in addition to turning on the touch screen display and displaying the lock screen, the one-time pressing while the touch screen display being turned off initiates the

Art Unit: 2646

fingerprint authentication function, the lock screen is displayed on the touch screen display when the fingerprint authentication function initiated by the one-time pressing is being performed,

a lock state of the terminal continues when the fingerprint authentication function fails to authenticate a user, and the lock state is released for enabling other functions of the terminal when the fingerprint authentication function authenticates a user in response to the onetime pressing of the activation button while the touch screen display being turned off- ,wherein the terminal is further configured to perform at least one function other than the fingerprint authentication function in addition to turning on the touch screen display for displaying the lock screen in response to the one-time pressing of the activation button when the one-time pressing is for long time longer than a reference time period, wherein the at least one function to perform in addition to turning on the touch screen display for displaying the lock screen in response to the one-time pressing for long time is associated with initiating a hands-free operation of the terminal.

**5. (Canceled)**

11. (Currently Amended) A method of operating a mobile computing terminal, the method comprising:

providing a mobile computing terminal which comprises a touch screen display, a camera, a power button for pressing to turn on/off the terminal, and an activation button for pressing to turn on the touch screen display, the activation button located outside the touch screen display; detecting one-time pressing of the activation button while the terminal is in an inactive state in which the touch screen display is turned off; in response to the one-time pressing, changing the terminal from the inactive state to an active state in which the touch

Art Unit: 2646

screen display is turned on; and in addition to changing to the active state, further performing a fingerprint authentication function using fingerprint recognition without additional user input, wherein in changing to the active state and performing the fingerprint authentication function, the terminal operates such that:

a lock screen is displayed on the touch screen display upon changing the terminal from the inactive state to the active state in response to the one-time pressing of the activation button while the terminal being in the inactive state,

in addition to changing the terminal to the active state, the one-time pressing while the terminal being in the inactive state initiates the fingerprint authentication function,

the lock screen is displayed on the touch screen display when the fingerprint authentication function initiated by the one-time pressing is being performed,

a lock state of the terminal continues when the fingerprint authentication function fails to authenticate a user, and the lock state is released for enabling other functions of the terminal when the fingerprint authentication function authenticates a user in response to the onetime pressing of the activation button while the terminal being in the inactive state, wherein the method further comprises performing at least one function other than the fingerprint authentication function in addition to changing to the active state in response to the one-time pressing during the terminal's inactive state when the one-time pressing is for long time longer than a reference time period, wherein the at least one function to perform in addition to turning on the touch screen display for displaying the lock screen in response to the one-time pressing for long time is associated with initiating a hands-free operation of the terminal.

**15. (Canceled)**

Art Unit: 2646

***Conclusion***

Any inquiry concerning this communication or earlier communications from the examiner should be directed to CHARLES SHEDRICK whose telephone number is (571)272-8621. The examiner can normally be reached on Monday thru Friday 8:00AM-4:30PM.

Examiner interviews are available via telephone, in-person, and video conferencing using a USPTO supplied web-based collaboration tool. To schedule an interview, applicant is encouraged to use the USPTO Automated Interview Request (AIR) at <http://www.uspto.gov/interviewpractice>.

If attempts to reach the examiner by telephone are unsuccessful, the examiner's supervisor, Lester Kincaid can be reached on (571)-272-7922. The fax phone number for the organization where this application or proceeding is assigned is 571-273-8300.

Information regarding the status of an application may be obtained from the Patent Application Information Retrieval (PAIR) system. Status information for published applications may be obtained from either Private PAIR or Public PAIR. Status information for unpublished applications is available through Private PAIR only. For more information about the PAIR system, see <http://pair-direct.uspto.gov>. Should you have questions on access to the Private PAIR system, contact the Electronic Business Center (EBC) at 866-217-9197 (toll-free). If you would like assistance from a USPTO Customer Service Representative or access to the automated information system, call 800-786-9199 (IN USA OR CANADA) or 571-272-1000.

/CHARLES SHEDRICK/  
Primary Examiner, Art Unit 2646

<b>Examiner-Initiated Interview Summary</b>	<b>Application No.</b> 14/848,191	<b>Applicant(s)</b> JUNG ET AL.	
	<b>Examiner</b> CHARLES SHEDRICK	<b>Art Unit</b> 2646	

All participants (applicant, applicant's representative, PTO personnel):

(1) CHARLES SHEDRICK. (3)\_\_\_\_\_.

(2) Mincheol Kim 51,306. (4)\_\_\_\_\_.

Date of Interview: 14 July 2017.

Type:  Telephonic  Video Conference  
 Personal [copy given to:  applicant  applicant's representative]

Exhibit shown or demonstration conducted:  Yes  No.  
If Yes, brief description: \_\_\_\_\_.

Issues Discussed 101 112 102 103 Others  
(For each of the checked box(es) above, please describe below the issue and detailed description of the discussion)

Claim(s) discussed: independent.

Identification of prior art discussed: \_\_\_\_\_.

**Substance of Interview**

(For each issue discussed, provide a detailed description and indicate if agreement was reached. Some topics may include: identification or clarification of a reference or a portion thereof, claim interpretation, proposed amendments, arguments of any applied references etc...)

Applicant and Examiner discussed and agreed on claimed amendments to place the case in condition for allowance.

**Applicant recordation instructions:** It is not necessary for applicant to provide a separate record of the substance of interview.

**Examiner recordation instructions:** Examiners must summarize the substance of any interview of record. A complete and proper recordation of the substance of an interview should include the items listed in MPEP 713.04 for complete and proper recordation including the identification of the general thrust of each argument or issue discussed, a general indication of any other pertinent matters discussed regarding patentability and the general results or outcome of the interview, to include an indication as to whether or not agreement was reached on the issues raised.

Attachment

/CHARLES SHEDRICK/  
Primary Examiner, Art Unit 2646

<b>INFORMATION DISCLOSURE STATEMENT BY APPLICANT</b> ( Not for submission under 37 CFR 1.99)	Application Number	14848191
	Filing Date	2015-09-08
	First Named Inventor	Jae Lark Jung
	Art Unit	2646
	Examiner Name	Shedrick, Charles Terrell
	Attorney Docket Number	UNIS005.001C2

U.S.PATENTS							Remove
Examiner Initial*	Cite No	Patent Number	Kind Code <sup>1</sup>	Issue Date	Name of Patentee or Applicant of cited Document	Pages,Columns,Lines where Relevant Passages or Relevant Figures Appear	
	1						

If you wish to add additional U.S. Patent citation information please click the Add button.

U.S.PATENT APPLICATION PUBLICATIONS							Remove
Examiner Initial*	Cite No	Publication Number	Kind Code <sup>1</sup>	Publication Date	Name of Patentee or Applicant of cited Document	Pages,Columns,Lines where Relevant Passages or Relevant Figures Appear	
	1	20100257490	A1	2010-10-07	Lyon et al.		

If you wish to add additional U.S. Published Application citation information please click the Add button.

FOREIGN PATENT DOCUMENTS								Remove
Examiner Initial*	Cite No	Foreign Document Number <sup>3</sup>	Country Code <sup>2</sup>	Kind Code <sup>4</sup>	Publication Date	Name of Patentee or Applicant of cited Document	Pages,Columns,Lines where Relevant Passages or Relevant Figures Appear	T <sup>5</sup>
	1							

If you wish to add additional Foreign Patent Document citation information please click the Add button.

NON-PATENT LITERATURE DOCUMENTS								Remove
Examiner Initials*	Cite No	Include name of the author (in CAPITAL LETTERS), title of the article (when appropriate), title of the item (book, magazine, journal, serial, symposium, catalog, etc), date, pages(s), volume-issue number(s), publisher, city and/or country where published.						T <sup>5</sup>

ALL REFERENCES CONSIDERED EXCEPT WHERE LINED THROUGH. /C.T.S/

<b>INFORMATION DISCLOSURE STATEMENT BY APPLICANT</b> ( Not for submission under 37 CFR 1.99)	Application Number	14848191
	Filing Date	2015-09-08
	First Named Inventor	Jae Lark Jung
	Art Unit	2646
	Examiner Name	Shedrick, Charles Terrell
	Attorney Docket Number	UNIS005.001C2

1	
---	--

If you wish to add additional non-patent literature document citation information please click the Add button

**EXAMINER SIGNATURE**

Examiner Signature	/CHARLES T SHEDRICK/	Date Considered	07/18/2017
--------------------	----------------------	-----------------	------------

\*EXAMINER: Initial if reference considered, whether or not citation is in conformance with MPEP 609. Draw line through a citation if not in conformance and not considered. Include copy of this form with next communication to applicant.

<sup>1</sup> See Kind Codes of USPTO Patent Documents at [www.USPTO.GOV](http://www.USPTO.GOV) or MPEP 901.04. <sup>2</sup> Enter office that issued the document, by the two-letter code (WIPO Standard ST.3). <sup>3</sup> For Japanese patent documents, the indication of the year of the reign of the Emperor must precede the serial number of the patent document. <sup>4</sup> Kind of document by the appropriate symbols as indicated on the document under WIPO Standard ST.16 if possible. <sup>5</sup> Applicant is to place a check mark here if English language translation is attached.

ALL REFERENCES CONSIDERED EXCEPT WHERE LINED THROUGH. /C.T.S/

**INFORMATION DISCLOSURE  
STATEMENT BY APPLICANT**  
( Not for submission under 37 CFR 1.99)

Application Number	14848191
Filing Date	2015-09-08
First Named Inventor	Jae Lark Jung
Art Unit	2646
Examiner Name	Shedrick, Charles Terrell
Attorney Docket Number	UNIS005.001C2

**CERTIFICATION STATEMENT**

Please see 37 CFR 1.97 and 1.98 to make the appropriate selection(s):

That each item of information contained in the information disclosure statement was first cited in any communication from a foreign patent office in a counterpart foreign application not more than three months prior to the filing of the information disclosure statement. See 37 CFR 1.97(e)(1).

**OR**

That no item of information contained in the information disclosure statement was cited in a communication from a foreign patent office in a counterpart foreign application, and, to the knowledge of the person signing the certification after making reasonable inquiry, no item of information contained in the information disclosure statement was known to any individual designated in 37 CFR 1.56(c) more than three months prior to the filing of the information disclosure statement. See 37 CFR 1.97(e)(2).

See attached certification statement.

The fee set forth in 37 CFR 1.17 (p) has been submitted herewith.

A certification statement is not submitted herewith.

**SIGNATURE**

A signature of the applicant or representative is required in accordance with CFR 1.33, 10.18. Please see CFR 1.4(d) for the form of the signature.

Signature	/Mincheol Kim/	Date (YYYY-MM-DD)	2017-04-14
Name/Print	Mincheol Kim	Registration Number	51306

This collection of information is required by 37 CFR 1.97 and 1.98. The information is required to obtain or retain a benefit by the public which is to file (and by the USPTO to process) an application. Confidentiality is governed by 35 U.S.C. 122 and 37 CFR 1.14. This collection is estimated to take 1 hour to complete, including gathering, preparing and submitting the completed application form to the USPTO. Time will vary depending upon the individual case. Any comments on the amount of time you require to complete this form and/or suggestions for reducing this burden, should be sent to the Chief Information Officer, U.S. Patent and Trademark Office, U.S. Department of Commerce, P.O. Box 1450, Alexandria, VA 22313-1450. **DO NOT SEND FEES OR COMPLETED FORMS TO THIS ADDRESS. SEND TO: Commissioner for Patents, P.O. Box 1450, Alexandria, VA 22313-1450.**



## Privacy Act Statement

The Privacy Act of 1974 (P.L. 93-579) requires that you be given certain information in connection with your submission of the attached form related to a patent application or patent. Accordingly, pursuant to the requirements of the Act, please be advised that: (1) the general authority for the collection of this information is 35 U.S.C. 2(b)(2); (2) furnishing of the information solicited is voluntary; and (3) the principal purpose for which the information is used by the U.S. Patent and Trademark Office is to process and/or examine your submission related to a patent application or patent. If you do not furnish the requested information, the U.S. Patent and Trademark Office may not be able to process and/or examine your submission, which may result in termination of proceedings or abandonment of the application or expiration of the patent.

The information provided by you in this form will be subject to the following routine uses:

1. The information on this form will be treated confidentially to the extent allowed under the Freedom of Information Act (5 U.S.C. 552) and the Privacy Act (5 U.S.C. 552a). Records from this system of records may be disclosed to the Department of Justice to determine whether the Freedom of Information Act requires disclosure of these records.
2. A record from this system of records may be disclosed, as a routine use, in the course of presenting evidence to a court, magistrate, or administrative tribunal, including disclosures to opposing counsel in the course of settlement negotiations.
3. A record in this system of records may be disclosed, as a routine use, to a Member of Congress submitting a request involving an individual, to whom the record pertains, when the individual has requested assistance from the Member with respect to the subject matter of the record.
4. A record in this system of records may be disclosed, as a routine use, to a contractor of the Agency having need for the information in order to perform a contract. Recipients of information shall be required to comply with the requirements of the Privacy Act of 1974, as amended, pursuant to 5 U.S.C. 552a(m).
5. A record related to an International Application filed under the Patent Cooperation Treaty in this system of records may be disclosed, as a routine use, to the International Bureau of the World Intellectual Property Organization, pursuant to the Patent Cooperation Treaty.
6. A record in this system of records may be disclosed, as a routine use, to another federal agency for purposes of National Security review (35 U.S.C. 181) and for review pursuant to the Atomic Energy Act (42 U.S.C. 218(c)).
7. A record from this system of records may be disclosed, as a routine use, to the Administrator, General Services, or his/her designee, during an inspection of records conducted by GSA as part of that agency's responsibility to recommend improvements in records management practices and programs, under authority of 44 U.S.C. 2904 and 2906. Such disclosure shall be made in accordance with the GSA regulations governing inspection of records for this purpose, and any other relevant (i.e., GSA or Commerce) directive. Such disclosure shall not be used to make determinations about individuals.
8. A record from this system of records may be disclosed, as a routine use, to the public after either publication of the application pursuant to 35 U.S.C. 122(b) or issuance of a patent pursuant to 35 U.S.C. 151. Further, a record may be disclosed, subject to the limitations of 37 CFR 1.14, as a routine use, to the public if the record was filed in an application which became abandoned or in which the proceedings were terminated and which application is referenced by either a published application, an application open to public inspections or an issued patent.
9. A record from this system of records may be disclosed, as a routine use, to a Federal, State, or local law enforcement agency, if the USPTO becomes aware of a violation or potential violation of law or regulation.

<b>INFORMATION DISCLOSURE STATEMENT BY APPLICANT</b> ( Not for submission under 37 CFR 1.99)	Application Number	14848191
	Filing Date	2015-09-08
	First Named Inventor	Jae Lark Jung
	Art Unit	2646
	Examiner Name	Shedrick, Charles Terrell
	Attorney Docket Number	UNIS005.001C2

U.S.PATENTS						Remove
Examiner Initial*	Cite No	Patent Number	Kind Code <sup>1</sup>	Issue Date	Name of Patentee or Applicant of cited Document	Pages,Columns,Lines where Relevant Passages or Relevant Figures Appear
	1	7647638	B2	2010-01-12	Furuyama	
	2	8138886	B1	2012-03-20	Chang	
	3	8638305	B2	2014-01-28	Inami	
	4	8965449	B2	2015-02-24	Alvarez Rivera et al.	
	5	9027117	B2	2015-05-05	Wilairat	
	6	8793786	B2	2017-07-29	Bhesania et al.	
	7	9076008	B1	2015-07-07	Moy	
If you wish to add additional U.S. Patent citation information please click the Add button.						Add
<b>U.S.PATENT APPLICATION PUBLICATIONS</b>						Remove

ALL REFERENCES CONSIDERED EXCEPT WHERE LINED THROUGH. /C.T.S/

**INFORMATION DISCLOSURE  
STATEMENT BY APPLICANT**  
( Not for submission under 37 CFR 1.99)

Application Number	14848191
Filing Date	2015-09-08
First Named Inventor	Jae Lark Jung
Art Unit	2646
Examiner Name	Shedrick, Charles Terrell
Attorney Docket Number	UNIS005.001C2

Examiner Initial*	Cite No	Publication Number	Kind Code <sup>1</sup>	Publication Date	Name of Patentee or Applicant of cited Document	Pages, Columns, Lines where Relevant Passages or Relevant Figures Appear
	1	20080209547	A1	2008-08-28	Funahashi et al.	
	2	20090169070	A1	2009-07-02	Fadell et al.	
	3	20120071149	A1	2012-03-22	Bandyopadhyay et al.	Application Publication of US 8,311,514 B2
	4	20140310532	A1	2014-10-16	Ali et al.	

If you wish to add additional U.S. Published Application citation information please click the Add button.

**FOREIGN PATENT DOCUMENTS**

Examiner Initial*	Cite No	Foreign Document Number <sup>3</sup>	Country Code <sup>2</sup>	Kind Code <sup>4</sup>	Publication Date	Name of Patentee or Applicant of cited Document	Pages, Columns, Lines where Relevant Passages or Relevant Figures Appear	T <sup>5</sup>
	1	2192519	EP	A1	2010-06-02	RESEARCH IN MOTION LTD		

If you wish to add additional Foreign Patent Document citation information please click the Add button.

**NON-PATENT LITERATURE DOCUMENTS**

Examiner Initials*	Cite No	Include name of the author (in CAPITAL LETTERS), title of the article (when appropriate), title of the item (book, magazine, journal, serial, symposium, catalog, etc), date, pages(s), volume-issue number(s), publisher, city and/or country where published.	T <sup>5</sup>
	1	WROBLEWSKI, "Apple's Overloaded iPhone Button", August 17, 2011, downloaded from <a href="https://www.lukew.com/ffi/entry.asp?1382">https://www.lukew.com/ffi/entry.asp?1382</a>	

ALL REFERENCES CONSIDERED EXCEPT WHERE LINED THROUGH. /C.T.S/

<b>INFORMATION DISCLOSURE STATEMENT BY APPLICANT</b> ( Not for submission under 37 CFR 1.99)	Application Number	14848191
	Filing Date	2015-09-08
	First Named Inventor	Jae Lark Jung
	Art Unit	2646
	Examiner Name	Shedrick, Charles Terrell
	Attorney Docket Number	UNIS005.001C2

2	"WidgetLocker adds any widget to Android lock screen", Uploaded to YouTube on July 15, 2010, <a href="https://www.youtube.com/watch?v=cVXF1r6xd4E">https://www.youtube.com/watch?v=cVXF1r6xd4E</a>
3	GROBART, "16 Tips to Take Your iPhone to the Next Level", The New York Times, April 27, 2011 in 4 pages
4	"WidgetLocker Lockscreen Android App Review", Hemorrroidsnet, Uploaded to YouTube on July 26, 2010, <a href="https://www.youtube.com/watch?v=9lnD1QTy5IY">https://www.youtube.com/watch?v=9lnD1QTy5IY</a>
5	Office Action dated June 2, 2017 of related U.S. Application No. 15/013,951 (Attorney Docket No.: UNIS005.001C3) - 16 pages

If you wish to add additional non-patent literature document citation information please click the Add button

**EXAMINER SIGNATURE**

Examiner Signature	/CHARLES T SHEDRICK/	Date Considered	07/18/2017
--------------------	----------------------	-----------------	------------

\*EXAMINER: Initial if reference considered, whether or not citation is in conformance with MPEP 609. Draw line through a citation if not in conformance and not considered. Include copy of this form with next communication to applicant.

<sup>1</sup> See Kind Codes of USPTO Patent Documents at [www.USPTO.GOV](http://www.USPTO.GOV) or MPEP 901.04. <sup>2</sup> Enter office that issued the document, by the two-letter code (WIPO Standard ST.3). <sup>3</sup> For Japanese patent documents, the indication of the year of the reign of the Emperor must precede the serial number of the patent document. <sup>4</sup> Kind of document by the appropriate symbols as indicated on the document under WIPO Standard ST.16 if possible. <sup>5</sup> Applicant is to place a check mark here if English language translation is attached.

ALL REFERENCES CONSIDERED EXCEPT WHERE LINED THROUGH. /C.T.S/

**INFORMATION DISCLOSURE  
STATEMENT BY APPLICANT**  
( Not for submission under 37 CFR 1.99)

Application Number	14848191
Filing Date	2015-09-08
First Named Inventor	Jae Lark Jung
Art Unit	2646
Examiner Name	Shedrick, Charles Terrell
Attorney Docket Number	UNIS005.001C2

**CERTIFICATION STATEMENT**

Please see 37 CFR 1.97 and 1.98 to make the appropriate selection(s):

That each item of information contained in the information disclosure statement was first cited in any communication from a foreign patent office in a counterpart foreign application not more than three months prior to the filing of the information disclosure statement. See 37 CFR 1.97(e)(1).

**OR**

That no item of information contained in the information disclosure statement was cited in a communication from a foreign patent office in a counterpart foreign application, and, to the knowledge of the person signing the certification after making reasonable inquiry, no item of information contained in the information disclosure statement was known to any individual designated in 37 CFR 1.56(c) more than three months prior to the filing of the information disclosure statement. See 37 CFR 1.97(e)(2).

See attached certification statement.

The fee set forth in 37 CFR 1.17 (p) has been submitted herewith.

A certification statement is not submitted herewith.

**SIGNATURE**

A signature of the applicant or representative is required in accordance with CFR 1.33, 10.18. Please see CFR 1.4(d) for the form of the signature.

Signature	/Mincheol Kim/	Date (YYYY-MM-DD)	2017-06-29
Name/Print	Mincheol Kim	Registration Number	51306


This collection of information is required by 37 CFR 1.97 and 1.98. The information is required to obtain or retain a benefit by the public which is to file (and by the USPTO to process) an application. Confidentiality is governed by 35 U.S.C. 122 and 37 CFR 1.14. This collection is estimated to take 1 hour to complete, including gathering, preparing and submitting the completed application form to the USPTO. Time will vary depending upon the individual case. Any comments on the amount of time you require to complete this form and/or suggestions for reducing this burden, should be sent to the Chief Information Officer, U.S. Patent and Trademark Office, U.S. Department of Commerce, P.O. Box 1450, Alexandria, VA 22313-1450. **DO NOT SEND FEES OR COMPLETED FORMS TO THIS ADDRESS. SEND TO: Commissioner for Patents, P.O. Box 1450, Alexandria, VA 22313-1450.**

## Privacy Act Statement

The Privacy Act of 1974 (P.L. 93-579) requires that you be given certain information in connection with your submission of the attached form related to a patent application or patent. Accordingly, pursuant to the requirements of the Act, please be advised that: (1) the general authority for the collection of this information is 35 U.S.C. 2(b)(2); (2) furnishing of the information solicited is voluntary; and (3) the principal purpose for which the information is used by the U.S. Patent and Trademark Office is to process and/or examine your submission related to a patent application or patent. If you do not furnish the requested information, the U.S. Patent and Trademark Office may not be able to process and/or examine your submission, which may result in termination of proceedings or abandonment of the application or expiration of the patent.

The information provided by you in this form will be subject to the following routine uses:


1. The information on this form will be treated confidentially to the extent allowed under the Freedom of Information Act (5 U.S.C. 552) and the Privacy Act (5 U.S.C. 552a). Records from this system of records may be disclosed to the Department of Justice to determine whether the Freedom of Information Act requires disclosure of these records.
2. A record from this system of records may be disclosed, as a routine use, in the course of presenting evidence to a court, magistrate, or administrative tribunal, including disclosures to opposing counsel in the course of settlement negotiations.
3. A record in this system of records may be disclosed, as a routine use, to a Member of Congress submitting a request involving an individual, to whom the record pertains, when the individual has requested assistance from the Member with respect to the subject matter of the record.
4. A record in this system of records may be disclosed, as a routine use, to a contractor of the Agency having need for the information in order to perform a contract. Recipients of information shall be required to comply with the requirements of the Privacy Act of 1974, as amended, pursuant to 5 U.S.C. 552a(m).
5. A record related to an International Application filed under the Patent Cooperation Treaty in this system of records may be disclosed, as a routine use, to the International Bureau of the World Intellectual Property Organization, pursuant to the Patent Cooperation Treaty.
6. A record in this system of records may be disclosed, as a routine use, to another federal agency for purposes of National Security review (35 U.S.C. 181) and for review pursuant to the Atomic Energy Act (42 U.S.C. 218(c)).
7. A record from this system of records may be disclosed, as a routine use, to the Administrator, General Services, or his/her designee, during an inspection of records conducted by GSA as part of that agency's responsibility to recommend improvements in records management practices and programs, under authority of 44 U.S.C. 2904 and 2906. Such disclosure shall be made in accordance with the GSA regulations governing inspection of records for this purpose, and any other relevant (i.e., GSA or Commerce) directive. Such disclosure shall not be used to make determinations about individuals.
8. A record from this system of records may be disclosed, as a routine use, to the public after either publication of the application pursuant to 35 U.S.C. 122(b) or issuance of a patent pursuant to 35 U.S.C. 151. Further, a record may be disclosed, subject to the limitations of 37 CFR 1.14, as a routine use, to the public if the record was filed in an application which became abandoned or in which the proceedings were terminated and which application is referenced by either a published application, an application open to public inspections or an issued patent.
9. A record from this system of records may be disclosed, as a routine use, to a Federal, State, or local law enforcement agency, if the USPTO becomes aware of a violation or potential violation of law or regulation.

<b>Issue Classification</b> 	<b>Application/Control No.</b> 14848191	<b>Applicant(s)/Patent Under Reexamination</b> JUNG ET AL.
	<b>Examiner</b> CHARLES SHEDRICK	<b>Art Unit</b> 2646

CPC							
Symbol						Type	Version
G06Q	30	/	0262			F	2013-01-01
H04W	4	/	02			I	2013-01-01
H04W	4	/	22			A	2013-01-01
H04M	1	/	67			I	2013-01-01
H04M	1	/	7258			I	2013-01-01
H04M	2250	/	52			A	2013-01-01
H04M	1	/	72519			I	2013-01-01
H04W	8	/	22			I	2013-01-01
G06F	21	/	32			I	2013-01-01
H04W	12	/	06			I	2013-01-01
H04M	2250	/	12			A	2013-01-01
H04W	52	/	027			I	2013-01-01
G06F	3	/	04883			I	2013-01-01
G06K	9	/	00087			I	2013-01-01
H04W	88	/	02			A	2013-01-01
G06K	9	/	00006			I	2013-01-01
G06K	9	/	00221			I	2013-01-01
G06K	9	/	00597			I	2013-01-01
H04L	63	/	0861			I	2013-01-01
H04W	12	/	08			I	2013-01-01
G06Q	30	/	0241			I	2013-01-01
G06F	21	/	36			I	2013-01-01
G06F	21	/	62			I	2013-01-01
G06Q	30	/	0261			I	2013-01-01
G06Q	30	/	0267			I	2013-01-01
G06Q	30	/	0269			I	2013-01-01
Y02B	60	/	50			A	2013-01-01


CPC Combination Sets				
Symbol	Type	Set	Ranking	Version

NONE		<b>Total Claims Allowed:</b>	
(Assistant Examiner)	(Date)	18	
/CHARLES SHEDRICK/ Primary Examiner.Art Unit 2646	07/18/2017	O.G. Print Claim(s)	O.G. Print Figure
(Primary Examiner)	(Date)	1	1

<b>Issue Classification</b> 	<b>Application/Control No.</b> 14848191	<b>Applicant(s)/Patent Under Reexamination</b> JUNG ET AL.
	<b>Examiner</b> CHARLES SHEDRICK	<b>Art Unit</b> 2646



NONE		<b>Total Claims Allowed:</b>	
(Assistant Examiner)	(Date)	18	
/CHARLES SHEDRICK/ Primary Examiner.Art Unit 2646	07/18/2017	O.G. Print Claim(s)	O.G. Print Figure
(Primary Examiner)	(Date)	1	1



<b>Issue Classification</b> 	<b>Application/Control No.</b> 14848191	<b>Applicant(s)/Patent Under Reexamination</b> JUNG ET AL.
	<b>Examiner</b> CHARLES SHEDRICK	<b>Art Unit</b> 2646


US ORIGINAL CLASSIFICATION				INTERNATIONAL CLASSIFICATION									
CLASS		SUBCLASS		CLAIMED				NON-CLAIMED					
455		411		H	0	4	M	1 / 00 (2006.01.01)					
<b>CROSS REFERENCE(S)</b>													
CLASS	SUBCLASS (ONE SUBCLASS PER BLOCK)												
455	414.1	420											
726	1	16											

NONE		<b>Total Claims Allowed:</b>	
		18	
(Assistant Examiner)	(Date)	O.G. Print Claim(s)	O.G. Print Figure
/CHARLES SHEDRICK/ Primary Examiner. Art Unit 2646	07/18/2017	1	1
(Primary Examiner)	(Date)		

<b>Issue Classification</b> 	<b>Application/Control No.</b> 14848191	<b>Applicant(s)/Patent Under Reexamination</b> JUNG ET AL.
	<b>Examiner</b> CHARLES SHEDRICK	<b>Art Unit</b> 2646

<input checked="" type="checkbox"/> <b>Claims renumbered in the same order as presented by applicant</b>																<input type="checkbox"/> <b>CPA</b>		<input type="checkbox"/> <b>T.D.</b>		<input type="checkbox"/> <b>R.1.47</b>	
Final	Original	Final	Original	Final	Original	Final	Original	Final	Original	Final	Original	Final	Original	Final	Original						
1	1	15	17																		
2	2	16	18																		
3	3	17	19																		
4	4	18	20																		
	5																				
5	6																				
6	7																				
7	8																				
8	9																				
9	10																				
10	11																				
11	12																				
12	13																				
13	14																				
	15																				
14	16																				

NONE  (Assistant Examiner) _____ (Date) _____		<b>Total Claims Allowed:</b> 18	
/CHARLES SHEDRICK/ Primary Examiner. Art Unit 2646  (Primary Examiner) _____ (Date) _____		O.G. Print Claim(s) 1	O.G. Print Figure 1

<b>Search Notes</b>  	<b>Application/Control No.</b>  14848191	<b>Applicant(s)/Patent Under Reexamination</b>  JUNG ET AL.
	<b>Examiner</b>  CHARLES SHEDRICK	<b>Art Unit</b>  2646

<b>CPC- SEARCHED</b>		
Symbol	Date	Examiner
H04W 4/02 ; H04W 12/08 ; H04M 1/67 ; H04M 1/7258 ; H04M 2250/52 ; H04M 1/72519 ; H04W 8/22; H04W 52/027 ; G06F 21/32 ; H04W 12/06 ; H04M 22	1/26/2016	cs

<b>CPC COMBINATION SETS - SEARCHED</b>		
Symbol	Date	Examiner

<b>US CLASSIFICATION SEARCHED</b>			
Class	Subclass	Date	Examiner
455	411,414.1, 420,404.2, 410	1/26/2016	cs
726	1,16	1/26/2016	cs

\* See search history printout included with this form or the SEARCH NOTES box below to determine the scope of the search.

<b>SEARCH NOTES</b>		
Search Notes	Date	Examiner
EAST text search, CPC search, Inventor search	1/19/2016	cs
updated searched notes EAST cross reference text search with CPC and US classes	7/18/2017	CS

<b>INTERFERENCE SEARCH</b>			
US Class/ CPC Symbol	US Subclass / CPC Group	Date	Examiner
see searched notes and searched classes		11/28/2016	CS

	/CHARLES SHEDRICK/ Primary Examiner. Art Unit 2646
--	---



UNITED STATES PATENT AND TRADEMARK OFFICE

UNITED STATES DEPARTMENT OF COMMERCE
United States Patent and Trademark Office
Address: COMMISSIONER FOR PATENTS
P O Box 1450
Alexandria, Virginia 22313-1450
www.uspto.gov

Table with 5 columns: APPLICATION NO., FILING DATE, FIRST NAMED INVENTOR, ATTORNEY DOCKET NO., CONFIRMATION NO.
14/848,191 09/08/2015 Jae Lark JUNG UNIS005.001C2 9599

20995 7590 08/08/2017
KNOBBE MARTENS OLSON & BEAR LLP
2040 MAIN STREET
FOURTEENTH FLOOR
IRVINE, CA 92614

EXAMINER

SHEDRICK, CHARLES TERRELL

ART UNIT PAPER NUMBER

2646

NOTIFICATION DATE DELIVERY MODE

08/08/2017

ELECTRONIC

Please find below and/or attached an Office communication concerning this application or proceeding.

The time period for reply, if any, is set in the attached communication.

Notice of the Office communication was sent electronically on above-indicated "Notification Date" to the following e-mail address(es):

jayna.cartee@knobbe.com
efiling@knobbe.com

**Corrected  
Notice of Allowability**

<b>Application No.</b> 14/848,191	<b>Applicant(s)</b> JUNG ET AL.	
<b>Examiner</b> CHARLES SHEDRICK	<b>Art Unit</b> 2646	<b>AIA (First Inventor to File) Status</b> No

**-- The MAILING DATE of this communication appears on the cover sheet with the correspondence address--**

All claims being allowable, PROSECUTION ON THE MERITS IS (OR REMAINS) CLOSED in this application. If not included herewith (or previously mailed), a Notice of Allowance (PTOL-85) or other appropriate communication will be mailed in due course. **THIS NOTICE OF ALLOWABILITY IS NOT A GRANT OF PATENT RIGHTS.** This application is subject to withdrawal from issue at the initiative of the Office or upon petition by the applicant. See 37 CFR 1.313 and MPEP 1308.

1.  This communication is responsive to response to arguments dated 4/14/17 and interview dated 7/14/17.  
 A declaration(s)/affidavit(s) under 37 CFR 1.130(b) was/were filed on \_\_\_\_\_.
2.  An election was made by the applicant in response to a restriction requirement set forth during the interview on \_\_\_\_\_; the restriction requirement and election have been incorporated into this action.
3.  The allowed claim(s) is/are 1-4,6-14 and 16-20 renumbered 1-18. As a result of the allowed claim(s), you may be eligible to benefit from the **Patent Prosecution Highway** program at a participating intellectual property office for the corresponding application. For more information, please see [http://www.uspto.gov/patents/init\\_events/pph/index.jsp](http://www.uspto.gov/patents/init_events/pph/index.jsp) or send an inquiry to PPHfeedback@uspto.gov.
4.  Acknowledgment is made of a claim for foreign priority under 35 U.S.C. § 119(a)-(d) or (f).

**Certified copies:**

- a)  All    b)  Some    \*c)  None of the:
1.  Certified copies of the priority documents have been received.
  2.  Certified copies of the priority documents have been received in Application No. \_\_\_\_\_.
  3.  Copies of the certified copies of the priority documents have been received in this national stage application from the International Bureau (PCT Rule 17.2(a)).

\* Certified copies not received: \_\_\_\_\_.

Applicant has THREE MONTHS FROM THE "MAILING DATE" of this communication to file a reply complying with the requirements noted below. Failure to timely comply will result in ABANDONMENT of this application.

**THIS THREE-MONTH PERIOD IS NOT EXTENDABLE.**

5.  CORRECTED DRAWINGS ( as "replacement sheets") must be submitted.  
 including changes required by the attached Examiner's Amendment / Comment or in the Office action of Paper No./Mail Date \_\_\_\_\_.  
**Identifying indicia such as the application number (see 37 CFR 1.84(c)) should be written on the drawings in the front (not the back) of each sheet. Replacement sheet(s) should be labeled as such in the header according to 37 CFR 1.121(d).**
6.  DEPOSIT OF and/or INFORMATION about the deposit of BIOLOGICAL MATERIAL must be submitted. Note the attached Examiner's comment regarding REQUIREMENT FOR THE DEPOSIT OF BIOLOGICAL MATERIAL.

**Attachment(s)**

1.  Notice of References Cited (PTO-892)
2.  Information Disclosure Statements (PTO/SB/08),  
Paper No./Mail Date \_\_\_\_\_
3.  Examiner's Comment Regarding Requirement for Deposit  
of Biological Material
4.  Interview Summary (PTO-413),  
Paper No./Mail Date \_\_\_\_\_.
5.  Examiner's Amendment/Comment
6.  Examiner's Statement of Reasons for Allowance
7.  Other \_\_\_\_\_.

/CHARLES SHEDRICK/  
Primary Examiner, Art Unit 2646

Art Unit: 2646

1. The present application is being examined under the pre-AIA first to invent provisions.

### EXAMINER'S AMENDMENT

2. An examiner's amendment to the record appears below. Should the changes and/or additions be unacceptable to applicant, an amendment may be filed as provided by 37 CFR 1.312. To ensure consideration of such an amendment, it MUST be submitted no later than the payment of the issue fee.

Authorization for this examiner's amendment was given in an interview with Mincheol Kim Reg. No.: 51, 306 on 7/14/17.

The application has been amended as follows:

1. (Currently Amended) A mobile communication terminal comprising: a touch screen display;  
a power button configured to turn on and off the terminal by pressing; and an activation button separate from the power button and located outside the touch screen display, the activation button configured for pressing to turn on the touch screen display,  
wherein upon one-time pressing of the activation button while the touch screen display is turned off, the terminal is configured to turn on the touch screen display and perform a fingerprint authentication function in addition to turning on the touch screen display such that:  
a lock screen is displayed on the touch screen display upon turning on the touch screen display in response to the one-time pressing of the activation button while the touch screen display being turned off, in addition to turning on the touch screen display and displaying the lock screen, the one-time pressing while the touch screen display being turned off initiates the

Art Unit: 2646

fingerprint authentication function, the lock screen is displayed on the touch screen display when the fingerprint authentication function initiated by the one-time pressing is being performed,

a lock state of the terminal continues when the fingerprint authentication function fails to authenticate a user, and the lock state is released for enabling other functions of the terminal when the fingerprint authentication function authenticates a user in response to the onetime pressing of the activation button while the touch screen display being turned off- ,wherein the terminal is further configured to perform at least one function other than the fingerprint authentication function in addition to turning on the touch screen display for displaying the lock screen in response to the one-time pressing of the activation button when the one-time pressing is for long time longer than a reference time period, wherein the at least one function to perform in addition to turning on the touch screen display for displaying the lock screen in response to the one-time pressing for long time is associated with initiating a hands-free operation of the terminal.

**5. (Canceled)**

11. (Currently Amended) A method of operating a mobile computing terminal, the method comprising:

providing a mobile computing terminal which comprises a touch screen display, a camera, a power button for pressing to turn on/off the terminal, and an activation button for pressing to turn on the touch screen display, the activation button located outside the touch screen display; detecting one-time pressing of the activation button while the terminal is in an inactive state in which the touch screen display is turned off; in response to the one-time pressing, changing the terminal from the inactive state to an active state in which the touch

Art Unit: 2646

screen display is turned on; and in addition to changing to the active state, further performing a fingerprint authentication function using fingerprint recognition without additional user input, wherein in changing to the active state and performing the fingerprint authentication function, the terminal operates such that:

a lock screen is displayed on the touch screen display upon changing the terminal from the inactive state to the active state in response to the one-time pressing of the activation button while the terminal being in the inactive state,

in addition to changing the terminal to the active state, the one-time pressing while the terminal being in the inactive state initiates the fingerprint authentication function,

the lock screen is displayed on the touch screen display when the fingerprint authentication function initiated by the one-time pressing is being performed,

a lock state of the terminal continues when the fingerprint authentication function fails to authenticate a user, and the lock state is released for enabling other functions of the terminal when the fingerprint authentication function authenticates a user in response to the onetime pressing of the activation button while the terminal being in the inactive state, wherein the method further comprises performing at least one function other than the fingerprint authentication function in addition to changing to the active state in response to the one-time pressing during the terminal's inactive state when the one-time pressing is for long time longer than a reference time period, wherein the at least one function to perform in addition to turning on the touch screen display for displaying the lock screen in response to the one-time pressing for long time is associated with initiating a hands-free operation of the terminal.

**15. (Canceled)**



Art Unit: 2646

**19. (Currently Amended)** The method of Claim 11, wherein the method further comprises performing at least one function other than the fingerprint authentication function in addition to changing to the active state in response to the one-time pressing during the terminal's inactive state when the one-time pressing is for long time longer than ~~the~~ a reference time period.

***Conclusion***

Any inquiry concerning this communication or earlier communications from the examiner should be directed to CHARLES SHEDRICK whose telephone number is (571)272-8621. The examiner can normally be reached on Monday thru Friday 8:00AM-4:30PM.

Examiner interviews are available via telephone, in-person, and video conferencing using a USPTO supplied web-based collaboration tool. To schedule an interview, applicant is encouraged to use the USPTO Automated Interview Request (AIR) at <http://www.uspto.gov/interviewpractice>.

If attempts to reach the examiner by telephone are unsuccessful, the examiner's supervisor, Lester Kincaid can be reached on (571)-272-7922. The fax phone number for the organization where this application or proceeding is assigned is 571-273-8300.

Art Unit: 2646

Information regarding the status of an application may be obtained from the Patent Application Information Retrieval (PAIR) system. Status information for published applications may be obtained from either Private PAIR or Public PAIR. Status information for unpublished applications is available through Private PAIR only. For more information about the PAIR system, see <http://pair-direct.uspto.gov>. Should you have questions on access to the Private PAIR system, contact the Electronic Business Center (EBC) at 866-217-9197 (toll-free). If you would like assistance from a USPTO Customer Service Representative or access to the automated information system, call 800-786-9199 (IN USA OR CANADA) or 571-272-1000.

/CHARLES SHEDRICK/  
Primary Examiner, Art Unit 2646

<b>Examiner-Initiated Interview Summary</b>	<b>Application No.</b> 14/848,191	<b>Applicant(s)</b> JUNG ET AL.	
	<b>Examiner</b> CHARLES SHEDRICK	<b>Art Unit</b> 2646	

All participants (applicant, applicant's representative, PTO personnel):

(1) CHARLES SHEDRICK. (3)\_\_\_\_\_.

(2) Mincheol Kim 51,306. (4)\_\_\_\_\_.

Date of Interview: 14 July 2017.

Type:  Telephonic  Video Conference  
 Personal [copy given to:  applicant  applicant's representative]

Exhibit shown or demonstration conducted:  Yes  No.  
If Yes, brief description: \_\_\_\_\_.

Issues Discussed 101 112 102 103 Others  
(For each of the checked box(es) above, please describe below the issue and detailed description of the discussion)

Claim(s) discussed: independent.

Identification of prior art discussed: \_\_\_\_\_.

**Substance of Interview**

(For each issue discussed, provide a detailed description and indicate if agreement was reached. Some topics may include: identification or clarification of a reference or a portion thereof, claim interpretation, proposed amendments, arguments of any applied references etc...)


Applicant and Examiner discussed and agreed on claimed amendments to place the case in condition for allowance.

**Applicant recordation instructions:** It is not necessary for applicant to provide a separate record of the substance of interview.

**Examiner recordation instructions:** Examiners must summarize the substance of any interview of record. A complete and proper recordation of the substance of an interview should include the items listed in MPEP 713.04 for complete and proper recordation including the identification of the general thrust of each argument or issue discussed, a general indication of any other pertinent matters discussed regarding patentability and the general results or outcome of the interview, to include an indication as to whether or not agreement was reached on the issues raised.

Attachment

/CHARLES SHEDRICK/  
Primary Examiner, Art Unit 2646

<b>Search Notes</b>  	<b>Application/Control No.</b>  14848191	<b>Applicant(s)/Patent Under Reexamination</b>  JUNG ET AL.
	<b>Examiner</b>  CHARLES SHEDRICK	<b>Art Unit</b>  2646

CPC- SEARCHED		
Symbol	Date	Examiner
H04W 4/02 ; H04W 12/08 ; H04M 1/67 ; H04M 1/7258 ; H04M 2250/52 ; H04M 1/72519 ; H04W 8/22; H04W 52/027 ; G06F 21/32 ; H04W 12/06 ; H04M 22	1/26/2016	cs

CPC COMBINATION SETS - SEARCHED		
Symbol	Date	Examiner


US CLASSIFICATION SEARCHED			
Class	Subclass	Date	Examiner
455	411,414.1, 420,404.2, 410	1/26/2016	cs
726	1,16	1/26/2016	cs

\* See search history printout included with this form or the SEARCH NOTES box below to determine the scope of the search.

SEARCH NOTES		
Search Notes	Date	Examiner
EAST text search, CPC search, Inventor search	1/19/2016	cs
updated searched notes EAST cross reference text search with CPC and US classes	7/18/2017	CS

INTERFERENCE SEARCH			
US Class/ CPC Symbol	US Subclass / CPC Group	Date	Examiner
see searched notes and searched classes		11/28/2016	CS


--	--

<b>Issue Classification</b> 	<b>Application/Control No.</b> 14848191	<b>Applicant(s)/Patent Under Reexamination</b> JUNG ET AL.
	<b>Examiner</b> CHARLES SHEDRICK	<b>Art Unit</b> 2646

CPC						
Symbol					Type	Version
G06Q	30	0262			F	2013-01-01
H04W	4	02			I	2013-01-01
H04W	4	22			A	2013-01-01
H04M	1	67			I	2013-01-01
H04M	1	7258			I	2013-01-01
H04M	2250	52			A	2013-01-01
H04M	1	72519			I	2013-01-01
H04W	8	22			I	2013-01-01
G06F	21	32			I	2013-01-01
H04W	12	06			I	2013-01-01
H04M	2250	12			A	2013-01-01
H04W	52	027			I	2013-01-01
G06F	3	04883			I	2013-01-01
G06K	9	00087			I	2013-01-01
H04W	88	02			A	2013-01-01
G06K	9	00006			I	2013-01-01
G06K	9	00221			I	2013-01-01
G06K	9	00597			I	2013-01-01
H04L	63	0861			I	2013-01-01
H04W	12	08			I	2013-01-01
G06Q	30	0241			I	2013-01-01
G06F	21	36			I	2013-01-01
G06F	21	62			I	2013-01-01
G06Q	30	0261			I	2013-01-01
G06Q	30	0267			I	2013-01-01
G06Q	30	0269			I	2013-01-01
Y02B	60	50			A	2013-01-01


CPC Combination Sets				
Symbol	Type	Set	Ranking	Version

NONE		<b>Total Claims Allowed:</b>	
(Assistant Examiner)	(Date)	18	
/CHARLES SHEDRICK/ Primary Examiner.Art Unit 2646	07/18/2017	O.G. Print Claim(s)	O.G. Print Figure
(Primary Examiner)	(Date)	1	1

<b>Issue Classification</b> 	<b>Application/Control No.</b> 14848191	<b>Applicant(s)/Patent Under Reexamination</b> JUNG ET AL.
	<b>Examiner</b> CHARLES SHEDRICK	<b>Art Unit</b> 2646


--	--	--	--	--	--

NONE		<b>Total Claims Allowed:</b>	
(Assistant Examiner)	(Date)	18	
/CHARLES SHEDRICK/ Primary Examiner. Art Unit 2646	07/18/2017	O.G. Print Claim(s)	O.G. Print Figure
(Primary Examiner)	(Date)	1	1

<b>Issue Classification</b> 	<b>Application/Control No.</b> 14848191	<b>Applicant(s)/Patent Under Reexamination</b> JUNG ET AL.
	<b>Examiner</b> CHARLES SHEDRICK	<b>Art Unit</b> 2646

US ORIGINAL CLASSIFICATION				INTERNATIONAL CLASSIFICATION									
CLASS		SUBCLASS		CLAIMED				NON-CLAIMED					
455		411		H	0	4	M	1 / 00					
<b>CROSS REFERENCE(S)</b>													
CLASS	SUBCLASS (ONE SUBCLASS PER BLOCK)												
455	414.1	420											
726	1	16											

NONE		<b>Total Claims Allowed:</b>	
		18	
(Assistant Examiner)	(Date)	O.G. Print Claim(s)	O.G. Print Figure
/CHARLES SHEDRICK/ Primary Examiner, Art Unit 2646	07/18/2017	1	1
(Primary Examiner)	(Date)		

<b>Issue Classification</b> 	<b>Application/Control No.</b> 14848191	<b>Applicant(s)/Patent Under Reexamination</b> JUNG ET AL.
	<b>Examiner</b> CHARLES SHEDRICK	<b>Art Unit</b> 2646

<input checked="" type="checkbox"/> <b>Claims renumbered in the same order as presented by applicant</b>																<input type="checkbox"/> <b>CPA</b>		<input type="checkbox"/> <b>T.D.</b>		<input type="checkbox"/> <b>R.1.47</b>	
Final	Original	Final	Original	Final	Original	Final	Original	Final	Original	Final	Original	Final	Original	Final	Original						
1	1	15	17																		
2	2	16	18																		
3	3	17	19																		
4	4	18	20																		
	5																				
5	6																				
6	7																				
7	8																				
8	9																				
9	10																				
10	11																				
11	12																				
12	13																				
13	14																				
	15																				
14	16																				

NONE  (Assistant Examiner) _____ (Date) _____		<b>Total Claims Allowed:</b> 18	
/CHARLES SHEDRICK/ Primary Examiner. Art Unit 2646  (Primary Examiner) _____ (Date) _____		O.G. Print Claim(s) 1	O.G. Print Figure 1



Document Description: Issue Fee Payment (PTO-85B)

**Issue Fee Transmittal Form**

Application Number	Filing Date	First Named Inventor	Atty. Docket No.	Confirmation No.
14848191	08-Sep-2015	Jae Lark JUNG	UNIS005.001C2	9599

**TITLE OF INVENTION :**

ACTIVATING DISPLAY AND PERFORMING USER AUTHENTICATION IN MOBILE TERMINAL WITH ONE-TIME USER INPUT

Entity Status	Application Type	Art Unit	Class - Subclass	EXAMINER
Small	Utility under 35 USC 111(a)	2646	411000	CHARLES SHEDRICK
Issue Fee Due	Publication Due	Total Fee(s) Due	Date Due	Prev. Paid Fee
\$480	\$0	\$480	27-Oct-2017	\$0

**1.Change of Correspondence Address and/or Indication Of Fee Address (37 CFR 1.33 & 1.363)**

Current Correspondence Address:	Current Indicated Fee Address :
20995 KNOBBE MARTENS OLSON & BEAR LLP  2040 MAIN STREET FOURTEENTH FLOOR IRVINE CA 92614 UNITED STATES 949-760-0404 efilings@knobbe.com	
<input type="checkbox"/> Change of correspondence address requested, system generated AIA/122-EFS form attached	<input type="checkbox"/> Fee Address indication requested, system generated SB/47-EFS form attached

**2.Entity Status****Change in Entity Status**

Applicant certifying micro entity status; system generated Micro Entity certification form attached. See 37 CFR 1.29.

Note: Absent a valid certification of micro entity status, issue fee payment in the micro entity amount will not be accepted at the risk of application abandonment.

- If this box is checked, you will be prompted to choose a micro entity status on the gross income basis (37 CFR 1.29(a)) or the institution of higher education basis (37 CFR 1.29(d)), and make the applicable certification online.

- Applicant asserting small entity status. See 37 CFR 1.27.

Note: If the application was previously under micro entity status, checking this box will be taken to be a notification of loss of entitlement to micro entity status.

- Applicant changing to regular undiscounted fee status.

Note: Checking this box will be taken to be a notification of loss of entitlement to small or micro entity status, as applicable.

Document Description: Issue Fee Payment (PTO-85B)

**3.The Following Fee(s) Are Submitted:**

Issue Fee  I authorize USPTO to apply my previously paid issue fee to the current fees due

Publication Fee  The Director is hereby authorized to apply my previously paid issue fee to the current fee due and to charge deficient fees to Deposit Account Number \_\_\_\_\_

Advance Order - # of copies \_\_\_\_\_  **If in addition to the payment of the issue fee amount submitted with this form, there are any discrepancies in any amount(s) due, the Director is authorized to charge any deficiency, or credit any overpayment, to Deposit Account Number 111410. The issue fee must be submitted with this form. If payment of the issue fee does not accompany this form, checking this box and providing a deposit account number will NOT be effective to satisfy full payment of the fee(s) due.**

**4.Firm and/or Attorney Names To Be Printed**

**NOTE: If no name is listed, no name will be printed**  
For printing on the patent front page, list to be displayed as entered

1. KNOBBE MARTENS OLSON & BEAR LLP
- 2.
- 3.

**5.Assignee Name(s) and Residence Data To Be Printed**

PLEASE NOTE: Unless an assignee is identified below, no assignee data will appear on the patent. If an assignee is identified below, the document has been filed for recordation as set forth in 37 CFR 3.11. Completion of this form is NOT a substitute for filing an assignment.

Name	City	State	Country	Category
FIRSTFACE CO., LTD.	Seoul		korea, republic of	corporation

**6.Signature**

I certify, in accordance with 37 CFR 1.4(d)(4) that I am an attorney or agent registered to practice before the Patent and Trademark Office who has filed and has been granted power of attorney in this application. I also certify that this Fee(s) Transmittal form is being transmitted to the USPTO via EFS-WEB on the date indicated below.

<b>Signature</b>	/Mincheol Kim/	<b>Date</b>	08-30-2017
<b>Name</b>	Mincheol Kim	<b>Registration Number</b>	51306

## Electronic Patent Application Fee Transmittal

<b>Application Number:</b>	14848191
<b>Filing Date:</b>	08-Sep-2015
<b>Title of Invention:</b>	ACTIVATING DISPLAY AND PERFORMING USER AUTHENTICATION IN MOBILE TERMINAL WITH ONE-TIME USER INPUT
<b>First Named Inventor/Applicant Name:</b>	Jae Lark JUNG
<b>Filer:</b>	Mincheol Kim/Imran Ahmed
<b>Attorney Docket Number:</b>	UNIS005.001C2

Filed as Small Entity

### Filing Fees for Utility under 35 USC 111(a)

Description	Fee Code	Quantity	Amount	Sub-Total in USD(\$)
<b>Basic Filing:</b>				
UTILITY APPL ISSUE FEE	2501	1	480	480
PUBL. FEE- EARLY, VOLUNTARY, OR NORMAL	1504	1	0	0

**Pages:**

**Claims:**

**Miscellaneous-Filing:**

**Petition:**

**Patent-Appeals-and-Interference:**

Description	Fee Code	Quantity	Amount	Sub-Total in USD(\$)
<b>Post-Allowance-and-Post-Issuance:</b>				
<b>Extension-of-Time:</b>				
<b>Miscellaneous:</b>				
			<b>Total in USD (\$)</b>	<b>480</b>

## Electronic Acknowledgement Receipt

<b>EFS ID:</b>	30224180
<b>Application Number:</b>	14848191
<b>International Application Number:</b>	
<b>Confirmation Number:</b>	9599
<b>Title of Invention:</b>	ACTIVATING DISPLAY AND PERFORMING USER AUTHENTICATION IN MOBILE TERMINAL WITH ONE-TIME USER INPUT
<b>First Named Inventor/Applicant Name:</b>	Jae Lark JUNG
<b>Customer Number:</b>	20995
<b>Filer:</b>	Mincheol Kim/Imran Ahmed
<b>Filer Authorized By:</b>	Mincheol Kim
<b>Attorney Docket Number:</b>	UNIS005.001C2
<b>Receipt Date:</b>	30-AUG-2017
<b>Filing Date:</b>	08-SEP-2015
<b>Time Stamp:</b>	18:53:28
<b>Application Type:</b>	Utility under 35 USC 111(a)

### Payment information:

Submitted with Payment	yes
Payment Type	CARD
Payment was successfully received in RAM	\$480
RAM confirmation Number	083117INTEFSW18532500
Deposit Account	
Authorized User	

The Director of the USPTO is hereby authorized to charge indicated fees and credit any overpayment as follows:

--	--	--	--	--	--

**File Listing:**

Document Number	Document Description	File Name	File Size(Bytes)/ Message Digest	Multi Part /.zip	Pages (if appl.)
1	Issue Fee Payment (PTO-85B)	Web85b.pdf	46204	no	2
			930d1c3716e5466a87aa94858cb174f0d95d9cb		

**Warnings:**

**Information:**

2	Fee Worksheet (SB06)	fee-info.pdf	32128	no	2
			816c62a691aa2e6da1d51d988f0814add91d6a89		

**Warnings:**

**Information:**

<b>Total Files Size (in bytes):</b>			78332		
-------------------------------------	--	--	-------	--	--

**This Acknowledgement Receipt evidences receipt on the noted date by the USPTO of the indicated documents, characterized by the applicant, and including page counts, where applicable. It serves as evidence of receipt similar to a Post Card, as described in MPEP 503.**

**New Applications Under 35 U.S.C. 111**

**If a new application is being filed and the application includes the necessary components for a filing date (see 37 CFR 1.53(b)-(d) and MPEP 506), a Filing Receipt (37 CFR 1.54) will be issued in due course and the date shown on this Acknowledgement Receipt will establish the filing date of the application.**

**National Stage of an International Application under 35 U.S.C. 371**

**If a timely submission to enter the national stage of an international application is compliant with the conditions of 35 U.S.C. 371 and other applicable requirements a Form PCT/DO/EO/903 indicating acceptance of the application as a national stage submission under 35 U.S.C. 371 will be issued in addition to the Filing Receipt, in due course.**

**New International Application Filed with the USPTO as a Receiving Office**

**If a new international application is being filed and the international application includes the necessary components for an international filing date (see PCT Article 11 and MPEP 1810), a Notification of the International Application Number and of the International Filing Date (Form PCT/RO/105) will be issued in due course, subject to prescriptions concerning national security, and the date shown on this Acknowledgement Receipt will establish the international filing date of the application.**

<b>INFORMATION DISCLOSURE STATEMENT BY APPLICANT</b> ( Not for submission under 37 CFR 1.99)	Application Number	14848191
	Filing Date	2015-09-08
	First Named Inventor	Jae Lark Jung
	Art Unit	2646
	Examiner Name	Shedrick, Charles Terrell
	Attorney Docket Number	UNIS005.001C2

U.S.PATENTS							Remove
Examiner Initial*	Cite No	Patent Number	Kind Code <sup>1</sup>	Issue Date	Name of Patentee or Applicant of cited Document	Pages, Columns, Lines where Relevant Passages or Relevant Figures Appear	
	1	7647638	B2	2010-01-12	Furuyama		
	2	8138886	B1	2012-03-20	Chang		
	3	8638305	B2	2014-01-28	Inami		
	4	8965449	B2	2015-02-24	Alvarez Rivera et al.		
	5	9027117	B2	2015-05-05	Wilairat		
(change(s) applied to document. 2/11/2017	6	8793786	B2	<del>07/2014</del> 2017-07-29	Bhesania et al.		
	7	9076008	B1	2015-07-07	Moy		
If you wish to add additional U.S. Patent citation information please click the Add button.							Add
U.S.PATENT APPLICATION PUBLICATIONS							Remove

ALL REFERENCES CONSIDERED EXCEPT WHERE LINED THROUGH. /C.T.S/



# UNITED STATES PATENT AND TRADEMARK OFFICE

UNITED STATES DEPARTMENT OF COMMERCE  
United States Patent and Trademark Office  
Address: COMMISSIONER FOR PATENTS  
P O Box 1450  
Alexandria, Virginia 22313-1450  
www.uspto.gov

APPLICATION NO.	ISSUE DATE	PATENT NO.	ATTORNEY DOCKET NO.	CONFIRMATION NO.
14/848,191	10/03/2017	9779419	UNIS005.001C2	9599

20995 7590 09/13/2017  
KNOBBE MARTENS OLSON & BEAR LLP  
2040 MAIN STREET  
FOURTEENTH FLOOR  
IRVINE, CA 92614

## ISSUE NOTIFICATION

The projected patent number and issue date are specified above.

### **Determination of Patent Term Adjustment under 35 U.S.C. 154 (b)** (application filed on or after May 29, 2000)

The Patent Term Adjustment is 0 day(s). Any patent to issue from the above-identified application will include an indication of the adjustment on the front page.

If a Continued Prosecution Application (CPA) was filed in the above-identified application, the filing date that determines Patent Term Adjustment is the filing date of the most recent CPA.

Applicant will be able to obtain more detailed information by accessing the Patent Application Information Retrieval (PAIR) WEB site (<http://pair.uspto.gov>).

Any questions regarding the Patent Term Extension or Adjustment determination should be directed to the Office of Patent Legal Administration at (571)-272-7702. Questions relating to issue and publication fee payments should be directed to the Application Assistance Unit (AAU) of the Office of Data Management (ODM) at (571)-272-4200.

**APPLICANT(s)** (Please see PAIR WEB site <http://pair.uspto.gov> for additional applicants):

Jae Lark JUNG, Goyang-si, KOREA, REPUBLIC OF;  
FIRSTFACE CO., LTD., Seoul, KOREA, REPUBLIC OF;  
Kyoung duck BAE, Seoul, KOREA, REPUBLIC OF;

The United States represents the largest, most dynamic marketplace in the world and is an unparalleled location for business investment, innovation, and commercialization of new technologies. The USA offers tremendous resources and advantages for those who invest and manufacture goods here. Through SelectUSA, our nation works to encourage and facilitate business investment. To learn more about why the USA is the best country in the world to develop technology, manufacture products, and grow your business, visit [SelectUSA.gov](http://SelectUSA.gov).



**UNITED STATES PATENT AND TRADEMARK OFFICE  
CERTIFICATE OF CORRECTION**

**PATENT NO.** : 9,779,419  
**APPLICATION NO.** : 14/848,191  
**ISSUE DATE** : October 3, 2017  
**INVENTOR(S)** : Jae Lark Jung

Page 1 of 1

It is certified that errors appear in the above-identified patent and that said Letters Patent is hereby corrected as shown below:

In column 13 at line 24, in Claim 1, change "for long time" to --for a long time,--.

In column 13 at line 28, in Claim 1, change "for long time" to --for the long time--.

In column 13 at lines 42-43, in Claim 3, change "for long time longer than a reference time period," to --for the long time, longer than the reference time period,--.

In column 13 at line 48, in Claim 4, change "for long time," to --for the long time,--.

In column 14 at lines 2-3, in Claim 7, change "for long time longer than a reference time period." to --for the long time, longer than the reference time period.--.

In column 14 at lines 59-60, in Claim 10, change "for long time" to --for a long time,--.

In column 14 at line 64, in Claim 10, change "for long time" to --for the long time--.

In column 15 at line 9, in Claim 12, change "for long time longer than a reference time period," to --for the long time, longer than the reference time period,--.

In column 15 at line 16, in Claim 13, change "for long time," to --for the long time,--.

In column 16 at line 13, in Claim 17, change "for long time longer than a reference time period." to --for the long time, longer than the reference time period.--.

27138373

**MAILING ADDRESS OF SENDER:**

Mincheol Kim  
KNOBBE, MARTENS, OLSON & BEAR, LLP  
2040 Main Street, 14<sup>th</sup> Floor  
Irvine, California 92614

DOCKET NO. UNIS005.001C2

Please Direct All Correspondence to Customer Number 20995

**REQUEST FOR CERTIFICATE OF CORRECTION**

First Inventor : Jae Lark JUNG  
App. No. : 14/848,191  
Filed : September 8, 2015  
Patent No. : 9,779,419  
Issue Date : October 3, 2017  
Conf. No. : 9599

Commissioner for Patents  
Office of Data Management  
**Attention:** Certificates of Correction Branch  
P.O. Box 1450  
Alexandria, VA 22313-1450

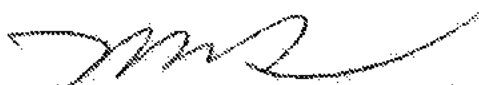
Dear Commissioner:

Enclosed for filing is a Certificate of Correction in connection with the above-identified patent.

The fee of \$100 will be paid via EFS Web. Please charge any additional fees to our Deposit Account No. 11-1410.

Respectfully submitted,  
Knobbe, Martens, Olson & Bear, LLP

Dated: 2019-12-01

By:   
Mincheol Kim  
Registration No. 51,306  
Registered Practitioner  
Customer No. 20995  
(949) 760-0404

27120416

## Electronic Patent Application Fee Transmittal

<b>Application Number:</b>	14848191
<b>Filing Date:</b>	08-Sep-2015
<b>Title of Invention:</b>	ACTIVATING DISPLAY AND PERFORMING USER AUTHENTICATION IN MOBILE TERMINAL WITH ONE-TIME USER INPUT
<b>First Named Inventor/Applicant Name:</b>	Jae Lark JUNG
<b>Filer:</b>	Mincheol Kim/Jacquie O'Brien
<b>Attorney Docket Number:</b>	UNIS005.001C2

Filed as Small Entity

**Filing Fees for Utility under 35 USC 111(a)**

Description	Fee Code	Quantity	Amount	Sub-Total in USD(\$)
<b>Basic Filing:</b>				
<b>Pages:</b>				
<b>Claims:</b>				
<b>Miscellaneous-Filing:</b>				
<b>Petition:</b>				
<b>Patent-Appeals-and-Interference:</b>				
<b>Post-Allowance-and-Post-Issuance:</b>				
CERTIFICATE OF CORRECTION	2811	1	100	100

Description	Fee Code	Quantity	Amount	Sub-Total in USD(\$)
<b>Extension-of-Time:</b>				
<b>Miscellaneous:</b>				
<b>Total in USD (\$)</b>				<b>100</b>

## Electronic Acknowledgement Receipt

<b>EFS ID:</b>	31109872
<b>Application Number:</b>	14848191
<b>International Application Number:</b>	
<b>Confirmation Number:</b>	9599
<b>Title of Invention:</b>	ACTIVATING DISPLAY AND PERFORMING USER AUTHENTICATION IN MOBILE TERMINAL WITH ONE-TIME USER INPUT
<b>First Named Inventor/Applicant Name:</b>	Jae Lark JUNG
<b>Customer Number:</b>	20995
<b>Filer:</b>	Mincheol Kim/Jennifer Neat
<b>Filer Authorized By:</b>	Mincheol Kim
<b>Attorney Docket Number:</b>	UNIS005.001C2
<b>Receipt Date:</b>	01-DEC-2017
<b>Filing Date:</b>	08-SEP-2015
<b>Time Stamp:</b>	20:01:06
<b>Application Type:</b>	Utility under 35 USC 111(a)

### Payment information:

Submitted with Payment	yes
Payment Type	CARD
Payment was successfully received in RAM	\$100
RAM confirmation Number	120417INTEFSW20013300
Deposit Account	111410
Authorized User	Jennifer Neat

The Director of the USPTO is hereby authorized to charge indicated fees and credit any overpayment as follows:

37 CFR 1.16 (National application filing, search, and examination fees)

37 CFR 1.17 (Patent application and reexamination processing fees)

--	--	--	--	--	--

**File Listing:**

Document Number	Document Description	File Name	File Size(Bytes)/ Message Digest	Multi Part /.zip	Pages (if appl.)
1		CertificateCorrection-UNIS005_001 C2.pdf	145565	yes	2
			f4f91484b47d6cb9ad746857a14fa5c3df88f4a		

Multipart Description/PDF files in .zip description					
Document Description		Start	End		
Request for Certificate of Correction		2	2		
Miscellaneous Incoming Letter		1	1		

**Warnings:**

**Information:**

2	Fee Worksheet (SB06)	fee-info.pdf	30602	no	2
			59ae2bbe749dd3f8b0e68ce708bec16df978f45		

**Warnings:**

**Information:**

<b>Total Files Size (in bytes):</b>	176167
-------------------------------------	--------

**This Acknowledgement Receipt evidences receipt on the noted date by the USPTO of the indicated documents, characterized by the applicant, and including page counts, where applicable. It serves as evidence of receipt similar to a Post Card, as described in MPEP 503.**

**New Applications Under 35 U.S.C. 111**

**If a new application is being filed and the application includes the necessary components for a filing date (see 37 CFR 1.53(b)-(d) and MPEP 506), a Filing Receipt (37 CFR 1.54) will be issued in due course and the date shown on this Acknowledgement Receipt will establish the filing date of the application.**

**National Stage of an International Application under 35 U.S.C. 371**

**If a timely submission to enter the national stage of an international application is compliant with the conditions of 35 U.S.C. 371 and other applicable requirements a Form PCT/DO/EO/903 indicating acceptance of the application as a national stage submission under 35 U.S.C. 371 will be issued in addition to the Filing Receipt, in due course.**

**New International Application Filed with the USPTO as a Receiving Office**

**If a new international application is being filed and the international application includes the necessary components for an international filing date (see PCT Article 11 and MPEP 1810), a Notification of the International Application Number and of the International Filing Date (Form PCT/RO/105) will be issued in due course, subject to prescriptions concerning national security, and the date shown on this Acknowledgement Receipt will establish the international filing date of the application.**



UNITED STATES PATENT AND TRADEMARK OFFICE

UNITED STATES DEPARTMENT OF COMMERCE
United States Patent and Trademark Office
Address: COMMISSIONER FOR PATENTS
P O Box 1450
Alexandria, Virginia 22313-1450
www.uspto.gov

Table with 5 columns: APPLICATION NO., FILING DATE, FIRST NAMED INVENTOR, ATTORNEY DOCKET NO., CONFIRMATION NO.
14/848,191 09/08/2015 Jae Lark JUNG UNIS005.001C2 9599

20995 7590 02/28/2018
KNOBBE MARTENS OLSON & BEAR LLP
2040 MAIN STREET
FOURTEENTH FLOOR
IRVINE, CA 92614

EXAMINER

SHEDRICK, CHARLES TERRELL

ART UNIT PAPER NUMBER

2646

NOTIFICATION DATE DELIVERY MODE

02/28/2018

ELECTRONIC

Please find below and/or attached an Office communication concerning this application or proceeding.

The time period for reply, if any, is set in the attached communication.

Notice of the Office communication was sent electronically on above-indicated "Notification Date" to the following e-mail address(es):

jayna.cartee@knobbe.com
efiling@knobbe.com



**UNITED STATES PATENT AND TRADEMARK OFFICE**

Commissioner for Patents  
United States Patent and Trademark Office  
P.O. Box 1450  
Alexandria, VA 22313-1450  
www.uspto.gov

Patent No. 9779419  
Issued Date: 03 October, 2017  
Appl. No: 14/848,191  
Filed.: 08 September 2015

**PART (A) RESPONSE FOR CERTIFICATES OF CORRECTION**

This is a decision on the Certificate of Correction request filed 01 December 2017.

The request for issuance of Certificate of Correction for the above-identified correction(s) under the provisions of 37 CFR 1.322 and/or 1.323 is hereby:

(Check one)

Approved       Approved in Part       Denied

Comments:

**PART (B) PETITION UNDER 37 CFR 1.324 OR 37 CFR 1.48**

This is a decision on the petition filed \_\_\_\_\_ to correct inventorship under 37 CFR 1.324.

This is a decision on the request under 37 CFR 1.48, petition filed \_\_\_\_\_. In view of the fact that the patent has already issued, the request under 37 CFR 1.48 has been treated as a petition to correct inventorship under 37 CFR 1.324.

The petition is hereby:       Granted       Dismissed

Comment:

The patented filed is being forwarded to Certificate of Corrections Branch for issuance of a certificate naming only the actual inventor or inventors.

/LESTER KINCAID/  
Supervisory Patent Examiner, Art Unit 2646  
Technology Center 2600  
Phone: (571)272-7922

Certificates of Correction Branch email: CustomerServiceCoC@uspto.gov CoC Central Phone Number: (703) 756-1814



UNITED STATES PATENT AND TRADEMARK OFFICE  
**CERTIFICATE OF CORRECTION**

PATENT NO. : 9,779,419 B2  
APPLICATION NO. : 14/848191  
DATED : October 3, 2017  
INVENTOR(S) : Jae Lark Jung

Page 1 of 1

It is certified that error appears in the above-identified patent and that said Letters Patent is hereby corrected as shown below:

**In the Claims**

In Column 13 at Line 24, in Claim 1, change “for long time” to --for a long time,--.

In Column 13 at Line 28, in Claim 1, change “for long time” to --for the long time--.

In Column 13 at Lines 42-43, in Claim 3, change “for long time longer than a reference time period,” to --for the long time, longer than the reference time period,--.

In Column 13 at Line 48, in Claim 4, change “for long time,” to --for the long time,--.

In Column 14 at Lines 2-3, in Claim 7, change “for long time longer than a reference time period.” to -  
-for the long time, longer than the reference time period.--.

In Column 14 at Lines 59-60, in Claim 10, change “for long time” to --for a long time,--.

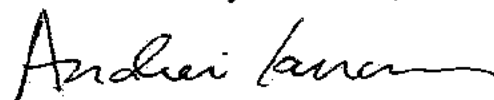
In Column 14 at Line 64, in Claim 10, change “for long time” to --for the long time--.

In Column 15 at Line 9, in Claim 12, change “for long time longer than a reference time period,” to  
--for the long time, longer than the reference time period,--.

In Column 15 at Line 16, in Claim 13, change “for long time,” to --for the long time,--.

In Column 16 at Line 13, in Claim 17, change “for long time longer than a reference time period.” to  
--for the long time, longer than the reference time period.--.

Signed and Sealed this  
Twentieth Day of March, 2018



Andrei Iancu  
*Director of the United States Patent and Trademark Office*

<b>TO: Mail Stop 8</b> <b>Director of the U.S. Patent &amp; Trademark Office</b> <b>P.O. Box 1450</b> <b>Alexandria, VA 22313-1450</b>	<b>REPORT ON THE</b> <b>FILING OR DETERMINATION OF AN</b> <b>ACTION REGARDING A PATENT OR</b> <b>TRADEMARK</b>
---	---

In Compliance with 35 § 290 and/or 15 U.S.C. § 1116 you are hereby advised that a court action has been filed in the U.S. District Court Northern District of California on the following:  
 (X) Patents or ( ) Trademarks

DOCKET NO: 18-cv-02245-LB      DATE FILED: April 16, 2018      UNITED STATES DISTRICT COURT  
 Phillip Burton Federal Building  
 450 Golden Gate Avenue  
 San Francisco, CA 94102

PLAINTIFF: Firstface Co., Ltd.      DEFENDANT: Apple, Inc.

PATENT OR TRADEMARK NO.	DATE OF PATENT OR TRADEMARK	HOLDER OF PATENT OR TRADEMARK
1. 8531557		<del>SEE ATTACHED COMPLAINT</del>
2. 9633313		
3. 9779419		
4.		
5.		

In the above-entitled case, the following patent(s) have been included.

DATE INCLUDED      INCLUDED BY:  
 ( ) Amendment      ( ) Answer      ( ) Cross Bill      ( ) Other Pleading

PATENT OR TRADEMARK NO.	DATE OF PATENT OR TRADEMARK	HOLDER OF PATENT OR TRADEMARK
1.		
2.		
3.		
4.		
5.		

In the above-entitled case, the following decision has been rendered or judgment issued:

DECISION/JUDGEMENT:

*Susan Y. Soong*  
 Susan Y. Soong, Clerk

*Felicia Brown*  
 (by) Deputy Clerk, Felicia Brown

- Copy 1 – Upon initiation of action, mail this copy to Commissioner
- Copy 2 – Upon filing document adding patent(s) mail this copy to Commissioner
- Copy 3 – Upon termination of action, mail this copy to the Commissioner
- Copy 4 – Case file copy