

Under the Paperwork Reduction Act of 1995 no persons are required to respond to a collection of information unless it displays a valid OMB control number

UTILITY PATENT APPLICATION TRANSMITTAL <i>(Only for new nonprovisional applications under 37 CFR 1.53(b))</i>	Attorney Docket No.	10963.3835
	First Named Inventor	Malcolm K. Beyer, Jr.
	Title	METHOD TO PROVIDE AD HOC AND PASSWORD PROTECTED DIGITAL AND VO
	Express Mail Label No.	Filed Electronically

<p style="text-align: center;">APPLICATION ELEMENTS</p> <p style="text-align: center;"><i>See MPEP chapter 600 concerning utility patent application contents.</i></p> <p>1. <input checked="" type="checkbox"/> Fee Transmittal Form (PTO/SB/17 or equivalent)</p> <p>2. <input checked="" type="checkbox"/> Applicant asserts small entity status. See 37 CFR 1.27</p> <p>3. <input type="checkbox"/> Applicant certifies micro entity status. See 37 CFR 1.29. Applicant must attach form PTO/SB/15A or B or equivalent.</p> <p>4. <input checked="" type="checkbox"/> Specification [Total Pages <u>30</u>] Both the claims and abstract must start on a new page. (See MPEP § 608.01(a) for information on the preferred arrangement)</p> <p>5. <input checked="" type="checkbox"/> Drawing(s) (35 U.S.C. 113) [Total Sheets <u>7</u>]</p> <p>6. Inventor's Oath or Declaration [Total Pages <u>3</u>] (including substitute statements under 37 CFR 1.64 and assignments serving as an oath or declaration under 37 CFR 1.63(e))</p> <p>a. <input checked="" type="checkbox"/> Newly executed (original or copy)</p> <p>b. <input type="checkbox"/> A copy from a prior application (37 CFR 1.63(d))</p> <p>7. <input checked="" type="checkbox"/> Application Data Sheet * See note below. See 37 CFR 1.76 (PTO/AIA/14 or equivalent)</p> <p>8. CD-ROM or CD-R in duplicate, large table, or Computer Program (Appendix)</p> <p><input type="checkbox"/> Landscape Table on CD</p> <p>9. Nucleotide and/or Amino Acid Sequence Submission (if applicable, items a. – c. are required)</p> <p>a. <input type="checkbox"/> Computer Readable Form (CRF)</p> <p>b. <input type="checkbox"/> Specification Sequence Listing on:</p> <p>i. <input type="checkbox"/> CD-ROM or CD-R (2 copies); or</p> <p>ii. <input type="checkbox"/> Paper</p> <p>c. <input type="checkbox"/> Statements verifying identity of above copies</p>	<p style="text-align: center;">ADDRESS TO:</p> <p style="text-align: center;">Commissioner for Patents P.O. Box 1450 Alexandria, VA 22313-1450</p> <p style="text-align: center;">ACCOMPANYING APPLICATION PAPERS</p> <p>10. <input type="checkbox"/> Assignment Papers (cover sheet & document(s)) Name of Assignee _____</p> <p>11. <input type="checkbox"/> 37 CFR 3.73(c) Statement <input checked="" type="checkbox"/> Power of Attorney (when there is an assignee)</p> <p>12. <input type="checkbox"/> English Translation Document (if applicable)</p> <p>13. <input checked="" type="checkbox"/> Information Disclosure Statement (PTO/SB/08 or PTO-1449) <input checked="" type="checkbox"/> Copies of citations attached</p> <p>14. <input type="checkbox"/> Preliminary Amendment</p> <p>15. <input type="checkbox"/> Return Receipt Postcard (MPEP § 503) (Should be specifically itemized)</p> <p>16. <input type="checkbox"/> Certified Copy of Priority Document(s) (if foreign priority is claimed)</p> <p>17. <input type="checkbox"/> Nonpublication Request Under 35 U.S.C. 122(b)(2)(B)(i). Applicant must attach form PTO/SB/35 or equivalent.</p> <p>18. <input checked="" type="checkbox"/> Other: Petition to Make Special Based on Age _____ _____ _____</p>
--	---

*Note: (1) Benefit claims under 37 CFR 1.78 and foreign priority claims under 1.55 **must** be included in an Application Data Sheet (ADS).
(2) For applications filed under 35 U.S.C. 111, the application must contain an ADS specifying the applicant if the applicant is an assignee, person to whom the inventor is under an obligation to assign, or person who otherwise shows sufficient proprietary interest in the matter. See 37 CFR 1.46(b).

19. CORRESPONDENCE ADDRESS

The address associated with Customer Number: 22235 OR Correspondence address below

Name			
Address			
City	State	Zip Code	
Country	Telephone	Email	
Signature	/barry l. haley/	Date	February 27, 2015
Name (Print/Type)	Barry L. Haley	Registration No. (Attorney/Agent)	25339

This collection of information is required by 37 CFR 1.53(b). The information is required to obtain or retain a benefit by the public which is to file (and by the USPTO to process) an application. Confidentiality is governed by 35 U.S.C. 122 and 37 CFR 1.11 and 1.14. This collection is estimated to take 12 minutes to complete, including gathering, preparing, and submitting the completed application form to the USPTO. Time will vary depending upon the individual case. Any comments on the amount of time you require to complete this form and/or suggestions for reducing this burden, should be sent to the Chief Information Officer, U.S. Patent and Trademark Office, U.S. Department of Commerce, P.O. Box 1450, Alexandria, VA 22313-1450. DO NOT SEND FEES OR COMPLETED FORMS TO THIS ADDRESS. **SEND TO: Commissioner for Patents, P.O. Box 1450, Alexandria, VA 22313-1450.**

If you need assistance in completing the form, call 1-800-PTO-9199 and select option 2.

Apple Inc. 1002 Part 1 of 2
U.S. Patent No. 9,445,251

Privacy Act Statement

The **Privacy Act of 1974 (P.L. 93-579)** requires that you be given certain information in connection with your submission of the attached form related to a patent application or patent. Accordingly, pursuant to the requirements of the Act, please be advised that: (1) the general authority for the collection of this information is 35 U.S.C. 2(b)(2); (2) furnishing of the information solicited is voluntary; and (3) the principal purpose for which the information is used by the U.S. Patent and Trademark Office is to process and/or examine your submission related to a patent application or patent. If you do not furnish the requested information, the U.S. Patent and Trademark Office may not be able to process and/or examine your submission, which may result in termination of proceedings or abandonment of the application or expiration of the patent.

The information provided by you in this form will be subject to the following routine uses:

1. The information on this form will be treated confidentially to the extent allowed under the Freedom of Information Act (5 U.S.C. 552) and the Privacy Act (5 U.S.C. 552a). Records from this system of records may be disclosed to the Department of Justice to determine whether disclosure of these records is required by the Freedom of Information Act.
2. A record from this system of records may be disclosed, as a routine use, in the course of presenting evidence to a court, magistrate, or administrative tribunal, including disclosures to opposing counsel in the course of settlement negotiations.
3. A record in this system of records may be disclosed, as a routine use, to a Member of Congress submitting a request involving an individual, to whom the record pertains, when the individual has requested assistance from the Member with respect to the subject matter of the record.
4. A record in this system of records may be disclosed, as a routine use, to a contractor of the Agency having need for the information in order to perform a contract. Recipients of information shall be required to comply with the requirements of the Privacy Act of 1974, as amended, pursuant to 5 U.S.C. 552a(m).
5. A record related to an International Application filed under the Patent Cooperation Treaty in this system of records may be disclosed, as a routine use, to the International Bureau of the World Intellectual Property Organization, pursuant to the Patent Cooperation Treaty.
6. A record in this system of records may be disclosed, as a routine use, to another federal agency for purposes of National Security review (35 U.S.C. 181) and for review pursuant to the Atomic Energy Act (42 U.S.C. 218(c)).
7. A record from this system of records may be disclosed, as a routine use, to the Administrator, General Services, or his/her designee, during an inspection of records conducted by GSA as part of that agency's responsibility to recommend improvements in records management practices and programs, under authority of 44 U.S.C. 2904 and 2906. Such disclosure shall be made in accordance with the GSA regulations governing inspection of records for this purpose, and any other relevant (*i.e.*, GSA or Commerce) directive. Such disclosure shall not be used to make determinations about individuals.
8. A record from this system of records may be disclosed, as a routine use, to the public after either publication of the application pursuant to 35 U.S.C. 122(b) or issuance of a patent pursuant to 35 U.S.C. 151. Further, a record may be disclosed, subject to the limitations of 37 CFR 1.14, as a routine use, to the public if the record was filed in an application which became abandoned or in which the proceedings were terminated and which application is referenced by either a published application, an application open to public inspection or an issued patent.
9. A record from this system of records may be disclosed, as a routine use, to a Federal, State, or local law enforcement agency, if the USPTO becomes aware of a violation or potential violation of law or regulation.

**METHOD TO PROVIDE AD HOC AND PASSWORD PROTECTED DIGITAL AND
VOICE NETWORKS**

CROSS REFERENCE TO RELATED APPLICATIONS

[0001] This application is a continuation of co-pending U.S. Patent Application Serial No. 14/529,978, filed on October 31, 2014, which is a continuation of U.S. Patent Application Serial No. 14/027,410, filed on September 16, 2013, now U.S. Patent No. 8,880,042, issued November 4, 2014, which is a continuation of U.S. Patent Application Serial No. 13/751,453 filed January 28, 2013, now U.S. Patent No. 8,538,393 issued September 17, 2013, which is a continuation-in-part of U.S. Patent Application Serial No. 12/761,533 filed on April 16, 2010, now U.S. Patent No. 8,364,129 issued January 29, 2013, which is a continuation-in-part of U.S. Patent Application Serial No. 11/615,472 filed on December 22, 2006, now U.S. Patent No. 8,126,441 issued on February 28, 2012, which is a continuation-in-part of U.S. Patent Application Serial No. 11/308,648 filed April 17, 2006, now U.S. Patent No. 7,630,724 issued on December 8, 2009, which is a continuation-in-part of U.S. Patent Application Serial No. 10/711,490, filed on September 21, 2004, now U.S. Patent No. 7,031,728 issued on April 18, 2006. All of the proceeding applications are incorporated herein by reference in their entirety

BACKGROUND OF THE INVENTION

Field of the Invention

[0002] A communications method and system using a plurality of cellular phones each having an integrated Personal Digital Assistant (PDA) and Global Positioning System (GPS) receiver for the management of two or more people through the use of a communications network. The method and system provide each user with an integrated handheld cellular/PDA/GPS/phone that has Advanced Communication Software application programs

(hereinafter referred to as ACS) and databases used in conjunction with a remote Server that enable a user to quickly establish a communication network of cell phone participants having a common temporary ad hoc network using mobile wireless communication devices.

[0003] The invention includes a method and communication system to quickly set up and provide ad hoc, password protected, digital and voice networks to allow a group of people to be able to set up a network easily and rapidly, especially in an emergency situation.

Description of Related Art

[0004] The purpose of a communications system is to transmit digital messages from a source, located at one point, to user destination(s), located at other point(s) some distance away. A communications system is generally comprised of three basic elements: transmitter, information channel and receiver. One form of communication in recent years is cellular phone telephony. A network of cellular communication systems set up around an area such as the United States allows multiple users to talk to each other, either on individual calls or on group calls. Some cellular phone services enable a cellular phone to engage in conference calls with a small number of users. Furthermore, cellular conference calls can be established through 800 number services. Cellular telephony also now includes systems that include GPS navigation that utilizes satellite navigation. These devices thus unite cellular phone technology with navigation information, computer information transmission and receipt of data.

[0005] The method and operation of communication devices used herein are described in U.S. Patent 7,031,728 which is hereby incorporated by reference and U.S. Patent No. 7,630,724.

[0006] Military, first responder, and other public and private emergency groups need to be able to set up ad hoc digital and voice networks easily and rapidly. These private networks may be temporary or longer lasting in nature. The users need to be able to rapidly coordinate their

activities eliminating the need for pre-entry of data into a web and or identifying others by name, phone numbers or email addresses so that all intended participants that enter the agreed ad hoc network name and password are both digitally and voice interconnected. When a user or users leave the network, no data concerning the network participants need be retained.

[0007] Coordinating different organizations at the scene of a disaster presents several problems as there are voice and digital data (text messages) communications that need to be constantly occurring up and down the chain of command. As an example, communications are required from a police chief to a police captain to a police lieutenant to a police sergeant to a policeman and then back up the same chain of command. Digital data exchange of GPS data or other means provides the location component of the units. Digital chat, text messages, white boards and photo video exchange provide extensive collaboration. However, during a disaster, other first responders such as fire departments must become engaged. While the fire department users may have voice and digital data (text messages) communications up and down their chain of command, these individuals do not have the ability to cross communicate necessarily with police units without a substantial degree of immediate coordination. The method and system in accordance with the present invention described herein discloses how digital communications along with Personal Computer (PC) and PDA devices can be used to quickly establish user specific password protected private ad hoc voice and data networks to enable both data and voice communications up and down their chain of command and simultaneously with different, not pre-known, organizations responding to a disaster. The invention defines a method of accomplishing this by providing all personnel that need to communicate with each other with a PC or PDA which are interconnected to a Server using cellular or other communications.

SUMMARY OF THE INVENTION

[0008] Applicant's communication system and method described herein is embodied in the Advanced Communication Software (ACS) application programs developed by applicant and installed in the integrated PDA/GPS cell phones used herein and remote Servers.

[0009] A plurality of Internet Protocol (IP) capable PDA/GPS devices each having ACS application programs and databases provides a communication network in conjunction with a remote Server that provides the ability to: a) establish an ad hoc network of devices so that the devices can either broadcast to a group or selectively transmit to each of the other; each PDA / GPS phone starts by requesting access to the Server and identifying a mutually agreed to network name and password and once granted, reports its GPS position and status; the Server then routes the data to all signed on network participants so that each of the devices exchange location, status and other information; (b) force the received information to the recipient's display and enable the recipient to acquire additional information by touching the display screen at a remote phone's location on the PDA display; (c) make calls to or send data to remote phones by touching their display symbols and selecting the appropriate soft switch; (d) layer a sufficient number of soft switches or buttons on the PDA display to perform the above functions without overlaying the map; and (e) allow a polling mode in each cell phone that permits a user to contact other cell phone users that have a common interest or relationship with a password and identifier for communication and to establish quickly a temporary ad hoc network especially in an emergency.

[00010] A communication Server acts as a forwarder for IP communications between any combination of cell phone/PDA users and/or PC based users. Network participant location, identity and status messages are sent to the Server by each user. Network participant entered

tracks are also sent to the Server. Because this network participant location and track data is of interest to all the network participants, the Server forwards the data received from one participant to all other participants, causing their displays automatically, without any operator action, to display the received information, thus providing the information necessary for all network participants to know the identity, location and status of all other network participants.

[00011] The Server also acts as a forwarder of data addressed from one participant to one or more addressed participants, thus permitting the transmission of free text, preformatted messages, photographs, video, Email and Uniform Resource Locator (URL) data from one network participant to other selected network participants.

[00012] The above functions can also be accomplished using peer to peer WiFi, WiMax or other peer to peer communications. However, for use with cellular communications and to assure the level of security that cell phone companies require, a centralized static IP routable Server is used.

[00013] The IP Server also fills another role of being a database from which data can be requested by network participants (i.e. maps, satellite images, and the like) or can be pushed to network participants (i.e. symbology and soft switch changes, and the like). The Server is used to establish an ad hoc network within certain groups using an ad hoc event name and password.

[00014] This invention provides a method and a system establishing an ad hoc password protected digital and voice network that can be temporarily set up or longer lasting in nature. The invention described herein allows users to rapidly coordinate their activities without having to pre-enter data into a web or identify others by name, E mail addresses or phone numbers. Essentially the users that establish the ad hoc and password protected digital and voice networks are required to enter the Server's IP address and an ad hoc event name and a password. In the

case of military and first responders, the name of the user's unit may also be used. This action causes the specific PDA or PC of the user to commence reporting directly to the Server's IP address. Once the Server receives the initial IP message from the user's PDA or PC, the server can commence to exchange data with the user's PDA or PC. The initial IP message may also contain additional data such as a license number and, if desired, a phone number manually entered or automatically acquired by the ACS. The IP address of the PDA and PC unit sending the initial IP message is stored by the Server. The Server then responds with a message notifying the user that his PC / PDA is connected to the Server. The user PDA/PC then reports its GPS location and other status information directly to the Server. This information is retained by the Server even when there are no other devices initially communicating with the Server. When the other user's devices sign on to the Server with the same ad hoc event name and password, the Server software then recognizes all the users and stores their IP addresses in the Server. Thus the Server has all the users IP addresses stored and can pass location and status information among the ad hoc network participants even though the network participants have not entered other network participants' names, phone numbers or email addresses. Thus one of the purposes of the invention is to allow an ad hoc network to be formed on a temporary basis in a rapid manner.

[00015] When using the PTT feature, the ACS can enable the network participant to: 1. PTT with all that are in the ad hoc digital network, or 2. PTT with select specific network participants, by touching their symbol(s) and then selecting PTT soft switch or 3. Specify a group of the network participants by assigning their symbols or unit names to a list of network participants and then associating the list with a soft switch whose function is to enable the operator to have PTT communications with all in the list.

[00016] Since only one person is transmitting on a PTT voice network at any given time, the receiving network participant's ACS can relate the PTT IP address to the IP address of the unit transmitting his identification on the digital ad hoc network. This information can then be used by the other PTT networked participant's ACS to: 1. flash the transmitting unit's name on their PDA / PC screens or 2. if a photograph has been attached to the ad hoc digital network symbol of the PTT transmitting person, to flash that photograph on the receiving unit's PDA / PC display.

[00017] It is an object of this invention to enable each participant in the communication network to join other ad hoc network participants to form an ad hoc digital and voice network with other cell phone users rapidly for coordinating member activities.

[00018] In accordance with these and other objects which will become apparent hereinafter, the instant invention will now be described with particular reference to the accompanying drawings.

BRIEF DESCRIPTION OF THE DRAWINGS

[00019] Figure 1 shows a front plan view of a cellular phone/PDA/GPS having a touch screen.

[00020] Figure 2 shows the screen IP address entry menu.

[00021] Figure 3 shows ad hoc net names and password screen entry name.

[00022] Figure 4 shows a screen entry identifying user.

[00023] Figure 5 shows a flow chart of the network as users sign on to the network.

[00024] Figure 6 shows a flow chart that depicts how a group commander can command networked PDAs / PCS and radios to load a Push To Talk (PTT) channel.

[00025] Figure 7 shows a flow chart that depicts how networked radio units respond to receipt of the Push-to-Talk (PTT) Commanded Channel.

[00026] Figure 8 shows a PDA screen geographical display that represents the area covered by the network.

[00027] Figure 9 shows a diagram that enables determining location, status, ViOP, PTT, and video communication between radios and cell phones.

[00028] Figure 10 shows a diagram that describes enabling non RFID equipped PDA phones to receive RFID tag data.

PREFERRED EMBODIMENT OF THE INVENTION

[00029] A method and communication system that joins a communications network of participants using handheld cell phones having integrated PDA and GPS circuitry with ACS application programs that allow a participant having an ACS equipped cell phone to provide an ad hoc and password protected digital and voice network.

[00030] A communication Server acts as a forwarder for IP communications between any combination of cell phone/PDA users and/or PC based user. Network participant location, identity and status messages are sent to the Server by each user. Network participant entered tracks are also sent to the Server. Because this data is of interest to all the network participants, the Server forwards the data received from one participant to all other participants, thus providing the information necessary for all network participants to know the identity, location and status of all other network participants.

[00031] The Server allows the set up of the ad hoc network with an ad hoc event name and a password.

[00032] The Server also acts as a forwarder of data addressed from one participant to one or more addressed participants, thus permitting the transmission of free text, preformatted

messages, photographs, video, email and URL data from one network participant to other selected network participants.

[00033] Referring now to the drawings and, in particular, to Figure 1, a small handheld cellular phone 10 is shown that includes a PDA and a GPS communications device integrated in housing 12 that includes an on/off power switch 19, a microphone 38, and a Liquid Crystal Display (LCD) display 16 that is also a touch screen system. The small area 16a is the navigation bar that depicts the telephone, GPS and other status data and the active software. Each cell phone includes a Central Processing Unit (CPU) and databases that store information useful in the communication network. The CPU also includes a symbol generator for creating touch screen display symbols discussed herein. With the touch screen 16, the screen symbols are entered through GPS inputs or by the operator using a stylus 14 (or operator finger) by manipulatively directing the stylus 14 to literally touch display 16. The soft switches 16d displayed on the display 16 are likewise activated by using a stylus 14 and physically and manipulatively directing the stylus to literally touch display 16. The display x, y coordinates of the touched point are known by a CPU in the PDA section of the communication system in housing 12 that can coordinate various information contained in the PDA relative to the x, y coordinate position on the display 16. Inside housing 12 is contained the conventional cellular phone elements including a modem, a CPU for use with a PDA and associated circuitry connected to speaker 24 and microphone 38. A GPS navigational receiver that receives signals from satellites that can determine the latitude and longitude of the cellular phone housing 12 can be internal or external to the housing 12. Conventional PDA/cellular phones are currently on sale and sold as a unit (or with an external connected GPS) that can be used for cellular telephone calls and sending cellular Short Message Service (SMS) and Transmission Control

Protocol (TCP) TCP/IP or other messages using the PDA's display 16 and computer CPU. The GPS system including a receiver in housing 12 is capable of determining the latitude and longitude and through SMS, TCP/IP, WiFi or other digital messaging software, to also transmit this latitude and longitude information of housing 12 to other cellular phones in the communication network via cellular communications, WiFi or radio. The device 10 includes a pair of cellular phone hardware activating buttons 20 to turn the cellular phone on and 22 to turn the cellular phone off. Navigation pad actuator 18 is similar to a joy or force stick in that the actuator 18 manually provides movement commands that can be used by the PDA's software to move a cursor on display 16. Switches 26 and 28 are designed to quickly select an operator specified network software program. Speaker 24 and microphone 38 are used for audio messages. Switch 19 at the top left of device 10 is the power on and power off switch for the entire device.

[00034] The heart of the invention lies in the applicant's ACS application programs provided in the device. The ACS programs are activated by clicking on an icon on the display to turn the ACS programs on or off. Mounted within housing 12 as part of the PDA is the display 16 and the CPU. The internal CPU includes databases and software application programs that provide for a geographical map and georeferenced entities that are shown as display portion 16b that includes as part of the display various areas of interest in the particular local map section.

[00035] When looking at display 16, the software switches (soft switches) which appear at the very bottom of the display 16d are used to control by touch many of the software driven functions of the cellular phone and PDA. The soft switches are activated through the operator's use of the navigation pad 18, or a small track ball, force stick or similar hardware display cursor pointing device. Alternatively, the operator may choose to activate the software switches by

touching the screen with a stylus 14 (or finger) at the switches' 16d locations. When some of the software switches are activated, different software switches appear. The bar display 16d shows the software switches "ZM IN (zoom in)," "ZM OT (zoom out)," "CENT (center)" and "GRAB (pan/grab)" at the bottom of the screen. These software switches enable the operator to perform these functions. The "SWITH (switch)" software switch at the lower right causes a matrix of layered software switches (soft switches) to appear above the bottom row of switches. Through use of the software switches, the operator can also manipulate the geographical map 16b or chart display. When looking at Figure 1, display symbols depicting permanent geographical locations and buildings are shown. For example, the police station is shown and, when the symbol is touched by the stylus or finger, the latitude and longitude of the symbol's location, as shown in display section 16c, is displayed at the bottom left of the screen. The bottom right side of display 16c is a multifunction inset area that can contain a variety of information including: a) a list of the communication link participants; b) a list of received messages; c) a map, aerial photograph or satellite image with an indication of the zoom and offset location of the main map display, which is indicated by a square that depicts the area actually displayed in the main geographical screen 16b; d) applicable status information; and e) a list of the communication net participants. Each participant user would have a device 10 shown in Figure 1.

[00036] Also shown on the display screen 16, specifically the geographical display 16b, is a pair of different looking symbols 30 and 34, a small triangle and a small square, which are not labeled. These symbols 30 and 34 can represent communication net participants having cellular phones in the displayed geographical area that are part of the overall cellular phone communications net, each participant having the same device 10 used. The latitude and longitude of symbol 30 is associated within a database with a specific cell phone number and, if

available, its IP address and email address. The screen display 16b, which is a touch screen, provides x and y coordinates of the screen 16b to the CPU's software from a map in a geographical database. The software has an algorithm that relates the x and y coordinates to latitude and longitude and can access a communications net participant's symbol or a fixed or movable entity's symbol as being the one closest to that point.

[00037] In order to initiate a telephone call to the cellular phone user (communication net participant) represented by symbol (triangle) 30 at a specific latitude and longitude display on chart 16b, the operator touches the triangle 30 symbol with the stylus 14. The user then touches a "call" software switch from a matrix of displayed soft switches that would overlay the display area 16c. Immediately, the cellular phone will initiate a cellular telephone call to the cellular phone user at the geographical location shown that represents symbol 30. A second cellular phone user (communication net participant) is represented by symbol 34 which is a small square (but could be any shape or icon) to represent an individual cellular phone device in the display area. The ring 32 around symbol 30 indicates that the symbol 30 has been touched and that a telephone call can be initiated by touching the soft switch that says "call." When this is done, the telephone call is initiated. Other types of symbolic elements on the display 16 can indicate that a cellular phone call is in effect. Additionally, the operator can touch both symbol 34 and symbol 30 and can activate a conference call between the two cellular phones and users represented by symbols 30 and 34. Again, a symbolic ring around symbol 34 indicates that a call has been initiated.

[00038] Equally important, a user can call the police station, or any other specific geographical facility displayed on the map including: buildings, locations of people, vehicles, facilities, restaurants, or the like, whose cellular phone numbers and, if available, Email

addresses, IP addresses and their URLs (previously stored in the database) by touching a specific facility location on the map display using the stylus 14 and then touching the cellular phone call switch. As an example, the operator can touch and point to call a restaurant using a soft switch by touching the restaurant location with a stylus and then touching the call soft switch. The cellular phone will then call the restaurant. Thus, using the present invention, each participant can touch and point to call to one or more other net participants symbolically displayed on the map, each of whom has a device as shown in Figure 1, and can also point to call facilities that had been previously stored in the phone's database. Furthermore, this symbol hooking and soft switch technique can be used to go to a fixed facility's website or to automatically enter the fixed facility's email address in an email.

[00039] Each cellular phone/PDA/GPS user device is identified on the map display of the other network participant user's phone devices by a display symbol that is generated on each user phone display to indicate each user's own location and identity. Each symbol is placed at the correct geographical location on the user display and is correlated with the map on the display and is transmitted and automatically displayed on the other network participant's PC and PDA devices. The operator of each cellular phone/PDA/GPS device may also enter one or more other fixed entities (buildings, facilities, restaurants, police stations, etc.) and geo-referenced events such as fires, accidents, etc., into its database. This information can be likewise transmitted to all the other participants on the communications net and automatically displayed. The map, fixed entities, events and cellular phone/PDA/GPS device communication net participants' latitude and longitude information is related to the "x" and "y" location on the touch screen display map by a mathematical correlation algorithm.

[00040] When the cellular phone/PDA/GPS device user uses a stylus or finger to touch one or more of the symbols or a location displayed on the cellular phone map display, the system's software causes the status and latitude and longitude information concerning that symbol or location to be displayed. In order to hook a symbol or "track" such as another net participant which represents an entity on the geo-referenced map display, or a fixed geographical entity such as a restaurant, police station or a new entity observed by a cell phone user which is discussed below, the operator touches at or near the location of a geo-referenced symbol appearing on the cellular phone/PDA display that represents a specific track or specific participant or other entity. The hook application software determines that the stylus (or finger) is pointed close to or at the location of the symbol and puts a circle, square or other indication around the symbol indicating that amplification information concerning the symbol is to be displayed. The operator can hook entered tracks or his own track symbol and add data or change data associated with the indicated symbol. The hook application code then sends a message to the database application code to store the facility or entity's updated data. The display application code retrieves the primary data and amplification data concerning the symbol or entity from the database and displays the information at the correct screen location. The operator can then read the amplification data that relates to that specific symbol at the specific location. The cell phone operator can also select soft switches on the touch screen display to change the primary data and amplification data. Furthermore, the operator can use a similar method of hooking and selecting to activate particular soft switches to take other actions which could include: making cellular phone calls, conference calls, 800 number calls; sending a free text message, operator selected preformatted messages, photographs or videos to the hooked symbol; or to drop an entered symbol.

[00041] Each known net participant has a cellular phone number, IP address and, if available, Email address that is stored in each participant's device database.

[00042] To use the communication system, a user starts the PDA/cellular phone device system by turning on the cell phone power and selecting the cell phone and network software which causes: a) the cellular phone to be activated (if it has not already been activated); b) the GPS interface receiver to be established; c) a map of the geographic area where the operator is located and operator's own unit symbol to appear at the correct latitude and longitude on the map on the display; d) the locations of fixed facilities such as restaurants, hotels, fire departments, police stations, and military barracks, that are part of the database to appear as symbols on the map; e) the device selected item read out area which provides amplification information for the communications net participants or the entity that has been hooked (on the display screen) to appear on the display; f) an insert area that contains various data including: the list of net participants, a list of messages to be read, an indication of what portion of the map is being displayed in major map area and other information to appear on the display; and g) a row of primary software created "soft switches" that are always present on the display to appear.

[00043] For point to call network units and fixed facilities, the application code detects the x, y display screen location of the symbol that is designated by the user's stylus and translates the x, y coordinates to latitude and longitude and then: (1) searches the database to find the symbol at that location, (2) places a "hook" indicator (a circle, square or other shape) around the symbol, (3) displays any amplifying data and (4) obtains the symbol's associated phone number (or, for Voice over IP (VoIP) an IP address) from the database. Upon receiving a "call" designation from the soft switch, the operator's device's ACS causes the appropriate phone number or IP address to be called. Upon receiving an indication that the phone number is being called, the

application code places a box around the symbol (color, dashed or the like). When the call is connected, the box changes to indicate that the connection is made. When the other party hangs up, the box disappears.

[00044] As each of the cell phone participants reports its identity, location and status to the other participants' devices, the received data is automatically geo-referenced and filed in their databases that are accessible by identity and by location. This data is then displayed on each cell phone display. When a request for data is received by touching the display screen, a location search is made by the ACS and a symbol modifier (circle, square, etc.) is generated around the symbol closest to the x, y position of the stylus. When the application code receives a soft switch command to place a phone call or send data, the software uses the phone number (or IP address) associated with the unit to place the call or to send data.

[00045] If a cell phone device receives a digital message that a call is being received, the receiving cell phone's ACS application code places a box or similar object around the transmitter symbol indicating who the call is from. When the call is answered, the application software changes the visual characteristics of the box. In a similar manner, when a phone receives a digital text message, photograph or video, a box appears around the transmitter's symbol indicating the transmitter of the message. The point to call network devices are network participants and each one has a PC / PDA device with the same software for use as a total participant network. Other situations for calling facilities that are not network participants are also described below.

[00046] Thus, a user is capable of initiating a cellular phone call by touch only and initiating conference calls by touching the geo-referenced map symbols. Furthermore, by using a similar symbol touching technique, a cellular phone can send user selected messages to cause a remote

cellular phone to display and optionally announce emergency and other messages and to optionally elicit a response from the remote cellular phone.

[00047] All of the network participants have the same communication cell phone/PDA/GPS device described herein. The method and system include the ability of a specific user to provide polling in which other cellular phones, using SMS, internet or WiFi, report periodically based on criteria such as time, speed, distance traveled, or a combination of time, speed and distance traveled. A user can manually poll any or all other cell phone devices that are used by all of the participants in the communication network having the same devices. The receiving cellular phone application code responds to the polling command with the receiving cellular phone's location and status which could include battery level, GPS status, signal strength and entered track data. Optionally, the phone operators can set their phones to report automatically, based on time or distance traveled intervals or another criterion.

[00048] The soft switch application software causes a visual display of a matrix such as five across by six up (or another matrix) in which switch names are placed on the cellular/PDA display. The soft switch network application software knows the touch screen location of each of the switches in the matrix and the software routines that will be activated upon touching the switch.

[00049] The bottom row of soft switches displayed on the touch screen remains visually fixed. These switches concern the functions that are the most often used. One of the switches causes a matrix of other soft switches to appear above the visually fixed soft switches. These switches are function soft switches, the activation of any one of which causes a different matrix of soft switches to appear, which are known as the action soft switches. When the action soft switches appear, the function soft switch, which caused the action soft switches to appear, itself appears as

a label in the lower left (or some other standard location) indicating to the operator the function soft switch that has been selected. When the operator selects an action soft switch, the appropriate application software to accomplish the action is activated.

[00050] Upon receiving a soft switch activation message, the ACS accesses the appropriate task execution software which accomplishes the required tasks including: entry of track data, entry of track amplification data, transmission of alpha/numeric messages, photographs, videos, display of messages to be read, selection of map types, placing voice calls, placing conference calls and 800 conference calls, presenting different potential operator selections, control of the display actions, polling network participants, establishing nets of participants (groups) so that communications with all in the group can be accomplished with a single soft switch action, and dropping a previously entered track. By providing a matrix and layers of soft switches which are easily manipulated by a stylus, each cell phone device in the communication network is extremely efficient in accessing and coordinating the appropriate application program for the device to perform.

[00051] Users such as emergency groups, police, fire personal, military, first responders and other groups need to be able to set up ad hoc digital and voice networks easily and rapidly. The users need to be able to rapidly coordinate activities eliminating the need for pre-entry data as discussed above. Users are required to enter the Servers' IP address and an ad hoc event name, a password and, for first responders and military, the names of their units. This will normally be controlled by the PDA/PC user's position in the chain of command. For others it can be any selected name and, if desired, password.

[00052] Referring now to Figure 2, the PDA/PC screen displays an IP address entry menu. The user inserts the Server's IP address. Thus, as shown in Figure 2, the user has entered in the

cell phone/PDA the Server IP address and port number along with the GPS port listing and other information. Once that information is entered, referring now to Figure 3, the user now enters the ad hoc event network name which is shown in this example as “Katrina” along with a password. Referring now to Figure 4, the user then enters the user name or a unit name. Figure 4 shows the entered user name and a phone number. The phone number may be automatically entered by the ACS or manually entered. The phone number is not required unless using the phone system (not VoIP) to make calls. These are the initial user steps required to establish an ad hoc network or to join onto an existing ad hoc network.

[00053] Referring now to Figure 5, these actions cause the user cell phone/PDA or PC to commence reporting to the Server. Upon receipt of the initial message from the user’s PDA/PC, which may also contain additional data such as a license number, the Server stores the IP address of the user’s PDA/PC unit and responds with a message notifying the user that he or she is connected to the Server. The PDA/PC then automatically commences to report its GPS derived location and other status information to the Server. Since there are no other devices initially communicating with the Server, the Server just retains the information. When other devices sign on to the Server with the same ad hoc event name and password, the Server’s software recognizes this and stores their IP addresses. Since the Server has all parties’ IP addresses, the server is able to pass location and status information automatically between the ad hoc network participants. This can occur even though the ad hoc network participants have not entered other network participant’s names, telephone numbers or Email addresses and do not have the other network participants’ IP addresses, phone numbers or Email addresses. Once this connection is made, data types that are entered on one display that is of interest to all is sent from the server to

all others in the network. Such data types include track location and track amplification data, geo-referenced white boards, and chat.

[00054] When the PDA/PC user wants to address particular data (a text message, photograph, video clip, voice recording, white board, or chat), the user enters the name of the other ad hoc network participant by either entering a name or touching his or her symbol. Since the Server knows the IP address of the name or symbol, the Server forwards the data appropriately to that network participant. When a unit signs off the network, it transmits a message to the Server which then transmits a message to all the network participants to drop the unit and its associated tracks. If a unit loses communications for a variable time period, the unit's data is flushed from each of the recipient network participants systems according to a variable time period. After a separate variable time period, the Server also flushes the non-reporting units data.

[00055] As can be seen in Figure 6, provisions have been made for the PDA / PC to report on multiple networks thus allowing both digital communications up and down the chain of command and with adjacent units that have entered a common ad hoc network name and password.

[00056] Typically military and First Responder units use Push-to-Talk (PTT) communications. Units in an organization's chain of command typically have instituted a method to establish voice communications between themselves for they know each other's cellular phone numbers, PTT cellular group identifiers and radio frequencies or channel numbers. However, in a disaster there are many different units (fire, police, EMS, Military, and the like) involved all of whom need to establish voice communications between each other. The issue then becomes how to coordinate these PTT voice communications with the ad hoc digital communications so that all on the digital data network automatically also have PTT voice

communications with each other. If the PCs and PDAs in a group have manually entered their phone numbers, or the ACS has automatically entered their phone numbers, and sent their phone numbers as part of their initial message to the Server, this data is then sent by the Server to all others in the network. Upon receiving the phone number data, the recipients' ACS loads the cell phones numbers into their databases creating a phone number PTT group common with the digital IP network group.

[00057] The issue when using radios, however, is different. PTT radio coordination between multiple people is achieved by using a common radio frequency "Channel".

[00058] Furthermore, it is desirable to enable it so that, when new network participants join the digital network, they are automatically included in the voice network and, when they leave the digital network, they are automatically dropped from the digital network.

[00059] As can be seen in Figure 6 and Figure 7, a network participant currently can establish a new ad hoc digital network or join an existing ad hoc digital network by entering the ad hoc network name and password into his PDA/PC. To enable voice coordination with all that are a part of the ad hoc digital network, the user then enters (if user is authorized to do so) a Channel or Group number that the user is commanding all in the ad hoc network to establish as their PTT voice net. As seen in Figure 6, the operator has commanded all to shift to Radio Channel or to a specific PTT cellular or radio channel; i.e. Group 7.

[00060] This action causes the PTT Channel, or PTT Group 7, to be sent to the other PDA / PC users in the ad hoc password protected network through the Server.

[00061] As shown in Figure 6 and Figure 7, the Group leader enters the Katrina Fire ad hoc network and issues a command which is sent to the Server to cause the PDAs / PCs that are in the Katrina Fire Group to automatically shift their Radio or cellular device to Channel 7. Each

PDA cell phone can connect to the user's Radio for control with a USB cable, or WiFi, Bluetooth, or Near Field Communications (NFC) signals or other communications that are contained in the PDA/PC cellular device. This enables the Radios to shift to a common channel. This action is received by the Server which then sends the "Shift to Channel 7 Command" to all network participants in the Katrina Fire ad hoc network. When the PDA / PC / Tablet Katrina Fire network participant's software receives the command to shift its Radio Channel PPT to Group 7, this action causes the PDA's ACS to establish a new Channel 7 group (or to override an old Channel 7 group) that consists of all on the digital ad hoc network. The PC and PDAs then send their radios' digital interfaces messages to shift to Channel 7 or to the frequency associated with Channel 7. The digitally networked PC's and PDA's ACS devices then send a message to all on the digital network that they have shifted to Channel 7 (or to the appropriate frequency) and also further send the Group Leader's identifier and Command to shift to Channel 7 so that the ACS' devices associated with new users joining the digital network will automatically digitally set their radios to Channel 7 or the appropriate frequency.

[00062] As shown in Figure 7, each time one of the network participants reports to the Katrina Fire network its Name, Position and Status, it now also reports that it is in PTT Channel 7 enabling the PTT group to grows in size until it encompasses all in the ad hoc password protected digital network. When units drop out of the Common Interest Network or lose communications because they are no longer active or they are out of range, their PTT Channel data is likewise dropped as they dropped out of the digital because their reports have not been received for a set, but adjustable, time period. If a unit rejoins the network, their PTT Name and Phone number is again automatically added to the Katrina Fire Interest Group as they are accepted by the Server into the Katrina Fire Interest digital Group.

[00063] When using the PTT feature, the ACS can enable the network participant to: 1. PTT with all that are in the ad hoc digital network, or 2. PTT with select specific network participants, by touching their symbol(s) and then selecting PTT soft switch or 3. Specify a group of the network participants by assigning their symbol or unit name to a list of network participants and then associating the list with a soft switch whose function is to enable the operator to have PTT communications with all in the list.

[00064] Since only one person is transmitting on a PTT voice network at any given time, the receiving network participant's ACS can relate the PTT IP address to the IP address of the unit transmitting his identification on the digital ad hoc network. This information can then be used by the other PTT networked participant's ACS to: 1. flash the transmitting unit's name on their PDA / PC screens or 2. if a photograph has been attached to the ad hoc digital network symbol of the PTT transmitting person, to flash that photograph on the receiving unit's PDA / PC display.

[00065] Referring now to Figure 8, for some Emergency events, and in particular military operations, it is desirable to further define ad hoc networks so that the networks encompass only a certain geographical area defined by boundary lines on a map. To accomplish this, an enhancement to the ad hoc digital and voice PTT password protected network is provided. As an example, once the Katrina Fire digital and PTT network is established, the ad hoc network can be further refined by the Group Leader defining a map area that limits the participating group to only those users within a geographically defined area by the Group Leader, creating on his PC / PDA display a box that defines a geographic area on a map.

[00066] As shown in Figure 8, the Latitude / Longitude points that define the rectangle of the boundary area are sent from the Group Leader's device to the Server which relays the data to the other participating unit PC / PDA devices in the Katrina Fire network. When the participating

unit devices receive the Latitude / Longitude points, their software computes whether their PC / PDA unit is inside or outside a boundary area. If the users are inside the defined area, the users retain but disregard the Latitude / Longitude data and continue to report on the digital password protected network and to use the commanded PTT channel / frequency. However, if the users are outside the area, the users send a “drop me message” to the Katrina Fire PDA/PC digital network Server and cease reporting on the network. When Katrina Fire network PDA/PC user units leave the defined area or lose communications for a specified, but adjustable, time period, the Server drops the unit from the network and informs all network users that the unit is dropped from the digital network and from voice PTT Channel 7 which causes all others on the network to drop them. When Katrina Fire networked PDA/PC user units re-enter the area, the unit’s ACS detects the fact and commences reporting as it receives reports from other network participants it will receive the current PTT channel or frequency.

[00067] In disasters, battery life is essential as there may not be extra batteries available or a power available to recharge the battery. It is therefore essential to lessen battery utilization. The normal method by which this is accomplished is to not use software that keeps the display on, uses the GPS or transmits on the communications. However, deactivating any one of these processes produces a problem with providing location data to all on the network.

[00068] With location sharing there are essentially two times when the location information is essential: a) Where the user wants all to know his/her location and status and the location and status of others and b) When the commander wants to know the location and status of all or of a particular unit.

[00069] When the user wants others to know the user location and status, the user can simply turn on location reporting software which then turns on the display, the GPS and the

communications reporting software causing the reporting of the user location to the ad hoc password protected digital network. However, when the commander or someone else wants to know the location and status of the PDA/PC unit that is conserving battery usage by having user display, GPS and communications transmission turned on, the commander has no method to accomplish this.

[00070] This problem is overcome by enabling the commander to transmit a “turn on” IP message to the battery conserving(s) unit(s) by addressing the message to the ad hoc network Server which then sends an SMS message to the addressed phone. The SMS message will be received as long as the phone is powered on, as SMS is integrated with the cell phone’s voice communications. The Server could also send a turn on IP message to networked radios, which will then cause the radio’s computer to send a digital message to the receiving PC / PDA to activate the user display and location and status reporting software.

[00071] Referring now to Figure 9, the diagram illustrates the enabling of location, status, VoIP, PTT, and video communications between radios and cell phones. The server maintains a temporary retention of names and IP addresses and sends data between all with the same ad hoc name unless addressed to a specific IP address. This requires that there is a radio with digital capabilities attached to the server shown in Figures 5, 6, and 7. These radios are set so that they each have a unique IP address. All of the participants have either PDA cell phones or PDAs without cellular. Those that also have PDAs without cellular (or choose not to use cellular) are connected to their radios via a USB cable or Wi-Fi, Bluetooth, or near field communications (NFC) that is part of the PDA/PC OR PDA cell phone. This is illustrated in Figure 9.

[00072] Referring now to Figure 10 the diagram shows enabling non-RFID equipped PDA phones to receive RFID tag data. The server maintains a temporary retention of how Tags relate

to names and sends data to local display and to other ACS network participants. Currently RFID tags are used for many functions, one of which is to track personnel inside a building to the room or compartment in which they are located. This is accomplished by RFID readers that are in each of the rooms. When personnel with an RFID tag get within a particular distance or range of the RFID reader, the reader detects their presence and sends it to a central site server via a USB cable or Wi-Fi. The PC connected to the server displays the personnel room locations. With the invention described herein, the server would then send the location to the ACS PDA/PC phones that would be carried by individuals located throughout the building or ship. The PDA/PC phones would display the room or ships compartments and the location of individuals with RFID tags and simultaneously enable PTT, chat, messaging, whiteboards, commands geo-fence penetration alerts or other types of messages between each of the PDA cell phones. The RFID tag would provide room location data of all to all that are on the ACS Wi-Fi network without their PDA cell phone having an RFID Reader attached to it. The operation is explained in detail in Figure 10.

[00073] The instant invention has been shown and described herein in what is considered to be the most practical and preferred embodiment. It is recognized, however, that departures may be made there from within the scope of the invention and that obvious modifications will occur to a person skilled in the art.

CLAIMS

What is claimed is:

1. A computer-implemented method comprising:
 - sending a respective first map to each one of a plurality of devices wherein the device is configured to display the first map;
 - receiving at various times from one or more of the devices respective information comprising a location of the device and sending the location to one or more other devices, wherein each of the other devices is configured to display a respective symbol representing the location on the first map;
 - receiving from a first device information indicating user selection of one or more of the displayed symbols corresponding to second devices and, based thereon:
 - obtaining a respective contact information for each of the second devices; and
 - facilitating a respective communication between the first device and each of the second devices using the contact information of the second device.
2. The method of claim 1 wherein a particular communication is a phone call, a short message service message, a voice message, a text message, an electronic mail message, an image, or a video.
3. The method of claim 1 wherein first device and the second devices are part of a same group or within a user-specified geographic area.
4. The method of claim 3 wherein the group is a friends or family group.
5. The method of claim 1 wherein particular contact information is a phone number or an Internet Protocol address.
6. The method of claim 1, further comprising:
 - performed by one of the devices:
 - receiving user selection of a symbol on the first map;
 - obtaining contact information associated with the symbol; and
 - performing an action using the contact information wherein the action is initiating a phone call, transferring data, sending an electronic mail message, or opening a web page.

7. The method of claim 6 wherein the symbol represents a facility or a person's home.
8. The method of claim 1 wherein a particular device is a smart phone, a personal data assistant, a tablet computer, a desktop computer, or a laptop computer.
9. The method of claim 1, further comprising:
 - receiving a request for a map from a third device wherein the request comprises one or more parameters and wherein a parameter specifies a map location or a zoom indication;
 - obtaining a second map that conforms to the attributes; and
 - sending the second map to the third device.
10. The method of claim 1 wherein the first device does not have access to the phone numbers or Internet Protocol addresses of the second devices.
11. The method of claim 1 wherein the first map is an aerial photograph, a satellite image, or a chart.
12. The method of claim 1 wherein receiving at various times from a particular device information comprises receiving the information from the particular device at a time based on one or more of: speed of the particular device, distance traveled by the particular device, or travel time of the particular device.
13. A system comprising:
 - one or more computers programmed to perform operations comprising:
 - sending a respective first map to each one of a plurality of devices wherein the device is configured to display the first map;
 - receiving at various times from one or more of the devices respective information comprising a location of the device and sending the location to one or more other devices, wherein each of the other devices is configured to display a respective symbol representing the location on the first map;
 - receiving from a first device information indicating user selection of one or more of the displayed symbols corresponding to second devices and, based thereon:
 - obtaining a respective contact information for each of the second devices; and
 - facilitating a respective communication between the first device and each of the second devices using the contact information of the second device.

14. The system of claim 13 wherein a particular communication is a phone call, a short message service message, a voice message, a text message, an electronic mail message, an image, or a video.
15. The system of claim 13 wherein first device and the second devices are part of a same group or within a user-specified geographic area.
16. The system of claim 15 wherein the group is a friends or family group.
17. The system of claim 13 wherein particular contact information is a phone number or an Internet Protocol address.
18. The system of claim 13, wherein the operations further comprise:
performed by one of the devices:
 - receiving user selection of a symbol on the first map;
 - obtaining contact information associated with the symbol; and
 - performing an action using the contact information wherein the action is initiating a phone call, transferring data, sending an electronic mail message, or opening a web page.
19. The system of claim 18 wherein the symbol represents a facility or a person's home.
20. The system of claim 13 wherein a particular device is a smart phone, a personal data assistant, a tablet computer, a desktop computer, or a laptop computer.
21. The system of claim 13, wherein the operations further comprise:
 - receiving a request for a map from a third device wherein the request comprises one or more parameters and wherein a parameter specifies a map location or a zoom indication;
 - obtaining a second map that conforms to the attributes; and
 - sending the second map to the third device.
22. The system of claim 13 wherein the first device does not have access to the phone numbers or Internet Protocol addresses of the second devices.
23. The system of claim 13 wherein the first map is an aerial photograph, a satellite image, or a chart
24. The system of claim 13 wherein receiving at various times from a particular device information comprises receiving the information from the particular device at a time based on one or more of: speed of the particular device, distance traveled by the particular device, or travel time of the particular device.

ABSTRACT

A method and system includes the ability for individuals to set up an ad hoc digital and voice network easily and rapidly to allow users to coordinate their activities by eliminating the need for pre-entry of data into a web or identifying others by name, phone numbers or email. This method is especially useful for police, fire fighters, military, first responders or other emergency situations for coordinating different organizations at the scene of a disaster to elevate conventional communication problems either up and down the chain of command or cross communication between different emergency units. The method and system provides that the users are only required to enter a specific Server IP address and an ad hoc event name, a password and perhaps the name of the particular unit.

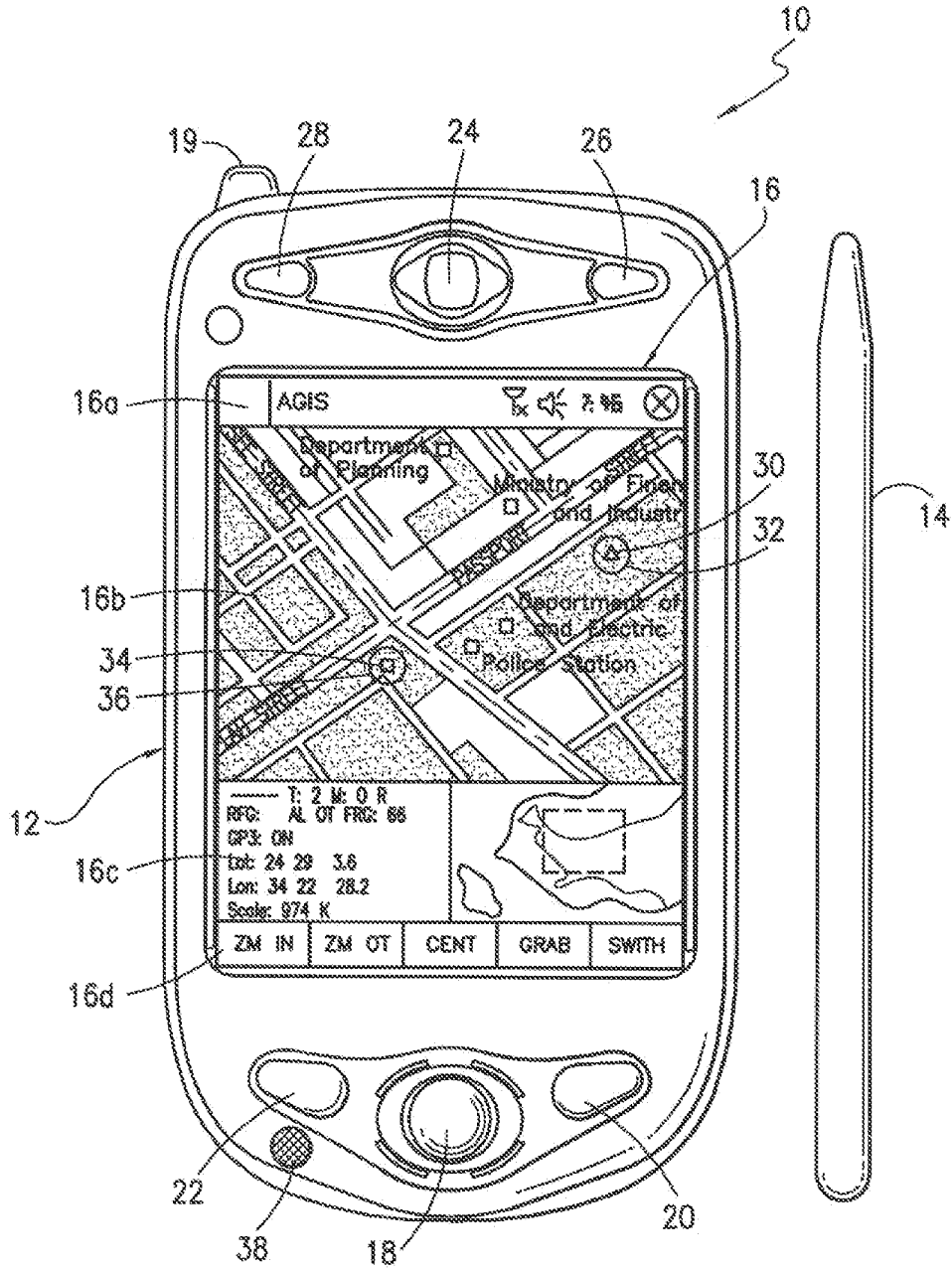

FIG. 1

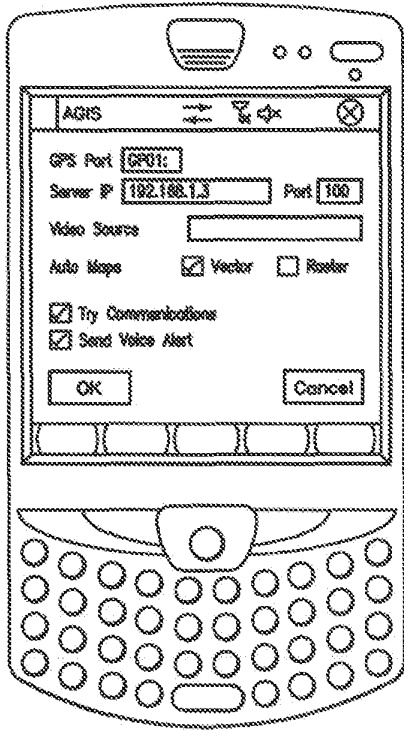

FIG. 2

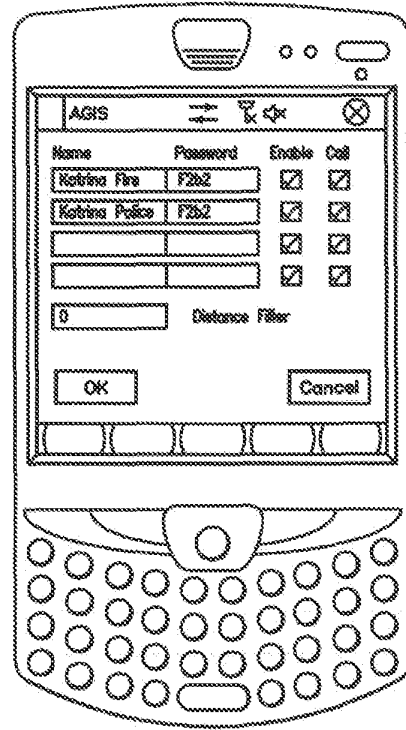

FIG. 3

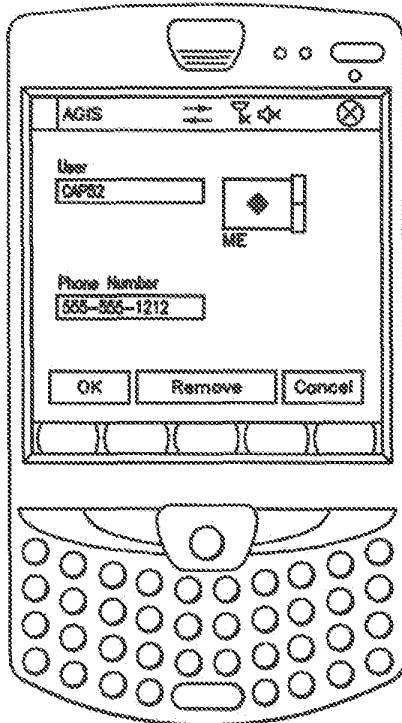

FIG. 4

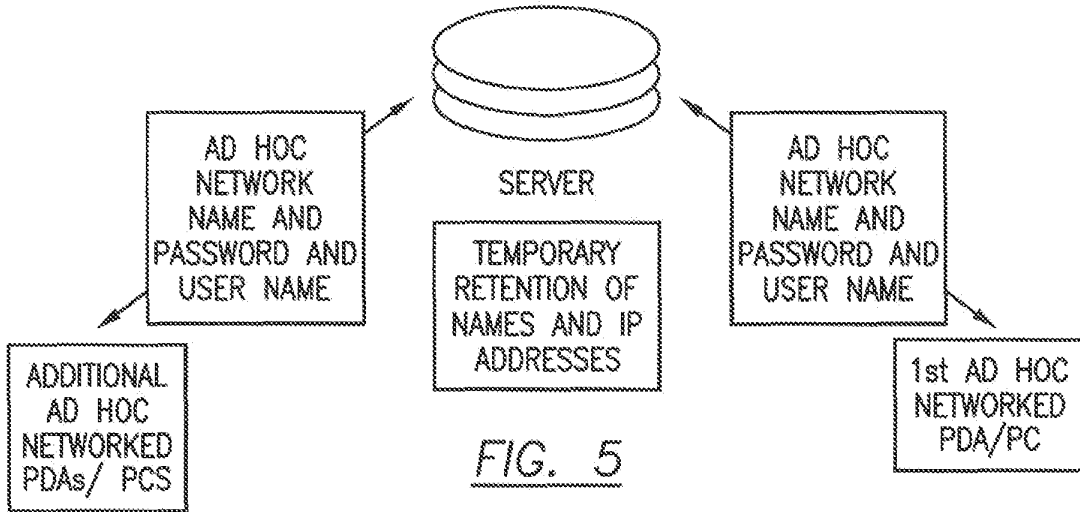
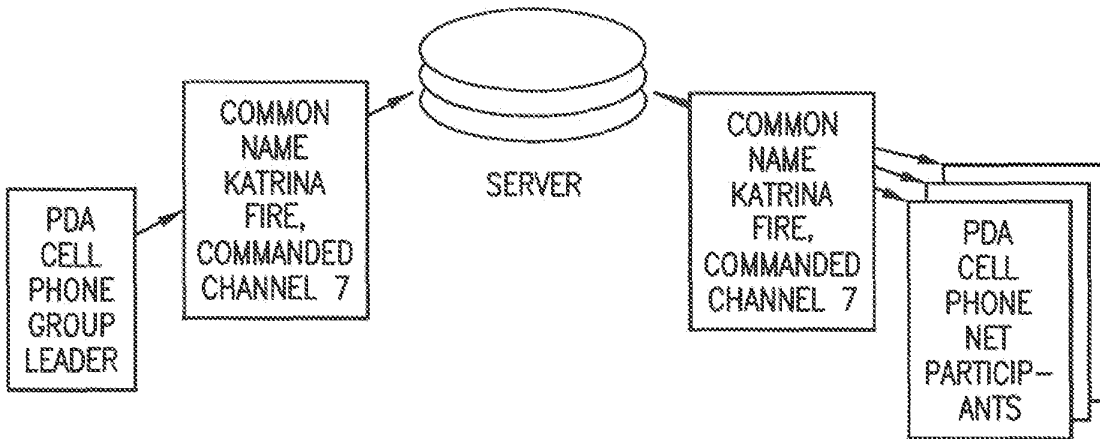

FIG. 5



LEADER SIGNS ON TO THE AD HOC PASSWORD PROTECTED KATRINA FIRE NETWORK AND ENTERS A PTT GROUP CHANNEL.

AS NET PARTICIPANTS SIGN ON TO THE AD HOC PASSWORD PROTECTED KATRINA FIRE NETWORK THEY RECEIVE A PTT GROUP DESIGNATOR. THEIR PDA AUTOMATICALLY USES THE PTT DATA TO SHIFT TO THE COMMANDED VOICE CHANNEL.

FIG. 6

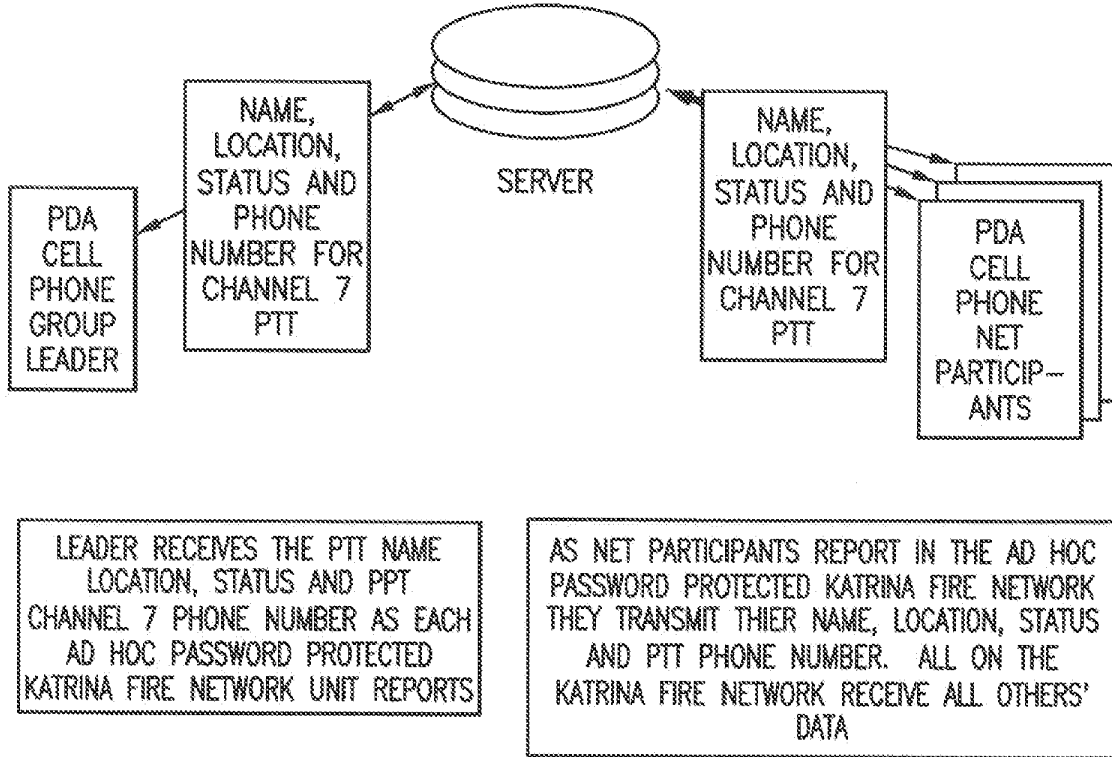

FIG. 7

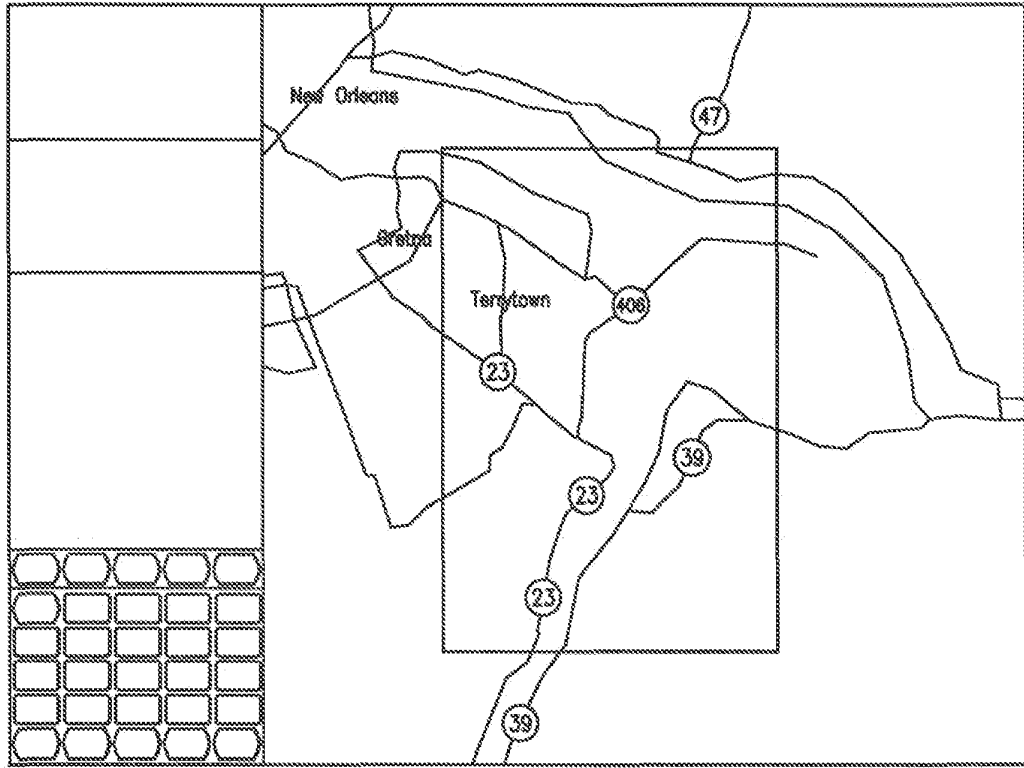

FIG. 8

ENABLING LOCATION, STATUS, VoIP, PTT AND VIDEO COMMUNICATIONS BETWEEN
RADIO AND CELL PHONES

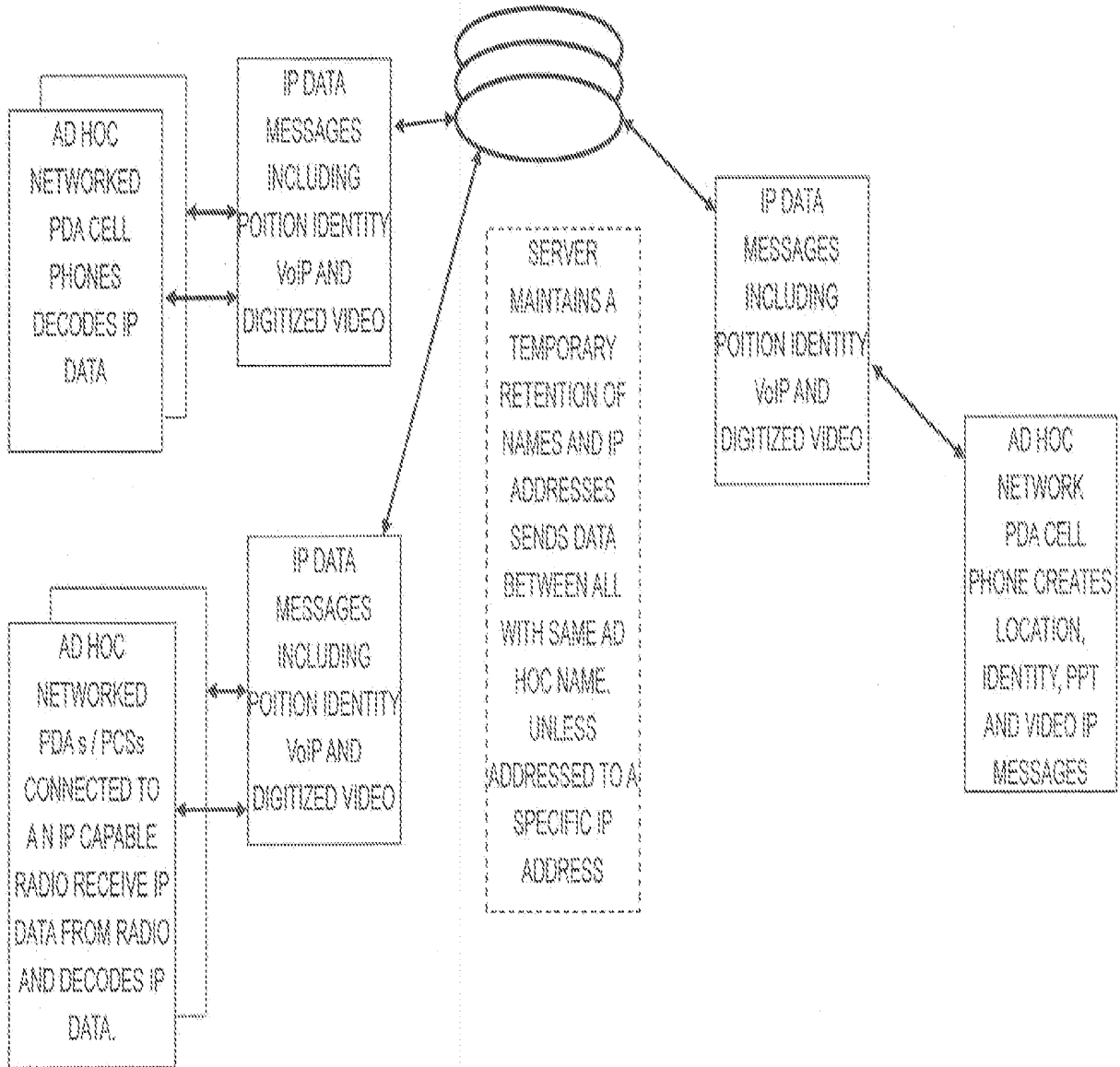

FIG. 9

ENABLING NON RFID EQUIPPED PDA PHONES TO RECEIVE RFID TAG DATA.

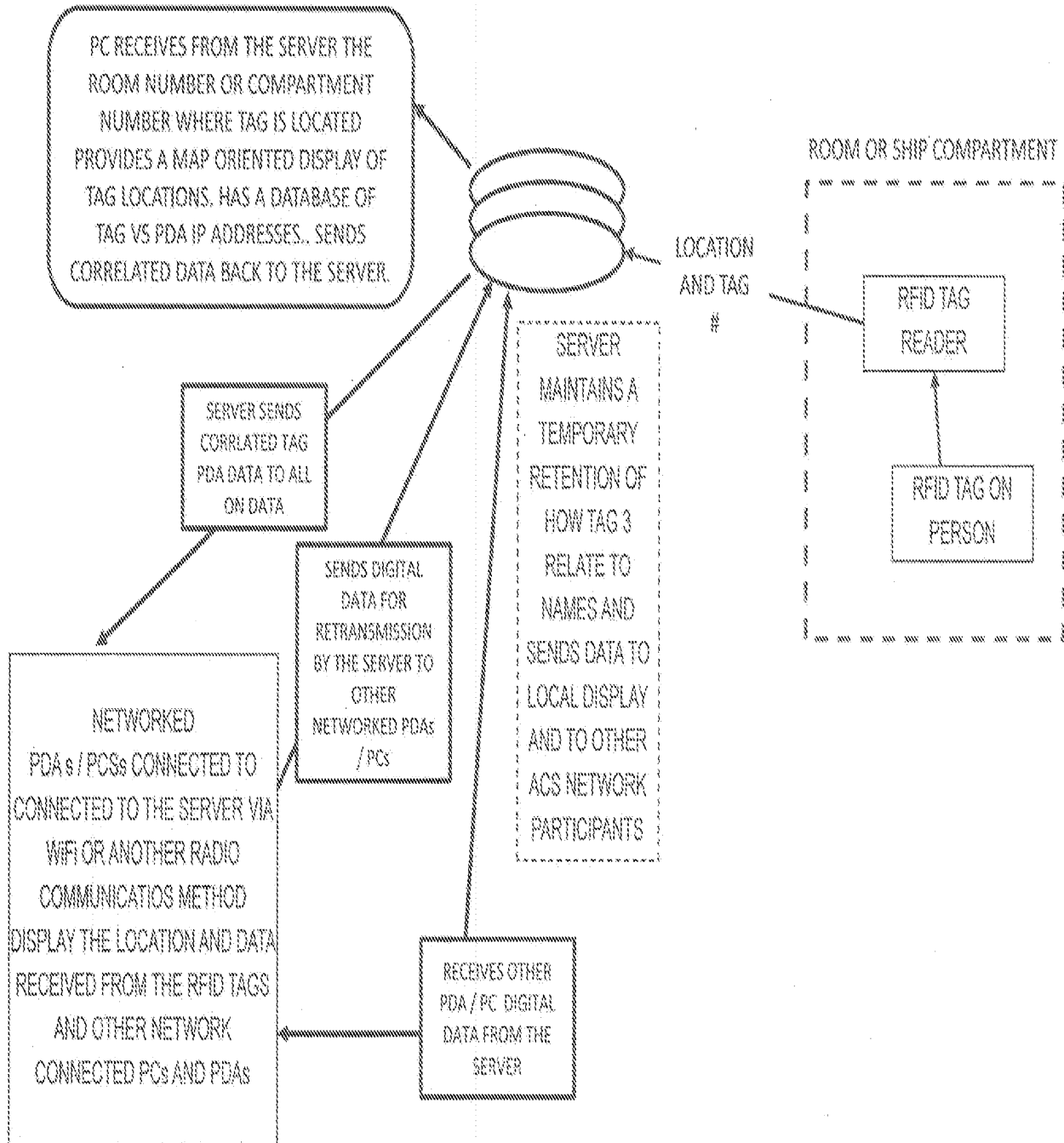

FIG. 10

Doc Code: Oath

Document Description: Oath or declaration filed

PTO/AIA/08 (06-12)

Approved for use through 01/31/2014. OMB 0551-0032
U.S. Patent and Trademark Office; U.S. DEPARTMENT OF COMMERCE

Under the Paperwork Reduction Act of 1995, no persons are required to respond to a collection of information unless it contains a valid OMB control number.

<p style="text-align: center;">DECLARATION FOR UTILITY OR DESIGN PATENT APPLICATION (37 CFR 1.63)</p> <p> <input checked="" type="checkbox"/> Declaration Submitted With Initial Filing OR <input type="checkbox"/> Declaration Submitted After Initial Filing (surcharge (37 CFR 1.16(f)) required) </p>	Attorney Docket Number	10963.3835
	First Named Inventor	BEYER, Jr., Malcolm K.
	COMPLETE IF KNOWN	
	Application Number	
	Filing Date	February 27, 2015
	Art Unit	
Examiner Name		

METHOD TO PROVIDE AD HOC AND PASSWORD PROTECTED DIGITAL AND VOICE NETWORKS

(Title of the Invention)

As a below named inventor, I hereby declare that:

This declaration is directed to:

The attached application,

OR

United States Application Number or PCT International application number _____
filed on _____.

The above-identified application was made or authorized to be made by me.

I believe I am the original inventor or an original joint inventor of a claimed invention in the application.

I hereby acknowledge that any willful false statement made in this declaration is punishable under 18 U.S.C. 1001 by fine or imprisonment of not more than five (5) years, or both.

Authorization To Permit Access To Application by Participating Office

If checked, the undersigned hereby grants the USPTO authority to provide the European Patent Office (EPO), the Japan Patent Office (JPO), the Korean Intellectual Property Office (KIPO), the World Intellectual Property Office (WIPO), and any other intellectual property offices in which a foreign application claiming priority to the above-identified patent application is filed access to the above-identified patent application. See 37 CFR 1.14(c) and (h). This box should not be checked if the applicant does not wish the EPO, JPO, KIPO, WIPO, or other intellectual property office in which a foreign application claiming priority to the above-identified patent application is filed to have access to the above-identified patent application.

In accordance with 37 CFR 1.14(h)(3), access will be provided to a copy of the above-identified patent application with respect to: 1) the above-identified patent application-as-filed; 2) any foreign application to which the above-identified patent application claims priority under 35 U.S.C. 119(a)-(d) if a copy of the foreign application that satisfies the certified copy requirement of 37 CFR 1.55 has been filed in the above-identified patent application; and 3) any U.S. application-as-filed from which benefit is sought in the above-identified patent application.

In accordance with 37 CFR 1.14(c), access may be provided to information concerning the date of filing the Authorization to Permit Access to Application by Participating Offices.

[Page 1 of 2]

This collection of information is required by 35 U.S.C. 115 and 37 CFR 1.63. The information is required to obtain or retain a benefit by the public which is to file (and by the USPTO to process) an application. Confidentiality is governed by 35 U.S.C. 122 and 37 CFR 1.11 and 1.14. This collection is estimated to take 21 minutes to complete, including gathering, preparing, and submitting the completed application form to the USPTO. Time will vary depending upon the individual case. Any comments on the amount of time you require to complete this form and/or suggestions for reducing this burden, should be sent to the Chief Information Officer, U.S. Patent and Trademark Office, U.S. Department of Commerce, P.O. Box 1450, Alexandria, VA 22313-1450. DO NOT SEND FEES OR COMPLETED FORMS TO THIS ADDRESS. SEND TO: Commissioner for Patents, P.O. Box 1450, Alexandria, VA 22313-1450.

If you need assistance in completing the form, call 1-800-PTO-9199 and select option 2.

DECLARATION — Unity or Design Patent Application

Direct all correspondence to: The address associated with Customer Number: **22235** OR Correspondence address below

Name: _____

Address: _____

City: _____ State: _____ Zip: _____

Country: _____ Telephone: _____ Email: _____

WARNING:

Petitioner/applicant is cautioned to avoid submitting personal information in documents filed in a patent application that may contribute to identify theft. Personal information such as social security numbers, bank account numbers, or credit card numbers (other than a check or credit card authorization form PTO-2038 submitted for payment purposes) is never required by the USPTO to support a petition or an application. If this type of personal information is included in documents submitted to the USPTO, petitioners/applicants should consider redacting such personal information from the documents before submitting them to the USPTO. Petitioner/applicant is advised that the record of a patent application is available to the public after publication of the application (unless a non-publication request in compliance with 37 CFR 1.213(a) is made in the application) or issuance of a patent. Furthermore, the record from an abandoned application may also be available to the public if the application is referenced in a published application or an issued patent (see 37 CFR 1.14). Checks and credit card authorization forms PTO-2038 submitted for payment purposes are not retained in the application file and therefore are not publicly available. Petitioner/applicant is advised that documents which form the record of a patent application (such as the PTO/SB/01) are placed into the Privacy Act system of records DEPARTMENT OF COMMERCE, COMMERCE-PAT-7. System name: Patent Application Files. Documents not retained in an application file (such as the PTO-2038) are placed into the Privacy Act system of COMMERCE/PAT-TM-10. System name: Deposit Accounts and Electronic Funds Transfer Profiles.

LEGAL NAME OF SOLE OR FIRST INVENTOR:

(E.g., Given Name (first and middle (if any)) and Family Name or Surname)

Malcolm K. Beyer, Jr.

Inventor's Signature: *Malcolm K. Beyer Jr.* Date (Optional): _____

Residence: City: **Jupiter** State: **FL** Country: **US**

Mailing Address: _____

92 Lighthouse Drive

City: **Jupiter** State: **FL** Zip: **33469** Country: **US**

Additional inventors are being named on the supplement sheet(s) PTO/AIA-10 attached hereto

SUPPLEMENTAL SHEET FOR DECLARATION	ADDITIONAL INVENTOR(S)
	Supplemental Sheet (for PTO/AIA/08,09) Page _____ of _____

Legal Name of Additional Joint Inventor, if any:			
(E.g., Given Name (first and middle (if any)) and Family Name or Surname)			
Christopher R. Rice			
Inventor's Signature		Date (Optional)	
<i>Christopher R. Rice</i>		2-12-15	
Residence: City	State	Country	
Redmond	WA	US	
Mailing Address			
P.O. Box 3583			
City	State	Zip	Country
Redmond	WA	98073	US
Legal Name of Additional Joint Inventor, if any:			
(E.g., Given Name (first and middle (if any)) and Family Name or Surname)			
Inventor's Signature		Date (Optional)	
Residence: City	State	Country	
Mailing Address			
City	State	Zip	Country
Legal Name of Additional Joint Inventor, if any:			
(E.g., Given Name (first and middle (if any)) and Family Name or Surname)			
Inventor's Signature		Date (Optional)	
Residence: City	State	Country	
Mailing Address			
City	State	Zip	Country

This collection of information is required by 35 U.S.C. 115 and 37 CFR 1.63. The information is required to obtain or retain a benefit by the public which is to file (and by the USPTO to process) an application. Confidentiality is governed by 35 U.S.C. 122 and 37 CFR 1.11 and 1.14. This collection is estimated to take 21 minutes to complete, including gathering, preparing, and submitting the completed application form to the USPTO. Time will vary depending upon the individual case. Any comments on the amount of time you require to complete this form and/or suggestions for reducing this burden, should be sent to the Chief Information Officer, U.S. Patent and Trademark Office, U.S. Department of Commerce, P.O. Box 1450, Alexandria, VA 22313-1450. DO NOT SEND FEES OR COMPLETED FORMS TO THIS ADDRESS. SEND TO: Commissioner for Patents, P.O. Box 1450, Alexandria, VA 22313-1450.

If you need assistance in completing the form, call 1-800-PTO-9199 (1-800-760-9199) and select option 2.

INFORMATION DISCLOSURE STATEMENT BY APPLICANT (Not for submission under 37 CFR 1.99)	Application Number		
	Filing Date		
	First Named Inventor	BEYER, JR., Malcolm K.	
	Art Unit		
	Examiner Name		
	Attorney Docket Number	10963.3835	

U.S. PATENTS						Remove
Examiner Initial*	Cite No	Patent Number	Kind Code ¹	Issue Date	Name of Patentee or Applicant of cited Document	Pages, Columns, Lines where Relevant Passages or Relevant Figures Appear
	1	5898434	A	1999-04-27	SMALL et al.	
	2	6366782	B1	2002-04-02	FUMAROLO et al.	
	3	6292747	B1	2001-09-18	AMRO et al.	
	4	6385465	B1	2002-05-07	YOSHIOKA	
	5	6662016	B1	2003-12-09	BUCKHAM et al.	
	6	6716101	B1	2004-04-06	MEADOWS et al.	
	7	6775560	B2	2004-08-10	KING et al.	
	8	6868333	B2	2005-03-15	MELEN	

**INFORMATION DISCLOSURE
STATEMENT BY APPLICANT**
(Not for submission under 37 CFR 1.99)

Application Number		
Filing Date		
First Named Inventor	BEYER, JR., Malcolm K.	
Art Unit		
Examiner Name		
Attorney Docket Number	10963.3835	

	9	6868337	B2	2005-03-15	MURAMATSU	
	10	6885874	B2	2005-04-26	GRUBE et al.	
	11	7024207	B2	2006-04-04	GORDAY et al.	
	12	7031700	B1	2006-04-18	WEAVER et al.	
	13	7292935	B2	2007-11-06	YOON	
	14	7299075	B2	2007-11-20	GOTTLIEB et al.	
	15	7499799	B2	2009-03-03	PARK	
	16	6204844	B1	2001-03-20	FUMAROLO et al.	
	17	5555286	A	1996-09-10	TENDLER	
	18	6542475	B1	2003-04-01	BALA et al.	
	19	7593740	B2	2009-09-22	CROWLEY et al.	

**INFORMATION DISCLOSURE
STATEMENT BY APPLICANT**
(Not for submission under 37 CFR 1.99)

Application Number		
Filing Date		
First Named Inventor	BEYER, JR., Malcolm K.	
Art Unit		
Examiner Name		
Attorney Docket Number	10963.3835	

If you wish to add additional U.S. Patent citation information please click the Add button. [Add](#)

U.S.PATENT APPLICATION PUBLICATIONS						Remove
Examiner Initial*	Cite No	Publication Number	Kind Code ¹	Publication Date	Name of Patentee or Applicant of cited Document	Pages, Columns, Lines where Relevant Passages or Relevant Figures Appear
	1	20030013461	A1	2003-01-16	MIZUNE et al.	
	2	20030149527	A1	2003-08-07	SIKILA	
	3	20040192299	A1	2004-09-30	WILSON et al.	
	4	20070281689	A1	2007-12-06	ALTMAN et al.	
	5	20080132243	A1	2008-06-05	SPALINK et al.	
	6	20070150444	A1	2007-06-28	CHESNAIS et al.	
	7	20060030339	A1	2006-02-09	ZHOVNIROVSKY et al.	
	8	20060047825	A1	2006-03-02	STREENSTRA et al.	
	9	20030200259	A1	2003-10-23	TSUGE	

**INFORMATION DISCLOSURE
STATEMENT BY APPLICANT**
(Not for submission under 37 CFR 1.99)

Application Number		
Filing Date		
First Named Inventor	BEYER, JR., Malcolm K.	
Art Unit		
Examiner Name		
Attorney Docket Number	10963.3835	

	10	20060031927	A1	2006-02-09	MIZUNO et al.	
	11	20040204070	A1	2004-10-14	AUGUST et al.	
	12	20040266456	A1	2004-12-30	BOSTROM et al.	
	13	20030139150	A1	2003-07-24	RODRIGUEZ et al.	
	14	20010044321	A1	2001-11-22	AUSEMS et al.	
	15	20050130634	A1	2005-06-16	GODFREY	
	16	20030093405	A1	2003-05-15	MAYER	

If you wish to add additional U.S. Published Application citation information please click the Add button. **Add**

FOREIGN PATENT DOCUMENTS

Remove

Examiner Initial*	Cite No	Foreign Document Number ³	Country Code ² j	Kind Code ⁴	Publication Date	Name of Patentee or Applicant of cited Document	Pages, Columns, Lines where Relevant Passages or Relevant Figures Appear	T ⁵
	1	JPH085394	JP		1996-01-12	OZAKI et al.		<input type="checkbox"/>
	2	JPH09113288	JP		1997-05-02	SATOSHI		<input type="checkbox"/>

**INFORMATION DISCLOSURE
STATEMENT BY APPLICANT**
(Not for submission under 37 CFR 1.99)

Application Number	
Filing Date	
First Named Inventor	BEYER, JR., Malcolm K.
Art Unit	
Examiner Name	
Attorney Docket Number	10963.3835

3	JP2002245336	JP		2002-08-30	SHIMADA et al.	<input type="checkbox"/>
4	03074973	WO	A2	2003-09-12	SHEHA et al.	<input type="checkbox"/>

If you wish to add additional Foreign Patent Document citation information please click the Add button **Add**

NON-PATENT LITERATURE DOCUMENTS

Remove

Examiner Initials*	Cite No	Include name of the author (in CAPITAL LETTERS), title of the article (when appropriate), title of the item (book, magazine, journal, serial, symposium, catalog, etc), date, pages(s), volume-issue number(s), publisher, city and/or country where published.	T ⁵
	1	Gate5, "Mobile Community Solution: Context-sensitive application suite for mobile communities," published in 2002	<input type="checkbox"/>
	2	Gate5, "Mobile Guide Solution: Context-sensitive applications for PDA based mobile city and travel guides," published in 2002	<input type="checkbox"/>
	3	Batista, "Your Boss May Know Where You Are," Wired News, published May 31, 2002	<input type="checkbox"/>
	4	Edlund, Therese et al., "Mobile Services for truck drivers," Master thesis in Mobile Informatics, IT University of Goteborg, Sweden, 2003	<input type="checkbox"/>
	5	The Gate5 system, which, upon information and belief, was sold and/or publicly used within the U.S. prior to 2004 and at least as early as 2002	<input type="checkbox"/>
	6	Kim, Ryan, "Find Friends by cell phone/Loopt application's GPS program can beam map location," published November 14, 2006 by SFGate	<input type="checkbox"/>
	7	LocatioNet Press Release: "LocatioNet Releases Ground Breaking Mass Market LBS Application Suite - LocatioNet MyMap," published May 6, 2003	<input type="checkbox"/>

INFORMATION DISCLOSURE STATEMENT BY APPLICANT (Not for submission under 37 CFR 1.99)	Application Number		
	Filing Date		
	First Named Inventor	BEYER, JR., Malcolm K.	
	Art Unit		
	Examiner Name		
	Attorney Docket Number	10963.3835	

8	LocatioNet LBS Applications: MyMap description web page, published before 2004 upon information and belief	<input type="checkbox"/>
9	The LocatioNet system which, upon information and belief, was sold and/or publically used within the U.S. prior to 2004 and at least as early as 2003	<input type="checkbox"/>
10	Luna, Lynnette, "This Man Knows You Live...and Work and Play," Wireless Review, September 2002; pages 24-32	<input type="checkbox"/>
11	Meggers, Jens et al., "A Multimedia Communication Architecture for Handheld Devices," IEEE Paper 0-7803-4872-9/98, published 1998	<input type="checkbox"/>
12	Memory Map Remote Tracking, available at https://web.archive.org/web/20060202161013/http://memory-map.com/	<input type="checkbox"/>
13	Ostman, Lennart, "A Study of Location-Based Services Including a Design and Implementation of an Enhanced Friend Finder Client with Mapping Capabilities," Lulea Tekniska Univeritet, 2001	<input type="checkbox"/>

If you wish to add additional non-patent literature document citation information please click the Add button **Add**

EXAMINER SIGNATURE

Examiner Signature		Date Considered	
--------------------	--	-----------------	--

*EXAMINER: Initial if reference considered, whether or not citation is in conformance with MPEP 609. Draw line through a citation if not in conformance and not considered. Include copy of this form with next communication to applicant.

¹ See Kind Codes of USPTO Patent Documents at www.USPTO.GOV or MPEP 901.04. ² Enter office that issued the document, by the two-letter code (WIPO Standard ST.3). ³ For Japanese patent documents, the indication of the year of the reign of the Emperor must precede the serial number of the patent document. ⁴ Kind of document by the appropriate symbols as indicated on the document under WIPO Standard ST.16 if possible. ⁵ Applicant is to place a check mark here if English language translation is attached.

INFORMATION DISCLOSURE STATEMENT BY APPLICANT (Not for submission under 37 CFR 1.99)	Application Number		
	Filing Date		
	First Named Inventor	BEYER, JR., Malcolm K.	
	Art Unit		
	Examiner Name		
	Attorney Docket Number	10963.3835	

CERTIFICATION STATEMENT

Please see 37 CFR 1.97 and 1.98 to make the appropriate selection(s):

That each item of information contained in the information disclosure statement was first cited in any communication from a foreign patent office in a counterpart foreign application not more than three months prior to the filing of the information disclosure statement. See 37 CFR 1.97(e)(1).

OR

That no item of information contained in the information disclosure statement was cited in a communication from a foreign patent office in a counterpart foreign application, and, to the knowledge of the person signing the certification after making reasonable inquiry, no item of information contained in the information disclosure statement was known to any individual designated in 37 CFR 1.56(c) more than three months prior to the filing of the information disclosure statement. See 37 CFR 1.97(e)(2).

See attached certification statement.

The fee set forth in 37 CFR 1.17 (p) has been submitted herewith.

A certification statement is not submitted herewith.

SIGNATURE

A signature of the applicant or representative is required in accordance with CFR 1.33, 10.18. Please see CFR 1.4(d) for the form of the signature.

Signature	/barry l. haley/	Date (YYYY-MM-DD)	2015-02-27
Name/Print	Barry L. Haley	Registration Number	25339

This collection of information is required by 37 CFR 1.97 and 1.98. The information is required to obtain or retain a benefit by the public which is to file (and by the USPTO to process) an application. Confidentiality is governed by 35 U.S.C. 122 and 37 CFR 1.14. This collection is estimated to take 1 hour to complete, including gathering, preparing and submitting the completed application form to the USPTO. Time will vary depending upon the individual case. Any comments on the amount of time you require to complete this form and/or suggestions for reducing this burden, should be sent to the Chief Information Officer, U.S. Patent and Trademark Office, U.S. Department of Commerce, P.O. Box 1450, Alexandria, VA 22313-1450. **DO NOT SEND FEES OR COMPLETED FORMS TO THIS ADDRESS. SEND TO: Commissioner for Patents, P.O. Box 1450, Alexandria, VA 22313-1450.**

Privacy Act Statement

The Privacy Act of 1974 (P.L. 93-579) requires that you be given certain information in connection with your submission of the attached form related to a patent application or patent. Accordingly, pursuant to the requirements of the Act, please be advised that: (1) the general authority for the collection of this information is 35 U.S.C. 2(b)(2); (2) furnishing of the information solicited is voluntary; and (3) the principal purpose for which the information is used by the U.S. Patent and Trademark Office is to process and/or examine your submission related to a patent application or patent. If you do not furnish the requested information, the U.S. Patent and Trademark Office may not be able to process and/or examine your submission, which may result in termination of proceedings or abandonment of the application or expiration of the patent.

The information provided by you in this form will be subject to the following routine uses:

1. The information on this form will be treated confidentially to the extent allowed under the Freedom of Information Act (5 U.S.C. 552) and the Privacy Act (5 U.S.C. 552a). Records from this system of records may be disclosed to the Department of Justice to determine whether the Freedom of Information Act requires disclosure of these records.
2. A record from this system of records may be disclosed, as a routine use, in the course of presenting evidence to a court, magistrate, or administrative tribunal, including disclosures to opposing counsel in the course of settlement negotiations.
3. A record in this system of records may be disclosed, as a routine use, to a Member of Congress submitting a request involving an individual, to whom the record pertains, when the individual has requested assistance from the Member with respect to the subject matter of the record.
4. A record in this system of records may be disclosed, as a routine use, to a contractor of the Agency having need for the information in order to perform a contract. Recipients of information shall be required to comply with the requirements of the Privacy Act of 1974, as amended, pursuant to 5 U.S.C. 552a(m).
5. A record related to an International Application filed under the Patent Cooperation Treaty in this system of records may be disclosed, as a routine use, to the International Bureau of the World Intellectual Property Organization, pursuant to the Patent Cooperation Treaty.
6. A record in this system of records may be disclosed, as a routine use, to another federal agency for purposes of National Security review (35 U.S.C. 181) and for review pursuant to the Atomic Energy Act (42 U.S.C. 218(c)).
7. A record from this system of records may be disclosed, as a routine use, to the Administrator, General Services, or his/her designee, during an inspection of records conducted by GSA as part of that agency's responsibility to recommend improvements in records management practices and programs, under authority of 44 U.S.C. 2904 and 2906. Such disclosure shall be made in accordance with the GSA regulations governing inspection of records for this purpose, and any other relevant (i.e., GSA or Commerce) directive. Such disclosure shall not be used to make determinations about individuals.
8. A record from this system of records may be disclosed, as a routine use, to the public after either publication of the application pursuant to 35 U.S.C. 122(b) or issuance of a patent pursuant to 35 U.S.C. 151. Further, a record may be disclosed, subject to the limitations of 37 CFR 1.14, as a routine use, to the public if the record was filed in an application which became abandoned or in which the proceedings were terminated and which application is referenced by either a published application, an application open to public inspections or an issued patent.
9. A record from this system of records may be disclosed, as a routine use, to a Federal, State, or local law enforcement agency, if the USPTO becomes aware of a violation or potential violation of law or regulation.



Morningside
Translations

TRANSLATOR CERTIFICATION

450 7th Avenue
10th Floor
New York, NY 10123
Tel: 212.643.8800
Fax: 212.643.0005
www.morningtrans.com

County of New York
State of New York

Date: July 28, 2014

To whom it may concern:

This is to certify that the attached translation from Japanese into English is an accurate representation of the documents received by this office.

The documents are designated as:

- JPH085394A

Jamie Sirota, Project Manager in this company, attests to the following:

"To the best of my knowledge, the aforementioned documents are a true, full and accurate translation of the specified documents."



Signature of Jamie Sirota

Accurate Translation Services 24/7

(19) Japan Patent Office (JP)

(12) Publication of Unexamined Patent Application (A)

(11) Japanese Patent Application Publication Number

Unexamined Patent Application Publication No. 5334

(13) Publication Date January 22, 1996

(52) Int. Cl.

Classification Number

G

G 01 C 1/00
G 04 G 1/0526
G 08 B 29/00

H 04B

7/25

H
106 A

Request for Examination Not requested Number of Independent Claims: 27 Cl. (Total 31 pages) Continued on last page

(21) Application Number:	Parent Application: Hei 6-139187	(71) Applicant:	06005188 Hitachi Ltd. 8-8 Kanda Surugodai, Chiyoda-Ku, Tokyo-To
(22) Filing Date:	June 21, 1994	(72) Inventor:	TOMOYA OKANO 292 Yoshida Machi, Totsuka-Ku, Yokohama City, Kanagawa Prefecture In Video Media Research Center, Hitachi Ltd.
		(73) Invention:	Hitachi Research Center 242 Yoshida Machi, Totsuka-Ku, Yokohama City, Kanagawa Prefecture In Video Media Research Center, Hitachi Ltd.
		(74) Inventor:	Hitachi Research Center 292 Yoshida Machi, Totsuka-Ku, Yokohama City, Kanagawa Prefecture In Video Media Research Center, Hitachi Ltd.
		(74) Representative:	Attorney Kanjyo TAKE

Continued on last page

(54) [Title of the Invention] Portable-terminal Device and Communication System Using the Same

(57) [Abstract]

[Object]

To be able mutually to confirm another party's position when acting in a group or the like.

[Constitution]

Calculate a present position using radio waves from a GPS satellite on a portable terminal device 100a and send that to another portable terminal device 100b. At the portable terminal device 100b, position information sent from the portable terminal device 100a is displayed superimposed over a map. For that reason, equipped on each portable terminal device are map-data memory means for storing map data; map-display means for displaying the map data managed by the map-data memory means; position-detection means for detecting a present position; sending means for sending a position detected by the position-detection means on another portable terminal device;

reception means for receiving a position sent by another portable terminal device; and position-display means for displaying a mark on a position received by the reception means on map data displayed by map-display means.

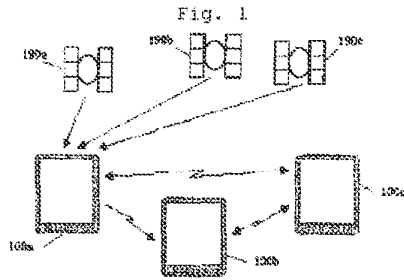

[Scope of Claims for Patent]

[Claim 1]

In a portable terminal device that communicates with another portable terminal device, a portable terminal device characterized by displaying a position of another portable terminal device.

[Claim 2]

A portable terminal device characterized by being equipped with reception means for receiving a position sent from another portable terminal device; map-display means for displaying a map; and position-display means for displaying a mark at a position received by the reception means, on map data displayed by the map-display means.

[Claim 3]

A portable terminal device characterized by being equipped with position-detection means for detecting a present position; and sending means for sending the position detected by the position-detection means.

[Claim 4]

A portable terminal device characterized by being equipped with map-data memory means for storing map data; map display means for displaying the map data managed by the map-data memory means; position-detection means for detecting a present position; sending means for sending a position detected by the position-detection means on another portable terminal device; reception means for receiving a position sent by another portable terminal device;

and position-display means for displaying a mark on a position received by the reception means on map data displayed by map-display means.

[Claim 5]

The portable terminal device according to claim 4, characterized by being equipped with:

own-position display means for displaying a mark at a position detected by your own position-detection means, on map data managed by the map-display means.

[Claim 6]

The portable terminal device according to claim 4 or claim 5, characterized by:

being equipped with mark-management means for controlling data indicating a correspondence relationship of the portable terminal device and a mark displayed on a screen, and the data, reading a mark that corresponds to another portable terminal device by using the mark-management means when displaying a position of another portable terminal device that was received by the reception means; and displaying the mark on the map data using the position-display means.

[Claim 7]

The portable terminal device according to claim 4, claim 5, or claim 6, characterized by being equipped with:

distance-calculation means for calculating a distance between a position received by reception means and a position of your own

portable terminal device; and color-management means for managing a correspondence relationship of distance and color, wherein a color is read from the color-management means according to a distance calculated by distance-calculation means to display a mark with the color read previously, when displaying a mark on the map using position-display means.

[Claim 8]

The portable terminal device according to claim 4 to claim 7, characterized by being equipped with:

speed-calculation means for calculating a speed from a position received by reception means; and speed-display means for displaying the speed calculated by speed-calculation means, with an arrow that uses the position displayed by position-display means as a starting point.

[Claim 9]

A portable terminal device characterized by being equipped with map-data memory means for storing map data; map-display means for displaying the map data managed by the map-data memory means; position-detection means for detecting a present position; speed-detection means for detecting a present speed; sending means for sending a position detected by the position-detection means, and a speed detected by the speed-detection means, on another portable terminal device; reception means for receiving a position and a speed sent from another portable terminal device; position-display means for displaying a position

received by the receiving means superimposed on map data displayed by map-display means; and speed-display means for displaying with an arrow a speed received by the receiving means, using a position displayed by position-display means as a starting point.

[Claim 10]

The portable terminal device according to claim 8 or claim 9, characterized by:

a length of the arrow displayed by speed-display means is proportionate to an absolute value of speed.

[Claim 11]

The portable terminal device according to claim 8 or claim 9, characterized by being equipped with

selection means for selecting a mark to be displayed on a screen; distance-calculation means for calculating a distance between the portable terminal device on which a mark selected by the selection means is represented and your own portable terminal device; time-calculation means for finding a time required to move calculated using a speed received by reception means and a distance found by the distance-calculation means; and time-difference display means for displaying a time required to move found by the time-calculation means, when a mark is selected by the selection means.

[Claim 12]

The portable terminal device according to claim 4 to claim 10,

characterized by being equipped with:

selection means for selecting a mark to be displayed on a screen; and user-information display means for displaying information that relates to a user for which a selected mark is represented.

[Claim 13]

The portable terminal device according to any one of claims 4 to 10, characterized by being equipped with:

selection means for selecting a mark to be displayed on a screen; distance-calculation means for calculating a distance between a portable terminal device on which a mark selected by the selection means is represented and your own portable terminal device; and distance-display means for displaying a distance calculated by the distance-calculation means, when the mark is selected by the selection means.

[Claim 14]

A portable terminal device characterized by being equipped with map-data memory means for storing map data; map-display means for displaying the map data managed by the map-data memory means; position-detection means for detecting a present position; image-input means for loading an image; sending means for sending to another portable terminal device a position detected by the position-detection means and an image loaded by the image-input means; reception means for receiving the position and the image sent by another portable terminal device; position-

display means for displaying a position received by the reception means superimposed on map data displayed by map-display means; selection means for selecting a mark displayed by the position-display means; and image-display means for displaying on a screen an image that corresponds to the mark, when a mark is selected by the selection means.

[Claim 15]

The portable terminal device according to claim 14, characterized by being equipped with:

image-display means for displaying on a display screen an image loaded by the image-input means; screen-selection means for specifying to switch the map-display means and the image-display means; and image-loading specification means for specifying loading an image when the image-display means is selected by the image-selection means.

[Claim 16]

The portable terminal device according to claim 14 or claim 15, characterized by a camera for inputting an image is disposed near a vehicle windshield as image-input means.

[Claim 17]

The portable terminal device according to any one of claim 4 to claim 16, characterized by being equipped with:

traffic-information reception means for receiving traffic information; and traffic-information display means for displaying traffic information received by the

traffic-information reception means, superimposed on a map.

[Claim 18]

The portable terminal device according to any one of claim 4 to claim 17, characterized by being equipped with:

position-memory means for storing a position detected by the position-detection means; that sends using the sending means when a distance between a present position detected by the position-detection means and a position stored by the position-memory means exceeds a fixed value, and stores a position detected by the position-detection means, using position memory means.

[Claim 19]

The portable terminal device according to any one of claim 4 to claim 18, characterized by:

using a wireless telephone in the sending means and the reception means.

[Claim 20]

The portable terminal device according to any one of claim 4 to claim 18, characterized by:

using a wireless telephone in the sending means and a pager in the reception means.

[Claim 21]

The portable terminal device according to any one of claim 4 to claim 18, characterized by:

using a personal wireless device in the sending means and the reception means.

[Claim 22]

A portable terminal device characterized by being equipped with map-data memory means for storing map data; map-display means for displaying the map data managed by the map-data memory means; position-detection means for detecting a present position; image-input means for loading an image; position-display means for displaying a position detected by the position-detection means superimposed on map data displayed by map-display means; selection means for selecting a mark displayed by the position-display means; and image-display means for displaying on a screen an image that corresponds to the mark, when a mark is selected by the selection means.

[Claim 23]

The portable terminal device according to claim 22, characterized by being equipped with:

image-display means for displaying on a display screen an image loaded by the image-input means; screen-selection means for specifying to switch the map-display means and the image-display means; and image-loading specification means for specifying loading an image when the image-display means is selected by the image-selection means.

[Claim 24]

A communication system characterized by being used by a portable terminal device according to any one of claims 1 to 21.

[Claim 25]

In a host station, and a communication system composed of a plurality of portable terminal devices that implement communication with the host station, a communication system equipped with position-management means for managing a position sent from the portable terminal device to the host station; and position-notification means for notifying the portable terminal device of a position of the portable terminal device managed by the position-management means; and

on the portable terminal device, map-data memory means for storing map data; map-display means for displaying the map data managed by the map-data memory means; position-detection means for detecting a present position; registration means for registering a position detected by the position-detection means; reception means for receiving a position sent from the host station; and position-display means for displaying a position received by the reception means superimposed on map data displayed by map-display means.

[Claim 26]

The communication system according to claim 25, characterized by:

using a wireless telephone in the registration means and the reception means of the portable terminal device, and in the notification means of the host station.

[Claim 27]

The communication system according to claim 25, characterized by

using a wireless telephone in the registration means of the portable terminal device, and using a pager in the reception means of the portable terminal device and the notification means of the host station.

[Detailed Description of the Invention]

[0001]

[Industrial Field of Application]

The present invention relates to portable terminal devices that are used by being carried, and communication systems that use such devices.

[0002]

[Prior Art]

There is a system for portable terminal devices that uses radio waves from a satellite to search for and to display on a map your own present position. An example of this kind of system is a vehicle-navigation system that is equipped with GPS (a Global Positioning System).

[0003]

[Problems to be Solved by the Invention]

With the system described above, however, while your own position can be known, there is a problem in that it is not possible for scattered group members mutually to confirm their positions when acting in a group.

[0004]

Therefore, an object of the present invention is to make it possible mutually, and visually to confirm a position of a portable terminal device possessed by a member of the group when acting in a group.

{0005}

[Means for Solving the Problem]

In order to attain the object, the present invention equips on each portable terminal device map-data memory means for storing map data; map-display means for displaying the map data managed by the map-data memory means; position-detection means for detecting a present position; sending means for sending a position detected by the position-detection means on another portable terminal device; reception means for receiving a position sent by another portable terminal device; and position-display means for displaying a mark on a position received by the reception means on map data displayed by map-display means. Furthermore, with the present invention, in order to enable a display of a position of your own portable terminal device, own-position display means for displaying a mark at a position detected by your own position-detection means, on map data managed by map-display means. Also, in order to enable changing a color according to a distance between your own portable terminal device and another portable terminal device, distance-calculation means for calculating a distance between a position received by reception means and a position of your own portable terminal device, and color management means for managing a correspondence relationship of

distance and color are disposed; a color is read from color-management means according to a distance calculated by distance-calculation means to display a mark with the color read previously, when displaying a mark on the map using position-display means. Also, with the present invention, in order visually to confirm a movement speed of each portable terminal device, equipped are speed-calculation means for calculating a speed from a position received by reception means, and speed-display means for displaying the speed calculated by speed-calculation means, with an arrow that uses the position displayed by position-display means as a starting point.

{0006}

Also, there is another method for visually confirming a movement speed of each portable terminal device. With that method, equipped on each portable terminal device are map-data memory means for storing map data; map-display means for displaying the map data managed by the map-data memory means; position-detection means for detecting a present position; speed-detection means for detecting a present speed; sending means for sending a position detected by the position-detection means, and a speed detected by the speed-detection means, on another portable terminal device; reception means for receiving a position and a speed sent from another portable terminal device; position-display means for displaying a position received by the reception means superimposed on map data displayed by map display means; and speed display means for displaying with

an arrow a speed received by the reception means, using a position displayed by position-display means as a starting point.

[0007]

Also, with the present invention, it is possible to display information relating to a member possessing a portable terminal device represented on which is a mark displayed on the map. In other words, with the present invention, in addition to means described above are selection means for selecting a mark to be displayed on a screen; and user-information display means for displaying information that relates to a user for which a selected mark is represented. Furthermore, in order to know a distance between your own portable terminal device and another portable terminal device and a time required for movement, in addition to selection means, further equipped are distance-calculation means for calculating a distance between the portable terminal device on which a mark selected by selection means is represented and your own portable terminal device; distance-display means for display a distance calculated by distance-calculation means; time-calculation means for calculating a time required to move calculated using a speed received by reception means and a distance found by the distance-calculation means; distance-display means for displaying the distance found by the distance-calculation means when a mark is selected by selection means; and time-difference display means for displaying a time required to move found by the time calculation means.

[0008]

Also, with the present invention, it is possible to display traffic information on a map, to confirm whether a member is caught in a traffic jam. In other words, with the present invention, in addition the configuration described above, equipped are traffic-information reception means for receiving traffic information; and traffic-information display means for displaying superimposed on the map the traffic information received by traffic-information reception means.

[0009]

Also, with the present invention, along with information relating to a position such as a portable terminal device, it is possible to send and to receive still images loaded by a portable terminal device. In other words, with the present invention, equipped are map-data memory means for storing map data; map-display means for displaying the map data managed by the map-data memory means; position-detection means for detecting a present position; image-input means for loading an image; sending means for sending to another portable terminal device, a position detected by position-detection means and an image loaded by the image-input means; reception means for receiving the position and the image sent from another portable terminal device; position-display means for displaying a position received by the reception means superimposed on map data displayed by map-display means; selection means for selecting a mark displayed by the position-display means; and image-display

means for displaying on a screen an image that corresponds to the mark, when a mark is selected by the selection means.

[0010]

Still further, with the present invention, in order to load an image while the user can confirm the image to load, when loading an image, equipped are image-display means for displaying an image loaded by the image-input means; image-selection means for specifying switching the map-display means and the image-display means; and image-loading specification means for specifying loading an image when the image-display means is selected by the image-selection means.

[0011]

Still further, with the present invention, it is possible to send and receive information such as a position between each portable terminal device via a host station. In other words, with the present invention, equipped at a host station are host-reception means for receiving a position sent from the portable terminal device; position-management means for managing a position received by the host-reception means; and position-notification means for notifying a portable terminal device, a position of a portable terminal device that is managed by position-management means; and equipped on each portable terminal device are map-data memory means for storing map data; map-display means for displaying the map data managed by the map-data memory means; position-detection means for detecting a present position;

registration means for registering a position detected by position-detection means; a second reception means for receiving a position of another portable terminal device from the host station; and position-display means for displaying a position received by reception means superimposed on map data displayed by map-display means.

[0012]

[Action]

Initially, a method for displaying on a portable terminal device b information regarding a position and a speed of a portable terminal device a will be described. In such a case, at the portable terminal device a, a present position is obtained by position-detection means; the searched position information is sent to the portable terminal device b using sending means. At the portable terminal device b, initially, position information from the portable terminal device a is received using reception means. Also, map data managed by map-management means is displayed by map-display means, and the previously received position information is displayed superimposed over that map using position-display means. Also, at the portable terminal device b, the present position of the portable terminal device b itself is displayed on a map by the own-position display means. Furthermore, when a mark is displayed by the position-detection means at a position of another portable terminal device on the map, it is possible to calculate a distance between your own portable terminal device and another portable

terminal device using distance-calculation means and to read a color that corresponds to a calculated distance, using color-management means, and to display a mark with the previously read color. Also, it is possible to calculate a movement speed of another portable terminal device and to display a speed with an arrow using speed-display means.

[0013]

Next, a different method for displaying on a portable terminal device b information of a position and a speed of a portable terminal device a will be described. With a different method for displaying the speed, at a portable terminal device a, a present position is obtained by position-detection means and a movement speed is obtained by speed-detection means; the detected position and speed are sent to another portable terminal device b using sending means. Initially, position and speed information from the portable terminal device a are received at the portable terminal device b using reception means. Also, map data managed by map-management means is displayed by map-display means, and the previously received position information is displayed using position-display means, or the speed information is displayed using speed-display means, each superimposed over that map.

[0014]

Next, a method for displaying information relating to a user will now be described. Next, information relating to a mark selected by selection means is displayed by user-information display means.

Furthermore, a distance calculated by distance-calculation means is displayed by distance-display means and a time difference found by a time-calculation means is displayed by a time-difference display means as information relating to a mark selected by the selection means.

[0015]

Next, a method for displaying traffic information will now be described. In such a case, traffic information is received by traffic-information reception means and displayed superimposed over a map.

[0016]

Next, a method for sending position information and a still image of the portable terminal device a to portable terminal device b and displaying that on the portable terminal device b. Initially, at the portable terminal device a, a still image is loaded by image-input means. Also, the present position is obtained by position-detection means, and the position information detected by the sending means and the still image obtained previously are sent to the portable terminal device b. Initially, position information and the still image from the portable terminal device a are received at the portable terminal device b using reception means. Also, map data managed by map-management means is displayed by map-display means, and the previously received position information is displayed superimposed over that map using position-display means. Next, when a mark displayed on the map is selected by selection means, the still image is displayed on the screen by still-image display means.

[0017]

Next, a method for loading the still image will now be described. Initially, switch the screen using screen-selection means, and display the image inputted by the image-input means on the screen using image-display means. Then, by instructing to load an image using image-loading specifying means, the image inputted by the image-input means is loaded.

[0018]

Next, a method for displaying information such as a position of the portable terminal device a or the like on the portable terminal device b, via a host station will now be described. Initially, at the portable terminal device a, a present position is obtained by position-detection means; the position information detected using registration means is sent to the host station. At the host station, host-reception means receives position information of the portable terminal device a; position-management means stores the position information. Also, the host station sends to the portable terminal device b position information of the portable terminal device a using notification means. Initially, position information of the portable terminal device a is received at the portable terminal device b from the host station using second reception means. Also, map data managed by map-management means is displayed by map-display means, and the previously received position information is displayed superimposed over that map using position-display means.

[0019]

[Embodiment]

A detailed description of the present invention will now be described with reference to the drawings. Fig. 1 is a schematic view of a constitution of a communication system pursuant to an embodiment of the present invention. An overview of the embodiment will now be described with reference to Fig. 1.

[0020]

In Fig. 1, 100a, 100b, and 100c denote portable terminal devices. One member of the group, for example, has one portable terminal device 100. Also, 190a, 190b, 190c are GPS (Global Positioning System) satellites. The portable terminal device 100 receives radio waves from at least three GPS satellites to identify the present position. Also, portable terminal devices 100 mutually wirelessly exchange data between each other to learn whether a member is another member of the group, and to confirm their mutual positions.

[0021]

Fig. 3 is a block diagram of an internal configuration of the portable terminal device 100 depicted in Fig. 1. In the drawing, 101 denotes a control unit. This executes various processing programs relating to a control of peripheral units, and processing and communicating data requests or the like. 102 denotes a memory unit. This stores various programs and data relating to processing and communicating data requests or the like. The memory unit 102 uses RAM,

ROM, flash memory and a hard disk or the like. 103 denotes a communication unit. This exchanges data with other portable terminal devices. The communication unit 103 will be described below. 104 denotes a display unit. This is an LCD (Liquid Crystal Display) display device and a driver for driving the LCD. The display unit 104 can also use a CRT (Cathode Ray Tube) instead of the LCD. 105 denotes a GPS receiver. Radio waves from at least three GPS satellites 190 are received to identify the present position of the portable terminal device 100 itself. 106 denotes a map-management unit. This searches and reads map data. The map-management unit 106 uses a CD-ROM or flash memory as a recording medium. 107 denotes a clock. This manages the time and generates periodic interrupts. 108 denotes an input unit, for example a touch-panel that is integrated to the display, or buttons or the like, described below. Also, buttons are not necessary. 111 denotes a VICCS receiver for receiving traffic information; 113 denotes an image-input unit for loading images. Also, the VICCS receiver 111 and image-input unit 113 are not necessary.

[0022]

A method in the system with a constitution described above for the portable terminal devices 100 mutually to detect a position of other portable terminal devices 100 and for displaying on a screen of the portable terminal device will now be described.

[0023]

Initially, a position-management table 300 of your own and other

portable terminal devices 100 will now be described with reference to Fig. 6(a). The position-information management table 300 is stored in the memory unit 102 on the portable terminal device 100.

[0024]

The position-management table 300 is composed of an ID 301, a position 302, and a time 303. An identifier for identifying a user is stored in ID 301. Also, information (position information) for identifying a position of the user identified by the ID 301 is stored in the position 302. Also, as information for identifying a position, use a combination of latitude and longitude, or a combination of direction and distance from a specific point. Also, time 303 stores a time of a position measurement.

[0025]

Next, a member-management table 350 that manages information, such as a telephone number of the member's portable terminal device or other information that relates to a member will now be described with reference to Fig. 5. The member management table 350 is stored in the memory unit 102 on the portable terminal device 100.

[0026]

The member-management table 350 is composed of an ID 351, a name 352, and a telephone number 353. An identifier for identifying a user is stored in ID 351. A user name identified by the ID 351 is stored in the name 352. A telephone number of the portable terminal device possessed by the user identified by

the ID 351 is stored in the telephone number 353. Also, it is possible directly to use the name and telephone number in the ID 351. In such a case, it is not necessary to have an ID 351 composed of the identifier for identifying a user.

[0027]

Next, a position-detection process 500 that detects the present location of the portable terminal device 100 will now be described using the flowchart depicted in Fig. 9.

[0028]

The position-detection process 500 uses radio waves from at least three GPS satellites 190 using the GPS receiver 105 to calculate the present position (step 501). Also, the present position is received by the control unit 101 and the position information and time are stored in the position-management table 300. (Step 502) At step 502, the position information is stored at the position 302 of a record where an identifier of the owner of the portable terminal device 100 and the ID 301 match, and the time read from the clock 107 is stored in the time 303 of that record.

[0029]

Also, methods for determining a position using radio waves from the GPS satellites are described in the following literature.

Literature 1: The GPS Navigation Message, Navigation Vol 1.25, No. 2, pages 147 - 165; 1978; and

Literature 2: A Position Fixing Algorithm for the Low Cost GPS

Receiver, IEEE Trans. on AES; March, 1976

[0030]

Also, the position-detection process 500 is executed periodically using the clock 107.

[0031]

Next, a process for notifying the position of the portable terminal device 100a to the portable terminal devices 100b and 100c will now be described. Also, as a configuration of the communication unit 103, there are a method that uses a cellular telephone, a method that uses a specific, low-power wireless, and a method that uses both the cellular telephone and a pager.

[0032]

Initially, communication data 400 that is communicated between the portable terminal devices 100 will now be described with reference to Fig. 7(a). Also, a configuration of the communication data is the same for all three methods.

[0033]

The communication data 400 is composed of an ID 401, a position 402, and a time 403. An identifier for identifying a user is stored in ID 401. Also, position information of a user identified by the ID 401 is stored in the position 402. Also, time 403 stores a time of measurement of position information stored in the position 402.

[0034]

Initially, a process for notifying information relating to a position

of the portable terminal device 100a from the portable terminal device 100a to the portable terminal device 100b using a cellular telephone in the communication unit 103 will now be described with reference to the flowchart in Fig. 10. The notification process is composed of an information-sending process 510 in the portable terminal device 100a, and the information-receiving process 520 in the portable terminal device 100b.

[0035]

With the information-sending process 510, it is judged whether communication data 400 was sent to all members registered in the member-management table 350 (step 511). If it has been sent to all members, the information-sending process 510 ends. If it has not been sent to all members, a member to which it has not been sent is selected, and a telephone number is read from the telephone number 353 of the member-management table 350. (Step 512) Next, a telephone call is placed to the read telephone number and the line is connected. (Step 513) Also, the position information of the portable terminal device 100a is read from the position 302 of the record identified by the identifier of the owner of the portable terminal device 100a, of the position-management table 300, and is stored at the position 402 of the communication data 400, and the time is read from the time 303 of the record and stored in the time 403 of the communication data 400. The identifier of the owner of the portable terminal device 100a is stored in the ID 401 of the

communication data 400. Also, the communication data 400 is sent to the portable terminal device 100b through the line connected at step 513. (Step 514) The line is disconnected after sending ends. (Step 515) The system returns to step 511 after step 515 ends.

[0036]

Also, initially, with the information-receiving process 520, the communication data 400 is received from the portable terminal device 100a through the line established with the portable terminal device 100a. (Step 521) Next, at step 521, position information stored in position 402 of the communication data 400 is stored in position 302 of a record in position-management table 300 identified by ID 401 of the received communication data 400, and the time stored in the time 403 of the communication data 400 is stored in the time 303 of the record. (Step 522)

[0037]

Also, with this embodiment, a cellular telephone is used, but this can be implemented with the same method using a PHP (Personal Handy Phone) instead of a cellular telephone.

[0038]

Next, processing when a specified low-power wireless is used for the communication unit 103 will now be described using the flowchart depicted in Fig. 11. Processing when using the specified low-power wireless is composed of the information sending process 530 in the portable terminal device 100a,

and the information-receiving process 540 in the portable terminal device 100b.

[0039]

Also, in the information-sending process 530, the position information of the portable terminal device 100a is read from the position 302 of the record identified by the identifier of the owner of the portable terminal device 100a, of the position-management table 300, and is stored at the position 402 of the communication data 400, and the time is read from the time 303 of that record and stored in the time 403 of the communication data 400. The identifier of the owner of the portable terminal device 100a is stored in the ID 401 of the communication data 400. Also, the communication data 400 is sent at a preset frequency via the communication unit 103 (Step 531).

[0040]

Also, initially, in the information-receiving process 540, the communication data 400 is received from the portable terminal device 100a at a same frequency as the frequency emitted by the portable terminal device 100a. (Step 541) Next, position information stored in position 402 stored in position 402 is stored in position 302 of the record in position-management table 300 identified by ID 401 of the communication data 400 received at step 541, and the time stored in the time 403 is stored in the time 303 of that record (Step 542).

[0041]

Also, with this embodiment, a specified low-power wireless is used, but this can be implemented with the same method using an amateur wireless instead of the specified low-power wireless.

[0042]

Next, processing when a cellular telephone and a pager are used together will now be described using the flowchart depicted in Fig. 12. Processing when using both a cellular telephone and a pager includes an information-sending process 550 in the portable terminal device 100a, and an information-receiving process 560 in the portable terminal device 100b.

[0043]

With the information-sending process 550, a group-calling feature that has a pager is used. Also, the group-calling feature is a feature that simultaneously calls a plurality of pagers. With the information-sending process 550, initially, use the cellular telephone feature to place a call to the telephone number to call the group and connect the line. (Step 551) Next, the position information of the portable terminal device 100a is read from the position 302 of the record identified by the identifier of the owner of the portable terminal device 100a, of the position-management table 300, and is stored at the position 402 of the communication data 400, and the time is read from the time 303 of that record and stored in the time 403 of the communication data 400. The identifier of the owner of the portable terminal device 100a is stored in the ID 401 of the

communication data 400. Also, the communication data 400 is sent through the line established at step 551. (Step 552) Lastly, the line established at step 551 is disconnected (Step 553).

[0044]

Also, with the information-receiving process 560, the communication data 400 sent by the portable terminal device 100a is received at the pager receiver. (Step 561) Next, position information stored in position 402 is stored in position 302 of a record in the position-management table 300 identified by ID 401 of the communication data 400 received at step 561, and the time stored in the time 403 is stored in the time 303 of that record (Step 562).

[0045]

Also, in each example described above, information on the time that the position was measured is also sent from the portable terminal device 100a to the portable terminal device 100b, the time information is not always necessary when only the position is displayed.

[0046]

Next, methods for starting the information-sending process 510, the information-sending process 530, and the information-sending process 550 will now be described.

[0047]

There are two methods for starting the information-sending process 510, the information-sending process 530, and the information-sending process 550. One is a method for periodically starting, and the

other is a method for starting after moving more than a predetermined distance.

[0048]

When periodically starting, the clock 107 is used to start the information-sending process 510, the information-sending process 530, and the information-sending process 550.

[0049]

When starting if there is movement more than a fixed distance, the memory unit 102 stores the position information when the information-sending process 510, the information-sending process 530, and the information-sending process 550 are started. Also, the present position information obtained by the position-detection process 500 and the distance between the previously stored position information are calculated. When the measured distance is higher than a fixed value, the information-sending process 510, the information-sending process 530, and the information-sending process 550 are started, and the position information obtained at that time by the position-detection process is stored in the memory unit 102.

[0050]

If there is movement beyond a fixed distance, the information-sending process 510, the information-sending process 530, and the information-sending process 550 are started; when there is not movement, data is not sent. For that reason, it is possible to suppress power consumption of the portable terminal device 100.

[0051]

With the method described above, the portable terminal device 100b can detect a position of the portable terminal device 100a, in other words, it can detect the position of a member that is using the portable terminal device 100a.

[0052]

Next, a position-display process 700 that displays at the portable terminal device 100b information relating to a position received from the portable terminal device 100a, will now be described using the flowchart depicted in Fig. 13.

[0053]

With the position-display process 700, initially, position information of the portable terminal device 100b is read from the position 302 of a record identified by an identifier of the owner of the portable terminal device 100b, of the position-management table 300. (Step 701) Next, a map is read from the map-management unit 106. (Step 702) Next, the map read at step 702 is displayed on the display unit 104. (Step 703) Next, a mark that indicates a position of the portable terminal device 100b read at step 701 is displayed on the map. (Step 704) Next, it is judged whether the position of all members stored in the position-management table 300 is displayed. (Step 705) When displays of all members' positions end, the position-display process 700 ends. If there is a member whose position has not yet been displayed, the position of the member whose position has not yet been displayed is read from the

position-management table 300. (Step 706) Next, a mark that indicates the position read at step 706 is displayed superimposed over the map on the display unit 104. (Step 707) The system returns to step 705 after step 707 ends.

[0054]

Also, when the position of the portable terminal device 100b is not displayed on the screen, the processes of step 701 and step 704 can be omitted. Also, in the process to read the map at step 702, a map that includes the position of the portable terminal device 100b read at step 701 can be selected. This kind of technique is already implemented by vehicle navigation systems or the like.

[0055]

Also, by changing the process at step 702 to the map-selection process 710 depicted in Fig. 14, it is possible to display on one screen positions of all members stored in the position-management table 300.

[0056]

With the map-selection process 710 depicted in Fig. 14, all positions stored in the position-management table 300 are read. (Step 711) Also, maps that include all positions read at step 711 are read from the map-management unit 106 (Step 712).

[0057]

Also, in the embodiment described above, map data is read from the map-management unit 106. However, with the present invention, it is not always necessary to have map data in the portable terminal

devices 100. For example, it is possible to prepare a database system that manages map data, and to install onto the portable terminal device 100 means for accessing the database and to read the map data from the database system. Below, a working example for that is described. Furthermore, in such a case, it is necessary for the communication unit 103 to have a cellular telephone feature.

[0058]

Instead of step 702 in the map-display process 700, map data can be read from the database system using a map-data acquisition process 870. Also, implement a map-data supply process 880 in the database that manages map data. The map-data acquisition process 870 and the map-data supply process 880 will now be described with reference to a flowchart in Fig. 33.

[0059]

With the map-data acquisition process 870, for example, place a telephone call to the database system to establish a line with the database system. (Step 871) Next, send a request for map data to the database system. (Step 872) Then, receive the map data from the database system (Step 873).

[0060]

Also, with the map-data supply process 880, initially, send a request from the portable terminal device 100. (Step 881) Next, read the map according to the request. (Step 882) Next, the map read at step 882 is sent to the display unit 100 (Step 883).

[0061]

With these processes, it is possible to obtain map data from outside of the portable terminal device 100.

[0062]

Next, example displays of a screen on the portable terminal device 100 will be described with reference to Fig. 17. Fig. 17(a) is an example of a screen that displays the position of the portable terminal device 100a possessed by another member, on a screen of the portable terminal device 100b. In the drawing, 290 denotes a map displayed on the screen. Also, 201 (201a, 201b) denotes a mark that indicates a position of the portable terminal device 100a.

[0063]

Fig. 17(b) is an example of a screen that simultaneously displays the position of the portable terminal device 100b possessed by another member, and the position of your own portable terminal device 100a, on the screen of the portable terminal device 100b. In the drawing, 201 is a mark that indicates a position of the portable terminal device 100a. 202 is a mark that indicates the position of the portable terminal device 100b itself.

[0064]

In this way, by displaying positions of members on the map, it is possible to know at a glance where the members are located.

[0065]

Also, with the present invention, it is possible to display member names along with the mark 201 that represents the member's position. In such a case, at step 707 of the position-display process 700, a name of the member in the member-management table 350 is read from the name 352 of the record identified by the identifier of the member read at step 706, and is displayed below the mark 201, for example.

[0066]

Examples of screens that display the member's name below the mark using this process is shown in Fig. 17. In the drawing, 231 (231a, 231b) is a member's name. By displaying name 231 of members below the mark 201, it is possible to know at a glance where everyone is located.

[0067]

When there is a plurality of displays on one screen of the position of the portable terminal devices 100, it is possible to display individual marks for each of the portable terminal devices 100. In such a case, use the mark management table 360. The mark-management table is stored in the memory unit 102 on the portable terminal device 100.

[0068]

Fig. 20 shows a constitution of the mark-management table 360. An identifier for identifying a user is stored in ID 361. Marks displayed on the screen are stored in mark 362 in bitmap format, for example.

[0069]

To display different marks for each portable terminal device 100, when displaying the mark in step 704 and step 707 in the position-display process 700, read the mark to be displayed on the screen from the mark 362 of the record identified by the identifier of the user to be displayed in the mark-management table 360 to display it on the screen.

[0070]

With this process, different marks for each portable terminal device 100 are used. Examples of the screens that display the positions are depicted in Figs. 17(c) and 17(f). By using different marks for each member in this way (mark 201a is a circle, and mark 201b is a square in the depicted examples), it is possible to identify a member at a glance.

[0071]

Also, with the present invention, it is possible to change the color of the mark in line with a distance between the portable terminal device 100b and another portable terminal device 100. In such a case, use the distance-color-code table 370. Also, the distance-color-code table 370 is stored in the memory unit 102 on the portable terminal device 100.

[0072]

Fig. 29 shows a constitution of the distance-color-code table 370. Also, the distance-color-code table 370 is composed of a lower limit 371, an upper limit 372 and a color 373. For example, if the lower limit 371

is one kilometer, the upper limit 372 is five kilometers, and the color 373 is red, this means that when a distance to the portable terminal device 100b is one kilometer or more, and 5 kilometers or less, red will be displayed.

[0073]

To change the color of the mark that corresponds to the distance to the portable terminal device 100b, implement color selection 860 before step 707 in the position-display process 700. The color-selection process 860 will now be described with reference to the flowchart in Fig. 30.

[0074]

With the color-selection process 860, initially, a distance is calculated for two points, namely from the position information of the portable terminal device 100b read at step 701 and the position information of the member read at step 706 (Step 861). Next, it is judged whether upper limit and lower limit reading processes have been implemented, from all records of the distance-color-code table 370 (Step 862). When all records have been read, the color display is the color (default color) that was predetermined (Step 866). Initially, if there is a record that has not been read, read the lower limit from the lower limit 371 or the upper limit from the upper limit 372 in the distance-color-code table 370 (Step 864). Next, it is judged whether the distance calculated at step 861 is more than the lower limit and less than the upper limit (Step 864). If it is over the lower limit and less than the upper limit, the system

returns to step 862. If it is higher the lower limit and lower than the upper limit, a color to display the mark is read from the color 373 of the record that read the lower limit and the upper limit at step 864 (Step 865). Also, at step 707 in the position-display process 700, the mark is displayed with the color determined at step 865 or step 866.

[0075]

Fig. 31 shows an example of switching mark colors according to the distance to the portable terminal device 100b. In the drawing, 201 (201a, 201b) are marks that represent positions of other portable terminal devices. On paper, the color cannot be expressed, so in this example the color is expressed using shading. As described above, by changing the color of the mark in line with a distance between the portable terminal device 100b, it is possible to check a distance from another member at a glance.

[0076]

With the embodiment described above, only information relating to a position of the portable terminal device 100a on the portable terminal device 100b was displayed. However, with the present invention, it is also possible simultaneously to display information relating to movement speed. Below, a working example for that is described.

[0077]

Initially, a table that stores information relating to movement speed is described using Fig. 6(b).

[0078]

When displaying movement speed in addition to a position, switch the position-management table 300 described in the working example above, with a position-management table 310. The position-management table 310 is composed of an ID 311, a position 312, a time 313, and a speed 314. The same information as that in ID 301 is stored in ID 311. The same information as that in position 302 is stored in position 312. The same information as that in time 303 is stored in time 313. Also, time 313 stores information (movement-speed information) that relates to movement speed. As information relating to movement speed, a combination of speed and direction is used.

[0079]

There are two methods for detecting movement speed of the portable terminal device 100a with the portable terminal device 100b. One method calculates movement speed of the portable terminal device 100a at the portable terminal device 100b, and in another method the portable terminal device 100b receives the movement speed of the portable terminal device 100a from the portable terminal device 100a.

[0080]

Initially, an example of the former method using information-sending process 510 and information-receiving process 520 will be described. In this method, at the information-receiving process 520, a speed-calculation process 800 is implemented before step 521. The speed-calculation process 800 will

now be described with reference to the flowchart in Fig. 21.

[0081]

With the speed-calculation process 800, initially, time 313 is read from a record (record A) in the position-management table 310 identified by ID 401 in communication data 400, and the time difference with the time 403 in the communication data 400 is calculated (Step 801). Next, the position 312 is read from record A, and compared to position 302 in communication data 400 to determine the distance between the two positions (Step 802). At step 702, by dividing the calculated distance by the time determined at step 801, the speed can be found (Step 803). Also, the speed found at step 803 is stored in the speed 314 of record A (Step 804).

[0082]

Also, when using the information-sending process 530 and the information-receiving process 540, or the information-sending process 550 and information-receiving process 560, by inserting the speed-calculation process 700 before step 542 and step 562, it is possible to store the speed of the portable terminal device 100a in the speed 314 of the position-management table 310, and it is possible for the portable terminal device 100b to obtain information relating to the speed of the portable terminal device 100a.

[0083]

Next, the latter method will be described.

With this method, switch communication data 400 to communication data 410.

[0084]

Communication data 410 will be described with reference to Fig. 7(b). Communication data 410 is composed of an ID 401, a position 402, a time 403, and a speed 404. Speed 404 stores information that relates to a speed of the portable terminal device 100.

[0085]

With this method, a speed sensor is attached to the portable terminal device 100. The speed sensor detects movement-speed information of the portable terminal device 100.

[0086]

Next, a process for obtaining movement-speed information of the portable terminal device 100 will be described. In the position-detection process 500 for the portable terminal device 100a, after step 502, the movement-speed information obtained from the speed sensor is stored in the speed 314 of the record identified by the identifier of the owner of the portable terminal device 100a in the position-management table 310.

[0087]

Next, an example of a process for notifying the portable terminal device 100b of the movement-speed information of the portable terminal device 100a will be described using information-sending process 510 and information-receiving process 520. Before implementing step 514, the movement-speed information of the

portable terminal device 100a is read from the speed 314 of the record identified by an identifier of the owner of the portable terminal device 100a, of the position-management table 310, and is stored in the speed 404 of the communication data 410. (Below, this is called a speed-information sending-preparation process). Also, in the information-receiving process 520, before implementing step 522, the movement-speed information stored in the speed 404, is stored in the speed 314 of the record of the position-management table 310 identified by ID 401 of the communication data 410 received earlier. (Below, this is called a speed-information storage process).

[0089]

Also, when using the information-sending process 530 and the information-receiving process 540, or the information-sending process 550 and information-receiving process 560, by inserting the speed-information sending-preparation process before step 531 and step 552, and inserting the speed-information storage process before step 542 and step 562, it is possible to store the speed of the portable terminal device 100a in the speed 314 of the position-management table 310 on the portable terminal device 100b, and it is possible for the portable terminal device 100b to obtain information relating to the speed of the portable terminal device 100a.

[0090]

With the method described above, the portable terminal device 100b can detect information relating to

the speed of the portable terminal device 100a.

[0091]

Next, processing to display the movement-speed information of the portable terminal device 100a detected using the method described above on the portable terminal device 100b will be described. To display on the portable terminal device 100b screen the movement-speed information of another portable terminal device 100 (for example the portable terminal device 100a), add a speed-display process 810 after step 707 in the position-detection process 700. The speed-display process 810 will now be described with reference to the flowchart in Fig. 22.

[0092]

In the speed-display process 810, initially, movement-speed information is read from the speed 314 of the same record as the record that read the position information at step 706 in the position-management table 310 (Step 811) Next, as a starting point for the position read at step 706, the movement speed information read at step 811 is displayed with an arrow, for example. (Step 812) At this time, the direction indicated by the arrow is aligned with the direction of travel of the portable terminal device 100a. Also, when the arrow is displayed, the length of the arrow can be changed in proportion to a speed read at step 711. For example, the arrow will become longer as the movement speed increases.

[0093]

Fig. 17(c) is an example of displaying the position and the speed of the portable terminal device 100 possessed by another member. In the drawing, 211 (211a, 211b) denote a movement speed and a movement direction of the portable terminal device 100 indicated with mark 201 (201a, 201b).

[0094]

Also, at the portable terminal device 100b, it is possible simultaneously to display information relating to a speed of the portable terminal device 100a itself. In such a case, movement-speed information is read from the speed 314 of the record identified by the identifier of the owner of the portable terminal device 100b of the position-management table 310, and at step 704, the movement-speed information of the portable terminal device 100b read previously is displayed with an arrow, for example, as a starting position for the position read at step 701.

[0095]

Fig. 17(d) is an example of displaying the position and the speed of the portable terminal device 100 possessed by another member, and your own position and speed. In the drawing, the arrow 212 represents your own movement speed and movement direction. As shown in the drawing, by displaying the movement speed using an arrow, it is possible visually to confirm a direction that the member is traveling.

[0096]

With the embodiment described above, a member's position and speed are displayed. However, it is also possible to display information related to another member's distance with the present invention. Below, a working example for that is described. With this embodiment, in the memory unit 102 exist the position-management table 310 that manages a member position, and the member-management table 350 that manages information relating to a member.

[0097]

Initially, a member-information display process 820 in the portable terminal device 100b will now be described with reference to the flowchart in Fig. 23. Also, the member-information display process 820 is launched by the user touching the touch panel on the input unit 108.

[0098]

With the member-information display process 820, the position on the touch panel of the input unit 108 touched by the user is detected; this is converted into a coordinate on the map (Step 821). Next, a distance between two points is calculated using the position detected at step 821, and the position information stored in the position 312 of the position-management table 310. Distance calculation is implemented for all members that manage positions with the position-management table 310; a member that is nearest the position detected at step 821 is identified, and an identifier of the user is read from ID 311 (Step 822). Next, it is judged whether the distance of the member

identified at step 822 and the position detected at step 821 is within a fixed value (Step 823). When the distance is not within a fixed value, the member-display process 820 ends. If the distance is within a fixed value, information relating to the member is read from the record identified by the identifier of the user read at step 822, of the member-management table 350, and is displayed on the screen (Step 824).

[0099]

A member name read from the name 352 is an example of information displayed on the screen. Also, the information stored in the record of the member identified at step 822, of the position-management table 310, is displayed at the same time. The information displayed at this time includes position information stored in the position 312, movement-speed information stored in the speed 314, and the time stored in the time 313. Also, it is not absolutely necessary to display all of the information provided by way of example, as information to display at step 824.

[0100]

Also, at step 824, by adding a distance-calculation process, described below, it is possible to display a position of the portable terminal device 100b, and a distance to a member specified by the user via the input unit 108.

[0101]

With the distance-calculation process, initially, position information of the portable terminal device 100b is read from

the position 312 of a record identified by an identifier of the owner of the portable terminal device 100b, of the position-management table 312. Next, the position information of the member identified at step 822 is compared to find a distance between two points, and is displayed together with other information displayed at step 824, on the display unit 104.

[0102]

With the distance-calculation process described above, a straight line distance of the position of the portable terminal device 100b and the member specified by the user via the input unit 108 is found, but if information that relates to roads on a map is stored, it is possible to find the distance along a road. The distance found along a road is called the actual distance. Regarding methods for finding the actual distance, one method selects roads to shorten a distance along the roads at two points, and another method selects a road to shorten a distance along a road at two points for a road that is larger than a fixed width.

[0103]

Also, by adding a time-difference calculation process, described below, along with the distance-calculation process at step 824, the time required to arrive at a position where the member identified at step 822 by the portable terminal device 100b, or the time required to arrive (called a time difference with a member) at the position of the portable terminal device 100b by the member identified at step 822 can be displayed.

[0104]

With the time-difference calculation process, initially, the movement-speed information is read from the speed 314 of the record identified at step 822 of the position-management table 310, to find the speed (for example, miles-per-hour). Next, by dividing the actual distance found by the distance-calculation process by the speed calculated earlier, it is possible to calculate the time difference with the member. Thereafter, this is displayed together with other information displayed at step 824, on the display unit 104.

[0105]

Also, with the time-difference calculation process, an actual distance was used to find the time difference with another member, but when it is not possible to find the actual distance, it is possible to use a straight-line distance. However, when using the straight line distance, precision will drop compared to the use of the actual distance.

[0106]

Also, with the working example described above, the position-management table 310 was used, but it is possible also to use the position-management table 300. In such a case, at step 824, it is not possible to display movement-speed information. Also, it is not possible to implement the time-difference calculation process, so it is not possible to display the time difference with the members.

[0107]

Fig. 24 shows an example of a screen displaying member information. In the drawing, 260 denotes information relating to the member. As described above, the user can know detailed information about the selected member simply by selecting a mark on the screen.

[0108]

With the working example described above, position information and movement-speed information were sent and received between portable terminal devices 100, but it is possible to send and receive still images by disposing an image-input unit 113 in the portable terminal devices 100. Below, a working example for that is described.

[0109]

Figs. 25(a) and 25(b) illustrate examples of an external appearance of portable terminal devices 100 that include the image-input unit 113. In the drawings, 151 denotes a view button, and 152 denotes an image-load button. Also, 153 denotes a capturing unit that includes a lens for loading an image. Behaviors when the view button 151 and the image load button are pressed will be described below.

[0110]

Also, an example with the portable terminal device 100 that includes the image-input unit 113 installed on a vehicle is depicted in Fig. 25(c). In the drawings, 171 denotes a front windshield of the vehicle, and 172 denotes a steering wheel. Also, 155 denotes a connecting line that connects a camera (video camera) that includes the portable

terminal device 100 and capturing unit 153. When installed in a vehicle, it is possible to capture a scene that is the same as a scene viewed by the vehicle driver, by installing the capturing unit 153 that includes a lens, near the front windshield 171.

[0111]

Next, a still-image management table 490 that manages still images in the portable terminal device 100 will now be described with reference to Fig. 18.

[0112]

The still-image management table 490 is composed of a position 491, and an image 492. Position information relating to the still image is stored in the position 491. Still image data is stored in the image 492. Still image data stored in the image 492 can be compressed. Also, when there is no position information stored in the position 491 of the still-image management table (for example, when the value is 0), that record is empty.

[0113]

Next, communication data 420 that transfers the still image between portable terminal devices 100 will now be described with reference to Fig. 7(c). Communication data 420 is composed of an ID 401, a position 402, a time 403, and an image 405. A still image is stored in the image 405.

[0114]

Next, a still-image loading process for loading a still image with the portable terminal device 100a will now be described using the

flowchart depicted in Fig. 26. The still-image loading process 830 is launched by pressing the view button 151.

[0115]

With the still-image loading process 830, initially, an image captured by the camera is loaded via the image-input unit 113, and is displayed on the display unit 104. At that time, the original image is kept in the memory unit 102. (Step 831) Next, wait until the user presses the view button 151 or the load button 152. When the load button 152 is pressed, the system shifts to step 833. When view button 151 is pressed, the system shifts to step 834. At step 833, when the load button 152 is pressed, the image inputted via the image-input unit 113 is stored in the memory unit 102. Also, the still image stored in the memory unit 102 is transferred to the portable terminal device 100b using the information-sending process. At step 834, the image kept in the memory unit 102 at step 831 is returned to its original state.

[0116]

With the still-image loading process, a user can load an image to be loaded while visually checking it. With this, it is possible to load the image the user actually wants.

[0117]

Next, a process for sending to the portable terminal device 100b a still image loaded by the portable terminal device 100a will be described using information-sending process 510 and information-receiving process 520 described above in relation to Fig. 10.

[0118]

To send to the portable terminal device 100b a still image loaded by the portable terminal device 100a, at the information-sending process 510, the still image stored in the memory unit 102 at step 833 of the still-image loading process 830, is stored in the image 405 of the communication data 420 (see Fig. 7(c)), before implementing step 514. (This process is called the still-image sending-preparation process.) Also, in the information-receiving process 520, before implementing step 522, the position information is read from the position 402 of the communication data 420 received previously, and is stored in the position 491 of the empty record in the still-image management table 490. Also, the still image read from the image 405 of the communication data 420 is stored in the image 492 of the same record of the still-image management table 490. (These two steps are collectively called the still-image loading process.)

[0119]

Also, when using the information-sending process 530 and the information-receiving process 540, or the information-sending process 550 and information-receiving process 560, by inserting the still-image sending-preparation process before step 531 and step 552, and inserting the still-image storage process before step 542 and step 562, it is possible to store the still image loaded by the portable terminal device 100a in the still-image management table 490 on the portable terminal device 100b.

[0120]

With the method described above, the portable terminal device 100b can receive the still image loaded by the portable terminal device 100a. Also, the process for transferring the still image indicated above is executed by the information-sending process 510 immediately after the still-image loading process 830 is implemented.

[0121]

Next, processing to display the still image on the portable terminal device 100b will now be described using the display example depicted in Fig. 19, and the flowcharts depicted in Figs. 27 and 28. With the present invention, to display a still image, implement an image-position display process 840 and a still-image display process 850.

[0122]

Initially, the image-position display process 840 for displaying on a map the position where the still image exists will now be described using the flowchart depicted in Fig. 27.

[0123]

With the image-position display process 840, initially, it is judged whether position information has been read for all still images stored in the still-image management table 490 (Step 841). If position information for all still images has been read, the image-position display process 840 ends. If there is a still image for which position information has not yet been read, the position information

is read from the position 491 of the record for which the position information of the still-image management table 490 has not been read (Step 842). Next, it is judged whether the position read at step 842 will fit in the map displayed at present on the display unit 104 (Step 843). If it will not fit in the map, the system returns to step 841. If the image will fit in the map, a mark that corresponds to the position read at step 842 is displayed on the map displayed on the display unit 104.

[0124]

With this process, the position where the portable terminal device 100a loaded the still image can be displayed on the map.

[0125]

Next, the still-image display process 850 for displaying on a screen a still image specified by the user will now be described using the flowchart depicted in Fig. 28. Also, the still-image display process 850 is launched by the user touching the touch panel on the input unit 108.

[0126]

With the still-image display process 850, the position on the touch panel of the input unit 108 touched by the user is detected; this is converted into a coordinate on the map. (Step 851) Next, a distance between two points is calculated using the position detected at step 851, and the position information stored in the position 491 of the position-management table 490. Distance calculation is implemented for all

still images stored in the still-image management table 490, and a record that is nearest the position detected at step 851 is identified, and the position information is read from the position 491 of that record (Step 852). Next, it is judged whether the distance of the position detected at step 852 and the position detected at step 851 is within a fixed value (Step 853). When the distance is not within a fixed value, the still-image display process 850 ends. When the distance is within the fixed value, the still image is loaded from the image 492 of a record identified at step 852, of the still-image management table 490 and displayed on the screen (Step 854).

{0127}

With this process, it is possible to display on the screen a still image specified by the user.

{0128}

Fig. 19(a) shows an example of displaying a position of the still image on a map. In the drawing, 251 denotes a mark that indicates a position of the still image. Here, a star shaped mark is used. Different marks may also be used, if they are prepared. Fig. 19(b) shows an example of a screen displaying the still image. In the drawing, 252 denotes the still image displayed when the mark 251 is specified. When transferring the still image is possible, it is possible for a user of the portable terminal device 100b surely to know a meeting place by loading, on the portable terminal device 100a, for example, an image of the meeting place, and transferring it to the portable terminal device 100b.

{0129}

In the working example described above, a still image is used, but it is also possible to use a video with the present invention. In such a case, the display for loading a still image can also be made into a display for loading a video.

{0130}

Also, with the present position, not only is it possible to send the loaded still image to another portable terminal device 100b, it is possible to save the loaded still image on the portable terminal device 100a. In such a case, at step 833 of the still-image loading process 830, position information is read from the position 312 of the record identified by the identifier of the owner of the portable terminal device 100a of the position-management table 310, and can be stored at the position 491 of the empty record of the still-image management table 490; the loaded image can be stored via the image-input unit 113 in the image 492 of the same record.

{0131}

With the working example described above, position information is sent along with the still image using communication data 420, but it is also possible to send the still image along with the position information and the speed information by using the communication data 430. Below, a working example for that is described.

{0132}

First, a constitution of the communication data 430 will now be described with reference to Fig. 7(d). Communication data 420 is composed of an ID 401, a position 402, a time 403, a speed 404, and an image 405.

[0133]

Next, a method for sending the position information, the speed information and the still image will now be described. In order to send the position information, the speed information and the still image, when using the information-sending process 510 and the information-receiving process 520, or the information-sending process 530 and information receiving process 540, or the information-sending process 550 and information-receiving process 560, it is acceptable to insert the speed-information sending-preparation process and the still-image sending-preparation process before step 514, step 531, and step 552, and to insert the speed-information storage process and still-image storage process before step 522, step 542, and step 562.

[0134]

Also, with the present invention, a VICCS receiver 111 is equipped to receive traffic information on the portable terminal device 100. It is possible visually to check whether a member is caught in a traffic jam by checking on the map traffic jam information by superimposing the received traffic information on a display of a map displayed on the display unit 104. Fig. 32 shows an example of traffic information superimposed on a map. In the drawing, 240 denotes an area

indicated by the symbol 240 experiencing a traffic jam.

[0135]

An example was provided with the embodiment described above for sending information relating to a position from the portable terminal device 100a to the portable terminal device 100b. However, this is the same for sending information relating to a position of the portable terminal device 100b to the portable terminal device 100a and displaying the position of the portable terminal device 100b on the portable terminal device 100a.

[0136]

With the system configuration in the working example described above, information relating to the position of the portable terminal device 100a is received from the portable terminal device 100a on the portable terminal device 100b. However, with the present invention, it is possible to dispose a host station and to receive the information relating to the position or the like of another portable terminal device from the host station. Below, a working example for that is described.

[0137]

Fig. 2 is a schematic view of a constitution of a communication system when a host station is disposed. In the drawing, 180 is the host station. Also, 100a, 100b, and 100c are portable terminal devices; 190a, 190b, 190c are GPS satellites.

[0138]

Next, a constitution of the host station 180 will now be described with reference to Fig. 4. In the drawing, 181 denotes a control unit. This executes various processing programs relating to a control of peripheral units, and processing and communicating data requests or the like. 182 denotes a memory unit. This stores various programs and data relating to processing and communicating data requests or the like. The memory unit 182 uses RAM, ROM, flash memory and a hard disk or the like. 183 denotes a communication unit. This exchanges data with the portable terminal device 100. 184 denotes a display unit, for example, this can be composed of a CRT display device. 187 denotes a clock. This manages the time and generates periodic interrupts. 188 denotes an input unit, for example, this can be composed of a keyboard, a touch panel, a mouse and a stylus-like input means.

[0139]

When the host station 180 is disposed, the data-exchange format with the portable terminal device 100 is different from the system configuration described with Fig. 1. However, the data stored on the portable terminal device 100, the position-detection process 500 and the position-display process 700 are the same. Specifically, with the system configuration described with Fig. 1, the data-exchange format between portable terminal devices 100 uses the information-sending process 510 and the information-receiving process 520, or the information-sending process 530 and the information receiving process 540, or the information-

sending process 550 and the information-receiving process 560, but with the system configuration depicted in Fig. 2, a different data-exchange format is used. Below, the data-exchange format with the system configuration depicted in Fig. 2 will now be described.

[0140]

Initially, a host-position management table 450 that manages a position of the portable terminal device 100 at the host station will now be described with reference to Fig. 9(a). Also, the host-position management table 450 is stored in the memory unit 182 at the host station 180.

[0141]

The host-position management table 450 is composed of an ID 451, a position 452, and a time 453. The ID 451 stores an identifier for identifying a user. Also, position information of a user identified by the ID 451 is stored in the position 452. Also, time 453 stores a time of a position measurement.

[0142]

Next, a process for notifying the position of the portable terminal device 100a to the portable terminal devices 100b and 100c will now be described. For the system configuration, position information of the portable terminal device 100 is stored once at the host station 180, and then later the other portable terminal devices 100b and 100c are notified. Also, as a configuration of the communication unit 103 on the portable terminal devices 100, there is a method that uses a cellular telephone, and a

method that uses both the cellular telephone and a pager. Also, communication data 400 is used as communication data between the portable terminal devices 100 and the host station 180. Also, at the portable terminal device 100, the position-management table 300 is used to manage member positions.

[0143]

Initially, the method using the cellular telephone in the communication unit 103 will be described using the flowchart in Fig. 15. This method is composed of a client process 600 on the portable terminal device 100a, and the host process 610 at the host station 180.

[0144]

With the client process 600, a telephone call is placed to the host station 180 via the cellular telephone in the communication unit 103 to connect the line (Step 601). Also, the position information of the portable terminal device 100a is read from the position 302 of the record identified by the identifier of the owner of the portable terminal device 100a, of the position-management table 300, and is stored at the position 402 of the communication data 400, and the time is read from the time 303 of the record and stored in the time 403 of the communication data 400. The identifier of the owner of the portable terminal device 100a is stored in the ID 401 of the communication data 400. Also, the communication data 400 is sent to the host station 180 through the line connected at step 601 (Step 602). Next, the position information of another member is

received from the host station 180. With reception of the position information of the other member, it is judged whether an end code has been sent from the host station 180. (Step 603) If the end code has been sent, the line established at step 601 is disconnected. (Step 605) If the end code has not been sent, communication data 400 from host station 180 is received. (Step 604) At step 604, position information stored in position 402 is stored in position 302 of the record in the position-management table 300 identified by ID 401 of the communication data 400, and the time stored in the time 403 is stored in the time 303 of the record (Step 605). Thereafter, the system returns to step 603.

[0145]

With the host process 610, communication data 400 sent at step 602 of the client process 600, is received (Step 611). Next, position information stored in position 402 is stored in position 452 of the record of the host-position management table 450 identified by ID 401 of the communication data 400 received at step 611, and the time stored in the time 403 is stored in the time 453 of the record (Step 612). Next, member-position information registered in the host-position management table 450 is sent to the portable terminal device 100a. To send this, initially, it is judged whether the position information for all members (however, this excludes members identified by ID 401 in communication data 400 received at step 611) stored in the host-position management table 450, has been sent (Step 613). If position

information for all members has been sent, the end code is sent and processing ends. (Step 615) If position information has not been sent for all members, records of members for which position information has not been sent is identified. Next, the user identifier is read from the ID 451 of the identified record and stored in the ID 401 of the communication data 400, the position information is read from the position 452 and stored in the position 402, and the time is read from the time 452 and stored in the time 403. Also, this communication data 400 is sent to the portable terminal device 100a. (Step 614) Thereafter, the system returns to step 613. Also, the host process 610 is launched when the line is established with the portable terminal device 100.

[0146]

At the other portable terminal devices 100b and 100c as well, it is possible to obtain the position information of the portable terminal device 100a by implementing the client process 600.

[0147]

Next, the method that uses the cellular telephone and a pager in the communication unit 103 will be described using the flowchart in Fig. 16. This method is composed of a client-information sending process 620 on the portable terminal device 100, a client-information receiving process 640, a host-information receiving process 630 at the host station 180, and a host-information sending process 650.

[0148]

With the client-information sending process 620, a telephone call is placed to the host station 180 via the cellular telephone in the communication unit 103 to connect the line (Step 621). Also, the position information of the portable terminal device 100a is read from the position 302 of the record identified by the identifier of the owner of the portable terminal device 100a, of the position-management table 300, and is stored at the position 402 of the communication data 400, and the time is read from the time 303 of the record and stored in the time 403. The identifier of the owner of the portable terminal device 100a is stored in the ID 401 of the communication data 400. Also, the communication data 400 is sent to the host station 180 through the line connected at step 621 (Step 622). Thereafter, the line established at step 621 is disconnected (Step 623).

[0149]

With the host-information receiving process 630, communication data 400 sent at step 622 of the client-information sending process 620, is received. (Step 631) Next, position information stored in position 402 is stored in position 452 of the record of the host-position management table 450 identified by ID 401 of the communication data 400 received at step 631, and the time stored in the time 403 is stored in the time 453 of the record (Step 632). Also, the host-information receiving process 630 is launched when the line is established with the portable terminal device 100.

[0150]

The position information of the portable terminal device 100a can be registered in the host station 180 using the client-information sending process 620 and the host-information receiving process 630. Next, the host-information sending process 650 for notifying a position of another member, and the client-information receiving process 640, in the portable terminal device 100a, will now be described.

[0151]

Also, the host-information sending process 650 is periodically launched using the clock 187. Furthermore, with the host-information sending process 650 of one time, implements processing of information of one member managed by the host-position management table 450, in other words, it processes only one record. The host-information sending process 650 sends position information and the like of a member managed by the host-position management table 450, for example, in order from the top record. In other words, at host-position management table 450, when information is managed for three members, namely A, B, and C, with the initial host-information sending process, information for A is sent. Specifically, this is sent in order; the second time, the information for B is sent, and the third time C is sent. In the fourth time, A is sent.

[0152]

With the host-information sending process 650, initially, the user identifier is read from the ID 451

of the record in order in the host-position management table 450, and is stored in the ID 401 of the communication data 400, the position information is read from the position 452 and stored in the position 402, and the time is read from the time 453 and stored in the time 403. Also, this communication data 400 is sent to the portable terminal device 100a using the pager's broadcast feature (Step 651).

[0153]

With the client-information receiving process 640, initially, communication data 420 is received from the host station 180 via the pager in the communication unit 103. (Step 641) Next, position information stored in position 402 is stored in position 302 of a record in the position-management table 300 identified by ID 401 of the communication data 400 received at step 641, and the time stored in the time 403 is stored in the time 303 of the record. (Step 642) Furthermore, the client-information receiving process 640 is launched when the communication data 400 from the host station 180 is detected by the pager of the communication unit 103.

[0154]

Also, with the working example described above, the position-management table 300 and the communication data 400 are used, but it is possible also to use the position-management table 310 instead of the position-management table 300, and the communication data 410 instead of the communication data 400. In such a case, instead of the host-position

management table 450, use a host-position management table 460.

[0155]

The constitution of the host-position management table 460 is shown in Fig. 8(b). The host-position management table 460 is composed of an ID 451, a position 452, a time 453, and a speed 454. Speed 454 stores speed information.

[0156]

Initially, shown are use of the cellular telephone in the communication unit 103, and use of the position-management table 310 and the communication data 410. In such a case, implement the speed-information sending-preparation process described in a different embodiment, before step 602 in the client process 600. Also, implement the speed-information storage process before step 605. Still further, in the host process 610, store the movement-speed information stored in the speed 404 in communication data 410, in the speed 454 of the record of the host-position management table 460 identified by ID 401 of the communication data 410 received at step 611, before implementing step 612. (Below, this is called a host-speed-information storage process). Also, at step 614, read the speed information from the speed 454 of the record that is the same as the record that read the position information of the host-position management table 460, and store it in the speed 404 of the communication data 410 before sending the data. (Below, this is called the host-speed-information-sending preparation process.)

[0157]

Next, shown are when using the cellular telephone and the pager in the communication unit 103, using the position-management table 310 and the communication data 410. In such a case, implement the speed-information sending-preparation process before step 620, in the client-information sending process 620. Also, implement the host-speed-information storage process before step 632, in the host-information receiving process 630. Also, implement the host-speed-information-sending preparation process before sending the communication data 410 in the host-information sending process 650. Also, implement the host information storage process before step 642, in the client-information receiving process 640.

[0158]

With the method described above, it is possible to notify speed information of the portable terminal device 100a to another portable terminal device 100 via the host station 180.

[0159]

Also, it is possible to send still images by using the still-image management table 490 and the communication data 420 instead of the communication data 410. In such a case, instead of the host-position management table 460, use a host-position management table 470.

[0160]

The constitution of the host-position management table 470 is

depicted in Fig. 8(c). The host-position management table 470 is composed of an ID 451, a position 452, a time 453, and an image 455. Still image data is stored in the image 455.

[0161]

Initially, the method for sending and receiving a still image using the cellular telephone in the communication unit 103 will be described. In such a case, implement the still-image sending-preparation process before step 602, in the client process 600. Also, implement the still-image storage process before step 605. Still further, in the host process 610, read the still image from the image 405 of the communication data 420 received previously, before step 612, and store it in the image 455 of the record of the host-position management table 470 identified by ID 401 of the communication data 420. (Below, this is called a host-still-image storage process). Also, at step 614, read and store the still image from the image 455 of the record that is the same as the record that read the position information of the host-position management table 470, in the image 405 of the communication data 420 before sending the communication data 420. Also, after sending, clear the image 455 (for example, set it to 0). (Collectively, the two steps are called the host-still-image-sending preparation process.)

[0162]

With this process, the still image loaded by the portable terminal device 100a can be sent to another portable terminal device 100b.

[0163]

Next, a method for sending and receiving still images when using the cellular telephone and the pager in the communication unit 103 will be described. In such a case, implement the still-image-sending-preparation process before step 622, in the client-information sending process 620. Also, implement the host-still-image-storage process before step 632, in the host-information receiving process 630. Also, implement the host-still-image-sending preparation process before sending the communication data 420 at step 651 of the host-information sending process 650. Also, implement the still-image storage process before step 642, in the client-information receiving process 640.

[0164]

With these processes, the still image loaded by the portable terminal device 100a can be sent to another portable terminal device 100b.

[0165]

With the working example described above, position information is sent along with the still image using communication data 420, but it is also possible to send the still image along with the position information and the speed information by using the communication data 430. Below, a working example for that is described. In such a case, instead of the host-position management table 470, use the host-position management table 480. The constitution of the host-position management table 480 is shown in

Fig. 8(d). The host-position management table 480 is composed of an ID 451, a position 452, a time 453, a speed 454, and an image 455.

[0166]

Initially, the processes that use the cellular telephone in the communication unit 103 will be described. In such a case, insert the speed-information sending-preparation process and the still-image sending-preparation process before step 602, in the client process 600, and insert the speed-information storage process and the still-image storage process before step 605 to send the still image along with the position information and the speed information. Also, insert the host-speed-information storage process and the host-still-image storage process before step 612 in the host process 610, and insert the host-speed-information-sending preparation process and the host-still-image sending preparation process before sending the communication data 430 in step 614.

[0167]

Next, a process that uses the cellular telephone and the pager in the communication unit 103 will be described. In such a case, implement the speed-information-sending-preparation process and the still-image-sending-preparation process before step 622, in the client-information sending process 620. Also, implement the host-speed-information-storage process and the host-still-image storage process before step 632, in the host-information receiving process 630. Also, implement the host-speed-information-sending

preparation process and the host-still-image-sending preparation process before sending the communication data 430 at step 651 in the host-information sending process 650. Furthermore, implement the speed-information-storage process and the still-image-storage process before step 642, in the client-information receiving process 640.

[0168]

As described above, even when a host station 180 is disposed, it is possible to receive at another portable terminal device 100b the speed information of the portable terminal device 100a, and the still images loaded by the portable terminal device 100a.

[0169]

[Effect of the Invention]

As described above, the present invention has an effect of making it possible visually to confirm a position of a member that possesses the portable terminal device. Furthermore, the movement direction of the member is displayed, so it is possible to know at a glance whether the member is heading in a correct direction. Also, by changing a color that corresponds to a distance between yourself and a member, it is possible easily to know a distance from another member. Also, by changing a length of an arrow that corresponds to a movement speed of another member, it is possible easily to know at a glance a movement speed of the other member.

[0170]

Also, by being able to transfer still images, it is possible accurately to know a meeting place of a user of portable terminal device 100b, by loading an image of a meeting place by portable terminal device 100a, and transferring that to portable terminal device 100b. Also, with the present invention, it is possible to load the still image while visually confirming the image to load, so it is possible for the user simply to load a desired image.

[0171]

Still further, it is possible to suppress power consumption of the portable terminal device when it is not moving, by sending position information to another portable terminal device only when it has moved more than a fixed distance.

[Brief Description of the Drawings]

Fig. 1 is a view for explaining an overview of a communication system pursuant to a first embodiment of the present invention;

Fig. 2 is a view for explaining an overview of a communication system pursuant to another embodiment of the present invention;

Fig. 3 is a block diagram of the portable terminal device in Fig. 1;

Fig. 4 is a block diagram of a host station in Fig. 2;

Fig. 5 is a configuration diagram of a member-management table used in the embodiments of the present invention;

Fig. 6 is a configuration diagram of a position-management table used

in the embodiments of the present invention;

Fig. 7 is a configuration diagram of communication data used in the embodiments of the present invention;

Fig. 8 is a configuration diagram of a host-position management table used in the embodiments of the present invention;

Fig. 9 is a flowchart showing an overview of a position-detection process used in the embodiments of the present invention;

Fig. 10 is a flowchart showing an overview of an information-sending process and an information-receiving process pursuant to the embodiments of the present invention;

Fig. 11 is a flowchart showing an overview of an information-sending process and an information-receiving process pursuant to the embodiments of the present invention;

Fig. 12 is a flowchart showing an overview of an information-sending process and an information-receiving process pursuant to the embodiments of the present invention;

Fig. 13 is a flowchart showing an overview of a position-display process used in the embodiments of the present invention;

Fig. 14 is a flowchart showing an overview of a map-selection process used in the embodiments of the present invention;

Fig. 15 is a flowchart showing an overview of a client process and a

host process pursuant to the embodiments of the present invention;

Fig. 16 is a flowchart showing an overview of a client-information sending process, a client-information receiving process, a host-information sending process, and a host-information receiving process pursuant to the embodiments of the present invention;

Fig. 17 is a view for explaining a display example of a screen pursuant to the embodiments of the present invention;

Fig. 18 is a configuration diagram of a still-image management table used in the embodiments of the present invention;

Fig. 19 is a view for explaining a display example of a screen pursuant to the embodiments of the present invention;

Fig. 20 is a configuration diagram of a mark-management table used in the embodiments of the present invention;

Fig. 21 is a flowchart showing an overview of a speed-calculation process used in the embodiments of the present invention;

Fig. 22 is a flowchart showing an overview of a speed-display process used in the embodiments of the present invention;

Fig. 23 is a flowchart showing an overview of a member-display process used in the embodiments of the present invention;

Fig. 24 is a view for explaining a display example of a screen

pursuant to the embodiments of the present invention;

Fig. 25 is an explanatory view showing an example of an external appearance of the portable terminal device pursuant to embodiments of the present invention;

Fig. 26 is a flowchart showing an overview of a still-image loading process pursuant to embodiments of the present invention;

Fig. 27 is a flowchart showing an overview of an image-position display process pursuant to embodiments of the present invention;

Fig. 28 is a flowchart showing an overview of a still-image display process pursuant to embodiments of the present invention;

Fig. 29 is a configuration diagram of a distance-color-code table used in the embodiments of the present invention;

Fig. 30 is a flowchart showing an overview of a color-selection process pursuant to embodiments of the present invention;

Fig. 31 is a view for explaining a display example of a screen pursuant to the embodiments of the present invention;

Fig. 32 is a view for explaining a display example of a screen pursuant to the embodiments of the present invention; and

Fig. 33 is a flowchart showing an overview of a map-data acquisition process, and a map-data supply process pursuant to the embodiments of the present invention.

[Explanation of Letters or Numerals]	
100 Portable terminal device	106 Map-control unit
180 Host station	107, 187 Clock
101, 181 Control unit	108, 188 Input unit
102, 182 Memory unit	190 GPS satellite
103, 183 Communication unit	151 View button
104, 184 Display unit	152 Image-load button
105 GPS receiver	153 Capturing unit

Fig. 1

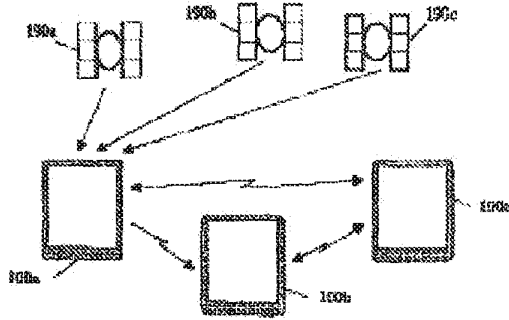

Fig. 2

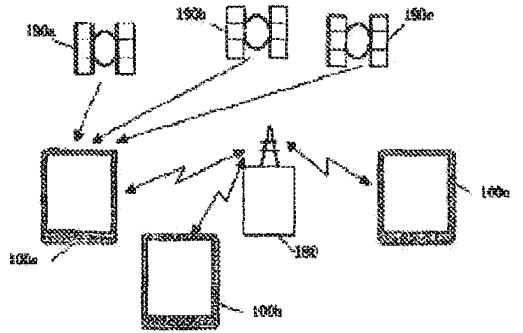

Fig. 3

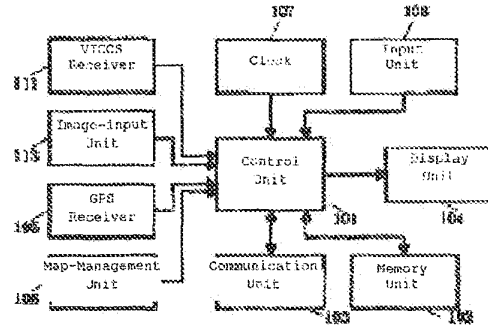

Fig. 4

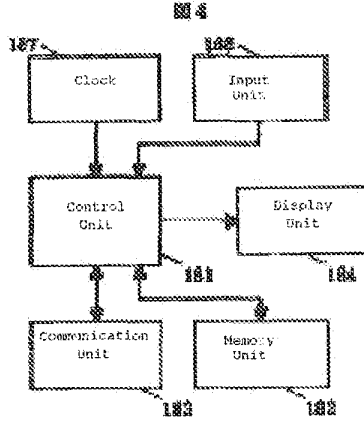

Fig. 5

ID	Name	Telephone Number

Fig. 6

ID	Position	Time	Speed

(a)

ID	Position	Time	Speed

(b)

Fig. 7

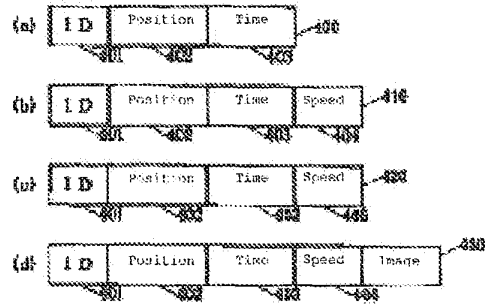

Fig. 8

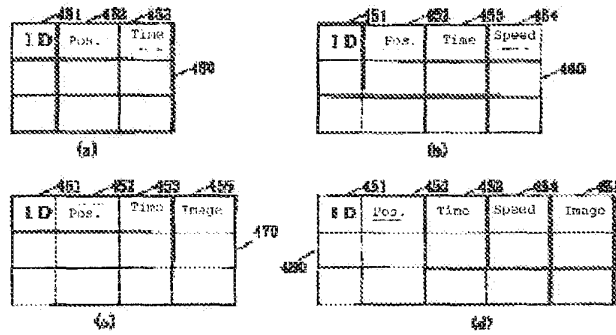

Fig. 9

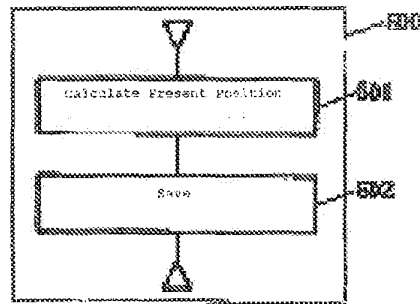

Fig. 10

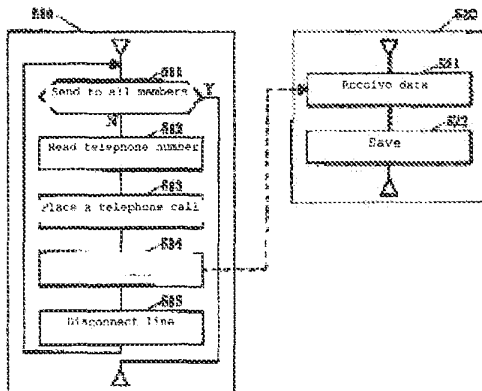

Fig. 11

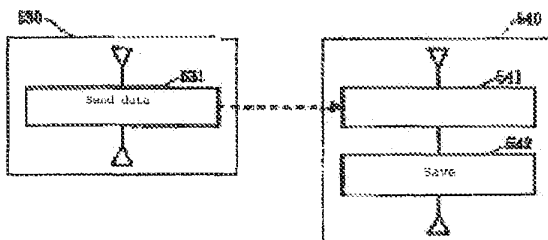

Fig. 12

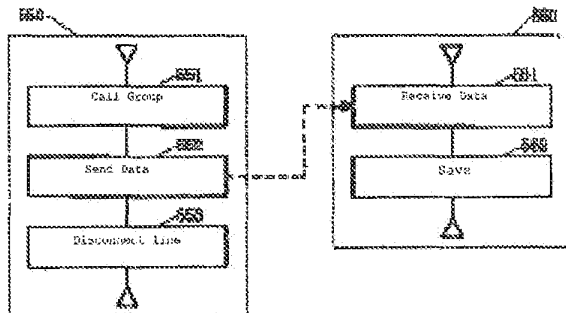

Fig. 13

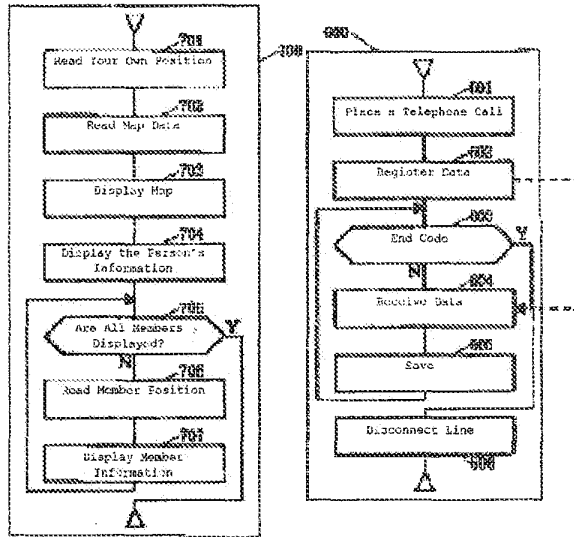

Fig. 14

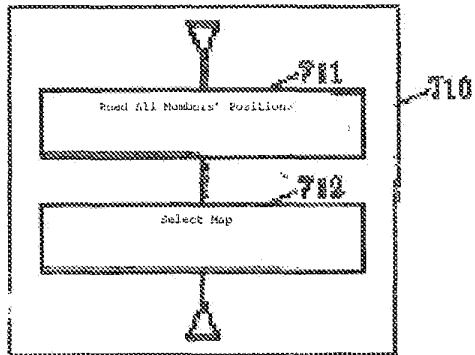

Fig. 15

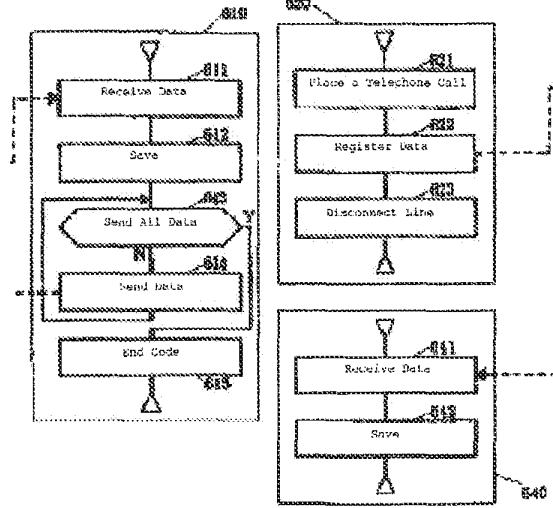

Fig. 16

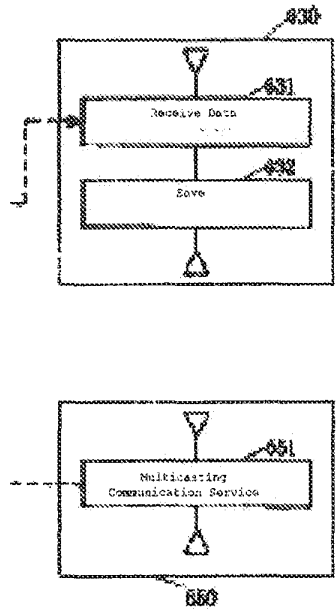

Fig. 17

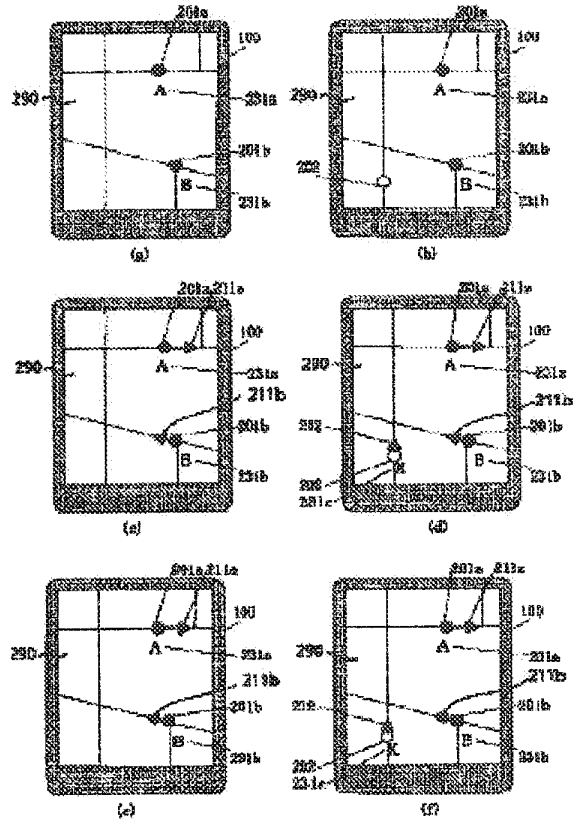

Fig. 18

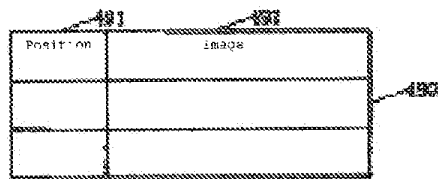

Fig. 19

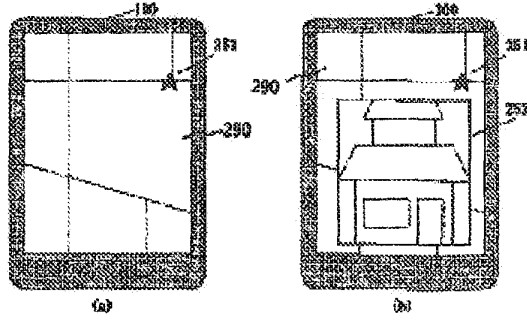

Fig. 20

ID	Mark

Fig. 21

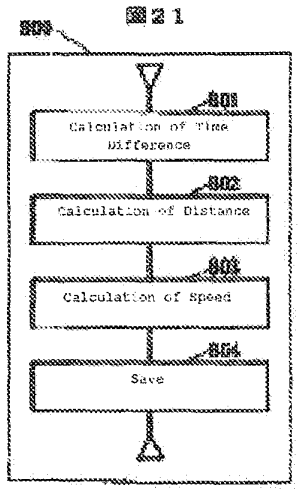

Fig. 22

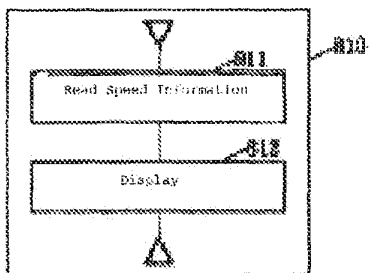

Fig. 23

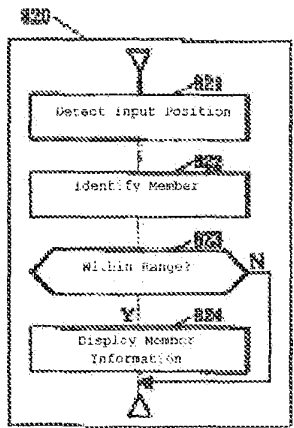

Fig. 24

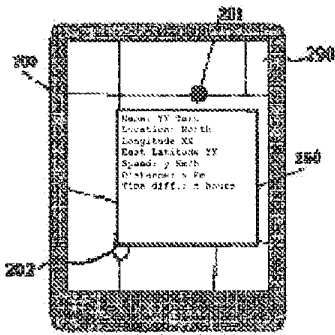

Fig. 25

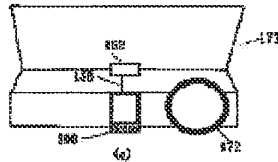
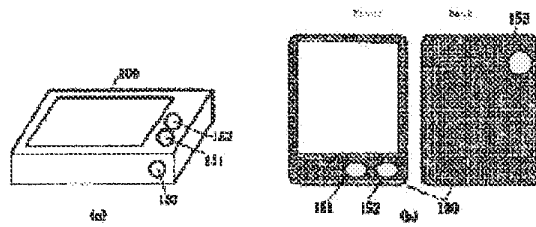

Fig. 26

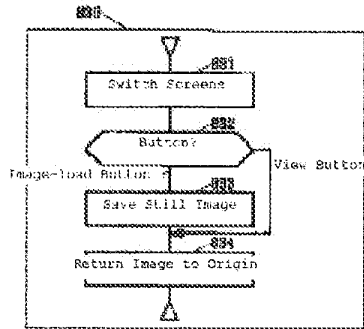

Fig. 27

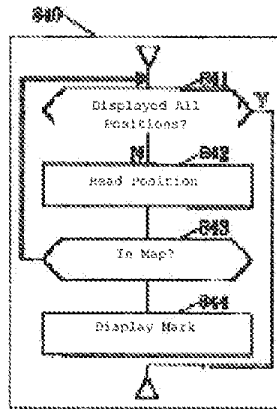

Fig. 28

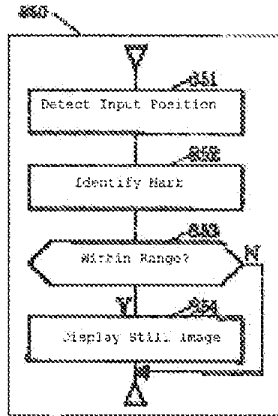

Fig. 29

871 Lower Limit	872 Upper Limit	873 Color

870

Fig. 30

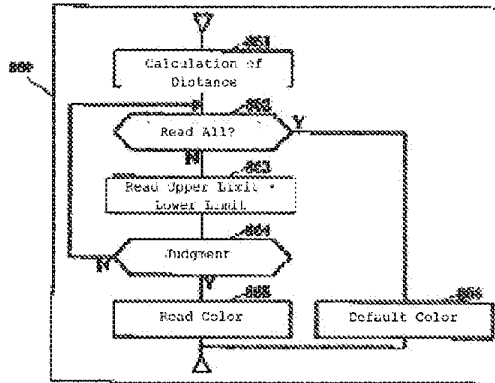

Fig. 31

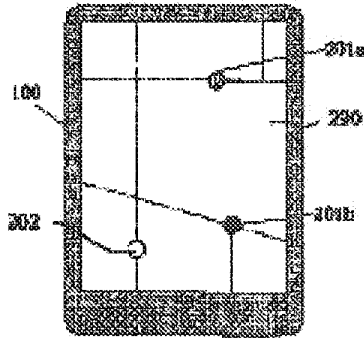

Fig. 32

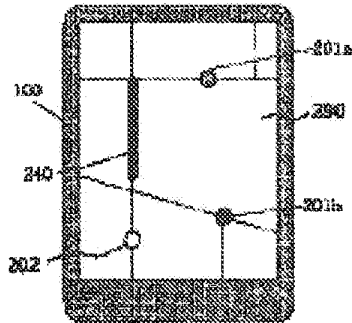
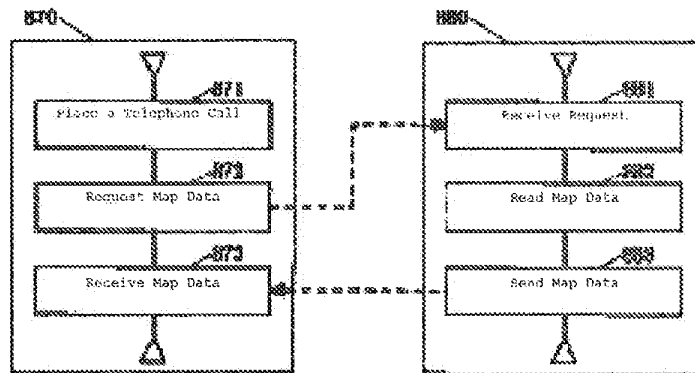

Fig. 33



Continued from front page

(51) Int.Cl. ⁶	Identification Number	JPO File Number	FI	Technical Indications
G 09 B	29/10			
H 04 B	7/26			
H 04 Q	7/34			
H 04 M	11/00	302		

(19) 日本国特許庁 (J P)

(12) 公開特許公報 (A)

(11) 特許出願公開番号

特開平8-5394

(43) 公開日 平成8年(1996)1月12日

(51) Int.Cl. ⁶	識別記号	庁内整理番号	F I	技術表示箇所
G 0 1 C	21/00	Z		
G 0 8 G	1/0969			
G 0 9 B	29/00			
			H 0 4 B 7/26	H
				1 0 6 A
審査請求 未請求 請求項の数27 O L (全 21 頁) 最終頁に続く				

(21) 出願番号	特願平8-139187	(71) 出願人	000005108 株式会社日立製作所 東京都千代田区神田豊河台四丁目6番地
(22) 出願日	平成8年(1994)6月21日	(72) 発明者	尾崎 友哉 神奈川県横浜市戸塚区吉田町292番地 株式会社日立製作所映像メディア研究所内
		(72) 発明者	日瀬 道弘 神奈川県横浜市戸塚区吉田町292番地 株式会社日立製作所映像メディア研究所内
		(72) 発明者	清水 宏 神奈川県横浜市戸塚区吉田町292番地 株式会社日立製作所映像メディア研究所内
		(74) 代理人	弁理士 武 嗣次郎

(54) 【発明の名称】 携帯端末装置及びそれを用いた通信システム

(57) 【要約】

【目的】 グループ等で行動する時に、互いに相手の位置を確認できるようにすること。

【構成】 携帯端末装置100aにおいて、GPS衛星190の電波から現在位置を計算し、他の携帯端末装置100bに送信する。携帯端末装置100bにおいては、携帯端末装置100aから送信された位置情報を地図に重ねて表示する。そのため、各携帯端末装置に、地図データを記憶する地図データ記憶手段と、地図データ記憶手段により管理される地図データを表示する地図表示手段と、現在位置を検出する位置検出手段と、他の携帯端末装置に上記位置検出手段によって検出した位置を送信する送信手段と、他の携帯端末装置より送信された位置を受信する受信手段と、地図表示手段により表示された地図データ上の、上記受信手段により受信した位置に、印を表示する位置表示手段を設けている。

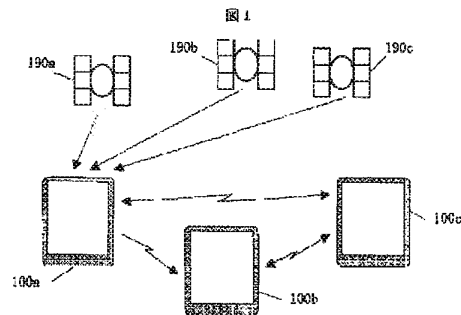

【特許請求の範囲】

【請求項1】 他の携帯端末装置と通信できる携帯端末装置において、他の携帯端末装置の位置を表示できることを特徴とする携帯端末装置。

【請求項2】 他の携帯端末装置より送信された位置を受信する受信手段と、地図を表示する地図表示手段と、該地図表示手段により表示された地図データ上の、前記受信手段により受信した位置に、印を表示する位置表示手段とを、備えたことを特徴とする携帯端末装置。

【請求項3】 現在位置を検出する位置検出手段と、他の携帯端末装置に前記位置検出手段によって検出した位置を送信する送信手段とを、備えたことを特徴とする携帯端末装置。

【請求項4】 地図データを記憶する地図データ記憶手段と、該地図データ記憶手段により管理される地図データを表示する地図表示手段と、現在位置を検出する位置検出手段と、他の携帯端末装置に前記位置検出手段によって検出した位置を送信する送信手段と、他の携帯端末装置より送信された位置を受信する受信手段と、前記地図表示手段により表示された地図データ上の、前記受信手段により受信した位置に、印を表示する位置表示手段とを、備えたことを特徴とする携帯端末装置。

【請求項5】 請求項4記載において、前記地図表示手段により表示された地図データ上の、自身の前記位置検出手段により検出した位置に、印を表示する自位置表示手段を備えたことを特徴とする携帯端末装置。

【請求項6】 請求項4または5記載において、携帯端末装置と画面に表示する印の対応関係を示したデータと、該データを管理するマーク管理手段を設け、前記受信手段により受信した他携帯端末装置の位置を表示するときに、前記マーク管理手段を用いて他携帯端末装置に対応する印を読み出し、前記位置表示手段により地図データ上に、該印を表示することを特徴とする携帯端末装置。

【請求項7】 請求項4または5または6記載において、前記受信手段により受信した位置と自携帯端末装置の位置との間の距離を計算する距離計算手段と、距離と色との対応関係を管理する色管理手段とを備え、前記距離計算手段により計算した距離に従って前記色管理手段から色を読み出し、前記位置表示手段により地図データ上に印を表示するときに、先に読み出した色で表示することを特徴とする携帯端末装置。

【請求項8】 請求項4乃至7の何れかに記載において、前記受信手段により受信した位置から速度を計算する速度計算手段と、前記位置表示手段により表示した位置を始点とする矢印で、前記速度計算手段により計算した速度を表示する速度表示手段とを、備えたことを特徴とする

る携帯端末装置。

【請求項9】 地図データを記憶する地図データ記憶手段と、該地図データ記憶手段により管理される地図データを表示する地図表示手段と、現在位置を検出する位置検出手段と、現在の速度を検出する速度検出手段と、他の携帯端末装置に、前記位置検出手段によって検出した位置及び前記速度検出手段によって検出した速度を送信する送信手段と、他の携帯端末装置より送信された位置及び速度を受信する受信手段と、該受信手段により受信した位置を、前記地図表示手段により表示された地図データに重ねて表示する位置表示手段と、前記受信手段により受信した速度を、前記位置表示手段により表示した位置を始点とする矢印で表示する速度表示手段とを、備えたことを特徴とする携帯端末装置。

【請求項10】 請求項8または9記載において、前記速度表示手段により表示する矢印の長さを、速度の絶対値に比例させることを特徴とする携帯端末装置。

【請求項11】 請求項8または9記載において、両面に表示されている印を選択する選択手段と、該選択手段により選択された印があらゆる携帯端末装置と自携帯端末装置との間の距離を計算する距離計算手段と、前記受信手段により受信した速度と前記距離計算手段により求めた距離とから、移動に要する時間を求める時間計算手段と、前記選択手段により印が選択されたときに、前記時間計算手段により求めた移動に要する時間を表示する時間差表示手段とを、備えたことを特徴とする携帯端末装置。

【請求項12】 請求項4乃至10の何れかに記載において、画面に表示されている印を選択する選択手段と、該選択手段により印が選択されたときに、選択された印があらゆるユーザに関する情報を表示するユーザ情報表示手段とを、備えたことを特徴とする携帯端末装置。

【請求項13】 請求項4乃至10の何れかに記載において、画面に表示されている印を選択する選択手段と、該選択手段により選択された印があらゆる携帯端末装置と自携帯端末装置との間の距離を計算する距離計算手段と、前記選択手段により印が選択されたときに、前記距離計算手段により計算した距離を表示する距離表示手段とを、備えたことを特徴とする携帯端末装置。

【請求項14】 地図データを記憶する地図データ記憶手段と、該地図データ記憶手段により管理される地図データを表示する地図表示手段と、現在位置を検出する位置検出手段と、画像を取り込む画像入力手段と、他の携帯端末装置に、前記位置検出手段によって検出した位置及び前記画像入力手段により取り込んだ画像を送信する送信手段と、他の携帯端末装置より送信された位置及び画像を受信する受信手段と、該受信手段により受信した位置を、前記地図表示手段により表示された地図データ

に重ねて表示する位置表示手段と、前記位置表示手段により表示された印を選択する選択手段と、該選択手段により印が選択されたときに、印に対応する画像を画面に表示する画像表示手段とを、備えたことを特徴とする携帯端末装置。

【請求項15】 請求項14記載において、表示画面に前記画像入力手段によって取り込まれた画像を表示する画像表示手段と、前記地図表示手段と前記画像表示手段との切り替えを指定する画面選択手段と、該画面選択手段により前記画像表示手段が選択されているときに画像の取り込みを指示する画像取り込み指示手段とを、設けたことを特徴とする携帯端末装置。

【請求項16】 請求項14または15記載において、前記画像入力手段として、画像を入力するためのカメラを自動車の前面ガラス付近に設置したことを特徴とする携帯端末装置。

【請求項17】 請求項4乃至16の何れかに記載において、交通情報を受信する交通情報受信手段と、該交通情報受信手段により受信した交通情報を地図上に重ねて表示する交通情報表示手段とを、備えたことを特徴とする携帯端末装置。

【請求項18】 請求項4乃至17の何れかに記載において、前記位置検出手段により検出した位置を記憶する位置記憶手段を設け、前記位置検出手段により検出する現在の位置と前記位置記憶手段が記憶する位置との間の距離が一定の値を超えたときに、前記送信手段により送信を行うと共に、前記位置検出手段によって検出した位置を、前記位置記憶手段により記憶することを特徴とする携帯端末装置。

【請求項19】 請求項4乃至18の何れかに記載において、前記送信手段及び前記受信手段に無線電話を使用したことを特徴とする携帯端末装置。

【請求項20】 請求項4乃至18の何れかに記載において、前記送信手段に無線電話、前記受信手段にページャを用いたことを特徴とする携帯端末装置。

【請求項21】 請求項4乃至18の何れかに記載において、前記送信手段及び前記受信手段にパーソナル無線を使用したことを特徴とする携帯端末装置。

【請求項22】 地図データを記憶する地図データ記憶手段と、該地図データ記憶手段により管理される地図データを表示する地図表示手段と、現在位置を検出する位置検出手段と、画像を取り込む画像入力手段と、前記位置検出手段により検出した位置を前記地図表示手段により表示された地図データに重ねて表示する位置表示手段と、該位置表示手段により表示された印を選択する選択

手段と、該選択手段により印が選択されたときに、印に対応する画像を画面に表示する画像表示手段とを、備えたことを特徴とする携帯端末装置。

【請求項23】 請求項22記載において、表示画面に前記画像入力手段によって取り込まれた画像を表示する画像表示手段と、前記地図表示手段と前記画像表示手段との切り替えを指定する画面選択手段と、該画面選択手段により前記画像表示手段が選択されているときに、画像の取り込みを指示する画像取り込み指示手段とを、設けたことを特徴とする携帯端末装置。

【請求項24】 請求項1乃至21の何れかに記載した携帯端末装置が用いられることを特徴とする通信システム。

【請求項25】 ホスト局と、該ホスト局と通信を行う複数の携帯端末装置とからなる通信システムにおいて、前記ホスト局に、前記携帯端末装置から送信される位置を管理する位置管理手段と、該位置管理手段により管理する前記携帯端末装置の位置を、前記携帯端末装置に通知する位置通知手段とを、具備させ、前記携帯端末装置に、地図データを記憶する地図データ記憶手段と、該地図データ記憶手段により管理される地図データを表示する地図表示手段と、現在位置を検出する位置検出手段と、該位置検出手段によって検出した位置を登録する登録手段と、前記ホスト局から他の携帯端末装置の位置を受信する受信手段と、該受信手段により受信した位置を、前記地図表示手段により表示された地図データに重ねて表示する位置表示手段とを、具備させたことを特徴とする通信システム。

【請求項26】 請求項25記載において、前記携帯端末装置の前記登録手段及び前記受信手段、及び前記ホスト局の前記通知手段に、無線電話を使用することを特徴とする通信システム。

【請求項27】 請求項25記載において、前記携帯端末装置の前記登録手段に無線電話を使用し、前記携帯端末装置の前記受信手段及び前記ホスト局の前記通知手段にページャを使用することを特徴とする通信システム。

【発明の詳細な説明】

【0001】

【産業上の利用分野】本発明は、携帯して使用することが可能な携帯端末装置、及びそれを用いた通信システムに関するものである。

【0002】

【従来技術】携帯端末装置において、衛星からの電波を利用し、自分の現在位置を検出して地図上に表示するシステムがある。このようなシステムの例としては、例えば、GPS (Global Positioning System) を搭載した自動車用ナビゲーションシステムがある。

【0003】

【発明が解決しようとする課題】しかしながら、上記し

たシステムでは、自分の位置はわかるが、グループで行動する時などに、グループの散らばったメンバの位置を互いに確認できないという問題点がある。

【0004】そこで、本発明の目的は、グループで行動する時などにグループのメンバが所有する携帯端末装置の位置を、互いに、視覚的に確認できるようにすることにある。

【0005】

【課題を解決するための手段】上記目的を達成するために、本発明では、各携帯端末装置に、地図データを記憶する地図データ記憶手段と、地図データ記憶手段により管理される地図データを表示する地図表示手段と、現在位置を検出する位置検出手段と、他の携帯端末装置に上記位置検出手段によって検出した位置を送信する送信手段と、他の携帯端末装置より送信された位置を受信する受信手段と、地図表示手段により表示された地図データ上の、上記受信手段により受信した位置に、印を表示する位置表示手段とを、具備するようにしている。更に、本発明では、自携帯端末装置の位置を表示できるようにするために、地図表示手段により表示された地図データ上の、自身の位置検出手段により検出した位置に、印を表示する自位置表示手段を具備するようにしている。また、自携帯端末装置と他の携帯端末装置との間の距離に応じて色を変えることができるようにするために、受信手段により受信した位置と自携帯端末装置の位置との間の距離を計算する距離計算手段と、距離と色との対応関係を管理する色管理手段とを具備し、距離計算手段により計算した距離に従って色管理手段から色を読み出し、位置表示手段により地図データ上に印を表示する時に、先に読み出した色で印を表示するようにしている。また、本発明では、各携帯端末装置の移動速度を視覚的に確認できるようにするために、受信手段により受信した位置から速度を計算する速度計算手段と、位置表示手段により表示した位置を始点とする矢印で、速度計算手段により計算した速度を表示する速度表示手段とを、具備するようにしている。

【0006】なお、各携帯端末装置の移動速度を視覚的に確認できるようにするには、別の方法もある。この方法では、各携帯端末装置に、地図データを記憶する地図データ記憶手段と、地図データ記憶手段により管理される地図データを表示する地図表示手段と、現在位置を検出する位置検出手段と、現在の速度を検出する速度検出手段と、他の携帯端末装置に上記位置検出手段によって検出した位置、及び上記速度検出手段により検出した速度を送信する送信手段と、他の携帯端末装置より送信された位置及び速度を受信する受信手段と、上記受信手段により受信した位置を、地図表示手段により表示された地図データに重ねて表示する位置表示手段と、上記受信手段により受信した速度を、位置表示手段により表示した位置を始点とする矢印で表示する速度表示手段とを、

具備するようにしている。

【0007】また、本発明では、地図上に表示された印があらゆる携帯端末装置を持つメンバに関する情報も表示することができる。すなわち、本発明では、上記した手段に加えて、画面に表示されている印を選択する選択手段と、この選択手段により印が選択されたときに、選択された印があらゆるユーザに関する情報を表示するユーザ情報表示手段とを、具備するようにしている。また、自携帯端末装置と他携帯端末装置との間の距離や移動に要する時間を知ることができるようにするために、上記選択手段に加えて、上記選択手段により選択された印があらゆる携帯端末装置と自携帯端末装置との間の距離を計算する距離計算手段と、選択手段により印が選択されたときに、上記距離計算手段により計算した距離を表示する距離表示手段や、受信手段により受信した速度と距離計算手段により求めた距離から移動に要する時間を求める時間計算手段と、選択手段により印が選択されたときに、上記距離計算手段により求めた距離を表示する距離表示手段と、上記時間計算手段により求めた移動に要する時間を表示する時間差表示手段とを、具備するようにしている。

【0008】さらに、本発明では、地図上に交通情報を表示し、メンバが渋滞に巻き込まれているかなどを確認できるようにしている。すなわち、本発明では、上記した構成に加えて、交通情報を受信する交通情報受信手段と、この交通情報受信手段により受信した交通情報を地図上に重ねて表示する交通情報表示手段とを、具備するようにしている。

【0009】また、本発明では、携帯端末装置の位置などに関する情報とともに、携帯端末装置で取り込んだ静止画像を送受信できるようにしている。すなわち、本発明では、地図データを記憶する地図データ記憶手段と、地図データ記憶手段により管理される地図データを表示する地図表示手段と、現在位置を検出する位置検出手段と、画像を取り込む画像入力手段と、他の携帯端末装置に上記位置検出手段によって検出した位置、及び上記画像入力手段により取り込んだ画像を送信する送信手段と、他の携帯端末装置より送信された位置及び画像を受信する受信手段と、上記受信手段により受信した位置を、地図表示手段により表示された地図データに重ねて表示する位置表示手段と、位置表示手段により表示された印を選択する選択手段と、この選択手段により印が選択されたときに、印に対応する画像を画面に表示する画像表示手段とを、具備するようにしている。

【0010】さらにまた、本発明では、画像の取り込を行うときに、ユーザが取り込む画像を確認しながら画像の取り込を行えるように、両側入力手段によって取り込まれた画像を表示する画像表示手段と、地図表示手段と両側表示手段との切り替えを指定する両面選択手段と、両面選択手段により両側表示手段が選択されているとき

に、画像の取り込みを指示する画像取り込み指示手段とを、具備するようにしている。

【0011】なおまた、本発明は、ホスト局を介して、各携帯端末装置間で、位置などの情報を送受信することも可能である。すなわち、本発明では、ホスト局に、携帯端末装置からの送信される位置を受信するホスト受信手段と、ホスト受信手段によって受信した位置を管理する位置管理手段と、位置管理手段により管理する携帯端末装置の位置を携帯端末装置に通知する位置通知手段とを、具備させ、各携帯端末装置に、地図データを記憶する地図データ記憶手段と、地図データにより管理される地図データを表示する地図表示手段と、現在位置を検出する位置検出手段と、位置検出手段によって検出した位置を登録する登録手段と、ホスト局から他の携帯端末装置の位置を受信する第2の受信手段と、上記受信手段により受信した位置を、地図表示手段により表示された地図データに重ねて表示する位置表示手段とを、具備させるようにしている。

【0012】

【作用】まず、携帯端末装置 a の位置、速度の情報を、携帯端末装置 b で表示する方法について説明する。この場合、携帯端末装置 a において、位置検出手段により現在位置を取得し、送信手段を用いて検出した位置情報を携帯端末装置 b に送信する。携帯端末装置 b においては、まず、受信手段により携帯端末装置 a からの位置情報を受信する。そして、地図表示手段により、地図管理手段によって管理されている地図データを表示すると共に、先に受信した位置情報を、位置表示手段により地図に重ねて表示する。また、携帯端末装置 b において、自位置表示手段により、携帯端末装置 b 自身の現在位置を地図上に表示することができる。また、位置表示手段により地図上に他携帯端末装置の位置に印を表示するときに、距離計算手段によって自携帯端末装置と他携帯端末装置との距離を計算し、色管理手段により計算した距離に対応した色を読み出し、印を先に読み出した色で表示することができる。また、移動速度計算手段により、他携帯端末装置の移動速度を計算し、速度表示手段により矢印で速度を表示することができる。

【0013】次に、携帯端末装置 a の位置、速度の情報を、携帯端末装置 b で表示する別の方法について説明する。この速度を表示する別の方法では、ある携帯端末装置 a において、位置検出手段により現在位置を、速度検出手段により移動速度をそれぞれ取得し、送信手段を用いて検出した位置及び速度情報を、他の携帯端末装置 b に送信する。携帯端末装置 b においては、まず、受信手段により、携帯端末装置 a からの位置及び速度情報を受信する。そして、地図表示手段により、地図管理手段によって管理されている地図データを表示すると共に、先に受信した位置情報を位置表示手段により、また速度情報を速度表示手段により、それぞれ地図に重ねて表示す

る。

【0014】次に、ユーザに関する情報を表示する方法について説明する。まず、選択手段によって選択した印に関する情報を、ユーザ情報表示手段によって表示する。さらに、選択手段によって選択された印に関する情報として、距離計算手段によって計算した距離を距離表示手段で、また時間計算手段で求めた時間差を時間差表示手段で、それぞれ表示できるようにしている。

【0015】次に、交通情報を表示する方法について説明する。この場合、交通情報受信手段により、交通情報を受信し、地図に重ねて表示する。

【0016】次に、携帯端末装置 a の位置の情報と共に静止画像を携帯端末装置 b に送信し、携帯端末装置 b で表示する方法について説明する。まず、携帯端末装置 a において、画像入力手段により静止画像を取り込む。そして、位置検出手段により現在位置を取得し、送信手段を用いて検出した位置情報と先に取り込んだ静止画像とを携帯端末装置 b に送信する。携帯端末装置 b においては、まず、受信手段により携帯端末装置 a からの位置情報と静止画像を受信する。そして、地図表示手段により、地図管理手段によって管理されている地図データを表示すると共に、先に受信した位置情報を位置表示手段により地図に重ねて表示する。そして、選択手段によって地図上に表示された印を選択すると、静止画像表示手段により、静止画像を画面上に表示する。

【0017】次に、静止画像を取り込む方法について説明する。まず、画面選択手段により画面を切り替え、画像入力手段によって入力される画像を、画像表示手段により画面上に表示する。そして、画像取り込み指示手段により画像の取り込みを指示すると、画像入力手段によって入力される画像の取り込みを行う。

【0018】次に、ホスト局を介して、携帯端末装置 a の位置などの情報を、携帯端末装置 b で表示する方法について説明する。まず、携帯端末装置 a において、位置検出手段により現在位置を取得し、登録手段を用いて検出した位置情報をホスト局に送信する。ホスト局では、ホスト受信手段により、携帯端末装置 a の位置情報を受信し、位置管理手段により、該位置情報を保管する。そして、ホスト局は通知手段により、携帯端末装置 b に携帯端末装置 a の位置情報を送信する。携帯端末装置 b においては、まず、第2の受信手段により、ホスト局から携帯端末装置 a の位置情報を受信する。そして、地図表示手段により地図管理手段によって管理されている地図データを表示すると共に、先に受信した位置情報を位置表示手段により地図に重ねて表示する。

【0019】

【実施例】以下、本発明を図示した実施例によって説明する。図1は、本発明の1実施例に係る通信システムの構成概要を示す図である。まず、本実施例の概要について、図1を用いて説明する。

【0020】図1において、100a、100b、100cは携帯端末装置である。携帯端末装置100は、例えば、グループのメンバーが一人1台ずつ持っている。また、190a、190b、190cは、GPS(Global Positioning System)衛星である。携帯端末装置100は、少なくとも3個以上のGPS衛星からの電波を受信することで、現在位置を特定することができる。また、携帯端末装置100同士が、無線等を利用して互いにデータ交換を行うことにより、あるメンバーは、グループの他のメンバーがどこに居るのかを知ることができ、互いの位置を確認することができる。

【0021】図3は、図1に示した携帯端末装置100の内部構成を示すブロック図である。図中、101は制御部であり、周辺部の制御、データの要求や処理、通信等にかかわる各種処理プログラムの実行を行う。102は記憶部であり、データの要求や処理、通信等にかかわる各種プログラムやデータが格納される。記憶部102は、例えば、RAM、ROM、フラッシュメモリ、ハードディスク等を使用することができる。103は通信部であり、他の携帯端末装置とのデータ交換を行う。通信部103については、後で説明する。104は表示部であり、例えば、LCD(Liquid Crystal Display)表示器とLCDを駆動するためのドライバである。表示部104には、LCDに代えてCRT(CathodeRay Tube)を用いることもできる。105はGPS受信部であり、3個以上のGPS衛星190からの電波を受信し、携帯端末装置100自身の現在位置を計算する。106は地図管理部であり、地図データの検索・読み出しを行う。地図管理部106では、記憶媒体としてCD-ROMやフラッシュメモリを用いる。107は時計であり、時刻の管理や定期的な割り込みの発生を行う。108は入力部であり、例えば、表示一体型のタッチパネルや、後で説明するボタン等である。なお、ボタンに関しては必須ではない。111は、交通情報を受信するためのVICCS受信部であり、113は、画像を取り込むための画像入力部である。なお、VICCS受信部111、画像入力部113は必須ではない。

【0022】以上に説明した構成のシステムにおいて、携帯端末装置100が互いに他の端末装置100の位置を検知し、携帯端末装置の画面に表示する方法について説明する。

【0023】まず、自及び他の携帯端末装置100の位置を管理する位置管理テーブル300について、図6の(a)を用いて説明する。位置情報管理テーブル300は、携帯端末装置100の記憶部102に格納する。

【0024】位置管理テーブル300は、ID301、位置302、時刻303で構成する。ID301には、ユーザを特定するための識別子を格納する。また、位置302には、ID301で特定されるユーザの位置を特定するための情報(位置情報)を格納する。なお、位置

を特定するための情報としては、例えば、緯度と経度の組み合わせや、特定の地点からの方向と距離の組み合わせ等を使用する。また、時刻303には、位置の計測を行った時刻を格納する。

【0025】次に、メンバーの携帯端末装置の電話番号等のメンバーに関する情報を管理するメンバー管理テーブル350について、図5を用いて説明する。メンバー管理テーブル350は、携帯端末装置100の記憶部102に格納する。

【0026】メンバー管理テーブル350は、ID351、名前352、電話番号353で構成する。ID351には、ユーザを特定するための識別子を格納する。名前352には、ID351で特定されるユーザの名前を格納する。電話番号353には、ID351で特定されるユーザが所有する携帯端末装置の電話番号を格納する。なお、ID351には、名前や電話番号を直接使用することも可能である。この場合、ユーザを特定するための上記識別子よりなるID351を持つ必要はなくなる。

【0027】次に、携帯端末装置100が自分の現在地を検出する位置検出処理500について、図9のフローチャートを用いて説明する。

【0028】位置検出処理500では、まず、GPS受信部105で、少なくとも3個以上のGPS衛星190からの電波を利用し、現在の位置を計算する(ステップ501)。そして、制御部101で現在の位置情報を受け取り、位置情報及び時刻を位置管理テーブル300に格納する(ステップ502)。このステップ502では、携帯端末装置100の所有者の識別子とID301が一致するレコードの位置302に、位置情報を格納し、時計107から読み出した時刻を、上記の当該レコードの時刻303に格納する。

【0029】なお、GPS衛星からの電波により位置を決定する方法に関しては、

文献1:「ザ ジービーエス ナビゲーション メッセージ、ナビゲーション第25巻、第2号、第147~165頁(The GPS Navigation Message, Navigation Vol.25, No.2); 1978年」

文献2:「ア ポジション フィキシング アルゴリズム フォー ザ ローコスト ジービーエス レシーバ、アイイーイーイー トランザクションズ オン エーイーエス(A Position Fixing Algorithm for the Low Cost GPS Receiver, IEEE Trans. on AES); 1976年3月」

等に述べられている。

【0030】なおまた、上記の位置検出処理500は、時計107を利用して、定期的に行う。

【0031】次に、携帯端末装置100aの位置を、携帯端末装置100b、100cに通知する処理について説明する。なお、通信部103の構成としては、セル

ラ電話を用いる方法、特定小電力無線を使用する方法、セルラ電話とページャを併用する方法がある。

【0032】まず、携帯端末装置100の間で通信する通信データ400について、図7の(a)を用いて説明する。なお、通信データの構成は、上記の3方法において共通である。

【0033】通信データ400は、ID401、位置402、時刻403で構成する。ID401には、ユーザを特定するための識別子を格納する。また、位置402には、ID401で特定されるユーザの位置情報を格納する。また、時刻403には、位置402に格納する位置情報を計測した時刻を格納する。

【0034】まず、通信部103にセルラ電話を用いて、携帯端末装置100aから別の携帯端末装置100bに、携帯端末装置100aの位置に関する情報を通知する処理について、図10のフローチャートを用いて説明する。本通知処理は、携帯端末装置100aにおける情報送信処理510と、携帯端末装置100bにおける情報受信処理520とからなる。

【0035】情報送信処理510では、まず、メンバ管理テーブル350に登録されているすべてのメンバに通信データ400を送信したか否かを判定する(ステップ511)。全員に送信した場合、情報送信処理510を終了する。全員に送信していない場合、送信していないメンバを選択し、メンバ管理テーブル350の電話番号353から電話番号を読み出す(ステップ512)。次に、読み出した電話番号に電話をかけ、回線を接続する(ステップ513)。そして、位置管理テーブル300の、携帯端末装置100aの所有者の識別子で特定されるレコードの位置302から、携帯端末装置100aの位置情報を読み出し、通信データ400の位置402に格納すると共に、上記の当該レコードの時刻303から時刻を読み出し、通信データ400の時刻403に格納する。また、携帯端末装置100aの所有者の識別子を、通信データ400のID401に格納する。そして、この通信データ400を、ステップ513で接続した回線を通じて、携帯端末装置100bに送信する(ステップ514)。送信終了後、回線を切断する(ステップ515)。ステップ515終了後、ステップ511に戻る。

【0036】また、情報受信処理520では、まず、携帯端末装置100aとの間に確立した回線を通じて、携帯端末装置100aから通信データ400を受け取る(ステップ521)。次に、ステップ521で受け取った通信データ400のID401で特定される位置管理テーブル300のレコードの位置302に、通信データ400の位置402に格納されている位置情報を格納すると共に、上記の当該レコードの時刻303に、通信データ400の時刻403に格納されている時刻を格納する(ステップ522)。

【0037】なお、上記実施例では、セルラ電話を用いたが、セルラ電話の代わりにPHH (Personal Handy Phone)を用いても同様の方法で実現できる。

【0038】次に、通信部103に特定小電力無線を用いた場合の処理について、図11のフローチャートを用いて説明する。特定小電力無線を用いる場合の処理は、携帯端末装置100aにおける情報送信処理530と、携帯端末装置100bにおける情報受信処理540とからなる。

【0039】情報送信処理530では、位置管理テーブル300の、携帯端末装置100aの所有者の識別子で特定されるレコードの位置302から、携帯端末装置100aの位置情報を読み出し、通信データ400の位置402に格納すると共に、上記の当該レコードの時刻303から時刻を読み出し、通信データ400の時刻403に格納する。また、携帯端末装置100aの所有者の識別子を、通信データ400のID401に格納する。そして、通信部103を介して、あらかじめ設定された周波数で通信データ400を送信する(ステップ531)。

【0040】また、情報受信処理540では、まず、携帯端末装置100aが発進する周波数と同じ周波数にあわせた状態で、携帯端末装置100aから通信データ400を受け取る(ステップ541)。次に、ステップ541で受け取った通信データ400のID401で特定される位置管理テーブル300のレコードの位置302に、位置402に格納されている位置情報を格納すると共に、上記の当該レコードの時刻303に、時刻403に格納されている時刻を格納する。(ステップ542)。

【0041】なお、上記した例では、特定小電力無線を用いたが、特定小電力無線の代わりにアマチュア無線を用いても同様の方法で実現できる。

【0042】次に、セルラ電話とページャを併用した場合の処理について、図12のフローチャートを用いて説明する。セルラ電話とページャを併用した場合の処理は、携帯端末装置100aにおける情報送信処理550と、携帯端末装置100bにおける情報受信処理560とからなる。

【0043】情報送信処理550では、ページャの持つグループ呼び出し機能を利用する。なお、グループ呼び出し機能とは、複数のページャを同時に呼び出す機能である。情報送信処理550では、まず、セルラ電話の機能を利用し、グループ呼び出しを行うための電話番号に電話をし、回線を接続する(ステップ551)。次に、位置管理テーブル300の、携帯端末装置100aの所有者の識別子で特定されるレコードの位置302から、携帯端末装置100aの位置情報を読み出し、通信データ400の位置402に格納すると共に、上記の当該レコードの時刻303から時刻を読み出し、通信データ4

00の時刻403に格納する。また、携帯端末装置100aの所有者の識別子を、通信データ400のID401に格納する。そして、ステップ551で開設した回線を通じて、通信データ400を送信する(ステップ552)。最後に、ステップ551で開設した回線を切断する(ステップ553)。

【0044】また、情報受信処理560では、ページ受信部で携帯端末装置100aが送信した通信データ400を受信する(ステップ561)。次に、ステップ561で受け取った通信データ400のID401で特定される位置管理テーブル300のレコードの位置302に、位置402に格納されている位置情報を格納すると共に、上記の当該レコードの時刻303に、時刻403に格納されている時刻を格納する(ステップ562)。

【0045】なお、以上説明した各例では、位置の計測を行った時刻の情報も、携帯端末装置100aから携帯端末装置100bに送信しているが、位置のみを表示する場合、時刻の情報は必ずしも必要ではない。

【0046】次に、上述した情報送信処理510、情報送信処理530、情報送信処理550を起動する方法について説明する。

【0047】情報送信処理510、情報送信処理530、情報送信処理550を起動する方法としては、定期的に起動する方法、一定の距離以上移動したときに起動する方法の2種類がある。

【0048】定期的に起動する場合、時計107を用いて、一定の時間間隔で情報送信処理510、情報送信処理530、情報送信処理550を起動する。

【0049】一定の距離以上移動した時に起動する場合、記憶部102に、前回情報送信処理510、情報送信処理530、情報送信処理550を起動した時の位置情報を、記憶するようにする。そして、位置検出処理500で得られる現在の位置情報と、先に記憶した位置情報との間の距離を計算する。計算した距離が一定の値以上の場合、情報送信処理510、情報送信処理530、情報送信処理550を起動すると共に、そのとき位置検出処理によって得られた位置情報を、記憶部102に格納する。

【0050】一定の距離以上移動した時に情報送信処理510、情報送信処理530、情報送信処理550を起動するようにすると、移動していない時は、送信を行わないので、携帯端末装置100の消費電力を抑えることができる。

【0051】以上に示した方法で、携帯端末装置100bは、携帯端末装置100aの位置、つまり、携帯端末装置100aを使用しているメンバの位置を検出することができる。

【0052】次に、携帯情報端末100bで、携帯情報端末100aから受け取った位置に関する情報を表示する位置表示処理700について、図13のフローチャー

トを用いて説明する。

【0053】位置表示処理700では、まず、位置管理テーブル300の、携帯端末装置100bの所有者の識別子で特定されるレコードの位置302から、携帯端末装置100bの位置情報を読み出す(ステップ701)。次に、地図管理部106から地図を読み出す(ステップ702)。次に、ステップ702で読み出した地図を表示部104で表示する(ステップ703)。次に、ステップ701で読み出した携帯端末装置100bの位置を示すマークを、地図の上に表示する(ステップ704)。次に、位置管理テーブル300に格納されているすべてのメンバの位置を表示したか否かを判定する(ステップ705)。すべてのメンバの位置の表示が終了した場合、位置表示処理700を終了する。また位置の表示を行っていないメンバが存在する場合、まだ位置の表示を行っていないメンバの位置を、位置管理テーブル300から読み出す(ステップ706)。そして、ステップ706で読み出したメンバの位置を示すマークを、表示部104で地図に重ねあわせて表示する(ステップ707)。ステップ707の終了後、ステップ705に戻る。

【0054】なお、携帯端末装置100bの位置を画面に表示しない場合、ステップ701及びステップ704の処理を省略することができる。また、ステップ702の地図を読み出す処理において、ステップ701で読み出した携帯端末装置100bの位置が含まれる地図を選択することもできる。このような技術は、既に、車両用ナビゲーションシステム等で実現されている。

【0055】また、ステップ702の処理を、図14に示した地図選択処理710に変更することで、位置管理テーブル300に格納されているすべてのメンバの位置を、一つの画面に表示することも可能である。

【0056】図14に示す地図選択処理710では、まず、位置管理テーブル300に格納されている位置を全て読み出す(ステップ711)。そして、ステップ711で読み出した位置が全て含まれるような地図を、地図管理部106から読み出す(ステップ712)。

【0057】また、上記した実施例においては、地図データを地図管理部106から読み出したが、本発明においては、地図データを必ずしも携帯端末装置100内に持っている必要はない。例えば、地図データを管理するデータベースシステムを用意し、携帯端末装置100に、該データベースにアクセスする手段を持たせ、地図データをデータベースシステムから読み出すことも可能である。以下、その実施例を示す。なおこの場合、通信部103は、セルラ電話機能を持つ必要がある。

【0058】データベースシステムから地図データを読み出すためには、位置表示処理700のステップ702の代わりに、地図データ取得処理870を行う。また、地図データを管理するデータベースにおいて、地図デー

タ提供処理880を行う、地図データ取得処理870、及び、地図データ提供処理880について、図33のフローチャートを用いて説明する。

【0059】地図データ取得処理870では、まず、データベースシステムに例えば電話をすることで、データベースシステムとの間の回線確立する(ステップ871)。次に、データベースシステムに対して、地図データの要求を送信する(ステップ872)。そして、データベースシステムから、地図データを受信する(873)。

【0060】また、地図データ提供処理880では、まず、携帯端末装置100からの要求を受信する(ステップ881)。次に、要求にしたがって、地図データを読み出す(ステップ882)。次に、ステップ882で読み出した地図データを、携帯端末装置100に送信する(ステップ883)。

【0061】以上の処理を行うことにより、携帯端末装置100の外部から地図データを取得することも可能である。

【0062】次に、携帯端末装置100の画面の表示例を、図17を用いて説明する。図17の(a)は、携帯端末装置100bの画面に、他のメンバが持つ携帯端末装置100aの位置を表示した画面の例である。図中、290は、画面に表示された地図である。また、201(201a, 201b)は、他の携帯端末装置100aの位置を示すマークである。

【0063】また、図17の(b)は、携帯端末装置100bの画面に、他のメンバが持つ携帯端末装置100aの位置、及び携帯端末装置100b自身の位置を同時に表示した画面の例である。図中、201は、他の携帯端末装置100aの位置を示すマークであり、202は、携帯端末装置100b自身の位置を示すマークである。

【0064】以上のように、地図上にメンバの位置を表示することにより、メンバがどこに居るのかを一目で確認できる。

【0065】なお、本発明では、メンバの位置をあらわすマーク201とともに、メンバの名前を表示することもできる。その場合、位置表示処理700のステップ707において、メンバ管理テーブル350の、ステップ706で読み出したメンバの識別子で特定されるレコードの名前352からメンバの名前を読み出し、例えばマーク201の下に表示する。

【0066】上記処理により、マークの下にメンバの名前を表示した画面の例を図17に示す。図中、231(231a, 231b)がメンバの名前である。このようにマーク201の下にメンバの名前231を表示することにより、だれがどこに居るのかを一目で確認できる。

【0067】また、携帯端末装置100の位置を一つの

画面に複数表示する場合、携帯端末装置100毎に別々のマークを表示することも可能である。この場合、マーク管理テーブル360を使用する。なお、マーク管理テーブルは、携帯端末装置100の記憶部102に記憶する。

【0068】図20に、マーク管理テーブル360の構成を示す。ID361には、ユーザを特定するための識別子を格納する。マーク362には、画面に表示するマークを例えばビットマップ形式で格納する。

【0069】携帯端末装置100ごとに別々のマークを表示するためには、位置表示処理700のステップ704、及びステップ707において、マークを表示する際に、マーク管理テーブル360の、表示するユーザの識別子で特定されるレコードのマーク362から、画面に表示するマークを読み出し、画面に表示するようにする。

【0070】上記処理により、携帯端末装置100ごとに別々のマークを使用して、位置の表示を行った画面の例を、図17の(e)、(f)に示す。このようにメンバ毎に別々のマーク(図示の例では、マーク201aが丸、マーク201bが四角)を使用することにより、特定のメンバがどこに居るのかを一目で確認できる。

【0071】また、本発明では、携帯端末装置100bと他の携帯端末装置100との距離に応じて、マークの色を変えることもできる。この場合、距離・色対応テーブル370を使用する。なお、距離・色対応テーブル370は、携帯端末装置100の記憶部102に記憶する。

【0072】図29に、距離・色対応テーブルの構成を示す。距離・色対応テーブル370は、下限371、上限372、色373で構成する。例えば、下限371に1キロメートル、上限372に5キロメートル、色373に赤がそれぞれ入っている場合、携帯端末装置100bとの距離が、1キロメートル以上で5キロメートル未満の時に、赤色で表示することを意味する。

【0073】携帯端末装置100bとの距離に応じてマークの色を変えるためには、位置表示処理700のステップ707の前に、色選択860を行うようにする。色選択処理860について、図30のフローチャートを用いて説明する。

【0074】色選択処理860では、まず、ステップ701で読み出した携帯端末装置100bの位置情報と、ステップ706で読み出したメンバの位置情報とから、2地点の距離を計算する(ステップ861)。次に、距離・色対応テーブル370のすべてのレコードから、下限及び上限の読み出し処理を行ったか否かを判定する(ステップ862)。すべてのレコードを読み出した場合、表示する色をあらかじめ決めておいた色(デフォルト色)にする(ステップ866)。まだ、読み出していないレコードが存在する場合、距離・色対応テーブル3

70の下限371から下限を、また、上限372から上限を読み出す(ステップ864)。次に、ステップ861で計算した距離が、下限以上で上限未満となっているか否かを判定する(ステップ864)。下限以上で上限未満でない場合、ステップ862にもどる。下限以上で上限未満の場合には、ステップ864で下限及び上限を読み出したレコードの色373から、マークを表示する色を読み出す(ステップ865)。そして、位置表示処理700のステップ707では、ステップ865またはステップ866で決定した色でマークを表示するようにする。

【0075】図31に、携帯端末装置100bとの距離によって、マークの色を代えた例を示す。図中、201(201a, 201b)が他携帯端末装置の位置を表わすマークである。紙上では、色を表現することができないので、この例では、色を濃淡で表現している。以上のように、携帯端末装置100bとの距離に応じて色を変えることにより、一目で他のメンバとの距離を確認できるようにすることもできる。

【0076】以上の実施例では、携帯端末装置100bにおいて、携帯端末装置100aの位置に関する情報のみを表示したが、本発明では、移動速度に関する情報も同時に表示することができる。以下、その実施例を示す。

【0077】まず、移動速度に関する情報を保管するテーブルについて、図6の(b)を用いて説明する。

【0078】位置に加えて移動速度も表示する場合、先の実施例における位置管理テーブル300を位置管理テーブル310に置き換える。位置管理テーブル310は、ID311、位置312、時刻313、速度314で構成する。ID311には、ID301と同じ情報を格納する。位置312には、位置302と同じ情報を格納する。時刻313には、時刻303と同じ情報を格納する。また、速度313には、移動速度に関する情報(移動速度情報)を格納する。移動速度に関する情報としては、例えば、速度と方向の組み合わせを使用する。

【0079】携帯端末装置100aの移動速度を、携帯端末装置100bで検出する方法としては、携帯端末装置100aの移動速度を、携帯端末装置100bにおいて計算する方法、携帯端末装置100aの移動速度を、携帯端末装置100bが携帯端末装置100aから受け取る方法、の2種類の方法がある。

【0080】まず、前者の方法について、情報送信処理510と情報受信処理520を利用した場合の例を説明する。本方法では、情報受信処理520において、ステップ521を行う前に、速度計算処理800を行う。速度計算処理800について、図21のフローチャートを用いて説明する。

【0081】速度計算処理800では、まず、通信データ400のID401で特定される位置管理テーブル3

10のレコード(レコードAとする)から、時刻313を読み出し、通信データ400の時刻403との時間差を計算する(801)。次に、レコードAから位置312を読み出し、通信データ400の位置302と比較し、2つの位置の間の距離を求める(ステップ802)。ステップ702で計算した距離をステップ801で求めた時間で割ることにより、速度を求める(ステップ803)。そして、ステップ803で求めた速度を、レコードAの速度314に格納する(ステップ804)。

【0082】なお、情報送信処理530と情報受信処理540、あるいは、情報送信処理550と情報受信処理560を利用する場合に関しても、ステップ542、ステップ562の前に、速度計算処理700をそれぞれ挿入することにより、携帯端末装置100aの速度を、位置管理テーブル310の速度314に格納することができ、携帯端末装置100bにおいて、携帯端末装置100aの速度に関する情報を取得することが可能である。

【0083】次に、後者の方法について説明する。本方法の場合、通信データ400を通信データ410で置き換える。

【0084】通信データ410について、図7の(b)を用いて説明する。通信データ410は、ID401、位置402、時刻403、速度404で構成する。速度404には、携帯端末装置100の速度に関する情報を格納する。

【0085】本方式では、携帯情報端末100に速度センサーを取り付ける。速度センサーは、携帯端末装置100の移動速度情報を検出する。

【0086】次に、携帯情報端末100aにおいて、移動速度情報を取得する処理について説明する。携帯端末装置100aの位置検出処理500において、ステップ502の後に、速度センサーから得られた移動速度情報を、位置管理テーブル310の携帯端末装置100aの所有者の識別子で特定されるレコードの速度314に格納する。

【0087】次に、携帯端末装置100aの移動速度情報を、携帯情報端末100bに通知する処理について、情報送信処理510と情報受信処理520を利用した場合の例を説明する。

【0088】移動速度情報を通知するためには、情報送信処理510において、ステップ514を行う前に、位置管理テーブル310の、携帯端末装置100aの所有者の識別子で特定されるレコードの速度314から、携帯端末装置100aの移動速度情報を読み出し、通信データ410の速度404に格納するようにする(以下、これを速度情報送信準備処理と呼ぶことにする)。また、情報受信処理520において、ステップ522を行う前に、先に受信した通信データ410のID401で特定される位置管理テーブル310のレコードの速度3

14に、速度404に格納されている移動速度情報を格納するようにする（以下、これを速度情報格納処理と呼ぶことにする）。

【0089】なお、情報送信処理530と情報受信処理540、あるいは、情報送信処理550と情報受信処理560を利用する場合に関しても、ステップ531、ステップ552の前に、それぞれ速度情報送信準備処理を挿入し、ステップ542、ステップ562の前に、それぞれ速度情報格納処理を挿入することにより、携帯端末装置100aの速度を、携帯端末装置100bの位置管理テーブル310の速度314に格納することができ、携帯端末装置100bにおいて携帯端末装置100aの速度に関する情報を取得することが可能である。

【0090】以上に示した方法により、携帯端末装置100bにおいて、携帯端末装置100aの速度に関する情報を検出することが可能となる。

【0091】次に、上記方法により検出した携帯端末装置100aの移動速度情報を、携帯端末装置100bで表示する処理について説明する。他の携帯端末100（例えば携帯端末装置100a）の移動速度情報を、携帯端末装置100bの画面に表示するためには、位置表示処理700のステップ707の後に速度表示処理810を加えるようにする。速度表示処理810について、図22のフローチャートを用いて説明する。

【0092】速度表示処理810においては、まず、位置管理テーブル310のステップ706で位置情報を読み出したレコードと同じレコードの速度314から、移動速度情報を読み出す（ステップ811）。次に、ステップ706で読み出した位置を始点として、ステップ811で読み出した移動速度情報を、例えば矢印で表示する（ステップ812）。このとき、矢印の指す方向が携帯端末装置100aの進行方向をあらわすようにする。また、矢印を表示するとき、ステップ711で読み出した速度の大きさに比例して、矢印の長さを変えるようにしてもよい。例えば、移動速度が速いほど矢印を長くする。

【0093】図17の(c)に、他のメンバが持つ携帯端末装置100の位置及び速度を表示した例を示す。図中、矢印211(211a, 211b)は、マーク201(201a, 201b)で示される携帯端末装置100の移動速度と移動方向をあらわす。

【0094】また、携帯端末装置100bにおいて、携帯端末装置100b自身の速度に関する情報を同時に表示することも可能である。この場合、位置管理テーブル310の携帯端末装置100bの所有者の識別子で特定されるレコードのレコードの速度314から、移動速度情報を読み出し、ステップ704において、ステップ701で読み出した位置を始点として、先に読み出した携帯端末装置100bの移動速度情報を、例えば矢印で表示する。

【0095】図17の(d)に、他のメンバが持つ携帯端末装置100の位置と速度、及び自らの位置と速度を表示した例を示す。図中、矢印212は、自らの移動速度と移動方向をあらわす。図に示したように、移動速度を矢印で表示することにより、メンバがどの方向に移動しているのかを視覚的に確認できる。

【0096】以上の実施例においては、メンバの位置及び速度の表示を行ったが、本発明では、他のメンバとの距離等の情報を表示することもできる。以下、その実施例を示す。本実施例においては、記憶部102に、メンバの位置を管理するために位置管理テーブル310、及びメンバに関する情報を管理するメンバ管理テーブル350が存在する。

【0097】まず、携帯端末装置100bにおけるメンバ情報表示処理820について、図23のフローチャートを用いて説明する。なお、メンバ情報表示処理820は、ユーザが入力部108のタッチパネルに触れたときに起動する。

【0098】メンバ情報表示処理820では、まず、入力部108のタッチパネル上でユーザが触れた位置を検出し、地図上の座標に変換する（ステップ821）。次に、ステップ821で検出した位置と、位置管理テーブル310の位置312に格納されている位置情報とから、2地点間の距離を計算する。距離の計算を位置管理テーブル310で位置を管理されているすべてのメンバに対して行い、ステップ821で検出した位置に最も近いメンバを特定し、ID311からユーザの識別子を読み出す（ステップ822）。次に、ステップ822で特定したメンバとステップ821で検出した位置の距離が一定の値以内か否かを判定する（ステップ823）。距離が一定の値以内でない場合、メンバ表示処理820を終了する。距離が一定の値以内の場合、メンバ管理テーブル350の、ステップ822で読み出したユーザの識別子で特定されるレコードから、メンバに関する情報を読み出して画面上に表示する（ステップ824）。

【0099】画面上に表示する情報としては、例えば、名前352から読み出したメンバ名前等が挙げられる。また、同時に位置管理テーブル310の、ステップ822で特定されたメンバのレコードに格納されている情報を読み出して表示する。このとき表示する情報としては、位置312に格納されている位置情報、速度314に格納されている移動速度情報、時刻313に格納されている時刻などがある。なお、ステップ824において表示する情報に関しては、先に例を挙げた全ての情報を必ずしも表示する必要はない。

【0100】そして、ステップ824において、次に示す距離計算処理を付け加えることにより、携帯端末装置100bの位置とユーザが入力部108を介して指定したメンバとの間の距離を表示することもできる。

【0101】距離計算処理では、まず、位置管理テーブ

ル310の、携帯端末装置100bの所有者の識別子で特定されるレコードの位置312から、携帯端末装置100bの位置情報を読み出す。つぎに、ステップ822で特定されるメンバの位置情報と比較し、2地点の距離(直線距離)を求め、ステップ824で表示する他の情報と一緒に表示部104に表示する。

【0102】上記の距離計算処理では、携帯端末装置100bの位置とユーザが入力部108を介して指定したメンバとの間の直線距離をもとめたが、地図に道路に関する情報も格納されている場合、道路に沿って距離を求めることもできる。道路に沿って求めた距離を実距離と呼ぶことにする。実距離を求める方法としては、例えば、2地点の道路に沿った距離を最短にする経路を選択する方法や、一定の幅以上の道路について2地点の道路に沿った距離を最短にする経路を選択する方法等がある。

【0103】また、ステップ824に距離計算処理とともに、次に説明する時間差計算処理を加えることにより、携帯端末装置100bがステップ822で特定されたメンバのいる位置に到達するのに要する時間、または、ステップ822で特定されたメンバが携帯端末装置100bの位置に到達するのに要する時間(メンバとの時間差と呼ぶことにする)を表示することができる。

【0104】時間差計算処理では、まず、位置管理テーブル310のステップ822で特定されるレコードの速度314から移動速度情報を読み出し、速さ(例えば時速)を求める。次に、距離計算処理によって求めた実距離を先に計算した速さで割ることにより、メンバとの時間差を計算することができる。その後、ステップ824で表示する他の情報と一緒に表示部104に表示する。

【0105】なお、上記の時間差計算処理では、メンバとの時間差を求めるために実距離を用いたが、実距離を求めることができない場合は、直線距離を使用することもできる。ただし、直線距離を使用すると、実距離を使用したときに比べ精度が落ちる。

【0106】なお、上記実施例では、位置管理テーブル310を使用した。位置管理テーブル300を使用することもできる。その場合、ステップ824において、移動速度情報の表示をすることはできない。また、時間差計算処理を行うことはできないので、メンバの時間差を表示することもできない。

【0107】図24に、メンバの情報を表示した画面の例を示す。図中、260がメンバに関する情報である。以上のように、ユーザは、画面上の印を選択するだけで、選択したメンバに関する詳しい情報を知ることが可能となる。

【0108】以上の実施例では、携帯端末装置100間で、位置情報や移動速度情報の送受信を行っていたが、携帯端末装置100に画像入力部113を設けることにより、静止画を送受信することもできる。以下、その実

施例を示す。

【0109】画像入力部113を有する携帯端末装置100の外観の一例を、図25の(a)、(b)に示す。図中、151はビューボタンであり、152は画像取り込ボタンである。また、153は、画像を取り込むためのレンズを含む撮像部である。ビューボタン151、及び、画像取り込ボタン152を押したときの動作については、後で説明する。

【0110】また、画像入力部113を有する携帯端末装置100を自動車に搭載したときの例を、図25の(c)に示す。図中、171は自動車の前面ガラスであり、172はハンドルである。また、155は、携帯端末装置100と撮像部153を含むカメラ(ビデオカメラ)とを接続するための接続線である。自動車に搭載する場合、レンズを含む撮像部153を前面ガラス171付近に設置することにより、自動車の運転者がみる景色と同様の景色を取り込むことが可能になる。

【0111】次に、携帯端末装置100において静止画像を管理するための静止画像管理テーブル490について、図18を用いて説明する。

【0112】静止画像管理テーブル490は、位置491と画像492で構成する。位置491には、静止画像に関する位置情報を格納する。画像492には、静止画像データを格納する。画像492に格納する静止画像は、圧縮されていてもよい。なお、静止画像管理テーブルの位置491に位置情報が格納されていないとき(例えば値が0のとき)、そのレコードは空きであるとする。

【0113】次に、携帯端末装置100の間で静止画像を転送するために使用する通信データ420について、図7の(c)を用いて説明する。通信データ420は、ID401、位置402、時刻403、画像405で構成する。画像405には、静止画像を格納する。

【0114】次に、携帯端末装置100aで静止画像を取り込む、静止画取り込み処理について、図26のフローチャートを用いて説明する。静止画像取り込み処理830は、ビューボタン151を押すことにより起動される。

【0115】静止画像取り込み処理830では、まず、カメラに映る画像を画像入力部113を介して取り込み、表示部104で表示するようにする。このとき、元の画面を記憶部102に待避する(ステップ831)。次に、ユーザがビューボタン151、または、取り込みボタン152を押すまで待つ。取り込みボタン152が押された場合、ステップ833に移る。ビューボタン151が押された場合、ステップ834に移る。ステップ833では、取り込みボタン152が押されたときに、画像入力部113を介して入力されている画像を記憶部102に格納する。なお、記憶部102に格納した静止画像は、情報送信処理を利用して携帯端末装置100b

に転送する。ステップ834では、ステップ831で記憶部102に退避した画面を元に戻す。

【0116】静止画像取り込み処理により、ユーザは、取り込むべき画像を視覚的に確認しながら取り込むことが可能になる。これにより、ユーザが本当に望む画像を取り込むことができる。

【0117】次に、携帯端末装置100aで取り込んだ静止画像を、携帯情報端末100bに送信する処理について、先に図10で説明した情報送信処理510と情報受信処理520を利用した場合の例を説明する。

【0118】携帯端末装置100aで取り込んだ静止画像を携帯情報端末100bに送信するためには、情報送信処理510において、ステップ514を行う前に、静止画像取り込み処理830のステップ833で記憶部102に格納した静止画像を、通信データ420(図7の(c))の画像405に格納するようにする(この処理を静止画像送信準備処理と呼ぶことにする)。また、情報受信処理520において、ステップ522を行う前に、先に受信した通信データ420の位置402から位置情報を読み出し、静止画像管理テーブル490の空きレコードの位置491に格納するようにする。また、静止画像管理テーブル490の同じレコードの画像492に、通信データ400の画像405から読み出した静止画像を格納するようにする(以上2つのステップをまとめて、静止画像格納処理と呼ぶことにする)。

【0119】なお、情報送信処理530と情報受信処理540、あるいは、情報送信処理550と情報受信処理560を利用する場合に関しても、ステップ531、ステップ552の前に、静止画像送信準備処理をそれぞれ挿入し、ステップ542、ステップ562の前に、静止画像格納処理をそれぞれ挿入することにより、携帯端末装置100aで取り込んだ静止画像を、携帯情報端末100bの静止画像管理テーブル490に格納することができる。

【0120】以上に示した方法により、携帯端末装置100bにおいて、携帯情報端末100aで取り込んだ静止画像を受け取ることが可能となる。なお、以上に示した静止画像を転送するための処理は、静止画像取り込み処理830が行われた直後の情報送信処理510において実行される。

【0121】次に、端末装置100bにおいて静止画像を表示する処理について、図19の表示例と、図27、図28のフローチャートを用いて説明する。本発明では、静止画像を表示するために、画像位置表示処理840と静止画像表示処理850を行う。

【0122】まず、静止画像が存在する位置を地図上に表示するための画像位置表示処理840について、図27のフローチャートを用いて説明する。

【0123】画像位置表示処理840では、まず、静止画像管理テーブル490に格納されている全ての静止画

像について、位置情報の読み出しを行ったか否かを判定する(ステップ841)。すべての静止画像について位置情報の読み出しを行った場合、画像位置表示処理840を終了する。位置情報の読み出しを行っていない静止画像が存在する場合、静止画像管理テーブル490の位置情報の読み出しを行っていないレコードの位置491から位置情報を読み出す(ステップ842)。次に、ステップ842で読み出した位置が、現在表示部104で表示している地図内に入っているか否かを判定する(ステップ843)。地図内に入っていない場合、ステップ841に戻る。地図内に入っている場合、表示部104で表示している地図上の、ステップ842で読み出した位置に、該当するマークを表示する。

【0124】以上の処理により、携帯端末装置100aが静止画像を取り込んだ位置を、地図上に表示することができる。

【0125】次に、ユーザが指定した静止画像を画面上に表示するための静止画像表示処理850について、図28のフローチャートを用いて説明する。なお、この静止画像表示処理850は、ユーザが入力部108のタッチパネルに触れたときに起動する。

【0126】静止画像表示処理850では、まず、入力部108のタッチパネル上でユーザが触れた位置を検出し、地図上の座標に変換する(ステップ851)。次に、ステップ851で検出した位置と、静止画像管理テーブル490の位置491に格納されている位置情報とから、2地点の間の距離を計算する。距離の計算を、静止画像管理テーブル490に格納されているすべての静止画像に対して行い、ステップ851で検出した位置に最も近いレコードを特定し、そのレコードの位置491から位置情報を読み出す(ステップ852)。次に、ステップ852で読み出した位置とステップ851で検出した位置との距離が、一定の値以内か否かを判定する(ステップ853)。

距離が一定の値以内でない場合、静止画像表示処理850を終了する。距離が一定の値以内の場合、静止画像管理テーブル490の、ステップ852で特定したレコードの画像492から、静止画像を読み出して画面上に表示する(ステップ854)。

【0127】以上の処理により、ユーザが指定した静止画像を画面上に表示することが可能となる。

【0128】図19の(a)に、静止画像の位置を地図上に表示した例を示す。図中、251が静止画像の位置を示すマークである。ここでは、星型のマークを使用した。様々なマークを用意すれば、別のマークを使用することも可能である。また、図19の(b)に、静止画像を表示している画面の例を示す。図中、252は、ユーザがマーク251を指定したときに表示される静止画像である。静止画像を転送できるようにすると、例えば、携帯端末装置100aで待ち合わせ場所の画像を取り込み、携帯情報端末100bに転送することで、携帯

端末装置100bのユーザは、待ち合わせ場所を確実に把握することができる。

【0129】上記実施例では静止画を使用した。本発明では、動画を使用することもできる。その場合、静止画像の取り込み及び表示を、動画の取り込み及び表示にすればよい。

【0130】なお、本発明では、取り込んだ静止画像を他の携帯端末装置100bに送信するだけでなく、端末装置100aに取り込んだ静止画像を記憶しておくこともできる。この場合、静止画像取り込み処理830のステップ833で、位置管理テーブル310の携帯端末装置100aの所有者の識別子で特定されるレコードの位置312から、位置情報を読み出し、静止画像管理テーブル490の空きレコードの位置491に格納し、同じレコードの画像492に画像入力部113を介して取り込んだ画像を記憶するようにすればよい。

【0131】以上の実施例においては、通信データ420を使用し、位置情報とともに静止画像を送信したが、通信データ430を使用することにより、位置情報、速度情報とともに静止画像を送信することもできる。以下、その実施例を示す。

【0132】まず、通信データ430の構成について、図7の(d)を用いて説明する。通信データ420は、ID401、位置402、時刻403、速度404、画像405で構成する。

【0133】次に、位置情報、速度情報とともに静止画像を送信する方法について説明する。位置情報、速度情報とともに静止画像を送信するためには、情報送信処理510と情報受信処理520、あるいは情報送信処理530と情報受信処理540、あるいは情報送信処理550と情報受信処理560を利用する場合のそれぞれについて、ステップ514、ステップ531、ステップ552の前に、速度情報送信準備処理と静止画像送信準備処理とを挿入し、ステップ522、ステップ542、ステップ562の前に、速度情報格納処理と静止画像格納処理とを挿入すればよい。

【0134】また、本発明においては、携帯端末装置100に交通情報を受信するためのVICCS受信部111を具備させ、受信した交通情報を、表示部104で表示している地図に重ねて表示することにより、渋滞情報などを地図上で確認でき、メンバが渋滞に巻き込まれているといったことを視覚的に確認できる。図32に交通情報を地図に重ねた表示した例を示す。図中、240は、240の示す区間が渋滞していることをあらわす。

【0135】以上の実施例では、携帯端末装置100aから携帯端末装置100bに位置に関する情報を送信する例を示したが、携帯端末装置100bの位置に関する情報を携帯端末装置100aに送信し、携帯端末装置100aで携帯端末装置100bの位置を表示する場合も同様である。

【0136】ここで、以上の実施例のシステム構成では、携帯端末装置100bにおいて、携帯端末装置100aの位置に関する情報は、他の携帯端末装置100aから受け取っていた。しかし、本発明では、ホスト局を設け、このホスト局から他の携帯端末装置の位置等に関する情報を受け取ることもできる。以下、その実施例を示す。

【0137】図2に、ホスト局を設けた場合の通信システムの構成の概要を示す。図中、180は、ホスト局である。また、100a、100b、100cは、携帯端末装置であり、190a、190b、190cは、GPS衛星である。

【0138】次に、ホスト局180の構成について、図4を用いて説明する。図中、181は制御部であり、周辺部の制御、データの要求や処理、通信等にかかわる各種処理プログラムの実行を行う。182は記憶部であり、データの要求や処理、通信等にかかわる各種プログラムやデータが格納される。記憶部182は、例えば、RAM、ROM、フラッシュメモリ、ハードディスク等を使用することができる。183は通信部であり、携帯端末装置100とのデータ交換を行う。184は表示部であり、例えばCRT表示装置よりなる。187は時計であり、時刻の管理や定期的な割り込みの発生を行う。188は入力部であり、例えば、キーボード、タッチパネル、マウス、ペン型入力手段等である。

【0139】ホスト局180を設けた場合、図1に示したシステム構成の場合と携帯端末装置100間のデータ交換方式が異なるが、携帯端末装置100で記憶するデータや、位置検出処理500や位置表示処理700は同じである。つまり、図1に示したシステム構成の場合では、携帯端末装置100間のデータ交換方式として、情報送信処理510と情報受信処理520、または、情報送信処理530と情報受信処理540、または、情報送信処理550と情報受信処理560を用いたが、図2に示すシステム構成の場合、別のデータ交換方式を用いる。以下、図2に示したシステム構成の場合のデータ交換方式について説明する。

【0140】まず、ホスト局において、携帯端末装置100の位置を管理するホスト位置管理テーブル450について、図8の(a)を用いて説明する。なお、ホスト位置管理テーブル450は、ホスト局180の記憶部182に格納する。

【0141】ホスト位置管理テーブル450は、ID451、位置452、時刻453で構成する。ID451には、ユーザを特定するための識別子を格納する。また、位置452には、ID451で特定されるユーザの位置情報を格納する。また、時刻453には、位置の計測を行った時刻を格納する。

【0142】次に、携帯端末装置100aの位置を、携帯端末装置100b、100cに通知する処理について

説明する。本システム構成の場合、携帯端末装置100aの位置情報は、一旦ホスト局180に貯えられた後、他の携帯端末装置100b、100cに通知される。なお、携帯端末装置100の通信部103の構成としては、セルラ電話を用いる方法、セルラ電話とページャを併用する方法がある。また、携帯端末装置100とホスト局180の間の通信データとしては、通信データ400を用いる。また、各携帯端末装置100においては、メンバの位置を管理するために位置管理テーブル300を用いる。

【0143】まず、通信部103にセルラ電話を用いる方式について、図15のフローチャートを用いて説明する。本方式は、携帯端末装置100aにおけるクライアント処理600と、ホスト局180におけるホスト処理610とからなる。

【0144】クライアント処理600では、まず、通信部103のセルラ電話を介してホスト局180に電話をし、回線を接続する(ステップ601)。そして、位置管理テーブル300の、携帯端末装置100aの所有者の識別子で特定されるレコードの位置302から、携帯端末装置100aの位置情報を読み出し、通信データ400の位置402に格納すると共に、上記の当該レコードの時刻303から時刻を読み出し、通信データ400の時刻403に格納する。また、携帯端末装置100aの所有者の識別子を、通信データ400のID401に格納する。そして、この通信データ400を、ステップ601で接続した回線を通じて、ホスト局180に送信する(ステップ602)。次に、ホスト局180から、他のメンバの位置情報を受信する。他のメンバの位置情報の受信では、まず、ホスト局180から終了コードが送られてきたか否かを判定する(ステップ603)。終了コードが送られてきた場合、ステップ601で確立した回線を切断する(ステップ606)。終了コードが送られていない場合、ホスト局180からの通信データ400を受信する(604)。ステップ604で受け取った通信データ400のID401で特定される位置管理テーブル300のレコードの位置302に、位置402に格納されている位置情報を格納すると共に、上記の当該レコードの時刻303に、時刻403に格納されている時刻を格納する(ステップ605)。その後、ステップ603に戻る。

【0145】ホスト処理610では、まず、クライアント処理600のステップ602で送信された通信データ400を受信する(ステップ611)。次に、ステップ611で受け取った通信データ400のID401で特定されるホスト位置管理テーブル450のレコードの位置452に、位置402に格納されている位置情報を格納すると共に、上記の当該レコードの時刻453に、時刻403に格納されている時刻を格納する(ステップ612)。次に、ホスト位置管理テーブル450に登録さ

れているメンバの位置情報を、携帯端末装置100aに送信する。送信する場合、まず、ホスト位置管理テーブル450に格納されているメンバ全員(ただし、ステップ611で受信した通信データ400のID401で特定されるメンバを除く)の位置情報を、送信したか否かを判定する(ステップ613)。メンバ全員の位置情報を送信した場合は、終了コードを送信し、処理を終了する(ステップ615)。メンバ全員の位置情報を送信していない場合、ホスト位置管理テーブル450から、位置情報を送信していないメンバのレコードを特定する。次に、特定したレコードのID451からユーザの識別子を読み出して通信データ400のID401に格納し、位置452から位置情報を読み出し位置402に格納し、時刻452から時刻を読み出し時刻403に格納する。そして、この通信データ400を携帯端末装置100aに送信する(ステップ614)。その後、ステップ613に戻る。なお、ホスト処理610は、携帯端末装置100との間の回線が確立したときに起動するようにする。

【0146】他の携帯端末装置100b、100cにおいても、クライアント処理600を行うことで、携帯端末装置100aの位置情報を獲得できる。

【0147】次に、通信部103に、セルラ電話とページャを併用する方法について、図16のフローチャートを用いて説明する。本方式は、携帯端末装置100におけるクライアント情報送信処理620、クライアント情報受信処理640、及び、ホスト局180におけるホスト情報受信処理630、ホスト情報送信処理650からなる。

【0148】クライアント情報送信処理620では、まず、通信部103のセルラ電話を介してホスト局180に電話をし、回線を接続する(ステップ621)。そして、位置管理テーブル300の、携帯端末装置100aの所有者の識別子で特定されるレコードの位置302から、携帯端末装置100aの位置情報を読み出し、通信データ400の位置402に格納すると共に、上記の当該レコードの時刻303から時刻を読み出し、時刻403に格納する。また、携帯端末装置100aの所有者の識別子を通信データ400のID401に格納する。そして、この通信データ400を、ステップ621で接続した回線を通じて、ホスト局180に送信する(ステップ622)。その後、ステップ621で確立した回線を切断する(ステップ623)。

【0149】ホスト情報受信処理630では、クライアント情報送信処理620のステップ622で送信された通信データ400を受信する(ステップ631)。次に、ステップ631で受け取った通信データ400のID401で特定されるホスト位置管理テーブル450のレコードの位置452に、位置402に格納されている位置情報を格納すると共に、上記の当該レコードの時刻

453に、時刻403に格納されている時刻を格納する(ステップ632)。なお、ホスト情報受信処理630は、携帯端末装置100との間の回線が確立したときに、起動するようにする。

【0150】クライアント情報送信処理620とホスト情報受信処理630により、携帯端末装置100aの位置情報を、ホスト局180に登録することができる。次に、携帯端末装置100aに、他のメンバの位置を通知するためのホスト情報送信処理650と、クライアント情報受信処理640について説明する。

【0151】なお、ホスト情報送信処理650は、時計187を利用して、定期的に起動される。また、一回のホスト情報送信処理650では、ホスト位置管理テーブル450で管理される一人のメンバの情報、つまり、一つのレコードについてのみ処理を行う。ホスト情報送信処理650は、例えば、ホスト位置管理テーブル450で管理されるメンバの位置情報などを、先頭のレコードから順番に送信するようにする。つまり、ホスト位置管理テーブル450において、A、B、Cの3人のメンバの情報が管理されていたとすると、最初のホスト情報送信処理ではAの情報を送信し、2回目はB、3回目はC、4回目はAという順番で処理を行う。

【0152】ホスト情報送信処理650では、まず、ホスト位置管理テーブル450の順番にあたったレコードのID451からユーザの識別子を読み出して、通信データ400のID401に格納し、位置452から位置情報を読み出して位置402に格納し、時刻453から時刻を読み出して時刻403に格納する。そして、通信データ400をページの同報通信機能を利用して、携帯端末装置100aに送信する(ステップ651)。

【0153】クライアント情報受信処理640では、まず、通信部103のページャを介してホスト局180からの通信データ400を受信する(ステップ641)。次に、ステップ641で受信した通信データの400のID401で特定される位置管理テーブル300のレコードの位置302に、位置402に格納されている位置情報を格納すると共に、上記の当該レコードの時刻303に、時刻403に格納されている時刻を格納する(ステップ642)。なお、クライアント情報受信処理640は、通信部103のページャによりホスト局180からの通信データ400を検知したときに、起動するようにする。

【0154】なお、上記実施例においては、位置管理テーブル300と通信データ400を使用したか、位置管理テーブル300の代わりに位置管理テーブル310を、通信データ400の代わりに通信データ410を使用することもできる。この場合、ホスト位置管理テーブル450の代わりに、ホスト位置管理テーブル460を使用する。

【0155】ホスト位置管理テーブル460の構成を、

図8の(b)に示す。ホスト位置管理テーブル460は、ID451、位置452、時刻453、速度454で構成する。速度454には、速度情報を格納する。

【0156】まず、通信部103にセルラ電話を使用した場合について、位置管理テーブル310と通信データ410を利用した場合を示す。この場合、クライアント処理600のステップ602の前に、別の実施例で説明した速度情報送信準備処理を行うようにする。また、ステップ605の前に、速度情報格納処理を行うようにする。さらに、ホスト処理610において、ステップ612を行う前に、ステップ611で受け取った通信データ410のID401で特定されるホスト位置管理テーブル460のレコードの速度454に、通信データ410の速度404に格納されている移動速度情報を格納するようにする(ホスト速度情報格納処理と呼ぶことにする)。また、ステップ614において、データを送信する前に、通信データ410の速度404に、ホスト位置管理テーブル460の位置情報を読み出したレコードと同じレコードの速度454から速度情報を読み出して、格納するようにする(ホスト速度情報送信準備処理と呼ぶことにする)。

【0157】次に、通信部103にセルラ電話とページャを使用した場合について、位置管理テーブル310と通信データ410を利用した場合を示す。この場合、クライアント情報送信処理620において、ステップ622の前に速度情報送信準備処理を行うようにする。また、ホスト情報受信処理630において、ステップ632の前に、ホスト速度情報格納処理を行うようにする。さらに、ホスト情報送信処理650において、通信データ410を送信する前に、ホスト速度情報送信準備処理を行うようにする。さらに、クライアント情報受信処理640において、ステップ642の前に、速度情報格納処理を行うようにする。

【0158】以上説明した方法により、ホスト局180を介して、携帯端末装置100aの速度情報を他の携帯端末装置100に通知することができる。

【0159】また、静止画像管理テーブル490を使用し、さらに通信データ410の代わりに通信データ420を使用することにより、静止画像を送信することもできる。この場合、ホスト位置管理テーブル460の代わりに、ホスト位置管理テーブル470を使用する。

【0160】ホスト位置管理テーブル470の構成を図8の(c)に示す。ホスト位置管理テーブル470は、ID451、位置452、時刻453、画像455で構成する。画像455には、静止画像データを格納する。

【0161】まず、通信部103にセルラ電話を使用した場合について、静止画像を送受信する方法を説明する。この場合、クライアント処理600において、ステップ602の前に、静止画像送信準備処理を行うようにする。また、ステップ605の前で、静止画像格納処理

を行うようにする。さらに、ホスト処理610において、ステップ612の前に、先に受信した通信データ420の画像405から静止画像を読み出し、通信データ420のID401で特定されるホスト位置管理テーブル470のレコードの画像455に格納する（この処理を、ホスト静止画像格納処理と呼ぶことにする）。また、ステップ614において、通信データ420を送信する前に、通信データ420の画像405に、ホスト位置管理テーブル470の位置情報を読み出したレコードと同じレコードの画像455から静止画像を読み出して、格納するようにする。また、送信後は、画像455をクリア（例えば、0をセット）するようにする（以上の2ステップをまとめて、ホスト静止画像送信準備処理と呼ぶことにする）。

【0162】以上の処理により、ある携帯端末装置100aで取り込んだ静止画像を、他の携帯端末装置100bに送信することができる。

【0163】次に、通信部103にセルラ電話とページャを使用した場合について、静止画像を送受信する方法を説明する。この場合、クライアント情報送信処理620のステップ622の前に、静止画像送信準備処理を行うようにする。また、ホスト情報受信処理630のステップ632の前に、ホスト静止画像格納処理を行うようにする。また、ホスト情報送信処理650のステップ651において、通信データ420を送信する前に、ホスト静止画像送信準備処理を行うようにする。また、クライアント情報受信処理640において、ステップ642の前に、静止画像格納処理を行うようにする。

【0164】以上の処理により、ある携帯端末装置100aで取り込んだ静止画像を、他の携帯端末装置100bに送信することができる。

【0165】以上の実施例においては、通信データ420を使用し、位置情報とともに静止画像を送信したが、通信データ430を使用することにより、位置情報、速度情報とともに静止画像を送信することもできる。以下、その実施例を示す。この場合、ホスト位置管理テーブル470の代わりに、ホスト位置管理テーブル480を使用する。ホスト位置管理テーブル480の構成を、図8の(d)に示す。ホスト位置管理テーブル480は、ID451、位置452、時刻453、速度454、画像455で構成する。

【0166】まず、通信部103にセルラ電話を使用した場合の処理を説明する。この場合、位置情報、速度情報とともに静止画像を送信するためには、クライアント処理600において、ステップ602の前に、速度情報送信準備処理と静止画像送信準備処理を挿入し、ステップ605の前に、速度情報格納処理と静止画像格納処理を挿入するようにする。また、ホスト処理610において、ステップ612の前に、ホスト速度情報格納処理とホスト静止画像格納処理を挿入し、ステップ614にお

いて、通信データ430を送信する前に、ホスト速度情報送信準備処理とホスト静止画像送信準備処理を行うようにする。

【0167】次に、通信部103に、セルラ電話とページャを使用した場合の処理を説明する。この場合、クライアント情報送信処理620において、ステップ622の前に、速度情報送信準備処理と静止画像送信準備処理を行うようにする。また、ホスト情報受信処理630において、ステップ632の前に、ホスト速度情報格納処理とホスト静止画像格納処理を行うようにする。また、ホスト情報送信処理650において、ステップ651で通信データ430を送信する前に、ホスト速度情報送信準備処理とホスト静止画像送信準備処理を行うようにする。さらに、クライアント情報受信処理640において、ステップ642の前に、速度情報格納処理と静止画像格納処理を行うようにする。

【0168】以上のようにすることで、ホスト局180を設けた場合でも、携帯端末装置100aの速度情報や、携帯端末装置100aで取り込んだ静止画像を、他の携帯端末装置100bで受け取ることができる。

【0169】

【発明の効果】以上示したように、本発明によれば、携帯端末装置を持つメンバの位置を視覚的に確認できるという効果がある。さらに、メンバの移動方向も表示できるので、メンバが正しい方向に向かっているかを一目で確認できる。また、自分とメンバとの距離に応じて色を変えることにより、メンバとの距離を把握することが容易になる。また、他のメンバの移動速度に応じて矢印の長さを変えることにより、メンバの移動速度を一目で把握できる。

【0170】また、静止画像を転送できるようにすると、例えば、携帯端末装置aで待ち合わせ場所の画像を取り込み、携帯端末装置bに転送することで、携帯端末装置bのユーザは、待ち合わせ場所を確実に把握することができる。さらに、本発明では、取り込むべき画像を視覚的に確認しながら取り込むことを可能にしているので、ユーザが本当に望む画像を簡単に取り込むことができる。

【0171】さらに、一定の距離以上移動したときのみ、位置情報を他の携帯端末装置に送信するようにすることにより、移動していない際の携帯端末装置の消費電力を抑えることができる。

【図面の簡単な説明】

【図1】本発明の1実施例に係る通信システムの概要を示す説明図である。

【図2】本発明の他の1実施例に係る通信システムの概要を示す説明図である。

【図3】図1の携帯端末装置のブロック構成図である。

【図4】図2のホスト局のブロック構成図である。

【図5】本発明の実施例で用いられるメンバ管理テーブ

ルの構成図である。

【図6】本発明の実施例で用いられる位置管理テーブルの構成図である。

【図7】本発明の実施例で用いられる通信データの構成図である。

【図8】本発明の実施例で用いられるホスト位置管理テーブルの構成図である。

【図9】本発明の実施例による位置検出処理の概要を示すフローチャート図である。

【図10】本発明の実施例による情報送信処理、及び情報受信処理の概要を示すフローチャート図である。

【図11】本発明の実施例による情報送信処理、及び情報受信処理の概要を示すフローチャート図である。

【図12】本発明の実施例による情報送信処理、及び情報受信処理の概要を示すフローチャート図である。

【図13】本発明の実施例による位置表示処理の概要を示すフローチャート図である。

【図14】本発明の実施例による地図選択処理の概要を示すフローチャート図である。

【図15】本発明の実施例によるクライアント処理、及びホスト処理の概要を示すフローチャートである。

【図16】本発明の実施例によるクライアント情報送信処理、及びクライアント情報受信処理、及びホスト情報送信処理、及びホスト情報受信処理の概要を示すフローチャート図である。

【図17】本発明の実施例による画面の表示例を示す説明図である。

【図18】本発明の実施例で用いられる静止画像管理テーブルの構成図である。

【図19】本発明の実施例による画面の表示例を示す説明図である。

【図20】本発明の実施例で用いられるマーク管理テーブルの構成図である。

【図21】本発明の実施例による速度計算処理の概要を示すフローチャート図である。

【図22】本発明の実施例による速度表示処理の概要を示すフローチャート図である。

【図23】本発明の実施例によるメンバ表示処理の概要

を示すフローチャート図である。

【図24】本発明の実施例による画面の表示例を示す説明図である。

【図25】本発明の実施例に係る携帯端末装置の外観の例を示す説明図である。

【図26】本発明の実施例による静止画像取り込み処理の概要を示すフローチャート図である。

【図27】本発明の実施例による画像位置表示処理の概要を示すフローチャート図である。

【図28】本発明の実施例による静止画像表示処理の概要を示すフローチャート図である。

【図29】本発明の実施例で用いられる距離・色対応テーブルの構成図である。

【図30】本発明の実施例による色選択処理の概要を示すフローチャート図である。

【図31】本発明の実施例による画面の表示例を示す説明図である。

【図32】本発明の実施例による画面の表示例を示す説明図である。

【図33】本発明の実施例による地図データ取得処理、及び地図データ提供処理の概要を示すフローチャート図である。

【符号の説明】

- 100 携帯端末装置
- 180 ホスト局
- 101, 181 制御部
- 102, 182 記憶部
- 103, 183 通信部
- 104, 184 表示部
- 105 GPS受信部
- 106 地図管理部
- 107, 187 時計
- 108, 188 入力部
- 190 GPS衛星
- 151 ビューボタン
- 152 画像取り込みボタン
- 153 撮像部

【図4】

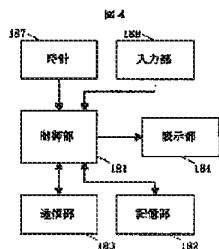

【図5】

ID	名前	電話番号
381	382	383

【図6】

ID	位置	時刻	速度
301	302	303	304
311	312	313	314

【図1】

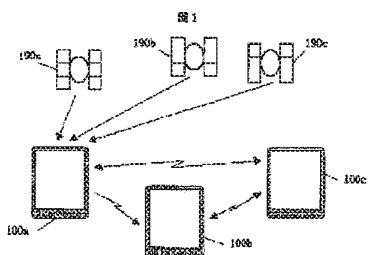

【図2】

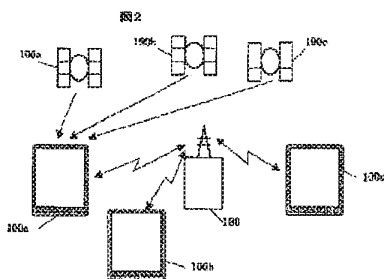

【図9】

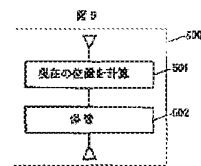

【図3】

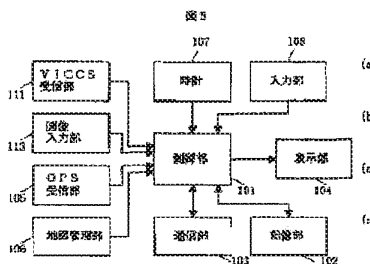

【図7】

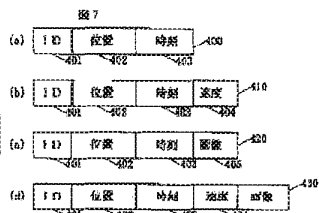

【図14】

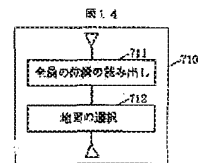

【図8】

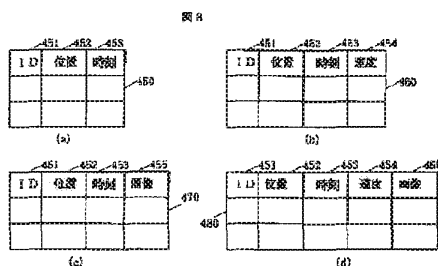

【図10】

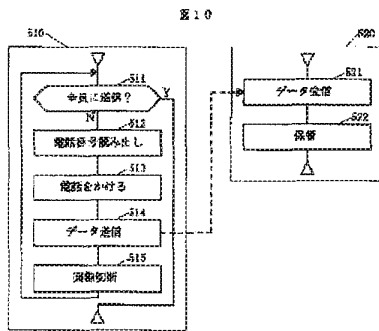

【図11】

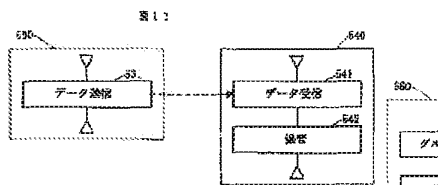

【図12】

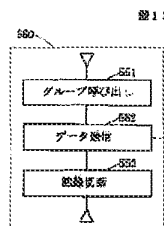

【図22】

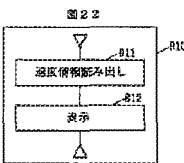

【図13】

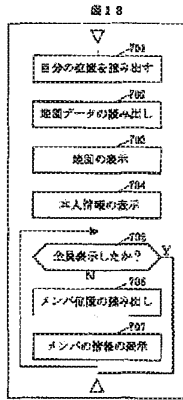

【図15】

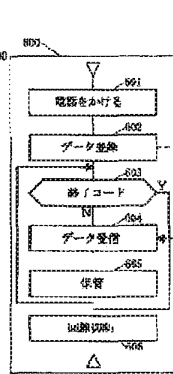

【図16】

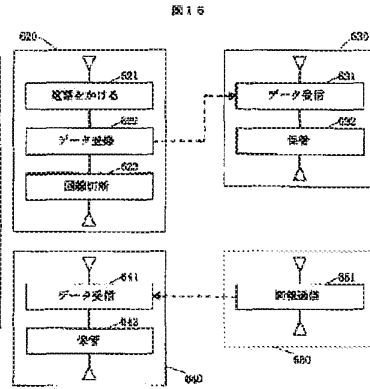

【図17】

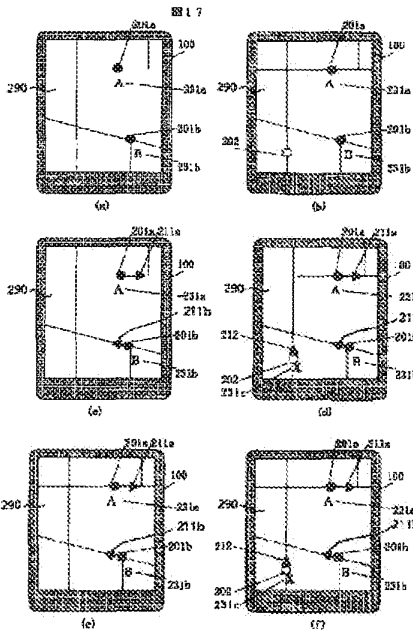

【図18】

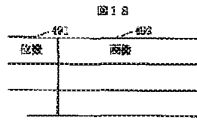

【図20】

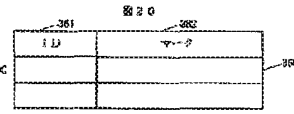

【図19】

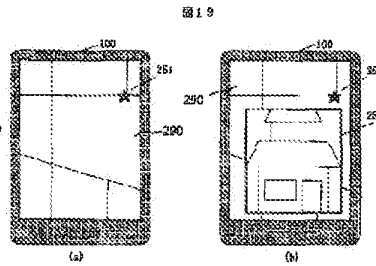

【図21】

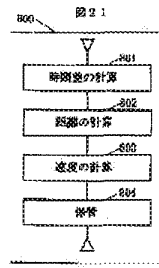

【図23】

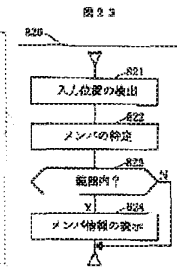

【図27】

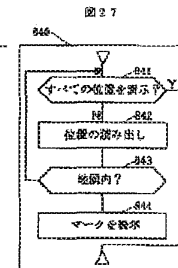

【図29】

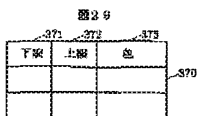

【図24】

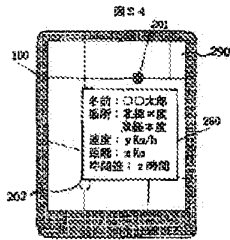

【図25】

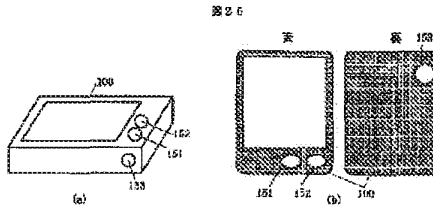

【図26】

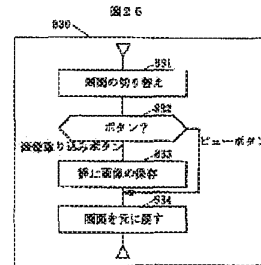

【図28】

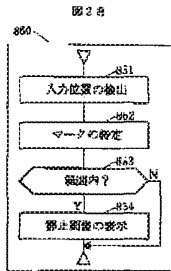

【図30】

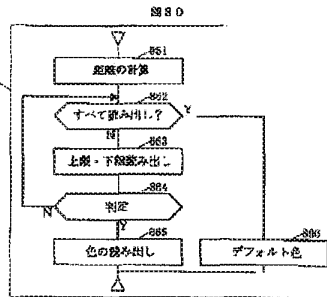

【図31】

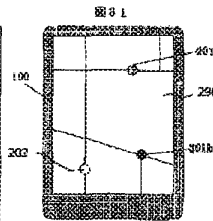

【図32】

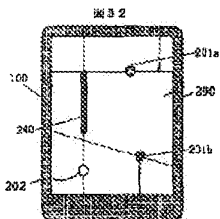

【図33】

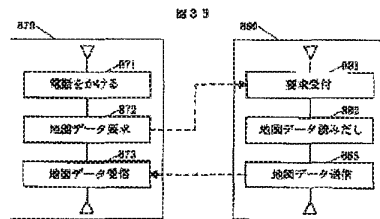

フロントページの続き

(51)Int. Cl.⁶

G 0 9 B 39/10

H 0 4 B 7/26

H 0 4 Q 7/34

H 0 4 M 11/00

識別記号

庁内整理番号

F I

技術表示箇所

3 0 2



Patent Translate

Powered by EPO and Google

Notice

This translation is machine-generated. It cannot be guaranteed that it is intelligible, accurate, complete, reliable or fit for specific purposes. Critical decisions, such as commercially relevant or financial decisions, should not be based on machine-translation output.

DESCRIPTION JPH09113288

[0001]

Running position display device for displaying on the display device together with the map the current position of the vehicle or the like (navigation device), this invention relates to relates to a running position display device having a point registration function

[0002]

8 Description of the Prior Art, shows the outline of the vehicle running-position display device of the prior art.

8, 1 is a direction sensor, a distance sensor for generating a pulse corresponding to the rotational speed of the wheel 2 in the various sensor signals on-off signals brake switch and a parking switch, and the power supply voltage monitoring signal 3 some.

Sensor signal processing unit for processing the sensor signal direction sensor 1, and a distance sensor 2, GPS 5 is (Global Positioning System) receiver, 4 operation receives radio waves transmitted from a plurality of satellites to the GPS receiver 5 it is one that can be obtained (latitude, longitude) position of the receiving point by the.

6 is a CD-ROM drive, the CD-ROM drive 6 serves to read the map data from the CD-ROM7 map data is recorded.

8 is a display and operating unit which is installed in the passenger compartment, made of an operation switch 8B and a plurality of liquid crystal display 8A for displaying driving current position, orientation, etc of the vehicle and the map, the display and operation unit 8, the operation such as switch for instructing switch, the point of registration for indicating expansion of the map display, and reduction, the map scroll is provided to switch 8B

9 is an apparatus main body.

[0003]

I will describe the configuration of the apparatus body 9 next.

CPU for performing various kinds of computation (central processing unit). 11 the azimuth sensor 1, the distance sensor 2, GPS receiver 5, CD ROM programs of various operations performed in CPU10 is stored (read only memory), 12 10 memory for storing the results of operations in the CPU10 and data from 6 mag-ROM drive (DRAM), 13 the backup to keep the necessary data even when the power supply to the apparatus main body 9 s stopped Memory (SRAM), 14 to form a display image based on such present position data of the vehicle and map data (kanji, font ROM), the memory 15 of the pattern characters to be displayed on the liquid crystal display 8A, and symbols are stored is displayed on the liquid crystal display 8A by combining kanji map data outputted from the CPU10, street outputted Kanji and position data, from the font ROM14 current, such as street name, a font image processing semiconductor devices to, 16 a memory for storing image (VRAM), 17 denotes an RGB conversion circuit for converting a color signal output of the data VRAM16, the color signal is output to the liquid crystal display 8A from RGB conversion circuit 17.

18 The communication interface 19 is an audio processor, and is intended to create a voice message for a predetermined based on the command of CPU10, a voice message created by the audio processor 19 is output from the speaker 20 to the audio processor 19.

[0004]

Figure 9 is an overview of the registration point means at the time of registration point.

The central portion of the map displayed on the liquid crystal display 8A on the scrolls the map display by using the operation unit of the 8B point to be registered.

21 is a mark indicating the center of the screen.

To tell people to operate that when the point comes in the central part, pushing the operation section 8B in order to perform registration, and the registered and displays the registered point mark 22.

This mark can be selected more than one type of

[0005]

Figure 10 is a screen for displaying a list of points that the spot registration, a person who operates the name A point point registered, B point, C point, ..., or stored automatically later and is stored in the memory by entering any character.

It is intended to be displayed on the liquid crystal display name of this point is stored is read from the memory.

[0006]

Figure 11 shows an example where a plurality of display on the liquid crystal display 8A on the point that the spot registration.

[0007]

In the running position display device of the conventional [problem to be solved by the invention, the name and location of the point, which is point registration is only known, such as when you want to call there, and notebooks and personal phone book had to be with reference to, make a phone call.

[0008]

It is intended to solve the above conventional problems, by selecting on the screen the point registered Optionally, the present invention aims to provide a running position display device having a function of making a call to it is intended.

[0009]

In order to achieve the above object, a storage unit for the road data is recorded. at least, the first aspect of the present invention means to achieve the above object, a current position detecting means for detecting the current position of the vehicle a display means for displaying the current position obtained by the current position detecting means and the road map read out from the storage means, communication means for performing communication by entering the communication destination number, any of the above road map It is one that is characterized by comprising a registration unit for registering the communication destination number and points, and a communication connecting means for connecting to the communication destination for the communication unit reads the communication destination number of the point that was registered by the registration unit

[0010]

When specifying an arbitrary point of the map displayed on the display unit, the second aspect of the present invention, and the communication destination location name of the point of the specified point near by, the point of which is registered in the registration unit It is characterized in that it is displayed on the display unit number.

[0011]

When specifying an arbitrary point of the map displayed on the display unit, the third aspect of the present invention includes
http://translationportal.epo.org/emtp/translate/?ACTION=description-retrieval&COUNTRY=JP&ENGINE=google&FORMAT=docdb&KIND=A&LOCALE=en_... 2/4

a display unit and location names of the locations of the designated points near by, the point of which is registered in the registration unit a communication connecting means for connecting to the communication destination communication unit reads the communication destination number stored in the register means corresponding to the location name by the display apparatus displaying in, to specify the location names that are displayed on the display unit It is characterized by comprising a.

[0012]

Therefore, according to the present invention, by registering at the same time the communication destination number and location registration means to select the location on the map or table, and displays the phone number and name of the sites, and to also automatically and in which it is possible to make a call.

[0013]

It will be described with reference to FIGS. 1-7 embodiments of the present invention in the following, an embodiment of the invention].

[0014]

Figure 2 shows an overview of a cabin installed at the vehicle interior according to this embodiment FIG 1 (first embodiment) and also outlines the running position display device according to an embodiment of the present invention.

1 and 2, 8 is a display and operation unit, a liquid crystal display 8A, the display and operation unit 8 and an operation switch 8B.

9 is an apparatus body, the apparatus main body 9 is the same structure as that shown in FIG

Antenna GPS receiver 5, 33 call connection unit 20 is a speaker, the speaker of the audio device installed in the passenger compartment is also used, the speaker 20 outputs the received audio of the mobile phone 35 to 32.

34 is a microphone which is located near the driver's seat, the microphone 34 is used as the audio input of the mobile phone 35.

36 is an antenna of the mobile phone 35.

[0015]

Figure 3 shows the processing for the telephone number registration and location registration to be executed by CPU10 in the present embodiment.

In Figure 3, performs the location registration similarly to the conventional step S1, displays the registration mark to the point at step S2.

Enter the phone number in step S4 If you select whether or not to register the phone number in step S3, it chose to the register.

Change can be seen that the phone number is entered markings of the registration point in step S5 phone number input is completed.

And displayed on the liquid crystal display 8A is a list of phone number and the name of the point in step S6, to highlight the point you just typed it.

[0016]

Figure 4 is showing a display example in the liquid crystal display 8A.

In Figure 4, T mark indicating that the telephone number is input, 26 is the telephone number entered, 27 shows a portion of the highlighted 25.

By selecting a predetermined point in the display screen shown in FIG 4, it is possible to make a call.

For example, the input telephone number, selecting an arbitrary number by the cursor to each digit of the telephone number input screen for any digits of which are displayed on the display screen and operating the up-down switch of the operation switch 8B in it is one that is carried out by

[0017]

Next, will be described with reference to the flow diagram shown in Figure 5 for the operation when you call in the present embodiment.

If the number and locations of the plurality are registered as shown in FIG 6, the operator can select the point 35 of the screen in step S1 in FIG 5. selecting the phone number call function, displayed on the screen in step S2 are arranged on the right edge of the screen are in the order, from the point to call the location names registered point F that is, G, H, I, et is selected in step S3.

If you select (point H, for example) a certain point the operator in step S4, the highlight that you highlight the point name, as shown at 37 in Figure 6, has been selected (step S5).

When you determine the point you want to call in step S6, call the phone number from memory the telephone number of the point is stored in step S7, the display on the right end of the wide screen in step S8, a telephone call in step S9.

For example, to highlight the color of the frame of the name of the H point if you select a point of H.

[0018]

Figure 7 shows a display screen of the liquid crystal display 8A after the H point is selected

The displayed at the right end of the wide screen phone number, as shown at 38 in FIG 7, and the guide of the call in step S10.

39 is what you have to understand the calling point registration mark flashes in Figure 7.

And displays a message such as "The line is busy," it is determined whether the call in step S11, if busy, as in step S12.

The call Once you have connected the line to the other party in the step S13, the call is finished. the line is disconnected in step S14

Note that in which it is possible to make calls easily at home, friend's home, and restaurants and performs a location registration home, such as a restaurant or a friend's home in the above example, if you add a phone number for the location.

[0019]

It should be noted that in the above embodiment, an example of the telephone, but is similarly implemented in other data communications or fax the present invention.

The liquid crystal display 8A of the embodiment is of a long wide screen horizontal dimension of the screen is compared to the display generally, the aspect ratio of the screen may be used as a conventional general is intended

[0020]

In the above embodiment, it is possible to draw a map, and the vehicle mark CPU10, by drawing the registered point name multiple CPU10, to synthesize both screens in the image processing for the semiconductor device 15, the liquid crystal display 8A It is intended for displaying a map, and location on the left screen, and displays the registration spot multiple names on the right screen, it may be top or bottom of the screen

[0021]

By connecting to the communication destination communication means reading the communication destination number of points registered in the registration means registers the communication destination number and name to the registration point, the present invention is, or list as above, according to the present invention By selecting the location on the map, can be used to display the telephone number and the name of the point, to place a call automatically further, for example, and the other party easily without opening the notebook or personal phonebook I have the advantage of being able to communicate.

(19) 日本国特許庁 (J P)

(12) 公開特許公報 (A)

(11) 特許出願公開番号

特開平9-113288

(43) 公開日 平成9年(1997)5月2日

(51) Int.Cl. ⁶	識別記号	庁内整理番号	F I	技術表示箇所
G 0 1 C	21/00		G 0 1 C 21/00	C
G 0 8 G	1/0909		G 0 8 G 1/0909	
G 0 9 B	29/10		G 0 9 B 29/10	A
H 0 4 M	1/27		H 0 4 M 1/27	
	11/00	3 0 3	11/00	3 0 3

審査請求 未請求 請求項の数4 O L (全 7 頁)

(21) 出願番号 特願平7-286700

(22) 出願日 平成7年(1995)10月16日

(71) 出願人 000095821

松下電器産業株式会社
大阪府門真市大字門真1006番地

(72) 発明者 堀田 聡

神奈川県横浜市港北区綱島東四丁目3番1
号 松下電器工業株式会社内

(74) 代理人 弁理士 滝本 習之 (外1名)

(54) 【発明の名称】 走行位置表示装置

(57) 【要約】

【課題】 自車位置を地図とともに表示装置に表示する走行位置表示装置に関し、任意の地点を登録する際に電話番号も同時に登録でき、更にその地点を呼び出すときに電話番号を表示したり自動的に電話をかけることを可能とする。な走行位置表示装置を提供する

【解決手段】 液晶ディスプレイ8A画面のある地点を選び、電話番号呼出機能を選択すると、選択した地点から近い順に画面の右端に並べ、操作者がある地点を選択すると地点名称を反転表示し選択されていることを強調し、その地点の電話番号を格納されている部分から呼び出しワイド画面の右端に表示し、更に自動的に電話をかける。

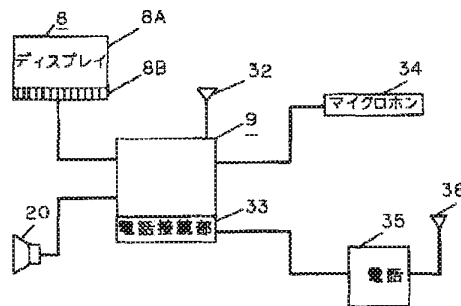

【特許請求の範囲】

【請求項1】 少なくとも道路データが記録された記憶手段と、自車の現在位置を検出する現在位置検出手段と、上記記憶手段から読出された道路地図と上記現在位置検出手段で求められた現在位置とを表示する表示手段と、通信先番号を入力して通信を行う通信手段と、上記道路地図上の任意の地点および通信先番号を登録する登録手段と、上記登録手段で登録した地点の通信先番号を読み出し上記通信手段を通信先に接続する通信接続手段とを具備してなる走行位置表示装置。

【請求項2】 電話を通信手段とした請求項1記載の走行位置表示装置。

【請求項3】 表示手段に表示されている地図の任意の点を指定した際に、登録手段に登録されている地点の内上記指定点近傍の地点の地点名称と通信先番号を表示手段に表示することを特徴とする請求項1記載の走行位置表示装置。

【請求項4】 表示手段に表示されている地図の任意の点を指定した際に、登録手段に登録されている地点の内上記指定点近傍の地点の地点名称を表示手段に表示するとともに、上記表示手段に表示されている地点名称を指定することによりこの地点名称に対応して登録手段に記憶された通信先番号を読み出し通信手段を通信先に接続する通信接続手段とを具備してなる請求項1記載の走行位置表示装置。

【発明の詳細な説明】

【0001】

【発明の属する技術分野】本発明は、自動車等の現在位置を地図とともに表示装置に表示する走行位置表示装置（ナビゲーション装置）、特に地点登録機能を有する走行位置表示装置に関する。

【0002】

【従来の技術】図8は、従来の車載用走行位置表示装置の概要を示している。図8において、1は方位センサ、2は車輪の回転数に応じたパルスを発生する距離センサ、3はブレーキスイッチ、パーキングスイッチなどのオン・オフ信号、電源電圧監視用信号などの各種センサ信号である。4は方位センサ1、距離センサ2などのセンサ信号を処理するセンサ信号処理部、5はGPS（Global Positioning System）レシーバであり、このGPSレシーバ5は複数の衛星から送信される電波を受信し演算することにより受信点の位置（緯度、経度）を求めることができるものである。6はCD-ROMドライブであり、このCD-ROMドライブ6は、地図データが記録されたCD-ROM7から地図データを読み出すものである。8は車室内に設置される表示・操作部であり、この表示・操作部8は、地図及び自動車の現在走行位置、方位等を表示する液晶ディスプレイ8Aと複数の操作スイッチ8Bとからなり、操作スイッチ8Bには表示地図の拡大、縮小などを指示するためのスイッチ、地点

登録を指示するスイッチ、地図スクロールを行うスイッチなどが具備されている。9は装置本体である。

【0003】次に装置本体9の構成について説明する。10は各種の演算を行うCPU（中央処理装置）、11はCPU10で行う各種の演算のプログラムが記憶されたROM（リードオンリーメモリ）、12は方位センサ1、距離センサ2、GPSレシーバ5、CD-ROMドライブ6等からのデータやCPU10での演算結果等を記憶するメモリ（DRAM）、13は装置本体9への電源供給が停止した際にも必要なデータを保持しておくためのバックアップ用メモリ（SRAM）、14は液晶ディスプレイ8Aに表示する文字、記号などのパターンが記憶されたメモリ（漢字、フォントROM）、15は地図データや自車の現在位置データなどに基づいて表示画像を形成するための画像処理用半導体素子、16はCPU10から出力される地図データ、現在位置データ及び漢字、フォントROM14から出力される町名、道路名などの漢字、フォントを合成して液晶ディスプレイ8Aに表示する画像を記憶するメモリ（VRAM）、17はVRAM16の出力データを色信号に変換するためのRGB変換回路であり、色信号はRGB変換回路17から液晶ディスプレイ8Aに出力される。18は通信インターフェース、19は音声プロセッサであり、この音声プロセッサ19はCPU10の指令に基づき所定の音声メッセージを作成するものであり、音声プロセッサ19で作成された音声メッセージがスピーカ20より出力される。

【0004】図9は地点登録の際の地点登録手段の概要を説明する。液晶ディスプレイ8A上に表示されている地図の中央部に、登録したい地点を8Bの操作部を用いて表示地図をスクロールさせる。21は画面の中央を示すマークである。中央部にその地点が来た時点で、登録を行うために8Bの操作部を押し、登録したことを操作する人に伝えるため、登録地点マーク22を表示する。このマークは複数の種類が選択できる。

【0005】図10は、地点登録をした地点を一覧表示するための画面であり、登録した地点の名称A地点、B地点、C地点・・・が自動的に記憶され、または操作する人が後で任意の文字を入力することによりメモリに記憶される。この記憶された地点の名称がメモリから読み出されて液晶ディスプレイに表示されるものである。

【0006】図11は地点登録をした地点を液晶ディスプレイ8A上に複数表示した例である。

【0007】

【発明が解決しようとする課題】上記従来の走行位置表示装置においては、地点登録された地点の場所や名称がわかるだけで、そこへ電話をかけたときなどは、電話帳や個人の手帳などを参考にし、電話をかける必要があった。

【0008】本発明は、上記従来の問題点を解決するも

のであり、任意に登録した地点を画面上で選択するだけで、そこに電話をかける機能を有する走行位置表示装置を提供することを目的とするものである。

【0009】

【課題を解決するための手段】本発明の第1の発明は、上記目的を達成するために、少なくとも道路データが記録された記憶手段と、自車の現在位置を検出する現在位置検出手段と、上記記憶手段から読出された道路地図と上記現在位置検出手段で求められた現在位置とを表示する表示手段と、通信先番号を入力して通信を行う通信手段と、上記道路地図上の任意の地点および通信先番号を登録する登録手段と、上記登録手段で登録した地点の通信先番号を読み出し上記通信手段を通信先に接続する通信接続手段とを具備したことを特徴とするものである。

【0010】本発明の第2の発明は、表示手段に表示されている地図の任意の点を指定した際に、登録手段に登録されている地点の内上記指定点近傍の地点の地点名称と通信先番号を表示手段に表示することを特徴とするものである。

【0011】本発明の第3の発明は、表示手段に表示されている地図の任意の点を指定した際に、登録手段に登録されている地点の内上記指定点近傍の地点の地点名称を表示手段に表示するとともに、上記表示手段に表示されている地点名称を指定することによりこの地点名称に対応して登録手段に記憶された通信先番号を読み出し通信手段を通信先に接続する通信接続手段とを具備したことを特徴とするものである。

【0012】したがって、本発明によれば、登録手段に地点と通信先番号も同時に登録し、一覧表もしくは地図上でその地点を選択することにより、その地点の名称と電話番号を表示し、更に自動的に電話をかけることができるものである。

【0013】

【発明の実施の形態】以下に本発明の実施の形態について図1～図7とともに説明する。

【0014】(実施の形態1)図1は本発明の一実施の形態における走行位置表示装置の概要を示し、また図2は本実施の形態を車室内に設置した車室の概要を示している。図1、図2において、8は表示・操作部であり、この表示・操作部8は液晶ディスプレイ8Aと、操作スイッチ8Bから構成される。9は装置本体であり、この装置本体9は図8に示すものと同一構成である。32はGPSレシーバ5のアンテナ、33は電話接続部、20はスピーカであり、このスピーカ20は車室内に設置されたオーディオ装置のスピーカが兼用され、携帯電話35の受信音声出力する。34は運転席の近傍に配置されたマイクロホンであり、このマイクロホン34は携帯電話35の音声入力用として使用される。36は携帯電話35のアンテナである。

【0015】図3は本実施の形態においてCPU10で

実行される地点登録及び電話番号登録を行う処理を示している。図3において、ステップS1で従来と同様な地点登録を行い、ステップS2にてその地点に登録マークを表示する。ステップS3で電話番号を登録するか否かを選択し、登録するを選んだ場合ステップS4で電話番号を入力する。電話番号の入力が終わるとステップS5にて登録地点の表示マークを電話番号が入力されたことがわかるように変更する。ステップS6では地点の名称と電話番号の一覧を液晶ディスプレイ8Aに表示し、先ほど入力したばかりの地点を強調表示する。

【0016】図4は液晶ディスプレイ8Aにおける表示例を示している。図4において、25は電話番号が入力されたことを示すTのマーク、26は入力された電話番号、27は強調表示された部分を示している。図4に示す表示画面で所定の地点を選択することにより、電話をかけることができる。なお、電話番号の入力は、例えば、表示画面に表示された任意の桁の電話番号入力画面の各桁にカーソルを合わせ、操作スイッチ8B内のアップダウンスイッチを操作することにより任意の数字を選択して行うものである。

【0017】次に、本実施の形態において電話をかける際の動作について図5に示すフロー図により説明する。図6に示すように複数の地点及び電話番号が登録されている場合、図5のステップS1で操作者が画面のある地点35を選び、電話番号呼出機能を選択すると、ステップS2で画面に表示された登録地点F、G、H、Iから地点名称を呼び出し、ステップS3で選択した地点から近い順に画面の右端に並べる。ステップS4で操作者がある地点(例えば地点H)を選択すると、図6で37で示すように地点名称を反転表示し、選択されていることを強調表示する(ステップS5)。ステップS6で電話をかける地点を決定すると、ステップS7でその地点の電話番号が記憶されているメモリから電話番号を呼び出し、ステップS8でワイド画面の右端に表示し、ステップS9で電話をかける。例えばHの地点を選択するとH地点の名称の枠の色を反転表示する。

【0018】図7はH地点が選択された後の液晶ディスプレイ8Aの表示画面を示している。図7に38で示すように電話番号をワイド画面の右端に表示し、ステップS10で呼び出し中の案内をする。図7において39は地点登録マークが点滅し呼出中をわかるようにしているものである。ステップS11で通話中かを判断し、ステップS12のように通話中なら「話中です」などのメッセージを表示する。ステップS13で相手との回線が接続したら通話し、通話が終了すると、ステップS14で回線を切断する。なお上記実施例で自宅、友人宅またはレストランなどの地点登録を行うとともに、この地点の電話番号を登録しておく自宅、友人宅、レストランなどに容易に電話をかけることができるものである。

【0019】なお、上記実施の形態では、電話の例であ

るが、本発明はファクシミリや他のデータ通信でも同様に実施することができる。また、上記実施の形態の液晶ディスプレイ8Aは、画面の横寸法が一般のディスプレイに比較して長いワイド画面のものであるが、画面の縦横比が従来の一般的なものを使用してもよいのである。

【0020】また、上記実施の形態では、CPU10で地図、自車マークなどを描画するとともに、CPU10で複数の登録地点名称を描画し、画像処理用半導体素子15で両画面を合成することにより、液晶ディスプレイ8Aの左側画面に地図、現在地などを表示し、右側画面に複数の登録地点名称を表示しているが、画面の上部又は下部に表示してもよいものである。

【0021】

【発明の効果】以上のように本発明は、登録地点に名称と通信先番号を登録し登録手段で登録した地点の通信先番号を読み出し通信手段を通信先に接続することにより、一覧表もしくは地図上でその地点を選択することにより、その地点の名称と電話番号を表示し、更に自動的に電話をかけることができ、例えば、電話帳や個人の手帳を開かなくても容易に先方と通信ができる利点を有する。

【図面の簡単な説明】

【図1】本発明の実施の形態における走行位置表示装置のブロック図

【図2】同実施の形態の走行位置表示装置を設置した車室内を示す斜視図

【図3】同実施の形態の動作を示すフロー図

【図4】同実施の形態の登録地点の一覧表の表示例を示す表示図

【図5】同実施の形態の動作を示すフロー図

【図6】同実施の形態の地点登録を行った際の表示例を示す表示図

【図7】同実施の形態の地点登録を行った際の表示例を示す表示図

【図8】従来の走行位置表示装置のブロック図

【図9】従来の走行位置表示装置の地点登録を行った際の表示例を示す表示図

【図10】従来の走行位置表示装置の登録地点の一覧表の表示例を示す表示図

【図11】従来の走行位置表示装置の地点登録を行った際の表示例を示す表示図

【符号の説明】

- 8 表示・操作部
- 8A 液晶ディスプレイ
- 8B 操作スイッチ
- 9 装置本体
- 10 CPU
- 20 スピーカ
- 32 アンテナ
- 33 電話接続部
- 35 電話
- 36 アンテナ

【図1】

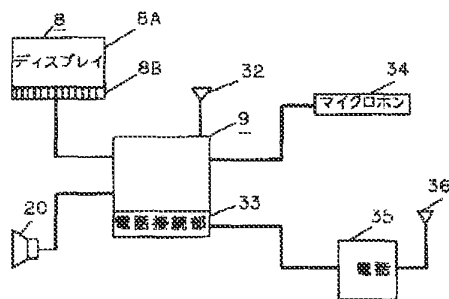

【図2】

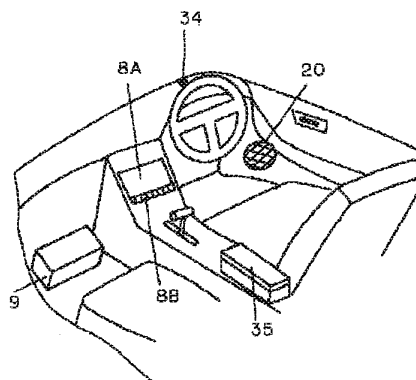

【図3】

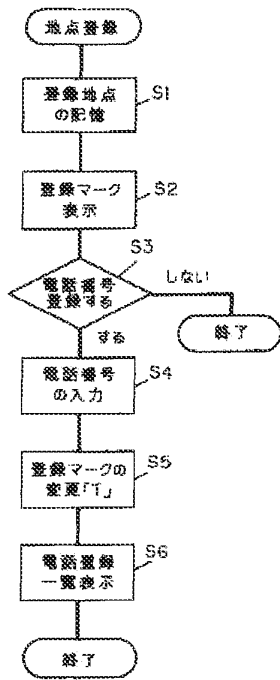

【図4】

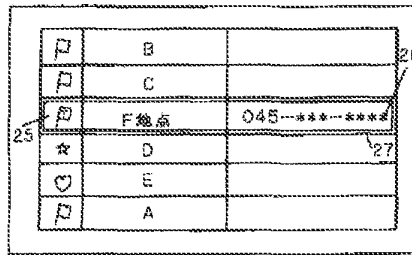

【図7】

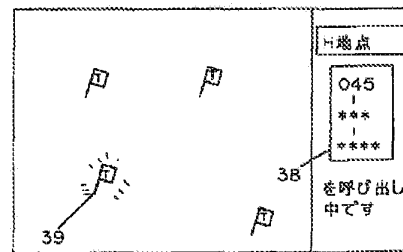

【図6】

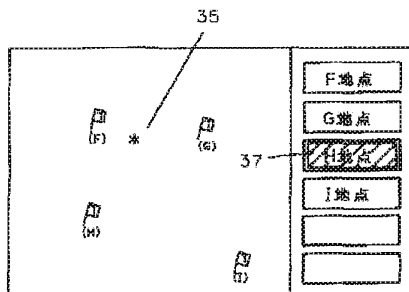

【図9】

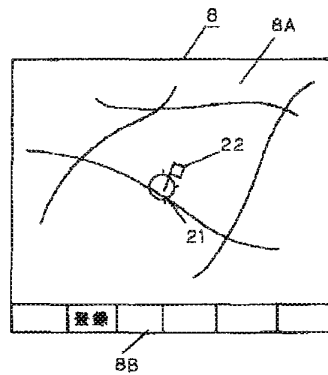

【図5】

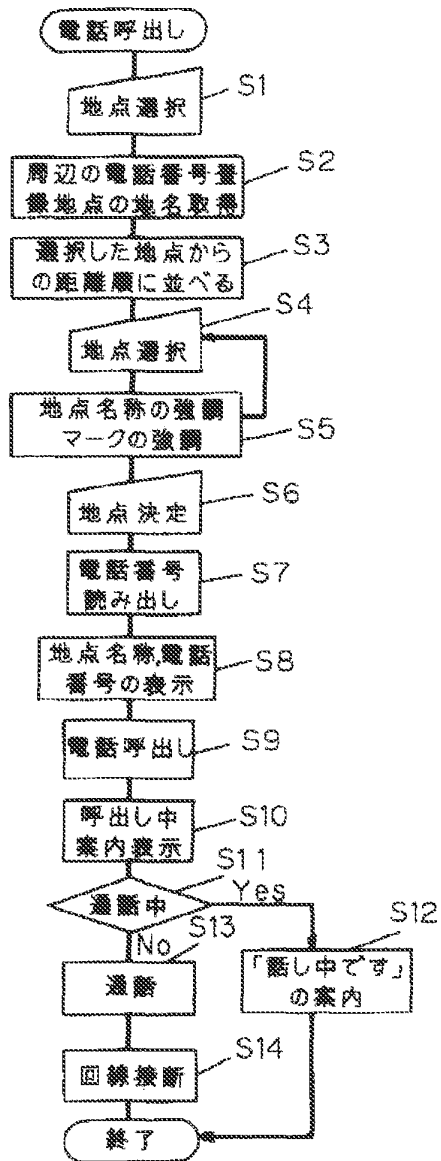

【図10】

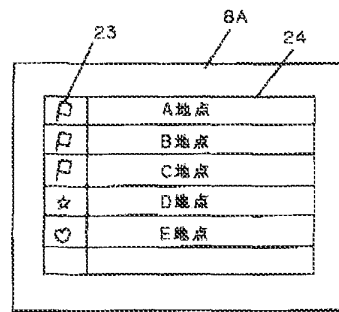

【図11】

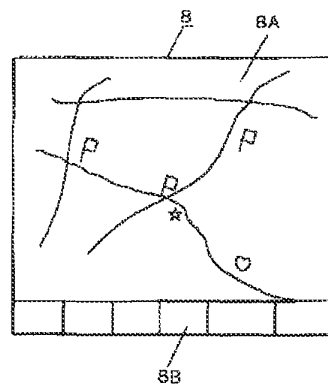

【図8】

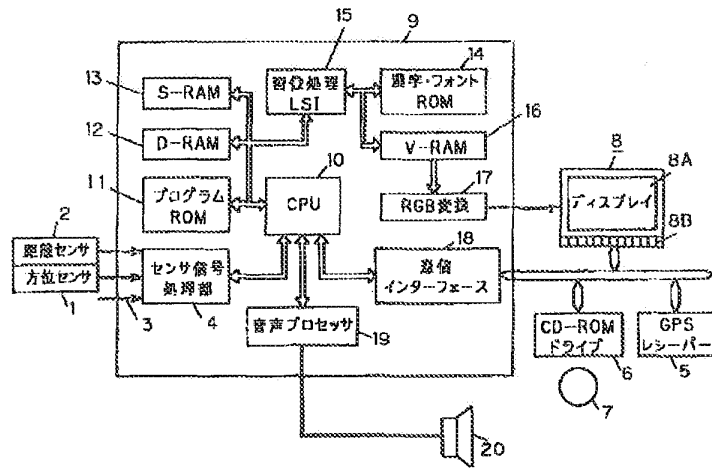



Morningside
Translations

TRANSLATOR CERTIFICATION

450 7th Avenue
10th Floor
New York, NY 10123
Tel: 212.643.8800
Fax: 212.643.0005
www.morningtrans.com

County of New York
State of New York

Date: July 28, 2014

To whom it may concern:

This is to certify that the attached translation from Japanese into English is an accurate representation of the documents received by this office.

The documents are designated as:

- JP2002245336A

Jamie Sirota, Project Manager in this company, attests to the following:

"To the best of my knowledge, the aforementioned documents are a true, full and accurate translation of the specified documents."

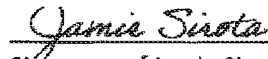

Signature of Jamie Sirota

Accurate Translation Services 24/7

(19) Japan Patent Office (JP) (12) Publication of Unexamined Patent Application (A)

(11) Japanese Parent Application Publication Number
 Unexamined Patent Application Publication 2002 - 245336
 (P2002-245336A)
 (43) Publication Date August 30, 2002

(51) Int. Cl.	Identification Number	FI	Class	Class	Theme code (Reference)
G06F 12/00	150	0607	15/00	570	50070
	300			260	50070
	301			300	50005
	306			400	
	500			500	

(51) Application Number:	Patent Application: 2001-81208 (P2001-81208)	(71) Applicant:	SHINKO BISHI Shinko Bishi Co., Ltd. 2-2-24 Higashi 2-ch. Nagasaki City, Nagasaki Prefecture
(52) Filing Date: February 15, 2001		(72) Inventor: Shunichi SHIMIZU	1 - 190 Fujinohs, Nagasaki City, Nagasaki Prefecture Shinko Bishi Co., Ltd. R&D Center
		(72) Inventor: Kenjiro OKAMOTO	1 - 150 Fujinohs, Nagasaki City, Nagasaki Prefecture Shinko Bishi Co., Ltd. R&D Center
		(72) Inventor: Tetsuya SUDO	1 - 190 Fujinohs, Nagasaki City, Nagasaki Prefecture Shinko Bishi Co., Ltd. R&D Center

(54) [Title of the Invention]
 Information-communication System

(57) [Abstract]

[Problem]

To provide a new information-communication system that easily implements data communications between a plurality of users.

[Resolving Means]

In display means 30 on an information-display apparatus 100 possessed by a user, that sends to the user a targeted material such as map data 501, 502, additional data 503 or a service or the like that is included in the map data 501, 502, relating to a fixed range of a present position, by a server 400 receiving a position signal relating to the present position of the user, an information-communication system implements the service along with displaying the map data 501, 502, and the additional data 503. Included is a memory region 412 for the user to set grouping-conditions data 605 for determining a condition for building/dissolving a group that can share the targeted material with other users, and security data 607 for defining a level of access

of other users to the targeted material when building the group.

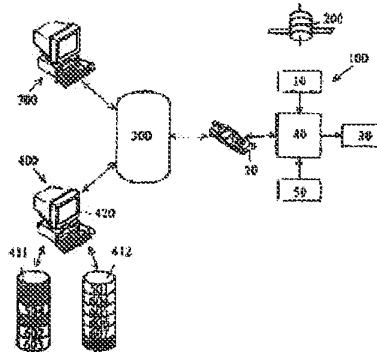

[Scope of Claims for Patent]

[Claim 1]

An information-communication system that sends to a user map data relating to a fixed range of the present position, and additional data or a service that is included in the map data by a server receiving a position signal relating to the user's present position, and that displays on display means of an information-display apparatus possessed by the user, the map data, and the additional data, or executes the service, characterized by including a memory region for the user to set a grouping procedure program that executes building or dissolving of the group by judging and executing grouping-conditions data for defining a condition for building or dissolving a group that can share targeted materials such as execution data or an executable program or the like for executing with other users the additional data or the service, or a user interface feature, or a security-management program for executing access to the targeted materials by judging or executing the level.

[Claim 2]

An information-communication system is composed of a server for storing targeted material such as map data, additional data or a service included in the map data, or data or a program for executing a user interface feature; and an information-display apparatus for displaying by receiving from the server by communicating with the server while held by the user, the data or the program, and enabling execution of the service, wherein the information-display apparatus includes detection means for determining a present position of the user; communication means for sending to the server the position signal relating to the present position and receiving from the server the data and the service; display means for displaying based

on the data; control means for controlling at least the detection means and the displaying means, and for executing the service; and input means for giving an instruction to the control means, wherein the server includes a memory region for a user to set a grouping-procedure program for executing building or dissolving of the group by judging or executing grouping-conditions data for defining a condition for building or dissolving a group that can store the map data and the additional information, and share targeted materials with another user, and a security-management program for executing access to the targeted materials by judging or executing the level, communication means for sending to the user the map data that relates to a fixed range of the present position by receiving a position signal that relates to the present position of the user and the additional data or the service in response to a status in which the user is, and control means for controlling at least the communication means.

[Claim 3]

The information-communication system according to claim 1 or claim 2, characterized by automatically building the group using the grouping-procedure program and the security-management program when a plurality of users satisfy the conditions of the grouping-conditions data, displaying the present position of the users other than yourself using the display means of the information-display apparatus of the user, and sharing targeted material according to the level in the security data.

[Claim 4]

The information-communication system according to claim 1 or claim 2, wherein the grouping-conditions data or the security data include the condition and the level when executing building or

dissolving the group, using a plurality of existing groups as configuring elements for a new group, or when configuring a new group by randomly combining the user which is a configuring element of the existing group, and when adding a third party to the existing group as a user, or as a configuring element to the existing group.

[Claim 5]

The information-communication system according to claim 3 or claim 4, wherein the condition of the grouping-conditions data is content based on a spatial element using the present position of the user and any point, and/or a temporal element based on a present time, a random time difference or limit.

[Claim 6]

The information-communication system according to claim 3 or claim 4, wherein the level of the security data is content that determines access such as reading/writing restrictions and the like to the targeted material.

[Claim 7]

The information-communication system according to claim 3 or claim 4, wherein the level of the security data is content that determines access such as reading/writing restrictions and the like to the targeted material shared in the group.

[Claim 8]

The information-communication system according to any one of claims 4 to 7, wherein the content of the grouping-conditions data and/or the security data can be set for each user.

[Claim 9]

The information-communication system according to claim 1 or claim 2, wherein the user-interface feature includes a feature for

changing or setting data or a program for customizing the information-display apparatus by selection by the user, an operation method on the server, a data search method, or convenience of the user interface, and an agent feature such as a procedures program provided to automate an operating means aid for the user by using a suitable method such as a statistical method for data relating to individual information data of the user, an operation log, a search result for the targeted material, or a usage log of the service, or at least a portion of the operation means.

[Detailed Description of the Invention]

[0001]

[Field of the Invention]

The present invention relates to a new information-communication system that sends and receives various data by being carried along with a mobile body.

[0002]

[Prior Art]

Communication is rapidly becoming popularized that can be used in any location, via electrical communication lines, by an individual having an information-display device as data-communication means such as a cellular telephone, PHS (hereinafter collectively referred to as a cellular telephone), a laptop type PC embedded with a modem, or Palm device (hereinafter collectively referred to as a personal data communication device); an environment is becoming established for easy communication with other people without limitation to time or place. At present, a focus of the communication via an information-display apparatus that implements sending and receiving of various data by being carried along with this kind of mobile body is audio

information and character information. However, eventually, a ratio of still-image information and video information will increase; it is thought that an overall volume of data will dramatically increase.

[0003]

Also, disclosed in Japanese unexamined patent application publication Hei 10-13961 is a mobile communication system that responds to a user's various needs by supplying targeted material such as data or a service related to the position of the mobile device, and not only map information that shows the mobile device's present position, by communication with an information center that maintains and provides various information using the information-display device.

[0004]

[Problems to be Solved by the Invention]

However, communication between the user and the server is an object of the information-display device; a limitation to usage formats was disliked.

[0005]

An object of the present invention is to provide a new information-communication system that implements sending and receiving of targeted material by being carried along with the mobile body, such as being carried by the user or being installed onboard a vehicle being driven by the user. The object of the present invention is to provide a new information communication system that easily implements communication between a plurality of users, and implements synchronized communication along with the targeted material between the users that compose the group.

[0006]

[Means for Solving the Problem]

To solve the problems described above, according to claim 1, the information-communication system of the present invention is an information-communication system that sends to a user map data relating to a fixed range of the present position, and additional data or a service that is included in the map data by a server receiving a position signal relating to the user's present position, and that displays on display means of an information-display apparatus possessed by the user, the map data, and the additional data, or executes the service, characterized by including a memory region for the user to set a grouping-procedure program that executes building or dissolving of the group by judging and executing grouping-conditions data for defining a condition for building or dissolving a group that can share targeted materials such as execution data or an executable program or the like for executing with other users the additional data or the service, or a user interface feature, or a security-management program for executing access to the targeted materials by judging or executing the level.

[0007]

According to claim 2, composed are a server for storing targeted material such as map data, additional data or a service included in the map data, or data or a program for executing a user-interface feature; and an information-display apparatus for displaying by receiving from the server by communicating with the server while held by the user, the data or the program, and enabling execution of the service, wherein the information-display apparatus includes detection means for determining a present position of the user; communication means for sending to the server the position signal relating to the present position and receiving from the server the data and the service;

display means for displaying based on the data; control means for controlling at least the detection means and the displaying means, and for executing the service; and input means for giving an instruction to the control means, wherein the server includes a memory region for a user to set a grouping-procedure program for executing building or dissolving of the group by judging or executing grouping-conditions data for defining a condition for building or dissolving a group that can store the map data and the additional information, and share targeted materials with another user, and a security-management program for executing access to the targeted materials by judging or executing the level, communication means for sending to the user the map data that relates to a fixed range of the present position by receiving a position signal that relates to the present position of the user and the additional data or the service in response to a status in which the user is, and control means for controlling at least the communication means.

[0008]

Also, according to claim 3, as in claim 1 or claim 2, characterized by automatically building the group using the grouping-procedure program and the security-management program when a plurality of users satisfy the conditions of the grouping-conditions data, displaying the present position of the users other than yourself using the display means of the information-display apparatus of the user, to share targeted material according to the level in the security data.

[0009]

Also, according to claim 4, as in claim 1 or claim 2, wherein the grouping-conditions data or the security data include the condition and the level when executing building or dissolving the group,

using a plurality of existing groups as configuring elements for a new group, or when configuring a new group by randomly combining the user which is a configuring element of the existing group, and when adding a third party to the existing group as a user, or as a configuring element to the existing group.

[0010]

Also, according to claim 5, as in claim 3 or claim 4, wherein the conditions of the grouping-conditions data is content based on a spatial element using the present position of the user and any point, and/or a temporal element based on a present time, a random time difference or limit.

[0011]

Also, according to claim 6, as in claim 3 or claim 4, wherein the level of the security data is content that determines access such as reading/writing restrictions and the like to the targeted material.

[0012]

Also, according to claim 7, as in claim 3 or claim 4, wherein the level of the security data is content that determines access such as reading/writing restrictions and the like to the targeted material that is shared in the group.

[0013]

Also, according to claim 8, as in claim 4 to claim 7, wherein the content of the grouping-conditions data and/or the security data can be set for each user.

[0014]

Also, according to claim 9, as in claim 1 or claim 2, wherein the user-interface feature includes a feature for changing or setting data or a program for customizing the information-display apparatus by selection by the user, an operation method on the server, a data search method, or convenience

of the user interface, and an agent feature such as a procedures program provided to automate an operating means aid for the user by using a suitable method such as a statistical method for data relating to individual information data or the user, an operation log, a search result for the targeted material, or a usage log of the service, or at least a portion of the operation means.

[0015]

With this, it is possible to provide a new information-communication system that easily implements data communications between a plurality of users.

[0016]

[Mode for Carrying Out the Invention]

The present invention will now be described based on an embodiment depicted in appended drawings.

[0017]

Figs. 1 and 2 are a schematic view and a block diagram for describing a constitution of a mobile body, for example an information-display device 100 that is used by being installed on a vehicle. Included are detection means 10 for getting one's present position data that relates to one's present position; data-communication means 20 for communication with a remotely located server (described below); display means 30 for sending one's present position data to the server via the data-communication means 20, receives another person's present position data relating to a specific person's present position for one or more people other than yourself, and map data or a service (described below), and that synthesizes and displays the received data and one's present position data; control means for controlling at least the detection means 10 and the display means 30 and executing the service; and input means 50 for giving an instruction to the control means 40.

Also, 60 denotes audio-output means that is composed of a speaker for reading aloud when the data is audio data.

[0018]

The detection means 10 is a well-known GPS receiver with a main body 11 housed in a trunk, for receiving with an antenna 12 from a GPS satellite 200 outside of the vehicle. This obtains one's present position by measuring the present position, and can be composed by a sensor for obtaining one's present position from the vehicle movement information such as a pulse signal or the like that is generated in response to vehicle's traveling without using signals from the GPS satellite 200. Although it is acceptable to combine a sensor and GPS receiver, it is preferable to use the GPS receiver in consideration of portability.

[0019]

The data-communication means 20 is a portable telephone (for example, a cellular telephone that can be used by a so-called "i-mode" available from IDO Corporation). The data is sent and received by communication with a remotely located server; it is acceptable for an article other than a cellular telephone. For example, a wired telephone or an information-display device such as a personal data communication device is acceptable. However, considering portability, a cellular telephone is preferred. Also, for the electrical communication line, it is acceptable to use a dedicated line, and not a public-telephone line 300. However, considering costs, it is preferable to use the public telephone line 300, and particularly because it is necessary constantly to be connected to the server for communication of position information, it is preferable for packet communication that is charged a usage fee in line with an

amount of the data that is used, and not for a connection time.

[0020]

Display means 30 is composed of a display member 31 that is highly portable such as color liquid-crystal display elements, and a drive circuit 32 to drive that. The display member is disposed at a location in front of a user, such as a driver or the like of the vehicle, and implements a predetermined display using actual or virtual images based on the data.

[0021]

The control means 40, composed of a micro-computer, controls updating one's present position using at least the detection means 10, by implementing a predetermined process according to a predetermined program, or controls display switching or the like on the display means 30, and includes a computing unit 41 that executes the service; a memory unit 42; and an I/O unit 43 for receiving a signal with the input means 50, for example. The memory unit 42 is composed of ROM 42a and RAM 42b, for example. The input unit 43 includes a digital I/O unit 43a for signal control, positioned between the computing unit 43 and the data-communication means 20, and an analog I/O unit 43b for signal control, positioned between the computing unit 41, the input means 50 and the audio-output means 60, and can be composed by being incorporated in the computing unit 41.

[0022]

The ROM 42a and RAM 42b that compose the memory unit 42 in this control means 40 store the data when sending or receiving the data implemented via data-communication means 20, for example, and store data such as image data that corresponds to content displayed on the display member 31 on the display means 30, and audio data or the like that corresponds to

content output from the audio-output means 60.

[0023]

The input means 50 is composed of an operation switch 51 and a microphone 52 disposed near a steering wheel, for example. By the user operating these, the control means 40 intercommunicates with the server via the data-communication means 20 and implements instructions for a preferred display on the display member 31 of the display means 30. Also, the operation switch 51 is composed to send a signal wirelessly, for example, via an infrared ray, to the I/O unit 43 of the control means 40. However, it is acceptable for the configuration to be wired. When it is not necessary to give instructions by audio input, the microphone 52 is unnecessary.

[0024]

Figs. 3 and 4 are schematic views for describing a constitution of an information-communication system that includes the information-display apparatus 100 and data stored therein. Included is a server 400 connected to the public-telephone line 300, for implementing sending and receiving of the data by communication with the information-display apparatus 100. The server 400 includes an individual memory region 411 that can be used by the user or only by a group (described below) that includes the user, and basic memory region 412, prepared in advance by the server 400, that can be used by only the user. These drawings show the user intercommunicating with the server 400 via the public-telephone line by using the information display apparatus 100 that is used by being installed on the mobile body.

[0025]

A first map data 501 that includes only a minimum limit of information called a base map is stored in the basic memory region 412 on the

server 400. A second map data 502 that includes more detailed information than the first map data 501, and additional data 503 that is set by the second map data 502, individual data 504 that is set by the user, and one's present position data 601 that relates to one's present position of the user are stored in the individual memory region 411 on the server 400, to be displayed on the same display member 31 (display means 30) while composing a stage structure depicted in Fig. 5.

[0026]

Further to describe the various data, stored in the various data stored in each memory region 411 and 412 on the server 400 not only are the first map data 501 for display by the information-display apparatus 100 of the user, second map data 502, additional data 503, individual data 504, one's present position data 601, but also schedule-book data 602 of the user, and a data-address book data 603 and the like are stored in the individual-memory region 411. Also, stored in the basic memory region 412 are send-setting data 604 that determines data to send to the user (in other words, it determines content to display on the display means 30); grouping-conditions data 605 such as setting/dissolving the group; keyword data 606 that is used when searching for a user; security data 607 that defines an access level, such as which data stored in the individual-memory region 411 to release when building the group; and a UI data 608, and the like (execution data or execution program for executing the UI feature) relating to a user interface (UI) feature.

[0027]

Also, the user schedule-book data 602 is stored further defined into "day," "week," "month," and "year" and the address-book data 603 can be stored further defined into "home," "company," and "hobbies" or

the like. The data 602 and 603 are "character data" such as personal information of the user, for example, a name, a nickname, an address, home telephone number, cellular telephone number, email address and activity schedule and similar information, "audio data" such as a message registered for the user, "still-image data" such as the user, or family photograph, or a home photo or the like, and "video data" such as a movie captured by the user, or the like, and can be updated at any time by the user operating the input means 50.

[0028]

Also, sending-setting data 604, grouping-conditions data 605, keyword data 606, and the security data 607 and the like are set by the user; the user interface data 608 can be set by being prepared by the server 400 or by being added by the user.

[0029]

By the server 400 receiving a position signal relating to the user's present position, a second map data 502 stored in the individual-memory region 411, that belongs in the first map data 501 stored in the basic memory region 412 that relates to a fixed range of the present position, is sent to the user. Display content of the second map data 502 can be set by the user and/or the server 400. Furthermore, displaying or hiding the second map data 502 in the display means 30 on the information-display apparatus 100 can be set by the user and/or the server. These are controlled by sending-setting data 604 that can be set or changed by the user.

[0030]

The grouping-conditions data 605 defines a condition for building/dissolving a group that can share data between other members; content is based on spatial elements in line with the

user's present position, and/or temporal elements based on a present time. Also, specific usage of the grouping-conditions data 605 will be described below.

[0031]

The keyword data 606 defines a way for searching for a user. For example, by the user setting a word (keyword) such as "vehicle," "ski," "trip," or "Italian cuisine," a third party can search for the user using the keyword; this is helpful when building the group. Furthermore, the keyword data 606 will be described below.

[0032]

The security data 607 defines a release level for user data to another user when building the group. This content determines the type of data to release, and access such as reading/writing restrictions and the like to that data. By setting a different plurality of content, data to be released can be set for each release level. Also, detailed usage of the security data 607 will be described below.

[0033]

In addition to each memory region 411, and 412, the server 400 includes communication means (not shown in the drawing) for sending the data or the service to the user by implementing communication via the user's information-display apparatus 100 and public telephone line 300, and control means 420 for controlling access at least to the memory means 411, and 412 and the communication means.

[0034]

Next, a specific usage example of the information-communication system will be described based on Figs. 5 - 8. Refer to Figs. 1 - 4 for portions not shown in Figs. 5 - 8.

[0035]

For example, as shown in Fig. 5, four users a - d each possess information-display apparatuses 100a - 100d (these are the same as the information-display apparatus 100 depicted in Figs. 1 and 2; the same applies below.) Each user a - d finds their own present position data 601 relating to their own present position using detection means 10 in the information-display apparatuses 100a - 100d that each is using, implements communication with servers 400a - 400d (these are the same as the server 400 depicted in Fig. 3; the same applies below) via the public-telephone line 300 using data communication means 20, and stores that in individual-memory regions 411a - 411d as statuses of the users a - d. The control means 40 controls one's present position data 601 so that it is automatically updated (uploaded) at a predetermined timing.

[0036]

The user a (and other users b - d) operates the input means 50 at any point in time to load (download) to the memory unit 42 of their own information-display apparatus 100a from the individual-memory region 411 and basic memory region 412 by communicating (accessing) with the server 400a via the public-telephone line 300 using the data communication means 20. For example, when the server 400a stores one's present position data 601 that corresponds to one's present position for the status of the user a, the server 400a selects the one that corresponds to the status from each data stored in each memory region 411a, 412a according to the status of user a. In other words, this is updated and outputted. Also, the basic memory region 412a (basic memory regions 412b - 412d) is the same as the basic memory region 412 depicted in Fig. 3.

[0037]

Each of the downloaded data is displayed by being overlapped in

the display member 31 in the display means 30. When doing so, obviously, steps are implemented so that inconsistencies are not generated when these data 501 - 504 compose one screen. For example, this displays by overlapping based on geographical information (latitude and longitude). With this, information of one's present position 601 or the like is displayed using a map A (based on the first and the second map data 501, 502) as a background, as shown in Fig. 6, for example. However, at this point or before, in the same way as the user a customizing the display design of the display member 31 to a personal computer screen of their own liking, this can be freely set. For this setting, a preferred UI can be copied to the memory unit 42 from UI data 608 registered in the basic memory region 412a by the server 400a administrator. Included in this UI are icons that can be given predetermined meanings, such as an icon B (based on one's present position data 601) that shows your own present position, icon C (described below) that shows another person's present position, icon D that shows your own home, icon E that shows another person's home, icon F that shows a location to implement automatic reception of your own email, icon G (based on schedule-book data 602) that is used when displaying an activity schedule, an icon H (based on address-book data 603) that is used when displaying a contact.

[0038]

However, the user a positional relationship and the like can be known at a glance using the UI upon which appears icons B - H on map A. By operating the cursor I that appears on the display member 31 using the input means 50 and selecting (clicking) a predetermined icon, it is possible to implement predetermined work.

[0039]

For example, by selecting the icon E using the cursor I, telephone numbers for other people are displayed; by selecting from them the desired telephone number, a telephone call can automatically be placed. In other words, by sending to the server 400a one's present position data 601 of the user a found using the detection means 10, it is possible to execute an instruction for the information-display apparatus 100 to place a telephone call by receiving a telephone number registered as the E icon, for example, as data relating to one's present position data 601 from the server 400a, and to execute a service that corresponds to map data 501, 502.

[0040]

Also, at the point the icon F is arranged partway on your own scheduled route of travel and icon B matches icon F, automatically communication will be implemented with the server 400a or an Internet service provider 700 (see Fig. 3) to receive your own email, and to execute a service that corresponds to map data 501, 502.

[0041]

For example, it is possible to use this to check email every morning during a commute to work; it is convenient to automate regular daily activities. In other words, by sending to the server 400a as a status of the user a, one's present position data 601 of the user a found using the detection means 10, it is possible to receive email as data relating one's present position data 601 from the server 400a. Such a setting is stored in the basic memory region 412a as sending setting data 604.

[0042]

Next, to describe a display of the additional data 503, by the server 400a receiving a position signal relating to the present position of the user a, map data 501, 502 relating to a fixed region of the

present position is sent to the user a, and that is displayed overlapping the map data 501, 502 on the display member 31 of the information-display apparatus 100 possessed by the user a (see Fig. 7(a)). The status that is a timing for the server 400a to send an announcement to the user a is when a distance between the present position B of user a and a setting point X of the second map data 502 that relates to additional data 503 has reached within a fixed distance, for example, when the distance between the present position B and the setting point X is 10 meters or less, the server 400a will send to the user a an announcement Y that prompts the user to view additional data 503 (see Fig. 7(b)), and in the event that the user answers back accepting the announcement Y, the server 400a will provide (send) to the user a additional data 503 that corresponds to the map data 501, 502. (See Fig. 7(c)) At that time, it is acceptable either to view or to hide individual data 504. Such a setting is stored in the basic memory region 412a as sending-setting data 604.

[0043]

Also, after the user a accept reception to the additional data 503, it is acceptable to set not to receive the announcement Y relating to the additional data 503 from the server 400a or to set to resend the announcement when the user a is in the status again. The user a can make the setting using the server 400a. Such a setting is stored in the basic memory region 412a as sending-setting data 604.

[0044]

In this way, it is possible to display the additional data 503 according to the status of the user a by overlapping the various data, thereby making it possible to provide a new information-display system that is socioeconomically preferable, without inviting a

larger information-display apparatus 100a or higher costs and without constantly providing various data for the server 400a that sends that data.

[0045]

In the event that the setting point X set in the second map data 502 is set to hide for the information-display apparatus 100a, the user a will not be able to know of an existence of a point that displays the additional data 503. However, in such a case, when the distance between the present position B of user a and the setting point X (hidden) of the second map data 502 that relates to the additional data 503 is 10 meters or less, it is possible to display as described below if the server 400a sends to the user a an announcement Y prompting the user to view the additional data 503. In such a case, the user a will suddenly receive the announcement Y, implementing a new information-display system by including sending and receiving various data that is unpredictable like a game. Such a setting is stored in the basic memory region 412a as sending-setting data 604.

[0046]

With this embodiment, one's present position data 601 is used as a status of user a. However, it is also acceptable to use time data (a date, a day of the week, a time, and a usage time of the information-display apparatus 100a or similar data) as the status. The server 400a selects that which corresponds to the status from the second map data 502 stored by the basic memory region 412a in response to the time data, in other words, it is updated and outputted. For example, the content of the second map data 502 that corresponds to the time automatically is changed to either of the selected data preset by the server 400a, such as "restaurant data," "leisure facility data," or "hotel facility data" or the like.

Conversely, depending on the desire of the user a, it is acceptable to switch these with the display means 30 on the information-display apparatus 100 by changing at will, by selecting the selected data. In such a case, it can go without saying that the additional data 503 is also changed in line with the switching of the second map data 502. Such a setting is stored in the basic memory region 412a as sending-setting data 604.

[0047]

The additional data 503 is not limited to character information such as that depicted in Fig. 7(c). It is acceptable to use audio information or to be a virtual world or game-like or the like, continuing on from the setting point X. It is also acceptable for the content displayed on the display means 30 of the information-display apparatus 100 to be completely different content, using the display point X as a check point. Such a setting is stored in the basic memory region 412a as sending-setting data 604.

[0048]

With this embodiment, a constitution was described for setting display possibility of the additional data 503 to the second map data 502 as the setting point X to indicate to the user a. However, it is acceptable to have a constitution that sets the first and the second map data 501, and 502 as one map data. Such a setting is stored in the basic memory region 412a as sending-setting data 604.

[0049]

Next, building and dissolving the group will now be described.

[0050]

User a sets and stores in advance in the basic memory region 412a at their own server 400a the grouping conditions data 605 and the

security data 607. This also applies to other users b - d. These grouping-conditions data 605 and security data 607 can be set for each of the users a - d. However, the users a - d set as a condition for the grouping-conditions data 605 "set a group when I am in a range of 10 kilometers or less in diameter (a spatial element) from my present position and when it is between 9:00 AM and 5:00 PM Monday to Friday (a temporal element) are satisfied," or "build a group when I am within 20 kilometers or less in diameter from a specific point on the map or I am in a range of 20 meters or less (a spatial element) of a specific National Route or along a National Route, and between January 1 and the 31st (a temporal element), and as the security data 607 level, to "configure a group by releasing to a third party second map data 502, additional data 503, one's present position data 601 and UI data 608 (all called "targeted material")" and when users a - d are set with the same content (see the shaded portions of individual memory region 411a in Fig. 3), for the user a, when user b satisfies these conditions (user b also has the same settings, so for user b, user a satisfies the conditions, omitted from the explanation below), the display member 31 (display means 30) of user a's information-display apparatus 100a implements a display like that depicted in Fig. 8. In the same drawing, symbol Ba denotes an icon that indicates the user a's present position. Symbol Cb denotes an icon that indicates user b's present position. Also, symbols Cc and Cd denote icons that indicate the user c and d's present position, but at the present point, users c and d do not satisfy the conditions, so the icons Cc and Cd are not displayed.

[0051]

In this way, if the relationship of yourself (user a) and a third user (user b) satisfy the conditions, the servers 400a and 400b will

automatically build a group composed of users a and b. While the conditions are being satisfied, mutual targeted materials are shared and displayed according to the level of the security data 607. With this, it is possible to know your mutual positional relationship, and to share data and user interface features, and it is possible to communicate using this and to share the usability. Also, it is possible to set the content of the grouping-conditions data 605 to maintain a group that was built even when conditions are not being met. In such a case, this is dissolved according to the user a's intention (operation of the input means 50).

{0052}

Also, when the content of the conditions of the grouping-conditions data 605 are different between users a and b, a group is built using the content of each, so the group becomes a one-way, biased one.

{0053}

Also, in the event that one user, for example, user a sets a plurality of content is set as a condition for the grouping-conditions data 605, it is possible simultaneously to build a plurality of groups such as a group for users a and b and a group for users a and c in a range that satisfies these content, for example.

{0054}

Still further, when users a and b build a group and users c and d build another group, it is possible to rebuild these two groups into one group depending on the intention of users a - d and the content of the conditions in the grouping-conditions data 605. Conversely, when users a - d build a group, it is possible to rebuild a new group composed of users b and c without dissolving that group, for example, according to the intention of users a - d, or

according to the content of the conditions in the grouping-conditions data 605.

{0055}

Also, by clicking user b icon Cb with the cursor's icon I, a menu such as one to answer a telephone call to the user b or to send an email is displayed (not shown in the drawing), and it is possible to set to be able to execute a predetermined service. This kind of control is one type of service that corresponds to the map data 501, and 502, and can be set using a program in the control means 40 of the information-display apparatus 100.

{0056}

To build the group, the grouping-conditions data 605 was used. However, it is possible to build a group for example, by user a specifying a specific keyword using a search feature of the server 400a and checking at each of the servers 400b - 400d, keyword data 606 stored in basic memory regions 412a - 412d on each server 400b - 400d thereby building the group by picking up users that apply. However, in such a case, a condition is that users that are picked up by matching the keyword do not reject forming a group. This depends on the content of the level of the security data 607 when sharing the targeted materials.

{0057}

Conversely, in addition to the grouping-conditions data 605 that stores the map data and the additional data for the conditions, and defines the conditions for building or dissolving a group that can share the targeted materials with other users, it is possible to set using a grouping-procedure program that executes building or dissolving of the group by judging and executing the conditions. Also, in addition to the security data 607 that defines the level of access for the level to the

targeted materials of other users when building the group, it is possible to set using a security management program that executes access to the targeted materials by judging and accessing the level.

[0058]

Also a display format on the display means 30 when implementing these, or HTML (Hyper Text Markup Language) that is used for the Internet today, as various data that is used, can be used or XML (Extensible Markup Language) or the like that is a structured document using a markup language that codes dictionary data used by meta data, numerical data, graphic data, video data, audio and sound data, audio read-aloud or voice-recognition programs or the like.

[0059]

Also, users a - d do not need to prepare individual servers 400a - 400d. It is acceptable to have one basic memory region 412 managed by at least one server 400, and individual memory regions 411a - 411d that store individual data of each user a - d. Obviously, it is acceptable to have one communication means and control means 420.

[0060]

Also, the UI feature changes and sets operating methods or data searching methods of the information-display apparatus 100 or server 400 according to a selection by the user, or data or programs for customizing the convenience of the UI, or can include an agent feature such as an aid for operating means of the user by using a suitable method such as a statistical method or the like for data relating to individual information data or an operating log of the user, search results for the targeted materials, or a usage log of the service, or a procedural program provide for automating a portion of the operating means.

[0061]

[Effect of the Invention]

The present invention provides a new information-communication system that easily implements data communication between a plurality of users, and provides an information-communication system that can share targeted materials at a set level by the plurality of users building or dissolving a group when set conditions are satisfied, and that is extremely highly convenient.

[Brief Description of the Drawings]

Fig. 1 is a schematic view of an information-display apparatus pursuant to an embodiment of the present invention;

Fig. 2 is a block diagram of the same;

Fig. 3 is a schematic view for describing the embodiment of the information-display apparatus pursuant to the present invention;

Fig. 4 is a perspective view for describing data pursuant to the same;

Fig. 5 is a schematic view for describing a group pursuant to the same;

Fig. 6 is a view for describing a display pursuant to the same;

Fig. 7 is a view for describing a display pursuant to the same; and

Fig. 8 is a view for describing a display pursuant to the same.

[Explanation of Letters or Numerals]

100 (100a - 100d) Information-display apparatus

10 Detection means

20 Data communication means

30 Display means

31 Display member

40 Control means

41 Computing unit

42 Memory unit	503 Additional data
50 Input means	504 Individual data
200 GPS satellite	601 One's present position data
300 Public telephone line (electrical communication line)	602 Schedule-book data
400 (400a - 400d) Server	603 Data address-book data
411 (411a - 411d) Individual memory region	604 Sending-setting data
412 (412a - 4121d) Basic memory region	605 Grouping-conditions data
501 First map data	606 Keyword data
502 Second map data	607 Security data
	608 User interface

Fig. 1

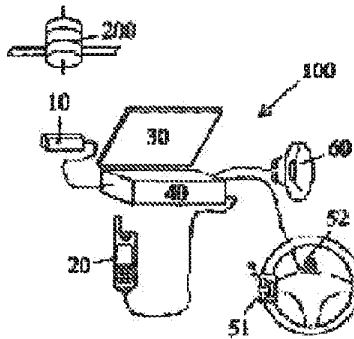

Fig. 2

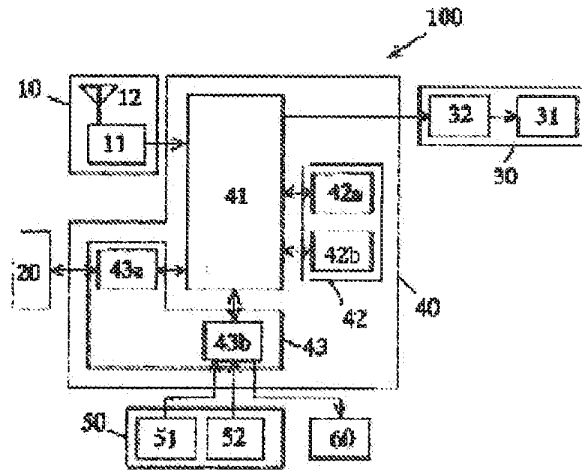

Fig. 6

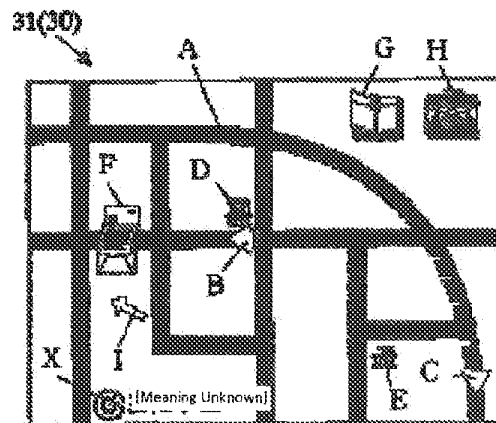

Fig. 3

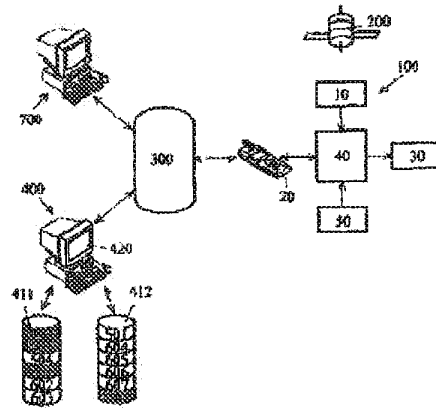

Fig. 4

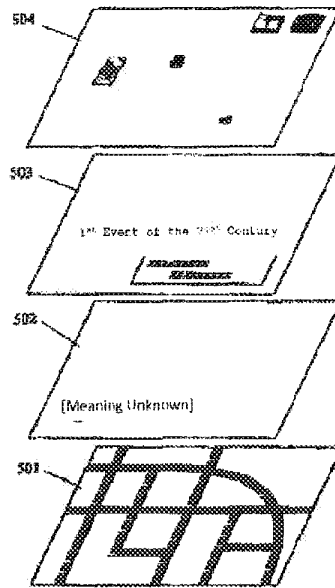

Fig. 5

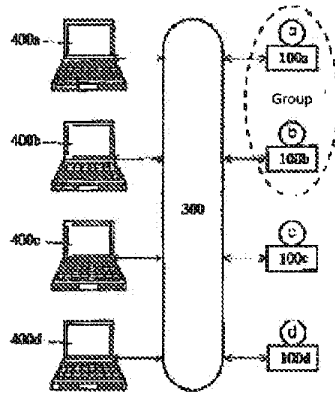

Fig. 3

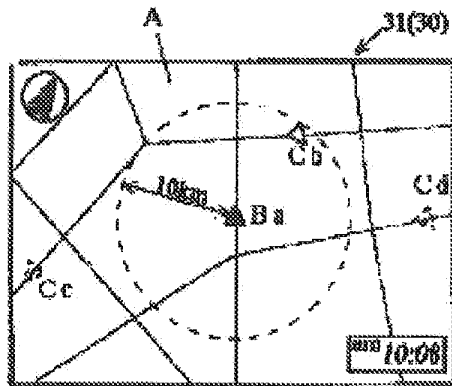
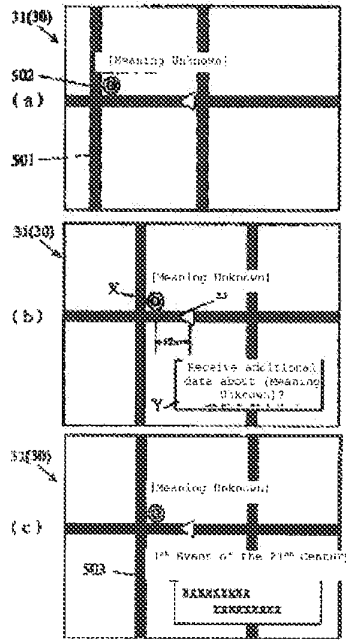

Fig. 7



Continued from front page

(51) Int.Cl.	Identification Symbol	FI	SI2	(Reference)
G 06 F 17/60	B ¹²	G 06 F 17/60	510C	
	510	13/00	330D	
	330	15/00	110G	
	110	17/30	170C	
	170		340A	
	340			
G 09 B 29/00		G 09 B 29/00	A	
		29/10	A	

F Term (Reference) 20032 BB05 BB08 BB22 BB25 BC08
 BC16 BC23 BC27 BC21 BB03
 50075 KK07 KK13 KK33 KK37 KK43
 KK54 KK63 ND03 ND06 ND20
 ND22 ND23 ND35 PQ02 QL13
 PQ09 PR03 PR10 PU14
 50085 3007

(19) 日本特許庁 (J P)

(12) 公開特許公報 (A)

(11) 特許出願公開番号
特開2002-245336
(P2002-245336A)

(43) 公開日 平成14年8月30日 (2002. 8. 30)

(51) Int.Cl. ⁷	識別記号	F I	7-コード ⁸ (参考)
G 0 6 F 17/60	3 2 6	G 0 6 F 17/60	3 2 6 2 C 0 3 2
	Z E C		Z E C 5 B 0 7 5
	3 0 2		3 0 2 E 5 B 0 8 5
	3 3 6		3 3 6
	5 0 6		5 0 6

審査請求 未請求 請求項の数 9 O L (全 11 頁) 最終頁に続く

(21) 出願番号 特願2001-41268(P2001-41268)

(22) 出願日 平成13年2月19日 (2001. 2. 19)

(71) 出願人 000231512

日本精機株式会社
新潟県長岡市東葉土2丁目2番34号

(72) 発明者 藤田 一彦

新潟県長岡市藤巻1丁目190番地1 日本
精機株式会社オールアンドデイセンター内

(72) 発明者 羽藤 勝博

新潟県長岡市藤巻1丁目190番地1 日本
精機株式会社オールアンドデイセンター内

(72) 発明者 江尻 剛十

新潟県長岡市藤巻1丁目190番地1 日本
精機株式会社オールアンドデイセンター内

最終頁に続く

(54) 【発明の名称】 情報通信システム

(57) 【要約】

【課題】 複数の利用者間におけるデータ通信を容易に行うことのできる新規な情報通信システムを提供する。

【解決手段】 情報通信システムは、利用者の現在位置に関する位置信号をサーバ400が受信することにより前記現在位置の一定範囲内に関する地図データ501、502及びこの地図データ501、502に含まれる付加データ503やサービス等の対象物を前記利用者へ送信し、前記利用者が有する情報表示装置100の表示手段30において地図データ501、502及び付加データ503を表示すると共に前記サービスを実行可能とする。他の利用者との間で前記対象物を共有することのできるグループを構築/解消する条件を定めるグループ化条件データ605と、前記グループを構築した際に前記他の利用者の前記対象物へのアクセスのレベルを定めるセキュリティデータ607とを前記利用者が設定するための記憶領域412を有する。

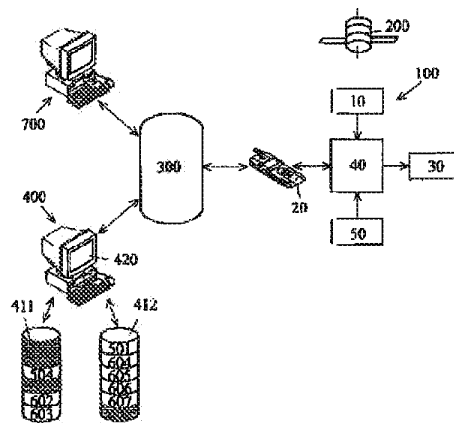

【特許請求の範囲】

【請求項1】 利用者の現在位置に関する位置信号をサーバが受信することにより前記現在位置の一定範囲内に関する地図データ、及び、この地図データに含まれる付加データやサービスを前記利用者へ送信し、前記利用者が有する情報表示装置の表示手段で前記地図データ、及び、前記付加データを表示すると共に前記サービスを実行可能とする情報通信システムであって、他の利用者との間で前記付加データや前記サービス、あるいは、ユーザインターフェース機能を実行するための実行データや実行プログラム等の対象物を共有することのできるグループを構築/解消する条件を定めるグループ化条件データ、又は、前記条件を判断や実行することにより前記グループの構築/解消を実行するグループ化手続きプログラムと、前記グループを構築した際に前記他の利用者の前記対象物へのアクセスのレベルを定めるセキュリティデータ、又は、前記レベルを判断や実行することにより前記対象物へのアクセスを実行させるセキュリティ管理プログラムと、を前記利用者が設定するための記憶領域を有することを特徴とする情報通信システム。

【請求項2】 地図データとこの地図データに含まれる付加データやサービス、あるいは、ユーザインターフェース機能を実行するためのデータやプログラム等の対象物を格納すると共に利用者と交信するサーバと、前記利用者が保持しながら前記サーバと交信することにより前記サーバから前記各データや前記プログラムを受信して表示すると共に前記サービスを実行可能とする情報表示装置と、から成り、この情報表示装置は、前記利用者の現在位置を求める検出手段と、前記現在位置に関する位置信号を前記サーバへ送信すると共に前記サーバから前記データ及び前記サービスを受信する通信手段と、前記データに基づいて表示を行う表示手段と、少なくとも前記検出手段及び前記表示手段を制御すると共に前記サービスを実行可能とする制御手段と、前記制御手段へ指示を与える入力手段と、を有し、前記サーバは、前記地図データや前記付加データを格納すると共に他の利用者との間で前記対象物を共有することのできるグループを構築/解消する条件を定めるグループ化条件データ、又は、前記条件を判断や実行することにより前記グループの構築/解消を実行するグループ化手続きプログラムと、前記グループを構築した際に前記他の利用者の前記対象物へのアクセスのレベルを定めるセキュリティデータ、又は、前記レベルを判断や実行することにより前記対象物へのアクセスを実行させるセキュリティ管理プログラムと、を前記利用者が設定するための記憶領域と、前記利用者の前記現在位置に関する位置信号を受信することにより前記現在位置の一定範囲内に関する前記地図データを送信し及び前記利用者の状況に応じて前記付加データや前記サービスを前記利用者へ送信する送信手段と、少なくとも前記送信手段を制御する制御手段と、を

有することを特徴とする情報通信システム。

【請求項3】 複数の前記利用者が前記グループ化条件データの前提条件を満たす場合に、又は、前記グループ化手続きプログラム及び前記セキュリティ管理プログラムにより自動的に前記グループを構築し、前記利用者の前記情報表示装置の前記表示手段で自己以外の前記利用者の前記現在位置を表示し、前記セキュリティデータの前提レベルに従い前記対象物を共有することを特徴とする請求項1又は請求項2に記載の情報通信システム。

【請求項4】 前記グループ化条件データ、又は、前記セキュリティデータは、前記グループの構築/解除を実行する際に、複数の既存グループを新規のグループ構成要素とする場合や、既存グループの構成要素である前記利用者の任意の組み合わせにより新規グループを構成する場合や、既存グループへ第三者を前記利用者として前記既存グループへ構成要素として加える場合の前記条件及び前記レベルを有すること特徴とする請求項1又は請求項2に記載の情報通信システム。

【請求項5】 前記グループ化条件データの前提条件は、前記利用者の現在位置や任意の地点を基準とした空間的要素、及び/又は、現在時刻や任意の時間間隔や期限を基準とした時間的要素に基づく内容であることを特徴とする請求項3又は請求項4に記載の情報通信システム。

【請求項6】 前記セキュリティデータの前提レベルは、前記対象物に対する読み/書き制限等のアクセスを決める内容であることを特徴とする請求項3又は請求項4に記載の情報通信システム。

【請求項7】 前記セキュリティデータの前提レベルは、前記グループ内で共有する前記対象物に対する読み/書き制限等のアクセスを決める内容であることを特徴とする請求項3又は請求項4に記載の情報通信システム。

【請求項8】 前記グループ化条件データ、及び/又は、前記セキュリティデータの内容は、前記利用者毎に設定可能であることを特徴とする請求項4から請求項7の何れかに記載の情報通信システム。

【請求項9】 前記ユーザインターフェース機能は、前記利用者の選択により前記情報表示装置、又は、前記サーバにおける操作方法やデータ検索方法やユーザインターフェースの使い勝手をカスタマイズするためのデータやプログラムを変更/設定できる機能、又は、前記利用者の個人情報データや操作履歴や前記対象物の検索結果や前記サービスの利用履歴等に関するデータを統計的な手法等の適宜手法を用いて前記利用者の操作手段の補助や少なくとも一部の前記操作手段の自動化のために供される手続きプログラム等のエージェント機能を有することを特徴とする請求項1又は請求項2に記載の情報通信システム。

【発明の詳細な説明】

【0001】

【発明の属する技術分野】本発明は、移動体と帯同して各種データの送受信を行う新規な情報通信システムに関する。

【0002】

【従来の技術】携帯電話やPHS（以下、これらを携帯式電話と称する）やモデム内蔵の所謂ノート・ブック型パソコン、Palm機等（以下、これらをパーソナルデータ通信機器と称する）と言ったデータ伝送手段たる情報表示装置を個人が所持して、電気通信回線を介することで使用場所を選ばない通信が急速に普及しており、時と場所に限定されることなく他者と気軽にコミュニケーションを取れる環境が整備されつつある。このような移動体と帯同して各種データの送受信を行う情報表示装置を介する前記通信の中心は、現在の処、音声情報や文字情報であるが、やがては静止画像情報や動画情報の割合が増加し、データ量全体としても飛躍的に増加するものと思われる。

【0003】また、特開平10-13961号公報には、前記情報表示装置を用いて各種情報を保持提供する情報センタと通信することにより、前記移動体の現在位置を示す地図情報だけでなく、前記移動体の位置に関連するデータ又はサービス等の対象物を提供することにより、ユーザの多様なニーズに応じられるようにする移動通信システムが開示されている。

【0004】

【発明が解決しようとする課題】ところで、前記情報表示装置の利用は、前記利用者と前記サーバとの間の通信が目的であり、その利用形態は限定されたものとなる嫌があった。

【0005】この発明は、前記利用者が携帯あるいは前記利用者が運転する車両に搭載される等の移動体と帯同して前記対象物の送受信を行う新規な情報通信システムを提供し、その目的とするところは、複数の前記利用者間における通信、更に前記グループを構成する前記利用者間における前記対象物の共有と同期通信を容易に行うことのできる新規な情報通信システムを提供することにある。

【0006】

【課題を解決するための手段】前記課題を解決するため、本発明の情報通信システムは、請求項1に記載の通り、利用者の現在位置に関する位置信号をサーバが受信することにより前記現在位置の一定範囲内に関する地図データ、及び、この地図データに含まれる付加データやサービスを前記利用者へ送信し、前記利用者が有する情報表示装置の表示手段で前記地図データ、及び、前記付加データを表示すると共に前記サービスを実行可能とする情報通信システムであって、他の利用者との間で前記付加データや前記サービス、あるいは、ユーザインターフェース機能を実行するための実行データや実行プログ

ラム等の対象物を共有することのできるグループを構築／解消する条件を定めるグループ化条件データ、又は、前記条件を判断や実行することにより前記グループの構築／解消を実行するグループ化手続きプログラムと、前記グループを構築した際に前記他の利用者の前記対象物へのアクセスのレベルを定めるセキュリティデータ、又は、前記レベルを判断や実行することにより前記対象物へのアクセスを実行させるセキュリティ管理プログラムと、を前記利用者が設定するための記憶領域を有することを特徴とする。

【0007】また、請求項2に記載の通り、地図データとこの地図データに含まれる付加データやサービス、あるいは、ユーザインターフェース機能を実行するためのデータやプログラム等の対象物を格納すると共に利用者と通信するサーバと、前記利用者が保持しながら前記サーバと通信することにより前記サーバから前記各データや前記プログラムを受信して表示すると共に前記サービスを実行可能とする情報表示装置と、から成り、この情報表示装置は、前記利用者の現在位置を求める検出手段と、前記現在位置に関する位置信号を前記サーバへ送信すると共に前記サーバから前記データ及び前記サービスを受信する通信手段と、前記データに基づいて表示を行う表示手段と、少なくとも前記検出手段及び前記表示手段を制御すると共に前記サービスを実行可能とする制御手段と、前記制御手段へ指示を与える入力手段と、を有し、前記サーバは、前記地図データや前記付加データを格納すると共に他の利用者との間で前記対象物を共有することのできるグループを構築／解消する条件を定めるグループ化条件データ、又は、前記条件を判断や実行することにより前記グループの構築／解消を実行するグループ化手続きプログラムと、前記グループを構築した際に前記他の利用者の前記対象物へのアクセスのレベルを定めるセキュリティデータ、又は、前記レベルを判断や実行することにより前記対象物へのアクセスを実行させるセキュリティ管理プログラムと、を前記利用者が設定するための記憶領域と、前記利用者の前記現在位置に関する位置信号を受信することにより前記現在位置の一定範囲内に関する前記地図データを送信し及び前記利用者の状況に応じて前記付加データや前記サービスを前記利用者へ送信する通信手段と、少なくとも前記通信手段を制御する制御手段と、を有することを特徴とする。

【0008】また、請求項1又は請求項2において請求項3に記載の通り、複数の前記利用者が前記グループ化条件データの前記条件を満たす場合に、又は、前記グループ化手続きプログラム及び前記セキュリティ管理プログラムにより自動的に前記グループを構築し、前記利用者の前記情報表示装置の前記表示手段で自己以外の前記利用者の前記現在位置を表示し、前記セキュリティデータの前記レベルに従い前記対象物を共有することを特徴とする。

【0009】また、請求項1又は請求項2において請求項4に記載の通り、前記グループ化条件データ、又は、前記セキュリティデータは、前記グループの構成/解除を実行する際に、複数の既存グループを新規のグループ構成要素とする場合や、既存グループの構成要素である前記利用者の任意の組み合わせにより新規グループを構成する場合や、既存グループへ第三者を前記利用者として前記既存グループへ構成要素として加える場合の前記条件及び前記レベルを有することを特徴とする。

【0010】また、請求項3又は請求項4において請求項5に記載の通り、前記グループ化条件データの前記条件は、前記利用者の現在位置や任意の地点を基準とした空間的要素、及び/又は、現在時刻や任意の時間間隔や期限を基準とした時間的要素に基づく内容であることを特徴とする。

【0011】また、請求項3又は請求項4において請求項6に記載の通り、前記セキュリティデータの前記レベルは、前記対象物に対する読み/書き制限等のアクセスを決める内容であることを特徴とする。

【0012】また、請求項3又は請求項4において請求項7に記載の通り、前記セキュリティデータの前記レベルは、前記グループ内で共有する前記対象物に対する読み/書き制限等のアクセスを決める内容であることを特徴とする。

【0013】また、請求項4から請求項7において請求項8に記載の通り、前記グループ化条件データ、及び/又は、前記セキュリティデータの内容は、前記利用者毎に設定可能であることを特徴とする。

【0014】また、請求項1又は請求項2において請求項9に記載の通り、前記ユーザインターフェース機能は、前記利用者の選択により前記情報表示装置、又は、前記サーバにおける操作方法やデータ検索方法やユーザインターフェースの使い勝手をカスタマイズするためのデータやプログラムを変更/設定できる機能、又は、前記利用者の個人情報データや操作履歴や前記対象物の検索結果や前記サービスの利用履歴等に関するデータを統計的な手法等の適宜手法を用いて前記利用者の操作手段の補助や少なくとも一部の前記操作手段の自動化のために供される手続きプログラム等のエージェント機能を有することを特徴とする。

【0015】これにより、複数の利用者間におけるデータ通信を容易に行うことのできる新規な情報通信システムを提供することができる。

【0016】

【発明の実施の形態】本発明を、添付図面に示した実施の形態に基づき説明する。

【0017】図1、図2は、移動体、例えば、車両に搭載して使用する情報表示装置100の構成を説明する概略図、ブロック図であり、自己の現在位置に関する自己現在位置データを求める検出手段10と、離れた場所

あるサーバ(後述する)と通信するデータ通信手段20と、このデータ通信手段20を介して前記自己現在位置データを前記サーバへ送信及び前記自己以外の一人以上の特定の人物の現在位置に関する他者現在位置データ及び地図データあるいはサービス(後述する)を受信してこれら受信したデータと前記自己現在位置データとを合成して表示可能な表示手段30と、少なくとも検出手段10及び表示手段30を制御すると共に前記サービスを実行可能とする制御手段40と、制御手段40へ指示を与える入力手段50と、を有している。なお、60は、前記データが音声データである場合に読み上げるスピーカから成る音声出力手段であり、専用に用意しても良いし、カーオーディオのスピーカ等と兼用することもできる。

【0018】検出手段10は、例えば、本体11はトラックルームに収納されて、車外に望むアンテナ12でGPS衛星200からの緯度、経度、高度等の位置信号を受信する周知なGPSレシーバであり、自己の現在位置を測定して自己現在位置データを求めるもので、GPS衛星200からの信号を利用しないで前記車両の走行に応じて発生するパルス信号等の前記車両移動情報から前記自己現在位置データを求めるためのセンサで構成することも可能であり、また、前記センサと前記GPSレシーバとを組み合わせても良いが、携帯性を考慮すると前記GPSレシーバを用いることが望ましい。

【0019】データ通信手段20は、電気通信回線、例えば、公衆電話回線300に接続し各種のデータを無線によるパケット通信で送受信可能な携帯式電話(例えば、日本移動通信株式会社の所謂「iモード」が利用可能な携帯電話)であり、離れた場所にある前記サーバと通信することにより、前記データを送受信するもので、携帯式電話以外であっても良く、例えば、有線の電話や前記パーソナルデータ通信機器のような前記情報表示装置であっても良いが、携帯性を考慮すると、前記携帯式電話が望ましい。また、前記電気通信回線としては、公衆電話回線300ではなく専用の回線を利用することも可能であるが、コストを考慮すると、公衆電話回線300を利用することが望ましく、特に、位置情報を送信するために前記サーバと常時接続する必要があることから、接続時間ではなく利用する前記データの量に応じて利用料金が課金されるパケット通信が望ましい。

【0020】表示手段30は、例えば、カラー液晶表示素子のような携帯性に優れた表示部材31と、これを駆動する駆動回路32とからなり、表示部材は、前記車両の運転者等である利用者の前方個所に設置されて前記データに基づく所定の表示を、実像又は虚像により行う。

【0021】制御手段40は、例えば、マイクロコンピュータから成り所定のプログラムに従い所定の処理、少なくとも検出手段10による前記自己現在位置データの更新制御あるいは表示手段30における表示切替等を制

御すると共に前記サービスを実行可能とする演算部41と、記憶部42と、入力手段50との間で信号の授受を行う入出力部43とを有し、記憶部42は、例えば、ROM42aやRAM42bから成り、入出力部43は、演算部41とデータ通信手段20との間に位置して信号制御するデジタル入出力部43aと、演算部41と入力手段50及び音声出力手段60との間に位置して信号制御するアナログ入出力部43bとを有し、この入出力部43は、演算部41の内部に取り込んで構成することも可能である。

【0022】この制御手段40の記憶部42を構成するROM42aやRAM42bは、例えば、データ通信手段20を介して行われる前記データの送受信時における前記データの保管や表示手段30の表示部材31で表示する内容に応じた画像データや音声出力手段60から出力する内容に応じた音声データ等のデータを保管する。

【0023】入力手段50は、例えば、ハンドルの近傍に設置される操作スイッチ51やマイク52から成り、前記利用者の操作により、制御手段40がデータ通信手段20を介して前記サーバと通信したり、表示手段30の表示部材31における表示を所望のものとするための指示を行う。なお、操作スイッチ51は、制御手段40の入出力部43に対して無線、例えば、赤外線により信号を送る構成となっているが、有線であっても構わないし、音声入力による前記指示を必要としない場合、マイク52は不要である。

【0024】図3、図4は、情報表示装置100を含む情報通信システムの構成及びそこに格納されるデータを説明する概略図であり、公衆電話回線300に接続され、情報表示装置100との間で通信することにより前記データの送受信を行うサーバ400を有し、このサーバ400には、前記利用者又はこの利用者を含むグループ(後述する)だけが利用可能な個別記憶領域411と、サーバ400側が予め用意して前記利用者のみ利用可能な基本記憶領域412とを有し、前記利用者は、移動体に搭載して利用する情報表示装置100を使用することで公衆電話回線300を介してサーバ400と通信する場合を示している。

【0025】サーバ400の基本記憶領域412には、白地図と呼ばれる最小限度の情報のみを有する第1の地図データ501が格納されており、サーバ400の個別記憶領域411には、第1の地図データ501よりは詳しい情報を有する第2の地図データ502及び第2の地図データ502に設定されている付加データ503、及び、前記利用者が設定した個人データ504、更に、前記利用者の自己の現在位置に関する自己現在位置データ601が、図5で示す階層構造を構成しながら同一の表示部材31(表示手段30)で表示されるように格納されている。

【0026】各種データについて更に説明すると、サー

バ400の各記憶領域411、412に格納されるこれら各種データには、前記利用者の情報表示装置100での表示に供される第1の地図データ501、第2の地図データ502、付加データ503、個人データ504、自己現在位置データ601だけでなく、例えば個別記憶領域411には、前記利用者のスケジュール帳データ602、データアドレス帳データ603等が格納されており、また、基本記憶領域412には、前記利用者へ送信するデータを定める(すなわち、表示手段30で表示される内容を定める)送信設定データ604、前記グループの設定/解除等のグループ化条件データ605、前記利用者を検索する際に利用されるキーワードデータ606、前記グループを構築する際に個別記憶領域411に格納されているどのデータを公開するかといったアクセスのレベルを定めるセキュリティデータ607、ユーザーインターフェース(UI)機能に関するUIデータ(UI機能を実行するための実行データや実行プログラム)608等が格納されている。

【0027】なお、前記利用者のスケジュール帳データ602は「当日」「週間」「月間」「年間」のように細分化して格納されたり、また、アドレス帳データ603も「家族」「会社」「趣味」等のように細分化して格納されても良く、これらのデータ602、603は、前記利用者の個人情報、例えば、名前、愛称、住所、自宅電話番号、携帯電話番号、電子メールアドレス、行動予定等の「文字データ」、前記利用者の登録したメッセージ等の「音声データ」、前記利用者や家族の写真、自宅の写真等の「静止画像データ」、前記利用者が撮影したムービー等の「動画データ」といったもので、前記利用者が入力手段50を操作することにより随時更新される。

【0028】また、送信設定データ604、グループ化条件データ605、キーワードデータ606、セキュリティデータ607等は前記利用者が設定するもので、ユーザーインターフェースデータ608はサーバ400が用意または前記利用者による追加により設定することができる。

【0029】個別記憶領域411に格納されている第2の地図データ502は、前記利用者の前記現在位置に関する位置信号をサーバ400が受信することにより前記現在位置の一定範囲内に関する基本記憶領域412に格納されている第1の地図データ501内に属するものを前記利用者へ送信するもので、この第2の地図データ502の表示内容は、前記利用者、及び/又は、サーバ400により設定可能であり、また、情報表示装置100の表示手段30における第2の地図データ502の表示又は非表示は、前記利用者、及び/又は、前記サーバにより設定可能であり、これらは前記利用者により設定や変更が可能な送信設定データ604により制御される。

【0030】グループ化条件データ605は、他の利用者との間でデータを共有することのできるグループを構

築/解消する条件を定めるもので、前記利用者の現在位置を基準とした空間的要素、及び/又は、現在時刻を基準とした時間的要素に基づく内容である。なお、グループ化条件データ605の具体的な運用については後述する。

【0031】キーワードデータ606は、前記利用者を検索する際の手がかりを定めるもので、例えば、「車」「スキー」「旅行」「イタリア料理」等の単語(キーワード)を前記利用者が設定しておく、第三者は前記単語から前記利用者を検索することができる、これは前記グループを構築する際に役立てることができる。なお、キーワードデータ606の具体的な運用については後述する。

【0032】セキュリティデータ607は、前記グループを構築した際に前記他の利用者へ前記利用者のデータの公開レベルを定めるもので、公開されるデータの種類やそのデータに対する読み/書き制限等のアクセスを決める内容であり、異なる複数の前記内容を設定することにより、公開するデータを前記公開レベル毎に設定することができる。なお、セキュリティデータ607の具体的な運用については後述する。

【0033】サーバ400には、各記憶領域411、412の他に、前記利用者の情報表示装置100と公衆電話回線300を介して発信を行うことにより、前記各データや前記サービスを前記利用者へ送信する発信手段(図示しない)や、少なくとも記憶領域411、412へのアクセスや前記発信手段を制御する制御手段420とを有する。

【0034】次に、この情報通信システムについての具体的な使用例について、図5~図8に基づいて説明するが、以下の説明において図5~図8に示されていない箇所については、図1~図4を参照するものとする。

【0035】例えば、図5で示すように、4人の利用者a~dが個々に情報表示装置100a~100d(図1、図2の情報表示装置100と同じ、以下同じ)を所持している。各利用者a~dは、自己の現在位置に関する自己現在位置データ601を各々が使用している情報表示装置100a~100dの検出手段10により求め、データ発信手段20を用いて公衆電話回線300を介してサーバ400a~400d(図3のサーバ400と同じ、以下同じ)と発信を行い、利用者a~dの状況として個別記憶領域411a~411d(図3の個別記憶領域411と同じ、以下同じ)に記憶させるもので、自己現在位置データ601は、所定のタイミングで自動的に更新(アップロード)されるように制御手段40が制御している。

【0036】利用者a(利用者b~dも同様)は、任意の時点に入力手段50を操作して、データ発信手段20を用いて公衆電話回線300を介してサーバ400aへ発信(アクセス)して、個別記憶領域411a及び基本

記憶領域412aから自己の情報表示装置100aの記憶部42に取り込む(ダウンロード)。例えば、サーバ400aが、利用者aの状況たる前記自己現在位置に応じた自己現在位置データ601を格納すると、そのサーバ400aは、利用者aの状況に応じて各記憶領域411a、412aで格納されている各データから前記状況(前記自己現在位置)に応じたものを選択して、すなわち、更新して出力するものである。なお、基本記憶領域412a(基本記憶領域412b~412d)は、図3の基本記憶領域412と同じである。

【0037】ダウンロードされた各データは、表示手段30の表示部材31において重ねて表示されるもので、この際に、例えば、これらのデータ501~504が一つの画面を構成する際に矛盾が生じないように手立てを施すことは当然であって、例えば、地理的情報(緯度や経度)を基準に重ねて表示されるもので、これにより、例えば図6で示すように、地図A(第1、第2の地図データ501、502に基づく)を背景として、自己現在位置データ601等の情報が表示されるが、この時点、あるいは、事前に、利用者aは表示部材31の表示デザインを、例えば、パソコンの画面を自分好みにカスタマイズすると同様に、自由に設定するもので、この設定のため、サーバ400aの管理者によって基本記憶領域412aに登録されているUIデータ608から好みのUIを記憶部42に複写しておく。このUIには、自己の現在位置を示すアイコンB(自己現在位置データ601に基づく)、他者の現在位置を示すアイコンC(後述する)、自己の自宅を示すアイコンD、他者の自宅を示すアイコンE、自己宛電子メール自動受信を行う地点を示すアイコンF、行動予定を表示する際に利用するアイコンG(スケジュール帳データ602に基づく)、連絡先を表示する際に利用するアイコンH(アドレス帳データ603に基づく)等の所定の意味を持たせたアイコンが含まれている。

【0038】しかして、地図A上にアイコンB~Hが表現されるUIにより、利用者aの位置関係等が一目で分かり、表示部材31に現れるカーソルIを入力手段50で操作して所定の前記アイコンを選択(クリック)することにより、所定の作業を行わせることも可能である。

【0039】例えば、カーソルIでアイコンHを選択すると、他者の電話番号が表示され、この中から希望の電話番号を選択することにより、自動的に電話をかけることができる。すなわち、検出手段10で求まる利用者aの自己現在位置データ601をサーバ400aへ送信することにより、サーバ400aから自己現在位置データ601に関するデータとして、例えば、アイコンHとして登録していた電話番号を受信して情報表示装置100aが電話をかけるという命令を実行することができ、地図データ501、502に応じたサービスを実行可能とする。

【0040】また、アイコンFを自己の走行予定道路途中に配置し、アイコンBがアイコンFと一致した時点で自動的にサーバ400aあるいはインターネットサービスプロバイダ700（図3参照）と交信して、自己宛の電子メールの受信を行わせることができ、地図データ501、502に応じたサービスを実行可能とする。

【0041】例えば、毎朝通勤途中で電子メールをチェックする場合等に利用できるもので、日常の定期的行為を自動化することができて便利である。すなわち、検出手段10で求まる利用者aの自己現在位置データ601を利用者aの状況としてサーバ400aへ送信することにより、サーバ400aから自己現在位置データ601に関するデータとして電子メールを受信するものである。このような設定は、送信設定データ604として基本記憶領域412aに格納される。

【0042】次に、付加データ503の表示について説明すると、利用者aの現在位置に関する位置信号をサーバ400aが受信することにより前記現在位置の一定範囲内に関する地図データ501、502を利用者aへ送信し、利用者aが有する情報表示装置100aの表示部材31（表示手段30）において地図データ501、502と重ねて表示する（図7（a）参照）。サーバ400aがアナウンスを利用者aへ送信するタイミングである前記状況は、利用者aの現在位置Bと付加データ503に関する第2の地図データ502の設定地点Xとの間隔が一定距離内に達したとき、例えば、現在位置Bと設定地点Xとの距離が10メートル以内となったときに、サーバ400aが付加データ503の閲覧を促すアナウンスYを利用者aへ送信し（図7（b）参照）、アナウンスYを容認する利用者aからのアンサーバックが行われた場合にサーバ400aが利用者aへ地図データ501、502に応じた付加データ503を提供（送信）する（図7（c）参照）。この際、個人データ504は表示又は非表示の何れでも良い。このような設定は、送信設定データ604として基本記憶領域412aに格納される。

【0043】なお、利用者aが付加データ503に対して一度受信を容認した後は、再度前記状況になったときには、サーバ400aは同じ付加データ503に関するアナウンスYを送信しない設定、あるいは、再度送信する設定の何れでも良く、利用者a又はサーバ400aにより設定可能である。このような設定は、送信設定データ604として基本記憶領域412aに格納される。

【0044】このように、前記各種データを重み付けして、付加データ503を利用者aの前記状況に応じて表示可能とすることにより、情報表示装置100aの大型化や高価化を招くことなく、また、それらのデータを送信するサーバ400aにとっても、あらゆるデータを常時提供することなく、社会経済的にも好ましい新規な情報通信システムを提供することができる。

【0045】第2の地図データ502に設定した設定地点Xが情報表示装置100aで非表示の設定にある場合には、利用者aは付加データ503を表示する地点の存在を知り得ないことになるが、この場合においても、利用者aの現在位置Bと付加データ503に関する第2の地図データ502の設定地点X（隠されている）との距離が10メートル以内となった場合にサーバ400aが付加データ503の閲覧を促すアナウンスYを利用者aへ送信すれば、前述と同様な表示を行うことができる。この場合には、利用者aが不意にアナウンスYを受けることになり、ゲーム感覚のような意表を突く各種データの送受信を含むより新規な情報通信システムを実現することになる。このような設定は、送信設定データ604として基本記憶領域412aに格納される。

【0046】前記実施の形態では、利用者aの状況として自己現在位置データ601を用いたが、他にも時間データ（日付、曜日、時刻、情報表示装置100aの利用時間等）を前記状況として用いることができ、サーバ400aは前記時間データに応じて基本記憶領域412aで格納されている第2の地図データ502から前記状況に応じたものを選択、すなわち、更新して出力することもできる。例えば、時刻に応じて第2の地図データ502の内容を、サーバ400aで予め設定してある「飲食店データ」「レジャー施設データ」「宿泊施設データ」等のセレクトデータの何れかへ自動的に変更したり、あるいは、利用者aの希望により前記セレクトデータを選択して任意に変更して、これらを情報表示装置100の表示手段30で切替表示させることもできる。この場合には、付加データ503も第2の地図データ502の切替に伴って変更されることは言うまでもない。このような設定は、送信設定データ604として基本記憶領域412aに格納される。

【0047】付加データ503は、図7（c）で示したような文字情報に限らず、音声情報であっても良いし、あるいは、設定地点Xから続く仮想的な世界又はゲーム等であっても良く、表示地点Xをチェックポイントとして情報表示装置100の表示手段30で表示される内容が全く異なる内容であっても良い。このような設定は、送信設定データ604として基本記憶領域412aに格納される。

【0048】前記実施の形態では、付加データ503の表示可能性を利用者aへ示す設定地点Xとして、第2の地図データ502に設定する構成について示したが、第1、第2の地図データ501、502を1個の地図データとしてこれらに設定する構成であっても良い。このような設定は、送信設定データ604として基本記憶領域412aに格納される。

【0049】次に、前記グループの構築／解消について説明する。

【0050】利用者aは、予め自己のサーバ400aの

基本記憶領域412aにグループ化条件データ605及びセキュリティデータ607を設定して格納しており、他の利用者b~dも同様である。これらのグループ化条件データ605及びセキュリティデータ607は、利用者a~d毎に設定可能であるが、例えば、利用者a~dが、各々のグループ化条件データ605の条件として、「自己の現在位置から半径10キロメートル以内の範囲内に存在し(空間的要素)かつ月曜日~金曜日の午前9時から午後5時である(時間的要素)を満たす場合にグループを設定する」、あるいは、「地図上の特定の地点から半径20キロメートル以内、又は、特定の国道及び国道沿い20メートル以内(空間的要素)の範囲、かつ、1月1日から同月31日まで(時間的要素)でグループを構築する」等と設定し、セキュリティデータ607のレベルとして、「第2の地図データ502、付加データ503、自己現在位置データ601、及び、UIデータ608(以上を「対象物」と言う)を第三者に開放してグループを構成する」と、利用者a~dが同一内容で設定した場合(図3の個別記憶領域411aの網点箇所参照)、利用者aにとって、例えば、利用者bが前記条件を満たす場合(利用者bも同じ設定なので利用者bにとって利用者aが前記条件を満たすことになるが、以下では説明を省略する)、利用者aの情報表示装置100aの表示部材31(表示手段30)は、図8で示すような表示を行う。同図において、符号Baは利用者aの現在位置を示すアイコンであり、符号Cbは利用者bの現在位置を示すアイコンである。なお、符号Cc、Cdは、利用者c、dの現在位置を示すアイコンであるが、利用者c、dは現時点では前記条件を満たしていないアイコンCc、Cdは表示されていない。

【0051】このように、自己(利用者a)及び第三者(利用者b)との関係が、前記条件を満たすものとなると、サーバ400a、400bは自動的に利用者a、bから構成されるグループを構築し、前記条件が満たされている間は、セキュリティデータ607の前記レベルに従って互いの前記対象物を共有して表示するものである。これにより、互いの位置関係を知ることができるだけでなく、各々のデータや前記ユーザインターフェース機能を共有することができ、これを用いるコミュニケーションや前記使い勝手の共有が可能となる。なお、前記条件が満たされなくなっても構築されたグループを維持するようにグループ化条件データ605の内容を設定することも可能であり、この場合には利用者aの意思(入力手段50の操作)により解消することになる。

【0052】また、グループ化条件データ605の前記条件の内容が利用者a、b間で異なる場合には、夫々の内容でグループが構築されるため、一方通行的な偏面的なグループ化となる。

【0053】また、一人の利用者、例えば、利用者aがグループ化条件データ605の前記条件として複数の内

容を定めている場合には、それらの内容を満足する範囲において、例えば、利用者a、bのグループと、利用者a、cのグループのように、同時に複数のグループを構築することも可能である。

【0054】更に、例えば、利用者a、bがあるグループを構築し、利用者c、dが他のグループを構築している場合において、これら2つのグループを利用者a~dの意思により、あるいは、グループ化条件データ605の前記条件の内容により、1つのグループとして再構築することも可能であり、反対に、利用者a~dがあるグループを構築している場合において、利用者a~dの意思により、あるいは、グループ化条件データ605の前記条件の内容により、例えば、そのグループを解消することなく利用者b、cにて構成される新規なグループを再構築することも可能である。

【0055】また、カーソルのアイコンIで利用者bのアイコンCbをクリックすることで、利用者bへ電話をかけたり電子メールを送信する等のメニューが表示され(図示しない)、所望のサービスを実行することができるように設定する事も可能である。このような制御は、地図データ501、502に応じたサービスの一つであり、情報表示装置100の制御手段40のプログラムにより設定することができる。

【0056】ところで、前記グループの構築には、グループ化条件データ605を用いたが、例えば、利用者aがサーバ400aの検索機能で特定のキーワードを指定し、他のサーバ400b~400dを巡回して、各サーバ400b~400dの基本記憶領域412a~412dに格納されているキーワードデータ606をチェックすることにより、該当する利用者をピックアップして前記グループを構築することもできる。但し、この場合には、前記キーワードに合致してピックアップされた前記利用者が、グループ化を拒否していないことが条件となり、前記対象物の共有に当たっては、セキュリティデータ607の前記レベルの内容に因ることになる。

【0057】あるいは、前記条件は、前記地図データや前記付加データを格納すると共に他の利用者との間で前記対象物を共有することのできるグループを構築/解消する前記条件を定めるグループ化条件データ605の他に、前記条件を判断や実行することにより前記グループの構築/解消を実行するグループ化手続きプログラムにて設定することも可能であり、また、前記レベルは、前記グループを構築した際に前記他の利用者の前記対象物へのアクセスの前記レベルを定めるセキュリティデータ607の他に、前記レベルを判断や実行することにより前記対象物へのアクセスを実行させるセキュリティ管理プログラムにて設定することも可能である。

【0058】なお、これらを実現する際における表示手段30での表示の形式(フォーマット)、又は、利用される各種データとしては、現在インターネットで利用さ

れているHTML (Hyper Text Markup Language) や、メタデータ、数値データ、グラフィックデータ、動画データ、音声/音データ、音声読み上げや音声認識プログラム等により使用される辞書データ等を記述できるマーク付け言語による構造化文章XML (Extensible Markup Language) 等が利用できる。

【0059】また、利用者a~dは、個別のサーバ400a~400dを用意する必要はなく、少なくとも1つのサーバ400と、これにより管理される1つの基本記憶領域412と、利用者a~dの個別のデータを格納する個別記憶領域411a~411dがあれば良い。当然ながら、前記送信手段や制御手段420は1つあれば良い。

【0060】また、前記U1機能は、前記利用者の選択により情報表示装置100、又は、サーバ400における操作方法やデータ検索方法や前記U1の使い勝手をカスタマイズするためのデータやプログラムを変更・設定できる機能、又は、前記利用者の個人情報データや操作履歴や前記対象物の検索結果や前記サービスの利用履歴等に関するデータを統計的な手法等の適宜手法を用いて前記利用者の操作手段の補助や少なくとも一部の前記操作手段の自動化のために供される手続きプログラム等のエージェント機能を有するものとすることも可能である。

【0061】

【発明の効果】この発明は、複数の利用者間におけるデータ交換を容易に行うことのできる新規な情報通信システムを提供するもので、設定した条件を満たす場合に前記複数の利用者がグループを構築/解消することにより、設定したレベルで対象物の共有を行うことが可能となり、極めて利便性の高い情報通信システムを提供することができる。

【図面の簡単な説明】

【図1】 本発明の実施の形態に係る情報表示装置を説明する概略図。

【図2】 同上のブロック図。

【図3】 本発明である情報通信システムの実施の形態を説明する概略図。

【図4】 同上におけるデータを説明する斜視図。

【図5】 同上においてグループ化を説明する概略図。

【図6】 同上の表示を説明する図。

【図7】 同上の表示を説明する図。

【図8】 同上の表示を説明する図。

【符号の説明】

- 100 (100a~100d) 情報表示装置
- 10 検出手段
- 20 データ受信手段
- 30 表示手段
- 31 表示部材
- 40 制御手段
- 41 演算部
- 42 記憶部
- 50 入力手段
- 200 GPS衛星
- 300 公衆電話回線 (電気通信回線)
- 400 (400a~400d) サーバ
- 411 (411a~411d) 個別記憶領域
- 412 (412a~412d) 基本記憶領域
- 501 第1の地図データ
- 502 第2の地図データ
- 503 付加データ
- 504 個人データ
- 601 自己現在位置データ
- 602 スケジュール帳データ
- 603 データアドレス帳データ
- 604 送信設定データ
- 605 グループ化条件データ
- 606 キーワードデータ
- 607 セキュリティデータ
- 608 ユーザーインターフェースデータ

【図1】

【図2】

【図6】

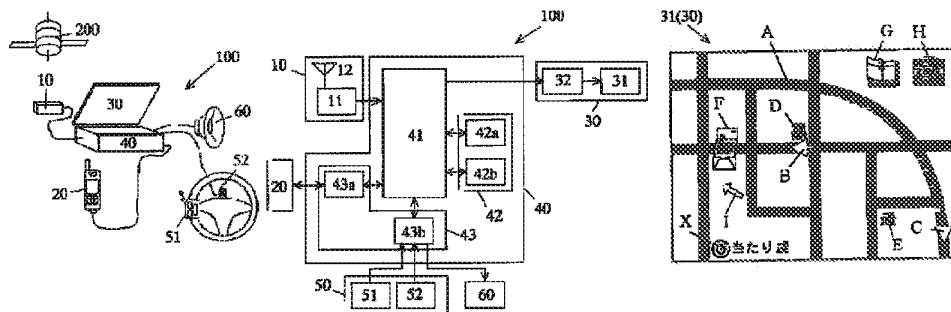

【図3】

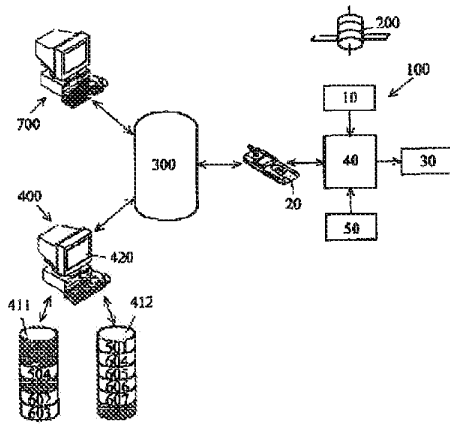

【図4】

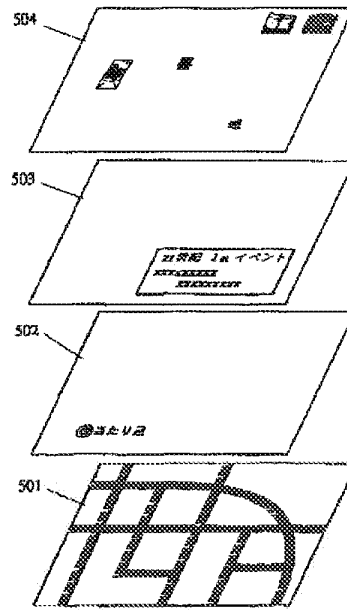

【図5】

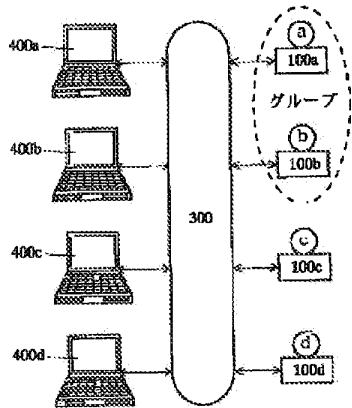

【図8】

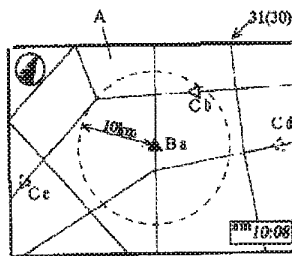

【図7】

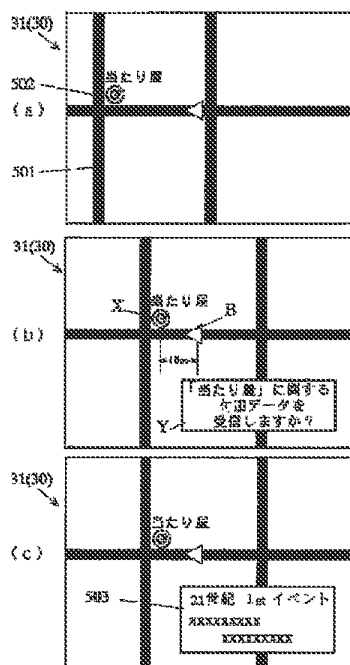

フロントページの続き

(51)Int. Cl. ⁷	識別記号	F 1	(参考)
G 0 6 F 17/60	5 1 2	G 0 6 F 17/60	5 1 2
13/00	5 1 0	13/00	5 1 0 G
15/00	3 3 0	15/00	3 3 0 D
17/30	1 1 0	17/30	1 1 0 G
	1 7 0		1 7 0 C
	3 4 0		3 4 0 A
G 0 9 B 29/00		G 0 9 B 29/00	A
29/10		29/10	A

Fターム(参考) 2C032 HB05 HB08 HB22 HB25 HC08
 HC16 HC23 HC27 HC31 HD03
 5B075 KK07 KK13 KK33 KK37 KK43
 KK54 KK63 ND03 ND06 ND20
 ND22 ND23 ND35 PQ02 PQ13
 PQ32 PR03 PR08 UU14
 5B085 BG07

(12) INTERNATIONAL APPLICATION PUBLISHED UNDER THE PATENT COOPERATION TREATY (PCT)

(19) World Intellectual Property Organization
International Bureau



(43) International Publication Date
12 September 2003 (12.09.2003)

PCT

(10) International Publication Number
WO 03/074973 A2

- (51) International Patent Classification⁷: G01C 21/36, G08G 1/13, 1/137
- (21) International Application Number: PCT/US03/06663
- (22) International Filing Date: 3 March 2003 (03.03.2003)
- (25) Filing Language: English
- (26) Publication Language: English
- (30) Priority Data:
60/360,737 1 March 2002 (01.03.2002) US
- (63) Related by continuation (CON) or continuation-in-part (CIP) to earlier application:
US Not furnished (CIP)
Filed on 3 March 2003 (03.03.2003)
- (71) Applicant (for all designated States except US): NETWORKS IN MOTION, INC. [US/US]; 18872 Bardeen Avenue, Irvine, CA 92612 (US).
- (72) Inventors; and
- (75) Inventors/Applicants (for US only): SHEHA, Michael, A. [US/US]; 8 Larkfield Lane, Laguna Niguel, CA 92677 (US). SHEHA, Angie [US/US]; 5 Larkfield Lane, Laguna Niguel, CA 92677 (US). PETILLI, Stephen [US/US]; 11 Tattersall, Laguna Niguel, CA 92677 (US).
- (74) Agents: YANG, David, T. et al.; Morrison & Foerster LLP, 555 West Fifth Street, Suite 3500, Los Angeles, CA 90013-1024 (US).
- (81) Designated States (national): AE, AG, AL, AM, AT, AU, AZ, BA, BB, BG, BR, BY, BZ, CA, CH, CN, CO, CR, CU, CZ, DE, DK, DM, DZ, EC, EE, ES, FI, GB, GD, GE, GH, GM, HR, HU, ID, IL, IN, IS, JP, KE, KG, KP, KR, KZ, LC, LK, LR, LS, LT, LU, LV, MA, MD, MG, MK, MN, MW, MX, MZ, NO, NZ, PH, PL, PT, RO, RU, SC, SD, SE, SG, SK, SL, TJ, TM, TN, TR, TT, TZ, UA, UG, US, UZ, VC, VN, YU, ZA, ZW.
- (84) Designated States (regional): ARIPO patent (GH, GM, KE, LS, MW, MZ, SD, SL, SZ, TZ, UG, ZM, ZW), Eurasian patent (AM, AZ, BY, KG, KZ, MD, RU, TJ, TM), European patent (AT, BE, BG, CH, CY, CZ, DE, DK, EE, ES, FI, FR, GB, GR, HU, IE, IT, LU, MC, NL, PT, RO, SE, SI, SK, TR), OAPI patent (BF, BJ, CF, CG, CI, CM, GA, GN, GQ, GW, ML, MR, NE, SN, TD, TG).

Published:

— without international search report and to be republished upon receipt of that report

For two-letter codes and other abbreviations, refer to the "Guidance Notes on Codes and Abbreviations" appearing at the beginning of each regular issue of the PCT Gazette.

WO 03/074973 A2

(54) Title: METHOD AND APPARATUS FOR SENDING, RETRIEVING, AND PLANNING LOCATION RELEVANT INFORMATION

(57) Abstract: The present invention is directed to a method and apparatus for sending and retrieving location relevant information to a user by selecting and designating a point of interest that is displayed on a graphical user interface and sending the location information associated with that point of interest to a receiver that is also selected using the graphical user interface. The location relevant information may also include mapped routes, waypoints, geo-fenced areas, moving vehicles etc. Updated location relevant information may also be continuously sent to the user while generating updated mapping information on the graphical user interface. The present invention may be practiced by using communication devices such as a personal computer, a personal digital assistance, in-vehicle navigation systems, or a mobile telephone.

**METHOD AND APPARATUS FOR SENDING, RETRIEVING, AND PLANNING
LOCATION RELEVANT INFORMATION**

BACKGROUND

5 **1. Field of Invention**

 This present invention relates to a computerized mapping and real-time communication software program, and more specifically, to integrating or coupling computerized mapping and real-time communication software for the purpose of transferring location-related information using a real-time communication system.

10 **2. Description of the Related Art**

 Computerized mapping and real-time communication software are independently achieving widespread use today. Such mapping programs are commonly used to automate tasks of calculating routes, viewing location-specific geographical areas for their spatial content, such as addresses, roadways, rivers, etc., and for the purpose of being used with
15 Global Positioning System (GPS) devices for various applications, such as a personal navigation application. Mapping software programs apply to a wide variety of uses, such as personal navigation, telematics, thematic mapping, resource planning, routing, fleet tracking, safety dispatching (i.e., Police, Fire, and Rescue organizations), and a wide variety of specialized Geographic Information System (GIS) applications, all of which are well known
20 to people skilled in the art.

 Real-time communication software applications are also being used today in various applications, like Instant Messaging (IM) applications such as American Online's (AOL) IM (AIM), Yahoo's IM, and Microsoft's IM, all of which are well known to people skilled in the art. None of these prior art IM software applications contain mapping capabilities. These

applications provide presence information about other users on a user's roster or buddy list, such as online, busy, away, on the phone, offline, etc., and are primarily used for non-commercial applications, such as for conversing with friends or buddies that are online.

Prior art applications provide various features, such as displaying driving directions
5 (i.e., routes), Points Of Interest (POI), waypoints (such as personalized, user-specific, points on a route or along a track), etc., but do not enable the transfer of such information to other users in real-time. A user will typically copy an image of a map from a standard mapping program, usually with a highlighted route, and e-mail the bitmap image and/or directions to another user or group of users for the purpose of meeting at a specific location or POI, such
10 as a restaurant. Alternatively, with the adoption of IM programs, users can transfer these images and directions, typically by using an integrated file transfer program (FTP) connection, in real-time to other users based on their presence, and obtain real-time feedback from their buddies about the destination POI or location and specific route used to get to the destination.

15 Current applications that integrate both mapping and real-time messaging are well known in the art, such as the Automatic Vehicle Location (AVL) or Fleet Tracking industry, where vehicles that have position devices, such as GPS, report their position to a centralized computer for the mapping and display of the vehicles' locations. Some of these prior art systems may incorporate real-time messaging for the transfer of logistical information, such
20 as pickup and drop-off status messages. However, these existing applications do not provide a method for dynamically and graphically transferring location-relevant information coupled with a spatial map. Additionally, these applications typically provide only one-way transfer of position information, from the mobile vehicle to the dispatcher application, either on a

web-based or desktop-based program. Usually, there is no need to transfer the dispatcher's location to the mobile vehicle since the dispatcher's location is always stationary. Mobile devices typically use location telemetry devices to transmit their location in a pre-defined manner or by request, where the dispatcher's location request is usually initiated by clicking
5 on a Graphical User Interface (GUI) or by using a set of preferences to automatically request position updates. These preferences are based on various parameters, such as reporting location updates based on the distance traveled by the vehicle or by using various time intervals to trigger position updates either by a push or pull method relative to the telemetry device.

10 Another problem with existing AVL software solutions are that most applications are web-based applications that only allow for static image-based mapping, such as those provided by various online mapping companies like MapQuest. Also, the mapping and communication systems are disjointed from each other, as is the case with various companies, such as Televoke, Inc. These static image-based mapping applications do not
15 enable real-time graphical manipulation of POIs on the map, nor do they provide a graphical connection between the map and vehicle roster listing. Some AVL software solutions provide the ability to display moving vehicles on dynamically viewable maps. However, these solutions do not enable the user to select a vehicle on the map, nor a stationary representation of a vehicle in a roster list, in real-time for the purpose of sending the vehicle's location to
20 other users, and thus do not allow the creation of ad-hoc position transfers between various parties. Some dynamic mapping applications, such as Microsoft's MapPoint application, allow users to select Points Of Interest (POI) generally for the purpose of providing additional information about the POI or enabling the user to add the POI to a route planner as

a route start, end, or stop point. This POI is selected by ‘right-clicking’ on the object after it has been selected and then choosing the specific route option. However, prior art fails to provide real-time communication capability with location-relevant information (i.e., POIs) for the purpose of graphically sending location-relevant information in established or ad-hoc
5 networks to other users or location-enabled devices.

Another problem with prior art, such as in the case of AVL software solutions, is that vehicles or other mobile devices that a user wishes to map must first be selected from a list of available position-enabled vehicles. These vehicles, however, must already be configured for mapping on a dispatcher’s mapping application and do not enable position requests in an ad-
10 hoc environment. Prior art AVL mapping and tracking systems, such as At Road Inc., only allow users to select from a list of pre-configured location-updating vehicles, and then require the user to press a button in order to map the location of the selected vehicle(s). A much better solution, as people skilled in the art will appreciate, is to select a user, device, or group of users and devices in a roster list and graphically drag-and-drop the selection onto an
15 active map. This method significantly simplifies the process of identifying a single or group of user(s)/device(s) and mapping their location appropriately. Additionally, prior art AVL systems do not allow for the case of users or devices to disallow their position from being mapped on the current mapping application.

There also exists a need for the consideration of permissions in such a case of privacy
20 concerns, where a real-time location request be sent across the real-time communication connection to the user, vehicle, or device, whose location information is being requested. The user, vehicle, or device can select the resolution of position information they want to communicate (i.e., latitude and longitude, or city, or state, or etc.) to control the level of

accuracy to which they can be mapped. Once approved, this ad-hoc transfer of position information occurs and the graphical mapping of the received position information is completed on the requestor's mapping application. Thus, allowing users to initiate position requests graphically and in real-time, and providing the capability of ad-hoc position requests to other users not pre-configured to allow their location information to be mapped, provides an extremely efficient method and system when compared to prior art systems.

Another drawback of prior art is that integrated mapping and communication programs, such as AVL applications, provide the ability for the receiving of position information for mapping purposes only. These prior art systems do not provide the capability of sending, or pushing, location-relevant information, such as POIs, to other mapping programs or textual devices, such as Personal Digital Assistants (PDA), pagers, cell phones, etc. For instance, prior art mapping systems, such as Microsoft's MapPoint, allow the user to select POIs, such as restaurants and gas stations, but does not allow the user to transfer these POIs to other users, and more specifically does not allow users to graphically drag-and-drop these selections (i.e., POIs) for various purposes, such as to dynamically add them to a route planner for inclusion in an undefined route or pre-calculated route.

The integration of a highly dynamic mapping application and a real-time communication system enables users to select POIs, such as houses, theaters, city names, roads, etc., or icon representations of other users on a mapping program for the purpose of graphically sending location-relevant graphical information, such as the selected POIs, to a specific user on a roster listing of available online users in real-time. As people skilled in the art will appreciate, graphical location-relevant information is not limited to only POIs, but also includes mapped routes, waypoints, geo-fenced areas, planes, etc. A valuable feature

that prior art fails to provide is the transfer mechanism that allows the ability to drag-and-drop this location-relevant map information (i.e., routes, geo-fenced areas, etc.) to the current application's roster list for such transfers.

Prior art systems, such as AVL software, also fail to provide the capability of
5 allowing the map application user (i.e., in the case of an AVL software solution the user is typically denoted as the dispatcher) to send the position information of one vehicle to another vehicle on the user's roster list for an ad-hoc location transfer. This method of transferring information is best performed by dragging the icon representation of one vehicle to the icon representation of another vehicle in the user's roster list. Before the completion of the
10 transfer of one vehicle's location information to another vehicle, where the user or dispatcher acts as the location-transfer hub, each user sets the appropriate permissions to allow the transfer. Thus, each of the vehicles' roster lists do not need to be included in the other vehicle's roster list, since the user or dispatcher has both vehicles on its roster list and acts as the hub for the transfer of the position information. This creates a dynamic environment for
15 ad-hoc position transfers that are not available in prior art systems.

As an additional drawback of prior art systems, there is no way to provide real-time route planning of a system consisting of a real-time communication system integrated with a mapping and real-time communication program. In other words, it is not currently possible for a roster icon representation of a vehicle or user to be graphically selected into, or
20 dragged-and-dropped onto, a route planner for the purpose of setting a user's current position as a route's destination points, where the term 'destination' refers to a point or location on a map that the user indicates as a start of a trip, end of a trip, or stop or waypoint along a trip. Origin also is used to refer to the start of a trip. This route planning operation also applies to

POI locations. For instance, prior art systems, such as Microsoft's MapPoint allows users to graphically alter a pre-calculated route, such as graphically indicating the portion of the route to alter.

However, current art systems do not allow the capability of selecting real-time
5 location-enabled or static POIs (such as vehicles, restaurants, people, gas stations, houses, etc.) for the purpose of graphically adding to, or updating, a route's destination points in an undefined or pre-calculated route. Additionally, this prior art system application only allows the alteration of a route to a new destination by dragging the selected portion of the route to that new location. A more useful method, which can incorporate the integrated real-time
10 communication system, is by allowing the user to drag a graphical representation of a location-relevant object, such as POI (i.e., restaurant, gas station, house, user, etc.), to the pre-calculated route itself or to a route planner, thus graphically altering the pre-calculated route by creating a destination point based on the dragged POI's location information. If the POI has a static location, and its position information is already known, then the real-time
15 communication system is not utilized. However, if the POI is dynamic (i.e., a moving vehicle), then the real-time communication system is utilized to obtain the position information of the selected dynamic POI in real-time, thus producing a dynamically moving route, where the destination point can change its position in real-time, thus causing the route to continually update its parameters based on the moving object. Another advantage for using
20 the dynamic route calculation, is as the POI moves its location, the entire route need not be re-calculated in real-time, but only that portion of the route that needs to be re-calculated.

An additional problem with current map planning applications or integrated mapping and real-time communication software applications, such as AVL software solutions, is that

they do not provide the capability of allowing users to graphically transfer routes to other users in real-time. Current prior art systems that are capable of generating routes allow users to send route representations, such as bitmap images or driving directions, to other users either by e-mail or FTP connection, where these routes representations only provide a static set of information, such as the starting and ending (i.e., destination) points of the predefined route. The route is usually generated based on the sender's origin and destination, or is based on generic major roadways that are easily identifiable in the immediate area.

A more useful implementation, when compared to prior art systems, would enable users to transfer or 'share' pre-defined routes, including all of the destination and turn points of the route and all of the metrics used to calculate the route, in real-time, so that they can be incorporated into the recipient user's routes or dynamically viewed on the recipient user's map. In the case of an in-vehicle navigational system, transferring a vehicle's actual route to another vehicle or graphical application allows the other user to view in real-time the exact location of that vehicle relative to the route that vehicle is traveling along. An additional benefit of this more useful application would be that the recipient of the route would be able to use in their route planner tool the sent destination points (i.e., stop points, end point, etc.), and use their own current location as the route's origin. For example, prior art systems, such as MapQuest or MapBlast, allow users to send image representations of static routes to other users. However, these routes are relative to the sender's location. There needs to be a method to create a route that can automatically include the received route's destination points while recalculating the route relative to the recipient's current position.

Thus, a need exists for a method and system that allows users to graphically send, request, and plan, in real-time, location-relevant information between users and devices.

Until now, an adequate solution to those problems has eluded those skilled in the art. Providing a solution enabling users to graphically send, request, and plan, in real-time, location-relevant information between users and devices would prove especially useful for wireless devices that incorporate positioning technologies, such as Global Positioning
5 Satellite (GPS) devices. This provides great benefits to wireless in-vehicle navigational systems (i.e., telematics) and fleet tracking systems, since they would be able to make more efficient use of position information by including a real-time communication infrastructure and application with a graphically enabled interface.

SUMMARY OF THE INVENTION

It is an object of the present invention to provide a method and system for the receipt of location-relevant information, or user or group contact information, such as personal data information (i.e., vcard or personal profile information), from a list of users or group of users, where users can include inanimate objects (i.e., phones, vehicles, boats, database, device, etc.) or living things (i.e., people, pets, etc.), for the purpose of mapping the location information by graphically selecting and dragging the icon representation of the user, contact, or group of users and/or contacts to a map.

In accordance with the preferred embodiment of the present invention, the location-relevant information can be stored locally, typically with contact information, cached from a recently received location update, or location information can be automatically requested in real-time from a specified user or group of users where a user may include an online database storage system. Once the location-relevant information (e.g., latitude, longitude, altitude, heading, etc.) has been received, that location is mapped based on varying resolution and size. In one embodiment, a user can select another user, typically from a roster list, and drag-and-drop the user onto a map in order to automatically map this other user's current location. The mapped user can be in the form of a contact, where the location information (i.e., vcard), such as an address, is typically stored locally in the storage system of the computing device, or the user can be in the form of a roster list of users connected via a real-time communication system. In the case of a roster list, the location information can be in the form of vcard information, and may also include position information from various positioning devices, such as a GPS device. In both cases, the remote user to be mapped (e.g., person,

phone, vehicle, etc.) could receive a message showing the request for their position information.

Upon accepting the request to send their position information, the requesting user's real-time communication program would receive the remote user's position information from the remote user and transfer the remote user's position information to the requesting user's mapping application to be displayed on a graphical map. The remote user can also be considered to be in the form of an online database storage system. In essence, all of the previous steps are performed using a simple selection and drag-and-drop operation. It should be noted that the mapping application and the real-time communication application do not have to be fully integrated (i.e., they can be separate applications), but do preferably include a conduit for transferring position information between the two applications. Integrating the two applications typically provides for a better user experience, but is not required by this object.

It is another object of the present invention to provide a method and system for receiving location-relevant information from a list of users or group of users, where users can include inanimate objects (i.e., phones, vehicles, boats, etc.) or living things (i.e., people, pets, etc.), for the purpose of requesting, in real-time and in an ad-hoc environment, the users' position information for mapping their location(s) by pushing a button or selecting from a menu list in a real-time communication program, such as an instant message application. In one embodiment, a user engaged in an instant message conversation with a mobile wireless phone user desires to obtain the position of said wireless phone user. The requesting user can push a button on the instant message window, or select a menu bar option, to initiate the request of the wireless phone user's position information. After the

mobile wireless phone user has allowed the transfer of its own position information, the requesting user's mapping application can automatically display the location of the wireless phone user. Additionally, the requesting user could have also initiated the position request by selecting the body of an instant message window and performing a drag-and-drop operation
5 onto the mapping application. In this manner, the user is able to request the position information of another user and automatically map it quickly, easily, using an ad-hoc position request method and system.

It is another object of the present invention to provide a method and system for sending location-relevant information to a single or list of users or group of users, in real-
10 time and ad-hoc environment, by pushing a button on a real-time communication instant message window. In one embodiment, a user engaged in an instant message session can push a button to send their own position information to the other user or group of users that are currently participating in the instant message session. The recipient user or group of users can have the option to accept or decline the transfer of the said position information, and,
15 upon acceptance, the recipient user's mapping application can automatically perform a mapping operation.

It is another object of the present invention to provide a method and system for sending location-relevant information objects, such as routes, POIs, waypoints, user's locations, geo-fenced areas, vehicles, planes, etc., to other users or groups of users, where
20 users can include inanimate objects (i.e., devices, phones, vehicles, boats, database, etc.) or living things (i.e., people, pets, etc.), by means of a graphical operation on a user or group in a list or on a graphical icon representation of a user or group and via a real-time communications system.

It is another object of the present invention to provide a method and system for selecting location-relevant information object(s) (e.g., routes, users, POI, etc.) on a graphical map for the purpose of sending location-relevant information object(s) to other users or a group of users by first selecting the location-relevant information object(s) and either using a graphical operation, such as dragging and dropping, the object(s) to a user or group listing representation, such as an icon of the destination user or group, or by selecting from a menu the user or group list of the destination user or group of users to send the location-relevant object(s) information to. In one embodiment, a user can select a position-enabled object (e.g. POI) from a graphical map and either drag-and-drop the POI to a user or group in a list, or select from a menu list the specific destination user or group of users to which the POI should be sent.

It is another object of the present invention to provide a method and system for allowing a user to accept or reject the receipt of location-relevant information, such as routes, another user's location information, POIs, etc., by their real-time communication program. Upon receipt of said location-relevant information, the information can be automatically mapped in an accompanying mapping application. The mapping application and the real-time communication application do not have to be fully integrated (i.e., they can be separate applications), but they do require a conduit, such as a software application program interface (API), for transferring said position information between the two applications. In one embodiment, a remote user that has been sent location-relevant information, such as a POI, can receive a notification message indicating that the POI will be transferred upon acceptance of the request. Upon acceptance of the request, the POI will be transferred to the destination user, who can then have the option to map the received POI or display the textual

location and name of the POI, or both. This preference information can be configured in real-time or pre-configured in the application preferences of the real-time communication application.

It is another object of the present invention to provide a method and system for
5 allowing a user to graphically initiate the transfer of location information, in an established or ad-hoc real-time environment, between a user or group of users, or any combination thereof. In one embodiment, a user that has a list of N other users can select an icon representation of a user or group of users and initiate the transfer of the location information of the selected user or group of users to a destination user or group of users other than themselves. The
10 initiating user essentially acts as the hub for graphically initiating and transferring the location information between users and/or groups of users. The initiating user can perform this graphical initiation of a location transfer by highlighting a user or group of users from a list or graphical icon representation, and select from a pop-up menu or list the destination user or group of users to which the location information should be sent. Additionally, the
15 initiator can start the location transfer by selecting the icon representation of the user or group of users from a list or graphical icon representation, and then dragging-and-dropping it to another icon or list representation of a user or group of users, or any combination thereof, for the purpose of sending or transferring said location information. Before the location transfer is completed, permission settings can be obtained from the origin and destination
20 users or groups of users. It is not a requirement that the origin and destination user or group of users include each other in their own roster list, since only the initiating user needs to have both origin and destination users or groups of users in their roster lists.

It is another object of the present invention to provide a method and system for sending your position information to a list of users or group of users, in real-time, by selecting a graphical icon representation of yourself and dragging and dropping the icon onto a user or group of users. In one embodiment, a user wanting to send their own position information to a group of users can select their own icon representation and drag-and-drop said icon representation onto the icon representation of the group of users who should receive said position information. In one embodiment, each user in the group will have the option of accepting or declining said position information transfer, and each receiving user that accepts the position information transfer has a mapping application that automatically performs a mapping operation to display the received position information on a graphical map.

It is another object of the present invention to provide a method and system for receiving a route that may or may not include the sender's real-time location along that route for display in real-time on the recipient's graphical mapping application. In one embodiment, an in-vehicle navigation system on a defined route may need to transfer that route to a desktop computer. The route, and all of its parameters, can be transferred to the desktop's mapping application for display. Additionally, the sender of the route can include and send their own real-time position information with the route for display on the desktop computer's mapping application. When the sender initiates such a transfer, the sender's real-time communication application is configured to send its own location on the route to the recipient, via a real-time communication system, at any given interval of time, distance change, or upon the sender's request. The recipient's real-time communication application is configured to receive these location updates from the sender, which then triggers the recipient's mapping application to display the updated location of the sender. Thus, the real-

time communication application not only provides the ability to send the route, but to transfer the vehicle's real-time position information in order for it to be mapped.

It is another object of the present invention to provide a method and system for sending routes to other users and enabling the recipients of said routes to dynamically change
5 the received route's origin to be the recipient's current location or the closest starting position relative to the received route. The destinations in the received route can remain a common element between the sender and the recipient, but the origin, or closest starting position relative to the received route, can change to be the recipient's current position information on the received route, thus allowing a new route to be calculated based on the recipient's current
10 position information and a common set of received destinations. All of the received destinations are optional, but at least one received destination is required to calculate a new route from the recipient's current position. For example, if the initiator sends, or shares, their current route with another user (i.e., recipient), the recipient user can receive the sent route with the original origin and destinations of the route. The recipient's mapping application can
15 then dynamically re-calculate a new route based on all or a subset of the received route's destinations and with an origin being the recipient's current real-time position information.

It is another object of the present invention to provide a method and system for graphically selecting a user or group of users, where a user can include an inanimate object (i.e., phone, vehicle, boat, etc.) or living thing (i.e., person, pet, etc.), or a contact, all of
20 which have position information associated with them, and graphically modifying a pre-calculated route to include the location of the selected user(s) for the purpose of preparing and calculating a new route. In one embodiment, a user can select an icon representation of another user, group of users, or contact from a list and drag-and-drop said icon representation

onto a pre-calculated graphically-displayed route for the purpose of modifying said route by inserting into that route as destinations the location(s) of the selected user(s), such that the inserted destinations are placed after the destination point that immediately preceded the route segment where the icon was dropped, and before the destination point that immediately followed the route segment where the icon was dropped. In this manner, the user is able to add a new route destination simply by dragging an icon representation of the user, group of users, or contact onto a pre-calculated route.

The position information can be either locally stored, as is typically the case with contacts, or can be retrieved and updated in real-time as the position information changes, which may be very useful for a user that is defined as a mobile phone or vehicle. One advantage of the present invention is that the entire route need not be recomputed each time a destination is updated. Only the portion of the route that was changed can be recalculated. For example, if a route consists of origin point A and destination points B then C, and an additional destination is added in-between points A and B, then only the portion of the route between A and B needs to be recalculated to include the added destination. In another embodiment, a user can select another user, group of users, or contact icon representation from a list and drag-and-drop said icon representation into a route planner window, such that the order of the route destinations are arranged as previously described, with the new destination point being inserted in the route between the points immediately preceding and following the point where the icon was dropped. If there is no destination point immediately preceding or immediately following the point where the icon was dropped, then that new route destination point becomes the origin or destination, respectively, of the new route. The minimal route calculation can compute the route segment consisting of the new destination

point and the destination points immediately preceding and immediately following the new destination point can then be recalculated. However, the entire route may be recalculated to maximize overall route optimization. The retrieval of the position information is the same as described in previous objects, but in this embodiment the route would not automatically
5 calculate a new route until the user instructs it to be calculated.

It is another object of the present invention to provide a method and system for graphically adding location-relevant information objects, such as POIs, city names, street names, user icon representations, vehicles, etc., as additional destinations to a pre-calculated route or to a route planner. In a mapping application, graphically selecting location-relevant
10 information objects, such as POIs, dragging said objects to a pre-calculated graphically-displayed route, and dropping said objects onto the route enables the addition of destination points, based on the selected location-relevant information objects, along said route at the point where they were graphically dropped. The need for the mapping program to calculate which portion of the route to alter is eliminated since the user selects the appropriate portion
15 directly with the selected location-relevant information object. In one embodiment, a location-relevant object, such as a gas station POI, is selected and dragged to the graphically displayed pre-calculated route, and then dropped onto a particular route segment on the map. This action automatically adds the POI as a destination point, where the order of the destination point in the route is determined by the object's drop point, and automatically
20 recalculates the route with the new inserted destination point included. Another benefit is that the entire route need not be recalculated, but only the segment of the route upon which the object was dropped needs to be computed. For example if 6 points define a route and a POI is added between points 5 and 6, the drop point being labeled point 5a, then only the route

segments from point 5 to 5a and from point 5a to 6 need to be calculated, not the entire route (i.e., points 1, 2, 3, 4, 5, 5a, and 6).

This object also applies to another embodiment of a method for graphically selecting location-relevant information objects, such as POIs, and dragging-and-dropping said objects to a route planner for the purpose of adding additional origin or destination points along said route. The difference in this embodiment is that the POI is not dropped onto a pre-calculated graphically displayed route, but onto a route planner instead. The benefit of the previous embodiment also applies to this embodiment, in that the entire route does not need to be recalculated, but only the portion of the route into which the new destination point is inserted can be recomputed. Also the route can be a pre-calculated route or a route that is being planned and still needs to be calculated.

It is another object of the present invention to provide a method and system for selecting a graphical icon representation of a user on a map and dragging it onto a POI on a map, or visa versa, for the purpose of creating a dynamically-generated real-time route and adding that route between the location user and POI to a route planner. The selected user's position information is updated either through the real-time communications system, or if the selected user is the application user, the position information is updated from a locally connected positioning device (e.g. GPS). The POI is sometimes considered a static location-relevant object, such as a gas station, house, restaurant, city location identifier, etc., whose position remains relatively unchanged. In one embodiment, a user tracking a vehicle on a map that wishes to obtain a route for said vehicle to a gas station can select the vehicle's graphical icon representation on the map and drag-and-drop it onto an icon representation of a restaurant on the map. This action can generate a route from the selected vehicle's current

position on the map to the location of the restaurant and may create a new route in a route planner consisting of the origin as the selected vehicle's current location and the destination as the selected POI's location.

One advantage of this method and system is that the real-time communication system
5 allows the vehicle to move while the route is dynamically updated using the vehicle's new position information as the origin of the route and using the restaurant POI as the destination. Another benefit of this object is that if there are two or more destinations (i.e., three or more route points) the entire route does not need to be recalculated, but only the portion of the route that has been changed, by real-time position updates of location-relevant objects such
10 as the vehicle, needs to be computed.

It is another object of the present invention to provide a method and system for graphically creating a dynamic route between two moving location-relevant objects on a map. A location-relevant object is a map object that has a spatial component associated with it, such as latitude and longitude values, and is graphically selectable by the user. Selecting
15 an icon representation for a dynamic location-relevant object, such as a vehicle, person, plane, boat, etc., where the position of the dynamic location-relevant object can change with time and its real-time position updates can be received via the real-time communications system or locally when connected to a local positioning device such as a GPS receiver, and dragging and dropping said object representation onto another icon representation of a
20 dynamic location-relevant object will create a route between the two dynamic objects and/or add the objects into a route planner, depending on the user's preferences. The object that was first selected is considered the starting point, or origin, of the route, and the second selected object is considered the destination point of the route. If any new position updates for either

dynamic location-relevant object occurs, the route between the two dynamic location-relevant objects will be re-calculated, thus enabling a constantly updated dynamic route. Another benefit of this object is that if there are two or more destinations (i.e., three or more route points) the entire route does not have to be recalculated, but only the portion of the route that has changed, including any real-time position updates of location-relevant objects.

It is another object of the present invention to provide a method and system for graphically adding location-relevant objects on a map to a route planner. The selection of an icon representation of a location-relevant object on a map, such as a vehicle, pet, person, boat, wireless phone, computer, city name, street name, park, etc., followed by the use of a drag-and-drop operation to a route planner window in order to drop said location-relevant object into the route planner window adds the said object to the route planner for the purpose of either updating a pre-calculated route or creating a new route. The order that the location-relevant object is dropped into the route planner window directly affects the order of the destination points of the route, and thus the route itself. In one embodiment, a route planner window display consists of a route with three destination points (i.e., four route points including the origin). Selecting an icon representation of a location-relevant object, such as a wireless phone, and then dragging-and-dropping the icon into the route planner between the first and second destination points causes the wireless phone object to become the second destination in the route. Since the wireless phone's location can change with time, the route will be a dynamically calculated route based on changes in its position. Another benefit of this object is that if there are two or more destinations (i.e., three or more route points) the entire route does not have to be recalculated, but only the portion of the route that has changed, including any real-time position updates of location-relevant objects.

It is another object of the present invention to provide a method and system for creating a route by graphically dragging-and-dropping a list or icon representation of a user or group of users onto another list or icon representation of another user or group of users. A route can then be generated between the two location-relevant user objects, or the objects can
5 be included in a route planner window for the purpose of planning a new route. In one embodiment, the origin route point is defined as the first selected and dragged location-relevant user object, and the destination route point is defined as the location-relevant user object that the first object was dropped upon. The position information for these location-relevant user objects, if not stored locally, can be retrieved in real-time using the real-time
10 communication system. In another embodiment, the location retrieval process is based on the approval of the transfer of the required location information by the users.

It is another object of the present invention to provide a method and system for generating or planning a route from a user's current position information to or from the location of a location-relative object that is selected from a list or graphical icon
15 representation on a map using a drag-and-drop action. In one embodiment, a user can select a graphical icon representation of themselves in a list and drag said representation to the graphical icon representation in a list or on a map of any location-relevant object on a map, such as another user or a static POI, for the purpose of generating a route. The route's origin can be the user's current position information, and the destination can be the position
20 information of either a dynamic location-relevant object, such as a mobile user, where the real-time position information is received via the real-time communications system, or can be a static location-relevant object, such as a POI (i.e., gas station), where the position information may already be known. In the case where the position information for a POI is

not known, it can be retrieved using the real-time communication system connected to a database where the appropriate position information is stored.

It is another object of the present invention to provide a method and system for generating a graphical route history based on a dynamically generated or changing route. A pre-calculated route with two or more destination points will be recalculated when any of
5 those destination points change due to a position update via the real-time communication system. Instead of deleting the previous pre-calculated-route, the route portion that is different from the original route is graphically displayed differently than the recalculated route, thus providing the user with a greater amount of information. In one embodiment, an
10 icon representation of a location-relevant object, such as a car, that has been included into a pre-calculated route along with a stationary POI, such as a gas station, can initially display the pre-calculated route on a map. If the car's position, as updated via the real-time communication system, changes and is updated on the map display, such that the previous pre-calculated route no longer applies, a new route can be calculated based on its new
15 position information and displayed. The previous pre-calculated route can be displayed using a different highlighted color and pattern than the new route that was just calculated. Another benefit of this object is that if there are two or more destinations (i.e., three or more route points) the entire route does not have to be recalculated, but only the portion of the route that has changed will be displayed differently than the new route segment.

BRIEF DESCRIPTION OF THE DRAWINGS

FIG. 1 illustrates a computer system and a network system that provide an operating environment for the present invention;

FIG. 2 illustrates one embodiment of the present invention showing a real-time
5 communications program with an integrated mapping environment that displays various location-relevant objects on a map;

FIG. 3 illustrates one embodiment of the present invention for dynamically mapping a roster list of users and/or contacts using a drag-and-drop operation;

FIG. 4 illustrates one embodiment of the present invention for dynamically
10 mapping a user from an Instant Message window;

FIG. 4A illustrates one embodiment of the present invention for receiving location-relevant information in an Instant Message program and then mapping the received information in a separate mapping program;

FIG. 4B illustrates one embodiment of the present invention for displaying a
15 location request from another user;

FIG. 5 illustrates one embodiment of the present invention for displaying the location of a user on a graphical map;

FIG. 6 illustrates one embodiment of the present invention for sending, or sharing, a route with another user by using a graphical drag-and-drop operation;

FIG. 6A illustrates one embodiment of the present invention for sending, or
20 sharing, a route with another user by using a graphical menu selection operation;

FIG. 7 illustrates one embodiment of the present invention for sending, or sharing, a route with a user or group of users by using a menu selection operation;

FIG. 8 illustrates one embodiment of the present invention for selecting a user for the purpose of sending, or sharing, a route with a user on a menu list;

FIG. 9 illustrates one embodiment of the present invention for selecting a POI and graphically sending the location-relevant object to a vehicle by means of a real-time
5 communication system;

FIG. 10 illustrates one embodiment of the present invention for selecting a POI and graphically sending the location-relevant object to a user selected from a menu list;

FIG. 11 illustrates one embodiment of the present invention for selecting a POI and graphically sending the location-relevant object to a vehicle selected from a menu list;

10 FIG. 12 illustrates one embodiment of the present invention for graphically displaying the request to transfer a location-relevant object;

FIG. 13 illustrates one embodiment of the present invention for graphically transferring location-relevant information or objects from a user-to-user, or object-to-user where the initiator of the transfer acts as the hub;

15 FIG. 14 illustrates one embodiment of the present invention for graphically transferring one's own location information to another user;

FIG. 15 illustrates one embodiment of the present invention for graphically displaying a received route from another user, and that other user's current location along that route on a map;

20 FIG. 16 illustrates one embodiment of the present invention for graphically displaying the originally received route and the newly calculated route based on the local user's position information and the received destination points;

FIG. 17 illustrates one embodiment of the present invention for graphically adding a roster list user as a destination point to the graphical representation of a pre-calculated route;

FIG. 18 illustrates one embodiment of the present invention for graphically adding
5 a roster list user as a destination point in a route planner window;

FIG. 19 illustrates one embodiment of the present invention for displaying the graphical route created in FIG. 18;

FIG. 20 illustrates one embodiment of the present invention for graphically adding location-relevant object icon representations to a pre-calculated route;

10 FIG. 21 illustrates one embodiment of the present invention for displaying the graphical route created in FIG. 20;

FIG. 22 illustrates one embodiment of the present invention for graphically creating a route using location-relevant objects on a map, where one of the objects is a roster list user and the other is a POI;

15 FIG. 23 illustrates one embodiment of the present invention for graphically displaying the route created in FIG. 22;

FIG. 24 illustrates one embodiment of the present invention for graphically creating a route from location-relevant objects on a map, where both of the objects are icon representations of roster list users.

20 FIG. 25 illustrates one embodiment of the present invention for displaying the graphical route created in FIG. 24;

FIG. 26 illustrates one embodiment of the present invention for graphically adding location-relevant objects to a route planner using their icon representations;

FIG. 27 illustrates one embodiment of the present invention for graphically adding destination points to a route using location-relevant objects;

FIG. 28 illustrates one embodiment of the present invention for displaying the graphical route created in FIG. 24;

5 FIG. 29 illustrates one embodiment of the present invention for graphically creating routes using a roster list of users or contacts, where the local user is the origin of the route;

FIG. 30 illustrates one embodiment of the present invention for graphically creating routes using location-relevant objects on a map, where the local user is the origin of
10 the route;

FIG. 31 illustrates one embodiment of the present invention for displaying the graphical route created in FIG. 30; and

FIG. 32 illustrates one embodiment of the present invention for displaying a current dynamic route and a history of previous routes on the same map.

DETAILED DESCRIPTION OF THE EMBODIMENTS

The details of the preferred embodiments of the present invention will now be described with references to Figures 1-32.

The present invention provides a method and system for graphically sending (and
5 sharing), retrieving, and planning location-relevant information with a mapping and real-time
communications applications, where both applications can be integrated into one application
or each application is separate and capable of communicating with the other. The present
invention may be embodied in a mapping and real-time communication application, such as
the "Map Messenger" application owned and licensed by the Networks In Motion
10 Corporation of Pasadena, California.

FIG. 1 illustrates a high-level diagram of one environment that is a suitable
computing and networking environment in which the invention may be implemented. The
invention will be described in the general context of an application that executes on an
operating system in conjunction with a personal computer, but those skilled in the art will
15 realize that this invention also may be implemented in combination with other program
modules. Program modules typically include routines, programs, data structures, etc. that
perform particular tasks or implement particular abstract data types. This invention is not
limited to a typical personal computer, but may also be utilized with other computing
systems, such as handheld devices, mobile laptop computers, wireless phones, in-vehicle
20 navigation systems, programmable consumer electronics, mainframe computers, distributed
computer systems, etc., and the like.

FIG. 1 includes a typical personal computer **100**, that includes a central processing
unit (CPU) **135**, video adapter **134**, hard disk drive **107**, optical disk **108**, serial port **109**,

magnetic disk drive **110**, system bus **106**, and network interface **136**. The hard disk drive **107** typically refers to a local non-volatile storage system for storing large amounts of data, such as map data. The optical disk **108** typically refers to a CD-ROM disk used for storing read-only data, such as an installation program. The serial port interface **109** is typically used to
5 connect **113** the computer **100** to external devices **111**, such as a keyboard, mouse, and graphical touch screen interface, and also can connect **137** to positioning devices **138**, such as a GPS receiver. The keyboard and mouse **111**, amongst other input devices **138**, enable users to input information into the computer **100**. The connection **113** & **137** cables can include a serial cable or universal serial bus (USB) cable. Other input devices, that are not shown, may
10 include a joystick, scanner, camera, microphone, or the like.

The magnetic disk drive **110** is typically used to store small amounts data, in comparison to a hard **107** or optical **108** disk drive, and typically lacks the data transfer rates of those other storage drives, but it enables both readable and writable capability. The hard disk drive **107**, optical disk drive **108**, serial port interface **109**, and magnetic disk drive **110**
15 are all connected to the main system bus **106** of the computer **100** for transferring data. A monitor **116** or other type of display device, such as a LCD display, is connected **117** to the computer system's **100** video adapter **134**, which is connected to the system bus **106**. Additional peripheral output devices, which are not included in this embodiment, such as a printer, speaker, etc., can also be connected to a personal computer **100**. The system bus **106**
20 also connects to the network interface **136**, central processing unit (CPU) **135**, and system memory **101**. The system memory **101** contains both random access memory (RAM) **103**, and read only memory (ROM) **102**, that typically consists of the BIOS (Basic Input/Output System) of the computer, necessary for containing basic routines that enable the transfer of

information between elements within the personal computer **100**. The RAM **103** stores a number of program modules, such as the Mapping and Communication Program, including Map Data, **105**, and the Operating System **104** of the personal computing device **100** or personal computer **100**. One example of such a program module **105** can be the “Map
5 Messenger” program previously mentioned.

A network interface **136**, shown in FIG. 1, illustrates how data is typically transferred between other computing devices **122**, **126**, **127**, & **130** and a computer **100** through an Internet, Intranet, or Extranet network **124**. Additionally, this connection **115** can be implemented using a MODEM **112** that is connected **114** to the personal computing device
10 **100** by using a serial port interface **109**. In one embodiment, a computer **100** can connect **121** to a network **124**, such as an Internet, Intranet, or Extranet, by various means that are well known in the art, such as by using a Digital Subscriber Line (DSL) cable. Additionally, a computing device **100** can also connect to the Internet **124** by means of a wireless connection
15 **120** to a wireless base station **122**, where the antenna is coupled **119** to the network interface **136** of the computing device or personal computer **100**. The wireless base station **122** is also connected **123** to the Internet, Intranet, or Extranet network **124** by some means well known to people skilled in the art, such as a T1 connection. A wireless base station **122** can represent a local area network (LAN) base station, such as that used in an office building, or a wide area network (WAN) base station, such as that used in a cellular, Personal
20 Communications System (PCS), 3G, or the like, wireless phone network. The Internet, Intranet, or Extranet **124** allows for connection **129** & **128** to other personal computing devices **126** & **127**, such as a wireless phone, hand-held device, in-vehicle navigation (i.e., telematics device), or the like. The Internet, Intranet, or Extranet **124** is also connected **125**

to a central or distributed server system **130**, however this connection is not necessary in a peer-to-peer environment. This server system **130** can contain a real-time communication server **132**, a mapping server **133** which can provide map data for devices that do not have large storage capabilities, and a database **131** where location-relevant information such as
5 POIs can be stored.

The real-time communication system **150**, as illustrated in FIG. 1A, can be either one of two possible systems, both of which apply to this invention. The first embodiment is a peer-to-peer system, where each computing device **100, 126, & 127** is connected to the Internet, Intranet, or Extranet **124** by some means **120, 122, & 123, or 121, or 115, 112, &**
10 **114, or 129 or 128**, such as a wireless connection or landline connection. This connection provides the capability for all computing devices **100, 126, & 127** to communicate directly with each other, in a peer-to-peer manner. This peer-to-peer environment allows for an ad-hoc user-to-user configuration for sending data to and from all users. The second embodiment, sometime referred to as a star configuration system to people skilled in the art,
15 uses a centralized (or distributed) server system **130** that is connected **125** to the Internet, Intranet, or Extranet **124** providing the infrastructure for all computing devices (**100, 126, & 127**) where each user's computing device **100, 126, & 127** is connected directly to the server system **130**. The server system effectively acts as a router for passing location data to and from individual or groups of users.

20 FIG. 2 illustrates an application screen display of the Real-Time Communication and Mapping Program (RTCMP) **201** with a sample map **224** displayed below a menu bar **200**. A location-relevant object is a map object that has a spatial component associated with it, such as latitude and longitude values, and is graphically selectable by the user. Identified on the

map display **224** are several location-relevant objects **211, 210, 212, 206, 205, 203, & 204**, that are selectable either in the RTCMP **201**, or, when the two applications have been separated, such as shown in FIG. 4A, in the mapping application **419**. A user is an entity, which can be an inanimate object (i.e., phone, vehicle, boat, etc.) or a living thing (i.e.,
5 person, pet, etc.) that uses the real-time communications system to communicate with other users. An example of various location-relevant objects, as shown in the sample map **224**, includes a person (i.e., user) **211**, vehicle (i.e., user) **205**, plane (i.e., user) **203**, POI (i.e., a gas station) **210**, map identifier (i.e., city name) **212**, route **206**, and a geo-fenced boundary **204**. A route **206** is comprised of an origin **207** and one or more destination points **209 &**
10 **202**, which can each be considered a “link”. the route is illustrated as a series of links, such as link **209** that connects an origin **207** and a destination **202**. It should be noted, and appreciated to those skilled in the art, that a link need not be a straight line as illustrated in the sample map **224**, but rather follows the topography of the roadways calculated between two route points, such as an origin **207** and destination **202** point. However, for simplicity, all
15 links are illustrated as straight lines.

Also provided in the RTCMP **201** is an icon pointer **208**, or cursor, that provides a signal to the RTCMP **201** to indicate an active segment of the display **201**. When an element or object of the screen display is coincident with the focus of the icon pointer **208**, that element or object is said to have the focus of the icon pointer **208**. When the input device,
20 such as a mouse, receives a triggered input, such as a mouse click or tap of a touchpad, the element having the focus of the icon pointer **208** at that moment is selected.

The real-time communication **212** part of the application is illustrated to the left of the map **224**. The real-time communication feature **212**, denoted as the messenger window,

preferably provides a listing of users that are connected, in real-time communication, to the user's application. This list of users **212** is denoted as a roster list of users. The top-level user **213**, or the controller of the RTCMP **201** program, is illustrated as "User A" **213**. "User A" **213** has two groups **214** & **219** beneath it, with each group consisting of four users. The first group, denoted as "Group 1" **214**, has four users organized within it, "User 1" **215**, "User 2" **216**, "User 3" **217**, and "User 4" **218**. The second group, denoted as "Group 2" **219**, also has four users beneath it **220**, **221**, **222**, & **223**, where a user in this group **219** is represented here as, for instance, a vehicle.

FIG. 3 illustrates one embodiment of a situation where a user can map another user's location using a simple graphical method of selecting a user, contact, or group of users or contacts, and dragging-and-dropping its graphical representation onto the map display **224**. For example, in order to map "User 1" **215** icon pointer **301** is used to select the roster list representation of "User 1" **215**, typically by such mechanisms as a mouse "click-hold" or a "tap-hold" of a touchpad for a handheld device. This action typically provides feedback to the user by highlighting or outlining **306** the selected user, such as "User 1" **215**. The list representation of "User 1" **215** is then dragged **302** into the map display **224**, and "dropped" **303**, such as when the mouse "click" (or button) or the tapped-hold in a handheld device is dropped. People skilled in the art know that a "drag" or "drop" operation for a desktop computer with a mouse is different than a handheld device, but the essence of both operations remains the same. The drop action generally occurs when the user stops dragging the icon pointer and releases the mouse button. The release of the mouse button, at the point of the focus of the pointer **301** and at the moment the mouse button is released anywhere on the map display **224**, is identified by the RTCMP **201**.

This “drag-and-drop” operation signals to the RTCMP **201** program to initiate a location request, depending on whether the location information for the selected roster list user is stored locally, as in the form of a contact **311**, or remotely, as in the form of a user **215** connected by the real-time communication system **150**. If the selected user’s location information is stored locally, as is the case with a contact whose location information is typically stored in a vcard that is located locally in the storage medium (such as a hard disk drive **107** or magnetic disk drive **110**) of the computing device **100**, then the location request retrieves the said location information and uses that for the mapping operation. If the location information is stored remotely, or is updated in an on-demand format, then the real-time communication system **150** is used to retrieve the location information from the remote user, such as “User 1” **215**.

In one embodiment, “User 1” **215** represents a user with a wireless phone. After the process of “dragging-and-dropping” the user’s graphical representation, such as “User 1” **215**, onto the map display **224**, the RTCMP **201** uses the real-time communication system **150** to initiate a request for “User 1’s” **215** location. This location request is communicated via the real-time communication system **150** to “User 1’s” **215** computing device application and either notifies “User 1” of the location request or automatically retrieves “User 1’s” current location information from “User 1’s” RTCMP **126**. A notification of a location request is given to “User 1” if its permissions and/or preferences that specify notifications of location requests are preferably required for “User A” or for all users on “User 1’s” roster list. Note that “User 1’s” RTCMP **126** does not have to be in the exact form of “User A’s” RTCMP **201**, but only provide the functionality required by the real-time communication system **150** for the sending of location-relevant information. For instance, “User 1” **215** does

not have to have a positioning device, such as a GPS device **138**, connected to their RTCMP **126**. The location information for “User 1” **215** may only include its vcard information, which is stored locally on “User 1’s” computing device. After the location information from “User 1” **215** has been retrieved and sent back through the real-time communication system **150**, “User A’s” RTCMP **201** maps “User 1’s” **215** retrieved location on the map display **224** of varying resolution and size. FIG. 5 illustrates “User 1’s” current position **501** on a map display **224** of “User A’s” RTCMP **201**.

Additionally, in another embodiment shown in FIG. 3, “User A” **213** can select **304** a contact, such as “Contact 1” **311**, and, using the same “drag **305** and drop **303**” method, can map the contact’s location information on the map display **224** of varying resolution and size. As people skilled in the art will appreciate, this “drag-and-drop” method allows users to retrieve and map location information locally or remotely through a real-time communication system **150**. In another embodiment, illustrated in FIG. 4, a typical Instant Message (IM) window **407**, known to people skilled in the art, includes, for desktop computing devices, a menu bar **410**, text entry window **405**, and a send button **406** for use in transferring composed messages. An IM window **407** typically also displays the user identification token **409** (i.e. user’s name, email address, etc.) of the remote user to which these instant messages are being sent. While engaged in an instant message session with another user **409**, the local user (i.e., “User A” **213**) preferably types messages that are viewable in the message window display **408**, also included in a typical IM window **407**. As people skilled in the art will appreciate, in one embodiment, a method for mapping **401** and requesting a user’s text location **403** information, as shown in FIG. 4, can be implemented by pressing a button **402** & **403** on an IM window application. For example, if a user wishes to receive another user’s

current geo-coded street address information, without mapping that user's location on a map, such as receiving the text "738 Lawrence Road, Pasadena, CA, 91101", a user only need to press a button **403** on an IM window **407**. The real-time communication system **150** preferably request from the other user their current location information, which includes
5 obtaining their permission for transferring the said location information.

One embodiment of such a permission request is illustrated in FIG. 4B. For example, a user using a similar IM window **452**, which illustrates that real-time communication (i.e. instant messaging) is occurring with "User A" **450**. The other similarities to the previous IM window **407**, such as the menu bar **460**, send button **453**, and message composition window
10 **454** are also shown. The location request **459** may resemble a message in the message window display **451**, displaying the option to accept **455** or decline **458** the location request **459**. A user can accept **455** or decline **458** the location request **459** by using an icon pointer **457** to select either choice. Upon accepting the location request **459** from "User A" **450**, the local RTCMP would acquire its current position information from a positioning device **138**
15 or from pre-defined position information, such as a default home address stored locally in a computer file. After the location information for the accepting user has been sent to the requesting user's (i.e. "User A") real-time communication program, the IM window **407** will display said location information.

In another embodiment, "User A" **213** can request "User 1's" **409** location
20 information for mapping. The same process is initiated and once the location information for "User 1" **409** has been obtained, a mapping program **413** or map display **224** preferably display on a map of varying resolution and size "User 1's" **409** current location **501**. Additionally, another embodiment for mapping "User 1's" **409** location information using

the real-time communication system **150** is to graphically select **404** the message display window **408** of the IM window **407** and “drag **411** and drop **412**” onto a mapping program **413**. This would cause the mapping program **413** to map the user’s current location of varying resolution in the map display of the mapping program **413**. For both embodiments, where the real-time communication program **407** is not part of the mapping program **413**, a hardware or software conduit (e.g., API) is necessary in order to pass the necessary commands that will trigger the mapping program **413** to map the desired location of varying resolution. This mapping operation can also be completed using the ‘Locate On Map’ **402** button or from a similar action familiar to those skilled in the art.

10. An additional benefit of this invention, as illustrated in FIG. 4A, is that both the real-time communication program **414** and mapping program **419** need not be integrated into one application. The only requirement is that the two applications allow the transfer of the necessary data required for this invention, which can be accomplished, as people skilled in the art know, by using software API, DLLs, or the like. In another embodiment, as shown in
15 FIG. 4A, a location request and mapping event can be triggered using a real-time communication program **414**, by selecting from a menu **417** the function **418** to map a user’s location. Current prior art system, such as Microsoft’s MapPoint can be integrated with a PIM manger, such as Microsoft’s Outlook to allow a user to initiate the MapPoint application such that it displays the address information of a contact by clicking a button in the PIM
20 manager. However, the advantage of this invention over this and other prior art systems, as people skilled in the art will appreciate, is that the location-relevant data is obtained, in a graphical manner, via a real-time communication system **150** from other users or from an Internet-connected database **131**.

In another embodiment, a user can use an icon pointer **416** to select a user **421**, or set of users **415**, whose location information should be mapped on a separate, non-integrated mapping program **419**. The user can then invoke the appearance of a pop-up menu **417** or a menu available from the menu bar of the application **422**, and then choose the option from either menu to map the user's location. The appearance of the pop-up menu **417** can be invoked either by "right-clicking" the selected user's graphical representation in the roster list, or by using a tap-and-hold operation on a handheld device, which are all well known techniques to people skilled in the art. The pop-up menu **417** would illustrate various actions, one of which is mapping the selected user's location **418**. Selecting the option to map the selected user's location would cause the location information to be retrieved as previously described in this section. Once the real-time communication program **414** has received the location information from the appropriate user **421**, the program **414** would establish a connection with the mapping program **419** and pass the necessary data to initiate the mapping of varying resolution and size of the retrieved location information **420**.

This invention provides the ability send location-relevant objects to other users, and as people skilled in the art will appreciate, location-relevant objects may include routes. In one embodiment, as shown in FIG. 6, a pre-calculated route **206** is defined as having an origin **207** and one or more destinations **209 & 202**. Making a route selectable by an icon pointer **604** enables the local user **213** to initiate the process of sending the route to a user, or group of users in their roster list, as shown in FIG. 6. To send a route to a user or group of users, a local user **213** first selects the route **206** with their icon pointer **604** and drags **602** the route to the graphical representation for the specific roster list user, such as "User 1" **215**, to which the route should be sent. The graphical representation for "User 1" **215** illustrates

some feedback to the local user **213** controlling the pointer that the route selected **601** is ready to be sent. The feedback, as know to people skilled in the art, is typically shown as a highlighted image **603** on the graphical representation of the selected user that the dragged object should be sent to.

5 The two displayed icon pointers **604** & **601** in FIG. 6 illustrate different actions. Specifically, the first pointer **604** illustrates that a user is about to select a location-relevant object, while a second pointer **601** illustrates that an object has been selected and is now being dragged with the pointer **604**. Once the route **206** has been dropped onto the graphical representation of the destination user “User 1” **215**, the route is sent via the real-time
10 communication system **150** to the destination user “User 1” **215**. In this embodiment, the destination user “User 1” **215** has an option to accept **1203** or decline **1204** the receipt of the route from the sender “User A” **213**. In one embodiment, as shown in FIG. 12, “User 1” **215** can receive in its IM window **1205** the request for the receipt of location-relevant information, indicating the option to accept or decline the receiving of said route by a
15 message text question **1211** within the IM window’s text display **1208**. The IM window **1205** is similar to the previously mentioned IM windows **407** & **452**, since it also includes a menu bar **1210**, a user identification display of the current user the message window is connected with **1209**, a text entry window **1207** and a send button **1206**. The remote user, “User 1” **215** can accept **1203** or decline **1204** the transfer using their icon pointer **1202**.

20 Additionally, in another embodiment, a user can send a route **206**, shown in FIG. 6A, using a similar approach. For example, a user **213** can select the route **608** and then immediately select the user “User 1” **215** to which the route **206** should be sent. This process does not require the drag-and-drop method, displays a different line type **607** to indicate the

route sending selection process has begun, and consists of two back-to-back selection processes. The first selection **608** is the selection of the route **206** or location-relevant object, and the second selection **605** is the selection of the destination user **215** to which the route **206** should be sent. Prior to the second selection **605**, the local user **213** can move the pointer

5 **608** over the destined user **215**, where the user **215** can highlight **606** indicating that the user **215** has been selected. Once the second selection **605** has been made, a menu **609** would pop-up displaying the options for the local user **213** to take, one of which, as in this case, is to send the route to the highlighted **606** user “User 1” **215**. Once the local user **213** moves the icon pointer **608** over the menu **609** and selects “Send ‘Route’ To User 1” **610**, as shown in

10 FIG. 6A, the route **206** will be sent to the user “User 1” **215** using the real-time communication system **150**.

Other embodiments exist for this invention for sending location-relevant objects, such as selecting a location-relevant object, such as a route **206**, as shown in FIG. 7. After the route **206** has been selected using the icon pointer **700**, a pop-up menu appears **701** that

15 displays the local user’s **702** roster list of users and groups of users, including the local user **702** itself. Using the icon pointer **802**, as illustrated in FIG. 8, the local user **213** can select **801** the graphical representation of the user **704** to which the route **206** should be sent. The process is completed when the user “clicks” or “taps” the destination user or group of users, or by an equivalent mechanism known to people skilled in the art. In this embodiment, the

20 route **206** that is sent includes all necessary information to completely re-create the route **206** on the remote user’s **704** application without any loss of information.

Other location-relevant objects, as people skilled in the art will appreciate, include POIs, such as map identifiers which include names associated specifically with a map, such

as city names, street names, highways names, interstates names, rivers names, state names, or a map name that is associated with a location. A POI can include, without limitation, a house, business, person, pet, map identifier, etc., and is also a well known term to people skilled in the art. For example, if a map displays a name on a map display, then that location on the map can be assumed to be the location associated with the displayed name. This invention allows users to send map identifiers using the real-time communication system 150 to other users in their roster list or, in an ad-hoc manner, to other users identified by a unique identifier, such as an e-mail address, telephone number, or the like.

On a map display 224 a user 213 preferably uses the icon pointer 901 to select 903 a map identifier, such as a city name 902. After selecting 903 the city name 902, the user can drag 904 the location-relevant object to the graphical representation for another user 220 in the local user's 213 roster list. As an aid to the user 213, the application can highlight 906 the specific user 220 that the icon pointer 905 is focused 220 on. Once the user 213 releases, or drops, the location-relevant object 902 on the destination user 220, then the location-transfer process begins by using the real-time communication system 150, sending the POI to the selected user as previously described, thus allowing the receiving user 220 to utilize the location-relevant object for a number of purposes, such as mapping, routing, etc.

Another embodiment of sending POIs, which include map identifiers, is illustrated in FIG. 10. After a user selects a map identifier, such as the city name Pasadena 902, with an icon pointer 1001, a new pop-up menu would appear 1002 showing the main user's 213 roster list. Selecting a user "Vehicle 1" 309 from this pop-up menu will initiate the sending of the selected POI 902 to the selected user 309. Using the icon pointer 1101, shown in FIG.

11, to select **1103** the specific user **309** to send the POI to allow the local user to effectively send POIs over the real-time communication system **150** to any user in their roster list.

As people skilled in the art will appreciate, a local user of the RTCMP **201** program can transfer location-relevant information between users on their roster list, where the initiator acts as the location transfer hub of said location information. In one embodiment, as shown in FIG. 13, the local user **213** of the RTCMP **201** program can send the location information of "User 1" **215** to "User 4" **218** by using a graphical method. For example, the local user "User A" **213** can use the icon pointer **1316** to select **1302** the source user "User 1" **215**, where a selection is known to be made when the icon pointer **1301** is illustrative of a selected object, when compared to the normal icon pointer symbol **1316**. The graphical representation of "User 1" **215** can then be dragged **1304** to its destination position, which in this example is the graphical representation for "User 4" **218**, so that the location information of "User 1" **215** is transferred to "User 4" **218**. This action is completed in the RTCMP **201** program by moving the icon pointer **1301** to the new location **1303** over the destination user "User 4" **218**. The destination user "User 4" **218** is highlighted **1317** when the icon pointer **1303** is focused on the destination user "User 4" **218**.

The real-time communication system **150** provides the infrastructure for this transfer. The transfer occurs by requesting the location information from "User 1" **215** and after "User 1" **215** has agreed to sending their location information to "User 4" **218**, the location transfer can occur using a number of methods of the real-time communication system **150**. For example, a peer-to-peer method can be employed, sending the information directly from "User 1" **215** to "User 4" **218**, or the location-information can be sent to a real-time communication server **132** and then redirected to the "User 4" **218**. Additionally, the

location-information can be sent from "User 1" 215 to the RTCMP 201 of the initiating user "User A" 213 and then sent to "User 4" 218. The first two methods allow "User A" 213 to initiate the transfer, even if "User 1" 215 and "User 4" 218 do not have each other in their own roster lists, and the location-information does not necessarily ever have to be sent to the
5 initiating user "User A" 213. As people skilled in the art will appreciate, the mapping program does not need to be integrated with the real-time communication program in order to compete this transaction, as shown in FIG. 4A as "Application 1" 414.

Another embodiment of transferring location information between other users, where the initiator acts as the location-transfer hub, is shown in FIG. 13. If the destination user is
10 illustrated as an icon map object 1312, representing "Vehicle 1" 220, location-relevant information and objects can be transferred to the vehicle icon 1312, and thus the user of "Vehicle 1" 220 by selecting objects and dragging and dropping them onto the icon representation of "Vehicle 1" 1312 on a map display 224. For example, by selecting 1315 "Vehicle 4" 223, using the icon pointer 1314, "User A" can drag 1313 the icon list
15 representation of "Vehicle 4" 223 onto the map icon representation of "Vehicle 1" 1312, and drop or select the icon map representation of "Vehicle 1" 1312 using the icon pointer 1311. This will initiate, as previously described, the transfer process of sending "Vehicle 4's" 223 location information to "Vehicle 1" 220 using a graphical method. Also, this process can be reversed, since the local user 213 can select 1311, drag 1313 and drop 1314 the vehicle icon
20 representation of "Vehicle 1" 1312 to the "Vehicle 4" user list representation 223, thus initiating the location transfer from user "Vehicle 1" 220 to user "Vehicle 4" 223. Additionally, this process can be done using a user's icon map representation 1308 to graphically initiate the transfer of "User 2's" 1308 current location information to another

user's icon map representation, such as "Vehicle 1" **1312**. In another embodiment, selecting "User 2's" **216** icon map representation **1308**, and using the icon pointer **1309** to drag **1310** and using the icon pointer **1309** to drop the icon onto the "Vehicle 1" **220** user map icon representation **1312** initiates the location-transfer from "User 2" **216** to "Vehicle 1" **220**.

5 In another embodiment, a local user **213** can select **1306** a POI **1305**, such as a gas station, drag **1307** it to the vehicle icon map representation **1312**, and drop it, using the icon pointer **1311**, onto the vehicle icon map representation **1312** of "Vehicle 1" **220** in order to initiate the transfer of the POI **1305** to "Vehicle 1" **220**. The difference of this scenario compared to the previous location-transfers, is that the location for the POI **1305** is known, or
10 not changing since the POI **1305** is a static object (i.e., similar to a map identifier), prior to the start of the location transfer process. Thus, a location request need not be sent to the POI **1305**, since its location is already known. The real-time communication program of the RTCMP **201** will then transfer the location-information of the POI **1305** to the selected user **1312** immediately upon their acceptance of the transfer.

15 Another advantage of this invention is that it allows a local user **213** to send their current location to another user on their roster list graphically. In one embodiment, shown in FIG. 14, "User A" **213** uses the icon pointer **1402** to select **1401** their own icon list representation and then drags **1403** the icon pointer **1405** to another user's icon list representation **218**. The highlight **1404** is shown to illustrate that the icon pointer **1405** is
20 over "User 4's" **218** icon list representation. Dropping or releasing the icon pointer **1405** initiates the transfer of the location information of "User A" **213** to the selected user "User 4" **218**, and sends the location information after the requested user "User 4" **218** has accepted the transfer of said location information. As people skilled in the art will appreciate, this

graphical transfer of the local user's location information significantly reduces the process required in prior art systems.

As illustrated in FIG. 6, the invention allows a user to send a route to another user. After the destination user has accepted the route, as illustrated in FIG. 12, if the remote destination user is running a RTCMP **126** similar to the sender's RTCMP the received route **1505** will be displayed in the destination user's map display **224**, as shown in FIG. 15. The received route **1505** is the same as the original route **206**, with the same origin **1501** and destination points **1502** and **1503** as the original route **206**, except that the received route **1505** is being displayed on the destination user's ("User 1") **215** RTCMP **126**. Additionally, the sender **213** has the option to also send their own real-time location information **1504** via the real-time communication system **150** to the destination user **215**, which can then be graphically displayed on the map display **224** of the destination user's ("User 1") **215** RTCMP **126**. As people skilled in the art will appreciate, this allows users to send or share routes with other users in real-time.

An additional benefit of this invention, as shown in FIG. 16, is that the received route **206** does not have to include only the sending user's ("User A") **213** original route origin and destination points, amongst all the other parameters that completely define the sent route, such as the map database identifier, all relevant turn points, user preferences, etc. The destination user's ("User 1") **215** RTCMP **126** can automatically adjust the received route's **206** origin and destination points based on the destination user's ("User 1") **215** RTCMP **126** preferences. For example, the new origin of the received route can be automatically changed to the destination user's ("User 1") **215** current location information or to a chosen origin

location, and the sent route **206** can then be recalculated and displayed on the destination user's map display **224**.

In one embodiment, illustrated in FIG. 16, the original received route **1505**, consisting of origin **1501** and destination points **1502 & 1503**, is displayed on the local user's ("User 1") **215** map display **224**. Additionally, the real-time location information **1504** of the sending user ("User A") **213** is also sent to the local user's ("User 1") real-time communication program and displayed on the map display **224** of the local user's ("User 1") **215** RTCMP **126**. A received route may include a destination location where the local user ("User 1") **215** may want to meet the sending user ("User A"). In this case, the local user ("User 1") **215** would want to calculate a new route **1602** based on its own current location information **1601** and the desired meeting and/or destination points **1502 & 1503** present in the received route **206**. A benefit of this invention is that all links **1603** in the route need not be re-calculated, but only the part of the received route **206** that has changed.

For example, the portion **1505** of the received route **206** (which consists of route points **1501, 1502, & 1503** and links **1505 & 1603** as shown in FIG. 16) between points **1501** and **1502** is the only portion of the route **1505** that needs to be recalculated, since the destination points **1502 & 1503** are common between both users. Thus, a new link **1602** can be calculated based on the received route's first destination point **1502** and the local user's ("User 1") **215** current location **1601** or preferred origin point. The rest of the route links **1603** can remain common between both users. Additionally, as shown in FIG. 16, the original received route **206** could be displayed in combination with the new route **1602** and the real-time location of both users **1504 & 1601** along those routes can also be displayed.

In addition to having the capability to map roster list users and contacts, send location-relevant information and objects, such as POIs, routes, etc., and handle permission issues with sending and receiving said location-relevant information and objects, all using the real-time communication system **150**, this invention also has the capability to modify, create, and save routes using the real-time communication system **150**. As people skilled in the art will appreciate, modifying, creating, and saving routes via a real-time communication system **150** allows users to make use of mapping and routing applications not available in current or prior art. The following figures relating to routes assume the application is in a route-planner mode, except as otherwise noted, since some of the same actions that are used for sending and mapping POIs can also be utilized for modifying, creating, planning, and retrieving routes.

As illustrated in FIG. 17, a route **1708** is defined as a combination of destination points **1701**, **1702**, & **1703**, or an origin **1701** and one or more destination points **1702** & **1703**. A map display **224** showing a pre-calculated route **1708** provides a user with a graphical illustration of the route, which provides better planning capabilities than standard driving directions or text information. Current prior art, such as Microsoft's MapPoint application, allows the ability to graphically add destination points to a pre-calculated route by selecting a point on the route and dragging-and-dropping the selected point to a new location in order to add a new destination point or change an existing one. As people skilled in the art will appreciate, using a real-time communication system **150** with a mapping application allows the capability to add users, contacts, or groups of users and contacts, using a graphical mechanism, to a pre-calculated route. In one embodiment, as shown in FIG. 17, a user can select **1704a** user **215** from a roster list of users using a icon pointer **1705**. The user

can then drag **1706** the selected user **215** to a point **1709** on the pre-calculated route **1708** to dynamically add a new destination point **1709** to the pre-calculated route **1708**, which corresponds to the current location information for the selected user which is obtained from the real-time communication system **150**. As an additional benefit, a user can select a point

5 **1709** on a pre-calculated route **1708** using the icon pointer **1707** where a new destination point should be added, and drag **1706** that point **1709** with the icon pointer **1705** to a user, contact, or group of users and contacts in the messenger window **212**.

Once the selection in the messenger window **212** is highlighted **1704**, the icon pointer **1705** is dropped or released over the icon list representation for a user "User 1" **215**. This

10 action would cause the current location information for "User 1" **215**, obtained using the real-time communication system **150**, to be added as a new destination point in the route **1708**. As people skilled in the art will appreciate, the real-time communication system **150** does not have to be used, since the location information can be retrieved locally, as is typically the case with a user's contact information.

15 Both of the previously described methods for adding a user, contact, or group of users or contacts to a pre-calculated route involve adding them to a portion of the pre-calculated route. In the provided embodiments, as shown in FIG. 17, this was between the pre-calculated route points "1" **1701** and "2" **1702**. The location information of the user, contact, or group of users or contacts can be incorporated into the route as a new destination point

20 between these two points. The result is a system without the burden of recalculating the preferred order of destinations each time a new destination is added. The new destination is directly inserted in the proper order because the user is presented with the graphical representation of the pre-calculated route and has graphically identified the order position of

the new destination point. The RTCMP **126** does not need to recalculate the entire route, but rather only the portion that was altered by the addition of the new destination.

Another aspect of this invention is allowing the user to directly add destinations, similar to the previous embodiments, except that the user selects **1801** the user, contact, or group of users or contacts with the icon pointer **1802** and drags **1803** the listing representation of the user "User 1" **215** to a route planner window **1710** and adds **1804** the selected **1801** user "User 1" **215** in the preferred destination order. Similarly, as illustrated before, the destination order is determined by the order that the user adds the new destinations to the route planner window **1710** or the position in which they are added if an origin **1701** and/or destination points **1702 & 1703** already exist. For example, Los Angeles, CA **1701** is the origin, while Kansas City, MS **1702** is the second stop and New York, NY **1703** is the final destination. When the user adds the location of the selected **1801** user "User 1" **215** in-between **1804** the origin **1701** and first destination **1702**, the route is recalculated based on the new order and on the retrieved location-information of the user "User 1" **215** added to the route **1708** in the route planner window **1710**. The location information for user "User 1" **215** is retrieved using the real-time communication system **150**.

As illustrated in FIG. 19, the map display **224** shows a new route **1901** that includes the new destination point of Dallas, TX **1902**. The route planner window **1710** illustrates the added destination point of Dallas, TX **1902** as the first destination point (i.e., point #2), the order of which was determined by the point at which the dropping or releasing action occurred, typically by using a mouse click release or any other acceptable mechanism for releasing the element with the focus of the icon pointer **1804**, as shown in the previous

figure. The origin and destination order of the route **1708** in the route planner window **1710** is follows that displayed in the map display window **224**.

In one embodiment, when the route planner window **2013**, as shown in FIG. 20, is open, the system is considered to be in a route-planning mode. Figures 20-21 illustrate the addition of roster list users and POIs to a pre-calculated route using a graphical method. As shown in FIG. 20, a pre-calculated route **2004** is has an origin of Los Angeles, CA **2001** and destination points Kansas City, MS **2002** and New York, NY **2003**. The origin and destination points are shown graphically on the map display **224** in the form of a route **2004** and in the route planner window **2013** in the form of a list. Both static POIs, whose positions are stored in the map data of the RTCMP **201** and dynamic POIs, which are graphical icon representations of roster list users whose position information is obtained using the real-time communication system **150**, can be selected on the map display **224** using a graphical method defined by this invention to graphically add origin and destination points to a pre-calculated route.

In one embodiment, a user can select **2006** a graphical icon representation of a user **2005**, whose position information is obtained using the real-time communication system **150**, then using the icon pointer **2006**, drag **2012** the icon representation of the user **2005** to a pre-calculated route **2004**. The point **2014** at which the user releases the selected object using the icon pointer **2007** is added to the pre-calculated route as a new destination point. Additionally, a user can select a static POI **2009**, such as a gas station, using the icon pointer **2008**, and drag **2013** the POI icon to the route planner window **2013** in order to add the new destination point in between the first **2002** and second **2003** destination points. Adding a new destination point can automatically recalculate the new route, or the user can initiate the new

route calculation. Also, the user can drag **2011** the selected static POI **2009** to the pre-calculated route **2004** and add a new destination point to the pre-calculated route **2004** at the point **2015** where the POI icon was dropped by releasing the selected POI **2010**, which is done, as known to people skilled in the art, by a mouse click release, tap release, etc.

5 The newly added destination points can also be illustrated in the route planner window **2013** as italicized, indicating that they are to be added once the route has been recalculated. As shown in FIG. 21, the new route that was calculated in the previous example includes the new origin **2001** and destination points **2101**, **2002**, **2102**, & **2003**. The new destination points that were added are shown in FIG. 21 as San Jose, CA **2101**, which is the
10 position of another user **2005** updated using the real-time communication system **150**, and Blacksburg, VA **2102**, the position of the POI **2009**. It should be noted, and appreciated by those skilled in the art, that the only the links of the route that have changed are the ones that need to be recalculated and not the entire route. Under this example, the entire route needs to
15 be recalculated.

15 Another benefit of this invention is illustrated in FIG. 22. In route-planner mode a user can select **2206** a POI **2205**, such as a gas station, and drag **2204** it to a graphical icon representation **2202** of a roster list user on the map display **224**, and then drop or release the icon pointer **2201** with the focus over the graphical icon representation **2202** of a roster list user in order to create a route from the location of that roster list user to the selected POI
20 **2205**. Additionally, after having selected the POI **2205**, when the icon pointer **2201** is focused over the graphical icon representation **2202** of the roster list user on the map display **224**, the messenger window **212** icon listing of said user **220** will also highlight **2203**, as illustrated in FIG. 22. It should be noted that the location information of the roster list user

whose graphical icon representation **2202** was selected was known and can be periodically updated using the real-time communication system **150**. The calculated route **2304** between “Vehicle 1” **2202** and the “Gas Station” **2205** whose address is in Pittsburgh, PA is displayed in the map display **224** of Fig 23. Additionally, the route planner window **2303** illustrates the
5 order of the origin **2301** and destination **2302** of the route **2304**.

As people skilled in the art will appreciate, multiple POIs can be added to the route **2304** using this approach, such that each POI, in this embodiment, is added as the last destination in the route **2304** and displayed as such in the route planner window **2303**. Additionally, this method of adding a destination to a route can be reversed, such that, in one
10 embodiment, the graphical icon representation **2202** of the roster list user “Vehicle 1” **220** can be dragged onto a POI’s graphical icon representation **2205** on the map display **224**. In this embodiment, the order of the destinations is chronological, according to the time a new destination point was added to the route **2304**. In both of these embodiments the route is dynamically calculated based on location updates from the real-time communication system
15 **150**.

An added benefit of this invention is that the destination points of the previous embodiments do not have to be static POIs, but can be dynamic POIs that represent roster list users and the real-time communication system **150** can be used to obtain real-time location updates. One embodiment, shown in FIG. 24, includes two graphical icon representations
20 **2403 & 2406** of roster list users “Vehicle 1” **220** and “User 4” **218**, respectively. The selection of the graphical icon representation **2406** of roster list user “User 4” **218** causes the roster list window **212** list representation of “User 4” **218** to highlight **2407**. Dragging the select user **2406** using the icon pointer **2405** so that it is positioned over the graphical icon

representation **2403** of roster list user “Vehicle 1” **220** causes the roster list window **212** representation of user “Vehicle 1” **220** to highlight **2402**. Once the graphical icon representation **2406** of roster list user “User 4” **218** is dropped or released onto the graphical icon representation **2403** of roster list user “Vehicle 1” **2403**, a real-time route between the
5 first user **2406** (‘destination’) and the second user **2403** (‘origin’) is created. Since the initial location information for both users are known, the real-time communication system **150** can be used when new position updates arrive, and then a new route is recalculated based on those new locations. Shown in FIG. 25 is the route **2504** calculated between the graphical icon representations for the origin user **2403** and destination user **2406**.

10 The route planner window **2501** also shows the order of the route between the two users, where the origin **2502** is the location of “Vehicle 1” **220** and the destination **2503** is the location of “User 4” **218**. As people skilled in the art will appreciate, multiple destinations can be added to this route using both static (i.e., POIs) and dynamic (i.e., roster users) location-relevant objects, where the order, in this embodiment, of the new destination point is
15 based on the order it was added.

Using this invention also allows for adding POIs to a route planner using a drag-and-drop method. In one embodiment, as shown in FIG. 26, a POI **2601**, such as a map identifier (i.e., city name of Pasadena), can be graphically selected using an icon pointer **2602** and using a dragging motion **2603** or some other accepted practice used by those in the art. The
20 selected POI **2601** can then be dragged into a route planner window **2609**. The user can then use the icon pointer **2604** to drop the POI **2601** into the route planner window **2609**, where the focus of the icon pointer **2604** relative to the current origin **2606** and destination points **2607 & 2608** determines the new order of the origin and destination points. For example, the

POI **2601** was added to the end of the list of origin and destination points in the route planner window **2609**, thus causing this POI **2601** to be the last destination **2605** of the route, which can be either a pre-calculated or a previously-uncalculated route.

Illustrating the use of a combination of both static POIs and dynamic POIs, which
5 represent roster list users, in the graphical creation of a route is further shown in FIG. 27. In one embodiment, with the program in a route mode operation, a user can create a route by selecting **2701** the icon list representation of a roster list user "User 1" **215** using an icon pointer **2702**. Then by dragging **2703** the roster list user icon list representation **215** to a graphical icon representation **2704** on a map display **224** and releasing it with the icon
10 pointer **2705** focused over the destined object **2704**, so that the destined object's **2704** roster list representation **223** is highlighted **2709** in the roster list window **212**. This action will add both objects to a route in the route planner window **2710**.

For instance, the origin **2711** is the location of the destined object **2704** of the drag
2703 operation, and the first destination point **2712** is the location of the roster list user **215**.
15 The same process can be completed using a static POI **2707**, where the user selects the POI **2707** using an icon pointer **2708** and drags **2706** the icon pointer to the desired map object **2704**. When the icon pointer **2705** is focused on the desired map object **2704** on the map display **224** and then released both objects will be added to the route in the route planner window **2710**. Since the destination object is already the origin **2711** in the route planner, the
20 POI **2707** is added to the end of the destination points **2713** in the route planner window **2710**. It should be noted that as location updates arrive using the real-time communication system **150**, the location of all points in the route planner window **2710** that are tied to the real-time communication system **150** could be updated accordingly.

In one embodiment as shown in Fig. 28, after all destination points have been added using this graphical system and method, and a route is computed, a route **2805** is displayed in the route planner window **2801** and on the map display **224**. The origin will be the user **2802** that was first selected and the first destination is that object **2803** upon which the first
5 selected object was dropped. The second destination will be the POI **2804** that was added to the first selected object **2802**. Thus, the new route **2805** will display the origin and destination points **2802 & 2803 & 2804** in both the map display **224** and route planner window **2801**.

Another aspect of this invention, while in a route planner mode, allows an extremely
10 efficient mechanism for creating routes to and from the local user's "User A" **213** current location. In one embodiment, for an in-vehicle navigation application, creating a route from the local user's "User A" **213** current location to the location of another user or contact simply involves selecting the local user's "User A" **213** roster list representation **213** with the icon pointer **2902**, which will cause it to be highlighted **2901**, and dragging **2905** it to another
15 roster list user's list representation, such as "User 4" **218**. When the icon pointer **2904** is focused over the user's list representation **218**, as illustrated by it being highlighted **2903**, and then dropped or released a route **2914** from the local user's "User A" location to the user's "User 4" **218** location is created. Additionally, selecting local user's "User A" roster list representation **213**, which becomes highlighted upon selection, using the icon pointer **2902**,
20 then dragging **2906** the icon pointer **2907** to the list representation of a contact **2909**, illustrated by the contact's list representation being highlighted **2908**, and finally dropping or releasing it will create a route **2911** from the local user's "User A" location to the location of "Contact 1" **2909**. Both of these embodiments can use the real-time communication system

150 for location updates. If both the user's and the contact's location information is stored locally or cached, then the real-time communication system **150** is not necessary. As illustrated in FIG. 29, the double arrows **2905 & 2906** indicate that the dragging operation process can be reversed, and the contacts and other users can be selected and then dragged and dropped into the local user's "User A" roster list representation **213** with the icon pointer.

Other objects that can be used for route creation in an in-vehicle navigation system in route planner mode, such as shown in FIG. 30, include POIs or any graphical map object (i.e., map identifiers, users, etc.). In one embodiment, the local user's "User A" roster list representation **213** can be selected with the icon pointer **3002**, illustrated by the local user's icon representation **213** being highlighted **3001**, and then dragged **3003** and dropped using the icon pointer **3005** onto a POI **3004** in order to create a route. As illustrated in FIG. 31, a route **3105** is generated between the current location **3106** of "User A" **213** and the location of the POI **3104**. Additionally, the route planner window **3103** is updated to include both the origin **3101** and destination **3102** points. It should be noted that the origin could be a moving point when it represents an object whose location information is updated locally or through the real-time communication system **150**.

As people skilled in the art will appreciate, having a history trail based on a moving origin or destination points can provide a very necessary capability for graphically viewing location history trails based on real-world routes. In one embodiment, as shown in FIG. 32, an original route **3207** between an origin **3201** and destination **3202** is displayed in a route planner window **3210**. The original route **3207** that was created is shown in the map display **224**. As location updates arrive via the real-time communication system **150**, the origin

location of "Vehicle 1" **3201 & 220** changes thus changing its location on the map display **224**.

The new origin location on the map display **224** is shown **3205**, as well as the original destination point **3203**. Additionally, a new route **3208** is computed between the new origin **3205** and original destination **3203**. When the location of the origin **3201** changes again **3206** a new route **3209** will be computed based on the new origin location **3201 & 3206** and the original destination **3202 & 3203**. Instead of erasing the original route **3207**, it is displayed as a different color and pattern than the newly updated routes **3208 & 3209**. In another embodiment, a legend can even be displayed to illustrate the pattern and color of the routes correlated with the time when they were updated. This route history allows the user to better graphically analyze the route information when using a dynamically updated route origin or destination.

It should be noted that the present invention may be embodied in forms other than the preferred embodiments described above without departing from the spirit or essential characteristics thereof. The specification contained herein provides sufficient disclosure for one skilled in the art to implement the various embodiments of the present invention, including the preferred embodiment, which should be considered in all aspect as illustrative and not restrictive; all changes or alternatives that fall within the meaning and range or equivalency of the claim are intended to be embraced within.

WE CLAIM:

1. A computer-readable medium for use by a sender in a sender communication device having a processor, a data storage medium, an input device, and a display device for providing a graphical interface, said graphical interface including a movable graphical pointer for selecting and moving graphical icons displayed on the graphical interface, said computer-readable medium including executable instructions for causing the processor to execute the steps of:
- 5 displaying a receiver graphical icon representing a receiver;
displaying a point-of-interest graphical icon representing a point of interest; and
10 in response to a user command signal, sending, to a receiver communication device, location information associated with the point of interest, said user command signal being generated by the user moving the graphical pointer to select and move the point-of-interest graphical icon towards the receiver graphical icon.
- 15 2. The computer-readable medium of claim 1, wherein said processor further executes the step of displaying a graphical representation of a map.
3. The computer-readable medium of claim 1, wherein said processor further executes the step of receiving location information associated with the point of interest.
- 20 4. The computer-readable medium of claim 1, wherein said processor further executes the step of displaying a graphical representation of a route connecting between a location of the receiver and a location of the point of interest.

5. The computer-readable medium of claim 1, wherein said processor further executes the step of receiving location information associated with the receiver.

5 6. The computer-readable medium of claim 5, wherein the location information associated with the receiver is retrieved from the data storage medium.

7. The computer-readable medium of claim 5, wherein the location information associated with the receiver is retrieved from the receiver communication device.

10

8. The computer-readable medium of claim 5, wherein said processor further executes the step of receiving updated location information associated with the receiver.

9. The computer-readable medium of claim 1, wherein said processor further
15 executes the step of displaying a graphical representation of a route connecting between a location of the sender and a location of the receiver.

10. The computer-readable medium of claim 1, wherein said processor further
executes the steps of displaying a graphical representation of a route connecting between a
20 location of the sender and a location of the point of interest.

11. The computer-readable medium of claim 1, wherein said processor further executes the steps of displaying a graphical representation of a route connecting between a location of the sender and a location of the receiver.

5 12. The computer-readable medium of claim 1, wherein said processor further executes the steps of:

receiving location information associated with the receiver indicating a location of the receiver;

10 displaying a graphical representation of a first route connecting between the location of the receiver and a location of the point of interest;

receiving updated location information associated with the receiver indicating an updated location of the receiver;

displaying a graphical representation of a second route connecting between the updated location of the receiver and the location of the point of interest.

15

13. The computer-readable medium of claim 12, wherein said processor further executes the step of altering the graphical representation of the first route.

14. The computer-readable medium of claim 12, wherein said processor further
20 executes the step of deleting the display of the graphical representation of the first route.

15. The computer-readable medium of claim 1, wherein said processor further executes the step of requesting permission from the receiver to send data to the receiver communication device.

5 16 The computer-readable medium of claim 4, wherein said processor further executes the step of sending to the receiver communication device route information associated with the route connecting between the location of the receiver and the location of the point of interest.

10 17. The computer-readable medium of claim 12, wherein said processor further executes the steps of:

 sending to the receiver communication device first route information associated with the first route; and

 sending to the receiver communication device second route information associated
15 with the second route.

18. The computer-readable medium of claim 4, wherein said processor further executes the steps of:

displaying a second point-of-interest graphical icon representing a second point of interest; and

5 in response to a route recalculation signal, displaying a graphical representation of a second route connecting between the location of the receiver, the location of the point of interest, and the location of the second point of interest, said route recalculation signal being generated by the user moving the graphical pointer to select and move the second point-of-interest graphical icon towards the graphical representation of the route connecting between
10 the location of the receiver and the location of the point of interest.

19. The computer-readable medium of claim 16, wherein the processor further executes the steps of:

displaying a second point-of-interest graphical icon representing a second point of interest;

5 in response to a route recalculation signal, displaying a graphical representation of a second route connecting between the location of the receiver, the location of the point of interest, and the location of the second point of interest, said route recalculation signal being generated by the user moving the graphical pointer to select and move the second point-of-interest graphical icon towards the graphical representation of the route connecting between
10 the location of the receiver and the location of the point of interest; and

sending to the receiver communication device route information associated with the second route connecting between the location of the receiver, the location of the point of interest, and the location of the second point of interest.

20. A computer-readable medium for use by a sender in a sender communication device having a processor, a data storage medium, an input device, and a display device for providing a graphical interface, said graphical interface including a movable graphical pointer for selecting and moving graphical icons displayed on the graphical interface, said
5 computer-readable medium including executable instructions for causing the processor to execute the steps of:

displaying a receiver graphical icon representing a receiver;

displaying a sender graphical icon representing the sender;

retrieving sender location information associated with a location of the sender; and

10 in response to a user command signal, sending to a receiver communication device the sender location information, said user command signal being generated by the user moving the graphical pointer to select and move the sender graphical icon towards the receiver graphical icon.

15 21. The computer-readable medium of claim 20, wherein the sender location information is retrieved from the data storage medium.

22. The computer-readable medium of claim 20, wherein the sender location information is retrieved from a global positioning system device.

20

23. The computer-readable medium of claim 20, wherein the processor further executes the steps of:

retrieving receiver location information associated with a location of the receiver; and

displaying a route connecting between the location of the receiver and the location of

5 the sender.

24. The computer-readable medium of claim 23, wherein the processor further executes the step of sending to the receiver communication device route information associated with the route connecting between the location of the receiver and the location of

10 the sender.

25. The computer-readable medium of claim 23, wherein the receiver location information is retrieved from the receiver communication device.

26. The computer-readable medium of claim 23, wherein the processor further executes the step of

displaying a point-of-interest graphical icon representing a point of interest; and

in response to a route recalculation signal, retrieving point-of-interest location information associated with the point of interest and displaying a route connecting between

20 the location of the sender, the location of the point of interest, and the location of the receiver.

27. The computer-readable medium of claim 26, wherein the point-of-interest location information is retrieved from the data storage medium.

28. The computer-readable medium of claim 20, wherein the processor further
5 executes the steps of:

retrieving updated sender location information associated with an updated location of the sender; and

10 sending to the receiver communication device the updated sender location information.

29. The computer-readable medium of claim 23, wherein the processor further
executes the steps of:

retrieving updated location information associated with an updated location of the receiver; and

15 displaying an updated route connecting between the updated location of the receiver and the location of the sender.

67

30. A computer-readable medium for use in a communication device having a processor, a data storage medium, an input device, and a display device for providing a graphical interface, said graphical interface including a movable graphical pointer for selecting and moving graphical icons displayed on the graphical interface, said computer-
5 readable medium including executable instructions for causing the processor to execute the steps of:

displaying a first user graphical icon representing a first user;

displaying a second user graphical icon representing the second user;

retrieving first user location information associated with a location of the first user;

10 and

in response to a command signal, sending to the second user the first user location information, said command signal being generated by the sender moving the graphical pointer to select and move the first user graphical icon towards the second user graphical icon.

15

31. The computer-readable medium of claim 30, wherein the first user location information is retrieved from the data storage medium.

32. The computer-readable medium of claim 30, wherein the first user location
20 information is retrieved from the first user.

33. The computer-readable medium of claim 30, wherein the processor further executes the step of requesting permission from the first user to retrieve the first user location information.

5 34. The computer-readable medium of claim 30, wherein the processor further executes the step of requesting permission from the first user to send to the second user the first user location information.

35. The computer-readable medium of claim 30, wherein the processor further
10 executes the steps of:

retrieve second user location information associated with a location of the second user; and

displaying a graphical representation of a route connecting between the location of the first user and the location of the second user.

15

36. The computer-readable medium of claim 35, wherein the second user location information is retrieve from the data storage medium.

37. The computer-readable medium of claim 35, wherein the processor further executes the steps of:

retrieving updated first user location information associated with an updated location of the first user; and

5 in response to a route recalculation signal, displaying a graphical representation of an updated route connecting between the updated location of the first user and the location of the second user.

38. The computer-readable medium of claim 37, wherein the processor further executes the steps of:

retrieving updated second user location information associated with an updated location of the second user; and

5 in response to a second route recalculation signal, displaying a graphical representation of a second updated route connecting between the updated location of the first user and the updated location of the second user.

39. The computer-readable medium of claim 37, wherein the processor further
10 executes the step of deleting the graphical representation of the route connecting between the location of the first user and the location of the second user.

40. The computer-readable medium of claim 38, wherein the processor further
15 executes the step of deleting the graphical representation of the updated route connecting between the updated location of the first user and the location of the second user.

41. In a sender communication device for use by a sender, said sender communication device including a data storage medium, an input device, and a display device for providing a graphical interface, said graphical interface including a movable graphical pointer for selecting and moving graphical icons displayed on the graphical interface, a programmed processor for executing the steps of:

5 displaying a receiver graphical icon representing a receiver;
displaying a point-of-interest graphical icon representing a point of interest; and
in response to a user command signal, sending, to a receiver communication device, location information associated with the point of interest, said user command signal being
10 generated by the user moving the graphical pointer to select and move the point-of-interest graphical icon towards the receiver graphical icon.

42. The programmed processor of claim 41, wherein said processor further executes the step of displaying a graphical representation of a map.

15

43. The programmed processor of claim 41, wherein said processor further executes the step of receiving location information associated with the point of interest.

44. The programmed processor of claim 41, wherein said processor further
20 executes the step of displaying a graphical representation of a route connecting between a location of the receiver and a location of the point of interest.

45. The programmed processor of claim 41, wherein said processor further executes the step of receiving location information associated with the receiver.

46. The programmed processor of claim 45, wherein the location information
5 associated with the receiver is retrieved from the data storage medium.

47. The programmed processor of claim 45, wherein the location information associated with the receiver is retrieved from the receiver communication device.

10 48. The programmed processor of claim 45, wherein said processor further executes the step of receiving updated location information associated with the receiver.

49. The programmed processor of claim 41, wherein said processor further executes the step of displaying a graphical representation of a route connecting between a
15 location of the sender and a location of the receiver.

50. The programmed processor of claim 41, wherein said processor further executes the steps of displaying a graphical representation of a route connecting between a location of the sender and a location of the point of interest.
20

51. The programmed processor of claim 41, wherein said processor further executes the steps of displaying a graphical representation of a route connecting between a location of the sender and a location of the receiver.

52. The programmed processor of claim 41, wherein said processor further executes the steps of:

receiving location information associated with the receiver indicating a location of the receiver;

5 displaying a graphical representation of a first route connecting between the location of the receiver and a location of the point of interest;

receiving updated location information associated with the receiver indicating an updated location of the receiver;

10 displaying a graphical representation of a second route connecting between the updated location of the receiver and the location of the point of interest.

53. The programmed processor of claim 52, wherein said processor further executes the step of altering the graphical representation of the first route.

15 54. The programmed processor of claim 52, wherein said processor further executes the step of deleting the display of the graphical representation of the first route.

55. The programmed processor of claim 41, wherein said processor further executes the step of requesting permission from the receiver to send data to the receiver
20 communication device.

56 The programmed processor of claim 44, wherein said processor further executes the step of sending to the receiver communication device route information associated with the route connecting between the location of the receiver and the location of the point of interest.

5

57. The programmed processor of claim 52, wherein said processor further executes the steps of:

 sending to the receiver communication device first route information associated with the first route; and

10 sending to the receiver communication device second route information associated with the second route.

58. The programmed processor of claim 44, wherein said processor further executes the steps of:

15 displaying a second point-of-interest graphical icon representing a second point of interest; and

 in response to a route recalculation signal, displaying a graphical representation of a second route connecting between the location of the receiver, the location of the point of interest, and the location of the second point of interest, said route recalculation signal being
20 generated by the user moving the graphical pointer to select and move the second point-of-interest graphical icon towards the graphical representation of the route connecting between the location of the receiver and the location of the point of interest.

59. The programmed processor of claim 56, wherein the processor further executes the steps of:

displaying a second point-of-interest graphical icon representing a second point of interest;

5 in response to a route recalculation signal, displaying a graphical representation of a second route connecting between the location of the receiver, the location of the point of interest, and the location of the second point of interest, said route recalculation signal being generated by the user moving the graphical pointer to select and move the second point-of-interest graphical icon towards the graphical representation of the route connecting between
10 the location of the receiver and the location of the point of interest; and

sending to the receiver communication device route information associated with the second route connecting between the location of the receiver, the location of the point of interest, and the location of the second point of interest.

60. In a sender communication device for use by a sender, said sender communication device including, a data storage medium, an input device, and a display device for providing a graphical interface, said graphical interface including a movable graphical pointer for selecting and moving graphical icons displayed on the graphical interface, a programmed processor for executing the steps of:

5 displaying a receiver graphical icon representing a receiver;
displaying a sender graphical icon representing the sender;
retrieving sender location information associated with a location of the sender; and
in response to a user command signal, sending to a receiver communication device

10 the sender location information, said user command signal being generated by the user moving the graphical pointer to select and move the sender graphical icon towards the receiver graphical icon.

61. The programmed processor of claim 60, wherein the sender location

15 information is retrieved from the data storage medium.

62. The programmed processor of claim 60, wherein the sender location information is retrieved from a global-positioning-system device.

63. The programmed processor of claim 60, wherein the processor further executes the steps of:

retrieving receiver location information associated with a location of the receiver; and

displaying a route connecting between the location of the receiver and the location of

5 the sender.

64. The programmed processor of claim 63, wherein the processor further executes the step of sending to the receiver communication device route information associated with the route connecting between the location of the receiver and the location of

10 the sender.

65. The programmed processor of claim 63, wherein the receiver location information is retrieved from the receiver communication device.

15 66. The programmed processor of claim 63, wherein the processor further executes the step of

displaying a point-of-interest graphical icon representing a point of interest; and

in response to a route recalculation signal, retrieving point-of-interest location information associated with the point of interest and displaying a route connecting between
20 the location of the sender, the location of the point of interest, and the location of the receiver.

67. The programmed processor of claim 66, wherein the point-of-interest location information is retrieved from the data storage medium.

68. The programmed processor of claim 60, wherein the processor further
5 executes the steps of:

retrieving updated sender location information associated with an updated location of the sender; and

sending to the receiver communication device the updated sender location information.

10

69. The programmed processor of claim 63, wherein the processor further executes the steps of:

retrieving updated location information associated with an updated location of the receiver; and

15 displaying an updated route connecting between the updated location of the receiver and the location of the sender.

70. In a communication device having a data storage medium, an input device, and a display device for providing a graphical interface, said graphical interface including a movable graphical pointer for selecting and moving graphical icons displayed on the graphical interface, a programmed processor for executing the steps of:

- 5 displaying a first user graphical icon representing a first user;
displaying a second user graphical icon representing the second user;
retrieving first user location information associated with a location of the first user;
and
in response to a command signal, sending to the second user the first user location
10 information, said command signal being generated by the sender moving the graphical
pointer to select and move the first user graphical icon towards the second user graphical
icon.

71. The programmed processor of claim 70, wherein the first user location
15 information is retrieved from the data storage medium.

72. The programmed processor of claim 70, wherein the first user location
information is retrieved from the first user.

20 73. The programmed processor of claim 70, wherein the processor further
executes the step of requesting permission from the first user to retrieve the first user location
information.

74. The programmed processor of claim 70, wherein the processor further executes the step of requesting permission from the first user to send to the second user the first user location information.

5 75. The programmed processor of claim 70, wherein the processor further executes the steps of:

retrieve second user location information associated with a location of the second user; and

10 displaying a graphical representation of a route connecting between the location of the first user and the location of the second user.

76. The programmed processor of claim 75, wherein the second user location information is retrieve from the data storage medium.

15 77. The programmed processor of claim 75, wherein the processor further executes the steps of:

retrieving updated first user location information associated with an updated location of the first user; and

20 in response to a route recalculation signal, displaying a graphical representation of an updated route connecting between the updated location of the first user and the location of the second user.

78. The programmed processor of claim 77, wherein the processor further executes the steps of:

retrieving updated second user location information associated with an updated location of the second user; and

5 in response to a second route recalculation signal, displaying a graphical representation of a second updated route connecting between the updated location of the first user and the updated location of the second user.

79. The programmed processor of claim 77, wherein the processor further
10 executes the step of deleting the graphical representation of the route connecting between the location of the first user and the location of the second user.

80. The programmed processor of claim 78, wherein the processor further
15 executes the step of deleting the graphical representation of the updated route connecting between the updated location of the first user and the location of the second user.

81. A method of sending location information using a sender communication device, said sender communication device being used by a sender and including a processor, a data storage medium, an input device, and a display device for providing a graphical interface, said graphical interface including a movable graphical pointer for selecting and moving graphical icons displayed on the graphical interface, the method comprising the steps of:

displaying a receiver graphical icon representing a receiver;
displaying a point-of-interest graphical icon representing a point of interest; and
in response to a user command signal, sending, to a receiver communication device,
location information associated with the point of interest, said user command signal being
generated by the user moving the graphical pointer to select and move the point-of-interest
graphical icon towards the receiver graphical icon.

82. The method of claim 81, further comprising the step of displaying a graphical
representation of a map.

83. The method of claim 81, further comprising the step of receiving location
information associated with the point of interest.

84. The method of claim 81, further comprising the step of displaying a graphical
representation of a route connecting between a location of the receiver and a location of the
point of interest.

85. The method of claim 81, further comprising the step of receiving location information associated with the receiver.

86. The method of claim 85, wherein the location information associated with the receiver is retrieved from the data storage medium.

87. The method of claim 85, wherein the location information associated with the receiver is retrieved from the receiver communication device.

88. The method of claim 85, further comprising the step of receiving updated location information associated with the receiver.

89. The method of claim 81, further comprising the step of displaying a graphical representation of a route connecting between a location of the sender and a location of the receiver.

90. The method of claim 81, further comprising the steps of displaying a graphical representation of a route connecting between a location of the sender and a location of the point of interest.

91. The method of claim 81, further comprising the steps of displaying a graphical representation of a route connecting between a location of the sender and a location of the receiver.

92. The method of claim 81, further comprising the steps of:
- receiving location information associated with the receiver indicating a location of the receiver;
 - displaying a graphical representation of a first route connecting between the location
5 of the receiver and a location of the point of interest;
 - receiving updated location information associated with the receiver indicating an updated location of the receiver;
 - displaying a graphical representation of a second route connecting between the updated location of the receiver and the location of the point of interest.
- 10
93. The method of claim 92, further comprising the step of altering the graphical representation of the first route.
94. The method of claim 92, further comprising the step of deleting the display of
15 the graphical representation of the first route.
95. The method of claim 81, further comprising the step of requesting permission from the receiver to send data to the receiver communication device.

96 The method of claim 84, further comprising the step of sending to the receiver communication device route information associated with the route connecting between the location of the receiver and the location of the point of interest.

5 97. The method of claim 92, further comprising the steps of:
sending to the receiver communication device first route information associated with the first route; and
sending to the receiver communication device second route information associated with the second route.

10 98. The method of claim 84, further comprising the steps of:
displaying a second point-of-interest graphical icon representing a second point of interest; and
in response to a route recalculation signal, displaying a graphical representation of a
15 second route connecting between the location of the receiver, the location of the point of interest, and the location of the second point of interest, said route recalculation signal being generated by the user moving the graphical pointer to select and move the second point-of-interest graphical icon towards the graphical representation of the route connecting between the location of the receiver and the location of the point of interest.

20

99. The method of claim 96, further comprising the steps of:

displaying a second point-of-interest graphical icon representing a second point of interest;

in response to a route recalculation signal, displaying a graphical representation of a
5 second route connecting between the location of the receiver, the location of the point of interest, and the location of the second point of interest, said route recalculation signal being generated by the user moving the graphical pointer to select and move the second point-of-interest graphical icon towards the graphical representation of the route connecting between the location of the receiver and the location of the point of interest; and

10 sending to the receiver communication device route information associated with the second route connecting between the location of the receiver, the location of the point of interest, and the location of the second point of interest.

100. A method of sending location information using a sender communication device, said sender communication device being used by a sender and including a processor, a data storage medium, an input device, and a display device for providing a graphical interface, said graphical interface including a movable graphical pointer for selecting and
5 moving graphical icons displayed on the graphical interface, the method comprising the steps of:

displaying a receiver graphical icon representing a receiver;

displaying a sender graphical icon representing the sender;

retrieving sender location information associated with a location of the sender; and

10 in response to a user command signal, sending to a receiver communication device the sender location information, said user command signal being generated by the user moving the graphical pointer to select and move the sender graphical icon towards the receiver graphical icon.

15 101. The method of claim 100, wherein the sender location information is retrieved from the data storage medium.

102. The method of claim 100, wherein the sender location information is retrieved from a global positioning system device.

20

103. The method of claim 100, wherein the method further comprising the steps of:
retrieving receiver location information associated with a location of the receiver; and
displaying a route connecting between the location of the receiver and the location of
the sender.

5

104. The method of claim 103, wherein the method further comprising the step of
sending to the receiver communication device route information associated with the route
connecting between the location of the receiver and the location of the sender.

10

105. The method of claim 103, wherein the receiver location information is
retrieved from the receiver communication device.

15

106. The method of claim 103, wherein the method further comprising the step of
displaying a point-of-interest graphical icon representing a point of interest; and
in response to a route recalculation signal, retrieving point-of-interest location
information associated with the point of interest and displaying a route connecting between
the location of the sender, the location of the point of interest, and the location of the
receiver.

20

107. The method of claim 106, wherein the point-of-interest location information is
retrieved from the data storage medium.

108. The method of claim 100, wherein the method further comprising the steps of:
retrieving updated sender location information associated with an updated location of
the sender; and
sending to the receiver communication device the updated sender location
5 information.

109. The method of claim 103, wherein the method further comprising the steps of:
retrieving updated location information associated with an updated location of the
receiver; and
10 displaying an updated route connecting between the updated location of the receiver
and the location of the sender.

110. A method for sending location information using a communication device having a processor, a data storage medium, an input device, and a display device for providing a graphical interface, said graphical interface including a movable graphical pointer for selecting and moving graphical icons displayed on the graphical interface, said

5 method comprising the steps of:

displaying a first user graphical icon representing a first user;

displaying a second user graphical icon representing the second user;

retrieving first user location information associated with a location of the first user;

and

10 in response to a command signal, sending to the second user the first user location information, said command signal being generated by the sender moving the graphical pointer to select and move the first user graphical icon towards the second user graphical icon.

15 111. The method of claim 110, wherein the first user location information is retrieved from the data storage medium.

112. The method of claim 110, wherein the first user location information is retrieved from the first user.

20

113. The method of claim 110, wherein the method further comprising the step of requesting permission from the first user to retrieve the first user location information.

114. The method of claim 110, wherein the method further comprising the step of requesting permission from the first user to send to the second user the first user location information.

5 115. The method of claim 110, wherein the method further comprising the steps of: retrieve second user location information associated with a location of the second user; and

displaying a graphical representation of a route connecting between the location of the first user and the location of the second user.

10

116. The method of claim 115, wherein the second user location information is retrieve from the data storage medium.

117. The method of claim 115, wherein the method further comprising the steps of:
15 retrieving updated first user location information associated with an updated location of the first user; and

in response to a route recalculation signal, displaying a graphical representation of an updated route connecting between the updated location of the first user and the location of the second user.

20

118. The method of claim 117, wherein the method further comprising the steps of:
retrieving updated second user location information associated with an updated
location of the second user; and

5 in response to a second route recalculation signal, displaying a graphical
representation of a second updated route connecting between the updated location of the first
user and the updated location of the second user.

119. The method of claim 117, wherein the method further comprising the step of
deleting the graphical representation of the route connecting between the location of the first
10 user and the location of the second user.

120. The method of claim 118, wherein the method further comprising the step of
deleting the graphical representation of the updated route connecting between the updated
location of the first user and the location of the second user.

121. A computer-readable medium for use by a sender in a sender communication device, said sender communication device being a wireless mobile communication device and including a processor, a data storage medium, an input device, and a display device, said computer-readable medium including executable instructions for causing the processor to

5 execute the steps of:

- displaying a receiver entry representing a receiver;
- displaying a point-of-interest entry representing a point of interest;
- receiving a user signal selecting the point-of-interest entry for sending point-of-interest location information associated with a location of the point of interest;
- 10 receiving a user signal selecting the receiver entry for sending the point-of-interest location information to the receiver; and
- sending the point-of-interest location information to the receiver.

122. The computer-readable medium of claim 121, wherein the processor further

15 executes the step of retrieving the point-of-interest location information from the data storage medium.

123. The computer-readable medium of claim 121, wherein the processor further

executes the step of displaying a graphical representation of a route connecting between the

20 location of the point of interest and a location of the receiver.

124. The computer-readable medium of claim 121, wherein the processor further executes the steps of:

receiving location information associated with the receiver indicating a location of the receiver;

5 displaying a graphical representation of a first route connecting between the location of the receiver and a location of the point of interest;

receiving updated location information associated with the receiver indicating an updated location of the receiver;

10 displaying a graphical representation of a second route connecting between the updated location of the receiver and the location of the point of interest.

125. The computer-readable medium of claim 124, wherein the wireless mobile communication device is a personal digital assistant.

126. In a sender communication device for use by a sender, said sender communication device being a wireless mobile communication device and including a data storage medium, an input device, and a display device, a programmed processor for executing the steps of:

- 5 displaying a receiver entry representing a receiver;
 displaying a point-of-interest entry representing a point of interest;
 receiving a user signal selecting the point-of-interest entry for sending point-of-interest location information associated with a location of the point of interest;
 receiving a user signal selecting the receiver entry for sending the point-of-interest
10 location information to the receiver; and
 sending the point-of-interest location information to the receiver.

127. The programmed processor of claim 126, wherein the processor further executes the step of retrieving the point-of-interest location information from the data storage
15 medium.

128. The programmed processor of claim 126, wherein the processor further executes the step of displaying a graphical representation of a route connecting between the location of the point of interest and a location of the receiver.
20

129. The programmed processor of claim 126, wherein the processor further executes the steps of:

receiving location information associated with the receiver indicating a location of the receiver;

5 displaying a graphical representation of a first route connecting between the location of the receiver and a location of the point of interest;

receiving updated location information associated with the receiver indicating an updated location of the receiver;

10 displaying a graphical representation of a second route connecting between the updated location of the receiver and the location of the point of interest.

130. The programmed processor of claim 129, wherein the wireless mobile communication device is a personal digital assistant.

131. A method of sending location information using a sender communication device for use by a sender, said sender communication device being a wireless mobile communication device and including a processor, a data storage medium, an input device, and a display device, the method comprising the steps of:

- 5 displaying a receiver entry representing a receiver;
 displaying a point-of-interest entry representing a point of interest;
 receiving a user signal selecting the point-of-interest entry for sending point-of-interest location information associated with a location of the point of interest;
 receiving a user signal selecting the receiver entry for sending the point-of-interest
10 location information to the receiver; and
 sending the point-of-interest location information to the receiver.

132. The method of claim 131, further comprising the step of retrieving the point-of-interest location information from the data storage medium.

15

133. The method of claim 131, further comprising the step of displaying a graphical representation of a route connecting between the location of the point of interest and a location of the receiver.

134. The method of claim 131, further comprising the steps of:

receiving location information associated with the receiver indicating a location of the receiver;

displaying a graphical representation of a first route connecting between the location

5 of the receiver and a location of the point of interest;

receiving updated location information associated with the receiver indicating an updated location of the receiver;

displaying a graphical representation of a second route connecting between the updated location of the receiver and the location of the point of interest.

10

135. The method of claim 134, wherein the wireless mobile communication device is a personal digital assistant.

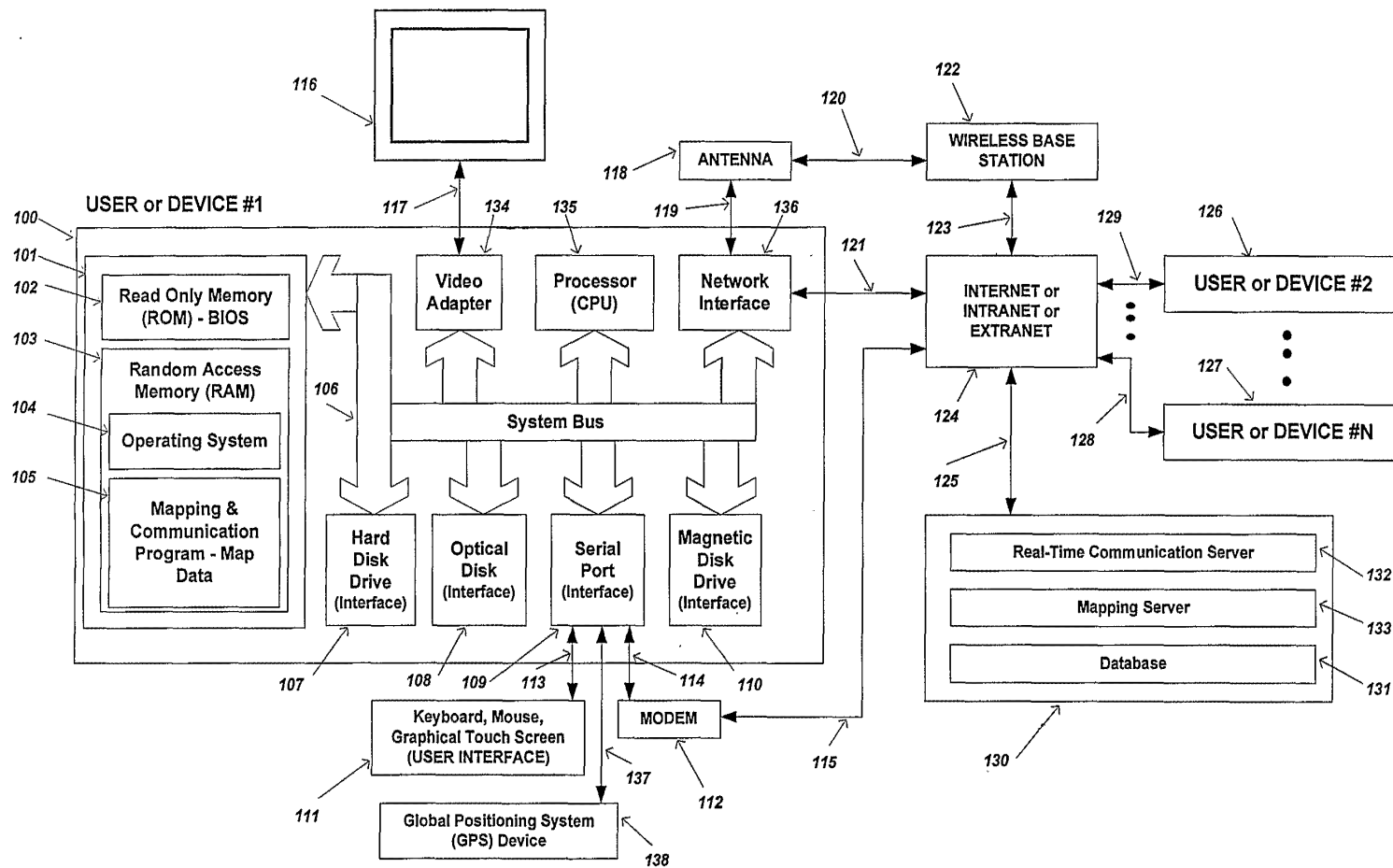

FIG. 1

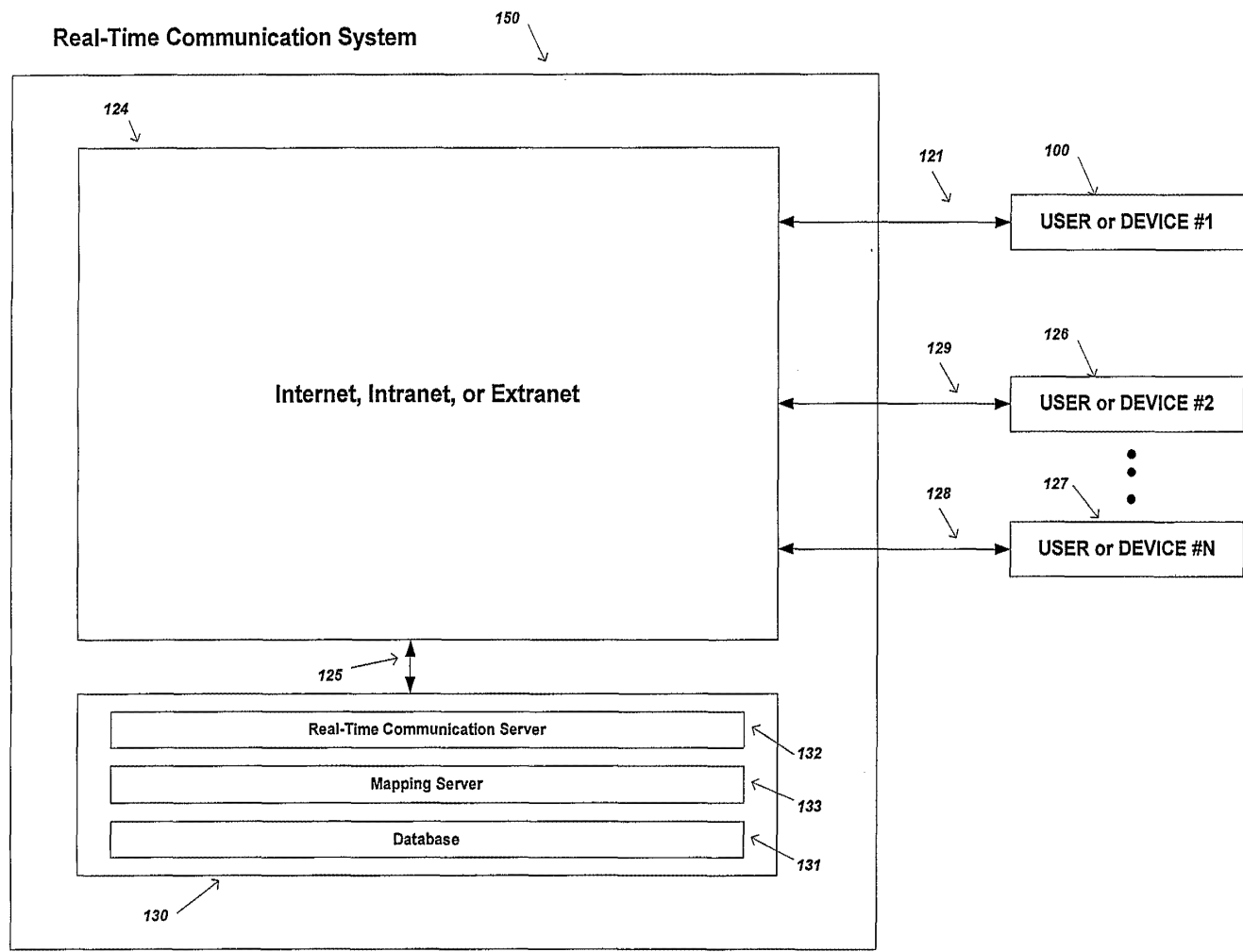

FIG. 1A

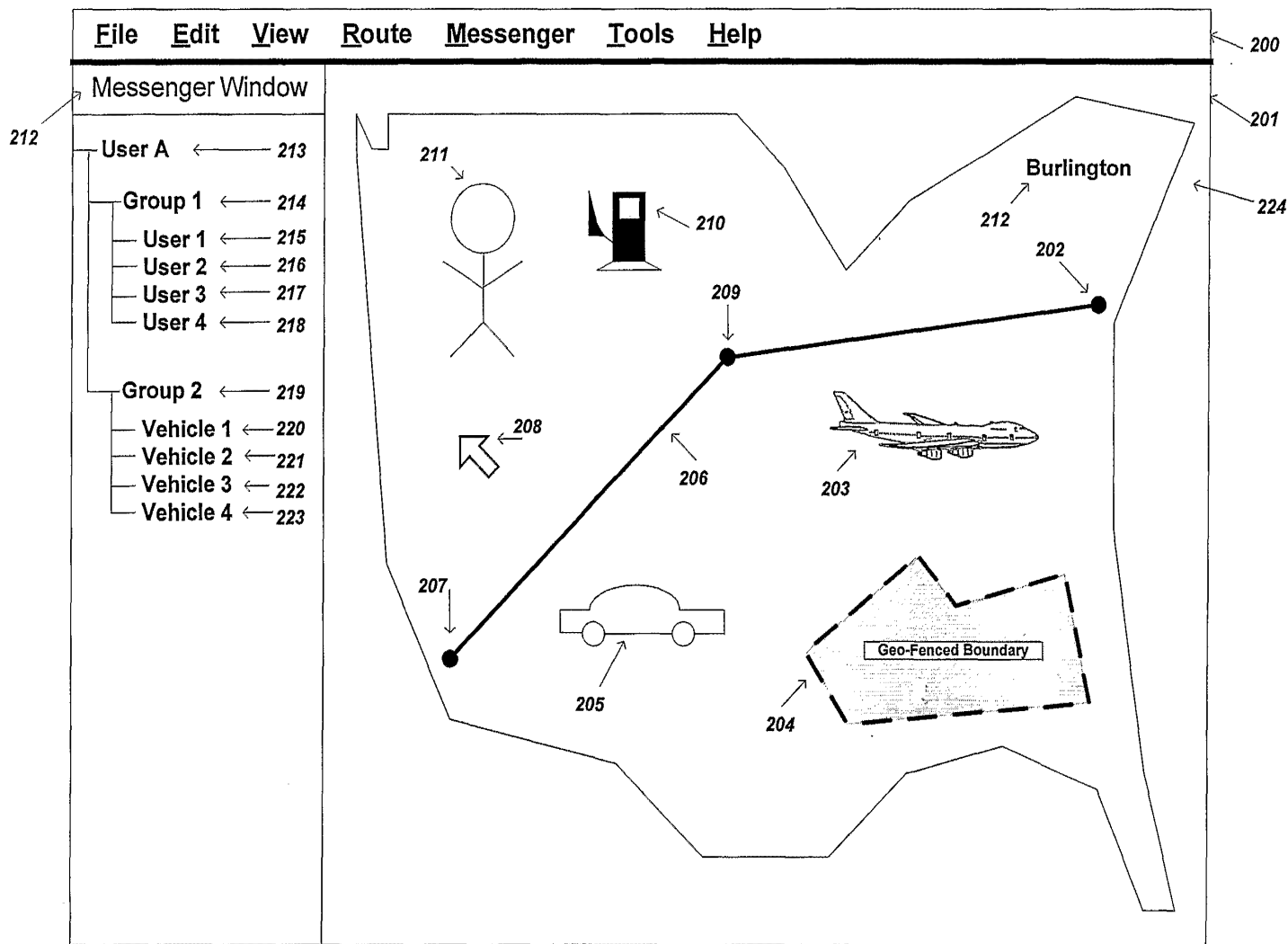

FIG. 2

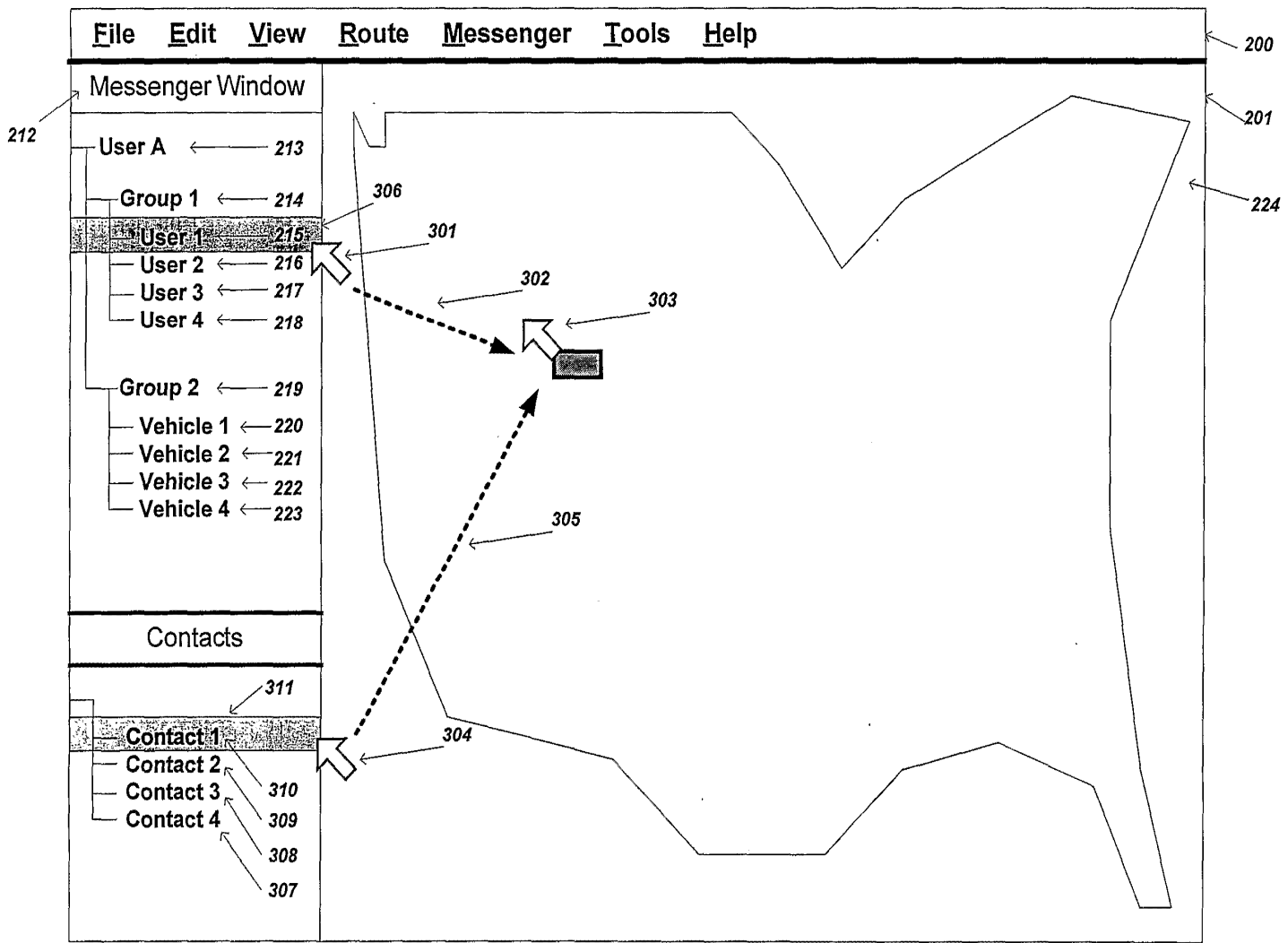

FIG. 3

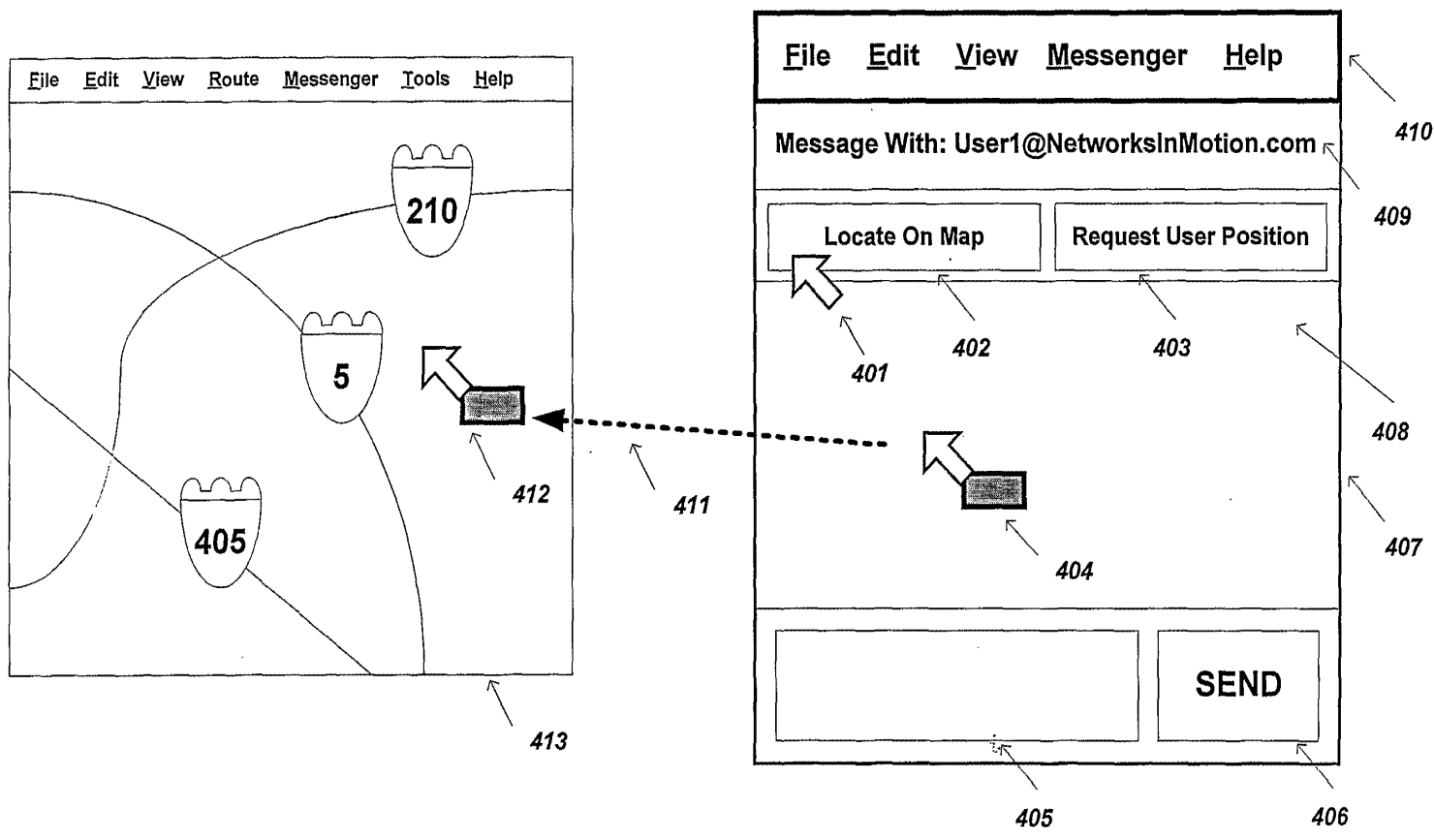
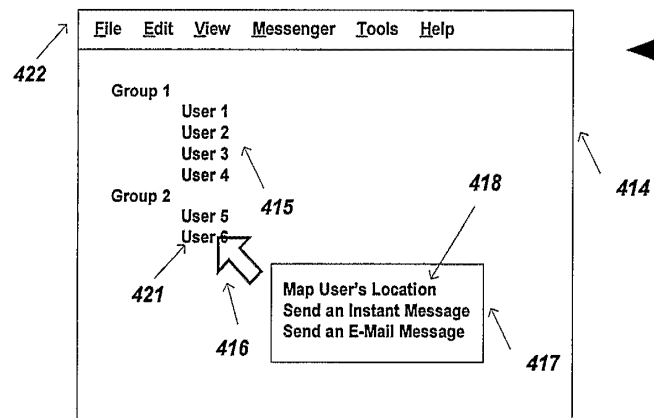

FIG. 4



← Application - 1

Application - 2 →

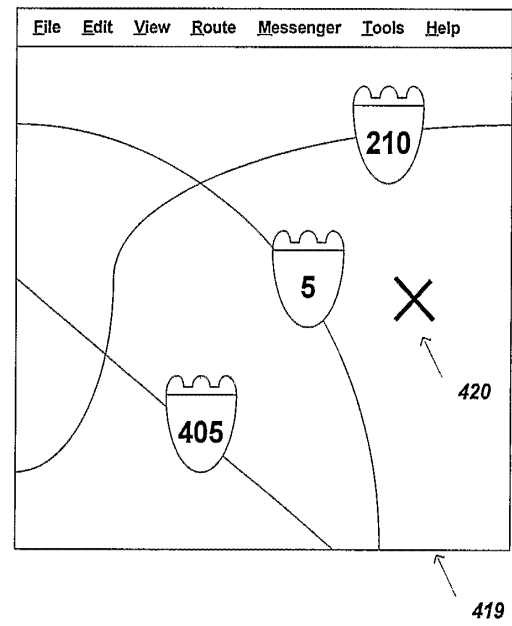

FIG. 4A

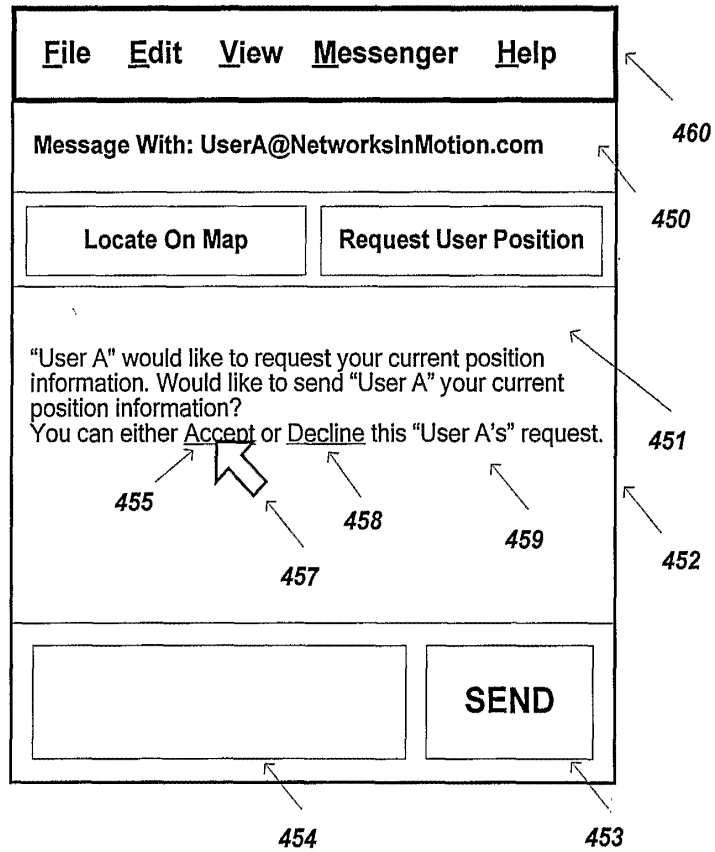

FIG. 4B

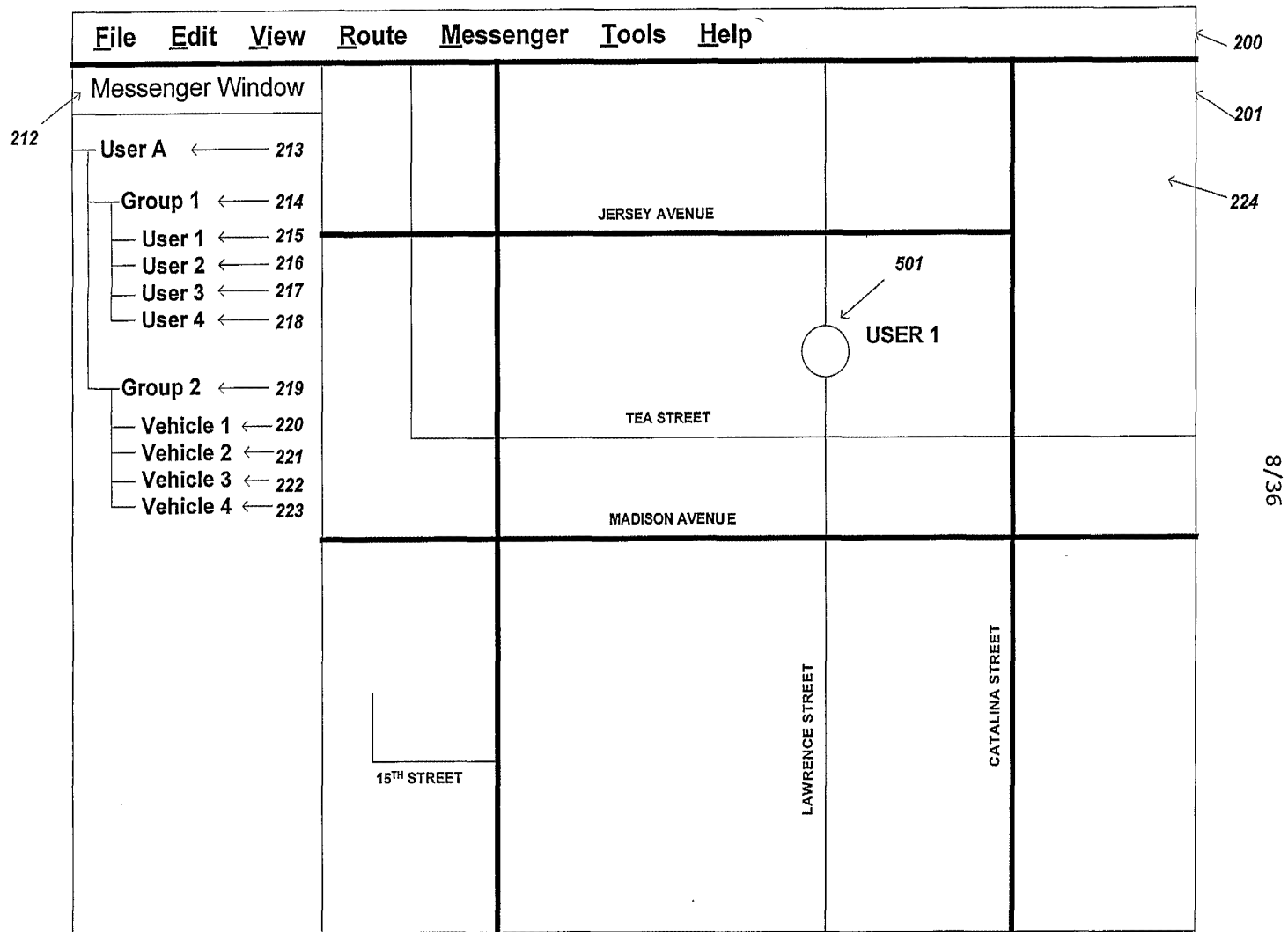

FIG. 5

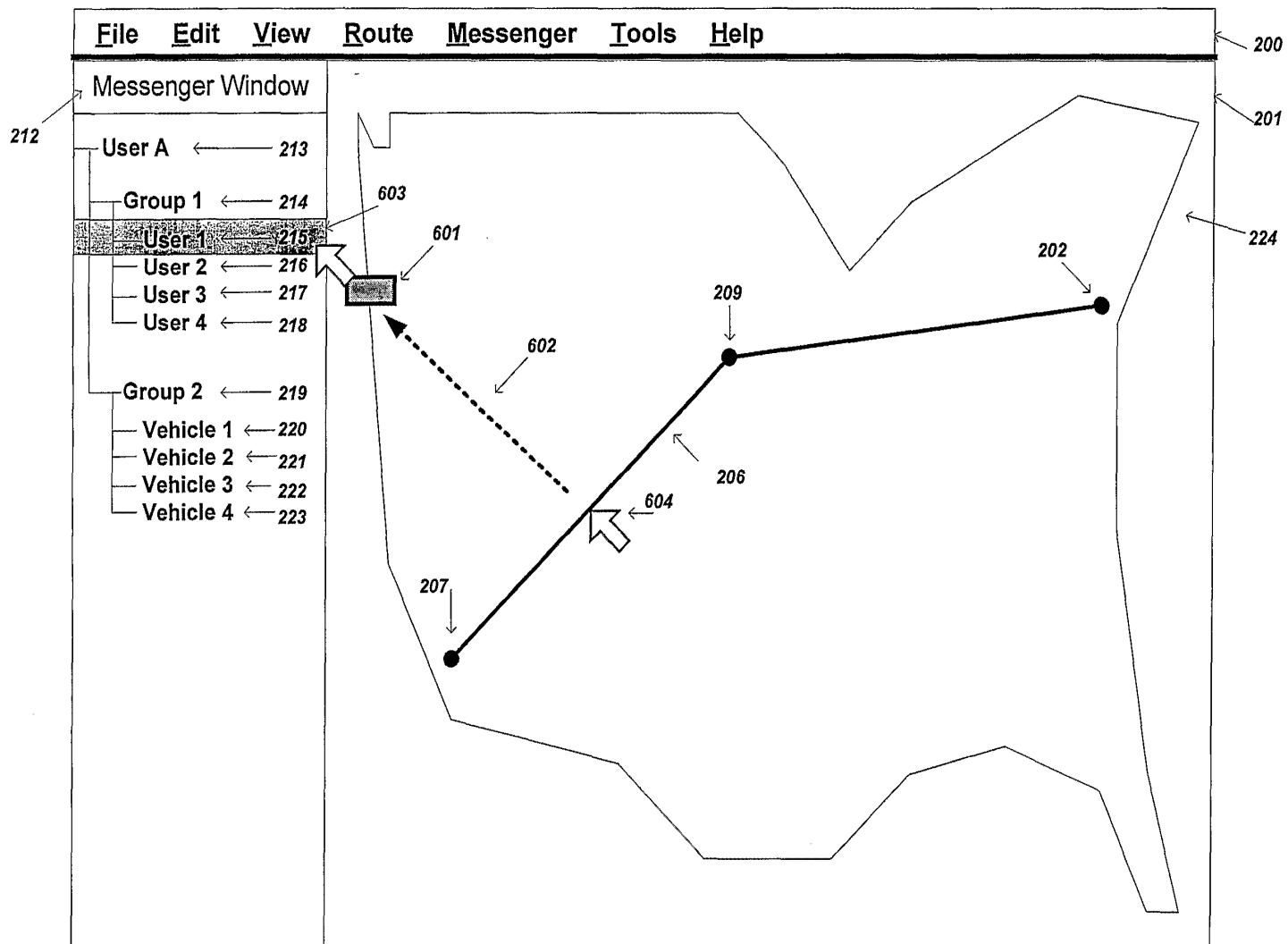

FIG. 6

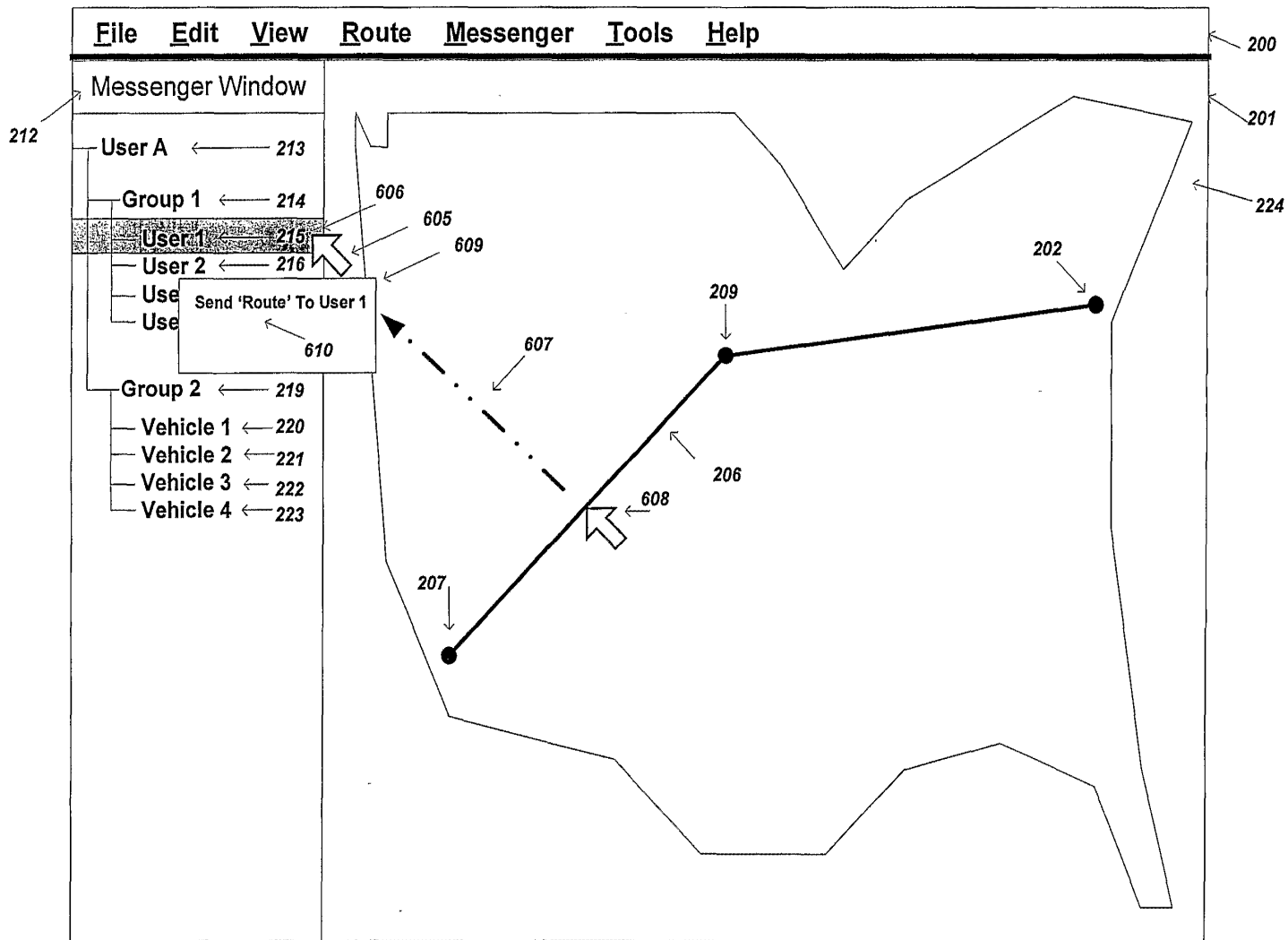

FIG. 6A

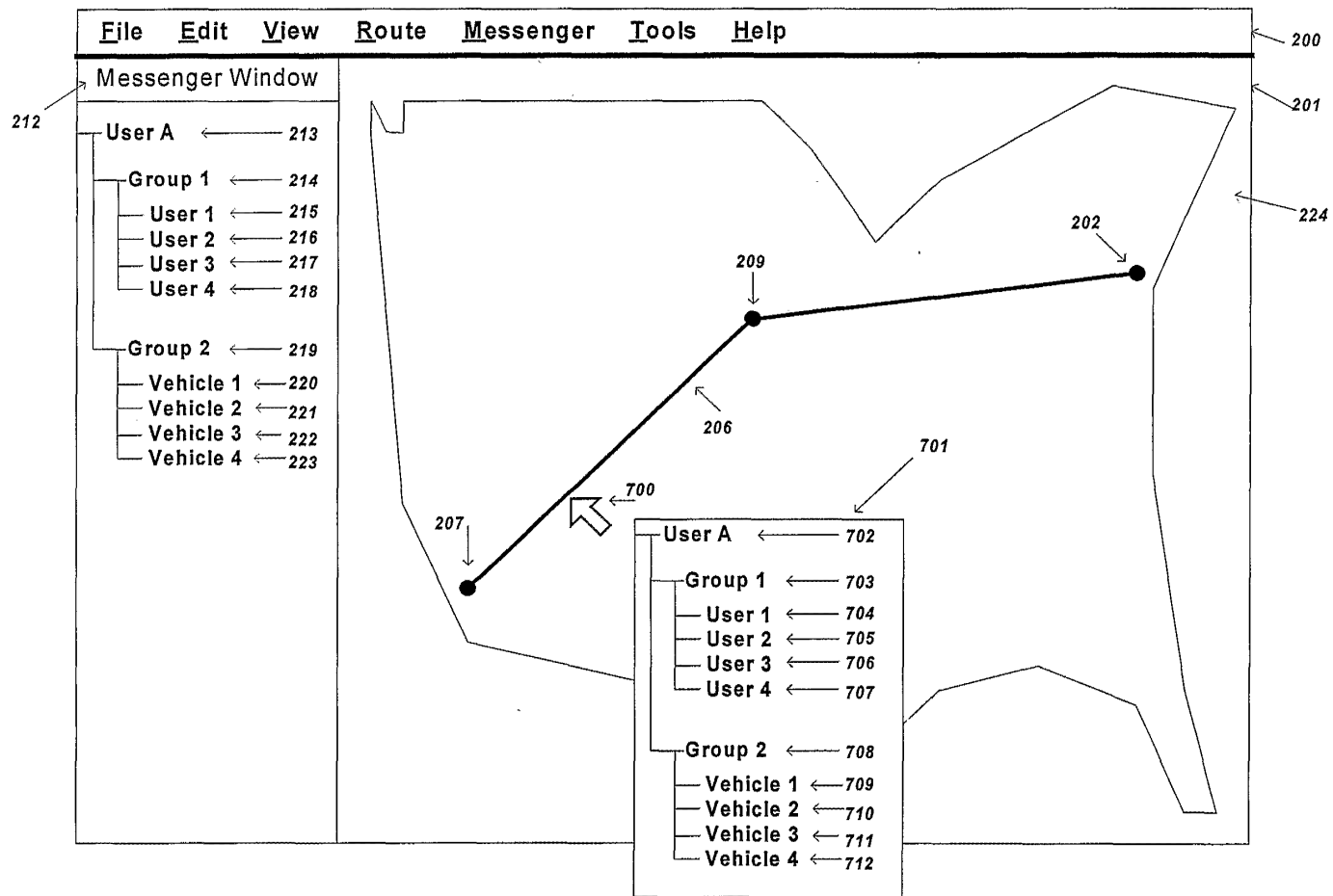

FIG. 7

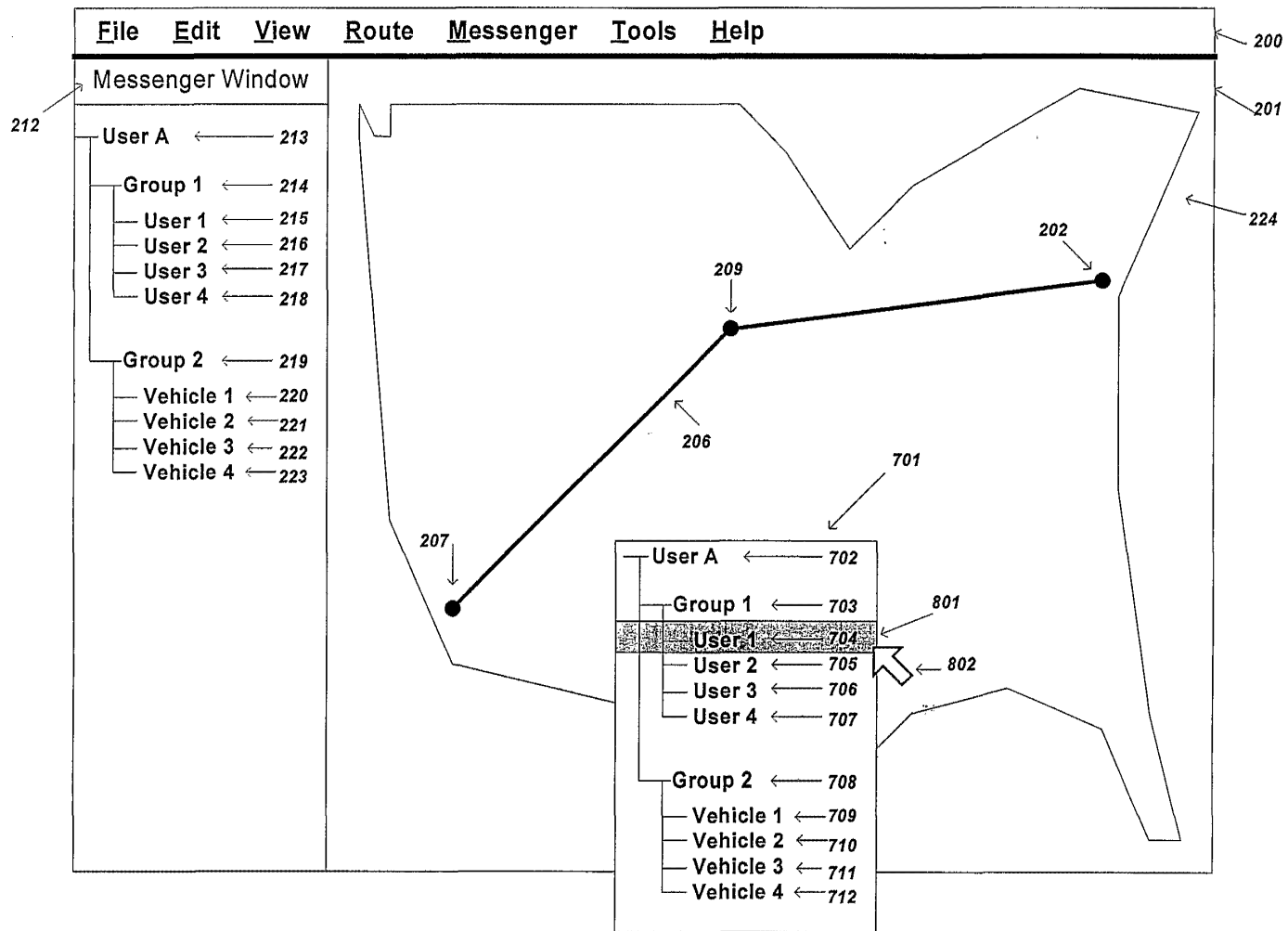

FIG. 8

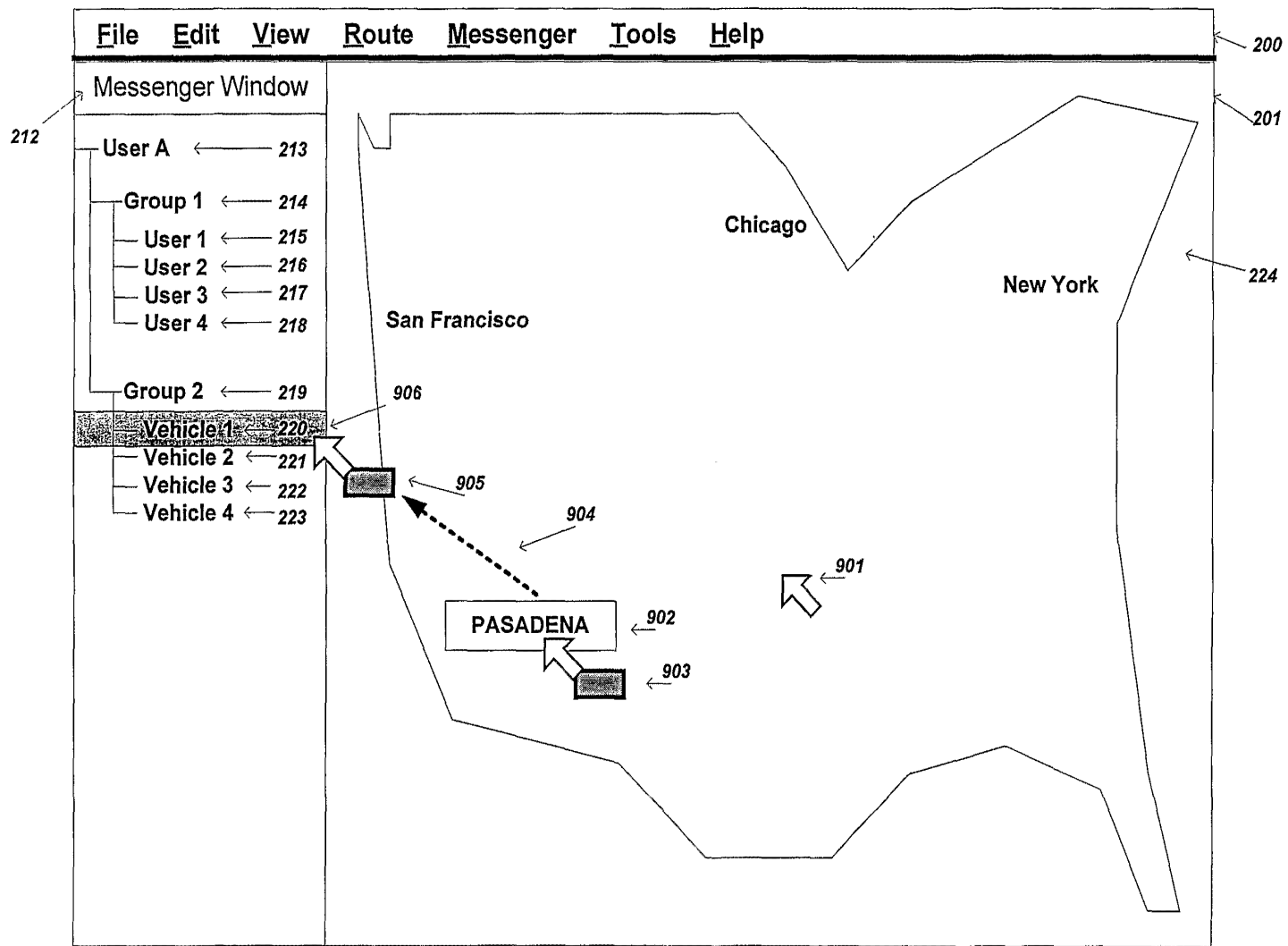

FIG. 9

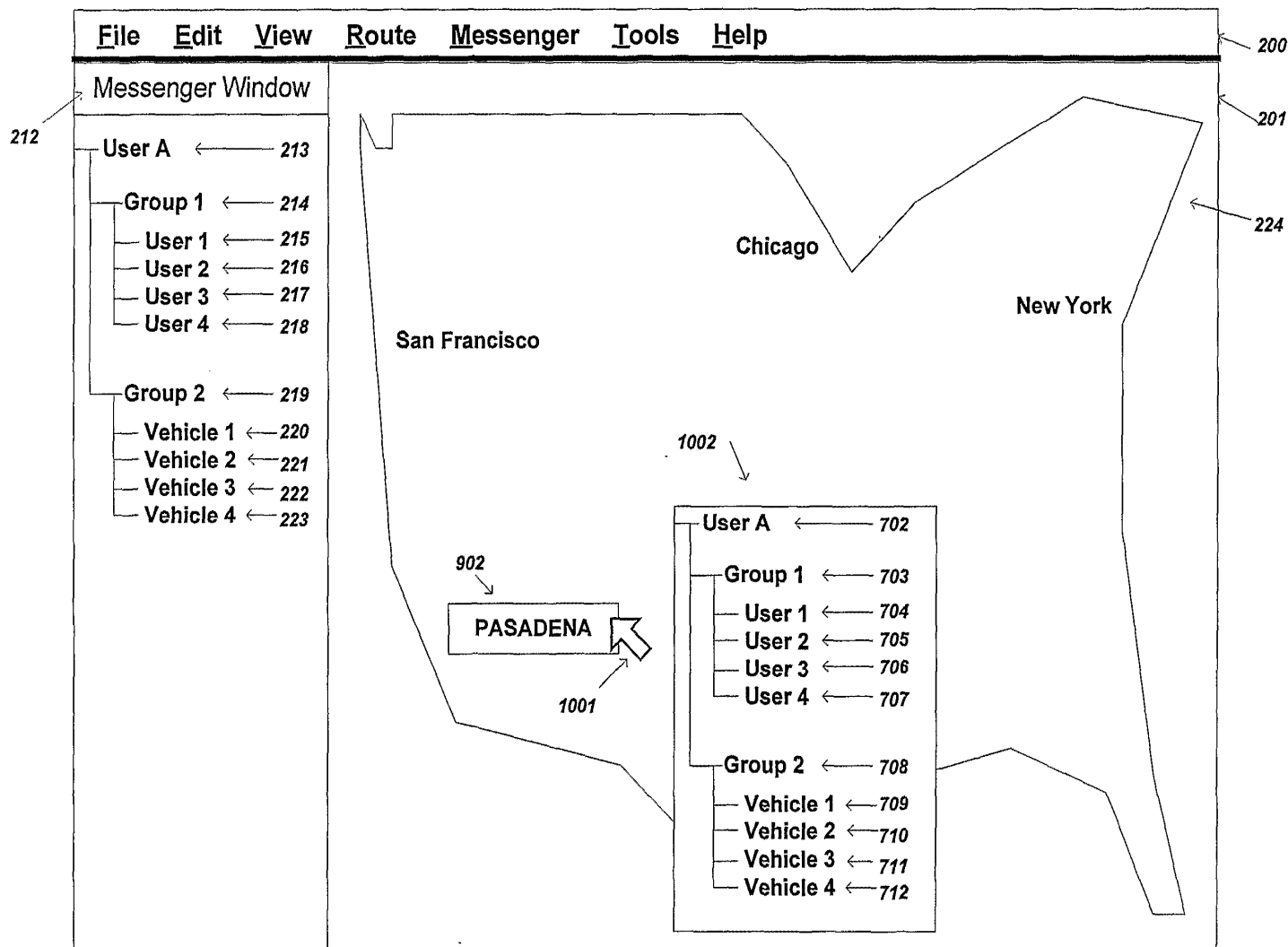

FIG. 10

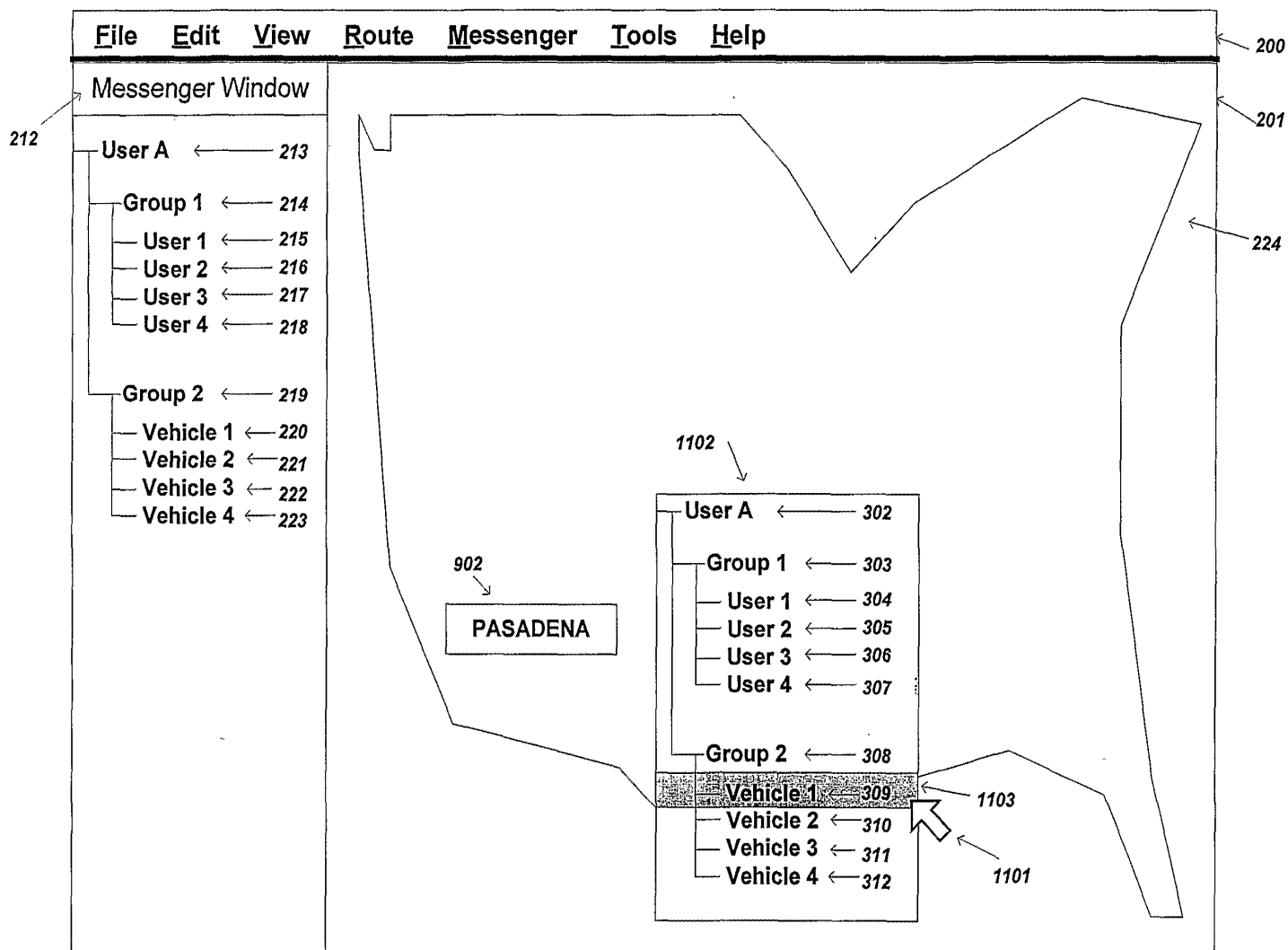

FIG. 11

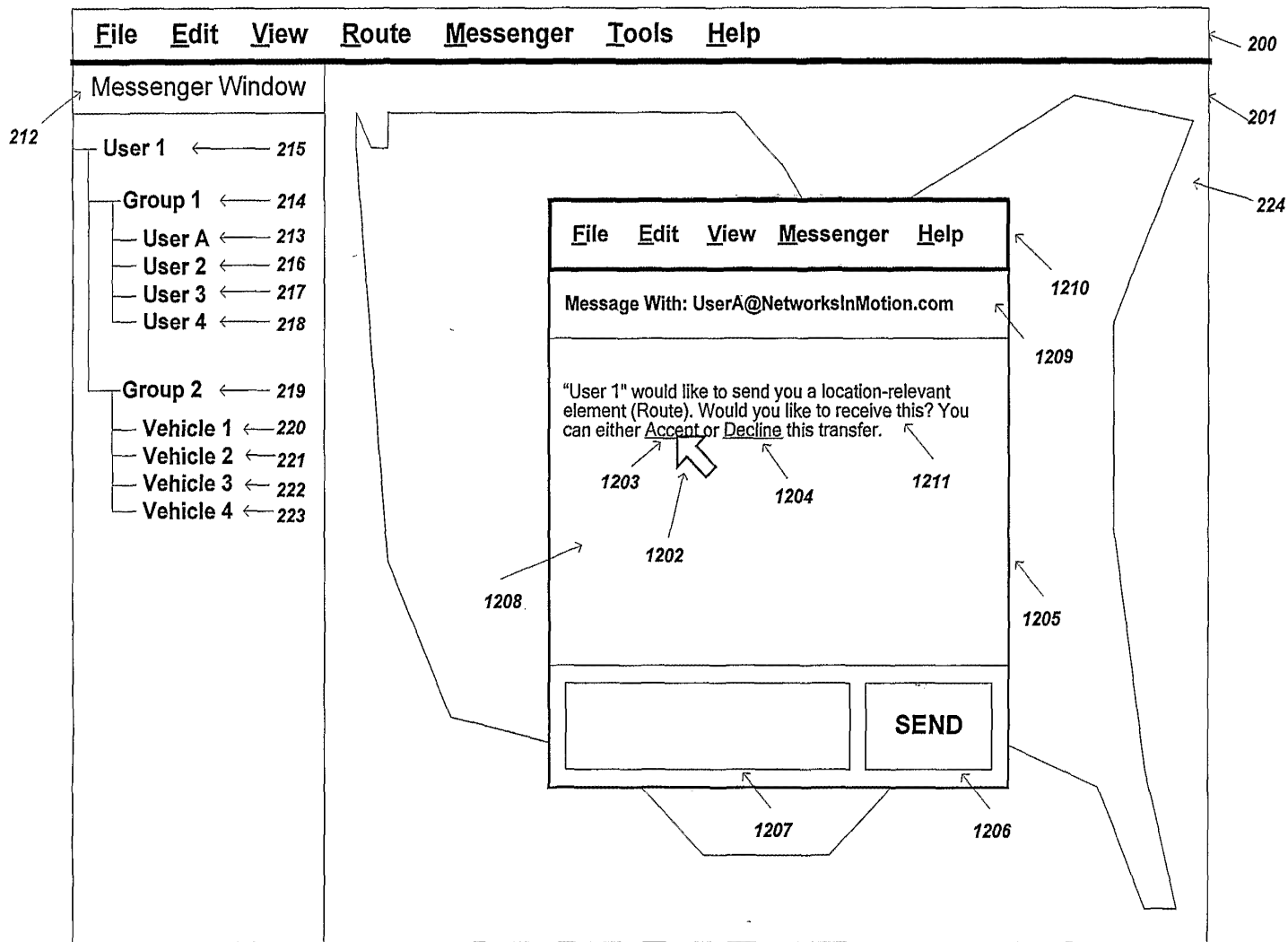

FIG. 12

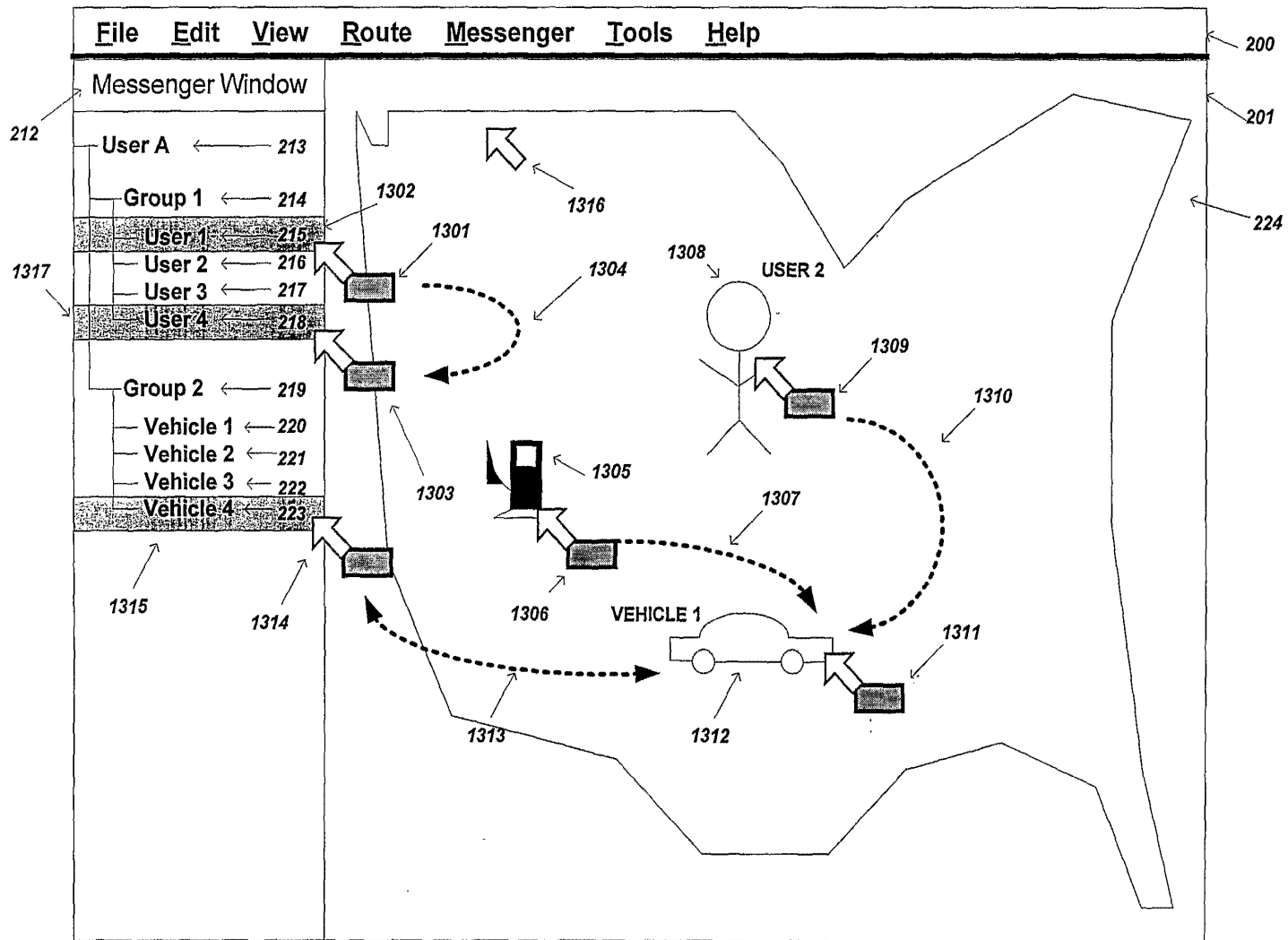

FIG. 13

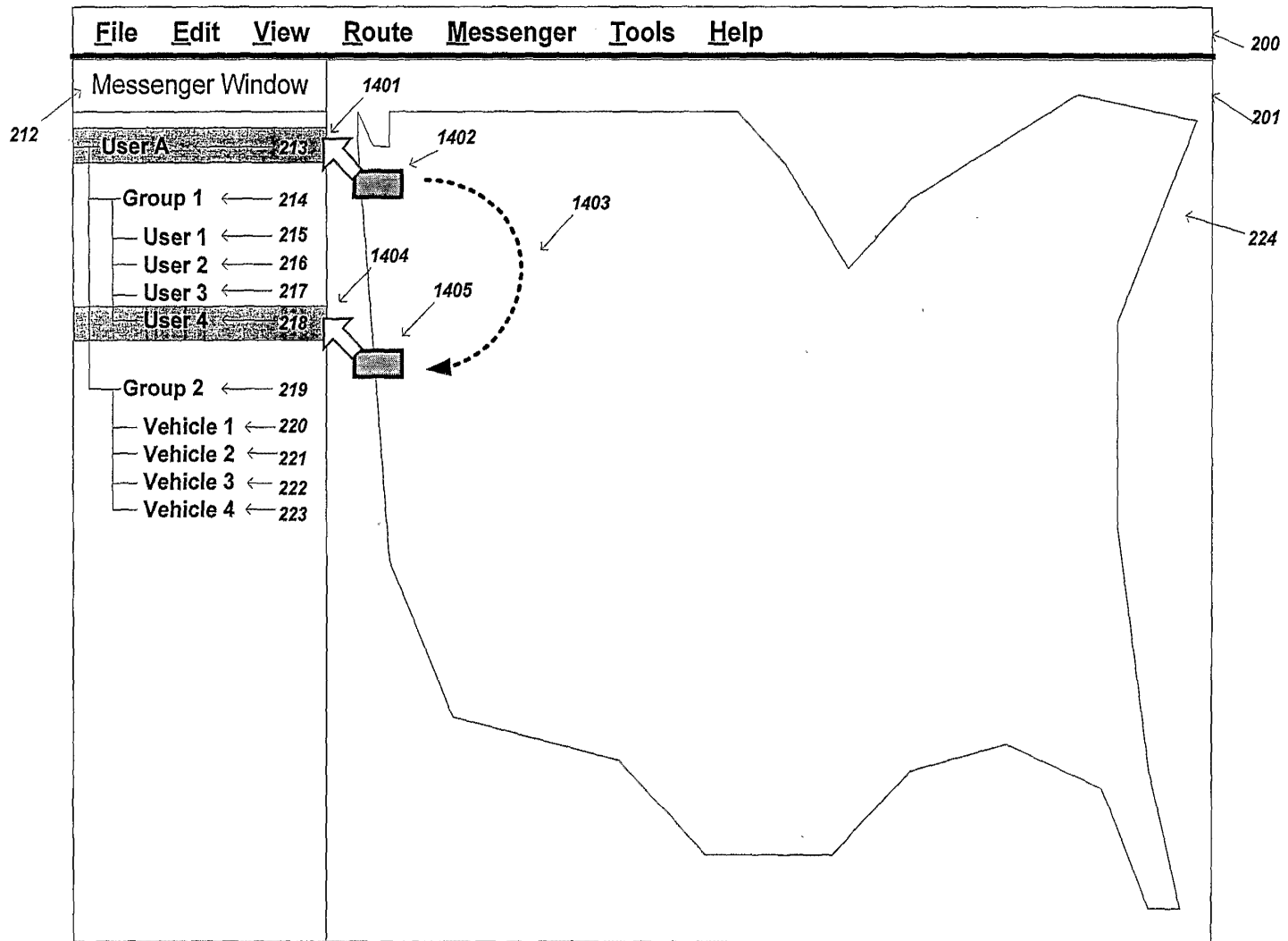

FIG. 14

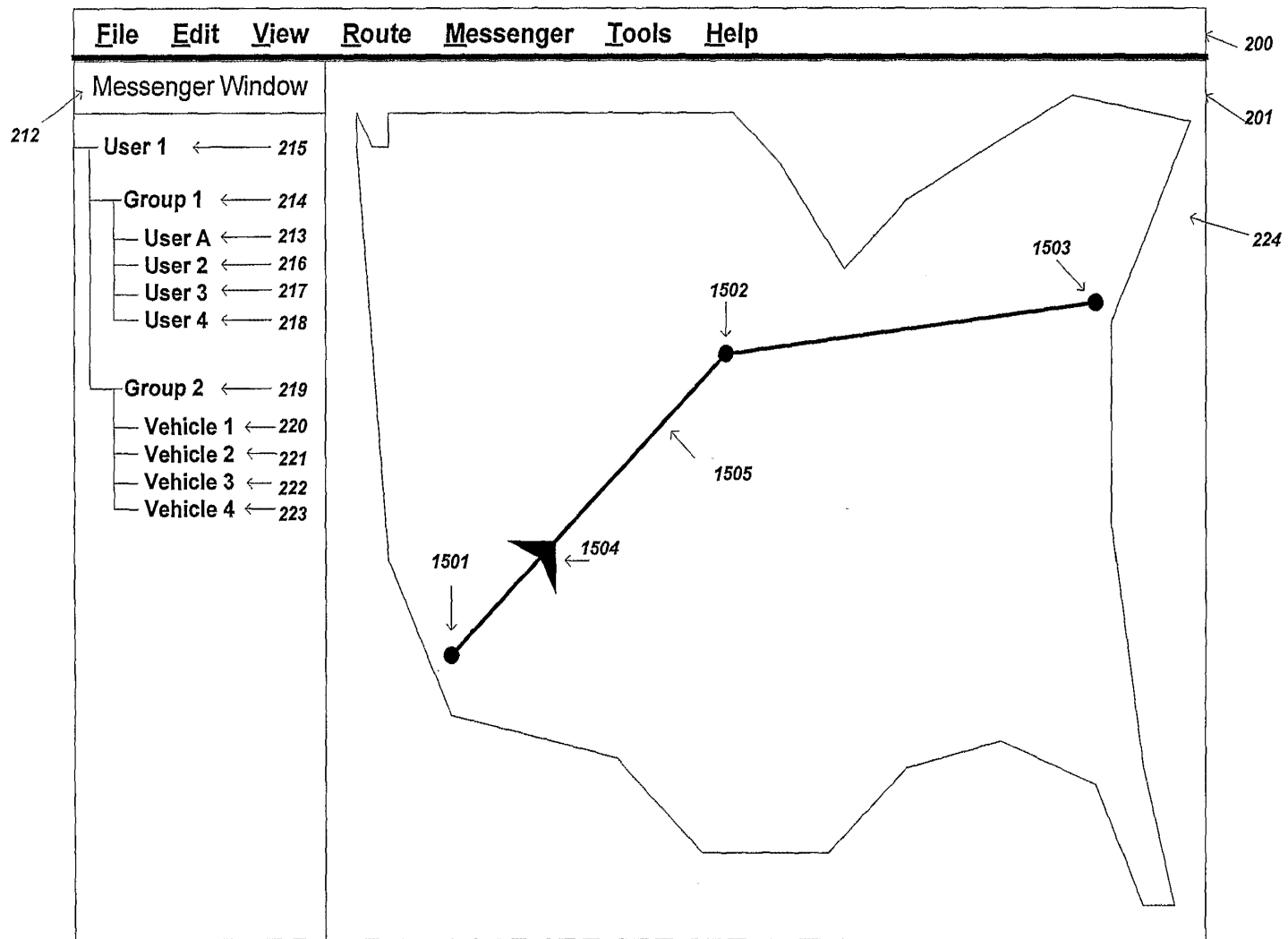

FIG. 15

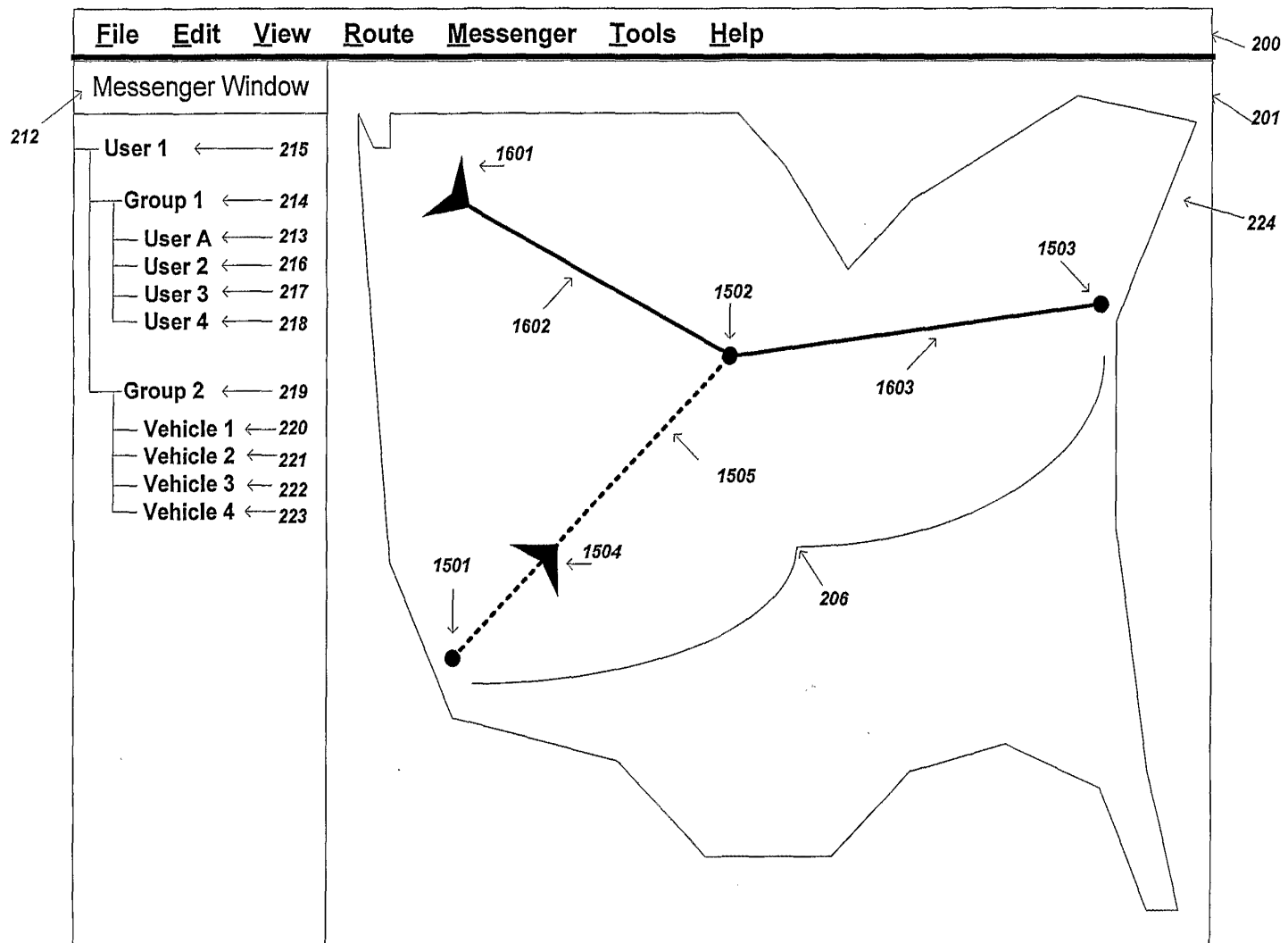

FIG. 16

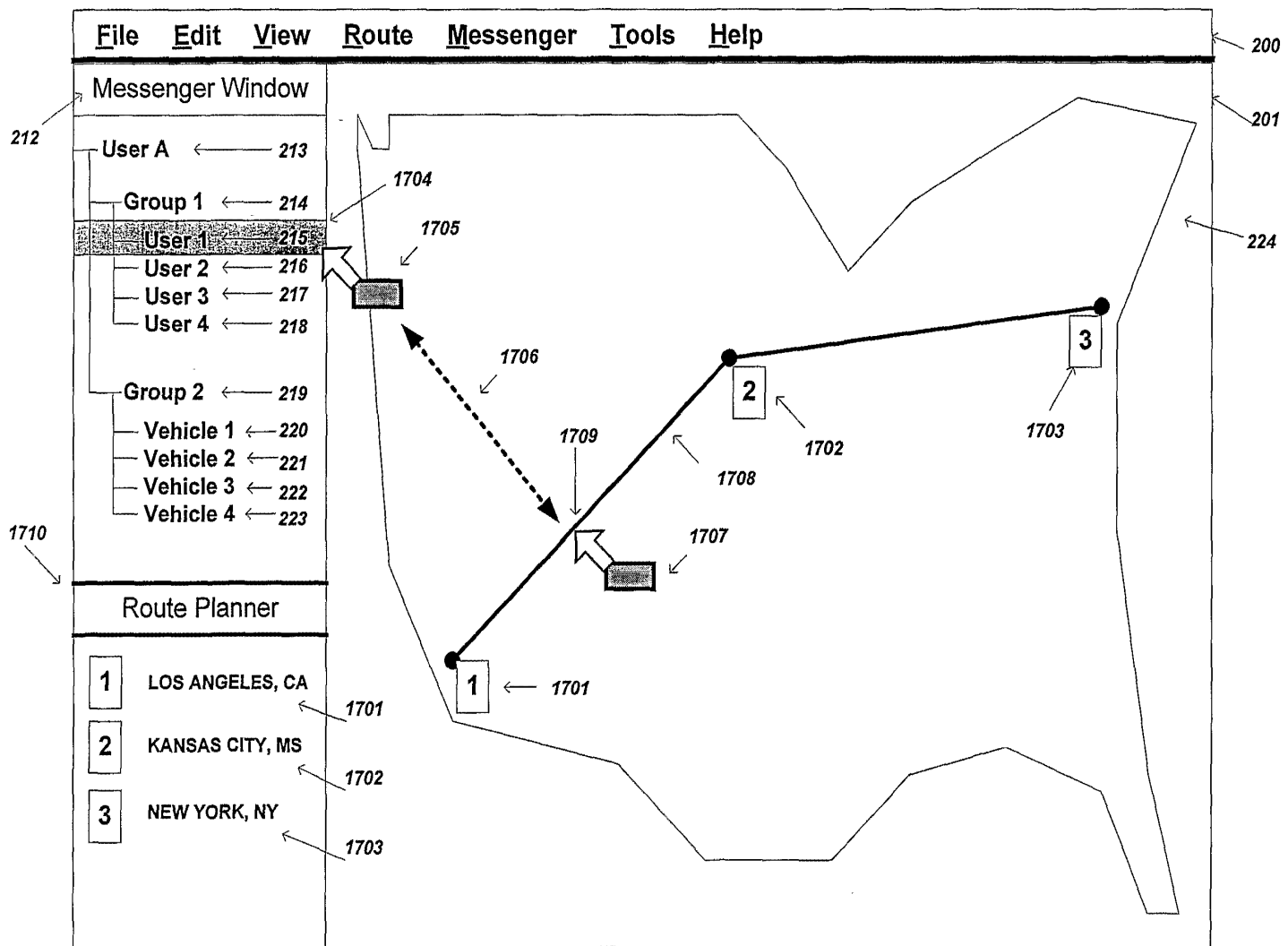

FIG. 17

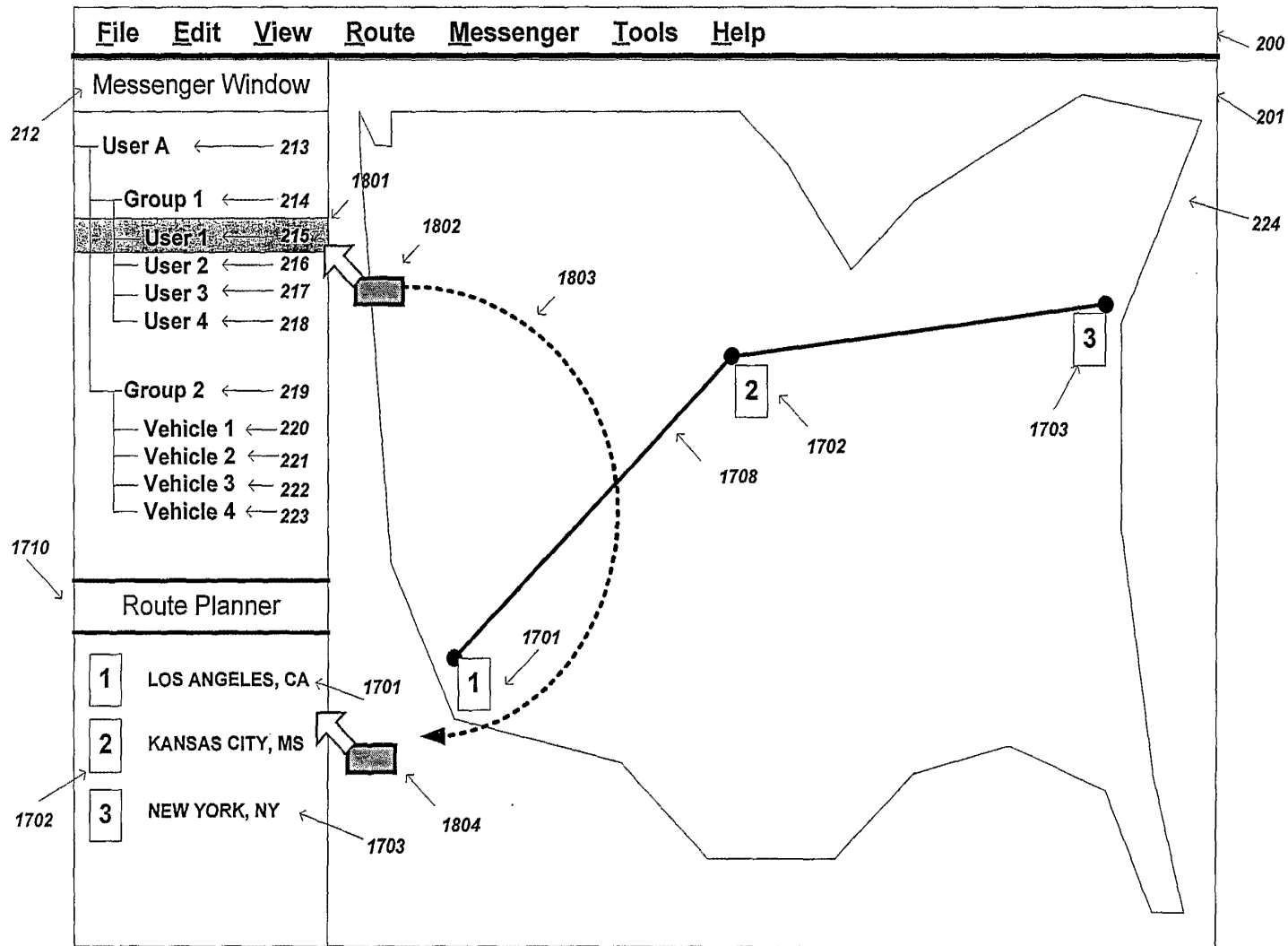

FIG. 18

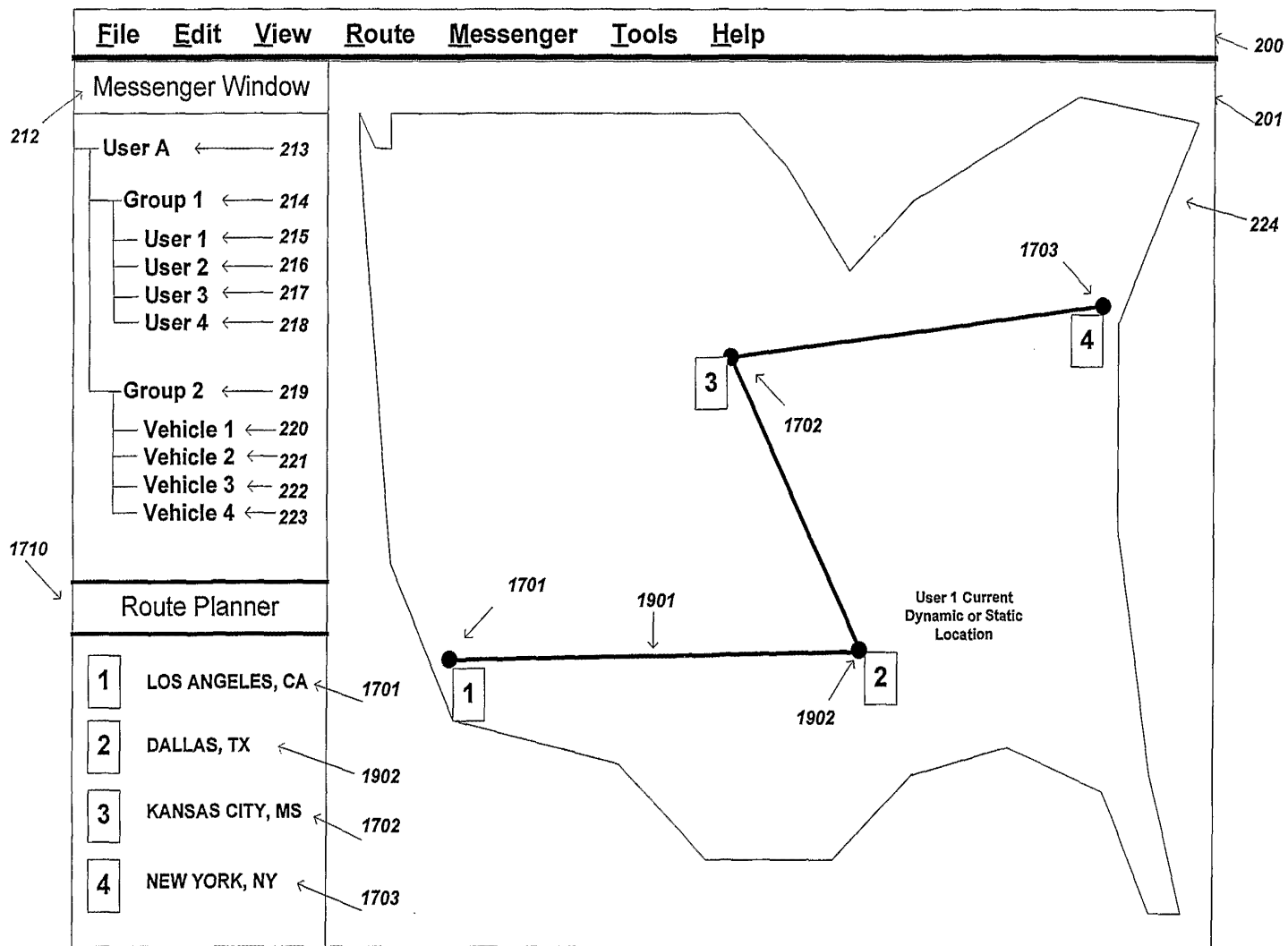

FIG. 19

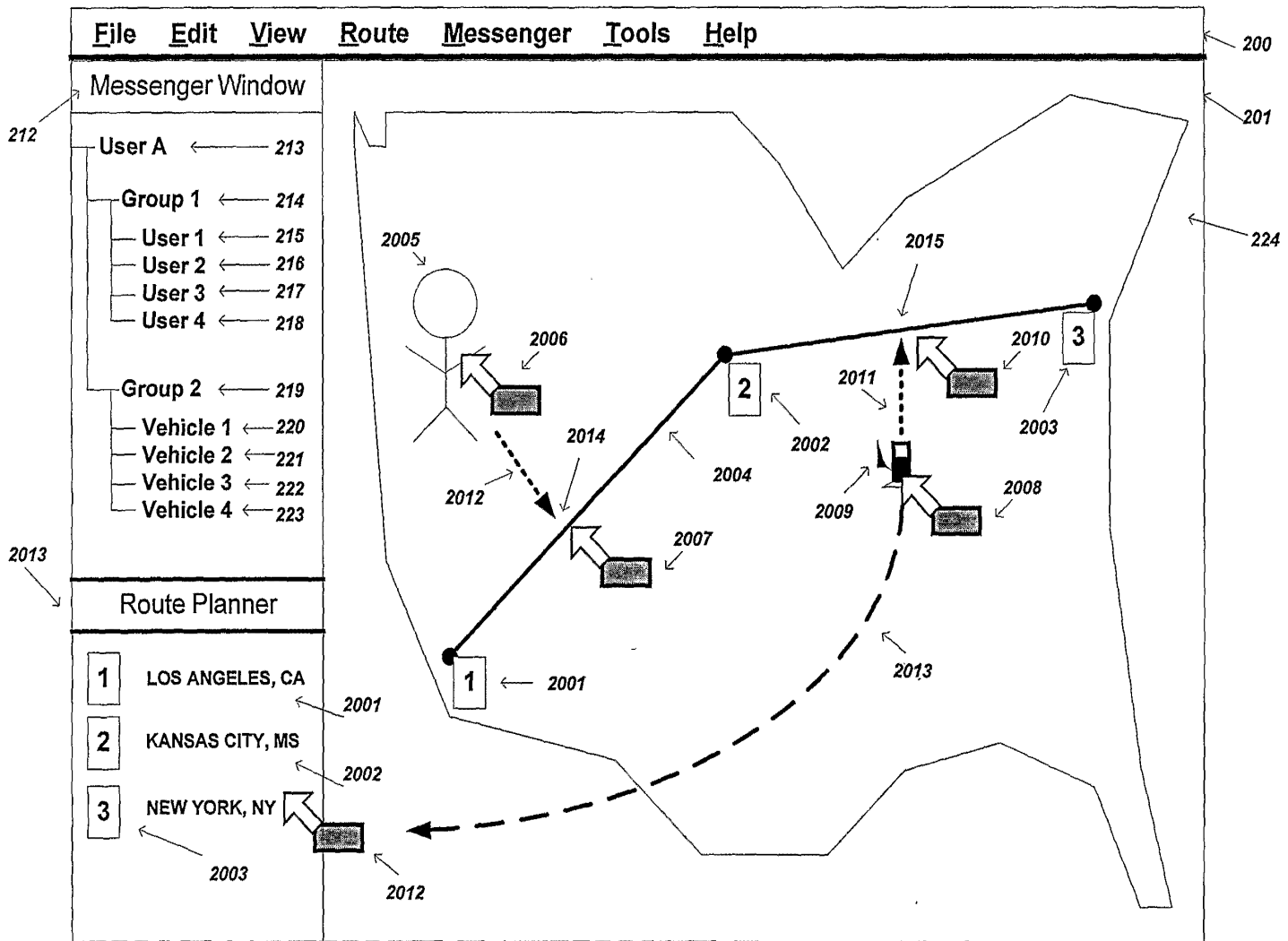

FIG. 20

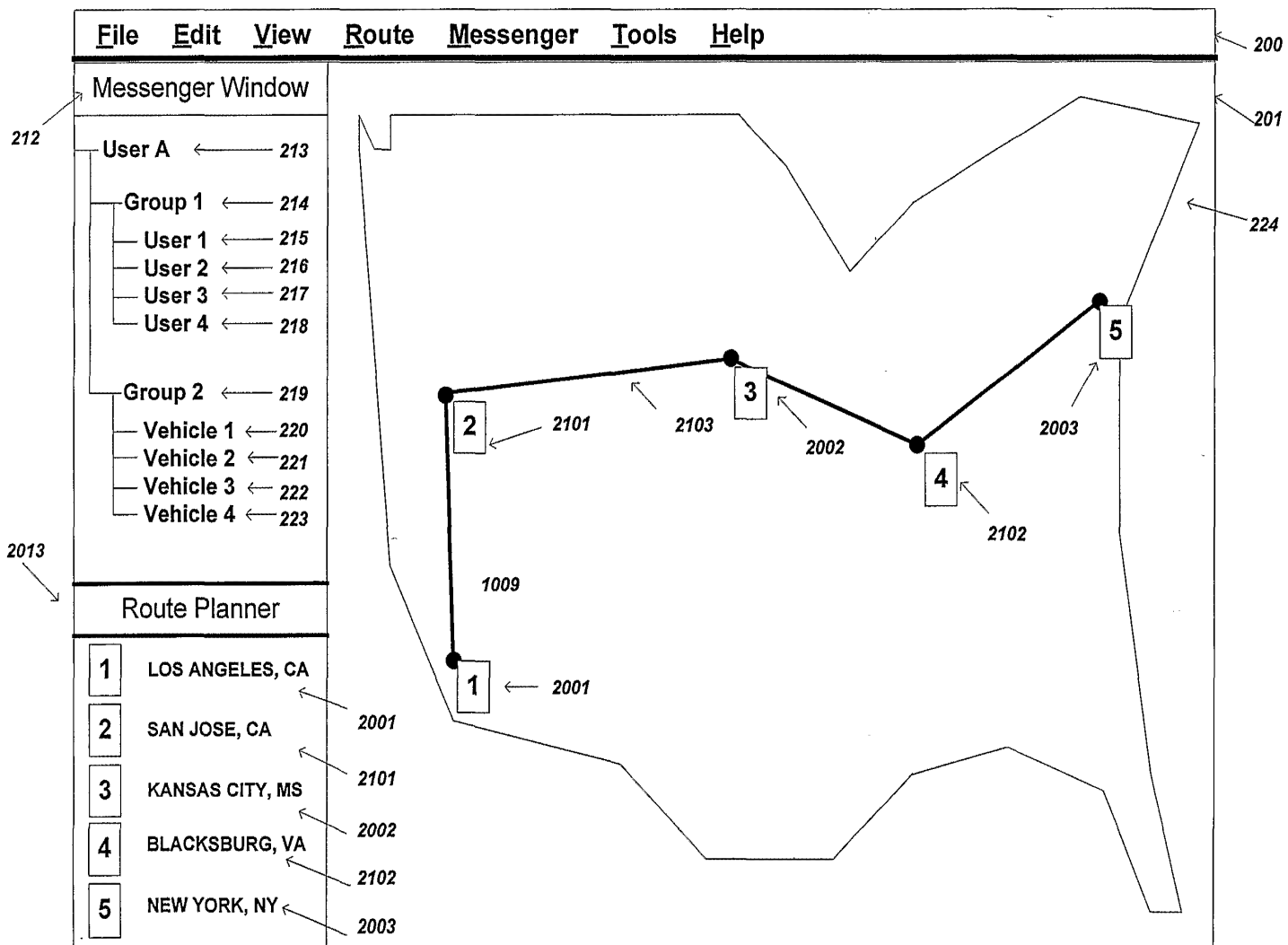

FIG. 21

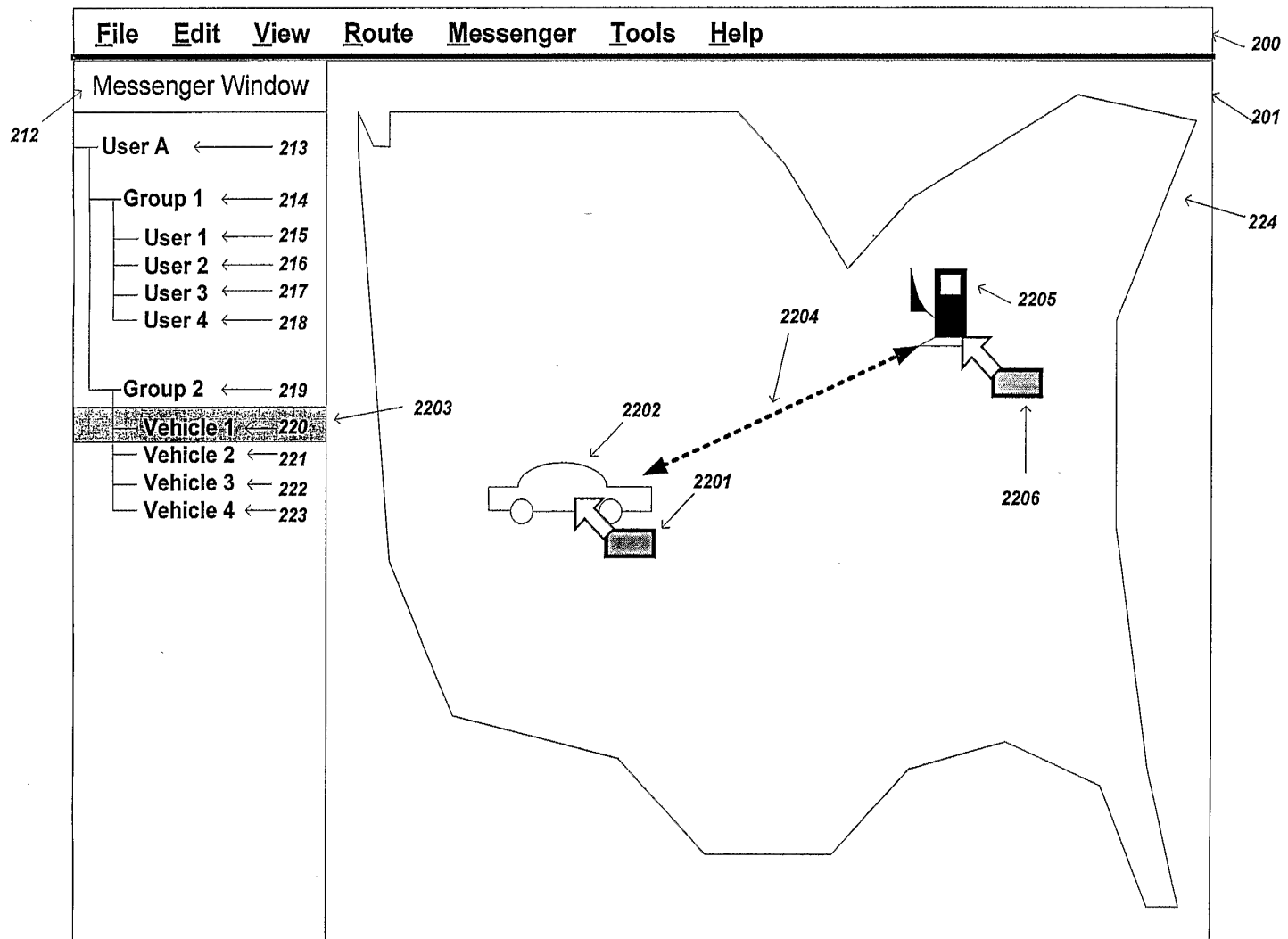

FIG. 22

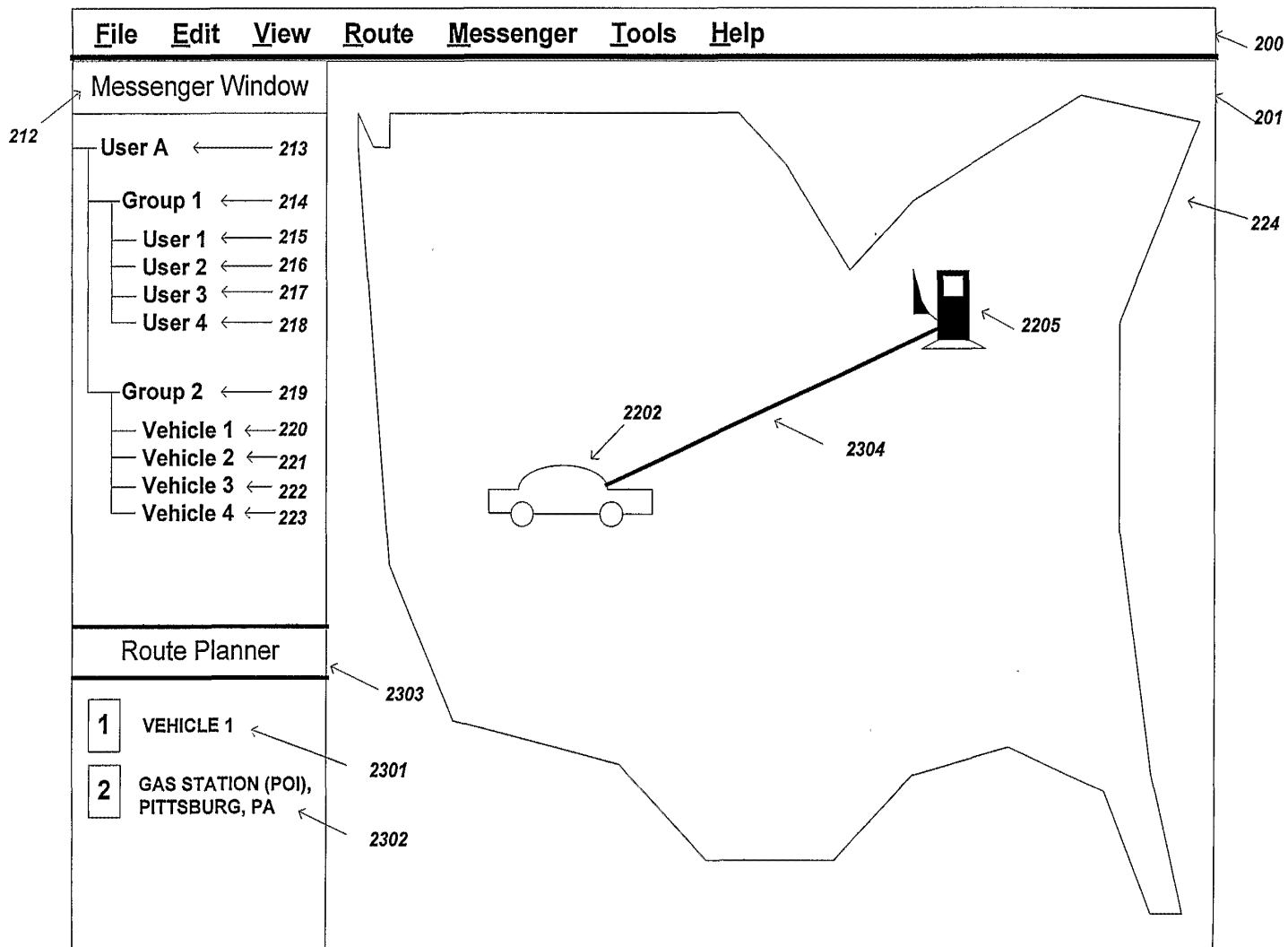

FIG. 23

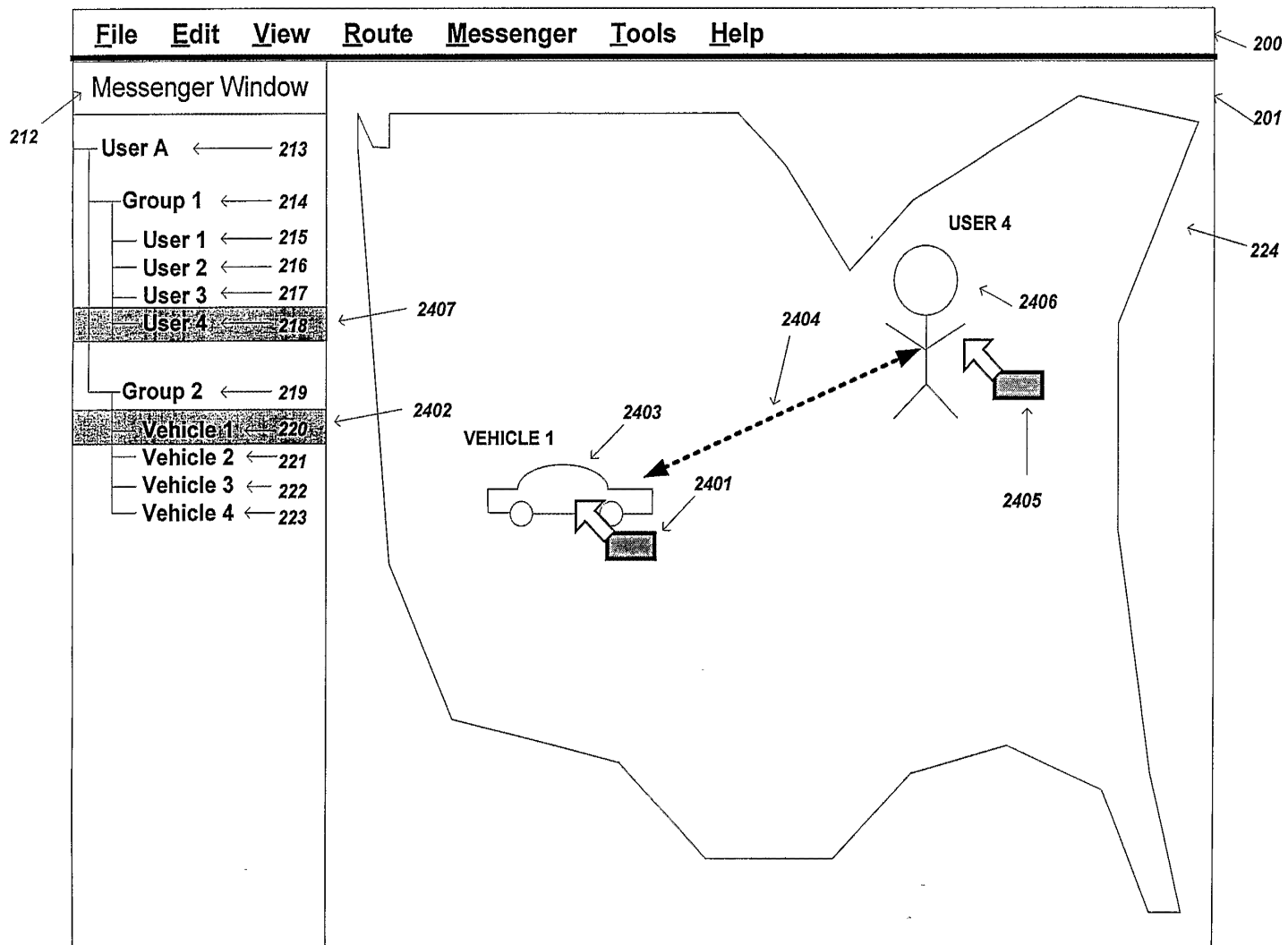

FIG. 24

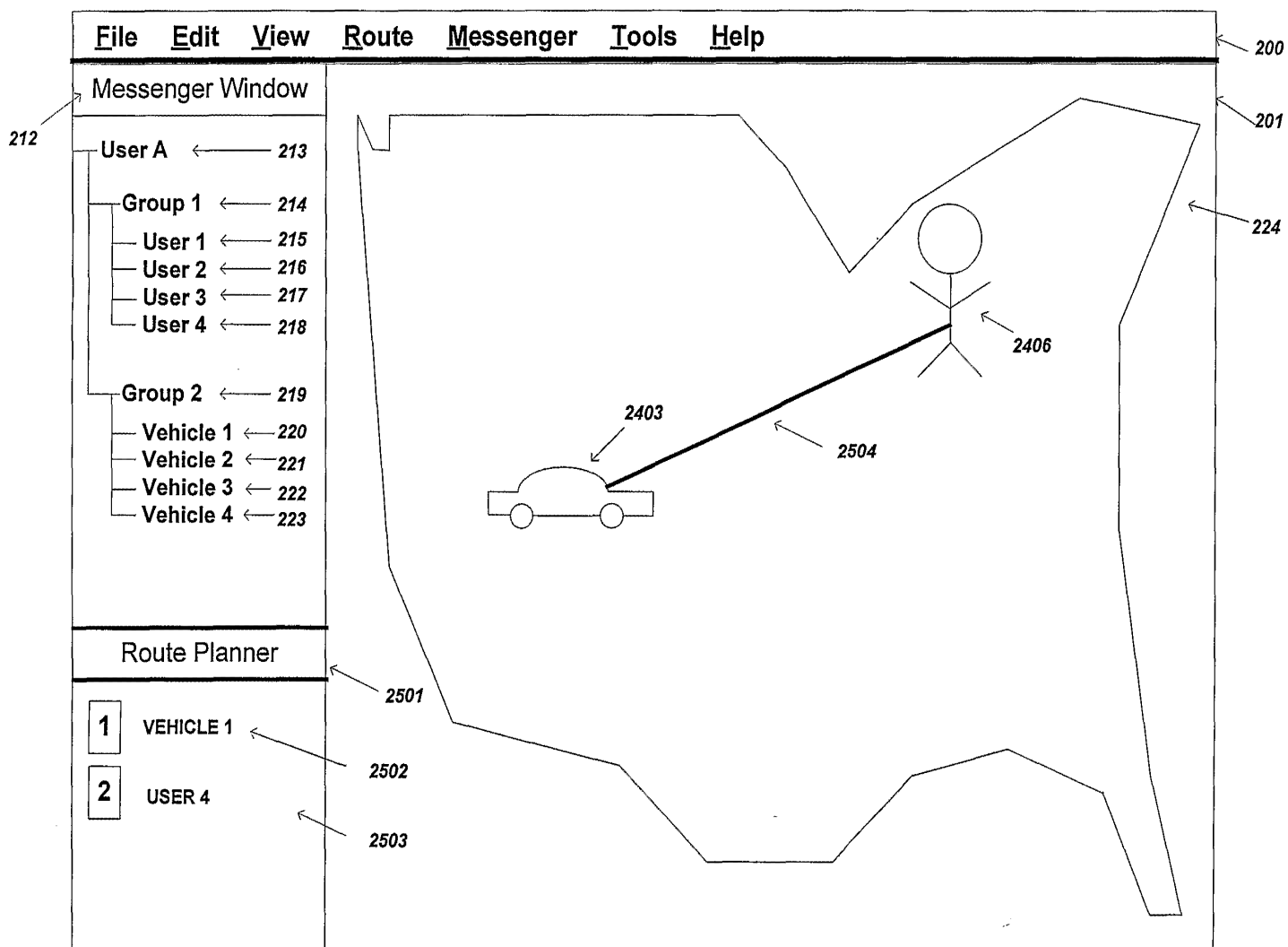

FIG. 25

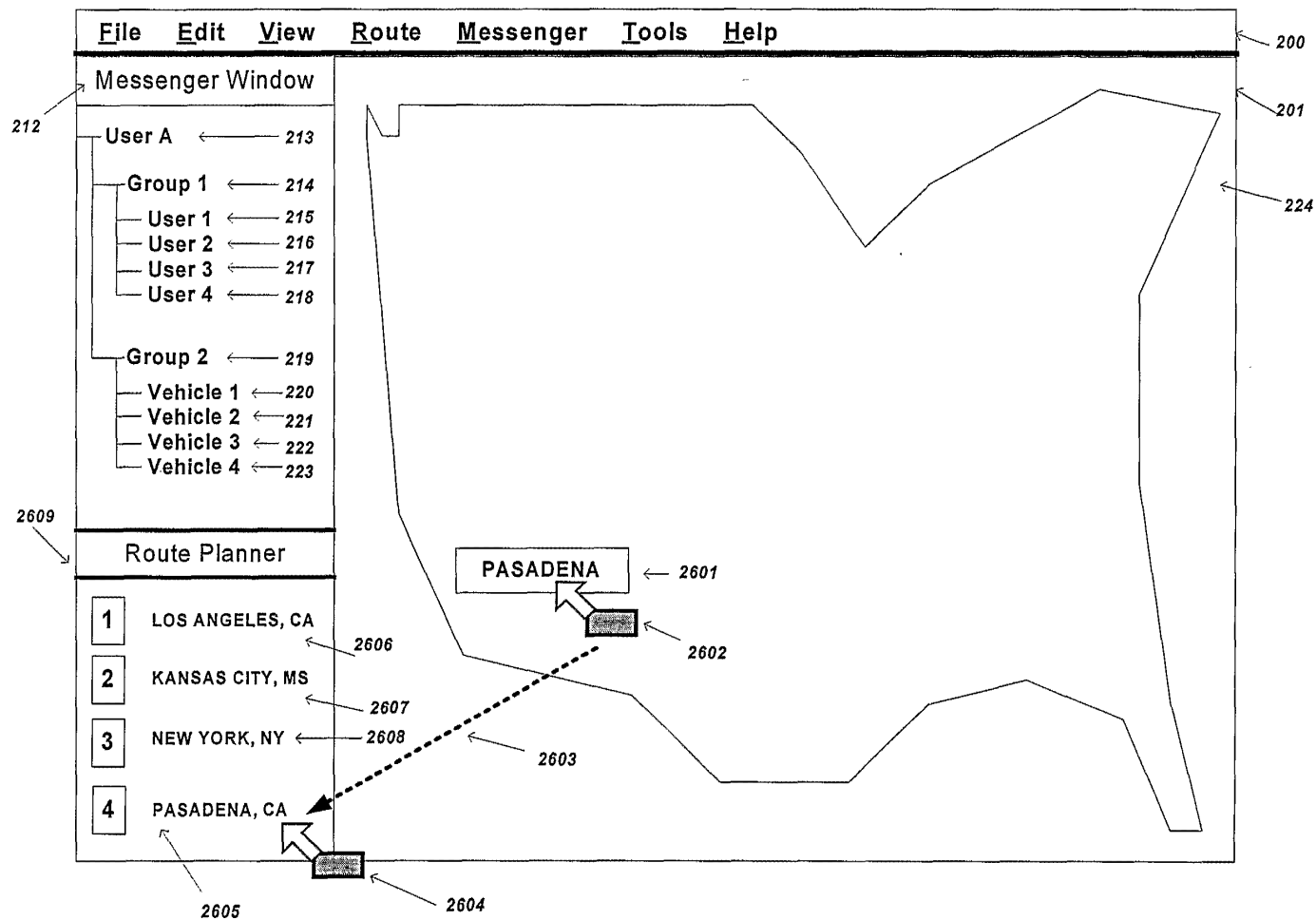

FIG. 26

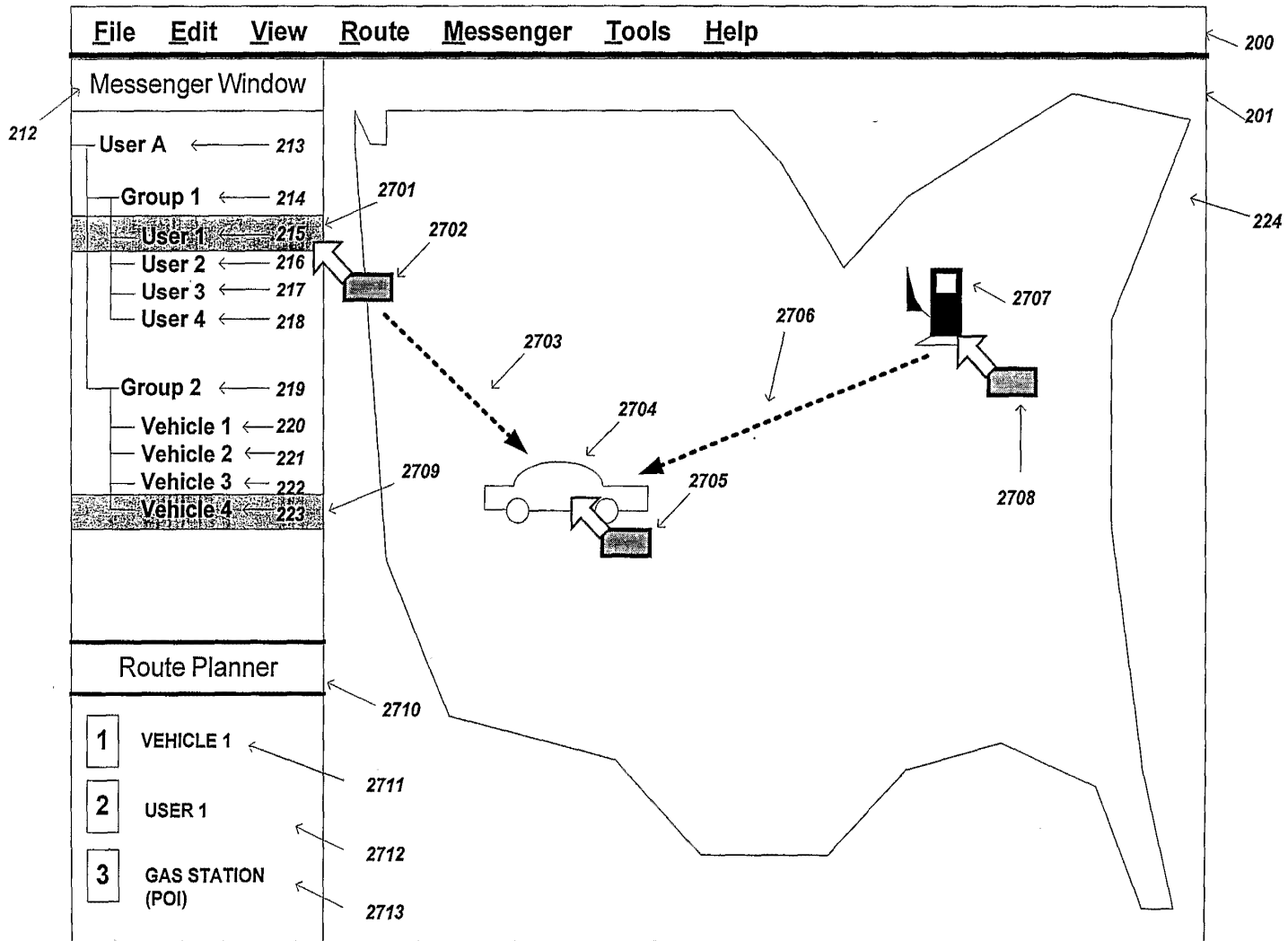

FIG. 27

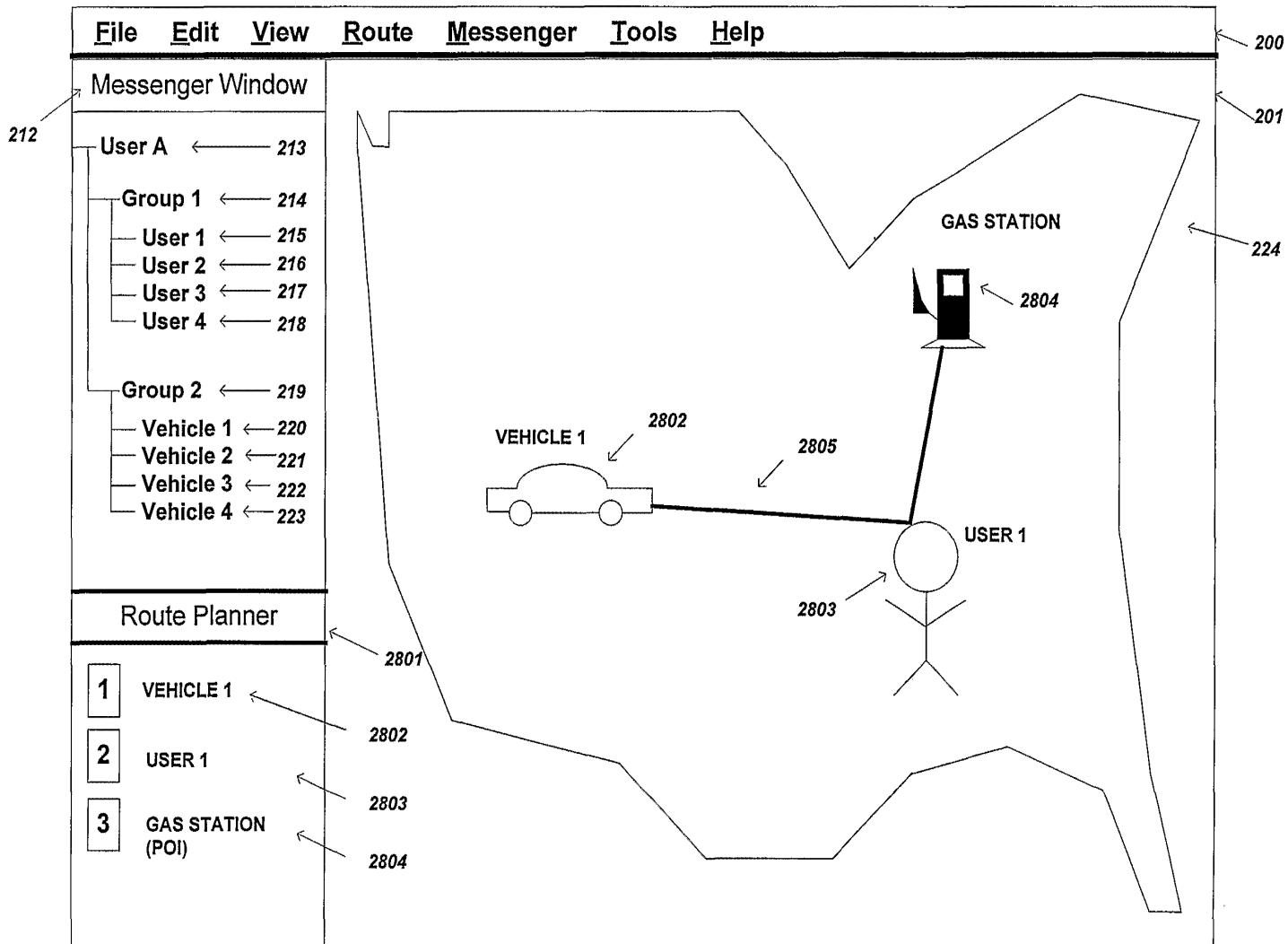

FIG. 28

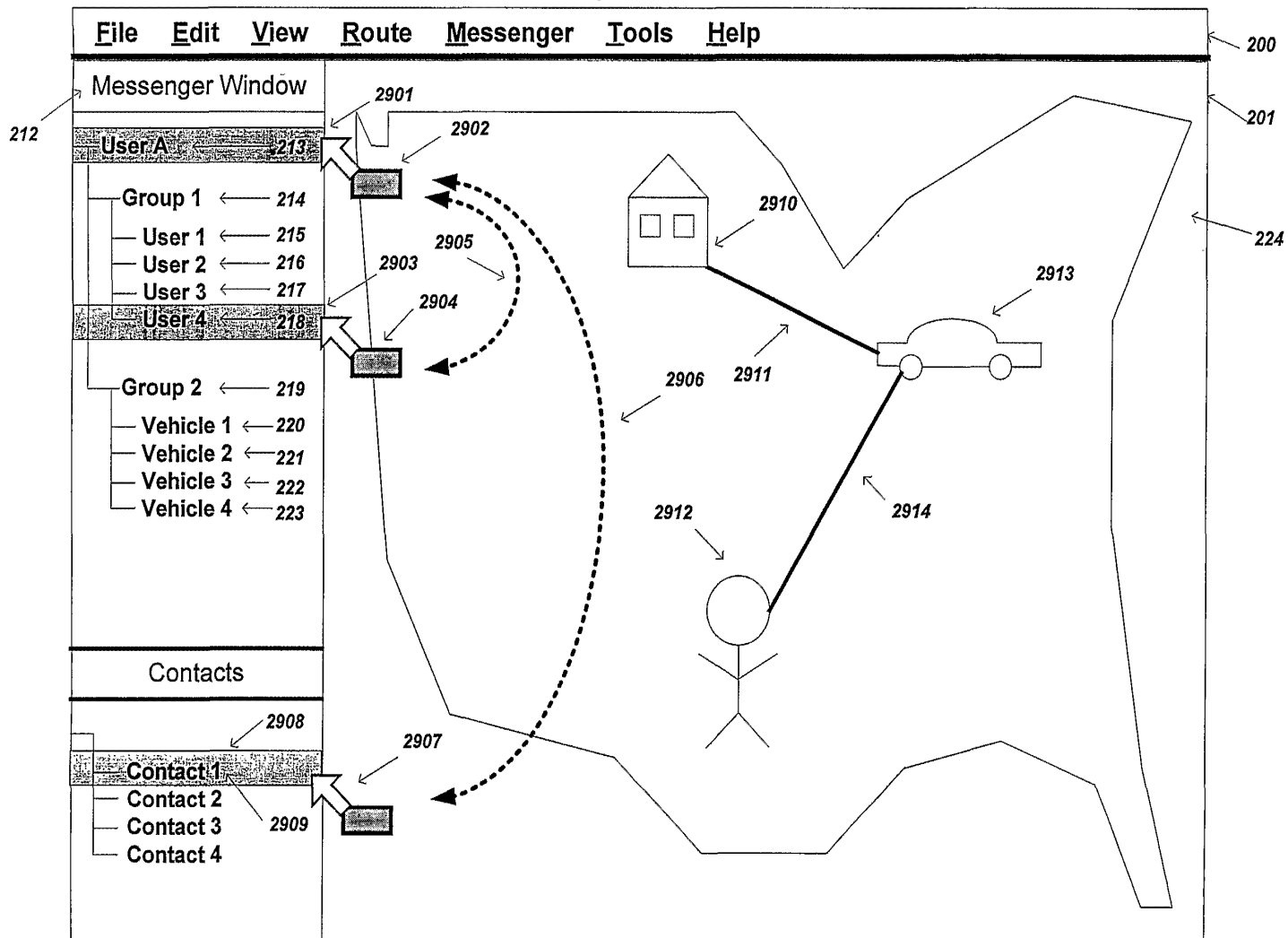

FIG. 29

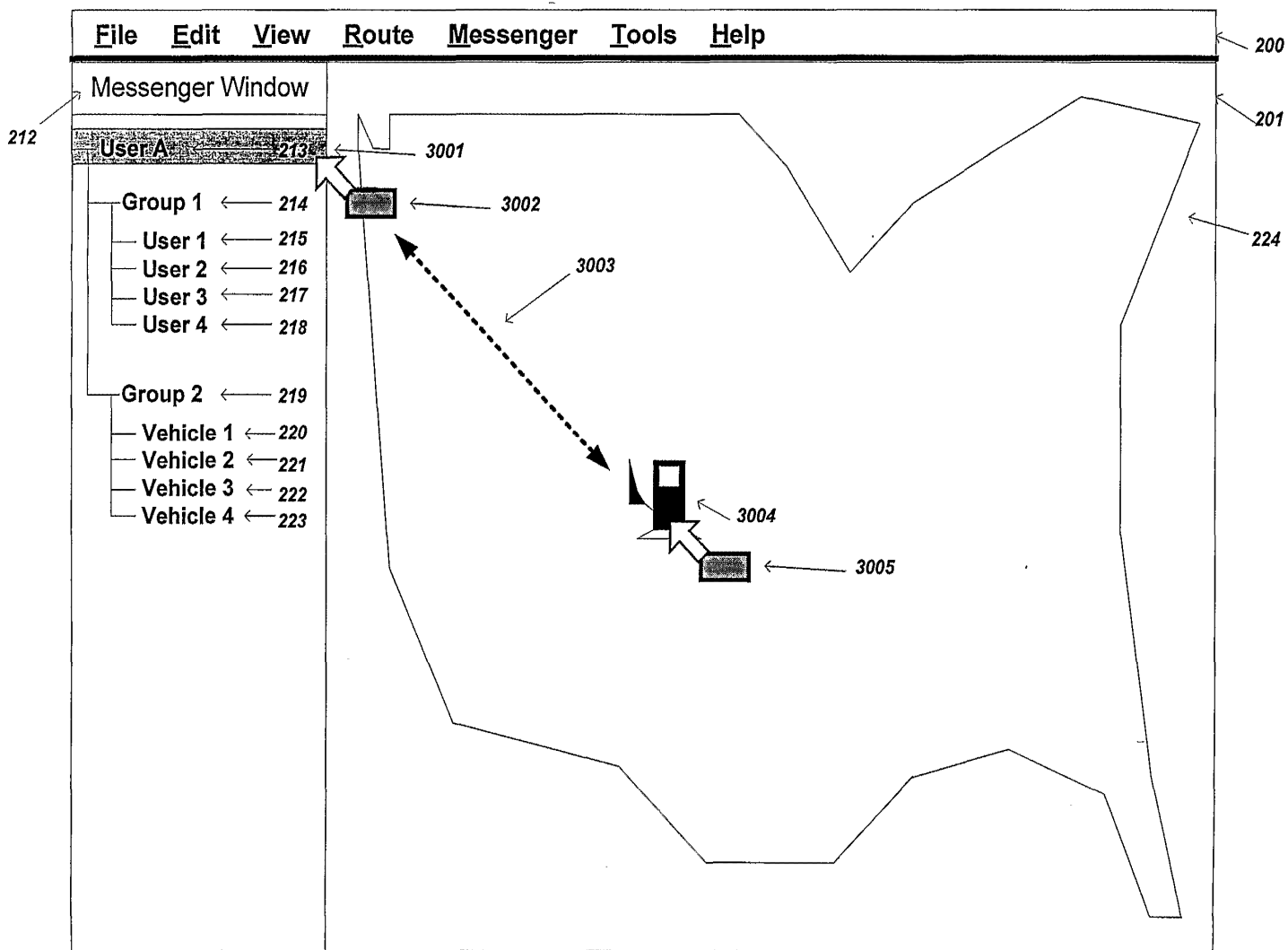

FIG. 30

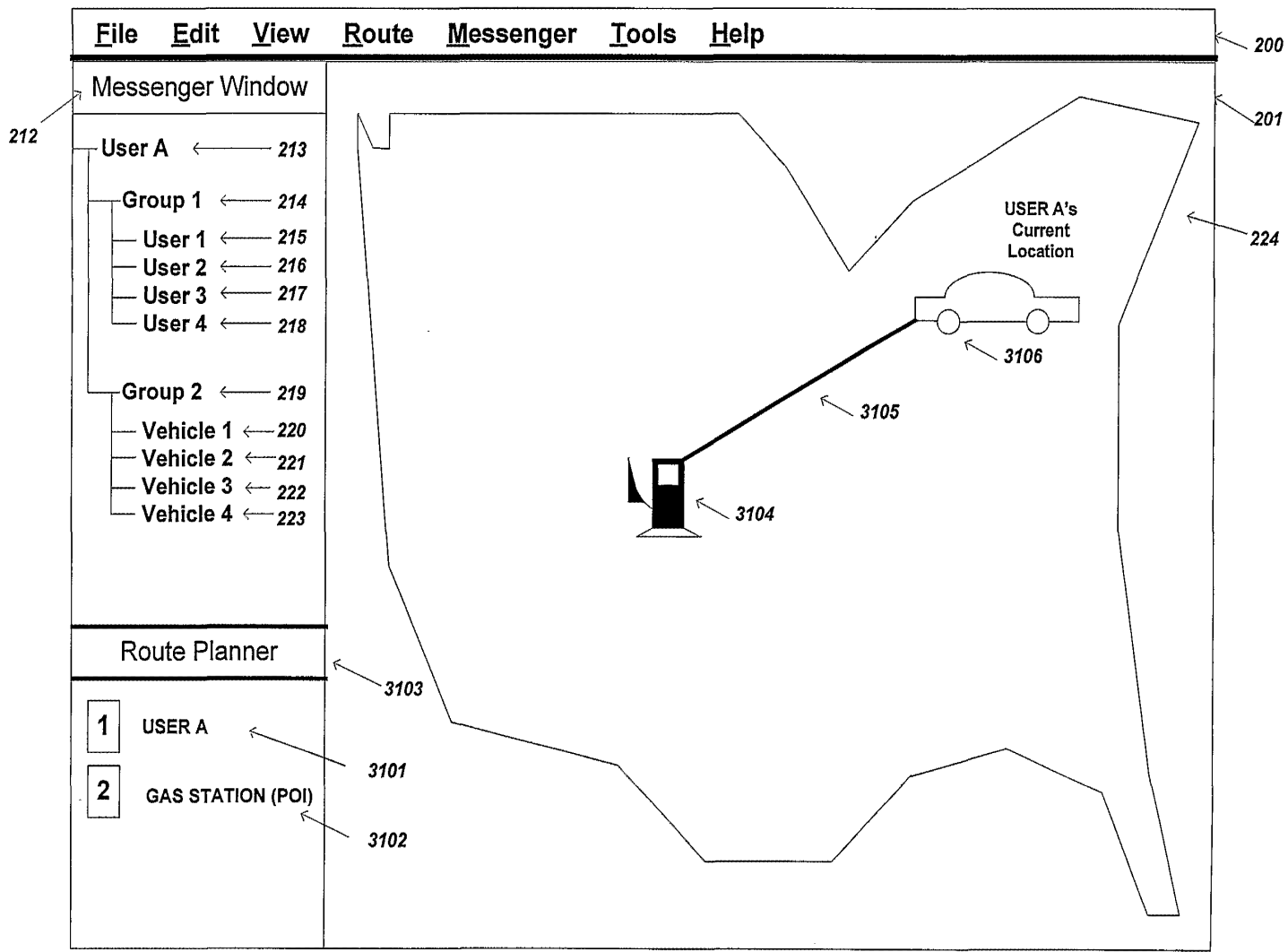

FIG. 31

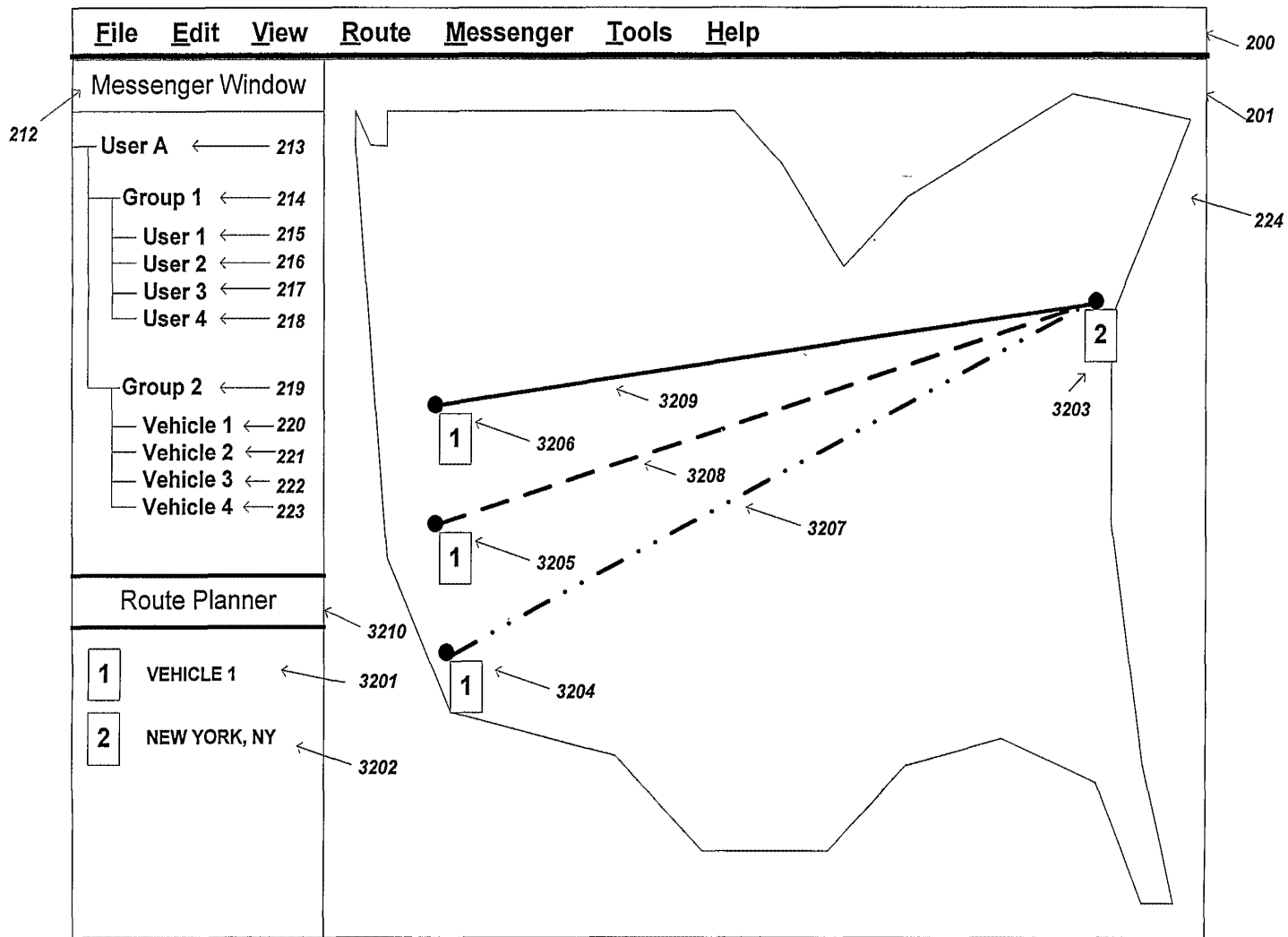

FIG. 32

Electronic Patent Application Fee Transmittal

Application Number:				
Filing Date:				
Title of Invention:	METHOD TO PROVIDE AD HOC AND PASSWORD PROTECTED DIGITAL AND VOICE NETWORKS			
First Named Inventor/Applicant Name:	Malcolm K. Beyer			
Filer:	Barry Lee Haley/Amy Allen			
Attorney Docket Number:	10963.3835			
Filed as Small Entity				
Filing Fees for Utility under 35 USC 111(a)				
Description	Fee Code	Quantity	Amount	Sub-Total in USD(\$)
Basic Filing:				
Utility filing Fee (Electronic filing)	4011	1	70	70
Utility Search Fee	2111	1	300	300
Utility Examination Fee	2311	1	360	360
Pages:				
Claims:				
Claims in excess of 20	2202	4	40	160
Miscellaneous-Filing:				
Petition:				

Description	Fee Code	Quantity	Amount	Sub-Total in USD(\$)
Patent-Appeals-and-Interference:				
Post-Allowance-and-Post-Issuance:				
Extension-of-Time:				
Miscellaneous:				
Total in USD (\$)				890

Electronic Acknowledgement Receipt

EFS ID:	21620595
Application Number:	14633804
International Application Number:	
Confirmation Number:	8573
Title of Invention:	METHOD TO PROVIDE AD HOC AND PASSWORD PROTECTED DIGITAL AND VOICE NETWORKS
First Named Inventor/Applicant Name:	Malcolm K. Beyer
Customer Number:	22235
Filer:	Barry Lee Haley/Amy Allen
Filer Authorized By:	Barry Lee Haley
Attorney Docket Number:	10963.3835
Receipt Date:	27-FEB-2015
Filing Date:	
Time Stamp:	15:23:58
Application Type:	Utility under 35 USC 111(a)

Payment information:

Submitted with Payment	yes
Payment Type	Deposit Account
Payment was successfully received in RAM	\$890
RAM confirmation Number	1986
Deposit Account	131130
Authorized User	
The Director of the USPTO is hereby authorized to charge indicated fees and credit any overpayment as follows:	
Charge any Additional Fees required under 37 C.F.R. Section 1.17 (Patent application and reexamination processing fees)	

Charge any Additional Fees required under 37 C.F.R. Section 1.20 (Post Issuance fees)

Charge any Additional Fees required under 37 C.F.R. Section 1.21 (Miscellaneous fees and charges)

File Listing:

Document Number	Document Description	File Name	File Size(Bytes)/ Message Digest	Multi Part /.zip	Pages (if appl.)
1	Application Data Sheet	WebADS.pdf	130988	no	6
			b2d6e5395685f6fb7a008d8aefba7cc2059a8128		
Warnings:					
Information:					
2	Transmittal of New Application	01_AppTransmittalSheet.pdf	277089	no	2
			004c356e45efe0b2ea32ed67e35aa2b6fa401edc		
Warnings:					
Information:					
3		04_ContApplication.pdf	175119	yes	30
			2040d9c9146d6b8cac9931530009fc25843e35cf		
	Multipart Description/PDF files in .zip description				
	Document Description		Start	End	
	Specification		1	26	
	Claims		27	29	
	Abstract		30	30	
Warnings:					
Information:					
4	Drawings-only black and white line drawings	05_Drawings.pdf	2106054	no	7
			b8da4326562fa88e873c87c2891842d47efd85d		
Warnings:					
Information:					
5	Oath or Declaration filed	06_Declaration.pdf	827929	no	3
			92c6944f3df4c6ffd450c5a0f6faae993454c46c		
Warnings:					
Information:					
6	Information Disclosure Statement (IDS) Form (SB08)	10_IDS.pdf	614311	no	8
			5cb936f2e9ad94805507e59e76ef4725dd102fe1		

Warnings:					
Information:					
7	Foreign Reference	34_JPH085394_Ozaki_et_al.pdf	3518801 98e2cd4fdce03c10758cf9006f20bc27a716b0b	no	76
Warnings:					
Information:					
8	Foreign Reference	35_JPH09113288_Satoshi.pdf	1026856 3b92c0a7d357dd7d6cf5ef83f96c5f35e6a7ebc6	no	11
Warnings:					
Information:					
9	Foreign Reference	36_JP2002245336_Shimada_et_al.pdf	1654424 fffb55f0e61f78709c77abbc6c1dcbe638fca5ab	no	32
Warnings:					
Information:					
10	Foreign Reference	37_WO03074973_Sheha.pdf	4673091 185c5951ce74f8efe0e2f912fc208a06ff956eab	no	135
Warnings:					
Information:					
11	Non Patent Literature	38_Gate5_Mobile_Community_Solution_NonPatent_Literature.pdf	904268 e104d2ef400540561385de28489982700415a26e	no	4
Warnings:					
Information:					
12	Non Patent Literature	39_Gate5_Mobile_Guide_Solution_NonPatent_Literature.pdf	1238848 d6089639b01b6d4d94d6493e6b9701b5555deb59	no	4
Warnings:					
Information:					
13	Non Patent Literature	40_Batista_NonPatent_Literature.pdf	281405 5a35ed48dee25ae272bedf3883b7e1329f6f72df	no	2
Warnings:					
Information:					
14	Non Patent Literature	41_Edlund_et_al_NonPatent_Literature.pdf	3119553 22ee109c83b10393381f6a153e8a02e686aba561	no	50
Warnings:					
Information:					
15	Non Patent Literature	42_Gate5_System.pdf	531523 8ed83dbbd1328125d62ebec67bb38c1c504a0c9d	no	8

Warnings:					
Information:					
16	Non Patent Literature	43_Ryan_NonPatent_Literature.pdf	300423 5e0c1713403afa4e25a90c9a3998c0741ac2e61e	no	3
Warnings:					
Information:					
17	Non Patent Literature	44_LocatioNet_Press_Release_NonPatent_Literature.pdf	149029 2c4fd90fb8b6f2a8d5939004dc0771945c941ab7	no	2
Warnings:					
Information:					
18	Non Patent Literature	45_LocatioNet_LBS_Apps_NonPatent_Literature.pdf	2185276 8833516f91db58f35b910b820810d8a97074bc05	no	13
Warnings:					
Information:					
19	Non Patent Literature	46_LocatioNet_System_NonPatent_Literature.pdf	657991 b5dde6ae817970ae4c8f36a2302821e9940f4288	no	6
Warnings:					
Information:					
20	Non Patent Literature	47_Luna_NonPatent_Literature.pdf	2015487 105a8f76ec9a2b3b9fe64b4a600de8cecb9e78a8	no	6
Warnings:					
Information:					
21	Non Patent Literature	48_Meggerts_NonPatent_Literature.pdf	899509 f09046c7607b4546d4baf4c9e83cb94f92afd7	no	5
Warnings:					
Information:					
22	Fee Worksheet (SB06)	fee-info.pdf	37191 dd984d2aca91551bf16611870d1ef961be8f8eb11	no	2
Warnings:					
Information:					
Total Files Size (in bytes):				27325165	

This Acknowledgement Receipt evidences receipt on the noted date by the USPTO of the indicated documents, characterized by the applicant, and including page counts, where applicable. It serves as evidence of receipt similar to a Post Card, as described in MPEP 503.

New Applications Under 35 U.S.C. 111

If a new application is being filed and the application includes the necessary components for a filing date (see 37 CFR 1.53(b)-(d) and MPEP 506), a Filing Receipt (37 CFR 1.54) will be issued in due course and the date shown on this Acknowledgement Receipt will establish the filing date of the application.

National Stage of an International Application under 35 U.S.C. 371

If a timely submission to enter the national stage of an international application is compliant with the conditions of 35 U.S.C. 371 and other applicable requirements a Form PCT/DO/EO/903 indicating acceptance of the application as a national stage submission under 35 U.S.C. 371 will be issued in addition to the Filing Receipt, in due course.

New International Application Filed with the USPTO as a Receiving Office

If a new international application is being filed and the international application includes the necessary components for an international filing date (see PCT Article 11 and MPEP 1810), a Notification of the International Application Number and of the International Filing Date (Form PCT/RO/105) will be issued in due course, subject to prescriptions concerning national security, and the date shown on this Acknowledgement Receipt will establish the international filing date of the application.

Application Data Sheet 37 CFR 1.76		Attorney Docket Number	10963.3835
		Application Number	
Title of Invention	METHOD TO PROVIDE AD HOC AND PASSWORD PROTECTED DIGITAL AND VOICE NETWORKS		
The application data sheet is part of the provisional or nonprovisional application for which it is being submitted. The following form contains the bibliographic data arranged in a format specified by the United States Patent and Trademark Office as outlined in 37 CFR 1.76. This document may be completed electronically and submitted to the Office in electronic format using the Electronic Filing System (EFS) or the document may be printed and included in a paper filed application.			

Secrecy Order 37 CFR 5.2

<input type="checkbox"/>	Portions or all of the application associated with this Application Data Sheet may fall under a Secrecy Order pursuant to 37 CFR 5.2(Paper filers only. Applications that fall under Secrecy Order may not be filed electronically.)
--------------------------	--

Inventor Information:

Inventor 1						<input type="button" value="Remove"/>
Legal Name						
Prefix	Given Name	Middle Name	Family Name	Suffix		
Mr.	Malcolm	K.	Beyer	Jr.		
Residence Information (Select One) <input checked="" type="radio"/> US Residency <input type="radio"/> Non US Residency <input type="radio"/> Active US Military Service						
City	Jupiter	State/Province	FL	Country of Residence	US	
Mailing Address of Inventor:						
Address 1	92 Lighthouse Drive					
Address 2						
City	Jupiter	State/Province	FL			
Postal Code	33469	Country	i	US		
Inventor 2						<input type="button" value="Remove"/>
Legal Name						
Prefix	Given Name	Middle Name	Family Name	Suffix		
Mr.	Christopher	R.	Rice			
Residence Information (Select One) <input checked="" type="radio"/> US Residency <input type="radio"/> Non US Residency <input type="radio"/> Active US Military Service						
City	Redmond	State/Province	WA	Country of Residence	US	
Mailing Address of Inventor:						
Address 1	P.O. Box 3583					
Address 2						
City	Redmond	State/Province	WA			
Postal Code	98073	Country	i	US		
All Inventors Must Be Listed - Additional Inventor Information blocks may be generated within this form by selecting the Add button.						<input type="button" value="Add"/>

Correspondence Information:

Enter either Customer Number or complete the Correspondence Information section below. For further information see 37 CFR 1.33(a).

Application Data Sheet 37 CFR 1.76		Attorney Docket Number	10963.3835
		Application Number	
Title of Invention	METHOD TO PROVIDE AD HOC AND PASSWORD PROTECTED DIGITAL AND VOICE NETWORKS		

<input type="checkbox"/> An Address is being provided for the correspondence information of this application.			
Customer Number	22235		
Email Address	info@mhdpatents.com	<input type="button" value="Add Email"/>	<input type="button" value="Remove Email"/>

Application Information:

Title of the Invention	METHOD TO PROVIDE AD HOC AND PASSWORD PROTECTED DIGITAL AND VOICE NETWORKS		
Attorney Docket Number	10963.3835	Small Entity Status Claimed	<input checked="" type="checkbox"/>
Application Type	Nonprovisional		
Subject Matter	Utility		
Total Number of Drawing Sheets (if any)	7	Suggested Figure for Publication (if any)	

Filing By Reference

Only complete this section when filing an application by reference under 35 U.S.C. 111(c) and 37 CFR 1.57(a). Do not complete this section if application papers including a specification and any drawings are being filed. Any domestic benefit or foreign priority information must be provided in the appropriate section(s) below (i.e., "Domestic Benefit/National Stage Information" and "Foreign Priority Information").

For the purposes of a filing date under 37 CFR 1.53(b), the description and any drawings of the present application are replaced by this reference to the previously filed application, subject to conditions and requirements of 37 CFR 1.57(a).

Application number of the previously filed application	Filing date (YYYY-MM-DD)	Intellectual Property Authority or Country i

Publication Information:

<input type="checkbox"/> Request Early Publication (Fee required at time of Request 37 CFR 1.219)
<input checked="" type="checkbox"/> Request Not to Publish. I hereby request that the attached application not be published under 35 U.S.C. 122(b) and certify that the invention disclosed in the attached application has not and will not be the subject of an application filed in another country, or under a multilateral international agreement, that requires publication at eighteen months after filing.

Representative Information:

Representative information should be provided for all practitioners having a power of attorney in the application. Providing this information in the Application Data Sheet does not constitute a power of attorney in the application (see 37 CFR 1.32). Either enter Customer Number or complete the Representative Name section below. If both sections are completed the customer Number will be used for the Representative Information during processing.			
Please Select One:	<input checked="" type="radio"/> Customer Number	<input type="radio"/> US Patent Practitioner	<input type="radio"/> Limited Recognition (37 CFR 11.9)
Customer Number	22235		
Additional Representative Information blocks may be generated within this form by selecting the Add button.			

Application Data Sheet 37 CFR 1.76		Attorney Docket Number	10963.3835
		Application Number	
Title of Invention	METHOD TO PROVIDE AD HOC AND PASSWORD PROTECTED DIGITAL AND VOICE NETWORKS		

Domestic Benefit/National Stage Information:

This section allows for the applicant to either claim benefit under 35 U.S.C. 119(e), 120, 121, or 365(c) or indicate National Stage entry from a PCT application. Providing this information in the application data sheet constitutes the specific reference required by 35 U.S.C. 119(e) or 120, and 37 CFR 1.78.

Prior Application Status	Pending		<input type="button" value="Remove"/>		
Application Number	Continuity Type	Prior Application Number	Filing Date (YYYY-MM-DD)		
	Continuation of	14529978	2014-10-31		
Prior Application Status	Patented		<input type="button" value="Remove"/>		
Application Number	Continuity Type	Prior Application Number	Filing Date (YYYY-MM-DD)	Patent Number	Issue Date (YYYY-MM-DD)
14529978	Continuation of	14027410	2013-09-16	8880042	2014-11-04
Prior Application Status	Patented		<input type="button" value="Remove"/>		
Application Number	Continuity Type	Prior Application Number	Filing Date (YYYY-MM-DD)	Patent Number	Issue Date (YYYY-MM-DD)
14027410	Continuation of	13751453	2013-01-28	8538393	2013-09-17
Prior Application Status	Patented		<input type="button" value="Remove"/>		
Application Number	Continuity Type	Prior Application Number	Filing Date (YYYY-MM-DD)	Patent Number	Issue Date (YYYY-MM-DD)
13751453	Continuation in part of	12761533	2010-04-16	8364129	2013-01-29
Prior Application Status	Patented		<input type="button" value="Remove"/>		
Application Number	Continuity Type	Prior Application Number	Filing Date (YYYY-MM-DD)	Patent Number	Issue Date (YYYY-MM-DD)
12761533	Continuation in part of	11615472	2006-12-22	8126441	2012-02-28
Prior Application Status	Patented		<input type="button" value="Remove"/>		
Application Number	Continuity Type	Prior Application Number	Filing Date (YYYY-MM-DD)	Patent Number	Issue Date (YYYY-MM-DD)
11615472	Continuation in part of	11308648	2006-04-17	7630724	2009-12-08
Prior Application Status	Patented		<input type="button" value="Remove"/>		
Application Number	Continuity Type	Prior Application Number	Filing Date (YYYY-MM-DD)	Patent Number	Issue Date (YYYY-MM-DD)
11308648	Continuation in part of	10711490	2004-09-21	7031728	2006-04-18
Additional Domestic Benefit/National Stage Data may be generated within this form by selecting the Add button.					

Foreign Priority Information:

This section allows for the applicant to claim priority to a foreign application. Providing this information in the application data sheet constitutes the claim for priority as required by 35 U.S.C. 119(b) and 37 CFR 1.55(d). When priority is claimed to a foreign application that is eligible for retrieval under the priority document exchange program (PDX) the information will be used by the Office to automatically attempt retrieval pursuant to 37 CFR 1.55(h)(1) and (2). Under the PDX program, applicant bears the ultimate responsibility for ensuring that a copy of the foreign application is received by the Office from the participating foreign intellectual property office, or a certified copy of the foreign priority application is filed, within the time period specified in 37 CFR 1.55(g)(1).

WEB ADS 1.0

Application Data Sheet 37 CFR 1.76		Attorney Docket Number	10963.3835
		Application Number	
Title of Invention	METHOD TO PROVIDE AD HOC AND PASSWORD PROTECTED DIGITAL AND VOICE NETWORKS		
Application Number	Country	Filing Date (YYYY-MM-DD)	<input type="button" value="Remove"/> Access Code (if applicable)
Additional Foreign Priority Data may be generated within this form by selecting the Add button.			

Statement under 37 CFR 1.55 or 1.78 for AIA (First Inventor to File) Transition Applications

<p>This application (1) claims priority to or the benefit of an application filed before March 16, 2013 and (2) also contains, or contained at any time, a claim to a claimed invention that has an effective filing date on or after March 16, 2013.</p> <p><input checked="" type="checkbox"/> NOTE: By providing this statement under 37 CFR 1.55 or 1.78, this application, with a filing date on or after March 16, 2013, will be examined under the first inventor to file provisions of the AIA.</p>

Authorization to Permit Access:

<input checked="" type="checkbox"/> Authorization to Permit Access to the Instant Application by the Participating Offices
<p>If checked, the undersigned hereby grants the USPTO authority to provide the European Patent Office (EPO), the Japan Patent Office (JPO), the Korean Intellectual Property Office (KIPO), the World Intellectual Property Office (WIPO), and any other intellectual property offices in which a foreign application claiming priority to the instant patent application is filed access to the instant patent application. See 37 CFR 1.14(c) and (h). This box should not be checked if the applicant does not wish the EPO, JPO, KIPO, WIPO, or other intellectual property office in which a foreign application claiming priority to the instant patent application is filed to have access to the instant patent application.</p> <p>In accordance with 37 CFR 1.14(h)(3), access will be provided to a copy of the instant patent application with respect to: 1) the instant patent application-as-filed; 2) any foreign application to which the instant patent application claims priority under 35 U.S.C. 119(a)-(d) if a copy of the foreign application that satisfies the certified copy requirement of 37 CFR 1.55 has been filed in the instant patent application; and 3) any U.S. application-as-filed from which benefit is sought in the instant patent application.</p> <p>In accordance with 37 CFR 1.14(c), access may be provided to information concerning the date of filing this Authorization.</p>

Applicant Information:

<p>Providing assignment information in this section does not substitute for compliance with any requirement of part 3 of Title 37 of CFR to have an assignment recorded by the Office.</p>
--

Application Data Sheet 37 CFR 1.76		Attorney Docket Number	10963.3835
		Application Number	
Title of Invention	METHOD TO PROVIDE AD HOC AND PASSWORD PROTECTED DIGITAL AND VOICE NETWORKS		

Applicant 1			
<p>If the applicant is the inventor (or the remaining joint inventor or inventors under 37 CFR 1.45), this section should not be completed. The information to be provided in this section is the name and address of the legal representative who is the applicant under 37 CFR 1.43; or the name and address of the assignee, person to whom the inventor is under an obligation to assign the invention, or person who otherwise shows sufficient proprietary interest in the matter who is the applicant under 37 CFR 1.46. If the applicant is an applicant under 37 CFR 1.46 (assignee, person to whom the inventor is obligated to assign, or person who otherwise shows sufficient proprietary interest) together with one or more joint inventors, then the joint inventor or inventors who are also the applicant should be identified in this section.</p>			
<input type="button" value="Clear"/>			
<input type="radio"/> Assignee	<input type="radio"/> Legal Representative under 35 U.S.C. 117	<input type="radio"/> Joint Inventor	
<input type="radio"/> Person to whom the inventor is obligated to assign.		<input type="radio"/> Person who shows sufficient proprietary interest	
If applicant is the legal representative, indicate the authority to file the patent application, the inventor is:			
Name of the Deceased or Legally Incapacitated Inventor :			
If the Applicant is an Organization check here. <input type="checkbox"/>			

Prefix	Given Name	Middle Name	Family Name	Suffix

Mailing Address Information:				
Address 1				
Address 2				
City		State/Province		
Country i		Postal Code		
Phone Number		Fax Number		
Email Address				

Additional Applicant Data may be generated within this form by selecting the Add button.

Assignee Information including Non-Applicant Assignee Information:

Providing assignment information in this section does not substitute for compliance with any requirement of part 3 of Title 37 of CFR to have an assignment recorded by the Office.

Assignee 1
<p>Complete this section if assignee information, including non-applicant assignee information, is desired to be included on the patent application publication. An assignee-applicant identified in the "Applicant Information" section will appear on the patent application publication as an applicant. For an assignee-applicant, complete this section only if identification as an assignee is also desired on the patent application publication.</p>

Application Data Sheet 37 CFR 1.76		Attorney Docket Number	10963.3835
		Application Number	
Title of Invention	METHOD TO PROVIDE AD HOC AND PASSWORD PROTECTED DIGITAL AND VOICE NETWORKS		

If the Assignee or Non-Applicant Assignee is an Organization check here <input type="checkbox"/>				
Prefix	Given Name	Middle Name	Family Name	Suffix
Mailing Address Information For Assignee including Non-Applicant Assignee:				
Address 1				
Address 2				
City		State/Province		
Country i		Postal Code		
Phone Number		Fax Number		
Email Address				
Additional Assignee or Non-Applicant Assignee Data may be generated within this form by selecting the Add button.				

Signature:

NOTE: This form must be signed in accordance with 37 CFR 1.33. See 37 CFR 1.4 for signature requirements and certifications					
Signature	/Barry L. Haley/				
First Name	Barry	Last Name	Haley	Registration Number	25339
Additional Signature may be generated within this form by selecting the Add button.					

Under the Paperwork Reduction Act of 1995, no persons are required to respond to a collection of information unless it displays a valid OMB control number.

TRANSMITTAL FOR POWER OF ATTORNEY TO ONE OR MORE REGISTERED PRACTITIONERS

NOTE: This form is to be submitted with the Power of Attorney by Applicant form (PTO/AIA/82B) to identify the application to which the Power of Attorney is directed, in accordance with 37 CFR 1.5, unless the application number and filing date are identified in the Power of Attorney by Applicant form. If neither form PTO/AIA/82A nor form PTO/AIA/82B identifies the application to which the Power of Attorney is directed, the Power of Attorney will not be recognized in the application.

Application Number	
Filing Date	February 27, 2015
First Named Inventor	Malcolm K. Beyer, Jr.
Title	METHOD TO PROVIDE AD HOC AND PASSWORD PROTECTED DIGITAL AND VOICE NETWORKS
Art Unit	
Examiner Name	
Attorney Docket Number	10963.3835

SIGNATURE of Applicant or Patent Practitioner			
Signature	/barry l. haley/	Date (Optional)	February 27, 2015
Name	Barry L. Haley	Registration Number	25339
Title (if Applicant is a juristic entity)			
Applicant Name (if Applicant is a juristic entity)			

NOTE: This form must be signed in accordance with 37 CFR 1.33. See 37 CFR 1.4(d) for signature requirements and certifications. If more than one applicant, use multiple forms.

*Total of _____ forms are submitted.

This collection of information is required by 37 CFR 1.131, 1.32, and 1.33. The information is required to obtain or retain a benefit by the public which is to file (and by the USPTO to process) an application. Confidentiality is governed by 35 U.S.C. 122 and 37 CFR 1.11 and 1.14. This collection is estimated to take 3 minutes to complete, including gathering, preparing, and submitting the completed application form to the USPTO. Time will vary depending upon the individual case. Any comments on the amount of time you require to complete this form and/or suggestions for reducing this burden, should be sent to the Chief Information Officer, U.S. Patent and Trademark Office, U.S. Department of Commerce, P.O. Box 1450, Alexandria, VA 22313-1450. DO NOT SEND FEES OR COMPLETED FORMS TO THIS ADDRESS. SEND TO: Commissioner for Patents, P.O. Box 1486, Alexandria, VA 22313-1450.

If you need assistance in completing the form, call 1-800-PTO-9199 and select option 2.

POWER OF ATTORNEY BY APPLICANT

I hereby revoke all previous powers of attorney given in the application identified in either the attached transmittal letter or the boxes below.

Application Number	Filing Date

(Note: The boxes above may be left blank if information is provided on form PTO/AIA/82A.)

- I hereby appoint the Patent Practitioner(s) associated with the following Customer Number as my/our attorney(s) or agent(s), and to transact all business in the United States Patent and Trademark Office connected therewith for the application referenced in the attached transmittal letter (form PTO/AIA/82A) or identified above: 22235
- OR
- I hereby appoint Practitioner(s) named in the attached list (form PTO/AIA/82C) as my/our attorney(s) or agent(s), and to transact all business in the United States Patent and Trademark Office connected therewith for the patent application referenced in the attached transmittal letter (form PTO/AIA/82A) or identified above. (Note: Complete form PTO/AIA/82C.)

Please recognize or change the correspondence address for the application identified in the attached transmittal letter or the boxes above to:

- The address associated with the above-mentioned Customer Number
- OR
- The address associated with Customer Number:
- OR

Firm or Individual Name			
Address			
City	State	Zip	
Country			
Telephone	Email		

I am the Applicant (if the Applicant is a juristic entity, list the Applicant name in the box):

- Inventor or Joint Inventor (title not required below)
- Legal Representative of a Deceased or Legally Incapacitated Inventor (title not required below)
- Assignee or Person to Whom the Inventor is Under an Obligation to Assign (provide signer's title if applicant is a juristic entity)
- Person Who Otherwise Shows Sufficient Proprietary Interest (e.g., a petition under 37 CFR 1.46(b)(2) was granted in the application or is concurrently being filed with this document) (provide signer's title if applicant is a juristic entity)

SIGNATURE of Applicant for Patent

The undersigned (whose title is supplied below) is authorized to act on behalf of the applicant (e.g., where the applicant is a juristic entity).

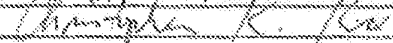
Signature 	Date (Optional) 2-12-15
Name Christopher R. Rice	
Title	

NOTE: Signature - This form must be signed by the applicant in accordance with 37 CFR 1.33. See 37 CFR 1.4 for signature requirements and certifications. If more than one applicant, use multiple forms.

Total of _____ forms are submitted.

This collection of information is required by 37 CFR 1.131, 1.32, and 1.33. The information is required to obtain or retain a benefit by the public which is to file (and by the USPTO to process) an application. Confidentiality is governed by 35 U.S.C. 122 and 37 CFR 1.11 and 1.14. This collection is estimated to take 3 minutes to complete, including gathering, preparing, and submitting the completed application form to the USPTO. Time will vary depending upon the individual case. Any comments on the amount of time you require to complete this form and/or suggestions for reducing this burden, should be sent to the Chief Information Officer, U.S. Patent and Trademark Office, U.S. Department of Commerce, P.O. Box 1450, Alexandria, VA 22313-1450. DO NOT SEND FEES OR COMPLETED FORMS TO THIS ADDRESS. SEND TO: Commissioner for Patents, P.O. Box 1458, Alexandria, VA 22313-1458.

If you need assistance in completing the form, call 1-800-PTO-9199 and select option 2.

Electronic Acknowledgement Receipt

EFS ID:	21625015
Application Number:	14633804
International Application Number:	
Confirmation Number:	8573
Title of Invention:	METHOD TO PROVIDE AD HOC AND PASSWORD PROTECTED DIGITAL AND VOICE NETWORKS
First Named Inventor/Applicant Name:	Malcolm K. Beyer
Customer Number:	22235
Filer:	Barry Lee Haley/Amy Allen
Filer Authorized By:	Barry Lee Haley
Attorney Docket Number:	10963.3835
Receipt Date:	27-FEB-2015
Filing Date:	
Time Stamp:	15:41:35
Application Type:	Utility under 35 USC 111(a)

Payment information:

Submitted with Payment	no
------------------------	----

File Listing:

Document Number	Document Description	File Name	File Size(Bytes)/ Message Digest	Multi Part /.zip	Pages (if appl.)
1	Non Patent Literature	49_Memory_Map_Webpage_NonPatent_Literature.pdf	299657 <small>b890fe68d5a4ebc9ebf27e25f36c03d795311470</small>	no	2

Warnings:

Information:

2	Non Patent Literature	50_Ostman_NonPatent_Literature.pdf	4676618 13d75f8d4d3ae7ceb875c63853e94a924701ea29	no	63
Warnings:					
Information:					
3	Power of Attorney	08_POA_Beyer.pdf	471975 844a748e3d1ac54d5c7ebc22b33949400a4d5c0b	no	2
Warnings:					
Information:					
4	Power of Attorney	07_POA_Rice.pdf	516602 9728b3e9b7c9d2d437cad7c55b95d206e1d7306	no	2
Warnings:					
Information:					
Total Files Size (in bytes):				5964852	
<p>This Acknowledgement Receipt evidences receipt on the noted date by the USPTO of the indicated documents, characterized by the applicant, and including page counts, where applicable. It serves as evidence of receipt similar to a Post Card, as described in MPEP 503.</p> <p><u>New Applications Under 35 U.S.C. 111</u> If a new application is being filed and the application includes the necessary components for a filing date (see 37 CFR 1.53(b)-(d) and MPEP 506), a Filing Receipt (37 CFR 1.54) will be issued in due course and the date shown on this Acknowledgement Receipt will establish the filing date of the application.</p> <p><u>National Stage of an International Application under 35 U.S.C. 371</u> If a timely submission to enter the national stage of an international application is compliant with the conditions of 35 U.S.C. 371 and other applicable requirements a Form PCT/DO/EO/903 indicating acceptance of the application as a national stage submission under 35 U.S.C. 371 will be issued in addition to the Filing Receipt, in due course.</p> <p><u>New International Application Filed with the USPTO as a Receiving Office</u> If a new international application is being filed and the international application includes the necessary components for an international filing date (see PCT Article 11 and MPEP 1810), a Notification of the International Application Number and of the International Filing Date (Form PCT/RO/105) will be issued in due course, subject to prescriptions concerning national security, and the date shown on this Acknowledgement Receipt will establish the international filing date of the application.</p>					

Under the Paperwork Reduction Act of 1995, no persons are required to respond to a collection of information unless it displays a valid OMB control number.

TRANSMITTAL FOR POWER OF ATTORNEY TO ONE OR MORE REGISTERED PRACTITIONERS

NOTE: This form is to be submitted with the Power of Attorney by Applicant form (PTO/AIA/82B) to identify the application to which the Power of Attorney is directed, in accordance with 37 CFR 1.5, unless the application number and filing date are identified in the Power of Attorney by Applicant form. If neither form PTO/AIA/82A nor form PTO/AIA/82B identifies the application to which the Power of Attorney is directed, the Power of Attorney will not be recognized in the application.

Application Number	
Filing Date	February 27, 2015
First Named Inventor	Malcolm K. Beyer, Jr.
Title	METHOD TO PROVIDE AD HOC AND PASSWORD PROTECTED DIGITAL AND VOICE NETWORKS
Art Unit	
Examiner Name	
Attorney Docket Number	10963.3835

SIGNATURE of Applicant or Patent Practitioner			
Signature	/barry l. haley/	Date (Optional)	February 27, 2015
Name	Barry L. Haley	Registration Number	25339
Title (if Applicant is a juristic entity)			
Applicant Name (if Applicant is a juristic entity)			

NOTE: This form must be signed in accordance with 37 CFR 1.33. See 37 CFR 1.4(d) for signature requirements and certifications. If more than one applicant, use multiple forms.

*Total of _____ forms are submitted.

This collection of information is required by 37 CFR 1.131, 1.32, and 1.33. The information is required to obtain or retain a benefit by the public which is to file (and by the USPTO to process) an application. Confidentiality is governed by 35 U.S.C. 122 and 37 CFR 1.11 and 1.14. This collection is estimated to take 3 minutes to complete, including gathering, preparing, and submitting the completed application form to the USPTO. Time will vary depending upon the individual case. Any comments on the amount of time you require to complete this form and/or suggestions for reducing this burden, should be sent to the Chief Information Officer, U.S. Patent and Trademark Office, U.S. Department of Commerce, P.O. Box 1450, Alexandria, VA 22313-1450. DO NOT SEND FEES OR COMPLETED FORMS TO THIS ADDRESS. SEND TO: Commissioner for Patents, P.O. Box 1450, Alexandria, VA 22313-1450.

If you need assistance in completing the form, call 1-800-PTO-9199 and select option 2.

Doc Code: PA..

Document Description: Power of Attorney

PTO/AIA/82B (07-10)

Approved for use through 11/06/2014, OMB 0651-0051

U.S. Patent and Trademark Office, U.S. DEPARTMENT OF COMMERCE

Under the Paperwork Reduction Act of 1995, no persons are required to respond to a collection of information unless it displays a valid OMB control number

POWER OF ATTORNEY BY APPLICANT

I hereby revoke all previous powers of attorney given in the application identified in either the attached transmittal letter or the boxes below.

Application Number	Filing Date

(Note: The boxes above may be left blank if information is provided on form PTO/AIA/82A.)

I hereby appoint the Patent Practitioner(s) associated with the following Customer Number as my/our attorney(s) or agent(s), and to transact all business in the United States Patent and Trademark Office connected therewith for the application referenced in the attached transmittal letter (form PTO/AIA/82A) or identified above:

22235

OR

I hereby appoint Practitioner(s) named in the attached list (form PTO/AIA/82C) as my/our attorney(s) or agent(s), and to transact all business in the United States Patent and Trademark Office connected therewith for the patent application referenced in the attached transmittal letter (form PTO/AIA/82A) or identified above. (Note: Complete form PTO/AIA/82C.)

Please recognize or change the correspondence address for the application identified in the attached transmittal letter or the boxes above to:

The address associated with the above-mentioned Customer Number

OR

The address associated with Customer Number

OR

Firm or Individual Name			
Address			
City	State	Zip	
Country			
Telephone	Email		

I am the Applicant (if the Applicant is a juristic entity, list the Applicant name in the box):

Inventor or Joint Inventor (title not required below)

Legal Representative of a Deceased or Legally Incapacitated Inventor (title not required below)

Assignee or Person to Whom the Inventor is Under an Obligation to Assign (provide signer's title if applicant is a juristic entity)

Person Who Otherwise Shows Sufficient Proprietary Interest (e.g., a petition under 37 CFR 1.46(b)(2) was granted in the application or is concurrently being filed with this document) (provide signer's title if applicant is a juristic entity)

SIGNATURE of Applicant for Patent

The undersigned (whose title is supplied below) is authorized to act on behalf of the applicant (e.g., where the applicant is a juristic entity).

Signature

Malcolm K. Beyer, Jr.

Date (Optional)

Name

Malcolm K. Beyer, Jr.

Title

NOTE: Signature - This form must be signed by the applicant in accordance with 37 CFR 1.33. See 37 CFR 1.4 for signature requirements and certifications. If more than one applicant, use multiple forms.

Total of _____ forms are submitted.

This collection of information is required by 37 CFR 1.131, 1.32, and 1.33. The information is required to obtain or retain a benefit by the public which is to file (and by the USPTO to process) an application. Confidentiality is governed by 25 U.S.C. 122 and 37 CFR 1.11 and 1.14. This collection is estimated to take 3 minutes to complete, including gathering, preparing, and submitting the completed application form to the USPTO. Time will vary depending upon the individual case. Any comments on the amount of time you require to complete this form and/or suggestions for reducing this burden, should be sent to the Chief Information Officer, U.S. Patent and Trademark Office, U.S. Department of Commerce, P.O. Box 1450, Alexandria, VA 22310-1450. DO NOT SEND FEES OR COMPLETED FORMS TO THIS ADDRESS. SEND TO: Commissioner for Patents, P.O. Box 1480, Alexandria, VA 22310-1480.

If you need assistance in completing the form, call 1-800-PTO-9199 and select option 2

PETITION TO MAKE SPECIAL BASED ON AGE FOR ADVANCEMENT OF EXAMINATION UNDER 37 CFR 1.102(c)(1)					
Application Information					
Application Number	14633804	Confirmation Number	8573	Filing Date	2015-02-27
Attorney Docket Number (optional)	10963.3835	Art Unit		Examiner	
First Named Inventor	Malcolm K. Beyer, Jr.				
Title of Invention	METHOD TO PROVIDE AD HOC AND PASSWORD PROTECTED DIGITAL AND VOICE NETWORKS				
<p>Attention: Office of Petitions</p> <p>An application may be made special for advancement of examination upon filing of a petition showing that the applicant is 65 years of age, or more. No fee is required with such a petition. See <u>37 CFR 1.102(c)(1)</u> and MPEP 708.02 (IV).</p> <p>APPLICANT HEREBY PETITIONS TO MAKE SPECIAL FOR ADVANCEMENT OF EXAMINATION IN THIS APPLICATION UNDER 37 CFR 1.102(c)(1) and MPEP 708.02 (IV) ON THE BASIS OF THE APPLICANT'S AGE.</p> <p>A grantable petition requires one of the following items: (1) Statement by one named inventor in the application that he/she is 65 years of age, or more; or (2) Certification by a registered attorney/agent having evidence such as a birth certificate, passport, driver's license, etc. showing one named inventor in the application is 65 years of age, or more.</p>					
Name of Inventor who is 65 years of age, or older					
Given Name	Middle Name	Family Name	Suffix		
Malcolm	K.	Beyer	Jr.		
<p>A signature of the applicant or representative is required in accordance with 37 CFR 1.33 and 10.18. Please see 37 CFR 1.4(d) for the format of the signature.</p> <p>Select (1) or (2) :</p> <p><input type="radio"/> (1) I am an inventor in this application and I am 65 years of age, or more.</p> <p><input checked="" type="radio"/> (2) I am an attorney or agent registered to practice before the Patent and Trademark Office, and I certify that I am in possession of evidence, and will retain such in the application file record, showing that the inventor listed above is 65 years of age, or more.</p>					
Signature	/Barry L. Haley/		Date (YYYY-MM-DD)	2015-02-27	
Name	Barry L. Haley		Registration Number	25339	

Privacy Act Statement

The Privacy Act of 1974 (P.L. 93-579) requires that you be given certain information in connection with your submission of the attached form related to a patent application or patent. Accordingly, pursuant to the requirements of the Act, please be advised that: (1) the general authority for the collection of this information is 35 U.S.C. 2(b)(2); (2) furnishing of the information solicited is voluntary; and (3) the principal purpose for which the information is used by the U.S. Patent and Trademark Office is to process and/or examine your submission related to a patent application or patent. If you do not furnish the requested information, the U.S. Patent and Trademark Office may not be able to process and/or examine your submission, which may result in termination of proceedings or abandonment of the application or expiration of the patent.

The information provided by you in this form will be subject to the following routine uses:

1. The information on this form will be treated confidentially to the extent allowed under the Freedom of Information Act (5 U.S.C. 552) and the Privacy Act (5 U.S.C. 552a). Records from this system of records may be disclosed to the Department of Justice to determine whether the Freedom of Information Act requires disclosure of these records.
2. A record from this system of records may be disclosed, as a routine use, in the course of presenting evidence to a court, magistrate, or administrative tribunal, including disclosures to opposing counsel in the course of settlement negotiations.
3. A record in this system of records may be disclosed, as a routine use, to a Member of Congress submitting a request involving an individual, to whom the record pertains, when the individual has requested assistance from the Member with respect to the subject matter of the record.
4. A record in this system of records may be disclosed, as a routine use, to a contractor of the Agency having need for the information in order to perform a contract. Recipients of information shall be required to comply with the requirements of the Privacy Act of 1974, as amended, pursuant to 5 U.S.C. 552a(m).
5. A record related to an International Application filed under the Patent Cooperation Treaty in this system of records may be disclosed, as a routine use, to the International Bureau of the World Intellectual Property Organization, pursuant to the Patent Cooperation Treaty.
6. A record in this system of records may be disclosed, as a routine use, to another federal agency for purposes of National Security review (35 U.S.C. 181) and for review pursuant to the Atomic Energy Act (42 U.S.C. 218(c)).
7. A record from this system of records may be disclosed, as a routine use, to the Administrator, General Services, or his/her designee, during an inspection of records conducted by GSA as part of that agency's responsibility to recommend improvements in records management practices and programs, under authority of 44 U.S.C. 2904 and 2906. Such disclosure shall be made in accordance with the GSA regulations governing inspection of records for this purpose, and any other relevant (i.e., GSA or Commerce) directive. Such disclosure shall not be used to make determinations about individuals.
8. A record from this system of records may be disclosed, as a routine use, to the public after either publication of the application pursuant to 35 U.S.C. 122(b) or issuance of a patent pursuant to 35 U.S.C. 151. Further, a record may be disclosed, subject to the limitations of 37 CFR 1.14, as a routine use, to the public if the record was filed in an application which became abandoned or in which the proceedings were terminated and which application is referenced by either a published application, an application open to public inspections or an issued patent.
9. A record from this system of records may be disclosed, as a routine use, to a Federal, State, or local law enforcement agency, if the USPTO becomes aware of a violation or potential violation of law or regulation.

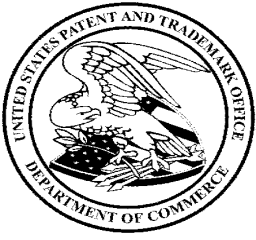

UNITED STATES PATENT AND TRADEMARK OFFICE

Commissioner for Patents
United States Patent and Trademark Office
P.O. Box 1450
Alexandria, VA 22313-1450
www.uspto.gov

In re Application of
Malcolm K. Beyer

Application No. 14633804

Filed:

Attorney Docket No. 10963.3835

:

:

:DECISION ON PETITION TO MAKE SPECIAL
:UNDER 37 CFR 1.102(c)(1)

:

This is a decision on the electronic petition under 37 CFR 1.102 (c)(1), filed 27-FEB-2015 to make the above-identified application special based on applicant's age as set forth in MPEP § 708.02, Section IV.

The petition is **GRANTED**.

A grantable petition to make an application special under 37 CFR 1.102(c)(1), MPEP § 708.02, Section IV: Applicant's Age must include a statement by applicant or a registered practitioner having evidence that applicant is at least 65 years of age. No fee is required.

Accordingly, the above-identified application has been accorded "special" status and will be taken up for action by the examiner upon the completion of all pre-examination processing.

Telephone inquiries concerning this electronic decision should be directed to the Electronic Business Center at 866-217-9197.

All other inquiries concerning either the examination or status of the application should be directed to the Technology Center.

Electronic Acknowledgement Receipt

EFS ID:	21625242
Application Number:	14633804
International Application Number:	
Confirmation Number:	8573
Title of Invention:	METHOD TO PROVIDE AD HOC AND PASSWORD PROTECTED DIGITAL AND VOICE NETWORKS
First Named Inventor/Applicant Name:	Malcolm K. Beyer
Customer Number:	22235
Filer:	Barry Lee Haley/Amy Allen
Filer Authorized By:	Barry Lee Haley
Attorney Docket Number:	10963.3835
Receipt Date:	27-FEB-2015
Filing Date:	
Time Stamp:	15:49:25
Application Type:	Utility under 35 USC 111(a)

Payment information:

Submitted with Payment	no
------------------------	----

File Listing:

Document Number	Document Description	File Name	File Size(Bytes)/ Message Digest	Multi Part /.zip	Pages (if appl.)
1	Petition automatically granted by EFS	11_PetitionToMakeSpecial_Ag e.pdf	1468880 8cb0454fedf2d2d6aa7d69397d80aa3581f4 f044	no	2

Warnings:

Information:

This Acknowledgement Receipt evidences receipt on the noted date by the USPTO of the indicated documents, characterized by the applicant, and including page counts, where applicable. It serves as evidence of receipt similar to a Post Card, as described in MPEP 503.

New Applications Under 35 U.S.C. 111

If a new application is being filed and the application includes the necessary components for a filing date (see 37 CFR 1.53(b)-(d) and MPEP 506), a Filing Receipt (37 CFR 1.54) will be issued in due course and the date shown on this Acknowledgement Receipt will establish the filing date of the application.

National Stage of an International Application under 35 U.S.C. 371

If a timely submission to enter the national stage of an international application is compliant with the conditions of 35 U.S.C. 371 and other applicable requirements a Form PCT/DO/EO/903 indicating acceptance of the application as a national stage submission under 35 U.S.C. 371 will be issued in addition to the Filing Receipt, in due course.

New International Application Filed with the USPTO as a Receiving Office

If a new international application is being filed and the international application includes the necessary components for an international filing date (see PCT Article 11 and MPEP 1810), a Notification of the International Application Number and of the International Filing Date (Form PCT/RO/105) will be issued in due course, subject to prescriptions concerning national security, and the date shown on this Acknowledgement Receipt will establish the international filing date of the application.

IN THE UNITED STATES PATENT AND TRADEMARK OFFICE

In re application of: BEYER, Jr., <i>et al.</i>)	
)	
Serial No.: 14/633,804)	Confirmation No: 8573
)	
Filed: February 27, 2015)	Group Art Unit: 2642
)	
Entitled: METHOD TO PROVIDE AD HOC)	Examiner: Not Assigned
AND PASSWORD PROTECTED DIGITAL)	
AND VOICE NETWORKS)	
_____)	

Commissioner for Patents
P.O. Box 1450
Alexandria, VA 22313-1450

March 19, 2015
Filed Electronically

PRELIMINARY AMENDMENT

Dear Sir:

Preliminary to the examination of the above-referenced application, please amend the application as follows:

Amendments to the claims begin on page 2 of this paper.

Remarks begin on page 6 of this paper.

CLAIM AMENDMENTS

Please amend the claims (~~strike through~~ indicating deletion and underline indicating insertion) as follows:

1. (Currently Amended) A computer-implemented method comprising:

~~sending a respective first map to each one of a plurality of devices wherein the device is configured to display the first map;~~

receiving at various times from one or more of the devices respective information comprising a location of the device and sending the location to one or more other devices, wherein each of the other devices is configured to display a respective symbol representing the location on ~~the~~ a respective first map;

receiving from a first device information indicating user selection of one or more of the displayed symbols corresponding to second devices and, based thereon:

obtaining a respective contact information for each of the second devices; and

facilitating a respective communication between the first device and each of the second devices using the contact information of the second device.

2. (Original) The method of claim 1 wherein a particular communication is a phone call, a short message service message, a voice message, a text message, an electronic mail message, an image, or a video.

3. (Original) The method of claim 1 wherein first device and the second devices are part of a same group or within a user-specified geographic area.

4. (Original) The method of claim 3 wherein the group is a friends or family group.

5. (Original) The method of claim 1 wherein particular contact information is a phone number or an Internet Protocol address.

6. (Canceled)
7. (Original) The method of claim 6 wherein the symbol represents a facility or a person's home.
8. (Original) The method of claim 1 wherein a particular device is a smart phone, a personal data assistant, a tablet computer, a desktop computer, or a laptop computer.
9. (Original) The method of claim 1, further comprising:
 - receiving a request for a map from a third device wherein the request comprises one or more parameters and wherein a parameter specifies a map location or a zoom indication;
 - obtaining a second map that conforms to the attributes; and
 - sending the second map to the third device.
10. (Original) The method of claim 1 wherein the first device does not have access to the phone numbers or Internet Protocol addresses of the second devices.
11. (Currently Amended) The method of claim 1 wherein the ~~first~~ map is an aerial photograph, a satellite image, or a chart.
12. (Currently Amended) The method of claim 1 wherein receiving at various times from a particular device information comprises receiving the information from the particular device at a time based on one or more of: speed of the particular device, distance traveled by the particular device, or ~~travel time of the particular device~~.
13. (Currently Amended) A system comprising:
 - one or more computers programmed to perform operations comprising:
 - ~~sending a respective first map to each one of a plurality of devices wherein the device is configured to display the first map;~~
 - receiving at various times from one or more of the devices respective information

comprising a location of the device and sending the location to one or more other devices, wherein each of the other devices is configured to display a respective symbol representing the location on ~~the a first~~ respective map;

receiving from a first device information indicating user selection of one or more of the displayed symbols corresponding to second devices and, based thereon:

obtaining a respective contact information for each of the second devices; and

facilitating a respective communication between the first device and each of the second devices using the contact information of the second device.

14. (Original) The system of claim 13 wherein a particular communication is a phone call, a short message service message, a voice message, a text message, an electronic mail message, an image, or a video.

15. (Original) The system of claim 13 wherein first device and the second devices are part of a same group or within a user-specified geographic area.

16. (Original) The system of claim 15 wherein the group is a friends or family group.

17. (Original) The system of claim 13 wherein particular contact information is a phone number or an Internet Protocol address.

18. (Canceled)

19. (Original) The system of claim 18 wherein the symbol represents a facility or a person's home.

20. (Original) The system of claim 13 wherein a particular device is a smart phone, a personal data assistant, a tablet computer, a desktop computer, or a laptop computer.

21. (Original) The system of claim 13, wherein the operations further comprise:

receiving a request for a map from a third device wherein the request comprises one or more

parameters and wherein a parameter specifies a map location or a zoom indication;

obtaining a second map that conforms to the attributes; and

sending the second map to the third device.

22. (Original) The system of claim 13 wherein the first device does not have access to the phone numbers or Internet Protocol addresses of the second devices.

23. (Currently Amended) The system of claim 13 wherein the first map is an aerial photograph, a satellite image, or a chart

24. (Currently Amended) The system of claim 13 wherein receiving at various times from a particular device information comprises receiving the information from the particular device at a time based on one or more of: speed of the particular device, distance traveled by the particular device, or ~~travel time of the particular device.~~

25. (New) The method of claim 1, further comprising:
sending a respective first map to each one of a plurality of devices wherein the device is configured to display the first map.

26. (New) The system of claim 13 wherein the operations further comprise:
sending a respective first map to each one of a plurality of devices wherein the device is configured to display the first map.

REMARKS

Preliminary to examination, kindly amend the claims as set forth above. Should the Examiner have any questions, comments, or concerns, the undersigned would appreciate a telephone conference in order to expedite this case.

Respectfully submitted,

/Barry L. Haley/
Barry L. Haley, Esq. (Reg. No. 25,339)

Customer No.: 22235
MALIN HALEY DiMAGGIO &
BOWEN, P.A.
1936 South Andrews Avenue
Fort Lauderdale, Florida 33316
Telephone: (954) 763-3303
Facsimile: (954) 522-6507
E-Mail: info@mhdpatents.com

Electronic Acknowledgement Receipt

EFS ID:	21816254
Application Number:	14633804
International Application Number:	
Confirmation Number:	8573
Title of Invention:	METHOD TO PROVIDE AD HOC AND PASSWORD PROTECTED DIGITAL AND VOICE NETWORKS
First Named Inventor/Applicant Name:	Malcolm K. Beyer
Customer Number:	22235
Filer:	Barry Lee Haley/Amy Allen
Filer Authorized By:	Barry Lee Haley
Attorney Docket Number:	10963.3835
Receipt Date:	19-MAR-2015
Filing Date:	27-FEB-2015
Time Stamp:	10:31:49
Application Type:	Utility under 35 USC 111(a)

Payment information:

Submitted with Payment	no
------------------------	----

File Listing:

Document Number	Document Description	File Name	File Size(Bytes)/ Message Digest	Multi Part /.zip	Pages (if appl.)
1		13_PreliminaryAmendment.pdf	103191 8c6723f48c0d7f9981cd0db4b33fc3a5eab c521	yes	6

Multipart Description/PDF files in .zip description		
Document Description	Start	End
Preliminary Amendment	1	1
Claims	2	5
Applicant Arguments/Remarks Made in an Amendment	6	6
Warnings:		
Information:		
Total Files Size (in bytes):	103191	
<p>This Acknowledgement Receipt evidences receipt on the noted date by the USPTO of the indicated documents, characterized by the applicant, and including page counts, where applicable. It serves as evidence of receipt similar to a Post Card, as described in MPEP 503.</p> <p><u>New Applications Under 35 U.S.C. 111</u> If a new application is being filed and the application includes the necessary components for a filing date (see 37 CFR 1.53(b)-(d) and MPEP 506), a Filing Receipt (37 CFR 1.54) will be issued in due course and the date shown on this Acknowledgement Receipt will establish the filing date of the application.</p> <p><u>National Stage of an International Application under 35 U.S.C. 371</u> If a timely submission to enter the national stage of an international application is compliant with the conditions of 35 U.S.C. 371 and other applicable requirements a Form PCT/DO/EO/903 indicating acceptance of the application as a national stage submission under 35 U.S.C. 371 will be issued in addition to the Filing Receipt, in due course.</p> <p><u>New International Application Filed with the USPTO as a Receiving Office</u> If a new international application is being filed and the international application includes the necessary components for an international filing date (see PCT Article 11 and MPEP 1810), a Notification of the International Application Number and of the International Filing Date (Form PCT/RO/105) will be issued in due course, subject to prescriptions concerning national security, and the date shown on this Acknowledgement Receipt will establish the international filing date of the application.</p>		

Under the Paperwork Reduction Act of 1995, no persons are required to respond to a collection of information unless it displays a valid OMB control number.

PATENT APPLICATION FEE DETERMINATION RECORD Substitute for Form PTO-875	Application or Docket Number 14/633,804	Filing Date 02/27/2015	<input type="checkbox"/> To be Mailed
---	---	----------------------------------	---------------------------------------

ENTITY: LARGE SMALL MICRO

APPLICATION AS FILED – PART I

FOR	NUMBER FILED	NUMBER EXTRA	RATE (\$)	FEE (\$)
<input type="checkbox"/> BASIC FEE (37 CFR 1.16(a), (b), or (c))	N/A	N/A	N/A	
<input type="checkbox"/> SEARCH FEE (37 CFR 1.16(k), (j), or (m))	N/A	N/A	N/A	
<input type="checkbox"/> EXAMINATION FEE (37 CFR 1.16(o), (p), or (q))	N/A	N/A	N/A	
TOTAL CLAIMS (37 CFR 1.16(i))	minus 20 = *	*	X \$ =	
INDEPENDENT CLAIMS (37 CFR 1.16(h))	minus 3 = *	*	X \$ =	
<input type="checkbox"/> APPLICATION SIZE FEE (37 CFR 1.16(s))	If the specification and drawings exceed 100 sheets of paper, the application size fee due is \$310 (\$155 for small entity) for each additional 50 sheets or fraction thereof. See 35 U.S.C. 41(a)(1)(G) and 37 CFR 1.16(s).			
<input type="checkbox"/> MULTIPLE DEPENDENT CLAIM PRESENT (37 CFR 1.16(j))				
* If the difference in column 1 is less than zero, enter "0" in column 2.			TOTAL	

APPLICATION AS AMENDED – PART II

	(Column 1)	(Column 2)	(Column 3)	(Column 3)	RATE (\$)	ADDITIONAL FEE (\$)
AMENDMENT	03/19/2015	CLAIMS REMAINING AFTER AMENDMENT	HIGHEST NUMBER PREVIOUSLY PAID FOR	PRESENT EXTRA		
	Total (37 CFR 1.16(i))	* 24	Minus	** 24	= 0	x \$40 = 0
	Independent (37 CFR 1.16(h))	* 2	Minus	***3	= 0	x \$210 = 0
	<input type="checkbox"/> Application Size Fee (37 CFR 1.16(s))					
	<input type="checkbox"/> FIRST PRESENTATION OF MULTIPLE DEPENDENT CLAIM (37 CFR 1.16(j))					
					TOTAL ADD'L FEE	0

	(Column 1)	(Column 2)	(Column 3)	(Column 3)	RATE (\$)	ADDITIONAL FEE (\$)
AMENDMENT		CLAIMS REMAINING AFTER AMENDMENT	HIGHEST NUMBER PREVIOUSLY PAID FOR	PRESENT EXTRA		
	Total (37 CFR 1.16(i))	*	Minus	**	=	X \$ =
	Independent (37 CFR 1.16(h))	*	Minus	***	=	X \$ =
	<input type="checkbox"/> Application Size Fee (37 CFR 1.16(s))					
	<input type="checkbox"/> FIRST PRESENTATION OF MULTIPLE DEPENDENT CLAIM (37 CFR 1.16(j))					
					TOTAL ADD'L FEE	

* If the entry in column 1 is less than the entry in column 2, write "0" in column 3.
 ** If the "Highest Number Previously Paid For" IN THIS SPACE is less than 20, enter "20".
 *** If the "Highest Number Previously Paid For" IN THIS SPACE is less than 3, enter "3".

The "Highest Number Previously Paid For" (Total or Independent) is the highest number found in the appropriate box in column 1.

LIE
 /VANESSA HODGES/

This collection of information is required by 37 CFR 1.16. The information is required to obtain or retain a benefit by the public which is to file (and by the USPTO to process) an application. Confidentiality is governed by 35 U.S.C. 122 and 37 CFR 1.14. This collection is estimated to take 12 minutes to complete, including gathering, preparing, and submitting the completed application form to the USPTO. Time will vary depending upon the individual case. Any comments on the amount of time you require to complete this form and/or suggestions for reducing this burden, should be sent to the Chief Information Officer, U.S. Patent and Trademark Office, U.S. Department of Commerce, P.O. Box 1450, Alexandria, VA 22313-1450. DO NOT SEND FEES OR COMPLETED FORMS TO THIS ADDRESS. **SEND TO: Commissioner for Patents, P.O. Box 1450, Alexandria, VA 22313-1450.**
 If you need assistance in completing the form, call 1-800-PTO-9199 and select option 2.



UNITED STATES PATENT AND TRADEMARK OFFICE

UNITED STATES DEPARTMENT OF COMMERCE
United States Patent and Trademark Office
Address: COMMISSIONER FOR PATENTS
P.O. Box 1450
Alexandria, Virginia 22313-1450
www.uspto.gov

Table with 4 columns: APPLICATION NUMBER (14/633,804), FILING OR 371(C) DATE (02/27/2015), FIRST NAMED APPLICANT (Malcolm K. Beyer JR.), ATTY. DOCKET NO./TITLE (10963.3835)

CONFIRMATION NO. 8573

22235

Malin Haley DiMaggio & Bowen, P.A.
1936 S ANDREWS AVENUE
FORT LAUDERDALE, FL 33316

FORMALITIES LETTER



Date Mailed: 03/20/2015

NOTICE TO FILE CORRECTED APPLICATION PAPERS

Filing Date Granted

An application number and filing date have been accorded to this application. The application is informal since it does not comply with the regulations for the reason(s) indicated below. Applicant is given TWO MONTHS from the date of this Notice within which to correct the informalities indicated below. Extensions of time may be obtained by filing a petition accompanied by the extension fee under the provisions of 37 CFR 1.136(a).

The required item(s) identified below must be timely submitted to avoid abandonment:

- Replacement drawings in compliance with 37 CFR 1.84 and 37 CFR 1.121(d) are required. The drawings submitted are not acceptable because:
• The drawings must be reasonably free from erasures and must be free from alterations, overwriting, interlineations, folds, and copy marks. See Figure(s) 9, 10.

Applicant is cautioned that correction of the above items may cause the specification and drawings page count to exceed 100 pages. If the specification and drawings exceed 100 pages, applicant will need to submit the required application size fee.

Replies must be received in the USPTO within the set time period or must include a proper Certificate of Mailing or Transmission under 37 CFR 1.8 with a mailing or transmission date within the set time period. For more information and a suggested format, see Form PTO/SB/92 and MPEP 512.

Replies should be mailed to:

Mail Stop Missing Parts
Commissioner for Patents
P.O. Box 1450
Alexandria VA 22313-1450

Registered users of EFS-Web may alternatively submit their reply to this notice via EFS-Web, including a copy of this Notice and selecting the document description "Applicant response to Pre-Exam Formalities Notice".
<https://sportal.uspto.gov/authenticate/AuthenticateUserLocalEPF.html>

For more information about EFS-Web please call the USPTO Electronic Business Center at **1-866-217-9197** or visit our website at <http://www.uspto.gov/ebc>.

If you are not using EFS-Web to submit your reply, you must include a copy of this notice.

/mmohamed/

Office of Data Management, Application Assistance Unit (571) 272-4000, or (571) 272-4200, or 1-888-786-0101

PATENT APPLICATION FEE DETERMINATION RECORD

Substitute for Form PTO-875

Application or Docket Number
14/633,804

APPLICATION AS FILED - PART I

(Column 1)			(Column 2)		SMALL ENTITY		OR	OTHER THAN SMALL ENTITY	
FOR	NUMBER FILED	NUMBER EXTRA	RATE(\$)	FEE(\$)	RATE(\$)	FEE(\$)		RATE(\$)	FEE(\$)
BASIC FEE (37 CFR 1.16(a), (b), or (c))	N/A	N/A	N/A	70	N/A			N/A	
SEARCH FEE (37 CFR 1.16(k), (i), or (m))	N/A	N/A	N/A	300	N/A			N/A	
EXAMINATION FEE (37 CFR 1.16(o), (p), or (q))	N/A	N/A	N/A	360	N/A			N/A	
TOTAL CLAIMS (37 CFR 1.16(i))	24	minus 20 = *	x 40 =	160			OR		
INDEPENDENT CLAIMS (37 CFR 1.16(h))	2	minus 3 = *	x 210 =	0.00					
APPLICATION SIZE FEE (37 CFR 1.16(s))	If the specification and drawings exceed 100 sheets of paper, the application size fee due is \$310 (\$155 for small entity) for each additional 50 sheets or fraction thereof. See 35 U.S.C. 41(a)(1)(G) and 37 CFR 1.16(s).			0.00					
MULTIPLE DEPENDENT CLAIM PRESENT (37 CFR 1.16(j))				0.00					
* If the difference in column 1 is less than zero, enter "0" in column 2.			TOTAL	890	TOTAL				

APPLICATION AS AMENDED - PART II

(Column 1)					(Column 2)		(Column 3)	SMALL ENTITY		OR	OTHER THAN SMALL ENTITY	
AMENDMENT A	CLAIMS REMAINING AFTER AMENDMENT		HIGHEST NUMBER PREVIOUSLY PAID FOR	PRESENT EXTRA	RATE(\$)	ADDITIONAL FEE(\$)		RATE(\$)	ADDITIONAL FEE(\$)			
	Total (37 CFR 1.16(i))	*	Minus	**	=	x	=	OR	x	=		
	Independent (37 CFR 1.16(h))	*	Minus	***	=	x	=	OR	x	=		
	Application Size Fee (37 CFR 1.16(s))							OR				
	FIRST PRESENTATION OF MULTIPLE DEPENDENT CLAIM (37 CFR 1.16(j))							OR				
					TOTAL ADD'L FEE		OR	TOTAL ADD'L FEE				
AMENDMENT B	CLAIMS REMAINING AFTER AMENDMENT		HIGHEST NUMBER PREVIOUSLY PAID FOR	PRESENT EXTRA	RATE(\$)	ADDITIONAL FEE(\$)		RATE(\$)	ADDITIONAL FEE(\$)			
	Total (37 CFR 1.16(i))	*	Minus	**	=	x	=	OR	x	=		
	Independent (37 CFR 1.16(h))	*	Minus	***	=	x	=	OR	x	=		
	Application Size Fee (37 CFR 1.16(s))							OR				
	FIRST PRESENTATION OF MULTIPLE DEPENDENT CLAIM (37 CFR 1.16(j))							OR				
					TOTAL ADD'L FEE		OR	TOTAL ADD'L FEE				

* If the entry in column 1 is less than the entry in column 2, write "0" in column 3.
 ** If the "Highest Number Previously Paid For" IN THIS SPACE is less than 20, enter "20".
 *** If the "Highest Number Previously Paid For" IN THIS SPACE is less than 3, enter "3".
 The "Highest Number Previously Paid For" (Total or Independent) is the highest found in the appropriate box in column 1.



UNITED STATES PATENT AND TRADEMARK OFFICE

UNITED STATES DEPARTMENT OF COMMERCE
United States Patent and Trademark Office
Address: COMMISSIONER FOR PATENTS
P.O. Box 1450
Alexandria, Virginia 22313-1450
www.uspto.gov

Table with 7 columns: APPLICATION NUMBER, FILING or 371(c) DATE, GRP ART UNIT, FIL FEE REC'D, ATTY.DOCKET.NO, TOT CLAIMS, IND CLAIMS. Row 1: 14/633,804, 02/27/2015, 2642, 890, 10963.3835, 24, 2

CONFIRMATION NO. 8573

22235
Malin Haley DiMaggio & Bowen, P.A.
1936 S ANDREWS AVENUE
FORT LAUDERDALE, FL 33316

FILING RECEIPT



Date Mailed: 03/20/2015

Receipt is acknowledged of this non-provisional patent application. The application will be taken up for examination in due course. Applicant will be notified as to the results of the examination. Any correspondence concerning the application must include the following identification information: the U.S. APPLICATION NUMBER, FILING DATE, NAME OF APPLICANT, and TITLE OF INVENTION. Fees transmitted by check or draft are subject to collection. Please verify the accuracy of the data presented on this receipt. If an error is noted on this Filing Receipt, please submit a written request for a Filing Receipt Correction. Please provide a copy of this Filing Receipt with the changes noted thereon. If you received a "Notice to File Missing Parts" for this application, please submit any corrections to this Filing Receipt with your reply to the Notice. When the USPTO processes the reply to the Notice, the USPTO will generate another Filing Receipt incorporating the requested corrections

Inventor(s)

Malcolm K. Beyer JR., Jupiter, FL;
Christopher R. Rice, Redmond, WA;

Applicant(s)

Malcolm K. Beyer JR., Jupiter, FL;
Christopher R. Rice, Redmond, WA;

Power of Attorney: The patent practitioners associated with Customer Number 22235

Domestic Priority data as claimed by applicant

This application is a CON of 14/529,978 10/31/2014
which is a CON of 14/027,410 09/16/2013 PAT 8880042
which is a CON of 13/751,453 01/28/2013 PAT 8538393
which is a CIP of 12/761,533 04/16/2010 PAT 8364129
which is a CIP of 11/615,472 12/22/2006 PAT 8126441
which is a CIP of 11/308,648 04/17/2006 PAT 7630724
which is a CIP of 10/711,490 09/21/2004 PAT 7031728

Foreign Applications for which priority is claimed (You may be eligible to benefit from the Patent Prosecution Highway program at the USPTO. Please see http://www.uspto.gov for more information.) - None.

Foreign application information must be provided in an Application Data Sheet in order to constitute a claim to foreign priority. See 37 CFR 1.55 and 1.76.

Permission to Access - A proper Authorization to Permit Access to Application by Participating Offices (PTO/SB/39 or its equivalent) has been received by the USPTO.

If Required, Foreign Filing License Granted: 03/19/2015

The country code and number of your priority application, to be used for filing abroad under the Paris Convention, is **US 14/633,804**

Projected Publication Date: Request for Non-Publication Acknowledged

Non-Publication Request: Yes

Early Publication Request: No

**** SMALL ENTITY ****

Title

METHOD TO PROVIDE AD HOC AND PASSWORD PROTECTED DIGITAL AND VOICE NETWORKS

Preliminary Class

455

Statement under 37 CFR 1.55 or 1.78 for AIA (First Inventor to File) Transition Applications: Yes

PROTECTING YOUR INVENTION OUTSIDE THE UNITED STATES

Since the rights granted by a U.S. patent extend only throughout the territory of the United States and have no effect in a foreign country, an inventor who wishes patent protection in another country must apply for a patent in a specific country or in regional patent offices. Applicants may wish to consider the filing of an international application under the Patent Cooperation Treaty (PCT). An international (PCT) application generally has the same effect as a regular national patent application in each PCT-member country. The PCT process **simplifies** the filing of patent applications on the same invention in member countries, but **does not result** in a grant of "an international patent" and does not eliminate the need of applicants to file additional documents and fees in countries where patent protection is desired.

Almost every country has its own patent law, and a person desiring a patent in a particular country must make an application for patent in that country in accordance with its particular laws. Since the laws of many countries differ in various respects from the patent law of the United States, applicants are advised to seek guidance from specific foreign countries to ensure that patent rights are not lost prematurely.

Applicants also are advised that in the case of inventions made in the United States, the Director of the USPTO must issue a license before applicants can apply for a patent in a foreign country. The filing of a U.S. patent application serves as a request for a foreign filing license. The application's filing receipt contains further information and guidance as to the status of applicant's license for foreign filing.

Applicants may wish to consult the USPTO booklet, "General Information Concerning Patents" (specifically, the section entitled "Treaties and Foreign Patents") for more information on timeframes and deadlines for filing foreign patent applications. The guide is available either by contacting the USPTO Contact Center at 800-786-9199, or it can be viewed on the USPTO website at <http://www.uspto.gov/web/offices/pac/doc/general/index.html>.

For information on preventing theft of your intellectual property (patents, trademarks and copyrights), you may wish to consult the U.S. Government website, <http://www.stopfakes.gov>. Part of a Department of Commerce initiative, this website includes self-help "toolkits" giving innovators guidance on how to protect intellectual property in specific countries such as China, Korea and Mexico. For questions regarding patent enforcement issues, applicants may call the U.S. Government hotline at 1-866-999-HALT (1-866-999-4258).

LICENSE FOR FOREIGN FILING UNDER
Title 35, United States Code, Section 184
Title 37, Code of Federal Regulations, 5.11 & 5.15

GRANTED

The applicant has been granted a license under 35 U.S.C. 184, if the phrase "IF REQUIRED, FOREIGN FILING LICENSE GRANTED" followed by a date appears on this form. Such licenses are issued in all applications where the conditions for issuance of a license have been met, regardless of whether or not a license may be required as set forth in 37 CFR 5.15. The scope and limitations of this license are set forth in 37 CFR 5.15(a) unless an earlier license has been issued under 37 CFR 5.15(b). The license is subject to revocation upon written notification. The date indicated is the effective date of the license, unless an earlier license of similar scope has been granted under 37 CFR 5.13 or 5.14.

This license is to be retained by the licensee and may be used at any time on or after the effective date thereof unless it is revoked. This license is automatically transferred to any related applications(s) filed under 37 CFR 1.53(d). This license is not retroactive.

The grant of a license does not in any way lessen the responsibility of a licensee for the security of the subject matter as imposed by any Government contract or the provisions of existing laws relating to espionage and the national security or the export of technical data. Licensees should apprise themselves of current regulations especially with respect to certain countries, of other agencies, particularly the Office of Defense Trade Controls, Department of State (with respect to Arms, Munitions and Implements of War (22 CFR 121-128)); the Bureau of Industry and Security, Department of Commerce (15 CFR parts 730-774); the Office of Foreign Assets Control, Department of Treasury (31 CFR Parts 500+) and the Department of Energy.

NOT GRANTED

No license under 35 U.S.C. 184 has been granted at this time, if the phrase "IF REQUIRED, FOREIGN FILING LICENSE GRANTED" DOES NOT appear on this form. Applicant may still petition for a license under 37 CFR 5.12, if a license is desired before the expiration of 6 months from the filing date of the application. If 6 months has lapsed from the filing date of this application and the licensee has not received any indication of a secrecy order under 35 U.S.C. 181, the licensee may foreign file the application pursuant to 37 CFR 5.15(b).

SelectUSA

The United States represents the largest, most dynamic marketplace in the world and is an unparalleled location for business investment, innovation, and commercialization of new technologies. The U.S. offers tremendous resources and advantages for those who invest and manufacture goods here. Through SelectUSA, our nation works to promote and facilitate business investment. SelectUSA provides information assistance to the international investor community; serves as an ombudsman for existing and potential investors; advocates on behalf of U.S. cities, states, and regions competing for global investment; and counsels U.S. economic development organizations on investment attraction best practices. To learn more about why the United States is the best country in the world to develop technology, manufacture products, deliver services, and grow your business, visit <http://www.SelectUSA.gov> or call +1-202-482-6800.

INFORMATION DISCLOSURE STATEMENT BY APPLICANT (Not for submission under 37 CFR 1.99)	Application Number		14633804	
	Filing Date		2015-02-27	
	First Named Inventor	BEYER, Jr., Malcolm K.		
	Art Unit	2642		
	Examiner Name	Not Assigned		
	Attorney Docket Number	10963.3835		

U.S. PATENTS	Remove
---------------------	--------

Examiner Initial*	Cite No	Patent Number	Kind Code ¹	Issue Date	Name of Patentee or Applicant of cited Document	Pages, Columns, Lines where Relevant Passages or Relevant Figures Appear
	1					

If you wish to add additional U.S. Patent citation information please click the Add button. Add

U.S. PATENT APPLICATION PUBLICATIONS	Remove
---	--------

Examiner Initial*	Cite No	Publication Number	Kind Code ¹	Publication Date	Name of Patentee or Applicant of cited Document	Pages, Columns, Lines where Relevant Passages or Relevant Figures Appear
	1					

If you wish to add additional U.S. Published Application citation information please click the Add button. Add

FOREIGN PATENT DOCUMENTS	Remove
---------------------------------	--------

Examiner Initial*	Cite No	Foreign Document Number ³	Country Code ² j	Kind Code ⁴	Publication Date	Name of Patentee or Applicant of cited Document	Pages, Columns, Lines where Relevant Passages or Relevant Figures Appear	T ⁵
	1							<input type="checkbox"/>

If you wish to add additional Foreign Patent Document citation information please click the Add button Add

NON-PATENT LITERATURE DOCUMENTS	Remove
--	--------

Examiner Initials*	Cite No	Include name of the author (in CAPITAL LETTERS), title of the article (when appropriate), title of the item (book, magazine, journal, serial, symposium, catalog, etc), date, pages(s), volume-issue number(s), publisher, city and/or country where published.	T ⁵

INFORMATION DISCLOSURE STATEMENT BY APPLICANT (Not for submission under 37 CFR 1.99)	Application Number		14633804
	Filing Date		2015-02-27
	First Named Inventor	BEYER, Jr., Malcolm K.	
	Art Unit	2642	
	Examiner Name	Not Assigned	
	Attorney Docket Number	10963.3835	

1	Benefon ESC! GSM + GPS Personal Navigation Phone, 1999, Benefon Oyj, Salo, Finland.	<input type="checkbox"/>
2	ELISA BATISTA, Your Boss May Know Where You Are, May 31, 2002, < http://archive.wired.com/gadgets/wireless/news/2002/05/52852?currentPage=all >.	<input type="checkbox"/>

If you wish to add additional non-patent literature document citation information please click the Add button **Add**

EXAMINER SIGNATURE

Examiner Signature		Date Considered	
--------------------	--	-----------------	--

*EXAMINER: Initial if reference considered, whether or not citation is in conformance with MPEP 609. Draw line through a citation if not in conformance and not considered. Include copy of this form with next communication to applicant.

¹ See Kind Codes of USPTO Patent Documents at www.USPTO.GOV or MPEP 901.04. ² Enter office that issued the document, by the two-letter code (WIPO Standard ST.3). ³ For Japanese patent documents, the indication of the year of the reign of the Emperor must precede the serial number of the patent document. ⁴ Kind of document by the appropriate symbols as indicated on the document under WIPO Standard ST.16 if possible. ⁵ Applicant is to place a check mark here if English language translation is attached.

INFORMATION DISCLOSURE STATEMENT BY APPLICANT (Not for submission under 37 CFR 1.99)	Application Number	14633804
	Filing Date	2015-02-27
	First Named Inventor	BEYER, Jr., Malcolm K.
	Art Unit	2642
	Examiner Name	Not Assigned
	Attorney Docket Number	10963.3835

CERTIFICATION STATEMENT

Please see 37 CFR 1.97 and 1.98 to make the appropriate selection(s):

That each item of information contained in the information disclosure statement was first cited in any communication from a foreign patent office in a counterpart foreign application not more than three months prior to the filing of the information disclosure statement. See 37 CFR 1.97(e)(1).

OR

That no item of information contained in the information disclosure statement was cited in a communication from a foreign patent office in a counterpart foreign application, and, to the knowledge of the person signing the certification after making reasonable inquiry, no item of information contained in the information disclosure statement was known to any individual designated in 37 CFR 1.56(c) more than three months prior to the filing of the information disclosure statement. See 37 CFR 1.97(e)(2).

See attached certification statement.

The fee set forth in 37 CFR 1.17 (p) has been submitted herewith.

A certification statement is not submitted herewith.

SIGNATURE

A signature of the applicant or representative is required in accordance with CFR 1.33, 10.18. Please see CFR 1.4(d) for the form of the signature.

Signature	/barry l. haley/	Date (YYYY-MM-DD)	2015-03-20
Name/Print	Barry L. Haley	Registration Number	25339

This collection of information is required by 37 CFR 1.97 and 1.98. The information is required to obtain or retain a benefit by the public which is to file (and by the USPTO to process) an application. Confidentiality is governed by 35 U.S.C. 122 and 37 CFR 1.14. This collection is estimated to take 1 hour to complete, including gathering, preparing and submitting the completed application form to the USPTO. Time will vary depending upon the individual case. Any comments on the amount of time you require to complete this form and/or suggestions for reducing this burden, should be sent to the Chief Information Officer, U.S. Patent and Trademark Office, U.S. Department of Commerce, P.O. Box 1450, Alexandria, VA 22313-1450. **DO NOT SEND FEES OR COMPLETED FORMS TO THIS ADDRESS. SEND TO: Commissioner for Patents, P.O. Box 1450, Alexandria, VA 22313-1450.**

Privacy Act Statement

The Privacy Act of 1974 (P.L. 93-579) requires that you be given certain information in connection with your submission of the attached form related to a patent application or patent. Accordingly, pursuant to the requirements of the Act, please be advised that: (1) the general authority for the collection of this information is 35 U.S.C. 2(b)(2); (2) furnishing of the information solicited is voluntary; and (3) the principal purpose for which the information is used by the U.S. Patent and Trademark Office is to process and/or examine your submission related to a patent application or patent. If you do not furnish the requested information, the U.S. Patent and Trademark Office may not be able to process and/or examine your submission, which may result in termination of proceedings or abandonment of the application or expiration of the patent.

The information provided by you in this form will be subject to the following routine uses:

1. The information on this form will be treated confidentially to the extent allowed under the Freedom of Information Act (5 U.S.C. 552) and the Privacy Act (5 U.S.C. 552a). Records from this system of records may be disclosed to the Department of Justice to determine whether the Freedom of Information Act requires disclosure of these records.
2. A record from this system of records may be disclosed, as a routine use, in the course of presenting evidence to a court, magistrate, or administrative tribunal, including disclosures to opposing counsel in the course of settlement negotiations.
3. A record in this system of records may be disclosed, as a routine use, to a Member of Congress submitting a request involving an individual, to whom the record pertains, when the individual has requested assistance from the Member with respect to the subject matter of the record.
4. A record in this system of records may be disclosed, as a routine use, to a contractor of the Agency having need for the information in order to perform a contract. Recipients of information shall be required to comply with the requirements of the Privacy Act of 1974, as amended, pursuant to 5 U.S.C. 552a(m).
5. A record related to an International Application filed under the Patent Cooperation Treaty in this system of records may be disclosed, as a routine use, to the International Bureau of the World Intellectual Property Organization, pursuant to the Patent Cooperation Treaty.
6. A record in this system of records may be disclosed, as a routine use, to another federal agency for purposes of National Security review (35 U.S.C. 181) and for review pursuant to the Atomic Energy Act (42 U.S.C. 218(c)).
7. A record from this system of records may be disclosed, as a routine use, to the Administrator, General Services, or his/her designee, during an inspection of records conducted by GSA as part of that agency's responsibility to recommend improvements in records management practices and programs, under authority of 44 U.S.C. 2904 and 2906. Such disclosure shall be made in accordance with the GSA regulations governing inspection of records for this purpose, and any other relevant (i.e., GSA or Commerce) directive. Such disclosure shall not be used to make determinations about individuals.
8. A record from this system of records may be disclosed, as a routine use, to the public after either publication of the application pursuant to 35 U.S.C. 122(b) or issuance of a patent pursuant to 35 U.S.C. 151. Further, a record may be disclosed, subject to the limitations of 37 CFR 1.14, as a routine use, to the public if the record was filed in an application which became abandoned or in which the proceedings were terminated and which application is referenced by either a published application, an application open to public inspections or an issued patent.
9. A record from this system of records may be disclosed, as a routine use, to a Federal, State, or local law enforcement agency, if the USPTO becomes aware of a violation or potential violation of law or regulation.

Electronic Acknowledgement Receipt

EFS ID:	21828758
Application Number:	14633804
International Application Number:	
Confirmation Number:	8573
Title of Invention:	METHOD TO PROVIDE AD HOC AND PASSWORD PROTECTED DIGITAL AND VOICE NETWORKS
First Named Inventor/Applicant Name:	Malcolm K. Beyer
Customer Number:	22235
Filer:	Barry Lee Haley/Amy Allen
Filer Authorized By:	Barry Lee Haley
Attorney Docket Number:	10963.3835
Receipt Date:	20-MAR-2015
Filing Date:	27-FEB-2015
Time Stamp:	09:21:58
Application Type:	Utility under 35 USC 111(a)

Payment information:

Submitted with Payment	no
------------------------	----

File Listing:

Document Number	Document Description	File Name	File Size(Bytes)/ Message Digest	Multi Part /.zip	Pages (if appl.)
1	Information Disclosure Statement (IDS) Form (SB08)	14_IDS2.pdf	612123 8eca8c7fb7d42cf025a984235e9e293c60809a71	no	4

Warnings:

Information:

A U.S. Patent Number Citation or a U.S. Publication Number Citation is required in the Information Disclosure Statement (IDS) form for autoloading of data into USPTO systems. You may remove the form to add the required data in order to correct the Informational Message if you are citing U.S. References. If you chose not to include U.S. References, the image of the form will be processed and be made available within the Image File Wrapper (IFW) system. However, no data will be extracted from this form. Any additional data such as Foreign Patent Documents or Non Patent Literature will be manually reviewed and keyed into USPTO systems.

2	Other Reference-Patent/App/Search documents	51_Benefon_Personal_Navigati on_Phone.pdf	4969178	no	4
			429748fc21257eff4e1d2f3a5601d9a7fb9a5 ef3		

Warnings:

Information:

3	Non Patent Literature	52_WIRED.pdf	1726971	no	3
			9806d417f9ad9272c17f063be498a8610b3 ee998		

Warnings:

Information:

Total Files Size (in bytes):			7308272		
-------------------------------------	--	--	---------	--	--

This Acknowledgement Receipt evidences receipt on the noted date by the USPTO of the indicated documents, characterized by the applicant, and including page counts, where applicable. It serves as evidence of receipt similar to a Post Card, as described in MPEP 503.

New Applications Under 35 U.S.C. 111

If a new application is being filed and the application includes the necessary components for a filing date (see 37 CFR 1.53(b)-(d) and MPEP 506), a Filing Receipt (37 CFR 1.54) will be issued in due course and the date shown on this Acknowledgement Receipt will establish the filing date of the application.

National Stage of an International Application under 35 U.S.C. 371

If a timely submission to enter the national stage of an international application is compliant with the conditions of 35 U.S.C. 371 and other applicable requirements a Form PCT/DO/EO/903 indicating acceptance of the application as a national stage submission under 35 U.S.C. 371 will be issued in addition to the Filing Receipt, in due course.

New International Application Filed with the USPTO as a Receiving Office

If a new international application is being filed and the international application includes the necessary components for an international filing date (see PCT Article 11 and MPEP 1810), a Notification of the International Application Number and of the International Filing Date (Form PCT/RO/105) will be issued in due course, subject to prescriptions concerning national security, and the date shown on this Acknowledgement Receipt will establish the international filing date of the application.

IN THE UNITED STATES PATENT AND TRADEMARK OFFICE

In re application of: BEYER, Jr., <i>et al.</i>)	
)	
Serial No.: 14/633,804)	Confirmation No: 8573
)	
Filed: February 27, 2015)	Group Art Unit: 2642
)	
Entitled: METHOD TO PROVIDE AD HOC)	Examiner: Not Assigned
AND PASSWORD PROTECTED DIGITAL)	
AND VOICE NETWORKS)	
_____)	

Commissioner for Patents
P.O. Box 1450
Alexandria, VA 22313-1450

April 1, 2015
Filed Electronically

PRELIMINARY AMENDMENT

Dear Sir:

Preliminary to the examination of the above-referenced application, please amend the application as follows:

Amendments to the claims begin on page 2 of this paper.

Remarks begin on page 7 of this paper.

CLAIM AMENDMENTS

Please amend the claims (~~strike through~~ indicating deletion and underline indicating insertion) as follows:

1. (Currently Amended) A computer-implemented method comprising:
receiving at various times from one or more ~~of the~~ devices respective information comprising a location of the device and sending the location to one or more other devices, wherein each of the other devices is configured to display a respective symbol representing the location on a respective map;
receiving from a first device information indicating user selection of one or more of the displayed symbols corresponding to second devices and, based thereon:
obtaining a respective contact information for each of the second devices; and
facilitating a respective communication between the first device and each of the second devices using the contact information of the second device.
2. (Original) The method of claim 1 wherein a particular communication is a phone call, a short message service message, a voice message, a text message, an electronic mail message, an image, or a video.
3. (Original) The method of claim 1 wherein first device and the second devices are part of a same group or within a user-specified geographic area.
4. (Original) The method of claim 3 wherein the group is a friends or family group.
5. (Original) The method of claim 1 wherein particular contact information is a phone number or an Internet Protocol address.
6. (Canceled)
7. (Original) The method of claim 6 wherein the symbol represents a facility or a person's home.

8. (Original) The method of claim 1 wherein a particular device is a smart phone, a personal data assistant, a tablet computer, a desktop computer, or a laptop computer.

9. (Original) The method of claim 1, further comprising:
receiving a request for a map from a third device wherein the request comprises one or more parameters and wherein a parameter specifies a map location or a zoom indication;
obtaining a second map that conforms to the attributes; and
sending the second map to the third device.

10. (Original) The method of claim 1 wherein the first device does not have access to the phone numbers or Internet Protocol addresses of the second devices.

11. (Previously Amended) The method of claim 1 wherein the map is an aerial photograph, a satellite image, or a chart.

12. (Previously Amended) The method of claim 1 wherein receiving at various times from a particular device information comprises receiving the information from the particular device at a time based on one or more of: speed of the particular device, distance traveled by the particular device, or time.

13. (Currently Amended) A system comprising:
one or more computers programmed to perform operations comprising:
receiving at various times from one or more ~~of the~~ devices respective information comprising a location of the device and sending the location to one or more other devices, wherein each of the other devices is configured to display a respective symbol representing the location on a respective map;
receiving from a first device information indicating user selection of one or more of the displayed symbols corresponding to second devices and, based thereon:
obtaining a respective contact information for each of the second devices; and

facilitating a respective communication between the first device and each of the second devices using the contact information of the second device.

14. (Original) The system of claim 13 wherein a particular communication is a phone call, a short message service message, a voice message, a text message, an electronic mail message, an image, or a video.

15. (Original) The system of claim 13 wherein first device and the second devices are part of a same group or within a user-specified geographic area.

16. (Original) The system of claim 15 wherein the group is a friends or family group.

17. (Original) The system of claim 13 wherein particular contact information is a phone number or an Internet Protocol address.

18. (Canceled)

19. (Original) The system of claim 18 wherein the symbol represents a facility or a person's home.

20. (Original) The system of claim 13 wherein a particular device is a smart phone, a personal data assistant, a tablet computer, a desktop computer, or a laptop computer.

21. (Original) The system of claim 13, wherein the operations further comprise:
receiving a request for a map from a third device wherein the request comprises one or more parameters and wherein a parameter specifies a map location or a zoom indication;
obtaining a second map that conforms to the attributes; and
sending the second map to the third device.

22. (Original) The system of claim 13 wherein the first device does not have access to the phone numbers or Internet Protocol addresses of the second devices.

23. (Currently Amended) The system of claim 13 wherein the map is an aerial photograph, a satellite image, or a chart.

24. (Previously Amended) The system of claim 13 wherein receiving at various times from a particular device information comprises receiving the information from the particular device at a time based on one or more of: speed of the particular device, distance traveled by the particular device, or time.

25. (Previously presented) The method of claim 1, further comprising:
sending a respective first map to each one of a plurality of devices wherein the device is configured to display the first map.

26. (Previously presented) The system of claim 13 wherein the operations further comprise:
sending a respective first map to each one of a plurality of devices wherein the device is configured to display the first map.

27. (New) A computer-implemented method comprising:
receiving at various times from one or more devices respective information comprising a location of the device and sending the location to one or more other devices, wherein each of the other devices is configured to display a respective symbol representing the location on a respective map;
receiving from a first device information indicating user selection of an action and based thereon:
obtaining respective contact information for each of the second devices; and
facilitating a respective communication between the first device and each of the second devices using the contact information of the second device.

28. (New) The method of claim 27 wherein a particular communication is a phone call, a short message service message, a voice message, a text message, an electronic mail message, an image, or a video.

29. (New) A system comprising:

one or more computers programmed to perform operations comprising:

receiving at various times from one or more devices respective information comprising a location of the device and sending the location to one or more other devices, wherein each of the other devices is configured to display a respective symbol representing the location on a respective map;

receiving from a first device information indicating user selection of an action and based thereon:

obtaining respective contact information for each of the second devices; and

facilitating a respective communication between the first device and each of the second devices using the contact information of the second device.

30. (New) The system of claim 29 wherein a particular communication is a phone call, a short message service message, a voice message, a text message, an electronic mail message, an image, or a video.

REMARKS

Preliminary to examination, kindly amend the claims as set forth above. Should the Examiner have any questions, comments, or concerns, the undersigned would appreciate a telephone conference in order to expedite this case.

Respectfully submitted,

/Barry L. Haley/
Barry L. Haley, Esq. (Reg. No. 25,339)

Customer No.: 22235
MALIN HALEY DiMAGGIO &
BOWEN, P.A.
1936 South Andrews Avenue
Fort Lauderdale, Florida 33316
Telephone: (954) 763-3303
Facsimile: (954) 522-6507
E-Mail: info@mhdpatents.com

Electronic Patent Application Fee Transmittal

Application Number:	14633804			
Filing Date:	27-Feb-2015			
Title of Invention:	METHOD TO PROVIDE AD HOC AND PASSWORD PROTECTED DIGITAL AND VOICE NETWORKS			
First Named Inventor/Applicant Name:	Malcolm K. Beyer			
Filer:	Barry Lee Haley			
Attorney Docket Number:	10963.3835			
Filed as Small Entity				
Filing Fees for Utility under 35 USC 111(a)				
Description	Fee Code	Quantity	Amount	Sub-Total in USD(\$)
Basic Filing:				
Pages:				
Claims:				
Claims in excess of 20	2202	4	40	160
Independent Claims in Excess of 3	2201	1	210	210
Miscellaneous-Filing:				
Petition:				
Patent-Appeals-and-Interference:				

Description	Fee Code	Quantity	Amount	Sub-Total in USD(\$)
Post-Allowance-and-Post-Issuance:				
Extension-of-Time:				
Miscellaneous:				
Total in USD (\$)				370

Electronic Acknowledgement Receipt

EFS ID:	21939565
Application Number:	14633804
International Application Number:	
Confirmation Number:	8573
Title of Invention:	METHOD TO PROVIDE AD HOC AND PASSWORD PROTECTED DIGITAL AND VOICE NETWORKS
First Named Inventor/Applicant Name:	Malcolm K. Beyer
Customer Number:	22235
Filer:	Barry Lee Haley
Filer Authorized By:	
Attorney Docket Number:	10963.3835
Receipt Date:	01-APR-2015
Filing Date:	27-FEB-2015
Time Stamp:	12:50:40
Application Type:	Utility under 35 USC 111(a)

Payment information:

Submitted with Payment	yes
Payment Type	Deposit Account
Payment was successfully received in RAM	\$370
RAM confirmation Number	10156
Deposit Account	131130
Authorized User	

The Director of the USPTO is hereby authorized to charge indicated fees and credit any overpayment as follows:

--	--	--	--	--	--

File Listing:

Document Number	Document Description	File Name	File Size(Bytes)/ Message Digest	Multi Part /.zip	Pages (if appl.)
1	Preliminary Amendment	15_SecondPreliminaryAmendment.pdf	117881	no	7
			be2e60da6a473c59bdf36d99df73c2da3c88e95		

Warnings:

Information:

2	Fee Worksheet (SB06)	fee-info.pdf	32078	no	2
			0924167f94c45aa45a4f4f4ba7d848870b10ce03		

Warnings:

Information:

Total Files Size (in bytes):	149959
-------------------------------------	--------

This Acknowledgement Receipt evidences receipt on the noted date by the USPTO of the indicated documents, characterized by the applicant, and including page counts, where applicable. It serves as evidence of receipt similar to a Post Card, as described in MPEP 503.

New Applications Under 35 U.S.C. 111

If a new application is being filed and the application includes the necessary components for a filing date (see 37 CFR 1.53(b)-(d) and MPEP 506), a Filing Receipt (37 CFR 1.54) will be issued in due course and the date shown on this Acknowledgement Receipt will establish the filing date of the application.

National Stage of an International Application under 35 U.S.C. 371

If a timely submission to enter the national stage of an international application is compliant with the conditions of 35 U.S.C. 371 and other applicable requirements a Form PCT/DO/EO/903 indicating acceptance of the application as a national stage submission under 35 U.S.C. 371 will be issued in addition to the Filing Receipt, in due course.

New International Application Filed with the USPTO as a Receiving Office

If a new international application is being filed and the international application includes the necessary components for an international filing date (see PCT Article 11 and MPEP 1810), a Notification of the International Application Number and of the International Filing Date (Form PCT/RO/105) will be issued in due course, subject to prescriptions concerning national security, and the date shown on this Acknowledgement Receipt will establish the international filing date of the application.

Under the Paperwork Reduction Act of 1995, no persons are required to respond to a collection of information unless it displays a valid OMB control number.

PATENT APPLICATION FEE DETERMINATION RECORD Substitute for Form PTO-875	Application or Docket Number 14/633,804	Filing Date 02/27/2015	<input type="checkbox"/> To be Mailed
---	---	----------------------------------	---------------------------------------

ENTITY: LARGE SMALL MICRO

APPLICATION AS FILED – PART I

FOR	NUMBER FILED	NUMBER EXTRA	RATE (\$)	FEE (\$)
<input type="checkbox"/> BASIC FEE (37 CFR 1.16(a), (b), or (c))	N/A	N/A	N/A	
<input type="checkbox"/> SEARCH FEE (37 CFR 1.16(k), (j), or (m))	N/A	N/A	N/A	
<input type="checkbox"/> EXAMINATION FEE (37 CFR 1.16(o), (p), or (q))	N/A	N/A	N/A	
TOTAL CLAIMS (37 CFR 1.16(i))	minus 20 =	*	X \$ =	
INDEPENDENT CLAIMS (37 CFR 1.16(h))	minus 3 =	*	X \$ =	
<input type="checkbox"/> APPLICATION SIZE FEE (37 CFR 1.16(s))	If the specification and drawings exceed 100 sheets of paper, the application size fee due is \$310 (\$155 for small entity) for each additional 50 sheets or fraction thereof. See 35 U.S.C. 41(a)(1)(G) and 37 CFR 1.16(s).			
<input type="checkbox"/> MULTIPLE DEPENDENT CLAIM PRESENT (37 CFR 1.16(j))				
* If the difference in column 1 is less than zero, enter "0" in column 2.			TOTAL	

APPLICATION AS AMENDED – PART II

	(Column 1)	(Column 2)	(Column 3)	(Column 3)	RATE (\$)	ADDITIONAL FEE (\$)
AMENDMENT	04/01/2015	CLAIMS REMAINING AFTER AMENDMENT	HIGHEST NUMBER PREVIOUSLY PAID FOR	PRESENT EXTRA		
	Total (37 CFR 1.16(i))	* 28	Minus	** 28	= 0	x \$40 = 0
	Independent (37 CFR 1.16(h))	* 4	Minus	***4	= 0	x \$210 = 0
	<input type="checkbox"/> Application Size Fee (37 CFR 1.16(s))					
<input type="checkbox"/> FIRST PRESENTATION OF MULTIPLE DEPENDENT CLAIM (37 CFR 1.16(j))						
					TOTAL ADD'L FEE	0

	(Column 1)	(Column 2)	(Column 3)	(Column 3)	RATE (\$)	ADDITIONAL FEE (\$)
AMENDMENT		CLAIMS REMAINING AFTER AMENDMENT	HIGHEST NUMBER PREVIOUSLY PAID FOR	PRESENT EXTRA		
	Total (37 CFR 1.16(i))	*	Minus	**	=	X \$ =
	Independent (37 CFR 1.16(h))	*	Minus	***	=	X \$ =
	<input type="checkbox"/> Application Size Fee (37 CFR 1.16(s))					
<input type="checkbox"/> FIRST PRESENTATION OF MULTIPLE DEPENDENT CLAIM (37 CFR 1.16(j))						
					TOTAL ADD'L FEE	

* If the entry in column 1 is less than the entry in column 2, write "0" in column 3.
 ** If the "Highest Number Previously Paid For" IN THIS SPACE is less than 20, enter "20".
 *** If the "Highest Number Previously Paid For" IN THIS SPACE is less than 3, enter "3".

The "Highest Number Previously Paid For" (Total or Independent) is the highest number found in the appropriate box in column 1.

LIE
 /VANESSA HODGES/

This collection of information is required by 37 CFR 1.16. The information is required to obtain or retain a benefit by the public which is to file (and by the USPTO to process) an application. Confidentiality is governed by 35 U.S.C. 122 and 37 CFR 1.14. This collection is estimated to take 12 minutes to complete, including gathering, preparing, and submitting the completed application form to the USPTO. Time will vary depending upon the individual case. Any comments on the amount of time you require to complete this form and/or suggestions for reducing this burden, should be sent to the Chief Information Officer, U.S. Patent and Trademark Office, U.S. Department of Commerce, P.O. Box 1450, Alexandria, VA 22313-1450. DO NOT SEND FEES OR COMPLETED FORMS TO THIS ADDRESS. **SEND TO: Commissioner for Patents, P.O. Box 1450, Alexandria, VA 22313-1450.**

If you need assistance in completing the form, call 1-800-PTO-9199 and select option 2.



UNITED STATES PATENT AND TRADEMARK OFFICE

UNITED STATES DEPARTMENT OF COMMERCE
United States Patent and Trademark Office
Address: COMMISSIONER FOR PATENTS
P.O. Box 1450
Alexandria, Virginia 22313-1450
www.uspto.gov

Table with 4 columns: APPLICATION NUMBER (14/633,804), FILING OR 371(C) DATE (02/27/2015), FIRST NAMED APPLICANT (Malcolm K. Beyer JR.), ATTY. DOCKET NO./TITLE (10963.3835)

CONFIRMATION NO. 8573

FORMALITIES LETTER

22235
Malin Haley DiMaggio & Bowen, P.A.
1936 S ANDREWS AVENUE
FORT LAUDERDALE, FL 33316



Date Mailed: 04/09/2015

NOTICE OF INCOMPLETE REPLY (NONPROVISIONAL)

Filing Date Granted

The U.S. Patent and Trademark Office has received your reply on 04/01/2015 to the Notice to File Missing Parts (Notice) mailed 03/20/2015 and it has been entered into the nonprovisional application. The reply, however, does not include the following items required in the Notice. A complete reply must be timely filed to prevent ABANDONMENT of the above-identified application. Replies should be mailed to: Mail Stop Missing Parts, Commissioner for Patents, P.O. Box 1450, Alexandria VA 22313-1450.

Applicant is given TWO MONTHS from the date of the Notice to File Missing Parts (Notice) mailed 03/20/2015 within which to file all required items and pay any fees required below to avoid abandonment. Extensions of time may be obtained by filing a petition accompanied by the extension fee under the provisions of 37 CFR 1.136(a).

Items Required to Avoid Abandonment:

The required items noted below SHOULD be filed along with any items required above. The filing date of this nonprovisional application will be the date of receipt of the items required above.

The application is informal since it does not comply with the regulations for the reason(s) indicated below.

The required item(s) identified below must be timely submitted to avoid abandonment:

- Replacement drawings in compliance with 37 CFR 1.84 and 37 CFR 1.121(d) are required. The drawings submitted are not acceptable because:
• The drawings must be reasonably free from erasures and must be free from alterations, overwriting, interlineations, folds, and copy marks. See Figure(s) 9, 10.

Applicant is cautioned that correction of the above items may cause the specification and drawings page count to exceed 100 pages. If the specification and drawings exceed 100 pages, applicant will need to submit the required application size fee.

Replies must be received in the USPTO within the set time period or must include a proper Certificate of Mailing or Transmission under 37 CFR 1.8 with a mailing or transmission date within the set time period. For more information and a suggested format, see Form PTO/SB/92 and MPEP 512.

Replies should be mailed to:

Mail Stop Missing Parts
Commissioner for Patents
P.O. Box 1450
Alexandria VA 22313-1450

Registered users of EFS-Web may alternatively submit their reply to this notice via EFS-Web, including a copy of this Notice and selecting the document description "Applicant response to Pre-Exam Formalities Notice".
<https://spportal.uspto.gov/authenticate/AuthenticateUserLocalEPF.html>

For more information about EFS-Web please call the USPTO Electronic Business Center at **1-866-217-9197** or visit our website at <http://www.uspto.gov/ebc>.

If you are not using EFS-Web to submit your reply, you must include a copy of this notice.

/nhassani/

Office of Data Management, Application Assistance Unit (571) 272-4000, or (571) 272-4200, or 1-888-786-0101

PATENT APPLICATION FEE DETERMINATION RECORD

Substitute for Form PTO-875

Application or Docket Number
14/633,804

APPLICATION AS FILED - PART I

FOR	(Column 1) NUMBER FILED	(Column 2) NUMBER EXTRA
BASIC FEE (37 CFR 1.16(a), (b), or (c))	N/A	N/A
SEARCH FEE (37 CFR 1.16(k), (i), or (m))	N/A	N/A
EXAMINATION FEE (37 CFR 1.16(o), (p), or (q))	N/A	N/A
TOTAL CLAIMS (37 CFR 1.16(i))	28 minus 20 = *	8
INDEPENDENT CLAIMS (37 CFR 1.16(h))	4 minus 3 = *	1
APPLICATION SIZE FEE (37 CFR 1.16(s))	If the specification and drawings exceed 100 sheets of paper, the application size fee due is \$310 (\$155 for small entity) for each additional 50 sheets or fraction thereof. See 35 U.S.C. 41(a)(1)(G) and 37 CFR 1.16(s).	
MULTIPLE DEPENDENT CLAIM PRESENT (37 CFR 1.16(j))		

SMALL ENTITY	
RATE(\$)	FEE(\$)
N/A	70
N/A	300
N/A	360
x 40 =	320
x 210 =	210
	0.00
	0.00
TOTAL	1260

OTHER THAN SMALL ENTITY

RATE(\$)	FEE(\$)
N/A	
N/A	
N/A	
TOTAL	

* If the difference in column 1 is less than zero, enter "0" in column 2.

APPLICATION AS AMENDED - PART II

AMENDMENT A	(Column 1)	(Column 2)	(Column 3)
	CLAIMS REMAINING AFTER AMENDMENT	HIGHEST NUMBER PREVIOUSLY PAID FOR	PRESENT EXTRA
	Total (37 CFR 1.16(i))	* Minus **	=
	Independent (37 CFR 1.16(h))	* Minus ***	=
	Application Size Fee (37 CFR 1.16(s))		
FIRST PRESENTATION OF MULTIPLE DEPENDENT CLAIM (37 CFR 1.16(j))			

SMALL ENTITY	
RATE(\$)	ADDITIONAL FEE(\$)
x =	
x =	
TOTAL ADD'L FEE	

OTHER THAN SMALL ENTITY

RATE(\$)	ADDITIONAL FEE(\$)
x =	
x =	
TOTAL ADD'L FEE	

AMENDMENT B	(Column 1)	(Column 2)	(Column 3)
	CLAIMS REMAINING AFTER AMENDMENT	HIGHEST NUMBER PREVIOUSLY PAID FOR	PRESENT EXTRA
	Total (37 CFR 1.16(i))	* Minus **	=
	Independent (37 CFR 1.16(h))	* Minus ***	=
	Application Size Fee (37 CFR 1.16(s))		
FIRST PRESENTATION OF MULTIPLE DEPENDENT CLAIM (37 CFR 1.16(j))			

RATE(\$)	ADDITIONAL FEE(\$)
x =	
x =	
TOTAL ADD'L FEE	

OTHER THAN SMALL ENTITY

RATE(\$)	ADDITIONAL FEE(\$)
x =	
x =	
TOTAL ADD'L FEE	

* If the entry in column 1 is less than the entry in column 2, write "0" in column 3.
 ** If the "Highest Number Previously Paid For" IN THIS SPACE is less than 20, enter "20".
 *** If the "Highest Number Previously Paid For" IN THIS SPACE is less than 3, enter "3".
 The "Highest Number Previously Paid For" (Total or Independent) is the highest found in the appropriate box in column 1.

ENABLING LOCATION, STATUS, VoIP, PTT AND VIDEO COMMUNICATIONS BETWEEN
RADIO AND CELL PHONES

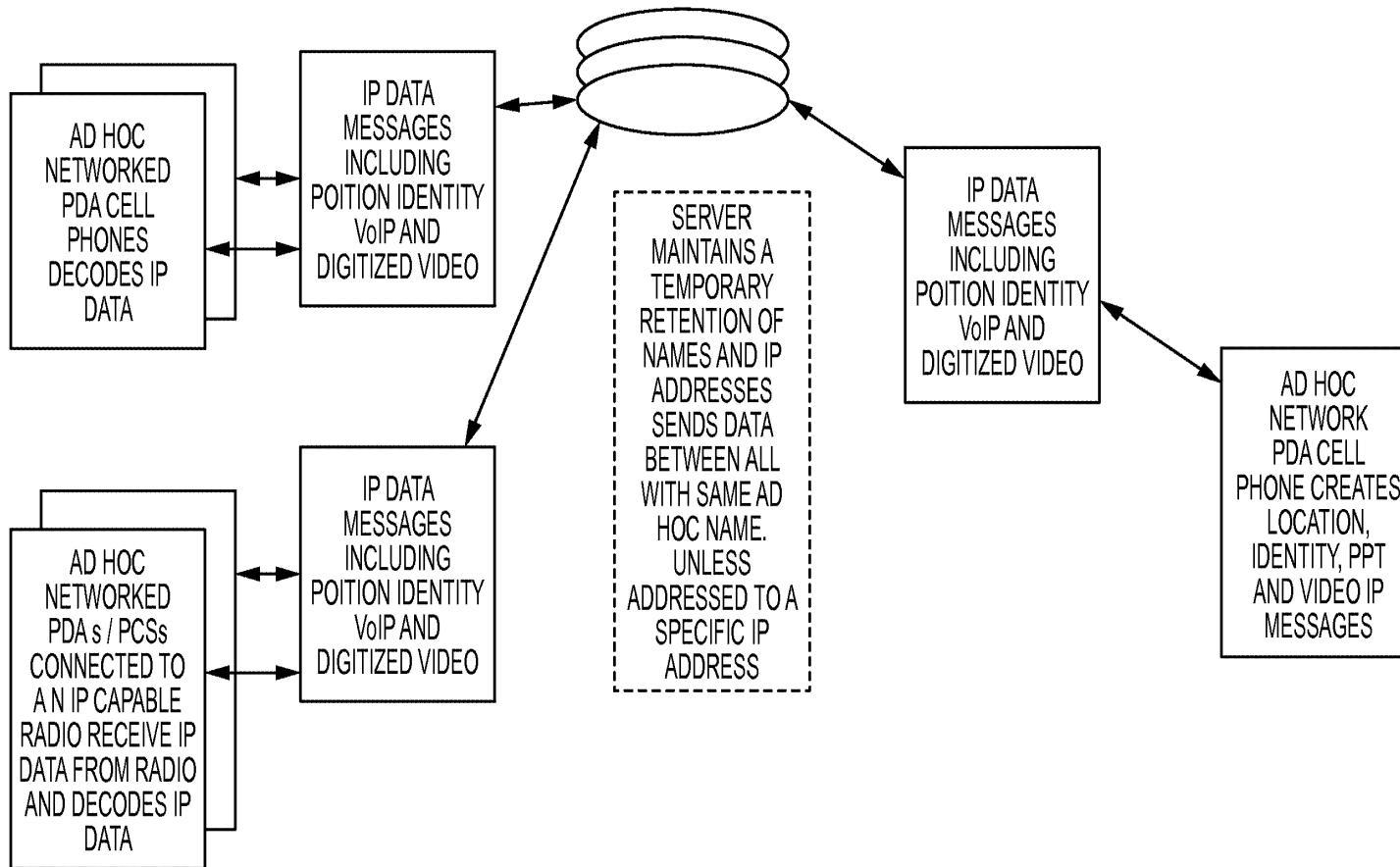
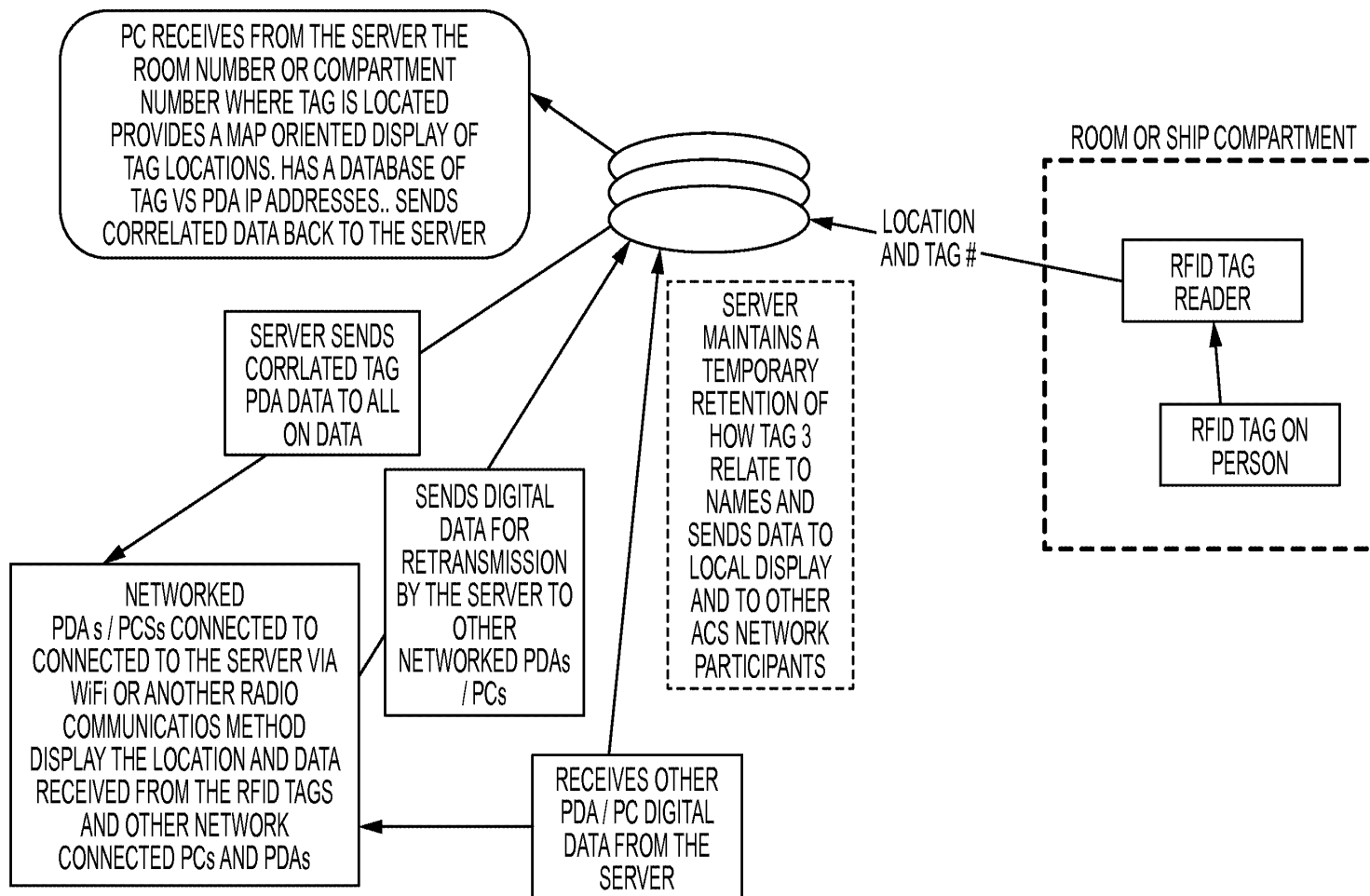

FIG. 9

ENABLING NON RFID EQUIPPED PDA PHONES TO RECEIVE RFID TAG DATA



7/7

REPLACEMENT SHEET

FIG. 10