

Electronic Patent Application Fee Transmittal

Application Number:	14633804			
Filing Date:	27-Feb-2015			
Title of Invention:	METHOD TO PROVIDE AD HOC AND PASSWORD PROTECTED DIGITAL AND VOICE NETWORKS			
First Named Inventor/Applicant Name:	Malcolm K. Beyer			
Filer:	Barry Lee Haley			
Attorney Docket Number:	10963.3835			
Filed as Small Entity				
Filing Fees for Utility under 35 USC 111(a)				
Description	Fee Code	Quantity	Amount	Sub-Total in USD(\$)
Basic Filing:				
Pages:				
Claims:				
Miscellaneous-Filing:				
Petition:				
Patent-Appeals-and-Interference:				
Post-Allowance-and-Post-Issuance:				
Extension-of-Time:				

Description	Fee Code	Quantity	Amount	Sub-Total in USD(\$)
Extension - 1 month with \$0 paid	2251	1	100	100
Miscellaneous:				
Total in USD (\$)				100

Electronic Acknowledgement Receipt

EFS ID:	22615634
Application Number:	14633804
International Application Number:	
Confirmation Number:	8573
Title of Invention:	METHOD TO PROVIDE AD HOC AND PASSWORD PROTECTED DIGITAL AND VOICE NETWORKS
First Named Inventor/Applicant Name:	Malcolm K. Beyer
Customer Number:	22235
Filer:	Barry Lee Haley
Filer Authorized By:	
Attorney Docket Number:	10963.3835
Receipt Date:	12-JUN-2015
Filing Date:	27-FEB-2015
Time Stamp:	13:34:05
Application Type:	Utility under 35 USC 111(a)

Payment information:

Submitted with Payment	yes
Payment Type	Deposit Account
Payment was successfully received in RAM	\$100
RAM confirmation Number	23722
Deposit Account	131130
Authorized User	HALEY, BARRY

The Director of the USPTO is hereby authorized to charge indicated fees and credit any overpayment as follows:

--	--	--	--	--	--

File Listing:

Document Number	Document Description	File Name	File Size(Bytes)/ Message Digest	Multi Part /.zip	Pages (if appl.)
1	Drawings-only black and white line drawings	16_ReplacementSheet.pdf	554464	no	2
			11fa43c5363d72f6ff3119ce4641e80ac585352a		

Warnings:

Information:

2	Fee Worksheet (SB06)	fee-info.pdf	30833	no	2
			636dfa473dcd2095b48cd64b0af5bcf0a96b9731		

Warnings:

Information:

Total Files Size (in bytes):	585297
-------------------------------------	--------

This Acknowledgement Receipt evidences receipt on the noted date by the USPTO of the indicated documents, characterized by the applicant, and including page counts, where applicable. It serves as evidence of receipt similar to a Post Card, as described in MPEP 503.

New Applications Under 35 U.S.C. 111

If a new application is being filed and the application includes the necessary components for a filing date (see 37 CFR 1.53(b)-(d) and MPEP 506), a Filing Receipt (37 CFR 1.54) will be issued in due course and the date shown on this Acknowledgement Receipt will establish the filing date of the application.

National Stage of an International Application under 35 U.S.C. 371

If a timely submission to enter the national stage of an international application is compliant with the conditions of 35 U.S.C. 371 and other applicable requirements a Form PCT/DO/EO/903 indicating acceptance of the application as a national stage submission under 35 U.S.C. 371 will be issued in addition to the Filing Receipt, in due course.

New International Application Filed with the USPTO as a Receiving Office

If a new international application is being filed and the international application includes the necessary components for an international filing date (see PCT Article 11 and MPEP 1810), a Notification of the International Application Number and of the International Filing Date (Form PCT/RO/105) will be issued in due course, subject to prescriptions concerning national security, and the date shown on this Acknowledgement Receipt will establish the international filing date of the application.

Docket No.: MOC-005
(PATENT)

IN THE UNITED STATES PATENT AND TRADEMARK OFFICE

In re Patent Application of:
Malcolm K. Beyer, Jr. et al.

Application No.: 14/633,804

Confirmation No.: 8573

Filed: February 27, 2015

Art Unit: 2642

For: METHOD TO PROVIDE AD HOC AND
PASSWORD PROTECTED DIGITAL AND
VOICE NETWORKS

Examiner: Not Yet Assigned

RESPONSE TO NOTICE OF INCOMPLETE REPLY (NONPROVISIONAL)

MS Missing Parts
Commissioner for Patents
P.O. Box 1450
Alexandria, VA 22313-1450

Dear Madam:

In response to the Notice of Incomplete Reply mailed April 9, 2015, and the Notice to File Corrected Application Papers mailed March 20, 2015, Applicant respectfully submits Replacement Drawing(s) (2 figures, 2 pages), and a Petition for Extension of Time.

Please charge our Credit Card in the amount of \$300.00 covering the fee set forth in 37 CFR 1.17(a)(2). The Director is hereby authorized to charge any deficiency in the fees filed, asserted to be filed or which should have been filed herewith to our Deposit Account No. 07-1700, under Order No. MOC-005.

Respectfully submitted,

Dated: July 7, 2015

/Daniel J. Burns/
Daniel J. Burns
Registration No.: 50,222

Customer Number: 77845
Goodwin Procter LLP
Telephone: (650) 752-3100

ACTIVE/82921851.1

ENABLING LOCATION, STATUS, VoIP, PTT AND VIDEO COMMUNICATIONS BETWEEN
RADIOS AND CELL PHONES

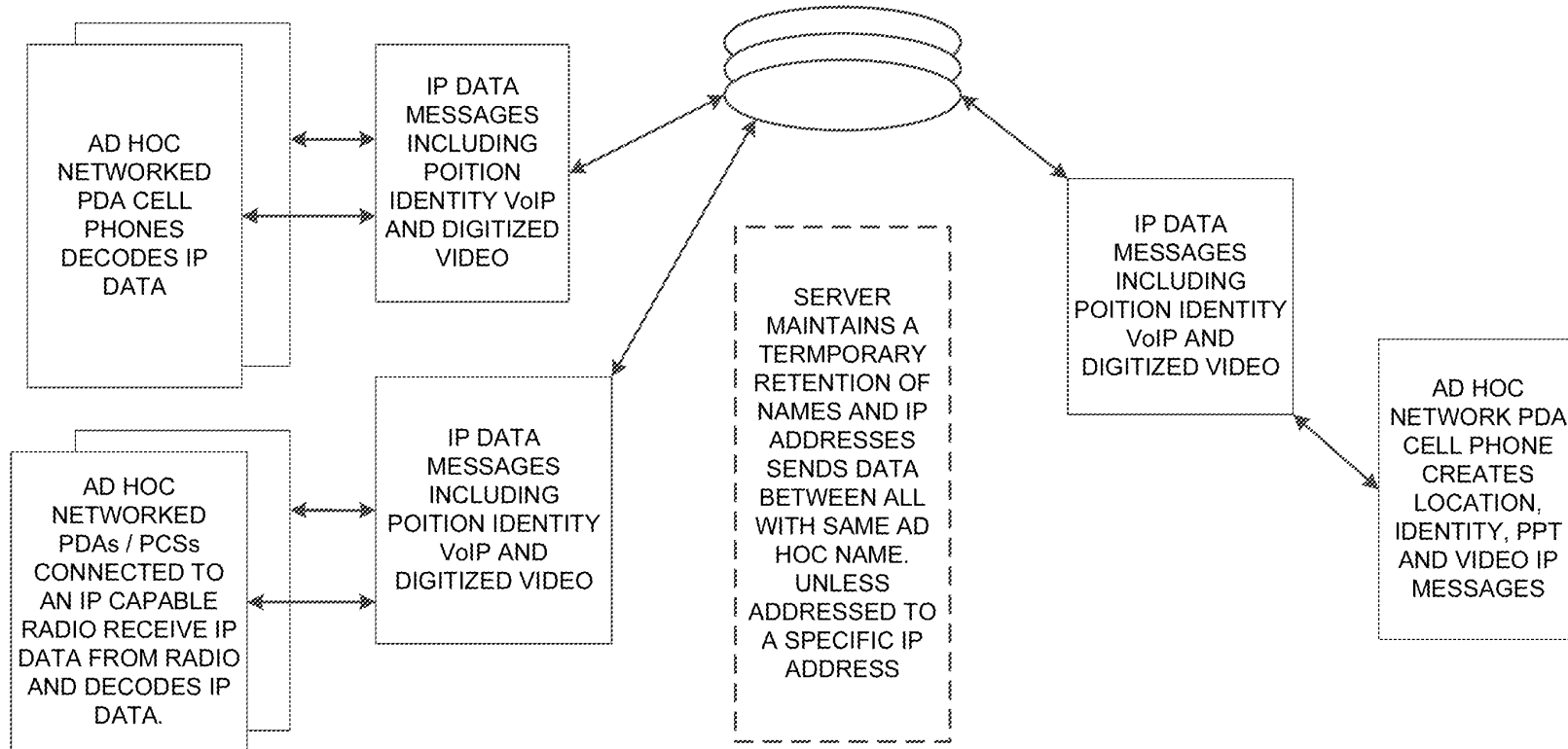

FIG. 9

ENABLING NON RFID EQUIPPED PDA PHONES TO RECEIVE RFID TAG DATA.

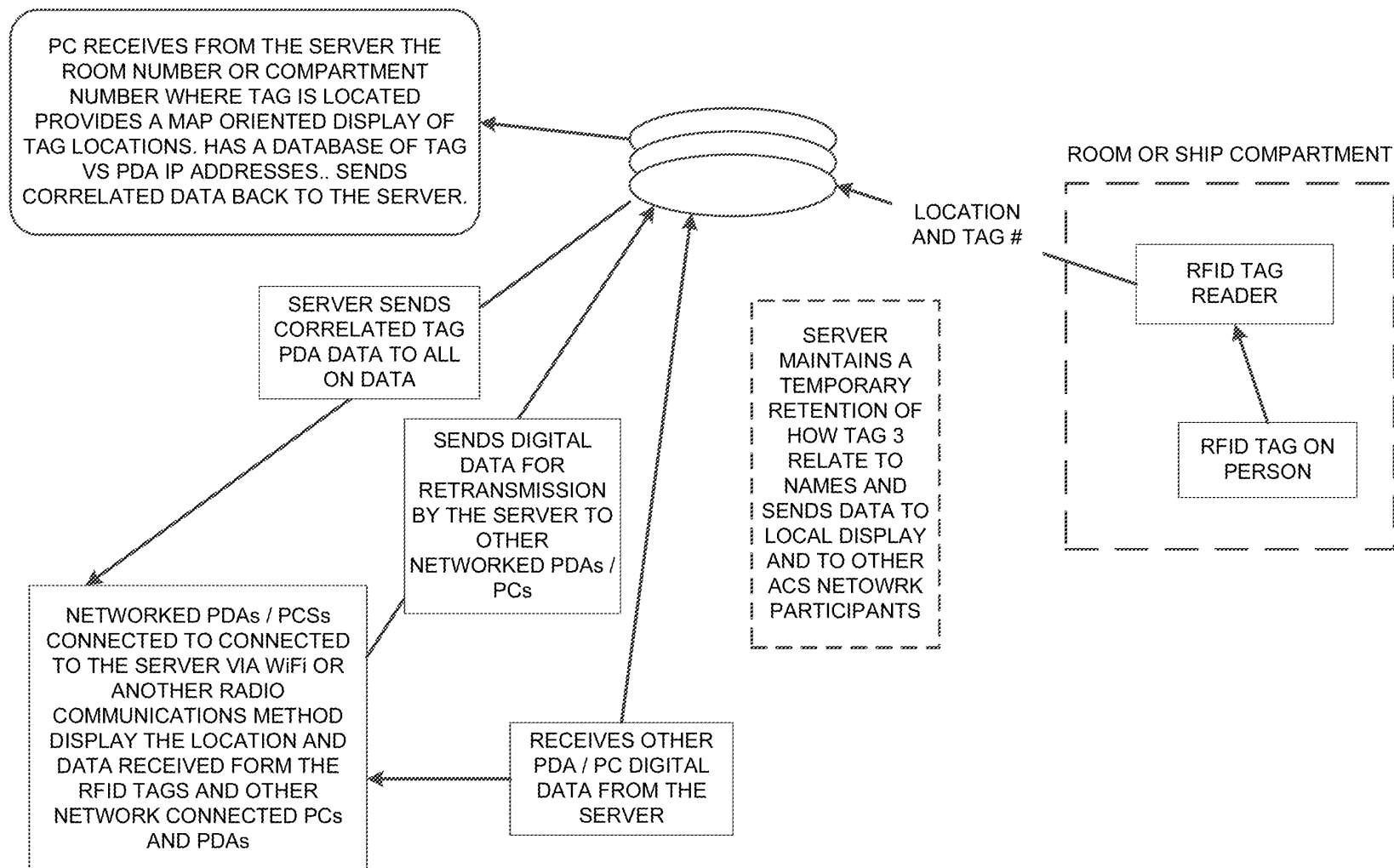

FIG. 10

PETITION FOR EXTENSION OF TIME UNDER 37 CFR 1.136(a)	Docket Number (Optional)
---	--------------------------

Application Number <u>14/633,804-Conf. #8573</u>	Filed <u>February 27, 2015</u>
--	--------------------------------

For
METHOD TO PROVIDE AD HOC AND PASSWORD PROTECTED DIGITAL AND VOICE NETWORKS

Art Unit <u>2642</u>	Examiner <u>Not Yet Assigned</u>
----------------------	----------------------------------

This is a request under the provisions of 37 CFR 1.136(a) to extend the period for filing a reply in the above-identified application.

The requested extension and fee are as follows (check time period desired and enter the appropriate fee below):

	<u>Fee</u>	<u>Small Entity Fee</u>	<u>Micro Entity Fee</u>	
<input type="checkbox"/> One month (37 CFR 1.17(a)(1))	\$200	\$100	\$50	\$ _____
<input checked="" type="checkbox"/> Two months (37 CFR 1.17(a)(2))	\$600	\$300	\$150	\$ <u>300.00</u>
<input type="checkbox"/> Three months (37 CFR 1.17(a)(3))	\$1,400	\$700	\$350	\$ _____
<input type="checkbox"/> Four months (37 CFR 1.17(a)(4))	\$2,200	\$1,100	\$550	\$ _____
<input type="checkbox"/> Five months (37 CFR 1.17(a)(5))	\$3,000	\$1,500	\$750	\$ _____

- Applicant asserts small entity status. See 37 CFR 1.27.
- Applicant certifies micro entity status. See 37 CFR 1.29.
Form PTO/SB/15A or B or equivalent must either be enclosed or have been submitted previously.
- A check in the amount of the fee is enclosed.
- Payment by credit card.
- The Director has already been authorized to charge fees in this application to a Deposit Account.
- The Director is hereby authorized to charge any fees which may be required, or credit any overpayment, to Deposit Account Number 07-1700.
- Payment made via EFS-Web.

WARNING: Information on this form may become public. Credit card information should not be included on this form. Provide credit card information and authorization on PTO-2038.

- I am the
- applicant.
 - attorney or agent of record. Registration number 50,222.
 - attorney or agent acting under 37 CFR 1.34. Registration number _____.

_____ /Daniel J. Burns/ Signature	_____ July 7, 2015 Date
_____ Daniel J. Burns Typed or printed name	_____ (650) 752-3100 Telephone Number

NOTE: This form must be signed in accordance with 37 CFR 1.33. See 37 CFR 1.4 for signature requirements and certifications. Submit multiple forms if more than one signature is required, see below*.

<input type="checkbox"/> * Total of <u>1</u> forms are submitted.

Electronic Patent Application Fee Transmittal

Application Number:	14633804			
Filing Date:	27-Feb-2015			
Title of Invention:	METHOD TO PROVIDE AD HOC AND PASSWORD PROTECTED DIGITAL AND VOICE NETWORKS			
First Named Inventor/Applicant Name:	Malcolm K. Beyer			
Filer:	Daniel J. Burns/Deanna Bridges			
Attorney Docket Number:	10963.3835			
Filed as Small Entity				
Filing Fees for Utility under 35 USC 111(a)				
Description	Fee Code	Quantity	Amount	Sub-Total in USD(\$)
Basic Filing:				
Pages:				
Claims:				
Miscellaneous-Filing:				
Petition:				
Patent-Appeals-and-Interference:				
Post-Allowance-and-Post-Issuance:				
Extension-of-Time:				

Description	Fee Code	Quantity	Amount	Sub-Total in USD(\$)
Extension - 2 months with \$0 paid	2252	1	300	300
Miscellaneous:				
Total in USD (\$)				300

Electronic Acknowledgement Receipt

EFS ID:	22840135
Application Number:	14633804
International Application Number:	
Confirmation Number:	8573
Title of Invention:	METHOD TO PROVIDE AD HOC AND PASSWORD PROTECTED DIGITAL AND VOICE NETWORKS
First Named Inventor/Applicant Name:	Malcolm K. Beyer
Customer Number:	22235
Filer:	Daniel J. Burns/Deanna Bridges
Filer Authorized By:	Daniel J. Burns
Attorney Docket Number:	10963.3835
Receipt Date:	07-JUL-2015
Filing Date:	27-FEB-2015
Time Stamp:	15:50:36
Application Type:	Utility under 35 USC 111(a)

Payment information:

Submitted with Payment	yes
Payment Type	Credit Card
Payment was successfully received in RAM	\$300
RAM confirmation Number	2227
Deposit Account	
Authorized User	

The Director of the USPTO is hereby authorized to charge indicated fees and credit any overpayment as follows:

--	--	--	--	--	--

File Listing:

Document Number	Document Description	File Name	File Size(Bytes)/ Message Digest	Multi Part /.zip	Pages (if appl.)
1	Applicant Response to Pre-Exam Formalities Notice	MOC-005_NOIR_Response.pdf	21627 56784a2c17fae654e2594867dbc8308c7bbe2e23	no	1

Warnings:

Information:

2	Drawings-only black and white line drawings	MOC-005_Replacement_Figures.pdf	808379 ea438daea5c69993a6641509fdca23e4cd8f7bea	no	2
---	---	---------------------------------	--	----	---

Warnings:

Information:

3	Extension of Time	MOC-005_EOT.pdf	26607 9ff0cb397cc9fda7a8a6926ea71796bfff6590611	no	1
---	-------------------	-----------------	--	----	---

Warnings:

Information:

4	Fee Worksheet (SB06)	fee-info.pdf	31141 46d4806c4c7e86ac9cff5df14e1c1bd6cd7abe54	no	2
---	----------------------	--------------	---	----	---

Warnings:

Information:

Total Files Size (in bytes):			887754		
-------------------------------------	--	--	--------	--	--

This Acknowledgement Receipt evidences receipt on the noted date by the USPTO of the indicated documents, characterized by the applicant, and including page counts, where applicable. It serves as evidence of receipt similar to a Post Card, as described in MPEP 503.

New Applications Under 35 U.S.C. 111

If a new application is being filed and the application includes the necessary components for a filing date (see 37 CFR 1.53(b)-(d) and MPEP 506), a Filing Receipt (37 CFR 1.54) will be issued in due course and the date shown on this Acknowledgement Receipt will establish the filing date of the application.

National Stage of an International Application under 35 U.S.C. 371

If a timely submission to enter the national stage of an international application is compliant with the conditions of 35 U.S.C. 371 and other applicable requirements a Form PCT/DO/EO/903 indicating acceptance of the application as a national stage submission under 35 U.S.C. 371 will be issued in addition to the Filing Receipt, in due course.

New International Application Filed with the USPTO as a Receiving Office

If a new international application is being filed and the international application includes the necessary components for an international filing date (see PCT Article 11 and MPEP 1810), a Notification of the International Application Number and of the International Filing Date (Form PCT/RO/105) will be issued in due course, subject to prescriptions concerning national security, and the date shown on this Acknowledgement Receipt will establish the international filing date of the application.

Document code: WFEE

United States Patent and Trademark Office
Sales Receipt for Accounting Date: 07/15/2015

ABALINAN ADJ #00000004 Mailroom Dt: 07/07/2015
Seq No: 2227 Sales Acctg Dt: 07/08/2015 14633804
01 FC : 2252 -300.00 OP

Document code: WFEE

United States Patent and Trademark Office
Sales Receipt for Accounting Date: 07/15/2015

ABALINAN RF #30163822 Mailroom Dt: 07/15/2015 14633804

Credit Card Refund Total: \$300.00

American Express

XXXXXXXXXXXX1096

PATENT APPLICATION FEE DETERMINATION RECORD

Substitute for Form PTO-875

Application or Docket Number
14/633,804

APPLICATION AS FILED - PART I

(Column 1)			(Column 2)		SMALL ENTITY		OR	OTHER THAN SMALL ENTITY	
FOR	NUMBER FILED	NUMBER EXTRA	RATE(\$)	FEE(\$)	RATE(\$)	FEE(\$)		RATE(\$)	FEE(\$)
BASIC FEE (37 CFR 1.16(a), (b), or (c))	N/A	N/A	N/A	70	N/A			N/A	
SEARCH FEE (37 CFR 1.16(k), (i), or (m))	N/A	N/A	N/A	300	N/A			N/A	
EXAMINATION FEE (37 CFR 1.16(o), (p), or (q))	N/A	N/A	N/A	360	N/A			N/A	
TOTAL CLAIMS (37 CFR 1.16(i))	28	minus 20 = *	x 40 =	320			OR		
INDEPENDENT CLAIMS (37 CFR 1.16(h))	4	minus 3 = *	x 210 =	210					
APPLICATION SIZE FEE (37 CFR 1.16(s))	If the specification and drawings exceed 100 sheets of paper, the application size fee due is \$310 (\$155 for small entity) for each additional 50 sheets or fraction thereof. See 35 U.S.C. 41(a)(1)(G) and 37 CFR 1.16(s).			0.00					
MULTIPLE DEPENDENT CLAIM PRESENT (37 CFR 1.16(j))				0.00					
* If the difference in column 1 is less than zero, enter "0" in column 2.			TOTAL	1260	TOTAL				

APPLICATION AS AMENDED - PART II

		(Column 1)	(Column 2)	(Column 3)	SMALL ENTITY		OR	OTHER THAN SMALL ENTITY	
AMENDMENT A		CLAIMS REMAINING AFTER AMENDMENT	HIGHEST NUMBER PREVIOUSLY PAID FOR	PRESENT EXTRA	RATE(\$)	ADDITIONAL FEE(\$)		RATE(\$)	ADDITIONAL FEE(\$)
	Total (37 CFR 1.16(i))	*	Minus	**	x	=	OR	x	=
	Independent (37 CFR 1.16(h))	*	Minus	***	x	=	OR	x	=
	Application Size Fee (37 CFR 1.16(s))						OR		
	FIRST PRESENTATION OF MULTIPLE DEPENDENT CLAIM (37 CFR 1.16(j))						OR		
					TOTAL ADD'L FEE		OR	TOTAL ADD'L FEE	
AMENDMENT B		CLAIMS REMAINING AFTER AMENDMENT	HIGHEST NUMBER PREVIOUSLY PAID FOR	PRESENT EXTRA	RATE(\$)	ADDITIONAL FEE(\$)		RATE(\$)	ADDITIONAL FEE(\$)
	Total (37 CFR 1.16(i))	*	Minus	**	x	=	OR	x	=
	Independent (37 CFR 1.16(h))	*	Minus	***	x	=	OR	x	=
	Application Size Fee (37 CFR 1.16(s))						OR		
	FIRST PRESENTATION OF MULTIPLE DEPENDENT CLAIM (37 CFR 1.16(j))						OR		
					TOTAL ADD'L FEE		OR	TOTAL ADD'L FEE	

* If the entry in column 1 is less than the entry in column 2, write "0" in column 3.

** If the "Highest Number Previously Paid For" IN THIS SPACE is less than 20, enter "20".

*** If the "Highest Number Previously Paid For" IN THIS SPACE is less than 3, enter "3".

The "Highest Number Previously Paid For" (Total or Independent) is the highest found in the appropriate box in column 1.



UNITED STATES PATENT AND TRADEMARK OFFICE

UNITED STATES DEPARTMENT OF COMMERCE
United States Patent and Trademark Office
Address: COMMISSIONER FOR PATENTS
P.O. Box 1450
Alexandria, Virginia 22313-1450
www.uspto.gov

Table with 7 columns: APPLICATION NUMBER, FILING or 371(c) DATE, GRP ART UNIT, FIL FEE REC'D, ATTY.DOCKET.NO, TOT CLAIMS, IND CLAIMS. Row 1: 14/633,804, 02/27/2015, 2642, 1260, MOC-005, 28, 4

CONFIRMATION NO. 8573

UPDATED FILING RECEIPT

22235

Malin Haley DiMaggio & Bowen, P.A.
1936 S ANDREWS AVENUE
FORT LAUDERDALE, FL 33316



Date Mailed: 07/20/2015

Receipt is acknowledged of this non-provisional patent application. The application will be taken up for examination in due course. Applicant will be notified as to the results of the examination. Any correspondence concerning the application must include the following identification information: the U.S. APPLICATION NUMBER, FILING DATE, NAME OF APPLICANT, and TITLE OF INVENTION. Fees transmitted by check or draft are subject to collection. Please verify the accuracy of the data presented on this receipt. If an error is noted on this Filing Receipt, please submit a written request for a Filing Receipt Correction. Please provide a copy of this Filing Receipt with the changes noted thereon. If you received a "Notice to File Missing Parts" for this application, please submit any corrections to this Filing Receipt with your reply to the Notice. When the USPTO processes the reply to the Notice, the USPTO will generate another Filing Receipt incorporating the requested corrections

Inventor(s)

Malcolm K. Beyer JR., Jupiter, FL;
Christopher R. Rice, Redmond, WA;

Applicant(s)

Malcolm K. Beyer JR., Jupiter, FL;
Christopher R. Rice, Redmond, WA;

Power of Attorney: The patent practitioners associated with Customer Number 22235

Domestic Priority data as claimed by applicant

This application is a CON of 14/529,978 10/31/2014
which is a CON of 14/027,410 09/16/2013 PAT 8880042
which is a CON of 13/751,453 01/28/2013 PAT 8538393
which is a CIP of 12/761,533 04/16/2010 PAT 8364129
which is a CIP of 11/615,472 12/22/2006 PAT 8126441
which is a CIP of 11/308,648 04/17/2006 PAT 7630724
which is a CIP of 10/711,490 09/21/2004 PAT 7031728

Foreign Applications for which priority is claimed (You may be eligible to benefit from the Patent Prosecution Highway program at the USPTO. Please see http://www.uspto.gov for more information.) - None.

Foreign application information must be provided in an Application Data Sheet in order to constitute a claim to foreign priority. See 37 CFR 1.55 and 1.76.

Permission to Access - A proper Authorization to Permit Access to Application by Participating Offices (PTO/SB/39 or its equivalent) has been received by the USPTO.

If Required, Foreign Filing License Granted: 03/19/2015

The country code and number of your priority application, to be used for filing abroad under the Paris Convention, is **US 14/633,804**

Projected Publication Date: Request for Non-Publication Acknowledged

Non-Publication Request: Yes

Early Publication Request: No

**** SMALL ENTITY ****

Title

METHOD TO PROVIDE AD HOC AND PASSWORD PROTECTED DIGITAL AND VOICE NETWORKS

Preliminary Class

455

Statement under 37 CFR 1.55 or 1.78 for AIA (First Inventor to File) Transition Applications: Yes

PROTECTING YOUR INVENTION OUTSIDE THE UNITED STATES

Since the rights granted by a U.S. patent extend only throughout the territory of the United States and have no effect in a foreign country, an inventor who wishes patent protection in another country must apply for a patent in a specific country or in regional patent offices. Applicants may wish to consider the filing of an international application under the Patent Cooperation Treaty (PCT). An international (PCT) application generally has the same effect as a regular national patent application in each PCT-member country. The PCT process **simplifies** the filing of patent applications on the same invention in member countries, but **does not result** in a grant of "an international patent" and does not eliminate the need of applicants to file additional documents and fees in countries where patent protection is desired.

Almost every country has its own patent law, and a person desiring a patent in a particular country must make an application for patent in that country in accordance with its particular laws. Since the laws of many countries differ in various respects from the patent law of the United States, applicants are advised to seek guidance from specific foreign countries to ensure that patent rights are not lost prematurely.

Applicants also are advised that in the case of inventions made in the United States, the Director of the USPTO must issue a license before applicants can apply for a patent in a foreign country. The filing of a U.S. patent application serves as a request for a foreign filing license. The application's filing receipt contains further information and guidance as to the status of applicant's license for foreign filing.

Applicants may wish to consult the USPTO booklet, "General Information Concerning Patents" (specifically, the section entitled "Treaties and Foreign Patents") for more information on timeframes and deadlines for filing foreign patent applications. The guide is available either by contacting the USPTO Contact Center at 800-786-9199, or it can be viewed on the USPTO website at <http://www.uspto.gov/web/offices/pac/doc/general/index.html>.

For information on preventing theft of your intellectual property (patents, trademarks and copyrights), you may wish to consult the U.S. Government website, <http://www.stopfakes.gov>. Part of a Department of Commerce initiative, this website includes self-help "toolkits" giving innovators guidance on how to protect intellectual property in specific countries such as China, Korea and Mexico. For questions regarding patent enforcement issues, applicants may call the U.S. Government hotline at 1-866-999-HALT (1-866-999-4258).

LICENSE FOR FOREIGN FILING UNDER
Title 35, United States Code, Section 184
Title 37, Code of Federal Regulations, 5.11 & 5.15

GRANTED

The applicant has been granted a license under 35 U.S.C. 184, if the phrase "IF REQUIRED, FOREIGN FILING LICENSE GRANTED" followed by a date appears on this form. Such licenses are issued in all applications where the conditions for issuance of a license have been met, regardless of whether or not a license may be required as set forth in 37 CFR 5.15. The scope and limitations of this license are set forth in 37 CFR 5.15(a) unless an earlier license has been issued under 37 CFR 5.15(b). The license is subject to revocation upon written notification. The date indicated is the effective date of the license, unless an earlier license of similar scope has been granted under 37 CFR 5.13 or 5.14.

This license is to be retained by the licensee and may be used at any time on or after the effective date thereof unless it is revoked. This license is automatically transferred to any related applications(s) filed under 37 CFR 1.53(d). This license is not retroactive.

The grant of a license does not in any way lessen the responsibility of a licensee for the security of the subject matter as imposed by any Government contract or the provisions of existing laws relating to espionage and the national security or the export of technical data. Licensees should apprise themselves of current regulations especially with respect to certain countries, of other agencies, particularly the Office of Defense Trade Controls, Department of State (with respect to Arms, Munitions and Implements of War (22 CFR 121-128)); the Bureau of Industry and Security, Department of Commerce (15 CFR parts 730-774); the Office of Foreign Assets Control, Department of Treasury (31 CFR Parts 500+) and the Department of Energy.

NOT GRANTED

No license under 35 U.S.C. 184 has been granted at this time, if the phrase "IF REQUIRED, FOREIGN FILING LICENSE GRANTED" DOES NOT appear on this form. Applicant may still petition for a license under 37 CFR 5.12, if a license is desired before the expiration of 6 months from the filing date of the application. If 6 months has lapsed from the filing date of this application and the licensee has not received any indication of a secrecy order under 35 U.S.C. 181, the licensee may foreign file the application pursuant to 37 CFR 5.15(b).

SelectUSA

The United States represents the largest, most dynamic marketplace in the world and is an unparalleled location for business investment, innovation, and commercialization of new technologies. The U.S. offers tremendous resources and advantages for those who invest and manufacture goods here. Through SelectUSA, our nation works to promote and facilitate business investment. SelectUSA provides information assistance to the international investor community; serves as an ombudsman for existing and potential investors; advocates on behalf of U.S. cities, states, and regions competing for global investment; and counsels U.S. economic development organizations on investment attraction best practices. To learn more about why the United States is the best country in the world to develop technology, manufacture products, deliver services, and grow your business, visit <http://www.SelectUSA.gov> or call +1-202-482-6800.

PATENT APPLICATION FEE DETERMINATION RECORD
Substitute for Form PTO-875

Application or Docket Number
14/633,804

APPLICATION AS FILED - PART I

(Column 1)		(Column 2)	SMALL ENTITY		OR	OTHER THAN SMALL ENTITY	
FOR	NUMBER FILED	NUMBER EXTRA	RATE(\$)	FEE(\$)		RATE(\$)	FEE(\$)
BASIC FEE (37 CFR 1.16(a), (b), or (c))	N/A	N/A	N/A	70		N/A	
SEARCH FEE (37 CFR 1.16(k), (i), or (m))	N/A	N/A	N/A	300		N/A	
EXAMINATION FEE (37 CFR 1.16(o), (p), or (q))	N/A	N/A	N/A	360		N/A	
TOTAL CLAIMS (37 CFR 1.16(i))	28 minus 20 = *	8	x 40 =	320	OR		
INDEPENDENT CLAIMS (37 CFR 1.16(h))	4 minus 3 = *	1	x 210 =	210			
APPLICATION SIZE FEE (37 CFR 1.16(s))	If the specification and drawings exceed 100 sheets of paper, the application size fee due is \$310 (\$155 for small entity) for each additional 50 sheets or fraction thereof. See 35 U.S.C. 41(a)(1)(G) and 37 CFR 1.16(s).			0.00			
MULTIPLE DEPENDENT CLAIM PRESENT (37 CFR 1.16(j))				0.00			
* If the difference in column 1 is less than zero, enter "0" in column 2.			TOTAL	1260		TOTAL	

APPLICATION AS AMENDED - PART II

(Column 1)		(Column 2)	(Column 3)	SMALL ENTITY		OR	OTHER THAN SMALL ENTITY	
AMENDMENT A	CLAIMS REMAINING AFTER AMENDMENT	HIGHEST NUMBER PREVIOUSLY PAID FOR	PRESENT EXTRA	RATE(\$)	ADDITIONAL FEE(\$)		RATE(\$)	ADDITIONAL FEE(\$)
Total (37 CFR 1.16(i))	*	Minus **	=	x =		OR	x =	
Independent (37 CFR 1.16(h))	*	Minus ***	=	x =		OR	x =	
Application Size Fee (37 CFR 1.16(s))						OR		
FIRST PRESENTATION OF MULTIPLE DEPENDENT CLAIM (37 CFR 1.16(j))						OR		
				TOTAL ADD'L FEE		OR	TOTAL ADD'L FEE	

(Column 1)		(Column 2)	(Column 3)	SMALL ENTITY		OR	OTHER THAN SMALL ENTITY	
AMENDMENT B	CLAIMS REMAINING AFTER AMENDMENT	HIGHEST NUMBER PREVIOUSLY PAID FOR	PRESENT EXTRA	RATE(\$)	ADDITIONAL FEE(\$)		RATE(\$)	ADDITIONAL FEE(\$)
Total (37 CFR 1.16(i))	*	Minus **	=	x =		OR	x =	
Independent (37 CFR 1.16(h))	*	Minus ***	=	x =		OR	x =	
Application Size Fee (37 CFR 1.16(s))						OR		
FIRST PRESENTATION OF MULTIPLE DEPENDENT CLAIM (37 CFR 1.16(j))						OR		
				TOTAL ADD'L FEE		OR	TOTAL ADD'L FEE	

* If the entry in column 1 is less than the entry in column 2, write "0" in column 3.
 ** If the "Highest Number Previously Paid For" IN THIS SPACE is less than 20, enter "20".
 *** If the "Highest Number Previously Paid For" IN THIS SPACE is less than 3, enter "3".
 The "Highest Number Previously Paid For" (Total or Independent) is the highest found in the appropriate box in column 1.



UNITED STATES PATENT AND TRADEMARK OFFICE

UNITED STATES DEPARTMENT OF COMMERCE
United States Patent and Trademark Office
Address: COMMISSIONER FOR PATENTS
P.O. Box 1450
Alexandria, Virginia 22313-1450
www.uspto.gov

Table with 5 columns: APPLICATION NO., FILING DATE, FIRST NAMED INVENTOR, ATTORNEY DOCKET NO., CONFIRMATION NO.
14/633,804 02/27/2015 Malcolm K. Beyer JR. MOC-005 8573

22235 7590 08/13/2015
Malin Haley DiMaggio & Bowen, P.A.
1936 S ANDREWS AVENUE
FORT LAUDERDALE, FL 33316

EXAMINER

OBAYANJU, OMONIYI

Table with 2 columns: ART UNIT, PAPER NUMBER
2646

Table with 2 columns: NOTIFICATION DATE, DELIVERY MODE
08/13/2015 ELECTRONIC

Please find below and/or attached an Office communication concerning this application or proceeding.

The time period for reply, if any, is set in the attached communication.

Notice of the Office communication was sent electronically on above-indicated "Notification Date" to the following e-mail address(es):

info@mhdpatents.com

Office Action Summary	Application No. 14/633,804	Applicant(s) BEYER ET AL.	
	Examiner OMONIYI OBAYANJU	Art Unit 2646	AIA (First Inventor to File) Status Yes

-- The MAILING DATE of this communication appears on the cover sheet with the correspondence address --

Period for Reply

A SHORTENED STATUTORY PERIOD FOR REPLY IS SET TO EXPIRE 3 MONTHS FROM THE MAILING DATE OF THIS COMMUNICATION.

- Extensions of time may be available under the provisions of 37 CFR 1.136(a). In no event, however, may a reply be timely filed after SIX (6) MONTHS from the mailing date of this communication.
- If NO period for reply is specified above, the maximum statutory period will apply and will expire SIX (6) MONTHS from the mailing date of this communication.
- Failure to reply within the set or extended period for reply will, by statute, cause the application to become ABANDONED (35 U.S.C. § 133). Any reply received by the Office later than three months after the mailing date of this communication, even if timely filed, may reduce any earned patent term adjustment. See 37 CFR 1.704(b).

Status

- 1) Responsive to communication(s) filed on 07/07/2015.
 A declaration(s)/affidavit(s) under **37 CFR 1.130(b)** was/were filed on _____.
- 2a) This action is **FINAL**. 2b) This action is non-final.
- 3) An election was made by the applicant in response to a restriction requirement set forth during the interview on _____; the restriction requirement and election have been incorporated into this action.
- 4) Since this application is in condition for allowance except for formal matters, prosecution as to the merits is closed in accordance with the practice under *Ex parte Quayle*, 1935 C.D. 11, 453 O.G. 213.

Disposition of Claims*

- 5) Claim(s) 1-5,7-17 and 19-30 is/are pending in the application.
5a) Of the above claim(s) _____ is/are withdrawn from consideration.
- 6) Claim(s) _____ is/are allowed.
- 7) Claim(s) 1-5,7-17 and 19-30 is/are rejected.
- 8) Claim(s) _____ is/are objected to.
- 9) Claim(s) _____ are subject to restriction and/or election requirement.

* If any claims have been determined allowable, you may be eligible to benefit from the **Patent Prosecution Highway** program at a participating intellectual property office for the corresponding application. For more information, please see http://www.uspto.gov/patents/init_events/pph/index.jsp or send an inquiry to PPHfeedback@uspto.gov.

Application Papers

- 10) The specification is objected to by the Examiner.
- 11) The drawing(s) filed on 07/07/2015 is/are: a) accepted or b) objected to by the Examiner.
Applicant may not request that any objection to the drawing(s) be held in abeyance. See 37 CFR 1.85(a).
Replacement drawing sheet(s) including the correction is required if the drawing(s) is objected to. See 37 CFR 1.121(d).

Priority under 35 U.S.C. § 119

- 12) Acknowledgment is made of a claim for foreign priority under 35 U.S.C. § 119(a)-(d) or (f).

Certified copies:

- a) All b) Some** c) None of the:
 - 1. Certified copies of the priority documents have been received.
 - 2. Certified copies of the priority documents have been received in Application No. _____.
 - 3. Copies of the certified copies of the priority documents have been received in this National Stage application from the International Bureau (PCT Rule 17.2(a)).

** See the attached detailed Office action for a list of the certified copies not received.

Attachment(s)

- 1) Notice of References Cited (PTO-892)
- 2) Information Disclosure Statement(s) (PTO/SB/08a and/or PTO/SB/08b)
Paper No(s)/Mail Date 03/20/2015, 02/27/2015.
- 3) Interview Summary (PTO-413)
Paper No(s)/Mail Date. _____.
- 4) Other: _____.

The present application, filed on or after March 16, 2013, is being examined under the first inventor to file provisions of the AIA.

DETAILED ACTION

Claim Objections

Claims 7 and 19 objected to because of the following informalities: Claims 7 and 19 depends on canceled claims 6 and 18 respectively. Appropriate correction is required. For examination purpose, the Examiner assumed that claims 7 and 19 depends from claims 1 and 13 respectively.

Claim Rejections - 35 USC § 102

The following is a quotation of the appropriate paragraphs of 35 U.S.C. 102 that form the basis for the rejections under this section made in this Office action:

A person shall be entitled to a patent unless –

(a)(2) the claimed invention was described in a patent issued under section 151, or in an application for patent published or deemed published under section 122(b), in which the patent or application, as the case may be, names another inventor and was effectively filed before the effective filing date of the claimed invention.

Claims 1-3, 5, 8-15, 17, and 20-30, are rejected under 35 U.S.C. 102(a)(2) as being anticipated by Melen (US Publication No. 20040148090).

As to **claims 1, 13, 27, and 29**, Melen teaches a computer-implemented method comprising: receiving at various times (**pp0033, real time tracking**) from one or more devices respective information comprising a location of the device and sending the location to one or more other devices (**fig. 1A and fig. 1B, and fig. 5, #506, receive location of each member**), wherein each of the other devices is configured to display a respective symbol representing the location on a respective map (**fig. 4, and pp0064, display icon of each car on map 406**) ; receiving from a first device information indicating user selection of one or more of the displayed symbols corresponding to second devices and, based thereon (**fig. 5, #509, #510, and pp0063, pp0070, touching icon to car**): obtaining a respective contact information for each of the second devices (**fig. 5, #511, and pp0045, cellular telephone number of member**); and facilitating a respective communication between the first device and each of the second devices using the contact information of the second device (**fig. 5, #512, and pp0063, pp0070, make a telephone call to the selected member**).

As to **claims 2, 14, 28, and 30**, Melen teaches wherein a particular communication is a phone call, a short message service message, a voice message, a text message, an electronic mail message, an image, or a video (**fig. 5, #512, and pp0063, pp0070, make a telephone call to the selected member**).

As to **claims 3 and 15**, Melen teaches wherein first device and the second devices are part of a same group or within a user-specified geographic area (**pp0004, group of members driving to common location**).

As to **claims 5 and 17**, Melen teaches wherein particular contact information is a phone number or an Internet Protocol address (**fig. 5, #511, and pp0045, cellular telephone number of member**).

As to **claims 8 and 20**, Melen teaches wherein a particular device is a smart phone, a personal data assistant, a tablet computer, a desktop computer, or a laptop computer (**pp0003, vehicles are equipped with cellular telephones**).

As to **claims 9 and 21**, Melen teaches further comprising: receiving a request for a map from a third device wherein the request comprises one or more parameters and wherein a parameter specifies a map location (**fig. 1B, fig. 4, each vehicle includes navigation system 300, fig. 5**) or a zoom indication; obtaining a second map that conforms to the attributes; and sending the second map to the third device location (**fig. 1B, fig. 4, each vehicle includes navigation system 300, fig. 5**).

As to **claims 10 and 22**, Melen teaches wherein the first device does not have access to the phone numbers or Internet Protocol addresses of the second devices (**pp0072, request permission**).

As to **claims 11 and 23**, Melen teaches wherein the map is an aerial photograph, a satellite image, or a chart (**fig. 4**).

As to **claims 12 and 24**, Melen teaches wherein receiving at various times from a particular device information comprises receiving the information from the particular device at a time based on one or more of: speed of the particular device, distance traveled by the particular device, or time (**pp0033, real time tracking and receiving location, and pp0070**).

As to **claims 25 and 26**, Melen teaches further comprising: sending a respective first map to each one of a plurality of devices wherein the device is configured to display the first map (**fig. 1B, fig. 4, each vehicle includes navigation system 300, to display the map of fig. 4, and fig. 5**).

Claim Rejections - 35 USC § 103

The following is a quotation of 35 U.S.C. 103 which forms the basis for all obviousness rejections set forth in this Office action:

A patent for a claimed invention may not be obtained, notwithstanding that the claimed invention is not identically disclosed as set forth in section 102 of this title, if the differences between the claimed invention and the prior art are such that the claimed invention as a whole would have been obvious before the effective filing date of the claimed invention to a person having ordinary skill in the art to which the claimed invention pertains. Patentability shall not be negated by the manner in which the invention was made.

Claims 4 and 16, are rejected under 35 U.S.C. 103 as being unpatentable over Melen (US Publication No. 20040148090) in view of Crowley et al. (US Patent No. 7593740).

As to **claims 4 and 16**, Melen teaches the limitations of the independent claims as discussed above. However, fails to explicitly teach wherein the group is a friends or family group.

In an analogous field of endeavor, Crowley teaches wherein the group is a friends or family group (fig. 3, friends near Luna lounge). Thus it would have been obvious to one of ordinary skill in the art before the effective filing data of the claimed invention to combine the teachings of Melen with the teachings Crowley to achieve the goal of efficiently providing a communication system wherein communication are very convenient, very easy to use, and very efficient (Crowley, col. 1, lines 26-28).

Claims 7 and 19, are rejected under 35 U.S.C. 103 as being unpatentable over Melen (US Publication No. 20040148090) in view of Steenstra et al. (US Publication No. 20060047825).

As to **claims 7 and 19**, Melen teaches the limitations of the independent claims as discussed above. However, fails to explicitly teach wherein the symbol represents a facility or a person's home.

In an analogous field of endeavor, Steenstra teaches wherein the symbol represents a facility or a person's home (fig. 5, pp0026). Thus it would have been obvious to one of ordinary skill in the art before the effective filing data of the claimed invention to combine the teachings of Melen with the teachings Streenstra to achieve the goal of efficiently and reliably creating and maintaining location based service social network in a communication system (Streenstra, pp0006).

Conclusion

Any inquiry concerning this communication or earlier communications from the examiner should be directed to OMONIYI OBAYANJU whose telephone number is (571)270-5885. The examiner can normally be reached on Mon - Fri, 7:30 - 5:00PM.

If attempts to reach the examiner by telephone are unsuccessful, the examiner's supervisor, KAMRAN AFSHAR can be reached on 571-272-7796. The fax phone number for the organization where this application or proceeding is assigned is 571-273-8300.

Information regarding the status of an application may be obtained from the Patent Application Information Retrieval (PAIR) system. Status information for published applications may be obtained from either Private PAIR or Public PAIR. Status information for unpublished applications is available through Private PAIR only. For more information about the PAIR system, see <http://pair-direct.uspto.gov>. Should you have questions on access to the Private PAIR system, contact the Electronic Business Center (EBC) at 866-217-9197 (toll-free). If you would like assistance from a USPTO Customer Service Representative or access to the automated information system, call 800-786-9199 (IN USA OR CANADA) or 571-272-1000.

/OMONIYI OBAYANJU/
Primary Examiner, Art Unit 2646

Notice of References Cited	Application/Control No. 14/633,804	Applicant(s)/Patent Under Reexamination BEYER ET AL.	
	Examiner OMONIYI OBAYANJU	Art Unit 2646	Page 1 of 1

U.S. PATENT DOCUMENTS

*	Document Number Country Code-Number-Kind Code	Date MM-YYYY	Name	Classification
*	A US-2004/0148090	07-2004	Melen, Roger D.	701/200
*	B US-2006/0047825	03-2006	Steenstra et al.	709/229
*	C US-7,593,740	09-2009	Crowley et al.	455/456.3
	D US-			
	E US-			
	F US-			
	G US-			
	H US-			
	I US-			
	J US-			
	K US-			
	L US-			
	M US-			

FOREIGN PATENT DOCUMENTS

*	Document Number Country Code-Number-Kind Code	Date MM-YYYY	Country	Name	Classification
	N				
	O				
	P				
	Q				
	R				
	S				
	T				

NON-PATENT DOCUMENTS

*	Document Number Country Code-Number-Kind Code	Date MM-YYYY	Country	Name	Classification
	Include as applicable: Author, Title Date, Publisher, Edition or Volume, Pertinent Pages)				
	U				
	V				
	W				
	X				

*A copy of this reference is not being furnished with this Office action. (See MPEP § 707.05(a).)
Dates in MM-YYYY format are publication dates. Classifications may be US or foreign.

Search Notes 	Application/Control No. 14633804	Applicant(s)/Patent Under Reexamination BEYER ET AL.
	Examiner OMONIYI OBAYANJU	Art Unit 2646

CPC- SEARCHED		
Symbol	Date	Examiner
H04W4/02	8/10/2015	OO

CPC COMBINATION SETS - SEARCHED		
Symbol	Date	Examiner

US CLASSIFICATION SEARCHED			
Class	Subclass	Date	Examiner
455	404.2, 456.1	8/10/2015	OO

SEARCH NOTES		
Search Notes	Date	Examiner
See Attached East Search History	8/10/2015	OO

INTERFERENCE SEARCH			
US Class/ CPC Symbol	US Subclass / CPC Group	Date	Examiner

--	--

Receipt date: 03/20/2015

14633804 - GALL: 2646

Doc code: IDS

Doc description: Information Disclosure Statement (IDS) Filed

Approved for use through 07/31/2012. OMB 0651-0031
U.S. Patent and Trademark Office; U.S. DEPARTMENT OF COMMERCE

Under the Paperwork Reduction Act of 1995, no persons are required to respond to a collection of information unless it contains a valid OMB control number.

INFORMATION DISCLOSURE STATEMENT BY APPLICANT (Not for submission under 37 CFR 1.99)	Application Number		14633804
	Filing Date		2015-02-27
	First Named Inventor	BEYER, Jr., Malcolm K.	
	Art Unit	2642	
	Examiner Name	Not Assigned	
	Attorney Docket Number	10963.3835	

U.S. PATENTS Remove

Examiner Initial*	Cite No	Patent Number	Kind Code ¹	Issue Date	Name of Patentee or Applicant of cited Document	Pages, Columns, Lines where Relevant Passages or Relevant Figures Appear
	1					

If you wish to add additional U.S. Patent citation information please click the Add button. Add

U.S. PATENT APPLICATION PUBLICATIONS Remove

Examiner Initial*	Cite No	Publication Number	Kind Code ¹	Publication Date	Name of Patentee or Applicant of cited Document	Pages, Columns, Lines where Relevant Passages or Relevant Figures Appear
	1					

If you wish to add additional U.S. Published Application citation information please click the Add button. Add

FOREIGN PATENT DOCUMENTS Remove

Examiner Initial*	Cite No	Foreign Document Number ³	Country Code ² j	Kind Code ⁴	Publication Date	Name of Patentee or Applicant of cited Document	Pages, Columns, Lines where Relevant Passages or Relevant Figures Appear	T ⁵
	1							<input type="checkbox"/>

If you wish to add additional Foreign Patent Document citation information please click the Add button Add

NON-PATENT LITERATURE DOCUMENTS Remove

Examiner Initials*	Cite No	Include name of the author (in CAPITAL LETTERS), title of the article (when appropriate), title of the item (book, magazine, journal, serial, symposium, catalog, etc), date, pages(s), volume-issue number(s), publisher, city and/or country where published.	T ⁵

ALL REFERENCES CONSIDERED EXCEPT WHERE LINED THROUGH. /O.O./

INFORMATION DISCLOSURE STATEMENT BY APPLICANT (Not for submission under 37 CFR 1.99)	Application Number		14633804	14633804 - GAU: 2646
	Filing Date		2015-02-27	
	First Named Inventor	BEYER, Jr., Malcolm K.		
	Art Unit	2642		
	Examiner Name	Not Assigned		
	Attorney Docket Number	10963.3835		

1	Benefon ESCI GSM + GPS Personal Navigation Phone, 1999, Benefon Oyj, Salo, Finland.	<input type="checkbox"/>
2	ELISA BATISTA, Your Boss May Know Where You Are, May 31, 2002, < http://archive.wired.com/gadgets/wireless/news/2002/05/52852?currentPage=all >.	<input type="checkbox"/>

If you wish to add additional non-patent literature document citation information please click the Add button **Add**

EXAMINER SIGNATURE

Examiner Signature	/Omoniyi Obayanju/	Date Considered	08/10/2015
--------------------	--------------------	-----------------	------------

*EXAMINER: Initial if reference considered, whether or not citation is in conformance with MPEP 609. Draw line through a citation if not in conformance and not considered. Include copy of this form with next communication to applicant.

¹ See Kind Codes of USPTO Patent Documents at www.USPTO.GOV or MPEP 901.04. ² Enter office that issued the document, by the two-letter code (WIPO Standard ST.3). ³ For Japanese patent documents, the indication of the year of the reign of the Emperor must precede the serial number of the patent document. ⁴ Kind of document by the appropriate symbols as indicated on the document under WIPO Standard ST.16 if possible. ⁵ Applicant is to place a check mark here if English language translation is attached.

ALL REFERENCES CONSIDERED EXCEPT WHERE LINED THROUGH. /O.O./

INFORMATION DISCLOSURE STATEMENT BY APPLICANT (Not for submission under 37 CFR 1.99)	Application Number	14633804	14633804 - GAU: 2646
	Filing Date	2015-02-27	
	First Named Inventor	BEYER, Jr., Malcolm K.	
	Art Unit	2642	
	Examiner Name	Not Assigned	
	Attorney Docket Number	10963.3835	

CERTIFICATION STATEMENT

Please see 37 CFR 1.97 and 1.98 to make the appropriate selection(s):

That each item of information contained in the information disclosure statement was first cited in any communication from a foreign patent office in a counterpart foreign application not more than three months prior to the filing of the information disclosure statement. See 37 CFR 1.97(e)(1).

OR

That no item of information contained in the information disclosure statement was cited in a communication from a foreign patent office in a counterpart foreign application, and, to the knowledge of the person signing the certification after making reasonable inquiry, no item of information contained in the information disclosure statement was known to any individual designated in 37 CFR 1.56(c) more than three months prior to the filing of the information disclosure statement. See 37 CFR 1.97(e)(2).

- See attached certification statement.
- The fee set forth in 37 CFR 1.17 (p) has been submitted herewith.
- A certification statement is not submitted herewith.

SIGNATURE

A signature of the applicant or representative is required in accordance with CFR 1.33, 10.18. Please see CFR 1.4(d) for the form of the signature.

Signature	/barry l. haley/	Date (YYYY-MM-DD)	2015-03-20
Name/Print	Barry L. Haley	Registration Number	25339

This collection of information is required by 37 CFR 1.97 and 1.98. The information is required to obtain or retain a benefit by the public which is to file (and by the USPTO to process) an application. Confidentiality is governed by 35 U.S.C. 122 and 37 CFR 1.14. This collection is estimated to take 1 hour to complete, including gathering, preparing and submitting the completed application form to the USPTO. Time will vary depending upon the individual case. Any comments on the amount of time you require to complete this form and/or suggestions for reducing this burden, should be sent to the Chief Information Officer, U.S. Patent and Trademark Office, U.S. Department of Commerce, P.O. Box 1450, Alexandria, VA 22313-1450. **DO NOT SEND FEES OR COMPLETED FORMS TO THIS ADDRESS. SEND TO: Commissioner for Patents, P.O. Box 1450, Alexandria, VA 22313-1450.**

Privacy Act Statement

The Privacy Act of 1974 (P.L. 93-579) requires that you be given certain information in connection with your submission of the attached form related to a patent application or patent. Accordingly, pursuant to the requirements of the Act, please be advised that: (1) the general authority for the collection of this information is 35 U.S.C. 2(b)(2); (2) furnishing of the information solicited is voluntary; and (3) the principal purpose for which the information is used by the U.S. Patent and Trademark Office is to process and/or examine your submission related to a patent application or patent. If you do not furnish the requested information, the U.S. Patent and Trademark Office may not be able to process and/or examine your submission, which may result in termination of proceedings or abandonment of the application or expiration of the patent.

The information provided by you in this form will be subject to the following routine uses:

1. The information on this form will be treated confidentially to the extent allowed under the Freedom of Information Act (5 U.S.C. 552) and the Privacy Act (5 U.S.C. 552a). Records from this system of records may be disclosed to the Department of Justice to determine whether the Freedom of Information Act requires disclosure of these records.
2. A record from this system of records may be disclosed, as a routine use, in the course of presenting evidence to a court, magistrate, or administrative tribunal, including disclosures to opposing counsel in the course of settlement negotiations.
3. A record in this system of records may be disclosed, as a routine use, to a Member of Congress submitting a request involving an individual, to whom the record pertains, when the individual has requested assistance from the Member with respect to the subject matter of the record.
4. A record in this system of records may be disclosed, as a routine use, to a contractor of the Agency having need for the information in order to perform a contract. Recipients of information shall be required to comply with the requirements of the Privacy Act of 1974, as amended, pursuant to 5 U.S.C. 552a(m).
5. A record related to an International Application filed under the Patent Cooperation Treaty in this system of records may be disclosed, as a routine use, to the International Bureau of the World Intellectual Property Organization, pursuant to the Patent Cooperation Treaty.
6. A record in this system of records may be disclosed, as a routine use, to another federal agency for purposes of National Security review (35 U.S.C. 181) and for review pursuant to the Atomic Energy Act (42 U.S.C. 218(c)).
7. A record from this system of records may be disclosed, as a routine use, to the Administrator, General Services, or his/her designee, during an inspection of records conducted by GSA as part of that agency's responsibility to recommend improvements in records management practices and programs, under authority of 44 U.S.C. 2904 and 2906. Such disclosure shall be made in accordance with the GSA regulations governing inspection of records for this purpose, and any other relevant (i.e., GSA or Commerce) directive. Such disclosure shall not be used to make determinations about individuals.
8. A record from this system of records may be disclosed, as a routine use, to the public after either publication of the application pursuant to 35 U.S.C. 122(b) or issuance of a patent pursuant to 35 U.S.C. 151. Further, a record may be disclosed, subject to the limitations of 37 CFR 1.14, as a routine use, to the public if the record was filed in an application which became abandoned or in which the proceedings were terminated and which application is referenced by either a published application, an application open to public inspections or an issued patent.
9. A record from this system of records may be disclosed, as a routine use, to a Federal, State, or local law enforcement agency, if the USPTO becomes aware of a violation or potential violation of law or regulation.

EAST Search History

EAST Search History (Prior Art)

Ref #	Hits	Search Query	DBs	Default Operator	Plurals	Time Stamp
L1	3	"20060047825"	US-PGPUB; USPAT; EPO; JPO; DERWENT; IBM_TDB	OR	ON	2015/08/10 08:58
L2	106	"7593740"	US-PGPUB; USPAT; EPO; JPO; DERWENT; IBM_TDB	OR	ON	2015/08/10 09:00
L3	1	beyer.inv. and (symbol and location and map and contact).clm.	US-PGPUB; USPAT; EPO; JPO; DERWENT; IBM_TDB	OR	ON	2015/08/10 09:32
L4	34	beyer.inv. and (symbol and location and map and contact)	US-PGPUB; USPAT; EPO; JPO; DERWENT; IBM_TDB	OR	ON	2015/08/10 09:33
L5	12	(beyer with malcolm).inv. and (symbol and location and map and contact)	US-PGPUB; USPAT; EPO; JPO; DERWENT; IBM_TDB	OR	ON	2015/08/10 09:34
L6	7	(advanced near3 ground).as. and (symbol and location and map and contact)	US-PGPUB; USPAT; EPO; JPO; DERWENT; IBM_TDB	OR	ON	2015/08/10 09:37
L7	0	6 not 5	US-PGPUB; USPAT; EPO; JPO; DERWENT; IBM_TDB	OR	ON	2015/08/10 09:37
L8	20783	455/456.1	US-PGPUB; USPAT; EPO; JPO; DERWENT; IBM_TDB	OR	ON	2015/08/10 10:00
L9	18188	h04w4/02.cpc.	US-PGPUB; USPAT; EPO; JPO; DERWENT; IBM_TDB	OR	ON	2015/08/10 10:00
S1	0	"14633804"	US-PGPUB; USPAT; EPO; JPO; DERWENT; IBM_TDB	OR	ON	2015/08/10 04:44

S2	1353	((track\$3 or monitor\$3 or display\$3 or view\$3) with (location or position) with ((other or different or another or second) near2 (device or terminal or apparatus or equipment or unit or component or ue or mt or station or phone or telephone))) same (map))	US-PGPUB; USPAT; EPO; JPO; DERWENT; IBM_TDB	OR	ON	2015/08/10 04:51
S3	84	((track\$3 or monitor\$3) with (location or position) with ((other or different or another or second) near2 (device or terminal or apparatus or equipment or unit or component or ue or mt or station or phone or telephone))) same ((display\$3 or view\$3) near5 (map)))	US-PGPUB; USPAT; EPO; JPO; DERWENT; IBM_TDB	OR	ON	2015/08/10 04:53
S4	11	S3 and (@ad<"20040921" or @pd<"20040921" or @rlad<"20040921")	US-PGPUB; USPAT; EPO; JPO; DERWENT; IBM_TDB	OR	ON	2015/08/10 04:54
S5	13	((track\$3 or monitor\$3) with (location or position) with ((other or different or another or second) near2 (vehicl\$5 or car or truck or auto or automobile or plane or aircraft or ship or boat))) same ((display\$3 or view\$3) near5 (map)))	US-PGPUB; USPAT; EPO; JPO; DERWENT; IBM_TDB	OR	ON	2015/08/10 05:19
S6	6	S5 and (@ad<"20040921" or @pd<"20040921" or @rlad<"20040921")	US-PGPUB; USPAT; EPO; JPO; DERWENT; IBM_TDB	OR	ON	2015/08/10 05:20
S7	320	((location or position) with ((other or different or another or second) near2 (vehicl\$5 or car or truck or auto or automobile or plane or aircraft or ship or boat))) same ((display\$3 or view\$3) near5 (map)))	US-PGPUB; USPAT; EPO; JPO; DERWENT; IBM_TDB	OR	ON	2015/08/10 05:28
S8	117	S7 and (@ad<"20040921" or @pd<"20040921" or @rlad<"20040921")	US-PGPUB; USPAT; EPO; JPO; DERWENT; IBM_TDB	OR	ON	2015/08/10 05:29
S9	111	S8 not S5	US-PGPUB; USPAT; EPO; JPO; DERWENT; IBM_TDB	OR	ON	2015/08/10 05:29
S10	181	((location or position) with ((other or different or another or second) adj2 (vehicl\$5 or car or truck or auto or automobile or plane or aircraft or ship or boat))) same ((display\$3 or view\$3) near5 (map)))	US-PGPUB; USPAT; EPO; JPO; DERWENT; IBM_TDB	OR	ON	2015/08/10 05:29
S11	47	S10 and (@ad<"20040921" or @pd<"20040921" or @rlad<"20040921")	US-PGPUB; USPAT; EPO; JPO; DERWENT; IBM_TDB	OR	ON	2015/08/10 05:30
S12	45	S11 not S5	US-PGPUB; USPAT; EPO; JPO;	OR	ON	2015/08/10 05:30

EAST Search History

				DERWENT, IBM_TDB			
--	--	--	--	---------------------	--	--	--

8/ 10/ 2015 10:01:01 AM

C:\Users\oobayanju\Documents\EAST\Workspaces\14633804.wsp



UNITED STATES PATENT AND TRADEMARK OFFICE

UNITED STATES DEPARTMENT OF COMMERCE
 United States Patent and Trademark Office
 Address: COMMISSIONER FOR PATENTS
 P.O. Box 1450
 Alexandria, Virginia 22313-1450
 www.uspto.gov

BIB DATA SHEET

CONFIRMATION NO. 8573

SERIAL NUMBER	FILING or 371(c) DATE RULE	CLASS	GROUP ART UNIT	ATTORNEY DOCKET NO.		
14/633,804	02/27/2015	455	2646	MOC-005		
APPLICANTS INVENTORS Malcolm K. Beyer JR., Jupiter, FL; Christopher R. Rice, Redmond, WA; ** CONTINUING DATA ***** This application is a CON of 14/529,978 10/31/2014 which is a CON of 14/027,410 09/16/2013 PAT 8880042 which is a CON of 13/751,453 01/28/2013 PAT 8538393 which is a CIP of 12/761,533 04/16/2010 PAT 8364129 which is a CIP of 11/615,472 12/22/2006 PAT 8126441 which is a CIP of 11/308,648 04/17/2006 PAT 7630724 which is a CIP of 10/711,490 09/21/2004 PAT 7031728 ** FOREIGN APPLICATIONS ***** ** IF REQUIRED, FOREIGN FILING LICENSE GRANTED ** ** SMALL ENTITY ** 03/19/2015						
Foreign Priority claimed <input type="checkbox"/> Yes <input checked="" type="checkbox"/> No 35 USC 119(a-d) conditions met <input type="checkbox"/> Yes <input checked="" type="checkbox"/> No Verified and /OMONIYI OBAYANJU/ Acknowledged Examiner's Signature		<input type="checkbox"/> Met after Allowance Initials	STATE OR COUNTRY FL	SHEETS DRAWINGS 7	TOTAL CLAIMS 28	INDEPENDENT CLAIMS 4
ADDRESS Malin Haley DiMaggio & Bowen, P.A. 1936 S ANDREWS AVENUE FORT LAUDERDALE, FL 33316 UNITED STATES						
TITLE METHOD TO PROVIDE AD HOC AND PASSWORD PROTECTED DIGITAL AND VOICE NETWORKS						
FILING FEE RECEIVED 1260	FEES: Authority has been given in Paper No. _____ to charge/credit DEPOSIT ACCOUNT No. _____ for following:		<input type="checkbox"/> All Fees <input type="checkbox"/> 1.16 Fees (Filing) <input type="checkbox"/> 1.17 Fees (Processing Ext. of time) <input type="checkbox"/> 1.18 Fees (Issue) <input type="checkbox"/> Other _____ <input type="checkbox"/> Credit			

Receipt date: 02/27/2015

14633804 - GALL: 2646

Doc code: IDS

Doc description: Information Disclosure Statement (IDS) Filed

Approved for use through 07/31/2012. OMB 0651-0031
U.S. Patent and Trademark Office; U.S. DEPARTMENT OF COMMERCE

Under the Paperwork Reduction Act of 1995, no persons are required to respond to a collection of information unless it contains a valid OMB control number.

INFORMATION DISCLOSURE STATEMENT BY APPLICANT (Not for submission under 37 CFR 1.99)	Application Number		
	Filing Date		
	First Named Inventor	BEYER, JR., Malcolm K.	
	Art Unit		
	Examiner Name		
	Attorney Docket Number	10963.3835	

U.S. PATENTS						Remove
Examiner Initial*	Cite No	Patent Number	Kind Code ¹	Issue Date	Name of Patentee or Applicant of cited Document	Pages, Columns, Lines where Relevant Passages or Relevant Figures Appear
	1	5898434	A	1999-04-27	SMALL et al.	
	2	6366782	B1	2002-04-02	FUMAROLO et al.	
	3	6292747	B1	2001-09-18	AMRO et al.	
	4	6385465	B1	2002-05-07	YOSHIOKA	
	5	6662016	B1	2003-12-09	BUCKHAM et al.	
	6	6716101	B1	2004-04-06	MEADOWS et al.	
	7	6775560	B2	2004-08-10	KING et al.	
	8	6868333	B2	2005-03-15	MELEN	

ALL REFERENCES CONSIDERED EXCEPT WHERE LINED THROUGH. /O.O./

Receipt date: 02/27/2015 INFORMATION DISCLOSURE STATEMENT BY APPLICANT (Not for submission under 37 CFR 1.99)	Application Number		14633804 - GAU: 2646	
	Filing Date			
	First Named Inventor	BEYER, JR., Malcolm K.		
	Art Unit			
	Examiner Name			
	Attorney Docket Number		10963.3835	

	9	6868337	B2	2005-03-15	MURAMATSU	
	10	6885874	B2	2005-04-26	GRUBE et al.	
	11	7024207	B2	2006-04-04	GORDAY et al.	
	12	7031700	B1	2006-04-18	WEAVER et al.	
	13	7292935	B2	2007-11-06	YOON	
	14	7299075	B2	2007-11-20	GOTTLIEB et al.	
	15	7499799	B2	2009-03-03	PARK	
	16	6204844	B1	2001-03-20	FUMAROLO et al.	
	17	5555286	A	1996-09-10	TENDLER	
	18	6542475	B1	2003-04-01	BALA et al.	
	19	7593740	B2	2009-09-22	CROWLEY et al.	

ALL REFERENCES CONSIDERED EXCEPT WHERE LINED THROUGH. /O.O./

Receipt date: 02/27/2015 INFORMATION DISCLOSURE STATEMENT BY APPLICANT (Not for submission under 37 CFR 1.99)	Application Number		14633804 - GAU: 2646	
	Filing Date			
	First Named Inventor	BEYER, JR., Malcolm K.		
	Art Unit			
	Examiner Name			
	Attorney Docket Number		10963.3835	

If you wish to add additional U.S. Patent citation information please click the Add button.						Add
U.S.PATENT APPLICATION PUBLICATIONS						Remove
Examiner Initial*	Cite No	Publication Number	Kind Code ¹	Publication Date	Name of Patentee or Applicant of cited Document	Pages, Columns, Lines where Relevant Passages or Relevant Figures Appear
	1	20030013461	A1	2003-01-16	MIZUNE et al.	
	2	20030149527	A1	2003-08-07	SIKILA	
	3	20040192299	A1	2004-09-30	WILSON et al.	
	4	20070281689	A1	2007-12-06	ALTMAN et al.	
	5	20080132243	A1	2008-06-05	SPALINK et al.	
	6	20070150444	A1	2007-06-28	CHESNAIS et al.	
	7	20060030339	A1	2006-02-09	ZHOVNIROVSKY et al.	
	8	20060047825	A1	2006-03-02	STREENSTRA et al.	
	9	20030200259	A1	2003-10-23	TSUGE	

ALL REFERENCES CONSIDERED EXCEPT WHERE LINED THROUGH. /O.O./

Receipt date: 02/27/2015 INFORMATION DISCLOSURE STATEMENT BY APPLICANT (Not for submission under 37 CFR 1.99)	Application Number		14633804 - GAU: 2646	
	Filing Date			
	First Named Inventor	BEYER, JR., Malcolm K.		
	Art Unit			
	Examiner Name			
	Attorney Docket Number		10963.3835	

	10	20060031927	A1	2006-02-09	MIZUNO et al.	
	11	20040204070	A1	2004-10-14	AUGUST et al.	
	12	20040266456	A1	2004-12-30	BOSTROM et al.	
	13	20030139150	A1	2003-07-24	RODRIGUEZ et al.	
	14	20010044321	A1	2001-11-22	AUSEMS et al.	
	15	20050130634	A1	2005-06-16	GODFREY	
	16	20030093405	A1	2003-05-15	MAYER	

If you wish to add additional U.S. Published Application citation information please click the Add button. **Add**

FOREIGN PATENT DOCUMENTS								Remove
Examiner Initial*	Cite No	Foreign Document Number ³	Country Code ² j	Kind Code ⁴	Publication Date	Name of Patentee or Applicant of cited Document	Pages, Columns, Lines where Relevant Passages or Relevant Figures Appear	T ⁵
	1	JPH085394	JP		1996-01-12	OZAKI et al.		<input type="checkbox"/>
	2	JPH09113288	JP		1997-05-02	SATOSHI		<input type="checkbox"/>

ALL REFERENCES CONSIDERED EXCEPT WHERE LINED THROUGH. /O.O./

INFORMATION DISCLOSURE STATEMENT BY APPLICANT (Not for submission under 37 CFR 1.99)	Receipt date: 02/27/2015		Application Number		14633804 - GAU: 2646		
			Filing Date				
			First Named Inventor	BEYER, JR., Malcolm K.			
			Art Unit				
			Examiner Name				
			Attorney Docket Number		10963.3835		

	3	JP2002245336	JP		2002-08-30	SHIMADA et al.		<input type="checkbox"/>
	4	03074973	WO	A2	2003-09-12	SHEHA et al.		<input type="checkbox"/>

If you wish to add additional Foreign Patent Document citation information please click the Add button **Add**

NON-PATENT LITERATURE DOCUMENTS **Remove**

Examiner Initials*	Cite No	Include name of the author (in CAPITAL LETTERS), title of the article (when appropriate), title of the item (book, magazine, journal, serial, symposium, catalog, etc), date, pages(s), volume-issue number(s), publisher, city and/or country where published.	T ⁵
	1	Gate5, "Mobile Community Solution: Context-sensitive application suite for mobile communities," published in 2002	<input type="checkbox"/>
	2	Gate5, "Mobile Guide Solution: Context-sensitive applications for PDA based mobile city and travel guides," published in 2002	<input type="checkbox"/>
	3	Batista, "Your Boss May Know Where You Are," Wired News, published May 31, 2002	<input type="checkbox"/>
	4	Edlund, Therese et al., "Mobile Services for truck drivers," Master thesis in Mobile Informatics, IT University of Goteborg, Sweden, 2003	<input type="checkbox"/>
	5	The Gate5 system, which, upon information and belief, was sold and/or publicly used within the U.S. prior to 2004 and at least as early as 2002	<input type="checkbox"/>
	6	Kim, Ryan, "Find Friends by cell phone/Loopt application's GPS program can beam map location," published November 14, 2006 by SFGate	<input type="checkbox"/>
	7	LocatioNet Press Release: "LocatioNet Releases Ground Breaking Mass Market LBS Application Suite - LocatioNet MyMap," published May 6, 2003	<input type="checkbox"/>

ALL REFERENCES CONSIDERED EXCEPT WHERE LINED THROUGH. /O.O./

INFORMATION DISCLOSURE STATEMENT BY APPLICANT (Not for submission under 37 CFR 1.99)	Application Number		14633804 - GAU: 2646	
	Filing Date			
	First Named Inventor	BEYER, JR., Malcolm K.		
	Art Unit			
	Examiner Name			
	Attorney Docket Number		10963.3835	

8	LocatioNet LBS Applications: MyMap description web page, published before 2004 upon information and belief	<input type="checkbox"/>
9	The LocatioNet system which, upon information and belief, was sold and/or publically used within the U.S. prior to 2004 and at least as early as 2003	<input type="checkbox"/>
10	Luna, Lynnette, "This Man Knows You Live...and Work and Play," Wireless Review, September 2002; pages 24-32	<input type="checkbox"/>
11	Meggers, Jens et al., "A Multimedia Communication Architecture for Handheld Devices," IEEE Paper 0-7803-4872-9/98, published 1998	<input type="checkbox"/>
12	Memory Map Remote Tracking, available at https://web.archive.org/web/20060202161013/http://memory-map.com/ NO DATE /O.O./ 08/10/2015	<input type="checkbox"/>
13	Ostman, Lennart, "A Study of Location-Based Services Including a Design and Implementation of an Enhanced Friend Finder Client with Mapping Capabilities," Lulea Tekniska Univeritet, 2001	<input type="checkbox"/>

If you wish to add additional non-patent literature document citation information please click the Add button **Add**

EXAMINER SIGNATURE

Examiner Signature	/Omoniyi Obayanju/	Date Considered	08/10/2015
--------------------	--------------------	-----------------	------------

*EXAMINER: Initial if reference considered, whether or not citation is in conformance with MPEP 609. Draw line through a citation if not in conformance and not considered. Include copy of this form with next communication to applicant.

¹ See Kind Codes of USPTO Patent Documents at www.USPTO.GOV or MPEP 901.04. ² Enter office that issued the document, by the two-letter code (WIPO Standard ST.3). ³ For Japanese patent documents, the indication of the year of the reign of the Emperor must precede the serial number of the patent document. ⁴ Kind of document by the appropriate symbols as indicated on the document under WIPO Standard ST.16 if possible. ⁵ Applicant is to place a check mark here if English language translation is attached.

ALL REFERENCES CONSIDERED EXCEPT WHERE LINED THROUGH. /O.O./

INFORMATION DISCLOSURE STATEMENT BY APPLICANT (Not for submission under 37 CFR 1.99)	Application Number	14633804 - GAU: 2646
	Filing Date	
	First Named Inventor	BEYER, JR., Malcolm K.
	Art Unit	
	Examiner Name	
	Attorney Docket Number	10963.3835

CERTIFICATION STATEMENT

Please see 37 CFR 1.97 and 1.98 to make the appropriate selection(s):

That each item of information contained in the information disclosure statement was first cited in any communication from a foreign patent office in a counterpart foreign application not more than three months prior to the filing of the information disclosure statement. See 37 CFR 1.97(e)(1).

OR

That no item of information contained in the information disclosure statement was cited in a communication from a foreign patent office in a counterpart foreign application, and, to the knowledge of the person signing the certification after making reasonable inquiry, no item of information contained in the information disclosure statement was known to any individual designated in 37 CFR 1.56(c) more than three months prior to the filing of the information disclosure statement. See 37 CFR 1.97(e)(2).

- See attached certification statement.
- The fee set forth in 37 CFR 1.17 (p) has been submitted herewith.
- A certification statement is not submitted herewith.

SIGNATURE

A signature of the applicant or representative is required in accordance with CFR 1.33, 10.18. Please see CFR 1.4(d) for the form of the signature.

Signature	/barry l. haley/	Date (YYYY-MM-DD)	2015-02-27
Name/Print	Barry L. Haley	Registration Number	25339

This collection of information is required by 37 CFR 1.97 and 1.98. The information is required to obtain or retain a benefit by the public which is to file (and by the USPTO to process) an application. Confidentiality is governed by 35 U.S.C. 122 and 37 CFR 1.14. This collection is estimated to take 1 hour to complete, including gathering, preparing and submitting the completed application form to the USPTO. Time will vary depending upon the individual case. Any comments on the amount of time you require to complete this form and/or suggestions for reducing this burden, should be sent to the Chief Information Officer, U.S. Patent and Trademark Office, U.S. Department of Commerce, P.O. Box 1450, Alexandria, VA 22313-1450. **DO NOT SEND FEES OR COMPLETED FORMS TO THIS ADDRESS. SEND TO: Commissioner for Patents, P.O. Box 1450, Alexandria, VA 22313-1450.**

Privacy Act Statement

The Privacy Act of 1974 (P.L. 93-579) requires that you be given certain information in connection with your submission of the attached form related to a patent application or patent. Accordingly, pursuant to the requirements of the Act, please be advised that: (1) the general authority for the collection of this information is 35 U.S.C. 2(b)(2); (2) furnishing of the information solicited is voluntary; and (3) the principal purpose for which the information is used by the U.S. Patent and Trademark Office is to process and/or examine your submission related to a patent application or patent. If you do not furnish the requested information, the U.S. Patent and Trademark Office may not be able to process and/or examine your submission, which may result in termination of proceedings or abandonment of the application or expiration of the patent.

The information provided by you in this form will be subject to the following routine uses:

1. The information on this form will be treated confidentially to the extent allowed under the Freedom of Information Act (5 U.S.C. 552) and the Privacy Act (5 U.S.C. 552a). Records from this system of records may be disclosed to the Department of Justice to determine whether the Freedom of Information Act requires disclosure of these records.
2. A record from this system of records may be disclosed, as a routine use, in the course of presenting evidence to a court, magistrate, or administrative tribunal, including disclosures to opposing counsel in the course of settlement negotiations.
3. A record in this system of records may be disclosed, as a routine use, to a Member of Congress submitting a request involving an individual, to whom the record pertains, when the individual has requested assistance from the Member with respect to the subject matter of the record.
4. A record in this system of records may be disclosed, as a routine use, to a contractor of the Agency having need for the information in order to perform a contract. Recipients of information shall be required to comply with the requirements of the Privacy Act of 1974, as amended, pursuant to 5 U.S.C. 552a(m).
5. A record related to an International Application filed under the Patent Cooperation Treaty in this system of records may be disclosed, as a routine use, to the International Bureau of the World Intellectual Property Organization, pursuant to the Patent Cooperation Treaty.
6. A record in this system of records may be disclosed, as a routine use, to another federal agency for purposes of National Security review (35 U.S.C. 181) and for review pursuant to the Atomic Energy Act (42 U.S.C. 218(c)).
7. A record from this system of records may be disclosed, as a routine use, to the Administrator, General Services, or his/her designee, during an inspection of records conducted by GSA as part of that agency's responsibility to recommend improvements in records management practices and programs, under authority of 44 U.S.C. 2904 and 2906. Such disclosure shall be made in accordance with the GSA regulations governing inspection of records for this purpose, and any other relevant (i.e., GSA or Commerce) directive. Such disclosure shall not be used to make determinations about individuals.
8. A record from this system of records may be disclosed, as a routine use, to the public after either publication of the application pursuant to 35 U.S.C. 122(b) or issuance of a patent pursuant to 35 U.S.C. 151. Further, a record may be disclosed, subject to the limitations of 37 CFR 1.14, as a routine use, to the public if the record was filed in an application which became abandoned or in which the proceedings were terminated and which application is referenced by either a published application, an application open to public inspections or an issued patent.
9. A record from this system of records may be disclosed, as a routine use, to a Federal, State, or local law enforcement agency, if the USPTO becomes aware of a violation or potential violation of law or regulation.

Index of Claims 	Application/Control No. 14633804	Applicant(s)/Patent Under Reexamination BEYER ET AL.
	Examiner OMONIYI OBAYANJU	Art Unit 2646

✓	Rejected
=	Allowed

-	Cancelled
÷	Restricted

N	Non-Elected
I	Interference

A	Appeal
O	Objected

Claims renumbered in the same order as presented by applicant
 CPA
 T.D.
 R.1.47

CLAIM		DATE									
Final	Original	08/10/2015									
	1	✓									
	2	✓									
	3	✓									
	4	✓									
	5	✓									
	6	-									
	7	✓									
	8	✓									
	9	✓									
	10	✓									
	11	✓									
	12	✓									
	13	✓									
	14	✓									
	15	✓									
	16	✓									
	17	✓									
	18	-									
	19	✓									
	20	✓									
	21	✓									
	22	✓									
	23	✓									
	24	✓									
	25	✓									
	26	✓									
	27	✓									
	28	✓									
	29	✓									
	30	✓									



UNITED STATES PATENT AND TRADEMARK OFFICE

UNITED STATES DEPARTMENT OF COMMERCE
United States Patent and Trademark Office
Address: COMMISSIONER FOR PATENTS
P.O. Box 1450
Alexandria, Virginia 22313-1450
www.uspto.gov

Table with 5 columns: APPLICATION NO., FILING DATE, FIRST NAMED INVENTOR, ATTORNEY DOCKET NO., CONFIRMATION NO.
14/633,804 02/27/2015 Malcolm K. Beyer JR. MOC-005 8573

22235 7590 08/25/2015
Malin Haley DiMaggio & Bowen, P.A.
1936 S ANDREWS AVENUE
FORT LAUDERDALE, FL 33316

Table with 1 column: EXAMINER

OBAYANJU, OMONIYI

Table with 2 columns: ART UNIT, PAPER NUMBER

2646

Table with 2 columns: NOTIFICATION DATE, DELIVERY MODE

08/25/2015

ELECTRONIC

Please find below and/or attached an Office communication concerning this application or proceeding.

The time period for reply, if any, is set in the attached communication.

Notice of the Office communication was sent electronically on above-indicated "Notification Date" to the following e-mail address(es):

info@mhdpatents.com



UNITED STATES DEPARTMENT OF COMMERCE

U.S. Patent and Trademark Office

Address: COMMISSIONER FOR PATENTS
P.O. Box 1450
Alexandria, Virginia 22313-1450

APPLICATION NO./ CONTROL NO.	FILING DATE	FIRST NAMED INVENTOR / PATENT IN REEXAMINATION	ATTORNEY DOCKET NO.
14/633,804	27 February, 2015	BEYER ET AL.	MOC-005

Malin Haley DiMaggio & Bowen, P.A. 1936 S ANDREWS AVENUE FORT LAUDERDALE, FL 33316	EXAMINER	
	KATISCHA R. WANZER	
	ART UNIT	PAPER
	OPIM	20150820

DATE MAILED:

Please find below and/or attached an Office communication concerning this application or proceeding.

Commissioner for Patents

Attached is a communication to applicant explaining that the instant application is being identified as a pre-AIA application despite applicant's statement under 37 CFR 1.55 or 1.78 made in the instant application, either on the Application Data Sheet (ADS) or in an otherwise filed paper.

**Application Identified as a Pre-AIA Application
Despite the 37 CFR 1.55 or 1.78 Statement of Record**

The statement under 37 CFR 1.55 or 1.78 (“the 1.55/1.78 statement”) and the domestic benefit/national stage information in this application conflict as to whether this application is to be examined under the AIA (First Inventor to File) or pre-AIA (First to Invent) law.

This application, with a filing date on or after March 16, 2013, contains the 1.55/1.78 statement indicating that this application should be examined under the AIA (First Inventor to File). This statement was either (1) on the Application Data Sheet (ADS) by virtue of the 1.55/1.78 statement for AIA (First Inventor to File) Transition Applications check box being selected or (2) in an otherwise filed paper. The 1.55/1.78 statement provided:

This application * * * contains, or contained at any time, a claim to a claimed invention that has an effective filing date on or after March 16, 2013.

However, this application is separately identified in the Domestic Benefit/National Stage Information section of the ADS as a continuation (CON) or divisional (DIV) of an application filed before March 16, 2013, indicating that this application should be examined under pre-AIA (First to Invent) law because it does not contain, or did not contained at any time, a claim to a claimed invention that has an effective filing date on or after March 16, 2013. DUE TO THIS APPLICATION BEING IDENTIFIED AS A CONTINUATION OR DIVISIONAL OF AN APPLICATION FILED BEFORE MARCH 16, 2013, THIS APPLICATION IS BEING IDENTIFIED AS A PRE-AIA (FIRST TO INVENT) APPLICATION DESPITE THE 1.55/1.78 STATEMENT OF RECORD.

Accordingly, this application is/will be examined under pre-AIA (First to Invent) law; all forthcoming Office actions on the merits will be labeled “**AIA (First Inventor to File) Status: No**” (see upper right box on form PTOL-37/37D and/or PTOL-326/326AE).

Moreover, if applicant has received any Office action on the merits, which identified the instant application as “**AIA (First Inventor to File) Status: Yes**,” said Status information was in error and is hereby corrected to “**No**” to indicate that that the present application is a pre-AIA (First to Invent) application.

NO RESPONSE TO THIS COMMUNICATION IS REQUIRED UNLESS APPLICANT BELIEVES THAT THE APPLICATION CONTAINS, OR EVER CONTAINED A CLAIM TO A CLAIMED INVENTION HAVING AN EFFECTIVE FILING DATE ON OR AFTER MARCH 16, 2013 AND IS AN AIA (FIRST INVENTOR TO FILE) APPLICATION.

If applicant believes that the application is an AIA (First Inventor to File) application, applicant must file a corrected ADS (with appropriate markings as set forth in 37 CFR 1.76(c)(2)) identifying the instant application as a **continuation-in-part (CIP)** application in the Domestic Benefit/National Stage Information section of the ADS and request in writing that the application

be examined under the AIA (First Inventor to File) because the identification of the application as a CON/DIV application on filing was an error. IN THIS SITUATION, APPLICANT'S RESPONSE IS DUE WITHIN TWO MONTHS OF THE MAILING DATE OF THIS COMMUNICATION; THE RESPONSE PERIOD IS NOT EXTENDABLE UNDER 37 CFR 1.136.

Questions regarding this communication may be directed to a TC AIA Specialist as appropriate.

Technology Center	TC AIA Specialist	Contact Information
1600, 1700, 2900	Kathleen Bragdon	(571) 272-0931
2100, 2400	Christopher Grant	(571) 272-7294
2600, 2800	Cassandra Spyrou	(571) 272-1624
3600, 3700	Tom Hughes	(571) 272-4357

<p align="center">RESCISSION OF PREVIOUS NONPUBLICATION REQUEST (35 U.S.C. 122(b)(2)(B)(ii)) AND, IF APPLICABLE, NOTICE OF FOREIGN FILING (35 U.S.C. 122(b)(2)(B)(iii))</p> <hr/> <p>Send completed form to: Mail Stop PG Pub Commissioner for Patents P.O. Box 1450 Alexandria, VA 22313-1450 FAX: (571) 273-8300</p>	Application Number	14/633,804-Conf. #8573
	Filing Date	February 27, 2015
	First Named Inventor	Malcolm K. Beyer, Jr.
	Title	METHOD TO PROVIDE AD HOC AND PASSWORD PROTECTED DIGITAL AND VOICE NETWORKS
	Atty Docket Number	MOC-005
	Art Unit	2646
	Examiner	O. Obayanju

A request that the above-identified application not be published under 35 U.S.C. 122(b) (nonpublication request) was included with the above-identified application on filing pursuant to 35 U.S.C. 122(b)(2)(B)(i).

I hereby **rescind** the previous nonpublication request.

If a notice of foreign or international filing is or will be required by 35 U.S.C. 122(b)(2)(B)(iii) and 37 CFR 1.213(c), I hereby provide such notice. This notice is being provided no later than forty five (45) days after the date of such foreign or international filing.

If a notice of subsequent foreign or international filing required by 35 U.S.C. 122(b)(2)(B)(iii) and 37 CFR 1.213(c) was not filed within forty five (45) days after the date of filing of the foreign or international application, the application is ABANDONED, and a petition to revive under 37 CFR 1.137(b) is required. See 37 CFR 1.137(f).

/Daniel J. Burns/
Signature

November 13, 2015
Date

Daniel J. Burns
Typed or printed name

50,222
Registration Number, if applicable

(650) 752-3137
Telephone Number

This request must be signed in compliance with 37 CFR 1.33(b).

If information or assistance is needed in completing this form, please contact the Pre-Grant Publication Division at (703)605-4283 or by e-mail at PGPub@USPTO.gov.

Corrected Application Data Sheet

Inventor Information

Inventor Number:: 1
Name Prefix:: Mr.
Given Name:: Malcolm
Middle Name:: K.
Family Name:: Beyer
Name Suffix:: Jr.
City of Residence:: Jupiter
State or Province of Residence:: FL
Country of Residence:: US
Street of mailing address:: 92 Lighthouse Drive
City of mailing address:: Jupiter
State or Province of mailing address:: FL
Postal or Zip Code of mailing address:: 33469

Inventor Number:: 2
Name Prefix:: Mr.
Given Name:: Christopher
Middle Name:: R.
Family Name:: Rice
City of Residence:: Redmond
State or Province of Residence:: WA

<u>Country of Residence::</u>	<u>US</u>
<u>Street of mailing address::</u>	<u>P.O. Box 3583</u>
<u>City of mailing address::</u>	<u>Redmond</u>
<u>State or Province of mailing address::</u>	<u>WA</u>
<u>Postal or Zip Code of mailing address::</u>	<u>98073</u>

Correspondence Information

Correspondence Customer Number::	22235
Email Address::	info@mhdpatents.com

Application Information

<u>Application Number::</u>	<u>14/633,804</u>
<u>Filing Date::</u>	<u>02/27/15</u>
Application Type::	Regular
Subject Matter::	Utility
CD-ROM or CD-R?::	None
Sequence submission?::	None
Computer Readable Form (CRF)?::	No
Title::	METHOD TO PROVIDE AD HOC AND PASSWORD PROTECTED DIGITAL AND VOICE NETWORKS
Attorney Docket Number::	10963.3835
Request for Early Publication?::	No
Request for Non-Publication?::	Yes <u>No</u>

Small Entity?::	No
Drawing Sheets::	7
Petition included?::	No
Portions or all of the application associated with this Application Data Sheet may fall under a Secrecy Order pursuant to 37 CFR 5.2::	No
Authorization to Permit Access to the Instant Application by the Participating Offices::	No

Representative Information

Representative Customer Number::	22235
----------------------------------	-------

Domestic Priority Information

Prior Application Status::	Pending
Application Number::	<u>14/695,233</u>
Continuity Type::	Continuation of
Prior Application Number::	14/529,978
Filing Date::	10/31/2014

Prior Application Status::	Patented
Application Number::	14/529,978
Continuity Type::	Continuation <u>in part</u> of
Prior Application Number::	14/027,410
Filing Date::	09/16/2013

Patent Number:: 8,880,042
Issue Date:: 11/04/2014

Prior Application Status:: Patented
Application Number:: 14/027,410
Continuity Type:: Continuation of
Prior Application Number:: 13/751,453
Filing Date:: 01/28/2013
Patent Number:: 8,538,393
Issue Date:: 09/17/2013

Prior Application Status:: Patented
Application Number:: 13/751,453
Continuity Type:: Continuation in part of
Prior Application Number:: 12/761,533
Filing Date:: 04/16/2010
Patent Number:: 8,364,129
Issue Date:: 01/29/2013

Prior Application Status:: Patented
Application Number:: 12/761,533
Continuity Type:: Continuation in part of
Prior Application Number:: 11/615,472
Filing Date:: 12/22/2006

Patent Number::	8,126,441
Issue Date::	02/28/2012
Prior Application Status::	Patented
Application Number::	11/615,472
Continuity Type::	Continuation in part of
Prior Application Number::	11/308,648
Filing Date::	04/17/2006
Patent Number::	7,630,724
Issue Date::	12/08/2009
Prior Application Status::	Patented
Application Number::	11/308,648
Continuity Type::	Continuation in part of
Prior Application Number::	10/711,490
Filing Date::	09/21/2004
Patent Number::	7,031,728
Issue Date::	04/18/2006

Foreign Priority Information

Applicant Information

Assignee Information Including Non-Applicant Assignee Information

Signature:

NOTE: This form must be signed in accordance with 37 CFR 1.33. See 37 CFR 1.4 for signature requirements and certifications.			
Signature	/Daniel J. Burns/	Date	November 13, 2015
Name	Daniel J. Burns	Registration Number	50,222

Electronic Acknowledgement Receipt

EFS ID:	24080366
Application Number:	14633804
International Application Number:	
Confirmation Number:	8573
Title of Invention:	METHOD TO PROVIDE AD HOC AND PASSWORD PROTECTED DIGITAL AND VOICE NETWORKS
First Named Inventor/Applicant Name:	Malcolm K. Beyer
Customer Number:	22235
Filer:	Daniel J. Burns/Deanna Bridges
Filer Authorized By:	Daniel J. Burns
Attorney Docket Number:	MOC-005
Receipt Date:	13-NOV-2015
Filing Date:	27-FEB-2015
Time Stamp:	17:01:19
Application Type:	Utility under 35 USC 111(a)

Payment information:

Submitted with Payment	no
------------------------	----

File Listing:

Document Number	Document Description	File Name	File Size(Bytes)/ Message Digest	Multi Part /.zip	Pages (if appl.)
1		MOC-005_Amendment_Respo nse.pdf	156664 <small>73f7c989a57f773e4055a142692bc977f2e8 a2be</small>	yes	15

Multipart Description/PDF files in .zip description					
Document Description			Start	End	
Amendment/Req. Reconsideration-After Non-Final Reject			1	1	
Specification			2	2	
Claims			3	9	
Applicant Arguments/Remarks Made in an Amendment			10	15	
Warnings:					
Information:					
2	Examination support document	MOC-005_Priority_Claim_Petition.pdf	154729	no	2
			e02906446ca9ae7ed10e6aa84e9757a80800277f		
Warnings:					
Information:					
3	Rescind Nonpublication Request for Pre Grant Pub	MOC-005_Rescission_Nonpublication.pdf	110511	no	1
			e63ccf0436432b2ddf08478b915acdb7ec391445		
Warnings:					
Information:					
4	Application Data Sheet	MOC-005_Corrected_ADS.pdf	63575	no	6
			edf1490ae34094f10e96a86ac501547f67d6738e		
Warnings:					
Information:					
This is not an USPTO supplied ADS fillable form					
Total Files Size (in bytes):			485479		

This Acknowledgement Receipt evidences receipt on the noted date by the USPTO of the indicated documents, characterized by the applicant, and including page counts, where applicable. It serves as evidence of receipt similar to a Post Card, as described in MPEP 503.

New Applications Under 35 U.S.C. 111

If a new application is being filed and the application includes the necessary components for a filing date (see 37 CFR 1.53(b)-(d) and MPEP 506), a Filing Receipt (37 CFR 1.54) will be issued in due course and the date shown on this Acknowledgement Receipt will establish the filing date of the application.

National Stage of an International Application under 35 U.S.C. 371

If a timely submission to enter the national stage of an international application is compliant with the conditions of 35 U.S.C. 371 and other applicable requirements a Form PCT/DO/EO/903 indicating acceptance of the application as a national stage submission under 35 U.S.C. 371 will be issued in addition to the Filing Receipt, in due course.

New International Application Filed with the USPTO as a Receiving Office

If a new international application is being filed and the international application includes the necessary components for an international filing date (see PCT Article 11 and MPEP 1810), a Notification of the International Application Number and of the International Filing Date (Form PCT/RO/105) will be issued in due course, subject to prescriptions concerning national security, and the date shown on this Acknowledgement Receipt will establish the international filing date of the application.

Docket No.: MOC-005
(PATENT)

IN THE UNITED STATES PATENT AND TRADEMARK OFFICE

In re Patent Application of:
Malcolm K. Beyer, Jr. et al.

Application No.: 14/633,804

Confirmation No.: 8573

Filed: February 27, 2015

Art Unit: 2646

For: METHOD TO PROVIDE AD HOC AND
PASSWORD PROTECTED DIGITAL AND
VOICE NETWORKS

Examiner: O. Obayanju

AMENDMENT IN RESPONSE TO NON-FINAL OFFICE ACTION
UNDER 37 C.F.R. § 1.111

MS Amendment
Commissioner for Patents
P.O. Box 1450
Alexandria, VA 22313-1450

INTRODUCTORY COMMENTS

In response to the Office Action dated August 13, 2015, please amend the above-identified U.S. patent application as follows:

Amendments to the Specification begin on page 2 of this paper.

Amendments to the Claims are reflected in the listing of claims which begins on page 3 of this paper.

Remarks/Arguments begin on page 10 of this paper.

AMENDMENTS TO THE SPECIFICATION

Please amend the first paragraph of the specification under the heading CROSS REFERENCE TO RELATED APPLICATIONS as indicated below. No new matter is added.

[0001] This application is a continuation of co-pending U.S. Patent Application Serial No. 14/529,978 filed on October 31, 2014, which is a continuation-in-part of U.S. Patent Application Serial No. 14/027,410 filed on September 16, 2013, now U.S. Patent No. 8,880,042, issued November 4, 2014, which is a continuation of U.S. Patent Application Serial No. 13/751,453 filed January 28, 2013, now U.S. Patent No. 8,538,393 issued September 17, 2013, which is a continuation-in-part of U.S. Patent Application Serial No. 12/761,533 filed on April 16, 2010, now U.S. Patent No. 8,364,129 issued January 29, 2013, which is a continuation-in-part of U.S. Patent Application Serial No. 11/615,472 filed on December 22, 2006, now U.S. Patent No. 8,126,441 issued on February 28, 2012, which is a continuation-in-part of U.S. Patent Application Serial No. 11/308,648 filed April 17, 2006, now U.S. Patent No. 7,630,724 issued on December 8, 2009, which is a continuation-in-part of U.S. Patent Application Serial No. 10/711,490, filed on September 21, 2004, now U.S. Patent No. 7,031,728 issued on April 18, 2006. All of the ~~proceeding~~ preceding applications are incorporated herein by reference in their entirety.

AMENDMENTS TO THE CLAIMS

This listing of claims replaces all prior versions and listings of claims in the application:

Listing of Claims

1. (Currently amended) A computer-implemented method comprising:
with a first device, receiving a message from a second device, wherein the message relates to joining a group;
based on receiving the message from the second device, participating in the group, wherein participating in the group includes ~~receiving at various times from one or more devices~~ ~~respective information comprising a location of the device and sending the location to one or more other devices,~~ sending first location information to a server and receiving second location information from the server, the first location information comprising a location of the first device, the second location information comprising a plurality of locations of a respective plurality of second devices included in the group;
wherein each of the other devices is configured to display a respective symbol representing the location on a respective map;presenting, via an interactive display of the first device, an interactive map comprising a plurality of user-selectable symbols corresponding to the plurality of second devices, wherein the symbols are positioned on the map at respective positions corresponding to the locations of the second devices; and
receiving from a first device information indicating user selection of one or more of the displayed symbols corresponding to second devices and, based thereon: obtaining a respective contact information for each of the second devices; and facilitating a respective communication between the first device and each of the second devices using the contact information of the second device;identifying user interaction with the interactive map selecting one or more of the user-selectable symbols corresponding to one or more of the second devices and user interaction with the display specifying an action and, based thereon, sending data to the one or more second devices via the server.
2. (Currently amended) The method of claim 1, wherein ~~a particular communication is the data includes a phone call,~~ a short message service message, ~~a voice message,~~ a text message, ~~an electronic mail message,~~ an image, or a video.

3-4. (Canceled)

5. (Currently amended) The method of claim 1, further comprising obtaining, by the first device, respective wherein particular contact information is a phone number or an Internet Protocol address addresses for the second devices.

6-7. (Canceled)

8. (Currently amended) The method of claim 1, wherein ~~a particular~~ the first device is a personal digital assistant (PDA) or a personal computer (PC) ~~smart phone, a personal data assistant, a tablet computer, a desktop computer, or a laptop computer.~~

9. (Currently amended) The method of claim 1, further comprising:
receiving sending, from the first device, a request for a second map, from a third device
wherein the request ~~comprises one or more parameters and wherein a parameter specifies a map location or a zoom indication; and~~
obtaining a second map that conforms to the attributes; and
sending receiving, from the server, the second map to the third device.

10. (Currently amended) The method of claim 1, wherein the first device does not have access to ~~the phone numbers or respective~~ Internet Protocol addresses of the second devices.

11. (Currently amended) The method of claim 1, wherein the map is ~~an aerial photograph, a satellite image, or a chart.~~

12. (Currently amended) The method of claim 1, further comprising sending, by the first device, updated location information comprising an updated location of the first device, the updated location information being sent based on passage of a predetermined time interval since sending previous location information comprising a previous location of the first device, displacement of the first device by a predetermined distance relative to a previous location of the

~~first device, or both, wherein receiving at various times from a particular device information comprises receiving the information from the particular device at a time based on one or more of: speed of the particular device, distance traveled by the particular device, or time.~~

13. (Currently amended) A system comprising:

~~one or more computers~~ a first device programmed to perform operations comprising:

receiving a message from a second device, wherein the message relates to joining a group;

based on receiving the message from the second device, participating in the group, wherein participating in the group includes receiving at various times from one or more devices respective information comprising a location of the device and sending the location to one or more other devices, sending first location information to a server and receiving second location information from the server, the first location information comprising a location of the first device, the second location information comprising a plurality of locations of a respective plurality of second devices included in the group;

wherein each of the other devices is configured to display a respective symbol representing the location on a respective map; presenting, via an interactive display of the first device, an interactive map comprising a plurality of user-selectable symbols corresponding to the plurality of second devices, wherein the symbols are positioned on the map at respective positions corresponding to the locations of the second devices; and

receiving from a first device information indicating user selection of one or more of the displayed symbols corresponding to second devices and, based thereon: obtaining a respective contact information for each of the second devices; and facilitating a respective communication between the first device and each of the second devices using the contact information of the second device; identifying user interaction with the interactive map selecting one or more of the user-selectable symbols corresponding to one or more of the second devices and user interaction with the display specifying an action and, based thereon, sending data to the one or more second devices via the server.

14. (Currently amended) The system of claim 13, wherein ~~a particular communication is a phone call,~~ the data includes a short message service message, ~~a voice message,~~ a text message, ~~an electronic mail message,~~ an image, or a video.

15-16. (Canceled)

17. (Currently amended) The system of claim 13, wherein the operations further comprise obtaining respective ~~wherein particular contact information is a phone number or an Internet Protocol address~~ addresses for the second devices.

18-19. (Canceled)

20. (Currently amended) The system of claim 13, wherein ~~a particular~~ the first device is a personal digital assistant (PDA) or a personal computer (PC) ~~smart phone, a personal data assistant, a tablet computer, a desktop computer, or a laptop computer.~~

21. (Currently amended) The system of claim 13, wherein the operations further comprise: ~~receiving~~ sending a request for a second map, ~~from a third device~~ wherein the request comprises one or more parameters and wherein a parameter specifies a map location or a zoom indication; and
~~obtaining a second map that conforms to the attributes; and~~
receiving, from the server, sending the second map to the third device.

22. (Currently amended) The system of claim 13, wherein the first device does not have access to ~~the phone numbers or~~ respective Internet Protocol addresses of the second devices.

23. (Currently amended) The system of claim 13, wherein the map is ~~an aerial photograph, a satellite image, or a chart.~~

24. (Currently amended) The system of claim 13, wherein the operations further comprise sending updated location information comprising an updated location of the first device, the

updated location information being sent based on passage of a predetermined time interval since sending previous location information comprising a previous location of the first device, displacement of the first device by a predetermined distance relative to a previous location of the first device, or both. ~~wherein receiving at various times from a particular device information comprises receiving the information from the particular device at a time based on one or more of: speed of the particular device, distance traveled by the particular device, or time.~~

25-30. (Canceled)

31. (New) The method of claim 1, further comprising identifying second user interaction with the interactive map selecting at least one of the user-selectable symbols corresponding to at least one of the second devices and user interaction with the display specifying an action and, based thereon, initiating a phone call or phone conference with the at least one second device.

32. (New) The method of claim 1, wherein the message from the second device is a Short Message Service (SMS) message or a text message.

33. (New) The method of claim 1, wherein participating in the group further includes sending first status information to the server and receiving second status information from the server, the first status information comprising a battery level of the first device and/or a signal strength of a wireless signal of the first device, the second location information comprising a plurality of battery levels of the respective plurality of second devices included in the group and/or a plurality of signal strengths of wireless signals of the respective plurality of second devices included in the group.

34. (New) The method of claim 1, wherein the first device is a smart phone.

35. (New) The method of claim 1, further comprising:
with the first device, transmitting a group identifier associated with a second group, the second group including a second plurality of second devices; and

based on transmitting the group identifier associated with the second group, participating in the second group, wherein participating in the second group includes receiving third location information from the server, the third location information comprising a plurality of locations of the respective second plurality of second devices included in the second group.

36. (New) The method of claim 1, wherein the data includes a voice recording.

37. (New) The system of claim 13, wherein the operations further comprise identifying second user interaction with the interactive map selecting at least one of the user-selectable symbols corresponding to at least one of the second devices and user interaction with the display specifying an action and, based thereon, initiating a phone call or phone conference with the at least one second device.

38. (New) The system of claim 13, wherein the message from the second device is a Short Message Service (SMS) message or a text message.

39. (New) The system of claim 13, wherein participating in the group further includes sending first status information to the server and receiving second status information from the server, the first status information comprising a battery level of the first device and/or a signal strength of a wireless signal of the first device, the second location information comprising a plurality of battery levels of the respective plurality of second devices included in the group and/or a plurality of signal strengths of wireless signals of the respective plurality of second devices included in the group.

40. (New) The system of claim 13, wherein the first device is a smart phone.

41. (New) The system of claim 13, wherein the operations further include:
with the first device, transmitting a group identifier associated with a second group, the second group including a second plurality of second devices; and
based on transmitting the group identifier associated with the second group, participating in the second group, wherein participating in the second group includes receiving third location

information from the server, the third location information comprising a plurality of locations of the respective second plurality of second devices included in the second group.

42. (New) The system of claim 13, wherein the data includes a voice recording.

REMARKS

Claims 1-5, 7-17, and 19-30 were pending. In the present Amendment, claims 1-2, 5, 8-14, 17, and 20-24 are amended, claims 3-4, 7, 15-16, 19, and 25-30 are canceled without prejudice or disclaimer, and new claims 31-42 are added.

No new matter is added. Support for the claims amendments and new claims can be found, for example, in the claims as originally filed, and in U.S. Patent No. 7,630,724 (e.g., in the Abstract; in col. 3:32-35, 3:42-51, 3:58-63, 6:1-23, 6:44-59, 9:31-47, 10:56-11:15, 12:12-62, 14:60-67, 15:7-16, and 17:45-51; and in FIG. 4). It is noted that the '724 patent was incorporated by reference into the present application at the time of the present application's filing.

Applicability of Post-AIA Provisions of the Patent Laws to the Present Application

The present application claims the benefit of U.S. Application No. 14/529,978, which contains or contained a claim having an effective filing date on or after March 16, 2013. Accordingly, it is understood that the present application will be examined under the post-AIA, first-to-file provisions of the patent laws. See MPEP 2159.02 (March 2014).

In the Application Data Sheet (ADS) filed on February 27, 2015, prior counsel asserted that the present application (1) claims priority to or the benefit of an application filed before March 16, 2013 and (2) also contains, or contained at any time, a claim to a claimed invention that has an effective filing date on or after March 16, 2013. This assertion is withdrawn. Since the present application claims the benefit of an earlier transition application in which a 37 CFR 1.55 or 37 CFR 1.78 statement has been filed, the Applicant is not required to (and does not) express any opinion as to whether the present application contains (or ever contained) such a claim. See MPEP 2159.04 (March 2014).

Rescission of Nonpublication Request

A Rescission of Previous Nonpublication Request is filed herewith. In addition, it is noted that the Nonpublication Request filed on February 27, 2015, may have been improper, because an international application (PCT/US2005/033384) claiming priority to U.S. Application No. 10/711,490 ("the '490 application") was filed prior to the filing of the present application, and the '490 application is included in the priority claim of the present application.

Amendments to the Specification

The specification is amended herein to correct an error in the priority claim. In particular, the priority claim has been corrected to indicate that the U.S. Application No. 14/529,978 is a continuation-in-part (rather than a continuation) of U.S. Application No. 14/027,410. The same correction is included in the Corrected Application Data Sheet (ADS) filed herewith. MPEP § 211.03 states that no petition or surcharge is required for correcting a timely submitted benefit claim to correct the indicated relationship between applications from “continuation” to “continuation-in-part.” Accordingly, entry of the correction and issuance of an updated Filing Receipt are respectfully requested.

In addition, for the Examiner’s benefit, it is noted that a Petition to Accept an Unintentionally Delayed Priority Claim Under 35 U.S.C. § 120 was filed in U.S. Patent No. 8,364,129 (“the ‘129 patent”) on September 21, 2015. The present application claims priority to the ‘129 patent, and claims priority through the ‘129 patent to other issued patents identified in the Petition. A copy of the Petition is filed herewith, for the Examiner’s reference.

Claim Objections

The Office Action objected to informalities in claims 7 and 19, which have been canceled. Accordingly, these objections are moot.

Claim Rejections Under 35 U.S.C. §§ 102 and 103

In the Office Action, independent claims 1 and 13 were rejected under 35 U.S.C. § 102 as purportedly being anticipated by U.S. Pub. No. 2004/0148090 (“Melen”). Each of the dependent claims was rejected under 35 U.S.C. § 102 as purportedly being anticipated by Melen, or under 35 U.S.C. § 103 as purportedly being obvious over Melen in view of U.S. Patent No. 7,593,740 (“Crowley”) or U.S. Pub. No. 2006/0047825 (“Steenstra”). These rejections are respectfully traversed as applied to the claims, as amended.

I. Independent Claim 1 and the Claims Depending Therefrom

As amended, independent claim 1 is directed to a method comprising:

with a first device, receiving a message from a second device, wherein the message relates to joining a group;

based on receiving the message from the second device, participating in the group, wherein participating in the group includes sending first location information to a server and receiving second location information from the server, the first location information comprising a location of the first device, the second location information comprising a plurality of locations of a respective plurality of second devices included in the group;

presenting, via an interactive display of the first device, an interactive map comprising a plurality of user-selectable symbols corresponding to the plurality of second devices, wherein the symbols are positioned on the map at respective positions corresponding to the locations of the second devices; and

identifying user interaction with the interactive map selecting one or more of the user-selectable symbols corresponding to one or more of the second devices and user interaction with the display specifying an action and, based thereon, sending data to the one or more second devices via the server. (Emphasis added.)

Melen does not teach at least “with a first device, receiving a message from a second device, wherein the message relates to joining a group” and “based on receiving the message from the second device, participating in the group, wherein participating in the group includes sending first location information to a server and receiving second location information from the server,” as recited in claim 1. Melen describes “vehicle navigation systems” that are said to be “capable of communicating with one another,” establishing a group, and “displaying the location of other vehicle navigation systems in the group” (Abstract). None of Melen’s techniques for establishing a group suggests the above-emphasized portion of claim 1.

Regarding the establishment of groups, Melen describes a process 504a:

[0071] FIG. 6A is a flowchart illustrating the step 504a of establishing a group of members according to a first embodiment of the present invention. The step 504a of FIG. 6A establishes the group of members by cooperation of the vehicle navigation system 300a and the vehicle network server 102 and is used with the group interaction system 100a described in FIG. 1A.

[0072] Referring to FIG. 6A, as the process begins 502, the vehicle navigation system 300a receives 604 selection of the members to be included in the group. Such selection of members may be input by using the touch sensitive screen 301 or the input device 302. ***The vehicle navigation system 300a transmits 606 such selection of group members to the vehicle network server 102. The vehicle network server 102 establishes 608 communications with the selected group members and requests 610 each selected member for permission to add the member to the group.*** Then, the vehicle network server 102 transmits 612 the results of the requests 610 back to the vehicle navigation system 300a. Thereafter, the vehicle network server 300a adds 614 the members giving permission to the enabled group. This group information may be shared with other

members of the group. To this end, the vehicle navigation system 300a transmits 616 the established group information to the vehicle navigation system 102, and the vehicle navigation system 102 in turn transmits 618 such established group information to the members of the group, and the process continues with step 506. (Emphasis added.)

In the process 504a, a server 102 communicates with a first navigation system 300 to add the first navigation system 300 to a group at the request of a second navigation system 300, but the first and second navigation systems do not communicate with each other until the server adds the first navigation system 300 to the group. The above-quoted passage of Melen therefore does not teach “with a first device, receiving a message from a second device, wherein the message relates to joining a group” and “based on receiving the message from the second device, participating in the group, wherein participating in the group includes sending first location information to a server and receiving second location information from the server,” as recited in claim 1.

Regarding the establishment of groups, Melen also describes a process 504b:

[0073] FIG. 6B is a flowchart illustrating step 504b of establishing a group of members according to a second embodiment of the present invention. The step 504b of FIG. 6B establishes the group of members in the vehicle network server 102 using information downloaded from an external source and downloads the group information to the vehicle navigation systems 300a.

[0074] Referring to FIG. 6B, as the process begins 502, the vehicle network server 102 receives 632 a list of members from an external source. For example, the vehicle network server 102 may download the list of members of the group from an Internet web server via its data communication module 212. As another example, a live operator may manually input the list of members of the group by using the input keys 204. The vehicle network server 102 establishes 634 the group of members for interaction by using the received list of members. Then, the vehicle network server 102 downloads 636 the established group information to the vehicle navigation systems 300a, 300b, 300c in the group, and the process continues with step 506.

In the process 504b, a list of group members is downloaded to a server 102 or keyed into the server, and the group is established by downloading the group information from the server 102 to the navigation systems 300 in the group. The above-quoted passage of Melen therefore does not teach “with a first device, receiving a message from a second device, wherein the message relates to joining a group” and “based on receiving the message from the second device, participating in the group, wherein participating in the group includes sending first location

information to a server and receiving second location information from the server,” as recited in claim 1.

For at least the foregoing reasons, Melen does not teach at least the above-emphasized limitations of claim 1. Claim 1 therefore patentably distinguishes over Melen. Withdrawal of the rejection of claim 1 under 35 U.S.C. § 102 is respectfully requested. Claims 2, 5, and 8-12 depend from claim 1 and are allowable for at least the same reasons. Withdrawal of the rejections of claims 2, 5, and 8-12 is respectfully requested. New claims 31-36 depend from claim 1 and are allowable for at least the same reasons.

II. Independent Claim 13 and the Claims Depending Therefrom

As amended, independent claim 13 is directed to a system comprising a first device programmed to perform operations comprising:

receiving a message from a second device, wherein the message relates to joining a group;

based on receiving the message from the second device, participating in the group, wherein participating in the group includes sending first location information to a server and receiving second location information from the server, the first location information comprising a location of the first device, the second location information comprising a plurality of locations of a respective plurality of second devices included in the group;

presenting, via an interactive display of the first device, an interactive map comprising a plurality of user-selectable symbols corresponding to the plurality of second devices, wherein the symbols are positioned on the map at respective positions corresponding to the locations of the second devices; and

identifying user interaction with the interactive map selecting one or more of the user-selectable symbols corresponding to one or more of the second devices and user interaction with the display specifying an action and, based thereon, sending data to the one or more second devices via the server. (Emphasis added.)

For reasons that should be apparent from the discussion above, Melen does not teach at least the above-emphasized limitations of claim 13. Claim 13 therefore patentably distinguishes over Melen. Withdrawal of the rejection of claim 13 under 35 U.S.C. § 102 is respectfully requested. Claims 14, 17, and 20-24 depend from claim 13 and are allowable for at least the same reasons. Withdrawal of the rejections of claims 14, 17, and 20-24 is respectfully requested. New claims 37-42 depend from claim 13 and are allowable for at least the same reasons.

CONCLUSION

The pending application is believed to be in condition for allowance. If, in the Examiner's opinion, further communication would expedite the favorable prosecution of the present application, the undersigned would welcome the opportunity to discuss any outstanding issues and to work with the Examiner toward placing the application in condition for allowance.

Respectfully submitted,

Dated: November 13, 2015

/Daniel J. Burns/
Daniel J. Burns
Registration No.: 50,222

Customer Number: 51414
Goodwin Procter LLP
Telephone: (650) 752-3100

Patent No.: 8,364,129
Application Serial No.: 12/761,533
Attorney Docket No.: 10963.3822
PATENT

IN THE UNITED STATES PATENT AND TRADEMARK OFFICE

Patent No. : 8,364,129 Issue Date: January 29, 2013
Application No. : 12/761,533 Filing Date: April 16, 2010
Title : **METHOD TO PROVIDE AD HOC AND PASSWORD
PROTECTED DIGITAL AND VOICE NETWORKS**

Mail Stop Petitions
Commissioner for Patents
P.O. Box 1450
Alexandria, VA 22313-1450

**PETITION TO ACCEPT
AN UNINTENTIONALLY DELAYED PRIORITY CLAIM UNDER 35 U.S.C. § 120**

In connection with the patent identified above, the Commissioner is respectfully petitioned to accept an unintentionally delayed priority claim under 35 U.S.C. § 120, pursuant to pre-AIA 37 C.F.R. § 1.78(a)(3).

The above-identified patent, U.S. Patent No. 8,364,129 (“the ‘129 patent”), issued on January 29, 2013, from U.S. Patent Application Serial No. 12/761,533 (“the ‘533 application”), which was filed on April 16, 2010. As originally filed, the ‘533 application claimed benefit under 35 U.S.C. § 120 as a continuation-in-part of U.S. Patent Application Serial No. 11/615,472, filed December 22, 2006. On May 13, 2014, a Request for Certificate of Correction of the ‘129 patent was filed, requesting that the first paragraph of the ‘129 patent be corrected to list the complete continuity data of the ‘129 patent, and on July 29, 2014, the requested Certificate of Correction was granted. The Certificate of Correction and the Request for Certificate of Correction include the following reference, as required by 35 U.S.C. § 120 and pre-AIA 37 C.F.R. § 1.78(a)(2):

CROSS-REFERENCE TO RELATED APPLICATIONS

This application is a continuation-in-part of U.S. Patent Application Serial No. 11/615,472 filed on December 22, 2006, now U.S. Patent No. 8,126,441 issued February 28, 2012, which is a continuation-in-part of U.S. Patent Application Serial No. 11/308,648 filed April 17, 2006, now U.S. Patent No. 7,630,724 issued December 8, 2009, which is a continuation-in-part of U.S. Patent Application No. 10/711,490 filed September 21, 2004, now U.S. Patent No. 7,031,728 issued April 18, 2006.

The priority claim deadline under pre-AIA 37 C.F.R. § 1.78(a)(2) was August 16, 2010 (four months from the filing date of the '533 application). The entire delay between the priority claim deadline under pre-AIA 37 C.F.R. § 1.78(a)(2) (i.e., August 16, 2010) and the date of filing the priority claim (i.e., May 13, 2014), was unintentional.

As required under pre-AIA 37 C.F.R. § 1.78(a)(3), submitted herewith are:

1. Authorization to charge the amount of \$850 to Deposit Account 13-1130, to cover the fee set forth in pre-AIA 37 C.F.R. § 1.17(t); and
2. The foregoing statement that the entire delay between the date the priority claim was due under 37 C.F.R. § 1.78(a)(2) and the date the claim was filed was unintentional.

As indicated above, the reference required by 35 U.S.C. § 120 and pre-AIA 37 C.F.R. § 1.78(a)(2) was previously submitted on May 13, 2014, in a Request for Certificate of Correction, which was subsequently granted.

The Commissioner is hereby authorized to charge any additional fees or credit any overpayments to Deposit Account 13-1130.

If the Office believes that a telephone conversation with the undersigned would expedite the granting of this petition, the Office is cordially invited to call the undersigned at (954) 763-3303.

Respectfully submitted,

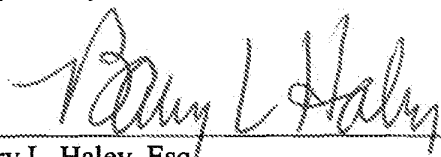

Barry L. Haley, Esq.
Reg. No. 25,339

Date: September 21, 2015

Customer Number 22235
MALIN HALEY DiMAGGIO & BOWEN, P.A.
1936 South Andrews Avenue
Fort Lauderdale, Florida 33316
Telephone: (954) 763-3303
Facsimile: (954) 522-6507
E-Mail: info@mhdpatents.com

Under the Paperwork Reduction Act of 1995, no persons are required to respond to a collection of information unless it displays a valid OMB control number.

PATENT APPLICATION FEE DETERMINATION RECORD Substitute for Form PTO-875	Application or Docket Number 14/633,804	Filing Date 02/27/2015	<input type="checkbox"/> To be Mailed
---	---	----------------------------------	---------------------------------------

ENTITY: LARGE SMALL MICRO

APPLICATION AS FILED – PART I

FOR	NUMBER FILED	NUMBER EXTRA	RATE (\$)	FEE (\$)
<input type="checkbox"/> BASIC FEE (37 CFR 1.16(a), (b), or (c))	N/A	N/A	N/A	
<input type="checkbox"/> SEARCH FEE (37 CFR 1.16(k), (j), or (m))	N/A	N/A	N/A	
<input type="checkbox"/> EXAMINATION FEE (37 CFR 1.16(o), (p), or (q))	N/A	N/A	N/A	
TOTAL CLAIMS (37 CFR 1.16(i))	minus 20 = *	*	X \$ =	
INDEPENDENT CLAIMS (37 CFR 1.16(h))	minus 3 = *	*	X \$ =	
<input type="checkbox"/> APPLICATION SIZE FEE (37 CFR 1.16(s))	If the specification and drawings exceed 100 sheets of paper, the application size fee due is \$310 (\$155 for small entity) for each additional 50 sheets or fraction thereof. See 35 U.S.C. 41(a)(1)(G) and 37 CFR 1.16(s).			
<input type="checkbox"/> MULTIPLE DEPENDENT CLAIM PRESENT (37 CFR 1.16(j))				
* If the difference in column 1 is less than zero, enter "0" in column 2.			TOTAL	

APPLICATION AS AMENDED – PART II

	(Column 1)	(Column 2)	(Column 3)	(Column 3)	RATE (\$)	ADDITIONAL FEE (\$)
AMENDMENT	11/13/2015	CLAIMS REMAINING AFTER AMENDMENT	HIGHEST NUMBER PREVIOUSLY PAID FOR	PRESENT EXTRA		
	Total (37 CFR 1.16(i))	* 28	Minus	** 28	= 0	x \$40 = 0
	Independent (37 CFR 1.16(h))	* 2	Minus	***4	= 0	x \$210 = 0
	<input type="checkbox"/> Application Size Fee (37 CFR 1.16(s))					
	<input type="checkbox"/> FIRST PRESENTATION OF MULTIPLE DEPENDENT CLAIM (37 CFR 1.16(j))					
					TOTAL ADD'L FEE	0

	(Column 1)	(Column 2)	(Column 3)	(Column 3)	RATE (\$)	ADDITIONAL FEE (\$)
AMENDMENT		CLAIMS REMAINING AFTER AMENDMENT	HIGHEST NUMBER PREVIOUSLY PAID FOR	PRESENT EXTRA		
	Total (37 CFR 1.16(i))	*	Minus	**	=	X \$ =
	Independent (37 CFR 1.16(h))	*	Minus	***	=	X \$ =
	<input type="checkbox"/> Application Size Fee (37 CFR 1.16(s))					
	<input type="checkbox"/> FIRST PRESENTATION OF MULTIPLE DEPENDENT CLAIM (37 CFR 1.16(j))					
					TOTAL ADD'L FEE	

* If the entry in column 1 is less than the entry in column 2, write "0" in column 3.
 ** If the "Highest Number Previously Paid For" IN THIS SPACE is less than 20, enter "20".
 *** If the "Highest Number Previously Paid For" IN THIS SPACE is less than 3, enter "3".

The "Highest Number Previously Paid For" (Total or Independent) is the highest number found in the appropriate box in column 1.

LIE
 /ANTHONY WILLIAMS/

This collection of information is required by 37 CFR 1.16. The information is required to obtain or retain a benefit by the public which is to file (and by the USPTO to process) an application. Confidentiality is governed by 35 U.S.C. 122 and 37 CFR 1.14. This collection is estimated to take 12 minutes to complete, including gathering, preparing, and submitting the completed application form to the USPTO. Time will vary depending upon the individual case. Any comments on the amount of time you require to complete this form and/or suggestions for reducing this burden, should be sent to the Chief Information Officer, U.S. Patent and Trademark Office, U.S. Department of Commerce, P.O. Box 1450, Alexandria, VA 22313-1450. DO NOT SEND FEES OR COMPLETED FORMS TO THIS ADDRESS. **SEND TO: Commissioner for Patents, P.O. Box 1450, Alexandria, VA 22313-1450.**

If you need assistance in completing the form, call 1-800-PTO-9199 and select option 2.



UNITED STATES PATENT AND TRADEMARK OFFICE

UNITED STATES DEPARTMENT OF COMMERCE
United States Patent and Trademark Office
Address: COMMISSIONER FOR PATENTS
P.O. Box 1450
Alexandria, Virginia 22313-1450
www.uspto.gov

Table with 4 columns: APPLICATION NUMBER (14/633,804), FILING OR 371(C) DATE (02/27/2015), FIRST NAMED APPLICANT (Malcolm K. Beyer JR.), ATTY. DOCKET NO./TITLE (MOC-005)

CONFIRMATION NO. 8573

22235
Malin Haley DiMaggio & Bowen, P.A.
1936 S ANDREWS AVENUE
FORT LAUDERDALE, FL 33316

NONPUBLICATION RESCISSION LETTER



Date Mailed: 11/19/2015

Communication Regarding Rescission Of Nonpublication Request and/or Notice of Foreign Filing

Applicant's rescission of the previously-filed nonpublication request and/or notice of foreign filing is acknowledged. The paper has been reflected in the Patent and Trademark Office's (USPTO's) computer records so that the earliest possible projected publication date can be assigned.

The projected publication date is 02/25/2016.

If applicant rescinded the nonpublication request before or on the date of "foreign filing,"¹ then no notice of foreign filing is required.

If applicant foreign filed the application after filing the above application and before filing the rescission, and the rescission did not also include a notice of foreign filing, then a notice of foreign filing (not merely a rescission) is required to be filed within 45 days of the date of foreign filing. See 35 U.S.C. § 122(b)(2)(B)(iii), and Clarification of the United States Patent and Trademark Office's Interpretation of the Provisions of 35 U.S.C. § 122(b)(2)(B)(ii)-(iv), 1272 Off. Gaz. Pat. Office 22 (July 1, 2003).

If a notice of foreign filing is required and is not filed within 45 days of the date of foreign filing, then the application becomes abandoned pursuant to 35 U.S.C. § 122(b)(2)(B)(iii). In this situation, applicant should either file a petition to revive or notify the Office that the application is abandoned. See 37 CFR 1.137(f). Any such petition to revive will be forwarded to the Office of Petitions for a decision. Note that the filing of the petition will not operate to stay any period of reply that may be running against the application.

Questions regarding petitions to revive should be directed to the Office of Petitions at (571) 272-3282.

¹ Note, for purpose of this notice, that "foreign filing" means "filing an application directed to the same invention in another country, or under a multilateral international agreement, that requires publication of applications 18 months after filing".

Questions about the contents of this notice and the requirements it sets forth should be directed to the Office of Data Management, Application Assistance Unit, at (571) 272-4000 or (571) 272-4200 or 1-888-786-0101.

/ctuazon/



UNITED STATES PATENT AND TRADEMARK OFFICE

UNITED STATES DEPARTMENT OF COMMERCE
United States Patent and Trademark Office
Address: COMMISSIONER FOR PATENTS
P.O. Box 1450
Alexandria, Virginia 22313-1450
www.uspto.gov

Table with 5 columns: APPLICATION NO., FILING DATE, FIRST NAMED INVENTOR, ATTORNEY DOCKET NO., CONFIRMATION NO.
14/633,804 02/27/2015 Malcolm K. Beyer JR. MOC-005 8573

22235 7590 12/10/2015
Malin Haley DiMaggio & Bowen, P.A.
1936 S ANDREWS AVENUE
FORT LAUDERDALE, FL 33316

Table with 1 column: EXAMINER

OBAYANJU, OMONIYI

Table with 2 columns: ART UNIT, PAPER NUMBER

2646

Table with 2 columns: NOTIFICATION DATE, DELIVERY MODE

12/10/2015

ELECTRONIC

Please find below and/or attached an Office communication concerning this application or proceeding.

The time period for reply, if any, is set in the attached communication.

Notice of the Office communication was sent electronically on above-indicated "Notification Date" to the following e-mail address(es):

info@mhdpatents.com

Office Action Summary	Application No. 14/633,804	Applicant(s) BEYER ET AL.	
	Examiner OMONIYI OBAYANJU	Art Unit 2646	AIA (First Inventor to File) Status No

-- The MAILING DATE of this communication appears on the cover sheet with the correspondence address --

Period for Reply

A SHORTENED STATUTORY PERIOD FOR REPLY IS SET TO EXPIRE 3 MONTHS FROM THE MAILING DATE OF THIS COMMUNICATION.

- Extensions of time may be available under the provisions of 37 CFR 1.136(a). In no event, however, may a reply be timely filed after SIX (6) MONTHS from the mailing date of this communication.
- If NO period for reply is specified above, the maximum statutory period will apply and will expire SIX (6) MONTHS from the mailing date of this communication.
- Failure to reply within the set or extended period for reply will, by statute, cause the application to become ABANDONED (35 U.S.C. § 133). Any reply received by the Office later than three months after the mailing date of this communication, even if timely filed, may reduce any earned patent term adjustment. See 37 CFR 1.704(b).

Status

- 1) Responsive to communication(s) filed on 11/13/2015.
 A declaration(s)/affidavit(s) under **37 CFR 1.130(b)** was/were filed on _____.
- 2a) This action is **FINAL**. 2b) This action is non-final.
- 3) An election was made by the applicant in response to a restriction requirement set forth during the interview on _____; the restriction requirement and election have been incorporated into this action.
- 4) Since this application is in condition for allowance except for formal matters, prosecution as to the merits is closed in accordance with the practice under *Ex parte Quayle*, 1935 C.D. 11, 453 O.G. 213.

Disposition of Claims*

- 5) Claim(s) 1,2,5,8-14,17,20-24 and 31-42 is/are pending in the application.
5a) Of the above claim(s) _____ is/are withdrawn from consideration.
- 6) Claim(s) _____ is/are allowed.
- 7) Claim(s) 1,2,5,8-14,17,20-24 and 31-42 is/are rejected.
- 8) Claim(s) _____ is/are objected to.
- 9) Claim(s) _____ are subject to restriction and/or election requirement.

* If any claims have been determined allowable, you may be eligible to benefit from the **Patent Prosecution Highway** program at a participating intellectual property office for the corresponding application. For more information, please see http://www.uspto.gov/patents/init_events/pph/index.jsp or send an inquiry to PPHfeedback@uspto.gov.

Application Papers

- 10) The specification is objected to by the Examiner.
- 11) The drawing(s) filed on _____ is/are: a) accepted or b) objected to by the Examiner.
Applicant may not request that any objection to the drawing(s) be held in abeyance. See 37 CFR 1.85(a).
Replacement drawing sheet(s) including the correction is required if the drawing(s) is objected to. See 37 CFR 1.121(d).

Priority under 35 U.S.C. § 119

- 12) Acknowledgment is made of a claim for foreign priority under 35 U.S.C. § 119(a)-(d) or (f).

Certified copies:

- a) All b) Some** c) None of the:
1. Certified copies of the priority documents have been received.
2. Certified copies of the priority documents have been received in Application No. _____.
3. Copies of the certified copies of the priority documents have been received in this National Stage application from the International Bureau (PCT Rule 17.2(a)).

** See the attached detailed Office action for a list of the certified copies not received.

Attachment(s)

- 1) Notice of References Cited (PTO-892)
- 2) Information Disclosure Statement(s) (PTO/SB/08a and/or PTO/SB/08b)
Paper No(s)/Mail Date _____.
- 3) Interview Summary (PTO-413)
Paper No(s)/Mail Date. _____.
- 4) Other: _____.

The present application is being examined under the pre-AIA first to invent provisions.

DETAILED ACTION

Response to Arguments

Applicant's arguments filed 11/13/2015 have been fully considered but they are not persuasive.

In response to applicant's argument that the reference Melen (U.S. Pub. No. 20040148090) fails to show certain amended features of applicant's invention (i.e. with a first device, receiving a message from a second device, wherein the message relates to joining a group). Applicant further argued and/or stated that **"the first and second navigation systems do not communicate with each other until the server adds the first navigation system 300 to the group"**.

Examiner very kindly directs the Applicant to reference Richardson: **In fig. 1, and ¶ [0036] and [0038]**, discussed the concept of group interaction in a communication system. Melen further discussed and/or stated that the navigation systems are **capable of establishing groups of members and communicating wirelessly with other navigation systems without the use of a vehicle network server**. Therefore, in contrast to the Applicant's argument above, the claim does not uniquely and particularly define the limitations so as to distinguish from the applied prior art. During patent

Art Unit: 2646

examination, the claims must be given their broadest reasonable interpretation. See also MPEP §2111. The at least claimed limitation in question is broadly claimed, therefore, is fairly characterized as discussed in **fig. 1, and ¶ [0036]**. Therefore it is believed that Melen teaches the claim limitations.

In regards to the amended and/or new dependent claims, arguments are moot and new grounds of rejection are applied as set forth below.

Applicant(s) are reminded that the Examiner is entitled to give the broadest reasonable interpretation to the language of the claim. The Examiner is not limited to Applicant's definition, which is not specifically set fourth in the claims, *In re Tanaka et aL*, 193 USPQ 139, (CCPA) 1977. Therefore, the previous rejection is maintained.

Claim Rejections - 35 USC § 112

The following is a quotation of the first paragraph of 35 U.S.C. 112(a):

(a) IN GENERAL.—The specification shall contain a written description of the invention, and of the manner and process of making and using it, in such full, clear, concise, and exact terms as to enable any person skilled in the art to which it pertains, or with which it is most nearly connected, to make and use the same, and shall set forth the best mode contemplated by the inventor or joint inventor of carrying out the invention.

The following is a quotation of the first paragraph of pre-AIA 35 U.S.C. 112:

The specification shall contain a written description of the invention, and of the manner and process of making and using it, in such full, clear, concise, and exact terms as to enable any person skilled in the art to which it pertains, or with which it is most nearly connected, to make and use the same, and shall set forth the best mode contemplated by the inventor of carrying out his invention.

Claims 9, 12, 21, 24, 35, and 41, are rejected under 35 U.S.C. 112(a) or 35 U.S.C. 112 (pre-AIA), first paragraph, as failing to comply with the written description requirement. The claim(s) contains subject matter which was not described in the specification in such a way as to reasonably convey to one skilled in the relevant art that the inventor or a joint inventor, or for pre-AIA the inventor(s), at the time the application was filed, had possession of the claimed invention.

In **regards to claims 9 and 21**, the claims recited at least “**sending, from the first device**, a request **for a second map**, wherein the request specifies **a map location**; and receiving, from the server, the second map.” (Emphasis Added). Upon further review of the Applicant’s original specification of file, the limitations stated above were not mentioned, inconsistent, and/or not clearly described so as to be readily understood by one of ordinary skill in the art. The Applicant’s specification did not mention anything about second or different map, therefore it is unclear what how the first device request at least a different or second map. Also, it is unclear as to what “**a map location**” is according to the specification.

In **regards to claims 12 and 24**, the claims recites at least in part “sending, by the first device, updated location information comprising an updated location of the first device, **the updated location information being sent based on passage of a predetermined time interval since sending previous location** information comprising a previous location of the first device, **displacement of the first device by a predetermined distance relative to a previous location** of the first device, or both.” (Emphasis Added). Upon further review of the Applicant’s original specification of file,

the limitations stated above were not mentioned, inconsistent, and/or not clearly described so as to be readily understood by one of ordinary skill in the art. The Applicant's original specification merely stated that "*The hook application software determines that the stylus (or finger) is pointed close to or at the location of the symbol and puts a circle, square or other indication around the symbol indicating that amplification information concerning the symbol is to be displayed. The operator can hook entered tracks or his own track symbol and add data or change data associated with the indicated symbol. The hook application code then sends a message to the database application code to store the facility or **entity's updated data.***" Thus, the introduction of the newly amended limitations that were not supported and/or clearly described by the specification raises the issue of new matter.

In **regards to claims 35 and 41**, the claims recites at least in part "with the first device, **transmitting a group identifier associated with a second group**, the second group including a second plurality of second devices; and based on transmitting the group identifier associated with the second group, participating in the second group, wherein participating in **the second group includes receiving third location information** from the server, the third location information comprising a plurality of **locations of the respective second plurality of second devices** included in the second group." (Emphasis Added). The limitations stated above were not mentioned, inconsistent, and/or not clearly described so as to be readily understood by one of ordinary skill in the art. Upon reviewing the Applicant's original specification, the specification stated that "Units in an organization's chain of command typically have

instituted a method to establish voice communications between themselves for they know each other's cellular phone numbers, PTT cellular group identifiers and radio frequencies or channel numbers.” However, it's unclear how the claimed limitations above are supported by the specification so as to be readily understood by one of ordinary skill in the art. Also, it is unclear as to which part of the specification discussed the at least limitations of **receiving third location information** from the server, the third location information comprising a plurality of **locations of the respective second plurality of second devices**. Thus, the introduction of the newly amended limitations that were not supported and/or clearly described by the specification raises the issue of new matter.

Therefore, as discussed above, for examination purpose, the Examiner has given the claims its' broadest reasonable interpretation.

Claim Rejections - 35 USC § 102

The following is a quotation of the appropriate paragraphs of 35 U.S.C. 102 that form the basis for the rejections under this section made in this Office action:

A person shall be entitled to a patent unless –

(a)(2) the claimed invention was described in a patent issued under section 151, or in an application for patent published or deemed published under section 122(b), in which the patent or application, as the case may be, names another inventor and was effectively filed before the effective filing date of the claimed invention.

Claims 1, 2, 9, 13, 14, 21, 31, 32, 34-38, and 40-42, are rejected under 35 U.S.C. 102(a)(2) as being anticipated by Melen (US Publication No. 20040148090).

As to **claims 1 and 13**, Melen teaches a computer-implemented method comprising: with a first device, receiving a message from a second device, wherein the message relates to joining a group (**fig. 1B, and pp0036, establishing groups of members and communicating wirelessly with other navigation systems, and fig. 5, #504**); based on receiving the message from the second device, participating in the group, wherein participating in the group includes sending first location information to a server and receiving second location information from the server (**fig. 1A and fig. 1B, and fig. 5, #506, receive location of each member, and pp0038, transmit or receive GPS information**), the first location information comprising a location of the first device, the second location information comprising a plurality of locations of a respective plurality of second devices included in the group (**fig. 1A and fig. 1B, and fig. 5, #506, receive location of each member, and pp0038, transmit or receive GPS information**); presenting, via an interactive display of the first device, an interactive map comprising a plurality of user-selectable symbols corresponding to the plurality of second devices (**fig. 4, and pp0064, display icon of each car on map 406**), wherein the symbols are positioned on the map at respective positions corresponding to the locations of the second devices (**fig. 4, and pp0064, display icon of each car on map 406**); and identifying user interaction with the interactive map selecting one or more of the user-selectable symbols corresponding to one or more of the second devices and

user interaction with the display specifying an action (**fig. 5, #509, #510, and pp0063, pp0070, touching icon to car**) and, based thereon, sending data to the one or more second devices via the server (**fig. 5, #512, and pp0063, pp0070, make a telephone call to the selected member, and pp0053**).

As to **claims 2 and 14**, Melen teaches wherein the data includes a short message service message, a text message, an image, or a video (**fig. 4, #404, and pp0029, pp0070, make a telephone call to the selected member**).

As to **claims 9 and 21**, Melen teaches further comprising: sending, from the first device, a request for a second map, wherein the request specifies a map location (**fig. 1B, fig. 4, each vehicle includes navigation system 300, fig. 5**); and receiving the second map (**fig. 1B, fig. 4, each vehicle includes navigation system 300, fig. 5**).

As to **claims 31 and 37**, Melen teaches further comprising identifying second user interaction with the interactive map selecting at least one of the user-selectable symbols corresponding to at least one of the second devices and user interaction with the display specifying an action (**fig. 5, #509, #510, and pp0063, pp0070, touching icon to car**) and, based thereon, initiating a phone call or phone conference with the at least one second device (**fig. 5, #509, #510, and pp0063, pp0070, touching icon to car, pp0077**).

As to **claims 32 and 38**, Melen teaches wherein the message from the second device is a Short Message Service (SMS) message or a text message (**fig. 4, #404, and pp0029, pp0070, make a telephone call to the selected member**).

As to **claims 34 and 40**, Melen teaches wherein the first device is a smart phone (**pp0003, pp0027, cellular telephone communication**).

As to **claims 35 and 41**, Melen teaches further comprising: with the first device, transmitting a group identifier associated with a second group (**fig. 6, establish communication with selected group members by using identification information, transmit group information to members of group**), the second group including a second plurality of second devices; and based on transmitting the group identifier associated with the second group, participating in the second group (**fig. 6, establish communication with selected group members by using identification information, transmit group information to members of group**), wherein participating in the second group includes receiving third location information from the server, the third location information comprising a plurality of locations of the respective second plurality of second devices included in the second group (**fig. 6, establish communication with selected group members by using identification information, transmit group information to members of group, fig. 1A and fig. 1B, and fig. 5, #506, receive location of each member, and pp0038, transmit or receive GPS information**).

As to **claims 36 and 42**, Melen teaches wherein the data includes a voice recording (**pp0039, pp0040, voice data, voice mail service**).

Claim Rejections - 35 USC § 103

The following is a quotation of 35 U.S.C. 103 which forms the basis for all obviousness rejections set forth in this Office action:

A patent for a claimed invention may not be obtained, notwithstanding that the claimed invention is not identically disclosed as set forth in section 102 of this title, if the differences between the claimed invention and the prior art are such that the claimed invention as a whole would have been obvious before the effective filing date of the claimed invention to a person having ordinary skill in the art to which the claimed invention pertains. Patentability shall not be negated by the manner in which the invention was made.

Claims 8, 11, 20, and 23, are rejected under 35 U.S.C. 103 as being unpatentable over Melen (US Publication No. 20040148090) in view of Steenstra et al. (US Publication No. 20060047825).

As to **claims 8 and 20**, Melen teaches the limitations of the independent claims as discussed above. However, fails to explicitly teach wherein the first device is a personal digital assistant (PDA) or a personal computer (PC).

In an analogous field of endeavor, Steenstra teaches wherein the first device is a personal digital assistant (PDA) or a personal computer (PC) (fig. 5, pp0019). Thus it would have been obvious to one of ordinary skill in the art before the effective filing data of the claimed invention to combine the teachings of Melen with the teachings Streenstra to achieve the goal of efficiently and reliably creating and maintaining location based service social network in a communication system (Steenstra, pp0006).

As to **claims 11 and 23**, Melen in view of Steenstra teaches wherein the map is a satellite image, (**Steenstra, fig. 5, pp0027**).

Claims 5, 10, 17, and 22, are rejected under 35 U.S.C. 103 as being unpatentable over Melen (US Publication No. 20040148090) in view of Hymes (US Patent No. 8014763).

As to **claims 5 and 17**, Melen teaches the limitations of the independent claims as discussed above. Melen further discussed that users communicate or interact over the internet (**pp0046**). However, Melen fails to explicitly mention obtaining, by the first device, respective internet protocol addresses for the second devices.

In an analogous field of endeavor, Hymes teaches obtaining, by the first device, respective internet protocol addresses for the second devices (**fig. 6, group communication col. 16, lines 28-34, whenever one device makes a transmission to another device, regardless of whether that transmission is a broadcast to all nearby devices or a transmission addressed to one particular device, that transmission includes the unique address information of the sending device: a unique identification number (device ID#) and a network address (for example, telephone number, IP address, email address) and col. 29, lines 48-55**). Thus it would have been obvious to one of ordinary skill in the art at time invention was made to combine the teachings of Melen with the teachings of Hymes to achieve the goal of

efficiently and reliably improving and facilitating communication among users in communication system (**Hymes, col. 2, lines 1-15**).

As to **claims 10 and 22**, Melen in view of Hymes teaches wherein the first device does not have access to respective Internet Protocol addresses of the second devices (**pp0072, request permission**).

Claims 12 and 24 are rejected under 35 U.S.C. 103 as being unpatentable over Melen (US Publication No. 20040148090) in view of Tengler et al. (US Publication No. 20040252050).

As to **claims 12 and 24**, Melen teaches the limitations of independent claims as discussed above. Melen further teaches real time location tracking (**pp0033, real time tracking and receiving location, and pp0070**). However, did not explicitly teach sending, by the first device, updated location information comprising an updated location of the first device, the updated location information being sent based on passage of a predetermined time interval since sending previous location information comprising a previous location of the first device, displacement of the first device by a predetermined distance relative to a previous location of the first device, or both.

In an analogous field of endeavor, Tengler teaches sending, by the first device, updated location information comprising an updated location of the first device, the updated location information being sent based on passage of a predetermined time

interval since sending previous location information comprising a previous location of the first device, displacement of the first device by a predetermined distance relative to a previous location of the first device, or both (**fig. 1, and pp0023, pp0007, transmitting signal to update positional information of devices at a predetermined spaced time interval**). Thus it would have been obvious to one of ordinary skill in the art at time invention was made to combine the teachings of Melen with the teachings Tengler to achieve the goal of efficiently and reliably monitoring and/or tracking the location of plurality of devices in a communication system (**Tengler, pp0008**).

Claims 33 and 39 are rejected under 35 U.S.C. 103 as being unpatentable over Melen (US Publication No. 20040148090) in view of Levy et al. (US Publication No. 20050130666).

As to **claims 33 and 39**, Melen teaches the limitations of independent claims as discussed above. However, fails to explicitly teach wherein participating in the group further includes sending first status information to the server and receiving second status information from the server, the first status information comprising a battery level of the first device and/or a signal strength of a wireless signal of the first device, the second location information comprising a plurality of battery levels of the respective plurality of second devices included in the group and/or a plurality of signal strengths of wireless signals of the respective plurality of second devices included in the group.

In an analogous field of endeavor, Levy teaches wherein participating in the group further includes sending first status information to the server and receiving second status information from the server, the first status information comprising a battery level of the first device (**fig. 1 and pp0042, transmitting the condition of battery level between different mobile unit**) and/or a signal strength of a wireless signal of the first device, the second location information comprising a plurality of battery levels of the respective plurality of second devices included in the group and/or a plurality of signal strengths of wireless signals of the respective plurality of second devices included in the group (**fig. 1 and pp0042, transmitting the condition of battery level between different mobile unit**). Thus it would have been obvious to one of ordinary skill in the art at time invention was made to combine the teachings of Melen with the teachings Levy to achieve the goal of efficiently and reliably exchanging particular conditions of the operational parameters of communication devices in a communication system (**Levy, pp0008**).

Conclusion

Applicant's amendment necessitated the new ground(s) of rejection presented in this Office action. Accordingly, **THIS ACTION IS MADE FINAL**. See MPEP § 706.07(a). Applicant is reminded of the extension of time policy as set forth in 37 CFR 1.136(a).

A shortened statutory period for reply to this final action is set to expire **THREE MONTHS** from the mailing date of this action. In the event a first reply is

filed within TWO MONTHS of the mailing date of this final action and the advisory action is not mailed until after the end of the THREE-MONTH shortened statutory period, then the shortened statutory period will expire on the date the advisory action is mailed, and any extension fee pursuant to 37 CFR 1.136(a) will be calculated from the mailing date of the advisory action. In no event, however, will the statutory period for reply expire later than SIX MONTHS from the date of this final action.

Any inquiry concerning this communication or earlier communications from the examiner should be directed to OMONIYI OBAYANJU whose telephone number is (571)270-5885. The examiner can normally be reached on Mon - Fri, 7:30 - 5:00PM.

If attempts to reach the examiner by telephone are unsuccessful, the examiner's supervisor, KAMRAN AFSHAR can be reached on 571-272-7796. The fax phone number for the organization where this application or proceeding is assigned is 571-273-8300.

Information regarding the status of an application may be obtained from the Patent Application Information Retrieval (PAIR) system. Status information for published applications may be obtained from either Private PAIR or Public PAIR. Status information for unpublished applications is available through Private PAIR only. For more information about the PAIR system, see <http://pair-direct.uspto.gov>. Should you have questions on access to the Private PAIR system, contact the Electronic Business Center (EBC) at 866-217-9197 (toll-free). If you would like assistance from a USPTO Customer Service Representative or access to the automated information system, call 800-786-9199 (IN USA OR CANADA) or 571-272-1000.

/OMONIYI OBAYANJU/
Primary Examiner, Art Unit 2646

Notice of References Cited	Application/Control No. 14/633,804	Applicant(s)/Patent Under Reexamination BEYER ET AL.	
	Examiner OMONIYI OBAYANJU	Art Unit 2646	Page 1 of 1

U.S. PATENT DOCUMENTS

*	Document Number Country Code-Number-Kind Code	Date MM-YYYY	Name	CPC Classification	US Classification
*	A US-2004/0252050 A1	12-2004	Tengler, Steven C.	G01S5/0072	342/357.31
*	B US-2005/0130666 A1	06-2005	Levy, Rami C.	H04W8/24	455/452.2
*	C US-8,014,763 B2	09-2011	Hymes; Charles Martin	H04M1/26	455/414.2
	D US-				
	E US-				
	F US-				
	G US-				
	H US-				
	I US-				
	J US-				
	K US-				
	L US-				
	M US-				

FOREIGN PATENT DOCUMENTS

*	Document Number Country Code-Number-Kind Code	Date MM-YYYY	Country	Name	CPC Classification
	N				
	O				
	P				
	Q				
	R				
	S				
	T				

NON-PATENT DOCUMENTS

*	Document Number Country Code-Number-Kind Code	Date MM-YYYY	Country	Name	CPC Classification
	Include as applicable: Author, Title Date, Publisher, Edition or Volume, Pertinent Pages)				
	U				
	V				
	W				
	X				

*A copy of this reference is not being furnished with this Office action. (See MPEP § 707.05(a).)
Dates in MM-YYYY format are publication dates. Classifications may be US or foreign.

Search Notes 	Application/Control No. 14633804	Applicant(s)/Patent Under Reexamination BEYER ET AL.
	Examiner OMONIYI OBAYANJU	Art Unit 2646

CPC- SEARCHED		
Symbol	Date	Examiner
H04W4/02	8/10/2015	OO

CPC COMBINATION SETS - SEARCHED		
Symbol	Date	Examiner

US CLASSIFICATION SEARCHED			
Class	Subclass	Date	Examiner
455	404.2, 456.1	8/10/2015	OO

SEARCH NOTES		
Search Notes	Date	Examiner
See Attached East Search History	8/10/2015	OO
See Attached East Search History (Updated)	12/8/2015	OO

INTERFERENCE SEARCH			
US Class/ CPC Symbol	US Subclass / CPC Group	Date	Examiner

--	--

EAST Search History

EAST Search History (Prior Art)

Ref #	Hits	Search Query	DBs	Default Operator	Plurals	Time Stamp
L6	22	"8014763"	US-PGPUB; USPAT; EPO; JPO; DERWENT; IBM_TDB	OR	ON	2015/12/08 05:14
S1	0	"14633804"	US-PGPUB; USPAT; EPO; JPO; DERWENT; IBM_TDB	OR	ON	2015/08/10 04:44
S2	1353	((track\$3 or monitor\$3 or display\$3 or view\$3) with (location or position) with ((other or different or another or second) near2 (device or terminal or apparatus or equipment or unit or component or ue or mt or station or phone or telephone))) same (map))	US-PGPUB; USPAT; EPO; JPO; DERWENT; IBM_TDB	OR	ON	2015/08/10 04:51
S3	84	((track\$3 or monitor\$3) with (location or position) with ((other or different or another or second) near2 (device or terminal or apparatus or equipment or unit or component or ue or mt or station or phone or telephone))) same ((display\$3 or view\$3) near5 (map)))	US-PGPUB; USPAT; EPO; JPO; DERWENT; IBM_TDB	OR	ON	2015/08/10 04:53
S4	11	S3 and (@ad<"20040921" or @pd<"20040921" or @rlad<"20040921")	US-PGPUB; USPAT; EPO; JPO; DERWENT; IBM_TDB	OR	ON	2015/08/10 04:54
S5	13	((track\$3 or monitor\$3) with (location or position) with ((other or different or another or second) near2 (vehicl\$5 or car or truck or auto or automobile or plane or aircraft or ship or boat))) same ((display\$3 or view\$3) near5 (map)))	US-PGPUB; USPAT; EPO; JPO; DERWENT; IBM_TDB	OR	ON	2015/08/10 05:19
S6	6	S5 and (@ad<"20040921" or @pd<"20040921" or @rlad<"20040921")	US-PGPUB; USPAT; EPO; JPO; DERWENT; IBM_TDB	OR	ON	2015/08/10 05:20
S7	320	((location or position) with ((other or different or another or second) near2 (vehicl\$5 or car or truck or auto or automobile or plane or aircraft or ship or boat))) same ((display\$3 or view\$3) near5 (map)))	US-PGPUB; USPAT; EPO; JPO; DERWENT; IBM_TDB	OR	ON	2015/08/10 05:28
S8	117	S7 and (@ad<"20040921" or @pd<"20040921" or @rlad<"20040921")	US-PGPUB; USPAT; EPO; JPO; DERWENT;	OR	ON	2015/08/10 05:29

			IBM_TDB			
S9	111	S8 not S5	US-PGPUB; USPAT; EPO; JPO; DERWENT; IBM_TDB	OR	ON	2015/08/10 05:29
S10	181	((location or position) with ((other or different or another or second) adj2 (vehicl\$5 or car or truck or auto or automobile or plane or aircraft or ship or boat))) same ((display\$3 or view\$3) near5 (map)))	US-PGPUB; USPAT; EPO; JPO; DERWENT; IBM_TDB	OR	ON	2015/08/10 05:29
S11	47	S10 and (@ad<"20040921" or @pd<"20040921" or @rlad<"20040921")	US-PGPUB; USPAT; EPO; JPO; DERWENT; IBM_TDB	OR	ON	2015/08/10 05:30
S12	45	S11 not S5	US-PGPUB; USPAT; EPO; JPO; DERWENT; IBM_TDB	OR	ON	2015/08/10 05:30
S13	3	"20060047825"	US-PGPUB; USPAT; EPO; JPO; DERWENT; IBM_TDB	OR	ON	2015/08/10 08:58
S14	106	"7593740"	US-PGPUB; USPAT; EPO; JPO; DERWENT; IBM_TDB	OR	ON	2015/08/10 09:00
S15	1	beyer.inv. and (symbol and location and map and contact).clm.	US-PGPUB; USPAT; EPO; JPO; DERWENT; IBM_TDB	OR	ON	2015/08/10 09:32
S16	34	beyer.inv. and (symbol and location and map and contact)	US-PGPUB; USPAT; EPO; JPO; DERWENT; IBM_TDB	OR	ON	2015/08/10 09:33
S17	12	(beyer with malcolm).inv. and (symbol and location and map and contact)	US-PGPUB; USPAT; EPO; JPO; DERWENT; IBM_TDB	OR	ON	2015/08/10 09:34
S18	7	(advanced near3 ground).as. and (symbol and location and map and contact)	US-PGPUB; USPAT; EPO; JPO; DERWENT; IBM_TDB	OR	ON	2015/08/10 09:37
S19	0	S18 not S17	US-PGPUB; USPAT; EPO; JPO; DERWENT; IBM_TDB	OR	ON	2015/08/10 09:37
S20	20783	455/456.1	US-PGPUB; USPAT; EPO; JPO;	OR	ON	2015/08/10 10:00

			DERWENT; IBM_TDB			
S21	18188	h04w4/02.cpc.	US-PGPUB; USPAT; EPO; JPO; DERWENT; IBM_TDB	OR	ON	2015/08/10 10:00
S22	0	"14529978"	US-PGPUB; USPAT; EPO; JPO; DERWENT; IBM_TDB	OR	ON	2015/08/14 03:54
S23	0	"14695233"	US-PGPUB; USPAT; EPO; JPO; DERWENT; IBM_TDB	OR	ON	2015/08/14 03:55
S24	0	"14695251"	US-PGPUB; USPAT; EPO; JPO; DERWENT; IBM_TDB	OR	ON	2015/08/14 03:55
S25	0	"14633764"	US-PGPUB; USPAT; EPO; JPO; DERWENT; IBM_TDB	OR	ON	2015/08/14 03:57
S31	3	"20060047825"	US-PGPUB; USPAT; EPO; JPO; DERWENT; IBM_TDB	OR	ON	2015/08/17 23:59
S32	0	"14633804"	US-PGPUB; USPAT; EPO; JPO; DERWENT; IBM_TDB	OR	ON	2015/08/18 00:09
S34	153	"6377210"	US-PGPUB; USPAT; EPO; JPO; DERWENT; IBM_TDB	OR	ON	2015/12/03 03:15
S35	5229	((group or multiple or second or another or other or different) near4 (device or terminal or unit or component or apparatus) same (battery near2 (status or level or condition))	US-PGPUB; USPAT; EPO; JPO; DERWENT; IBM_TDB	OR	ON	2015/12/03 18:28
S36	1573	S35 and (@ad<"20040921" or @pd<"20040921" or @rlad<"20040921")	US-PGPUB; USPAT; EPO; JPO; DERWENT; IBM_TDB	OR	ON	2015/12/03 18:29
S37	467	((group) near4 (device or terminal or unit or component or apparatus) same (battery near2 (status or level or condition))	US-PGPUB; USPAT; EPO; JPO; DERWENT; IBM_TDB	OR	ON	2015/12/03 18:29
S38	116	S37 and (@ad<"20040921" or @pd<"20040921" or @rlad<"20040921")	US-PGPUB; USPAT; EPO; JPO;	OR	ON	2015/12/03 18:30

EAST Search History

			DERWENT; IBM_TDB			
S39	164	((multiple or second or another or other or different) near2 (device or terminal or unit or component or apparatus)) same ((exchang\$3 or transmit\$4 or send\$3 or obtain\$3 or retriev\$3 or receive or receiving) near3 (battery near2 (status or level or condition)))	US-PGPUB; USPAT; EPO; JPO; DERWENT; IBM_TDB	OR	ON	2015/12/03 18:43
S40	41	S39 and (@ad<"20040921" or @pd<"20040921" or @rlad<"20040921")	US-PGPUB; USPAT; EPO; JPO; DERWENT; IBM_TDB	OR	ON	2015/12/03 18:44
S41	41	S40 not S38	US-PGPUB; USPAT; EPO; JPO; DERWENT; IBM_TDB	OR	ON	2015/12/03 18:44
S42	119	"7593740"	US-PGPUB; USPAT; EPO; JPO; DERWENT; IBM_TDB	OR	ON	2015/12/08 02:02
S43	0	"14633804"	US-PGPUB; USPAT; EPO; JPO; DERWENT; IBM_TDB	OR	ON	2015/12/08 02:06

12/ 8/ 2015 5:26:10 AM

C:\Users\oobayanju\Documents\EAST Workspaces\14633804.wsp

Index of Claims 	Application/Control No. 14633804	Applicant(s)/Patent Under Reexamination BEYER ET AL.
	Examiner OMONIYI OBAYANJU	Art Unit 2646

✓	Rejected
=	Allowed

-	Cancelled
÷	Restricted

N	Non-Elected
I	Interference

A	Appeal
O	Objected

<input type="checkbox"/> Claims renumbered in the same order as presented by applicant		<input type="checkbox"/> CPA		<input type="checkbox"/> T.D.		<input type="checkbox"/> R.1.47			
CLAIM		DATE							
Final	Original	08/10/2015	12/08/2015						
	1	✓	✓						
	2	✓	✓						
	3	✓	-						
	4	✓	-						
	5	✓	✓						
	6	-	-						
	7	✓	-						
	8	✓	✓						
	9	✓	✓						
	10	✓	✓						
	11	✓	✓						
	12	✓	✓						
	13	✓	✓						
	14	✓	✓						
	15	✓	-						
	16	✓	-						
	17	✓	✓						
	18	-	-						
	19	✓	-						
	20	✓	✓						
	21	✓	✓						
	22	✓	✓						
	23	✓	✓						
	24	✓	✓						
	25	✓	-						
	26	✓	-						
	27	✓	-						
	28	✓	-						
	29	✓	-						
	30	✓	-						
	31		✓						
	32		✓						
	33		✓						
	34		✓						
	35		✓						
	36		✓						

<i>Index of Claims</i> 	Application/Control No. 14633804	Applicant(s)/Patent Under Reexamination BEYER ET AL.
	Examiner OMONIYI OBAYANJU	Art Unit 2646

✓	Rejected
=	Allowed

-	Cancelled
÷	Restricted

N	Non-Elected
I	Interference

A	Appeal
O	Objected

<input type="checkbox"/> Claims renumbered in the same order as presented by applicant		<input type="checkbox"/> CPA		<input type="checkbox"/> T.D.		<input type="checkbox"/> R.1.47			
CLAIM		DATE							
Final	Original	08/10/2015	12/08/2015						
	37		✓						
	38		✓						
	39		✓						
	40		✓						
	41		✓						
	42		✓						

POWER OF ATTORNEY TO PROSECUTE APPLICATIONS BEFORE THE USPTO

I hereby revoke all previous powers of attorney given in the application identified in the attached statement under 37 CFR 3.73(c).

I hereby appoint

Practitioners associated with the Customer Number:

051414

OR

Practitioner(s) named below (if more than ten patent practitioners are to be named, then a customer number must be used):

Name	Registration Number	Name	Registration Number

as attorney(s) or agent(s) to represent the undersigned before the United States Patent and Trademark Office (USPTO) in connection with any and all patent applications assigned only to the undersigned according to the USPTO assignment records or assignment documents attached to this form in accordance with 37 CFR 3.73(c).

Please change the correspondence address for the application identified in the attached statement under 37 CFR 3.73(c) to:

The address associated with Customer Number:

051414

OR

Firm or Individual Name

Address

City

State

Zip

Country

Telephone

Email

Assignee Name and Address:

Advanced Ground Information Systems, Inc.

A copy of this form, together with a statement under 37 CFR 3.73(c) (Form PTO/SB/98 or equivalent) is required to be filed in each application in which this form is used. The statement under 37 CFR 3.73(c) may be completed by one of the practitioners appointed in this form, and must identify the application in which this Power of Attorney is to be filed.

SIGNATURE of Assignee of Record

The individual whose signature and title is supplied below is authorized to act on behalf of the assignee.

Signature	<i>Malcolm K. Beyer, Jr.</i>	Date	April 17, 2015
Name	Malcolm K. Beyer, Jr.	Telephone	561 744 3213
Title	CEO/CHAIRMAN.		

Under the Paperwork Reduction Act of 1995, no persons are required to respond to a collection of information unless it displays a valid OMB control number.

STATEMENT UNDER 37 CFR 3.73(c)

Applicant/Patent Owner: Advanced Ground Information Systems, Inc.

Application No./Patent No.: 14/633,804 Filed/Issue Date: February 27, 2015

Titled: **METHOD TO PROVIDE AD HOC AND PASSWORD PROTECTED DIGITAL AND VOICE NETWORKS**

Advanced Ground Information Systems, Inc. a corporation
(Name of Assignee) (Type of Assignee, e.g., corporation, partnership, university, government agency, etc.)

states that, for the patent application/patent identified above, it is (choose **one** of options 1, 2, 3 or 4 below):

- 1. The assignee of the entire right, title, and interest.
- 2. An assignee of less than the entire right, title, and interest (check applicable box):
 - The extent (by percentage) of its ownership interest is _____ %. Additional Statement(s) by the owners holding the balance of the interest **must be submitted** to account for 100% of the ownership interest.
 - There are unspecified percentages of ownership. The other parties, including inventors, who together own the entire right, title and interest are:

Empty rectangular box for additional statements.

Additional Statement(s) by the owner(s) holding the balance of the interest **must be submitted** to account for the entire right, title, and interest.

- 3. The assignee of an undivided interest in the entirety (a complete assignment from one of the joint inventors was made). The other parties, including inventors, who together own the entire right, title, and interest are:

Empty rectangular box for additional statements.

Additional Statement(s) by the owner(s) holding the balance of the interest **must be submitted** to account for the entire right, title, and interest.

- 4. The recipient, via a court proceeding or the like (e.g., bankruptcy, probate), of an undivided interest in the entirety (a complete transfer of ownership interest was made). The certified document(s) showing the transfer is attached.

The interest identified in option 1, 2 or 3 above (not option 4) is evidenced by either (choose **one** of options A or B below):

- A. An assignment from the inventor(s) of the patent application/patent identified above. The assignment was recorded in the United States Patent and Trademark Office at Reel 037501 , Frame 0071 , or for which a copy thereof is attached.
- B. A chain of title from the inventor(s), of the patent application/patent identified above, to the current assignee as follows:
 - 1. From: _____ To: _____
The document was recorded in the United States Patent and Trademark Office at Reel _____ , Frame _____ , or for which a copy thereof is attached.
 - 2. From: _____ To: _____
The document was recorded in the United States Patent and Trademark Office at Reel _____ , Frame _____ , or for which a copy thereof is attached.

STATEMENT UNDER 37 CFR 3.73(c)

3. From: _____ To: _____

The document was recorded in the United States Patent and Trademark Office at
Reel _____, Frame _____, or for which a copy thereof is attached.

4. From: _____ To: _____

The document was recorded in the United States Patent and Trademark Office at
Reel _____, Frame _____, or for which a copy thereof is attached.

5. From: _____ To: _____

The document was recorded in the United States Patent and Trademark Office at
Reel _____, Frame _____, or for which a copy thereof is attached.

6. From: _____ To: _____

The document was recorded in the United States Patent and Trademark Office at
Reel _____, Frame _____, or for which a copy thereof is attached. Additional documents in the chain of title are listed on a supplemental sheet(s). As required by 37 CFR 3.73(c)(1)(i), the documentary evidence of the chain of title from the original owner to the assignee was, or concurrently is being, submitted for recordation pursuant to 37 CFR 3.11.

[NOTE: A separate copy (i.e., a true copy of the original assignment document(s)) must be submitted to Assignment Division in accordance with 37 CFR Part 3, to record the assignment in the records of the USPTO. See MPEP 302.08]

The undersigned (whose title is supplied below) is authorized to act on behalf of the assignee.

Signature /Daniel J. Burns/_____
Date January 20, 2016_____
Printed or Typed Name Daniel J. Burns_____
Title or Registration Number 50,222

Corrected Application Data Sheet

Inventor Information

Inventor Number::	1
Name Prefix::	Mr.
Given Name::	Malcolm
Middle Name::	K.
Family Name::	Beyer
Name Suffix::	Jr.
City of Residence::	Jupiter
State or Province of Residence::	FL
Country of Residence::	US
Street of mailing address::	92 Lighthouse Drive
City of mailing address::	Jupiter
State or Province of mailing address::	FL
Postal or Zip Code of mailing address::	33469

Inventor Number::	2
Name Prefix::	Mr.
Given Name::	Christopher
Middle Name::	R.
Family Name::	Rice
City of Residence::	Redmond
State or Province of Residence::	WA

Country of Residence:: US
Street of mailing address:: P.O. Box 3583
City of mailing address:: Redmond
State or Province of mailing address:: WA
Postal or Zip Code of mailing address:: 98073

Correspondence Information

Correspondence Customer Number:: 22235 051414
Email Address:: info@mhdpatents.com
patentbos@goodwinprocter.com

Application Information

Application Number:: 14/633,804
Filing Date:: 02/27/15
Application Type:: Regular
Subject Matter:: Utility
CD-ROM or CD-R?: None
Sequence submission?: None
Computer Readable Form (CRF)?:: No
Title:: METHOD TO PROVIDE AD HOC
AND PASSWORD PROTECTED
DIGITAL AND VOICE NETWORKS
Attorney Docket Number:: ~~10963-3835~~ MOC-005
Request for Early Publication?: No

Request for Non-Publication?::	No
Small Entity?::	No
Drawing Sheets::	7
Petition included?::	No
Portions or all of the application associated with this Application Data Sheet may fall under a Secrecy Order pursuant to 37 CFR 5.2::	No
Authorization to Permit Access to the Instant Application by the Participating Offices::	No

Representative Information

Representative Customer Number::	22235 <u>051414</u>
----------------------------------	--------------------------------

Domestic Priority Information

Prior Application Status::	Pending
Application Number::	14/695,233
Continuity Type::	Continuation of
Prior Application Number::	14/529,978
Filing Date::	10/31/2014
Prior Application Status::	Patented
Application Number::	14/529,978
Continuity Type::	Continuation in part of
Prior Application Number::	14/027,410

Filing Date:: 09/16/2013
Patent Number:: 8,880,042
Issue Date:: 11/04/2014

Prior Application Status:: Patented
Application Number:: 14/027,410
Continuity Type:: Continuation of
Prior Application Number:: 13/751,453
Filing Date:: 01/28/2013
Patent Number:: 8,538,393
Issue Date:: 09/17/2013

Prior Application Status:: Patented
Application Number:: 13/751,453
Continuity Type:: Continuation in part of
Prior Application Number:: 12/761,533
Filing Date:: 04/16/2010
Patent Number:: 8,364,129
Issue Date:: 01/29/2013

Prior Application Status:: Patented
Application Number:: 12/761,533
Continuity Type:: Continuation in part of
Prior Application Number:: 11/615,472

Filing Date:: 12/22/2006
Patent Number:: 8,126,441
Issue Date:: 02/28/2012

Prior Application Status:: Patented
Application Number:: 11/615,472
Continuity Type:: Continuation in part of
Prior Application Number:: 11/308,648
Filing Date:: 04/17/2006
Patent Number:: 7,630,724
Issue Date:: 12/08/2009

Prior Application Status:: Patented
Application Number:: 11/308,648
Continuity Type:: Continuation in part of
Prior Application Number:: 10/711,490
Filing Date:: 09/21/2004
Patent Number:: 7,031,728
Issue Date:: 04/18/2006

Foreign Priority Information

Applicant Information

Applicant Number:: 1

<u>Applicant Type::</u>	<u>Assignee</u>
<u>Organization Name::</u>	<u>Advanced Ground Information Systems, Inc.</u>
<u>Street of mailing address::</u>	<u>92 Lighthouse Drive</u>
<u>City of mailing address::</u>	<u>Jupiter</u>
<u>State or Province of mailing address::</u>	<u>FL</u>
<u>Postal or Zip Code of mailing address::</u>	<u>33469</u>

Assignee Information Including Non-Applicant Assignee Information

<u>Assignee::</u>	<u>1</u>
<u>Organization Name::</u>	<u>Advanced Ground Information Systems, Inc.</u>
<u>Street of mailing address::</u>	<u>92 Lighthouse Drive</u>
<u>City of mailing address::</u>	<u>Jupiter</u>
<u>State or Province of mailing address::</u>	<u>FL</u>
<u>Postal or Zip Code of mailing address::</u>	<u>33469</u>

Signature:

NOTE: This form must be signed in accordance with 37 CFR 1.33. See 37 CFR 1.4 for signature requirements and certifications.			
Signature	/Daniel J. Burns/	Date	January 20, 2016
Name	Daniel J. Burns	Registration Number	50,222

Electronic Acknowledgement Receipt

EFS ID:	24660668
Application Number:	14633804
International Application Number:	
Confirmation Number:	8573
Title of Invention:	METHOD TO PROVIDE AD HOC AND PASSWORD PROTECTED DIGITAL AND VOICE NETWORKS
First Named Inventor/Applicant Name:	Malcolm K. Beyer
Customer Number:	22235
Filer:	Daniel J. Burns/Deanna Bridges
Filer Authorized By:	Daniel J. Burns
Attorney Docket Number:	MOC-005
Receipt Date:	20-JAN-2016
Filing Date:	27-FEB-2015
Time Stamp:	13:03:57
Application Type:	Utility under 35 USC 111(a)

Payment information:

Submitted with Payment	no
------------------------	----

File Listing:

Document Number	Document Description	File Name	File Size(Bytes)/ Message Digest	Multi Part /.zip	Pages (if appl.)
1	Transmittal Letter	MOC-005_Transmittal.pdf	82545 ee18b791dd32cd938986f52450369e5087461291	no	1

Warnings:

Information:

2	Power of Attorney	MOC-005_POA.pdf	1406392 9388dec580c5f5386d2eed649b5445data0a1a6	no	1
Warnings:					
Information:					
3	Assignee showing of ownership per 37 CFR 3.73	MOC-005_3_73_Statement.pdf	88805 cc6f21981758b2ad7012c2ed61dc6d3ae50e5772	no	2
Warnings:					
Information:					
4	Application Data Sheet	MOC-005_Corrected_ADS.pdf	63934 0f0aae68ad715786d02407497a5cf07a803ebf22	no	6
Warnings:					
Information:					
This is not an USPTO supplied ADS fillable form					
Total Files Size (in bytes):			1641676		
<p>This Acknowledgement Receipt evidences receipt on the noted date by the USPTO of the indicated documents, characterized by the applicant, and including page counts, where applicable. It serves as evidence of receipt similar to a Post Card, as described in MPEP 503.</p> <p><u>New Applications Under 35 U.S.C. 111</u> If a new application is being filed and the application includes the necessary components for a filing date (see 37 CFR 1.53(b)-(d) and MPEP 506), a Filing Receipt (37 CFR 1.54) will be issued in due course and the date shown on this Acknowledgement Receipt will establish the filing date of the application.</p> <p><u>National Stage of an International Application under 35 U.S.C. 371</u> If a timely submission to enter the national stage of an international application is compliant with the conditions of 35 U.S.C. 371 and other applicable requirements a Form PCT/DO/EO/903 indicating acceptance of the application as a national stage submission under 35 U.S.C. 371 will be issued in addition to the Filing Receipt, in due course.</p> <p><u>New International Application Filed with the USPTO as a Receiving Office</u> If a new international application is being filed and the international application includes the necessary components for an international filing date (see PCT Article 11 and MPEP 1810), a Notification of the International Application Number and of the International Filing Date (Form PCT/RO/105) will be issued in due course, subject to prescriptions concerning national security, and the date shown on this Acknowledgement Receipt will establish the international filing date of the application.</p>					

Docket No.: MOC-005
(PATENT)

IN THE UNITED STATES PATENT AND TRADEMARK OFFICE

First Named Inventor:
Malcolm K. Beyer, Jr. et al.

Application No.: 14/633,804

Confirmation No.: 8573

Filed: February 27, 2015

Art Unit: 2646

For: METHOD TO PROVIDE AD HOC AND
PASSWORD PROTECTED DIGITAL AND
VOICE NETWORKS

Examiner: O. Obayanju

Commissioner for Patents
P.O. Box 1450
Alexandria, VA 22313-1450

TRANSMITTAL LETTER

In connection with the patent application identified above, the following are submitted:

- Statement Under 37 C.F.R. 3.73(c)
- Power of Attorney
- Corrected Application Data Sheet

It is hereby requested, under 37 C.F.R. 1.46(c), that the Applicant for the present application be changed to the Assignee, Advanced Ground Information Systems, Inc., as indicated in the enclosed Corrected Application Data Sheet.

The Director is hereby authorized to charge any deficiency in the fees filed, asserted to be filed or which should have been filed herewith to our Deposit Account No. 50-4634, under Order No. MOC-005.

Dated: January 20, 2016

Respectfully submitted,

Customer Number 051414
GOODWIN PROCTER LLP
Telephone: (650) 752-3137
Facsimile: (650) 853-1038

Electronic signature: /Daniel J. Burns/
Daniel J. Burns
Registration No.: 50,222

Under the Paperwork Reduction Act of 1995, no persons are required to respond to a collection of information unless it contains a valid OMB control number.

REQUEST FOR CONTINUED EXAMINATION(RCE)TRANSMITTAL (Submitted Only via EFS-Web)

Application Number	14/633,804	Filing Date	2015-02-27	Docket Number (if applicable)	MOC-005	Art Unit	2646
First Named Inventor	Malcolm K. Beyer, Jr.			Examiner Name	O. Obayanju		

This is a Request for Continued Examination (RCE) under 37 CFR 1.114 of the above-identified application.
 Request for Continued Examination (RCE) practice under 37 CFR 1.114 does not apply to any utility or plant application filed prior to June 8, 1995, to any international application that does not comply with the requirements of 35 U.S.C. 371, or to any design application. The Instruction Sheet for this form is located at WWW.USPTO.GOV.

SUBMISSION REQUIRED UNDER 37 CFR 1.114

Note: If the RCE is proper, any previously filed unentered amendments and amendments enclosed with the RCE will be entered in the order in which they were filed unless applicant instructs otherwise. If applicant does not wish to have any previously filed unentered amendment(s) entered, applicant must request non-entry of such amendment(s).

Previously submitted. If a final Office action is outstanding, any amendments filed after the final Office action may be considered as a submission even if this box is not checked.

Consider the arguments in the Appeal Brief or Reply Brief previously filed on _____

Other _____

Enclosed

Amendment/Reply

Information Disclosure Statement (IDS)

Affidavit(s)/ Declaration(s)

Other _____

MISCELLANEOUS

Suspension of action on the above-identified application is requested under 37 CFR 1.103(c) for a period of months _____
(Period of suspension shall not exceed 3 months; Fee under 37 CFR 1.17(i) required)

Other _____

FEES

The RCE fee under 37 CFR 1.17(e) is required by 37 CFR 1.114 when the RCE is filed.

The Director is hereby authorized to charge any underpayment of fees, or credit any overpayments, to
 Deposit Account No 504634

SIGNATURE OF APPLICANT, ATTORNEY, OR AGENT REQUIRED

Patent Practitioner Signature

Applicant Signature

Doc description: Request for Continued Examination (RCE)

Approved for use through 07/31/2016. OMB 0651-0031
U.S. Patent and Trademark Office; U.S. DEPARTMENT OF COMMERCE

Under the Paperwork Reduction Act of 1995, no persons are required to respond to a collection of information unless it contains a valid OMB control number.

Signature of Registered U.S. Patent Practitioner			
Signature	/Daniel J. Burns/	Date (YYYY-MM-DD)	2016-01-26
Name	Daniel J. Burns	Registration Number	50222

This collection of information is required by 37 CFR 1.114. The information is required to obtain or retain a benefit by the public which is to file (and by the USPTO to process) an application. Confidentiality is governed by 35 U.S.C. 122 and 37 CFR 1.11 and 1.14. This collection is estimated to take 12 minutes to complete, including gathering, preparing, and submitting the completed application form to the USPTO. Time will vary depending upon the individual case. Any comments on the amount of time you require to complete this form and/or suggestions for reducing this burden, should be sent to the Chief Information Officer, U.S. Patent and Trademark Office, U.S. Department of Commerce, P.O. Box 1450, Alexandria, VA 22313-1450.

If you need assistance in completing the form, call 1-800-PTO-9199 and select option 2.

Privacy Act Statement

The Privacy Act of 1974 (P.L. 93-579) requires that you be given certain information in connection with your submission of the attached form related to a patent application or patent. Accordingly, pursuant to the requirements of the Act, please be advised that: (1) the general authority for the collection of this information is 35 U.S.C. 2(b)(2); (2) furnishing of the information solicited is voluntary; and (3) the principal purpose for which the information is used by the U.S. Patent and Trademark Office is to process and/or examine your submission related to a patent application or patent. If you do not furnish the requested information, the U.S. Patent and Trademark Office may not be able to process and/or examine your submission, which may result in termination of proceedings or abandonment of the application or expiration of the patent.

The information provided by you in this form will be subject to the following routine uses:

1. The information on this form will be treated confidentially to the extent allowed under the Freedom of Information Act (5 U.S.C. 552) and the Privacy Act (5 U.S.C. 552a). Records from this system of records may be disclosed to the Department of Justice to determine whether the Freedom of Information Act requires disclosure of these records.
2. A record from this system of records may be disclosed, as a routine use, in the course of presenting evidence to a court, magistrate, or administrative tribunal, including disclosures to opposing counsel in the course of settlement negotiations.
3. A record in this system of records may be disclosed, as a routine use, to a Member of Congress submitting a request involving an individual, to whom the record pertains, when the individual has requested assistance from the Member with respect to the subject matter of the record.
4. A record in this system of records may be disclosed, as a routine use, to a contractor of the Agency having need for the information in order to perform a contract. Recipients of information shall be required to comply with the requirements of the Privacy Act of 1974, as amended, pursuant to 5 U.S.C. 552a(m).
5. A record related to an International Application filed under the Patent Cooperation Treaty in this system of records may be disclosed, as a routine use, to the International Bureau of the World Intellectual Property Organization, pursuant to the Patent Cooperation Treaty.
6. A record in this system of records may be disclosed, as a routine use, to another federal agency for purposes of National Security review (35 U.S.C. 181) and for review pursuant to the Atomic Energy Act (42 U.S.C. 218(c)).
7. A record from this system of records may be disclosed, as a routine use, to the Administrator, General Services, or his/her designee, during an inspection of records conducted by GSA as part of that agency's responsibility to recommend improvements in records management practices and programs, under authority of 44 U.S.C. 2904 and 2906. Such disclosure shall be made in accordance with the GSA regulations governing inspection of records for this purpose, and any other relevant (i.e., GSA or Commerce) directive. Such disclosure shall not be used to make determinations about individuals.
8. A record from this system of records may be disclosed, as a routine use, to the public after either publication of the application pursuant to 35 U.S.C. 122(b) or issuance of a patent pursuant to 35 U.S.C. 151. Further, a record may be disclosed, subject to the limitations of 37 CFR 1.14, as a routine use, to the public if the record was filed in an application which became abandoned or in which the proceedings were terminated and which application is referenced by either a published application, an application open to public inspections or an issued patent.
9. A record from this system of records may be disclosed, as a routine use, to a Federal, State, or local law enforcement agency, if the USPTO becomes aware of a violation or potential violation of law or regulation.

Electronic Patent Application Fee Transmittal

Application Number:	14633804			
Filing Date:	27-Feb-2015			
Title of Invention:	METHOD TO PROVIDE AD HOC AND PASSWORD PROTECTED DIGITAL AND VOICE NETWORKS			
First Named Inventor/Applicant Name:	Malcolm K. Beyer			
Filer:	Daniel J. Burns			
Attorney Docket Number:	MOC-005			
Filed as Small Entity				
Filing Fees for Utility under 35 USC 111(a)				
Description	Fee Code	Quantity	Amount	Sub-Total in USD(\$)
Basic Filing:				
Pages:				
Claims:				
Miscellaneous-Filing:				
Petition:				
Patent-Appeals-and-Interference:				
Post-Allowance-and-Post-Issuance:				
Extension-of-Time:				

Description	Fee Code	Quantity	Amount	Sub-Total in USD(\$)
Miscellaneous:				
Request for Continued Examination	2801	1	600	600
Total in USD (\$)				600

Electronic Acknowledgement Receipt

EFS ID:	24730774
Application Number:	14633804
International Application Number:	
Confirmation Number:	8573
Title of Invention:	METHOD TO PROVIDE AD HOC AND PASSWORD PROTECTED DIGITAL AND VOICE NETWORKS
First Named Inventor/Applicant Name:	Malcolm K. Beyer
Customer Number:	22235
Filer:	Daniel J. Burns
Filer Authorized By:	
Attorney Docket Number:	MOC-005
Receipt Date:	26-JAN-2016
Filing Date:	27-FEB-2015
Time Stamp:	20:06:06
Application Type:	Utility under 35 USC 111(a)

Payment information:

Submitted with Payment	yes
Payment Type	Credit Card
Payment was successfully received in RAM	\$600
RAM confirmation Number	5410
Deposit Account	504634
Authorized User	BURNS, DAN

The Director of the USPTO is hereby authorized to charge indicated fees and credit any overpayment as follows:

Charge any Additional Fees required under 37 CFR 1.21 (Miscellaneous fees and charges)

File Listing:

Document Number	Document Description	File Name	File Size(Bytes)/ Message Digest	Multi Part /.zip	Pages (if appl.)
1	Amendment/Req. Reconsideration-After Non-Final Reject	RESPONSETRANS.pdf	89722	no	1
			4e23650907a8a111a66d8d4074670efb33f df2e3		
Warnings:					
Information:					
2	Claims	RESPONSECLAIMS.pdf	101517	no	6
			8821065317e1a853aa913e941890757a705 341c7		
Warnings:					
Information:					
3	Miscellaneous Incoming Letter	INTERVIEWAGENDA.pdf	95874	no	3
			a22eac51869a62222f45cb73deadd82de5 cf7be		
Warnings:					
Information:					
4	Miscellaneous Incoming Letter	INTERVIEWAGENDA_EMAIL.pdf	144409	no	1
			aa446370100b567388c66258411d2f761b9 7045b		
Warnings:					
Information:					
5	Applicant Arguments/Remarks Made in an Amendment	RESPONSEARGUE.pdf	120920	no	8
			8609b732f9ddc2e59361c90d0481755fdb8 bcb90		
Warnings:					
Information:					
6	Request for Continued Examination (RCE)	RCE.pdf	92638	no	3
			5f63e9864becf5b5cef006a6cc1e90e1a85e 97c3		
Warnings:					
This is not a USPTO supplied RCE SB30 form.					
Information:					
7	Fee Worksheet (SB06)	fee-info.pdf	30675	no	2
			45a1574eeb99187e8729dcl3796cefd1f8 14e88		
Warnings:					
Information:					
Total Files Size (in bytes):			675755		

This Acknowledgement Receipt evidences receipt on the noted date by the USPTO of the indicated documents, characterized by the applicant, and including page counts, where applicable. It serves as evidence of receipt similar to a Post Card, as described in MPEP 503.

New Applications Under 35 U.S.C. 111

If a new application is being filed and the application includes the necessary components for a filing date (see 37 CFR 1.53(b)-(d) and MPEP 506), a Filing Receipt (37 CFR 1.54) will be issued in due course and the date shown on this Acknowledgement Receipt will establish the filing date of the application.

National Stage of an International Application under 35 U.S.C. 371

If a timely submission to enter the national stage of an international application is compliant with the conditions of 35 U.S.C. 371 and other applicable requirements a Form PCT/DO/EO/903 indicating acceptance of the application as a national stage submission under 35 U.S.C. 371 will be issued in addition to the Filing Receipt, in due course.

New International Application Filed with the USPTO as a Receiving Office

If a new international application is being filed and the international application includes the necessary components for an international filing date (see PCT Article 11 and MPEP 1810), a Notification of the International Application Number and of the International Filing Date (Form PCT/RO/105) will be issued in due course, subject to prescriptions concerning national security, and the date shown on this Acknowledgement Receipt will establish the international filing date of the application.

Docket No.: MOC-005
(PATENT)

IN THE UNITED STATES PATENT AND TRADEMARK OFFICE

First Named Inventor:
Malcolm K. Beyer, Jr.

Application No.: 14/633,804

Confirmation No.: 8573

Filed: February 27, 2015

Art Unit: 2646

For: METHOD TO PROVIDE AD HOC AND
PASSWORD PROTECTED DIGITAL AND
VOICE NETWORKS

Examiner: O. Obayanju

AMENDMENT FILED WITH REQUEST FOR CONTINUED EXAMINATION (RCE)

Mail Stop RCE
Commissioner for Patents
P.O. Box 1450
Alexandria, VA 22313-1450

INTRODUCTORY COMMENTS

In response to the Final Office Action dated December 10, 2015, please amend the above-identified U.S. patent application as follows:

Amendments to the Claims are reflected in the listing of claims which begins on page 2 of this paper.

Remarks/Arguments begin on page 8 of this paper.

AMENDMENTS TO THE CLAIMS

This listing of claims replaces all prior versions and listings of claims in the application:

Listing of Claims

1. (Currently amended) A computer-implemented method comprising:
 - with a first device, receiving a message from a second device, wherein the message relates to joining a group;
 - based on receiving the message from the second device, participating in the group, wherein participating in the group includes sending first location information to a server and receiving second location information from the server, the first location information comprising a location of the first device, the second location information comprising a plurality of locations of a respective plurality of second devices included in the group;
 - presenting, via an interactive display of the first device, an interactive map comprising a plurality of user-selectable symbols corresponding to the plurality of second devices, wherein the symbols are positioned on the map at respective positions corresponding to the locations of the second devices; and
 - identifying user interaction with the interactive map selecting one or more of the user-selectable symbols corresponding to one or more of the second devices and user interaction with the display specifying an action and, based thereon, sending using an Internet Protocol to send data to the one or more second devices via the server,
 - wherein the first device does not have access to respective Internet Protocol addresses of the second devices.

2. (Previously presented) The method of claim 1, wherein the data includes a short message service message, a text message, an image, or a video.

- 3-7. (Canceled)

8. (Previously presented) The method of claim 1, wherein the first device is a personal digital assistant (PDA) or a personal computer (PC).

9. (Previously presented) The method of claim 1, further comprising:
 - sending, from the first device, a request for a second map, wherein the request specifies a map location; and
 - receiving, from the server, the second map.

10. (Canceled)

11. (Previously presented) The method of claim 1, wherein the map is a satellite image.

12. (Previously presented) The method of claim 1, further comprising sending, by the first device, updated location information comprising an updated location of the first device, the updated location information being sent based on passage of a predetermined time interval since sending previous location information comprising a previous location of the first device, displacement of the first device by a predetermined distance relative to a previous location of the first device, or both.

13. (Currently amended) A system comprising:
 - a first device programmed to perform operations comprising:
 - receiving a message from a second device, wherein the message relates to joining a group;
 - based on receiving the message from the second device, participating in the group, wherein participating in the group includes sending first location information to a server and receiving second location information from the server, the first location information comprising a location of the first device, the second location information comprising a plurality of locations of a respective plurality of second devices included in the group;
 - presenting, via an interactive display of the first device, an interactive map comprising a plurality of user-selectable symbols corresponding to the plurality of second

devices, wherein the symbols are positioned on the map at respective positions corresponding to the locations of the second devices; and

identifying user interaction with the interactive map selecting one or more of the user-selectable symbols corresponding to one or more of the second devices and user interaction with the display specifying an action and, based thereon, sending using an Internet Protocol to send data to the one or more second devices via the server,

wherein the first device does not have access to respective Internet Protocol addresses of the second devices.

14. (Previously presented) The system of claim 13, wherein the data includes a short message service message, a text message, an image, or a video.

15-19. (Canceled)

20. (Previously presented) The system of claim 13, wherein the first device is a personal digital assistant (PDA) or a personal computer (PC).

21. (Previously presented) The system of claim 13, wherein the operations further comprise: sending a request for a second map, wherein the request specifies a map location; and receiving, from the server, the second map.

22. (Canceled)

23. (Previously presented) The system of claim 13, wherein the map is a satellite image.

24. (Previously presented) The system of claim 13, wherein the operations further comprise sending updated location information comprising an updated location of the first device, the updated location information being sent based on passage of a predetermined time interval since sending previous location information comprising a previous location of the first device,

displacement of the first device by a predetermined distance relative to a previous location of the first device, or both.

25-30. (Canceled)

31. (Previously presented) The method of claim 1, further comprising identifying second user interaction with the interactive map selecting at least one of the user-selectable symbols corresponding to at least one of the second devices and user interaction with the display specifying an action and, based thereon, initiating a phone call or phone conference with the at least one second device.

32. (Previously presented) The method of claim 1, wherein the message from the second device is a Short Message Service (SMS) message or a text message.

33. (Previously presented) The method of claim 1, wherein participating in the group further includes sending first status information to the server and receiving second status information from the server, the first status information comprising a battery level of the first device and/or a signal strength of a wireless signal of the first device, the second location information comprising a plurality of battery levels of the respective plurality of second devices included in the group and/or a plurality of signal strengths of wireless signals of the respective plurality of second devices included in the group.

34. (Previously presented) The method of claim 1, wherein the first device is a smart phone.

35. (Previously presented) The method of claim 1, further comprising:
with the first device, transmitting a group identifier associated with a second group, the second group including a second plurality of second devices; and
based on transmitting the group identifier associated with the second group, participating in the second group, wherein participating in the second group includes receiving third location

information from the server, the third location information comprising a plurality of locations of the respective second plurality of second devices included in the second group.

36. (Previously presented) The method of claim 1, wherein the data includes a voice recording.

37. (Previously presented) The system of claim 13, wherein the operations further comprise identifying second user interaction with the interactive map selecting at least one of the user-selectable symbols corresponding to at least one of the second devices and user interaction with the display specifying an action and, based thereon, initiating a phone call or phone conference with the at least one second device.

38. (Previously presented) The system of claim 13, wherein the message from the second device is a Short Message Service (SMS) message or a text message.

39. (Previously presented) The system of claim 13, wherein participating in the group further includes sending first status information to the server and receiving second status information from the server, the first status information comprising a battery level of the first device and/or a signal strength of a wireless signal of the first device, the second location information comprising a plurality of battery levels of the respective plurality of second devices included in the group and/or a plurality of signal strengths of wireless signals of the respective plurality of second devices included in the group.

40. (Previously presented) The system of claim 13, wherein the first device is a smart phone.

41. (Previously presented) The system of claim 13, wherein the operations further include:
with the first device, transmitting a group identifier associated with a second group, the second group including a second plurality of second devices; and
based on transmitting the group identifier associated with the second group, participating in the second group, wherein participating in the second group includes receiving third location

information from the server, the third location information comprising a plurality of locations of the respective second plurality of second devices included in the second group.

42. (Previously presented) The system of claim 13, wherein the data includes a voice recording.

43. (New) The method of claim 1, further comprising: using a Global Positioning Satellite (GPS) receiver of the first device to obtain data indicative of the location of the first device, wherein sending the first location information to the server comprises using the Internet Protocol (IP) to send the first location information to the server.

44. (New) The system of claim 13, wherein the first device includes a Global Positioning Satellite (GPS) receiver, and wherein the operations further include: using the GPS receiver to obtain data indicative of the location of the first device, wherein sending the first location information to the server comprises using the Internet Protocol (IP) to send the first location information to the server.

IN THE UNITED STATES PATENT AND TRADEMARK OFFICE

First Named Inventor:
Malcolm K. Beyer, Jr.

Application No.: 14/633,804

Confirmation No.: 8573

Filed: February 27, 2015

Art Unit: 2646

For: Method to Provide Ad Hoc and Password
Protected Digital and Voice Networks

Examiner: O. Obayanju

Commissioner for Patents
P.O. Box 1450
Alexandria, VA 22313-1450

PROPOSED INTERVIEW AGENDA

Applicant thanks Examiner Obayanju for agreeing to conduct a telephone interview with Applicant's undersigned representative (Daniel J. Burns) and Applicant's attorney (Samuel S. Stone) on January 21, 2016 at 3:00 PM EST. During the interview, the participants would appreciate discussing the rejection of claim 1 as purportedly being anticipated by Melen. In particular, the participants would appreciate discussing how the Examiner is interpreting Melen as purportedly teaching the portion of claim 1 that recites

with a first device, receiving a message from a second device, wherein the message relates to joining a group;

based on receiving the message from the second device, participating in the group, wherein participating in the group includes **sending first location information to a server** and receiving second location information from the server. (Emphasis added.)

During the interview, the participants may refer to the following portions of Melen:

- Melen appears to describe a system that “enables its user to establish a group with which to interact while simultaneously tracking the location of the vehicle navigation systems in the group” (Melen, paragraph [0010]).
- Melen appears to describe two implementations of a group interaction system 100. See #100a and #100b in FIGS. 1A and 1B of Melen.

- The first “group interaction system 100a establishes the group of members for wireless communication or other types of interaction using various methods such as those described in FIGS. 6A and 6B. For example, the group may be established in the navigation systems 300a, 300b, 300c by manual input by its users. The group may also be input and stored on a web server (not shown) on the Internet 112 and downloaded from the web site to the vehicle network server 102 via wired data communication 120. The vehicle network server 102 in turn provides the group information to the respective navigation systems 300a, 300b, 300c via the communications service provider 104a.” (Melen, paragraph [0031].) Also, in the first system 100a, “all communication or interaction among the selected members [of a group] is accomplished through [a] vehicle network server 102” (Melen, paragraph [0027]).
- According to Melen, “[in] contrast to the group interaction system 100a shown in FIG. 1A that uses a vehicle network server 102, the group interaction system 100b in FIG. 1B is modified to be a peer-to-peer system enabling wireless communication without the use of a vehicle network server 102” (Melen, paragraph [0034]). Melen further states, the “navigation systems 300d, 300e, 300f [of system 100b] are different from the navigation systems 300a, 300b, 300c in FIG. 1A, in that they are capable of establishing groups of members and communicating wirelessly with other navigation systems without the use of a vehicle network server. That is, the navigation systems 300d, 300e, 300f are capable peer-to-peer wireless communication 140, 146, 150 among selected members within the group without the use of a vehicle network server.” (Melen, paragraph [0036].) According to Melen, the system 100b “establishes the enabled group for wireless communication or other types of interaction using various methods such as those described in FIGS. 6A and 6B. For example, the group may be established in the navigation systems 300d, 300e, 300f by manual input by its users.” (Melen, paragraph [0041].)
- In FIG. 5, Melen illustrates a method for interacting with members of a group (Melen, paragraph [0068]). The method includes a step 504 in which a group of members is established (Melen, paragraph [0068]). Melen appears to describe two implementations of the step 504 for establishing groups. See 504a and 504b in FIGS. 6A and 6B.
- Melen’s step 504a for establishing groups is illustrated in FIG. 6A and described in paragraphs [0071] and [0072]. “The step 504a of FIG. 6A establishes the group of members by cooperation of the vehicle navigation system 300a and the vehicle network server 102 and is used with the group interaction system 100a described in FIG. 1B” (Melen, paragraph [0071]). In step 504a, the “vehicle navigation system 300a transmits [a] selection of group members to the vehicle network server 102,” and the “vehicle network server 102 establishes 608 communications with the selected group members and requests 610 each selected member for permission to add the member to the group” (Melen, paragraph [0072]).
- Melen’s step 504b for establishing groups is illustrated in FIG. 6B and described in paragraphs [0073] and [0074]. “The step 504b of FIG. 6B establishes the group of

members in the vehicle network server 102 using information downloaded from an external source and downloads the group information to the vehicle navigation systems 300a” (Melen, paragraph [0073]).

- Melen describes other techniques for establishing a group in paragraph [0075].

Dated: January 20, 2016

Respectfully submitted,

Electronic signature: /Daniel J. Burns/

Daniel J. Burns

Registration No.: 50,222

GOODWIN PROCTER LLP

(650) 752-3100

Moores, Michael

To: Burns, Dan
Subject: RE: Proposed Interview Agenda for U.S. App. No. 14/633,804

From: Stone, Samuel S.
Sent: Wednesday, January 20, 2016 10:20 PM
To: omoniyi.obayanju@uspto.gov
Cc: Burns, Dan
Subject: Proposed Interview Agenda for U.S. App. No. 14/633,804

Dear Examiner Obayanju,

Thank you for your courtesy in granting a telephone interview today (Thursday, January 21, 2016), in Application Serial No. 14/633,804. A proposed agenda for the interview is attached.

Regards,
Sam

Sent by Samuel S. Stone on behalf of:

Daniel J. Burns
Goodwin Procter LLP
T: (650) 752-3100
dburns@goodwinprocter.com

REMARKS

Administrative Overview

Prior to the Office Action of December 10, 2015, claims 1-2, 5, 8-14, 17, 20-24, and 31-42 were pending. In the Office Action:

- claims 9, 12, 21, 24, 35, and 41 were rejected under 35 U.S.C. § 112 as purportedly failing to comply with the written description requirement;
- claims 1, 2, 9, 13, 14, 21, 31, 32, 34-38, and 40-42 were rejected under 35 U.S.C. § 102 as purportedly being anticipated by U.S. Pub. No. 2004/0148090 (“Melen”);
- claims 8, 11, 20, and 23 were rejected under 35 U.S.C. § 103 as purportedly being obvious over Melen in view of U.S. Pub. No. 2006/0047825 (“Steenstra”);
- claims 5, 10, 17, and 22 were rejected under 35 U.S.C. § 103 as purportedly being obvious over Melen in view of U.S. Patent No. 8,014,763 (“Hymes”);
- claims 12 and 24 were rejected under 35 U.S.C. § 103 as purportedly being obvious over Melen in view of U.S. Pub. No. 2004/0252050 (“Tengler”); and
- claims 33 and 39 were rejected under 35 U.S.C. § 103 as purportedly being obvious over Melen in view of U.S. Pub. No. 2005/0130666 (“Levy”).

In the present Amendment, claims 5, 10, 17, and 22 are canceled without prejudice or disclaimer. Claims 1 and 13 are amended to recite the subject matter of previously-pending claims 10 and 22, respectively, and are further amended to recite “using an Internet Protocol to send data.” Claims 43 and 44 are added.

No new matter is added. Support for the claim amendments can be found, for example, in U.S. Patent No. 7,630,724 (e.g., in col. 10:57 - col. 11:15, col. 12:63 - col. 13:26; and col. 16:42-59). Support for the new claims can be found, for example, in the ‘724 patent (e.g., in col. 4:52-65). It is noted that the ‘724 patent was incorporated by reference into the present application at the time of the present application’s filing.

Applicability of Post-AIA Provisions of the Patent Laws to the Present Application

The Office Action (p. 2) states that “[t]he present application is being examined under the pre-AIA first to invent provisions” of the patent laws. For the reasons stated in the Response

filed on November 13, 2015, it is understood that the present application will be examined under the post-AIA, first-to-file provisions of the patent laws.

Interview Summary

Applicant thanks Examiner Obayanju for conducting a telephonic interview on January 21, 2016. The participants included Examiner Obayanju, Applicant's undersigned representative (Daniel J. Burns), and Applicant's attorney (Samuel S. Stone). The interview was held pursuant to a Proposed Interview Agenda that was emailed to the Examiner on January 21, 2016. Copies of the Interview Agenda and the email message are submitted herewith. A summary of the interview is provided below.

During the interview, the participants discussed the rejections of claims 1 and 32 under 35 U.S.C. § 102 as purportedly being anticipated by Melen. Applicant's representatives referred to the portions of Melen identified in the Proposed Interview Agenda, and pointed out that those portions of Melen do not teach or suggest the limitations of claim 1, nor the limitations of claim 32. No agreement was reached with respect to claim 1. Regarding claim 32, the Examiner agreed that the claim was not anticipated by Melen.

Claim Rejections Under 35 U.S.C. § 112

Claims 9, 12, 21, 24, 35, and 41 were rejected under 35 U.S.C. § 112 as purportedly failing to comply with the written description requirement. Reconsideration is respectfully requested. Since the application describes the subject matter of each of the claims in sufficient detail that one of ordinary skill in the art can reasonably conclude that the inventors had possession of the claimed subject matter at the time of the application's filing, each of the claims satisfies the written description requirement.

In particular, the Office Action alleges that there is insufficient written description support for sending "a request for a second map, wherein the request specifies a map location," as recited in claims 9 and 21. Support for the subject matter of claims 9 and 21 is found, for example, in U.S. Patent No. 7,630,724, which was incorporated by reference into the present application at the time of the present application's filing. For example, the '724 patent states that "[t]he cell phone device application software, however, can also provide the user the ability to

request a specific geo-referenced map or chart, aerial photograph or satellite image from a remote image server by pointing at the specific location desired for the map” (‘724 patent, col. 18:57 - col. 19:7). Based on at least the foregoing passage of the ‘724 patent, one of ordinary skill in the art can reasonably conclude that the inventors had possession of the subject matter of claims 9 and 21. Accordingly, withdrawal of the rejections of claims 9 and 21 under 35 U.S.C. § 112 is respectfully requested.

In addition, the Office Action alleges that there is insufficient written description support for sending “updated location information comprising an updated location of the first device, the updated location information being sent based on passage of a predetermined time interval since sending previous location information comprising a previous location of the first device, displacement of the first device by a predetermined distance relative to a previous location of the first device, or both,” as recited in claims 12 and 24. Support for the subject matter of claims 12 and 24 is found, for example, in U.S. Patent No. 7,630,724, which, as noted above, was incorporated by reference into the present application at the time of the application’s filing. The ‘724 patent describes:

... **an integrated communications system using a plurality of cellular/PDA/GPS phones** for the management of a group of people through the use of a communications net and, specifically, to provide each user with a cellular/PDA/GPS/phone that has software application programs and databases **that permit all the users to continuously know each other's locations** and status, to rapidly call and communicate voice, high speed internet data, photographs and video clips among the users by touching display screen symbols and to enable the users to easily access data concerning other users and other database information. (‘724 patent, col. 1:6-17.)

A plurality of cellular phone/WiFi/PDA/GPS devices each having application software and databases to provide a communication network having: a) the ability to selectively poll each of the other PDA/GPS phone devices with each participant **to start reporting its position** and status information directly to all or selected users equipped with the same cellular phone/PDA communication/ GPS devices in the communications net so that each of the devices that the data is transmitted to is provided a display of the location, status and other information of the other users; b) **the ability of each of the cellular phone/PDA devices to report to another device at an operator selected time rate or at a rate based on distance traveled** (‘724 patent, col. 2:48-60.)

The present cell phone/PDA/GPS device to create the communication network wherein all of the participants have the same communication device described

herein also includes the ability of a specific operator device to provide polling in which **other cellular phones using SMS, internet or WiFi report periodically based on criteria such as time, speed, distance traveled, or a combination of a time, speed and distance traveled.** The operator can manually poll any or all of the cell phone devices that are used by all of the participants in the communication network having the same device as described herein for the invention. The receiving cellular phone application code responds to the polling device with the receiving cellular phone's location and status which could include battery level, GPS status, signal strength and entered track data. Optionally, **the phone operators can set their phones to report automatically, based on time or distance traveled intervals** or another criteria. ('724 patent, col. 9:31-47.)

Based on at least the foregoing passages of the '724 patent, one of ordinary skill in the art can reasonably conclude that the inventors had possession of the subject matter of claims 12 and 24. Accordingly, withdrawal of the rejections of claims 12 and 24 under 35 U.S.C. § 112 is respectfully requested.

In addition, the Office Action alleges that there is insufficient written description support for "with the first device, transmitting a group identifier associated with a second group, the second group including a second plurality of second devices; and based on transmitting the group identifier associated with the second group, participating in the second group, wherein participating in the second group includes receiving third location information from the server, the third location information comprising a plurality of locations of the respective second plurality of second devices included in the second group," as recited in claims 35 and 41. Support for the subject matter of claims 35 and 41 is found, for example, in U.S. Patent No. 7,630,724, which, as noted above, was incorporated by reference into the present application at the time of the application's filing. For example, the '724 patent states that "[t]here are several ways that the network can be established including: ... for each phone to have a group identification that is transmitted in its initial message which relates it to a particular group who are their own net, only those with that identifier (i.e. singles, coin collectors, etc.) are permitted to join that net" ('724 patent, col. 14:60-61 and col. 15:10-15). Based on at least the foregoing passages of the '724 patent, one of ordinary skill in the art can reasonably conclude that the inventors had possession of the subject matter of claims 35 and 41. Accordingly, withdrawal of the rejections of claims 35 and 41 under 35 U.S.C. § 112 is respectfully requested.

Claim Rejections Under 35 U.S.C. §§ 102 and 103

In the Office Action, independent claims 1 and 13 were rejected under 35 U.S.C. § 102 as purportedly being anticipated by Melen, and previously-pending dependent claims 10 and 22 were rejected under 35 U.S.C. § 103 as purportedly being obvious over Melen in view of Hymes. Without acceding to the rejections, claims 1 and 13 are amended to recite the subject matter of previously-pending claims 10 and 22, respectively, and are further amended to recite “using an Internet Protocol to send data.” The rejections of claims 10 and 22 are respectfully traversed as applied to claims 1 and 13, as amended. Even assuming (without conceding) that Melen and Hymes could have been properly combined, the proposed combination of Melen and Hymes does not teach or suggest all the limitations of any of the claims.

I. **Independent Claim 1 and the Claims Depending Therefrom**

As amended, independent claim 1 is directed to a method comprising:

with a first device, receiving a message from a second device, wherein the message relates to joining a group;

based on receiving the message from the second device, participating in the group, wherein participating in the group includes sending first location information to a server and receiving second location information from the server, the first location information comprising a location of the first device, the second location information comprising a plurality of locations of a respective plurality of second devices included in the group;

presenting, via an interactive display of the first device, an interactive map comprising a plurality of user-selectable symbols corresponding to the plurality of second devices, wherein the symbols are positioned on the map at respective positions corresponding to the locations of the second devices; and

identifying user interaction with the interactive map selecting one or more of the user-selectable symbols corresponding to one or more of the second devices and user interaction with the display specifying an action and, based thereon, **using an Internet protocol to send data to the one or more second devices via the server.**

wherein the first device does not have access to respective Internet Protocol addresses of the second devices. (Emphasis added.)

Melen does not teach at least “with a first device, ... using an Internet protocol to send data to the one or more second devices via the server, wherein the first device does not have access to respective Internet Protocol addresses of the second devices,” as recited in claim 1. Melen describes “vehicle navigation systems” that are said to be “capable of communicating

with one another,” establishing a group, and “displaying the location of other vehicle navigation systems in the group” (Abstract). In addition, paragraph [0072] of Melen, which was cited by the Office Action in the rejection of previously-pending claim 10, states:

Referring to FIG. 6A, as the process begins 502, the vehicle navigation system 300a receives 604 selection of the members to be included in the group. Such selection of members may be input by using the touch sensitive screen 301 or the input device 302. The vehicle navigation system 300a transmits 606 such selection of group members to the vehicle network server 102. The vehicle network server 102 establishes 608 communications with the selected group members and requests 610 each selected member for permission to add the member to the group. Then, the vehicle network server 102 transmits 612 the results of the requests 610 back to the vehicle navigation system 300a. Thereafter, the vehicle network server 300a adds 614 the members giving permission to the enabled group. This group information may be shared with other members of the group. To this end, the vehicle navigation system 300a transmits 616 the established group information to the vehicle navigation system 102, and the vehicle navigation system 102 in turn transmits 618 such established group information to the members of the group, and the process continues with step 506.

As can be seen, the cited portion of Melen does not teach or suggest “with a first device, ... using an Internet protocol to send data to the one or more second devices via the server, wherein the first device does not have access to respective Internet Protocol addresses of the second devices,” as recited in claim 1.

Hymes does not cure the deficiencies of Melen at least with respect to the above-emphasized portions of claim 1. Rather, Hymes appears to describe “sending information from [a] first electronic device indicating an intent to conditionally communicate with the recipient only upon an expression of interest from the recipient in communicating with a user of the first electronic device,” (Abstract), which does not teach or suggest “with a first device, ... using an Internet protocol to send data to the one or more second devices via the server, wherein the first device does not have access to respective Internet Protocol addresses of the second devices,” as recited in claim 1.

For at least the foregoing reasons, Melen and Hymes (individually or in combination) do not teach at least the above-emphasized limitations of claim 1. Claim 1 therefore patentably distinguishes over the cited art. Withdrawal of the rejection of claim 1 is respectfully requested. Claims 2, 8, 9, 11, 12, 31-36, and 43 depend from claim 1 and are allowable for at least the same reasons.

II. Independent Claim 13 and the Claims Depending Therefrom

As amended, independent claim 13 is directed to a system comprising a first device programmed to perform operations comprising:

receiving a message from a second device, wherein the message relates to joining a group;

based on receiving the message from the second device, participating in the group, wherein participating in the group includes sending first location information to a server and receiving second location information from the server, the first location information comprising a location of the first device, the second location information comprising a plurality of locations of a respective plurality of second devices included in the group;

presenting, via an interactive display of the first device, an interactive map comprising a plurality of user-selectable symbols corresponding to the plurality of second devices, wherein the symbols are positioned on the map at respective positions corresponding to the locations of the second devices; and

identifying user interaction with the interactive map selecting one or more of the user-selectable symbols corresponding to one or more of the second devices and user interaction with the display specifying an action and, based thereon, **using an Internet Protocol to send data to the one or more second devices via the server,**

wherein the first device does not have access to respective Internet Protocol addresses of the second devices. (Emphasis added.)

For reasons that should be apparent from the discussion above, Melen and Hymes (individually or in combination) do not teach or suggest at least the above-emphasized limitations of claim 13. Claim 13 therefore patentably distinguishes over the cited art. Withdrawal of the rejection of claim 13 is respectfully requested. Claims 14, 20, 21, 23, 24, 37-42, and 44 depend from claim 13 and are allowable for at least the same reasons.

CONCLUSION

By responding in the foregoing remarks only to particular positions taken by the Examiner, Applicant does not acquiesce with other positions that have not been explicitly addressed. In addition, Applicant's arguments for the patentability of a claim should not be understood as implying that no other reasons for the patentability of that claim exist. Finally, Applicant's decision to amend or cancel any claim should not be understood as implying that Applicant agrees with any positions taken by the Examiner with respect to that claim or other claims.

The pending application is believed to be in condition for allowance. If, in the Examiner's opinion, further communication would expedite the favorable prosecution of the present application, the undersigned would welcome the opportunity to discuss any outstanding issues and to work with the Examiner toward placing the application in condition for allowance.

A Request for Continued Examination and the corresponding fees are submitted herewith. No other fees are believed to be necessary for entry and consideration of this paper. The Commissioner, however, is hereby authorized to charge any deficiency in the fees filed, asserted to be filed, or which should have been filed herewith to our Deposit Account No. 50-4634, with reference to Order No. MOC-005.

Respectfully submitted,

Dated: January 26, 2016

/Daniel J. Burns/
Daniel J. Burns
Registration No.: 50,222

Customer Number: 51414
Goodwin Procter LLP
Telephone: (650) 752-3100

Under the Paperwork Reduction Act of 1995, no persons are required to respond to a collection of information unless it displays a valid OMB control number.

PATENT APPLICATION FEE DETERMINATION RECORD Substitute for Form PTO-875	Application or Docket Number 14/633,804	Filing Date 02/27/2015	<input type="checkbox"/> To be Mailed
---	---	----------------------------------	---------------------------------------

ENTITY: LARGE SMALL MICRO

APPLICATION AS FILED – PART I

FOR	NUMBER FILED	NUMBER EXTRA	RATE (\$)	FEE (\$)
<input type="checkbox"/> BASIC FEE (37 CFR 1.16(a), (b), or (c))	N/A	N/A	N/A	
<input type="checkbox"/> SEARCH FEE (37 CFR 1.16(k), (j), or (m))	N/A	N/A	N/A	
<input type="checkbox"/> EXAMINATION FEE (37 CFR 1.16(o), (p), or (q))	N/A	N/A	N/A	
TOTAL CLAIMS (37 CFR 1.16(i))	minus 20 = *	*	X \$ =	
INDEPENDENT CLAIMS (37 CFR 1.16(h))	minus 3 = *	*	X \$ =	
<input type="checkbox"/> APPLICATION SIZE FEE (37 CFR 1.16(s))	If the specification and drawings exceed 100 sheets of paper, the application size fee due is \$310 (\$155 for small entity) for each additional 50 sheets or fraction thereof. See 35 U.S.C. 41(a)(1)(G) and 37 CFR 1.16(s).			
<input type="checkbox"/> MULTIPLE DEPENDENT CLAIM PRESENT (37 CFR 1.16(j))				
* If the difference in column 1 is less than zero, enter "0" in column 2.			TOTAL	

APPLICATION AS AMENDED – PART II

	(Column 1)	(Column 2)	(Column 3)	(Column 3)	RATE (\$)	ADDITIONAL FEE (\$)
AMENDMENT	01/26/2016	CLAIMS REMAINING AFTER AMENDMENT	HIGHEST NUMBER PREVIOUSLY PAID FOR	PRESENT EXTRA		
	Total (37 CFR 1.16(i))	* 26	Minus	** 28	= 0	x \$40 = 0
	Independent (37 CFR 1.16(h))	* 2	Minus	***4	= 0	x \$210 = 0
	<input type="checkbox"/> Application Size Fee (37 CFR 1.16(s))					
<input type="checkbox"/> FIRST PRESENTATION OF MULTIPLE DEPENDENT CLAIM (37 CFR 1.16(j))						
					TOTAL ADD'L FEE	0

	(Column 1)	(Column 2)	(Column 3)	(Column 3)	RATE (\$)	ADDITIONAL FEE (\$)
AMENDMENT		CLAIMS REMAINING AFTER AMENDMENT	HIGHEST NUMBER PREVIOUSLY PAID FOR	PRESENT EXTRA		
	Total (37 CFR 1.16(i))	*	Minus	**	=	X \$ =
	Independent (37 CFR 1.16(h))	*	Minus	***	=	X \$ =
	<input type="checkbox"/> Application Size Fee (37 CFR 1.16(s))					
<input type="checkbox"/> FIRST PRESENTATION OF MULTIPLE DEPENDENT CLAIM (37 CFR 1.16(j))						
					TOTAL ADD'L FEE	

* If the entry in column 1 is less than the entry in column 2, write "0" in column 3.
 ** If the "Highest Number Previously Paid For" IN THIS SPACE is less than 20, enter "20".
 *** If the "Highest Number Previously Paid For" IN THIS SPACE is less than 3, enter "3".

The "Highest Number Previously Paid For" (Total or Independent) is the highest number found in the appropriate box in column 1.

LIE
/DEBRA SAVOY/

This collection of information is required by 37 CFR 1.16. The information is required to obtain or retain a benefit by the public which is to file (and by the USPTO to process) an application. Confidentiality is governed by 35 U.S.C. 122 and 37 CFR 1.14. This collection is estimated to take 12 minutes to complete, including gathering, preparing, and submitting the completed application form to the USPTO. Time will vary depending upon the individual case. Any comments on the amount of time you require to complete this form and/or suggestions for reducing this burden, should be sent to the Chief Information Officer, U.S. Patent and Trademark Office, U.S. Department of Commerce, P.O. Box 1450, Alexandria, VA 22313-1450. DO NOT SEND FEES OR COMPLETED FORMS TO THIS ADDRESS. **SEND TO: Commissioner for Patents, P.O. Box 1450, Alexandria, VA 22313-1450.**

If you need assistance in completing the form, call 1-800-PTO-9199 and select option 2.



UNITED STATES PATENT AND TRADEMARK OFFICE

UNITED STATES DEPARTMENT OF COMMERCE
United States Patent and Trademark Office
Address: COMMISSIONER FOR PATENTS
P.O. Box 1450
Alexandria, Virginia 22313-1450
www.uspto.gov

Table with 5 columns: APPLICATION NO., FILING DATE, FIRST NAMED INVENTOR, ATTORNEY DOCKET NO., CONFIRMATION NO.
14/633,804 02/27/2015 Malcolm K. Beyer JR. MOC-005 8573

22235 7590 02/02/2016
Malin Haley DiMaggio & Bowen, P.A.
1936 S ANDREWS AVENUE
FORT LAUDERDALE, FL 33316

Table with 1 column: EXAMINER

OBAYANJU, OMONIYI

Table with 2 columns: ART UNIT, PAPER NUMBER

2646

Table with 2 columns: NOTIFICATION DATE, DELIVERY MODE

02/02/2016

ELECTRONIC

Please find below and/or attached an Office communication concerning this application or proceeding.

The time period for reply, if any, is set in the attached communication.

Notice of the Office communication was sent electronically on above-indicated "Notification Date" to the following e-mail address(es):

info@mhdpatents.com

Applicant-Initiated Interview Summary	Application No. 14/633,804	Applicant(s) BEYER ET AL.	
	Examiner OMONIYI OBAYANJU	Art Unit 2646	

All participants (applicant, applicant's representative, PTO personnel):

- (1) OMONIYI OBAYANJU. (3) Sam Stone.
(2) Dan Burns (50,222). (4) _____.

Date of Interview: 21 January 2016.

Type: Telephonic Video Conference
 Personal [copy given to: applicant applicant's representative]

Exhibit shown or demonstration conducted: Yes No.
If Yes, brief description: NA.

Issues Discussed 101 112 102 103 Others
(For each of the checked box(es) above, please describe below the issue and detailed description of the discussion)

Claim(s) discussed: 1.

Identification of prior art discussed: Melen.

Substance of Interview

(For each issue discussed, provide a detailed description and indicate if agreement was reached. Some topics may include: identification or clarification of a reference or a portion thereof, claim interpretation, proposed amendments, arguments of any applied references etc...)

The Applicant initiated an interview to discuss the rejection on file. The Examiner provided further clarification. However, no agreement was reached.

Applicant recordation instructions: The formal written reply to the last Office action must include the substance of the interview. (See MPEP section 713.04). If a reply to the last Office action has already been filed, applicant is given a non-extendable period of the longer of one month or thirty days from this interview date, or the mailing date of this interview summary form, whichever is later, to file a statement of the substance of the interview

Examiner recordation instructions: Examiners must summarize the substance of any interview of record. A complete and proper recordation of the substance of an interview should include the items listed in MPEP 713.04 for complete and proper recordation including the identification of the general thrust of each argument or issue discussed, a general indication of any other pertinent matters discussed regarding patentability and the general results or outcome of the interview, to include an indication as to whether or not agreement was reached on the issues raised.

Attachment

/OMONIYI OBAYANJU/
Primary Examiner, Art Unit 2646

Summary of Record of Interview Requirements

Manual of Patent Examining Procedure (MPEP), Section 713.04, Substance of Interview Must be Made of Record

A complete written statement as to the substance of any face-to-face, video conference, or telephone interview with regard to an application must be made of record in the application whether or not an agreement with the examiner was reached at the interview.

Title 37 Code of Federal Regulations (CFR) § 1.133 Interviews

Paragraph (b)

In every instance where reconsideration is requested in view of an interview with an examiner, a complete written statement of the reasons presented at the interview as warranting favorable action must be filed by the applicant. An interview does not remove the necessity for reply to Office action as specified in §§ 1.111, 1.135. (35 U.S.C. 132)

37 CFR §1.2 Business to be transacted in writing.

All business with the Patent or Trademark Office should be transacted in writing. The personal attendance of applicants or their attorneys or agents at the Patent and Trademark Office is unnecessary. The action of the Patent and Trademark Office will be based exclusively on the written record in the Office. No attention will be paid to any alleged oral promise, stipulation, or understanding in relation to which there is disagreement or doubt.

The action of the Patent and Trademark Office cannot be based exclusively on the written record in the Office if that record is itself incomplete through the failure to record the substance of interviews.

It is the responsibility of the applicant or the attorney or agent to make the substance of an interview of record in the application file, unless the examiner indicates he or she will do so. It is the examiner's responsibility to see that such a record is made and to correct material inaccuracies which bear directly on the question of patentability.

Examiners must complete an Interview Summary Form for each interview held where a matter of substance has been discussed during the interview by checking the appropriate boxes and filling in the blanks. Discussions regarding only procedural matters, directed solely to restriction requirements for which interview recordation is otherwise provided for in Section 812.01 of the Manual of Patent Examining Procedure, or pointing out typographical errors or unreadable script in Office actions or the like, are excluded from the interview recordation procedures below. Where the substance of an interview is completely recorded in an Examiners Amendment, no separate Interview Summary Record is required.

The Interview Summary Form shall be given an appropriate Paper No., placed in the right hand portion of the file, and listed on the "Contents" section of the file wrapper. In a personal interview, a duplicate of the Form is given to the applicant (or attorney or agent) at the conclusion of the interview. In the case of a telephone or video-conference interview, the copy is mailed to the applicant's correspondence address either with or prior to the next official communication. If additional correspondence from the examiner is not likely before an allowance or if other circumstances dictate, the Form should be mailed promptly after the interview rather than with the next official communication.

The Form provides for recordation of the following information:

- Application Number (Series Code and Serial Number)
- Name of applicant
- Name of examiner
- Date of interview
- Type of interview (telephonic, video-conference, or personal)
- Name of participant(s) (applicant, attorney or agent, examiner, other PTO personnel, etc.)
- An indication whether or not an exhibit was shown or a demonstration conducted
- An identification of the specific prior art discussed
- An indication whether an agreement was reached and if so, a description of the general nature of the agreement (may be by attachment of a copy of amendments or claims agreed as being allowable). Note: Agreement as to allowability is tentative and does not restrict further action by the examiner to the contrary.
- The signature of the examiner who conducted the interview (if Form is not an attachment to a signed Office action)

It is desirable that the examiner orally remind the applicant of his or her obligation to record the substance of the interview of each case. It should be noted, however, that the Interview Summary Form will not normally be considered a complete and proper recordation of the interview unless it includes, or is supplemented by the applicant or the examiner to include, all of the applicable items required below concerning the substance of the interview.

A complete and proper recordation of the substance of any interview should include at least the following applicable items:

- 1) A brief description of the nature of any exhibit shown or any demonstration conducted,
- 2) an identification of the claims discussed,
- 3) an identification of the specific prior art discussed,
- 4) an identification of the principal proposed amendments of a substantive nature discussed, unless these are already described on the Interview Summary Form completed by the Examiner,
- 5) a brief identification of the general thrust of the principal arguments presented to the examiner,
(The identification of arguments need not be lengthy or elaborate. A verbatim or highly detailed description of the arguments is not required. The identification of the arguments is sufficient if the general nature or thrust of the principal arguments made to the examiner can be understood in the context of the application file. Of course, the applicant may desire to emphasize and fully describe those arguments which he or she feels were or might be persuasive to the examiner.)
- 6) a general indication of any other pertinent matters discussed, and
- 7) if appropriate, the general results or outcome of the interview unless already described in the Interview Summary Form completed by the examiner.

Examiners are expected to carefully review the applicant's record of the substance of an interview. If the record is not complete and accurate, the examiner will give the applicant an extendable one month time period to correct the record.

Examiner to Check for Accuracy

If the claims are allowable for other reasons of record, the examiner should send a letter setting forth the examiner's version of the statement attributed to him or her. If the record is complete and accurate, the examiner should place the indication, "Interview Record OK" on the paper recording the substance of the interview along with the date and the examiner's initials.



UNITED STATES PATENT AND TRADEMARK OFFICE

UNITED STATES DEPARTMENT OF COMMERCE
United States Patent and Trademark Office
Address: COMMISSIONER FOR PATENTS
P.O. Box 1450
Alexandria, Virginia 22313-1450
www.uspto.gov

APPLICATION NUMBER	FILING OR 371(C) DATE	FIRST NAMED APPLICANT	ATTY. DOCKET NO./TITLE
14/633,804	02/27/2015	Malcolm K. Beyer JR.	MOC-005

CONFIRMATION NO. 8573

POA ACCEPTANCE LETTER



OC00000080271097

51414
GOODWIN PROCTER LLP
PATENT ADMINISTRATOR
53 STATE STREET
EXCHANGE PLACE
BOSTON, MA 02109-2881

Date Mailed: 02/03/2016

NOTICE OF ACCEPTANCE OF POWER OF ATTORNEY

This is in response to the Power of Attorney filed 01/20/2016.

The Power of Attorney in this application is accepted. Correspondence in this application will be mailed to the above address as provided by 37 CFR 1.33.

Questions about the contents of this notice and the requirements it sets forth should be directed to the Office of Data Management, Application Assistance Unit, at (571) 272-4000 or (571) 272-4200 or 1-888-786-0101.

/mabebe/



UNITED STATES PATENT AND TRADEMARK OFFICE

UNITED STATES DEPARTMENT OF COMMERCE
United States Patent and Trademark Office
Address: COMMISSIONER FOR PATENTS
P.O. Box 1450
Alexandria, Virginia 22313-1450
www.uspto.gov

Table with 4 columns: APPLICATION NUMBER (14/633,804), FILING OR 371(C) DATE (02/27/2015), FIRST NAMED APPLICANT (Malcolm K. Beyer JR.), ATTY. DOCKET NO./TITLE (MOC-005)

CONFIRMATION NO. 8573

POWER OF ATTORNEY NOTICE

22235
Malin Haley DiMaggio & Bowen, P.A.
1936 S ANDREWS AVENUE
FORT LAUDERDALE, FL 33316



Date Mailed: 02/03/2016

NOTICE REGARDING CHANGE OF POWER OF ATTORNEY

This is in response to the Power of Attorney filed 01/20/2016.

- The Power of Attorney to you in this application has been revoked by the applicant. Future correspondence will be mailed to the new address of record(37 CFR 1.33).

Questions about the contents of this notice and the requirements it sets forth should be directed to the Office of Data Management, Application Assistance Unit, at (571) 272-4000 or (571) 272-4200 or 1-888-786-0101.

/mabebe/



UNITED STATES PATENT AND TRADEMARK OFFICE

UNITED STATES DEPARTMENT OF COMMERCE
United States Patent and Trademark Office
Address: COMMISSIONER FOR PATENTS
P.O. Box 1450
Alexandria, Virginia 22313-1450
www.uspto.gov

Table with 7 columns: APPLICATION NUMBER, FILING or 371(c) DATE, GRP ART UNIT, FIL FEE REC'D, ATTY.DOCKET.NO, TOT CLAIMS, IND CLAIMS. Row 1: 14/633,804, 02/27/2015, 2646, 1260, MOC-005, 28, 4

CONFIRMATION NO. 8573

CORRECTED FILING RECEIPT



51414
GOODWIN PROCTER LLP
PATENT ADMINISTRATOR
53 STATE STREET
EXCHANGE PLACE
BOSTON, MA 02109-2881

Date Mailed: 02/03/2016

Receipt is acknowledged of this non-provisional patent application. The application will be taken up for examination in due course. Applicant will be notified as to the results of the examination. Any correspondence concerning the application must include the following identification information: the U.S. APPLICATION NUMBER, FILING DATE, NAME OF APPLICANT, and TITLE OF INVENTION. Fees transmitted by check or draft are subject to collection. Please verify the accuracy of the data presented on this receipt. If an error is noted on this Filing Receipt, please submit a written request for a Filing Receipt Correction. Please provide a copy of this Filing Receipt with the changes noted thereon. If you received a "Notice to File Missing Parts" for this application, please submit any corrections to this Filing Receipt with your reply to the Notice. When the USPTO processes the reply to the Notice, the USPTO will generate another Filing Receipt incorporating the requested corrections

Inventor(s)

Malcolm K. Beyer JR., Jupiter, FL;
Christopher R. Rice, Redmond, WA;

Applicant(s)

Advanced Ground Information Systems, Inc., Jupiter, FL;

Assignment For Published Patent Application

Advanced Ground Information Systems, Inc., Jupiter, FL

Power of Attorney: The patent practitioners associated with Customer Number 051414

Domestic Priority data as claimed by applicant

This application is a CON of 14/529,978 10/31/2014
which is a CON of 14/027,410 09/16/2013 PAT 8880042
which is a CON of 13/751,453 01/28/2013 PAT 8538393
which is a CIP of 12/761,533 04/16/2010 PAT 8364129
which is a CIP of 11/615,472 12/22/2006 PAT 8126441
which is a CIP of 11/308,648 04/17/2006 PAT 7630724
which is a CIP of 10/711,490 09/21/2004 PAT 7031728

Foreign Applications for which priority is claimed (You may be eligible to benefit from the Patent Prosecution Highway program at the USPTO. Please see http://www.uspto.gov for more information.) - None.

Foreign application information must be provided in an Application Data Sheet in order to constitute a claim to foreign priority. See 37 CFR 1.55 and 1.76.

Permission to Access Application via Priority Document Exchange: Yes

Permission to Access Search Results: No

Applicant may provide or rescind an authorization for access using Form PTO/SB/39 or Form PTO/SB/69 as appropriate.

If Required, Foreign Filing License Granted: 03/19/2015

The country code and number of your priority application, to be used for filing abroad under the Paris Convention, is **US 14/633,804**

Projected Publication Date: 02/25/2016

Non-Publication Request: No

Early Publication Request: No

**** SMALL ENTITY ****

Title

METHOD TO PROVIDE AD HOC AND PASSWORD PROTECTED DIGITAL AND VOICE NETWORKS

Preliminary Class

455

Statement under 37 CFR 1.55 or 1.78 for AIA (First Inventor to File) Transition Applications: Yes

PROTECTING YOUR INVENTION OUTSIDE THE UNITED STATES

Since the rights granted by a U.S. patent extend only throughout the territory of the United States and have no effect in a foreign country, an inventor who wishes patent protection in another country must apply for a patent in a specific country or in regional patent offices. Applicants may wish to consider the filing of an international application under the Patent Cooperation Treaty (PCT). An international (PCT) application generally has the same effect as a regular national patent application in each PCT-member country. The PCT process **simplifies** the filing of patent applications on the same invention in member countries, but **does not result** in a grant of "an international patent" and does not eliminate the need of applicants to file additional documents and fees in countries where patent protection is desired.

Almost every country has its own patent law, and a person desiring a patent in a particular country must make an application for patent in that country in accordance with its particular laws. Since the laws of many countries differ in various respects from the patent law of the United States, applicants are advised to seek guidance from specific foreign countries to ensure that patent rights are not lost prematurely.

Applicants also are advised that in the case of inventions made in the United States, the Director of the USPTO must issue a license before applicants can apply for a patent in a foreign country. The filing of a U.S. patent application serves as a request for a foreign filing license. The application's filing receipt contains further information and guidance as to the status of applicant's license for foreign filing.

Applicants may wish to consult the USPTO booklet, "General Information Concerning Patents" (specifically, the section entitled "Treaties and Foreign Patents") for more information on timeframes and deadlines for filing foreign patent applications. The guide is available either by contacting the USPTO Contact Center at 800-786-9199, or it can be viewed on the USPTO website at <http://www.uspto.gov/web/offices/pac/doc/general/index.html>.

For information on preventing theft of your intellectual property (patents, trademarks and copyrights), you may wish to consult the U.S. Government website, <http://www.stopfakes.gov>. Part of a Department of Commerce initiative, this website includes self-help "toolkits" giving innovators guidance on how to protect intellectual property in specific countries such as China, Korea and Mexico. For questions regarding patent enforcement issues, applicants may call the U.S. Government hotline at 1-866-999-HALT (1-866-999-4258).

**LICENSE FOR FOREIGN FILING UNDER
Title 35, United States Code, Section 184
Title 37, Code of Federal Regulations, 5.11 & 5.15**

GRANTED

The applicant has been granted a license under 35 U.S.C. 184, if the phrase "IF REQUIRED, FOREIGN FILING LICENSE GRANTED" followed by a date appears on this form. Such licenses are issued in all applications where the conditions for issuance of a license have been met, regardless of whether or not a license may be required as set forth in 37 CFR 5.15. The scope and limitations of this license are set forth in 37 CFR 5.15(a) unless an earlier license has been issued under 37 CFR 5.15(b). The license is subject to revocation upon written notification. The date indicated is the effective date of the license, unless an earlier license of similar scope has been granted under 37 CFR 5.13 or 5.14.

This license is to be retained by the licensee and may be used at any time on or after the effective date thereof unless it is revoked. This license is automatically transferred to any related applications(s) filed under 37 CFR 1.53(d). This license is not retroactive.

The grant of a license does not in any way lessen the responsibility of a licensee for the security of the subject matter as imposed by any Government contract or the provisions of existing laws relating to espionage and the national security or the export of technical data. Licensees should apprise themselves of current regulations especially with respect to certain countries, of other agencies, particularly the Office of Defense Trade Controls, Department of State (with respect to Arms, Munitions and Implements of War (22 CFR 121-128)); the Bureau of Industry and Security, Department of Commerce (15 CFR parts 730-774); the Office of Foreign Assets Control, Department of Treasury (31 CFR Parts 500+) and the Department of Energy.

NOT GRANTED

No license under 35 U.S.C. 184 has been granted at this time, if the phrase "IF REQUIRED, FOREIGN FILING LICENSE GRANTED" DOES NOT appear on this form. Applicant may still petition for a license under 37 CFR 5.12, if a license is desired before the expiration of 6 months from the filing date of the application. If 6 months has lapsed from the filing date of this application and the licensee has not received any indication of a secrecy order under 35 U.S.C. 181, the licensee may foreign file the application pursuant to 37 CFR 5.15(b).

SelectUSA

The United States represents the largest, most dynamic marketplace in the world and is an unparalleled location for business investment, innovation, and commercialization of new technologies. The U.S. offers tremendous resources and advantages for those who invest and manufacture goods here. Through SelectUSA, our nation works to promote and facilitate business investment. SelectUSA provides information assistance to the international investor

community; serves as an ombudsman for existing and potential investors; advocates on behalf of U.S. cities, states, and regions competing for global investment; and counsels U.S. economic development organizations on investment attraction best practices. To learn more about why the United States is the best country in the world to develop technology, manufacture products, deliver services, and grow your business, visit <http://www.SelectUSA.gov> or call +1-202-482-6800.



UNITED STATES PATENT AND TRADEMARK OFFICE

UNITED STATES DEPARTMENT OF COMMERCE
United States Patent and Trademark Office
Address: COMMISSIONER FOR PATENTS
P.O. Box 1450
Alexandria, Virginia 22313-1450
www.uspto.gov

Table with 5 columns: APPLICATION NO., FILING DATE, FIRST NAMED INVENTOR, ATTORNEY DOCKET NO., CONFIRMATION NO.
14/633,804 02/27/2015 Malcolm K. Beyer JR. MOC-005 8573

51414 7590 02/19/2016
GOODWIN PROCTER LLP
PATENT ADMINISTRATOR
53 STATE STREET
EXCHANGE PLACE
BOSTON, MA 02109-2881

Table with 1 column: EXAMINER

OBAYANJU, OMONIYI

Table with 2 columns: ART UNIT, PAPER NUMBER

2646

Table with 2 columns: NOTIFICATION DATE, DELIVERY MODE

02/19/2016

ELECTRONIC

Please find below and/or attached an Office communication concerning this application or proceeding.

The time period for reply, if any, is set in the attached communication.

Notice of the Office communication was sent electronically on above-indicated "Notification Date" to the following e-mail address(es):

PATENTBOS@GOODWINPROCTER.COM
PSOUSA-ATWOOD@GOODWINPROCTER.COM
GLENN.WILLIAMS@GOODWINPROCTER.COM

Office Action Summary	Application No. 14/633,804	Applicant(s) BEYER ET AL.	
	Examiner OMONIYI OBAYANJU	Art Unit 2646	AIA (First Inventor to File) Status No

-- The MAILING DATE of this communication appears on the cover sheet with the correspondence address --

Period for Reply

A SHORTENED STATUTORY PERIOD FOR REPLY IS SET TO EXPIRE 3 MONTHS FROM THE MAILING DATE OF THIS COMMUNICATION.

- Extensions of time may be available under the provisions of 37 CFR 1.136(a). In no event, however, may a reply be timely filed after SIX (6) MONTHS from the mailing date of this communication.
- If NO period for reply is specified above, the maximum statutory period will apply and will expire SIX (6) MONTHS from the mailing date of this communication.
- Failure to reply within the set or extended period for reply will, by statute, cause the application to become ABANDONED (35 U.S.C. § 133). Any reply received by the Office later than three months after the mailing date of this communication, even if timely filed, may reduce any earned patent term adjustment. See 37 CFR 1.704(b).

Status

- 1) Responsive to communication(s) filed on 01/26/2016.
 A declaration(s)/affidavit(s) under **37 CFR 1.130(b)** was/were filed on _____.
- 2a) This action is **FINAL**. 2b) This action is non-final.
- 3) An election was made by the applicant in response to a restriction requirement set forth during the interview on _____; the restriction requirement and election have been incorporated into this action.
- 4) Since this application is in condition for allowance except for formal matters, prosecution as to the merits is closed in accordance with the practice under *Ex parte Quayle*, 1935 C.D. 11, 453 O.G. 213.

Disposition of Claims*

- 5) Claim(s) 1,2,8,9,11-14,20,21,23,24 and 31-44 is/are pending in the application.
5a) Of the above claim(s) _____ is/are withdrawn from consideration.
- 6) Claim(s) _____ is/are allowed.
- 7) Claim(s) 1,2,8,9,11-14,20,21,23,24 and 31-44 is/are rejected.
- 8) Claim(s) _____ is/are objected to.
- 9) Claim(s) _____ are subject to restriction and/or election requirement.

* If any claims have been determined allowable, you may be eligible to benefit from the **Patent Prosecution Highway** program at a participating intellectual property office for the corresponding application. For more information, please see http://www.uspto.gov/patents/init_events/pph/index.jsp or send an inquiry to PPHfeedback@uspto.gov.

Application Papers

- 10) The specification is objected to by the Examiner.
- 11) The drawing(s) filed on _____ is/are: a) accepted or b) objected to by the Examiner.
Applicant may not request that any objection to the drawing(s) be held in abeyance. See 37 CFR 1.85(a).
Replacement drawing sheet(s) including the correction is required if the drawing(s) is objected to. See 37 CFR 1.121(d).

Priority under 35 U.S.C. § 119

- 12) Acknowledgment is made of a claim for foreign priority under 35 U.S.C. § 119(a)-(d) or (f).

Certified copies:

- a) All b) Some** c) None of the:
1. Certified copies of the priority documents have been received.
2. Certified copies of the priority documents have been received in Application No. _____.
3. Copies of the certified copies of the priority documents have been received in this National Stage application from the International Bureau (PCT Rule 17.2(a)).

** See the attached detailed Office action for a list of the certified copies not received.

Attachment(s)

- 1) Notice of References Cited (PTO-892)
- 2) Information Disclosure Statement(s) (PTO/SB/08a and/or PTO/SB/08b)
Paper No(s)/Mail Date _____.
- 3) Interview Summary (PTO-413)
Paper No(s)/Mail Date. _____.
- 4) Other: _____.

The present application is being examined under the pre-AIA first to invent provisions.

DETAILED ACTION

Continued Examination Under 37 CFR 1.114

A request for continued examination under 37 CFR 1.114, including the fee set forth in 37 CFR 1.17(e), was filed in this application after final rejection. Since this application is eligible for continued examination under 37 CFR 1.114, and the fee set forth in 37 CFR 1.17(e) has been timely paid, the finality of the previous Office action has been withdrawn pursuant to 37 CFR 1.114. Applicant's submission filed on 01/26/2016 has been entered.

Response to Arguments

Applicant's arguments with respect to independent claims 1 and 13 have been considered but are moot because the arguments do not apply to any of the references being used in the current rejection.

However, first, the Applicant's stated that during the interview, "Regarding claim 32, the Examiner agreed that the claim was not anticipated by Melen."

In response and/or on record the Examiner did not agree that claim 32 was not anticipated by Melen during the interview. The Examiner believe that this was a typo on the Applicant's part.

Furthermore, the Applicant amended and argued that the secondary prior art reference (Hymes) does not teach at least in part “with a first device, ... using an Internet protocol to send data to the one or more second devices via the server, wherein the first device does not have access to respective Internet Protocol addresses of the second devices,”.

In response the Examiner respectfully disagrees with the Applicant’s arguments. Hymes in **fig. 1, fig. 6, and col. 14, lines 5-13, col. 16, lines 52-54**, discussed the concept of a group user communicating with each other in communication system. Hymes further stated that “The **means of transmission between devices** is transparent to users and may be either direct (device to device) or indirect via a wireless connection to a network **such as the internet**, cable networks, satellite networks, telephone networks, cellular telephone networks; or some combination.” Hymes further stated that “the invention can **facilitate communication between people that are in physical proximity to each other**. Some embodiments do this by providing a user with the following capabilities: (1) the ability to communicate electronically (text, voice, image, or video) to specific other individuals (or vehicles automobiles, motorcycles, etc.) in his or her environment that have been identified visually, **but for whom contact information (telephone number, email address, etc.) may not be known**”

Thus, in regards to the at least claimed limitation in question, the claim limitation has not been particularly and/or uniquely defined so as to be distinguished from the applied prior art i.e. ... using an Internet protocol to send data (Hymes, col. 16, lines 52-54, communications over the internet)...., wherein the first device does not have access

to respective Internet Protocol addresses of the second devices (Hymes, col. 14, lines 5-13, user does not know the email address of the other user).

Therefore, it would have been obvious to one of ordinary skill in the art at time invention was made to combine the teachings of Melen with the teachings of Hymes to achieve the goal of efficiently and reliably improving and facilitating communication among users in communication system.

Claim Rejections - 35 USC § 103

The following is a quotation of pre-AIA 35 U.S.C. 103(a) which forms the basis for all obviousness rejections set forth in this Office action:

(a) A patent may not be obtained though the invention is not identically disclosed or described as set forth in section 102 of this title, if the differences between the subject matter sought to be patented and the prior art are such that the subject matter as a whole would have been obvious at the time the invention was made to a person having ordinary skill in the art to which said subject matter pertains. Patentability shall not be negated by the manner in which the invention was made.

Claims 1, 2, 9, 13, 14, 21, 31, 32, 34-38, and 40-44, rejected under pre-AIA 35 U.S.C. 103(a) as being unpatentable over Melen (US Publication No. 20040148090) in view of Hymes (US Patent No. 8014763).

As to **claims 1 and 13**, Melen teaches a computer-implemented method comprising: with a first device, receiving a message from a second device, wherein the message relates to joining a group (**fig. 1B, and pp0036, establishing groups of members and communicating wirelessly with other navigation systems, and fig. 5, #504**); based on receiving the message from the second device, participating in the

group, wherein participating in the group includes sending first location information to a server and receiving second location information from the server (**fig. 1A and fig. 1B, and fig. 5, #506, receive location of each member, and pp0038, transmit or receive GPS information**), the first location information comprising a location of the first device, the second location information comprising a plurality of locations of a respective plurality of second devices included in the group (**fig. 1A and fig. 1B, and fig. 5, #506, receive location of each member, and pp0038, transmit or receive GPS information**); presenting, via an interactive display of the first device, an interactive map comprising a plurality of user-selectable symbols corresponding to the plurality of second devices (**fig. 4, and pp0064, display icon of each car on map 406**), wherein the symbols are positioned on the map at respective positions corresponding to the locations of the second devices (**fig. 4, and pp0064, display icon of each car on map 406**); and identifying user interaction with the interactive map selecting one or more of the user-selectable symbols corresponding to one or more of the second devices and user interaction with the display specifying an action (**fig. 5, #509, #510, and pp0063, pp0070, touching icon to car**) and, based thereon, sending data to the one or more second devices via the server (**fig. 5, #512, and pp0063, pp0070, make a telephone call to the selected member, and pp0053**). However, Melen fails to explicitly teach using an Internet Protocol to send data, and wherein the first device does not have access to respective Internet Protocol addresses of the second devices.

In an analogous field of endeavor, Hymes teaches using an Internet Protocol to send data (**fig. 1, fig. 6, col. 16, lines 52-54, communications over the internet**),

and wherein the first device does not have access to respective Internet Protocol addresses of the second devices (**fig. 1, fig. 6, col. 14, lines 5-13, user does not know the email address of the other user**). Thus it would have been obvious to one of ordinary skill in the art at time invention was made to combine the teachings of Melen with the teachings of Hymes to achieve the goal of efficiently and reliably improving and facilitating communication among users in communication system (**Hymes, col. 2, lines 1-15**)

As to **claims 2 and 14**, Melen teaches wherein the data includes a short message service message, a text message, an image, or a video (**fig. 4, #404, and pp0029, pp0070, make a telephone call to the selected member**).

As to **claims 9 and 21**, Melen teaches further comprising: sending, from the first device, a request for a second map, wherein the request specifies a map location (**fig. 1B, fig. 4, each vehicle includes navigation system 300, fig. 5**); and receiving the second map (**fig. 1B, fig. 4, each vehicle includes navigation system 300, fig. 5**).

As to **claims 31 and 37**, Melen teaches further comprising identifying second user interaction with the interactive map selecting at least one of the user-selectable symbols corresponding to at least one of the second devices and user interaction with the display specifying an action (**fig. 5, #509, #510, and pp0063, pp0070, touching icon to car**) and, based thereon, initiating a phone call or phone conference with the at

least one second device (**fig. 5, #509, #510, and pp0063, pp0070, touching icon to car, pp0077**).

As to **claims 32 and 38**, Melen teaches wherein the message from the second device is a Short Message Service (SMS) message or a text message (**fig. 4, #404, and pp0029, pp0070, make a telephone call to the selected member**).

As to **claims 34 and 40**, Melen teaches wherein the first device is a smart phone (**pp0003, pp0027, cellular telephone communication**).

As to **claims 35 and 41**, Melen teaches further comprising: with the first device, transmitting a group identifier associated with a second group (**fig. 6, establish communication with selected group members by using identification information, transmit group information to members of group**), the second group including a second plurality of second devices; and based on transmitting the group identifier associated with the second group, participating in the second group (**fig. 6, establish communication with selected group members by using identification information, transmit group information to members of group**), wherein participating in the second group includes receiving third location information from the server, the third location information comprising a plurality of locations of the respective second plurality of second devices included in the second group (**fig. 6, establish communication with selected group members by using identification information, transmit group**

information to members of group, fig. 1A and fig. 1B, and fig. 5, #506, receive location of each member, and pp0038, transmit or receive GPS information).

As to **claims 36 and 42**, Melen teaches wherein the data includes a voice recording (**pp0039, pp0040, voice data, voice mail service**).

As to **claims 43 and 44**, Melen in view of Hymes teaches the limitations of the independent claims as discussed above. Melen further teaches further comprising: using a Global Positioning Satellite (GPS) receiver of the first device to obtain data indicative of the location of the first device, wherein sending the first location information to the server comprises to send the first location information to the server (**fig. 1B, fig. 5, #512, pp0002, pp0028**). Hymes further teaches using the Internet Protocol (IP) (**fig. 1, fig. 6, col. 16, lines 52-54, communications over the internet**)

Claims 8, 11, 20, and 23, are rejected under 35 U.S.C. 103 as being unpatentable over Melen (US Publication No. 20040148090) in view of Hymes (US Patent No. 8014763) and further in view of Steenstra et al. (US Publication No. 20060047825).

As to **claims 8 and 20**, Melen in view of Hymes teaches the limitations of the independent claims as discussed above. However, fails to explicitly teach wherein the first device is a personal digital assistant (PDA) or a personal computer (PC).

In an analogous field of endeavor, Steenstra teaches wherein the first device is a personal digital assistant (PDA) or a personal computer (PC) (fig. 5, pp0019). Thus it would have been obvious to one of ordinary skill in the art before the effective filing date of the claimed invention to combine the teachings of Melen and Hymes with the teachings of Steenstra to achieve the goal of efficiently and reliably creating and maintaining location based service social network in a communication system (Steenstra, pp0006).

As to **claims 11 and 23**, Melen in view of Hymes and further in view of Steenstra teaches wherein the map is a satellite image, (**Steenstra, fig. 5, pp0027**).

Claims 12 and 24 are rejected under 35 U.S.C. 103 as being unpatentable over Melen (US Publication No. 20040148090) in view of Hymes (US Patent No. 8014763) and further in view of Tengler et al. (US Publication No. 20040252050).

As to **claims 12 and 24**, Melen in view of Hymes teaches the limitations of independent claims as discussed above. Melen further teaches real time location tracking (**pp0033, real time tracking and receiving location, and pp0070**). However, Melen did not explicitly teach sending, by the first device, updated location information comprising an updated location of the first device, the updated location information being sent based on passage of a predetermined time interval since sending previous location information comprising a previous location of the first device, displacement of

the first device by a predetermined distance relative to a previous location of the first device, or both.

In an analogous field of endeavor, Tengler teaches sending, by the first device, updated location information comprising an updated location of the first device, the updated location information being sent based on passage of a predetermined time interval since sending previous location information comprising a previous location of the first device, displacement of the first device by a predetermined distance relative to a previous location of the first device, or both (**fig. 1, and pp0023, pp0007, transmitting signal to update positional information of devices at a predetermined spaced time interval**). Thus it would have been obvious to one of ordinary skill in the art at time invention was made to combine the teachings of Melen and Hymes with the teachings Tengler to achieve the goal of efficiently and reliably monitoring and/or tracking the location of plurality of devices in a communication system (**Tengler, pp0008**).

Claims 33 and 39 are rejected under 35 U.S.C. 103 as being unpatentable over Melen (US Publication No. 20040148090) in view of Hymes (US Patent No. 8014763) and further in view of Levy et al. (US Publication No. 20050130666).

As to claims 33 and 39, Melen in view of Hymes teaches the limitations of independent claims as discussed above. However, fails to explicitly teach wherein participating in the group further includes sending first status information to the server

and receiving second status information from the server, the first status information comprising a battery level of the first device and/or a signal strength of a wireless signal of the first device, the second location information comprising a plurality of battery levels of the respective plurality of second devices included in the group and/or a plurality of signal strengths of wireless signals of the respective plurality of second devices included in the group.

In an analogous field of endeavor, Levy teaches wherein participating in the group further includes sending first status information to the server and receiving second status information from the server, the first status information comprising a battery level of the first device (**fig. 1 and pp0042, transmitting the condition of battery level between different mobile unit**) and/or a signal strength of a wireless signal of the first device, the second location information comprising a plurality of battery levels of the respective plurality of second devices included in the group and/or a plurality of signal strengths of wireless signals of the respective plurality of second devices included in the group (**fig. 1 and pp0042, transmitting the condition of battery level between different mobile unit**). Thus it would have been obvious to one of ordinary skill in the art at time invention was made to combine the teachings of Melen and Hymes with the teachings Levy to achieve the goal of efficiently and reliably exchanging particular conditions of the operational parameters of communication devices in a communication system (**Levy, pp0008**).

Conclusion

Any inquiry concerning this communication or earlier communications from the examiner should be directed to OMONIYI OBAYANJU whose telephone number is (571)270-5885. The examiner can normally be reached on Mon - Fri, 7:30 - 5:00PM.

If attempts to reach the examiner by telephone are unsuccessful, the examiner's supervisor, KAMRAN AFSHAR can be reached on 571-272-7796. The fax phone number for the organization where this application or proceeding is assigned is 571-273-8300.

Information regarding the status of an application may be obtained from the Patent Application Information Retrieval (PAIR) system. Status information for published applications may be obtained from either Private PAIR or Public PAIR. Status information for unpublished applications is available through Private PAIR only. For more information about the PAIR system, see <http://pair-direct.uspto.gov>. Should you have questions on access to the Private PAIR system, contact the Electronic Business Center (EBC) at 866-217-9197 (toll-free). If you would like assistance from a USPTO Customer Service Representative or access to the automated information system, call 800-786-9199 (IN USA OR CANADA) or 571-272-1000.

/OMONIYI OBAYANJU/
Primary Examiner, Art Unit 2646

Index of Claims 	Application/Control No. 14633804	Applicant(s)/Patent Under Reexamination BEYER ET AL.
	Examiner OMONIYI OBAYANJU	Art Unit 2646

✓	Rejected
=	Allowed

-	Cancelled
÷	Restricted

N	Non-Elected
I	Interference

A	Appeal
O	Objected

<input type="checkbox"/> Claims renumbered in the same order as presented by applicant						<input type="checkbox"/> CPA		<input type="checkbox"/> T.D.		<input type="checkbox"/> R.1.47	
CLAIM		DATE									
Final	Original	08/10/2015	12/08/2015	02/12/2016							
	1	✓	✓	✓							
	2	✓	✓	✓							
	3	✓	-	-							
	4	✓	-	-							
	5	✓	✓	-							
	6	-	-	-							
	7	✓	-	-							
	8	✓	✓	✓							
	9	✓	✓	✓							
	10	✓	✓	-							
	11	✓	✓	✓							
	12	✓	✓	✓							
	13	✓	✓	✓							
	14	✓	✓	✓							
	15	✓	-	-							
	16	✓	-	-							
	17	✓	✓	-							
	18	-	-	-							
	19	✓	-	-							
	20	✓	✓	✓							
	21	✓	✓	✓							
	22	✓	✓	-							
	23	✓	✓	✓							
	24	✓	✓	✓							
	25	✓	-	-							
	26	✓	-	-							
	27	✓	-	-							
	28	✓	-	-							
	29	✓	-	-							
	30	✓	-	-							
	31		✓	✓							
	32		✓	✓							
	33		✓	✓							
	34		✓	✓							
	35		✓	✓							
	36		✓	✓							

<i>Index of Claims</i> 	Application/Control No. 14633804	Applicant(s)/Patent Under Reexamination BEYER ET AL.
	Examiner OMONIYI OBAYANJU	Art Unit 2646

✓	Rejected
=	Allowed

-	Cancelled
÷	Restricted

N	Non-Elected
I	Interference

A	Appeal
O	Objected

<input type="checkbox"/> Claims renumbered in the same order as presented by applicant		<input type="checkbox"/> CPA		<input type="checkbox"/> T.D.		<input type="checkbox"/> R.1.47			
CLAIM		DATE							
Final	Original	08/10/2015	12/08/2015	02/12/2016					
	37		✓	✓					
	38		✓	✓					
	39		✓	✓					
	40		✓	✓					
	41		✓	✓					
	42		✓	✓					
	43			✓					
	44			✓					

Search Notes 	Application/Control No. 14633804	Applicant(s)/Patent Under Reexamination BEYER ET AL.
	Examiner OMONIYI OBAYANJU	Art Unit 2646

CPC- SEARCHED		
Symbol	Date	Examiner
H04W4/02	8/10/2015	OO

CPC COMBINATION SETS - SEARCHED		
Symbol	Date	Examiner

US CLASSIFICATION SEARCHED			
Class	Subclass	Date	Examiner
455	404.2, 456.1	8/10/2015	OO

SEARCH NOTES		
Search Notes	Date	Examiner
See Attached East Search History	8/10/2015	OO
See Attached East Search History (Updated)	12/8/2015	OO

INTERFERENCE SEARCH			
US Class/ CPC Symbol	US Subclass / CPC Group	Date	Examiner

--	--



UNITED STATES PATENT AND TRADEMARK OFFICE

UNITED STATES DEPARTMENT OF COMMERCE
United States Patent and Trademark Office
Address: COMMISSIONER FOR PATENTS
P.O. Box 1450
Alexandria, Virginia 22313-1450
www.uspto.gov

Table with 4 columns: APPLICATION NUMBER (14/633,804), FILING OR 371(C) DATE (02/27/2015), FIRST NAMED APPLICANT (Malcolm K. Beyer JR.), ATTY. DOCKET NO./TITLE (MOC-005)

CONFIRMATION NO. 8573

51414
GOODWIN PROCTER LLP
PATENT ADMINISTRATOR
53 STATE STREET
EXCHANGE PLACE
BOSTON, MA 02109-2881

PUBLICATION NOTICE



Title:METHOD TO PROVIDE AD HOC AND PASSWORD PROTECTED DIGITAL AND VOICE NETWORKS
Publication No.US-2016-0057598-A1
Publication Date:02/25/2016

NOTICE OF PUBLICATION OF APPLICATION

The above-identified application will be electronically published as a patent application publication pursuant to 37 CFR 1.211, et seq. The patent application publication number and publication date are set forth above.

The publication may be accessed through the USPTO's publically available Searchable Databases via the Internet at www.uspto.gov. The direct link to access the publication is currently http://www.uspto.gov/patft/.

The publication process established by the Office does not provide for mailing a copy of the publication to applicant. A copy of the publication may be obtained from the Office upon payment of the appropriate fee set forth in 37 CFR 1.19(a)(1). Orders for copies of patent application publications are handled by the USPTO's Office of Public Records. The Office of Public Records can be reached by telephone at (703) 308-9726 or (800) 972-6382, by facsimile at (703) 305-8759, by mail addressed to the United States Patent and Trademark Office, Office of Public Records, Alexandria, VA 22313-1450 or via the Internet.

In addition, information on the status of the application, including the mailing date of Office actions and the dates of receipt of correspondence filed in the Office, may also be accessed via the Internet through the Patent Electronic Business Center at www.uspto.gov using the public side of the Patent Application Information and Retrieval (PAIR) system. The direct link to access this status information is currently http://pair.uspto.gov/. Prior to publication, such status information is confidential and may only be obtained by applicant using the private side of PAIR.

Further assistance in electronically accessing the publication, or about PAIR, is available by calling the Patent Electronic Business Center at 1-866-217-9197.

Office of Data Management, Application Assistance Unit (571) 272-4000, or (571) 272-4200, or 1-888-786-0101



UNITED STATES PATENT AND TRADEMARK OFFICE

UNITED STATES DEPARTMENT OF COMMERCE
United States Patent and Trademark Office
Address: COMMISSIONER FOR PATENTS
P.O. Box 1450
Alexandria, Virginia 22313-1450
www.uspto.gov

Table with 5 columns: APPLICATION NO., FILING DATE, FIRST NAMED INVENTOR, ATTORNEY DOCKET NO., CONFIRMATION NO.
14/633,804 02/27/2015 Malcolm K. Beyer JR. MOC-005 8573

51414 7590 06/02/2016
GOODWIN PROCTER LLP
PATENT ADMINISTRATOR
53 STATE STREET
EXCHANGE PLACE
BOSTON, MA 02109-2881

Table with 1 column: EXAMINER

OBAYANJU, OMONIYI

Table with 2 columns: ART UNIT, PAPER NUMBER

2646

Table with 2 columns: NOTIFICATION DATE, DELIVERY MODE

06/02/2016

ELECTRONIC

Please find below and/or attached an Office communication concerning this application or proceeding.

The time period for reply, if any, is set in the attached communication.

Notice of the Office communication was sent electronically on above-indicated "Notification Date" to the following e-mail address(es):

PATENTBOS@GOODWINPROCTER.COM
PSOUSA-ATWOOD@GOODWINPROCTER.COM
GLENN.WILLIAMS@GOODWINPROCTER.COM

Applicant-Initiated Interview Summary	Application No. 14/633,804	Applicant(s) BEYER ET AL.	
	Examiner OMONIYI OBAYANJU	Art Unit 2646	

All participants (applicant, applicant's representative, PTO personnel):

- (1) OMONIYI OBAYANJU. (3) Dan Burns (50,222).
(2) Same Stone. (4) _____.

Date of Interview: 26 May 2016.

Type: Telephonic Video Conference
 Personal [copy given to: applicant applicant's representative]

Exhibit shown or demonstration conducted: Yes No.
If Yes, brief description: NA.

Issues Discussed 101 112 102 103 Others
(For each of the checked box(es) above, please describe below the issue and detailed description of the discussion)

Claim(s) discussed: 1.

Identification of prior art discussed: Melen and Hymes.

Substance of Interview

(For each issue discussed, provide a detailed description and indicate if agreement was reached. Some topics may include: identification or clarification of a reference or a portion thereof, claim interpretation, proposed amendments, arguments of any applied references etc...)

The Applicant initiated an interview to discuss the rejection on file. The Examiner provided further clarification, and the Applicant will consider our discussion while preparing the response and amendment. However, no agreement was reached.

Applicant recordation instructions: The formal written reply to the last Office action must include the substance of the interview. (See MPEP section 713.04). If a reply to the last Office action has already been filed, applicant is given a non-extendable period of the longer of one month or thirty days from this interview date, or the mailing date of this interview summary form, whichever is later, to file a statement of the substance of the interview

Examiner recordation instructions: Examiners must summarize the substance of any interview of record. A complete and proper recordation of the substance of an interview should include the items listed in MPEP 713.04 for complete and proper recordation including the identification of the general thrust of each argument or issue discussed, a general indication of any other pertinent matters discussed regarding patentability and the general results or outcome of the interview, to include an indication as to whether or not agreement was reached on the issues raised.

Attachment

/OMONIYI OBAYANJU/
Primary Examiner, Art Unit 2646

Summary of Record of Interview Requirements

Manual of Patent Examining Procedure (MPEP), Section 713.04, Substance of Interview Must be Made of Record

A complete written statement as to the substance of any face-to-face, video conference, or telephone interview with regard to an application must be made of record in the application whether or not an agreement with the examiner was reached at the interview.

Title 37 Code of Federal Regulations (CFR) § 1.133 Interviews Paragraph (b)

In every instance where reconsideration is requested in view of an interview with an examiner, a complete written statement of the reasons presented at the interview as warranting favorable action must be filed by the applicant. An interview does not remove the necessity for reply to Office action as specified in §§ 1.111, 1.135. (35 U.S.C. 132)

37 CFR §1.2 Business to be transacted in writing.

All business with the Patent or Trademark Office should be transacted in writing. The personal attendance of applicants or their attorneys or agents at the Patent and Trademark Office is unnecessary. The action of the Patent and Trademark Office will be based exclusively on the written record in the Office. No attention will be paid to any alleged oral promise, stipulation, or understanding in relation to which there is disagreement or doubt.

The action of the Patent and Trademark Office cannot be based exclusively on the written record in the Office if that record is itself incomplete through the failure to record the substance of interviews.

It is the responsibility of the applicant or the attorney or agent to make the substance of an interview of record in the application file, unless the examiner indicates he or she will do so. It is the examiner's responsibility to see that such a record is made and to correct material inaccuracies which bear directly on the question of patentability.

Examiners must complete an Interview Summary Form for each interview held where a matter of substance has been discussed during the interview by checking the appropriate boxes and filling in the blanks. Discussions regarding only procedural matters, directed solely to restriction requirements for which interview recordation is otherwise provided for in Section 812.01 of the Manual of Patent Examining Procedure, or pointing out typographical errors or unreadable script in Office actions or the like, are excluded from the interview recordation procedures below. Where the substance of an interview is completely recorded in an Examiners Amendment, no separate Interview Summary Record is required.

The Interview Summary Form shall be given an appropriate Paper No., placed in the right hand portion of the file, and listed on the "Contents" section of the file wrapper. In a personal interview, a duplicate of the Form is given to the applicant (or attorney or agent) at the conclusion of the interview. In the case of a telephone or video-conference interview, the copy is mailed to the applicant's correspondence address either with or prior to the next official communication. If additional correspondence from the examiner is not likely before an allowance or if other circumstances dictate, the Form should be mailed promptly after the interview rather than with the next official communication.

The Form provides for recordation of the following information:

- Application Number (Series Code and Serial Number)
- Name of applicant
- Name of examiner
- Date of interview
- Type of interview (telephonic, video-conference, or personal)
- Name of participant(s) (applicant, attorney or agent, examiner, other PTO personnel, etc.)
- An indication whether or not an exhibit was shown or a demonstration conducted
- An identification of the specific prior art discussed
- An indication whether an agreement was reached and if so, a description of the general nature of the agreement (may be by attachment of a copy of amendments or claims agreed as being allowable). Note: Agreement as to allowability is tentative and does not restrict further action by the examiner to the contrary.
- The signature of the examiner who conducted the interview (if Form is not an attachment to a signed Office action)

It is desirable that the examiner orally remind the applicant of his or her obligation to record the substance of the interview of each case. It should be noted, however, that the Interview Summary Form will not normally be considered a complete and proper recordation of the interview unless it includes, or is supplemented by the applicant or the examiner to include, all of the applicable items required below concerning the substance of the interview.

A complete and proper recordation of the substance of any interview should include at least the following applicable items:

- 1) A brief description of the nature of any exhibit shown or any demonstration conducted,
- 2) an identification of the claims discussed,
- 3) an identification of the specific prior art discussed,
- 4) an identification of the principal proposed amendments of a substantive nature discussed, unless these are already described on the Interview Summary Form completed by the Examiner,
- 5) a brief identification of the general thrust of the principal arguments presented to the examiner,
(The identification of arguments need not be lengthy or elaborate. A verbatim or highly detailed description of the arguments is not required. The identification of the arguments is sufficient if the general nature or thrust of the principal arguments made to the examiner can be understood in the context of the application file. Of course, the applicant may desire to emphasize and fully describe those arguments which he or she feels were or might be persuasive to the examiner.)
- 6) a general indication of any other pertinent matters discussed, and
- 7) if appropriate, the general results or outcome of the interview unless already described in the Interview Summary Form completed by the examiner.

Examiners are expected to carefully review the applicant's record of the substance of an interview. If the record is not complete and accurate, the examiner will give the applicant an extendable one month time period to correct the record.

Examiner to Check for Accuracy

If the claims are allowable for other reasons of record, the examiner should send a letter setting forth the examiner's version of the statement attributed to him or her. If the record is complete and accurate, the examiner should place the indication, "Interview Record OK" on the paper recording the substance of the interview along with the date and the examiner's initials.

Docket No.: MOC-005
(PATENT)

IN THE UNITED STATES PATENT AND TRADEMARK OFFICE

First Named Inventor:
Malcolm K. Beyer, Jr.

Application No.: 14/633,804

Confirmation No.: 8573

Filed: February 27, 2015

Art Unit: 2646

For: METHOD TO PROVIDE AD HOC AND
PASSWORD PROTECTED DIGITAL AND
VOICE NETWORKS

Examiner: O. Obayanju

AMENDMENT AND RESPONSE TO NON-FINAL OFFICE ACTION

Commissioner for Patents
P.O. Box 1450
Alexandria, VA 22313-1450

INTRODUCTORY COMMENTS

In response to the Office Action dated February 19, 2016, in connection with the patent application identified above, the following Amendment and Response is respectfully submitted, along with a request for a one-month extension of time. The Commissioner is hereby authorized to charge excess claim fees and extension of time fees to the credit card identified in this filing, and no additional fees are believed to be required. If any such fees are due, however, the Commissioner is hereby also authorized to charge such fees to our Deposit Account No. 50-4634, with reference to Order No. MOC-005.

Please amend the above-identified U.S. patent application as follows:

Amendments to the Claims are reflected in the listing of claims which begins on page 2 of this paper.

Remarks/Arguments begin on page 11 of this paper.

AMENDMENTS TO THE CLAIMS

This listing of claims replaces all prior versions and listings of claims in the application:

Listing of Claims

1. (Currently amended) A computer-implemented method comprising:
 - with a first device, receiving a message from a second device, wherein the message relates to joining a group;
 - based on receiving the message from the second device, participating in the group, wherein participating in the group includes sending first location information to a server and receiving second location information from the server, the first location information comprising a location of the first device, the second location information comprising a plurality of locations of a respective plurality of second devices included in the group;
 - presenting, via an interactive display of the first device, [[an]] a first interactive, georeferenced map comprising and a plurality of user-selectable symbols corresponding to the plurality of second devices, wherein the symbols are positioned on the first georeferenced map at respective positions corresponding to the locations of the second devices, and wherein the first georeferenced map includes data relating positions on the first georeferenced map to spatial coordinates; [[and]]
 - sending, from the first device to the server, a request for a second georeferenced map different from the first georeferenced map, wherein the request specifies a map location;
 - receiving, from the server, the second georeferenced map, wherein the second georeferenced map includes the requested location and data relating positions on the second georeferenced map to spatial coordinates;
 - presenting, via the interactive display of the first device, the second georeferenced map and the plurality of user-selectable symbols corresponding to the plurality of second devices, wherein the symbols are positioned on the second georeferenced map at respective positions corresponding to the locations of the second devices; and
 - identifying user interaction with the interactive [[map]] display selecting one or more of the user-selectable symbols corresponding to one or more of the second devices and positioned on the second georeferenced map and user interaction with the display specifying an action and,

based thereon, using an Internet Protocol to send data to the one or more second devices via the server,

wherein the first device does not have access to respective Internet Protocol addresses of the second devices.

2. (Previously presented) The method of claim 1, wherein the data includes a short message service message, a text message, an image, or a video.

3-7. (Canceled)

8. (Previously presented) The method of claim 1, wherein the first device is a personal digital assistant (PDA) or a personal computer (PC).

9-10. (Canceled)

11. (Currently amended) The method of claim 1, wherein the second map is a satellite image.

12. (Previously presented) The method of claim 1, further comprising sending, by the first device, updated location information comprising an updated location of the first device, the updated location information being sent based on passage of a predetermined time interval since sending previous location information comprising a previous location of the first device, displacement of the first device by a predetermined distance relative to a previous location of the first device, or both.

13. (Currently amended) A system comprising:
a first device programmed to perform operations comprising:
receiving a message from a second device, wherein the message relates to joining a group;
based on receiving the message from the second device, participating in the group, wherein participating in the group includes sending first location information to a

server and receiving second location information from the server, the first location information comprising a location of the first device, the second location information comprising a plurality of locations of a respective plurality of second devices included in the group;

presenting, via an interactive display of the first device, ~~[[an]]~~ a first interactive, georeferenced map comprising and a plurality of user-selectable symbols corresponding to the plurality of second devices, wherein the symbols are positioned on the first georeferenced map at respective positions corresponding to the locations of the second devices, and wherein the first georeferenced map includes data relating positions on the first georeferenced map to spatial coordinates; ~~[[and]]~~

sending, from the first device to the server, a request for a second georeferenced map different from the first georeferenced map, wherein the request specifies a map location;

receiving, from the server, the second georeferenced map, wherein the second georeferenced map includes the requested location and data relating positions on the second georeferenced map to spatial coordinates;

presenting, via the interactive display of the first device, the second georeferenced map and the plurality of user-selectable symbols corresponding to the plurality of second devices, wherein the symbols are positioned on the second georeferenced map at respective positions corresponding to the locations of the second devices; and

identifying user interaction with the interactive ~~[[map]]~~ display selecting one or more of the user-selectable symbols corresponding to one or more of the second devices and positioned on the second georeferenced map and user interaction with the display specifying an action and, based thereon, using an Internet Protocol to send data to the one or more second devices via the server,

wherein the first device does not have access to respective Internet Protocol addresses of the second devices.

14. (Previously presented) The system of claim 13, wherein the data includes a short message service message, a text message, an image, or a video.

15-19. (Canceled)

20. (Previously presented) The system of claim 13, wherein the first device is a personal digital assistant (PDA) or a personal computer (PC).

21-22. (Canceled)

23. (Currently amended) The system of claim 13, wherein the second map is a satellite image.

24. (Previously presented) The system of claim 13, wherein the operations further comprise sending updated location information comprising an updated location of the first device, the updated location information being sent based on passage of a predetermined time interval since sending previous location information comprising a previous location of the first device, displacement of the first device by a predetermined distance relative to a previous location of the first device, or both.

25-30. (Canceled)

31. (Currently amended) The method of claim 1, further comprising identifying second user interaction with the interactive display selecting at least one of the user-selectable symbols corresponding to at least one of the second devices and user interaction with the display specifying an action and, based thereon, initiating a phone call or phone conference with the at least one second device.

32. (Previously presented) The method of claim 1, wherein the message from the second device is a Short Message Service (SMS) message or a text message.

33. (Currently amended) The method of claim 1, wherein participating in the group further includes sending first status information to the server and receiving second status information

from the server, the first status information comprising a battery level of the first device, ~~and/or~~ a signal strength of a wireless signal of the first device, a status of a Global Positioning Satellite (GPS) receiver of the first device, or a combination thereof, the second location information comprising a plurality of battery levels of the respective plurality of second devices included in the group, ~~and/or~~ a plurality of signal strengths of wireless signals of the respective plurality of second devices included in the group, a plurality of statuses of GPS receivers of the respective plurality of second devices included in the group, or a combination thereof.

34. (Previously presented) The method of claim 1, wherein the first device is a smart phone.

35. (Previously presented) The method of claim 1, further comprising:

with the first device, transmitting a group identifier associated with a second group, the second group including a second plurality of second devices; and

based on transmitting the group identifier associated with the second group, participating in the second group, wherein participating in the second group includes receiving third location information from the server, the third location information comprising a plurality of locations of the respective second plurality of second devices included in the second group.

36. (Previously presented) The method of claim 1, wherein the data includes a voice recording.

37. (Currently amended) The system of claim 13, wherein the operations further comprise identifying second user interaction with the interactive [[map]]display selecting at least one of the user-selectable symbols corresponding to at least one of the second devices and user interaction with the display specifying an action and, based thereon, initiating a phone call or phone conference with the at least one second device.

38. (Previously presented) The system of claim 13, wherein the message from the second device is a Short Message Service (SMS) message or a text message.

39. (Currently amended) The system of claim 13, wherein participating in the group further includes sending first status information to the server and receiving second status information from the server, the first status information comprising a battery level of the first device, ~~and/or~~ a signal strength of a wireless signal of the first device, a status of a Global Positioning Satellite (GPS) receiver of the first device, or a combination thereof, the second location information comprising a plurality of battery levels of the respective plurality of second devices included in the group, ~~and/or~~ a plurality of signal strengths of wireless signals of the respective plurality of second devices included in the group, a plurality of statuses of GPS receivers of the respective plurality of second devices included in the group, or a combination thereof.

40. (Previously presented) The system of claim 13, wherein the first device is a smart phone.

41. (Previously presented) The system of claim 13, wherein the operations further include:
with the first device, transmitting a group identifier associated with a second group, the second group including a second plurality of second devices; and
based on transmitting the group identifier associated with the second group, participating in the second group, wherein participating in the second group includes receiving third location information from the server, the third location information comprising a plurality of locations of the respective second plurality of second devices included in the second group.

42. (Previously presented) The system of claim 13, wherein the data includes a voice recording.

43. (Previously presented) The method of claim 1, further comprising: using a Global Positioning Satellite (GPS) receiver of the first device to obtain data indicative of the location of the first device, wherein sending the first location information to the server comprises using the Internet Protocol (IP) to send the first location information to the server.

44. (Previously presented) The system of claim 13, wherein the first device includes a Global Positioning Satellite (GPS) receiver, and wherein the operations further include: using the GPS

receiver to obtain data indicative of the location of the first device, wherein sending the first location information to the server comprises using the Internet Protocol (IP) to send the first location information to the server.

45. (New) The method of claim 1, further comprising identifying, by the first device, user interaction with the display selecting a particular user-selectable symbol positioned on the second georeferenced map and corresponding to a particular second device, wherein identifying the user interaction selecting the particular user-selectable symbol comprises:

detecting user selection of a portion of the interactive display corresponding to a position on the second georeferenced map;

based at least in part on coordinates of the selected position on the second georeferenced map and on the data relating positions on the second georeferenced map to spatial coordinates, determining spatial coordinates of a location represented by the selected position on the second georeferenced map; and

identifying the particular user-selectable symbol based, at least in part, on the spatial coordinates represented by the selected position.

46. (New) The method of claim 45, wherein identifying the particular user-selectable symbol based, at least in part, on the spatial coordinates represented by the selected position comprises:

searching a database of entities for an entity located nearest to the spatial coordinates represented by the selected position, wherein the entities represented by data in the database include the second devices, wherein the database data include locations of the respective entities, and wherein the database is searchable by location; and

based on a result of searching the database, identifying the particular second device as the entity located nearest to the spatial coordinates represented by the selected position, wherein the particular user-selectable symbol corresponds to the particular second device.

47. (New) The method of claim 46, wherein the entity is a first entity, and wherein the method further comprises performing by the first device:

receiving user input via user interaction with the interactive display of the first device, the user input specifying a location and a symbol corresponding to a second entity other than the first device and the second devices; and

based on the user input, adding the user-specified symbol to the interactive display at a position on the second georeferenced map corresponding to the user-specified location of the second entity.

48. (New) The method of claim 47, further comprising performing by the first device:
transmitting the user-specified symbol and location of the second entity to the second devices for addition of the user-specified symbol to respective interactive displays of the second devices at respective positions on respective georeferenced maps corresponding to the user-specified location of the second entity.

49. (New) The method of claim 48, wherein the user input further specifies information associated with the second entity, and wherein the method further comprises performing, by the first device: transmitting the user-specified information associated with the second entity to the second devices.

50. (New) The method of claim 49, further comprising performing by the first device:
adding data representing the spatial coordinates of the location of the second entity and data representing the information associated with the second entity to the database.

51. (New) The method of claim 47, wherein the portion of the interactive display is a first portion, wherein the position of the symbol corresponding to the particular second device is a first position, and wherein receiving the user input specifying the location of the second entity comprises:

detecting user selection of a second portion of the interactive display corresponding to a second position on the second georeferenced map; and

based at least in part on coordinates of the second position on the second georeferenced map and on the data relating positions on the second georeferenced map to spatial coordinates,

determining spatial coordinates of a location represented by the second position on the second georeferenced map, wherein the location represented by the second position is the location of the second entity.

52. (New) The method of claim 46, wherein the database is stored on the first device.
53. (New) The method of claim 46, wherein the database is stored on the server.
54. (New) The method of claim 1, wherein the spatial coordinates comprise latitude and longitude coordinates.
55. (New) The method of claim 1, further comprising performing, by the first device:
identifying user interaction with the interactive display selecting a particular user-selectable symbol corresponding to a particular second device and user interaction with the display specifying an action and, based thereon, initiating voice-over-IP (VOIP) communication with the particular second device.

REMARKS

Administrative Overview

Prior to the Office Action of February 19, 2016, claims 1, 2, 8, 9, 11-14, 20, 21, 23, 24, and 31-44 were pending. In the Office Action:

- the independent claims (i.e., claims 1 and 13) were rejected under 35 U.S.C. § 103 as purportedly being obvious over U.S. Pub. No. 2004/0148090 (“Melen”) in view of U.S. Patent No. 8,014,763 (“Hymes”); and
- each of the dependent claims was rejected under 35 U.S.C. § 103 as purportedly being obvious over Melen / Hymes alone or in combination with other secondary references.

In the present Amendment, claims 9 and 21 are canceled without prejudice or disclaimer, claims 1, 11, 13, 23, 31, 33, 37, and 39 are amended, and claims 45-55 are added. No new matter is added.

Support for the claim amendments and for new claims 45-51 and 54 can be found, for example, in U.S. Patent No. 7,630,724 (“the ‘724 patent”) in col. 5, lines 51-67; col. 7, line 48 – col. 8, line 48; col. 9, lines 41-45; col. 10, lines 23-56; and col. 18, line 57 – col. 19, line 7. Support for new claims 52 and 53 can be found, for example, in the ‘724 patent in col. 10, lines 9-22. Support for new claim 55 can be found, for example, in the ‘724 patent in col. 2, lines 64-67; and col. 11, lines 2-7. It is noted that the ‘724 patent was incorporated by reference into the present application at the time of the present application’s filing.

Applicability of Post-AIA Provisions of the Patent Laws to the Present Application

The Office Action (p. 2) states that “[t]he present application is being examined under the pre-AIA first to invent provisions” of the patent laws. For the reasons stated in the Response filed on November 13, 2015, it is understood that the present application will be examined under the post-AIA, first-to-file provisions of the patent laws.

Interview Summary

Applicant thanks Examiner Obayanju for conducting a telephonic interview on May 26, 2016. The participants included Examiner Obayanju, Applicant’s undersigned representative

(Daniel J. Burns), Applicant's legal representative (Samuel S. Stone), and the first named inventor (Malcolm K. Beyer, Jr.). The interview was held pursuant to a Proposed Interview Agenda that was emailed to the Examiner on May 26, 2016. Copies of the Interview Agenda and the email message are submitted herewith. A summary of the interview is provided below.

During the interview, the participants discussed the rejections of claims 1 and 9 under 35 U.S.C. § 103 as purportedly being obvious over Melen and Hymes. Applicant's representatives pointed out that the proposed combination of Melen and Hymes would render Melen's navigation system unsuitable for its intended purpose. In addition, Applicant's representatives pointed out that Melen and Hymes do not teach or suggest the subject matter of previously-pending claim 9. On these points, no agreement was reached. The participants discussed clarifying amendments to claim 9, and the Examiner encouraged Applicant's representatives to submit amendments to the independent claims based on claim 9 along with further clarifying amendments. Accordingly, the independent claims are amended herein based on previously-pending claim 9, and are further amended to clarify distinctions between the claimed subject matter and the cited references.

Overview of Some Embodiments

At the time the invention was made, conventional mobile device interfaces for locating and communicating with entities (e.g., users, businesses, homes, etc.) were generally cumbersome to use. See '724 patent, col. 1, line 53 – col. 2, line 4. For example, to view contact information for an entity at a particular location, a conventional mobile device may have required a user to access a user interface that displays a map of georeferenced entities and select the entity of interest. See '724 patent, col. 1, lines 53-60. To use the contact information (e.g., a telephone number) to initiate a phone call to the entity, the conventional mobile device may have required the user to access another user interface and manually enter the entity's phone number. See '724 patent, col. 1, lines 60-63. To use the contact information to send data to the entity, the conventional mobile device may have required the user to access yet another user interface and manually enter the entity's contact information. See '724 patent, col. 1, line 64 – col. 2, line 4. Furthermore, to enter and share the location of an entity not shown on the map of georeferenced entities, the mobile device might require a user to manually enter coordinates of the new entity

using yet another user interface. See '724 patent, col. 2, lines 5-9. Needless to say, this process of switching between different user interfaces to communicate with other users and to view, enter, and share georeferenced information is quite inconvenient. Likewise, the processes of manually entering contact information to initiate communication and manually entering geographical coordinates to share the location of an entity are cumbersome.

The present application describes, among other things, some embodiments of a mobile device that presents a user interface through which a user can view, enter, and share georeferenced information (e.g., georeferenced information associated with other users or entities), and can communicate with other users. See, e.g., '724 patent: FIG. 1; col. 1, lines 6-17; col. 2, line 48 – col. 3, line 10; and col. 3, lines 24-28 and 36-52. For example, the user interface may permit a user to view the locations of other users (see '724 patent, col. 2, lines 48-57), which may be represented by symbols displayed on a map at positions corresponding to the users' locations (see '724 patent, col. 6, lines 44-49). Each user's location may be updated based on the passage of time and/or based on the user's movement (see '724 patent: col. 14, line 66 – col. 15, line 6; and col. 9, lines 34-38). In some embodiments, the user interface permits a user to initiate phone calls with other users or send data (e.g., text messages, images, or video) to other users by selecting the symbol(s) corresponding to the other user(s) (see '724 patent, col. 3, lines 42-52). The user interface may also permit a user to view the locations of other entities (e.g., restaurants, gas stations, hospitals, fire departments, etc.) and to access information about those entities (see '724 patent: col. 8, lines 23-48; and col. 20, lines 1-19). In some embodiments, the user interface permits a user to enter an additional georeferenced entity (e.g., vehicle, event, site, etc.) and share the location of the added entity with other users by touching the displayed map at a position corresponding to the location of the entity (see '724 patent: col. 10, lines 23-57). Thus, the present application describes, among other things, a device that coordinates the retrieval of information associated with real-world entities and the communication of information between such entities through an easy-to-use but powerful user interface in which the entities are represented by interactive symbols displayed on a georeferenced map at positions corresponding to the entities' locations.

In some embodiments, the mobile device uses the georeferenced map to facilitate the selection of symbols corresponding to other entities and/or to facilitate the addition of new

georeferenced entities to the user interface. For example, when a user touches a portion of a georeferenced map at a particular position on the display, the device may use the georeferenced map to determine spatial coordinates (e.g., latitude and longitude) of the location represented by the selected portion of the map ('724 patent, col. 7, lines 48-51). The device may then search a database of entities to identify the entity in the database that is located closest to the location selected by the user ('724 patent: col. 7, lines 51-52; and col. 8, lines 32-38). To facilitate such searches, the database of entities may be searchable by entity location ('724 patent, col. 7, line 65 – col. 8, line 1). Alternatively, when entering a new entity into the database, a user may specify the entity's location simply by touching the corresponding position on the georeferenced map, rather than manually providing an address or a set of spatial coordinates ('724 patent, col. 10, lines 23-56). In some embodiments, the mobile device obtains the georeferenced map from a server ('724 patent, col. 18, line 57 – col. 19, line 7).

The foregoing discussion of some embodiments is provided merely to assist the Examiner in appreciating various aspects of the subject matter described in the present application. However, not all of the description provided above necessarily applies to each of the independent claims pending in the application. Therefore, the Examiner is requested to not rely upon the foregoing summary in interpreting any of the claims or in determining whether they patentably distinguish over the prior art of record, but rather is requested to rely only upon the language of the claims themselves and the arguments specifically related thereto provided below.

Claim Rejections Under 35 U.S.C. § 103

In the Office Action, the independent claims (i.e., claims 1 and 13) were rejected under 35 U.S.C. § 103 as purportedly being obvious over Melen in view of Hymes. These rejections are respectfully traversed as applied to the claims as amended. Even assuming (without conceding) that Melen and Hymes could have been properly combined, the proposed combination of Melen and Hymes does not teach or suggest all the limitations of either of the independent claims.

I. Independent Claim 1 and the Claims Depending Therefrom

As amended, independent claim 1 is directed to a method comprising:

with a first device, receiving a message from a second device, wherein the message relates to joining a group;

based on receiving the message from the second device, participating in the group, wherein participating in the group includes sending first location information to a server and receiving second location information from the server, the first location information comprising a location of the first device, the second location information comprising a plurality of locations of a respective plurality of second devices included in the group;

presenting, via an interactive display of the first device, a first interactive, georeferenced map and a plurality of user-selectable symbols corresponding to the plurality of second devices, wherein the symbols are positioned on the first georeferenced map at respective positions corresponding to the locations of the second devices, and wherein the first georeferenced map includes data relating positions on the first georeferenced map to spatial coordinates;

sending, from the first device to the server, a request for a second georeferenced map different from the first georeferenced map, wherein the request specifies a map location;

receiving, from the server, the second georeferenced map, wherein the second georeferenced map includes the requested location and data relating positions on the second georeferenced map to spatial coordinates;

presenting, via the interactive display of the first device, the second georeferenced map and the plurality of user-selectable symbols corresponding to the plurality of second devices, wherein the symbols are positioned on the second georeferenced map at respective positions corresponding to the locations of the second devices; and

identifying user interaction with the interactive display selecting one or more of the user-selectable symbols corresponding to one or more of the second devices and positioned on the second georeferenced map and user interaction with the display specifying an action and, based thereon, using an Internet Protocol to send data to the one or more second devices via the server,

wherein the first device does not have access to respective Internet Protocol addresses of the second devices. (Emphasis added.)

Melen does not teach or suggest at least “sending, from the first device to the server, a request for a second georeferenced map different from the first georeferenced map,” and “receiving, from the server, the second georeferenced map, wherein the second georeferenced map includes the requested location and data relating positions on the second georeferenced map to spatial coordinates,” as recited in claim 1. Melen describes a group of vehicle navigation

systems that are said to be capable of “communicating with other vehicle navigation systems of a group and receiving location information of the other vehicle navigation systems in the group” and “displaying the location of the vehicle navigations systems in the group on a map” ([0008]). According to Melen, the navigation system may store the map on a CD, DVD, hard disk, or in flash memory ([0055]; see also [0002]). However, Melen does not teach or suggest that the navigation system obtains the map from a server. Thus, the cited portions of Melen do not teach or suggest “sending, from the first device to the server, a request for a second georeferenced map different from the first georeferenced map,” and “receiving, from the server, the second georeferenced map, wherein the second georeferenced map includes the requested location and data relating positions on the second georeferenced map to spatial coordinates,” as recited in claim 1.

Hymes does not cure the deficiencies of Melen at least with respect to the above-emphasized portions of claim 1. Rather, Hymes appears to describe “sending information from [a] first electronic device indicating an intent to conditionally communicate with the recipient only upon an expression of interest from the recipient in communicating with a user of the first electronic device” (Abstract). In addition, Hymes describes a set of “perceptual addressing” techniques whereby a first user is said to establish a communications channel with a second user who the first user “can see in his or her environment but for whom no contact information is known” (col. 14, lines 24-27). In one of the perceptual addressing techniques described by Hymes, a user views a “floor map” sent from a data processing system (DPS), which displays the positions of other users such that each user is represented by a symbol (col. 67, lines 7-17). However, Hymes does not teach or suggest that the floor map is a georeferenced map that includes data relating positions on the second georeferenced map to spatial coordinates. Thus, the above-referenced portions of Hymes does not teach or suggest “sending, from the first device to the server, a request for a second georeferenced map different from the first georeferenced map,” and “receiving, from the server, the second georeferenced map, wherein the second georeferenced map includes the requested location and data relating positions on the second georeferenced map to spatial coordinates,” as recited in claim 1.

For at least the foregoing reasons, the cited portions of Melen and Hymes (individually or in combination) do not teach at least the subject matter of the above-emphasized portions of

claim 1. Claim 1 therefore patentably distinguishes over the cited art. Withdrawal of the rejection of claim 1 is respectfully requested. Claims 2, 8, 11, 12, 31-36, 43, and 45-55 depend from claim 1 and are allowable for at least the same reasons.

II. Independent Claim 13 and the Claims Depending Therefrom

As amended, independent claim 13 is directed to a system comprising a first device programmed to perform operations comprising:

receiving a message from a second device, wherein the message relates to joining a group;

based on receiving the message from the second device, participating in the group, wherein participating in the group includes sending first location information to a server and receiving second location information from the server, the first location information comprising a location of the first device, the second location information comprising a plurality of locations of a respective plurality of second devices included in the group;

presenting, via an interactive display of the first device, a first interactive, georeferenced map and a plurality of user-selectable symbols corresponding to the plurality of second devices, wherein the symbols are positioned on the first georeferenced map at respective positions corresponding to the locations of the second devices, and wherein the first georeferenced map includes data relating positions on the first georeferenced map to spatial coordinates;

sending, from the first device to the server, a request for a second georeferenced map different from the first georeferenced map, wherein the request specifies a map location;

receiving, from the server, the second georeferenced map, wherein the second georeferenced map includes the requested location and data relating positions on the second georeferenced map to spatial coordinates;

presenting, via the interactive display of the first device, the second georeferenced map and the plurality of user-selectable symbols corresponding to the plurality of second devices, wherein the symbols are positioned on the second georeferenced map at respective positions corresponding to the locations of the second devices; and

identifying user interaction with the interactive display selecting one or more of the user-selectable symbols corresponding to one or more of the second devices and positioned on the second georeferenced map and user interaction with the display specifying an action and, based thereon, using an Internet Protocol to send data to the one or more second devices via the server,

wherein the first device does not have access to respective Internet Protocol addresses of the second devices. (Emphasis added.)

For reasons that should be apparent from the discussion above, the cited portions of Melen and Hymes (individually or in combination) do not teach or suggest at least the subject matter of the above-emphasized portions of claim 13. Claim 13 therefore patentably distinguishes over the cited art. Withdrawal of the rejection of claim 13 is respectfully requested. Claims 14, 20, 23, 24, 37-42, and 44 depend from claim 13 and are allowable for at least the same reasons.

CONCLUSION

By responding in the foregoing remarks only to particular positions taken by the Examiner, Applicant does not acquiesce with other positions that have not been explicitly addressed. In addition, Applicant's arguments for the patentability of a claim should not be understood as implying that no other reasons for the patentability of that claim exist. Finally, Applicant's decision to amend or cancel any claim should not be understood as implying that Applicant agrees with any positions taken by the Examiner with respect to that claim or other claims.

The pending application is believed to be in condition for allowance. If, in the Examiner's opinion, further communication would expedite the favorable prosecution of the present application, the undersigned would welcome the opportunity to discuss any outstanding issues and to work with the Examiner toward placing the application in condition for allowance.

Respectfully submitted,

Dated: June 3, 2016

/Daniel J. Burns/
Daniel J. Burns
Registration No.: 50,222

Customer Number: 51414
Goodwin Procter LLP
Telephone: (650) 752-3100

PETITION FOR EXTENSION OF TIME UNDER 37 CFR 1.136(a)		Docket Number (Optional) MOC-005																															
Application Number 14/633,804-Conf. #8573		Filed February 27, 2015																															
For METHOD TO PROVIDE AD HOC AND PASSWORD PROTECTED DIGITAL AND VOICE NETWORKS																																	
Art Unit 2646		Examiner O. Obayanju																															
<p>This is a request under the provisions of 37 CFR 1.136(a) to extend the period for filing a reply in the above-identified application. The requested extension and fee are as follows (check time period desired and enter the appropriate fee below):</p> <table border="1" style="width: 100%; border-collapse: collapse;"> <thead> <tr> <th></th> <th style="text-align: center;">Fee</th> <th style="text-align: center;">Small Entity Fee</th> <th style="text-align: center;">Micro Entity Fee</th> <th></th> </tr> </thead> <tbody> <tr> <td><input checked="" type="checkbox"/> One month (37 CFR 1.17(a)(1))</td> <td style="text-align: center;">\$200</td> <td style="text-align: center;">\$100</td> <td style="text-align: center;">\$50</td> <td style="text-align: center;">\$ 100.00</td> </tr> <tr> <td><input type="checkbox"/> Two months (37 CFR 1.17(a)(2))</td> <td style="text-align: center;">\$600</td> <td style="text-align: center;">\$300</td> <td style="text-align: center;">\$150</td> <td style="text-align: center;">\$ _____</td> </tr> <tr> <td><input type="checkbox"/> Three months (37 CFR 1.17(a)(3))</td> <td style="text-align: center;">\$1,400</td> <td style="text-align: center;">\$700</td> <td style="text-align: center;">\$350</td> <td style="text-align: center;">\$ _____</td> </tr> <tr> <td><input type="checkbox"/> Four months (37 CFR 1.17(a)(4))</td> <td style="text-align: center;">\$2,200</td> <td style="text-align: center;">\$1,100</td> <td style="text-align: center;">\$550</td> <td style="text-align: center;">\$ _____</td> </tr> <tr> <td><input type="checkbox"/> Five months (37 CFR 1.17(a)(5))</td> <td style="text-align: center;">\$3,000</td> <td style="text-align: center;">\$1,500</td> <td style="text-align: center;">\$750</td> <td style="text-align: center;">\$ _____</td> </tr> </tbody> </table> <p> <input checked="" type="checkbox"/> Applicant asserts small entity status. See 37 CFR 1.27. <input type="checkbox"/> Applicant certifies micro entity status. See 37 CFR 1.29. <small>Form PTO/SB/15A or B or equivalent must either be enclosed or have been submitted previously.</small> <input type="checkbox"/> A check in the amount of the fee is enclosed. <input checked="" type="checkbox"/> Payment by credit card. <input type="checkbox"/> The Director has already been authorized to charge fees in this application to a Deposit Account. <input checked="" type="checkbox"/> The Director is hereby authorized to charge any fees which may be required, or credit any overpayment, to Deposit Account Number <u>07-1700</u>. <input checked="" type="checkbox"/> Payment made via EFS-Web. </p> <p>WARNING: Information on this form may become public. Credit card information should not be included on this form. Provide credit card information and authorization on PTO-2038.</p> <p>I am the</p> <p> <input type="checkbox"/> applicant. <input type="checkbox"/> attorney or agent of record. Registration number _____. <input checked="" type="checkbox"/> attorney or agent acting under 37 CFR 1.34. Registration number <u>50,222</u>. </p> <p style="text-align: center;"> <u>/Daniel J. Burns/</u> Signature </p> <p style="text-align: center;"> <u>June 3, 2016</u> Date </p> <p style="text-align: center;"> <u>Daniel J. Burns</u> Typed or printed name </p> <p style="text-align: center;"> <u>(650) 752-3100</u> Telephone Number </p> <p>NOTE: This form must be signed in accordance with 37 CFR 1.33. See 37 CFR 1.4 for signature requirements and certifications. Submit multiple forms if more than one signature is required, see below*.</p>					Fee	Small Entity Fee	Micro Entity Fee		<input checked="" type="checkbox"/> One month (37 CFR 1.17(a)(1))	\$200	\$100	\$50	\$ 100.00	<input type="checkbox"/> Two months (37 CFR 1.17(a)(2))	\$600	\$300	\$150	\$ _____	<input type="checkbox"/> Three months (37 CFR 1.17(a)(3))	\$1,400	\$700	\$350	\$ _____	<input type="checkbox"/> Four months (37 CFR 1.17(a)(4))	\$2,200	\$1,100	\$550	\$ _____	<input type="checkbox"/> Five months (37 CFR 1.17(a)(5))	\$3,000	\$1,500	\$750	\$ _____
	Fee	Small Entity Fee	Micro Entity Fee																														
<input checked="" type="checkbox"/> One month (37 CFR 1.17(a)(1))	\$200	\$100	\$50	\$ 100.00																													
<input type="checkbox"/> Two months (37 CFR 1.17(a)(2))	\$600	\$300	\$150	\$ _____																													
<input type="checkbox"/> Three months (37 CFR 1.17(a)(3))	\$1,400	\$700	\$350	\$ _____																													
<input type="checkbox"/> Four months (37 CFR 1.17(a)(4))	\$2,200	\$1,100	\$550	\$ _____																													
<input type="checkbox"/> Five months (37 CFR 1.17(a)(5))	\$3,000	\$1,500	\$750	\$ _____																													

* Total of 1 forms are submitted.

Electronic Patent Application Fee Transmittal

Application Number:	14633804			
Filing Date:	27-Feb-2015			
Title of Invention:	METHOD TO PROVIDE AD HOC AND PASSWORD PROTECTED DIGITAL AND VOICE NETWORKS			
First Named Inventor/Applicant Name:	Malcolm K. Beyer			
Filer:	Daniel J. Burns/Samuel Stone			
Attorney Docket Number:	MOC-005			
Filed as Small Entity				
Filing Fees for Utility under 35 USC 111(a)				
Description	Fee Code	Quantity	Amount	Sub-Total in USD(\$)
Basic Filing:				
Pages:				
Claims:				
Claims in excess of 20	2202	7	40	280
Miscellaneous-Filing:				
Petition:				
Patent-Appeals-and-Interference:				
Post-Allowance-and-Post-Issuance:				

Description	Fee Code	Quantity	Amount	Sub-Total in USD(\$)
Extension-of-Time:				
Extension - 1 month with \$0 paid	2251	1	100	100
Miscellaneous:				
Total in USD (\$)				380

Electronic Acknowledgement Receipt

EFS ID:	25938274
Application Number:	14633804
International Application Number:	
Confirmation Number:	8573
Title of Invention:	METHOD TO PROVIDE AD HOC AND PASSWORD PROTECTED DIGITAL AND VOICE NETWORKS
First Named Inventor/Applicant Name:	Malcolm K. Beyer
Customer Number:	51414
Filer:	Daniel J. Burns/Samuel Stone
Filer Authorized By:	Daniel J. Burns
Attorney Docket Number:	MOC-005
Receipt Date:	03-JUN-2016
Filing Date:	27-FEB-2015
Time Stamp:	21:18:27
Application Type:	Utility under 35 USC 111(a)

Payment information:

Submitted with Payment	yes
Payment Type	Credit Card
Payment was successfully received in RAM	\$380
RAM confirmation Number	6391
Deposit Account	
Authorized User	

The Director of the USPTO is hereby authorized to charge indicated fees and credit any overpayment as follows:

File Listing:					
Document Number	Document Description	File Name	File Size(Bytes)/ Message Digest	Multi Part /.zip	Pages (if appl.)
1	Examination support document	MOC-005_Agenda.pdf	183227 0e59a117a4f891ff097aaaf21212fb02955b259a6f	no	2
Warnings:					
Information:					
2		MOC-005_Amendment.pdf	134018 ee724c5205025195bb016127d90df1cb2195efdb	yes	19
Multipart Description/PDF files in .zip description					
		Document Description	Start	End	
		Amendment/Req. Reconsideration-After Non-Final Reject	1	1	
		Claims	2	10	
		Applicant Arguments/Remarks Made in an Amendment	11	19	
Warnings:					
Information:					
3	Extension of Time	MOC-005_EOT.pdf	97656 9dfb999c95a7a86de5452750dde6d616a1715f13	no	1
Warnings:					
Information:					
4	Fee Worksheet (SB06)	fee-info.pdf	32618 606e4e174acd8aa45b35f3c7b139291ba6e436a4	no	2
Warnings:					
Information:					
Total Files Size (in bytes):			447519		

This Acknowledgement Receipt evidences receipt on the noted date by the USPTO of the indicated documents, characterized by the applicant, and including page counts, where applicable. It serves as evidence of receipt similar to a Post Card, as described in MPEP 503.

New Applications Under 35 U.S.C. 111

If a new application is being filed and the application includes the necessary components for a filing date (see 37 CFR 1.53(b)-(d) and MPEP 506), a Filing Receipt (37 CFR 1.54) will be issued in due course and the date shown on this Acknowledgement Receipt will establish the filing date of the application.

National Stage of an International Application under 35 U.S.C. 371

If a timely submission to enter the national stage of an international application is compliant with the conditions of 35 U.S.C. 371 and other applicable requirements a Form PCT/DO/EO/903 indicating acceptance of the application as a national stage submission under 35 U.S.C. 371 will be issued in addition to the Filing Receipt, in due course.

New International Application Filed with the USPTO as a Receiving Office

If a new international application is being filed and the international application includes the necessary components for an international filing date (see PCT Article 11 and MPEP 1810), a Notification of the International Application Number and of the International Filing Date (Form PCT/RO/105) will be issued in due course, subject to prescriptions concerning national security, and the date shown on this Acknowledgement Receipt will establish the international filing date of the application.

Stone, Samuel S.

From: Stone, Samuel S.
Sent: Thursday, May 26, 2016 11:48 AM
To: 'omoniyi.obayanju@uspto.gov'
Cc: Burns, Dan; 'Cap Beyer'
Subject: Proposed Interview Agendas for U.S. App. Nos. 14/695,233 and 14/633,804
Attachments: Agenda - 14-695233.docx; Agenda - 14-633804.docx

Importance: High

Dear Examiner Obayanju,

Thank you for your courtesy in granting a telephone interview today (Thursday, May 26, 2016, at 2pm EDT), in Application Serial Nos. 14/695,233 and 14/633,804. Proposed interview agendas for the two applications are attached. The agendas include the phone number of our conference bridge; please dial into the conference bridge for the interview.

Regards,
Sam

Sent by Samuel S. Stone on behalf of:

Daniel J. Burns
Goodwin Procter LLP
T: (650) 752-3100
dburns@goodwinprocter.com

IN THE UNITED STATES PATENT AND TRADEMARK OFFICE

First Named Inventor: Malcolm K. Beyer, Jr.

Application No.: 14/633,804

Confirmation No.: 8573

Filed: February 27, 2015

Art Unit: 2646

For: Method to Provide Ad Hoc and Password
Protected Digital and Voice Networks

Examiner: O. Obayanju

Commissioner for Patents
P.O. Box 1450
Alexandria, VA 22313-1450

PROPOSED INTERVIEW AGENDA

Applicant thanks Examiner Obayanju for agreeing to conduct a telephone interview with Applicant's undersigned representative (Daniel J. Burns), Applicant's legal representative (Samuel S. Stone), and the first named inventor (Malcolm K. Beyer, Jr.) on May 26, 2016 at 2:00 PM EST, regarding the above-identified application and related Application Serial No. 14/695,233. Applicant respectfully invites the Examiner to call Applicant's representatives at 1-877-659-4128 (access code 5701624) at the scheduled time.

With regard to Application Serial No. 14/633,804, Applicant's representatives would appreciate discussing the Office Action's assertion that it would have been obvious to one of ordinary skill in the art to combine the teachings of Melen and Hymes in the manner proposed in the rejection of claim 1. In addition, Applicant's representatives would appreciate discussing how the Examiner is interpreting Melen as teaching "sending, from the first device, a request for a second map, wherein the request specifies a map location; and receiving, from the server, the second map" as recited in claim 9.

Dated: May 25, 2016

Respectfully submitted,

Electronic signature: /Daniel J. Burns/

Daniel J. Burns

Registration No.: 50,222

GOODWIN PROCTER LLP

(650) 752-3100

Under the Paperwork Reduction Act of 1995, no persons are required to respond to a collection of information unless it displays a valid OMB control number.

PATENT APPLICATION FEE DETERMINATION RECORD Substitute for Form PTO-875	Application or Docket Number 14/633,804	Filing Date 02/27/2015	<input type="checkbox"/> To be Mailed
---	---	----------------------------------	---------------------------------------

ENTITY: LARGE SMALL MICRO

APPLICATION AS FILED – PART I

FOR	NUMBER FILED	NUMBER EXTRA	RATE (\$)	FEE (\$)
<input type="checkbox"/> BASIC FEE (37 CFR 1.16(a), (b), or (c))	N/A	N/A	N/A	
<input type="checkbox"/> SEARCH FEE (37 CFR 1.16(k), (l), or (m))	N/A	N/A	N/A	
<input type="checkbox"/> EXAMINATION FEE (37 CFR 1.16(o), (p), or (q))	N/A	N/A	N/A	
TOTAL CLAIMS (37 CFR 1.16(i))	minus 20 = *	*	X \$ =	
INDEPENDENT CLAIMS (37 CFR 1.16(h))	minus 3 = *	*	X \$ =	
<input type="checkbox"/> APPLICATION SIZE FEE (37 CFR 1.16(s))	If the specification and drawings exceed 100 sheets of paper, the application size fee due is \$310 (\$155 for small entity) for each additional 50 sheets or fraction thereof. See 35 U.S.C. 41(a)(1)(G) and 37 CFR 1.16(s).			
<input type="checkbox"/> MULTIPLE DEPENDENT CLAIM PRESENT (37 CFR 1.16(j))				
* If the difference in column 1 is less than zero, enter "0" in column 2.			TOTAL	

APPLICATION AS AMENDED – PART II

AMENDMENT	(Column 1)	(Column 2)	(Column 3)	(Column 3)	RATE (\$)	ADDITIONAL FEE (\$)	
	06/03/2016	CLAIMS REMAINING AFTER AMENDMENT	HIGHEST NUMBER PREVIOUSLY PAID FOR	PRESENT EXTRA			
	Total (37 CFR 1.16(i))	* 34	Minus ** 28	= 6	X \$40 =	240	
	Independent (37 CFR 1.16(h))	* 3	Minus ***4	= 0	X \$210 =	0	
	<input type="checkbox"/> Application Size Fee (37 CFR 1.16(s))						
	<input type="checkbox"/> FIRST PRESENTATION OF MULTIPLE DEPENDENT CLAIM (37 CFR 1.16(j))						
					TOTAL ADD'L FEE	240	

AMENDMENT	(Column 1)	(Column 2)	(Column 3)	(Column 3)	RATE (\$)	ADDITIONAL FEE (\$)	
		CLAIMS REMAINING AFTER AMENDMENT	HIGHEST NUMBER PREVIOUSLY PAID FOR	PRESENT EXTRA			
	Total (37 CFR 1.16(i))	*	Minus **	=	X \$ =		
	Independent (37 CFR 1.16(h))	*	Minus ***	=	X \$ =		
	<input type="checkbox"/> Application Size Fee (37 CFR 1.16(s))						
	<input type="checkbox"/> FIRST PRESENTATION OF MULTIPLE DEPENDENT CLAIM (37 CFR 1.16(j))						
					TOTAL ADD'L FEE		

* If the entry in column 1 is less than the entry in column 2, write "0" in column 3.
 ** If the "Highest Number Previously Paid For" IN THIS SPACE is less than 20, enter "20".
 *** If the "Highest Number Previously Paid For" IN THIS SPACE is less than 3, enter "3".

The "Highest Number Previously Paid For" (Total or Independent) is the highest number found in the appropriate box in column 1.

LIE
 /SHEILA D. CHAPMAN/

This collection of information is required by 37 CFR 1.16. The information is required to obtain or retain a benefit by the public which is to file (and by the USPTO to process) an application. Confidentiality is governed by 35 U.S.C. 122 and 37 CFR 1.14. This collection is estimated to take 12 minutes to complete, including gathering, preparing, and submitting the completed application form to the USPTO. Time will vary depending upon the individual case. Any comments on the amount of time you require to complete this form and/or suggestions for reducing this burden, should be sent to the Chief Information Officer, U.S. Patent and Trademark Office, U.S. Department of Commerce, P.O. Box 1450, Alexandria, VA 22313-1450. DO NOT SEND FEES OR COMPLETED FORMS TO THIS ADDRESS. **SEND TO: Commissioner for Patents, P.O. Box 1450, Alexandria, VA 22313-1450.**

If you need assistance in completing the form, call 1-800-PTO-9199 and select option 2.

Under the Paperwork Reduction Act of 1995, no persons are required to respond to a collection of information unless it contains a valid OMB control number.

Substitute for form 1449/PTO INFORMATION DISCLOSURE STATEMENT BY APPLICANT <i>(Use as many sheets as necessary)</i>				Complete if Known		
				Application Number	14/633,804	
				Filing Date	02/27/2015	
				First Named Inventor	Malcolm K. Beyer	
				Art Unit	2646	
				Examiner Name	O. Obayanju	
Sheet	1	of	2	Attorney Docket Number	MOC-005	

U.S. PATENT DOCUMENTS					
Examiner Initials*	Cite No. ¹	Document Number	Publication Date MM-DD-YYYY	Name of Patentee or Applicant of Cited Document	Pages, Columns, Lines, Where Relevant Passages or Relevant Figures Appear
		Number-Kind Code ² (if known)			
	A1	US-6,377,210	04-23-2002	Moore	
	A2	US-6,434,403	08-13-2002	Ausems et al.	
	A3	US-6,490,521	12-03-2002	Wiener	
	A4	US-6,518,957	02-11-2003	Lehtinen et al.	
	A5	US-6,549,768	04-15-2003	Fraccaroli	
	A6	US-6,882,856	04-19-2005	Alterman et al.	
	A7	US-7,330,112	02-12-2008	Emigh et al.	
	A8	US-7,486,648	02-03-2009	Baranowski	
	A9	US-8,014,763	09-06-2011	Hymes	
	A10	US-8,139,514	03-20-2012	Weber et al.	
	A11	US-2004/0054428	03-18-2004	Sheha et al.	
	A12	US-2004/0137884	07-15-2004	Engstrom et al.	
	A13	US-2004/0143391	07-22-2004	King et al.	
	A14	US-2004/0148090	07-29-2004	Melen	
	A15	US-2004/0252050	12-16-2004	Tengler et al.	
	A16	US-2005/0060069	03-17-2005	Breed et al.	
	A17	US-2005/0227705	10-13-2005	Rousu et al.	
	A18	US-2010/0052945	03-04-2010	Breed	

FOREIGN PATENT DOCUMENTS						
Examiner Initials*	Cite No. ¹	Foreign Patent Document	Publication Date MM-DD-YYYY	Name of Patentee or Applicant of Cited Document	Pages, Columns, Lines, Where Relevant Passages Or Relevant Figures Appear	T ⁶
		Country Code ³ -Number ⁴ -Kind Code ⁵ (if known)				
	B1	JP-2000-357296-A	12-26-2000	Matsushita Electric Ind Co Ltd		X
	B2	JP-2002-277256-A	09-25-2002	Mazda Motor Corp.		X

Examiner Signature		Date Considered	
-----------------------	--	--------------------	--

*EXAMINER: Initial if reference considered, whether or not citation is in conformance with MPEP 609. Draw line through citation if not in conformance and not considered. Include copy of this form with next communication to applicant. ¹ Applicant's unique citation designation number (optional). ² See Kinds Codes of USPTO Patent Documents at www.uspto.gov or MPEP 901.04. ³ Enter Office that issued the document, by the two-letter code (WIPO Standard ST.3). ⁴ For Japanese patent documents, the indication of the year of the reign of the Emperor must precede the serial number of the patent document. ⁵ Kind of document by the appropriate symbols as indicated on the document under WIPO Standard ST.16 if possible. ⁶ Applicant is to place a check mark here if English language Translation is attached. This collection of information is required by 37 CFR 1.97 and 1.98. The information is required to obtain or retain a benefit by the public which is to file (and by the USPTO to process) an application. Confidentiality is governed by 35 U.S.C. 122 and 37 CFR 1.14. This collection is estimated to take 2 hours to complete, including gathering, preparing, and submitting the completed application form to the USPTO. Time will vary depending upon the individual case. Any comments on the amount of time you require to complete this form and/or suggestions for reducing this burden, should be sent to the Chief Information Officer, U.S. Patent and Trademark Office, P.O. Box 1450, Alexandria, VA 22313-1450. DO NOT SEND FEES OR COMPLETED FORMS TO THIS ADDRESS. SEND TO: Commissioner for Patents, P.O. Box 1450, Alexandria, VA 22313-1450.

If you need assistance in completing the form, call 1-800-PTO-9199 (1-800-786-9199) and select option 2.

Under the Paperwork Reduction Act of 1995, no persons are required to respond to a collection of information unless it contains a valid OMB control number.

Substitute for form 1449/PTO INFORMATION DISCLOSURE STATEMENT BY APPLICANT (Use as many sheets as necessary)			Complete if Known		
			Application Number	14/633,804	
			Filing Date	02/27/2015	
			First Named Inventor	Malcolm K. Beyer	
			Art Unit	2646	
			Examiner Name	O. Obayanju	
Sheet	2		2	Attorney Docket Number	MOC-005

NON PATENT LITERATURE DOCUMENTS			
Examiner Initials*	Cite No. ¹	Include name of the author (in CAPITAL LETTERS), title of the article (when appropriate), title of the item (book, magazine, journal, serial, symposium, catalog, etc.), date, page(s), volume-issue number(s), publisher, city and/or country where published.	T ₂
	C1	Garmin rino 110 2-way Radio & Personal Navigator; Owner's Manual and Reference Guide; Apr. 2003; 88pgs	
	C2	Int'l Preliminary Report on Patentability (IPRP); for Int'l Patent App. No. PCT/JP2004/000250 dated 7/5/2005; 4pgs	
	C3	Life360's Rule 50(a) Motion for Judgment as a Matter of Law; AGIS, Inc. v. Life360, Inc. (S.D. FL.); 3/12/2015; 27pgs	
	C4	Plaintiff Advanced Ground Information Systems, Inc.'s Motions In Limine; AGIS, Inc. v. Life360, Inc. (S.D. FL.); 2/19/2015; 54pgs	
	C5	PRNewswire, "Trimble GPS Technology Enables Seiko Epson Communication Device and Wireless Data Service," Nov. 8, 1999, accessed on the internet at: http://www.prnewswire.com/news-releases/trimble-gps-technology-enables-seiko-epson-communication-device-and-wireless-data-service-77056402.html ; downloaded Jun. 16, 2016; 4pgs.	

Examiner Signature		Date Considered	
--------------------	--	-----------------	--

*EXAMINER: Initial if reference considered, whether or not citation is in conformance with MPEP 609. Draw line through citation if not in conformance and not considered. Include copy of this form with next communication to applicant. 1 Applicant's unique citation designation number (optional). 2 Applicant is to place a check mark here if English language Translation is attached. This collection of information is required by 37 CFR 1.98. The information is required to obtain or retain a benefit by the public which is to file (and by the USPTO to process) an application. Confidentiality is governed by 35 U.S.C. 122 and 37 CFR 1.14. This collection is estimated to take 2 hours to complete, including gathering, preparing, and submitting the completed application form to the USPTO. Time will vary depending upon the individual case. Any comments on the amount of time you require to complete this form and/or suggestions for reducing this burden, should be sent to the Chief Information Officer, U.S. Patent and Trademark Office, P.O. Box 1450, Alexandria, VA 22313-1450. DO NOT SEND FEES OR COMPLETED FORMS TO THIS ADDRESS. SEND TO: Commissioner for Patents, P.O. Box 1450, Alexandria, VA 22313-1450.
If you need assistance in completing the form, call 1-800-PTO-9199 (1-800-786-9199) and select option 2.

PATENT ABSTRACTS OF JAPAN

(11)Publication number : 2000-357296
 (43)Date of publication of application : 26.12.2000

(51)Int.Cl. G08G 1/137
 G01C 21/00

(21)Application number : 11-168694 (71)Applicant : MATSUSHITA ELECTRIC IND CO LTD
 (22)Date of filing : 15.06.1999 (72)Inventor : UNOKI TAKASHI

(54) METHOD AND DEVICE FOR PROVIDING VEHICLE POSITION INFORMATION

(57)Abstract:

PROBLEM TO BE SOLVED: To provide each vehicle with position information of plural other vehicles to enable them to confirm positions of each other.
 SOLUTION: Position information of each vehicle is collected by a car navigation device of the vehicle. This information is transmitted to a management center 1g by a telephone unit 1e. The management center 1g receives it by a telephone unit 1h. Position information on plural vehicles are managed by a vehicle position information management device 1i. These position information are delivered to each vehicle from the management center 1g by a satellite digital sound broadcasting transmitter 1j and received by a satellite digital sound broadcasting receiver 1f at the vehicle side. Marks are displayed in pertinent geographic positions on a digital map of a display device 1d on a vehicle so that the active state can be recognized. Each vehicle can confirm positions of plural vehicle including the vehicle itself and other vehicles. A vehicle mark on the digital map is selected to automatically telephone the pertinent vehicle, and speech and data transmission are performed.

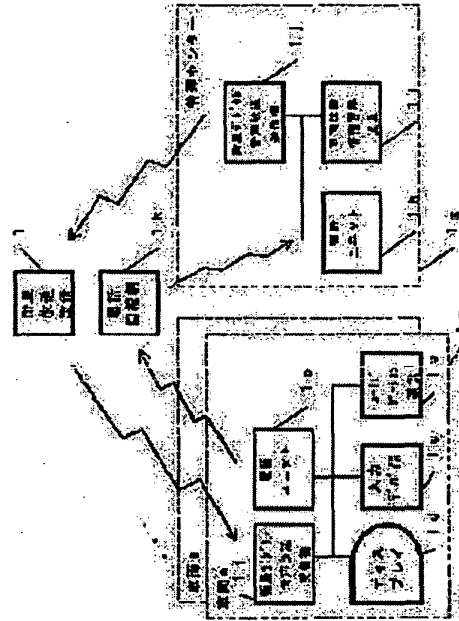

LEGAL STATUS

[Date of request for examination] 05.12.2001
 [Date of sending the examiner's decision of rejection] 25.02.2003
 [Kind of final disposal of application other than the examiner's decision of rejection or application converted registration]
 [Date of final disposal for application]
 [Patent number] 3454754

[Date of registration] 25.07.2003
[Number of appeal against examiner's decision of rejection] 2003-05004
[Date of requesting appeal against examiner's decision of rejection] 27.03.2003
[Date of extinction of right]

Copyright (C); 1998,2003 Japan Patent Office

(ENGLISH TRANSLATION)

Japanese Laid-open Patent

Laid-open Number: 2000-357296
Laid-open Date: December 26, 2000
Application Number: Hei 11-168694
Filing Date: June 15, 1999
Applicant: Matsushita Electric Industrial Co., Ltd.

(54) [Title of the Invention] Vehicle position information providing system and vehicle position information providing method

(57) [Summary]

[Object] To provide each vehicle with position information on a plurality of other vehicles to enable them to confirm positions of one another.

[Solving Means] A car navigation device of each vehicle is used to collect own-vehicle position information. This information is transmitted to a management center through a telephone unit thereof. This is received by the management center through a telephone unit thereof. Position information on a plurality of vehicles is managed by a vehicle position information management system. The position information is distributed to each vehicle from the management center through a satellite digital audio broadcast transmitter, and received by the vehicle through a satellite digital audio broadcast receiver thereof. Marks are displayed in corresponding geographic positions on a digital map of a display device on a vehicle such that the active state can be grasped. Each vehicle can confirm

positions of a plurality of vehicles including the own vehicle and the other vehicles. A vehicle mark on the digital map is selected to automatically call the corresponding vehicle by telephone, allowing voice communications and data transmission.

[Scope of Claims]

[Claim 1] A vehicle position information providing system, characterized by comprising: vehicles each provided with means for collecting own-vehicle position information, means for transmitting the own-vehicle position information to a management center, and an on-vehicle display device for displaying marks in corresponding positions of the plurality of vehicles on a digital map; and the management center provided with vehicle position information distributing means for distributing the vehicle position information to each of the vehicles.

[Claim 2] The vehicle position information providing system in accordance with claim 1, characterized in that: the vehicle position information distributing means is provided with means for adding a group identification number to position information to be distributed from the management center to each of the vehicles; and each of the vehicles is provided with means for identifying the group identification number and displaying only information on vehicles belonging to a group.

[Claim 3] The vehicle position information providing system in accordance with claim 1, characterized in that the vehicle position information distributing means is provided with means for adding a cellular telephone number of a telephone mounted to the vehicle to position information to be distributed from the management center to each of the vehicles.

[Claim 4] The vehicle position information providing system in accordance with claim 1, characterized in that the system is provided with means for, in response to selection of a vehicle mark on the digital map displayed on the on-vehicle display device, calling the corresponding vehicle by telephone to start voice communications.

[Claim 5] The vehicle position information providing system in accordance with claim 1, characterized in that the system is also provided with means for, in response to selection of a vehicle mark on the digital map displayed on the on-vehicle display device, calling the corresponding vehicle by telephone to transmit data such as a text message and route guidance to a destination.

[Claim 6] The vehicle position information providing system in accordance with claim 1, characterized in that the vehicle position information distributing means includes means for distributing the position information on the plurality of vehicles to each of the vehicles from the management center via a satellite digital audio broadcasting system.

[Claim 7] A vehicle position information providing method, characterized by comprising: collecting own-vehicle position information in each of vehicles; transmitting the own-vehicle position information to the management center; distributing the position information on a plurality of vehicles to each of the vehicles from the management center; and in each of the vehicles, displaying

marks in corresponding positions of the plurality of vehicles on a digital map of an on-vehicle display device.

[Claim 8] The vehicle position information providing method in accordance with claim 7, characterized by further comprising: adding a group identification number to the position information to be distributed from the management center to each of the vehicles; and in each of the vehicles, identifying the group identification number and displaying only information on vehicles belonging to a corresponding group.

[Claim 9] The vehicle position information providing method in accordance with claim 7, characterized by further comprising adding a cellular telephone number to the position information to be distributed from the management center to each of the vehicles.

[Claim 10] The vehicle position information providing method in accordance with claim 7, characterized by further comprising, in response to selection of a vehicle mark on the digital map displayed on the on-vehicle display device, calling the corresponding vehicle by telephone to start voice communications.

[Claim 11] The vehicle position information providing method in accordance with claim 7, characterized by further comprising, in response to selection of a vehicle mark on the digital map displayed on the on-vehicle display device, calling the corresponding vehicle by telephone to transmit various data such as a text message and route guidance to a destination.

[Claim 12] The vehicle position information providing method in accordance with claim 7, characterized by further comprising distributing the position information on the plurality of vehicles to each of the vehicles from the management center through a satellite digital audio broadcast.

[Detailed Description of the Invention]

[0001]

[Technical Field to which the Invention belongs] The present invention relates to a vehicle position information providing system, and more particularly to a vehicle position information providing system for managing dynamic states of respective vehicles by collecting own-vehicle position information from respective managing vehicles into one place by means of mobile communication, by displaying their own-vehicle position information as marks by use of a map display device, and by other such operations.

[0002]

[Prior Art] An on-vehicle device such as a car navigation system has a function of calculating a position of the own vehicle by using a GPS, a vehicle speed, a gyro, and a map matching technique. Position information calculated on this vehicle is transmitted to a management center by means of mobile communication such as a cellular telephone. In the management center, a map display device is used to display each vehicle as a mark on a map and thereby manage dynamic states of vehicles. Examples of such a vehicle position information

management system includes one disclosed in JP 5-67113 A. Fig. 6 shows an example of a conventional vehicle dynamic state management system.

[0003] An automobile 10 receives navigation radio waves containing tracking data and time from a plurality of GPS satellites 2 and measures an own-vehicle position. The automobile 10 is also equipped with a travel management recorder (VDR) 13 and collects travel management data. The travel management data and own-vehicle position data are transmitted to an office 20 by a mobile radio transmitter/receiver 12. In the office 20, the vehicle position and travel data are received and the vehicle position is displayed on a display device 24. Further, based on those data, an instruction and data necessary for delivery operation by automobile are obtained by a workstation 22 and transmitted to the automobile 10 via a mobile radio base station 21. In the automobile 10, the instruction and data received by the on-vehicle mobile radio transmitter/receiver 12 are displayed on an on-vehicle display device 14. Accordingly, the delivery operation can be performed according to the instruction from the office, making it possible to improve delivery operation efficiency.

[0004]

[Problem to be solved by the Invention] However, in the conventional vehicle dynamic state management system, own-vehicle position information on each vehicle is displayed on a display device on

a side of a fixed station such as an office or a management center, but cannot be displayed on a vehicle side. Therefore, vehicles cannot confirm positions of one another. For example, there is a problem in that it is impossible to perform patrolling with efficiency, to perform delivery operation with efficiency, and while driving, confirm the positions of one another among vehicles whose users are friends with one another.

[0005] The present invention has an object to solve the above problem, and to provide a vehicle with position information on a plurality of vehicles so as to allow the vehicles to confirm positions of one another.

[0006]

[Means for solving the Problem] In order to achieve the above object, according to the present invention, a vehicle position information providing system is configured to include: vehicles each provided with means for collecting own-vehicle position information, means for transmitting the own-vehicle position information to a management center, and an on-vehicle display device for displaying marks in corresponding positions of a plurality of vehicles on a digital map; and the management center provided with vehicle position information distributing means for distributing the position information on a plurality of vehicles to each of the vehicles.

[0007] The above configuration makes it possible to provide each of the vehicles with the position information on a plurality of

other vehicles and allows the vehicles to confirm the positions of one another.

[0008] Further, the vehicle position information distributing means is provided with means for adding a group identification number to the position information to be distributed from the management center to each of the vehicles, and each of the vehicles is provided with means for identifying the group identification number and displaying only information on vehicles belonging to a corresponding group. The above configuration makes it possible to share the position information only within the group.

[0009] Further, the vehicle position information distributing means is provided with means for adding a cellular telephone number to the position information to be distributed from the management center to each of the vehicles. By being thus configured, the system is also provided with means for, in response to selection of a vehicle mark on the digital map displayed on the on-vehicle display device, calling the corresponding vehicle by telephone to start voice communications. The above configuration makes it possible to automatically call a vehicle displayed on the map by telephone.

[0010] Further, the system is also provided with means for, in response to selection of a vehicle mark on the digital map displayed on the on-vehicle display device, calling the corresponding vehicle by telephone to transmit various data such as a text message and route guidance to a destination. The above configuration makes it possible

to automatically transmit the data to a vehicle displayed on the map.

[0011] Further, the vehicle position information distributing means is provided with means for distributing the position information on the plurality of vehicles to each of the vehicles from the management center via a satellite digital audio broadcasting system. The above configuration makes it possible to broadcast the vehicle position information to vehicles within a wide range.

[0012]

[Embodiment Mode of the Invention] According to the invention as described in claim 1 of the present invention, a vehicle position information providing system includes: vehicles each provided with means for collecting own-vehicle position information, means for transmitting the own-vehicle position information to a management center, and an on-vehicle display device for displaying marks in corresponding positions of the plurality of vehicles on a digital map; and the management center provided with vehicle position information distributing means for distributing vehicle position information to each of the vehicles, and has a function of providing a vehicle side with the position information on a plurality of other vehicles.

[0013] According to the invention as described in claim 2 of the present invention, in the vehicle position information providing system in accordance with claim 1, the vehicle position information

distributing means is provided with means for adding a group identification number to position information to be distributed from the management center to each of the vehicles; and each of the vehicles is provided with means for identifying the group identification number and displaying only information on vehicles belonging to a group, and has a function of limiting the provision of the vehicle position information to a group basis.

[0014] According to the invention as described in claim 3 of the present invention, in the vehicle position information providing system in accordance with claim 1, the vehicle position information distributing means is provided with means for adding a cellular telephone number to position information to be distributed from the management center to each of the vehicles, and has a function of transmitting the telephone number simultaneously with the position of a vehicle.

[0015] According to the invention as described in claim 4 of the present invention, the vehicle position information providing system in accordance with claim 1 is provided with means for, in response to selection of a vehicle mark on the digital map displayed on the on-vehicle display device, calling the corresponding vehicle by telephone to start voice communications, and has a function of calling by telephone a vehicle whose position is confirmed on the map by an operation of selecting the vehicle.

[0016] According to the invention as described in claim 5 of the

present invention, the vehicle position information providing system in accordance with claim 1 is provided with means for, in response to selection of a vehicle mark on the digital map displayed on the on-vehicle display device, calling the corresponding vehicle by telephone to transmit various data such as a text message and route guidance to a destination, and has a function of transmitting the data by an operation of selecting a vehicle whose position is confirmed on the map.

[0017] According to the invention as described in claim 6 of the present invention, in the vehicle position information providing system in accordance with claim 1, the vehicle position information distributing means includes means for distributing the position information on the plurality of vehicles to each of the vehicles from the management center via a satellite digital audio broadcasting system, and has a function of broadcasting the vehicle position information to vehicles within a wide range.

[0018] According to the invention as described in claim 7 of the present invention, a vehicle position information providing method includes: collecting own-vehicle position information on each of vehicles; transmitting the own-vehicle position information to a management center; distributing position information on a plurality of vehicles from the management center; and displaying marks in corresponding positions of the plurality of vehicles on a digital map on an on-vehicle display device of each of the vehicles, and

has a function of providing a vehicle side with the position information on a plurality of other vehicles.

[0019] According to the invention as described in claim 8 of the present invention, the vehicle position information providing method in accordance with claim 7 includes: adding a group identification number to the position information to be distributed from the management center to each of the vehicles; and in each of the vehicles, identifying the group identification number and displaying only information on vehicles belonging to a corresponding group, and has a function of limiting the provision of the vehicle position information to a group basis.

[0020] According to the invention as described in claim 9 of the present invention, the vehicle position information providing method in accordance with claim 7 includes adding a cellular telephone number to the position information to be distributed from the management center to each of the vehicles, and has a function of transmitting the telephone number simultaneously with the position of a vehicle.

[0021] According to the invention as described in claim 10 of the present invention, the vehicle position information providing method in accordance with claim 7 includes, in response to selection of a vehicle mark on the digital map displayed on the on-vehicle display device, calling the corresponding vehicle by telephone to start voice communications, and has a function of calling by telephone

a vehicle whose position is confirmed on the map by an operation of selecting the vehicle.

[0022] According to the invention as described in claim 11 of the present invention, the vehicle position information providing method in accordance with claim 7 includes, in response to selection of a vehicle mark on the digital map displayed on the on-vehicle display device, calling the corresponding vehicle by telephone to transmit various data such as a text message and route guidance to a destination, and has a function of transmitting the data by an operation of selecting a vehicle whose position is confirmed on the map.

[0023] According to the invention as described in claim 12 of the present invention, the vehicle position information providing method in accordance with claim 7 includes distributing the position information on the plurality of vehicles to each of the vehicles from the management center through a satellite digital audio broadcast, and has a function of broadcasting the vehicle position information to vehicles within a wide range.

[0024] Hereinafter, detailed description will be made of an embodiment of the present invention with reference to Figs. 1 to 5.

[0025] (Embodiment) The embodiment of the present invention provides a vehicle position information providing system in which each vehicle collects own-vehicle position information and sends the own-vehicle position information to a management center by means of a cellular

telephone or an automobile telephone, position information on a plurality of vehicles is sent from the management center to each vehicle through a satellite digital audio broadcast, and each vehicle references position information on another vehicle and automatically performs voice communications and data transmission with the other vehicle.

[0026] Fig. 1 is a functional block diagram of the vehicle position information providing system according to the embodiment of the present invention. In Fig. 1, a vehicle 1a is an automobile mounted with means for collecting, sending/receiving, and displaying vehicle position information, and exists in plurality as vehicles a, b, A car navigation device 1b is a device for detecting and displaying own-vehicle position information. An input device 1c is a touch panel or a remote control and serves to operate the car navigation device, a telephone unit, and a satellite digital audio broadcast receiver. A display 1d is a display device for the car navigation device, which displays information by control from the car navigation device.

[0027] A telephone unit 1e includes a cellular telephone or an automobile telephone and a modem unit, and is used for connection to a mobile telephone line or an automobile telephone line. The telephone unit 1e operates according to an instruction to transmit own-vehicle position information issued from the car navigation device, and serves to transmit the own-vehicle position information

from a vehicle to the management center and to automatically perform voice communications and data transmission with the other vehicle. A satellite digital audio broadcast receiver 1f receives a satellite digital audio broadcast, and serves to receive vehicle position information from the management center and transmit the information to a navigation system.

[0028] A management center 1g performs management and distribution of vehicle position information. A telephone unit 1h is connected to the public telephone line and used for receiving position information from vehicles. A vehicle position information management system 1i accumulates own-vehicle position information collected from each vehicle and issues an instruction to edit and transmit information to be distributed to the vehicles. A satellite digital audio broadcast transmitter/receiver 1j is connected to a satellite digital audio broadcasting facility and transmits the vehicle position information from the vehicle position information management system to the satellite digital audio broadcasting facility. A telephone line network 1k connects each vehicle with the management center and is composed of a mobile communication network and a fixed public line network. A satellite broadcasting facility 1l is composed of a broadcasting facility for transmitting broadcast data to a geostationary satellite and a satellite broadcasting facility such as a geostationary satellite for performing a broadcast to all receivers, and connects the management

center with each vehicle for distribution of the vehicle position information.

[0029] Fig. 2 is a functional block diagram of the car navigation device of the vehicle position information providing system according to the embodiment of the present invention. In Fig. 2, own-vehicle position detecting means 11a represents means for calculating an own-vehicle position based on a matching algorithm in which GPS information received by a GPS antenna, vehicle speed information detected by a vehicle speed sensor, and rotational information detected by a gyro sensor are compared with road information stored in a digital map database. Own-vehicle position displaying means 11b represents means for displaying a digital map with the detected own-vehicle position at the center. Route guidance means 11c represents means for guiding a user to a destination designated by the user by indicating a route.

[0030] Vehicle position information providing means 11d represents means for displaying vehicle marks in corresponding geographical positions on the digital map based on the position information on a plurality of vehicles including the own vehicle and the other vehicles which is received from the management center. Automatic voice communications means 11e represents means for selecting the vehicle mark on the digital map to automatically call the corresponding vehicle by telephone and start voice communications. Automatic data transmission means 11f represents means for selecting

the vehicle mark on the digital map to automatically call the corresponding vehicle by telephone and transmit data.

[0031] Fig. 3 is a process flow chart of the vehicle position information management system according to the embodiment of the present invention. In Fig. 3, own-vehicle position detecting process means 2a represents means for detecting the position of a vehicle. Own-vehicle position information editing process means 2b represents means for editing the own-vehicle position information into transmission information to be transferred to the management center. Own-vehicle position information transmitting process means 2c represents means for transmitting the own-vehicle position information to the management center. Own-vehicle position information receiving process means 2d represents means for receiving the own-vehicle position information from each vehicle via the public telephone line. Own-vehicle position information accumulating process means 2e represents means for temporarily accumulating the own-vehicle position information collected from each vehicle. Vehicle position information editing process means 2j represents means for editing the vehicle position information on all the vehicles into distribution information. Vehicle position information transmitting process means 2k represents means for transmitting the vehicle position information through a satellite digital audio broadcast.

[0032] Vehicle position information receiving process means 2l

represents means for receiving the vehicle position information from the management center through the satellite digital audio broadcast receiver. Vehicle position information displaying process means 2m represents means for displaying the vehicle marks on the digital map of the display. Vehicle-mark input process means 2n represents means for displaying a selection window or the like for selection between automatic voice communications and automatic data transmission. Vehicle-mark input judging process means 2o represents means for determining whether the automatic voice communications or the automatic data transmission has been selected. Automatic voice communications means 2p represents means for reading out a telephone number and issuing a call instruction to the telephone unit to start voice communications. Automatic data transmission means 2q represents means for performing data transmission.

[0033] Fig. 4 is an example of a telegraphic message transmitted from the management center to each vehicle through a satellite digital audio broadcast according to the embodiment of the present invention. In Fig. 4, a header part 3a is a part into which identification information is written. A data part 3b is a part into which position information and the like are written.

[0034] Fig. 5 is an example of a screen displayed on the vehicle dynamic state management system according to the embodiment of the present invention. In Fig. 5, a digital map 4a is a map displayed on the screen of the vehicle dynamic state management system. An

arrow 4b is a mark indicating the position and travel direction of a vehicle.

[0035] Description will be made of operations of the thus-configured vehicle position information providing system according to the embodiment of the present invention. First, the operations are performed on a vehicle side from own-vehicle position detection to own-vehicle position information transmitting process with respect to the management center. In the car navigation device, a GPS receiver, a vehicle speed sensor, a gyro sensor, a map matching process, and the like are used to detect a position on the vehicle (2a). The own-vehicle position information is edited into the transmission information to be transferred to the management center (2b). The car navigation device instructs the telephone unit to transmit the own-vehicle position information to thereby transmit it to the management center by a cellular telephone or an automobile telephone (2c).

[0036] Next, the operations are performed by a center from own-vehicle position information reception to distribution of vehicle position information to each vehicle. In the telephone unit, the own-vehicle position information is received from each vehicle via the public telephone line (2d). Here, even when receiving the own-vehicle position information, the vehicle position information management system does not perform the distribution thereof to each vehicle at that instant, but temporarily accumulates the own-vehicle

position information collected from each vehicle and collectively transmits the own-vehicle position information on all the vehicles at each predetermined interval. Accordingly, loads through the satellite digital audio broadcast are reduced. In addition, assuming that the data size per vehicle is within 100 bytes, through a satellite digital audio broadcast with a bandwidth of 256 Kbytes per channel, 250,000 vehicles per channel can be transmitted for 1 second. Therefore, if an updating interval is set to 5 seconds, 1,250,000 vehicles per channel can be transmitted at a time. As apparent from the above, in the vehicle position information management system, the own-vehicle position information is accumulated (2e). Each time a predetermined time elapses, the vehicle position information on all the vehicles is edited into the distribution information based on the latest information on the vehicle position of all the vehicles which has been accumulated up to then (2j). The vehicle position information management system instructs the satellite digital audio broadcast transmitter to transmit the vehicle position information to thereby transmit it to each of the vehicles through a satellite digital audio broadcast (2k).

[0037] As exemplified in Fig. 4, in the telegraphic message transmitted from the management center to each vehicle, the header part is assigned with a group identification number (3e). This makes it possible to place such a limitation that information can be received

by only vehicles within a particular group such as vehicles belonging to the same company. The header part is further assigned with a vehicle identification number (3d). This makes it possible to place such a limitation that individual response information can be received by only the corresponding vehicle. Also, the data part is assigned with a telephone number (3g) as well as position information (3f). This is the telephone number of the cellular telephone or automobile telephone owned by the corresponding vehicle, and it is possible to read out this telephone number to call thereto when the automatic voice communications and the automatic data transmission are processed in the vehicle.

[0038] Finally, the operations are performed on the vehicle side from vehicle position information reception to vehicle position information display, automatic voice communications, and automatic data transmission. The vehicle position information from the management center is received through the satellite digital audio broadcast receiver (2l). The vehicle position information is transmitted from the satellite digital audio broadcast receiver to the car navigation device, and the vehicle marks are displayed on the digital map of the display (2m).

[0039] As exemplified in Fig. 5, on the screen displayed on the vehicle dynamic state management system, the travel direction is expressed by the arrow direction in a position located in the corresponding latitude/longitude coordinates on the digital map

4a (4b). When the vehicle mark is selected from the digital map, a selection window or the like for selection between automatic voice communications and automatic data transmission is displayed (2n). It is determined in the selection window whether the automatic voice communications or the automatic data transmission has been selected (2o). If the selection is made for the automatic voice communications, the telephone number added to the vehicle position information on the corresponding vehicle is read out, and the call instruction is issued to the telephone unit to start voice communications (2p). If the selection is made for the automatic data transmission, transmission data such as an email message, a map detection result, or a route retrieval result is designated, the telephone number added to the vehicle position information on the corresponding vehicle is read out, the call instruction is issued to the telephone unit to start communication and perform data transmission (2q).

[0040] As described above, according to the embodiment of the present invention, the vehicle position information providing system is configured such that each vehicle collects the own-vehicle position information and sends the own-vehicle position information to the management center by means of the cellular telephone or the automobile telephone, the position information on the plurality of vehicles is sent from the management center to each vehicle through the satellite digital audio broadcast, and each vehicle references the position information on another vehicle and automatically performs

the voice communications and the data transmission with the other vehicle. As a result, it is possible to distribute the position information on the other vehicles to each vehicle and allow the vehicle position information to be displayed. Further, the designation of the vehicle mark makes it possible to easily perform the automatic voice communications and the automatic data transmission, and to transfer the information between the vehicles.

[0041]

[Effects of the Invention] As apparent from the above description, according to the present invention, the vehicle position information providing system is configured to include the own-vehicle position information collecting means provided to each vehicle, the means for transmitting this to the management center, the own-vehicle position information distributing means for distributing the own-vehicle position information on each vehicle from the management center, and the on-vehicle display device for displaying the marks in the corresponding geographic positions on the digital map in order for each vehicle to confirm the position of the plurality of vehicles including the own-vehicle and the other vehicles. Consequently, an effect can be produced in that the vehicles can confirm positions of one another, and patrolling and delivery operation are performed with efficiency.

[0042] Further, the own-vehicle position information distributing means is provided with the means for adding the group identification

number to the position information to be distributed from the management center to each vehicle, and the vehicle is provided with the means for identifying the group identification number and displaying only information on the vehicles belonging to the corresponding group. Consequently, an effect can be produced in that the position information can be shared within each group.

[0043] Further, the system is provided with the means for, by selecting the vehicle mark on the digital map displayed on the on-vehicle display device, automatically calling the corresponding vehicle by telephone to start voice communications. Consequently, an effect can be produced in that the vehicles can easily interact with each other by the voice communications.

[0044] Further, the own-vehicle position information distributing means is provided with the means for adding the cellular telephone number to the position information to be distributed from the management center to each vehicle. Consequently, an effect can be produced in that the calling by telephone can easily be made.

[0045] Further, the vehicle is provided with the means for, by selecting the vehicle mark on the digital map displayed on the on-vehicle display device, automatically calling the corresponding vehicle by telephone to transmit data such as characters describing transmission contents and route guidance to a destination. Consequently, an effect can be produced in that the data can easily be transferred between the vehicles.

[Brief Description of the Drawings]

[Fig. 1] A block diagram of a vehicle position information providing system according to an embodiment of the present invention.

[Fig. 2] A process block diagram of the car navigation device composing the vehicle position information providing system according to the embodiment of the present invention.

[Fig. 3] A process flow chart of the vehicle position information providing system according to the embodiment of the present invention.

[Fig. 4] An example of a telegraphic message transmitted/received through a satellite digital audio broadcast in the vehicle position information providing system according to the embodiment of the present invention.

[Fig. 5] An example of a screen displayed on the vehicle position information providing system according to the embodiment of the present invention.

[Fig. 6] A conceptual diagram of a conventional vehicle dynamic state management system.

[Description of Symbols]

- 2 GPS satellite
- 10 automobile
- 12 mobile radio transmitter/receiver
- 13 travel management recorder
- 14 on-vehicle display device

20 office
21 mobile radio base station
22 workstation
24 display device
1a vehicle
1b car navigation device
1c input device
1d display device
1e mobile unit
1f satellite digital audio broadcast receiver
1g management center
1h telephone unit
1i vehicle position information management system
1j satellite digital audio broadcast transmitter
1k telephone line network
1l satellite broadcasting facility
1la own-vehicle position detecting means
1lb own-vehicle position displaying means
1lc route guidance means
1ld vehicle position information providing means
1le automatic voice communications means
1lf automatic data transmission means
2a own-vehicle position detecting process means
2b own-vehicle position information editing process means

2c own-vehicle position information transmitting process means
2d own-vehicle position information receiving process means
2e own-vehicle position information accumulating process means
2j vehicle position information editing process means
2k vehicle position information transmitting process means
2l vehicle position information receiving process means
2m vehicle position information displaying process means
2n vehicle-mark input process means
2o vehicle-mark input judging means
2p automatic voice communications means
2q automatic data transmission means
3a header part
3b data part
3d vehicle identification number
3e group identification number
3f position information
3g telephone number
4a digital map
4b arrow

FIG. 1

- 1l SATELLITE BROADCASTING FACILITY
- 1k TELEPHONE LINE NETWORK
- 1a VEHICLE b
- VEHICLE a
- 1f SATELLITE DIGITAL AUDIO BROADCAST RECEIVER
- 1e TELEPHONE UNIT
- 1d DISPLAY
- 1c INPUT DEVICE
- 1b CAR NAVIGATION DEVICE
- 1g MANAGEMENT CENTER
- 1j SATELLITE DIGITAL AUDIO BROADCAST TRANSMITTER
- 1i VEHICLE POSITION INFORMATION MANAGEMENT SYSTEM

FIG. 2

- 11a OWN-VEHICLE POSITION DETECTING MEANS
- 11b OWN-VEHICLE POSITION DISPLAYING MEANS
- 11c ROUTE GUIDANCE MEANS
- 11d VEHICLE POSITION INFORMATION PROVIDING MEANS
- 11e AUTOMATIC VOICE COMMUNICATIONS MEANS
- 11f AUTOMATIC DATA TRANSMISSION MEANS

FIG. 3

VEHICLE

CENTER

- 2a OWN-VEHICLE POSITION DETECTING PROCESS MEANS
- 2b OWN-VEHICLE POSITION INFORMATION EDITING PROCESS MEANS
- 2c OWN-VEHICLE POSITION INFORMATION TRANSMITTING PROCESS MEANS
- 2d OWN-VEHICLE POSITION INFORMATION RECEIVING PROCESS MEANS
- 2e OWN-VEHICLE POSITION INFORMATION ACCUMULATING PROCESS MEANS
- 2j VEHICLE POSITION INFORMATION EDITING PROCESS MEANS
- 2k VEHICLE POSITION INFORMATION TRANSMITTING PROCESS MEANS
- 2l VEHICLE POSITION INFORMATION RECEIVING PROCESS MEANS
- 2m VEHICLE POSITION INFORMATION DISPLAYING PROCESS MEANS
- 2n VEHICLE-MARK INPUT PROCESS MEANS
- 2o VEHICLE-MARK INPUT JUDGING MEANS

FIG. 4

- 3a HEADER PART
- 3b DATA PART
- 3d VEHICLE IDENTIFICATION NUMBER
- 3e GROUP IDENTIFICATION NUMBER
- 3f POSITION INFORMATION
- 3g TELEPHONE NUMBER

FIG. 6

- 10 ON-VEHICLE SIDE
- 20 OFFICE SIDE

(19) 日本国特許庁 (J P)

(12) 公開特許公報 (A)

(11) 特許出願公開番号

特開2000-357296

(P 2 0 0 0 - 3 5 7 2 9 6 A)

(43) 公開日 平成12年12月26日 (2000.12.26)

(51) Int. Cl. ⁷	識別記号	F I	テマコード (参考)
G08G 1/137		G08G 1/137	2F029
G01C 21/00		G01C 21/00	B 5H180

審査請求 未請求 請求項の数12 O L (全9頁)

(21) 出願番号 特願平11-168694
 (22) 出願日 平成11年6月15日 (1999.6.15)

(71) 出願人 000005821
 松下電器産業株式会社
 大阪府門真市大字門真1006番地
 (72) 発明者 卯木 隆史
 神奈川県横浜市港北区綱島東四丁目3番1号
 松下通信工業株式会社内
 (74) 代理人 100099254
 弁理士 役 昌明 (外3名)
 Fターム(参考) 2F029 AA02 AB01 AB07 AB12 AB13
 AC02 AC14 AC16
 5H180 AA01 BB05 EE18 FF04 FF05
 FF13 FF22 FF27 FF40

(54) 【発明の名称】 車両位置情報提供装置とその方法

(57) 【要約】

【課題】 各車両に他の複数車両の位置情報を提供して、車両間でお互いの位置を確認しあうことができるようにする。

【解決手段】 各車両のカーナビゲーション装置で、自車位置情報を収集する。これを電話ユニットで管理センターに送信する。管理センターでは、これを電話ユニットで受信する。車両位置情報管理装置で複数車両の位置情報を管理する。管理センターから、衛星デジタル音声放送送信機で、各車両に配信する。車両側では、衛星デジタル音声放送受信機で受信する。車載ディスプレイ装置のデジタル地図上の地理的な該当位置に、活動状態が把握できるようにマーク表示する。各車両において自車両及び他車両の複数車両の位置を確認することができる。デジタル地図上の車両マークを選択することにより、該当車両に自動的に電話発信して、通話やデータ伝送を行うこともできる。

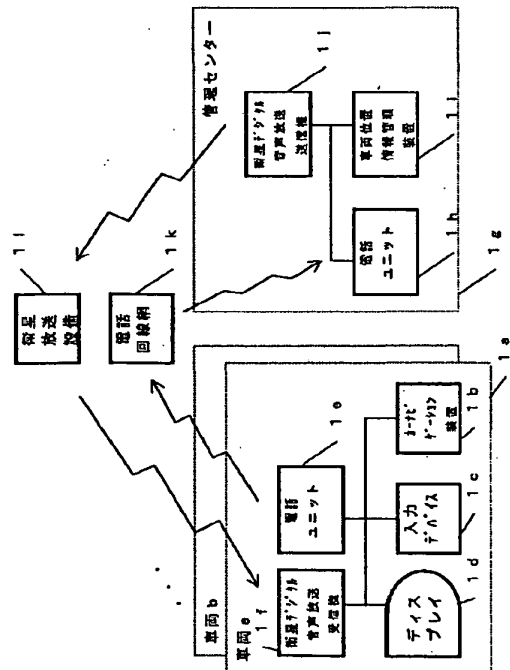

【特許請求の範囲】

【請求項1】 自車位置情報を収集する手段と、前記自車位置情報を管理センターに送信する手段と、デジタル地図上における複数の車両の該当位置にマークを表示する車載ディスプレイ装置とを各車両に設け、前記各車両に車両位置情報を配信する車両位置情報配信手段を前記管理センターに設けたことを特徴とする車両位置情報提供装置。

【請求項2】 前記車両位置情報配信手段に、前記管理センターから前記各車両へ配信する位置情報にグループ識別番号を付加する手段を設け、前記各車両に、前記グループ識別番号を識別してグループに所属している車両の情報のみを表示する手段を設けたことを特徴とする請求項1記載の車両位置情報提供装置。

【請求項3】 前記車両位置情報配信手段に、前記管理センターから前記各車両へ配信する位置情報に携帯電話番号を付加する手段を設けたことを特徴とする請求項1記載の車両位置情報提供装置。

【請求項4】 前記車載ディスプレイ装置に表示されたデジタル地図上の車両マークが選択されたことに応答して、当該車両に対して電話発信して通話を開始する手段を設けたことを特徴とする請求項1記載の車両位置情報提供装置。

【請求項5】 前記車載ディスプレイ装置に表示されたデジタル地図上の車両マークが選択されたことに応答して、当該車両に対して電話発信して、文字メッセージや経路案内等の各種データを送信する手段を設けたことを特徴とする請求項1記載の車両位置情報提供装置。

【請求項6】 前記車両位置情報配信手段は、前記管理センターから衛星デジタル音声放送装置を介して前記各車両に複数の車両の位置情報を配信する手段を含むことを特徴とする請求項1記載の車両位置情報提供装置。

【請求項7】 各車両において自車位置情報を収集し、前記自車位置情報を管理センターに送信し、前記管理センターから前記各車両に複数の車両の位置情報を配信し、前記各車両で車載ディスプレイ装置のデジタル地図上における複数の車両の該当位置にマークを表示することを特徴とする車両位置情報提供方法。

【請求項8】 前記管理センターから前記各車両へ配信する位置情報にグループ識別番号を付加し、前記各車両で前記グループ識別番号を識別して、グループに所属している車両の情報のみを表示することを特徴とする請求項7記載の車両位置情報提供方法。

【請求項9】 前記管理センターから前記各車両へ配信する位置情報に携帯電話番号を付加することを特徴とする請求項7記載の車両位置情報提供方法。

【請求項10】 前記車載ディスプレイ装置に表示されたデジタル地図上の車両マークが選択されたことに応答して、当該車両に対して電話発信して通話を開始することを特徴とする請求項7記載の車両位置情報提供方法。

【請求項11】 前記車載ディスプレイ装置に表示されたデジタル地図上の車両マークが選択されたことに応答して、当該車両に対して電話発信して、文字メッセージや経路案内等の各種データを送信することを特徴とする請求項7記載の車両位置情報提供方法。

【請求項12】 前記管理センターから衛星デジタル音声放送により前記各車両に複数の車両の位置情報を配信することを特徴とする請求項7記載の車両位置情報提供方法。

【発明の詳細な説明】

【0001】

【発明の属する技術分野】本発明は、車両位置情報提供装置に関し、特に、管理する各車両から自車位置情報を、移動体通信を利用して一箇所に集め、それを地図表示装置を用いて地図上にマーク表示するなどして各車両の車両動態管理を行う車両位置情報提供装置に関する。

【0002】

【従来の技術】カーナビゲーションシステムをはじめとした車載装置は、GPS、車速、ジャイロ及び地図マッチング技術を利用して、自分の車両の位置を算出する機能を有している。この車両において算出した位置情報を、携帯電話等の移動体通信を利用して管理センターに伝送する。管理センターでは、地図表示装置を用いて、各車両を地図上にマーク表示して、車両動態を管理している。このような車両動態管理装置の例としては、特開平5-67113号公報に開示されているものなどがある。図6に、従来の車両動態管理装置の例を示す。

【0003】自動車10は、複数のGPS衛星2から、軌道データと時刻を含む航法電波を受信して、自車位置を計測する。また、自動車の運行に関する運行データを記録する運行管理記録装置(VDR)13を搭載しており、運行管理データを収集する。この運行管理データと自車位置データを、移動無線送受信装置12により事務所20に送信する。事務所20では、この車両位置および運行データを受信して、その車両位置を表示装置24に表示する。また、これらのデータに基づいて、自動車の配送業務に必要な指示およびデータをワークステーション22により求めて、移動無線基地局21を介して自動車10に送信する。自動車10では、車載移動無線送受信装置12により受信した指示およびデータを、車載表示装置14に表示する。これにより、事務所からの指示に従って配送作業を行うことができ、配送業務効率を向上させることができる。

【0004】

【発明が解決しようとする課題】しかし、従来の車両動態管理システムでは、各車両の自車位置情報は、事務所や管理センター等の固定局側の表示装置に表示されるものであり、車両側で表示することはできなかった。そのため、各車両間で、お互いの車両の位置を確認しあうこ

とができなかった。例えば、巡回パトロールを効率的に行なったり、配送業務を効率的に行なったり、ドライブ中に仲間同士の車両間で位置を確認しあったりすることができないという問題があった。

【0005】本発明は、上記問題を解決し、車両側に複数車両の位置情報を提供して、車両間でお互いの位置を確認しあうことができるようにすることを目的とする。

【0006】

【課題を解決するための手段】上記課題を解決するために、本発明では、車両位置情報提供装置を、自車位置情報を収集する手段と、自車位置情報を管理センターに送信する手段と、デジタル地図上における複数の車両の該当位置にマークを表示する車載ディスプレイ装置とを各車両に設け、各車両に車両位置情報を配信する車両位置情報配信手段を管理センターに設けた構成とした。

【0007】このように構成したことにより、各車両に他の複数車両の位置情報を提供して、車両間でお互いの位置を確認しあうことができる。

【0008】また、車両位置情報配信手段に、管理センターから各車両へ配信する位置情報にグループ識別番号を付加する手段を設け、各車両に、グループ識別番号を識別してグループに所属している車両の情報のみを表示する手段を設けた。このように構成したことにより、グループ内でのみ位置情報を共有することができる。

【0009】また、車両位置情報配信手段に、管理センターから各車両へ配信する位置情報に携帯電話番号を付加する手段を設けた。このように構成したことにより、また、車載ディスプレイ装置に表示されたデジタル地図上の車両マークが選択されたことに応答して、当該車両に対して電話発信して通話を開始する手段を設けた。このように構成したことにより、地図に表示された車両に対して自動的に電話をかけることができる。

【0010】また、車載ディスプレイ装置に表示されたデジタル地図上の車両マークが選択されたことに応答して、当該車両に対して電話発信して、文字メッセージや経路案内等の各種データを送信する手段を設けた。このように構成したことにより、地図に表示された車両に対して自動的にデータを送信することができる。

【0011】また、車両位置情報配信手段は、管理センターから衛星デジタル音声放送装置を介して各車両に複数車両の位置情報を配信する手段を含む構成とした。このように構成したことにより、広範囲の車両に対して車両位置情報を放送することができる。

【0012】

【発明の実施の形態】本発明の請求項1記載の発明は、自車位置情報を収集する手段と、前記自車位置情報を管理センターに送信する手段と、デジタル地図上における複数の車両の該当位置にマークを表示する車載ディスプレイ装置とを各車両に設け、前記各車両に車両位置情報を配信する車両位置情報配信手段を前記管理センターに

設けた車両位置情報提供装置であり、車両側に他の複数車両の位置情報を提供するという作用を有する。

【0013】本発明の請求項2記載の発明は、請求項1記載の車両位置情報提供装置において、前記車両位置情報配信手段に、前記管理センターから前記各車両へ配信する位置情報にグループ識別番号を付加する手段を設け、前記各車両に、前記グループ識別番号を識別してグループに所属している車両の情報のみを表示する手段を設けたものであり、車両位置情報の提供をグループ単位に制限するという作用を有する。

【0014】本発明の請求項3記載の発明は、請求項1記載の車両位置情報提供装置において、前記車両位置情報配信手段に、前記管理センターから前記各車両へ配信する位置情報に携帯電話番号を付加する手段を設けたものであり、車両の位置とともに電話番号を同時に送るという作用を有する。

【0015】本発明の請求項4記載の発明は、請求項1記載の車両位置情報提供装置において、前記車載ディスプレイ装置に表示されたデジタル地図上の車両マークが選択されたことに応答して、当該車両に対して電話発信して通話を開始する手段を設けたものであり、地図上で位置を確認した車両を選択する操作により電話をかけるという作用を有する。

【0016】本発明の請求項5記載の発明は、請求項1記載の車両位置情報提供装置において、前記車載ディスプレイ装置に表示されたデジタル地図上の車両マークが選択されたことに応答して、当該車両に対して電話発信して、文字メッセージや経路案内等の各種データを送信する手段を設けたものであり、地図上で位置を確認した車両を選択する操作でデータを送信するという作用を有する。

【0017】本発明の請求項6記載の発明は、請求項1記載の車両位置情報提供装置において、前記車両位置情報配信手段は、前記管理センターから衛星デジタル音声放送装置を介して前記各車両に複数車両の位置情報を配信する手段を含むものであり、広い範囲に車両の位置情報を放送するという作用を有する。

【0018】本発明の請求項7記載の発明は、各車両において自車位置情報を収集し、前記自車位置情報を管理センターに送信し、前記管理センターから前記各車両に複数車両の位置情報を配信し、前記各車両で車載ディスプレイ装置のデジタル地図上における複数の車両の該当位置にマークを表示する車両位置情報提供方法であり、車両側に他の複数車両の位置情報を提供するという作用を有する。

【0019】本発明の請求項8記載の発明は、請求項7記載の車両位置情報提供方法において、前記管理センターから前記各車両へ配信する位置情報にグループ識別番号を付加し、前記各車両で前記グループ識別番号を識別して、グループに所属している車両の情報のみを表示す

るものであり、車両位置情報の提供をグループ単位に制限するという作用を有する。

【0020】本発明の請求項9記載の発明は、請求項7記載の車両位置情報提供方法において、前記管理センターから前記各車両へ配信する位置情報に携帯電話番号を付加するものであり、車両の位置とともに電話番号を同時に送るという作用を有する。

【0021】本発明の請求項10記載の発明は、請求項7記載の車両位置情報提供方法において、前記車載ディスプレイ装置に表示されたデジタル地図上の車両マークが選択されたことに応答して、当該車両に対して電話発信して通話を開始するものであり、地図上で位置を確認した車両を選択する操作により電話をかけるという作用を有する。

【0022】本発明の請求項11記載の発明は、請求項7記載の車両位置情報提供方法において、前記車載ディスプレイ装置に表示されたデジタル地図上の車両マークが選択されたことに応答して、当該車両に対して電話発信して、文字メッセージや経路案内等の各種データを送信するものであり、地図上で位置を確認した車両を選択する操作でデータを送信するという作用を有する。

【0023】本発明の請求項12記載の発明は、請求項7記載の車両位置情報提供方法において、前記管理センターから衛星デジタル音声放送により前記各車両に複数車両の位置情報を配信するものであり、広い範囲に車両の位置情報を放送するという作用を有する。

【0024】以下、本発明の実施の形態について、図1～図5を参照しながら詳細に説明する。

【0025】(実施の形態)本発明の実施の形態は、各車両において自車位置情報を収集し、これを携帯電話または自動車電話を利用して管理センターに送り、管理センターから衛星デジタル音声放送を利用して各車両に複数の車両位置情報を送り、各車両において、他の車両位置情報を参照したり、他車との自動通話をしたり、自動データ伝送を行う車両位置情報提供装置である。

【0026】図1は、本発明の実施の形態の車両位置情報提供装置の機能ブロック図である。図1において、車両1aは、車両位置情報を収集、送受信、表示する手段を搭載した自動車である。車両a、b、・・・のように複数存在する。カーナビゲーション装置1bは、自車位置情報を検出したり、表示する装置である。入力デバイス1cは、タッチパネルやリモコンであり、カーナビゲーション装置、電話ユニット及び衛星デジタル音声放送受信機を操作するものである。ディスプレイ1dは、カーナビゲーション装置の表示ディスプレイであり、カーナビゲーション装置からの制御により情報を表示する装置である。

【0027】電話ユニット1eは、携帯電話機または自動車電話機及びモデムユニット等により構成され、携帯電話回線または自動車電話回線に接続するものであり、

カーナビゲーション装置からの自車位置情報送信指示により動作し、車両から管理センターへの自車位置情報送信と、他車両への自動通話及び自動データ伝送に利用するものである。衛星デジタル音声放送受信機1fは、衛星デジタル音声放送を受信するものであり、管理センターから車両位置情報を受信し、ナビゲーションシステムに伝達する。

【0028】管理センター1gは、車両位置情報管理及び配信を行うものである。電話ユニット1hは、公衆電話回線に接続されるものであり、車両からの位置情報を受信するものである。車両位置情報管理装置1iは、各車両から収集した自車位置情報の蓄積、車両への配信情報編集及び送信指示を行うものである。衛星デジタル音声放送送信機1jは、衛星デジタル音声放送設備に接続されるものであり、車両位置情報管理装置からの車両位置情報を、衛星デジタル音声放送設備に送信するものである。電話回線網1kは、各車両と管理センターを接続するものであり、移動体通信網及び固定公衆回線網である。衛星放送設備1lは、静止衛星へ放送データを送信する放送設備と、全受信機へ放送を行う静止衛星等衛星放送設備であり、管理センターと各車両を接続し、車両位置情報を配信するものである。

【0029】図2は、本発明の実施の形態の車両位置情報提供装置におけるカーナビゲーション装置の機能ブロック図である。図2において、自車位置検出手段1laは、GPSアンテナから受信したGPS情報や、車速センサから検出した車速情報や、ジャイロセンサから検出した回転情報と、デジタル地図データベースの道路情報によるマッチングアルゴリズムにより自車位置を算出する手段である。自車位置表示手段1lbは、検出した自車位置を中心にデジタル地図を表示する手段である。経路案内手段1lcは、使用者が指定する目的地への経路案内を行う手段である。

【0030】車両位置情報提供手段1ldは、管理センターから受信した自車両及び他車両の複数の車両の位置情報を元に、デジタル地図上の地理的な該当位置に車両マークを表示する手段である。自動通話手段1leは、デジタル地図上の車両マークを選択することにより、該当車両に自動的に電話発信し通話を開始する手段である。自動データ伝送手段1lfは、デジタル地図上の車両マークを選択することにより、該当車両に自動的に電話発信しデータを送信する手段である。

【0031】図3は、本発明の実施の形態の車両位置情報管理装置の処理フロー図である。図3において、自車位置検出処理手段2aは、車両の位置検出を行う手段である。自車位置情報編集処理手段2bは、自車位置情報を管理センターに伝達するための送信情報に編集する手段である。自車位置情報送信処理手段2cは、管理センターに送信する手段である。自車位置情報受信処理手段2dは、各車両からの自車位置情報を公衆電話回線経由

で受信する手段である。自車位置情報蓄積処理手段2eは、各車両から収集した自車位置情報を一旦蓄積する手段である。車両位置情報編集処理手段2jは、全車両の車両位置情報を配信情報に編集する手段である。車両位置情報送信処理手段2kは、衛星デジタル音声放送により各車両に送信する手段である。

【0032】車両位置情報受信処理手段2lは、衛星デジタル音声放送受信装置により管理センターからの車両位置情報を受信する手段である。車両位置情報表示処理手段2mは、ディスプレイのデジタル地図上に車両マークを表示する手段である。車両マーク入力処理手段2nは、自動通話かまたは自動データ伝送かの選択ウィンドウなどを表示する手段である。車両マーク入力判断手段2oは、自動通話かまたは自動データ伝送かどちらが選択されたかを判定する手段である。自動通話手段2pは、電話番号を読み出し、電話ユニットへ発信指示を行い、通話を開始する手段である。自動データ伝送手段2qは、データ伝送を行う手段である。

【0033】図4は、本発明の実施の形態の衛星デジタル音声放送を利用した管理センターから各車両への送信電文例である。図4において、ヘッダ部3aは、識別情報を記載した部分である。データ部3bは、位置情報などを記載した部分である。

【0034】図5は、本発明の実施の形態の車両動態管理装置の画面表示例である。図5において、デジタル地図4aは、車両動態管理装置の画面に表示された地図である。矢印4bは、車両の位置と進行方向を示すマークである。

【0035】上記のように構成された本発明の実施の形態の車両位置情報提供装置の動作を説明する。まず、車両における自車位置検出から、管理センターへの自車位置情報送信処理を行う。カーナビゲーション装置において、GPS受信機、車速センサ、ジャイロセンサ及びマップマッチング処理等により、車両の位置検出を行う(2a)。自車位置情報を、管理センターに伝達するための送信情報に編集する(2b)。カーナビゲーション装置から電話ユニットへ、自車位置情報を送信するよう指示し、携帯電話または自動車電話により管理センターに送信する(2c)。

【0036】次に、センターにおける自車位置情報受信から、各車両への車両位置情報の配信までを行う。電話ユニットにおいて、各車両からの自車位置情報を、公衆電話回線経由で受信する(2d)。ここで、車両位置情報管理装置は、自車位置情報を受信しても、その時点で各車両への配信は行わず、各車両から収集した自車位置情報を一旦蓄積し、一定間隔ごとに全車両一括して送信する。これにより、衛星デジタル音声放送の負荷を軽減する。また、1台あたりのデータサイズは100byte以内とすれば、1チャンネルが256Kbyteである衛星デジタル音声放送で、1チャンネル当たり25万台を1秒で送信でき

る。したがって、更新間隔を5秒とした場合には、125万台分が送信可能である。以上のことから、車両位置情報管理装置では、自車位置情報を蓄積する(2e)。一定時間ごとに、それまで蓄積してきた全車両の自車位置の最新情報を元に、全車両の車両位置情報を配信情報に編集する(2j)。車両位置情報管理装置から衛星デジタル音声放送送信機へ、車両位置情報を送信するよう指示し、衛星デジタル音声放送により各車両に送信する(2k)。

10 【0037】管理センターから各車両への送信電文は、図4に例として示したように、ヘッダ部にグループ識別番号(3e)を付与する。これにより、同一会社内の車両等のように、特定グループ内の車両のみが情報を受信できるように制限することが可能となる。さらに、車両識別番号(3d)を付与する。これにより、個別応答情報を、該当の車両のみが受信できるように制限することが可能となる。また、データ部には、位置情報(3f)の他、電話番号(3g)を付与する。これは、該当車両が所有する携帯電話または自動車電話の電話番号であり、車両における自動通話及び自動データ伝送処理時に、この電話番号を読み出して発信することができる。

20 【0038】最後に、車両における車両位置情報受信から車両位置情報表示、自動通話及び自動データ伝送を行う。衛星デジタル音声放送受信装置により、管理センターからの車両位置情報を受信する(2l)。車両位置情報は、衛星デジタル音声放送受信装置からカーナビゲーション装置に送信され、ディスプレイのデジタル地図上に車両マークを表示する(2m)。

30 【0039】車両動態管理装置の画面表示では、図5に例を示したように、デジタル地図4a上の該当する経度緯度座標位置に、進行方向を矢印の方向で表現する(4b)。デジタル地図上の車両マークを選択すると、自動通話かまたは自動データ伝送かの選択ウィンドウなどが表示される(2n)。選択ウィンドウにて、自動通話または自動データ伝送のどちらが選択されたかを判定する(2o)。選択が自動通話であれば、該当車両について、車両位置情報に付加された電話番号を読み出し、電話ユニットへ発信指示を行い、通話を開始する(2p)。選択が自動データ伝送であれば、電子メッセージや地図検索結果や経路探索結果などの伝送データを指定して、該当車両について、車両位置情報に付加された電話番号を読み出し、電話ユニットへ発信指示を行い、通話を開始し、データ伝送を行う(2q)。

40 【0040】上記のように、本発明の実施の形態では、車両位置情報提供装置を、各車両において自車位置情報を収集し、これを携帯電話または自動車電話を利用して管理センターに送り、管理センターから衛星デジタル音声放送を利用して各車両に複数の車両位置情報を送り、各車両において、他の車両位置情報を参照したり、他車との自動通話をしたり、自動データ伝送を行う構成とし

たので、各車両に他の車両の位置情報を配信して車両位置を表示できる。さらには、その車両マークを指定することにより、自動通話及び自動データ伝送を簡単に行うことができ、車両間の情報伝達をスムーズにすることができる。

【 0 0 4 1 】

【発明の効果】以上の説明から明らかなように、本発明では、車両位置情報提供装置を、各車両ごとに設けられた自車位置情報収集手段と、これを管理センターに送信する手段と、管理センターから各車両の自車位置情報を配信する自車位置情報配信手段と、各車両において自車両及び他車両の複数の車両の位置を確認するためにデジタル地図上の地理的な該当位置にマーク表示する車載ディスプレイ装置とを備えた構成としたので、各車両間でお互いの車両の位置を確認しあって、巡回パトロールや配送業務を効率的に行なうことができるという効果が得られる。

【 0 0 4 2 】また、自車位置情報配信手段に、管理センターから各車両へ配信する位置情報にグループ識別番号を付加する手段を設け、車両側に、それを識別してグループに所属している車両のみ情報を表示する手段を設けたので、各グループ内で位置情報を共有することができるという効果が得られる。

【 0 0 4 3 】また、車載ディスプレイ装置に表示しているデジタル地図上の車両マークを選択することにより該当車両に自動的に電話発信し通話を開始する手段を設けたので、通話による車両間でのやりとりが容易にできるという効果が得られる。

【 0 0 4 4 】また、自車位置情報配信手段に管理センターから各車両へ配信する位置情報に携帯電話番号を付加する手段を設けたので、電話発信が容易にできるという効果が得られる。

【 0 0 4 5 】また、車両において伝達内容を記述した文字、目的地までの経路案内等各種データを車載ディスプレイ装置に表示しているデジタル地図上の車両マークを選択することにより該当車両に自動的に電話発信しデータを送信する手段を設けたので、車両間でのデータのやりとりが容易にできるという効果が得られる。

【図面の簡単な説明】

【図 1】本発明の実施の形態の車両位置情報提供装置のブロック図、

【図 2】本発明の実施の形態の車両位置情報提供装置を構成するカーナビゲーション装置の処理ブロック図、

【図 3】本発明の実施の形態の車両位置情報提供装置の処理フロー図、

【図 4】本発明の実施の形態の車両位置情報提供装置における衛星デジタル音声放送の送受信電文例、

【図 5】本発明の実施の形態の車両位置情報提供装置の画面表示例、

【図 6】従来の車両動態管理装置の概念図である。

- 【符号の説明】
- 2 GPS衛星
 - 10 自動車
 - 12 移動無線送受信装置
 - 13 運行管理記録装置
 - 14 車載表示装置
 - 20 事務所
 - 21 移動無線基地局
 - 22 ワークステーション
 - 10 24 表示装置
 - 1 a 車両
 - 1 b カーナビゲーション装置
 - 1 c 入力装置
 - 1 d ディスプレイ装置
 - 1 e 携帯ユニット
 - 1 f 衛星デジタル音声放送受信機
 - 1 g 管理センター
 - 1 h 電話ユニット
 - 1 i 車両位置情報管理装置
 - 20 1 j 衛星デジタル音声放送送信機
 - 1 k 電話回線網
 - 1 l 衛星放送設備
 - 11 a 自車位置検出手段
 - 11 b 自車位置表示手段
 - 11 c 経路案内手段
 - 11 d 車両位置情報提供手段
 - 11 e 自動通話手段
 - 11 f 自動データ伝送手段
 - 2 a 自車位置検出処理手段
 - 30 2 b 自車位置情報編集処理手段
 - 2 c 自車位置情報送信処理手段
 - 2 d 自車位置情報受信処理手段
 - 2 e 自車位置情報蓄積処理手段
 - 2 j 車両位置情報編集処理手段
 - 2 k 車両位置情報送信処理手段
 - 2 l 車両位置情報受信処理手段
 - 2 m 車両位置情報表示処理手段
 - 2 n 車両マーク入力処理手段
 - 2 o 車両マーク入力判断手段
 - 2 p 自動通話手段
 - 2 q 自動データ伝送手段
 - 3 a ヘッド部
 - 3 b データ部
 - 3 d 車両識別番号
 - 3 e グループ識別番号
 - 3 f 位置情報
 - 3 g 電話番号
 - 4 a デジタル地図
 - 4 b 矢印

【図1】

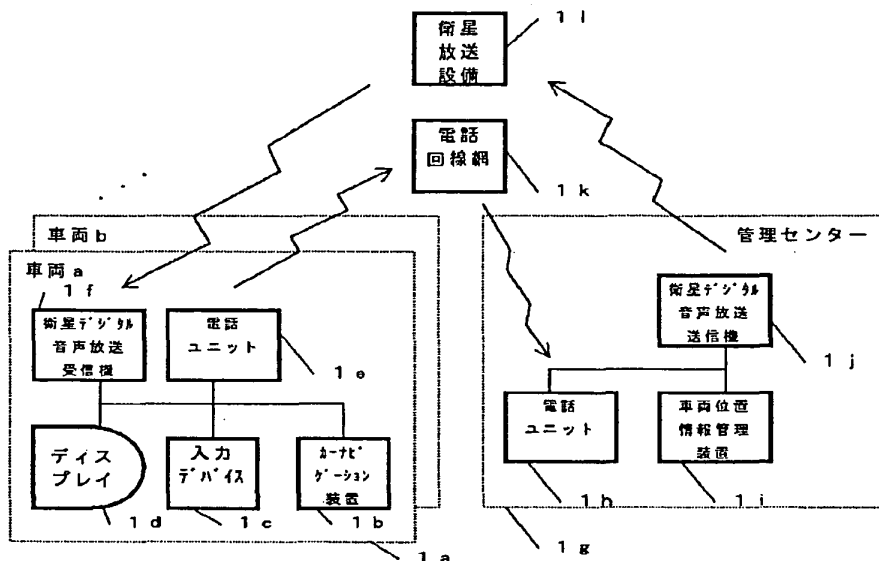

【図2】

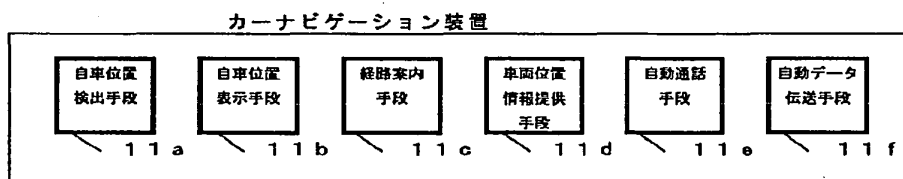

【図4】

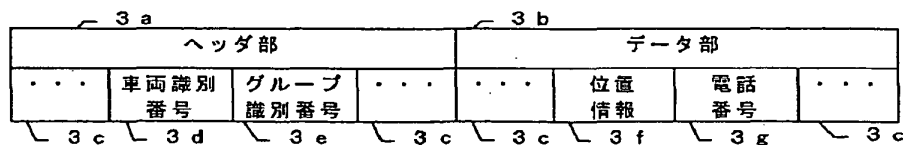

【図3】

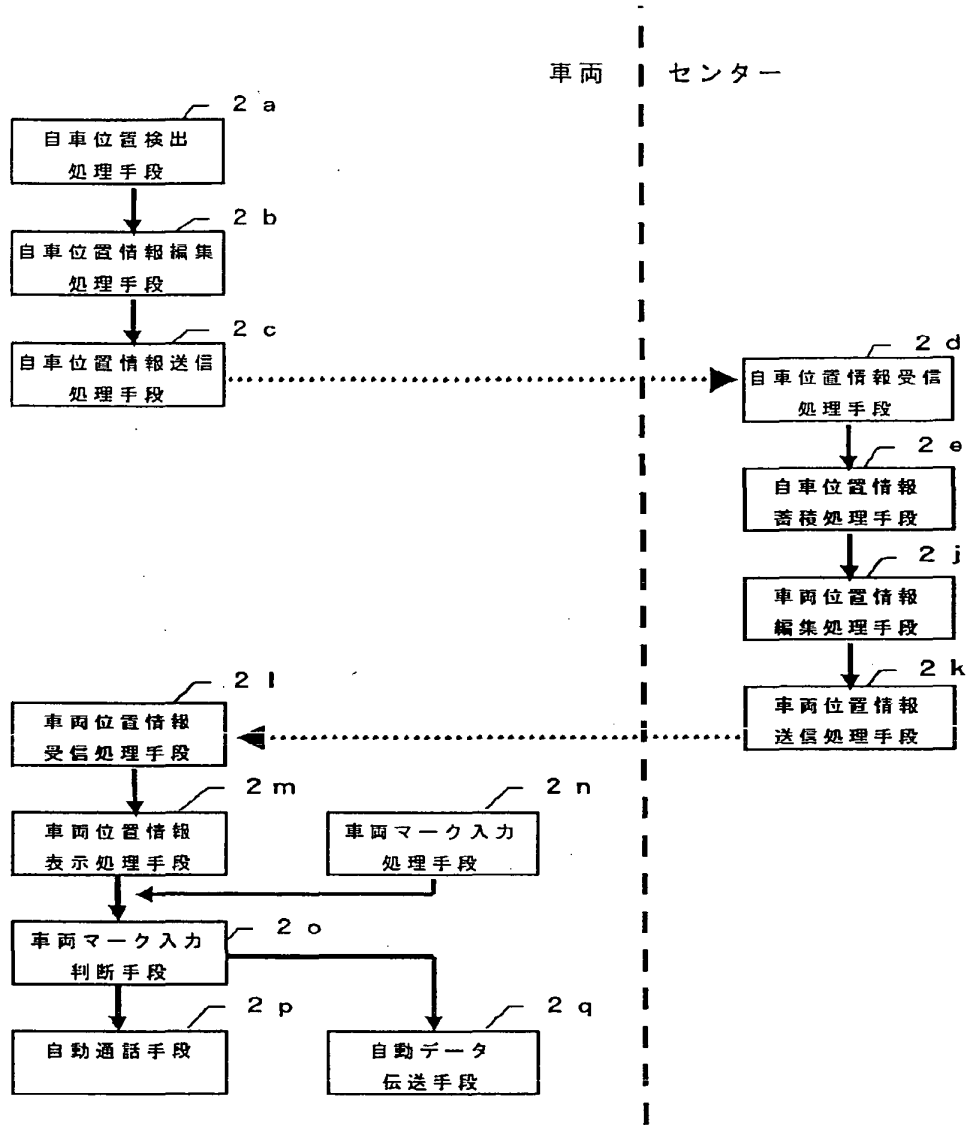

【図5】

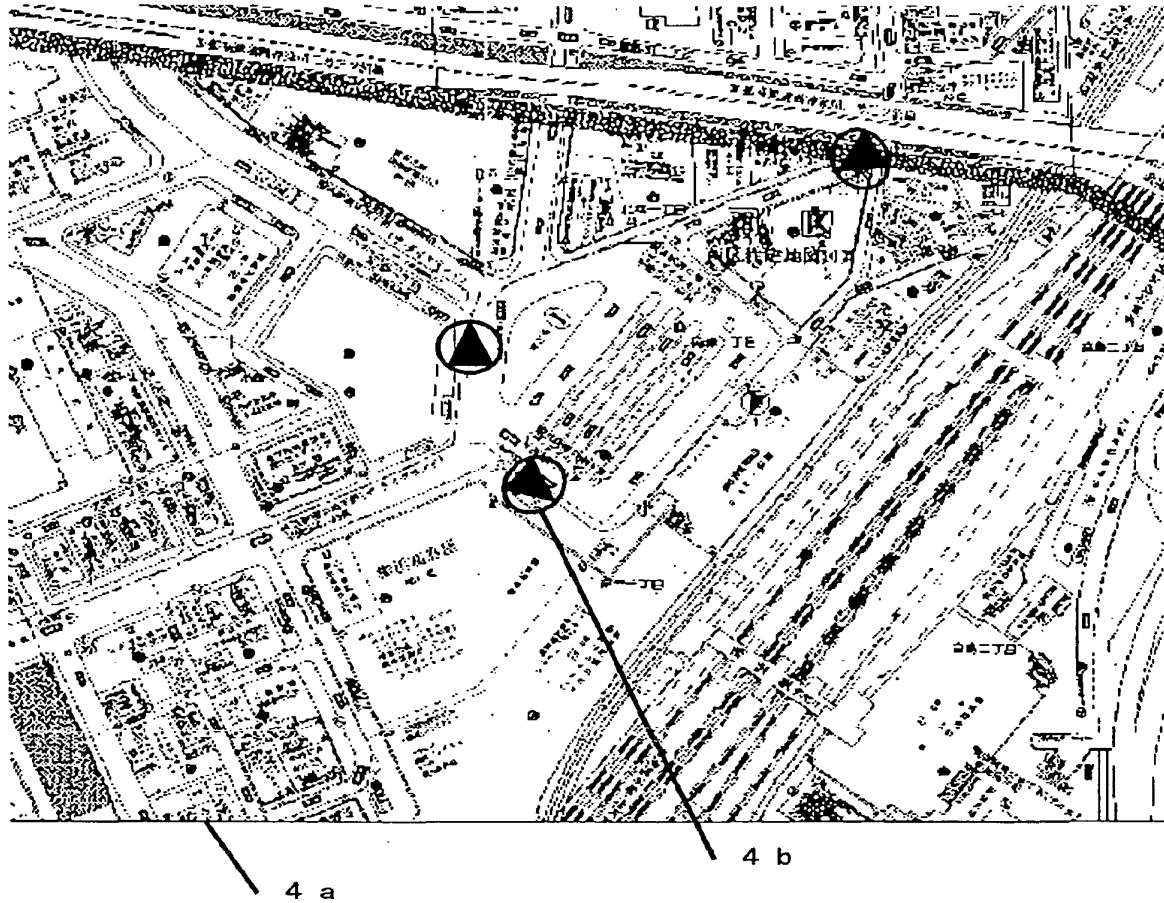

【図6】

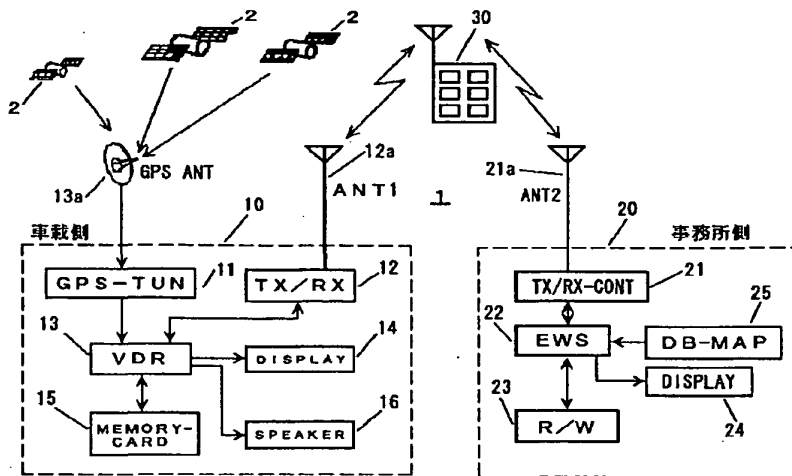

PATENT ABSTRACTS OF JAPAN

(11)Publication number : 2002-277256
 (43)Date of publication of application : 25.09.2002

(51)Int.Cl. G01C 21/00
 G06F 13/00
 G08G 1/09
 G08G 1/137
 G09B 29/00
 G09B 29/10
 H04B 7/26
 H04Q 7/38

(21)Application number : 2001-080674 (71)Applicant : MAZDA MOTOR CORP
 (22)Date of filing : 21.03.2001 (72)Inventor : IKEDA KENICHI
 OMURA HIROSHI

(54) MOBILE UNIT POSITION DISPLAY METHOD AND SYSTEM, AND INFORMATION MEDIATION APPARATUS AND ITS COMPUTER PROGRAM

(57)Abstract:

PROBLEM TO BE SOLVED: To easily perform intercommunication by performing communication directly between mobile units.

SOLUTION: A navigation 1 mounted to each of pluralities of vehicles for composing a group has a communication function; and transmits such information as time, a current position (coordinates information), vehicle state, and vehicle speed (driving distance) to an information center 2 in the form a file attached to an E-mail. The identification information of each vehicle for composing the group concerned is registered at the information center 2. When the information center 2 receives position information or the like by an E-mail from a certain vehicle, the center 2 provides the received information to a navigation apparatus 1 that is mounted to another vehicle in the same group by a file attached to an E-mail. The navigation apparatus 1 that is mounted to each vehicle displays a map screen including a specific symbol for indicating the current position of each vehicle on a display based on the received position information on another information, the received current position information on the detected own vehicle, and map information.

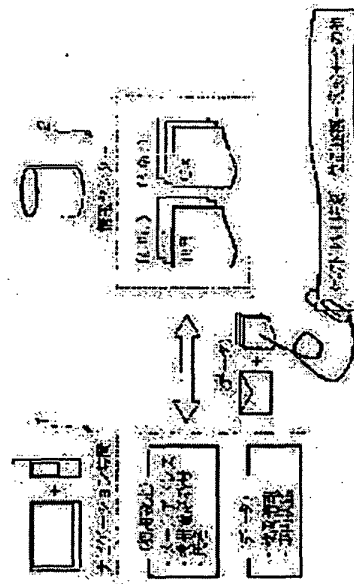

LEGAL STATUS

[Date of request for examination]
 [Date of sending the examiner's decision of

rejection]

[Kind of final disposal of application other than the examiner's decision of rejection or application converted registration]

[Date of final disposal for application]

[Patent number]

[Date of registration]

[Number of appeal against examiner's decision of rejection]

[Date of requesting appeal against examiner's decision of rejection]

[Date of extinction of right]

Copyright (C); 1998,2003 Japan Patent Office

(ENGLISH TRANSLATION)

Japanese Laid-open Patent

Laid-open Number: 2002-277256
Laid-open Date: September 25, 2002
Application Number: 2001-80674
Filing Date: March 21, 2001
Applicant: Mazda Motor Corporation

(54) [Title of the Invention] Mobile unit position display method, mobile unit position display system, information mediation apparatus, and computer program for the same

(57) [Summary]

[Object] To perform intercommunication between mobile units with ease without performing direct communication.

[Solving Means] A navigation 1 (*sic*) mounted to each of a plurality of vehicles composing a group has a communication function and sends information including time, a current position (coordinates information), a vehicle state, and a vehicle speed (travel distance) to an information center 2 in the form of a file attached to an email. In the information center 2, identification information is registered for each of the vehicles composing the group. When receiving position information or the like by an email from a given vehicle, the information center 2 provides the received information to a navigation apparatus 1 that is mounted to another vehicle in the same group by a file attached to an E-mail. The navigation apparatus 1 that is mounted to each vehicle displays a map screen

containing a predetermined symbol indicating the current position of each vehicle on a display based on the received position information on another vehicle, detected current position information on the own vehicle, and map information.

[Scope of Claims]

[Claim 1] A mobile unit position display method, which uses a communication system including: an information center provided with a database; and a communication terminal that can communicate with the information center and mounted to or carried by a mobile unit, the method being characterized by comprising:

a storage step for storing identification information on the communication terminals mounted to or carried by a plurality of mobile units composing a group in the database in association;

a communication control step for, when the information center is accessed by the communication terminal and it is judged that the communication terminal is included in the communication terminals mounted to or carried by the plurality of mobile units composing the group by use of the identification information stored in the database, sending position information received from the communication terminal to the other communication terminals in the same group; and

a display step for, in each communication terminal in the group, displaying a map screen that allows identification of current positions of the plurality of mobile units composing the group based on position information on the own communication terminal, position information on the other communication terminals received from the outside, and map information corresponding to those position information.

[Claim 2] The mobile unit position display method according to claim 1, characterized in that in the case where the identification information on the plurality of communication terminals corresponding to the group is stored in the database, the communication control step provides a Web page or a chat room valid only for the communication terminals.

[Claim 3] The mobile unit position display method according to claim 1, characterized in that in the case where, upon receiving a communication start request from a given communication terminal in the group, the association can be confirmed by referencing the database, the communication control step enables communication of the position information with the other communication terminals in the group.

[Claim 4] A mobile unit position display system, comprising: an information center provided with a database; and communication terminals that can communicate with the information center and mounted to or carried by a plurality of mobile units, characterized in that:

identification information on the communication terminals mounted to or carried by a plurality of mobile units composing a group is stored in the database in association;

the information center includes communication control means for, when the information center is accessed by the communication terminal and it is judged that the communication terminal is included

in the communication terminals mounted to or carried by the plurality of mobile units composing the group by use of the identification information stored in the database, sending position information received from the communication terminal to the other communication terminals in the same group; and

the communication terminal includes display means for displaying a map screen that allows identification of current positions of the plurality of mobile units composing the group based on position information on the own communication terminal, position information on the other communication terminals received from the outside, and map information corresponding to those position information.

[Claim 5] The mobile unit position display system according to claim 4, characterized in that in the information center, in the case where the identification information on the plurality of communication terminals corresponding to the group is stored in the database, the communication control means provides a Web page or a chat room valid only for the communication terminals.

[Claim 6] The mobile unit position display system according to claim 4, characterized in that in the information center, in the case where, when receiving a communication start request from a given communication terminal in the group, the association can be confirmed by referencing the database, the communication control means enables communication of the position information with another communication

terminal in the group.

[Claim 7] The mobile unit position display system according to claim 6, characterized in that in the information center, even in the case where the association can be confirmed as a result of referencing the database, when receiving an indication of refusal of communication from the other communication terminal, the communication control means eliminate the other communication terminal from communication among the communication terminals in the group.

[Claim 8] The mobile unit position display system according to claim 5, characterized in that the Web page is chargeable.

[Claim 9] The mobile unit position display system according to claim 5, characterized in that the communication terminal includes communication means for, when the Web page is provided by the information center, directly providing the other communication terminals in the group with an address of the Web page.

[Claim 10] The mobile unit position display system according to claim 7, characterized in that in the information center, when receiving the indication of refusal of communication from the other communication terminal, the communication control means notifies the communication terminals performing communication among the communication terminals in the group of the indication.

[Claim 11] The mobile unit position display system according to any one of claims 4 to 6, characterized in that in the information

center, the communication control means ends communication among the communication terminals in the group automatically when a predetermined period of time has elapsed and/or when there is left one communication terminal that participates in the communication.

[Claim 12] An information mediation apparatus for mediating communication with communication terminals mounted to or carried by a plurality of mobile units, characterized by comprising:

a database in which identification information on the communication terminals mounted to or carried by the plurality of mobile units composing a group is stored in association; and

communication control means for, when the information center (*sic*) is accessed by the communication terminal and it is judged that the communication terminal is included in the communication terminals mounted to or carried by the plurality of mobile units composing the group by use of the identification information stored in the database, sending position information received from the communication terminal to the other communication terminals in the same group.

[Claim 13] The information mediation apparatus according to claim 12, characterized in that in the case where the identification information on the plurality of communication terminals corresponding to the group is stored in the database, the communication control means provides a Web page or a chat room valid only for the communication terminals.

[Claim 14] The information mediation apparatus according to claim 12, characterized in that in the case where, when receiving a communication start request from a given communication terminal in the group, the association can be confirmed by referencing the database, the communication control means enables communication of the position information with another communication terminal in the group.

[Claim 15] A computer program, characterized by causing a computer to operate as the information mediation apparatus according to any one of claims 12 to 14.

[Detailed Description of the Invention]

[0001]

[Technical Field to which the Invention belongs] The present invention relates to a mobile unit position display method for displaying positions of mobile units such as vehicles and persons, a mobile unit position display system, an information mediation apparatus, and a computer program for the same.

[0002]

[Prior Art] Up to now, there has been proposed a navigation apparatus for directly performing inter-vehicle communication between a plurality of vehicles (mobile units) in, for example, JP 2000-59533 A, etc.

[0003]

[Problems to be solved by the Invention] According to the

above-mentioned prior art, increased convenience is provided in the case where a plurality of vehicles compose a group and move, but it is required to equip a navigation apparatus with a dedicated communication apparatus.

[0004] The present invention therefore has an object to provide a mobile unit position display method for performing intercommunication between mobile units with ease without performing direct communication, a mobile unit position display system, an information mediation apparatus, and a computer program for the same.

[0005]

[Means for solving the Problem] In order to achieve the above-mentioned object, a mobile unit position display system according to the present invention is characterized by the following configuration.

[0006] That is, the mobile unit position display system includes: an information center provided with a database; and communication terminals that can communicate with the information center and mounted to or carried by a plurality of mobile units, and is characterized in that: identification information on the communication terminals mounted to or carried by a plurality of mobile units composing a group is stored in the database in association; the information center includes communication control means for, when the information center is accessed by the

communication terminal and it is judged that the communication terminal is included in the communication terminals mounted to or carried by the plurality of mobile units composing the group by use of the identification information stored in the database, sending position information received from the communication terminal to the other communication terminals in the same group; and the communication terminal includes display means for displaying a map screen that allows identification of current positions of the plurality of mobile units composing the group based on position information on the own communication terminal, position information on the other communication terminals received from the outside, and map information corresponding to those position information.

[0007] Preferably, in the information center, in the case where the identification information on the plurality of communication terminals corresponding to the group is stored in the database, the communication control means may provide a Web page or a chat room valid only for the communication terminals.

[0008] Further, preferably, in the information center, in the case where, when receiving a communication start request from a given communication terminal in the group, the association can be confirmed by referencing the database, the communication control means may enable communication of the position information with another communication terminal in the group.

[0009] In each of the configurations described above, the information

center (*sic*), the communication control means may end communication among the communication terminals in the group automatically when a predetermined period of time has elapsed and/or when there is left one communication terminal that participates in the communication.

[0010] Note that the same object described above is achieved by an information mediation apparatus corresponding to an information center in each of the system configurations described above; a program code for implementing an operation of the apparatus by a computer; a storage medium readable by a computer which stores the program code; and a mobile unit position display method corresponding to each of the system configurations described above.

[0011]

[Effects of the Invention] According to the present invention described above, it becomes possible to provide a mobile unit position display method for performing intercommunication between mobile units with ease without performing direct communication, a mobile unit position display system, an information mediation apparatus, and a computer program for the same.

[0012] That is, according to the inventions of claims 1, 4, and 12, for example, the association based on the identification information is used (claim 6) without providing the dedicated communication apparatus on each mobile unit, thereby making it possible to display the position of each mobile unit (communication

apparatus) with ease.

[0013] Further, according to the inventions of claims 2, 5, and 13, the dedicated Web page or chat room is provided to each group, so that the constituent members of the group can share various kinds of information with ease even on the move.

[0014] Further, according to the inventions of claims 3, 6, and 14, the position checking can be started easily for one another, for example, among specific members who often act together in ordinary cases.

[0015] Further, according to the invention of claim 7, members composing a group can be adjusted appropriately, for example, among the specific members who often act together in ordinary cases, so that the privacy of each member can be ensured, thereby increasing the convenience.

[0016] Further, according to the invention of claim 8, the information center can be operated on a commercial base.

[0017] Further, according to the invention of claim 9, a plurality of members composing a group can be notified with ease that the dedicated Web page has been opened.

[0018] Further, according to the invention of claim 10, for example, among specific members who often act together in ordinary cases, all participating members can recognize current constituent members of the group, thereby increasing the convenience.

[0019] Further, according to the invention of claim 11, in the case

where the system is available not for flat-rate billing but for usage-based billing, the system can be used at lower cost, thereby increasing the convenience.

[0020]

[Embodiment Mode of the Invention] Hereinafter, detailed description will be made of an embodiment, in which a mobile unit position display system according to the present invention is applied to vehicles (automobiles) given as a typical example of mobile units, with reference to the drawings.

[0021] Note that in each embodiment (*sic*) below, the description is made by taking a navigation apparatus that is mounted to a vehicle and has a communication function as an example of a communication terminal that is mounted to or carried by a mobile unit. However, the communication terminal is not limited to such an apparatus configuration, and may be an information processor such as a personal digital assistant (PDA) or cellular telephone that has a positioning function (examples of the mobile unit thus including a person).

[0022] Fig. 1 is a diagram showing an entire configuration of the mobile unit position display system according to this embodiment.

[0023] In the figure, reference numeral 1 denotes a navigation apparatus mounted to a vehicle (an on-vehicle navigation apparatus with a communication function) given as an example of the mobile unit, which includes a communication interface 27 for performing communication with an external apparatus. In this embodiment, the

communication interface 27 is a public radio telephone such as a cellular telephone or a PHS telephone, and can be connected to the Internet 6 via a telephone base station 4 within the city and an internet service provider 5. In this embodiment, a representative vehicle, a vehicle A, a vehicle B, and a vehicle C are each mounted with the navigation apparatus 1 and the communication interface 27, which allow access to an information center 2.

[0024] Reference numeral 2 denotes an information center that functions as an information mediation apparatus in this embodiment. The hardware used as the information center 2 is itself a general server computer that can be connected to the Internet 6, and includes a database 7.

[0025] Fig. 2 is a block diagram showing an example of an internal configuration of the on-vehicle navigation apparatus with a communication function according to this embodiment.

[0026] In the figure, reference numeral 22 denotes a display such as a liquid crystal display; 23, an input device composed of key switches and various pointing devices; 24, a ROM that stores a boot program and the like; 25, a RAM that temporarily stores various processing results; 26, a storage device, such as a hard disk drive (an HDD), which stores map information for navigation, a browser program allowing access to the Internet 6, a program for sending/receiving an email, and the like; 27, a communication interface for performing communication with external apparatuses,

such as the information center 2 and the on-vehicle navigation apparatus with a communication function having a similar apparatus configuration, in the state of being connected to the Internet 6 via the telephone base station 4 within the city and the internet service provider 5; and 28, a GPS unit for detecting a current position based on a GPS (global positioning system) signal received from the outside. Those components are connected through an internal bus 29. A CPU (central processing unit) 21 executes an operation control of the entire navigation apparatus, a browser function for the access to the Internet 6, an email sending/receiving function, and the like according to software programs stored in the storage device 26.

[0027] The software programs may be burned onto the ROM 24 in advance to be read for execution by the CPU 21. Alternatively, the software programs may be read from a portable storage medium such as a DVD-ROM for the execution, or may be obtained from outside via a communication line 30 and appropriately stored in the storage device 26 to be read for the execution.

[0028] Next, description will be made of a functional outline of the mobile unit position display system implemented by the above-mentioned system configuration.

[0029] Note that in the following description, in the case where a plurality of vehicles are traveling toward an identical destination or for an identical purpose, the term "group traveling" represents

the state where the plurality of vehicles are traveling in an organized group. In that case, the vehicles in the organized group are arranged in either the state of being so close to one another that each driver can view the other vehicles or the state of being so far apart from one another that each driver can recognize the other vehicles only by using a position display system described below.

[0030] Fig. 3 is a block diagram showing the functional outline of the mobile unit position display system according to this embodiment.

[0031] Before using this system, a representative (for example, a driver of the representative vehicle) for a plurality of vehicles intending to perform the group traveling needs to perform the following initial settings in the state of having logged in to a predetermined Web page or the like of the information center 2. That is, for each of the plurality of vehicles composing a group, the representative needs to register, as predetermined identification information (ID) for specifying the navigation apparatus 1 (including the communication interface 27) mounted to the vehicle, information on the navigation apparatus 1 (communication interface 27) including an email address, a telephone number, and a name of the driver (user). Accordingly, the identification information on the respective navigation apparatuses 1 is stored in the database 7 of the information center 2 in association as a single group. In the information center 2, a predetermined

work area (predetermined Web page, memory area, chat room, or the like) is allocated to the group for a predetermined period of time (for example, about 3 days), which may, for example, be commercially available as a chargeable service.

[0032] After the initial settings are complete, among the navigation apparatuses 1 (communication interface 27) on the plurality of vehicles composing the group, a polling function is executed for a current position, for example, at predetermined time intervals or distance intervals. By an automatic connection function provided to the communication interface 27, information including time, the current position (coordinates information) detected by the GPS unit 28, a vehicle state, and a vehicle speed (travel distance) is sent to the information center 2 in the form of a file attached to an email.

[0033] In the case where the address of the email received from a given vehicle (first vehicle) is included in the identification information that has already been registered in the database 7 in association in the initial settings described above, the information center 2 sends an email attached with a file containing the current position information on the first vehicle to the navigation apparatus 1 mounted to each of vehicles (second vehicles) of the other constituent members of the group.

[0034] Note that in the above configuration, the position information or other such information on the other vehicles may be obtained

collectively when the polling function described above is executed to send the position information or other such information on the own vehicle to the information center 2.

[0035] The navigation apparatus 1 mounted to each of the vehicles composing the group uses a general map display function to display a map screen containing a predetermined symbol indicating the current position of each vehicle on the display 22 based on the current position information on the other vehicles received by the email from the information center 2, the current position information on the own vehicle detected by the GPS unit 28, and the map information stored in the storage device 26.

[0036] Fig. 4 is a flow chart showing state transitions that take place between the navigation apparatus 1 on each vehicle and the information center 2 until the position information is displayed in each vehicle.

[0037] In the representative vehicle driven by the representative for a given group (in this embodiment, the representative vehicle and the vehicles A to C), a predetermined operation is performed on the navigation apparatus 1 and communication interface 27 mounted to the vehicle for the initial settings described above with respect to the information center 2 (step S2), and then the registration relating to the group becomes complete with this system (step S3).

[0038] At this time, the information center 2 issues one group ID to the group composed of the registered vehicles (navigation

apparatuses 1), and at the same time, secures a Web page (or chat room) dedicated to the group for a predetermined period of time (step S4). The constituent members of the group can write desired information into this Web page (or chat room) through the navigation apparatuses 1 with the result that all the members can share various kinds of information with ease.

[0039] The issued group ID is sent by the information center 2 to each vehicle in the form of an email by use of the address registered in the database 7 (step S5 and step S6). Here, the group ID of which the constituent members of a given group are notified may be identification information unique to each group, but in this embodiment, the group ID is assumed to be the address information (URL) on the dedicated Web page. Accordingly, the user of each vehicle that has received the group ID from the information center 2 in step S6 can recognize the existence of the dedicated Web page. At the same time, the position information display starts to include his/her own vehicle in the constituent members of the group, and the user recognizes that the other members are notified of the current position of his/her own vehicle.

[0040] Note that in the above configuration, the group ID and the address information on the dedicated Web page may be sent from the information center 2 only to the navigation apparatus 1 on the representative vehicle, and may then be sent from the representative vehicle to the other vehicles in the group.

[0041] In step S7, the information center 2 judges whether or not a signal indicating participation in the position information display according to this system is received from each of the vehicles composing the group (in this embodiment, the representative vehicle and the vehicles A to C). When the signal indicating the participation is received, the process advances to step S8. When a signal indicating non-participation is received, the process advances to step S14.

[0042] After receiving the signal indicating the non-participation from a given vehicle included in the group in step S7, the information center 2 deletes the vehicle from the constituent members of the group intending to use the system at this time (step S14), while using an email or the like to notify the other vehicles of the deletion of the vehicle from the constituent members intending to use the system at this time (step S15). Accordingly, all the members intending to use this system can recognize who are the members not intending to use this system (members intending to use this system), thereby increasing the convenience.

[0043] When the member is deleted from the constituent members intending to use the system at this time in step S14, the service provided to the member by the information center 2 ends (step S18). Accordingly, users of this system can be adjusted appropriately, for example, among the members who often act together in a group in ordinary cases, so that the privacy of each member can be ensured,

thereby increasing the convenience.

[0044] Meanwhile, in the case where the information center 2 receives the signal indicating the participation from a given vehicle included in the group in step S7, in step S8, the vehicle starts to execute the polling function for the current position of the own vehicle, for example, at predetermined time intervals or distance intervals, thereby automatically sending an email attached with a file containing the current position (coordinates information) detected by the GPS unit 28 to the information center 2.

[0045] Upon receiving the email, the information center 2 refers to the database 7 to thereby send an email containing the received attached file to the vehicles of the other members included in the same group. Accordingly, each vehicle that has received the signal indicating the participation from a given vehicle included in the group in step S7 uses the function of the navigation apparatus 1 mounted thereto to display the map screen containing a predetermined symbol indicating the current position of each vehicle on the display 22 based on the received current position information on the other vehicles, the current position information on the own vehicle detected by the GPS unit 28, and the map information stored in the storage device 26 (step S8).

[0046] If the email containing the position information is not sent from each of the vehicles that are the constituent members intending to use the system at this time within a predetermined period of

time (for example, about 30 minutes) (step S9), the information center 2 notifies at least the navigation apparatus 1 of the representative vehicle to that effect by use of an email or the like (step S10). At this time, if no response is obtained from the representative vehicle or the like, which is the user, it is judged that the use of the system by the group at this time has ended, and the system is forced to end (step S13).

[0047] Alternatively, if the constituent members decrease in number during the use of the system in a so-called dispersion-like manner to finally leave any one of the members (step S11), the position display for one another is no longer performed thereafter. Therefore, the information center 2 notifies the last one member to that effect by use of an email or the like (step S12), while forcing to end the service for the group at this time (step S13). Accordingly, in the case where the system is available not for flat-rate billing but for usage-based billing, the system can be used at lower cost, thereby increasing the convenience.

[0048] Also during the use of the system described above (step S8), in such cases where, for example, an indication of end of the use of the system is obtained from the member of the representative vehicle or the expiry date (in a predetermined period of time, for example, about 3 days later) for the Web page or the like secured for the group in the information center 2 has been reached, it is checked whether the use of the system is to be ended with at least

the member of the representative vehicle by an email or the like (step S16). If the checking results in information indicating the continuous use, the use of the system is continued (step S8), and if the checking results in information indicating the end of the use of the system, the other members are notified of the end of the use of the system by an email or the like (step S17), while the service for the group at this time is ended (step S18). Therefore, according to this embodiment described above, the position information on one another can be sent/received through the information center 2 even if the dedicated communication apparatus capable of direct communication between the vehicles is not provided. Consequently, by using the map display function provided to the navigation apparatus 1 mounted to each of the vehicles, it is possible to display the map screen containing a predetermined symbol indicating the current position of each vehicle on the display with ease and at low cost.

[0049] Note that in this embodiment described above, the position information (coordinates information) and the like are sent/received through the Internet 6 in the form of a file attached to an email. However, this embodiment is not limited to this method, and any transmission forms may be adopted as long as information on necessary items can be sent/received.

[0050] Further, this embodiment is described above on the assumption that the navigation apparatus 1 on each vehicle is previously provided

with the polling function for sending the current position of the own vehicle to the information center 2. However, this embodiment is not limited to this system configuration, and may be configured such that when the navigation apparatus 1 on each vehicle accesses (logs in to) the Web page prior to the group traveling, software implementing the polling function is provided to the accessing navigation apparatus 1 from the information center 2. More specifically, it is a possible configuration that in the case where, for example, the navigation apparatus 1 is provided with an environment allowing the apparatus to operate as a Java Virtual Machine, the Web page dedicated to a group is secured in the information center 2, and when the navigation apparatus 1 on each vehicle accesses (logs in to) the Web page prior to the group traveling, a Java program representing the polling function is downloaded to the accessing navigation apparatus 1 from the information center 2.

[Brief Description of the Drawings]

[Fig. 1] A diagram showing an entire configuration of a mobile unit position display system according to this embodiment (*sic*).

[Fig. 2] A block diagram showing an example of an internal configuration of an on-vehicle navigation apparatus with a communication function according to this embodiment.

[Fig. 3] A block diagram showing a functional outline of the mobile unit position display system according to this embodiment.

[Fig. 4] A flow chart showing state transitions that take place between a navigation apparatus 1 on each vehicle and an information center 2 until position information is displayed in each vehicle.

[Description of Reference Numerals]

- 1: navigation apparatus
- 2: information center
- 4: telephone base station
- 5: internet service provider
- 6: Internet
- 7: database
- 21: CPU
- 22: display
- 23: input device
- 24: ROM
- 25: RAM
- 26: storage device
- 27: communication interface
- 28: GPS unit
- 29: internal bus
- 30: communication line

FIG. 1

27 COMMUNICATION INTERFACE

(REPRESENTATIVE VEHICLE)

1 NAVIGATION APPARATUS

VEHICLE A

4 TELEPHONE BASE STATION

7 DATABASE

GROUP DATA

2 INFORMATION CENTER

FIG. 2

22 DISPLAY

23 INPUT DEVICE

29 INTERNAL PATH

MAP INFORMATION

26 STORAGE DEVICE

28 GPS UNIT

30 COMMUNICATION LINE

FIG. 3

(INITIAL SETTING)

EMAIL ADDRESS

CELLULAR TELEPHONE NUMBER

NAME

(DATA)

POSITION INFORMATION

VEHICLE STATE

YAMADA

EMAIL ADDRESS + TIME + POSITION COORDINATES + STATE + OTHERS

FIG. 4

START

S2 PERFORM GROUP TRAVELING SYSTEM REGISTRATION BY REPRESENTATIVE
S3 PERFORM RECEPTION/REGISTRATION BY INFORMATION CENTER
S4 ISSUE GROUP ID AND CREATE PAGE
S5 SEND GROUP ID TO EACH MEMBER
S6 RECEIVE GROUP ID BY EACH MEMBER
S7 READY TO START SYSTEM?
S8 USE SYSTEM
S9 IF NOT USED FOR PREDETERMINED PERIOD
S10 NOTIFY TO THAT EFFECT
S11 IF ONE MEMBER IS LEFT BY OTHER MEMBERS
S13 FORCE TO END
S14 DELETE FROM REGISTERED MEMBERS
S15 NOTIFY OTHER MEMBERS TO THAT EFFECT
S16 END SYSTEM?
S18 END

(19) 日本国特許庁 (J P)

(12) 公開特許公報 (A)

(11) 特許出願公開番号
特開2002-277256

(P 2 0 0 2 - 2 7 7 2 5 6 A)

(43) 公開日 平成14年9月25日(2002.9.25)

(51) Int. Cl. ⁷	識別記号	F I	テマコード (参考)
G01C 21/00		G01C 21/00	B 2C032
G06F 13/00	630	G06F 13/00	A 2F029
G08G 9/00 1/137		G08G 1/09 1/137	H 5H180 5K067
G09B 29/00		G09B 29/00	A

審査請求 未請求 請求項の数15 O L (全9頁) 最終頁に続く

(21) 出願番号 特願2001-80674(P 2001-80674)

(22) 出願日 平成13年3月21日(2001.3.21)

(71) 出願人 000003137
マツダ株式会社
広島県安芸郡府中町新地3番1号

(72) 発明者 池田 健一
広島県安芸郡府中町新地3番1号 マツダ株式会社内

(72) 発明者 大村 博志
広島県安芸郡府中町新地3番1号 マツダ株式会社内

(74) 代理人 100076428
弁理士 大塚 康德 (外3名)

最終頁に続く

(54) 【発明の名称】 移動体位置表示方法、移動体位置表示システム、情報仲介装置及びそのコンピュータプログラム

(57) 【要約】

【課題】 各移動体間において直接通信を行うことなく、相互通信を容易に行う。

【解決手段】 グループを構成する複数車両にそれぞれ搭載されたナビゲーション1は通信機能を備えており、時刻、現在位置(座標情報)、車両状態、並びに車速(走行距離)等の情報を、情報センター2への電子メールに添付した添付ファイルの形態で送信する。情報センター2には、当該グループを構成する各車両の識別情報が登録されており、ある車両から電子メールによって位置情報等を受信すると、情報センター2は、受信した情報を同グループ内の他車両に搭載されたナビゲーション装置1に対して、電子メールの添付ファイルにより提供する。各車両に搭載されたナビゲーション装置1では、受信した他車両の位置情報、検出した自車両の現在位置情報、並びに地図情報に基づいて、各車両の所在位置を表わす所定のシンボルを含む地図画面を、ディスプレイに表示する。

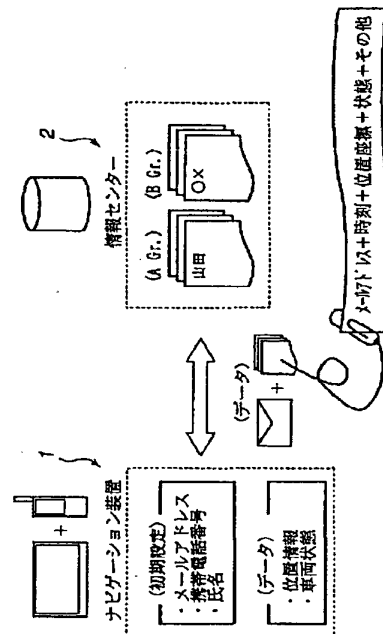

【特許請求の範囲】

【請求項 1】 データベースを備える情報センターと、前記情報センターと通信可能であって移動体に搭載または携帯された通信端末とを含む通信システムを用いる移動体位置表示方法であって、

前記データベースに、グループを構成する複数の移動体に搭載または携帯された通信端末の識別情報を関連付けして記憶する記憶工程と、

前記情報センターに対して通信端末からアクセスがなされたときに、前記データベースに記憶されている識別情報を利用して、その通信端末が前記グループを構成する移動体に搭載または携帯された通信端末であると判断したときに、該通信端末から受信した位置情報を、そのグループ内の他の通信端末に対して送信する通信制御工程と、

前記グループ内の各通信端末において、自通信端末の位置情報、外部より受信した他の通信端末の位置情報、並びにそれら位置情報に対応する地図情報に基づいて、前記グループを構成する複数の移動体の所在位置を識別可能な地図画面を表示する表示工程と、を有することを特徴とする移動体位置表示方法。

【請求項 2】 前記通信制御工程では、前記データベースに前記グループに対応する複数の通信端末の識別情報が記憶されている場合に、それら通信端末に対してのみ有効な Web ページまたはチャットルームを提供することを特徴とする請求項 1 記載の移動体位置表示方法。

【請求項 3】 前記通信制御工程では、前記グループ内のある通信端末から通信開始要求を受信したときに、前記データベースを参照することによって関連付けが確認できた場合に、前記グループ内の他の通信端末との位置情報の通信を可能な状態にすることを特徴とする請求項 1 記載の移動体位置表示方法。

【請求項 4】 データベースを備える情報センターと、その情報センターと通信可能であって複数の移動体に搭載または携帯された通信端末とを含む移動体位置表示システムであって、

前記データベースには、グループを構成する複数の移動体に搭載または携帯された通信端末の識別情報が関連付けられて記憶されており、

前記情報センターは、前記情報センターに対して通信端末からアクセスがなされたときに、前記データベースに記憶されている識別情報を利用して、その通信端末が前記グループを構成する移動体に搭載または携帯された通信端末であると判断したときに、該通信端末から受信した位置情報を、そのグループ内の他の通信端末に対して送信する通信制御手段を備え、

前記通信端末は、自通信端末の位置情報、外部より受信した他の通信端末の位置情報、並びにそれら位置情報に対応する地図情報に基づいて、前記グループを構成する複数の移動体の所在位置を識別可能な地図画面を表示す

る表示手段を備えることを特徴とする移動体位置表示システム。

【請求項 5】 前記情報センターにおいて、前記通信制御手段は、前記データベースに前記グループに対応する複数の通信端末の識別情報が記憶されている場合に、それら通信端末に対してのみ有効な Web ページまたはチャットルームを提供することを特徴とする請求項 4 記載の移動体位置表示システム。

【請求項 6】 前記情報センターにおいて、前記通信制御手段は、前記グループ内のある通信端末から通信開始要求を受信したときに、前記データベースを参照することによって関連付けが確認できた場合に、前記グループ内の他の通信端末との位置情報の通信を可能な状態にすることを特徴とする請求項 4 記載の移動体位置表示システム。

【請求項 7】 前記情報センターにおいて、前記通信制御手段は、前記データベースを参照した結果、関連付けが確認できた場合であっても、前記他の通信端末から通信を拒絶する旨を受信したときには、前記グループ内の通信端末間の通信から前記他の通信端末を除くことを特徴とする請求項 6 記載の移動体位置表示システム。

【請求項 8】 前記 Web ページは有償であることを特徴とする請求項 5 記載の移動体位置表示システム。

【請求項 9】 前記通信端末は、前記情報センターによって前記 Web ページが提供された場合に、その Web ページのアドレスを、前記グループ内の他の通信端末に直接提供する通信手段を備えることを特徴とする請求項 5 記載の移動体位置表示システム。

【請求項 10】 前記情報センターにおいて、前記通信制御手段は、前記他の通信端末から通信を拒絶する旨を受信したときに、その旨を、前記グループ内で通信端末間の通信を行う通信端末に対して報知することを特徴とする請求項 7 記載の移動体位置表示システム。

【請求項 11】 前記情報センターにおいて、前記通信制御手段は、前記グループ内の複数の通信端末による通信を、所定期間が経過したとき及び／または通信に参加している通信端末が 1 台となったときに、自動的に終了することを特徴とする請求項 4 乃至請求項 6 の何れかに記載の移動体位置表示システム。

【請求項 12】 複数の移動体に搭載または携帯された通信端末との通信を仲介する情報仲介装置であって、グループを構成する複数の移動体に搭載または携帯された通信端末の識別情報が関連付けされたデータベースと、

前記情報センターに対して通信端末からアクセスがなされたときに、前記データベースに記憶されている識別情報を利用して、その通信端末が前記グループを構成する移動体に搭載または携帯された通信端末であると判断したときに、該通信端末から受信した位置情報を、そのグ

ループ内の他の通信端末に対して送信する通信制御手段と、を備えることを特徴とする情報仲介装置。

【請求項 1 3】 前記通信制御手段は、前記データベースに前記グループに対応する複数の通信端末の識別情報が記憶されている場合に、それら通信端末に対してのみ有効な Web ページまたはチャットルームを提供することを特徴とする請求項 1 2 記載の情報仲介装置。

【請求項 1 4】 前記通信制御手段は、前記グループ内のある通信端末から通信開始要求を受信したときに、前記データベースを参照することによって関連付けが確認できた場合に、前記グループ内の他の通信端末との位置情報の通信を可能な状態にすることを特徴とする請求項 1 2 記載の情報仲介装置。

【請求項 1 5】 請求項 1 2 乃至請求項 1 4 の何れかに記載の情報仲介装置としてコンピュータを動作させることを特徴とするコンピュータプログラム。

【発明の詳細な説明】

【0 0 0 1】

【発明の属する技術分野】 本発明は、車両や人等の移動体の位置を表示する移動体位置表示方法、移動体位置表示システム、情報仲介装置及びそのコンピュータプログラムに関する。

【0 0 0 2】

【従来技術】 従来より、例えば特開 2 0 0 0 - 5 9 5 3 3 号等には、複数の車両（移動体）間において直接的に車車間通信を行うナビゲーション装置が提案されている。

【0 0 0 3】

【発明が解決しようとする課題】 上記の従来技術によれば、複数の車両においてグループを構成して移動する場合等に利便性が高いが、ナビゲーション装置に専用の通信装置を備える必要が有る。

【0 0 0 4】 本発明は、各移動体間において直接通信を行うことなく、相互通信を容易に行う移動体位置表示方法、移動体位置表示システム、情報仲介装置及びそのコンピュータプログラムの提供を目的とする。

【0 0 0 5】

【課題を解決するための手段】 上記の目的を達成するため、本発明に係る移動体位置表示システムは、以下の構成を特徴とする。

【0 0 0 6】 即ち、データベースを備える情報センターと、その情報センターと通信可能であって複数の移動体に搭載または携帯された通信端末とを含む移動体位置表示システムであって、前記データベースには、グループを構成する複数の移動体に搭載または携帯された通信端末の識別情報が関連付けされて記憶されており、前記情報センターは、前記情報センターに対して通信端末からアクセスがなされたときに、前記データベースに記憶されている識別情報を利用して、その通信端末が前記グループを構成する移動体に搭載または携帯された通信端末

であると判断したときに、該通信端末から受信した位置情報を、そのグループ内の他の通信端末に対して送信する通信制御手段を備え、前記通信端末は、自通信端末の位置情報、外部より受信した他の通信端末の位置情報、並びにそれら位置情報に対応する地図情報に基づいて、前記グループを構成する複数の移動体の所在位置を識別可能な地図画面を表示する表示手段を備えることを特徴とする。

【0 0 0 7】 好ましくは前記情報センターにおいて、前記通信制御手段は、前記データベースに前記グループに対応する複数の通信端末の識別情報が記憶されている場合に、それら通信端末に対してのみ有効な Web ページまたはチャットルームを提供すると良い。

【0 0 0 8】 また、好ましくは前記情報センターにおいて、前記通信制御手段は、前記グループ内のある通信端末から通信開始要求を受信したときに、前記データベースを参照することによって関連付けが確認できた場合に、前記グループ内の他の通信端末との位置情報の通信を可能な状態にすると良い。

【0 0 0 9】 上記の各構成において、前記情報センターは、前記通信制御手段は、前記グループ内の複数の通信端末による通信を、所定期間が経過したとき及び/または通信に参加している通信端末が 1 台となったときに、自動的に終了すると良い。

【0 0 1 0】 尚、上記の同目的は、上記の各システム構成における情報センターに対応する情報仲介装置、並びにその装置の動作を、コンピュータによって実現するプログラムコード、及びそのプログラムコードが格納されているコンピュータ読み取り可能な記憶媒体、そして上記の各システム構成に対応する移動体位置表示方法によっても達成される。

【0 0 1 1】

【発明の効果】 上記の本発明によれば、各移動体間において直接通信を行うことなく、相互通信を容易に行う移動体位置表示方法、移動体位置表示システム、情報仲介装置及びそのコンピュータプログラムの提供が実現する。

【0 0 1 2】 即ち、請求項 1、請求項 4、請求項 1 2 の発明によれば、各移動体間で専用の通信装置を用意することなく、例えば識別情報による関連付けを利用するので（請求項 6）、各移動体（通信装置）の位置を容易に表示することができる。

【0 0 1 3】 また、請求項 2、請求項 5、請求項 1 3 の発明によれば、グループ毎に専用の Web ページまたはチャットルームが提供されるので、そのグループの構成メンバーは、移動中においても各種の情報を容易に共有することができる。

【0 0 1 4】 また、請求項 3、請求項 6、請求項 1 4 の発明によれば、例えば通常一緒に行動することが多い特定のメンバー間における互いの位置確認を容易に開始す

ることができる。

【0015】また、請求項7の発明によれば、例えば通常一緒に行動することが多い特定のメンバー間において、グループを構成するメンバーを適宜調整することができるので、各メンバーのプライバシーを確保することができ、利便性が向上する。

【0016】また、請求項8の発明によれば、商業ベースで情報センターを運営することができる。

【0017】また、請求項9の発明によれば、グループを構成する複数のメンバーに、専用のWebページが開10 設されたことを容易に知らせることができる。

【0018】また、請求項10の発明によれば、例えば通常一緒に行動することが多い特定のメンバー間において、現在のグループの構成メンバーを参加メンバー全員が認識することができ、利便性が向上する。

【0019】また、請求項11の発明によれば、例えばシステムの利用が定額制による有料ではなく、従量制による有料である場合に、経済的な利用ができるので、利便性が向上する。

【0020】

【発明の実施の形態】以下、本発明に係る移動体位置表示システムを、代表的な移動体である車両（自動車）に適用した実施形態として、図面を参照して詳細に説明する。

【0021】尚、以下の各実施形態では、車両に搭載された通信機能を有するナビゲーション装置を、移動体に搭載または携帯された通信端末の一例として説明するが、この装置構成に限られるものではなく、通信端末は、測位機能を備える携帯情報端末（PDA）や携帯電話等の情報処理装置であっても良い（従って、移動体には人が含まれる）。

【0022】図1は、本実施形態における移動体位置表示システムの全体構成を示す図である。

【0023】同図において、1は、移動体の一例である車両に搭載されたナビゲーション装置（通信機能付き車載ナビゲーション装置）であり、外部装置との通信を行うための通信インタフェース27を含む。本実施形態において、通信インタフェース27は、携帯電話やPHS等の公衆無線電話装置であり、市中の電話基地局4及びインターネット・サービス・プロバイダ5を介して、インターネット6に接続可能である。本実施形態において、代表車両、車両A、車両B、車両Cの各車両には、ナビゲーション装置1及び通信インタフェース27がそれぞれ搭載されており、情報センター2へのアクセスが可能である。

【0024】2は、本実施形態において情報仲介装置として機能する情報センターである。情報センター2のハードウェア自体は、インターネット6に接続可能な一般的なサーバ・コンピュータであり、データベース7を備える。

【0025】図2は、本実施形態における通信機能付き車載ナビゲーション装置の内部構成を例示するブロック図である。

【0026】図中、22は、液晶表示器等のディスプレイ、23はキースイッチや各種ポインティング・デバイス等からなる入力装置である。24は、ブートプログラム等を記憶しているROMである。25は、各種処理結果を一時記憶するRAMである。26は、ナビゲーション用の地図情報や、インターネット6にアクセス可能なブラウザ・プログラム及び電子メールを送受信するプログラム等を記憶するハードディスクドライブ（HDD）等の記憶装置である。27は、市中の電話基地局4及びインターネット・サービス・プロバイダ5を介してインターネット6に接続した状態で、情報センター2や同様な装置構成を備える通信機能付き車載ナビゲーション装置等の外部装置との通信を行う通信インタフェースである。そして28は、外部より受信したGPS（グローバル・ポジショニング・システム）信号に基づいて現在位置を検出するGPSユニットである。これらの各構成20 は、内部バス29を介して接続されており、CPU（中央演算処理装置）21は記憶装置26に記憶したソフトウェアプログラムに従って、当該ナビゲーション装置の全体の動作制御、インターネット6へのブラウザ機能及び電子メールの送受信機能等を実行する。

【0027】係るソフトウェアプログラムは、CPU21において、ROM24に予め焼き込まれたものを読み出してから実行しても、DVD-ROM等の携帯可能な記憶媒体から読み出す、或いは通信回線30を介して外部より取得したものを記憶装置26に適宜格納しておき、読み出してから実行しても良い。

【0028】次に、上述したシステム構成において実現される移動体位置表示システムの機能概要について説明する。

【0029】尚、以下の説明において、グループ走行とは、同一の目的地等に向かって、或いは同一の目的に基づいて複数の車両が走行する場合に、それら複数の車両がグループを編成して走行する状態であり、この場合、編成されるグループにおいて、各車両の配置状態には、ドライバが他車両を目視可能な程に接近した状態の場合も、以下に説明する位置表示システムによってのみ他車両を認識することができる程に離間した状態の場合も含まれる。

【0030】図3は、本実施形態における移動体位置表示システムの機能概要を示すブロック図である。

【0031】グループ走行を行うであろう複数車両の代表者（例えば、代表車両のドライバ）は、本システムの利用に先立って、情報センター2の所定のWebページ等にログインした状態において、初期設定事項として、そのグループを構成する複数の車両について、それら車両に搭載されたナビゲーション装置1（通信インタフェ

ース 27 を含む) を特定する所定の識別情報 (ID) として、ナビゲーション装置 1 (通信インタフェース 27) のメールアドレス、電話番号、ドライバ (ユーザ) の氏名等を登録する必要がある。これにより、情報センター 2 のデータベース 7 には、各ナビゲーション装置 1 の識別情報が、1 つのグループとして関連付けされた状態で記憶され、情報センター 2 には、当該グループのために、所定の処理領域 (所定の Web ページ、メモリ領域、チャットルーム等) が、所定時間 (例えば 3 日程度) にわたって、例えば商業ベースの場合には有償で割り当てられる。

【0032】そして、係る初期設定が完了した状態において、当該グループを構成する複数車両のナビゲーション 1 (通信インタフェース 27) 間では、例えば所定の時間間隔または距離間隔で行われる現在位置のポーリング機能が実行されると、通信インタフェース 27 による自動的な接続機能により、時刻、GPS ユニット 28 によって検出された現在位置 (座標情報)、車両状態、並びに車速 (走行距離) 等の情報を、情報センター 2 への電子メールに添付した添付ファイルの形態で送信する。

【0033】情報センター 2 では、ある車両 (第 1 の車両) から受信した電子メールのアドレスが、上述した初期設定において既にデータベース 7 に関連付けして登録されたグループ内に含まれる場合に、そのグループ内の他の構成メンバーの各車両 (第 2 の車両) に搭載されたナビゲーション装置 1 に対して、第 1 の車両の現在位置情報を含むファイルが添付された電子メールを送信する。

【0034】尚、他車両に関する位置情報等の取得は、上記のポーリング機能によって自車両の位置情報等を情報センター 2 に送信したときに一括して行う構成としても良い。

【0035】当該グループを構成する各車両に搭載されたナビゲーション装置 1 では、情報センター 2 から電子メールにて受信した他の車両の現在位置情報、GPS ユニット 28 によって検出した自車両の現在位置情報、並びに記憶装置 26 に記憶している地図情報に基づいて、一般的な地図表示機能により、各車両の所在位置を表わす所定のシンボルを含む地図画面を、ディスプレイ 22 に表示する。

【0036】図 4 は、各車両において位置情報が表示されるまでの、各車両のナビゲーション装置 1 及び情報センター 2 間の状態遷移を示すフローチャートである。

【0037】あるグループ (本実施形態では、代表車両、車両 A 乃至 C) の代表者が乗車する代表車両において、その車両に搭載されたナビゲーション装置 1 及び通信インタフェース 27 の所定の操作が行われて、情報センター 2 に対する上記の初期設定が行われると (ステップ S 2)、当該グループに関する本システムへの登録が完了した状態となる (ステップ S 3)。

【0038】このとき、情報センター 2 は、登録された各車両 (各ナビゲーション装置 1) からなる当該グループに対して、1 つのグループ ID を発行すると共に、そのグループ専用の Web ページ (またはチャットルーム) を所定期間にわたって確保する (ステップ S 4)。この Web ページ (またはチャットルーム) には、当該グループの構成メンバーが、ナビゲーション装置 1 から所望の情報を書き込むことができ、これにより各メンバーは、各種情報を容易に共有することができる。

【0039】発行されたグループ ID は、データベース 7 に登録されたアドレスを利用して、情報センター 2 により、各車両に対して電子メールの形態で送信される (ステップ S 5、ステップ S 6)。ここで、あるグループの構成メンバーに対して共通に報知されるグループ ID は、各グループに固有の識別情報であっても良いが、本実施形態では、係るグループ ID を、専用の Web ページのアドレス情報 (URL) とすれば良い。これにより、ステップ S 6 にて情報センター 2 からグループ ID を受信した各車両のユーザは、専用の Web ページの存在を認識することができると共に、自車両がグループの構成メンバーに含まれる位置情報表示が開始され、自車両の現在位置が他のメンバーに報知されることを認識する。

【0040】尚、グループ ID や専用の Web ページのアドレス情報は、情報センター 2 から代表車両のナビゲーション装置 1 だけに送信し、その後、代表車両からグループ内の他車両に送信するように構成しても良い。

【0041】ステップ S 7 において、情報センター 2 は、当該グループを構成する各車両 (本実施形態では代表車両、車両 A 乃至 C) から、本システムによる位置情報表示に参加する旨の信号を受信したかを判断し、参加する旨の信号を受信した場合にはステップ S 8 に進み、不参加である旨の信号を受信した場合にはステップ S 14 に進む。

【0042】情報センター 2 は、ステップ S 7 において当該グループを構成するある車両から不参加である旨の信号を受信した場合、その車両を当該グループの今回のシステム利用における構成メンバーから削除する (ステップ S 14) と共に、その車両が今回のシステム利用の構成メンバーから削除されたことを、他のメンバーの車両に対して、電子メール等によって報知する (ステップ S 15)。これにより、本システムを今回利用しないメンバー (利用するメンバー) を、利用するメンバー全員が認識することができ、利便性が向上する。

【0043】ステップ S 14 において今回のシステム利用の構成メンバーから削除されると、そのメンバーに対する情報センター 2 によるサービスは終了する (ステップ S 18)。これにより、例えば通常一緒に行動することが多いグループ内のメンバー間において、本システムの利用者を適宜調整することができるので、各メンバー

のプライバシーを確保することができ、利便性が向上する。

【0044】一方、ステップS7において当該グループを構成するある車両から参加する旨の信号を受信した場合、ステップS8において、その車両では、自車両の現在位置のポーリング機能が、例えば所定の時間間隔または距離間隔で開始されることにより、GPSユニット28によって検出された現在位置（座標情報）を含むファイルが添付された電子メールが、自動的に情報センター2に送信される。

【0045】係る電子メールを受信した情報センター2は、データベース7を参照することによって同グループに含まれる他のメンバーの車両に対して、受信した添付ファイルを含む電子メールを送信する。これにより、ステップS7において当該グループを構成するある車両から参加する旨の信号を受信した各車両では、搭載されたナビゲーション装置1の機能により、受信した他の車両の現在位置情報、GPSユニット28によって検出した自車両の現在位置情報、並びに記憶装置26に記憶している地図情報に基づいて、各車両の所在位置を表わす所定のシンボルを含む地図画面がディスプレイ22に表示される（ステップS8）。

【0046】情報センター2では、本システムの今回の利用において構成メンバーである各車両から所定期間（例えば30分程度）にわたって位置情報を含む電子メールの送信が行われない場合（ステップS9）、その旨を少なくとも代表車両のナビゲーション装置1に対して、電子メール等を利用して連絡する（ステップS10）。このとき、利用者である代表車両等から何ら返答が得られないときには、そのグループによる今回のシステム利用は終了したものと判断して強制終了する（ステップS13）。

【0047】また、本システムの利用中に、所謂、流れ解散の如く構成メンバーが順次少なくなっていく、最後に何れかのメンバーが1人だけとなった場合（ステップS11）、それ以降は本システムによる互いの位置表示はできないので、情報センター2は、その最後の1人のメンバーに対してその旨を電子メール等を利用して連絡する（ステップS12）と共に、当該グループに対する今回のサービスを強制終了する（ステップS13）。これにより、例えばシステムの利用が定額制による有料ではなく、従量制による有料である場合に、経済的な利用ができるので、利便性が向上する。

【0048】また、上述したシステムの利用中（ステップS8）に、例えば代表車両のメンバーからシステム利用の終了指示を取得した場合、当該グループに対して情報センター2に確保したWebページ等の有効期限（例えば3日程度の所定時間）が到来した場合等には、今回のシステム利用を終了するかを、少なくとも代表車両のメンバーに対して電子メール等によって確認し（ステッ

プS16）、その確認の結果が、利用を継続する旨の情報である場合には本システムの利用を継続し（ステップS8）、利用を終了する旨の情報である場合には本システムの利用終了を、他のメンバーに対して電子メール等によって連絡する（ステップS17）と共に、当該グループに対する今回のサービスを終了する（ステップS18）。このように、上述した本実施形態によれば、各車両間において直接通信を行うことが可能な専用の通信装置を備えていなくても、情報センター2を介して互いの位置情報を送受信することができるので、各車両に搭載されたナビゲーション装置1が備える地図表示機能により、それら各車両の所在位置がシンボルによって示された地図画面を容易且つ低コストで表示することができる。

【0049】尚、上述した本実施形態では、位置情報（座標情報）等を、インターネット6を介して、電子メールの添付ファイルの形態で送受信したが、この方法に限られるものではなく、必要な項目の情報を送受信できるのであれば何れの伝送形態であっても良い。

【0050】また、上述した本実施形態では、各車両のナビゲーション装置1に自車両の現在位置を情報センター2に送信するポーリング機能を予め備える構成を前提に説明したが、このシステム構成に限られるものではなく、グループ走行に先立って各車両のナビゲーション装置1が当該Webページにアクセス（ログイン）した際、係るポーリング機能のソフトウェアを情報センター2からアクセス中のナビゲーション装置1に提供するように構成しても良い。より具体的には、例えばナビゲーション装置1がJavaの仮想マシンとして動作する環境を備える場合には、情報センター2にグループ専用のWebページが確保され、グループ走行に先立って各車両のナビゲーション装置1が当該Webページにアクセス（ログイン）した際、係るポーリング機能を表わすJavaプログラムを、情報センター2からアクセス中のナビゲーション装置1にダウンロードする構成が想定される。

【図面の簡単な説明】

【図1】本実施形態における移動体位置表示システムの全体構成を示す図である。

【図2】本実施形態における通信機能付き車載ナビゲーション装置の内部構成を例示するブロック図である。

【図3】本実施形態における移動体位置表示システムの機能概要を示すブロック図である。

【図4】各車両において位置情報が表示されるまでの、各車両のナビゲーション装置1及び情報センター2間の状態遷移を示すフローチャートである。

【符号の説明】

- 1：ナビゲーション装置、
- 2：情報センター、
- 4：電話基地局、

- 5 : インターネット・サービス・プロバイダ,
- 6 : インターネット,
- 7 : データベース,
- 21 : CPU,
- 22 : ディスプレイ,
- 23 : 入力装置,
- 24 : ROM,

- 25 : RAM,
- 26 : 記憶装置,
- 27 : 通信インタフェース,
- 28 : GPSユニット,
- 29 : 内部バス,
- 30 : 通信回線,

【図1】

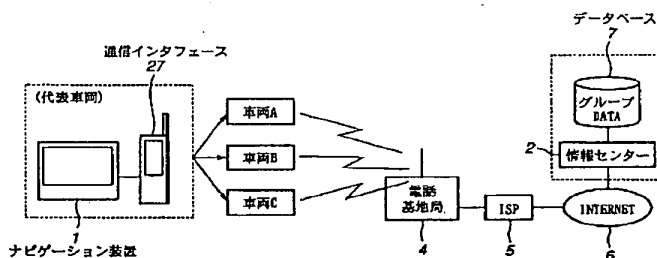

【図2】

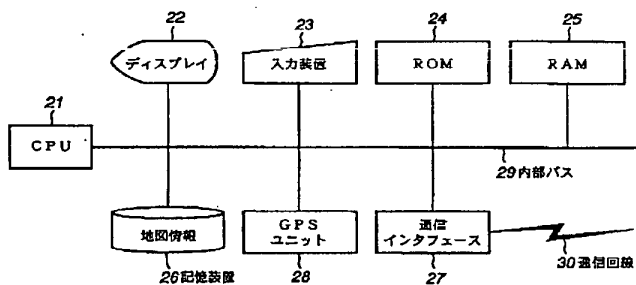

【図3】

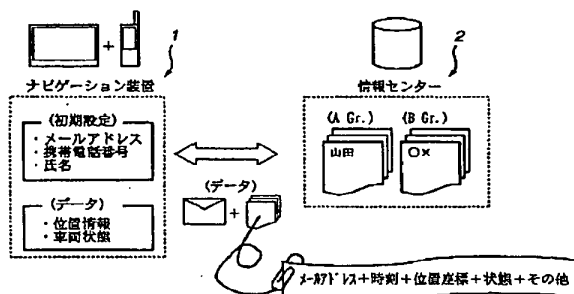

【図4】

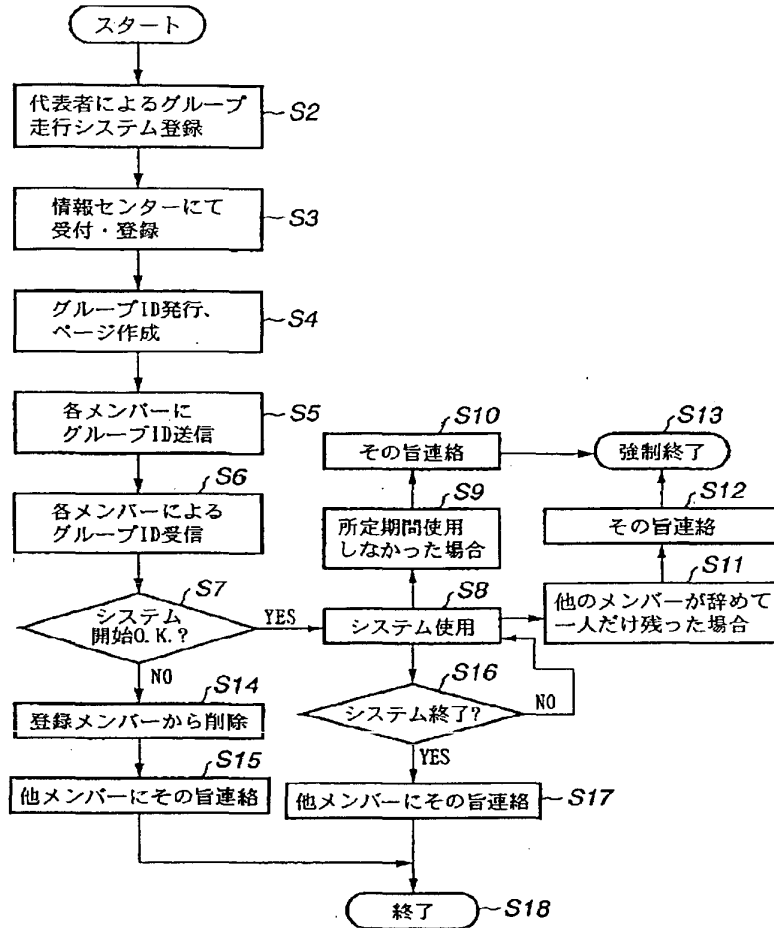

フロントページの続き

(51) Int. Cl.⁷

識別記号

F I

テマコード(参考)

G 0 9 B 29/10

G 0 9 B 29/10

A

H 0 4 B 7/26

H 0 4 B 7/26

E

H 0 4 Q 7/38

1 0 9 M

Fターム(参考) 2C032 HB02 HB05 HB22 HB25 HC08
HC11 HC13 HD03 HD13
2F029 AA02 AA07 AB07 AC02 AC14
AC19
5H180 AA01 AA21 BB02 BB04 BB05
BB13 CC12 FF04 FF05 FF13
FF27 FF33
5K067 AA21 BB04 BB26 BB36 DD17
DD20 DD52 EE02 EE10 EE16
FF03 FF23 HH11 HH22 KK13
KK15

PATENT COOPERATION TREATY

PCT

INTERNATIONAL PRELIMINARY REPORT ON PATENTABILITY
(Chapter I of the Patent Cooperation Treaty)

(PCT Rule 44bis)

Applicant's or agent's file reference 07186-1744	FOR FURTHER ACTION	See item 4 below
International application No. PCT/JP2004/000250	International filing date (<i>day/month/year</i>) 15 January 2004 (15.01.2004)	Priority date (<i>day/month/year</i>) 15 January 2003 (15.01.2003)]
International Patent Classification (IPC) or national classification and IPC G08G 1/09		
Applicant TOYOTA INFOTECHNOLOGY CENTER CO., LTD.		

1. This international preliminary report on patentability (Chapter I) is issued by the International Bureau on behalf of the International Searching Authority under Rule 44 bis.1(a).

2. This REPORT consists of a total of 4 sheets, including this cover sheet.

In the attached sheets, any reference to the written opinion of the International Searching Authority should be read as a reference to the international preliminary report on patentability (Chapter I) instead.

3. This report contains indications relating to the following items:

<input checked="" type="checkbox"/>	Box No. I	Basis of the report
<input type="checkbox"/>	Box No. II	Priority
<input type="checkbox"/>	Box No. III	Non-establishment of opinion with regard to novelty, inventive step and industrial applicability
<input type="checkbox"/>	Box No. IV	Lack of unity of invention
<input checked="" type="checkbox"/>	Box No. V	Reasoned statement under Article 35(2) with regard to novelty, inventive step or industrial applicability; citations and explanations supporting such statement
<input type="checkbox"/>	Box No. VI	Certain documents cited
<input type="checkbox"/>	Box No. VII	Certain defects in the international application
<input type="checkbox"/>	Box No. VIII	Certain observations on the international application

4. The International Bureau will communicate this report to designated Offices in accordance with Rules 44bis.3(c) and 93bis.1 but not, except where the applicant makes an express request under Article 23(2), before the expiration of 30 months from the priority date (Rule 44bis .2).

The International Bureau of WIPO 34, chemin des Colombettes 1211 Geneva 20, Switzerland Facsimile No. +41 22 740 14 35	Date of issuance of this report 15 July 2005 (15.07.2005)
	Authorized officer <p align="center">Masashi Honda</p> Telephone No. +41 22 338 70 10

PATENT COOPERATION TREATY

From the
INTERNATIONAL SEARCHING AUTHORITY

PCT **RECD** **18 MAR 2004**
WIPO **PCT**

To:
YOSHIYUKI KAWAGUCHI

**Acropolis 21 Building 6th
floor, 4-10, Higashi
Nihonbashi 3-chome, Chuo-ku
Tokyo 1030004 Japan**

WRITTEN OPINION OF THE
INTERNATIONAL SEARCHING AUTHORITY

(PCT Rule 43bis.1)

Date of mailing
(day/month/year) **16.3.2004**

Applicant's or agent's file reference 07186-1744	FOR FURTHER ACTION See paragraph 2 below
--	--

International application No. PCT/JP2004/000250	International filing date (day/month/year) 15.01.2004	Priority date (day/month/year)
---	---	--------------------------------

International Patent Classification (IPC) or both national classification and IPC
Int.Cl.⁷ **G08G1/09**

Applicant
TOYOTA INFOTECHNOLOGY CENTER CO., LTD

1. This opinion contains indications relating to the following items:
- Box No. I Basis of the opinion
 - Box No. II Priority
 - Box No. III Non-establishment of opinion with regard to novelty, inventive step and industrial applicability
 - Box No. IV Lack of unity of invention
 - Box No. V Reasoned statement under Rule 43bis.1(a)(i) with regard to novelty, inventive step or industrial applicability; citations and explanations supporting such statement
 - Box No. VI Certain documents cited
 - Box No. VII Certain defects in the international application
 - Box No. VIII Certain observations on the international application
2. FURTHER ACTION
- If a demand for international preliminary examination is made, this opinion will be considered to be a written opinion of the International Preliminary Examining Authority ("IPEA") except that this does not apply where the applicant chooses an Authority other than this one to be the IPEA and the chosen IPEA has notified the International Bureau under Rule 66.1bis(b) that written opinions of this International Searching Authority will not be so considered.
- If this opinion is, as provided above, considered to be a written opinion of the IPEA, the applicant is invited to submit to the IPEA a written reply together, where appropriate, with amendments, before the expiration of 3 months from the date of mailing of Form PCT/ISA/220 or before the expiration of 22 months from the priority date, whichever expires later.
- For further options, see Form PCT/ISA/220.
3. For further details, see notes to Form PCT/ISA/220.

Name and mailing address of the ISA/JP Japan Patent Office 3-4-3, Kasumigaseki, Chiyoda-ku, Tokyo 100-8915, Japan	Authorized officer YOSHIE SASAKI Telephone No. +81-3-3581-1101 Ext. 3316	3H 9132
--	---	----------------

WRITTEN OPINION OF THE
INTERNATIONAL SEARCHING AUTHORITY

International application No.

PCT/JP 2004 / 000250

Box No. I Basis of the opinion

1. With regard to the **language**, this opinion has been established on the basis of the international application in the language in which it was filed, unless otherwise indicated under this item.

- This opinion has been established on the basis of a translation from the original language into the following language _____, which is the language of a translation furnished for the purposes of international search (under Rules 12.3 and 23.1(b)).

2. With regard to any **nucleotide and/or amino acid sequence** disclosed in the international application and necessary to the claimed invention, this opinion has been established on the basis of:

a. type of material

- a sequence listing
 table(s) related to the sequence listing

b. format of material

- in written format
 in computer readable form

c. time of filing/furnishing

- contained in the international application as filed.
 filed together with the international application in computer readable form.
 furnished subsequently to this Authority for the purposes of search.

3. In addition, in the case that more than one version or copy of a sequence listing and/or table relating thereto has been filed or furnished, the required statements that the information in the subsequent or additional copies is identical to that in the application as filed or does not go beyond the application as filed, as appropriate, were furnished.

4. Additional comments:

Electronic Patent Application Fee Transmittal

Application Number:	14633804			
Filing Date:	27-Feb-2015			
Title of Invention:	METHOD TO PROVIDE AD HOC AND PASSWORD PROTECTED DIGITAL AND VOICE NETWORKS			
First Named Inventor/Applicant Name:	Malcolm K. Beyer			
Filer:	Daniel J. Burns			
Attorney Docket Number:	MOC-005			
Filed as Small Entity				
Filing Fees for Utility under 35 USC 111(a)				
Description	Fee Code	Quantity	Amount	Sub-Total in USD(\$)
Basic Filing:				
Pages:				
Claims:				
Miscellaneous-Filing:				
Petition:				
Patent-Appeals-and-Interference:				
Post-Allowance-and-Post-Issuance:				
Extension-of-Time:				

Description	Fee Code	Quantity	Amount	Sub-Total in USD(\$)
Miscellaneous:				
Submission- Information Disclosure Stmt	2806	1	90	90
Total in USD (\$)				90

Electronic Acknowledgement Receipt

EFS ID:	26118058
Application Number:	14633804
International Application Number:	
Confirmation Number:	8573
Title of Invention:	METHOD TO PROVIDE AD HOC AND PASSWORD PROTECTED DIGITAL AND VOICE NETWORKS
First Named Inventor/Applicant Name:	Malcolm K. Beyer
Customer Number:	51414
Filer:	Daniel J. Burns
Filer Authorized By:	
Attorney Docket Number:	MOC-005
Receipt Date:	20-JUN-2016
Filing Date:	27-FEB-2015
Time Stamp:	19:27:56
Application Type:	Utility under 35 USC 111(a)

Payment information:

Submitted with Payment	yes
Payment Type	Credit Card
Payment was successfully received in RAM	\$90
RAM confirmation Number	6122
Deposit Account	071700
Authorized User	BURNS, DANIEL J
The Director of the USPTO is hereby authorized to charge indicated fees and credit any overpayment as follows:	

Charge any Additional Fees required under 37 CFR 1.21 (Miscellaneous fees and charges)

File Listing:

Document Number	Document Description	File Name	File Size(Bytes)/ Message Digest	Multi Part /.zip	Pages (if appl.)
1	Transmittal Letter	SUPPLIDSTRANSMITTAL.pdf	86094	no	3
			a6a0683809f26f046e8efa2a03d09e8737a81d9e		
Warnings:					
Information:					
2	Information Disclosure Statement (IDS) Form (SB08)	SB08.pdf	235156	no	2
			d8db11a029e67c220efa76e62e5d118d47d2fe68		
Warnings:					
Information:					
This is not an USPTO supplied IDS fillable form					
3	Foreign Reference	JP2000-357296A.pdf	1789012	no	41
			bbe8a835890d9aef8c6bdc17597a4ed67df4cb49		
Warnings:					
Information:					
4	Foreign Reference	JP2002-277256A.pdf	1582552	no	38
			6c1988fc8002d0144ee31800070181cc6435f4d8		
Warnings:					
Information:					
5	Non Patent Literature	Garmin_Rino110Navigator.pdf	8296043	no	88
			b20c1575a810c8f2a56ae40b20b088dd2aab0600		
Warnings:					
Information:					
6	Other Reference-Patent/App/Search documents	IPRP_PCT- JP2004-000250_071505.pdf	174987	no	4
			0d0dd8f6aa99c3670d5a1ae1c24eebd190a420c6		
Warnings:					
Information:					
7	Non Patent Literature	Life360_MotionForJudgment.pdf	177552	no	27
			9992cfe0b65724765bbc4f7080031db9b7f6ed		
Warnings:					
Information:					

8	Non Patent Literature	AGIS_MotionInLimine.pdf	1636887 8bdb9250149d547ad39cf54b1ef39713bd9 dbb92	no	54
Warnings:					
Information:					
9	Non Patent Literature	TrimbleGPSTechnology.pdf	819376 340efbdefe80d66e7948059fd4a6750e90f9 a60c	no	4
Warnings:					
Information:					
10	Fee Worksheet (SB06)	fee-info.pdf	30620 44766272eb9b71920b21ea807a890bd3e5 4073bc	no	2
Warnings:					
Information:					
Total Files Size (in bytes):				14828279	
<p>This Acknowledgement Receipt evidences receipt on the noted date by the USPTO of the indicated documents, characterized by the applicant, and including page counts, where applicable. It serves as evidence of receipt similar to a Post Card, as described in MPEP 503.</p> <p><u>New Applications Under 35 U.S.C. 111</u> If a new application is being filed and the application includes the necessary components for a filing date (see 37 CFR 1.53(b)-(d) and MPEP 506), a Filing Receipt (37 CFR 1.54) will be issued in due course and the date shown on this Acknowledgement Receipt will establish the filing date of the application.</p> <p><u>National Stage of an International Application under 35 U.S.C. 371</u> If a timely submission to enter the national stage of an international application is compliant with the conditions of 35 U.S.C. 371 and other applicable requirements a Form PCT/DO/EO/903 indicating acceptance of the application as a national stage submission under 35 U.S.C. 371 will be issued in addition to the Filing Receipt, in due course.</p> <p><u>New International Application Filed with the USPTO as a Receiving Office</u> If a new international application is being filed and the international application includes the necessary components for an international filing date (see PCT Article 11 and MPEP 1810), a Notification of the International Application Number and of the International Filing Date (Form PCT/RO/105) will be issued in due course, subject to prescriptions concerning national security, and the date shown on this Acknowledgement Receipt will establish the international filing date of the application.</p>					

IN THE UNITED STATES PATENT AND TRADEMARK OFFICE

In re Patent Application of:
Malcolm K. Beyers, et al.

Application No.: 14/633,804

Confirmation No.: 8573

Filed: February 27, 2015

Art Unit: 2646

For: METHOD TO PROVIDE AD HOC AND
PASSWORD PROTECTED DIGITAL AND
VOICE NETWORKS

Examiner: O. Obayanju

Commissioner for Patents
P.O. Box 1450
Alexandria, VA 22313-1450

SUPPLEMENTAL INFORMATION DISCLOSURE STATEMENT (SIDS)

Pursuant to 37 C.F.R. § 1.56, 1.97 and 1.98, the attention of the Patent and Trademark Office is hereby directed to the references listed on the attached form PTO/SB/08. It is respectfully requested that the information be expressly considered during the prosecution of this application, and that the references be made of record therein and appear among the "References Cited" on any patent to issue therefrom.

This Information Disclosure Statement is filed more than three months after the U.S. filing date, and after the mailing date of the first Office Action on the merits, but before the mailing date of any of a Final Office Action, a Notice of Allowance (37 C.F.R. § 1.97(c)) or an action that otherwise closes prosecution in the application.

In accordance with 37 C.F.R. § 1.98(a)(2)(ii), Applicant has not submitted copies of U.S. patents and U.S. patent applications.

In accordance with 37 C.F.R. § 1.97(g), the filing of this Information Disclosure Statement shall not be construed to mean that a search has been made or that no other material information as defined in 37 C.F.R. § 1.56(a) exists. In accordance with 37 C.F.R. § 1.97(h), the filing of this Information Disclosure Statement shall not be construed to be an admission that any patent, publication or other information referred to therein is "prior art" for this invention unless specifically designated as such.

Applicant hereby apprises the Examiner of the following co-pending patent applications, including the contents of the file wrappers, the claims, any Office Actions issued therein, and any Notices of Allowance issued therefor, and requests that the Examiner consider these documents:

Application Number	Filing Date	Title	Inventor
14/529,978	10/31/2014	Method to Provide Ad Hoc and Password Protected Digital and Voice Networks (MOC-001)	Malcolm K. Beyer, et al.
14/695,233	4/24/2015	Method to Provide Ad Hoc and Password Protected Digital and Voice Networks (MOC-003)	Malcolm K. Beyer
14/633,764	2/27/2015	Method to Provide Ad Hoc and Password Protected Digital and Voice Networks (MOC-006)	Malcolm K. Beyer, et al.

Applicant has cited for the Examiner's consideration certain co-pending U.S. patent applications that are owned at least in part by the assignee of this application, that describe subject matter that may be related to the present invention. The co-pending applications are listed herewith in accordance with M.P.E.P. 609.06 which states: "Applicant may wish to list U.S. patent application numbers on other than a form PTO/SB/08a and 08b format to avoid the application numbers of pending applications being published on the patent. If a citation is not printed on the patent but has been considered by the examiner, the patented file will reflect that fact as noted in MPEP § 609.05(b)."

No copies of the co-pending applications have been provided. If the Examiner wishes to have copies of the co-pending applications, Examiner should contact the Attorney of record.

It is submitted that the Information Disclosure Statement is in compliance with 37 C.F.R. § 1.98 and the Examiner is respectfully requested to consider the listed references.

Please charge our Credit Card in the amount of \$90.00 covering the fee set forth in 37 C.F.R. § 1.17(p). The Director is hereby authorized to charge any deficiency in the fees filed, asserted to be filed or which should have been filed herewith to our Deposit Account No. 07-1700, under Order No. MOC-005.

Dated: June 20, 2016

Respectfully submitted,

Electronic signature: /Daniel J. Burns/

Daniel J. Burns

Registration No.: 50,222

GOODWIN PROCTER LLP

135 Commonwealth Drive

Menlo Park, California 94025

(650) 752-3100

Attorney for Applicant



UNITED STATES PATENT AND TRADEMARK OFFICE

UNITED STATES DEPARTMENT OF COMMERCE
United States Patent and Trademark Office
Address: COMMISSIONER FOR PATENTS
P.O. Box 1450
Alexandria, Virginia 22313-1450
www.uspto.gov

NOTICE OF ALLOWANCE AND FEE(S) DUE

51414 7590 07/07/2016
GOODWIN PROCTER LLP
PATENT ADMINISTRATOR
100 Northern Avenue
BOSTON, MA 02210

EXAMINER

OBAYANJU, OMONIYI

ART UNIT PAPER NUMBER

2646

DATE MAILED: 07/07/2016

Table with 5 columns: APPLICATION NO., FILING DATE, FIRST NAMED INVENTOR, ATTORNEY DOCKET NO., CONFIRMATION NO.

TITLE OF INVENTION: METHOD TO PROVIDE AD HOC AND PASSWORD PROTECTED DIGITAL AND VOICE NETWORKS

Table with 7 columns: APPLN. TYPE, ENTITY STATUS, ISSUE FEE DUE, PUBLICATION FEE DUE, PREV. PAID ISSUE FEE, TOTAL FEE(S) DUE, DATE DUE

THE APPLICATION IDENTIFIED ABOVE HAS BEEN EXAMINED AND IS ALLOWED FOR ISSUANCE AS A PATENT. PROSECUTION ON THE MERITS IS CLOSED. THIS NOTICE OF ALLOWANCE IS NOT A GRANT OF PATENT RIGHTS. THIS APPLICATION IS SUBJECT TO WITHDRAWAL FROM ISSUE AT THE INITIATIVE OF THE OFFICE OR UPON PETITION BY THE APPLICANT. SEE 37 CFR 1.313 AND MPEP 1308.

THE ISSUE FEE AND PUBLICATION FEE (IF REQUIRED) MUST BE PAID WITHIN THREE MONTHS FROM THE MAILING DATE OF THIS NOTICE OR THIS APPLICATION SHALL BE REGARDED AS ABANDONED. THIS STATUTORY PERIOD CANNOT BE EXTENDED. SEE 35 U.S.C. 151. THE ISSUE FEE DUE INDICATED ABOVE DOES NOT REFLECT A CREDIT FOR ANY PREVIOUSLY PAID ISSUE FEE IN THIS APPLICATION. IF AN ISSUE FEE HAS PREVIOUSLY BEEN PAID IN THIS APPLICATION (AS SHOWN ABOVE), THE RETURN OF PART B OF THIS FORM WILL BE CONSIDERED A REQUEST TO REAPPLY THE PREVIOUSLY PAID ISSUE FEE TOWARD THE ISSUE FEE NOW DUE.

HOW TO REPLY TO THIS NOTICE:

I. Review the ENTITY STATUS shown above. If the ENTITY STATUS is shown as SMALL or MICRO, verify whether entitlement to that entity status still applies.

If the ENTITY STATUS is the same as shown above, pay the TOTAL FEE(S) DUE shown above.

If the ENTITY STATUS is changed from that shown above, on PART B - FEE(S) TRANSMITTAL, complete section number 5 titled "Change in Entity Status (from status indicated above)".

For purposes of this notice, small entity fees are 1/2 the amount of undiscounted fees, and micro entity fees are 1/2 the amount of small entity fees.

II. PART B - FEE(S) TRANSMITTAL, or its equivalent, must be completed and returned to the United States Patent and Trademark Office (USPTO) with your ISSUE FEE and PUBLICATION FEE (if required). If you are charging the fee(s) to your deposit account, section "4b" of Part B - Fee(s) Transmittal should be completed and an extra copy of the form should be submitted. If an equivalent of Part B is filed, a request to reapply a previously paid issue fee must be clearly made, and delays in processing may occur due to the difficulty in recognizing the paper as an equivalent of Part B.

III. All communications regarding this application must give the application number. Please direct all communications prior to issuance to Mail Stop ISSUE FEE unless advised to the contrary.

IMPORTANT REMINDER: Utility patents issuing on applications filed on or after Dec. 12, 1980 may require payment of maintenance fees. It is patentee's responsibility to ensure timely payment of maintenance fees when due.

PART B - FEE(S) TRANSMITTAL

**Complete and send this form, together with applicable fee(s), to: Mail Mail Stop ISSUE FEE
 Commissioner for Patents
 P.O. Box 1450
 Alexandria, Virginia 22313-1450
 or Fax (571)-273-2885**

INSTRUCTIONS: This form should be used for transmitting the ISSUE FEE and PUBLICATION FEE (if required). Blocks 1 through 5 should be completed where appropriate. All further correspondence including the Patent, advance orders and notification of maintenance fees will be mailed to the current correspondence address as indicated unless corrected below or directed otherwise in Block 1, by (a) specifying a new correspondence address; and/or (b) indicating a separate "FEE ADDRESS" for maintenance fee notifications.

CURRENT CORRESPONDENCE ADDRESS (Note: Use Block 1 for any change of address)

51414 7590 07/07/2016
GOODWIN PROCTER LLP
 PATENT ADMINISTRATOR
 100 Northern Avenue
 BOSTON, MA 02210

Note: A certificate of mailing can only be used for domestic mailings of the Fee(s) Transmittal. This certificate cannot be used for any other accompanying papers. Each additional paper, such as an assignment or formal drawing, must have its own certificate of mailing or transmission.

Certificate of Mailing or Transmission

I hereby certify that this Fee(s) Transmittal is being deposited with the United States Postal Service with sufficient postage for first class mail in an envelope addressed to the Mail Stop ISSUE FEE address above, or being facsimile transmitted to the USPTO (571) 273-2885, on the date indicated below.

_____ (Depositor's name)
_____ (Signature)
_____ (Date)

APPLICATION NO.	FILING DATE	FIRST NAMED INVENTOR	ATTORNEY DOCKET NO.	CONFIRMATION NO.
14/633,804	02/27/2015	Malcolm K. Beyer JR.	MOC-005	8573

TITLE OF INVENTION: METHOD TO PROVIDE AD HOC AND PASSWORD PROTECTED DIGITAL AND VOICE NETWORKS

APPLN. TYPE	ENTITY STATUS	ISSUE FEE DUE	PUBLICATION FEE DUE	PREV. PAID ISSUE FEE	TOTAL FEE(S) DUE	DATE DUE
nonprovisional	SMALL	\$480	\$0	\$0	\$480	10/07/2016

EXAMINER	ART UNIT	CLASS-SUBCLASS
OBAYANJU, OMONIYI	2646	455-404200

<p>1. Change of correspondence address or indication of "Fee Address" (37 CFR 1.363).</p> <p><input type="checkbox"/> Change of correspondence address (or Change of Correspondence Address form PTO/SB/122) attached.</p> <p><input type="checkbox"/> "Fee Address" indication (or "Fee Address" Indication form PTO/SB/47; Rev 03-02 or more recent) attached. Use of a Customer Number is required.</p>	<p>2. For printing on the patent front page, list</p> <p>(1) The names of up to 3 registered patent attorneys or agents OR, alternatively, 1 _____</p> <p>(2) The name of a single firm (having as a member a registered attorney or agent) and the names of up to 2 registered patent attorneys or agents. If no name is listed, no name will be printed. 2 _____</p> <p>3 _____</p>
---	---

3. ASSIGNEE NAME AND RESIDENCE DATA TO BE PRINTED ON THE PATENT (print or type)

PLEASE NOTE: Unless an assignee is identified below, no assignee data will appear on the patent. If an assignee is identified below, the document has been filed for recordation as set forth in 37 CFR 3.11. Completion of this form is NOT a substitute for filing an assignment.

(A) NAME OF ASSIGNEE _____ (B) RESIDENCE: (CITY and STATE OR COUNTRY) _____

Please check the appropriate assignee category or categories (will not be printed on the patent): Individual Corporation or other private group entity Government

<p>4a. The following fee(s) are submitted:</p> <p><input type="checkbox"/> Issue Fee</p> <p><input type="checkbox"/> Publication Fee (No small entity discount permitted)</p> <p><input type="checkbox"/> Advance Order - # of Copies _____</p>	<p>4b. Payment of Fee(s): (Please first reapply any previously paid issue fee shown above)</p> <p><input type="checkbox"/> A check is enclosed.</p> <p><input type="checkbox"/> Payment by credit card. Form PTO-2038 is attached.</p> <p><input type="checkbox"/> The director is hereby authorized to charge the required fee(s), any deficiency, or credits any overpayment, to Deposit Account Number _____ (enclose an extra copy of this form).</p>
---	---

5. **Change in Entity Status** (from status indicated above)

Applicant certifying micro entity status. See 37 CFR 1.29

Applicant asserting small entity status. See 37 CFR 1.27

Applicant changing to regular undiscounted fee status.

NOTE: Absent a valid certification of Micro Entity Status (see forms PTO/SB/15A and 15B), issue fee payment in the micro entity amount will not be accepted at the risk of application abandonment.

NOTE: If the application was previously under micro entity status, checking this box will be taken to be a notification of loss of entitlement to micro entity status.

NOTE: Checking this box will be taken to be a notification of loss of entitlement to small or micro entity status, as applicable.

NOTE: This form must be signed in accordance with 37 CFR 1.31 and 1.33. See 37 CFR 1.4 for signature requirements and certifications.

Authorized Signature _____ Date _____

Typed or printed name _____ Registration No. _____



UNITED STATES PATENT AND TRADEMARK OFFICE

UNITED STATES DEPARTMENT OF COMMERCE
United States Patent and Trademark Office
Address: COMMISSIONER FOR PATENTS
P.O. Box 1450
Alexandria, Virginia 22313-1450
www.uspto.gov

Table with 5 columns: APPLICATION NO., FILING DATE, FIRST NAMED INVENTOR, ATTORNEY DOCKET NO., CONFIRMATION NO.
14/633,804 02/27/2015 Malcolm K. Beyer JR. MOC-005 8573

51414 7590 07/07/2016
GOODWIN PROCTER LLP
PATENT ADMINISTRATOR
100 Northern Avenue
BOSTON, MA 02210

EXAMINER

OBAYANJU, OMONIYI

ART UNIT PAPER NUMBER

2646

DATE MAILED: 07/07/2016

Determination of Patent Term Adjustment under 35 U.S.C. 154 (b)
(Applications filed on or after May 29, 2000)

The Office has discontinued providing a Patent Term Adjustment (PTA) calculation with the Notice of Allowance.

Section 1(h)(2) of the AIA Technical Corrections Act amended 35 U.S.C. 154(b)(3)(B)(i) to eliminate the requirement that the Office provide a patent term adjustment determination with the notice of allowance. See Revisions to Patent Term Adjustment, 78 Fed. Reg. 19416, 19417 (Apr. 1, 2013). Therefore, the Office is no longer providing an initial patent term adjustment determination with the notice of allowance. The Office will continue to provide a patent term adjustment determination with the Issue Notification Letter that is mailed to applicant approximately three weeks prior to the issue date of the patent, and will include the patent term adjustment on the patent. Any request for reconsideration of the patent term adjustment determination (or reinstatement of patent term adjustment) should follow the process outlined in 37 CFR 1.705.

Any questions regarding the Patent Term Extension or Adjustment determination should be directed to the Office of Patent Legal Administration at (571)-272-7702. Questions relating to issue and publication fee payments should be directed to the Customer Service Center of the Office of Patent Publication at 1-(888)-786-0101 or (571)-272-4200.

OMB Clearance and PRA Burden Statement for PTOL-85 Part B

The Paperwork Reduction Act (PRA) of 1995 requires Federal agencies to obtain Office of Management and Budget approval before requesting most types of information from the public. When OMB approves an agency request to collect information from the public, OMB (i) provides a valid OMB Control Number and expiration date for the agency to display on the instrument that will be used to collect the information and (ii) requires the agency to inform the public about the OMB Control Number's legal significance in accordance with 5 CFR 1320.5(b).

The information collected by PTOL-85 Part B is required by 37 CFR 1.311. The information is required to obtain or retain a benefit by the public which is to file (and by the USPTO to process) an application. Confidentiality is governed by 35 U.S.C. 122 and 37 CFR 1.14. This collection is estimated to take 12 minutes to complete, including gathering, preparing, and submitting the completed application form to the USPTO. Time will vary depending upon the individual case. Any comments on the amount of time you require to complete this form and/or suggestions for reducing this burden, should be sent to the Chief Information Officer, U.S. Patent and Trademark Office, U.S. Department of Commerce, P.O. Box 1450, Alexandria, Virginia 22313-1450. DO NOT SEND FEES OR COMPLETED FORMS TO THIS ADDRESS. SEND TO: Commissioner for Patents, P.O. Box 1450, Alexandria, Virginia 22313-1450. Under the Paperwork Reduction Act of 1995, no persons are required to respond to a collection of information unless it displays a valid OMB control number.

Privacy Act Statement

The Privacy Act of 1974 (P.L. 93-579) requires that you be given certain information in connection with your submission of the attached form related to a patent application or patent. Accordingly, pursuant to the requirements of the Act, please be advised that: (1) the general authority for the collection of this information is 35 U.S.C. 2(b)(2); (2) furnishing of the information solicited is voluntary; and (3) the principal purpose for which the information is used by the U.S. Patent and Trademark Office is to process and/or examine your submission related to a patent application or patent. If you do not furnish the requested information, the U.S. Patent and Trademark Office may not be able to process and/or examine your submission, which may result in termination of proceedings or abandonment of the application or expiration of the patent.

The information provided by you in this form will be subject to the following routine uses:

1. The information on this form will be treated confidentially to the extent allowed under the Freedom of Information Act (5 U.S.C. 552) and the Privacy Act (5 U.S.C. 552a). Records from this system of records may be disclosed to the Department of Justice to determine whether disclosure of these records is required by the Freedom of Information Act.
2. A record from this system of records may be disclosed, as a routine use, in the course of presenting evidence to a court, magistrate, or administrative tribunal, including disclosures to opposing counsel in the course of settlement negotiations.
3. A record in this system of records may be disclosed, as a routine use, to a Member of Congress submitting a request involving an individual, to whom the record pertains, when the individual has requested assistance from the Member with respect to the subject matter of the record.
4. A record in this system of records may be disclosed, as a routine use, to a contractor of the Agency having need for the information in order to perform a contract. Recipients of information shall be required to comply with the requirements of the Privacy Act of 1974, as amended, pursuant to 5 U.S.C. 552a(m).
5. A record related to an International Application filed under the Patent Cooperation Treaty in this system of records may be disclosed, as a routine use, to the International Bureau of the World Intellectual Property Organization, pursuant to the Patent Cooperation Treaty.
6. A record in this system of records may be disclosed, as a routine use, to another federal agency for purposes of National Security review (35 U.S.C. 181) and for review pursuant to the Atomic Energy Act (42 U.S.C. 218(c)).
7. A record from this system of records may be disclosed, as a routine use, to the Administrator, General Services, or his/her designee, during an inspection of records conducted by GSA as part of that agency's responsibility to recommend improvements in records management practices and programs, under authority of 44 U.S.C. 2904 and 2906. Such disclosure shall be made in accordance with the GSA regulations governing inspection of records for this purpose, and any other relevant (i.e., GSA or Commerce) directive. Such disclosure shall not be used to make determinations about individuals.
8. A record from this system of records may be disclosed, as a routine use, to the public after either publication of the application pursuant to 35 U.S.C. 122(b) or issuance of a patent pursuant to 35 U.S.C. 151. Further, a record may be disclosed, subject to the limitations of 37 CFR 1.14, as a routine use, to the public if the record was filed in an application which became abandoned or in which the proceedings were terminated and which application is referenced by either a published application, an application open to public inspection or an issued patent.
9. A record from this system of records may be disclosed, as a routine use, to a Federal, State, or local law enforcement agency, if the USPTO becomes aware of a violation or potential violation of law or regulation.

Notice of Allowability	Application No. 14/633,804	Applicant(s) BEYER ET AL.	
	Examiner OMONIYI OBAYANJU	Art Unit 2646	AIA (First Inventor to File) Status No

-- The MAILING DATE of this communication appears on the cover sheet with the correspondence address--

All claims being allowable, PROSECUTION ON THE MERITS IS (OR REMAINS) CLOSED in this application. If not included herewith (or previously mailed), a Notice of Allowance (PTOL-85) or other appropriate communication will be mailed in due course. **THIS NOTICE OF ALLOWABILITY IS NOT A GRANT OF PATENT RIGHTS.** This application is subject to withdrawal from issue at the initiative of the Office or upon petition by the applicant. See 37 CFR 1.313 and MPEP 1308.

1. This communication is responsive to 06/20/2016.
 A declaration(s)/affidavit(s) under **37 CFR 1.130(b)** was/were filed on _____.
2. An election was made by the applicant in response to a restriction requirement set forth during the interview on _____; the restriction requirement and election have been incorporated into this action.
3. The allowed claim(s) is/are 1,2,8,11-14,20,23,24 and 31-55. As a result of the allowed claim(s), you may be eligible to benefit from the **Patent Prosecution Highway** program at a participating intellectual property office for the corresponding application. For more information, please see http://www.uspto.gov/patents/init_events/pph/index.jsp or send an inquiry to PPHfeedback@uspto.gov.
4. Acknowledgment is made of a claim for foreign priority under 35 U.S.C. § 119(a)-(d) or (f).

Certified copies:

- a) All b) Some *c) None of the:
1. Certified copies of the priority documents have been received.
 2. Certified copies of the priority documents have been received in Application No. _____.
 3. Copies of the certified copies of the priority documents have been received in this national stage application from the International Bureau (PCT Rule 17.2(a)).

* Certified copies not received: _____.

Applicant has THREE MONTHS FROM THE "MAILING DATE" of this communication to file a reply complying with the requirements noted below. Failure to timely comply will result in ABANDONMENT of this application.
THIS THREE-MONTH PERIOD IS NOT EXTENDABLE.

5. CORRECTED DRAWINGS (as "replacement sheets") must be submitted.
 including changes required by the attached Examiner's Amendment / Comment or in the Office action of Paper No./Mail Date _____.
Identifying indicia such as the application number (see 37 CFR 1.84(c)) should be written on the drawings in the front (not the back) of each sheet. Replacement sheet(s) should be labeled as such in the header according to 37 CFR 1.121(d).
6. DEPOSIT OF and/or INFORMATION about the deposit of BIOLOGICAL MATERIAL must be submitted. Note the attached Examiner's comment regarding REQUIREMENT FOR THE DEPOSIT OF BIOLOGICAL MATERIAL.

Attachment(s)

- | | |
|--|--|
| 1. <input type="checkbox"/> Notice of References Cited (PTO-892) | 5. <input type="checkbox"/> Examiner's Amendment/Comment |
| 2. <input checked="" type="checkbox"/> Information Disclosure Statements (PTO/SB/08),
Paper No./Mail Date <u>06/20/2016</u> | 6. <input checked="" type="checkbox"/> Examiner's Statement of Reasons for Allowance |
| 3. <input type="checkbox"/> Examiner's Comment Regarding Requirement for Deposit of Biological Material | 7. <input type="checkbox"/> Other _____. |
| 4. <input type="checkbox"/> Interview Summary (PTO-413),
Paper No./Mail Date _____. | |

/OMONIYI OBAYANJU/
Primary Examiner, Art Unit 2646

The present application is being examined under the pre-AIA first to invent provisions.

DETAILED ACTION

Allowable Subject Matter

Claims 1, 2, 8, 11-14, 20, 23, 24, and 31-55, are allowed.

The following is an examiner's statement of reasons for allowance: According to the Applicant's remarks and/or amendments filed on 06/03/2016, the prior art references (Melen and Hymes) does not teach the at least claim "A computer-implemented method comprising: with a first device, receiving a message from a second device, wherein the message relates to joining a group; based on receiving the message from the second device, participating in the group, wherein participating in the group includes sending first location information to a server and receiving second location information from the server, the first location information comprising a location of the first device, the second location information comprising a plurality of locations of a respective plurality of second devices included in the group; presenting, via an interactive display of the first device, a first interactive, georeferenced map and a plurality of user-selectable symbols corresponding to the plurality of second devices, wherein the symbols are positioned on the first georeferenced map at respective positions corresponding to the locations of the second devices, and wherein the first georeferenced map includes data relating positions on the first georeferenced map to

spatial coordinates; sending, from the first device to the server, a request for a second georeferenced map different from the first georeferenced map, wherein the request specifies a map location; receiving, from the server, the second georeferenced map, wherein the second georeferenced map includes the requested location and data relating positions on the second georeferenced map to spatial coordinates; presenting, via the interactive display of the first device, the second georeferenced map and the plurality of user-selectable symbols corresponding to the plurality of second devices, wherein the symbols are positioned on the second georeferenced map at respective positions corresponding to the locations of the second devices; and identifying user interaction with the interactive display selecting one or more of the user-selectable symbols corresponding to one or more of the second devices and positioned on the second georeferenced map and user interaction with the display specifying an action and, based thereon, using an Internet Protocol to send data to the one or more second devices via the server, wherein the first device does not have access to respective Internet Protocol addresses of the second devices.”

Any comments considered necessary by applicant must be submitted no later than the payment of the issue fee and, to avoid processing delays, should preferably accompany the issue fee. Such submissions should be clearly labeled “Comments on Statement of Reasons for Allowance.”

Conclusion

Any inquiry concerning this communication or earlier communications from the examiner should be directed to OMONIYI OBAYANJU whose telephone number is (571)270-5885. The examiner can normally be reached on Mon - Fri, 7:30 - 5:00PM.

If attempts to reach the examiner by telephone are unsuccessful, the examiner's supervisor, KAMRAN AFSHAR can be reached on 571-272-7796. The fax phone number for the organization where this application or proceeding is assigned is 571-273-8300.

Information regarding the status of an application may be obtained from the Patent Application Information Retrieval (PAIR) system. Status information for published applications may be obtained from either Private PAIR or Public PAIR. Status information for unpublished applications is available through Private PAIR only. For more information about the PAIR system, see <http://pair-direct.uspto.gov>. Should you have questions on access to the Private PAIR system, contact the Electronic Business Center (EBC) at 866-217-9197 (toll-free). If you would like assistance from a USPTO Customer Service Representative or access to the automated information system, call 800-786-9199 (IN USA OR CANADA) or 571-272-1000.

/OMONIYI OBAYANJU/
Primary Examiner, Art Unit 2646

EAST Search History

EAST Search History (Prior Art)

Ref #	Hits	Search Query	DBs	Default Operator	Plurals	Time Stamp
L1	1	"14633804"	US-PGPUB; USPAT; EPO; JPO; DERWENT; IBM_TDB	OR	ON	2016/06/30 10:57
S1	0	"14633804"	US-PGPUB; USPAT; EPO; JPO; DERWENT; IBM_TDB	OR	ON	2015/08/10 04:44
S2	1353	((track\$3 or monitor\$3 or display\$3 or view\$3) with (location or position) with ((other or different or another or second) near2 (device or terminal or apparatus or equipment or unit or component or ue or mt or station or phone or telephone))) same (map))	US-PGPUB; USPAT; EPO; JPO; DERWENT; IBM_TDB	OR	ON	2015/08/10 04:51
S3	84	((track\$3 or monitor\$3) with (location or position) with ((other or different or another or second) near2 (device or terminal or apparatus or equipment or unit or component or ue or mt or station or phone or telephone))) same ((display\$3 or view\$3) near5 (map)))	US-PGPUB; USPAT; EPO; JPO; DERWENT; IBM_TDB	OR	ON	2015/08/10 04:53
S4	11	S3 and (@ad<"20040921" or @pd<"20040921" or @rlad<"20040921")	US-PGPUB; USPAT; EPO; JPO; DERWENT; IBM_TDB	OR	ON	2015/08/10 04:54
S5	13	((track\$3 or monitor\$3) with (location or position) with ((other or different or another or second) near2 (vehicl\$5 or car or truck or auto or automobile or plane or aircraft or ship or boat))) same ((display\$3 or view\$3) near5 (map)))	US-PGPUB; USPAT; EPO; JPO; DERWENT; IBM_TDB	OR	ON	2015/08/10 05:19
S6	6	S5 and (@ad<"20040921" or @pd<"20040921" or @rlad<"20040921")	US-PGPUB; USPAT; EPO; JPO; DERWENT; IBM_TDB	OR	ON	2015/08/10 05:20
S7	320	((location or position) with ((other or different or another or second) near2 (vehicl\$5 or car or truck or auto or automobile or plane or aircraft or ship or boat))) same ((display\$3 or view\$3) near5 (map)))	US-PGPUB; USPAT; EPO; JPO; DERWENT; IBM_TDB	OR	ON	2015/08/10 05:28
S8	117	S7 and (@ad<"20040921" or @pd<"20040921" or @rlad<"20040921")	US-PGPUB; USPAT; EPO; JPO; DERWENT;	OR	ON	2015/08/10 05:29

			IBM_TDB			
S9	111	S8 not S5	US-PGPUB; USPAT; EPO; JPO; DERWENT; IBM_TDB	OR	ON	2015/08/10 05:29
S10	181	((location or position) with ((other or different or another or second) adj2 (vehicl\$5 or car or truck or auto or automobile or plane or aircraft or ship or boat))) same ((display\$3 or view\$3) near5 (map)))	US-PGPUB; USPAT; EPO; JPO; DERWENT; IBM_TDB	OR	ON	2015/08/10 05:29
S11	47	S10 and (@ad<"20040921" or @pd<"20040921" or @rlad<"20040921")	US-PGPUB; USPAT; EPO; JPO; DERWENT; IBM_TDB	OR	ON	2015/08/10 05:30
S12	45	S11 not S5	US-PGPUB; USPAT; EPO; JPO; DERWENT; IBM_TDB	OR	ON	2015/08/10 05:30
S13	3	"20060047825"	US-PGPUB; USPAT; EPO; JPO; DERWENT; IBM_TDB	OR	ON	2015/08/10 08:58
S14	106	"7593740"	US-PGPUB; USPAT; EPO; JPO; DERWENT; IBM_TDB	OR	ON	2015/08/10 09:00
S15	1	beyer.inv. and (symbol and location and map and contact).clm.	US-PGPUB; USPAT; EPO; JPO; DERWENT; IBM_TDB	OR	ON	2015/08/10 09:32
S16	34	beyer.inv. and (symbol and location and map and contact)	US-PGPUB; USPAT; EPO; JPO; DERWENT; IBM_TDB	OR	ON	2015/08/10 09:33
S17	12	(beyer with malcolm).inv. and (symbol and location and map and contact)	US-PGPUB; USPAT; EPO; JPO; DERWENT; IBM_TDB	OR	ON	2015/08/10 09:34
S18	7	(advanced near3 ground).as. and (symbol and location and map and contact)	US-PGPUB; USPAT; EPO; JPO; DERWENT; IBM_TDB	OR	ON	2015/08/10 09:37
S19	0	S18 not S17	US-PGPUB; USPAT; EPO; JPO; DERWENT; IBM_TDB	OR	ON	2015/08/10 09:37
S20	20783	455/456.1	US-PGPUB; USPAT; EPO; JPO;	OR	ON	2015/08/10 10:00

			DERWENT; IBM_TDB			
S21	18188	h04w4/02.cpc.	US-PGPUB; USPAT; EPO; JPO; DERWENT; IBM_TDB	OR	ON	2015/08/10 10:00
S22	0	"14529978"	US-PGPUB; USPAT; EPO; JPO; DERWENT; IBM_TDB	OR	ON	2015/08/14 03:54
S23	0	"14695233"	US-PGPUB; USPAT; EPO; JPO; DERWENT; IBM_TDB	OR	ON	2015/08/14 03:55
S24	0	"14695251"	US-PGPUB; USPAT; EPO; JPO; DERWENT; IBM_TDB	OR	ON	2015/08/14 03:55
S25	0	"14633764"	US-PGPUB; USPAT; EPO; JPO; DERWENT; IBM_TDB	OR	ON	2015/08/14 03:57
S31	3	"20060047825"	US-PGPUB; USPAT; EPO; JPO; DERWENT; IBM_TDB	OR	ON	2015/08/17 23:59
S32	0	"14633804"	US-PGPUB; USPAT; EPO; JPO; DERWENT; IBM_TDB	OR	ON	2015/08/18 00:09
S34	153	"6377210"	US-PGPUB; USPAT; EPO; JPO; DERWENT; IBM_TDB	OR	ON	2015/12/03 03:15
S35	5229	((group or multiple or second or another or other or different) near4 (device or terminal or unit or component or apparatus)) same (battery near2 (status or level or condition))	US-PGPUB; USPAT; EPO; JPO; DERWENT; IBM_TDB	OR	ON	2015/12/03 18:28
S36	1573	S35 and (@ad<"20040921" or @pd<"20040921" or @rlad<"20040921")	US-PGPUB; USPAT; EPO; JPO; DERWENT; IBM_TDB	OR	ON	2015/12/03 18:29
S37	467	((group) near4 (device or terminal or unit or component or apparatus)) same (battery near2 (status or level or condition))	US-PGPUB; USPAT; EPO; JPO; DERWENT; IBM_TDB	OR	ON	2015/12/03 18:29
S38	116	S37 and (@ad<"20040921" or @pd<"20040921" or @rlad<"20040921")	US-PGPUB; USPAT; EPO; JPO;	OR	ON	2015/12/03 18:30

			DERWENT; IBM_TDB			
S39	164	((multiple or second or another or other or different) near2 (device or terminal or unit or component or apparatus) same ((exchang\$3 or transmit\$4 or send\$3 or obtain\$3 or retriev\$3 or receive or receiving) near3 (battery near2 (status or level or condition)))	US-PGPUB; USPAT; EPO; JPO; DERWENT; IBM_TDB	OR	ON	2015/12/03 18:43
S40	41	S39 and (@ad<"20040921" or @pd<"20040921" or @rlad<"20040921")	US-PGPUB; USPAT; EPO; JPO; DERWENT; IBM_TDB	OR	ON	2015/12/03 18:44
S41	41	S40 not S38	US-PGPUB; USPAT; EPO; JPO; DERWENT; IBM_TDB	OR	ON	2015/12/03 18:44
S42	119	"7593740"	US-PGPUB; USPAT; EPO; JPO; DERWENT; IBM_TDB	OR	ON	2015/12/08 02:02
S43	0	"14633804"	US-PGPUB; USPAT; EPO; JPO; DERWENT; IBM_TDB	OR	ON	2015/12/08 02:06
S46	22	"8014763"	US-PGPUB; USPAT; EPO; JPO; DERWENT; IBM_TDB	OR	ON	2015/12/08 05:14
S47	41	(dating with location) and ((hid\$5 or private) near4 address)	US-PGPUB; USPAT; EPO; JPO; DERWENT; IBM_TDB	OR	ON	2016/02/12 05:26
S48	17	S47 and (@ad<"20040921" or @pd<"20040921" or @rlad<"20040921")	US-PGPUB; USPAT; EPO; JPO; DERWENT; IBM_TDB	OR	ON	2016/02/12 05:26
S49	5	(dating with location) and ((unknow\$3 or "not" adj know\$3) near4 address)	US-PGPUB; USPAT; EPO; JPO; DERWENT; IBM_TDB	OR	ON	2016/02/12 05:37
S50	0	S49 and (@ad<"20040921" or @pd<"20040921" or @rlad<"20040921")	US-PGPUB; USPAT; EPO; JPO; DERWENT; IBM_TDB	OR	ON	2016/02/12 05:38
S51	10	(dating same location) and ((unknow\$3 or "not" adj know\$3) near4 address)	US-PGPUB; USPAT; EPO; JPO; DERWENT; IBM_TDB	OR	ON	2016/02/12 05:38
S52	0	S51 and (@ad<"20040921" or	US-PGPUB;	OR	ON	2016/02/12

		@pd<"20040921" or @rlad<"20040921")	USPAT; EPO; JPO; DERWENT; IBM_TDB			05:38
S53	50	(dating) and ((unknow\$3 or "not" adj know\$3) near4 address)	US-PGPUB; USPAT; EPO; JPO; DERWENT; IBM_TDB	OR	ON	2016/02/12 05:38
S54	10	S53 and (@ad<"20040921" or @pd<"20040921" or @rlad<"20040921")	US-PGPUB; USPAT; EPO; JPO; DERWENT; IBM_TDB	OR	ON	2016/02/12 05:38
S55	111	(friend near2 finder) same map same (location or position)	US-PGPUB; USPAT; EPO; JPO; DERWENT; IBM_TDB	OR	ON	2016/06/29 13:50
S56	11	S55 and (@ad<"20040921" or @pd<"20040921" or @rlad<"20040921")	US-PGPUB; USPAT; EPO; JPO; DERWENT; IBM_TDB	OR	ON	2016/06/29 13:51
S57	112	((friend near2 finder) or friend\$finder) same map same (location or position)	US-PGPUB; USPAT; EPO; JPO; DERWENT; IBM_TDB	OR	ON	2016/06/29 13:55
S58	11	S57 and (@ad<"20040921" or @pd<"20040921" or @rlad<"20040921")	US-PGPUB; USPAT; EPO; JPO; DERWENT; IBM_TDB	OR	ON	2016/06/29 13:55
S59	483	((different or another or other or second or plural\$3 or multiple) near4 group near4 map) same (location or position)	US-PGPUB; USPAT; EPO; JPO; DERWENT; IBM_TDB	OR	ON	2016/06/29 14:19
S60	151	S59 and (@ad<"20040921" or @pd<"20040921" or @rlad<"20040921")	US-PGPUB; USPAT; EPO; JPO; DERWENT; IBM_TDB	OR	ON	2016/06/29 14:19
S61	205	((different or another or other or second or plural\$3 or multiple) adj2 group near4 map) same (location or position)	US-PGPUB; USPAT; EPO; JPO; DERWENT; IBM_TDB	OR	ON	2016/06/29 14:24
S62	57	S61 and (@ad<"20040921" or @pd<"20040921" or @rlad<"20040921")	US-PGPUB; USPAT; EPO; JPO; DERWENT; IBM_TDB	OR	ON	2016/06/29 14:24
S63	65	((second) near2 group near2 map) same (location or position)	US-PGPUB; USPAT; EPO; JPO; DERWENT; IBM_TDB	OR	ON	2016/06/29 14:29
S64	16	((second) near2 group near2 map) same	US-PGPUB;	OR	ON	2016/06/29

		(location or position) same display\$3	USPAT; EPO; JPO; DERWENT; IBM_TDB			14:31
S65	804	(group\$3 near2 (user or ue or device or terminal or wrtu or equipment or apparatus or node or station)) and ((second near2 map) same (location or position))	US-PGPUB; USPAT; EPO; JPO; DERWENT; IBM_TDB	OR	ON	2016/06/29 14:39
S66	120	(group\$3 near2 (user or ue or device or terminal or wrtu or equipment or apparatus or node or station)) and ((second adj map) same (location or position))	US-PGPUB; USPAT; EPO; JPO; DERWENT; IBM_TDB	OR	ON	2016/06/29 14:40
S67	361	(group\$3 near2 (user or ue or device or terminal or wrtu or equipment or apparatus or node or station)) and ((second adj2 map) same (location or position))	US-PGPUB; USPAT; EPO; JPO; DERWENT; IBM_TDB	OR	ON	2016/06/29 14:40
S68	109	S67 and (@ad<"20040921" or @pd<"20040921" or @rlad<"20040921")	US-PGPUB; USPAT; EPO; JPO; DERWENT; IBM_TDB	OR	ON	2016/06/29 14:41
S69	61	(grouping near2 (user or ue or device or terminal or wrtu or equipment or apparatus or node or station)) and ((second near2 map) same (location or position))	US-PGPUB; USPAT; EPO; JPO; DERWENT; IBM_TDB	OR	ON	2016/06/29 14:42
S70	8	S69 and (@ad<"20040921" or @pd<"20040921" or @rlad<"20040921")	US-PGPUB; USPAT; EPO; JPO; DERWENT; IBM_TDB	OR	ON	2016/06/29 14:42
S71	4	S64 and (@ad<"20040921" or @pd<"20040921" or @rlad<"20040921")	US-PGPUB; USPAT; EPO; JPO; DERWENT; IBM_TDB	OR	ON	2016/06/29 14:46
S72	17	S63 and (@ad<"20040921" or @pd<"20040921" or @rlad<"20040921")	US-PGPUB; USPAT; EPO; JPO; DERWENT; IBM_TDB	OR	ON	2016/06/29 14:52
S73	388	display\$3 with (second near2 map near2 (location or position))	US-PGPUB; USPAT; EPO; JPO; DERWENT; IBM_TDB	OR	ON	2016/06/29 14:55
S74	80	S73 and (@ad<"20040921" or @pd<"20040921" or @rlad<"20040921")	US-PGPUB; USPAT; EPO; JPO; DERWENT; IBM_TDB	OR	ON	2016/06/29 14:56
S75	88	(request\$3 near4 ((second or different or other) adj2 map)) same (location or position)	US-PGPUB; USPAT; EPO; JPO; DERWENT; IBM_TDB	OR	ON	2016/06/29 17:05
S76	36	S75 and (@ad<"20040921" or	US-PGPUB;	OR	ON	2016/06/29

EAST Search History

	@pd<"20040921" or @rlad<"20040921")	USPAT; EPO; JPO; DERWENT; IBM_TDB	17:06
--	-------------------------------------	--	-------

6/ 30/ 2016 11:24:04 AM

C:\ Users\ oobayanju\ Documents\ EAST\ Workspaces\ 14633804.wsp

Receipt date: 06/20/2016

14633804 - GAU: 2646

Docket No.: MOC-005
(PATENT)

IN THE UNITED STATES PATENT AND TRADEMARK OFFICE

In re Patent Application of:
Malcolm K. Beyers, et al.

Application No.: 14/633,804

Confirmation No.: 8573

Filed: February 27, 2015

Art Unit: 2646

For: METHOD TO PROVIDE AD HOC AND
PASSWORD PROTECTED DIGITAL AND
VOICE NETWORKS

Examiner: O. Obayanju

Commissioner for Patents
P.O. Box 1450
Alexandria, VA 22313-1450

SUPPLEMENTAL INFORMATION DISCLOSURE STATEMENT (SIDS)

Pursuant to 37 C.F.R. § 1.56, 1.97 and 1.98, the attention of the Patent and Trademark Office is hereby directed to the references listed on the attached form PTO/SB/08. It is respectfully requested that the information be expressly considered during the prosecution of this application, and that the references be made of record therein and appear among the "References Cited" on any patent to issue therefrom.

This Information Disclosure Statement is filed more than three months after the U.S. filing date, and after the mailing date of the first Office Action on the merits, but before the mailing date of any of a Final Office Action, a Notice of Allowance (37 C.F.R. § 1.97(c)) or an action that otherwise closes prosecution in the application.

In accordance with 37 C.F.R. § 1.98(a)(2)(ii), Applicant has not submitted copies of U.S. patents and U.S. patent applications.

In accordance with 37 C.F.R. § 1.97(g), the filing of this Information Disclosure Statement shall not be construed to mean that a search has been made or that no other material information as defined in 37 C.F.R. § 1.56(a) exists. In accordance with 37 C.F.R. § 1.97(h), the filing of this Information Disclosure Statement shall not be construed to be an admission that any patent, publication or other information referred to therein is "prior art" for this invention unless specifically designated as such.

ALL REFERENCES CONSIDERED EXCEPT WHERE LINED THROUGH. /O.O./

Applicant hereby apprises the Examiner of the following co-pending patent applications, including the contents of the file wrappers, the claims, any Office Actions issued therein, and any Notices of Allowance issued therefor, and requests that the Examiner consider these documents:

Application Number	Filing Date	Title	Inventor
14/529,978	10/31/2014	Method to Provide Ad Hoc and Password Protected Digital and Voice Networks (MOC-001)	Malcolm K. Beyer, et al.
14/695,233	4/24/2015	Method to Provide Ad Hoc and Password Protected Digital and Voice Networks (MOC-003)	Malcolm K. Beyer
14/633,764	2/27/2015	Method to Provide Ad Hoc and Password Protected Digital and Voice Networks (MOC-006)	Malcolm K. Beyer, et al.

Applicant has cited for the Examiner's consideration certain co-pending U.S. patent applications that are owned at least in part by the assignee of this application, that describe subject matter that may be related to the present invention. The co-pending applications are listed herewith in accordance with M.P.E.P. 609.06 which states: "Applicant may wish to list U.S. patent application numbers on other than a form PTO/SB/08a and 08b format to avoid the application numbers of pending applications being published on the patent. If a citation is not printed on the patent but has been considered by the examiner, the patented file will reflect that fact as noted in MPEP § 609.05(b)."

No copies of the co-pending applications have been provided. If the Examiner wishes to have copies of the co-pending applications, Examiner should contact the Attorney of record.

It is submitted that the Information Disclosure Statement is in compliance with 37 C.F.R. § 1.98 and the Examiner is respectfully requested to consider the listed references.

Receipt date: 06/20/2016

Application No.: 14/633,804

3

14633804 - GAU: 2646

Docket No.: MOC-005

Please charge our Credit Card in the amount of \$90.00 covering the fee set forth in 37 C.F.R. § 1.17(p). The Director is hereby authorized to charge any deficiency in the fees filed, asserted to be filed or which should have been filed herewith to our Deposit Account No. 07-1700, under Order No. MOC-005.

Dated: June 20, 2016

Respectfully submitted,

Electronic signature: /Daniel J. Burns/

Daniel J. Burns

Registration No.: 50,222

GOODWIN PROCTER LLP

135 Commonwealth Drive

Menlo Park, California 94025

(650) 752-3100

Attorney for Applicant

/Omoniyi Obayanju/

06/30/2016

ALL REFERENCES CONSIDERED EXCEPT WHERE LINED THROUGH. /O.O./

EAST Search History**EAST Search History (Interference)**

Ref #	Hits	Search Query	DBs	Default Operator	Plurals	Time Stamp
L2	0	((request\$3 near4 ((second or different or other or another) adj2 map)) and (location or position) and join\$3 and group and (symbol or icon) and spatial and (internet adj protocol or ip\$address or ip adj address) and server and display\$3).clm.	USPAT	OR	ON	2016/06/30 11:16
L3	0	((request\$3 near4 ((second or different or other or another) adj2 map)) and (location or position) and join\$3 and group and (symbol or icon) and (internet adj protocol or ip\$address or ip adj address) and server and display\$3).clm.	USPAT	OR	ON	2016/06/30 11:16
L4	0	((request\$3 near4 ((second or different or other or another) adj2 map)) and (location or position) and join\$3 and group and (symbol or icon) and spatial and (internet adj protocol or ip\$address or ip adj address) and display\$3).clm.	USPAT	OR	ON	2016/06/30 11:17
L5	0	((request\$3 near4 ((second or different or other or another) adj2 map)) and (location or position) and join\$3 and group and (symbol or icon) and spatial and (internet adj protocol or ip\$address or ip adj address) and server).clm.	USPAT	OR	ON	2016/06/30 11:17
L6	0	((request\$3 near4 ((second or different or other or another) adj2 map)) and (location or position) and join\$3 and group and (symbol or icon) and spatial and (internet adj protocol or ip\$address or ip adj address)).clm.	USPAT	OR	ON	2016/06/30 11:23

6/30/2016 11:24:50 AM**C:\Users\oobayanju\Documents\EAST\Workspaces\14633804.wsp**

Issue Classification 	Application/Control No. 14633804	Applicant(s)/Patent Under Reexamination BEYER ET AL.
	Examiner OMONIYI OBAYANJU	Art Unit 2646

CPC					
Symbol				Type	Version
H04W	4		22	F	2013-01-01
H04W	76		007	I	2013-01-01
H04M	1		72519	I	2013-01-01
H04W	76		021	A	2013-01-01
H04W	4		10	A	2013-01-01
H04W	68		00	I	2013-01-01
H04W	4		023	I	2013-01-01
H04W	4		026	A	2013-01-01
H04W	4		027	I	2013-01-01
H04M	1		27455	A	2013-01-01
H04M	1		72525	A	2013-01-01
H04M	1		72547	A	2013-01-01
H04M	1		72572	I	2013-01-01
H04M	1		72583	I	2013-01-01
H04W	4		02	I	2013-01-01
H04W	4		08	I	2013-01-01
H04W	64		00	I	2013-01-01
H04W	84		18	I	2013-01-01
H04M	2250		10	A	2013-01-01
H04M	2250		22	A	2013-01-01
H04M	2250		62	A	2013-01-01
H04W	12		08	I	2013-01-01
H04W	76		005	A	2013-01-01
H04W	12		02	I	2013-01-01
G06F	3		0482	I	2013-01-01
G06F	3		04842	I	2013-01-01
H04L	63		083	I	2013-01-01
H04L	67		18	I	2013-01-01
H04M	1		72536	I	2013-01-01
H04W	4		021	I	2013-01-01

NONE		Total Claims Allowed:	
(Assistant Examiner)	(Date)	35	
/OMONIYI OBAYANJU/ Primary Examiner.Art Unit 2646	06/30/2016	O.G. Print Claim(s)	O.G. Print Figure
(Primary Examiner)	(Date)	1	9

Issue Classification 	Application/Control No. 14633804	Applicant(s)/Patent Under Reexamination BEYER ET AL.
	Examiner OMONIYI OBAYANJU	Art Unit 2646

CPC Combination Sets				
Symbol	Type	Set	Ranking	Version

NONE		Total Claims Allowed:	
(Assistant Examiner)	(Date)	35	
/OMONIYI OBAYANJU/ Primary Examiner.Art Unit 2646	06/30/2016	O.G. Print Claim(s)	O.G. Print Figure
(Primary Examiner)	(Date)	1	9

Issue Classification 	Application/Control No. 14633804	Applicant(s)/Patent Under Reexamination BEYER ET AL.
	Examiner OMONIYI OBAYANJU	Art Unit 2646

<input type="checkbox"/> Claims renumbered in the same order as presented by applicant <input type="checkbox"/> CPA <input type="checkbox"/> T.D. <input type="checkbox"/> R.1.47															
Final	Original	Final	Original	Final	Original	Final	Original	Final	Original	Final	Original	Final	Original	Final	Original
1	1		17	8	33	17	49								
2	2		18	9	34	18	50								
	3		19	10	35	19	51								
	4	26	20	11	36	20	52								
	5		21	29	37	21	53								
	6		22	30	38	22	54								
	7	27	23	31	39	23	55								
3	8	28	24	32	40										
	9		25	33	41										
	10		26	34	42										
4	11		27	12	43										
5	12		28	35	44										
24	13		29	13	45										
25	14		30	14	46										
	15	6	31	15	47										
	16	7	32	16	48										

NONE		Total Claims Allowed:	
		35	
(Assistant Examiner)	(Date)		
/OMONIYI OBAYANJU/ Primary Examiner.Art Unit 2646	06/30/2016	O.G. Print Claim(s)	O.G. Print Figure
(Primary Examiner)	(Date)	1	9

Search Notes 	Application/Control No. 14633804	Applicant(s)/Patent Under Reexamination BEYER ET AL.
	Examiner OMONIYI OBAYANJU	Art Unit 2646

CPC- SEARCHED		
Symbol	Date	Examiner
H04W4/02	8/10/2015	OO

CPC COMBINATION SETS - SEARCHED		
Symbol	Date	Examiner

US CLASSIFICATION SEARCHED			
Class	Subclass	Date	Examiner
455	404.2, 456.1	8/10/2015	OO

SEARCH NOTES		
Search Notes	Date	Examiner
See Attached East Search History	8/10/2015	OO
See Attached East Search History (Updated)	12/8/2015	OO

INTERFERENCE SEARCH			
US Class/ CPC Symbol	US Subclass / CPC Group	Date	Examiner
Same As Above	Same As Above	6/30/2016	OO
Interference Search	East Patent and PG-PUB Claim Search	6/30/2016	OO

--	--

Receipt date: 06/20/2016

14633804 - GAU: 2646

PTO/SB/08a (07-09)

Approved for use through 07/31/2016. OMB 0651-0031

U.S. Patent and Trademark Office; U.S. DEPARTMENT OF COMMERCE

Under the Paperwork Reduction Act of 1995, no persons are required to respond to a collection of information unless it contains a valid OMB control number.

Substitute for form 1449/PTO INFORMATION DISCLOSURE STATEMENT BY APPLICANT (Use as many sheets as necessary)				Complete if Known		
				Application Number	14/633,804	
Sheet		1	of	2	Attorney Docket Number	MOC-005

U.S. PATENT DOCUMENTS					
Examiner Initials*	Cite No. ¹	Document Number	Publication Date MM-DD-YYYY	Name of Patentee or Applicant of Cited Document	Pages, Columns, Lines, Where Relevant Passages or Relevant Figures Appear
		Number-Kind Code ² (if known)			
	A1	US-6,377,210	04-23-2002	Moore	
	A2	US-6,434,403	08-13-2002	Ausems et al.	
	A3	US-6,490,521	12-03-2002	Wiener	
	A4	US-6,518,957	02-11-2003	Lehtinen et al.	
	A5	US-6,549,768	04-15-2003	Fraccaroli	
	A6	US-6,882,856	04-19-2005	Alterman et al.	
	A7	US-7,330,112	02-12-2008	Emigh et al.	
	A8	US-7,486,648	02-03-2009	Baranowski	
	A9	US-8,014,763	09-06-2011	Hymes	
	A10	US-8,139,514	03-20-2012	Weber et al.	
	A11	US-2004/0054428	03-18-2004	Sheha et al.	
	A12	US-2004/0137884	07-15-2004	Engstrom et al.	
	A13	US-2004/0143391	07-22-2004	King et al.	
	A14	US-2004/0148090	07-29-2004	Melen	
	A15	US-2004/0252050	12-16-2004	Tengler et al.	
	A16	US-2005/0060069	03-17-2005	Breed et al.	
	A17	US-2005/0227705	10-13-2005	Rousu et al.	
	A18	US-2010/0052945	03-04-2010	Breed	

FOREIGN PATENT DOCUMENTS						
Examiner Initials*	Cite No. ¹	Foreign Patent Document	Publication Date MM-DD-YYYY	Name of Patentee or Applicant of Cited Document	Pages, Columns, Lines, Where Relevant Passages Or Relevant Figures Appear	T ⁶
		Country Code ³ -Number ⁴ -Kind Code ⁵ (if known)				
	B1	JP-2000-357296-A	12-26-2000	Matsushita Electric Ind Co Ltd		X
	B2	JP-2002-277256-A	09-25-2002	Mazda Motor Corp.		X

Examiner Signature	/Omoniyi Obayanju/	Date Considered	06/30/2016
--------------------	--------------------	-----------------	------------

*EXAMINER: Initial if reference considered, whether or not citation is in conformance with MPEP 609. Draw line through citation if not in conformance and not considered. Include copy of this form with next communication to applicant. ¹ Applicant's unique citation designation number (optional). ² See Kinds Codes of USPTO Patent Documents at www.uspto.gov or MPEP 901.04. ³ Enter Office that issued the document, by the two-letter code (WIPO Standard ST.3). ⁴ For Japanese patent documents, the indication of the year of the reign of the Emperor must precede the serial number of the patent document. ⁵ Kind of document by the appropriate symbols as indicated on the document under WIPO Standard ST.16 if possible. ⁶ Applicant is to place a check mark here if English language Translation is attached. This collection of information is required by 37 CFR 1.97 and 1.98. The information is required to obtain or retain a benefit by the public which is to file (and by the USPTO to process) an application. Confidentiality is governed by 35 U.S.C. 122 and 37 CFR 1.14. This collection is estimated to take 2 hours to complete, including gathering, preparing, and submitting the completed application form to the USPTO. Time will vary depending upon the individual case. Any comments on the amount of time you require to complete this form and/or suggestions for reducing this burden, should be sent to the Chief Information Officer, U.S. Patent and Trademark Office, P.O. Box 1450, Alexandria, VA 22313-1450. DO NOT SEND FEES OR COMPLETED FORMS TO THIS ADDRESS. SEND TO: Commissioner for Patents, P.O. Box 1450, Alexandria, VA 22313-1450.
 If you need assistance in completing the form, call 1-800-PTO-9199 (1-800-786-9199) and select option 2.

ALL REFERENCES CONSIDERED EXCEPT WHERE LINED THROUGH. /O.O./

Receipt date: 06/20/2016

14633804 - GAU: 2646

PTO/SB/08b (07-09)
Approved for use through 07/31/2016. OMB 0651-0031
U.S. Patent and Trademark Office; U.S. DEPARTMENT OF COMMERCE

Under the Paperwork Reduction Act of 1995, no persons are required to respond to a collection of information unless it contains a valid OMB control number.

Substitute for form 1449/PTO INFORMATION DISCLOSURE STATEMENT BY APPLICANT (Use as many sheets as necessary)		Complete if Known		
		Application Number	14/633,804	
		Filing Date	02/27/2015	
		First Named Inventor	Malcolm K. Beyer	
		Art Unit	2646	
		Examiner Name	O. Obayanju	
Sheet	2	2	Attorney Docket Number	MOC-005

NON PATENT LITERATURE DOCUMENTS			
Examiner Initials*	Cite No. ¹	Include name of the author (in CAPITAL LETTERS), title of the article (when appropriate), title of the item (book, magazine, journal, serial, symposium, catalog, etc.), date, page(s), volume-issue number(s), publisher, city and/or country where published.	T ₂
	C1	Garmin rino 110 2-way Radio & Personal Navigator; Owner's Manual and Reference Guide; Apr. 2003; 88pgs	
	C2	Int'l Preliminary Report on Patentability (IPRP); for Int'l Patent App. No. PCT/JP2004/000250 dated 7/5/2005; 4pgs	
	C3	Life360's Rule 50(a) Motion for Judgment as a Matter of Law; AGIS, Inc. v. Life360, Inc. (S.D. FL.); 3/12/2015; 27pgs	
	C4	Plaintiff Advanced Ground Information Systems, Inc.'s Motions In Limine; AGIS, Inc. v. Life360, Inc. (S.D. FL.); 2/19/2015; 54pgs	
	C5	PRNewswire, "Trimble GPS Technology Enables Seiko Epson Communication Device and Wireless Data Service," Nov. 8, 1999, accessed on the internet at: http://www.prnewswire.com/news-releases/trimble-gps-technology-enables-seiko-epson-communication-device-and-wireless-data-service-77056402.html ; downloaded Jun. 16, 2016; 4pgs.	

Examiner Signature	/Omoniyi Obayanju/	Date Considered	06/30/2016
--------------------	--------------------	-----------------	------------

*EXAMINER: Initial if reference considered, whether or not citation is in conformance with MPEP 609. Draw line through citation if not in conformance and not considered. Include copy of this form with next communication to applicant. 1 Applicant's unique citation designation number (optional). 2 Applicant is to place a check mark here if English language Translation is attached. This collection of information is required by 37 CFR 1.98. The information is required to obtain or retain a benefit by the public which is to file (and by the USPTO to process) an application. Confidentiality is governed by 35 U.S.C. 122 and 37 CFR 1.14. This collection is estimated to take 2 hours to complete, including gathering, preparing, and submitting the completed application form to the USPTO. Time will vary depending upon the individual case. Any comments on the amount of time you require to complete this form and/or suggestions for reducing this burden, should be sent to the Chief Information Officer, U.S. Patent and Trademark Office, P.O. Box 1450, Alexandria, VA 22313-1450. DO NOT SEND FEES OR COMPLETED FORMS TO THIS ADDRESS. SEND TO: Commissioner for Patents, P.O. Box 1450, Alexandria, VA 22313-1450.
If you need assistance in completing the form, call 1-800-PTO-9199 (1-800-786-9199) and select option 2.

ALL REFERENCES CONSIDERED EXCEPT WHERE LINED THROUGH. /O.O./

PART B - FEE(S) TRANSMITTAL

**Complete and send this form, together with applicable fee(s), to: Mail Mail Stop ISSUE FEE
 Commissioner for Patents
 P.O. Box 1450
 Alexandria, Virginia 22313-1450
 or Fax (571)-273-2885**

INSTRUCTIONS: This form should be used for transmitting the ISSUE FEE and PUBLICATION FEE (if required). Blocks 1 through 5 should be completed where appropriate. All further correspondence including the Patent, advance orders and notification of maintenance fees will be mailed to the current correspondence address as indicated unless corrected below or directed otherwise in Block 1, by (a) specifying a new correspondence address; and/or (b) indicating a separate "FEE ADDRESS" for maintenance fee notifications.

CURRENT CORRESPONDENCE ADDRESS (Note: Use Block 1 for any change of address)

GOODWIN PROCTER LLP
 PATENT ADMINISTRATOR
 100 NORTHERN AVENUE
 BOSTON, MASSACHUSETTS 02210

Note: A certificate of mailing can only be used for domestic mailings of the Fee(s) Transmittal. This certificate cannot be used for any other accompanying papers. Each additional paper, such as an assignment or formal drawing, must have its own certificate of mailing or transmission.

Certificate of Mailing or Transmission

I hereby certify that this Fee(s) Transmittal is being deposited with the United States Postal Service with sufficient postage for first class mail in an envelope addressed to the Mail Stop ISSUE FEE address above, or being facsimile transmitted to the USPTO (571) 273-2885, on the date indicated below.

_____ (Depositor's name)
_____ (Signature)
_____ (Date)

APPLICATION NO.	FILING DATE	FIRST NAMED INVENTOR	ATTORNEY DOCKET NO.	CONFIRMATION NO.
14/633,804	02/27/2015	Malcolm K. Beyer, Jr.	MOC-005	8573

TITLE OF INVENTION: METHOD TO PROVIDE AD HOC AND PASSWORD PROTECTED DIGITAL AND VOICE NETWORKS

APPLN. TYPE	ENTITY STATUS	ISSUE FEE DUE	PUBLICATION FEE DUE	PREV. PAID ISSUE FEE	TOTAL FEE(S) DUE	DATE DUE
nonprovisional	SMALL	\$480.00			\$480.00	10/07/2016
		EXAMINER	ART UNIT	CLASS-SUBCLASS		
		O. Obayanju	2646	455-404200		

<p>1. Change of correspondence address or indication of "Fee Address" (37 CFR 1.363).</p> <p><input type="checkbox"/> Change of correspondence address (or Change of Correspondence Address form PTO/SB/122) attached.</p> <p><input type="checkbox"/> "Fee Address" indication (or "Fee Address" Indication form PTO/SB/47; Rev 03-02 or more recent) attached. Use of a Customer Number is required.</p>	<p>2. For printing on the patent front page, list</p> <p>(1) The names of up to 3 registered patent attorneys or agents OR, alternatively, 1 <u>Goodwin Procter LLP</u></p> <p>(2) The name of a single firm (having as a member a registered attorney or agent) and the names of up to 2 registered patent attorneys or agents. If no name is listed, no name will be printed. 2 _____</p> <p>3 _____</p>
---	--

3. ASSIGNEE NAME AND RESIDENCE DATA TO BE PRINTED ON THE PATENT (print or type)

PLEASE NOTE: Unless an assignee is identified below, no assignee data will appear on the patent. If an assignee is identified below, the document has been filed for recordation as set forth in 37 CFR 3.11. Completion of this form is NOT a substitute for filing an assignment.

(A) NAME OF ASSIGNEE: Advanced Ground Information Systems, Inc.

(B) RESIDENCE: (CITY and STATE OR COUNTRY) Jupiter, Florida

Please check the appropriate assignee category or categories (will not be printed on the patent): Individual Corporation or other private group entity Government

<p>4a. The following fee(s) are submitted:</p> <p><input checked="" type="checkbox"/> Issue Fee</p> <p><input type="checkbox"/> Publication Fee (No small entity discount permitted)</p> <p><input type="checkbox"/> Advance Order - # of Copies _____</p>	<p>4b. Payment of Fee(s): (Please first reapply any previously paid issue fee shown above)</p> <p><input type="checkbox"/> A check is enclosed.</p> <p><input checked="" type="checkbox"/> Payment by credit card.</p> <p><input checked="" type="checkbox"/> The Director is hereby authorized to charge the required fee(s), any deficiency, or credit any overpayment, to Deposit Account Number <u>07-1700</u></p>
--	--

5. Change in Entity Status (from status indicated above)

Applicant certifying micro entity status. See 37 CFR 1.29 **NOTE:** Absent a valid certification of Micro Entity Status (see forms PTO/SB/15A and 15B), issue fee payment in the micro entity amount will not be accepted at the risk of application abandonment.

Applicant asserting small entity status. See 37 CFR 1.27 **NOTE:** If the application was previously under micro entity status, checking this box will be taken to be a notification of loss of entitlement to micro entity status.

Applicant changing to regular undiscounted fee status. **NOTE:** Checking this box will be taken to be a notification of loss of entitlement to small or micro entity status, as applicable.

NOTE: This form must be signed in accordance with 37 CFR 1.31 and 1.33. See 37 CFR 1.4 for signature requirements and certifications.

Authorized Signature _____ /Daniel J. Burns/	Date <u>July 8, 2016</u>
Typed or printed name <u>Daniel J. Burns</u>	Registration No. <u>50,222</u>

Electronic Patent Application Fee Transmittal

Application Number:	14633804			
Filing Date:	27-Feb-2015			
Title of Invention:	METHOD TO PROVIDE AD HOC AND PASSWORD PROTECTED DIGITAL AND VOICE NETWORKS			
First Named Inventor/Applicant Name:	Malcolm K. Beyer			
Filer:	Daniel J. Burns/Deanna Bridges			
Attorney Docket Number:	MOC-005			
Filed as Small Entity				
Filing Fees for Utility under 35 USC 111(a)				
Description	Fee Code	Quantity	Amount	Sub-Total in USD(\$)
Basic Filing:				
Pages:				
Claims:				
Miscellaneous-Filing:				
Petition:				
Patent-Appeals-and-Interference:				
Post-Allowance-and-Post-Issuance:				
Utility Appl Issue Fee	2501	1	480	480

Description	Fee Code	Quantity	Amount	Sub-Total in USD(\$)
Extension-of-Time:				
Miscellaneous:				
Total in USD (\$)				480

Electronic Acknowledgement Receipt

EFS ID:	26299706
Application Number:	14633804
International Application Number:	
Confirmation Number:	8573
Title of Invention:	METHOD TO PROVIDE AD HOC AND PASSWORD PROTECTED DIGITAL AND VOICE NETWORKS
First Named Inventor/Applicant Name:	Malcolm K. Beyer
Customer Number:	51414
Filer:	Daniel J. Burns/Samuel Stone
Filer Authorized By:	Daniel J. Burns
Attorney Docket Number:	MOC-005
Receipt Date:	08-JUL-2016
Filing Date:	27-FEB-2015
Time Stamp:	18:20:21
Application Type:	Utility under 35 USC 111(a)

Payment information:

Submitted with Payment	yes
Payment Type	Credit Card
Payment was successfully received in RAM	\$480
RAM confirmation Number	4944
Deposit Account	
Authorized User	

The Director of the USPTO is hereby authorized to charge indicated fees and credit any overpayment as follows:

File Listing:					
Document Number	Document Description	File Name	File Size(Bytes)/ Message Digest	Multi Part /.zip	Pages (if appl.)
1	Post Allowance Communication - Incoming	MOC-005_Corrected_Filing_Receipt_Request.pdf	83295	no	1
			25ad651be0bd7bd3d4a1c6d669f6bf091ca031f		
Warnings:					
Information:					
2	Examination support document	MOC-005_Corrected_Filing_Receipt.pdf	196253	no	4
			753b2d0f7b62418f3f143bf9ac2e78a3069c9cfe5		
Warnings:					
Information:					
3	Issue Fee Payment (PTO-85B)	MOC-005_Issue_Fee.pdf	113371	no	1
			48605a0881bc0f63ab5fedcaabc140a940dfc90d		
Warnings:					
Information:					
4	Fee Worksheet (SB06)	fee-info.pdf	30836	no	2
			ed088f431db77c2b5fd9c1665b7b99db6f0d8298		
Warnings:					
Information:					
Total Files Size (in bytes):			423755		

This Acknowledgement Receipt evidences receipt on the noted date by the USPTO of the indicated documents, characterized by the applicant, and including page counts, where applicable. It serves as evidence of receipt similar to a Post Card, as described in MPEP 503.

New Applications Under 35 U.S.C. 111

If a new application is being filed and the application includes the necessary components for a filing date (see 37 CFR 1.53(b)-(d) and MPEP 506), a Filing Receipt (37 CFR 1.54) will be issued in due course and the date shown on this Acknowledgement Receipt will establish the filing date of the application.

National Stage of an International Application under 35 U.S.C. 371

If a timely submission to enter the national stage of an international application is compliant with the conditions of 35 U.S.C. 371 and other applicable requirements a Form PCT/DO/EO/903 indicating acceptance of the application as a national stage submission under 35 U.S.C. 371 will be issued in addition to the Filing Receipt, in due course.

New International Application Filed with the USPTO as a Receiving Office

If a new international application is being filed and the international application includes the necessary components for an international filing date (see PCT Article 11 and MPEP 1810), a Notification of the International Application Number and of the International Filing Date (Form PCT/RO/105) will be issued in due course, subject to prescriptions concerning national security, and the date shown on this Acknowledgement Receipt will establish the international filing date of the application.

Docket No.: MOC-005
(PATENT)

IN THE UNITED STATES PATENT AND TRADEMARK OFFICE

First Named Inventor: Malcolm K. Beyer, Jr.

Application No.: 14/633,804

Confirmation No.: 8573

Filed: February 27, 2015

Art Unit: 2646

For: Method to Provide Ad Hoc and Password
Protected Digital and Voice Networks

Examiner: O. Obayanju

Commissioner for Patents
P.O. Box 1450
Alexandria, VA 22313-1450

REQUEST FOR CORRECTED FILING RECEIPT

Applicant hereby requests that a corrected Filing Receipt be issued in the above-identified patent application. As indicated in the Amendment and in the Corrected Application Data Sheet (ADS) filed on November 13, 2015, the present application is a continuation of U.S. Patent Application Serial No. 14/529,978, which is a **continuation-in-part** of U.S. Application No. 14/027,410 (now U.S. Patent No. 8,880,042). However, the official Updated Filing Receipt mailed on February 3, 2016, a copy of which is attached hereto, has an error in the priority claim:

This application is a CON of 14/529,978 10/31/2014

which is a ~~CON~~ CIP of 14/027,410 09/16/2013 PAT 8880042

Applicant additionally requests that all pertinent U.S. Patent and Trademark Office records relating to the subject application be changed to reflect this correction.

Respectfully submitted,

Date: July 8, 2016

/Daniel J. Burns/

Daniel J. Burns

Reg. No. 50,222

Customer Number 51414
GOODWIN PROCTER LLP
Telephone: (650) 752-3137
Facsimile: (650) 853-1038

ACTIVE/86552310.1



UNITED STATES PATENT AND TRADEMARK OFFICE

UNITED STATES DEPARTMENT OF COMMERCE
United States Patent and Trademark Office
Address: COMMISSIONER FOR PATENTS
P.O. Box 1450
Alexandria, Virginia 22313-1450
www.uspto.gov

Table with 7 columns: APPLICATION NUMBER, FILING or 371(c) DATE, GRP ART UNIT, FIL FEE REC'D, ATTY.DOCKET.NO, TOT CLAIMS, IND CLAIMS. Row 1: 14/633,804, 02/27/2015, 2646, 1260, MOC-005, 28, 4

CONFIRMATION NO. 8573

CORRECTED FILING RECEIPT



51414
GOODWIN PROCTER LLP
PATENT ADMINISTRATOR
53 STATE STREET
EXCHANGE PLACE
BOSTON, MA 02109-2881

Date Mailed: 02/03/2016

Receipt is acknowledged of this non-provisional patent application. The application will be taken up for examination in due course. Applicant will be notified as to the results of the examination. Any correspondence concerning the application must include the following identification information: the U.S. APPLICATION NUMBER, FILING DATE, NAME OF APPLICANT, and TITLE OF INVENTION. Fees transmitted by check or draft are subject to collection. Please verify the accuracy of the data presented on this receipt. If an error is noted on this Filing Receipt, please submit a written request for a Filing Receipt Correction. Please provide a copy of this Filing Receipt with the changes noted thereon. If you received a "Notice to File Missing Parts" for this application, please submit any corrections to this Filing Receipt with your reply to the Notice. When the USPTO processes the reply to the Notice, the USPTO will generate another Filing Receipt incorporating the requested corrections

Inventor(s)

Malcolm K. Beyer JR., Jupiter, FL;
Christopher R. Rice, Redmond, WA;

Applicant(s)

Advanced Ground Information Systems, Inc., Jupiter, FL;

Assignment For Published Patent Application

Advanced Ground Information Systems, Inc., Jupiter, FL

Power of Attorney: The patent practitioners associated with Customer Number 051414

Domestic Priority data as claimed by applicant

This application is a CON of 14/529,978 10/31/2014
CIP which is a CON of 14/027,410 09/16/2013 PAT 8880042
which is a CON of 13/751,453 01/28/2013 PAT 8538393
which is a CIP of 12/761,533 04/16/2010 PAT 8364129
which is a CIP of 11/615,472 12/22/2006 PAT 8126441
which is a CIP of 11/308,648 04/17/2006 PAT 7630724
which is a CIP of 10/711,490 09/21/2004 PAT 7031728

Foreign Applications for which priority is claimed (You may be eligible to benefit from the Patent Prosecution Highway program at the USPTO. Please see http://www.uspto.gov for more information.) - None.

Foreign application information must be provided in an Application Data Sheet in order to constitute a claim to foreign priority. See 37 CFR 1.55 and 1.76.

Permission to Access Application via Priority Document Exchange: Yes

Permission to Access Search Results: No

Applicant may provide or rescind an authorization for access using Form PTO/SB/39 or Form PTO/SB/69 as appropriate.

If Required, Foreign Filing License Granted: 03/19/2015

The country code and number of your priority application, to be used for filing abroad under the Paris Convention, is **US 14/633,804**

Projected Publication Date: 02/25/2016

Non-Publication Request: No

Early Publication Request: No

**** SMALL ENTITY ****

Title

METHOD TO PROVIDE AD HOC AND PASSWORD PROTECTED DIGITAL AND VOICE NETWORKS

Preliminary Class

455

Statement under 37 CFR 1.55 or 1.78 for AIA (First Inventor to File) Transition Applications: Yes

PROTECTING YOUR INVENTION OUTSIDE THE UNITED STATES

Since the rights granted by a U.S. patent extend only throughout the territory of the United States and have no effect in a foreign country, an inventor who wishes patent protection in another country must apply for a patent in a specific country or in regional patent offices. Applicants may wish to consider the filing of an international application under the Patent Cooperation Treaty (PCT). An international (PCT) application generally has the same effect as a regular national patent application in each PCT-member country. The PCT process **simplifies** the filing of patent applications on the same invention in member countries, but **does not result** in a grant of "an international patent" and does not eliminate the need of applicants to file additional documents and fees in countries where patent protection is desired.

Almost every country has its own patent law, and a person desiring a patent in a particular country must make an application for patent in that country in accordance with its particular laws. Since the laws of many countries differ in various respects from the patent law of the United States, applicants are advised to seek guidance from specific foreign countries to ensure that patent rights are not lost prematurely.

Applicants also are advised that in the case of inventions made in the United States, the Director of the USPTO must issue a license before applicants can apply for a patent in a foreign country. The filing of a U.S. patent application serves as a request for a foreign filing license. The application's filing receipt contains further information and guidance as to the status of applicant's license for foreign filing.

Applicants may wish to consult the USPTO booklet, "General Information Concerning Patents" (specifically, the section entitled "Treaties and Foreign Patents") for more information on timeframes and deadlines for filing foreign patent applications. The guide is available either by contacting the USPTO Contact Center at 800-786-9199, or it can be viewed on the USPTO website at <http://www.uspto.gov/web/offices/pac/doc/general/index.html>.

For information on preventing theft of your intellectual property (patents, trademarks and copyrights), you may wish to consult the U.S. Government website, <http://www.stopfakes.gov>. Part of a Department of Commerce initiative, this website includes self-help "toolkits" giving innovators guidance on how to protect intellectual property in specific countries such as China, Korea and Mexico. For questions regarding patent enforcement issues, applicants may call the U.S. Government hotline at 1-866-999-HALT (1-866-999-4258).

**LICENSE FOR FOREIGN FILING UNDER
Title 35, United States Code, Section 184
Title 37, Code of Federal Regulations, 5.11 & 5.15**

GRANTED

The applicant has been granted a license under 35 U.S.C. 184, if the phrase "IF REQUIRED, FOREIGN FILING LICENSE GRANTED" followed by a date appears on this form. Such licenses are issued in all applications where the conditions for issuance of a license have been met, regardless of whether or not a license may be required as set forth in 37 CFR 5.15. The scope and limitations of this license are set forth in 37 CFR 5.15(a) unless an earlier license has been issued under 37 CFR 5.15(b). The license is subject to revocation upon written notification. The date indicated is the effective date of the license, unless an earlier license of similar scope has been granted under 37 CFR 5.13 or 5.14.

This license is to be retained by the licensee and may be used at any time on or after the effective date thereof unless it is revoked. This license is automatically transferred to any related applications(s) filed under 37 CFR 1.53(d). This license is not retroactive.

The grant of a license does not in any way lessen the responsibility of a licensee for the security of the subject matter as imposed by any Government contract or the provisions of existing laws relating to espionage and the national security or the export of technical data. Licensees should apprise themselves of current regulations especially with respect to certain countries, of other agencies, particularly the Office of Defense Trade Controls, Department of State (with respect to Arms, Munitions and Implements of War (22 CFR 121-128)); the Bureau of Industry and Security, Department of Commerce (15 CFR parts 730-774); the Office of Foreign Assets Control, Department of Treasury (31 CFR Parts 500+) and the Department of Energy.

NOT GRANTED

No license under 35 U.S.C. 184 has been granted at this time, if the phrase "IF REQUIRED, FOREIGN FILING LICENSE GRANTED" DOES NOT appear on this form. Applicant may still petition for a license under 37 CFR 5.12, if a license is desired before the expiration of 6 months from the filing date of the application. If 6 months has lapsed from the filing date of this application and the licensee has not received any indication of a secrecy order under 35 U.S.C. 181, the licensee may foreign file the application pursuant to 37 CFR 5.15(b).

SelectUSA

The United States represents the largest, most dynamic marketplace in the world and is an unparalleled location for business investment, innovation, and commercialization of new technologies. The U.S. offers tremendous resources and advantages for those who invest and manufacture goods here. Through SelectUSA, our nation works to promote and facilitate business investment. SelectUSA provides information assistance to the international investor

community; serves as an ombudsman for existing and potential investors; advocates on behalf of U.S. cities, states, and regions competing for global investment; and counsels U.S. economic development organizations on investment attraction best practices. To learn more about why the United States is the best country in the world to develop technology, manufacture products, deliver services, and grow your business, visit <http://www.SelectUSA.gov> or call +1-202-482-6800.



UNITED STATES PATENT AND TRADEMARK OFFICE

UNITED STATES DEPARTMENT OF COMMERCE
United States Patent and Trademark Office
Address: COMMISSIONER FOR PATENTS
P.O. Box 1450
Alexandria, Virginia 22313-1450
www.uspto.gov

Table with 7 columns: APPLICATION NUMBER, FILING or 371(c) DATE, GRP ART UNIT, FIL FEE REC'D, ATTY.DOCKET.NO, TOT CLAIMS, IND CLAIMS. Row 1: 14/633,804, 02/27/2015, 2646, 1540, MOC-005, 28, 4

CONFIRMATION NO. 8573

CORRECTED FILING RECEIPT



51414
GOODWIN PROCTER LLP
PATENT ADMINISTRATOR
100 Northern Avenue
BOSTON, MA 02210

Date Mailed: 07/18/2016

Receipt is acknowledged of this non-provisional patent application. The application will be taken up for examination in due course. Applicant will be notified as to the results of the examination. Any correspondence concerning the application must include the following identification information: the U.S. APPLICATION NUMBER, FILING DATE, NAME OF APPLICANT, and TITLE OF INVENTION. Fees transmitted by check or draft are subject to collection. Please verify the accuracy of the data presented on this receipt. If an error is noted on this Filing Receipt, please submit a written request for a Filing Receipt Correction. Please provide a copy of this Filing Receipt with the changes noted thereon. If you received a "Notice to File Missing Parts" for this application, please submit any corrections to this Filing Receipt with your reply to the Notice. When the USPTO processes the reply to the Notice, the USPTO will generate another Filing Receipt incorporating the requested corrections

Inventor(s)

Malcolm K. Beyer JR., Jupiter, FL;
Christopher R. Rice, Redmond, WA;

Applicant(s)

Advanced Ground Information Systems, Inc., Jupiter, FL;

Assignment For Published Patent Application

Advanced Ground Information Systems, Inc., Jupiter, FL

Power of Attorney: The patent practitioners associated with Customer Number 051414

Domestic Priority data as claimed by applicant

This application is a CON of 14/529,978 10/31/2014
which is a CIP of 14/027,410 09/16/2013 PAT 8880042
which is a CON of 13/751,453 01/28/2013 PAT 8538393
which is a CIP of 12/761,533 04/16/2010 PAT 8364129
which is a CIP of 11/615,472 12/22/2006 PAT 8126441
which is a CIP of 11/308,648 04/17/2006 PAT 7630724
which is a CIP of 10/711,490 09/21/2004 PAT 7031728

Foreign Applications for which priority is claimed (You may be eligible to benefit from the Patent Prosecution Highway program at the USPTO. Please see http://www.uspto.gov for more information.) - None.

Foreign application information must be provided in an Application Data Sheet in order to constitute a claim to foreign priority. See 37 CFR 1.55 and 1.76.

Permission to Access Application via Priority Document Exchange: Yes

Permission to Access Search Results: No

Applicant may provide or rescind an authorization for access using Form PTO/SB/39 or Form PTO/SB/69 as appropriate.

If Required, Foreign Filing License Granted: 03/19/2015

The country code and number of your priority application, to be used for filing abroad under the Paris Convention, is **US 14/633,804**

Projected Publication Date: Not Applicable

Non-Publication Request: No

Early Publication Request: No

**** SMALL ENTITY ****

Title

METHOD TO PROVIDE AD HOC AND PASSWORD PROTECTED DIGITAL AND VOICE NETWORKS

Preliminary Class

455

Statement under 37 CFR 1.55 or 1.78 for AIA (First Inventor to File) Transition Applications: Yes

PROTECTING YOUR INVENTION OUTSIDE THE UNITED STATES

Since the rights granted by a U.S. patent extend only throughout the territory of the United States and have no effect in a foreign country, an inventor who wishes patent protection in another country must apply for a patent in a specific country or in regional patent offices. Applicants may wish to consider the filing of an international application under the Patent Cooperation Treaty (PCT). An international (PCT) application generally has the same effect as a regular national patent application in each PCT-member country. The PCT process **simplifies** the filing of patent applications on the same invention in member countries, but **does not result** in a grant of "an international patent" and does not eliminate the need of applicants to file additional documents and fees in countries where patent protection is desired.

Almost every country has its own patent law, and a person desiring a patent in a particular country must make an application for patent in that country in accordance with its particular laws. Since the laws of many countries differ in various respects from the patent law of the United States, applicants are advised to seek guidance from specific foreign countries to ensure that patent rights are not lost prematurely.

Applicants also are advised that in the case of inventions made in the United States, the Director of the USPTO must issue a license before applicants can apply for a patent in a foreign country. The filing of a U.S. patent application serves as a request for a foreign filing license. The application's filing receipt contains further information and guidance as to the status of applicant's license for foreign filing.

Applicants may wish to consult the USPTO booklet, "General Information Concerning Patents" (specifically, the section entitled "Treaties and Foreign Patents") for more information on timeframes and deadlines for filing foreign patent applications. The guide is available either by contacting the USPTO Contact Center at 800-786-9199, or it can be viewed on the USPTO website at <http://www.uspto.gov/web/offices/pac/doc/general/index.html>.

For information on preventing theft of your intellectual property (patents, trademarks and copyrights), you may wish to consult the U.S. Government website, <http://www.stopfakes.gov>. Part of a Department of Commerce initiative, this website includes self-help "toolkits" giving innovators guidance on how to protect intellectual property in specific countries such as China, Korea and Mexico. For questions regarding patent enforcement issues, applicants may call the U.S. Government hotline at 1-866-999-HALT (1-866-999-4258).

**LICENSE FOR FOREIGN FILING UNDER
Title 35, United States Code, Section 184
Title 37, Code of Federal Regulations, 5.11 & 5.15**

GRANTED

The applicant has been granted a license under 35 U.S.C. 184, if the phrase "IF REQUIRED, FOREIGN FILING LICENSE GRANTED" followed by a date appears on this form. Such licenses are issued in all applications where the conditions for issuance of a license have been met, regardless of whether or not a license may be required as set forth in 37 CFR 5.15. The scope and limitations of this license are set forth in 37 CFR 5.15(a) unless an earlier license has been issued under 37 CFR 5.15(b). The license is subject to revocation upon written notification. The date indicated is the effective date of the license, unless an earlier license of similar scope has been granted under 37 CFR 5.13 or 5.14.

This license is to be retained by the licensee and may be used at any time on or after the effective date thereof unless it is revoked. This license is automatically transferred to any related applications(s) filed under 37 CFR 1.53(d). This license is not retroactive.

The grant of a license does not in any way lessen the responsibility of a licensee for the security of the subject matter as imposed by any Government contract or the provisions of existing laws relating to espionage and the national security or the export of technical data. Licensees should apprise themselves of current regulations especially with respect to certain countries, of other agencies, particularly the Office of Defense Trade Controls, Department of State (with respect to Arms, Munitions and Implements of War (22 CFR 121-128)); the Bureau of Industry and Security, Department of Commerce (15 CFR parts 730-774); the Office of Foreign Assets Control, Department of Treasury (31 CFR Parts 500+) and the Department of Energy.

NOT GRANTED

No license under 35 U.S.C. 184 has been granted at this time, if the phrase "IF REQUIRED, FOREIGN FILING LICENSE GRANTED" DOES NOT appear on this form. Applicant may still petition for a license under 37 CFR 5.12, if a license is desired before the expiration of 6 months from the filing date of the application. If 6 months has lapsed from the filing date of this application and the licensee has not received any indication of a secrecy order under 35 U.S.C. 181, the licensee may foreign file the application pursuant to 37 CFR 5.15(b).

SelectUSA

The United States represents the largest, most dynamic marketplace in the world and is an unparalleled location for business investment, innovation, and commercialization of new technologies. The U.S. offers tremendous resources and advantages for those who invest and manufacture goods here. Through SelectUSA, our nation works to promote and facilitate business investment. SelectUSA provides information assistance to the international investor

community; serves as an ombudsman for existing and potential investors; advocates on behalf of U.S. cities, states, and regions competing for global investment; and counsels U.S. economic development organizations on investment attraction best practices. To learn more about why the United States is the best country in the world to develop technology, manufacture products, deliver services, and grow your business, visit <http://www.SelectUSA.gov> or call +1-202-482-6800.



UNITED STATES PATENT AND TRADEMARK OFFICE

UNITED STATES DEPARTMENT OF COMMERCE
United States Patent and Trademark Office
Address: COMMISSIONER FOR PATENTS
P.O. Box 1450
Alexandria, Virginia 22313-1450
www.uspto.gov

Table with 5 columns: APPLICATION NO., FILING DATE, FIRST NAMED INVENTOR, ATTORNEY DOCKET NO., CONFIRMATION NO.
Row 1: 14/633,804, 02/27/2015, Malcolm K. Beyer JR., MOC-005, 8573
Row 2: 51414, 7590, 07/26/2016, GOODWIN PROCTER LLP, PATENT ADMINISTRATOR, 100 Northern Avenue, BOSTON, MA 02210, EXAMINER OBAYANJU, OMONIYI
Row 3: ART UNIT 2646, PAPER NUMBER
Row 4: NOTIFICATION DATE 07/26/2016, DELIVERY MODE ELECTRONIC

Please find below and/or attached an Office communication concerning this application or proceeding.

The time period for reply, if any, is set in the attached communication.

Notice of the Office communication was sent electronically on above-indicated "Notification Date" to the following e-mail address(es):

PATENTBOS@GOODWINPROCTER.COM
PSOUSA-ATWOOD@GOODWINPROCTER.COM
GLENN.WILLIAMS@GOODWINPROCTER.COM



UNITED STATES PATENT AND TRADEMARK OFFICE

Commissioner for Patents
United States Patent and Trademark Office
P.O. Box 1450
Alexandria, VA 22313-1450
www.uspto.gov

Application No. : 14633804
Applicant : Beyer, Jr.
Filing Date : 02/27/2015
Date Mailed : 07/26/2016

NOTICE TO FILE CORRECTED APPLICATION PAPERS

Notice of Allowance Mailed

This application has been accorded an Allowance Date and is being prepared for issuance. The application, however, is incomplete for the reasons below.

Applicant is given two (2) months from the mail date of this Notice within which to respond. This time period for reply is extendable under 37 CFR 1.136(a) for only TWO additional MONTHS.

The application is not in compliance with 37 CFR 1.78, as indicated in the attachment. The consequences of failure to respond within the above-identified time period are set forth in the attachment.

Even if the Office has recognized a benefit claim and has entered it into the Office's database and included it on applicant's filing receipt, the benefit claim is not a proper benefit claim unless the reference in compliance with 37 CFR 1.78 is included, depending upon the application's filing date and as indicated in the attachment, in an application data sheet or in the first sentence(s) of the specification and all other requirements are met.

See attachment.

*A copy of this notice **MUST** be returned with the reply. Please address response to "Mail Stop Issue Fee, Commissioner for Patents, P.O. Box 1450, Alexandria, VA 22313-1450".*

/Marty Willis/
Publication Branch
Office of Data Management
(571) 272-4200

Application No. 14633804

**APPLICATION FILED ON OR AFTER MARCH 16, 2013,
NOT IN COMPLIANCE WITH 37 CFR 1.78**

- The 37 CFR 1.78(c)(2) reference on the application data sheet does not indicate the relationship (continuation, division, continuation-in-part) to the prior U.S. nonprovisional application or international application designating the U.S. See document coded dated , listing application number(s) .
- The 37 CFR 1.78(c)(2) reference on the application data sheet does not provide the U.S. nonprovisional application number (series code and serial number) or, with respect to an international PCT application designating the U.S., it provides the international application number or international filing date but not both. See document coded dated , in which the following is missing: .
- The 37 CFR 1.78(c)(2) reference on the application data sheet shows an incorrect, incomplete, or illegible U.S. nonprovisional application number, international PCT application number, or international PCT filing date. See document coded ADS dated 01/20/2016, in which the following error was made: "14/695,233" appears in place of "This application 14/633,804".
- The 37 CFR 1.78(c)(2) reference to the prior U.S. nonprovisional application or international application designating the U.S. is not present on an application data sheet, thus removing the validating link under 35 U.S.C. 119(a)-(d) to a prior foreign application or under 35 U.S.C. 119(e) to a prior U.S. provisional application.
- The 37 CFR 1.78(c)(2) reference to the prior U.S. nonprovisional application or international application designating the U.S. is not present on an application data sheet.
- The 37 CFR 1.78(a)(3) reference to the prior U.S. provisional application is not present on an application data sheet.
- The 37 CFR 1.78(a)(3) reference to the prior U.S. provisional application on an application data sheet does not provide the provisional application number (series code and serial number). See document coded dated , in which the following is missing: .
- The 37 CFR 1.78(a)(3) reference to the prior U.S. provisional application on an application data sheet shows an incorrect, incomplete, or illegible U.S. provisional application number. See document coded dated , in which the following error was made: .
- Other: .

HOW TO RESPOND

A proper response to this notice would include: (1) a corrected Application Data Sheet (ADS) pursuant to 37 CFR 1.76(c) which provides the benefit information from the attached filing receipt which would make the benefit information comply with 37 CFR 1.78(c)(2) or 37 CFR 1.78(a)(3) or (2) a petition filed pursuant to the provisions of 37 CFR 1.78(b) or 37 CFR 1.78(d) if the benefit information from the attached filing receipt does not accurately reflect the benefits under 35 U.S.C. 119(e), 120, 121 or 365(c) as claimed by applicant (a grantable petition would include a corrected ADS as required by 37 CFR 1.78(b)(1) or 37 CFR 1.78(d)(1)).

WARNING: If Applicant fails to timely submit a proper response, the benefit information will be deleted and the patent will be printed without the benefit information present.

Docket No.: MOC-005
(PATENT)

IN THE UNITED STATES PATENT AND TRADEMARK OFFICE

In re Patent Application of:
Malcolm K. Beyer, Jr. et al.

Application No.: 14/633,804

Confirmation No.: 8573

Filed: February 27, 2015

Art Unit: 2646

For: METHOD TO PROVIDE AD HOC AND
PASSWORD PROTECTED DIGITAL AND
VOICE NETWORKS

Examiner: O. Obayanju

Commissioner for Patents
P.O. Box 1450
Alexandria, VA 22313-1450

RESPONSE TO NOTICE TO FILE CORRECTED APPLICATION PAPERS

In response to the Notice to File Corrected Application Papers mailed July 26, 2016 (“the Notice”), Applicant respectfully submits a Corrected Application Data Sheet (ADS). As indicated in the Notice, the ADS filed on January 20, 2016, listed the serial number of the present application incorrectly. In the Corrected ADS filed herewith, the serial number of the present application is correctly listed as 14/633,804.

Respectfully submitted,

Date: August 11, 2016

/Daniel J. Burns/

Daniel J. Burns

Reg. No. 50,222

Customer Number 51414
GOODWIN PROCTER LLP
Telephone: (650) 752-3137
Facsimile: (650) 853-1038

Corrected Application Data Sheet

Inventor Information

Inventor Number:: 1
Name Prefix:: Mr.
Given Name:: Malcolm
Middle Name:: K.
Family Name:: Beyer
Name Suffix:: Jr.
City of Residence:: Jupiter
State or Province of Residence:: FL
Country of Residence:: US
Street of mailing address:: 92 Lighthouse Drive
City of mailing address:: Jupiter
State or Province of mailing address:: FL
Postal or Zip Code of mailing address:: 33469

Inventor Number:: 2
Name Prefix:: Mr.
Given Name:: Christopher
Middle Name:: R.
Family Name:: Rice
City of Residence:: Redmond
State or Province of Residence:: WA
Country of Residence:: US

Street of mailing address:: P.O. Box 3583
City of mailing address:: Redmond
State or Province of mailing address:: WA
Postal or Zip Code of mailing address:: 98073

Correspondence Information

Correspondence Customer Number:: 051414
Email Address:: patentbos@goodwinprocter.com

Application Information

Application Number:: 14/633,804
Filing Date:: 02/27/15
Application Type:: Regular
Subject Matter:: Utility
CD-ROM or CD-R?:: None
Sequence submission?:: None
Computer Readable Form (CRF)?:: No
Title:: METHOD TO PROVIDE AD HOC
AND PASSWORD PROTECTED
DIGITAL AND VOICE NETWORKS
Attorney Docket Number:: MOC-005
Request for Early Publication?:: No
Request for Non-Publication?:: No
Small Entity?:: No

Drawing Sheets::	7
Petition included?::	No
Portions or all of the application associated with this Application Data Sheet may fall under a Secrecy Order pursuant to 37 CFR 5.2::	No
Authorization to Permit Access to the Instant Application by the Participating Offices::	No

Representative Information

Representative Customer Number::	051414
----------------------------------	--------

Domestic Priority Information

Prior Application Status::	Pending
Application Number::	14/695,233 <u>This application 14/633,804</u>
Continuity Type::	Continuation of
Prior Application Number::	14/529,978
Filing Date::	10/31/2014
Prior Application Status::	Patented
Application Number::	14/529,978
Continuity Type::	Continuation in part of
Prior Application Number::	14/027,410
Filing Date::	09/16/2013
Patent Number::	8,880,042

Issue Date:: 11/04/2014

Prior Application Status:: Patented

Application Number:: 14/027,410

Continuity Type:: Continuation of

Prior Application Number:: 13/751,453

Filing Date:: 01/28/2013

Patent Number:: 8,538,393

Issue Date:: 09/17/2013

Prior Application Status:: Patented

Application Number:: 13/751,453

Continuity Type:: Continuation in part of

Prior Application Number:: 12/761,533

Filing Date:: 04/16/2010

Patent Number:: 8,364,129

Issue Date:: 01/29/2013

Prior Application Status:: Patented

Application Number:: 12/761,533

Continuity Type:: Continuation in part of

Prior Application Number:: 11/615,472

Filing Date:: 12/22/2006

Patent Number:: 8,126,441

Issue Date:: 02/28/2012
Prior Application Status:: Patented
Application Number:: 11/615,472
Continuity Type:: Continuation in part of
Prior Application Number:: 11/308,648
Filing Date:: 04/17/2006
Patent Number:: 7,630,724
Issue Date:: 12/08/2009

Prior Application Status:: Patented
Application Number:: 11/308,648
Continuity Type:: Continuation in part of
Prior Application Number:: 10/711,490
Filing Date:: 09/21/2004
Patent Number:: 7,031,728
Issue Date:: 04/18/2006

Foreign Priority Information

Applicant Information

Applicant Number:: 1
Applicant Type:: Assignee
Organization Name:: Advanced Ground Information

Systems, Inc.
 Street of mailing address:: 92 Lighthouse Drive
 City of mailing address:: Jupiter
 State or Province of mailing address:: FL
 Postal or Zip Code of mailing address:: 33469

Assignee Information Including Non-Applicant Assignee Information

Assignee:: 1
 Organization Name:: Advanced Ground Information
 Systems, Inc.
 Street of mailing address:: 92 Lighthouse Drive
 City of mailing address:: Jupiter
 State or Province of mailing address:: FL
 Postal or Zip Code of mailing address:: 33469

Signature:

NOTE: This Application Data Sheet must be signed in accordance with 37 CFR 1.33(b). **However, if this Application Data Sheet is submitted with the INITIAL filing of the application and either box A or B is not checked in subsection 2 of the "Authorization or Opt-Out of Authorization to Permit Access" section, then this form must also be signed in accordance with 37 CFR 1.14(c).**

This Application Data Sheet **must** be signed by a patent practitioner if one or more of the applicants is a **juristic entity** (e.g., corporation or association). If the applicant is two or more joint inventors, this form must be signed by a patent practitioner, **all** joint inventors who are the applicant, or one or more joint inventor-applicants who have been given power of attorney (e.g., see USPTO Form PTO/AIA/81) on behalf of **all** joint inventor-applicants.

See 37 CFR 1.4(d) for the manner of making signatures and certifications.

Signature	/Daniel J. Burns/	Date (YYYY-MM-DD)	2016-08-11
Name	Daniel J. Burns	Registration Number	50,222

Electronic Acknowledgement Receipt

EFS ID:	26593626
Application Number:	14633804
International Application Number:	
Confirmation Number:	8573
Title of Invention:	METHOD TO PROVIDE AD HOC AND PASSWORD PROTECTED DIGITAL AND VOICE NETWORKS
First Named Inventor/Applicant Name:	Malcolm K. Beyer
Customer Number:	51414
Filer:	Daniel J. Burns/Deanna Bridges
Filer Authorized By:	Daniel J. Burns
Attorney Docket Number:	MOC-005
Receipt Date:	11-AUG-2016
Filing Date:	27-FEB-2015
Time Stamp:	15:33:57
Application Type:	Utility under 35 USC 111(a)

Payment information:

Submitted with Payment	no
------------------------	----

File Listing:

Document Number	Document Description	File Name	File Size(Bytes)/ Message Digest	Multi Part /.zip	Pages (if appl.)
1	Post Allowance Communication - Incoming	MOC-005_NTFCAP.pdf	123851 013922463a3559b13d199f8f3039c9417daf eb3a	no	3

Warnings:

Information:					
2	Transmittal Letter	MOC-005_NTFCAP_Response.pdf	76058 217246f19cf304ed3fd8696a79c1bae3b2322000	no	1
Warnings:					
Information:					
3	Application Data Sheet	MOC-005_Corrected_ADS.pdf	69333 500a7dec2fd2bfabc9dd135160a8b7819de5ba86	no	6
Warnings:					
Information:					
This is not an USPTO supplied ADS fillable form					
Total Files Size (in bytes):			269242		
<p>This Acknowledgement Receipt evidences receipt on the noted date by the USPTO of the indicated documents, characterized by the applicant, and including page counts, where applicable. It serves as evidence of receipt similar to a Post Card, as described in MPEP 503.</p> <p><u>New Applications Under 35 U.S.C. 111</u> If a new application is being filed and the application includes the necessary components for a filing date (see 37 CFR 1.53(b)-(d) and MPEP 506), a Filing Receipt (37 CFR 1.54) will be issued in due course and the date shown on this Acknowledgement Receipt will establish the filing date of the application.</p> <p><u>National Stage of an International Application under 35 U.S.C. 371</u> If a timely submission to enter the national stage of an international application is compliant with the conditions of 35 U.S.C. 371 and other applicable requirements a Form PCT/DO/EO/903 indicating acceptance of the application as a national stage submission under 35 U.S.C. 371 will be issued in addition to the Filing Receipt, in due course.</p> <p><u>New International Application Filed with the USPTO as a Receiving Office</u> If a new international application is being filed and the international application includes the necessary components for an international filing date (see PCT Article 11 and MPEP 1810), a Notification of the International Application Number and of the International Filing Date (Form PCT/RO/105) will be issued in due course, subject to prescriptions concerning national security, and the date shown on this Acknowledgement Receipt will establish the international filing date of the application.</p>					



UNITED STATES PATENT AND TRADEMARK OFFICE

UNITED STATES DEPARTMENT OF COMMERCE
United States Patent and Trademark Office
Address: COMMISSIONER FOR PATENTS
P.O. Box 1450
Alexandria, Virginia 22313-1450
www.uspto.gov

Table with 5 columns: APPLICATION NO., FILING DATE, FIRST NAMED INVENTOR, ATTORNEY DOCKET NO., CONFIRMATION NO. Includes fields for EXAMINER (OBAYANJU, OMONIYI), ART UNIT (2646), PAPER NUMBER, NOTIFICATION DATE (07/26/2016), and DELIVERY MODE (ELECTRONIC).

Please find below and/or attached an Office communication concerning this application or proceeding.

The time period for reply, if any, is set in the attached communication.

Notice of the Office communication was sent electronically on above-indicated "Notification Date" to the following e-mail address(es):

PATENTBOS@GOODWINPROCTER.COM
PSOUSA-ATWOOD@GOODWINPROCTER.COM
GLENN.WILLIAMS@GOODWINPROCTER.COM



UNITED STATES PATENT AND TRADEMARK OFFICE

Commissioner for Patents
United States Patent and Trademark Office
P.O. Box 1450
Alexandria, VA 22313-1450
www.uspto.gov

Application No. : 14633804
Applicant : Beyer, Jr.
Filing Date : 02/27/2015
Date Mailed : 07/26/2016

NOTICE TO FILE CORRECTED APPLICATION PAPERS

Notice of Allowance Mailed

This application has been accorded an Allowance Date and is being prepared for issuance. The application, however, is incomplete for the reasons below.

Applicant is given two (2) months from the mail date of this Notice within which to respond. This time period for reply is extendable under 37 CFR 1.136(a) for only TWO additional MONTHS.

The application is not in compliance with 37 CFR 1.78, as indicated in the attachment. The consequences of failure to respond within the above-identified time period are set forth in the attachment.

Even if the Office has recognized a benefit claim and has entered it into the Office's database and included it on applicant's filing receipt, the benefit claim is not a proper benefit claim unless the reference in compliance with 37 CFR 1.78 is included, depending upon the application's filing date and as indicated in the attachment, in an application data sheet or in the first sentence(s) of the specification and all other requirements are met.

See attachment.

*A copy of this notice **MUST** be returned with the reply. Please address response to
"Mail Stop Issue Fee, Commissioner for Patents,
P.O. Box 1450, Alexandria, VA 22313-1450".*

/Marty Willis/
Publication Branch
Office of Data Management
(571) 272-4200

Application No. 14633804

**APPLICATION FILED ON OR AFTER MARCH 16, 2013,
NOT IN COMPLIANCE WITH 37 CFR 1.78**

- The 37 CFR 1.78(c)(2) reference on the application data sheet does not indicate the relationship (continuation, division, continuation-in-part) to the prior U.S. nonprovisional application or international application designating the U.S. See document coded , dated , listing application number(s) .
- The 37 CFR 1.78(c)(2) reference on the application data sheet does not provide the U.S. nonprovisional application number (series code and serial number) or, with respect to an international PCT application designating the U.S., it provides the international application number or international filing date but not both. See document coded , dated , in which the following is missing: .
- The 37 CFR 1.78(c)(2) reference on the application data sheet shows an incorrect, incomplete, or illegible U.S. nonprovisional application number, international PCT application number, or international PCT filing date. See document coded ADS dated 01/20/2016, in which the following error was made: "14/695,233" appears in place of "This application 14/633,804".
- The 37 CFR 1.78(c)(2) reference to the prior U.S. nonprovisional application or international application designating the U.S. is not present on an application data sheet, thus removing the validating link under 35 U.S.C. 119(a)-(d) to a prior foreign application or under 35 U.S.C. 119(e) to a prior U.S. provisional application.
- The 37 CFR 1.78(c)(2) reference to the prior U.S. nonprovisional application or international application designating the U.S. is not present on an application data sheet.
- The 37 CFR 1.78(a)(3) reference to the prior U.S. provisional application is not present on an application data sheet.
- The 37 CFR 1.78(a)(3) reference to the prior U.S. provisional application on an application data sheet does not provide the provisional application number (series code and serial number). See document coded , dated , in which the following is missing: .
- The 37 CFR 1.78(a)(3) reference to the prior U.S. provisional application on an application data sheet shows an incorrect, incomplete, or illegible U.S. provisional application number. See document coded , dated , in which the following error was made: .
- Other: .

HOW TO RESPOND

A proper response to this notice would include: (1) a corrected Application Data Sheet (ADS) pursuant to 37 CFR 1.76(c) which provides the benefit information from the attached filing receipt which would make the benefit information comply with 37 CFR 1.78(c)(2) or 37 CFR 1.78(a)(3) or (2) a petition filed pursuant to the provisions of 37 CFR 1.78(b) or 37 CFR 1.78(d) if the benefit information from the attached filing receipt does not accurately reflect the benefits under 35 U.S.C. 119(e), 120, 121 or 365(c) as claimed by applicant (a grantable petition would include a corrected ADS as required by 37 CFR 1.78(b)(1) or 37 CFR 1.78(d)(1)).

WARNING: If Applicant fails to timely submit a proper response, the benefit information will be deleted and the patent will be printed without the benefit information present.



UNITED STATES PATENT AND TRADEMARK OFFICE

UNITED STATES DEPARTMENT OF COMMERCE
United States Patent and Trademark Office
Address: COMMISSIONER FOR PATENTS
P.O. Box 1450
Alexandria, Virginia 22313-1450
www.uspto.gov

Table with 7 columns: APPLICATION NUMBER, FILING or 371(c) DATE, GRP ART UNIT, FIL FEE REC'D, ATTY DOCKET NO, TOT CLAIMS, IND CLAIMS. Row 1: 14/633,804, 02/27/2015, 2646, 1540, MOC-005, 28, 4

CONFIRMATION NO. 8573

CORRECTED FILING RECEIPT



51414
GOODWIN PROCTER LLP
PATENT ADMINISTRATOR
100 Northern Avenue
BOSTON, MA 02210

Date Mailed: 08/15/2016

Receipt is acknowledged of this non-provisional patent application. The application will be taken up for examination in due course. Applicant will be notified as to the results of the examination. Any correspondence concerning the application must include the following identification information: the U.S. APPLICATION NUMBER, FILING DATE, NAME OF APPLICANT, and TITLE OF INVENTION. Fees transmitted by check or draft are subject to collection. Please verify the accuracy of the data presented on this receipt. If an error is noted on this Filing Receipt, please submit a written request for a Filing Receipt Correction. Please provide a copy of this Filing Receipt with the changes noted thereon. If you received a "Notice to File Missing Parts" for this application, please submit any corrections to this Filing Receipt with your reply to the Notice. When the USPTO processes the reply to the Notice, the USPTO will generate another Filing Receipt incorporating the requested corrections

Inventor(s)

Malcolm K. Beyer JR., Jupiter, FL;
Christopher R. Rice, Redmond, WA;

Applicant(s)

Advanced Ground Information Systems, Inc., Jupiter, FL;

Assignment For Published Patent Application

Advanced Ground Information Systems, Inc., Jupiter, FL

Power of Attorney: The patent practitioners associated with Customer Number 051414

Domestic Priority data as claimed by applicant

This application is a CON of 14/529,978 10/31/2014
which is a CIP of 14/027,410 09/16/2013 PAT 8880042
which is a CON of 13/751,453 01/28/2013 PAT 8538393
which is a CIP of 12/761,533 04/16/2010 PAT 8364129
which is a CIP of 11/615,472 12/22/2006 PAT 8126441
which is a CIP of 11/308,648 04/17/2006 PAT 7630724
which is a CIP of 10/711,490 09/21/2004 PAT 7031728

Foreign Applications for which priority is claimed (You may be eligible to benefit from the Patent Prosecution Highway program at the USPTO. Please see http://www.uspto.gov for more information.) - None.

Foreign application information must be provided in an Application Data Sheet in order to constitute a claim to foreign priority. See 37 CFR 1.55 and 1.76.

Permission to Access Application via Priority Document Exchange: Yes

Permission to Access Search Results: No

Applicant may provide or rescind an authorization for access using Form PTO/SB/39 or Form PTO/SB/69 as appropriate.

If Required, Foreign Filing License Granted: 03/19/2015

The country code and number of your priority application, to be used for filing abroad under the Paris Convention, is **US 14/633,804**

Projected Publication Date: Not Applicable

Non-Publication Request: No

Early Publication Request: No

**** SMALL ENTITY ****

Title

METHOD TO PROVIDE AD HOC AND PASSWORD PROTECTED DIGITAL AND VOICE NETWORKS

Preliminary Class

455

Statement under 37 CFR 1.55 or 1.78 for AIA (First Inventor to File) Transition Applications: Yes

PROTECTING YOUR INVENTION OUTSIDE THE UNITED STATES

Since the rights granted by a U.S. patent extend only throughout the territory of the United States and have no effect in a foreign country, an inventor who wishes patent protection in another country must apply for a patent in a specific country or in regional patent offices. Applicants may wish to consider the filing of an international application under the Patent Cooperation Treaty (PCT). An international (PCT) application generally has the same effect as a regular national patent application in each PCT-member country. The PCT process **simplifies** the filing of patent applications on the same invention in member countries, but **does not result** in a grant of "an international patent" and does not eliminate the need of applicants to file additional documents and fees in countries where patent protection is desired.

Almost every country has its own patent law, and a person desiring a patent in a particular country must make an application for patent in that country in accordance with its particular laws. Since the laws of many countries differ in various respects from the patent law of the United States, applicants are advised to seek guidance from specific foreign countries to ensure that patent rights are not lost prematurely.

Applicants also are advised that in the case of inventions made in the United States, the Director of the USPTO must issue a license before applicants can apply for a patent in a foreign country. The filing of a U.S. patent application serves as a request for a foreign filing license. The application's filing receipt contains further information and guidance as to the status of applicant's license for foreign filing.

Applicants may wish to consult the USPTO booklet, "General Information Concerning Patents" (specifically, the section entitled "Treaties and Foreign Patents") for more information on timeframes and deadlines for filing foreign patent applications. The guide is available either by contacting the USPTO Contact Center at 800-786-9199, or it can be viewed on the USPTO website at <http://www.uspto.gov/web/offices/pac/doc/general/index.html>.

For information on preventing theft of your intellectual property (patents, trademarks and copyrights), you may wish to consult the U.S. Government website, <http://www.stopfakes.gov>. Part of a Department of Commerce initiative, this website includes self-help "toolkits" giving innovators guidance on how to protect intellectual property in specific countries such as China, Korea and Mexico. For questions regarding patent enforcement issues, applicants may call the U.S. Government hotline at 1-866-999-HALT (1-866-999-4258).

**LICENSE FOR FOREIGN FILING UNDER
Title 35, United States Code, Section 184
Title 37, Code of Federal Regulations, 5.11 & 5.15**

GRANTED

The applicant has been granted a license under 35 U.S.C. 184, if the phrase "IF REQUIRED, FOREIGN FILING LICENSE GRANTED" followed by a date appears on this form. Such licenses are issued in all applications where the conditions for issuance of a license have been met, regardless of whether or not a license may be required as set forth in 37 CFR 5.15. The scope and limitations of this license are set forth in 37 CFR 5.15(a) unless an earlier license has been issued under 37 CFR 5.15(b). The license is subject to revocation upon written notification. The date indicated is the effective date of the license, unless an earlier license of similar scope has been granted under 37 CFR 5.13 or 5.14.

This license is to be retained by the licensee and may be used at any time on or after the effective date thereof unless it is revoked. This license is automatically transferred to any related applications(s) filed under 37 CFR 1.53(d). This license is not retroactive.

The grant of a license does not in any way lessen the responsibility of a licensee for the security of the subject matter as imposed by any Government contract or the provisions of existing laws relating to espionage and the national security or the export of technical data. Licensees should apprise themselves of current regulations especially with respect to certain countries, of other agencies, particularly the Office of Defense Trade Controls, Department of State (with respect to Arms, Munitions and Implements of War (22 CFR 121-128)); the Bureau of Industry and Security, Department of Commerce (15 CFR parts 730-774); the Office of Foreign Assets Control, Department of Treasury (31 CFR Parts 500+) and the Department of Energy.

NOT GRANTED

No license under 35 U.S.C. 184 has been granted at this time, if the phrase "IF REQUIRED, FOREIGN FILING LICENSE GRANTED" DOES NOT appear on this form. Applicant may still petition for a license under 37 CFR 5.12, if a license is desired before the expiration of 6 months from the filing date of the application. If 6 months has lapsed from the filing date of this application and the licensee has not received any indication of a secrecy order under 35 U.S.C. 181, the licensee may foreign file the application pursuant to 37 CFR 5.15(b).

SelectUSA

The United States represents the largest, most dynamic marketplace in the world and is an unparalleled location for business investment, innovation, and commercialization of new technologies. The U.S. offers tremendous resources and advantages for those who invest and manufacture goods here. Through SelectUSA, our nation works to promote and facilitate business investment. SelectUSA provides information assistance to the international investor

community; serves as an ombudsman for existing and potential investors; advocates on behalf of U.S. cities, states, and regions competing for global investment; and counsels U.S. economic development organizations on investment attraction best practices. To learn more about why the United States is the best country in the world to develop technology, manufacture products, deliver services, and grow your business, visit <http://www.SelectUSA.gov> or call +1-202-482-6800.



UNITED STATES PATENT AND TRADEMARK OFFICE

UNITED STATES DEPARTMENT OF COMMERCE
United States Patent and Trademark Office
Address: COMMISSIONER FOR PATENTS
P. O. Box 1450
Alexandria, Virginia 22313-1450
www.uspto.gov

Table with 5 columns: APPLICATION NO., ISSUE DATE, PATENT NO., ATTORNEY DOCKET NO., CONFIRMATION NO.
Row 1: 14/633,804, 09/13/2016, 9445251, MOC-005, 8573

51414 7590 08/24/2016
GOODWIN PROCTER LLP
PATENT ADMINISTRATOR
100 Northern Avenue
BOSTON, MA 02210

ISSUE NOTIFICATION

The projected patent number and issue date are specified above.

Determination of Patent Term Adjustment under 35 U.S.C. 154 (b)
(application filed on or after May 29, 2000)

The Patent Term Adjustment is 0 day(s). Any patent to issue from the above-identified application will include an indication of the adjustment on the front page.

If a Continued Prosecution Application (CPA) was filed in the above-identified application, the filing date that determines Patent Term Adjustment is the filing date of the most recent CPA.

Applicant will be able to obtain more detailed information by accessing the Patent Application Information Retrieval (PAIR) WEB site (http://pair.uspto.gov).

Any questions regarding the Patent Term Extension or Adjustment determination should be directed to the Office of Patent Legal Administration at (571)-272-7702. Questions relating to issue and publication fee payments should be directed to the Application Assistance Unit (AAU) of the Office of Data Management (ODM) at (571)-272-4200.

APPLICANT(s) (Please see PAIR WEB site http://pair.uspto.gov for additional applicants):

Malcolm K. Beyer JR., Jupiter, FL;
Advanced Ground Information Systems, Inc., Jupiter, FL;
Christopher R. Rice, Redmond, WA;

The United States represents the largest, most dynamic marketplace in the world and is an unparalleled location for business investment, innovation, and commercialization of new technologies. The USA offers tremendous resources and advantages for those who invest and manufacture goods here. Through SelectUSA, our nation works to encourage and facilitate business investment. To learn more about why the USA is the best country in the world to develop technology, manufacture products, and grow your business, visit SelectUSA.gov.

TO: <p style="text-align: center;">Mail Stop 8 Director of the U.S. Patent and Trademark Office P.O. Box 1450 Alexandria, VA 22313-1450</p>	REPORT ON THE FILING OR DETERMINATION OF AN ACTION REGARDING A PATENT OR TRADEMARK
--	---

In Compliance with 35 U.S.C. § 290 and/or 15 U.S.C. § 1116 you are hereby advised that a court action has been filed in the U.S. District Court for the Eastern District of Texas - Marshall Division on the following

Trademarks or Patents. (the patent action involves 35 U.S.C. § 292.);

DOCKET NO. 2:17-cv-00517-JRG	DATE FILED June 21, 2017	U.S. DISTRICT COURT Eastern District of Texas - Marshall Division
PLAINTIFF AGIS Software Development LLC		DEFENDANT ZTE Corporation , et al.
PATENT OR TRADEMARK NO.	DATE OF PATENT OR TRADEMARK	HOLDER OF PATENT OR TRADEMARK
1 8,213,970	July 3, 2012	AGIS Software Development LLC
2 9,408,055	August 2, 2016	AGIS Software Development LLC
3 9,445,251	September 13, 2016	AGIS Software Development LLC
4 9,467,838	October 11, 2016	AGIS Software Development LLC
5		

In the above—entitled case, the following patent(s)/ trademark(s) have been included:

DATE INCLUDED	INCLUDED BY <input type="checkbox"/> Amendment <input type="checkbox"/> Answer <input type="checkbox"/> Cross Bill <input type="checkbox"/> Other Pleading		
PATENT OR TRADEMARK NO.	DATE OF PATENT OR TRADEMARK	HOLDER OF PATENT OR TRADEMARK	
1			
2			
3			
4			
5			

In the above—entitled case, the following decision has been rendered or judgement issued:

DECISION/JUDGEMENT

CLERK	(BY) DEPUTY CLERK	DATE
-------	-------------------	------

Copy 1—Upon initiation of action, mail this copy to Director Copy 3—Upon termination of action, mail this copy to Director
 Copy 2—Upon filing document adding patent(s), mail this copy to Director Copy 4—Case file copy

TO: Mail Stop 8 Director of the U.S. Patent and Trademark Office P.O. Box 1450 Alexandria, VA 22313-1450	REPORT ON THE FILING OR DETERMINATION OF AN ACTION REGARDING A PATENT OR TRADEMARK
--	---

In Compliance with 35 U.S.C. § 290 and/or 15 U.S.C. § 1116 you are hereby advised that a court action has been filed in the U.S. District Court for the Eastern District of Texas - Marshall Division on the following

Trademarks or Patents. (the patent action involves 35 U.S.C. § 292.):

DOCKET NO. 2:17-cv-00515-JRG	DATE FILED June 21, 2017	U.S. DISTRICT COURT Eastern District of Texas - Marshall Division
PLAINTIFF AGIS Software Development LLC		DEFENDANT LG Electronics, Inc.
PATENT OR TRADEMARK NO.	DATE OF PATENT OR TRADEMARK	HOLDER OF PATENT OR TRADEMARK
1 8,213,970	July 3, 2012	AGIS Software Development LLC
2 9,408,055	August 2, 2016	AGIS Software Development LLC
3 9,445,251	September 13, 2016	AGIS Software Development LLC
4 9,467,838	October 11, 2016	AGIS Software Development LLC
5		

In the above—entitled case, the following patent(s)/ trademark(s) have been included:

DATE INCLUDED	INCLUDED BY <input type="checkbox"/> Amendment <input type="checkbox"/> Answer <input type="checkbox"/> Cross Bill <input type="checkbox"/> Other Pleading		
PATENT OR TRADEMARK NO.	DATE OF PATENT OR TRADEMARK	HOLDER OF PATENT OR TRADEMARK	
1			
2			
3			
4			
5			

In the above—entitled case, the following decision has been rendered or judgement issued:

DECISION/JUDGEMENT

CLERK	(BY) DEPUTY CLERK	DATE
-------	-------------------	------

Copy 1—Upon initiation of action, mail this copy to Director Copy 3—Upon termination of action, mail this copy to Director
 Copy 2—Upon filing document adding patent(s), mail this copy to Director Copy 4—Case file copy

TO: Mail Stop 8 Director of the U.S. Patent and Trademark Office P.O. Box 1450 Alexandria, VA 22313-1450	REPORT ON THE FILING OR DETERMINATION OF AN ACTION REGARDING A PATENT OR TRADEMARK
---	---

In Compliance with 35 U.S.C. § 290 and/or 15 U.S.C. § 1116 you are hereby advised that a court action has been filed in the U.S. District Court for the Eastern District of Texas - Marshall Division on the following

Trademarks or Patents. (the patent action involves 35 U.S.C. § 292.);

DOCKET NO. 2:17-cv-00513-JRG	DATE FILED June 21, 2017	U.S. DISTRICT COURT Eastern District of Texas - Marshall Division
PLAINTIFF AGIS Software Development LLC		DEFENDANT Huawei Device USA Inc., et al.
PATENT OR TRADEMARK NO.	DATE OF PATENT OR TRADEMARK	HOLDER OF PATENT OR TRADEMARK
1 8,213,970	July 3, 2012	AGIS Software Development LLC
2 9,408,055	August 2, 2016	AGIS Software Development LLC
3 9,445,251	September 13, 2016	AGIS Software Development LLC
4 9,467,838	October 11, 2016	AGIS Software Development LLC
5		

In the above—entitled case, the following patent(s)/ trademark(s) have been included:

DATE INCLUDED	INCLUDED BY <input type="checkbox"/> Amendment <input type="checkbox"/> Answer <input type="checkbox"/> Cross Bill <input type="checkbox"/> Other Pleading	
PATENT OR TRADEMARK NO.	DATE OF PATENT OR TRADEMARK	HOLDER OF PATENT OR TRADEMARK
1		
2		
3		
4		
5		

In the above—entitled case, the following decision has been rendered or judgement issued:

DECISION/JUDGEMENT

CLERK	(BY) DEPUTY CLERK	DATE
-------	-------------------	------

Copy 1—Upon initiation of action, mail this copy to Director Copy 3—Upon termination of action, mail this copy to Director
Copy 2—Upon filing document adding patent(s), mail this copy to Director Copy 4—Case file copy

TO: Mail Stop 8 Director of the U.S. Patent and Trademark Office P.O. Box 1450 Alexandria, VA 22313-1450	REPORT ON THE FILING OR DETERMINATION OF AN ACTION REGARDING A PATENT OR TRADEMARK
--	---

In Compliance with 35 U.S.C. § 290 and/or 15 U.S.C. § 1116 you are hereby advised that a court action has been filed in the U.S. District Court for the Eastern District of Texas - Marshall Division on the following

Trademarks or Patents. (the patent action involves 35 U.S.C. § 292.);

DOCKET NO. 2:17-cv-00516-JRG	DATE FILED June 21, 2017	U.S. DISTRICT COURT Eastern District of Texas - Marshall Division
PLAINTIFF AGIS Software Development LLC		DEFENDANT Apple, Inc.
PATENT OR TRADEMARK NO.	DATE OF PATENT OR TRADEMARK	HOLDER OF PATENT OR TRADEMARK
1 8,213,970	July 3, 2012	AGIS Software Development LLC
2 9,408,055	August 2, 2016	AGIS Software Development LLC
3 9,445,251	September 13, 2016	AGIS Software Development LLC
4 9,467,838	October 11, 2016	AGIS Software Development LLC
5		

In the above—entitled case, the following patent(s)/ trademark(s) have been included:

DATE INCLUDED	INCLUDED BY <input type="checkbox"/> Amendment <input type="checkbox"/> Answer <input type="checkbox"/> Cross Bill <input type="checkbox"/> Other Pleading	
PATENT OR TRADEMARK NO.	DATE OF PATENT OR TRADEMARK	HOLDER OF PATENT OR TRADEMARK
1		
2		
3		
4		
5		

In the above—entitled case, the following decision has been rendered or judgement issued:

DECISION/JUDGEMENT

CLERK	(BY) DEPUTY CLERK	DATE
-------	-------------------	------

Copy 1—Upon initiation of action, mail this copy to Director Copy 3—Upon termination of action, mail this copy to Director
 Copy 2—Upon filing document adding patent(s), mail this copy to Director Copy 4—Case file copy

TO: <p style="text-align: center;">Mail Stop 8 Director of the U.S. Patent and Trademark Office P.O. Box 1450 Alexandria, VA 22313-1450</p>	REPORT ON THE FILING OR DETERMINATION OF AN ACTION REGARDING A PATENT OR TRADEMARK
--	---

In Compliance with 35 U.S.C. § 290 and/or 15 U.S.C. § 1116 you are hereby advised that a court action has been filed in the U.S. District Court for the Eastern District of Texas - Marshall Division on the following

Trademarks or Patents. (the patent action involves 35 U.S.C. § 292.);

DOCKET NO. 2:17-cv-00514-JRG	DATE FILED June 21, 2017	U.S. DISTRICT COURT Eastern District of Texas - Marshall Division
PLAINTIFF AGIS Software Development LLC		DEFENDANT HTC Corporation
PATENT OR TRADEMARK NO.	DATE OF PATENT OR TRADEMARK	HOLDER OF PATENT OR TRADEMARK
1 8,213,970	July 3, 2012	AGIS Software Development LLC
2 9,408,055	August 2, 2016	AGIS Software Development LLC
3 9,445,251	September 13, 2016	AGIS Software Development LLC
4 9,467,838	October 11, 2016	AGIS Software Development LLC
5		

In the above--entitled case, the following patent(s)/ trademark(s) have been included:

DATE INCLUDED	INCLUDED BY <input type="checkbox"/> Amendment <input type="checkbox"/> Answer <input type="checkbox"/> Cross Bill <input type="checkbox"/> Other Pleading		
PATENT OR TRADEMARK NO.	DATE OF PATENT OR TRADEMARK	HOLDER OF PATENT OR TRADEMARK	
1			
2			
3			
4			
5			

In the above--entitled case, the following decision has been rendered or judgement issued:

DECISION/JUDGEMENT

CLERK	(BY) DEPUTY CLERK	DATE
-------	-------------------	------

Copy 1—Upon initiation of action, mail this copy to Director Copy 3—Upon termination of action, mail this copy to Director
 Copy 2—Upon filing document adding patent(s), mail this copy to Director Copy 4—Case file copy

AO 120 (Rev. 08/10)

TO: <p style="text-align: center;">Mail Stop 8 Director of the U.S. Patent and Trademark Office P.O. Box 1450 Alexandria, VA 22313-1450</p>	REPORT ON THE FILING OR DETERMINATION OF AN ACTION REGARDING A PATENT OR TRADEMARK
--	--

In Compliance with 35 U.S.C. § 290 and/or 15 U.S.C. § 1116 you are hereby advised that a court action has been filed in the U.S. District Court for the Eastern District of Texas - Marshall Division on the following

Trademarks or Patents. (the patent action involves 35 U.S.C. § 292.);

DOCKET NO. 2:17-cv-00515-JRG	DATE FILED June 21, 2017	U.S. DISTRICT COURT Eastern District of Texas - Marshall Division
PLAINTIFF AGIS Software Development LLC		DEFENDANT LG Electronics, Inc.
PATENT OR TRADEMARK NO.	DATE OF PATENT OR TRADEMARK	HOLDER OF PATENT OR TRADEMARK
1 8,213,970	July 3, 2012	AGIS Software Development LLC
2 9,408,055	August 2, 2016	AGIS Software Development LLC
3 9,445,251	September 13, 2016	AGIS Software Development LLC
4 9,467,838	October 11, 2016	AGIS Software Development LLC
5		

In the above—entitled case, the following patent(s)/ trademark(s) have been included:

DATE INCLUDED	INCLUDED BY <input type="checkbox"/> Amendment <input type="checkbox"/> Answer <input type="checkbox"/> Cross Bill <input type="checkbox"/> Other Pleading	
PATENT OR TRADEMARK NO.	DATE OF PATENT OR TRADEMARK	HOLDER OF PATENT OR TRADEMARK
1		
2		
3		
4		
5		

In the above—entitled case, the following decision has been rendered or judgement issued:

DECISION/JUDGEMENT

CLERK	(BY) DEPUTY CLERK	DATE
-------	-------------------	------

Copy 1—Upon initiation of action, mail this copy to Director Copy 3—Upon termination of action, mail this copy to Director
 Copy 2—Upon filing document adding patent(s), mail this copy to Director Copy 4—Case file copy

AO 120 (Rev. 08/10)

TO: Mail Stop 8 Director of the U.S. Patent and Trademark Office P.O. Box 1450 Alexandria, VA 22313-1450	REPORT ON THE FILING OR DETERMINATION OF AN ACTION REGARDING A PATENT OR TRADEMARK
---	---

In Compliance with 35 U.S.C. § 290 and/or 15 U.S.C. § 1116 you are hereby advised that a court action has been filed in the U.S. District Court for the Eastern District of Texas - Marshall Division on the following

Trademarks or Patents. (the patent action involves 35 U.S.C. § 292.);

DOCKET NO. 2:17-cv-00513-JRG	DATE FILED June 21, 2017	U.S. DISTRICT COURT Eastern District of Texas - Marshall Division
PLAINTIFF AGIS Software Development LLC		DEFENDANT Huawei Device USA Inc., et al.
PATENT OR TRADEMARK NO.	DATE OF PATENT OR TRADEMARK	HOLDER OF PATENT OR TRADEMARK
1 8,213,970	July 3, 2012	AGIS Software Development LLC
2 9,408,055	August 2, 2016	AGIS Software Development LLC
3 9,445,251	September 13, 2016	AGIS Software Development LLC
4 9,467,838	October 11, 2016	AGIS Software Development LLC
5		

In the above—entitled case, the following patent(s)/ trademark(s) have been included:

DATE INCLUDED	INCLUDED BY <input type="checkbox"/> Amendment <input type="checkbox"/> Answer <input type="checkbox"/> Cross Bill <input type="checkbox"/> Other Pleading	
PATENT OR TRADEMARK NO.	DATE OF PATENT OR TRADEMARK	HOLDER OF PATENT OR TRADEMARK
1		
2		
3		
4		
5		

In the above—entitled case, the following decision has been rendered or judgement issued:

DECISION/JUDGEMENT

CLERK	(BY) DEPUTY CLERK	DATE
-------	-------------------	------

Copy 1—Upon initiation of action, mail this copy to Director Copy 3—Upon termination of action, mail this copy to Director
 Copy 2—Upon filing document adding patent(s), mail this copy to Director Copy 4—Case file copy

AO 120 (Rev. 08/10)

TO: Mail Stop 8 Director of the U.S. Patent and Trademark Office P.O. Box 1450 Alexandria, VA 22313-1450	REPORT ON THE FILING OR DETERMINATION OF AN ACTION REGARDING A PATENT OR TRADEMARK
---	---

In Compliance with 35 U.S.C. § 290 and/or 15 U.S.C. § 1116 you are hereby advised that a court action has been filed in the U.S. District Court for the Eastern District of Texas - Marshall Division on the following

Trademarks or Patents. (the patent action involves 35 U.S.C. § 292.);

DOCKET NO. 2:17-cv-00514-JRG	DATE FILED June 21, 2017	U.S. DISTRICT COURT Eastern District of Texas - Marshall Division
PLAINTIFF AGIS Software Development LLC		DEFENDANT HTC Corporation
PATENT OR TRADEMARK NO.	DATE OF PATENT OR TRADEMARK	HOLDER OF PATENT OR TRADEMARK
1 8,213,970	July 3, 2012	AGIS Software Development LLC
2 9,408,055	August 2, 2016	AGIS Software Development LLC
3 9,445,251	September 13, 2016	AGIS Software Development LLC
4 9,467,838	October 11, 2016	AGIS Software Development LLC
5		

In the above—entitled case, the following patent(s)/ trademark(s) have been included:

DATE INCLUDED	INCLUDED BY <input type="checkbox"/> Amendment <input type="checkbox"/> Answer <input type="checkbox"/> Cross Bill <input type="checkbox"/> Other Pleading
PATENT OR TRADEMARK NO.	DATE OF PATENT OR TRADEMARK
1	HOLDER OF PATENT OR TRADEMARK
2	
3	
4	
5	

In the above—entitled case, the following decision has been rendered or judgement issued:

DECISION/JUDGEMENT

CLERK	(BY) DEPUTY CLERK	DATE
-------	-------------------	------

Copy 1—Upon initiation of action, mail this copy to Director Copy 3—Upon termination of action, mail this copy to Director
 Copy 2—Upon filing document adding patent(s), mail this copy to Director Copy 4—Case file copy

AO 120 (Rev. 08/10)

TO: Mail Stop 8 Director of the U.S. Patent and Trademark Office P.O. Box 1450 Alexandria, VA 22313-1450	REPORT ON THE FILING OR DETERMINATION OF AN ACTION REGARDING A PATENT OR TRADEMARK
---	---

In Compliance with 35 U.S.C. § 290 and/or 15 U.S.C. § 1116 you are hereby advised that a court action has been filed in the U.S. District Court for the Eastern District of Texas - Marshall Division on the following

Trademarks or Patents. (the patent action involves 35 U.S.C. § 292.);

DOCKET NO. 2:17-cv-00517-JRG	DATE FILED June 21, 2017	U.S. DISTRICT COURT Eastern District of Texas - Marshall Division
PLAINTIFF AGIS Software Development LLC		DEFENDANT ZTE Corporation , et al.
PATENT OR TRADEMARK NO.	DATE OF PATENT OR TRADEMARK	HOLDER OF PATENT OR TRADEMARK
1 8,213,970	July 3, 2012	AGIS Software Development LLC
2 9,408,055	August 2, 2016	AGIS Software Development LLC
3 9,445,251	September 13, 2016	AGIS Software Development LLC
4 9,467,838	October 11, 2016	AGIS Software Development LLC
5		

In the above—entitled case, the following patent(s)/ trademark(s) have been included:

DATE INCLUDED	INCLUDED BY <input type="checkbox"/> Amendment <input type="checkbox"/> Answer <input type="checkbox"/> Cross Bill <input type="checkbox"/> Other Pleading	
PATENT OR TRADEMARK NO.	DATE OF PATENT OR TRADEMARK	HOLDER OF PATENT OR TRADEMARK
1		
2		
3		
4		
5		

In the above—entitled case, the following decision has been rendered or judgement issued:

DECISION/JUDGEMENT

CLERK	(BY) DEPUTY CLERK	DATE
-------	-------------------	------

Copy 1—Upon initiation of action, mail this copy to Director Copy 3—Upon termination of action, mail this copy to Director
 Copy 2—Upon filing document adding patent(s), mail this copy to Director Copy 4—Case file copy

AO 120 (Rev. 08/10)

TO: Mail Stop 8 Director of the U.S. Patent and Trademark Office P.O. Box 1450 Alexandria, VA 22313-1450	REPORT ON THE FILING OR DETERMINATION OF AN ACTION REGARDING A PATENT OR TRADEMARK
---	---

In Compliance with 35 U.S.C. § 290 and/or 15 U.S.C. § 1116 you are hereby advised that a court action has been filed in the U.S. District Court for the Eastern District of Texas - Marshall Division on the following

Trademarks or Patents. (the patent action involves 35 U.S.C. § 292.);

DOCKET NO. 2:17-cv-00516-JRG	DATE FILED June 21, 2017	U.S. DISTRICT COURT Eastern District of Texas - Marshall Division
PLAINTIFF AGIS Software Development LLC		DEFENDANT Apple, Inc.
PATENT OR TRADEMARK NO.	DATE OF PATENT OR TRADEMARK	HOLDER OF PATENT OR TRADEMARK
1 8,213,970	July 3, 2012	AGIS Software Development LLC
2 9,408,055	August 2, 2016	AGIS Software Development LLC
3 9,445,251	September 13, 2016	AGIS Software Development LLC
4 9,467,838	October 11, 2016	AGIS Software Development LLC
5		

In the above—entitled case, the following patent(s)/ trademark(s) have been included:

DATE INCLUDED	INCLUDED BY <input type="checkbox"/> Amendment <input type="checkbox"/> Answer <input type="checkbox"/> Cross Bill <input type="checkbox"/> Other Pleading	
PATENT OR TRADEMARK NO.	DATE OF PATENT OR TRADEMARK	HOLDER OF PATENT OR TRADEMARK
1		
2		
3		
4		
5		

In the above—entitled case, the following decision has been rendered or judgement issued:

DECISION/JUDGEMENT

CLERK	(BY) DEPUTY CLERK	DATE
-------	-------------------	------

Copy 1—Upon initiation of action, mail this copy to Director Copy 3—Upon termination of action, mail this copy to Director
 Copy 2—Upon filing document adding patent(s), mail this copy to Director Copy 4—Case file copy