



UNITED STATES PATENT AND TRADEMARK OFFICE

UNITED STATES DEPARTMENT OF COMMERCE  
United States Patent and Trademark Office  
Address: COMMISSIONER FOR PATENTS  
P.O. Box 1450  
Alexandria, Virginia 22313-1450  
www.uspto.gov

APPLICATION NUMBER	FILING OR 371(C) DATE	FIRST NAMED APPLICANT	ATTY. DOCKET NO./TITLE
12/569,116	09/29/2009	Alan J. Lipton	4079-101

**CONFIRMATION NO. 7686**

**POWER OF ATTORNEY NOTICE**

6449  
ROTHWELL, FIGG, ERNST & MANBECK, P.C.  
607 14th Street, N.W.  
SUITE 800  
WASHINGTON, DC 20005



Date Mailed: 09/06/2017

**NOTICE REGARDING CHANGE OF POWER OF ATTORNEY**

This is in response to the Power of Attorney filed 08/28/2017.

- The Power of Attorney to you in this application has been revoked by the assignee who has intervened as provided by 37 CFR 3.71. Future correspondence will be mailed to the new address of record(37 CFR 1.33).

Questions about the contents of this notice and the requirements it sets forth should be directed to the Office of Data Management, Application Assistance Unit, at (571) 272-4000 or (571) 272-4200 or 1-888-786-0101.

/tnguyen/



UNITED STATES PATENT AND TRADEMARK OFFICE

UNITED STATES DEPARTMENT OF COMMERCE  
United States Patent and Trademark Office  
Address: COMMISSIONER FOR PATENTS  
P.O. Box 1450  
Alexandria, Virginia 22313-1450  
www.uspto.gov

APPLICATION NUMBER	FILING OR 371(C) DATE	FIRST NAMED APPLICANT	ATTY. DOCKET NO./TITLE
12/569,116	09/29/2009	Alan J. Lipton	4079-101

**CONFIRMATION NO. 7686**

**POA ACCEPTANCE LETTER**

145076  
Avigilon Corporation  
Box 378, #101-1001 West Broadway  
Vancouver, BC V6H 4E4  
CANADA



Date Mailed: 09/06/2017

**NOTICE OF ACCEPTANCE OF POWER OF ATTORNEY**

This is in response to the Power of Attorney filed 08/28/2017.

The Power of Attorney in this application is accepted. Correspondence in this application will be mailed to the above address as provided by 37 CFR 1.33.

Questions about the contents of this notice and the requirements it sets forth should be directed to the Office of Data Management, Application Assistance Unit, at (571) 272-4000 or (571) 272-4200 or 1-888-786-0101.

/tnguyen/

Under the Paperwork Reduction Act of 1995, no persons are required to respond to a collection of information unless it displays a valid OMB control number.

**POWER OF ATTORNEY TO PROSECUTE APPLICATIONS BEFORE THE USPTO**

I hereby revoke all previous powers of attorney given in the application identified in the attached statement under 37 CFR 3.73(c).

I hereby appoint:



Practitioners associated with Customer Number:

145076

OR



Practitioner(s) named below (if more than ten patent practitioners are to be named, then a customer number must be used):

Name	Registration Number

Name	Registration Number

As attorney(s) or agent(s) to represent the undersigned before the United States Patent and Trademark Office (USPTO) in connection with any and all patent applications assigned only to the undersigned according to the USPTO assignment records or assignments documents attached to this form in accordance with 37 CFR 3.73(c).

Please change the correspondence address for the application identified in the attached statement under 37 CFR 3.73(c) to:



The address associated with Customer Number:

145076

OR

<input type="checkbox"/>	Firm or Individual Name			
<input type="checkbox"/>	Address			
<input type="checkbox"/>	City	State	Zip	
<input type="checkbox"/>	Country			
<input type="checkbox"/>	Telephone	Email		

Assignee Name and Address: Avigilon Fortress Corporation  
2900 - 550 Burrard Street  
Vancouver, British Columbia, Canada V6C 0A3**A copy of this form, together with a statement under 37 CFR 3.73(c) (Form PTO/AIA/96 or equivalent) is required to be Filed in each application in which this form is used. The statement under 37 CFR 3.73(c) may be completed by one of The practitioners appointed in this form, and must identify the application in which this Power of Attorney is to be filed.****SIGNATURE of Assignee of Record**

The individual whose signature and title is supplied below is authorized to act on behalf of the assignee

Signature		Date	August 25, 2017
Name	Joel Schuster	Telephone	604-639-5182
Title	Secretary and Director		

This collection of information is required by 37 CFR 1.31, 1.32 and 1.33. The information is required to obtain or retain a benefit by the public which is to file (and by the USPTO to process) an application. Confidentiality is governed by 35 U.S.C. 122 and 37 CFR 1.11 and 1.14. This collection is estimated to take 3 minutes to complete, including gathering, preparing, and submitting the completed application form to the USPTO. Time will vary depending upon the individual case. Any comments on the amount of time you require to complete this form and/or suggestions for reducing this burden, should be sent to the Chief Information Officer, U.S. Patent and Trademark Office, U.S. Department of Commerce, P.O. Box 1450, Alexandria, VA 22313-1450. DO NOT SEND FEES OR COMPLETED FORMS TO THIS ADDRESS. SEND TO: Commissioner for Patents, P.O. Box 1450, Alexandria, VA 22313-1450.

If you need assistance in completing the form, call 1-800-PTO-9199 and select option 2.

## Privacy Act Statement

The **Privacy Act of 1974 (P.L. 93-579)** requires that you be given certain information in connection with your submission of the attached form related to a patent application or patent. Accordingly, pursuant to the requirements of the Act, please be advised that: (1) the general authority for the collection of this information is 35 U.S.C. 2(b)(2); (2) furnishing of the information solicited is voluntary; and (3) the principal purpose for which the information is used by the U.S. Patent and Trademark Office is to process and/or examine your submission related to a patent application or patent. If you do not furnish the requested information, the U.S. Patent and Trademark Office may not be able to process and/or examine your submission, which may result in termination of proceedings or abandonment of the application or expiration of the patent.

The information provided by you in this form will be subject to the following routine uses:

1. The information on this form will be treated confidentially to the extent allowed under the Freedom of Information Act (5 U.S.C. 552) and the Privacy Act (5 U.S.C. 552a). Records from this system of records may be disclosed to the Department of Justice to determine whether disclosure of these records is required by the Freedom of Information Act.
2. A record from this system of records may be disclosed, as a routine use, in the course of presenting evidence to a court, magistrate, or administrative tribunal, including disclosures to opposing counsel in the course of settlement negotiations.
3. A record in this system of records may be disclosed, as a routine use, to a Member of Congress submitting a request involving an individual, to whom the record pertains, when the individual has requested assistance from the Member with respect to the subject matter of the record.
4. A record in this system of records may be disclosed, as a routine use, to a contractor of the Agency having need for the information in order to perform a contract. Recipients of information shall be required to comply with the requirements of the Privacy Act of 1974, as amended, pursuant to 5 U.S.C. 552a(m).
5. A record related to an International Application filed under the Patent Cooperation Treaty in this system of records may be disclosed, as a routine use, to the International Bureau of the World Intellectual Property Organization, pursuant to the Patent Cooperation Treaty.
6. A record in this system of records may be disclosed, as a routine use, to another federal agency for purposes of National Security review (35 U.S.C. 181) and for review pursuant to the Atomic Energy Act (42 U.S.C. 218(c)).
7. A record from this system of records may be disclosed, as a routine use, to the Administrator, General Services, or his/her designee, during an inspection of records conducted by GSA as part of that agency's responsibility to recommend improvements in records management practices and programs, under authority of 44 U.S.C. 2904 and 2906. Such disclosure shall be made in accordance with the GSA regulations governing inspection of records for this purpose, and any other relevant (*i.e.*, GSA or Commerce) directive. Such disclosure shall not be used to make determinations about individuals.
8. A record from this system of records may be disclosed, as a routine use, to the public after either publication of the application pursuant to 35 U.S.C. 122(b) or issuance of a patent pursuant to 35 U.S.C. 151. Further, a record may be disclosed, subject to the limitations of 37 CFR 1.14, as a routine use, to the public if the record was filed in an application which became abandoned or in which the proceedings were terminated and which application is referenced by either a published application, an application open to public inspection or an issued patent.
9. A record from this system of records may be disclosed, as a routine use, to a Federal, State, or local law enforcement agency, if the USPTO becomes aware of a violation or potential violation of law or regulation.



Under the Paperwork Reduction Act of 1995, no persons are required to respond to a collection of information unless it displays a valid OMB control number.

**STATEMENT UNDER 37 CFR 3.73(c)**Applicant/Patent Owner: Avigilon Fortress CorporationApplication No./Patent No.: 7,932,923 Filed/Issue Date: April 26, 2011Titled: VIDEO SURVEILLANCE SYSTEM EMPLOYING VIDEO PRIMITIVESAvigilon Fortress Corporation, a Corporation

(Name of Assignee)

(Type of Assignee, e.g., corporation, partnership, university, government agency, etc.)

states that, for the patent application/patent identified above, it is (choose **one** of options 1, 2, 3 or 4 below):

1.  The assignee of the entire right, title, and interest.
2.  An assignee of less than the entire right, title, and interest (check applicable box):
- The extent (by percentage) of its ownership interest is \_\_\_\_\_%. Additional Statement(s) by the owners holding the balance of the interest must be submitted to account for 100% of the ownership interest.
- There are unspecified percentages of ownership. The other parties, including inventors, who together own the entire right, title and interest are:

Additional Statement(s) by the owner(s) holding the balance of the interest must be submitted to account for the entire right, title, and interest.

3.  The assignee of an undivided interest in the entirety (a complete assignment from one of the joint inventors was made). The other parties, including inventors, who together own the entire right, title, and interest are:

Additional Statement(s) by the owner(s) holding the balance of the interest must be submitted to account for the entire right, title, and interest.

4.  The recipient, via a court proceeding or the like (e.g., bankruptcy, probate), of an undivided interest in the entirety (a complete transfer of ownership interest was made). The certified document(s) showing the transfer is attached.

The interest identified in option 1, 2 or 3 above (not option 4) is evidenced by either (choose **one** of options A or B below):

- A.  An assignment from the inventor(s) of the patent application/patent identified above. The assignment was recorded in the United States Patent and Trademark Office at Reel \_\_\_\_\_, Frame \_\_\_\_\_, or for which a copy thereof is attached.
- B.  A chain of title from the inventor(s), of the patent application/patent identified above, to the current assignee as follows:

1. From: LIPTON, ALAN J., et al. To: DIAMONDBACK VISION, INCThe document was recorded in the United States Patent and Trademark Office at  
Reel 026900, Frame 0001, or for which a copy thereof is attached.2. From: DIAMONDBACK VISION, INC To: OBJECTVIDEO, INC.The document was recorded in the United States Patent and Trademark Office at  
Reel 031973, Frame 0593, or for which a copy thereof is attached.

[Page 1 of 2]

This collection of information is required by 37 CFR 3.73(b). The information is required to obtain or retain a benefit by the public which is to file (and by the USPTO to process) an application. Confidentiality is governed by 35 U.S.C. 122 and 37 CFR 1.11 and 1.14. This collection is estimated to take 12 minutes to complete, including gathering, preparing, and submitting the completed application form to the USPTO. Time will vary depending upon the individual case. Any comments on the amount of time you require to complete this form and/or suggestions for reducing this burden, should be sent to the Chief Information Officer, U.S. Patent and Trademark Office, U.S. Department of Commerce, P.O. Box 1450, Alexandria, VA 22313-1450. DO NOT SEND FEES OR COMPLETED FORMS TO THIS ADDRESS. **SEND TO: Commissioner for Patents, P.O. Box 1450, Alexandria, VA 22313-1450.**

If you need assistance in completing the form, call 1-800-PTO-9199 and select option 2.

Under the Paperwork Reduction Act of 1995, no persons are required to respond to a collection of information unless it displays a valid OMB control number.

**STATEMENT UNDER 37 CFR 3.73(c)**

3. From: OBJECTVIDEO, INC. To: AVIGILON FORTRESS CORPORATION

The document was recorded in the United States Patent and Trademark Office at  
Reel 034552, Frame 0376, or for which a copy thereof is attached.

4. From: \_\_\_\_\_ To: \_\_\_\_\_

The document was recorded in the United States Patent and Trademark Office at  
Reel \_\_\_\_\_, Frame \_\_\_\_\_, or for which a copy thereof is attached.

5. From: \_\_\_\_\_ To: \_\_\_\_\_

The document was recorded in the United States Patent and Trademark Office at  
Reel \_\_\_\_\_, Frame \_\_\_\_\_, or for which a copy thereof is attached.

6. From: \_\_\_\_\_ To: \_\_\_\_\_

The document was recorded in the United States Patent and Trademark Office at  
Reel \_\_\_\_\_, Frame \_\_\_\_\_, or for which a copy thereof is attached.

Additional documents in the chain of title are listed on a supplemental sheet(s).

As required by 37 CFR 3.73(c)(1)(i), the documentary evidence of the chain of title from the original owner to the assignee was, or concurrently is being, submitted for recordation pursuant to 37 CFR 3.11.

[NOTE: A separate copy (i.e., a true copy of the original assignment document(s)) must be submitted to Assignment Division in accordance with 37 CFR Part 3, to record the assignment in the records of the USPTO. See MPEP 302.08]

The undersigned (whose title is supplied below) is authorized to act on behalf of the assignee.

/Daniel Hammond/

Signature

Daniel Hammond

Printed or Typed Name

August 25, 2017

Date

56642

Title or Registration Number

## Privacy Act Statement

The **Privacy Act of 1974 (P.L. 93-579)** requires that you be given certain information in connection with your submission of the attached form related to a patent application or patent. Accordingly, pursuant to the requirements of the Act, please be advised that: (1) the general authority for the collection of this information is 35 U.S.C. 2(b)(2); (2) furnishing of the information solicited is voluntary; and (3) the principal purpose for which the information is used by the U.S. Patent and Trademark Office is to process and/or examine your submission related to a patent application or patent. If you do not furnish the requested information, the U.S. Patent and Trademark Office may not be able to process and/or examine your submission, which may result in termination of proceedings or abandonment of the application or expiration of the patent.

The information provided by you in this form will be subject to the following routine uses:

1. The information on this form will be treated confidentially to the extent allowed under the Freedom of Information Act (5 U.S.C. 552) and the Privacy Act (5 U.S.C. 552a). Records from this system of records may be disclosed to the Department of Justice to determine whether disclosure of these records is required by the Freedom of Information Act.
2. A record from this system of records may be disclosed, as a routine use, in the course of presenting evidence to a court, magistrate, or administrative tribunal, including disclosures to opposing counsel in the course of settlement negotiations.
3. A record in this system of records may be disclosed, as a routine use, to a Member of Congress submitting a request involving an individual, to whom the record pertains, when the individual has requested assistance from the Member with respect to the subject matter of the record.
4. A record in this system of records may be disclosed, as a routine use, to a contractor of the Agency having need for the information in order to perform a contract. Recipients of information shall be required to comply with the requirements of the Privacy Act of 1974, as amended, pursuant to 5 U.S.C. 552a(m).
5. A record related to an International Application filed under the Patent Cooperation Treaty in this system of records may be disclosed, as a routine use, to the International Bureau of the World Intellectual Property Organization, pursuant to the Patent Cooperation Treaty.
6. A record in this system of records may be disclosed, as a routine use, to another federal agency for purposes of National Security review (35 U.S.C. 181) and for review pursuant to the Atomic Energy Act (42 U.S.C. 218(c)).
7. A record from this system of records may be disclosed, as a routine use, to the Administrator, General Services, or his/her designee, during an inspection of records conducted by GSA as part of that agency's responsibility to recommend improvements in records management practices and programs, under authority of 44 U.S.C. 2904 and 2906. Such disclosure shall be made in accordance with the GSA regulations governing inspection of records for this purpose, and any other relevant (*i.e.*, GSA or Commerce) directive. Such disclosure shall not be used to make determinations about individuals.
8. A record from this system of records may be disclosed, as a routine use, to the public after either publication of the application pursuant to 35 U.S.C. 122(b) or issuance of a patent pursuant to 35 U.S.C. 151. Further, a record may be disclosed, subject to the limitations of 37 CFR 1.14, as a routine use, to the public if the record was filed in an application which became abandoned or in which the proceedings were terminated and which application is referenced by either a published application, an application open to public inspection or an issued patent.
9. A record from this system of records may be disclosed, as a routine use, to a Federal, State, or local law enforcement agency, if the USPTO becomes aware of a violation or potential violation of law or regulation.

## Electronic Acknowledgement Receipt

<b>EFS ID:</b>	30205736
<b>Application Number:</b>	12569116
<b>International Application Number:</b>	
<b>Confirmation Number:</b>	7686
<b>Title of Invention:</b>	VIDEO SURVEILLANCE SYSTEM EMPLOYING VIDEO PRIMITIVES
<b>First Named Inventor/Applicant Name:</b>	Alan J. Lipton
<b>Customer Number:</b>	6449
<b>Filer:</b>	Daniel A. Hammond/Susan Pon
<b>Filer Authorized By:</b>	Daniel A. Hammond
<b>Attorney Docket Number:</b>	4079-101
<b>Receipt Date:</b>	28-AUG-2017
<b>Filing Date:</b>	29-SEP-2009
<b>Time Stamp:</b>	19:56:26
<b>Application Type:</b>	Utility under 35 USC 111(a)

### Payment information:

Submitted with Payment	no
------------------------	----

### File Listing:

Document Number	Document Description	File Name	File Size(Bytes)/ Message Digest	Multi Part /.zip	Pages (if appl.)
1	Power of Attorney	POA_Avigilon_Fortress_Corporation.pdf	887562  <small>35110485e03a4bc6025fbaa70d7e3950fe01f65d</small>	no	2

### Warnings:

The page size in the PDF is too large. The pages should be 8.5 x 11 or A4. If this PDF is submitted, the pages will be resized upon entry into the Image File Wrapper and may affect subsequent processing

**Information:**

2	Assignee showing of ownership per 37 CFR 3.73	StatementUnder37.pdf	93739	no	3
			40244e52252af53044a9e0609591b98e6f6eb674		

**Warnings:**

**Information:**

<b>Total Files Size (in bytes):</b>	981301
-------------------------------------	--------

**This Acknowledgement Receipt evidences receipt on the noted date by the USPTO of the indicated documents, characterized by the applicant, and including page counts, where applicable. It serves as evidence of receipt similar to a Post Card, as described in MPEP 503.**

**New Applications Under 35 U.S.C. 111**

**If a new application is being filed and the application includes the necessary components for a filing date (see 37 CFR 1.53(b)-(d) and MPEP 506), a Filing Receipt (37 CFR 1.54) will be issued in due course and the date shown on this Acknowledgement Receipt will establish the filing date of the application.**

**National Stage of an International Application under 35 U.S.C. 371**

**If a timely submission to enter the national stage of an international application is compliant with the conditions of 35 U.S.C. 371 and other applicable requirements a Form PCT/DO/EO/903 indicating acceptance of the application as a national stage submission under 35 U.S.C. 371 will be issued in addition to the Filing Receipt, in due course.**

**New International Application Filed with the USPTO as a Receiving Office**

**If a new international application is being filed and the international application includes the necessary components for an international filing date (see PCT Article 11 and MPEP 1810), a Notification of the International Application Number and of the International Filing Date (Form PCT/RO/105) will be issued in due course, subject to prescriptions concerning national security, and the date shown on this Acknowledgement Receipt will establish the international filing date of the application.**

# PATENT ASSIGNMENT COVER SHEET

Electronic Version v1.1  
 Stylesheet Version v1.2

EPAS ID: PAT3301766

<b>SUBMISSION TYPE:</b>	NEW ASSIGNMENT
<b>NATURE OF CONVEYANCE:</b>	SECURITY INTEREST

**CONVEYING PARTY DATA**

Name	Execution Date
AVIGILON FORTRESS CORPORATION	04/07/2015

**RECEIVING PARTY DATA**

<b>Name:</b>	HSBC BANK CANADA
<b>Street Address:</b>	885 WEST GEORGIA STREET
<b>Internal Address:</b>	SUITE 200
<b>City:</b>	VANCOUVER
<b>State/Country:</b>	CANADA
<b>Postal Code:</b>	V6C 3G1

**PROPERTY NUMBERS Total: 102**

Property Type	Number
Patent Number:	6696945
Patent Number:	7046732
Patent Number:	6987883
Patent Number:	6999600
Patent Number:	7224852
Patent Number:	6970083
Patent Number:	7646401
Patent Number:	7733369
Patent Number:	7391907
Patent Number:	7424167
Patent Number:	7583815
Patent Number:	7868912
Patent Number:	7613322
Patent Number:	7825954
Patent Number:	7613324
Patent Number:	7796780
Patent Number:	7884849
Patent Number:	8711217
Patent Number:	7891330

<b>Property Type</b>	<b>Number</b>
<b>Patent Number:</b>	7424175
<b>Patent Number:</b>	7949150
<b>Patent Number:</b>	8334906
<b>Patent Number:</b>	7925536
<b>Patent Number:</b>	7822275
<b>Patent Number:</b>	8564661
<b>Patent Number:</b>	8180490
<b>Patent Number:</b>	8405720
<b>Patent Number:</b>	8150103
<b>Patent Number:</b>	8401229
<b>Patent Number:</b>	8848053
<b>Patent Number:</b>	8457401
<b>Patent Number:</b>	7932923
<b>Patent Number:</b>	8497906
<b>Patent Number:</b>	8823804
<b>Patent Number:</b>	8526678
<b>Patent Number:</b>	8948458
<b>Application Number:</b>	11057154
<b>Application Number:</b>	11167218
<b>Application Number:</b>	11220970
<b>Application Number:</b>	11602490
<b>Application Number:</b>	11826324
<b>Application Number:</b>	12155476
<b>Application Number:</b>	13082686
<b>Application Number:</b>	13673178
<b>Application Number:</b>	13684025
<b>Application Number:</b>	13713674
<b>Application Number:</b>	13744264
<b>Application Number:</b>	13744266
<b>Application Number:</b>	13744251
<b>Application Number:</b>	13744254
<b>Application Number:</b>	13781240
<b>Application Number:</b>	13804280
<b>Application Number:</b>	13838511
<b>Application Number:</b>	14634838
<b>Application Number:</b>	13843455
<b>Application Number:</b>	13838665
<b>Application Number:</b>	13886420

<b>Property Type</b>	<b>Number</b>
<b>Application Number:</b>	14610582
<b>Application Number:</b>	14058423
<b>Application Number:</b>	14203065
<b>Application Number:</b>	61968015
<b>Application Number:</b>	14674889
<b>Application Number:</b>	61973611
<b>Application Number:</b>	14252661
<b>Application Number:</b>	61988666
<b>Application Number:</b>	14455868
<b>Application Number:</b>	14470848
<b>Application Number:</b>	14500108
<b>Application Number:</b>	62061935
<b>Application Number:</b>	62066734
<b>Application Number:</b>	62088316
<b>Application Number:</b>	62088373
<b>Application Number:</b>	62088394
<b>Application Number:</b>	62088443
<b>Application Number:</b>	62088446
<b>Application Number:</b>	14576818
<b>Application Number:</b>	62101755
<b>Application Number:</b>	62101733
<b>Application Number:</b>	62101707
<b>Application Number:</b>	62101646
<b>Application Number:</b>	62104507
<b>Application Number:</b>	62104480
<b>Application Number:</b>	62109748
<b>Application Number:</b>	62109780
<b>Application Number:</b>	62109768
<b>Application Number:</b>	62109802
<b>Application Number:</b>	62109817
<b>Application Number:</b>	62110174
<b>Application Number:</b>	62110184
<b>Application Number:</b>	62110190
<b>Application Number:</b>	62110199
<b>Application Number:</b>	62110249
<b>Application Number:</b>	62109841
<b>Application Number:</b>	62109861
<b>Application Number:</b>	62109889



Property Type	Number
Application Number:	62109907
Application Number:	62109922
Application Number:	62110085
Application Number:	62110251
Application Number:	62110266
Application Number:	62110297
Application Number:	62110273

**CORRESPONDENCE DATA**

**Fax Number:**

*Correspondence will be sent to the e-mail address first; if that is unsuccessful, it will be sent using a fax number, if provided; if that is unsuccessful, it will be sent via US Mail.*

**Phone:** 3127018944

**Email:** ptierney@mayerbrown.com, msherlock@mayerbrown.com, ipdocket@mayerbrown.com

**Correspondent Name:** PATRICK TIERNEY

**Address Line 1:** PO BOX 2828

**Address Line 4:** CHICAGO, ILLINOIS 60690-2828

<b>ATTORNEY DOCKET NUMBER:</b>	15475652
<b>NAME OF SUBMITTER:</b>	PATRICK TIERNEY
<b>SIGNATURE:</b>	/PT/
<b>DATE SIGNED:</b>	04/08/2015
	This document serves as an Oath/Declaration (37 CFR 1.63).

**Total Attachments: 22**

- source=Patent Pledge - Avigilon Fortress\_pdf#page1.tif
- source=Patent Pledge - Avigilon Fortress\_pdf#page2.tif
- source=Patent Pledge - Avigilon Fortress\_pdf#page3.tif
- source=Patent Pledge - Avigilon Fortress\_pdf#page4.tif
- source=Patent Pledge - Avigilon Fortress\_pdf#page5.tif
- source=Patent Pledge - Avigilon Fortress\_pdf#page6.tif
- source=Patent Pledge - Avigilon Fortress\_pdf#page7.tif
- source=Patent Pledge - Avigilon Fortress\_pdf#page8.tif
- source=Patent Pledge - Avigilon Fortress\_pdf#page9.tif
- source=Patent Pledge - Avigilon Fortress\_pdf#page10.tif
- source=Patent Pledge - Avigilon Fortress\_pdf#page11.tif
- source=Patent Pledge - Avigilon Fortress\_pdf#page12.tif
- source=Patent Pledge - Avigilon Fortress\_pdf#page13.tif
- source=Patent Pledge - Avigilon Fortress\_pdf#page14.tif
- source=Patent Pledge - Avigilon Fortress\_pdf#page15.tif
- source=Patent Pledge - Avigilon Fortress\_pdf#page16.tif
- source=Patent Pledge - Avigilon Fortress\_pdf#page17.tif
- source=Patent Pledge - Avigilon Fortress\_pdf#page18.tif
- source=Patent Pledge - Avigilon Fortress\_pdf#page19.tif

source=Patent Pledge - Avigilon Fortress\_pdf#page20.tif

source=Patent Pledge - Avigilon Fortress\_pdf#page21.tif

source=Patent Pledge - Avigilon Fortress\_pdf#page22.tif

## PATENT PLEDGE AND SECURITY AGREEMENT

PATENT PLEDGE AND SECURITY AGREEMENT (this "Agreement") dated as of April 7, 2015, between Avigilon Fortress Corporation (the "Grantor") and HSBC BANK CANADA as administration agent (the "Agent").

WHEREAS, in connection with and as a condition to that certain Credit Agreement dated as of April 7, 2015, by and among, Avigilon Corporation, as borrower, the other Loan Parties party from time to time thereto, the Agent, as administration agent for and on behalf of the Lenders, and the Lenders party from time to time thereto (as further amended, restated, supplemented or otherwise modified from time to time, the "Credit Agreement"), the Grantor, in its best interest, is party to a General Security Agreement, dated as of April 7, 2015 (as amended, supplemented, amended and restated or otherwise modified from time to time, the "Security Agreement"), by and between the Grantor and the Agent for the benefit of the Secured Creditors;

WHEREAS, pursuant to the Security Agreement, the Grantor has granted to the Agent a security interest in certain of the Grantor's personal property and fixture assets, including without limitation the patents and patent applications listed on Schedule A attached hereto, all to secure the payment and performance of the Secured Obligations; and

WHEREAS, pursuant to the Security Agreement, the Grantor is required to execute and deliver to the Agent, for the benefit of the Secured Creditors, an agreement in substantially the form of this Agreement;

WHEREAS, this Agreement is supplemental to the provisions contained in the Security Agreement;

NOW, THEREFORE, in consideration of the premises contained herein and for other good and valuable consideration, the receipt and sufficiency of which are hereby acknowledged, the parties hereto hereby agree as follows:

### 1. DEFINITIONS.

Capitalized terms used herein and not otherwise defined herein shall have the respective meanings provided therefor in the Credit Agreement and the Security Agreement.

"Patent Collateral" means (a) all inventions and discoveries, whether patentable or not, all letters patent and applications for letters patent throughout the world, including without limitation those patents referred to in Schedule A hereto, and any patent applications in preparation for filing, (b) all reissues, divisions, continuations, continuations-in-part, extensions, renewals and reexaminations of any of the items described in clause (a), (c) all patent licenses, and other agreements providing the Grantor with the right to use any items of the type referred to in clauses (a) and (b) above, and (d) all proceeds of, and rights associated with, the foregoing (including licenses, royalties income, payments, claims, damages and proceeds of infringement suits), the right to sue third parties for past, present or future infringements of any patent or patent application, and for breach or enforcement of any patent license.

**2. GRANT OF SECURITY INTEREST.**

The Grantor hereby unconditionally grants, assigns and pledges to Agent, for the benefit of the Secured Creditors, to secure the Secured Obligations, a continuing security interest in all of the Grantor's right, title and interest in and to the Patent Collateral, whether now owned or hereafter acquired or arising, which includes, without limitation, the Patent Collateral with respect to those patents referred to on Schedule A (the "Security Interest"). This Agreement and the Security Interest created hereby secures the prompt and indefeasible payment in full and performance of the Secured Obligations, whether now existing or arising hereafter.

**3. REPRESENTATIONS AND WARRANTIES.**

The Grantor represents that except for the Patent Collateral specified in Schedule A hereto, the Grantor does not own and has no interests in any Patent Collateral as of the date hereof. The Grantor further represents and warrants that, with respect to all Patent Collateral specified in Schedule A hereto, (a) such Patent Collateral (except for any Patent Collateral that is immaterial to the business of the Grantor) is valid, subsisting, unexpired and enforceable and has not been abandoned or adjudged invalid or unenforceable, in whole or in part, except to the extent that any invalidity, non-subsistence, expiry, unenforceability, abandonment, adjudged invalidity or adjudged unenforceability of any such Patent Collateral has not had nor could reasonably be expected to have a Material Adverse Effect, (b) the Grantor is the sole and exclusive owner of the entire and unencumbered right, title and interest in and to such Patent Collateral (except for any Patent Collateral that is immaterial to the business of the Grantor), subject to Permitted Encumbrances, and no claim has been made that the use of such Patent Collateral does or may, conflict with, infringe, misappropriate, dilute, misuse or otherwise violate any of the rights of any third party in any material respects, (c) the Grantor has made, or intends to make, all necessary filings and recordations to protect its interest in such material Patent Collateral, including recordations of any of its interests in such material Patent Collateral in the United States Patent and Trademark Office and in corresponding offices throughout the world, and, to the extent necessary, has used, or intends to use, proper statutory notice in connection with its use of any material patent, (d) the Grantor has not made a previous assignment, sale, transfer or agreement constituting a present or future assignment, sale or transfer of any Patent Collateral for purposes of granting a security interest or as Collateral that has not been terminated or released (other than Permitted Encumbrances), and (e) the consummation of the transactions contemplated by the Credit Agreement and the Security Agreement will not result in the termination or material impairment of any material portion of the Patent Collateral, except to the extent that any termination or material impairment of any material portion of any Patent Collateral has not had nor could reasonably be expected to have a Material Adverse Effect.

**4. SECURITY AGREEMENT.**

The Security Interest granted pursuant to this Agreement is granted in conjunction with the security interests granted to Agent, for the benefit of the Secured Creditors, pursuant to the Security Agreement. The Grantor hereby acknowledges and affirms that the rights and remedies of the Agent with respect of the Security Interest in the Patent Collateral made and granted hereby are more fully set forth in the Security Agreement, the terms and provisions of which are incorporated by reference herein as if fully set forth herein. Nothing contained in this Agreement shall be deemed to extend the time of attachment or perfection of or otherwise impair the security interest in any of the Patent

Collateral granted to the Agent under the Security Agreement. To the extent there is any inconsistency between this Agreement and the Security Agreement, the Security Agreement shall control.

5. TERMINATION.

This Agreement shall terminate automatically upon termination of the Security Agreement.

6. GOVERNING LAW; CONSENT TO JURISDICTION.

This Agreement shall be governed by and construed in accordance with the laws of the State of New York and the federal laws of the United States applicable therein. The Grantor and each of the Beneficiaries each hereby attorn and submit to the non-exclusive jurisdiction of the courts of the State of New York. For the purpose of all legal proceedings, this Agreement shall be deemed to have been performed in the State of New York and the courts of the State of New York shall have jurisdiction to entertain any action or proceeding arising under this Agreement. Notwithstanding the foregoing, nothing herein shall be construed nor operate to limit the right of the Grantor or any Beneficiary to commence any action or proceeding relating hereto in any other jurisdiction, nor to limit the right of the courts of any other jurisdiction to take jurisdiction over any action, proceeding or matter relating hereto.

**THE GRANTOR IRREVOCABLY AND UNCONDITIONALLY SUBMITS, FOR ITSELF AND ITS PROPERTY, TO THE NONEXCLUSIVE JURISDICTION OF THE COURTS OF THE STATE OF NEW YORK SITTING IN NEW YORK COUNTY AND OF THE UNITED STATES DISTRICT COURT OF THE SOUTHERN DISTRICT OF NEW YORK, AND ANY APPELLATE COURT FROM ANY THEREOF, IN ANY ACTION OR PROCEEDING ARISING OUT OF OR RELATING TO THIS AGREEMENT, OR FOR RECOGNITION OR ENFORCEMENT OF ANY JUDGMENT, AND THE GRANTOR IRREVOCABLY AND UNCONDITIONALLY AGREES THAT ALL CLAIMS IN RESPECT OF ANY SUCH ACTION OR PROCEEDING MAY BE HEARD AND DETERMINED IN SUCH NEW YORK STATE COURT OR, TO THE FULLEST EXTENT PERMITTED BY APPLICABLE LAW, IN SUCH FEDERAL COURT. THE GRANTOR AGREES THAT A FINAL JUDGMENT IN ANY SUCH ACTION OR PROCEEDING SHALL BE CONCLUSIVE AND MAY BE ENFORCED IN OTHER JURISDICTIONS BY SUIT ON THE JUDGMENT OR IN ANY OTHER MANNER PROVIDED BY LAW. NOTHING IN THIS AGREEMENT SHALL AFFECT ANY RIGHT THAT ANY SECURED PARTY MAY OTHERWISE HAVE TO BRING ANY ACTION OR PROCEEDING RELATING TO THIS AGREEMENT AGAINST ANY OTHER GRANTOR OR ITS PROPERTIES IN THE COURTS OF ANY JURISDICTION.**

7. WAIVER OF JURY TRIAL; WAIVER OF VENUE.

**THE GRANTOR HEREBY KNOWINGLY, VOLUNTARILY AND INTENTIONALLY WAIVES TO THE FULLEST EXTENT PERMITTED BY LAW ANY RIGHTS IT MAY HAVE TO A TRIAL BY JURY IN RESPECT OF ANY LITIGATION BASED HEREON, OR ARISING OUT OF, UNDER, OR IN CONNECTION WITH, EACH DOCUMENT, OR ANY COURSE OF CONDUCT, COURSE OF DEALING, STATEMENTS (WHETHER ORAL OR WRITTEN) OR ACTIONS OF THE AGENT, ANY OTHER SECURED PARTY OR ANY OBLIGOR IN CONNECTION THEREWITH. THE GRANTOR ACKNOWLEDGES AND AGREES THAT**

IT HAS RECEIVED FULL AND SUFFICIENT CONSIDERATION FOR THIS PROVISION (AND EACH OTHER PROVISION OF EACH OTHER DOCUMENT TO WHICH IT IS A PARTY) AND THAT THIS PROVISION IS A MATERIAL INDUCEMENT FOR THE AGENT, EACH LENDER AND ISSUING LENDER ENTERING INTO THE DOCUMENTS.

THE GRANTOR IRREVOCABLY AND UNCONDITIONALLY WAIVES, TO THE FULLEST EXTENT PERMITTED BY APPLICABLE LEGAL REQUIREMENT, ANY OBJECTION THAT IT MAY NOW OR HEREAFTER HAVE TO THE LAYING OF VENUE OF ANY ACTION OR PROCEEDING ARISING OUT OF OR RELATING TO THIS AGREEMENT IN ANY COURT REFERRED TO IN SECTION 7. THE GRANTOR HERETO HEREBY IRREVOCABLY WAIVES, TO THE FULLEST EXTENT PERMITTED BY APPLICABLE LEGAL REQUIREMENT, THE DEFENSE OF AN INCONVENIENT FORUM TO THE MAINTENANCE OF SUCH ACTION OR PROCEEDING IN ANY SUCH COURT.

**8. COUNTERPARTS.**

This Agreement may be executed in counterparts, each of which shall constitute an original, but all of which when taken together shall constitute a single contract. This Agreement shall become effective when the Agent shall have received counterparts of this Agreement that, when taken together, bear the signatures of the Grantor and the Agent. Delivery of an executed signature page to this Agreement by facsimile transmission shall be as effective as delivery of a manually signed counterpart of this Agreement. Delivery by a party of an executed signature page of this Agreement by portable document format (.pdf) or any other electronic means intended to preserve the original graphic and pictorial appearance of a signature has the same effect as delivery of an executed original of this Agreement.

**9. AMENDMENTS, ETC.**

This Agreement may not be amended or modified in any respect except by written instrument signed by the Grantor and the Agent. No waiver of any provision of this Agreement by the Agent shall be effective unless the same is in writing and signed by the Agent, and then such waiver shall be effective only in the specific instance and for the specific purpose for which it is given. The rights of the Agent under this Agreement may only be assigned in accordance with the requirements of the Credit Agreement. The Grantor may not assign its obligations under this Agreement.

**10. MISCELLANEOUS.**

This Agreement is a Document executed pursuant to the Credit Agreement and shall unless otherwise expressly indicated herein) be construed, administered and applied in accordance with the terms and provisions thereof.

The headings of each section of this Agreement are for convenience only and shall not define or limit the provisions thereof. This Agreement and all rights and obligations hereunder shall be binding upon the Grantor and its successors and assigns, and shall inure to the benefit of the Agent and its successors and assigns, subject to the limitations as set forth in the Credit Agreement. If any term of this Agreement shall be held to be invalid, illegal or unenforceable, the validity of all other terms hereof shall

in no way be affected thereby, and this Agreement shall be construed and be enforceable as if such invalid, illegal or unenforceable term had not been included herein.

All references to instruments, documents, contracts, and agreements (including this Agreement) are references to such instruments, documents, contracts, and agreements as the same may be amended, supplemented, and otherwise modified from time to time, unless otherwise specified and shall include all schedules and exhibits thereto unless otherwise specified. The words “hereof”, “herein”, and “hereunder” and words of similar import when used in this Agreement shall refer to this Agreement as a whole and not to any particular provision of this Agreement. The term “including” means “including, without limitation,”.

[Signature Pages to Follow]

IN WITNESS WHEREOF, this Agreement has been executed as of the day and year first above written.

AVIGILON FORTRESS CORPORATION

By:

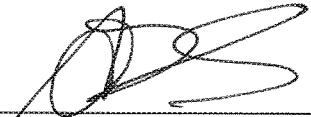

\_\_\_\_\_  
Name: Alexander Fernandes  
Title: President



HSBC BANK CANADA, as Agent

By: \_\_\_\_\_

Name: **CURTIS STANDERWICK**  
Title: **ASSISTANT VICE PRESIDENT  
LARGE CORPORATE BC**

By: \_\_\_\_\_

Name: **TODD PATCHELL**  
Title: **VICE PRESIDENT  
REGION HEAD OF LARGE CORPORATE**

SCHEDULE A

Issued Patents

<u>Country</u>	<u>Filing Date</u>	<u>Patent No</u>	<u>Title</u>
US	July 3, 2000	6,738,424	Scene Model Generation from Video For Use in Video Processing
US	October 24, 2000	6,954,498	Interactive Video Manipulation
US	March 16, 2001	7,321,624	Bit-Rate Allocation for Object-Based Video Encoding
US	March 23, 2001	6,625,310	Video Segmentation using Statistical Pixel Modeling
CN	October 9, 2002	ZL02819985.5	Video Tripwire
DE	October 9, 2002	60239883	Video Tripwire
DK	October 9, 2002	1435170	Video Tripwire
EP	October 9, 2002	1435170	Video Tripwire
ES	October 9, 2002	1435170	Video Tripwire
FI	October 9, 2002	1435170	Video Tripwire
FR	October 9, 2002	1435170	Video Tripwire
GB	October 9, 2002	1435170	Video Tripwire
HK	October 9, 2002	1071956	Video Tripwire
IT	October 9, 2002	1435170	Video Tripwire
KR	October 9, 2002	10-0905504	Video Tripwire
MX	October 9, 2002	256447	Video Tripwire
NL	October 9, 2002	1435170	Video Tripwire

SE	October 9, 2002	1435170	Video Tripwire
US	October 9, 2001	6,696,945	Video Tripwire
US	October 18, 2001	7,046,732	Video Coloring Book
US	December 31, 2002	6,987,883	Video Scene Background Maintenance using Statistical Pixel Modeling
CN	December 23, 2003	ZL200380110119.4	Video Scene Background Maintenance using Change Detection and Classification
DE	December 23, 2003	60340236	Video Scene Background Maintenance using Change Detection and Classification
DK	December 23, 2003	1588317	Video Scene Background Maintenance using Change Detection and Classification
FI	December 23, 2003	1588317	Video Scene Background Maintenance using Change Detection and Classification
FR	December 23, 2003	1588317	Video Scene Background Maintenance using Change Detection and Classification
GB	December 23, 2003	1588317	Video Scene Background Maintenance using Change Detection and Classification
HK	October 3, 2006	1088968	Video Scene Background Maintenance using Change Detection and Classification
IT	December 23, 2003	1588317	Video Scene Background Maintenance using Change Detection and Classification
MX	December 23, 2003	258937	Video Scene Background Maintenance using Change Detection and Classification
NL	December 23, 2003	1588317	Video Scene Background Maintenance using Change Detection and Classification
SG	December 23, 2003	114035	Video Scene Background Maintenance using Change Detection and Classification
US	January 30, 2003	6,999,600	Video Scene Background Maintenance using Change Detection and Classification
US	September 22, 2003	7,224,852	Video Segmentation using Statistical Pixel Modeling

KR	June 9, 2006	10-1085578	Video Tripwire (CIP)
MX	May 12, 2006	264306	Video Tripwire (CIP)
SG	November 12, 2004	122,329	Video Tripwire (CIP)
US	November 12, 2003	6,970,083	Video Tripwire (CIP)
US	January 30, 2004	7,646,401	Video Based Passback Event Detection
US	September 28, 2004	7,733,369	View Handling in Video Surveillance Systems
YU	June 7, 2006	1872583	Method of Video Processing, Computer Readable Medium Containing Instructions Implementing Said Method and Video Processing System
US	October 1, 2004	7,391,907	Spurious Object Detection in a Video Surveillance System
US	October 1, 2004	7,424,167	Tide Filtering for Video Surveillance System
US	April 5, 2005	7,583,815	Wide-Area Site-Based Video Surveillance System
AL	April 5, 2006	1872583	Method of Video Processing, Computer Readable Medium Containing Instructions Implementing Said Method and Video Processing System
AT	April 5, 2006	1872583	Method of Video Processing, Computer Readable Medium Containing Instructions Implementing Said Method and Video Processing System
BA	April 5, 2006	1872583	Method of Video Processing, Computer Readable Medium Containing Instructions Implementing Said Method and Video Processing System
BE	April 5, 2006	1872583	Method of Video Processing, Computer Readable Medium Containing Instructions Implementing Said Method and Video Processing System

BG	April 5, 2006	1872583	Method of Video Processing, Computer Readable Medium Containing Instructions Implementing Said Method and Video Processing System
CH	April 5, 2006	1872583	Method of Video Processing, Computer Readable Medium Containing Instructions Implementing Said Method and Video Processing System
CN	June 27, 2006	ZL200680030697 .0	Video Surveillance System Employing Video Primitives
CY	April 5, 2006	1872583	Method of Video Processing, Computer Readable Medium Containing Instructions Implementing Said Method and Video Processing System
CZ	April 5, 2006	1872583	Method of Video Processing, Computer Readable Medium Containing Instructions Implementing Said Method and Video Processing System
DE	April 5, 2006	1872583	Method of Video Processing, Computer Readable Medium Containing Instructions Implementing Said Method and Video Processing System
DK	April 5, 2006	1872583	Method of Video Processing, Computer Readable Medium Containing Instructions Implementing Said Method and Video Processing System
EE	April 5, 2006	1872583	Method of Video Processing, Computer Readable Medium Containing Instructions Implementing Said Method and Video Processing System
ES	April 5, 2006	1872583	Method of Video Processing, Computer Readable Medium Containing Instructions Implementing Said Method and Video Processing System
FI	April 5, 2006	1872583	Method of Video Processing, Computer Readable Medium Containing Instructions Implementing Said Method and Video Processing System

FR	April 5, 2006	1872583	Method of Video Processing, Computer Readable Medium Containing Instructions Implementing Said Method and Video Processing System
GB	April 5, 2006	1872583	Method of Video Processing, Computer Readable Medium Containing Instructions Implementing Said Method and Video Processing System
GR	April 5, 2006	1872583	Method of Video Processing, Computer Readable Medium Containing Instructions Implementing Said Method and Video Processing System
HR	April 5, 2006	1872583	Method of Video Processing, Computer Readable Medium Containing Instructions Implementing Said Method and Video Processing System
HU	April 5, 2006	1872583	Method of Video Processing, Computer Readable Medium Containing Instructions Implementing Said Method and Video Processing System
IE	April 5, 2006	1872583	Method of Video Processing, Computer Readable Medium Containing Instructions Implementing Said Method and Video Processing System
IS	April 5, 2006	1872583	Method of Video Processing, Computer Readable Medium Containing Instructions Implementing Said Method and Video Processing System
IT	April 5, 2006	1872583	Method of Video Processing, Computer Readable Medium Containing Instructions Implementing Said Method and Video Processing System
LT	April 5, 2006	1872583	Method of Video Processing, Computer Readable Medium Containing Instructions Implementing Said Method and Video Processing System
LU	April 5, 2006	1872583	Method of Video Processing, Computer Readable Medium Containing Instructions Implementing Said Method and Video Processing System

LV	April 5, 2006	1872583	Method of Video Processing, Computer Readable Medium Containing Instructions Implementing Said Method and Video Processing System
MC	April 5, 2006	1872583	Method of Video Processing, Computer Readable Medium Containing Instructions Implementing Said Method and Video Processing System
MK	April 5, 2006	1872583	Method of Video Processing, Computer Readable Medium Containing Instructions Implementing Said Method and Video Processing System
NL	April 5, 2006	1872583	Method of Video Processing, Computer Readable Medium Containing Instructions Implementing Said Method and Video Processing System
PL	April 5, 2006	1872583	Method of Video Processing, Computer Readable Medium Containing Instructions Implementing Said Method and Video Processing System
PT	April 5, 2006	1872583	Method of Video Processing, Computer Readable Medium Containing Instructions Implementing Said Method and Video Processing System
RO	April 5, 2006	1872583	Method of Video Processing, Computer Readable Medium Containing Instructions Implementing Said Method and Video Processing System
SE	April 5, 2006	1872583	Method of Video Processing, Computer Readable Medium Containing Instructions Implementing Said Method and Video Processing System
SI	April 5, 2006	1872583	Method of Video Processing, Computer Readable Medium Containing Instructions Implementing Said Method and Video Processing System
SK	April 5, 2006	1872583	Method of Video Processing, Computer Readable Medium Containing Instructions Implementing Said Method and Video Processing System

TR	April 5, 2006	1872583	Method of Video Processing, Computer Readable Medium Containing Instructions Implementing Said Method and Video Processing System
US	April 5, 2005	7,868,912	Video Surveillance System Employing Video Primitives
US	May 19, 2005	7,613,322	Periodic Motion Detection with Applications to Multi-Grabbing
US	May 31, 2005	7,825,954	Multi-state Target Tracking
US	June 24, 2005	7,613,324	Detection of Change of Posture in Video
US	June 24, 2005	7,796,780	Target Detection and Tracking from Overhead Video Streams
US	September 26, 2005	7,884,849	Video Surveillance System with Omni-directional Camera
US	December 15, 2005	8,711,217	Video Surveillance System Employing Video Primitives
US	January 31, 2007	7,801,330	Target Detection and Tracking from Video Streams
CN	March 1, 2007	ZL200780017762.0	Video Segmentation Using Statistical Pixel Modeling
KR	November 13, 2008	10-1392294	Video Segmentation Using Statistical Pixel Modeling
US	February 27, 2007	7,424,175	Video Segmentation using Statistical Pixel Modeling
US	April 2, 2007	7,949,150	Automatic Camera Calibration and Geo-Registration Using Objects that Provide Positional Information
US	May 4, 2007	8,334,906	Video Imagery-Based Sensor
US	May 25, 2007	7,925,536	Intelligent Video Verification Of Point-Of-Sale (Pos) Transactions
US	June 4, 2007	7,822,275	Methods for Detecting Water Regions in Video



US	July 26, 2007	8,564,661	Video Analytic Rule Detection System and Method
US	January 4, 2008	8,180,490	Video-based Sensing for Daylighting Controls
US	August 8, 2008	8,405,720	Automatic calibration of PTZ Camera system
US	September 3, 2008	8,150,103	Background Modeling With Feature Blocks
US	September 4, 2008	8,401,229	Stationary Target Detection by Exploiting Changes in Background Model
US	September 26, 2008	8,848,053	Automatic Extraction of Secondary Video Streams
US	February 10, 2009	8,457,401	Video Segmentation using Statistical Pixel Modeling
CN	July 17, 2002	ZL02822772.7	Video Surveillance System Employing Video Primitives
HK	August 11, 2005	1073375	Video Surveillance System Employing Video Primitives
JP	July 17, 2002	4369233	Video Surveillance System Employing Video Primitives
US	September 29, 2009	7,932,923	Video Surveillance System Employing Video Primitives
US	May 17, 2010	8,497,906	View Handling in Video Surveillance Systems
US	January 19, 2012	8,823,804	Method for Finding Paths in Video
US	February 19, 2013	8,526,678	Stationary Target Detection by Exploiting Changes in Background Model
KR	June 13, 2008	10-1375583	Object Density Estimation in Video
US	August 2, 2013	8,948,458	Stationary Target Detection by Exploiting Changes in Background Model (Cont)
ES	December 23, 2003	1588317	Video Scene Background Maintenance using Change Detection and Classification

SE	December 23, 2003	1588317	Video Scene Background Maintenance using Change Detection and Classification
----	-------------------	---------	--

Pending Patent Applications

<u>Country</u>	<u>Filing Date</u>	<u>Application No.</u>	<u>Title</u>
US	February 2, 2005	11/057,154	Video surveillance system employing video primitives
EP	July 17, 2002	02 752 397.6	Video Surveillance System Employing Video Primitives
CA	November 12, 2004	2545535	Video Tripwire
US	June 28, 2005	11/167,218	Video Surveillance System Employing Video Primitives
US	September 8, 2005	11/220,970	Scanning Camera-Based Video Surveillance System
CN	January 26, 2006	CN 200680012471	Video surveillance system employing video primitives
CN	April 5, 2006	CN 200680019911	Video Surveillance System Employing Video Primitives
EP	June 23, 2006	EP20060785442	Target Detection And Tracking From Overhead Video Streams
EP	June 27, 2006	EP20060774199	Video Surveillance System Employing Video Primitives
US	November 21, 2006	11/602,490	Object Density Estimation In Video
US	July 13, 2007	11/826,324	Video Analysis For Retail Business Process Monitoring
US	June 4, 2008	12/155,476	Intelligent Video Network Protocol
HK	April 5, 2006	8107304.8	Video Surveillance System Employing Video Primitives
HK	September 5, 2008	8109917.3	Target Detection And Tracking From Overhead Video Streams

US	April 8, 2011	13/082,686	Intelligent Video Verification Of Point-Of-Sale (POS) Transactions (Div)
EP	January 31, 2012	12151067.1	Video Surveillance System Employing Video Primitives (CIP)
EP	January 31, 2012	12151069.7	Video Surveillance System Employing Video Primitives (CIP)
US	November 9, 2012	13/673,178	Video Imagery-Based Sensor (Cont)
US	November 21, 2012	13/684,025	Automatic Event Detection, Text Generation, and Use Thereof
US	December 13, 2012	13/713,674	A Multichannel Video Content Analysis System using Video Multiplexing
US	January 17, 2013	13/744,264	System and method for building automation using video content analysis with depth sensing
US	January 17, 2013	13/744,266	System and method for home health care monitoring
US	January 17, 2013	13/744,251	System and method for monitoring a retail environment using video content analysis with depth sensing
US	January 17, 2013	13/744,254	System and method for video content analysis using depth sensing
US	February 28, 2013	13/781,240	Automatic Calibration Of PTZ Camera System (Div)
US	March 14, 2013	13/804,280	People tracking and best shot detection system
US	March 15, 2013	13/838,511	Crowd Estimation And Monitoring System Using A Generic Human Model
US	March 1, 2015	14/634,838	Crowd Estimation And Monitoring System Using A Generic Human Model
AE	September 12, 2013	(PCT/US2013/059471)	Methods, devices and systems for detecting objects in a video

AU	September 12, 2013	2013315491	Methods, devices and systems for detecting objects in a video
BR	September 12, 2013	BR112015005282-7	Methods, devices and systems for detecting objects in a video
CA	September 12, 2013	2884383	Methods, devices and systems for detecting objects in a video
CN	September 12, 2013	(PCT/US2013/059471)	Methods, devices and systems for detecting objects in a video
EG	September 12, 2013	PCT388/2015	Methods, devices and systems for detecting objects in a video
EP	September 12, 2013	(PCT/US2013/059471)	Methods, devices and systems for detecting objects in a video
ID	September 12, 2013	P00201501382	Methods, devices and systems for detecting objects in a video
IL	September 12, 2013	(PCT/US2013/059471)	Methods, devices and systems for detecting objects in a video
IN	September 12, 2013	(PCT/US2013/059471)	Methods, devices and systems for detecting objects in a video
JP	September 12, 2013	(PCT/US2013/059471)	Methods, devices and systems for detecting objects in a video
KR	September 12, 2013	(PCT/US2013/059471)	Methods, devices and systems for detecting objects in a video
MX	September 12, 2013	(PCT/US2013/059471)	Methods, devices and systems for detecting objects in a video
MY	September 12, 2013	PI 2015000611	Methods, devices and systems for detecting objects in a video
NZ	September 12, 2013	(PCT/US2013/059471)	Methods, devices and systems for detecting objects in a video
RU	September 12, 2013	2015109072	Methods, devices and systems for detecting objects in a video
SA	September 12, 2013	(PCT/US2013/059471)	Methods, devices and systems for detecting objects in a video
SG	September 12, 2013	11201501725R	Methods, devices and systems for detecting objects in a video

TH	September 12, 2013	1501001359	Methods, devices and systems for detecting objects in a video
VN	September 12, 2013	1-2015-00830	Methods, devices and systems for detecting objects in a video
WO	September 12, 2013	PCT/US2013/059471	Methods, devices and systems for detecting objects in a video
US	March 15, 2013	13/843,455	Video Surveillance Systems, Devices And Methods With Improved 3D Human Pose And Shape Modeling
US	March 15, 2013	13/838,665	View Handling In Video Surveillance Systems (Cont)
US	May 3, 2013	13/886,420	Video Segmentation Using Statistical Pixel Modeling (Cont)
US	January 30, 2015	14/610,582	Stationary Target Detection by Exploiting Changes in Background Model (Cont)
US	October 21, 2013	14/058,423	Video Analytic Rule Detection System And Method
US	March 10, 2014	14/203,065	Video Surveillance System Employing Video Primitives
USP	March 20, 2014	61/968,015	System and Method for Identifying Faces in Unconstrained Media
US	March 31, 2015	14/674889	SYSTEM AND METHOD FOR RECOGNITION OF COMPLEX EVENTS UNDER UNCERTAINTY
USP	April 1, 2014	61/973,611	SYSTEM AND METHOD FOR RECOGNITION OF COMPLEX EVENTS UNDER UNCERTAINTY
US	April 14, 2014	14/252,661	Graph Matching By Sub-Graph Grouping and Indexing
USP	May 5, 2014	61/988,666	Real-Time Video Overlays
US	August 8, 2014	14/455,868	Method for Finding Paths in Video

US	August 27, 2014	14/470,848	Systems and Methods for Processing Crowd-Sourced Multimedia Items
US	September 29, 2014	14/500,108	Automatic Extraction Of Secondary Video Streams
USP	October 9, 2014	62/061,935	System and Method for Large Volume Data Analytics
USP	October 21, 2014	62/066,734	Method and System for Thermal Image Analysis
EP	November 18, 2014	14193634.4	Video Surveillance System Employing Video Primitives
USP	December 5, 2014	62/088,316	Using Digital Elevation Model Data to Identify and Classify Targets
USP	December 5, 2014	62/088,373	Fixed Feature Removal
USP	December 5, 2014	62/088,394	Time-Of-Approach Rule
USP	December 5, 2014	62/088,443	Automatic Rule Creation
USP	December 5, 2014	62/088,446	Rules Based on Map Data
US	December 19, 2014	14/576,818	System and Method for Identifying Faces in Unconstrained Media
WO	December 19, 2014	PCT/US2014/071548	System and Method for Identifying Faces in Unconstrained Media
USP	January 5, 2015	62/099,836	Automatic Ship Verification
USP	January 9, 2015	62/101,755	SMUDGE REMOVAL
USP	January 9, 2015	62/101,733	Automated Scene Understanding
USP	January 9, 2015	62/101,707	3D Reconstruction Using UAVs
USP	January 9, 2015	62/101,646	TIME OF FLIGHT
USP	January 16, 2015	62/104,507	SMART GATE
USP	January 16, 2015	62/104,480	Geo-Registration of Moving Ground Sensors

USP	January 30, 2015	62/109,748	SCENE ELEMENT EXTRACTION AND CLASSIFICATION
USP	January 30, 2015	62/109,780	OBJECT RE-IDENTIFICATION BY TRANSFER LEARNING
USP	January 30, 2015	62/109,768	TRACKING BASKETBALL PLAYERS IN REALTIME
USP	January 30, 2015	62/109,802	REPEATED PATTERN DETECTION AND MATCHING
USP	January 30, 2015	62/109,817	RECORDING USER INTERFACES
USP	January 30, 2015	62/110,174	DISTRIBUTED ARCHITECTURE FOR SKYLINE MATCHING
USP	January 30, 2015	62/110,184	MULTI-USER SUPPORT IN REALTIME MAP OVERLAY
USP	January 30, 2015	62/110,190	VIDEO IMAGE SUMMARY
USP	January 30, 2015	62/110199	MODELING TRAFFIC PATTERNS
USP	January 30, 2015	62/110,249	HASHTAG TREND PREDICTION
USP	January 30, 2015	62/109,841	DEM DATA BOUNDARY HANDLING
USP	January 30, 2015	62/109,861	CAMERA CALIBRATION DATA COMBINED WITH DEM DATA
USP	January 30, 2015	62/109,889	OPTIMIZED TRANSFORM CODING
USP	January 30, 2015	62/109,907	ENFORCED PERFORMANCE CONSTRAINTS
USP	January 30, 2015	62/110,085	SATELLITE STEREO MATCHING TO OBTAIN HEIGHTS
USP	January 30, 2015	62/110,251	LANDMARK CONFIGURATION MATCHING
USP	January 30, 2015	62/110,266	CHARACTER OCR
USP	January 30, 2015	62/110,297	PRIVACY PROTECTION

USP	January 30, 2015	62/110,273	PERIMETER COVERAGE ASSESSMENT
USP	January 30, 2015	62/109,922	MULTI-SOURCE CAMERA CALIBRATION



AO 120 (Rev. 08/10)

<b>TO:</b> Mail Stop 8 Director of the U.S. Patent and Trademark Office P.O. Box 1450 Alexandria, VA 22313-1450	<b>REPORT ON THE                  FILING OR DETERMINATION OF AN                  ACTION REGARDING A PATENT OR                  TRADEMARK</b>
---	--

In Compliance with 35 U.S.C. § 290 and/or 15 U.S.C. § 1116 you are hereby advised that a court action has been filed in the U.S. District Court Eastern District of Virginia on the following

Trademarks or  Patents. (  the patent action involves 35 U.S.C. § 292.):

DOCKET NO. 3:12CV363	DATE FILED 3/11/2012	U.S. DISTRICT COURT Richmond
PLAINTIFF ObjectVideo, Inc.		DEFENDANT Pelco, Inc.
PATENT OR TRADEMARK NO.	DATE OF PATENT OR TRADEMARK	HOLDER OF PATENT OR TRADEMARK
1	6,696,945	2/24/2004
2	6,970,083	11/29/2005
3	7,868,912	1/11/2011
4	7,932,923	4/26/2011
5		

In the above—entitled case, the following patent(s)/ trademark(s) have been included:

DATE INCLUDED	INCLUDED BY	
	<input type="checkbox"/> Amendment <input type="checkbox"/> Answer <input type="checkbox"/> Cross Bill <input type="checkbox"/> Other Pleading	
PATENT OR TRADEMARK NO.	DATE OF PATENT OR TRADEMARK	HOLDER OF PATENT OR TRADEMARK
1		
2		
3		
4		
5		

In the above—entitled case, the following decision has been rendered or judgement issued:

DECISION/JUDGEMENT
--------------------

CLERK Fernando Galindo	(BY) DEPUTY CLERK Robert L. Walker	DATE 5/14/2012
---------------------------	---------------------------------------	-------------------

Copy 1—Upon initiation of action, mail this copy to Director    Copy 3—Upon termination of action, mail this copy to Director  
 Copy 2—Upon filing document adding patent(s), mail this copy to Director    Copy 4—Case file copy



UNITED STATES PATENT AND TRADEMARK OFFICE

UNITED STATES DEPARTMENT OF COMMERCE  
United States Patent and Trademark Office  
Address: COMMISSIONER FOR PATENTS  
P.O. Box 1450  
Alexandria, Virginia 22313-1450  
www.uspto.gov

APPLICATION NUMBER	FILING OR 371(C) DATE	FIRST NAMED APPLICANT	ATTY. DOCKET NO./TITLE
12/569,116	09/29/2009	Alan J. Lipton	OV-101

**CONFIRMATION NO. 7686**

**POWER OF ATTORNEY NOTICE**



74712  
Muir Patent Consulting, PLLC  
9913 Georgetown Pike, Suite 200  
P.O. Box 1213  
Great Falls, VA 22066

Date Mailed: 04/30/2012

**NOTICE REGARDING CHANGE OF POWER OF ATTORNEY**

This is in response to the Power of Attorney filed 04/26/2012.

- The Power of Attorney to you in this application has been revoked by the assignee who has intervened as provided by 37 CFR 3.71. Future correspondence will be mailed to the new address of record(37 CFR 1.33).

/jawhitfield/

Office of Data Management, Application Assistance Unit (571) 272-4000, or (571) 272-4200, or 1-888-786-0101



UNITED STATES PATENT AND TRADEMARK OFFICE

UNITED STATES DEPARTMENT OF COMMERCE  
United States Patent and Trademark Office  
Address: COMMISSIONER FOR PATENTS  
P.O. Box 1450  
Alexandria, Virginia 22313-1450  
www.uspto.gov

APPLICATION NUMBER	FILING OR 371(C) DATE	FIRST NAMED APPLICANT	ATTY. DOCKET NO./TITLE
12/569,116	09/29/2009	Alan J. Lipton	OV-101

**CONFIRMATION NO. 7686**

**POA ACCEPTANCE LETTER**

6449  
ROTHWELL, FIGG, ERNST & MANBECK, P.C.  
607 14th Street, N.W.  
SUITE 800  
WASHINGTON, DC 20005



Date Mailed: 04/30/2012

**NOTICE OF ACCEPTANCE OF POWER OF ATTORNEY**

This is in response to the Power of Attorney filed 04/26/2012.

The Power of Attorney in this application is accepted. Correspondence in this application will be mailed to the above address as provided by 37 CFR 1.33.

/jawhitfield/

Office of Data Management, Application Assistance Unit (571) 272-4000, or (571) 272-4200, or 1-888-786-0101

**To:** PTO-PAT-Email@rfem.com,,  
**From:** PAIR\_eOfficeAction@uspto.gov  
**Cc:** PAIR\_eOfficeAction@uspto.gov  
**Subject:** Private PAIR Correspondence Notification for Customer Number 6449

Apr 30, 2012 05:18:14 AM

Dear PAIR Customer:

ROTHWELL, FIGG, ERNST & MANBECK, P.C.  
607 14th Street, N.W.  
SUITE 800  
WASHINGTON, DC 20005  
UNITED STATES

The following USPTO patent application(s) associated with your Customer Number, 6449 , have new outgoing correspondence. This correspondence is now available for viewing in Private PAIR.

The official date of notification of the outgoing correspondence will be indicated on the form PTOL-90 accompanying the correspondence.

**Disclaimer:**

The list of documents shown below is provided as a courtesy and is not part of the official file wrapper. The content of the images shown in PAIR is the official record.

Application	Document	Mailroom Date	Attorney Docket No.
12569116	N570	04/30/2012	OV-101
	N570	04/30/2012	OV-101

To view your correspondence online or update your email addresses, please visit us anytime at <https://sportal.uspto.gov/secure/myportal/privatepair>.

If you have any questions, please email the Electronic Business Center (EBC) at [EBC@uspto.gov](mailto:EBC@uspto.gov) with 'e-Office Action' on the subject line or call 1-866-217-9197 during the following hours:

Monday - Friday 6:00 a.m. to 12:00 a.m.

Thank you for prompt attention to this notice,

UNITED STATES PATENT AND TRADEMARK OFFICE  
PATENT APPLICATION INFORMATION RETRIEVAL SYSTEM

<b>POWER OF ATTORNEY and CORRESPONDENCE ADDRESS INDICATION FORM</b>	<b>Application Number</b>	12/569,116
	<b>Filing Date</b>	September 29, 2009
	<b>First Named Inventor</b>	Venetianer et al.
	<b>Art Unit</b>	
	<b>Examiner Name</b>	
	<b>Attorney Docket Number</b>	4079-101
	<b>Title</b>	Video Surveillance System Employing Video Primitives
<p>The below-named Assignee of record of the entire interest in the subject application, through its authorized representative identified below, hereby revokes all previous powers of attorney given in the above-identified application and hereby appoints the practitioners associated with the Customer Number 06449 as my/our attorney(s) or agent(s) to prosecute the application identified above, and to transact all business in the United States Patent and Trademark Office connected therewith.</p>		
<i>Statement under 37 CFR 3.73(b)</i>		
<p>A chain of title from the inventors, of the patent application/patent identified above, to the current assignee as follows:</p> <ol style="list-style-type: none"> <li>1. Assignment From: Peter L. Venetianer, Alan J. Lipton, Andrew J. Chosak, Matthew F. Frazier, Niels Haering, Weihong Yin, Zhong Zhang, Gary W. Myers To: ObjectVideo, Inc. The document was recorded in the U.S. Patent and Trademark Office at Reel 016453, Frame 0968.</li> <li>2. Security Agreement From: ObjectVideo, Inc. To: RJF OV, LLC The document was recorded in the U.S. Patent and Trademark Office at Reel 020478, Frame 0711.</li> <li>3. Grant of Security Interest in Patent Rights From: ObjectVideo, Inc. To: RJF OV, LLC The document was recorded in the U.S. Patent and Trademark Office at Reel 021744, Frame 0464.</li> <li>4. Release of Security Agreement/Interest From: RJF OV LLC To: ObjectVideo, Inc. The document was recorded in the U.S. Patent and Trademark Office at Reel 027810, Frame 0117.</li> </ol>		
<b>ACKNOWLEDGEMENT AND CONSENT BY ASSIGNEE TO OBTAIN INSTRUCTIONS FROM ANOTHER PARTY</b>		
<p>Assignee, through its undersigned authorized representative, hereby acknowledges that the practitioners appointed herein may obtain instructions as to any action to be taken in the U.S. Patent and Trademark Office on any application to which this power of attorney may be directed, or on any patent which may issue on any such application, from assignee's third-party agents or attorneys, or other designee, who have been authorized by assignee to convey such instructions, and assignee expressly consents to this arrangement. In the event of a change in the persons from whom instructions are to be taken, the practitioners appointed herein shall be so notified by the assignee.</p>		

<b>Assignee Name</b>	<b>ObjectVideo, Inc.</b>
<b>Signature of Authorized Representative</b>	
<b>Typed or Printed Name</b>	Christopher Capuano
<b>Typed or Printed Title</b>	General Counsel & VP, Corporate Development
<b>Date</b>	April 26, 2012

**CERTIFICATE OF SERVICE**

It is hereby certified that the attached **POWER OF ATTORNEY AND CORRESPONDENCE ADDRESS INDICATION FORM** is being served on the attorney of record for the 3rd party Requester in the above-captioned Reexamination by first class mail at the third party requester's address:

Kenyon & Kenyon LLP  
One Broadway  
New York, NY 10004

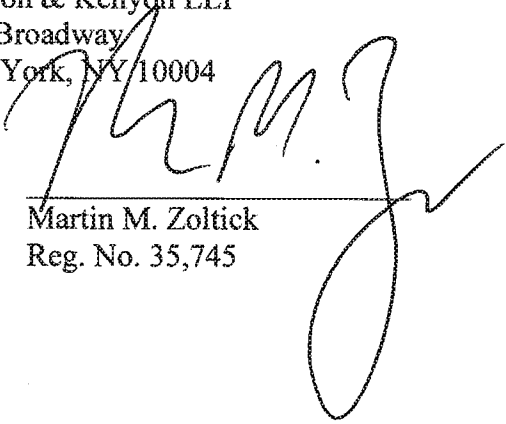

Martin M. Zoltick  
Reg. No. 35,745

April 26, 2012

## Electronic Acknowledgement Receipt

<b>EFS ID:</b>	12636635
<b>Application Number:</b>	12569116
<b>International Application Number:</b>	
<b>Confirmation Number:</b>	7686
<b>Title of Invention:</b>	VIDEO SURVEILLANCE SYSTEM EMPLOYING VIDEO PRIMITIVES
<b>First Named Inventor/Applicant Name:</b>	Alan J. Lipton
<b>Customer Number:</b>	74712
<b>Filer:</b>	Martin M. Zoltick/Carolyn Harty
<b>Filer Authorized By:</b>	Martin M. Zoltick
<b>Attorney Docket Number:</b>	OV-101
<b>Receipt Date:</b>	26-APR-2012
<b>Filing Date:</b>	29-SEP-2009
<b>Time Stamp:</b>	15:19:00
<b>Application Type:</b>	Utility under 35 USC 111(a)

### Payment information:

Submitted with Payment	no
------------------------	----

### File Listing:

Document Number	Document Description	File Name	File Size(Bytes)/ Message Digest	Multi Part /.zip	Pages (if appl.)
1	Power of Attorney	poa1.pdf	113881 <small>503bb2399d5d24e51576107e36bccf9f9cd3e0d2</small>	no	2

### Warnings:

### Information:



2	Miscellaneous Incoming Letter	certserv.pdf	21215	no	1
			654b9e448a116c7a846a1ca734eefbc73637c0e		

**Warnings:**

The page size in the PDF is too large. The pages should be 8.5 x 11 or A4. If this PDF is submitted, the pages will be resized upon entry into the Image File Wrapper and may affect subsequent processing

**Information:**

<b>Total Files Size (in bytes):</b>	135096
-------------------------------------	--------

**This Acknowledgement Receipt evidences receipt on the noted date by the USPTO of the indicated documents, characterized by the applicant, and including page counts, where applicable. It serves as evidence of receipt similar to a Post Card, as described in MPEP 503.**

**New Applications Under 35 U.S.C. 111**

**If a new application is being filed and the application includes the necessary components for a filing date (see 37 CFR 1.53(b)-(d) and MPEP 506), a Filing Receipt (37 CFR 1.54) will be issued in due course and the date shown on this Acknowledgement Receipt will establish the filing date of the application.**

**National Stage of an International Application under 35 U.S.C. 371**

**If a timely submission to enter the national stage of an international application is compliant with the conditions of 35 U.S.C. 371 and other applicable requirements a Form PCT/DO/EO/903 indicating acceptance of the application as a national stage submission under 35 U.S.C. 371 will be issued in addition to the Filing Receipt, in due course.**

**New International Application Filed with the USPTO as a Receiving Office**

**If a new international application is being filed and the international application includes the necessary components for an international filing date (see PCT Article 11 and MPEP 1810), a Notification of the International Application Number and of the International Filing Date (Form PCT/RO/105) will be issued in due course, subject to prescriptions concerning national security, and the date shown on this Acknowledgement Receipt will establish the international filing date of the application.**

<b>POWER OF ATTORNEY and CORRESPONDENCE ADDRESS INDICATION FORM</b>	<b>Application Number</b>	12/569,116
	<b>Filing Date</b>	September 29, 2009
	<b>First Named Inventor</b>	Venetianer et al.
	<b>Art Unit</b>	
	<b>Examiner Name</b>	
	<b>Attorney Docket Number</b>	4079-101
	<b>Title</b>	Video Surveillance System Employing Video Primitives
<p>The below-named Assignee of record of the entire interest in the subject application, through its authorized representative identified below, hereby revokes all previous powers of attorney given in the above-identified application and hereby appoints the practitioners associated with the Customer Number 06449 as my/our attorney(s) or agent(s) to prosecute the application identified above, and to transact all business in the United States Patent and Trademark Office connected therewith.</p>		
<p><i>Statement under 37 CFR 3.73(b)</i></p>		
<p>A chain of title from the inventors, of the patent application/patent identified above, to the current assignee as follows:</p> <ol style="list-style-type: none"> <li>1. Assignment From: Peter L. Venetianer, Alan J. Lipton, Andrew J. Chosak, Matthew F. Frazier, Niels Haering, Weihong Yin, Zhong Zhang, Gary W. Myers To: ObjectVideo, Inc. The document was recorded in the U.S. Patent and Trademark Office at Reel 016453, Frame 0968.</li> <li>2. Security Agreement From: ObjectVideo, Inc. To: RJF OV, LLC The document was recorded in the U.S. Patent and Trademark Office at Reel 020478, Frame 0711.</li> <li>3. Grant of Security Interest in Patent Rights From: ObjectVideo, Inc. To: RJF OV, LLC The document was recorded in the U.S. Patent and Trademark Office at Reel 021744, Frame 0464.</li> <li>4. Release of Security Agreement/Interest From: RJF OV LLC To: ObjectVideo, Inc. The document was recorded in the U.S. Patent and Trademark Office at Reel 027810, Frame 0117.</li> </ol>		
<p><b>ACKNOWLEDGEMENT AND CONSENT BY ASSIGNEE TO OBTAIN INSTRUCTIONS FROM ANOTHER PARTY</b></p>		
<p>Assignee, through its undersigned authorized representative, hereby acknowledges that the practitioners appointed herein may obtain instructions as to any action to be taken in the U.S. Patent and Trademark Office on any application to which this power of attorney may be directed, or on any patent which may issue on any such application, from assignee's third-party agents or attorneys, or other designee, who have been authorized by assignee to convey such instructions, and assignee expressly consents to this arrangement. In the event of a change in the persons from whom instructions are to be taken, the practitioners appointed herein shall be so notified by the assignee.</p>		

<b>Assignee Name</b>	<b>ObjectVideo, Inc.</b>
<b>Signature of Authorized Representative</b>	
<b>Typed or Printed Name</b>	Christopher Capuano
<b>Typed or Printed Title</b>	General Counsel & VP, Corporate Development
<b>Date</b>	April 26, 2012

**CERTIFICATE OF SERVICE**

It is hereby certified that the attached **POWER OF ATTORNEY AND CORRESPONDENCE ADDRESS INDICATION FORM** is being served on the attorney of record for the 3rd party Requester in the above-captioned Reexamination by first class mail at the third party requester's address:

Kenyon & Kenyon LLP  
One Broadway  
New York, NY 10004

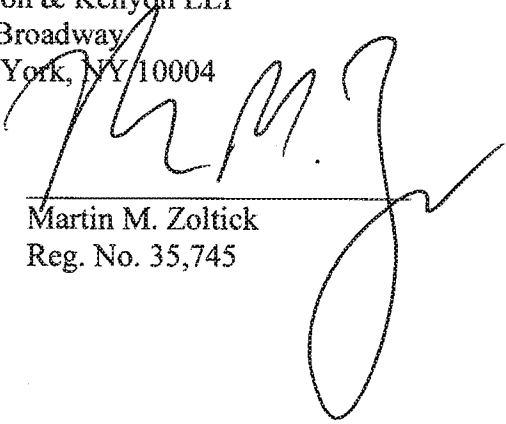

Martin M. Zoltick  
Reg. No. 35,745

April 26, 2012

## Electronic Acknowledgement Receipt

<b>EFS ID:</b>	12637496
<b>Application Number:</b>	12569116
<b>International Application Number:</b>	
<b>Confirmation Number:</b>	7686
<b>Title of Invention:</b>	VIDEO SURVEILLANCE SYSTEM EMPLOYING VIDEO PRIMITIVES
<b>First Named Inventor/Applicant Name:</b>	Alan J. Lipton
<b>Customer Number:</b>	74712
<b>Filer:</b>	Martin M. Zoltick/Carolyn Harty
<b>Filer Authorized By:</b>	Martin M. Zoltick
<b>Attorney Docket Number:</b>	OV-101
<b>Receipt Date:</b>	26-APR-2012
<b>Filing Date:</b>	29-SEP-2009
<b>Time Stamp:</b>	15:22:48
<b>Application Type:</b>	Utility under 35 USC 111(a)

### Payment information:

Submitted with Payment	no
------------------------	----

### File Listing:

Document Number	Document Description	File Name	File Size(Bytes)/ Message Digest	Multi Part /.zip	Pages (if appl.)
1	Power of Attorney	poa1.pdf	113881 <small>503bb2399d5d24e51576107e36bccf9f9cd3e0d2</small>	no	2

### Warnings:

### Information:

2	Miscellaneous Incoming Letter	certserv.pdf	21215 d3960208160af0eb11a12ac8e6ef1d9835a967f	no	1
---	-------------------------------	--------------	--	----	---

**Warnings:**

The page size in the PDF is too large. The pages should be 8.5 x 11 or A4. If this PDF is submitted, the pages will be resized upon entry into the Image File Wrapper and may affect subsequent processing

**Information:**

<b>Total Files Size (in bytes):</b>	135096
-------------------------------------	--------

**This Acknowledgement Receipt evidences receipt on the noted date by the USPTO of the indicated documents, characterized by the applicant, and including page counts, where applicable. It serves as evidence of receipt similar to a Post Card, as described in MPEP 503.**

**New Applications Under 35 U.S.C. 111**

**If a new application is being filed and the application includes the necessary components for a filing date (see 37 CFR 1.53(b)-(d) and MPEP 506), a Filing Receipt (37 CFR 1.54) will be issued in due course and the date shown on this Acknowledgement Receipt will establish the filing date of the application.**

**National Stage of an International Application under 35 U.S.C. 371**

**If a timely submission to enter the national stage of an international application is compliant with the conditions of 35 U.S.C. 371 and other applicable requirements a Form PCT/DO/EO/903 indicating acceptance of the application as a national stage submission under 35 U.S.C. 371 will be issued in addition to the Filing Receipt, in due course.**

**New International Application Filed with the USPTO as a Receiving Office**

**If a new international application is being filed and the international application includes the necessary components for an international filing date (see PCT Article 11 and MPEP 1810), a Notification of the International Application Number and of the International Filing Date (Form PCT/RO/105) will be issued in due course, subject to prescriptions concerning national security, and the date shown on this Acknowledgement Receipt will establish the international filing date of the application.**



APPLICATION NO.	ISSUE DATE	PATENT NO.	ATTORNEY DOCKET NO.	CONFIRMATION NO.
12/569,116	04/26/2011	7932923	OV-101	7686

74712 7590 04/06/2011  
Muir Patent Consulting, PLLC  
9913 Georgetown Pike, Suite 200  
P.O. Box 1213  
Great Falls, VA 22066

### ISSUE NOTIFICATION

The projected patent number and issue date are specified above.

**Determination of Patent Term Adjustment under 35 U.S.C. 154 (b)**  
(application filed on or after May 29, 2000)

The Patent Term Adjustment is 0 day(s). Any patent to issue from the above-identified application will include an indication of the adjustment on the front page.

If a Continued Prosecution Application (CPA) was filed in the above-identified application, the filing date that determines Patent Term Adjustment is the filing date of the most recent CPA.

Applicant will be able to obtain more detailed information by accessing the Patent Application Information Retrieval (PAIR) WEB site (<http://pair.uspto.gov>).

Any questions regarding the Patent Term Extension or Adjustment determination should be directed to the Office of Patent Legal Administration at (571)-272-7702. Questions relating to issue and publication fee payments should be directed to the Application Assistance Unit (AAU) of the Office of Data Management (ODM) at (571)-272-4200.

APPLICANT(s) (Please see PAIR WEB site <http://pair.uspto.gov> for additional applicants):

- Alan J. Lipton, Falls Church, VA;
- Thomas M. Strat, Pakton, VA;
- Peter L. Venetianer, McLean, VA;
- Mark C. Allmen, Morrison, CO;
- William E. Severson, Littleton, CO;
- Niels Haering, Arlington, VA;
- Andrew J. Chosak, McLean, VA;
- Zhong Zhang, Herndon, VA;
- Matthew F. Frazier, Arlington, VA;
- James S. Seekas, Arlington, VA;
- Tasuki Hirata, Silver Spring, MD;
- John Clark, Leesburg, VA;

Receipt date: 12/31/2009

12569116 - GAI: 2621

Doc code: IDS

Doc description: Information Disclosure Statement (IDS) Filed

Approved for use through 07/31/2012. OMB 0651-0031  
U.S. Patent and Trademark Office; U.S. DEPARTMENT OF COMMERCE

Under the Paperwork Reduction Act of 1995, no persons are required to respond to a collection of information unless it contains a valid OMB control number.

<b>INFORMATION DISCLOSURE STATEMENT BY APPLICANT</b> ( Not for submission under 37 CFR 1.99)	Application Number		12596116	
	Filing Date		2009-09-11	
	First Named Inventor	Alan J. Lipton		
	Art Unit	2621		
	Examiner Name	Tung Vo		
	Attorney Docket Number	OV-101		

U.S.PATENTS							Remove
Examiner Initial*	Cite No	Patent Number	Kind Code <sup>1</sup>	Issue Date	Name of Patentee or Applicant of cited Document	Pages, Columns, Lines where Relevant Passages or Relevant Figures Appear	
	1	5912980	A	1999-06-15	Hunke, H. Martin		
	2	6025877	A	<del>2001</del> 2000-02-15	Chang et al.		
	3	6097429	A	2000-08-01	Seeley et al.		
	4	6360234	B2	2002-03-19	Jain et al.		
	5	7197072	B1	2007-03-27	Hsu et al.		
	6	7227893	B1	2007-06-05	Srinivasa et al.		
	7	7356830	B1	2008-04-08	Dimitrova, Nevenka		
	8	7447331	B2	2008-11-04	Brown et al.		

Change(s) applied to document, /G.H./ 3/29/2011



<b>INFORMATION DISCLOSURE STATEMENT BY APPLICANT</b> ( Not for submission under 37 CFR 1.99)	Application Number		12596116	12569116 - GAU: 2621
	Filing Date		2009-09-11	
	First Named Inventor	Alan J. Lipton		
	Art Unit		2621	
	Examiner Name	Tung Vo		
	Attorney Docket Number		OV-101	
	Receipt date: 12/31/2009			

	31	5926210		1999-07-20	Hackett et al.	
	32	6069653		2000-05-30	Hudson et al.	
	33	6297844		2001-10-02	Schatz et al.	
	34	6424370		2002-07-23	Courtney	
Change(s) applied to document, /K.D.D./ 3/26/2011	35	6542840		2003-04-01	Okamoto et al. <del>Shusaku et al.</del>	
	36	6696945		2004-02-24	Venetianer et al.	
	37	6727938		2004-04-27	Randall	
	38	6738424		2004-05-18	Allmen et al.	
	39	6954498		2005-10-11	Lipton	
	40	6987883		2006-01-17	Lipton et al.	
	41	6351265	B1	2002-02-26	Bulman	



UNITED STATES PATENT AND TRADEMARK OFFICE

UNITED STATES DEPARTMENT OF COMMERCE
United States Patent and Trademark Office
Address: COMMISSIONER FOR PATENTS
P.O. Box 1450
Alexandria, Virginia 22313-1450
www.uspto.gov

Table with 5 columns: APPLICATION NO., FILING DATE, FIRST NAMED INVENTOR, ATTORNEY DOCKET NO., CONFIRMATION NO.

12/569,116 09/29/2009 Alan J. Lipton OV-101 7686

74712 7590 03/23/2011
Muir Patent Consulting, PLLC
9913 Georgetown Pike, Suite 200
P.O. Box 1213
Great Falls, VA 22066

Table with 1 column: EXAMINER

VO, TUNG T

Table with 2 columns: ART UNIT, PAPER NUMBER

2486

Table with 2 columns: MAIL DATE, DELIVERY MODE

03/23/2011 PAPER

Please find below and/or attached an Office communication concerning this application or proceeding.

The time period for reply, if any, is set in the attached communication.



**UNITED STATES DEPARTMENT OF COMMERCE**

**U.S. Patent and Trademark Office**

Address : COMMISSIONER FOR PATENTS  
P.O. Box 1450  
Alexandria, Virginia 22313-1450

<b>APPLICATION NO./ CONTROL NO.</b>	<b>FILING DATE</b>	<b>FIRST NAMED INVENTOR / PATENT IN REEXAMINATION</b>	<b>ATTORNEY DOCKET NO.</b>
12569116	9/29/09	LIPTON ET AL.	OV-101

Muir Patent Consulting, PLLC  
9913 Georgetown Pike, Suite 200  
P.O. Box 1213  
Great Falls, VA 22066

**EXAMINER**

Nhon T. Diep

<b>ART UNIT</b>	<b>PAPER</b>
-----------------	--------------

2486

20110321

DATE MAILED:

**Please find below and/or attached an Office communication concerning this application or proceeding.**

**Commissioner for Patents**

IDS filed 10/13/2010 had been considered, and a copy of the initialed IDS is attached

/Nhon T Diep/  
Primary Examiner, Art Unit 2486

<b>Search Notes</b>  	<b>Application/Control No.</b>  12569116	<b>Applicant(s)/Patent Under Reexamination</b>  LIPTON ET AL.
	<b>Examiner</b>  Tung Vo	<b>Art Unit</b>  2486

<b>SEARCHED</b>			
<b>Class</b>	<b>Subclass</b>	<b>Date</b>	<b>Examiner</b>
375	143, 144, 145, 148	6/14/2010	TV
H04N	7/18	2/8/2011	TV

<b>SEARCH NOTES</b>		
<b>Search Notes</b>	<b>Date</b>	<b>Examiner</b>
EAST/WEST	6/14/2010	TV
INVENTOR SEARCH	2/8/2011	TV
CLAIM SEARCH	2/8/2011	TV
INTERFERENCE SEARCH	2/8/2011	TV

<b>INTERFERENCE SEARCH</b>			
<b>Class</b>	<b>Subclass</b>	<b>Date</b>	<b>Examiner</b>
348	143	6/14/2010	TV

--	--

IDS Form PTO/SB/08: Substitute for form 1449A/PTO			<b>Complete if Known</b>		
<b>INFORMATION DISCLOSURE STATEMENT BY APPLICANT</b>  <i>(Use as many sheets as necessary)</i>			<i>Application Number</i>	12/569,116	
			<i>Filing Date</i>	09-29-2009	
			<i>First Named Inventor</i>	Alan J. Lipton	
			<i>Art Unit</i>	2621	
			<i>Examiner Name</i>	Tung Vo	
Sheet	1	of	1	<i>Attorney Docket Number</i>	OV-101

<b>U.S. PATENTS AND PUBLISHED U.S. PATENT APPLICATIONS</b>						
Examiner Initials	Cite No. <sup>1</sup>	Document Number		Issue or Publication Date MM-DD-YYYY	Name of Patentee or Applicant of Cited Document	Pages, Columns, Lines, Where Relevant Passages or Relevant Figures Appear
		Number-Kind Code <sup>2</sup> (if known)				
/N.D./	1	US-2004/0130620 A1		07-08-2004	Buehler et al.	
/N.D./	2	US-2005/0198063 A1		09-08-2005	Thomas et al.	

**Note: Submission of copies of U.S. Patents and published U.S. Patent Applications is not required.**

<b>FOREIGN PATENT DOCUMENTS</b>							
Examiner Initials	Cite No. <sup>1</sup>	Foreign Patent Document		Publication Date MM-DD-YYYY	Name of Patentee or Applicant of Cited Document	Pages, Columns, Lines, Where Relevant Passages or Relevant Figures Appear	Translation <sup>6</sup>
		Country Code <sup>3</sup>	Number <sup>4</sup> Kind Code <sup>5</sup> (if known)				
	1						
	2						
	3						

<b>NONPATENT LITERATURE DOCUMENTS</b>			
Examiner Initials	Cite No. <sup>1</sup>	Include name of the author (in CAPITAL LETTERS), title of the article (when appropriate), title of the item (book, magazine, journal, serial, symposium, catalog, etc.), date, page(s), volume-issue number(s), publisher, city and/or country where published.	Translation <sup>6</sup>

Examiner Signature	/Nhon T Diep/	Date Considered	03/21/2011
--------------------	---------------	-----------------	------------

EXAMINER: Initial if reference considered, whether or not citation is in conformance with MPEP 609. Draw line through citation if not in conformance and not considered. Include copy of this form with next communication to applicant.



UNITED STATES PATENT AND TRADEMARK OFFICE

UNITED STATES DEPARTMENT OF COMMERCE  
 United States Patent and Trademark Office  
 Address: COMMISSIONER FOR PATENTS  
 P.O. Box 1450  
 Alexandria, Virginia 22313-1450  
 www.uspto.gov



Bib Data Sheet

CONFIRMATION NO. 7686

<b>SERIAL NUMBER</b> 12/569,116	<b>FILING OR 371(c) DATE</b> 09/29/2009 <b>RULE</b>	<b>CLASS</b> 348	<b>GROUP ART UNIT</b> 2486	<b>ATTORNEY DOCKET NO.</b> OV-101
------------------------------------	---	---------------------	-------------------------------	--------------------------------------

**APPLICANTS**  
 Alan J. Lipton, Falls Church, VA;  
 Thomas M. Strat, Pakton, VA;  
 Pèter L. Venetianer, McLean, VA;  
 Mark C. Allmen, Morrison, CO;  
 William E. Severson, Littleton, CO;  
 Niels Haering, Arlington, VA;  
 Andrew J. Chosak, McLean, VA;  
 Zhong Zhang, Herndon, VA;  
 Matthew F. Frazier, Arlington, VA;  
 James S. Seekas, Arlington, VA;  
 Tasuki Hirata, Silver Spring, MD;  
 John Clark, Leesburg, VA;

**\*\* CONTINUING DATA \*\*\*\*\***

**\*\* FOREIGN APPLICATIONS \*\*\*\*\***

**IF REQUIRED, FOREIGN FILING LICENSE GRANTED\*\* SMALL ENTITY \*\***  
 \*\* 10/09/2009

Foreign Priority claimed <input type="checkbox"/> yes <input checked="" type="checkbox"/> no	<b>STATE OR COUNTRY</b> VA	<b>SHEETS DRAWING</b> 7	<b>TOTAL CLAIMS</b> 26	<b>INDEPENDENT CLAIMS</b> 4
35 USC 119 (a-d) conditions met <input type="checkbox"/> yes <input checked="" type="checkbox"/> no <input type="checkbox"/> Met after Allowance				
Verified and Acknowledged	Examiner's Signature	Initials		

**ADDRESS**  
74712

**TITLE**  
VIDEO SURVEILLANCE SYSTEM EMPLOYING VIDEO PRIMITIVES

<b>FILING FEE RECEIVED</b> 1748	FEES: Authority has been given in Paper No. _____ to charge/credit DEPOSIT ACCOUNT No. _____ for following:	<input type="checkbox"/> All Fees
		<input type="checkbox"/> 1.16 Fees ( Filing )
		<input type="checkbox"/> 1.17 Fees ( Processing Ext. of time )
		<input type="checkbox"/> 1.18 Fees ( Issue )
		<input type="checkbox"/> Other _____
		<input type="checkbox"/> Credit

**PART B - FEE(S) TRANSMITTAL**

Complete and send this form, together with applicable fee(s), to: **Mail** **Mail Stop ISSUE FEE**  
**Commissioner for Patents**  
**P.O. Box 1450**  
**Alexandria, Virginia 22313-1450**  
 or **Fax** **(571) 273-2885**

**INSTRUCTIONS:** This form should be used for transmitting the ISSUE FEE and PUBLICATION FEE (if required). Blocks 1 through 5 should be completed where appropriate. All further correspondence including the Patent, advance orders and notification of maintenance fees will be mailed to the current correspondence address as indicated unless corrected below or directed otherwise in Block 1, by (a) specifying a new correspondence address; and/or (b) indicating a separate "FEE ADDRESS" for maintenance fee notifications.

CURRENT CORRESPONDENCE ADDRESS (Note: Use Block 1 for any change of address)

Note: A certificate of mailing can only be used for domestic mailings of the Fee(s) Transmittal. This certificate cannot be used for any other accompanying papers. Each additional paper, such as an assignment or formal drawing, must have its own certificate of mailing or transmission.

Muir Patent Consulting, PLLC  
 9913 Georgetown Pike, Suite 200  
 P.O. Box 1213  
 Great Falls, VA 22066

**Certificate of Mailing or Transmission**

I hereby certify that this Fee(s) Transmittal is being deposited with the United States Postal Service with sufficient postage for first class mail in an envelope addressed to the Mail Stop ISSUE FEE address above, or being facsimile transmitted to the USPTO (571) 273-2885, on the date indicated below.

(Depositor's name)
(Signature)
(Date)

APPLICATION NO.	FILING DATE	FIRST NAMED INVENTOR	ATTORNEY DOCKET NO.	CONFIRMATION NO.
12/569,116	2009-09-29	Alan J. Lipton	OV-101	7686

TITLE OF INVENTION:

APPLN. TYPE	SMALL ENTITY	ISSUE FEE	PUBLICATION FEE	TOTAL FEE(S) DUE	DATE DUE
nonprovisional	yes	755	300	1055	2011-05-18

EXAMINER	ART UNIT	CLASS-SUBCLASS

1. Change of correspondence address or indication of "Fee Address" (37 CFR 1.363). <input type="checkbox"/> Change of correspondence address (or Change of Correspondence Address form PTO/SB/122) attached. <input type="checkbox"/> "Fee Address" indication (or "Fee Address" Indication form PTO/SB/47; Rev 03-02 or more recent) attached. Use of a Customer Number is required.	2. For printing on the patent front page, list (1) the names of up to 3 registered patent attorneys or agents OR, alternatively, (2) the name of a single firm (having as a member a registered attorney or agent) and the names of up to 2 registered patent attorneys or agents. If no name is listed, no name will be printed.	1. <u>Muir Patent Consulting, PLLC</u> 2. <u> </u> 3. <u> </u>
---	---	--

3. ASSIGNEE NAME AND RESIDENCE DATA TO BE PRINTED ON THE PATENT (print or type)

PLEASE NOTE: Unless an assignee is identified below, no assignee data will appear on the patent. If an assignee is identified below, the document has been filed for recordation as set forth in 37 CFR 3.11. Completion of this form is NOT a substitute for filing an assignment.

(A) NAME OF ASSIGNEE <b>ObjectVideo, Inc.</b>	(B) RESIDENCE: (CITY and STATE OR COUNTRY) <b>11600 Sunrise Valley Drive, Suite 290</b> <b>Reston, VA 20191</b>
--	---

Please check the appropriate assignee category or categories (will not be printed on the patent) :  Individual  Corporation or other private group entity  Government

4a. The following fee(s) are enclosed: <input checked="" type="checkbox"/> Issue Fee <input checked="" type="checkbox"/> Publication Fee (No small entity discount permitted) <input type="checkbox"/> Advance Order - # of Copies <u> </u>	4b. Payment of Fee(s): <input type="checkbox"/> A check in the amount of the fee(s) is enclosed. <input checked="" type="checkbox"/> Payment by credit card. Form PTO-2038 is attached. <input checked="" type="checkbox"/> The Director is hereby authorized by charge the required fee(s), or credit any overpayment, to Deposit Account Number <b>50-4574</b>
--	---

5. Change in Entity Status (from status indicated above)

a. Applicant claims SMALL ENTITY status. See 37 CFR 1.27.  b. Applicant is no longer claiming SMALL ENTITY status. See 37 CFR 1.27(g)(2).

The Director of the USPTO is requested to apply the Issue Fee and Publication Fee (if any) or to re-apply any previously paid issue fee to the application identified above. NOTE: The Issue Fee and Publication Fee (if required) will not be accepted from anyone other than the applicant; a registered attorney or agent; or the assignee or other party in interest as shown by the records of the United States Patent and Trademark Office.

Authorized Signature <u>/Patrick D. Muir/</u>	Date <b>2011-02-23</b>
Typed or printed name <b>Patrick D. Muir, Reg. #37,403</b>	Registration No. <b>37,403</b>

This collection of information is required by 37 CFR 1.311. The information is required to obtain or retain a benefit by the public which is to file (and by the USPTO to process) an application. Confidentiality is governed by 35 U.S.C. 122 and 37 CFR 1.14. This collection is estimated to take 12 minutes to complete, including gathering, preparing, and submitting the completed application form to the USPTO. Time will vary depending upon the individual case. Any comments on the amount of time you require to complete this form and/or suggestions for reducing this burden, should be sent to the Chief Information Officer, U.S. Patent and Trademark Office, U.S. Department of Commerce, P.O. Box 1450, Alexandria, Virginia 22313-1450. DO NOT SEND FEES OR COMPLETED FORMS TO THIS ADDRESS. SEND TO: Commissioner for Patents, P.O. Box 1450, Alexandria, Virginia 22313-1450.

Under the Paperwork Reduction Act of 1995, no persons are required to respond to a collection of information unless it displays a valid OMB control number.

## Privacy Act Statement

**The Privacy Act of 1974 (P.L. 93-579)** requires that you be given certain information in connection with your submission of the attached form related to a patent application or patent. Accordingly, pursuant to the requirements of the Act, please be advised that: (1) the general authority for the collection of this information is 35 U.S.C. 2(b)(2); (2) furnishing of the information solicited is voluntary; and (3) the principal purpose for which the information is used by the U.S. Patent and Trademark Office is to process and/or examine your submission related to a patent application or patent. If you do not furnish the requested information, the U.S. Patent and Trademark Office may not be able to process and/or examine your submission, which may result in termination of proceedings or abandonment of the application or expiration of the patent.

The information provided by you in this form will be subject to the following routine uses:

1. The information on this form will be treated confidentially to the extent allowed under the Freedom of Information Act (5 U.S.C. 552) and the Privacy Act (5 U.S.C. 552a). Records from this system of records may be disclosed to the Department of Justice to determine whether disclosure of these records is required by the Freedom of Information Act.
2. A record from this system of records may be disclosed, as a routine use, in the course of presenting evidence to a court, magistrate, or administrative tribunal, including disclosures to opposing counsel in the course of settlement negotiations.
3. A record in this system of records may be disclosed, as a routine use, to a Member of Congress submitting a request involving an individual, to whom the record pertains, when the individual has requested assistance from the Member with respect to the subject matter of the record.
4. A record in this system of records may be disclosed, as a routine use, to a contractor of the Agency having need for the information in order to perform a contract. Recipients of information shall be required to comply with the requirements of the Privacy Act of 1974, as amended, pursuant to 5 U.S.C. 552a(m).
5. A record related to an International Application filed under the Patent Cooperation Treaty in this system of records may be disclosed, as a routine use, to the International Bureau of the World Intellectual Property Organization, pursuant to the Patent Cooperation Treaty.
6. A record in this system of records may be disclosed, as a routine use, to another federal agency for purposes of National Security review (35 U.S.C. 181) and for review pursuant to the Atomic Energy Act (42 U.S.C. 218(c)).
7. A record from this system of records may be disclosed, as a routine use, to the Administrator, General Services, or his/her designee, during an inspection of records conducted by GSA as part of that agency's responsibility to recommend improvements in records management practices and programs, under authority of 44 U.S.C. 2904 and 2906. Such disclosure shall be made in accordance with the GSA regulations governing inspection of records for this purpose, and any other relevant (i.e., GSA or Commerce) directive. Such disclosure shall not be used to make determinations about individuals.
8. A record from this system of records may be disclosed, as a routine use, to the public after either publication of the application pursuant to 35 U.S.C. 122(b) or issuance of a patent pursuant to 35 U.S.C. 151. Further, a record may be disclosed, subject to the limitations of 37 CFR 1.14, as a routine use, to the public if the record was filed in an application which became abandoned or in which the proceedings were terminated and which application is referenced by either a published application, an application open to public inspection or an issued patent.
9. A record from this system of records may be disclosed, as a routine use, to a Federal, State, or local law enforcement agency, if the USPTO becomes aware of a violation or potential violation of law or regulation.



## Electronic Patent Application Fee Transmittal

<b>Application Number:</b>	12569116
<b>Filing Date:</b>	29-Sep-2009
<b>Title of Invention:</b>	VIDEO SURVEILLANCE SYSTEM EMPLOYING VIDEO PRIMITIVES
<b>First Named Inventor/Applicant Name:</b>	Alan J. Lipton
<b>Filer:</b>	Patrick Daniel Muir/Melissa McGinn
<b>Attorney Docket Number:</b>	OV-101

Filed as Small Entity

### Utility under 35 USC 111(a) Filing Fees

Description	Fee Code	Quantity	Amount	Sub-Total in USD(\$)
<b>Basic Filing:</b>				
<b>Pages:</b>				
<b>Claims:</b>				
<b>Miscellaneous-Filing:</b>				
<b>Petition:</b>				
<b>Patent-Appeals-and-Interference:</b>				
<b>Post-Allowance-and-Post-Issuance:</b>				
Utility Appl issue fee	2501	1	755	755
Publ. Fee- early, voluntary, or normal	1504	1	300	300

Description	Fee Code	Quantity	Amount	Sub-Total in USD(\$)
<b>Extension-of-Time:</b>				
<b>Miscellaneous:</b>				
<b>Total in USD (\$)</b>				<b>1055</b>

## Electronic Acknowledgement Receipt

<b>EFS ID:</b>	9507483
<b>Application Number:</b>	12569116
<b>International Application Number:</b>	
<b>Confirmation Number:</b>	7686
<b>Title of Invention:</b>	VIDEO SURVEILLANCE SYSTEM EMPLOYING VIDEO PRIMITIVES
<b>First Named Inventor/Applicant Name:</b>	Alan J. Lipton
<b>Customer Number:</b>	74712
<b>Filer:</b>	Patrick Daniel Muir/Melissa McGinn
<b>Filer Authorized By:</b>	Patrick Daniel Muir
<b>Attorney Docket Number:</b>	OV-101
<b>Receipt Date:</b>	23-FEB-2011
<b>Filing Date:</b>	29-SEP-2009
<b>Time Stamp:</b>	14:00:18
<b>Application Type:</b>	Utility under 35 USC 111(a)

### Payment information:

Submitted with Payment	yes
Payment Type	Credit Card
Payment was successfully received in RAM	\$1055
RAM confirmation Number	348
Deposit Account	504574
Authorized User	MUIR,PATRICK D.

The Director of the USPTO is hereby authorized to charge indicated fees and credit any overpayment as follows:

Charge any Additional Fees required under 37 C.F.R. Section 1.16 (National application filing, search, and examination fees)

Charge any Additional Fees required under 37 C.F.R. Section 1.17 (Patent application and reexamination processing fees)

Charge any Additional Fees required under 37 C.F.R. Section 1.19 (Document supply fees)

Charge any Additional Fees required under 37 C.F.R. Section 1.20 (Post Issuance fees)

Charge any Additional Fees required under 37 C.F.R. Section 1.21 (Miscellaneous fees and charges)

### File Listing:

Document Number	Document Description	File Name	File Size(Bytes)/ Message Digest	Multi Part /.zip	Pages (if appl.)
1	Issue Fee Payment (PTO-85B)	OV_101_issue_fee.pdf	229657 21e59a4b2350243057336c474f41d1027d33d325	no	2

### Warnings:

### Information:

2	Fee Worksheet (PTO-875)	fee-info.pdf	31631 8ee382c8a695d9361a3a5515b769ab0854eb3648	no	2
---	-------------------------	--------------	---	----	---

### Warnings:

### Information:

**Total Files Size (in bytes):** 261288

**This Acknowledgement Receipt evidences receipt on the noted date by the USPTO of the indicated documents, characterized by the applicant, and including page counts, where applicable. It serves as evidence of receipt similar to a Post Card, as described in MPEP 503.**

#### **New Applications Under 35 U.S.C. 111**

**If a new application is being filed and the application includes the necessary components for a filing date (see 37 CFR 1.53(b)-(d) and MPEP 506), a Filing Receipt (37 CFR 1.54) will be issued in due course and the date shown on this Acknowledgement Receipt will establish the filing date of the application.**

#### **National Stage of an International Application under 35 U.S.C. 371**

**If a timely submission to enter the national stage of an international application is compliant with the conditions of 35 U.S.C. 371 and other applicable requirements a Form PCT/DO/EO/903 indicating acceptance of the application as a national stage submission under 35 U.S.C. 371 will be issued in addition to the Filing Receipt, in due course.**

#### **New International Application Filed with the USPTO as a Receiving Office**

**If a new international application is being filed and the international application includes the necessary components for an international filing date (see PCT Article 11 and MPEP 1810), a Notification of the International Application Number and of the International Filing Date (Form PCT/RO/105) will be issued in due course, subject to prescriptions concerning national security, and the date shown on this Acknowledgement Receipt will establish the international filing date of the application.**



NOTICE OF ALLOWANCE AND FEE(S) DUE

74712 7590 02/18/2011
Muir Patent Consulting, PLLC
9913 Georgetown Pike, Suite 200
P.O. Box 1213
Great Falls, VA 22066

EXAMINER
VO, TUNG T
ART UNIT PAPER NUMBER
2486

DATE MAILED: 02/18/2011

Table with 5 columns: APPLICATION NO., FILING DATE, FIRST NAMED INVENTOR, ATTORNEY DOCKET NO., CONFIRMATION NO.

12/569,116 09/29/2009 Alan J. Lipton OV-101 7686

TITLE OF INVENTION: VIDEO SURVEILLANCE SYSTEM EMPLOYING VIDEO PRIMITIVES

Table with 7 columns: APPLN. TYPE, SMALL ENTITY, ISSUE FEE DUE, PUBLICATION FEE DUE, PREV. PAID ISSUE FEE, TOTAL FEE(S) DUE, DATE DUE

nonprovisional YES \$755 \$300 \$0 \$1055 05/18/2011

THE APPLICATION IDENTIFIED ABOVE HAS BEEN EXAMINED AND IS ALLOWED FOR ISSUANCE AS A PATENT. PROSECUTION ON THE MERITS IS CLOSED. THIS NOTICE OF ALLOWANCE IS NOT A GRANT OF PATENT RIGHTS. THIS APPLICATION IS SUBJECT TO WITHDRAWAL FROM ISSUE AT THE INITIATIVE OF THE OFFICE OR UPON PETITION BY THE APPLICANT. SEE 37 CFR 1.313 AND MPEP 1308.

THE ISSUE FEE AND PUBLICATION FEE (IF REQUIRED) MUST BE PAID WITHIN THREE MONTHS FROM THE MAILING DATE OF THIS NOTICE OR THIS APPLICATION SHALL BE REGARDED AS ABANDONED. THIS STATUTORY PERIOD CANNOT BE EXTENDED. SEE 35 U.S.C. 151. THE ISSUE FEE DUE INDICATED ABOVE DOES NOT REFLECT A CREDIT FOR ANY PREVIOUSLY PAID ISSUE FEE IN THIS APPLICATION. IF AN ISSUE FEE HAS PREVIOUSLY BEEN PAID IN THIS APPLICATION (AS SHOWN ABOVE), THE RETURN OF PART B OF THIS FORM WILL BE CONSIDERED A REQUEST TO REAPPLY THE PREVIOUSLY PAID ISSUE FEE TOWARD THE ISSUE FEE NOW DUE.

HOW TO REPLY TO THIS NOTICE:

I. Review the SMALL ENTITY status shown above.

If the SMALL ENTITY is shown as YES, verify your current SMALL ENTITY status:

A. If the status is the same, pay the TOTAL FEE(S) DUE shown above.

B. If the status above is to be removed, check box 5b on Part B - Fee(s) Transmittal and pay the PUBLICATION FEE (if required) and twice the amount of the ISSUE FEE shown above, or

If the SMALL ENTITY is shown as NO:

A. Pay TOTAL FEE(S) DUE shown above, or

B. If applicant claimed SMALL ENTITY status before, or is now claiming SMALL ENTITY status, check box 5a on Part B - Fee(s) Transmittal and pay the PUBLICATION FEE (if required) and 1/2 the ISSUE FEE shown above.

II. PART B - FEE(S) TRANSMITTAL, or its equivalent, must be completed and returned to the United States Patent and Trademark Office (USPTO) with your ISSUE FEE and PUBLICATION FEE (if required). If you are charging the fee(s) to your deposit account, section "4b" of Part B - Fee(s) Transmittal should be completed and an extra copy of the form should be submitted. If an equivalent of Part B is filed, a request to reapply a previously paid issue fee must be clearly made, and delays in processing may occur due to the difficulty in recognizing the paper as an equivalent of Part B.

III. All communications regarding this application must give the application number. Please direct all communications prior to issuance to Mail Stop ISSUE FEE unless advised to the contrary.

IMPORTANT REMINDER: Utility patents issuing on applications filed on or after Dec. 12, 1980 may require payment of maintenance fees. It is patentee's responsibility to ensure timely payment of maintenance fees when due.

**PART B - FEE(S) TRANSMITTAL**

**Complete and send this form, together with applicable fee(s), to: Mail Mail Stop ISSUE FEE  
 Commissioner for Patents  
 P.O. Box 1450  
 Alexandria, Virginia 22313-1450  
 or Fax (571)-273-2885**

**INSTRUCTIONS:** This form should be used for transmitting the ISSUE FEE and PUBLICATION FEE (if required). Blocks 1 through 5 should be completed where appropriate. All further correspondence including the Patent, advance orders and notification of maintenance fees will be mailed to the current correspondence address as indicated unless corrected below or directed otherwise in Block 1, by (a) specifying a new correspondence address; and/or (b) indicating a separate "FEE ADDRESS" for maintenance fee notifications.

CURRENT CORRESPONDENCE ADDRESS (Note: Use Block 1 for any change of address)

Note: A certificate of mailing can only be used for domestic mailings of the Fee(s) Transmittal. This certificate cannot be used for any other accompanying papers. Each additional paper, such as an assignment or formal drawing, must have its own certificate of mailing or transmission.

74712 7590 02/18/2011  
 Muir Patent Consulting, PLLC  
 9913 Georgetown Pike, Suite 200  
 P.O. Box 1213  
 Great Falls, VA 22066

**Certificate of Mailing or Transmission**

I hereby certify that this Fee(s) Transmittal is being deposited with the United States Postal Service with sufficient postage for first class mail in an envelope addressed to the Mail Stop ISSUE FEE address above, or being facsimile transmitted to the USPTO (571) 273-2885, on the date indicated below.

_____ (Depositor's name)
_____ (Signature)
_____ (Date)

APPLICATION NO.	FILING DATE	FIRST NAMED INVENTOR	ATTORNEY DOCKET NO.	CONFIRMATION NO.
12/569,116	09/29/2009	Alan J. Lipton	OV-101	7686

TITLE OF INVENTION: VIDEO SURVEILLANCE SYSTEM EMPLOYING VIDEO PRIMITIVES

APPLN. TYPE	SMALL ENTITY	ISSUE FEE DUE	PUBLICATION FEE DUE	PREV. PAID ISSUE FEE	TOTAL FEE(S) DUE	DATE DUE
nonprovisional	YES	\$755	\$300	\$0	\$1055	05/18/2011

EXAMINER	ART UNIT	CLASS-SUBCLASS
VO, TUNG T	2486	348-143000

<p>1. Change of correspondence address or indication of "Fee Address" (37 CFR 1.363).</p> <p><input type="checkbox"/> Change of correspondence address (or Change of Correspondence Address form PTO/SB/122) attached.</p> <p><input type="checkbox"/> "Fee Address" indication (or "Fee Address" Indication form PTO/SB/47; Rev 03-02 or more recent) attached. <b>Use of a Customer Number is required.</b></p>	<p>2. For printing on the patent front page, list</p> <p>(1) the names of up to 3 registered patent attorneys or agents OR, alternatively, 1 _____</p> <p>(2) the name of a single firm (having as a member a registered attorney or agent) and the names of up to 2 registered patent attorneys or agents. If no name is listed, no name will be printed. 2 _____</p> <p>3 _____</p>
---	---

3. ASSIGNEE NAME AND RESIDENCE DATA TO BE PRINTED ON THE PATENT (print or type)

PLEASE NOTE: Unless an assignee is identified below, no assignee data will appear on the patent. If an assignee is identified below, the document has been filed for recordation as set forth in 37 CFR 3.11. Completion of this form is NOT a substitute for filing an assignment.

(A) NAME OF ASSIGNEE \_\_\_\_\_ (B) RESIDENCE: (CITY and STATE OR COUNTRY) \_\_\_\_\_

Please check the appropriate assignee category or categories (will not be printed on the patent) :  Individual  Corporation or other private group entity  Government

<p>4a. The following fee(s) are submitted:</p> <p><input type="checkbox"/> Issue Fee</p> <p><input type="checkbox"/> Publication Fee (No small entity discount permitted)</p> <p><input type="checkbox"/> Advance Order - # of Copies _____</p>	<p>4b. Payment of Fee(s); (Please first reapply any previously paid issue fee shown above)</p> <p><input type="checkbox"/> A check is enclosed.</p> <p><input type="checkbox"/> Payment by credit card. Form PTO-2038 is attached.</p> <p><input type="checkbox"/> The Director is hereby authorized to charge the required fee(s), any deficiency, or credit any overpayment, to Deposit Account Number _____ (enclose an extra copy of this form).</p>
---	--

5. Change in Entity Status (from status indicated above)

a. Applicant claims SMALL ENTITY status. See 37 CFR 1.27.  b. Applicant is no longer claiming SMALL ENTITY status. See 37 CFR 1.27(g)(2).

NOTE: The Issue Fee and Publication Fee (if required) will not be accepted from anyone other than the applicant; a registered attorney or agent; or the assignee or other party in interest as shown by the records of the United States Patent and Trademark Office.

Authorized Signature \_\_\_\_\_ Date \_\_\_\_\_

Typed or printed name \_\_\_\_\_ Registration No. \_\_\_\_\_

This collection of information is required by 37 CFR 1.311. The information is required to obtain or retain a benefit by the public which is to file (and by the USPTO to process) an application. Confidentiality is governed by 35 U.S.C. 122 and 37 CFR 1.14. This collection is estimated to take 12 minutes to complete, including gathering, preparing, and submitting the completed application form to the USPTO. Time will vary depending upon the individual case. Any comments on the amount of time you require to complete this form and/or suggestions for reducing this burden, should be sent to the Chief Information Officer, U.S. Patent and Trademark Office, U.S. Department of Commerce, P.O. Box 1450, Alexandria, Virginia 22313-1450. DO NOT SEND FEES OR COMPLETED FORMS TO THIS ADDRESS. SEND TO: Commissioner for Patents, P.O. Box 1450, Alexandria, Virginia 22313-1450.

Under the Paperwork Reduction Act of 1995, no persons are required to respond to a collection of information unless it displays a valid OMB control number.



UNITED STATES PATENT AND TRADEMARK OFFICE

UNITED STATES DEPARTMENT OF COMMERCE
United States Patent and Trademark Office
Address: COMMISSIONER FOR PATENTS
P.O. Box 1450
Alexandria, Virginia 22313-1450
www.uspto.gov

Table with 5 columns: APPLICATION NO., FILING DATE, FIRST NAMED INVENTOR, ATTORNEY DOCKET NO., CONFIRMATION NO.
12/569,116 09/29/2009 Alan J. Lipton OV-101 7686

74712 7590 02/18/2011
Muir Patent Consulting, PLLC
9913 Georgetown Pike, Suite 200
P.O. Box 1213
Great Falls, VA 22066

Table with 2 columns: EXAMINER, ART UNIT, PAPER NUMBER
EXAMINER: VO, TUNG T
ART UNIT: 2486
PAPER NUMBER: (empty)

DATE MAILED: 02/18/2011

Determination of Patent Term Adjustment under 35 U.S.C. 154 (b)

(application filed on or after May 29, 2000)

The Patent Term Adjustment to date is 0 day(s). If the issue fee is paid on the date that is three months after the mailing date of this notice and the patent issues on the Tuesday before the date that is 28 weeks (six and a half months) after the mailing date of this notice, the Patent Term Adjustment will be 0 day(s).

If a Continued Prosecution Application (CPA) was filed in the above-identified application, the filing date that determines Patent Term Adjustment is the filing date of the most recent CPA.

Applicant will be able to obtain more detailed information by accessing the Patent Application Information Retrieval (PAIR) WEB site (http://pair.uspto.gov).

Any questions regarding the Patent Term Extension or Adjustment determination should be directed to the Office of Patent Legal Administration at (571)-272-7702. Questions relating to issue and publication fee payments should be directed to the Customer Service Center of the Office of Patent Publication at 1-(888)-786-0101 or (571)-272-4200.

## Privacy Act Statement

**The Privacy Act of 1974 (P.L. 93-579)** requires that you be given certain information in connection with your submission of the attached form related to a patent application or patent. Accordingly, pursuant to the requirements of the Act, please be advised that: (1) the general authority for the collection of this information is 35 U.S.C. 2(b)(2); (2) furnishing of the information solicited is voluntary; and (3) the principal purpose for which the information is used by the U.S. Patent and Trademark Office is to process and/or examine your submission related to a patent application or patent. If you do not furnish the requested information, the U.S. Patent and Trademark Office may not be able to process and/or examine your submission, which may result in termination of proceedings or abandonment of the application or expiration of the patent.

The information provided by you in this form will be subject to the following routine uses:

1. The information on this form will be treated confidentially to the extent allowed under the Freedom of Information Act (5 U.S.C. 552) and the Privacy Act (5 U.S.C. 552a). Records from this system of records may be disclosed to the Department of Justice to determine whether disclosure of these records is required by the Freedom of Information Act.
2. A record from this system of records may be disclosed, as a routine use, in the course of presenting evidence to a court, magistrate, or administrative tribunal, including disclosures to opposing counsel in the course of settlement negotiations.
3. A record in this system of records may be disclosed, as a routine use, to a Member of Congress submitting a request involving an individual, to whom the record pertains, when the individual has requested assistance from the Member with respect to the subject matter of the record.
4. A record in this system of records may be disclosed, as a routine use, to a contractor of the Agency having need for the information in order to perform a contract. Recipients of information shall be required to comply with the requirements of the Privacy Act of 1974, as amended, pursuant to 5 U.S.C. 552a(m).
5. A record related to an International Application filed under the Patent Cooperation Treaty in this system of records may be disclosed, as a routine use, to the International Bureau of the World Intellectual Property Organization, pursuant to the Patent Cooperation Treaty.
6. A record in this system of records may be disclosed, as a routine use, to another federal agency for purposes of National Security review (35 U.S.C. 181) and for review pursuant to the Atomic Energy Act (42 U.S.C. 218(c)).
7. A record from this system of records may be disclosed, as a routine use, to the Administrator, General Services, or his/her designee, during an inspection of records conducted by GSA as part of that agency's responsibility to recommend improvements in records management practices and programs, under authority of 44 U.S.C. 2904 and 2906. Such disclosure shall be made in accordance with the GSA regulations governing inspection of records for this purpose, and any other relevant (i.e., GSA or Commerce) directive. Such disclosure shall not be used to make determinations about individuals.
8. A record from this system of records may be disclosed, as a routine use, to the public after either publication of the application pursuant to 35 U.S.C. 122(b) or issuance of a patent pursuant to 35 U.S.C. 151. Further, a record may be disclosed, subject to the limitations of 37 CFR 1.14, as a routine use, to the public if the record was filed in an application which became abandoned or in which the proceedings were terminated and which application is referenced by either a published application, an application open to public inspection or an issued patent.
9. A record from this system of records may be disclosed, as a routine use, to a Federal, State, or local law enforcement agency, if the USPTO becomes aware of a violation or potential violation of law or regulation.



**Notice of Allowability**

**Application No.**

12/569,116

**Examiner**

Tung Vo

**Applicant(s)**

LIPTON ET AL.

**Art Unit**

2483

**-- The MAILING DATE of this communication appears on the cover sheet with the correspondence address--**

All claims being allowable, PROSECUTION ON THE MERITS IS (OR REMAINS) CLOSED in this application. If not included herewith (or previously mailed), a Notice of Allowance (PTOL-85) or other appropriate communication will be mailed in due course. **THIS NOTICE OF ALLOWABILITY IS NOT A GRANT OF PATENT RIGHTS.** This application is subject to withdrawal from issue at the initiative of the Office or upon petition by the applicant. See 37 CFR 1.313 and MPEP 1308.

- 1.  This communication is responsive to the second supplemental amendment filed on 02/04/2011.
- 2.  The allowed claim(s) is/are 27,29-41,43-50 and 52-70.
- 3.  Acknowledgment is made of a claim for foreign priority under 35 U.S.C. § 119(a)-(d) or (f).
  - a)  All b)  Some\* c)  None of the:
    - 1.  Certified copies of the priority documents have been received.
    - 2.  Certified copies of the priority documents have been received in Application No. \_\_\_\_\_.
    - 3.  Copies of the certified copies of the priority documents have been received in this national stage application from the International Bureau (PCT Rule 17.2(a)).

\* Certified copies not received: \_\_\_\_\_.

Applicant has THREE MONTHS FROM THE "MAILING DATE" of this communication to file a reply complying with the requirements noted below. Failure to timely comply will result in ABANDONMENT of this application.

**THIS THREE-MONTH PERIOD IS NOT EXTENDABLE.**

- 4.  A SUBSTITUTE OATH OR DECLARATION must be submitted. Note the attached EXAMINER'S AMENDMENT or NOTICE OF INFORMAL PATENT APPLICATION (PTO-152) which gives reason(s) why the oath or declaration is deficient.
  - 5.  CORRECTED DRAWINGS ( as "replacement sheets") must be submitted.
    - (a)  including changes required by the Notice of Draftsperson's Patent Drawing Review ( PTO-948) attached
      - 1)  hereto or 2)  to Paper No./Mail Date \_\_\_\_\_.
    - (b)  including changes required by the attached Examiner's Amendment / Comment or in the Office action of Paper No./Mail Date \_\_\_\_\_.
- Identifying indicia such as the application number (see 37 CFR 1.84(c)) should be written on the drawings in the front (not the back) of each sheet. Replacement sheet(s) should be labeled as such in the header according to 37 CFR 1.121(d).**
- 6.  DEPOSIT OF and/or INFORMATION about the deposit of BIOLOGICAL MATERIAL must be submitted. Note the attached Examiner's comment regarding REQUIREMENT FOR THE DEPOSIT OF BIOLOGICAL MATERIAL.

**Attachment(s)**

- 1.  Notice of References Cited (PTO-892)
- 2.  Notice of Draftsperson's Patent Drawing Review (PTO-948)
- 3.  Information Disclosure Statements (PTO/SB/08), Paper No./Mail Date \_\_\_\_\_
- 4.  Examiner's Comment Regarding Requirement for Deposit of Biological Material
- 5.  Notice of Informal Patent Application
- 6.  Interview Summary (PTO-413), Paper No./Mail Date \_\_\_\_\_.
- 7.  Examiner's Amendment/Comment
- 8.  Examiner's Statement of Reasons for Allowance
- 9.  Other \_\_\_\_\_.

/Tung Vo/  
Primary Examiner, Art Unit 2483

Art Unit: 2483

**Allowable Subject Matter**

1. Claims 27, 29-41, 43-50, 52-70 are allowed.
2. The following is an examiner's statement of reasons for allowance: the prior art does not disclose a method comprising: detecting an object in a video; detecting a plurality of attributes of the object by analyzing the video, the plurality of attributes including at least one of a physical attribute and a temporal attribute, each attribute representing a characteristic of the detected object; selecting a new user rule after detecting the plurality of attributes; and after detecting the plurality of attributes and after selecting of the new user rule, identifying an event of the object that is not one of the detected attributes of the object by applying the new user rule to the plurality of detected attributes; wherein the plurality of attributes that are detected are independent of which event is identified, and wherein the step of identifying the event of the object identifies the event without reprocessing the video as presented by the applicant's arguments filed on 02/04/2011.

Any comments considered necessary by applicant must be submitted no later than the payment of the issue fee and, to avoid processing delays, should preferably accompany the issue fee. Such submissions should be clearly labeled "Comments on Statement of Reasons for Allowance."

3. Any inquiry concerning this communication or earlier communications from the examiner should be directed to Tung Vo whose telephone number is 571-272-7340. The examiner can normally be reached on Monday-Wednesday, Friday.

Art Unit: 2483

If attempts to reach the examiner by telephone are unsuccessful, the examiner's supervisor, Joseph Ustaris can be reached on 571-272-7383. The fax phone number for the organization where this application or proceeding is assigned is 571-273-8300.

Information regarding the status of an application may be obtained from the Patent Application Information Retrieval (PAIR) system. Status information for published applications may be obtained from either Private PAIR or Public PAIR. Status information for unpublished applications is available through Private PAIR only. For more information about the PAIR system, see <http://pair-direct.uspto.gov>. Should you have questions on access to the Private PAIR system, contact the Electronic Business Center (EBC) at 866-217-9197 (toll-free). If you would like assistance from a USPTO Customer Service Representative or access to the automated information system, call 800-786-9199 (IN USA OR CANADA) or 571-272-1000.

/Tung Vo/  
Primary Examiner, Art Unit 2483

<b>Issue Classification</b>  <b>*12569116*</b>	<b>Application/Control No.</b> 12569116	<b>Applicant(s)/Patent Under Reexamination</b> LIPTON ET AL.
	<b>Examiner</b> Tung Vo	<b>Art Unit</b> 2483

ORIGINAL						INTERNATIONAL CLASSIFICATION												
CLASS			SUBCLASS			CLAIMED					NON-CLAIMED							
348			143			H	O	4	N	7 / 18 (2006.01.01)								
<b>CROSS REFERENCE(S)</b>																		
CLASS	SUBCLASS (ONE SUBCLASS PER BLOCK)																	

<input type="checkbox"/> <b>Claims renumbered in the same order as presented by applicant</b> <input type="checkbox"/> <b>CPA</b> <input type="checkbox"/> <b>T.D.</b> <input type="checkbox"/> <b>R.1.47</b>															
Final	Original	Final	Original	Final	Original	Final	Original	Final	Original	Final	Original	Final	Original	Final	Original
1	27	15	43	30	59										
	28	16	44	31	60										
2	29	17	45	32	61										
3	30	18	46	33	62										
4	31	19	47	34	63										
5	32	20	48	35	64										
6	33	21	49	36	65										
7	34	22	50	37	66										
8	35		51	38	67										
9	36	23	52	39	68										
10	37	24	53	40	69										
11	38	25	54	41	70										
12	39	26	55												
13	40	27	56												
14	41	28	57												
	42	29	58												

NONE		<b>Total Claims Allowed:</b>	
		1	
(Assistant Examiner)	(Date)	O.G. Print Claim(s)	O.G. Print Figure
/Tung Vo/ Primary Examiner.Art Unit 2483	02/08/2011	1	1
(Primary Examiner)	(Date)		

<b>Search Notes</b>  *1256911 6**11481 640*	<b>Application/Control No.</b>  1256911611481640	<b>Applicant(s)/Patent Under Reexamination</b>  LIPTON ET AL.CHENG, CHIN-HUNG
	<b>Examiner</b>  Tung VoTung Vo	<b>Art Unit</b>  26212483

<b>SEARCHED</b>			
<b>Class</b>	<b>Subclass</b>	<b>Date</b>	<b>Examiner</b>
348	158-160, 14.02, 155	11/18/2010	TV
340375	541143, 144, 145, 148	11/18/20106/14/2010	TVTV
H04N	7/18	2/8/2011	TV

<b>SEARCH NOTES</b>		
<b>Search Notes</b>	<b>Date</b>	<b>Examiner</b>
EAST/WEST	6/14/2010	TV
INVENTOR SEARCH	2/8/2011	TV
CLAIM SEARCH	2/8/2011	TV
INTERFERENCE SEARCH	2/8/2011	TV

<b>INTERFERENCE SEARCH</b>			
<b>Class</b>	<b>Subclass</b>	<b>Date</b>	<b>Examiner</b>
348348	158143	11/18/20106/14/2010	TVTV

--	--



UNITED STATES PATENT AND TRADEMARK OFFICE

UNITED STATES DEPARTMENT OF COMMERCE  
 United States Patent and Trademark Office  
 Address: COMMISSIONER FOR PATENTS  
 P.O. Box 1450  
 Alexandria, Virginia 22313-1450  
 www.uspto.gov

BIB DATA SHEET

CONFIRMATION NO. 7686

SERIAL NUMBER	FILING or 371(c) DATE	CLASS	GROUP ART UNIT	ATTORNEY DOCKET NO.
12/569,116	09/29/2009	348	2486	OV-101
	RULE			

**APPLICANTS**

Alan J. Lipton, Falls Church, VA;  
 Thomas M. Strat, Pakton, VA;  
 Pèter L. Venetianer, McLean, VA;  
 Mark C. Allmen, Morrison, CO;  
 William E. Severson, Littleton, CO;  
 Niels Haering, Arlington, VA;  
 Andrew J. Chosak, McLean, VA;  
 Zhong Zhang, Herndon, VA;  
 Matthew F. Frazier, Arlington, VA;  
 James S. Seekas, Arlington, VA;  
 Tasuki Hirata, Silver Spring, MD;  
 John Clark, Leesburg, VA;

**\*\* CONTINUING DATA \*\*\*\*\***

This application is a CON of 09/987,707 11/15/2001 ABN  
 which is a CIP of 09/694,712 10/24/2000 PAT 6,954,498

**\*\* FOREIGN APPLICATIONS \*\*\*\*\***

**\*\* IF REQUIRED, FOREIGN FILING LICENSE GRANTED \*\*\* SMALL ENTITY \*\***  
 10/09/2009

Foreign Priority claimed <input type="checkbox"/> Yes <input checked="" type="checkbox"/> No	<input type="checkbox"/> Met after Allowance	<b>STATE OR COUNTRY</b>	<b>SHEETS DRAWINGS</b>	<b>TOTAL CLAIMS</b>	<b>INDEPENDENT CLAIMS</b>
35 USC 119(a-d) conditions met <input type="checkbox"/> Yes <input checked="" type="checkbox"/> No	Initials	VA	7	26	4
Verified and Acknowledged	/TUNG T VO/ Examiner's Signature				

**ADDRESS**

Muir Patent Consulting, PLLC  
 9913 Georgetown Pike, Suite 200  
 P.O. Box 1213  
 Great Falls, VA 22066  
 UNITED STATES

**TITLE**

Video Surveillance System Employing Video Primitives

<b>FILING FEE RECEIVED</b> 1448	FEES: Authority has been given in Paper No. _____ to charge/credit DEPOSIT ACCOUNT No. _____ for following:	<input type="checkbox"/> All Fees
		<input type="checkbox"/> 1.16 Fees (Filing)
		<input type="checkbox"/> 1.17 Fees (Processing Ext. of time)
		<input type="checkbox"/> 1.18 Fees (Issue)
		<input type="checkbox"/> Other _____
		<input type="checkbox"/> Credit

## EAST Search History

## EAST Search History (Prior Art)

Ref #	Hits	Search Query	DBs	Default Operator	Plurals	Time Stamp
L1	1	detect\$4 same attributes same video same camera same rule same event same object	US-PGPUB; USPAT; EPO; JPO; DERWENT; IBM_TDB	AND	ON	2011/02/08 09:55
L2	91737	alan.in.	US-PGPUB; USPAT; EPO; JPO; DERWENT; IBM_TDB	AND	ON	2011/02/08 09:55
L3	896	lipton.in.	US-PGPUB; USPAT; EPO; JPO; DERWENT; IBM_TDB	AND	ON	2011/02/08 09:55
L4	137	objectvideo	US-PGPUB; USPAT; EPO; JPO; DERWENT; IBM_TDB	AND	ON	2011/02/08 09:55
L5	67	2 and 3 and 4	US-PGPUB; USPAT; EPO; JPO; DERWENT; IBM_TDB	AND	ON	2011/02/08 09:55
L6	323299	peter.in.	US-PGPUB; USPAT; EPO; JPO; DERWENT; IBM_TDB	AND	ON	2011/02/08 09:56
L7	136	venetianer.in.	US-PGPUB; USPAT; EPO; JPO; DERWENT; IBM_TDB	AND	ON	2011/02/08 09:56
L8	77	6 and 7	US-PGPUB; USPAT; EPO; JPO; DERWENT; IBM_TDB	AND	ON	2011/02/08 09:57

L9	304	detect\$4 same attributes same video same camera	US-PGPUB; USPAT; EPO; JPO; DERWENT; IBM_TDB	AND	ON	2011/02/08 09:57
L10	2	8 and 9	US-PGPUB; USPAT; EPO; JPO; DERWENT; IBM_TDB	AND	ON	2011/02/08 09:57

### EAST Search History (I nterference)

Ref #	Hits	Search Query	DBs	Default Operator	Plurals	Time Stamp
L11	107	detect\$4 same attributes same video same camera	USPAT; UPAD	AND	ON	2011/02/08 09:57
L12	0	detect\$4 same attributes same video same camera same rule same event same object	USPAT; UPAD	AND	ON	2011/02/08 09:57
L13	122424	peter.in.	USPAT; UPAD	AND	ON	2011/02/08 09:57
L14	20	venetianer.in.	USPAT; UPAD	AND	ON	2011/02/08 09:57
L15	18	13 and 14	USPAT; UPAD	AND	ON	2011/02/08 09:57
L16	101	11 and "9"	USPAT; UPAD	AND	ON	2011/02/08 09:58
L17	1	11 and 14 and 13	USPAT; UPAD	AND	ON	2011/02/08 09:58

2/ 8/ 2011 9:58:59 AM

C:\ Documents and Settings\ tvo1\ My Documents\ EAST\ Workspaces\ Default EAST Workspace ( Flat Panel).wsp



**IN THE UNITED STATES PATENT AND TRADEMARK OFFICE**

In re the application of: Alan J Lipton et al. Attorney Docket: OV-101  
Serial Number: 12/569,116 Group Art Unit: 2621  
Filed: September 29, 2009 Examiner: Tung Vo  
Confirmation Number: 7686

Title: **VIDEO SURVEILLANCE SYSTEM EMPLOYING VIDEO  
PRIMITIVES**

SECOND SUPPLEMENTAL AMENDMENT AND INTERVIEW SUMMARY

Commissioner for Patents  
P.O. Box 1450  
Alexandria, VA 22313

Dear Sir:

This is a further Supplemental Amendment to the response filed October 13, 2010.

Please enter the following amendment and consider the following remarks.

**Amendments to the Claims:**

This listing of claims will replace all prior versions and listings of claims in the application:

**Listing of Claims:**

Claims 1-26 (Cancelled).

27. (Currently Amended) A method comprising:  
detecting an object in a video from a single camera;  
detecting a plurality of attributes of the object by analyzing the video from said single camera, the plurality of attributes including at least one of a physical attribute and a temporal attribute, each attribute representing a characteristic of the detected object;  
selecting a new user rule after detecting the plurality of attributes; and  
after detecting the plurality of attributes and after selecting the new user rule, identifying an event of the object that is not one of the detected attributes of the object by applying the new user rule to the plurality of detected attributes;  
wherein the plurality of attributes that are detected are independent of which event is identified, ~~and~~  
wherein the step of identifying the event of the object identifies the event without reprocessing the video, and  
wherein the event of the object refers to the object engaged in an activity.

28. (Cancelled).

29. (Previously Presented) The method of claim 27, wherein selecting the new user rule comprises selecting a subset of the plurality of attributes for analysis.

30. (Previously Presented) The method of claim 27, wherein the plurality of attributes that are detected are defined in a device prior to a selection of a subset of the plurality of attributes.

31. (Previously Presented) The method of claim 27, wherein no analysis is performed on at least some of the detected attributes to detect an event.

32. (Previously Presented) The method of claim 27, wherein the plurality of attributes include plural physical attributes and the method comprises applying the new user rule to a plural number of physical attributes.

33. (Previously Presented) The method of claim 27, wherein the plurality of attributes include plural temporal attributes and the method comprises applying the new user rule to a plural number of temporal attributes.

34. (Previously Presented) The method of claim 27, further comprising:  
storing the detected attributes in memory; and

identifying the event of the object by analyzing only a subset of the attributes stored in the memory.

35. (Currently Amended) A method comprising:  
detecting first and second objects in a video from a single camera;  
detecting a plurality of attributes of each of the detected first and second objects by analyzing the video from said single camera, each attribute representing a characteristic of the respective detected object;  
selecting a new user rule; and  
after detecting the plurality of attributes, identifying an event that is not one of the detected attributes of the first and second objects by applying the new user rule to the plurality of detected attributes;  
wherein the plurality of attributes that are detected are independent of which event is identified,  
wherein the step of identifying an event of the object comprises identifying a first event of the first object interacting with the second object by analyzing the detected attributes of the first and second objects, the first event not being one of the detected attributes, and  
wherein the event of the object refers to the object engaged in an activity.

36. (Currently Amended) A video device comprising:  
means for detecting an object in a video from a single camera;

means for detecting a plurality of attributes of the object by analyzing the video from said single camera, the plurality of attributes including at least a physical attribute and a temporal attribute, each attribute representing a characteristic of the detected object;

a memory storing the plurality of detected attributes;

means for selecting a new user rule after the plurality of detected attributes are stored in memory; and

means for identifying an event of the object that is not one of the detected attributes of the object by applying a selected new user rule to the plurality of attributes stored in memory, for identifying the event independent of when the attributes are stored in memory and for identifying the event without reprocessing the video, and

wherein the event of the object refers to the object engaged in an activity.

37. (Previously Presented) The video device of claim 36, further comprising:  
a video camera operable to obtain the video.

38. (Previously Presented) The video device of claim 36, wherein the means for identifying an event of the object comprises means for identifying a first event of the object in real time by analyzing, of the plurality of attributes, only a first selected subset of the plurality of attributes.

39. (Previously Presented) The video device of claim 38, wherein the means for identifying an event of the object comprises means for identifying a second event of

the object by analyzing, of the plurality of attributes, only a second selected subset of the plurality of attributes that have been archived.

40. (Previously Presented) The video device of claim 36, wherein applying a selected new user rule comprises analyzing, of the plurality of attributes, only a selected subset of the plurality of attributes.

41. (Currently Amended) The video device of claim 36,  
wherein the memory [[is]] is configured to store at least some of the plurality of attributes for at least two months, and

wherein the means for identifying an event of the object includes means for identifying an event of the object by analyzing only a selected subset of the plurality of attributes including the at least some of the plurality of attributes stored for at least two months.

42. (Cancelled).

43. (Previously Presented) The video device of claim 36, wherein the means for identifying an event includes means for identifying the event by analyzing at least two selected physical attributes of the plurality of attributes.

44. (Previously Presented) The video device of claim 36, wherein the identifying means identifies an event by analyzing a selection of individual ones of the detected plural attributes.

45. (Previously Presented) The video device of claim 36, wherein the plural attributes detected by the means for detecting are defined in the video device independent of a selection of the detected plural attributes.

46. (Previously Presented) The video device of claim 36, wherein the video surveillance device is a computer system configured as a video surveillance device.

47. (Previously Presented) The video device of claim 36, further comprising video sensors.

48. (Currently Amended) A method comprising:  
providing a video device which detects an object upon analyzing a video from a single camera and which detects plural attributes of the detected object upon analyzing the video from said single camera, the plurality of attributes including at least a physical attribute and a temporal attribute; and  
then, selecting a rule, which is not a rule used to detect any individual attribute, as a new user rule, the new user rule providing an analysis of a combination of the attributes to detect an event that is not one of the detected attributes,

wherein the attributes to be detected are independent of the event to be detected,  
and  
wherein the event of the object refers to the object engaged in an activity.

49. (Previously Presented) The method of claim 48, further comprising:  
providing a video device which detects an object upon analyzing a video and  
which detects plural physical attributes and plural temporal attributes of the detected  
object upon analyzing the video; and  
then, selecting the new user rule to provide an analysis of a combination of the  
plural physical attributes and the plural temporal attributes to detect the event.

50. (Currently Amended) A non-transitory computer-readable storage medium  
containing instructions that when executed by a computer system cause said computer  
system to implement the following method comprising:

detecting an object in a video from a single camera;  
detecting a plurality of attributes of the object by analyzing the video from said  
single camera, the plurality of attributes including at least one of a physical attribute and  
a temporal attribute, each attribute representing a characteristic of the detected object;  
selecting a new user rule after detecting the plurality of attributes; and  
after detecting the plurality of attributes and after selecting the new user rule,  
identifying an event of the object that is not one of the detected attributes of the object  
by applying the new user rule to the plurality of detected attributes, the event of the  
object being identified without reprocessing the video;



wherein the plurality of attributes that are detected are independent of which event is identified, and

wherein the event of the object refers to the object engaged in an activity.

51. (Cancelled).

52. (Previously Presented) The non-transitory computer-readable storage medium of claim 50, wherein selecting the new user rule comprises selecting a subset of the plurality of attributes for analysis.

53. (Previously Presented) The non-transitory computer-readable storage medium of claim 50, wherein the plurality of attributes that are detected are defined in a device prior to a selection of a subset of the plurality of attributes.

54. (Previously Presented) The non-transitory computer-readable storage medium of claim 50, wherein the instructions executed by the computer system do not cause the computer system to perform an analysis on at least some of the detected attributes to detect an event.

55. (Previously Presented) The non-transitory computer-readable storage medium of claim 50,

wherein the plurality of attributes include plural physical attributes, and

wherein the method implemented by the computer system further comprises applying the new user rule to a plural number of physical attributes.

56. (Previously Presented) The non-transitory computer-readable storage medium of claim 50,

wherein the plurality of attributes include plural temporal attributes, and

wherein the method implemented by the computer system further comprises applying the new user rule to a plural number of temporal attributes.

57. (Previously Presented) The non-transitory computer-readable storage medium of claim 50, wherein the method implemented by the computer system further comprises:

storing the detected attributes in memory; and

identifying the event of the object by analyzing only a subset of the attributes stored in the memory.

58. (Currently Amended) A non-transitory computer-readable storage medium containing instructions that when executed by a computer system cause said computer system to implement the following method comprising:

detecting first and second objects in a video from a single camera;

detecting a plurality of attributes of each of the detected first and second objects by analyzing the video from said single camera, each attribute representing a characteristic of the respective detected object;

selecting a new user rule; and  
after detecting the plurality of attributes, identifying an event that is not one of the detected attributes of the first and second objects by applying the new user rule to the plurality of detected attributes;

wherein the plurality of attributes that are detected are independent of which event is identified,

wherein the step of identifying an event comprises identifying a first event of the first object interacting with the second object by analyzing the detected attributes of the first and second objects, the first event not being one of the detected attributes, and

wherein the event of the object refers to the object engaged in an activity.

59. (Currently Amended) A video device comprising:

means for detecting first and second objects in a video from a single camera;

means for detecting a plurality of attributes of the object by analyzing the video from said single camera, each attribute representing a characteristic of the respective detected object;

a memory storing the plurality of detected attributes; and

means for identifying an event of the first object interacting with the second object by applying a selected new user rule to the plurality of attributes stored in memory, and for identifying the event independent of when the attributes are stored in memory, the event not being one of the detected attributes,

wherein the event of the object refers to the object engaged in an activity.

60. (Previously Presented) The video device of claim 59, further comprising:  
a video camera operable to obtain the video.

61. (Previously Presented) The video device of claim 59, wherein the means for identifying an event of the first object interacting with the second object comprises means for identifying a first event in real time by analyzing, of the plurality of attributes, only a first selected subset of the plurality of attributes.

62. (Previously Presented) The video device of claim 61, wherein the means for identifying an event of the first object interacting with the second object comprises means for identifying a second event by analyzing, of the plurality of attributes, only a second selected subset of the plurality of attributes which have been archived.

63. (Previously Presented) The video device of claim 59, wherein applying a selected new user rule comprises analyzing, of the plurality of attributes, only a selected subset of the plurality of attributes.

64. (Previously Presented) The video device of claim 59,  
wherein the memory is configured to store at least some of the plurality of attributes for at least two months, and  
wherein the means for identifying an event of the first object interacting with the second object includes means for identifying the event by analyzing only a selected

subset of the plurality of attributes including the at least some of the plurality of attributes stored for at least two months.

65. (Previously Presented) The video device of claim 59, wherein the means for identifying an event includes means for identifying the event without reprocessing the video.

66. (Previously Presented) The video device of claim 59, wherein the means for identifying an event includes means for identifying the event by analyzing at least two selected physical attributes of the plurality of attributes.

67. (Previously Presented) The video device of claim 59, wherein the identifying means identifies an event by analyzing a selection of individual ones of the detected plural attributes.

68. (Previously Presented) The video device of claim 59, wherein the plural attributes detected by the means for detecting are defined in the video device independent of a selection of the detected plural attributes.

69. (Previously Presented) The video device of claim 59, wherein the video surveillance device is a computer system configured as a video surveillance device.

70. (Previously Presented) The video device of claim 59, further comprising video sensors.

### REMARKS

Claims 27, 29-41, 43-50 and 52-70 are pending in this application, of which claims 27, 35, 36, 48, 50, 58, and 59 are independent.

The Applicant thanks Examiner Vo for his time during the personal interview of January 26, 2011 with Patrick Muir and Peter Venetianer. During the interview, the Applicant and Examiner discussed U.S. Patent Publication 2003/0023612 to Carlbom and its corresponding priority provisional applications (Nos. 60/299,335 and 60/297,539), these documents recently brought to the Applicant's attention by the Examiner.

As discussed, while Carlbom teaches obtaining plural motion trajectories, a separate camera (or sets of cameras) is used to detect a corresponding trajectory (one camera for a first player, another camera for a second player and six other cameras for the ball). There is no teaching of detecting multiple attributes by analyzing a video from a single camera, and then identifying an event of the object by applying a new user rule to those attributes. Claim 27 has been amended to clearly set forth this feature. The other independent claims 35, 36, 48, 50, 58, and 59 have also been amended to clarify that the video to be analyzed for multiple attributes is a video from a single camera.

In more detail, the Carlbom documents teach a system for automated performance data mining associated with a domain-specific event based on analysis of sensor data. The performance data mining techniques may combine sensor analysis data with other

data sources stored in a database to discover interesting patterns/rules associated with the event. (See, e.g., paragraphs [0010] and [0010] of Carlbom '612.)

More specifically, Carlbom teaches an instantly indexed multimedia database system developed for the sport of tennis. Carlbom '335 describes:

Multiple synchronized video streams from eight cameras observing a tennis match feed into a domain-specific, real-time tracking subsystem. Two cameras are used for player tracking and six cameras are used for ball tracking. The tracking subsystem outputs motion trajectories (sequences of spatio-temporal coordinates of the players and the ball) to a database.

The database is continually updated with motion data meshed with other dynamic aspects of the environment such as scores ... The database also stores static information such as the geometry of the environment, calibration parameters of all cameras, and information related to the players, the tournament, and the rules of the game.

See Carlbom '335 at page 5.

As discussed during the interview, none of the Carlbom documents teach identifying an event of an object by applying a new user rule to a plurality of detected attributes, where those plurality of attributes are detected by analyzing a video from a single camera (see claim 27). For example, Carlbom '335 clarifies that "LucentVision uses visual tracking to identify and follow the players using two cameras, each covering one half of the court" (see page 7, lines 6 and 7). The bottom of page 9 of Carlbom '335 discusses the use of six cameras for ball tracking.



It is believed that this application is in condition for allowance, at least for the reasons given in the Response of October 13, 2010. Favorable consideration and prompt allowance are respectfully requested. In the event any fees are required in connection with this paper, please charge the Deposit Account No. 50-4574. Any overpayment of fees may be credited to Deposit Account No. 50-4574.

Respectfully submitted,

/Patrick D. Muir/ Reg. #37403

MUIR PATENT CONSULTING, PLLC.  
9913 Georgetown Pike, Suite 200  
Great Falls, VA 22066  
Fax: (703) 757-7447

---

Patrick D. Muir  
Attorney for Applicants,  
Registration No. 37,403  
Tel: (703) 757-7444

## Electronic Acknowledgement Receipt

<b>EFS ID:</b>	9376253
<b>Application Number:</b>	12569116
<b>International Application Number:</b>	
<b>Confirmation Number:</b>	7686
<b>Title of Invention:</b>	Video Surveillance System Employing Video Primitives
<b>First Named Inventor/Applicant Name:</b>	Alan J. Lipton
<b>Customer Number:</b>	74712
<b>Filer:</b>	Patrick Daniel Muir
<b>Filer Authorized By:</b>	
<b>Attorney Docket Number:</b>	OV-101
<b>Receipt Date:</b>	04-FEB-2011
<b>Filing Date:</b>	29-SEP-2009
<b>Time Stamp:</b>	12:12:04
<b>Application Type:</b>	Utility under 35 USC 111(a)

### Payment information:

Submitted with Payment	no
------------------------	----

### File Listing:

Document Number	Document Description	File Name	File Size(Bytes)/ Message Digest	Multi Part /.zip	Pages (if appl.)
1		12596166_Supp_Amendment_OV_101.pdf	99432 f5b49bb3e20b932b516d49c9f4787b12420461b6	yes	17

<b>Multipart Description/PDF files in .zip description</b>			
<b>Document Description</b>		<b>Start</b>	<b>End</b>
Supplemental Response or Supplemental Amendment		1	1
Claims		2	14
Applicant Arguments/Remarks Made in an Amendment		15	17

**Warnings:**

**Information:**

<b>Total Files Size (in bytes):</b>	99432
-------------------------------------	-------

**This Acknowledgement Receipt evidences receipt on the noted date by the USPTO of the indicated documents, characterized by the applicant, and including page counts, where applicable. It serves as evidence of receipt similar to a Post Card, as described in MPEP 503.**

**New Applications Under 35 U.S.C. 111**

**If a new application is being filed and the application includes the necessary components for a filing date (see 37 CFR 1.53(b)-(d) and MPEP 506), a Filing Receipt (37 CFR 1.54) will be issued in due course and the date shown on this Acknowledgement Receipt will establish the filing date of the application.**

**National Stage of an International Application under 35 U.S.C. 371**

**If a timely submission to enter the national stage of an international application is compliant with the conditions of 35 U.S.C. 371 and other applicable requirements a Form PCT/DO/EO/903 indicating acceptance of the application as a national stage submission under 35 U.S.C. 371 will be issued in addition to the Filing Receipt, in due course.**

**New International Application Filed with the USPTO as a Receiving Office**

**If a new international application is being filed and the international application includes the necessary components for an international filing date (see PCT Article 11 and MPEP 1810), a Notification of the International Application Number and of the International Filing Date (Form PCT/RO/105) will be issued in due course, subject to prescriptions concerning national security, and the date shown on this Acknowledgement Receipt will establish the international filing date of the application.**

Under the Paperwork Reduction Act of 1995, no persons are required to respond to a collection of information unless it displays a valid OMB control number.

<b>PATENT APPLICATION FEE DETERMINATION RECORD</b> Substitute for Form PTO-875	Application or Docket Number <b>12/569,116</b>	Filing Date <b>09/29/2009</b>	<input type="checkbox"/> To be Mailed
---	---	----------------------------------	---------------------------------------

APPLICATION AS FILED – PART I			OTHER THAN SMALL ENTITY			
	(Column 1)	(Column 2)	SMALL ENTITY <input checked="" type="checkbox"/>	OR		
FOR	NUMBER FILED	NUMBER EXTRA	RATE (\$)	FEE (\$)	RATE (\$)	FEE (\$)
<input type="checkbox"/> BASIC FEE <small>(37 CFR 1.16(a), (b), or (c))</small>	N/A	N/A	N/A		N/A	
<input type="checkbox"/> SEARCH FEE <small>(37 CFR 1.16(k), (j), or (m))</small>	N/A	N/A	N/A		N/A	
<input type="checkbox"/> EXAMINATION FEE <small>(37 CFR 1.16(o), (p), or (q))</small>	N/A	N/A	N/A		N/A	
TOTAL CLAIMS <small>(37 CFR 1.16(j))</small>	minus 20 =	*	X \$ =	OR	X \$ =	
INDEPENDENT CLAIMS <small>(37 CFR 1.16(h))</small>	minus 3 =	*	X \$ =		X \$ =	
<input type="checkbox"/> APPLICATION SIZE FEE <small>(37 CFR 1.16(s))</small>	If the specification and drawings exceed 100 sheets of paper, the application size fee due is \$250 (\$125 for small entity) for each additional 50 sheets or fraction thereof. See 35 U.S.C. 41(a)(1)(G) and 37 CFR 1.16(s).					
<input type="checkbox"/> MULTIPLE DEPENDENT CLAIM PRESENT <small>(37 CFR 1.16(j))</small>						
* If the difference in column 1 is less than zero, enter "0" in column 2.			TOTAL		TOTAL	

APPLICATION AS AMENDED – PART II					OTHER THAN SMALL ENTITY			
	(Column 1)	(Column 2)	(Column 3)					
AMENDMENT	<b>02/04/2011</b>	CLAIMS REMAINING AFTER AMENDMENT	HIGHEST NUMBER PREVIOUSLY PAID FOR	PRESENT EXTRA	RATE (\$)	ADDITIONAL FEE (\$)	RATE (\$)	ADDITIONAL FEE (\$)
	Total <small>(37 CFR 1.16(i))</small>	* 41	Minus ** 41	= 0	X \$26 =	0	OR	X \$ =
	Independent <small>(37 CFR 1.16(h))</small>	* 7	Minus *** 7	= 0	X \$110 =	0	OR	X \$ =
	<input type="checkbox"/> Application Size Fee <small>(37 CFR 1.16(s))</small>							
	<input type="checkbox"/> FIRST PRESENTATION OF MULTIPLE DEPENDENT CLAIM <small>(37 CFR 1.16(j))</small>						OR	
					TOTAL ADD'L FEE	<b>0</b>	OR	TOTAL ADD'L FEE

	(Column 1)	(Column 2)	(Column 3)					
AMENDMENT		CLAIMS REMAINING AFTER AMENDMENT	HIGHEST NUMBER PREVIOUSLY PAID FOR	PRESENT EXTRA	RATE (\$)	ADDITIONAL FEE (\$)	RATE (\$)	ADDITIONAL FEE (\$)
	Total <small>(37 CFR 1.16(i))</small>	*	Minus **	=	X \$ =		OR	X \$ =
	Independent <small>(37 CFR 1.16(h))</small>	*	Minus ***	=	X \$ =		OR	X \$ =
	<input type="checkbox"/> Application Size Fee <small>(37 CFR 1.16(s))</small>							
	<input type="checkbox"/> FIRST PRESENTATION OF MULTIPLE DEPENDENT CLAIM <small>(37 CFR 1.16(j))</small>						OR	
					TOTAL ADD'L FEE		OR	TOTAL ADD'L FEE

\* If the entry in column 1 is less than the entry in column 2, write "0" in column 3.  
 \*\* If the "Highest Number Previously Paid For" IN THIS SPACE is less than 20, enter "20".  
 \*\*\* If the "Highest Number Previously Paid For" IN THIS SPACE is less than 3, enter "3".  
 The "Highest Number Previously Paid For" (Total or Independent) is the highest number found in the appropriate box in column 1.

Legal Instrument Examiner:  
/JOY DOBBS/

This collection of information is required by 37 CFR 1.16. The information is required to obtain or retain a benefit by the public which is to file (and by the USPTO to process) an application. Confidentiality is governed by 35 U.S.C. 122 and 37 CFR 1.14. This collection is estimated to take 12 minutes to complete, including gathering, preparing, and submitting the completed application form to the USPTO. Time will vary depending upon the individual case. Any comments on the amount of time you require to complete this form and/or suggestions for reducing this burden, should be sent to the Chief Information Officer, U.S. Patent and Trademark Office, U.S. Department of Commerce, P.O. Box 1450, Alexandria, VA 22313-1450. DO NOT SEND FEES OR COMPLETED FORMS TO THIS ADDRESS. **SEND TO: Commissioner for Patents, P.O. Box 1450, Alexandria, VA 22313-1450.**

If you need assistance in completing the form, call 1-800-PTO-9199 and select option 2.

**IN THE UNITED STATES PATENT AND TRADEMARK OFFICE**

In re the application of: Alan J Lipton et al. Attorney Docket: OV-101  
Serial Number: 12/569,116 Group Art Unit: 2621  
Filed: September 29, 2009 Examiner: Tung Vo  
Confirmation Number: 7686

Title: **VIDEO SURVEILLANCE SYSTEM EMPLOYING VIDEO  
PRIMITIVES**

SUPPLEMENTAL AMENDMENT AND INTERVIEW SUMMARY

Commissioner for Patents  
P.O. Box 1450  
Alexandria, VA 22313

Dear Sir:

This is a Supplemental Amendment to the response filed October 13, 2010. Please enter the following amendment and consider the following remarks.

**Amendments to the Claims:**

This listing of claims will replace all prior versions and listings of claims in the application:

**Listing of Claims:**

Claims 1-26 (Cancelled).

27. (Currently Amended) A method comprising:

detecting an object in a video;

detecting a plurality of attributes of the object by analyzing the video, the plurality of attributes including at least one of a physical attribute and a temporal attribute, each attribute representing a characteristic of the detected object;

selecting a new user rule after detecting the plurality of attributes; and

after detecting the plurality of attributes and after selecting ~~of~~ the new user rule, identifying an event of the object that is not one of the detected attributes of the object by applying the new user rule to the plurality of detected attributes;

wherein the plurality of attributes that are detected are independent of which event is identified, and

wherein the step of identifying the event of the object identifies the event without reprocessing the video.

28. (Cancelled).

29. (Previously Presented) The method of claim 27, wherein selecting the new user rule comprises selecting a subset of the plurality of attributes for analysis.

30. (Previously Presented) The method of claim 27, wherein the plurality of attributes that are detected are defined in a device prior to a selection of a subset of the plurality of attributes.

31. (Previously Presented) The method of claim 27, wherein no analysis is performed on at least some of the detected attributes to detect an event.

32. (Previously Presented) The method of claim 27, wherein the plurality of attributes include plural physical attributes and the method comprises applying the new user rule to a plural number of physical attributes.

33. (Previously Presented) The method of claim 27, wherein the plurality of attributes include plural temporal attributes and the method comprises applying the new user rule to a plural number of temporal attributes.

34. (Previously Presented) The method of claim 27, further comprising:  
storing the detected attributes in memory; and

identifying the event of the object by analyzing only a subset of the attributes stored in the memory.

35. (Currently Amended) A method comprising:

- detecting first and second objects in a video;
- detecting a plurality of attributes of each of the detected first and second objects by analyzing the video, each attribute representing a characteristic of the respective detected object;
- selecting a new user rule; and
- after detecting the plurality of attributes, identifying an event that is not one of the detected attributes of the first and second objects by applying the new user rule to the plurality of detected attributes;

wherein the plurality of attributes that are detected are independent of which event is identified,

wherein the step of identifying an event of the object comprises identifying an a first event of the first object interacting with the second object by analyzing the detected attributes of the first and second objects, the first event not being one of the detected attributes.

36. (Currently Amended) A video device comprising:

- means for detecting an object in a video;



means for detecting a plurality of attributes of the object by analyzing the video, the plurality of attributes including at least a physical attribute and a temporal attribute, each attribute representing a characteristic of the detected object;

a memory storing the plurality of detected attributes;

~~means for selecting a new user rule, the means for selecting a new user rule~~  
~~capable of selecting the new user rule~~ after the plurality of detected attributes are stored in memory; and

means for identifying an event of the object that is not one of the detected attributes of the object by applying a selected new user rule to the plurality of attributes stored in memory, ~~wherein the means for identifying an event is capable of~~ for identifying the event independent of when the attributes are stored in memory and ~~is~~ capable of for identifying the event without reprocessing the video.

37. (Previously Presented) The video device of claim 36, further comprising:  
a video camera operable to obtain the video.

38. (Previously Presented) The video device of claim 36, wherein the means for identifying an event of the object comprises means for identifying a first event of the object in real time by analyzing, of the plurality of attributes, only a first selected subset of the plurality of attributes.

39. (Previously Presented) The video device of claim 38, wherein the means for identifying an event of the object comprises means for identifying a second event of

the object by analyzing, of the plurality of attributes, only a second selected subset of the plurality of attributes that have been archived.

40. (Previously Presented) The video device of claim 36, wherein applying a selected new user rule comprises analyzing, of the plurality of attributes, only a selected subset of the plurality of attributes.

41. (Currently Amended) The video device of claim 36,  
wherein the memory is ~~capable of storing~~ is configured to store at least some of the plurality of attributes for at least two months, and

wherein the means for identifying an event of the object is ~~capable of identifying~~ includes means for identifying an event of the object by analyzing only a selected subset of the plurality of attributes including the at least some of the plurality of attributes stored for at least two months.

42. (Cancelled).

43. (Currently Amended) The video device of claim 36, wherein the means for identifying an event is ~~capable of identifying~~ includes means for identifying the event by analyzing at least two selected physical attributes of the plurality of attributes.

44. (Previously Presented) The video device of claim 36, wherein the identifying means identifies an event by analyzing a selection of individual ones of the detected plural attributes.

45. (Previously Presented) The video device of claim 36, wherein the plural attributes detected by the means for detecting are defined in the video device independent of a selection of the detected plural attributes.

46. (Previously Presented) The video device of claim 36, wherein the video surveillance device is a computer system configured as a video surveillance device.

47. (Previously Presented) The video device of claim 36, further comprising video sensors.

48. (Currently Amended) A method comprising:  
providing a video device which detects an object upon analyzing a video and which detects plural attributes of the detected object upon analyzing the video, the plurality of attributes including at least a physical attribute and a temporal attribute;  
and

then, selecting a rule, which is not a rule used to detect any individual attribute, as a new user rule, the new user rule providing an analysis of a combination of the attributes to detect an event that is not one of the detected attributes,

wherein the attributes to be detected are independent of the event to be detected.

49. (Previously Presented) The method of claim 48, further comprising:  
providing a video device which detects an object upon analyzing a video and  
which detects plural physical attributes and plural temporal attributes of the detected  
object upon analyzing the video; and  
then, selecting the new user rule to provide an analysis of a combination of the  
plural physical attributes and the plural temporal attributes to detect the event.

50. (Currently Amended) A non-transitory computer-readable storage medium  
containing instructions that when executed by a computer system cause said computer  
system to implement the following method comprising:

detecting an object in a video;  
detecting a plurality of attributes of the object by analyzing the video, the  
plurality of attributes including at least one of a physical attribute and a temporal  
attribute, each attribute representing a characteristic of the detected object;  
selecting a new user rule after detecting the plurality of attributes; and  
after detecting the plurality of attributes and after selecting the new user rule,  
identifying an event of the object that is not one of the detected attributes of the object  
by applying the new user rule to the plurality of detected attributes, the event of the  
object being identified without reprocessing the video;  
wherein the plurality of attributes that are detected are independent of which  
event is identified.

51. (Cancelled).

52. (Previously Presented) The non-transitory computer-readable storage medium of claim 50, wherein selecting the new user rule comprises selecting a subset of the plurality of attributes for analysis.

53. (Previously Presented) The non-transitory computer-readable storage medium of claim 50, wherein the plurality of attributes that are detected are defined in a device prior to a selection of a subset of the plurality of attributes.

54. (Previously Presented) The non-transitory computer-readable storage medium of claim 50, wherein the instructions executed by the computer system do not cause the computer system to perform an analysis on at least some of the detected attributes to detect an event.

55. (Previously Presented) The non-transitory computer-readable storage medium of claim 50,  
wherein the plurality of attributes include plural physical attributes, and  
wherein the method implemented by the computer system further comprises applying the new user rule to a plural number of physical attributes.

56. (Previously Presented) The non-transitory computer-readable storage medium of claim 50,

wherein the plurality of attributes include plural temporal attributes, and  
wherein the method implemented by the computer system further comprises  
applying the new user rule to a plural number of temporal attributes.

57. (Previously Presented) The non-transitory computer-readable storage  
medium of claim 50, wherein the method implemented by the computer system further  
comprises:

storing the detected attributes in memory; and  
identifying the event of the object by analyzing only a subset of the attributes  
stored in the memory.

58. (Currently Amended) A non-transitory computer-readable storage medium  
containing instructions that when executed by a computer system cause said computer  
system to implement the following method comprising:

detecting first and second objects in a video;  
detecting a plurality of attributes of each of the detected first and second objects  
by analyzing the video, each attribute representing a characteristic of the respective  
detected object;  
selecting a new user rule; and  
after detecting the plurality of attributes, identifying an event that is not one of  
the detected attributes of the first and second objects by applying the new user rule to the  
plurality of detected attributes;

wherein the plurality of attributes that are detected are independent of which event is identified,

wherein the step of identifying an event comprises identifying ~~an~~ a first event of the first object interacting with the second object by analyzing the detected attributes of the first and second objects, the first event not being one of the detected attributes.

59. (Currently Amended) A video device comprising:  
means for detecting first and second objects in a video;  
means for detecting a plurality of attributes of the object by analyzing the video, each attribute representing a characteristic of the respective detected object;  
a memory storing the plurality of detected attributes; and  
means for identifying an event of the first object interacting with the second object by applying a selected new user rule to the plurality of attributes stored in memory, and for identifying the event independent of when the attributes are stored in memory, the event not being one of the detected attributes,  
~~wherein the means for identifying an event is capable of identifying the event independent of when the attributes are stored in memory.~~

60. (Previously Presented) The video device of claim 59, further comprising:  
a video camera operable to obtain the video.

61. (Previously Presented) The video device of claim 59, wherein the means for identifying an event of the first object interacting with the second object comprises

means for identifying a first event in real time by analyzing, of the plurality of attributes, only a first selected subset of the plurality of attributes.

62. (Previously Presented) The video device of claim 61, wherein the means for identifying an event of the first object interacting with the second object comprises means for identifying a second event by analyzing, of the plurality of attributes, only a second selected subset of the plurality of attributes which have been archived.

63. (Previously Presented) The video device of claim 59, wherein applying a selected new user rule comprises analyzing, of the plurality of attributes, only a selected subset of the plurality of attributes.

64. (Currently Amended) The video device of claim 59,  
wherein the memory is ~~capable of storing~~ configured to store at least some of the plurality of attributes for at least two months, and

wherein the means for identifying an event of the first object interacting with the second object is ~~capable of identifying~~ includes means for identifying the an event by analyzing only a selected subset of the plurality of attributes including the at least some of the plurality of attributes stored for at least two months.

65. (Currently Amended) The video device of claim 59, wherein the means for identifying an event is ~~capable of identifying~~ includes means for identifying the event without reprocessing the video.



66. (Currently Amended) The video device of claim 59, wherein the means for identifying an event is ~~capable of identifying~~ includes means for identifying the event by analyzing at least two selected physical attributes of the plurality of attributes.

67. (Previously Presented) The video device of claim 59, wherein the identifying means identifies an event by analyzing a selection of individual ones of the detected plural attributes.

68. (Previously Presented) The video device of claim 59, wherein the plural attributes detected by the means for detecting are defined in the video device independent of a selection of the detected plural attributes.

69. (Previously Presented) The video device of claim 59, wherein the video surveillance device is a computer system configured as a video surveillance device.

70. (Previously Presented) The video device of claim 59, further comprising video sensors.

### REMARKS

Claims 27, 29-41, 43-50 and 52-70 are pending in this application, of which claims 27, 35, 36, 48, 50, 58, and 59 are independent.

The Applicant thanks Examiner Vo for his time during the personal interview of November 17, 2010 with Patrick Muir and Peter Venetianer. During the interview, the Examiner requested certain amendments to the claims for formal purposes. Claims 27, 35, 36, 41, 43, 48, 58, 59, 64-66 have been amended to address formal issues consistent with this discussion. In addition, 27, 36, 48, and 50 have been amended to add further recitations regarding the recited attributes as suggested by Examiner Vo during the interview.

It is believed that this application is in condition for allowance, at least for the reasons given in the Response of October 13, 2010. Favorable consideration and prompt allowance are respectfully requested. In the event any fees are required in connection with this paper, please charge the Deposit Account No. 50-4574. Any overpayment of fees may be credited to Deposit Account No. 50-4574.

Respectfully submitted,

/Patrick D. Muir/ Reg. #37403

MUIR PATENT CONSULTING, PLLC.  
9913 Georgetown Pike, Suite 200  
Great Falls, VA 22066  
Fax: (703) 757-7447

---

Patrick D. Muir  
Attorney for Applicants,  
Registration No. 37,403  
Tel: (703) 757-7444

## Electronic Acknowledgement Receipt

<b>EFS ID:</b>	8957528
<b>Application Number:</b>	12569116
<b>International Application Number:</b>	
<b>Confirmation Number:</b>	7686
<b>Title of Invention:</b>	Video Surveillance System Employing Video Primitives
<b>First Named Inventor/Applicant Name:</b>	Alan J. Lipton
<b>Customer Number:</b>	74712
<b>Filer:</b>	Patrick Daniel Muir
<b>Filer Authorized By:</b>	
<b>Attorney Docket Number:</b>	OV-101
<b>Receipt Date:</b>	02-DEC-2010
<b>Filing Date:</b>	29-SEP-2009
<b>Time Stamp:</b>	18:24:57
<b>Application Type:</b>	Utility under 35 USC 111(a)

### Payment information:

Submitted with Payment	no
------------------------	----

### File Listing:

Document Number	Document Description	File Name	File Size(Bytes)/ Message Digest	Multi Part /.zip	Pages (if appl.)
1		12596166_Supp_Amendment_OV_101_2010_12_02.pdf	92378 333e0c3624430ddb46ad001d8b6bade0e72a10cd	yes	14

<b>Multipart Description/PDF files in .zip description</b>			
<b>Document Description</b>		<b>Start</b>	<b>End</b>
Supplemental Response or Supplemental Amendment		1	1
Claims		2	13
Applicant Arguments/Remarks Made in an Amendment		14	14

**Warnings:**

**Information:**

<b>Total Files Size (in bytes):</b>	92378
-------------------------------------	-------

**This Acknowledgement Receipt evidences receipt on the noted date by the USPTO of the indicated documents, characterized by the applicant, and including page counts, where applicable. It serves as evidence of receipt similar to a Post Card, as described in MPEP 503.**

**New Applications Under 35 U.S.C. 111**

**If a new application is being filed and the application includes the necessary components for a filing date (see 37 CFR 1.53(b)-(d) and MPEP 506), a Filing Receipt (37 CFR 1.54) will be issued in due course and the date shown on this Acknowledgement Receipt will establish the filing date of the application.**

**National Stage of an International Application under 35 U.S.C. 371**

**If a timely submission to enter the national stage of an international application is compliant with the conditions of 35 U.S.C. 371 and other applicable requirements a Form PCT/DO/EO/903 indicating acceptance of the application as a national stage submission under 35 U.S.C. 371 will be issued in addition to the Filing Receipt, in due course.**

**New International Application Filed with the USPTO as a Receiving Office**

**If a new international application is being filed and the international application includes the necessary components for an international filing date (see PCT Article 11 and MPEP 1810), a Notification of the International Application Number and of the International Filing Date (Form PCT/RO/105) will be issued in due course, subject to prescriptions concerning national security, and the date shown on this Acknowledgement Receipt will establish the international filing date of the application.**

Under the Paperwork Reduction Act of 1995, no persons are required to respond to a collection of information unless it displays a valid OMB control number.

<b>PATENT APPLICATION FEE DETERMINATION RECORD</b> Substitute for Form PTO-875	Application or Docket Number <b>12/569,116</b>	Filing Date <b>09/29/2009</b>	<input type="checkbox"/> To be Mailed
---	---	----------------------------------	---------------------------------------

APPLICATION AS FILED – PART I			OTHER THAN SMALL ENTITY				
(Column 1)		(Column 2)	SMALL ENTITY <input checked="" type="checkbox"/>		OR	SMALL ENTITY	
FOR	NUMBER FILED	NUMBER EXTRA	RATE (\$)	FEE (\$)		RATE (\$)	FEE (\$)
<input checked="" type="checkbox"/> BASIC FEE <small>(37 CFR 1.16(a), (b), or (c))</small>	N/A	N/A	N/A	<b>82</b>	OR	N/A	
<input type="checkbox"/> SEARCH FEE <small>(37 CFR 1.16(k), (l), or (m))</small>	N/A	N/A	N/A			N/A	
<input checked="" type="checkbox"/> EXAMINATION FEE <small>(37 CFR 1.16(o), (p), or (q))</small>	N/A	N/A	N/A	<b>110</b>		N/A	
TOTAL CLAIMS <small>(37 CFR 1.16(i))</small>	minus 20 =	*	X \$ =			X \$ =	
INDEPENDENT CLAIMS <small>(37 CFR 1.16(h))</small>	minus 3 =	*	X \$ =			X \$ =	
<input type="checkbox"/> APPLICATION SIZE FEE <small>(37 CFR 1.16(s))</small>	If the specification and drawings exceed 100 sheets of paper, the application size fee due is \$250 (\$125 for small entity) for each additional 50 sheets or fraction thereof. See 35 U.S.C. 41(a)(1)(G) and 37 CFR 1.16(s).						
<input type="checkbox"/> MULTIPLE DEPENDENT CLAIM PRESENT <small>(37 CFR 1.16(j))</small>							
* If the difference in column 1 is less than zero, enter "0" in column 2.			TOTAL	<b>192</b>		TOTAL	

APPLICATION AS AMENDED – PART II					OTHER THAN SMALL ENTITY				
(Column 1)		(Column 2)	(Column 3)		SMALL ENTITY		OR	SMALL ENTITY	
AMENDMENT	12/02/2010	CLAIMS REMAINING AFTER AMENDMENT	HIGHEST NUMBER PREVIOUSLY PAID FOR	PRESENT EXTRA	RATE (\$)	ADDITIONAL FEE (\$)		RATE (\$)	ADDITIONAL FEE (\$)
	Total <small>(37 CFR 1.16(i))</small>	* 41	Minus	** 41 = 0	X \$26 =	0	OR	X \$ =	
	Independent <small>(37 CFR 1.16(h))</small>	* 7	Minus	*** 7 = 0	X \$110 =	0	OR	X \$ =	
	<input type="checkbox"/> Application Size Fee <small>(37 CFR 1.16(s))</small>								
	<input type="checkbox"/> FIRST PRESENTATION OF MULTIPLE DEPENDENT CLAIM <small>(37 CFR 1.16(j))</small>						OR		
					TOTAL ADD'L FEE	<b>0</b>	OR	TOTAL ADD'L FEE	

APPLICATION AS AMENDED – PART II					OTHER THAN SMALL ENTITY				
(Column 1)		(Column 2)	(Column 3)		SMALL ENTITY		OR	SMALL ENTITY	
AMENDMENT	CLAIMS REMAINING AFTER AMENDMENT	HIGHEST NUMBER PREVIOUSLY PAID FOR	PRESENT EXTRA	RATE (\$)	ADDITIONAL FEE (\$)		RATE (\$)	ADDITIONAL FEE (\$)	
	Total <small>(37 CFR 1.16(i))</small>	*	Minus	** =	X \$ =		OR	X \$ =	
	Independent <small>(37 CFR 1.16(h))</small>	*	Minus	*** =	X \$ =		OR	X \$ =	
	<input type="checkbox"/> Application Size Fee <small>(37 CFR 1.16(s))</small>								
	<input type="checkbox"/> FIRST PRESENTATION OF MULTIPLE DEPENDENT CLAIM <small>(37 CFR 1.16(j))</small>						OR		
					TOTAL ADD'L FEE		OR	TOTAL ADD'L FEE	

\* If the entry in column 1 is less than the entry in column 2, write "0" in column 3.  
 \*\* If the "Highest Number Previously Paid For" IN THIS SPACE is less than 20, enter "20".  
 \*\*\* If the "Highest Number Previously Paid For" IN THIS SPACE is less than 3, enter "3".  
 The "Highest Number Previously Paid For" (Total or Independent) is the highest number found in the appropriate box in column 1.

Legal Instrument Examiner:  
 //Angela E. Jones//

This collection of information is required by 37 CFR 1.16. The information is required to obtain or retain a benefit by the public which is to file (and by the USPTO to process) an application. Confidentiality is governed by 35 U.S.C. 122 and 37 CFR 1.14. This collection is estimated to take 12 minutes to complete, including gathering, preparing, and submitting the completed application form to the USPTO. Time will vary depending upon the individual case. Any comments on the amount of time you require to complete this form and/or suggestions for reducing this burden, should be sent to the Chief Information Officer, U.S. Patent and Trademark Office, U.S. Department of Commerce, P.O. Box 1450, Alexandria, VA 22313-1450. DO NOT SEND FEES OR COMPLETED FORMS TO THIS ADDRESS. **SEND TO: Commissioner for Patents, P.O. Box 1450, Alexandria, VA 22313-1450.**  
 If you need assistance in completing the form, call 1-800-PTO-9199 and select option 2.



UNITED STATES PATENT AND TRADEMARK OFFICE

UNITED STATES DEPARTMENT OF COMMERCE
United States Patent and Trademark Office
Address: COMMISSIONER FOR PATENTS
P.O. Box 1450
Alexandria, Virginia 22313-1450
www.uspto.gov

Table with 5 columns: APPLICATION NO., FILING DATE, FIRST NAMED INVENTOR, ATTORNEY DOCKET NO., CONFIRMATION NO.

12/569,116 09/29/2009 Alan J. Lipton OV-101 7686

74712 7590 11/23/2010
Muir Patent Consulting, PLLC
9913 Georgetown Pike, Suite 200
P.O. Box 1213
Great Falls, VA 22066

Table with 1 column: EXAMINER

VO, TUNG T

Table with 2 columns: ART UNIT, PAPER NUMBER

2483

Table with 2 columns: MAIL DATE, DELIVERY MODE

11/23/2010 PAPER

Please find below and/or attached an Office communication concerning this application or proceeding.

The time period for reply, if any, is set in the attached communication.

<b>Interview Summary</b>	<b>Application No.</b> 12/569,116	<b>Applicant(s)</b> LIPTON ET AL.	
	<b>Examiner</b> Tung Vo	<b>Art Unit</b> 2483	

All participants (applicant, applicant's representative, PTO personnel):

- (1) Tung Vo. (3) Pete Venetianer.  
(2) Patrick D. Muir. (4) \_\_\_\_\_.

Date of Interview: 17 November 2010.

Type: a)  Telephonic b)  Video Conference  
c)  Personal [copy given to: 1)  applicant 2)  applicant's representative]

Exhibit shown or demonstration conducted: d)  Yes e)  No.  
If Yes, brief description: \_\_\_\_\_.

Claim(s) discussed: 27.

Identification of prior art discussed: \_\_\_\_\_.

Agreement with respect to the claims f)  was reached. g)  was not reached. h)  N/A.

Substance of Interview including description of the general nature of what was agreed to if an agreement was reached, or any other comments: The applicants discussed the independent claims.

(A fuller description, if necessary, and a copy of the amendments which the examiner agreed would render the claims allowable, if available, must be attached. Also, where no copy of the amendments that would render the claims allowable is available, a summary thereof must be attached.)

THE FORMAL WRITTEN REPLY TO THE LAST OFFICE ACTION MUST INCLUDE THE SUBSTANCE OF THE INTERVIEW. (See MPEP Section 713.04). If a reply to the last Office action has already been filed, APPLICANT IS GIVEN A NON-EXTENDABLE PERIOD OF THE LONGER OF ONE MONTH OR THIRTY DAYS FROM THIS INTERVIEW DATE, OR THE MAILING DATE OF THIS INTERVIEW SUMMARY FORM, WHICHEVER IS LATER, TO FILE A STATEMENT OF THE SUBSTANCE OF THE INTERVIEW. See Summary of Record of Interview requirements on reverse side or on attached sheet.

/Tung Vo/  
Primary Examiner, Art Unit 2483

## Summary of Record of Interview Requirements

### Manual of Patent Examining Procedure (MPEP), Section 713.04, Substance of Interview Must be Made of Record

A complete written statement as to the substance of any face-to-face, video conference, or telephone interview with regard to an application must be made of record in the application whether or not an agreement with the examiner was reached at the interview.

### Title 37 Code of Federal Regulations (CFR) § 1.133 Interviews Paragraph (b)

In every instance where reconsideration is requested in view of an interview with an examiner, a complete written statement of the reasons presented at the interview as warranting favorable action must be filed by the applicant. An interview does not remove the necessity for reply to Office action as specified in §§ 1.111, 1.135. (35 U.S.C. 132)

#### 37 CFR §1.2 Business to be transacted in writing.

All business with the Patent or Trademark Office should be transacted in writing. The personal attendance of applicants or their attorneys or agents at the Patent and Trademark Office is unnecessary. The action of the Patent and Trademark Office will be based exclusively on the written record in the Office. No attention will be paid to any alleged oral promise, stipulation, or understanding in relation to which there is disagreement or doubt.

The action of the Patent and Trademark Office cannot be based exclusively on the written record in the Office if that record is itself incomplete through the failure to record the substance of interviews.

It is the responsibility of the applicant or the attorney or agent to make the substance of an interview of record in the application file, unless the examiner indicates he or she will do so. It is the examiner's responsibility to see that such a record is made and to correct material inaccuracies which bear directly on the question of patentability.

Examiners must complete an Interview Summary Form for each interview held where a matter of substance has been discussed during the interview by checking the appropriate boxes and filling in the blanks. Discussions regarding only procedural matters, directed solely to restriction requirements for which interview recordation is otherwise provided for in Section 812.01 of the Manual of Patent Examining Procedure, or pointing out typographical errors or unreadable script in Office actions or the like, are excluded from the interview recordation procedures below. Where the substance of an interview is completely recorded in an Examiners Amendment, no separate Interview Summary Record is required.

The Interview Summary Form shall be given an appropriate Paper No., placed in the right hand portion of the file, and listed on the "Contents" section of the file wrapper. In a personal interview, a duplicate of the Form is given to the applicant (or attorney or agent) at the conclusion of the interview. In the case of a telephone or video-conference interview, the copy is mailed to the applicant's correspondence address either with or prior to the next official communication. If additional correspondence from the examiner is not likely before an allowance or if other circumstances dictate, the Form should be mailed promptly after the interview rather than with the next official communication.

The Form provides for recordation of the following information:

- Application Number (Series Code and Serial Number)
- Name of applicant
- Name of examiner
- Date of interview
- Type of interview (telephonic, video-conference, or personal)
- Name of participant(s) (applicant, attorney or agent, examiner, other PTO personnel, etc.)
- An indication whether or not an exhibit was shown or a demonstration conducted
- An identification of the specific prior art discussed
- An indication whether an agreement was reached and if so, a description of the general nature of the agreement (may be by attachment of a copy of amendments or claims agreed as being allowable). Note: Agreement as to allowability is tentative and does not restrict further action by the examiner to the contrary.
- The signature of the examiner who conducted the interview (if Form is not an attachment to a signed Office action)

It is desirable that the examiner orally remind the applicant of his or her obligation to record the substance of the interview of each case. It should be noted, however, that the Interview Summary Form will not normally be considered a complete and proper recordation of the interview unless it includes, or is supplemented by the applicant or the examiner to include, all of the applicable items required below concerning the substance of the interview.

A complete and proper recordation of the substance of any interview should include at least the following applicable items:

- 1) A brief description of the nature of any exhibit shown or any demonstration conducted,
- 2) an identification of the claims discussed,
- 3) an identification of the specific prior art discussed,
- 4) an identification of the principal proposed amendments of a substantive nature discussed, unless these are already described on the Interview Summary Form completed by the Examiner,
- 5) a brief identification of the general thrust of the principal arguments presented to the examiner,  
(The identification of arguments need not be lengthy or elaborate. A verbatim or highly detailed description of the arguments is not required. The identification of the arguments is sufficient if the general nature or thrust of the principal arguments made to the examiner can be understood in the context of the application file. Of course, the applicant may desire to emphasize and fully describe those arguments which he or she feels were or might be persuasive to the examiner.)
- 6) a general indication of any other pertinent matters discussed, and
- 7) if appropriate, the general results or outcome of the interview unless already described in the Interview Summary Form completed by the examiner.

Examiners are expected to carefully review the applicant's record of the substance of an interview. If the record is not complete and accurate, the examiner will give the applicant an extendable one month time period to correct the record.

### Examiner to Check for Accuracy

If the claims are allowable for other reasons of record, the examiner should send a letter setting forth the examiner's version of the statement attributed to him or her. If the record is complete and accurate, the examiner should place the indication, "Interview Record OK" on the paper recording the substance of the interview along with the date and the examiner's initials.



**IN THE UNITED STATES PATENT AND TRADEMARK OFFICE**

In re the application of: Alan J Lipton et al. Attorney Docket: OV-101  
Serial Number: 12/569,116 Group Art Unit: 2621  
Filed: September 29, 2009 Examiner: Tung Vo  
Confirmation Number: 7686

Title: **VIDEO SURVEILLANCE SYSTEM EMPLOYING VIDEO  
PRIMITIVES**

AMENDMENT AND INTERVIEW SUMMARY

Commissioner for Patents  
P.O. Box 1450  
Alexandria, VA 22313

Dear Sir:

This is a response to the Office Action of June 17, 2010. A petition for a one month's extension of time is filed herewith. Please enter the following amendment and consider the following remarks.

**Amendments to the Claims:**

This listing of claims will replace all prior versions and listings of claims in the application:

**Listing of Claims:**

Claims 1-26 (Cancelled).

27. (Currently Amended) A method comprising:  
detecting an object in a video;  
detecting a plurality of attributes of the object by analyzing the video, each attribute representing a characteristic of the detected object;  
selecting a new user rule after detecting the plurality of attributes; and  
after detecting the plurality of attributes and after selecting of the new user rule,  
identifying an event of the object that is not one of the detected attributes of the object by applying the new user rule to the plurality of detected attributes;  
wherein the plurality of attributes that are detected are independent of which event is identified, and  
wherein the step of identifying the event identifies the event without reprocessing the video.

28. (Cancelled).

29. (Previously Presented) The method of claim 27, wherein selecting the new user rule comprises selecting a subset of the plurality of attributes for analysis.

30. (Currently Amended) The method of claim 27, wherein the plurality of attributes that are detected are defined in a device prior to ~~the~~ a selection of ~~the~~ a subset of the plurality of attributes.

31. (Currently Amended) The method of claim 27, wherein no analysis is performed on at least some of the detected attributes to detect an event ~~which are not the subset of the plurality of attributes.~~

32. (Previously Presented) The method of claim 27, wherein the plurality of attributes include plural physical attributes and the method comprises applying the new user rule to a plural number of physical attributes.

33. (Previously Presented) The method of claim 27, wherein the plurality of attributes include plural temporal attributes and the method comprises applying the new user rule to a plural number of temporal attributes.

34. (Previously Presented) The method of claim 27, further comprising:  
storing the detected attributes in memory; and

identifying the event of the object by analyzing only a subset of the attributes stored in the memory.

35. (Currently Amended) ~~A~~ The method of claim 27, further comprising:  
detecting first and second objects in a video;  
detecting a plurality of attributes of each of the detected first and second objects by analyzing the video, each attribute representing a characteristic of the respective detected object;  
selecting a new user rule; and  
after detecting the plurality of attributes, identifying an event that is not one of the detected attributes of the first and second objects by applying the new user rule to the plurality of detected attributes;  
wherein the plurality of attributes that are detected are independent of which event is identified,  
wherein the step of identifying an event comprises identifying an event of the first object interacting with the second object by analyzing the detected attributes of the first and second objects, the event not being one of the detected attributes.

36. (Currently Amended) A video device comprising:  
means for detecting an object in a video;  
means for detecting a plurality of attributes of the object by analyzing the video, each attribute representing a characteristic of the detected object;  
a memory storing the plurality of detected attributes; ~~and~~

means for selecting a new user rule, the means for selecting a new user rule capable of selecting the new user rule after the plurality of detected attributes are stored in memory; and

means for identifying an event of the object that is not one of the detected attributes of the object by applying a selected new user rule to the plurality of attributes stored in memory,

wherein the means for identifying an event is capable of identifying the event independent of when the attributes are stored in memory and is capable of identifying the event without reprocessing the video.

37. (Previously Presented) The video device of claim 36, further comprising:  
a video camera operable to obtain the video.

38. (Previously Presented) The video device of claim 36, wherein the means for identifying an event of the object comprises means for identifying a first event of the object in real time by analyzing, of the plurality of attributes, only a first selected subset of the plurality of attributes.

39. (Currently Amended) The video device of claim 38, wherein the means for identifying an event of the object comprises means for identifying a second event of the object by analyzing, of the plurality of attributes, only a second selected subset of the plurality of attributes ~~which~~ that have been archived.

40. (Previously Presented) The video device of claim 36, wherein applying a selected new user rule comprises analyzing, of the plurality of attributes, only a selected subset of the plurality of attributes.

41. (Previously Presented) The video device of claim 36,  
wherein the memory is capable of storing at least some of the plurality of attributes for at least two months, and

wherein the means for identifying an event of the object is capable of identifying an event of the object by analyzing only a selected subset of the plurality of attributes including the at least some of the plurality of attributes stored for at least two months.

42. (Cancelled).

43. (Previously Presented) The video device of claim 36, wherein the means for identifying an event is capable of identifying the event by analyzing at least two selected physical attributes of the plurality of attributes.

44. (Previously Presented) The video device of claim 36, wherein the identifying means identifies an event by analyzing a selection of individual ones of the detected plural attributes.

45. (Previously Presented) The video device of claim 36, wherein the plural attributes detected by the means for detecting are defined in the video device independent of a selection of the detected plural attributes.

46. (Previously Presented) The video device of claim 36, wherein the video surveillance device is a computer system configured as a video surveillance device.

47. (Previously Presented) The video device of claim 36, further comprising video sensors.

48. (Previously Presented) A method comprising:  
providing a video device which detects an object upon analyzing a video and which detects plural attributes of the detected object upon analyzing the video; and  
then, selecting a rule, which is not a rule used to detect any individual attribute, as a new user rule, the new user rule providing an analysis of a combination of the attributes to detect an event that is not one of the detected attributes,  
wherein the attributes to be detected are independent of the event to be detected.

49. (Previously Presented) The method of claim 48, further comprising:  
providing a video device which detects an object upon analyzing a video and which detects plural physical attributes and plural temporal attributes of the detected object upon analyzing the video; and

then, selecting the new user rule to provide an analysis of a combination of the plural physical attributes and the plural temporal attributes to detect the event.

50. (Currently Amended) A non-transitory computer-readable storage medium containing instructions that when executed by a computer system cause said computer system to implement the following method comprising:

detecting an object in a video;

detecting a plurality of attributes of the object by analyzing the video, each attribute representing a characteristic of the detected object;

selecting a new user rule after detecting the plurality of attributes; and

after detecting the plurality of attributes and after selecting the new user rule, identifying an event of the object that is not one of the detected attributes of the object by applying the new user rule to the plurality of detected attributes, the event of the object being identified without reprocessing the video;

wherein the plurality of attributes that are detected are independent of which event is identified.

51. (Cancelled).

52. (Previously Presented) The non-transitory computer-readable storage medium of claim 50, wherein selecting the new user rule comprises selecting a subset of the plurality of attributes for analysis.



53. (Currently Amended) The non-transitory computer-readable storage medium of claim 50, wherein the plurality of attributes that are detected are defined in a device prior to ~~the~~ a selection of ~~the~~ a subset of the plurality of attributes.

54. (Currently Amended) The non-transitory computer-readable storage medium of claim 50, wherein the instructions executed by the computer system do not cause the computer system to perform an ~~no~~ analysis is performed on at least some of the detected attributes to detect an event ~~which are not the subset of the plurality of~~ attributes.

55. (Previously Presented) The non-transitory computer-readable storage medium of claim 50,  
wherein the plurality of attributes include plural physical attributes, and  
wherein the method implemented by the computer system further comprises applying the new user rule to a plural number of physical attributes.

56. (Previously Presented) The non-transitory computer-readable storage medium of claim 50,  
wherein the plurality of attributes include plural temporal attributes, and  
wherein the method implemented by the computer system further comprises applying the new user rule to a plural number of temporal attributes.

57. (Previously Presented) The non-transitory computer-readable storage medium of claim 50, wherein the method implemented by the computer system further comprises:

storing the detected attributes in memory; and  
identifying the event of the object by analyzing only a subset of the attributes stored in the memory.

58. (Currently Amended) A ~~The~~ non-transitory computer-readable storage medium of claim 50, wherein the method implemented by the computer system further ~~comprises~~ containing instructions that when executed by a computer system cause said computer system to implement the following method comprising:

detecting first and second objects in a video;  
detecting a plurality of attributes of each of the detected first and second objects by analyzing the video, each attribute representing a characteristic of the respective detected object;

selecting a new user rule; and  
after detecting the plurality of attributes, identifying an event that is not one of the detected attributes of the first and second objects by applying the new user rule to the plurality of detected attributes;

wherein the plurality of attributes that are detected are independent of which event is identified,

wherein the step of identifying an event comprises identifying an event of the first object interacting with the second object by analyzing the detected attributes of the first and second objects, the event not being one of the detected attributes.

59. (New) A video device comprising:  
means for detecting first and second objects in a video;  
means for detecting a plurality of attributes of the object by analyzing the video, each attribute representing a characteristic of the respective detected object;  
a memory storing the plurality of detected attributes; and  
means for identifying an event of the first object interacting with the second object by applying a selected new user rule to the plurality of attributes stored in memory, the event not being one of the detected attributes,  
wherein the means for identifying an event is capable of identifying the event independent of when the attributes are stored in memory.

60. (New) The video device of claim 59, further comprising:  
a video camera operable to obtain the video.

61. (New) The video device of claim 59, wherein the means for identifying an event of the first object interacting with the second object comprises means for identifying a first event in real time by analyzing, of the plurality of attributes, only a first selected subset of the plurality of attributes.

62. (New) The video device of claim 61, wherein the means for identifying an event of the first object interacting with the second object comprises means for identifying a second event by analyzing, of the plurality of attributes, only a second selected subset of the plurality of attributes which have been archived.

63. (New) The video device of claim 59, wherein applying a selected new user rule comprises analyzing, of the plurality of attributes, only a selected subset of the plurality of attributes.

64. (New) The video device of claim 59,  
wherein the memory is capable of storing at least some of the plurality of attributes for at least two months, and  
wherein the means for identifying an event of the first object interacting with the second object is capable of identifying an event by analyzing only a selected subset of the plurality of attributes including the at least some of the plurality of attributes stored for at least two months.

65. (New) The video device of claim 59, wherein the means for identifying an event is capable of identifying the event without reprocessing the video.

66. (New) The video device of claim 59, wherein the means for identifying an event is capable of identifying the event by analyzing at least two selected physical attributes of the plurality of attributes.

67. (New) The video device of claim 59, wherein the identifying means identifies an event by analyzing a selection of individual ones of the detected plural attributes.

68. (New) The video device of claim 59, wherein the plural attributes detected by the means for detecting are defined in the video device independent of a selection of the detected plural attributes.

69. (New) The video device of claim 59, wherein the video surveillance device is a computer system configured as a video surveillance device.

70. (New) The video device of claim 59, further comprising video sensors.

### REMARKS

Claims 27, 29-41, 43-50 and 52-70 are pending in this application, of which claims 27, 35, 36, 48, 50, 58, and 59 are independent. With this amendment:

- Claims 35 and 58, directed towards identifying an event of a first object interacting with a second object, have been put into independent form.
- New claims 59-70 are added. These claims correspond to original claims 36-47, with further recitations added directed to identifying an event of a first object interacting with a second object.
- Claims 27 and 50 have been amended to recite the selecting of a new user rule is after detecting the plurality of attributes, to further highlight the differences of these claims and the prior art.
- Claims 28, 42 and 51 are cancelled, similar limitations of these claims having been added to independent claims 27, 36 and 51, respectively.
- Claims 30, 31, 39, 53 and 54 are amended to address formal matters.

The Applicant thanks Examiner Vo for his time during the personal interview of July 22, 2010. During the interview, the Applicant discussed the Office Action, the applied references to Paek et al. and Qian et al. While no agreement was reached regarding the differences of the invention, the interview was still helpful to help focus the remaining issues with respect to the pending claims.

In the Office Action of June 17, 2010, claims 27-58 were rejected under 35 U.S.C. §103(a) as being unpatentable over Paek et al. (U.S. Patent No. 7,653,635) in view of Qian et al. (U.S. Patent No. 6,721,454). The Examiner is respectfully requested to reconsider the teachings of the references and their applicability to the pending claims.

Independent Claims 27 and 50

One aspect of the disclosure is directed to the capability of selecting a new rule after detection of attributes of an object in a video and identifying an event of the object by applying the new rule. In one example, a system may analyze archived video primitives without needing to review the entire source video. The example describes generating an event discriminator, such as “the number of people stopping more than 10 minutes in area A in the last two months.” The source video does not need to be reviewed – only video primitives from the last two months need to be reviewed. See paragraph [0148], e.g.

Claim 27 now recites (emphasis added):

detecting a plurality of attributes of the object by analyzing the video, each attribute representing a characteristic of the detected object;  
selecting a new user rule *after detecting the plurality of attributes*; and  
after detecting the plurality of attributes and after selecting of the new user rule, identifying an event of the object that is not one of the detected attributes of the object by applying the new user rule to the plurality of detected attributes ...  
wherein the step of identifying the event identifies the event without reprocessing the video.

Claim 50 is directed to a non-transitory computer-readable storage medium containing instructions that when executed by a computer system cause said computer system to implement such a method.

None of the cited prior art, including Paek et al. and Qian et al., teach or suggest this feature. Specifically, none of the prior art teach or suggest selecting a new user rule *after detecting* a plurality of attributes of an object in a video, and then identifying an event by applying that new user rule to the attributes (without reprocessing the video).

*Paek et al.*

Paek et al. is directed to a technique for capturing content embedded in multimedia information or organizing such content (col. 2, lines 64-67). Image and video content 205 may be a database of still images or moving video. Subsystems 210, 220, 230, 240, 250, 260, 270 and 280 operate on the image and video content 205 to generate descriptions 211, 221, 23, 241, 251, 271, 271 and 281 that are input into database 295 which a search engine 170 may access (col. 8, line 58 to col. 9, line 3).

Paek et al. does provide an example in which the content of a particular image has text annotations including the event that is represented by the picture. See col. 12, starting at line 49. However, Paek et al. describes the event is “determined *by the author* of the description” (col. 14, lines 2-4, emphasis added). Paek et al. does not teach or suggest that the event is “identified ... by applying the new user rule to the plurality of detected attributes” as recited by claim 27. As such, Paek et al. also fails to teach or suggest identifying an event by applying a new user rule to a plurality of



attributes, the new user rule being selected “after detecting the plurality of attributes” as recited by claim 27.

*Qian et al.*

Qian et al. fails to correct the deficiencies of Paek et al. Qian et al. teaches analyzing the content of a video, summarizing the analysis and inferring an event from the summary. Visual analysis of the video content, including shot detection, texture and color analysis, and object detection occurs at the lowest level of the technique. At the second level, each shot is summarized based on the results produced by the visual analysis. At the highest level of the technique, events are inferred from spatial and temporal phenomena disclosed in the shot summaries. See col. 2, lines 1-18. Qian et al. describes that the technique may be extended to a broad spectrum of video domains “by incorporating shot summarization and event inference modules that are, relatively, specific to the domain or subject area of the video which operate on data generated by visual analysis processes which are not domain specific.” See col. 2, lines 11-18 and col. 3, lines 9-35.

However, while Qian et al. describes a multi-level approach to inferring an event in a video, Qian et al. fails to teach or suggest “selecting a new user rule *after detecting the plurality of attributes*; and after detecting the plurality of attributes and after selecting of the new user rule, *identifying an event* of the object that is not one of the detected attributes of the object *by applying the new user rule to the plurality of detected attributes ...*” as recited by claim 27 (emphasis added). It is respectfully asserted that there simply is no teaching or suggestion of this sequence in Qian et al.

In view of the above, the Examiner is respectfully requested to reconsider and withdraw the rejection with respect to claim 27.

Claim 36

Claim 36 recites:

means for selecting a new user rule, the means for selecting a new user rule capable of *selecting the new user rule after the plurality of detected attributes are stored in memory*; and

means for *identifying an event* of the object that is not one of the detected attributes of the object *by applying a selected new user rule to the plurality of attributes stored in memory*,

(emphasis added).

The teachings of Paek et al. and Qian et al. have been discussed above.

However, neither Paek et al. nor Qian et al teach or suggest these recitations. The Examiner is therefore respectfully requested to reconsider and withdraw rejection with respect to claim 36.

Claim 48

Claim 48 recites (emphasis added):

providing a video device which detects an object upon analyzing a video and which detects plural attributes of the detected object upon analyzing the video; and

*then, selecting a rule*, which is not a rule used to detect any individual attribute, *as a new user rule, the new user rule providing an analysis of a combination of the attributes to detect an event* that is not one of the detected attributes, ...

Neither Paek et al. nor Qian et al. teach or suggest this sequence. The Examiner is therefore respectfully requested to reconsider and withdraw rejection with respect to claim 48.

Claim 35

Claim 35 recites:

after detecting the plurality of attributes, identifying an event that is not one of the detected attributes of the first and second objects by applying the new user rule to the plurality of detected attributes;

wherein the plurality of attributes that are detected are independent of which event is identified,

wherein the step of identifying an event comprises identifying an event of the first object interacting with the second object by analyzing the detected attributes of the first and second objects, the event not being one of the detected attributes.

Paek et al. and Qian et al. are silent regarding these recitations. Specifically, claim 35 recites identifying an event of a first object interacting with a second object by analyzing detected attributes (where the event is not one of the detected attributes). The Office Action references 18 and 22, Figure 1 and Figure 10 of Qian et al. as teaching this recitation. Figure 1 illustrates box 20 within box 18; numeral 18 references a third level of the technique of Qian et al. where events 22 are inferred from shot summaries by a domain specific event inference module 20 (see, e.g., col. 3, lines 6-8). Figure 10 of Qian et al. is directed to a state diagram of an animal hunt detection inference module, where a hunt event is inferred after detecting three shots containing hunt candidates (the video is tracking a fast moving animal) which are followed by a

shot in which the video is no longer tracking a fast moving animal. See col. 11, lines 58-64.

However, none of 18, 20, Figure 1 nor Figure 10 describe “identifying an event of the first object interacting with the second object by analyzing the detected attributes of the first and second objects, the event not being one of the detected attributes” as recited by claim 35. The remainder of Qian et al. is also silent regarding this feature. Paek et al. also fails to correct this deficiency. Therefore, the Examiner is therefore respectfully requested to reconsider and withdraw rejection with respect to claim 35.

#### Claim 58

Similar to claim 35, claim 58 recites “identifying an event of the first object interacting with the second object by analyzing the detected attributes of the first and second objects, the event not being one of the detected attributes.” For reasons similar to claim 35, the Examiner is respectfully requested to reconsider and withdraw the rejection of claim 35.

#### Claims 29-34, 37-41, 43-47, 49 and 52-57

Claims 29-34, 37-41, 43-47, 49 and 52-57 depend from one of independent claims 27, 36, 48 and 50 discussed above. These claims are allowable at least for this reason alone. Further, many of these dependent claim recitations are not taught or suggested by the prior art. For example:

- Claim 30 recites that the plurality of attributes are defined in a device prior to a selection of a subset of the attributes.

- Claim 31 recites that no analysis is performed on at least some of the detected attributes to detect an event.
- Claim 34 recites identifying the event by analyzing only a subset of the attributes stored in memory.
- Claim 39 recites means for identifying a second event of the object by analyzing only a second selected subset of the attributes that have been archived. It should also be noted that claim 39 depends from claim 38 which recites means for identifying a first event of the object in real time.

Features of these dependent claims may be reflected in other dependent claims not listed here. Further, the above highlighted features are non-exhaustive examples.

In view of the above, the Examiner is respectfully requested to withdraw this rejection and allow this application to issue.

New claims 59-70 have been added to further describe various aspects of the invention. These claims correspond to original claims 36-47, with further recitations added directed to identifying an event of a first object interacting with a second object. As noted above, the prior art fails to teach or suggest these features.

It is believed that this application is in condition for allowance. Favorable consideration and prompt allowance are respectfully requested. A petition for one month's extension of time is filed concurrently with this response. In the event any fees are required in connection with this paper, please charge the Deposit Account No. 50-4574. Any overpayment of fees may be credited to Deposit Account No. 50-4574.

Respectfully submitted,

/Patrick D. Muir/ Reg. #37403

MUIR PATENT CONSULTING, PLLC.  
9913 Georgetown Pike, Suite 200  
Great Falls, VA 22066  
Fax: (703) 757-7447

---

Patrick D. Muir  
Attorney for Applicants,  
Registration No. 37,403  
Tel: (703) 757-7444

**IN THE UNITED STATES PATENT AND TRADEMARK OFFICE**

In re the application of: Alan J. Lipton Attorney Docket No.: OV-101  
Serial No.: 12/569,116 Group Art Unit: 2621  
Filed: September 29, 2009 Examiner: Tung Vo  
Confirmation No.: 7686

Title: **VIDEO SURVEILLANCE SYSTEM EMPLOYING VIDEO PRIMITIVES**

INFORMATION DISCLOSURE STATEMENT UNDER 37 C.F.R. 1.97(c)

Commissioner for Patents  
P.O. Box 1450  
Alexandria, VA 22313

Dear Sir:

Pursuant to 37 C.F.R. 1.56 and 1.97(c), Applicant brings to the attention of the Examiner the listed documents on the attached SB/08 Form. Copies of listed U.S. patent documents are not enclosed. Copies of the listed foreign patent documents are submitted herewith.

This Information Disclosure Statement is filed after the mailing date of a first Office Action but before the mailing date of a final Office Action, or an action that otherwise closes prosecution. The fee set forth in 1.97(c)(2) is submitted herewith.

Applicant respectfully requests that the Examiner consider the listed documents and indicate that they were considered by making appropriate notations on the attached form. These documents have been cited by this Examiner in the June 2, 2010 Office Action

relating to U.S. Serial No. 11/167,218. It is believed that the remaining documents cited in that Office Action have been previously cited in the present application and are therefore not submitted with this IDS.

This submission does not represent that a search has been made or that no better art exists and does not constitute an admission that each or all of the listed documents are material or constitute "prior art". If the Examiner applies any of the documents as prior art against any claim in the application and Applicant determines that the cited documents do not constitute "prior art" under United States law, Applicant reserves the right to present to the U.S. Patent and Trademark Office the relevant facts and law regarding the appropriate status of such documents.

Applicant further reserves the right to take appropriate action to establish the patentability of the disclosed invention over the listed documents, should one or more of the documents be applied against the claims of the present application.

In the event any fees are required in connection with this paper, please charge the Deposit Account No. 50-4574.

Respectfully submitted,

/Patrick D. Muir/\_\_\_\_\_

MUIR PATENT CONSULTING, PLLC.  
9913 Georgetown Pike, Suite 200  
Great Falls, VA 22066

Patrick D. Muir, Reg. #37,403  
Tel: (703) 757-7444  
Fax: (703) 757-7447



IDS Form PTO/SB/08: Substitute for form 1449A/PTO			<b>Complete if Known</b>		
<b>INFORMATION DISCLOSURE STATEMENT BY APPLICANT</b>  <i>(Use as many sheets as necessary)</i>			<i>Application Number</i>	12/569,116	
			<i>Filing Date</i>	09-29-2009	
			<i>First Named Inventor</i>	Alan J. Lipton	
			<i>Art Unit</i>	2621	
			<i>Examiner Name</i>	Tung Vo	
Sheet	1	of	1	<i>Attorney Docket Number</i>	OV-101

<b>U.S. PATENTS AND PUBLISHED U.S. PATENT APPLICATIONS</b>					
Examiner Initials	Cite No. <sup>1</sup>	Document Number	Issue or Publication Date MM-DD-YYYY	Name of Patentee or Applicant of Cited Document	Pages, Columns, Lines, Where Relevant Passages or Relevant Figures Appear
		Number-Kind Code <sup>2</sup> (if known)			
	1	US-2004/0130620 A1	07-08-2004	Buehler et al.	
	2	US-2005/0198063 A1	09-08-2005	Thomas et al.	

**Note: Submission of copies of U.S. Patents and published U.S. Patent Applications is not required.**

<b>FOREIGN PATENT DOCUMENTS</b>						
Examiner Initials	Cite No. <sup>1</sup>	Foreign Patent Document	Publication Date MM-DD-YYYY	Name of Patentee or Applicant of Cited Document	Pages, Columns, Lines, Where Relevant Passages or Relevant Figures Appear	Translation <sup>6</sup>
		Country Code <sup>3</sup> Number <sup>4</sup> Kind Code <sup>5</sup> (if known)				
	1					
	2					
	3					

<b>NONPATENT LITERATURE DOCUMENTS</b>			
Examiner Initials	Cite No. <sup>1</sup>	Include name of the author (in CAPITAL LETTERS), title of the article (when appropriate), title of the item (book, magazine, journal, serial, symposium, catalog, etc.), date, page(s), volume-issue number(s), publisher, city and/or country where published.	Translation <sup>6</sup>

Examiner Signature		Date Considered	
--------------------	--	-----------------	--

EXAMINER: Initial if reference considered, whether or not citation is in conformance with MPEP 609. Draw line through citation if not in conformance and not considered. Include copy of this form with next communication to applicant.

## Electronic Patent Application Fee Transmittal

<b>Application Number:</b>	12569116
<b>Filing Date:</b>	29-Sep-2009
<b>Title of Invention:</b>	Video Surveillance System Employing Video Primitives
<b>First Named Inventor/Applicant Name:</b>	Alan J. Lipton
<b>Filer:</b>	Patrick Daniel Muir/Melissa McGinn
<b>Attorney Docket Number:</b>	OV-101

Filed as Large Entity

### Utility under 35 USC 111(a) Filing Fees

Description	Fee Code	Quantity	Amount	Sub-Total in USD(\$)
<b>Basic Filing:</b>				
<b>Pages:</b>				
<b>Claims:</b>				
Claims in excess of 20	1202	9	52	468
Independent claims in excess of 3	1201	3	220	660

### Miscellaneous-Filing:

**Petition:**

**Patent-Appeals-and-Interference:**

**Post-Allowance-and-Post-Issuance:**

Description	Fee Code	Quantity	Amount	Sub-Total in USD(\$)
<b>Extension-of-Time:</b>				
<b>Miscellaneous:</b>				
Submission- Information Disclosure Stmt	1806	1	180	180
<b>Total in USD (\$)</b>				<b>1308</b>

## Electronic Acknowledgement Receipt

<b>EFS ID:</b>	8620338
<b>Application Number:</b>	12569116
<b>International Application Number:</b>	
<b>Confirmation Number:</b>	7686
<b>Title of Invention:</b>	Video Surveillance System Employing Video Primitives
<b>First Named Inventor/Applicant Name:</b>	Alan J. Lipton
<b>Customer Number:</b>	74712
<b>Filer:</b>	Patrick Daniel Muir/Melissa McGinn
<b>Filer Authorized By:</b>	Patrick Daniel Muir
<b>Attorney Docket Number:</b>	OV-101
<b>Receipt Date:</b>	13-OCT-2010
<b>Filing Date:</b>	29-SEP-2009
<b>Time Stamp:</b>	17:09:51
<b>Application Type:</b>	Utility under 35 USC 111(a)

### Payment information:

Submitted with Payment	no
------------------------	----

### File Listing:

Document Number	Document Description	File Name	File Size(Bytes)/ Message Digest	Multi Part /.zip	Pages (if appl.)
1		12596166_Amendment_OV_101.pdf	138029 f4a21ab7e159da2942ef2f412a67eb7a23b6f379	yes	22

Multipart Description/PDF files in .zip description			
	Document Description	Start	End
	Amendment/Req. Reconsideration-After Non-Final Reject	1	1
	Claims	2	13
	Applicant Arguments/Remarks Made in an Amendment	14	22

**Warnings:**

**Information:**

2	Transmittal Letter	OV_101_IDS_transmittal.pdf	59847 ce639bd08d3e9f9931d9950b56aa9a20d0424d54	no	2
---	--------------------	----------------------------	---	----	---

**Warnings:**

**Information:**

3	Information Disclosure Statement (IDS) Filed (SB/08)	OV_101_IDS.pdf	78191 419f7b3c94eef361a5e0ac33167f3f47858a31db	no	1
---	--	----------------	---	----	---

**Warnings:**

**Information:**

This is not an USPTO supplied IDS fillable form

4	Fee Worksheet (PTO-875)	fee-info.pdf	33349 491ef867c415def952ab23876935c0d21ce5b5	no	2
---	-------------------------	--------------	---	----	---

**Warnings:**

**Information:**

**Total Files Size (in bytes):** 309416

**This Acknowledgement Receipt evidences receipt on the noted date by the USPTO of the indicated documents, characterized by the applicant, and including page counts, where applicable. It serves as evidence of receipt similar to a Post Card, as described in MPEP 503.**

**New Applications Under 35 U.S.C. 111**

**If a new application is being filed and the application includes the necessary components for a filing date (see 37 CFR 1.53(b)-(d) and MPEP 506), a Filing Receipt (37 CFR 1.54) will be issued in due course and the date shown on this Acknowledgement Receipt will establish the filing date of the application.**

**National Stage of an International Application under 35 U.S.C. 371**

**If a timely submission to enter the national stage of an international application is compliant with the conditions of 35 U.S.C. 371 and other applicable requirements a Form PCT/DO/EO/903 indicating acceptance of the application as a national stage submission under 35 U.S.C. 371 will be issued in addition to the Filing Receipt, in due course.**

**New International Application Filed with the USPTO as a Receiving Office**

**If a new international application is being filed and the international application includes the necessary components for an international filing date (see PCT Article 11 and MPEP 1810), a Notification of the International Application Number and of the International Filing Date (Form PCT/RO/105) will be issued in due course, subject to prescriptions concerning national security, and the date shown on this Acknowledgement Receipt will establish the international filing date of the application.**

## Electronic Patent Application Fee Transmittal

<b>Application Number:</b>	12569116
<b>Filing Date:</b>	29-Sep-2009
<b>Title of Invention:</b>	Video Surveillance System Employing Video Primitives
<b>First Named Inventor/Applicant Name:</b>	Alan J. Lipton
<b>Filer:</b>	Patrick Daniel Muir/Melissa McGinn
<b>Attorney Docket Number:</b>	OV-101

Filed as Small Entity

### Utility under 35 USC 111(a) Filing Fees

Description	Fee Code	Quantity	Amount	Sub-Total in USD(\$)
<b>Basic Filing:</b>				
<b>Pages:</b>				
<b>Claims:</b>				
Claims in excess of 20	2202	9	26	234
Independent claims in excess of 3	2201	3	110	330

### Miscellaneous-Filing:

**Petition:**

**Patent-Appeals-and-Interference:**

**Post-Allowance-and-Post-Issuance:**

Description	Fee Code	Quantity	Amount	Sub-Total in USD(\$)
<b>Extension-of-Time:</b>				
<b>Miscellaneous:</b>				
Submission- Information Disclosure Stmt	1806	1	180	180
<b>Total in USD (\$)</b>				<b>744</b>

## Electronic Acknowledgement Receipt

<b>EFS ID:</b>	8620513
<b>Application Number:</b>	12569116
<b>International Application Number:</b>	
<b>Confirmation Number:</b>	7686
<b>Title of Invention:</b>	Video Surveillance System Employing Video Primitives
<b>First Named Inventor/Applicant Name:</b>	Alan J. Lipton
<b>Customer Number:</b>	74712
<b>Filer:</b>	Patrick Daniel Muir/Melissa McGinn
<b>Filer Authorized By:</b>	Patrick Daniel Muir
<b>Attorney Docket Number:</b>	OV-101
<b>Receipt Date:</b>	13-OCT-2010
<b>Filing Date:</b>	29-SEP-2009
<b>Time Stamp:</b>	17:19:07
<b>Application Type:</b>	Utility under 35 USC 111(a)

### Payment information:

Submitted with Payment	yes
Payment Type	Credit Card
Payment was successfully received in RAM	\$744
RAM confirmation Number	4230
Deposit Account	504574
Authorized User	MUIR,PATRICK D.

The Director of the USPTO is hereby authorized to charge indicated fees and credit any overpayment as follows:

Charge any Additional Fees required under 37 C.F.R. Section 1.16 (National application filing, search, and examination fees)

Charge any Additional Fees required under 37 C.F.R. Section 1.17 (Patent application and reexamination processing fees)



Charge any Additional Fees required under 37 C.F.R. Section 1.19 (Document supply fees)

Charge any Additional Fees required under 37 C.F.R. Section 1.20 (Post Issuance fees)

Charge any Additional Fees required under 37 C.F.R. Section 1.21 (Miscellaneous fees and charges)

### File Listing:

Document Number	Document Description	File Name	File Size(Bytes)/ Message Digest	Multi Part /.zip	Pages (if appl.)
1	Fee Worksheet (PTO-875)	fee-info.pdf	33239 be4e61cdd66e4f853aea81211754acae062148dd	no	2

### Warnings:

### Information:

**Total Files Size (in bytes):**

33239

**This Acknowledgement Receipt evidences receipt on the noted date by the USPTO of the indicated documents, characterized by the applicant, and including page counts, where applicable. It serves as evidence of receipt similar to a Post Card, as described in MPEP 503.**

#### **New Applications Under 35 U.S.C. 111**

**If a new application is being filed and the application includes the necessary components for a filing date (see 37 CFR 1.53(b)-(d) and MPEP 506), a Filing Receipt (37 CFR 1.54) will be issued in due course and the date shown on this Acknowledgement Receipt will establish the filing date of the application.**

#### **National Stage of an International Application under 35 U.S.C. 371**

**If a timely submission to enter the national stage of an international application is compliant with the conditions of 35 U.S.C. 371 and other applicable requirements a Form PCT/DO/EO/903 indicating acceptance of the application as a national stage submission under 35 U.S.C. 371 will be issued in addition to the Filing Receipt, in due course.**

#### **New International Application Filed with the USPTO as a Receiving Office**

**If a new international application is being filed and the international application includes the necessary components for an international filing date (see PCT Article 11 and MPEP 1810), a Notification of the International Application Number and of the International Filing Date (Form PCT/RO/105) will be issued in due course, subject to prescriptions concerning national security, and the date shown on this Acknowledgement Receipt will establish the international filing date of the application.**

## Electronic Patent Application Fee Transmittal

<b>Application Number:</b>	12569116
<b>Filing Date:</b>	29-Sep-2009
<b>Title of Invention:</b>	Video Surveillance System Employing Video Primitives
<b>First Named Inventor/Applicant Name:</b>	Alan J. Lipton
<b>Filer:</b>	Bradley E. Edelman
<b>Attorney Docket Number:</b>	OV-101

Filed as Small Entity

### Utility under 35 USC 111(a) Filing Fees

Description	Fee Code	Quantity	Amount	Sub-Total in USD(\$)
<b>Basic Filing:</b>				
<b>Pages:</b>				
<b>Claims:</b>				
<b>Miscellaneous-Filing:</b>				
<b>Petition:</b>				
<b>Patent-Appeals-and-Interference:</b>				
<b>Post-Allowance-and-Post-Issuance:</b>				
<b>Extension-of-Time:</b>				
Extension - 1 month with \$0 paid	2251	1	65	65

Description	Fee Code	Quantity	Amount	Sub-Total in USD(\$)
<b>Miscellaneous:</b>				
<b>Total in USD (\$)</b>				<b>65</b>

## Electronic Acknowledgement Receipt

<b>EFS ID:</b>	8621811
<b>Application Number:</b>	12569116
<b>International Application Number:</b>	
<b>Confirmation Number:</b>	7686
<b>Title of Invention:</b>	Video Surveillance System Employing Video Primitives
<b>First Named Inventor/Applicant Name:</b>	Alan J. Lipton
<b>Customer Number:</b>	74712
<b>Filer:</b>	Bradley E. Edelman
<b>Filer Authorized By:</b>	
<b>Attorney Docket Number:</b>	OV-101
<b>Receipt Date:</b>	13-OCT-2010
<b>Filing Date:</b>	29-SEP-2009
<b>Time Stamp:</b>	19:14:34
<b>Application Type:</b>	Utility under 35 USC 111(a)

### Payment information:

Submitted with Payment	yes
Payment Type	Deposit Account
Payment was successfully received in RAM	\$65
RAM confirmation Number	5646
Deposit Account	504574
Authorized User	

The Director of the USPTO is hereby authorized to charge indicated fees and credit any overpayment as follows:

Charge any Additional Fees required under 37 C.F.R. Section 1.16 (National application filing, search, and examination fees)

Charge any Additional Fees required under 37 C.F.R. Section 1.17 (Patent application and reexamination processing fees)

**File Listing:**

Document Number	Document Description	File Name	File Size(Bytes)/ Message Digest	Multi Part /.zip	Pages (if appl.)
1	Fee Worksheet (PTO-875)	fee-info.pdf	29614 <small>efd7c3c3065acd17dbad5a151ad80e4bb23b2439</small>	no	2

**Warnings:****Information:**

<b>Total Files Size (in bytes):</b>	29614
-------------------------------------	-------

This Acknowledgement Receipt evidences receipt on the noted date by the USPTO of the indicated documents, characterized by the applicant, and including page counts, where applicable. It serves as evidence of receipt similar to a Post Card, as described in MPEP 503.

**New Applications Under 35 U.S.C. 111**

If a new application is being filed and the application includes the necessary components for a filing date (see 37 CFR 1.53(b)-(d) and MPEP 506), a Filing Receipt (37 CFR 1.54) will be issued in due course and the date shown on this Acknowledgement Receipt will establish the filing date of the application.

**National Stage of an International Application under 35 U.S.C. 371**

If a timely submission to enter the national stage of an international application is compliant with the conditions of 35 U.S.C. 371 and other applicable requirements a Form PCT/DO/EO/903 indicating acceptance of the application as a national stage submission under 35 U.S.C. 371 will be issued in addition to the Filing Receipt, in due course.

**New International Application Filed with the USPTO as a Receiving Office**

If a new international application is being filed and the international application includes the necessary components for an international filing date (see PCT Article 11 and MPEP 1810), a Notification of the International Application Number and of the International Filing Date (Form PCT/RO/105) will be issued in due course, subject to prescriptions concerning national security, and the date shown on this Acknowledgement Receipt will establish the international filing date of the application.



# UNITED STATES PATENT AND TRADEMARK OFFICE

UNITED STATES DEPARTMENT OF COMMERCE  
United States Patent and Trademark Office  
Address: COMMISSIONER FOR PATENTS  
P.O. Box 1450  
Alexandria, Virginia 22313-1450  
www.uspto.gov

APPLICATION NO.	FILING DATE	FIRST NAMED INVENTOR	ATTORNEY DOCKET NO.	CONFIRMATION NO.
12/569,116	09/29/2009	Alan J. Lipton	OV-101	7686
74712	7590	07/26/2010	EXAMINER	
MUIR PATENT CONSULTING, PLLC 9913 Georgetown Pike, Suite 200 P.O. Box 1213 GREAT FALLS, VA 22066			VO, TUNG T	
			ART UNIT	PAPER NUMBER
			2621	
			MAIL DATE	DELIVERY MODE
			07/26/2010	PAPER

**Please find below and/or attached an Office communication concerning this application or proceeding.**

The time period for reply, if any, is set in the attached communication.

<b>Interview Summary</b>	<b>Application No.</b> 12/569,116	<b>Applicant(s)</b> LIPTON ET AL.	
	<b>Examiner</b> Tung Vo	<b>Art Unit</b> 2621	

All participants (applicant, applicant's representative, PTO personnel):

- (1) Tung Vo. (3) Patrick D. Muir.  
(2) Peter Venetianer. (4) \_\_\_\_\_.

Date of Interview: 22 July 2010.

Type: a)  Telephonic b)  Video Conference  
c)  Personal [copy given to: 1)  applicant 2)  applicant's representative]

Exhibit shown or demonstration conducted: d)  Yes e)  No.  
If Yes, brief description: \_\_\_\_\_.

Claim(s) discussed: claims 27 & 45.

Identification of prior art discussed: Qian.

Agreement with respect to the claims f)  was reached. g)  was not reached. h)  N/A.

Substance of Interview including description of the general nature of what was agreed to if an agreement was reached, or any other comments: Discussed Qian reference and claimed limitations.

(A fuller description, if necessary, and a copy of the amendments which the examiner agreed would render the claims allowable, if available, must be attached. Also, where no copy of the amendments that would render the claims allowable is available, a summary thereof must be attached.)

THE FORMAL WRITTEN REPLY TO THE LAST OFFICE ACTION MUST INCLUDE THE SUBSTANCE OF THE INTERVIEW. (See MPEP Section 713.04). If a reply to the last Office action has already been filed, APPLICANT IS GIVEN A NON-EXTENDABLE PERIOD OF THE LONGER OF ONE MONTH OR THIRTY DAYS FROM THIS INTERVIEW DATE, OR THE MAILING DATE OF THIS INTERVIEW SUMMARY FORM, WHICHEVER IS LATER, TO FILE A STATEMENT OF THE SUBSTANCE OF THE INTERVIEW. See Summary of Record of Interview requirements on reverse side or on attached sheet.

/Tung Vo/  
Primary Examiner, Art Unit 2621

## Summary of Record of Interview Requirements

### Manual of Patent Examining Procedure (MPEP), Section 713.04, Substance of Interview Must be Made of Record

A complete written statement as to the substance of any face-to-face, video conference, or telephone interview with regard to an application must be made of record in the application whether or not an agreement with the examiner was reached at the interview.

### Title 37 Code of Federal Regulations (CFR) § 1.133 Interviews Paragraph (b)

In every instance where reconsideration is requested in view of an interview with an examiner, a complete written statement of the reasons presented at the interview as warranting favorable action must be filed by the applicant. An interview does not remove the necessity for reply to Office action as specified in §§ 1.111, 1.135. (35 U.S.C. 132)

#### 37 CFR §1.2 Business to be transacted in writing.

All business with the Patent or Trademark Office should be transacted in writing. The personal attendance of applicants or their attorneys or agents at the Patent and Trademark Office is unnecessary. The action of the Patent and Trademark Office will be based exclusively on the written record in the Office. No attention will be paid to any alleged oral promise, stipulation, or understanding in relation to which there is disagreement or doubt.

The action of the Patent and Trademark Office cannot be based exclusively on the written record in the Office if that record is itself incomplete through the failure to record the substance of interviews.

It is the responsibility of the applicant or the attorney or agent to make the substance of an interview of record in the application file, unless the examiner indicates he or she will do so. It is the examiner's responsibility to see that such a record is made and to correct material inaccuracies which bear directly on the question of patentability.

Examiners must complete an Interview Summary Form for each interview held where a matter of substance has been discussed during the interview by checking the appropriate boxes and filling in the blanks. Discussions regarding only procedural matters, directed solely to restriction requirements for which interview recordation is otherwise provided for in Section 812.01 of the Manual of Patent Examining Procedure, or pointing out typographical errors or unreadable script in Office actions or the like, are excluded from the interview recordation procedures below. Where the substance of an interview is completely recorded in an Examiners Amendment, no separate Interview Summary Record is required.

The Interview Summary Form shall be given an appropriate Paper No., placed in the right hand portion of the file, and listed on the "Contents" section of the file wrapper. In a personal interview, a duplicate of the Form is given to the applicant (or attorney or agent) at the conclusion of the interview. In the case of a telephone or video-conference interview, the copy is mailed to the applicant's correspondence address either with or prior to the next official communication. If additional correspondence from the examiner is not likely before an allowance or if other circumstances dictate, the Form should be mailed promptly after the interview rather than with the next official communication.

The Form provides for recordation of the following information:

- Application Number (Series Code and Serial Number)
- Name of applicant
- Name of examiner
- Date of interview
- Type of interview (telephonic, video-conference, or personal)
- Name of participant(s) (applicant, attorney or agent, examiner, other PTO personnel, etc.)
- An indication whether or not an exhibit was shown or a demonstration conducted
- An identification of the specific prior art discussed
- An indication whether an agreement was reached and if so, a description of the general nature of the agreement (may be by attachment of a copy of amendments or claims agreed as being allowable). Note: Agreement as to allowability is tentative and does not restrict further action by the examiner to the contrary.
- The signature of the examiner who conducted the interview (if Form is not an attachment to a signed Office action)

It is desirable that the examiner orally remind the applicant of his or her obligation to record the substance of the interview of each case. It should be noted, however, that the Interview Summary Form will not normally be considered a complete and proper recordation of the interview unless it includes, or is supplemented by the applicant or the examiner to include, all of the applicable items required below concerning the substance of the interview.

A complete and proper recordation of the substance of any interview should include at least the following applicable items:

- 1) A brief description of the nature of any exhibit shown or any demonstration conducted,
- 2) an identification of the claims discussed,
- 3) an identification of the specific prior art discussed,
- 4) an identification of the principal proposed amendments of a substantive nature discussed, unless these are already described on the Interview Summary Form completed by the Examiner,
- 5) a brief identification of the general thrust of the principal arguments presented to the examiner,  
(The identification of arguments need not be lengthy or elaborate. A verbatim or highly detailed description of the arguments is not required. The identification of the arguments is sufficient if the general nature or thrust of the principal arguments made to the examiner can be understood in the context of the application file. Of course, the applicant may desire to emphasize and fully describe those arguments which he or she feels were or might be persuasive to the examiner.)
- 6) a general indication of any other pertinent matters discussed, and
- 7) if appropriate, the general results or outcome of the interview unless already described in the Interview Summary Form completed by the examiner.

Examiners are expected to carefully review the applicant's record of the substance of an interview. If the record is not complete and accurate, the examiner will give the applicant an extendable one month time period to correct the record.

### Examiner to Check for Accuracy

If the claims are allowable for other reasons of record, the examiner should send a letter setting forth the examiner's version of the statement attributed to him or her. If the record is complete and accurate, the examiner should place the indication, "Interview Record OK" on the paper recording the substance of the interview along with the date and the examiner's initials.





UNITED STATES PATENT AND TRADEMARK OFFICE

UNITED STATES DEPARTMENT OF COMMERCE
United States Patent and Trademark Office
Address: COMMISSIONER FOR PATENTS
P.O. Box 1450
Alexandria, Virginia 22313-1450
www.uspto.gov

Table with 5 columns: APPLICATION NO., FILING DATE, FIRST NAMED INVENTOR, ATTORNEY DOCKET NO., CONFIRMATION NO.

12/569,116 09/29/2009 Alan J. Lipton OV-101 7686

74712 7590 06/17/2010
MUIR PATENT CONSULTING, PLLC
9913 Georgetown Pike, Suite 200
P.O. Box 1213
GREAT FALLS, VA 22066

Table with 1 column: EXAMINER

VO, TUNG T

Table with 2 columns: ART UNIT, PAPER NUMBER

2621

Table with 2 columns: MAIL DATE, DELIVERY MODE

06/17/2010 PAPER

Please find below and/or attached an Office communication concerning this application or proceeding.

The time period for reply, if any, is set in the attached communication.

<b>Office Action Summary</b>	<b>Application No.</b> 12/569,116	<b>Applicant(s)</b> LIPTON ET AL.	
	<b>Examiner</b> Tung Vo	<b>Art Unit</b> 2621	

-- The MAILING DATE of this communication appears on the cover sheet with the correspondence address --

**Period for Reply**

A SHORTENED STATUTORY PERIOD FOR REPLY IS SET TO EXPIRE 03 MONTH(S) OR THIRTY (30) DAYS, WHICHEVER IS LONGER, FROM THE MAILING DATE OF THIS COMMUNICATION.

- Extensions of time may be available under the provisions of 37 CFR 1.136(a). In no event, however, may a reply be timely filed after SIX (6) MONTHS from the mailing date of this communication.
- If NO period for reply is specified above, the maximum statutory period will apply and will expire SIX (6) MONTHS from the mailing date of this communication.
- Failure to reply within the set or extended period for reply will, by statute, cause the application to become ABANDONED (35 U.S.C. § 133). Any reply received by the Office later than three months after the mailing date of this communication, even if timely filed, may reduce any earned patent term adjustment. See 37 CFR 1.704(b).

**Status**

- 1)  Responsive to communication(s) filed on \_\_\_\_.
- 2a)  This action is **FINAL**.                      2b)  This action is non-final.
- 3)  Since this application is in condition for allowance except for formal matters, prosecution as to the merits is closed in accordance with the practice under *Ex parte Quayle*, 1935 C.D. 11, 453 O.G. 213.

**Disposition of Claims**

- 4)  Claim(s) 27-58 is/are pending in the application.  
4a) Of the above claim(s) \_\_\_\_ is/are withdrawn from consideration.
- 5)  Claim(s) \_\_\_\_ is/are allowed.
- 6)  Claim(s) 27-58 is/are rejected.
- 7)  Claim(s) \_\_\_\_ is/are objected to.
- 8)  Claim(s) \_\_\_\_ are subject to restriction and/or election requirement.

**Application Papers**

- 9)  The specification is objected to by the Examiner.
- 10)  The drawing(s) filed on 29 September 2009 is/are: a)  accepted or b)  objected to by the Examiner.  
Applicant may not request that any objection to the drawing(s) be held in abeyance. See 37 CFR 1.85(a).  
Replacement drawing sheet(s) including the correction is required if the drawing(s) is objected to. See 37 CFR 1.121(d).
- 11)  The oath or declaration is objected to by the Examiner. Note the attached Office Action or form PTO-152.

**Priority under 35 U.S.C. § 119**

- 12)  Acknowledgment is made of a claim for foreign priority under 35 U.S.C. § 119(a)-(d) or (f).  
a)  All    b)  Some \*    c)  None of:
1.  Certified copies of the priority documents have been received.
2.  Certified copies of the priority documents have been received in Application No. \_\_\_\_.
3.  Copies of the certified copies of the priority documents have been received in this National Stage application from the International Bureau (PCT Rule 17.2(a)).

\* See the attached detailed Office action for a list of the certified copies not received.

**Attachment(s)**

- |  |   |
|--|---|
| 1) <input checked="" type="checkbox"/> Notice of References Cited (PTO-892)  | 4) <input type="checkbox"/> Interview Summary (PTO-413)<br>Paper No(s)/Mail Date. ____. |
| 2) <input type="checkbox"/> Notice of Draftperson's Patent Drawing Review (PTO-948)  | 5) <input type="checkbox"/> Notice of Informal Patent Application                       |
| 3) <input checked="" type="checkbox"/> Information Disclosure Statement(s) (PTO/SB/08)<br>Paper No(s)/Mail Date <u>06/03/10, 4/6/10, 12/31/09, 12/31/09, 12/31/09.</u> | 6) <input type="checkbox"/> Other: ____.  |



## DETAILED ACTION

### *Claim Rejections - 35 USC § 103*

1. The following is a quotation of 35 U.S.C. 103(a) which forms the basis for all obviousness rejections set forth in this Office action:

(a) A patent may not be obtained though the invention is not identically disclosed or described as set forth in section 102 of this title, if the differences between the subject matter sought to be patented and the prior art are such that the subject matter as a whole would have been obvious at the time the invention was made to a person having ordinary skill in the art to which said subject matter pertains. Patentability shall not be negated by the manner in which the invention was made.

2. Claims 27-58 are rejected under 35 U.S.C. 103(a) as being unpatentable over Paek et al. (US 7,653,635) in view of Qain et al. (US 6,721,454).

Re claims 27, 36, 48, and 50, Paek teaches a video device (fig. 8) comprising:

means (820 of fig. 8) for detecting an object in a video;

means (823 of fig. 8) for detecting a plurality of attributes of the object by analyzing the video, each attribute representing a characteristic of the detected object (837 and 838 of fig. 8);

a memory (840 of fig. 8) storing the plurality of detected attributes; and

means (870 of fig. 8, note the applications for searching, filtering, and archiving any event of the object) for searching an event of the object that is not one of the detected attributes of the object by applying a selected new user search input to the plurality of attributes stored in memory,

wherein the means (870 of fig. 8) for searching an event is capable of identifying the event independent of when the attributes are stored in memory (840 of fig. 8).

Qain teaches a device (18 and 22 of fig. 1) for identifying an event of the object that is not one of the detected attributes of the object by applying the new user rule to the plurality of

Art Unit: 2621

detected attributes (col. 3, lines 31-55, see example figure 10, note events in other domains can be inferred by matching the occurrence of objects and their spatial and temporal relationships detected in the low-level visual analysis of the technique with higher-level rules specific to particular events in a specific domain ).

Re claim 37, Paek teaches a camera motion that would obviously show a video camera operable to obtain the video (col. 2, lines 22-41. Note Qain teaches the camera moves to track a moving object of interest, corresponding features may be located far apart in adjacent frames, col. 4, lines 1-19).

Re claims 30 and 53, Qain further discloses wherein the plurality of attributes that are detected are defined in a device prior to the selection of the subset of the plurality of attributes (e.g. 12 and 18 of fig. 1).

Re claim 38, Qain further teaches wherein the means for identifying an event of the object comprises means for identifying a first event of the object in real time by analyzing, of the plurality of attributes, only a first selected subset of the plurality of attributes (18 and 22 of fig. 1).

Re claims 31, 39, Qain further teaches wherein the means for identifying an event of the object comprises means for identifying a second event of the object by analyzing, of the plurality of attributes, only a second selected subset of the plurality of attributes which have been archived (18 and 22 of fig. 1).

Re claims 29, 40, Qain further teaches wherein applying a selected new user rule comprises analyzing, of the plurality of attributes, only a selected subset of the plurality of attributes (col. 3, lines 31-35, col. 12, lines 1-8).

Art Unit: 2621

Re claims 33, 34, 41, and 57, Paek further teaches wherein the memory is capable of storing at least some of the plurality of attributes for at least two months (840 of fig. 8), and wherein Qain further teaches the means (18 and 22 of fig. 1) for identifying an event of the object is capable of identifying an event (22 of fig. 1) of the object by analyzing only a selected subset of the plurality of attributes including the at least some of the plurality of attributes stored for at least two months (fig. 10).

Re claims 28, 42, and 51, Qain further teaches wherein the means for identifying an event is capable of identifying the event without reprocessing the video (fig. 10).

Re claims 32, 43, and 52, Qain further teaches wherein the means for identifying an event is capable of identifying the event by analyzing at least two selected physical attributes of the plurality of attributes (fig. 10).

Re claim 44, Qain further teaches wherein the identifying means identifies an event by analyzing a selection of individual ones of the detected plural attributes (fig. 10).

Re claim 45, Qain further teaches wherein the plural attributes detected by the means for detecting are defined in the video device independent of a selection of the detected plural attributes (fig. 10).

Re claims 46-47, Qain further teaches wherein the video surveillance device is a computer system configured as a video surveillance device and further comprising video sensors (col. 4, lines 1-19, more than one camera would obviously be used in different areas).

Re claims 35 and 58, Qain further discloses detecting first and second objects in a video (e.g. 4 of fig. 1); detecting a plurality of attributes of each of the detected first and second objects by analyzing the video (12 of fig. 1), each attribute representing a characteristic of the respective

Art Unit: 2621

detected object (16 of fig. 1); wherein the step of identifying an event comprises identifying an event of the first object interacting with the second object by analyzing the detected attributes of the first and second objects, the event not being one of the detected attributes (18 and 22 of fig. 1, see fig. 10).

Re claim 54, Qain further teaches wherein no analysis is performed on at least some of the detected attributes which are not the subset of the plurality of attributes (18 and 22 of fig. 1).

Re claims 49, 55, and 56, Qain further teaches providing a video device which detects an object upon analyzing a video and which detects plural physical attributes and plural temporal attributes of the detected object upon analyzing the video (4 and 12 of fig. 1); and then, selecting the new user rule to provide an analysis of a combination of the plural physical attributes and the plural temporal attributes to detect the event (28 and 22 of fig. 1).

### ***Conclusion***

3. The prior art made of record and not relied upon is considered pertinent to applicant's disclosure.

Brown et al. (US 7,447,331) discloses a system and method for generating a viewable video index for low bandwidth applications.

### ***Contact Information***

Any inquiry concerning this communication or earlier communications from the examiner should be directed to Tung Vo whose telephone number is 571-272-7340. The examiner can normally be reached on Monday-Wednesday, Friday.

Art Unit: 2621

If attempts to reach the examiner by telephone are unsuccessful, the examiner's supervisor, Mehrdad Dastouri can be reached on 571-272-7418. The fax phone number for the organization where this application or proceeding is assigned is 571-273-8300.

Information regarding the status of an application may be obtained from the Patent Application Information Retrieval (PAIR) system. Status information for published applications may be obtained from either Private PAIR or Public PAIR. Status information for unpublished applications is available through Private PAIR only. For more information about the PAIR system, see <http://pair-direct.uspto.gov>. Should you have questions on access to the Private PAIR system, contact the Electronic Business Center (EBC) at 866-217-9197 (toll-free). If you would like assistance from a USPTO Customer Service Representative or access to the automated information system, call 800-786-9199 (IN USA OR CANADA) or 571-272-1000.

/Tung Vo/  
Primary Examiner, Art Unit 2621



<b>Notice of References Cited</b>	Application/Control No. 12/569,116	Applicant(s)/Patent Under Reexamination LIPTON ET AL.	
	Examiner Tung Vo	Art Unit 2621	Page 1 of 1

**U.S. PATENT DOCUMENTS**

*	Document Number Country Code-Number-Kind Code	Date MM-YYYY	Name	Classification
*	A US-7,653,635	01-2010	Paek et al.	1/1
*	B US-6,721,454	04-2004	Qian et al.	382/224
C	US-			
D	US-			
E	US-			
F	US-			
G	US-			
H	US-			
I	US-			
J	US-			
K	US-			
L	US-			
M	US-			

**FOREIGN PATENT DOCUMENTS**

*	Document Number Country Code-Number-Kind Code	Date MM-YYYY	Country	Name	Classification
N					
O					
P					
Q					
R					
S					
T					

**NON-PATENT DOCUMENTS**

*	Document Number Country Code-Number-Kind Code	Date MM-YYYY	Country	Name	Classification
*	Include as applicable: Author, Title Date, Publisher, Edition or Volume, Pertinent Pages)				
U					
V					
W					
X					

\*A copy of this reference is not being furnished with this Office action. (See MPEP § 707.05(a).)  
Dates in MM-YYYY format are publication dates. Classifications may be US or foreign.

<b>Search Notes</b>  	<b>Application/Control No.</b>  12569116	<b>Applicant(s)/Patent Under Reexamination</b>  LIPTON ET AL.
	<b>Examiner</b>  Tung Vo	<b>Art Unit</b>  2621

<b>SEARCHED</b>			
<b>Class</b>	<b>Subclass</b>	<b>Date</b>	<b>Examiner</b>
375	143, 144, 145, 148	6/14/2010	TV

<b>SEARCH NOTES</b>		
<b>Search Notes</b>	<b>Date</b>	<b>Examiner</b>
EAST/WEST	6/14/2010	TV

<b>INTERFERENCE SEARCH</b>			
<b>Class</b>	<b>Subclass</b>	<b>Date</b>	<b>Examiner</b>
348	143	6/14/2010	TV

--	--

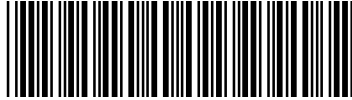
<b>Index of Claims</b>  	<b>Application/Control No.</b> 12569116	<b>Applicant(s)/Patent Under Reexamination</b> LIPTON ET AL.
	<b>Examiner</b> Tung Vo	<b>Art Unit</b> 2621

✓	<b>Rejected</b>
=	<b>Allowed</b>

-	<b>Cancelled</b>
÷	<b>Restricted</b>

N	<b>Non-Elected</b>
I	<b>Interference</b>

A	<b>Appeal</b>
O	<b>Objected</b>

Claims renumbered in the same order as presented by applicant
  CPA
  T.D.
  R.1.47

CLAIM		DATE							
Final	Original	06/14/2010							
	27	✓							
	28	✓							
	29	✓							
	30	✓							
	31	✓							
	32	✓							
	33	✓							
	34	✓							
	35	✓							
	36	✓							
	37	✓							
	38	✓							
	39	✓							
	40	✓							
	41	✓							
	42	✓							
	43	✓							
	44	✓							
	45	✓							
	46	✓							
	47	✓							
	48	✓							
	49	✓							
	50	✓							
	51	✓							
	52	✓							
	53	✓							
	54	✓							
	55	✓							
	56	✓							
	57	✓							
	58	✓							

## EAST Search History

## EAST Search History (Prior Art)

Ref #	Hits	Search Query	DBs	Default Operator	Plurals	Time Stamp
L1	2	"7447331"	US-PGPUB; USPAT; USOCR; FPRS; EPO; JPO; DERWENT; IBM_TDB	AND	ON	2010/04/26 13:31
L2	1	"12569116"	US-PGPUB; USPAT; USOCR; FPRS; EPO; JPO; DERWENT; IBM_TDB	AND	ON	2010/04/26 13:34
L3	5	"11098385"	US-PGPUB; USPAT; USOCR; FPRS; EPO; JPO; DERWENT; IBM_TDB	AND	ON	2010/04/26 13:34
L4	25	"6721454"	US-PGPUB; USPAT; USOCR; FPRS; EPO; JPO; DERWENT; IBM_TDB	AND	ON	2010/04/26 13:35
L5	6740	(texture or shot or motion or color or attribute\$4) same video same (summar\$4 or index)	US-PGPUB; USPAT; USOCR; FPRS; EPO; JPO; DERWENT; IBM_TDB	AND	ON	2010/04/26 13:37
L6	151079	detect\$4 with event	US-PGPUB; USPAT; USOCR; FPRS; EPO; JPO; DERWENT; IBM_TDB	AND	ON	2010/04/26 13:38
L7	127	5 same 6	US-PGPUB; USPAT; USOCR; FPRS; EPO; JPO; DERWENT; IBM_TDB	AND	ON	2010/04/26 13:38

L8	26	7 and @ad<= "20011115"	US-PGPUB; USPAT; USOCR; FPRS; EPO; JPO; DERWENT; IBM_TDB	AND	ON	2010/04/26 13:39
L9	23	("5664227"   "5821945"   "5969755").PN. OR ("6721454"). URPN.	US-PGPUB; USPAT; USOCR	AND	ON	2010/04/26 13:42

### EAST Search History (I nterference)

< This search history is empty >

4/ 26/ 2010 1:44:59 PM

C:\ Documents and Settings\ tvo1\ My Documents\ EAST\ Workspaces\ default.wsp

## EAST Search History

## EAST Search History (Prior Art)

Ref #	Hits	Search Query	DBs	Default Operator	Plurals	Time Stamp
L1	2	("5825430").PN.	US-PGPUB; USPAT; USOCR; FPRS; EPO; JPO; DERWENT; IBM_TDB	OR	OFF	2010/06/03 07:22
L2	8	((("5825430") or ("5159447") or ("5959677") or ("5963256")).PN.	US-PGPUB; USPAT; USOCR; FPRS; EPO; JPO; DERWENT; IBM_TDB	OR	OFF	2010/06/03 07:23
L3	79	detect\$4 same event same attribute\$4 same object same video	US-PGPUB; USPAT; USOCR; FPRS; EPO; JPO; DERWENT; IBM_TDB	AND	ON	2010/06/03 07:34
L4	21	"6954498"	US-PGPUB; USPAT; USOCR; FPRS; EPO; JPO; DERWENT; IBM_TDB	AND	ON	2010/06/03 07:39
L5	115	detect\$4 same event same object same video same (user with (define\$4 or parameter or selection or rule))	US-PGPUB; USPAT; USOCR; FPRS; EPO; JPO; DERWENT; IBM_TDB	AND	ON	2010/06/03 07:41
L6	17	5 and @ad<="20011115"	US-PGPUB; USPAT; USOCR; FPRS; EPO; JPO; DERWENT; IBM_TDB	AND	ON	2010/06/03 07:41
L7	156	detect\$4 same event same object same video same (user with (define\$4 or parameter or selection or rule or predetermined or predefined))	US-PGPUB; USPAT; USOCR; FPRS; EPO; JPO; DERWENT; IBM_TDB	AND	ON	2010/06/03 07:43

L8	23	7 and @ad<="20011115"	US-PGPUB; USPAT; USOCR; FPRS; EPO; JPO; DERWENT; IBM_TDB	AND	ON	2010/06/03 07:43
L9	671	detect\$4 same event same video same (user with (define\$4 or parameter or selection or rule or predetermined or predefined))	US-PGPUB; USPAT; USOCR; FPRS; EPO; JPO; DERWENT; IBM_TDB	AND	ON	2010/06/03 07:44
L10	434	(segment\$4 or extract\$4 or merg\$4) same attribute\$4 same object same video	US-PGPUB; USPAT; USOCR; FPRS; EPO; JPO; DERWENT; IBM_TDB	AND	ON	2010/06/03 07:45
L11	14	9 and 10	US-PGPUB; USPAT; USOCR; FPRS; EPO; JPO; DERWENT; IBM_TDB	AND	ON	2010/06/03 07:45
L12	450	(segment\$4 or extract\$4 or merg\$4) same attribute\$4 same object\$4 same video	US-PGPUB; USPAT; USOCR; FPRS; EPO; JPO; DERWENT; IBM_TDB	AND	ON	2010/06/03 07:48
L13	19631	(determin\$4 or creat\$4 or detect\$4 or merg\$4) same event same video	US-PGPUB; USPAT; USOCR; FPRS; EPO; JPO; DERWENT; IBM_TDB	AND	ON	2010/06/03 07:49
L14	625	(segment\$4 or extract\$4 or merg\$4) same object\$4 same video same (user with (define\$4 or parameter or selection or rule or predetermined or predefined))	US-PGPUB; USPAT; USOCR; FPRS; EPO; JPO; DERWENT; IBM_TDB	AND	ON	2010/06/03 07:49
L15	59	12 and 13 and 14	US-PGPUB; USPAT; USOCR; FPRS; EPO; JPO; DERWENT; IBM_TDB	AND	ON	2010/06/03 07:49

L16	6	15 and @ad<="20011115"	US-PGPUB; USPAT; USOCR; FPRS; EPO; JPO; DERWENT; IBM_TDB	AND	ON	2010/06/03 07:50
-----	---	------------------------	---	-----	----	---------------------

**EAST Search History (Interference)**

<This search history is empty>

**6/ 3/ 2010 8:54:41 AM**

**C:\ Documents and Settings\ tvo1 \ My Documents\ EAST\ Workspaces\ default.wsp**



## EAST Search History

## EAST Search History (Prior Art)

Ref #	Hits	Search Query	DBs	Default Operator	Plurals	Time Stamp
L1	2	("5825430").PN.	US-PGPUB; USPAT; USOCR; FPRS; EPO; JPO; DERWENT; IBM_TDB	OR	OFF	2010/06/03 07:22
L2	8	((("5825430") or ("5159447") or ("5959677") or ("5963256")).PN.	US-PGPUB; USPAT; USOCR; FPRS; EPO; JPO; DERWENT; IBM_TDB	OR	OFF	2010/06/03 07:23
L3	79	detect\$4 same event same attribute\$4 same object same video	US-PGPUB; USPAT; USOCR; FPRS; EPO; JPO; DERWENT; IBM_TDB	AND	ON	2010/06/03 07:34
L4	21	"6954498"	US-PGPUB; USPAT; USOCR; FPRS; EPO; JPO; DERWENT; IBM_TDB	AND	ON	2010/06/03 07:39
L5	115	detect\$4 same event same object same video same (user with (define\$4 or parameter or selection or rule))	US-PGPUB; USPAT; USOCR; FPRS; EPO; JPO; DERWENT; IBM_TDB	AND	ON	2010/06/03 07:41
L6	17	5 and @ad<="20011115"	US-PGPUB; USPAT; USOCR; FPRS; EPO; JPO; DERWENT; IBM_TDB	AND	ON	2010/06/03 07:41
L7	156	detect\$4 same event same object same video same (user with (define\$4 or parameter or selection or rule or predetermined or predefined))	US-PGPUB; USPAT; USOCR; FPRS; EPO; JPO; DERWENT; IBM_TDB	AND	ON	2010/06/03 07:43

L8	23	7 and @ad<="20011115"	US-PGPUB; USPAT; USOCR; FPRS; EPO; JPO; DERWENT; IBM_TDB	AND	ON	2010/06/03 07:43
L9	671	detect\$4 same event same video same (user with (define\$4 or parameter or selection or rule or predetermined or predefined))	US-PGPUB; USPAT; USOCR; FPRS; EPO; JPO; DERWENT; IBM_TDB	AND	ON	2010/06/03 07:44
L10	434	(segment\$4 or extract\$4 or merg\$4) same attribute\$4 same object same video	US-PGPUB; USPAT; USOCR; FPRS; EPO; JPO; DERWENT; IBM_TDB	AND	ON	2010/06/03 07:45
L11	14	9 and 10	US-PGPUB; USPAT; USOCR; FPRS; EPO; JPO; DERWENT; IBM_TDB	AND	ON	2010/06/03 07:45
L12	450	(segment\$4 or extract\$4 or merg\$4) same attribute\$4 same object\$4 same video	US-PGPUB; USPAT; USOCR; FPRS; EPO; JPO; DERWENT; IBM_TDB	AND	ON	2010/06/03 07:48
L13	19631	(determin\$4 or creat\$4 or detect\$4 or merg\$4) same event same video	US-PGPUB; USPAT; USOCR; FPRS; EPO; JPO; DERWENT; IBM_TDB	AND	ON	2010/06/03 07:49
L14	625	(segment\$4 or extract\$4 or merg\$4) same object\$4 same video same (user with (define\$4 or parameter or selection or rule or predetermined or predefined))	US-PGPUB; USPAT; USOCR; FPRS; EPO; JPO; DERWENT; IBM_TDB	AND	ON	2010/06/03 07:49
L15	59	12 and 13 and 14	US-PGPUB; USPAT; USOCR; FPRS; EPO; JPO; DERWENT; IBM_TDB	AND	ON	2010/06/03 07:49

L16	6	15 and @ad<="20011115"	US-PGPUB; USPAT; USOCR; FPRS; EPO; JPO; DERWENT; IBM_TDB	AND	ON	2010/06/03 07:50
L17	1	"12569116"	US-PGPUB; USPAT; USOCR; FPRS; EPO; JPO; DERWENT; IBM_TDB	AND	ON	2010/06/03 08:55
L18	31	(segment\$4 or extract\$4 or merg\$4) same object\$4 same video same (user with (define\$4 or parameter or selection or rule or predetermined or predefined)) same event same (surveillanc\$4 or monitoring or security)	US-PGPUB; USPAT; USOCR; FPRS; EPO; JPO; DERWENT; IBM_TDB	AND	ON	2010/06/03 09:03
L19	3	("6721454").PN.	US-PGPUB; USPAT; USOCR; FPRS; EPO; JPO; DERWENT; IBM_TDB	OR	OFF	2010/06/03 09:04
L20	23	("5664227"   "5821945"   "5969755").PN. OR ("6721454").URPN.	US-PGPUB; USPAT; USOCR	AND	ON	2010/06/03 09:28

### EAST Search History (I nterference)

<This search history is empty>

6/ 3/ 2010 10:14:23 AM

C:\ Documents and Settings\ tvo1 \ My Documents\ EAST\ Workspaces\ default.wsp

IDS Form PTO/SB/08: Substitute for form 1449A/PTO  <b>INFORMATION DISCLOSURE STATEMENT BY APPLICANT</b>  (Use as many sheets as necessary)			<b>Complete if Known</b>		
			Application Number	12/596,116	
			Filing Date	09-11-2009	
			First Named Inventor	Alan J. Lipton	
			Art Unit	2621	
			Examiner Name	Vo, Tung T.	
Sheet	1	of	1	Attorney Docket Number	OV-101

U.S. PATENTS AND PUBLISHED U.S. PATENT APPLICATIONS					
Examiner Initials	Cite No. <sup>1</sup>	Document Number	Issue or Publication Date MM-DD-YYYY	Name of Patentee or Applicant of Cited Document	Pages, Columns, Lines, Where Relevant Passages or Relevant Figures Appear
		Number-Kind Code <sup>2</sup> (if known)			
	1	US-5,850,352 A	12-15-1998	Moezzi et al.	
	2	US-6,721,454 B1	04-13-2004	Qian et al.	
	3	US-7,660,439 B1	02-09-2010	Lu et al.	
	4				
	5				
	6				
	7				
	8				
	9				
	10				
	11				
	12				
	13				

**Note: Submission of copies of U.S. Patents and published U.S. Patent Applications is not required.**

FOREIGN PATENT DOCUMENTS						
Examiner Initials	Cite No. <sup>1</sup>	Foreign Patent Document	Publication Date MM-DD-YYYY	Name of Patentee or Applicant of Cited Document	Pages, Columns, Lines, Where Relevant Passages or Relevant Figures Appear	Translation <sup>6</sup>
		Country Code <sup>3</sup> Number <sup>4</sup> Kind Code <sup>5</sup> (if known)				
	1					

NONPATENT LITERATURE DOCUMENTS			
Examiner Initials	Cite No. <sup>1</sup>	Include name of the author (in CAPITAL LETTERS), title of the article (when appropriate), title of the item (book, magazine, journal, serial, symposium, catalog, etc.), date, page(s), volume-issue number(s), publisher, city and/or country where published.	Translation <sup>6</sup>

Examiner Signature	/Tung Vo/ (06/09/2010)	Date Considered	06/09/2010
--------------------	------------------------	-----------------	------------

EXAMINER: Initial if reference considered, whether or not citation is in conformance with MPEP 609. Draw line through citation if not in conformance and not considered. Include copy of this form with next communication to applicant.

IDS Form PTO/SB/08: Substitute for form 1449A/PTO  <b>INFORMATION DISCLOSURE STATEMENT BY APPLICANT</b>  (Use as many sheets as necessary)			<b>Complete if Known</b>			
			Application Number		12/569,116	
			Filing Date		09-29-2009	
			First Named Inventor		Alan J. Lipton	
			Art Unit		2621	
Examiner Name		Tung Vo				
Attorney Docket Number		OV-101				
Sheet	1	of	1			

U.S. PATENTS AND PUBLISHED U.S. PATENT APPLICATIONS					
Examiner Initials	Cite No. <sup>1</sup>	Document Number	Issue or Publication Date MM-DD-YYYY	Name of Patentee or Applicant of Cited Document	Pages, Columns, Lines, Where Relevant Passages or Relevant Figures Appear
		Number-Kind Code <sup>2</sup> (if known)			
	1	US-2003/0043160 A1	03-06-2003	Elfving, et al.	
	2	US-2003/0085992 A1	05-08-2003	Arpa, et al.	

**Note: Submission of copies of U.S. Patents and published U.S. Patent Applications is not required.**

FOREIGN PATENT DOCUMENTS						
Examiner Initials	Cite No. <sup>1</sup>	Foreign Patent Document	Publication Date MM-DD-YYYY	Name of Patentee or Applicant of Cited Document	Pages, Columns, Lines, Where Relevant Passages or Relevant Figures Appear	Translation <sup>6</sup>
		Country Code <sup>3</sup> Number <sup>4</sup> Kind Code <sup>5</sup> (if known)				
	1	WO-2004/006184 A2	01-15-2004	Talmon et al.		
	2	WO-03/044727 A1	05-30-2003	Diamondback Vision Inc.		
	3	EP-0967584 A2	12-29-1999	Texas Instruments Inc.		

NONPATENT LITERATURE DOCUMENTS			
Examiner Initials	Cite No. <sup>1</sup>	Include name of the author (in CAPITAL LETTERS), title of the article (when appropriate), title of the item (book, magazine, journal, serial, symposium, catalog, etc.), date, page(s), volume-issue number(s), publisher, city and/or country where published.	Translation <sup>6</sup>

Examiner Signature	/Tung Vo/ (06/09/2010)	Date Considered	06/09/2010
--------------------	------------------------	-----------------	------------

EXAMINER: Initial if reference considered, whether or not citation is in conformance with MPEP 609. Draw line through citation if not in conformance and not considered. Include copy of this form with next communication to applicant.

PTO Notes regarding this form:

- <sup>1</sup> Applicant's unique citation designation number (optional).
  - <sup>2</sup> See Kinds Codes of USPTO Patent Documents at [www.uspto.gov](http://www.uspto.gov) or MPEP 901.04.
  - <sup>3</sup> Enter Office that issued the document, by the two-letter code (WIPO Standard ST.3).
  - <sup>4</sup> For Japanese patent documents, the indication of the year of the reign of the Emperor must precede the serial number of the patent document.
  - <sup>5</sup> Kind of document by the appropriate symbols as indicated on the document under WIPO Standard ST.16 if possible.
  - <sup>6</sup> Applicant is to place a check mark here if English language Translation is attached.
- This collection of information is required by 37 CFR 1.97 and 1.98. The information is required to obtain or retain a benefit by the public which is to file (and by the USPTO to process) an application. Confidentiality is governed by 35 U.S.C. 122 and CFR 1.14. This collection is estimated to take 2 hours to complete, including gathering, preparing, and submitting the completed application form to the USPTO. Time will vary depending upon the individual case. Any comments on the amount of time you require to complete this form and/or suggestions for reducing this burden, should be sent to the Chief Information Officer, U.S. Patent and Trademark Office, U.S. Department of Commerce, P.O. Box 1450, Alexandria, VA 22313-1450. DO NOT SEND FEES OR COMPLETED FORMS TO THIS ADDRESS. **SEND TO: Commissioner for Patents, P.O. Box 1450, Alexandria, VA 22313-1450.**

Receipt date: 12/31/2009

Doc code: IDS

Doc description: Information Disclosure Statement (IDS) Filed

Under the Paperwork Reduction Act of 1995, no persons are required to respond to a collection of information unless it contains a valid OMB control number.

12569116 - GAI: 2621

Approved for use through 07/31/2012. OMB 0651-0031

U.S. Patent and Trademark Office; U.S. DEPARTMENT OF COMMERCE

<b>INFORMATION DISCLOSURE STATEMENT BY APPLICANT</b> ( Not for submission under 37 CFR 1.99)	Application Number		12596116	
	Filing Date		2009-09-11	
	First Named Inventor	Alan J. Lipton		
	Art Unit		2621	
	Examiner Name	Tung Vo		
	Attorney Docket Number		OV-101	

U.S.PATENTS							Remove
Examiner Initial*	Cite No	Patent Number	Kind Code <sup>1</sup>	Issue Date	Name of Patentee or Applicant of cited Document	Pages,Columns,Lines where Relevant Passages or Relevant Figures Appear	
	1	5912980	A	1999-06-15	Hunke, H. Martin		
	2	6025877	A	2001-02-15	Chang et al.		
	3	6097429	A	2000-08-01	Seeley et al.		
	4	6360234	B2	2002-03-19	Jain et al.		
	5	7197072	B1	2007-03-27	Hsu et al.		
	6	7227893	B1	2007-06-05	Srinivasa et al.		
	7	7356830	B1	2008-04-08	Dimitrova, Nevenka		
	8	7447331	B2	2008-11-04	Brown et al.		

<b>INFORMATION DISCLOSURE STATEMENT BY APPLICANT</b> ( Not for submission under 37 CFR 1.99)	Application Number		12596116	12569116 - GAU: 2621
	Filing Date		2009-09-11	
	First Named Inventor	Alan J. Lipton		
	Art Unit		2621	
	Examiner Name	Tung Vo		
	Attorney Docket Number		OV-101	

	9	5956081		1999-09-21	Katz et al.	
	10	3812287		1974-05-21	Lemelson	
	11	6226388		2001-05-01	Qian et al.	
	12	6177886		2001-01-23	Billington et al.	
	13	5623249		1997-04-22	Camire	
	14	6091771		2000-07-18	Seeley et al.	
	15	6075560		2000-06-13	Katz	
	16	5491511		1996-02-13	Odle	
	17	5801943		1998-09-01	Nasburg	
	18	5696503		1997-12-09	Nasburg	
	19	6201473		2001-03-13	Schaffer	



<b>INFORMATION DISCLOSURE STATEMENT BY APPLICANT</b> ( Not for submission under 37 CFR 1.99)	Application Number		12596116	12569116 - GAU: 2621
	Filing Date		2009-09-11	
	First Named Inventor	Alan J. Lipton		
	Art Unit		2621	
	Examiner Name	Tung Vo		
	Attorney Docket Number		OV-101	

	20	5999189		1999-12-07	Kajiya et al.	
	21	5987211		1999-11-16	Abecassis	
	22	5886701		1999-03-23	Chauvin et al.	
	23	5860086		1999-01-12	Crump et al	
	24	5610653		1997-03-11	Abecassis	
	25	5448315		1995-09-05	Sooahoo	
	26	5959690		1999-09-28	Toebes, VIII et al.	
	27	6014461		2000-01-11	Hennessey et al.	
	28	6144375		2000-11-07	Jain et al	
	29	4249207		1981-02-03	Harman et al.	
	30	4257063		1981-03-17	Loughry et al.	

<b>INFORMATION DISCLOSURE STATEMENT BY APPLICANT</b> ( Not for submission under 37 CFR 1.99)	Application Number		12596116	12569116 - GAU: 2621
	Filing Date		2009-09-11	
	First Named Inventor	Alan J. Lipton		
	Art Unit		2621	
	Examiner Name	Tung Vo		
	Attorney Docket Number		OV-101	
	Receipt date: 12/31/2009			

	31	5926210		1999-07-20	Hackett et al.	
	32	6069653		2000-05-30	Hudson et al.	
	33	6297844		2001-10-02	Schatz et al.	
	34	6424370		2002-07-23	Courtney	
	35	6542840		2003-04-01	Shusaku et al.	
	36	6696945		2004-02-24	Venetianer et al.	
	37	6727938		2004-04-27	Randall	
	38	6738424		2004-05-18	Allmen et al.	
	39	6954498		2005-10-11	Lipton	
	40	6987883		2006-01-17	Lipton et al.	
	41	6351265	B1	2002-02-26	Bulman	

<b>INFORMATION DISCLOSURE STATEMENT BY APPLICANT</b> ( Not for submission under 37 CFR 1.99)	Application Number		12596116	12569116 - GAU: 2621
	Filing Date		2009-09-11	
	First Named Inventor	Alan J. Lipton		
	Art Unit		2621	
	Examiner Name	Tung Vo		
	Attorney Docket Number		OV-101	
	Receipt date: 12/31/2009			

	42	6166744	A	2000-12-26	Jaszlics et al.	
--	----	---------	---	------------	-----------------	--

If you wish to add additional U.S. Patent citation information please click the Add button.

[Add](#)

**U.S.PATENT APPLICATION PUBLICATIONS**

[Remove](#)

Examiner Initial*	Cite No	Publication Number	Kind Code <sup>1</sup>	Publication Date	Name of Patentee or Applicant of cited Document	Pages, Columns, Lines where Relevant Passages or Relevant Figures Appear
	1	20030231769	A1	2003-12-18	Bolle et al.	
	2	20040161133	A1	2004-08-19	Elazar et al.	
	3	20060279630	A1	2006-12-14	Aggarwal et al.	
	4	20060232673		2006-10-19	Lipton et al.	
	5	20070002141		2007-01-04	Lipton et al.	
	6	20070127774		2007-06-07	Zhang et al.	
	7	20070052803		2007-03-08	Chosak et al.	
	8	20030051255	A1	2003-03-13	Bulman et al.	

If you wish to add additional U.S. Published Application citation information please click the Add button.

[Add](#)

<b>Receipt date: 12/31/2009</b>  <b>INFORMATION DISCLOSURE STATEMENT BY APPLICANT</b> <b>( Not for submission under 37 CFR 1.99)</b>	Application Number		12596116	12569116 - GAU: 2621
	Filing Date		2009-09-11	
	First Named Inventor	Alan J. Lipton		
	Art Unit		2621	
	Examiner Name	Tung Vo		
	Attorney Docket Number		OV-101	

FOREIGN PATENT DOCUMENTS								Remove
Examiner Initial*	Cite No	Foreign Document Number <sup>3</sup>	Country Code <sup>2</sup> i	Kind Code <sup>4</sup>	Publication Date	Name of Patentee or Applicant of cited Document	Pages, Columns, Lines where Relevant Passages or Relevant Figures Appear	T <sup>5</sup>
	1	0293189	EP	B1	1994-07-13	Sony Corporation		<input type="checkbox"/>
	2	1024666	EP	A2	2000-08-02	Hitachi		<input type="checkbox"/>
	3	1120746	EP		2001-08-01	Matsushita Electric Ind. Co. Ltd		<input type="checkbox"/>
	4	1333682	EP	A1	2003-08-06	Samsung Electronics Co., Ltd.		<input type="checkbox"/>
	5	10-048008	JP		1998-02-20	Omron		<input type="checkbox"/>
	6	10-290449	JP		1998-10-27	Shimizu		<input type="checkbox"/>
	7	2000-175174	JP		2000-06-23	Mitsubishi		<input type="checkbox"/>
	8	2000-224542	JP		2000-11-08	Hitachi		<input type="checkbox"/>
	9	2000-339923	JP		2000-08-12	Mitsubishi		<input type="checkbox"/>

<b>INFORMATION DISCLOSURE STATEMENT BY APPLICANT</b> ( Not for submission under 37 CFR 1.99)	Application Number		12596116	12569116 - GAU: 2621
	Filing Date		2009-09-11	
	First Named Inventor	Alan J. Lipton		
	Art Unit		2621	
	Examiner Name	Tung Vo		
	Attorney Docket Number		OV-101	

10	2001-175868	JP		2001-06-29	Nippon Electric Co.	<input type="checkbox"/>
11	2001-285681	JP		2001-10-12	Matsushita Electric Ind. Co. Ltd.	<input type="checkbox"/>
12	2009-247654	JP	A	1997-09-19	Fujitsu General Ltd.	<input type="checkbox"/>
13	1994/003014	WO	A1	1994-02-03	Koz et al.	<input type="checkbox"/>
14	2001/62005	WO		2001-08-23	Wilson	<input type="checkbox"/>
15	0893923	EP	A1	1999-01-27	Texas Instruments France	<input type="checkbox"/>

If you wish to add additional Foreign Patent Document citation information please click the Add button

**NON-PATENT LITERATURE DOCUMENTS**

Examiner Initials*	Cite No	Include name of the author (in CAPITAL LETTERS), title of the article (when appropriate), title of the item (book, magazine, journal, serial, symposium, catalog, etc), date, pages(s), volume-issue number(s), publisher, city and/or country where published.	T <sup>5</sup>
	1	International Search Report for International Application No. PCT/US08/09073, dated November 3, 2008.	<input type="checkbox"/>
	2	Written Opinion for International Application No. PCT/US08/09073, dated November 3, 2008.	<input type="checkbox"/>
	3	A. SELINGER and L. WIXSON, "Classifying Moving Objects as Rigid or Non-Rigid Without Correspondences," Proceedings of DARPA Image Understanding Workshop, 1, November 1998, pp. 341-47.	<input type="checkbox"/>

<b>INFORMATION DISCLOSURE STATEMENT BY APPLICANT</b> ( Not for submission under 37 CFR 1.99)	Receipt date: 12/31/2009	Application Number	12596116	12569116 - GAU: 2621
	Filing Date	2009-09-11		
	First Named Inventor	Alan J. Lipton		
	Art Unit	2621		
	Examiner Name	Tung Vo		
	Attorney Docket Number	OV-101		

4	ALAN J. LIPTON, "Virtual Postman - An Illustrative Example of Virtual Video," International Journal of Robotics and Automation, Vol.15, No.1, January 2000, pp. 9-16.	<input type="checkbox"/>
5	ALAN J. LIPTON, "Virtual Postman - Real Time, Interactive Virtual Video," IASTED Conference on Computer Graphics and Imaging (CGIM '99), Palm Springs, October 25-27, 1999.	<input type="checkbox"/>
6	ROBERT T. COLLINS et al., "A System for Video Surveillance and Monitoring," Technical Report CMU-RI-TR-00-12, Robotics Institute, Carnegie Mellon University, May 2000.	<input type="checkbox"/>
7	Jemez Technology Corp., Variant iD Web-Site, www.variantid.com, printed August 25, 2003.	<input type="checkbox"/>
8	JP Office Action issued in PCT/US2002/22688 dated October 9, 2007	<input type="checkbox"/>
9	A. J. LIPTON et al., "Moving Target Classifications and Tracking from Real-time Video," IUW, pp. 159-175, May 1997.	<input type="checkbox"/>
10	A. J. LIPTON, "Local Application of Optic Flow to Analyze Rigid Versus Non-Rigid Motion," International Conference on Computer Vision, Corfu, Greece, September 1999.	<input type="checkbox"/>
11	A. J. LIPTON, H. FUJIYOSHI and R. S. PATIL, "Moving Target Classification and Tracking for Real-time Video," Proceedings of IEEE WACV'98, Princeton, NJ, 1998, pp. 8-14.	<input type="checkbox"/>
12	C. R. WREN et al., "Pfinder: Real-time Tracking of the Human Body," PAMI, vol.19, pp. 780-784, 1997.	<input type="checkbox"/>
13	C. R. WREN et al., "Pfinder: Real-time Tracking of the Human Body," Vismod, 1995.	<input type="checkbox"/>
14	CN Office Action for CN 02822772.7 on October 14, 2005	<input type="checkbox"/>

<b>INFORMATION DISCLOSURE STATEMENT BY APPLICANT</b> ( Not for submission under 37 CFR 1.99)	Application Number		12596116	12569116 - GAU: 2621
	Filing Date		2009-09-11	
	First Named Inventor	Alan J. Lipton		
	Art Unit		2621	
	Examiner Name	Tung Vo		
	Attorney Docket Number		OV-101	
	Receipt date: 12/31/2009			

15	D. M. GAVRILA, "The Visual Analysis of Human Movement: A Survey," CVIU, 73(1):82-98, January 1999.	<input type="checkbox"/>
16	F. BARTOLINI et al., "Counting People Getting In and Out of a Bus by Real-time Image-sequence Processing," IVC, 12(1):36-41, January 1994.	<input type="checkbox"/>
17	H. FUJIYOSHI and A. J. LIPTON, "Real-time Human Motion Analysis by Image Skeletonization," Proceedings of IEEE WACV'98, Princeton, NJ, 1998, pp. 15-21.	<input type="checkbox"/>
18	International Search Report for International Application No. PCT/2001/32614 on May 6, 2002.	<input type="checkbox"/>
19	International Search Report for International Application No. PCT/2006/25196, mailed January 16, 2008.	<input type="checkbox"/>
20	International Search Report for International Application No. PCT/US06/45625, mailed on September 24, 2007.	<input type="checkbox"/>
21	International Search Report for International Application No. PCT/US2002/22688 on December 11, 2002.	<input type="checkbox"/>
22	International Search Report for International Application No. PCT/US2006/012556, mailed on February 12, 2008.	<input type="checkbox"/>
23	International Search Report for International Application No. PCT/US2006/02700 dated April 13, 2007	<input type="checkbox"/>
24	J.P. DEPARIS et al., "A Device for Counting Passenger Making Use of Two Active Linear Cameras: Comparison of Algorithms," IEEE, pp. 1629-1634, 1996.	<input type="checkbox"/>
25	L. KHOUDOUR et al., "Real-time Pedestrian Counting by Active Linear Cameras," JEI, 5(4):452-459, October 1996.	<input type="checkbox"/>

<b>Receipt date: 12/31/2009</b>  <b>INFORMATION DISCLOSURE STATEMENT BY APPLICANT</b> <b>( Not for submission under 37 CFR 1.99)</b>	Application Number		12596116	12569116 - GAU: 2621
	Filing Date		2009-09-11	
	First Named Inventor	Alan J. Lipton		
	Art Unit		2621	
	Examiner Name	Tung Vo		
	Attorney Docket Number		OV-101	

26	L. WIXSON et al., "Detecting Salient Motion by Accumulating Directionally-Consistent Flow," IEEE 1999	<input type="checkbox"/>
27	L. WIXSON et al., "Detecting Salient Motion by Accumulating Directionally-Consistent Flow," IEEE Trans Pattern Anal. Mach. Intell., vol.22, pp. 774-781, Aug, 2000.	<input type="checkbox"/>
28	M. ROSSI et al., "Tracking and Counting Moving People," ICIP94, pp. 212-216, 1994.	<input type="checkbox"/>
29	M. ALLMEN et al., "Long-Range Spatiotemporal Motion Understanding Using Spatiotemporal Flow Curves," Proc. IEEE CVPR, Lahaina, Maui, Hawaii, pp. 303-309, 1991.	<input type="checkbox"/>
30	M. ISARD et al., "BraMBLe: A Bayesian Multiple-Blob Tracker," ICCV, 2001.	<input type="checkbox"/>
31	N. HAERING et al., "Visual Event Detection," Video Computing Series, Editor Mubarak Shah, 2001.	<input type="checkbox"/>
32	Notification for IL Application No. 161777 issued February 21, 2008.	<input type="checkbox"/>
33	R. T. COLLINS, Y. TSIN, J. R. MILLER and A. J. LIPTON, "Using a DEM to Determine Geospatial Object Trajectories" CMU-RI-TR-98-19, 1998.	<input type="checkbox"/>
34	S. IOFFE et al., "Probabilistic Methods for Finding People," IJCV, 43(1):45-68, June 2001.	<input type="checkbox"/>
35	SHIO et al., "Segmentation of People in Motion," Proc. IEEE, 1991, vol.79, pp. 325-332	<input type="checkbox"/>
36	T.J. OLSEN et al., "Moving Object Detection and Event Recognition Algorithm for Smart Cameras," IUW, pp. 159-175, May 1997.	<input type="checkbox"/>



<b>INFORMATION DISCLOSURE STATEMENT BY APPLICANT</b> ( Not for submission under 37 CFR 1.99)	Application Number		12596116	12569116 - GAU: 2621
	Filing Date		2009-09-11	
	First Named Inventor	Alan J. Lipton		
	Art Unit	2621		
	Examiner Name	Tung Vo		
	Attorney Docket Number	OV-101		

37	W.E.L. GRIMSON et al., "Using Adaptive Tracking to Classify and Monitor Activities in a Site," CVPR, pp.22-29, June 1998.	<input type="checkbox"/>
38	Written Opinion for International Application No. PCT/US2006/25196, mailed on January 16, 2008.	<input type="checkbox"/>
39	Written Opinion issued in PCT Application No. PCT/US2006/012556, mailed on February 12, 2008.	<input type="checkbox"/>
40	Written Opinion of the International Searching Authority issued for PCT Application No. PCT/US2006/45625, mailed on September 24, 2007.	<input type="checkbox"/>
41	A. J. LIPTON et al., "Moving Target Classifications and Tracking from Real-time Video," IUW, pp. 129-136, 1998.	<input type="checkbox"/>

If you wish to add additional non-patent literature document citation information please click the Add button

**EXAMINER SIGNATURE**

Examiner Signature	/Tung Vo/ (06/09/2010)	Date Considered	06/09/2010
--------------------	------------------------	-----------------	------------

\*EXAMINER: Initial if reference considered, whether or not citation is in conformance with MPEP 609. Draw line through a citation if not in conformance and not considered. Include copy of this form with next communication to applicant.

<sup>1</sup> See Kind Codes of USPTO Patent Documents at [www.USPTO.GOV](http://www.USPTO.GOV) or MPEP 901.04. <sup>2</sup> Enter office that issued the document, by the two-letter code (WIPO Standard ST.3). <sup>3</sup> For Japanese patent documents, the indication of the year of the reign of the Emperor must precede the serial number of the patent document. <sup>4</sup> Kind of document by the appropriate symbols as indicated on the document under WIPO Standard ST.16 if possible. <sup>5</sup> Applicant is to place a check mark here if English language translation is attached.

Receipt date: 12/31/2009

Doc code: IDS

Doc description: Information Disclosure Statement (IDS) Filed

Under the Paperwork Reduction Act of 1995, no persons are required to respond to a collection of information unless it contains a valid OMB control number.

12569116 - GAI: 2621

Approved for use through 07/31/2012. OMB 0651-0031

U.S. Patent and Trademark Office; U.S. DEPARTMENT OF COMMERCE

<b>INFORMATION DISCLOSURE STATEMENT BY APPLICANT</b> ( Not for submission under 37 CFR 1.99)	Application Number		12596116	
	Filing Date		2009-09-11	
	First Named Inventor	Alan J. Lipton		
	Art Unit		2621	
	Examiner Name	Tung Vo		
	Attorney Docket Number		OV-101	

U.S.PATENTS							Remove
Examiner Initial*	Cite No	Patent Number	Kind Code <sup>1</sup>	Issue Date	Name of Patentee or Applicant of cited Document	Pages,Columns,Lines where Relevant Passages or Relevant Figures Appear	
	1	6307885	B1	2001-10-23	Moon et al.		
	2	6351492	B1	2002-02-26	Kim		
	3	6151413	A	2000-11-21	Jang		
	4	6310916	B1	2001-10-30	Han		
	5	6326964	B1	2001-12-04	Snyder et al.		
	6	4737847		1988-12-04	Araki et al.		
	7	4908704		1990-03-13	Fujioka et al.		
	8	5802361		1998-09-01	Wang et al.		

<b>INFORMATION DISCLOSURE STATEMENT BY APPLICANT</b> ( Not for submission under 37 CFR 1.99)	Application Number		12596116	12569116 - GAU: 2621
	Filing Date		2009-09-11	
	First Named Inventor	Alan J. Lipton		
	Art Unit		2621	
	Examiner Name	Tung Vo		
	Attorney Docket Number		OV-101	

	9	5872865		1999-02-16	Normile et al.	
	10	6211907		2001-04-03	Scaman et al.	
	11	6542075		2003-04-01	Barker et al.	
	12	6123123		2000-09-26	Carder et al.	
	13	6552826		2003-04-22	Adler et al.	
	14	5963202		1999-10-05	Polish	
	15	7167519	B2	2007-01-23	Comaniciu et al.	
	16	7436887	B2	2008-10-14	Yeredor et al.	
	17	6865580	B1	2005-03-08	Bush	
	18	6741977		2004-05-25	Nagaya	
	19	6812835		2004-11-02	Ito et al.	

<b>INFORMATION DISCLOSURE STATEMENT BY APPLICANT</b> ( Not for submission under 37 CFR 1.99)	Application Number		12596116	12569116 - GAU: 2621
	Filing Date		2009-09-11	
	First Named Inventor	Alan J. Lipton		
	Art Unit		2621	
	Examiner Name	Tung Vo		
	Attorney Docket Number		OV-101	

	20	6940998		2005-09-06	Garoutte	
	21	6987528		2006-01-17	Nagahisa	
	22	7215795		2007-05-08	Ito et al.	
	23	7301536		2007-11-27	Ellenby	
	24	7307652		2007-12-11	Broemmelsiek	
	25	7479980		2009-01-20	Merheim et al.	
	26	5515453	A	1996-07-05	Hennessey et al.	
	27	5963203	A	1999-10-05	Goldberg et al.	
	28	5983147	A	1999-11-09	Krumm	
	29	6031573	A	2000-02-29	MacCormack et al.	
	30	6088484	A	2000-07-11	Mead	

<b>INFORMATION DISCLOSURE STATEMENT BY APPLICANT</b> ( Not for submission under 37 CFR 1.99)	Application Number		12596116	12569116 - GAU: 2621
	Filing Date		2009-09-11	
	First Named Inventor	Alan J. Lipton		
	Art Unit		2621	
	Examiner Name	Tung Vo		
	Attorney Docket Number		OV-101	
	Receipt date: 12/31/2009			

	31	6404455	B1	2002-06-11	Ito et al.	
	32	6411724	B1	2002-06-25	Vaithilingam et al.	
	33	6504479	B1	2003-01-07	Lemons et al.	
	34	6525658	B2	2003-02-25	Streetman et al	
	35	6570608	B1	2003-05-27	Tsemg	
	36	6573907	B1	2003-06-03	Madrane	
	37	6597800	B1	2003-07-22	Murray et al.	
	38	6628835	B1	2003-09-30	Brill et al.	

If you wish to add additional U.S. Patent citation information please click the Add button.

**U.S.PATENT APPLICATION PUBLICATIONS**

Examiner Initial*	Cite No	Publication Number	Kind Code <sup>1</sup>	Publication Date	Name of Patentee or Applicant of cited Document	Pages, Columns, Lines where Relevant Passages or Relevant Figures Appear
	1	20050146605		2005-07-07	Lipton et al.	

<b>INFORMATION DISCLOSURE STATEMENT BY APPLICANT</b> ( Not for submission under 37 CFR 1.99)	Application Number		12596116	12569116 - GAU: 2621
	Filing Date		2009-09-11	
	First Named Inventor	Alan J. Lipton		
	Art Unit		2621	
	Examiner Name	Tung Vo		
	Attorney Docket Number		OV-101	

	2	20040113933	A1	2004-06-17	Guler	
	3	20070013776		2007-01-18	Venetianer et al.	
	4	20020191851	A1	2002-12-19	Keinan	
	5	20030053659	A1	2003-03-20	Pavlidis et al.	
	6	20080100704	A1	2008-05-01	Venetianer et al.	
	7	20020008758	A1	2002-01-24	Broemmelsiek et al.	
	8	20020082769		2002-06-27	Church et al.	
	9	20050157169	A1	2005-07-21	Brodsky et al.	
	10	20050162515		2005-07-28	Venetianer et al.	
	11	20050168574		2005-08-04	Lipton et al.	
	12	20050169367		2005-08-04	Venetianer et al.	

<b>Receipt date: 12/31/2009</b>  <b>INFORMATION DISCLOSURE STATEMENT BY APPLICANT</b> ( Not for submission under 37 CFR 1.99)	Application Number		12596116	12569116 - GAU: 2621
	Filing Date		2009-09-11	
	First Named Inventor	Alan J. Lipton		
	Art Unit		2621	
	Examiner Name	Tung Vo		
	Attorney Docket Number		OV-101	

If you wish to add additional U.S. Published Application citation information please click the Add button.

**FOREIGN PATENT DOCUMENTS**

Examiner Initial*	Cite No	Foreign Document Number <sup>3</sup>	Country Code <sup>2</sup> i	Kind Code <sup>4</sup>	Publication Date	Name of Patentee or Applicant of cited Document	Pages, Columns, Lines where Relevant Passages or Relevant Figures Appear	T <sup>5</sup>
	1							<input type="checkbox"/>

If you wish to add additional Foreign Patent Document citation information please click the Add button

**NON-PATENT LITERATURE DOCUMENTS**

Examiner Initials*	Cite No	Include name of the author (in CAPITAL LETTERS), title of the article (when appropriate), title of the item (book, magazine, journal, serial, symposium, catalog, etc), date, pages(s), volume-issue number(s), publisher, city and/or country where published.	T <sup>5</sup>
	1		<input type="checkbox"/>

If you wish to add additional non-patent literature document citation information please click the Add button

**EXAMINER SIGNATURE**

Examiner Signature	/Tung Vo/ (06/09/2010)	Date Considered	06/09/2010
--------------------	------------------------	-----------------	------------

\*EXAMINER: Initial if reference considered, whether or not citation is in conformance with MPEP 609. Draw line through a citation if not in conformance and not considered. Include copy of this form with next communication to applicant.

<sup>1</sup> See Kind Codes of USPTO Patent Documents at [www.USPTO.GOV](http://www.USPTO.GOV) or MPEP 901.04. <sup>2</sup> Enter office that issued the document, by the two-letter code (WIPO Standard ST.3). <sup>3</sup> For Japanese patent documents, the indication of the year of the reign of the Emperor must precede the serial number of the patent document. <sup>4</sup> Kind of document by the appropriate symbols as indicated on the document under WIPO Standard ST.16 if possible. <sup>5</sup> Applicant is to place a check mark here if English language translation is attached.

Receipt date: 12/31/2009

12569116 - GAI: 2621

Doc code: IDS

Doc description: Information Disclosure Statement (IDS) Filed

Approved for use through 07/31/2012. OMB 0651-0031  
U.S. Patent and Trademark Office; U.S. DEPARTMENT OF COMMERCE

Under the Paperwork Reduction Act of 1995, no persons are required to respond to a collection of information unless it contains a valid OMB control number.

<b>INFORMATION DISCLOSURE STATEMENT BY APPLICANT</b> ( Not for submission under 37 CFR 1.99)	Application Number		12596116	
	Filing Date		2009-09-11	
	First Named Inventor	Alan J. Lipton		
	Art Unit	2621		
	Examiner Name	Tung Vo		
	Attorney Docket Number	OV-101		

U.S.PATENTS							Remove
Examiner Initial*	Cite No	Patent Number	Kind Code <sup>1</sup>	Issue Date	Name of Patentee or Applicant of cited Document	Pages,Columns,Lines where Relevant Passages or Relevant Figures Appear	
	1	6646676	B1	2003-11-11	DaGraca et al.		
	2	6707852	B1	2004-03-16	Wang		
	3	6724915	B1	2004-04-20	Toklu et al.		
	4	6801662	B1	2004-10-05	Owechko et al.		
	5	6816184	B1	2004-11-09	Brill et al.		
	6	6829371	B1	2004-12-07	Nichani et al.		
	7	6844818	B2	2005-01-18	Grech-Cini		
	8	6924801	B1	2005-08-02	Dorbie		



<b>Receipt date: 12/31/2009</b>  <b>INFORMATION DISCLOSURE STATEMENT BY APPLICANT</b> ( Not for submission under 37 CFR 1.99)	Application Number		12596116	12569116 - GAU: 2621
	Filing Date		2009-09-11	
	First Named Inventor	Alan J. Lipton		
	Art Unit		2621	
	Examiner Name	Tung Vo		
	Attorney Docket Number		OV-101	

9	7023469	B1	2006-04-04	Olson	
---	---------	----	------------	-------	--

If you wish to add additional U.S. Patent citation information please click the Add button.

**U.S.PATENT APPLICATION PUBLICATIONS**

Examiner Initial*	Cite No	Publication Number	Kind Code <sup>1</sup>	Publication Date	Name of Patentee or Applicant of cited Document	Pages, Columns, Lines where Relevant Passages or Relevant Figures Appear
	1	20020051058	A1	2002-05-02	Ito et al.	
	2	20020135483	A1	2002-09-26	Merheim et al.	
	3	20020024446	A1	2002-02-28	Grech-Cini	
	4	20020163521	A1	2002-11-07	Ellenby	
	5	20020095490	A1	2002-07-18	Barker et al.	
	6	20010019357	A1	2001-09-06	Ito et al.	
	7	20010033330	A1	2001-10-25	Garoutte	
	8	20010035907	A1	2001-11-01	Broemmelsiek	

<b>INFORMATION DISCLOSURE STATEMENT BY APPLICANT</b> ( Not for submission under 37 CFR 1.99)	Application Number		12596116	12569116 - GAU: 2621
	Filing Date		2009-09-11	
	First Named Inventor	Alan J. Lipton		
	Art Unit	2621		
	Examiner Name	Tung Vo		
	Attorney Docket Number	OV-101		

9	20040240542	A1	2004-12-02	Yeredor et al.	
---	-------------	----	------------	----------------	--

If you wish to add additional U.S. Published Application citation information please click the Add button.

**FOREIGN PATENT DOCUMENTS**

Examiner Initial*	Cite No	Foreign Document Number <sup>3</sup>	Country Code <sup>2</sup>	Kind Code <sup>4</sup>	Publication Date	Name of Patentee or Applicant of cited Document	Pages, Columns, Lines where Relevant Passages or Relevant Figures Appear	T <sup>5</sup>
	1							<input type="checkbox"/>

If you wish to add additional Foreign Patent Document citation information please click the Add button.

**NON-PATENT LITERATURE DOCUMENTS**

Examiner Initials*	Cite No	Include name of the author (in CAPITAL LETTERS), title of the article (when appropriate), title of the item (book, magazine, journal, serial, symposium, catalog, etc), date, pages(s), volume-issue number(s), publisher, city and/or country where published.	T <sup>5</sup>
	1		<input type="checkbox"/>

If you wish to add additional non-patent literature document citation information please click the Add button.

**EXAMINER SIGNATURE**

Examiner Signature	/Tung Vo/ (06/09/2010)	Date Considered	06/09/2010
--------------------	------------------------	-----------------	------------

\*EXAMINER: Initial if reference considered, whether or not citation is in conformance with MPEP 609. Draw line through a citation if not in conformance and not considered. Include copy of this form with next communication to applicant.

<sup>1</sup> See Kind Codes of USPTO Patent Documents at [www.USPTO.GOV](http://www.USPTO.GOV) or MPEP 901.04. <sup>2</sup> Enter office that issued the document, by the two-letter code (WIPO Standard ST.3). <sup>3</sup> For Japanese patent documents, the indication of the year of the reign of the Emperor must precede the serial number of the patent document. <sup>4</sup> Kind of document by the appropriate symbols as indicated on the document under WIPO Standard ST.16 if possible. <sup>5</sup> Applicant is to place a check mark here if English language translation is attached.



UNITED STATES PATENT AND TRADEMARK OFFICE

UNITED STATES DEPARTMENT OF COMMERCE  
 United States Patent and Trademark Office  
 Address: COMMISSIONER FOR PATENTS  
 P.O. Box 1450  
 Alexandria, Virginia 22313-1450  
 www.uspto.gov

BIB DATA SHEET

CONFIRMATION NO. 7686

SERIAL NUMBER	FILING or 371(c) DATE	CLASS	GROUP ART UNIT	ATTORNEY DOCKET NO.
12/569,116	09/29/2009	348	2621	OV-101
	RULE			

**APPLICANTS**

Alan J. Lipton, Falls Church, VA;  
 Thomas M. Strat, Pakton, VA;  
 Pèter L. Venetianer, McLean, VA;  
 Mark C. Allmen, Morrison, CO;  
 William E. Severson, Littleton, CO;  
 Niels Haering, Arlington, VA;  
 Andrew J. Chosak, McLean, VA;  
 Zhong Zhang, Herndon, VA;  
 Matthew F. Frazier, Arlington, VA;  
 James S. Seekas, Arlington, VA;  
 Tasuki Hirata, Silver Spring, MD;  
 John Clark, Leesburg, VA;

**\*\* CONTINUING DATA \*\*\*\*\***

This application is a CON of 09/987,707 11/15/2001 ABN  
 which is a CIP of 09/694,712 10/24/2000 PAT 6,954,498

**\*\* FOREIGN APPLICATIONS \*\*\*\*\***

**\*\* IF REQUIRED, FOREIGN FILING LICENSE GRANTED \*\*\* SMALL ENTITY \*\***  
 10/09/2009

Foreign Priority claimed <input type="checkbox"/> Yes <input checked="" type="checkbox"/> No	<input type="checkbox"/> Met after Allowance	<b>STATE OR COUNTRY</b>	<b>SHEETS DRAWINGS</b>	<b>TOTAL CLAIMS</b>	<b>INDEPENDENT CLAIMS</b>
35 USC 119(a-d) conditions met <input type="checkbox"/> Yes <input checked="" type="checkbox"/> No	Initials	VA	7	26	4
Verified and Acknowledged	/TUNG T VO/ Examiner's Signature				

**ADDRESS**

MUIR PATENT CONSULTING, PLLC  
 9913 Georgetown Pike, Suite 200  
 P.O. Box 1213  
 GREAT FALLS, VA 22066  
 UNITED STATES

**TITLE**

Video Surveillance System Employing Video Primitives

<b>FILING FEE RECEIVED</b> 884	FEES: Authority has been given in Paper No. _____ to charge/credit DEPOSIT ACCOUNT No. _____ for following:	<input type="checkbox"/> All Fees
		<input type="checkbox"/> 1.16 Fees (Filing)
		<input type="checkbox"/> 1.17 Fees (Processing Ext. of time)
		<input type="checkbox"/> 1.18 Fees (Issue)
		<input type="checkbox"/> Other _____
		<input type="checkbox"/> Credit

IDS Form PTO/SB/08: Substitute for form 1449A/PTO  <b>INFORMATION DISCLOSURE STATEMENT BY APPLICANT</b>  <i>(Use as many sheets as necessary)</i>			<b>Complete if Known</b>				
			Application Number		12/569,116		
			Filing Date		09-29-2009		
			First Named Inventor		Alan J. Lipton		
			Art Unit		2621		
Examiner Name		Tung Vo		Attorney Docket Number		OV-101	
Sheet	1	of	1				

U.S. PATENTS AND PUBLISHED U.S. PATENT APPLICATIONS					
Examiner Initials	Cite No. <sup>1</sup>	Document Number	Issue or Publication Date MM-DD-YYYY	Name of Patentee or Applicant of Cited Document	Pages, Columns, Lines, Where Relevant Passages or Relevant Figures Appear
		Number-Kind Code <sup>2</sup> (if known)			
	1	US-2003/0043160 A1	03-06-2003	Elfving, et al.	
	2	US-2003/0085992 A1	05-08-2003	Arpa, et al.	

**Note: Submission of copies of U.S. Patents and published U.S. Patent Applications is not required.**

FOREIGN PATENT DOCUMENTS						
Examiner Initials	Cite No. <sup>1</sup>	Foreign Patent Document	Publication Date MM-DD-YYYY	Name of Patentee or Applicant of Cited Document	Pages, Columns, Lines, Where Relevant Passages or Relevant Figures Appear	Translation <sup>6</sup>
		Country Code <sup>3</sup> Number <sup>4</sup> Kind Code <sup>5</sup> (if known)				
	1	WO-2004/006184 A2	01-15-2004	Talmon et al.		
	2	WO-03/044727 A1	05-30-2003	Diamondback Vision Inc.		
	3	EP-0967584 A2	12-29-1999	Texas Instruments Inc.		

NONPATENT LITERATURE DOCUMENTS			
Examiner Initials	Cite No. <sup>1</sup>	Include name of the author (in CAPITAL LETTERS), title of the article (when appropriate), title of the item (book, magazine, journal, serial, symposium, catalog, etc.), date, page(s), volume-issue number(s), publisher, city and/or country where published.	Translation <sup>6</sup>

Examiner Signature		Date Considered	
--------------------	--	-----------------	--

EXAMINER: Initial if reference considered, whether or not citation is in conformance with MPEP 609. Draw line through citation if not in conformance and not considered. Include copy of this form with next communication to applicant.

PTO Notes regarding this form:

- <sup>1</sup> Applicant's unique citation designation number (optional).
  - <sup>2</sup> See Kinds Codes of USPTO Patent Documents at [www.uspto.gov](http://www.uspto.gov) or MPEP 901.04.
  - <sup>3</sup> Enter Office that issued the document, by the two-letter code (WIPO Standard ST.3).
  - <sup>4</sup> For Japanese patent documents, the indication of the year of the reign of the Emperor must precede the serial number of the patent document.
  - <sup>5</sup> Kind of document by the appropriate symbols as indicated on the document under WIPO Standard ST.16 if possible.
  - <sup>6</sup> Applicant is to place a check mark here if English language Translation is attached.
- This collection of information is required by 37 CFR 1.97 and 1.98. The information is required to obtain or retain a benefit by the public which is to file (and by the USPTO to process) an application. Confidentiality is governed by 35 U.S.C. 122 and CFR 1.14. This collection is estimated to take 2 hours to complete, including gathering, preparing, and submitting the completed application form to the USPTO. Time will vary depending upon the individual case. Any comments on the amount of time you require to complete this form and/or suggestions for reducing this burden, should be sent to the Chief Information Officer, U.S. Patent and Trademark Office, U.S. Department of Commerce, P.O. Box 1450, Alexandria, VA 22313-1450. DO NOT SEND FEES OR COMPLETED FORMS TO THIS ADDRESS. **SEND TO: Commissioner for Patents, P.O. Box 1450, Alexandria, VA 22313-1450.**

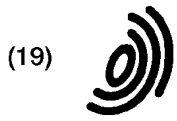

Europäisches Patentamt  
 European Patent Office  
 Office européen des brevets



(11) EP 0 967 584 A2

(12) EUROPEAN PATENT APPLICATION

(43) Date of publication:  
 29.12.1999 Bulletin 1999/52

(51) Int. Cl.<sup>6</sup>: G08B 13/194, G08B 15/00

(21) Application number: 99201370.6

(22) Date of filing: 29.04.1999

(84) Designated Contracting States:  
 AT BE CH CY DE DK ES FI FR GB GR IE IT LI LU  
 MC NL PT SE  
 Designated Extension States:  
 AL LT LV MK RO SI

(71) Applicant:  
 TEXAS INSTRUMENTS INCORPORATED  
 Dallas, TX 75265 (US)

(72) Inventor: Courtney, Jonathan D.  
 Richardson, TX (US)

(30) Priority: 30.04.1998 US 83644  
 29.06.1998 US 91263  
 30.04.1998 US 83711  
 30.04.1998 US 83718

(74) Representative: Holt, Michael  
 Texas Instruments Ltd.,  
 PO Box 5069  
 Northampton, Northamptonshire NN4 7ZE (GB)

(54) Automatic video monitoring system

(57) A system (10) for automatically monitoring an area includes a camera unit (12) having therein a video camera (23) and an image processing section (27). The image processing section saves a reference image from the video camera, compares subsequent images to the reference image, and detects and tracks change regions in the subsequent images. For each change region, the image processing section saves a path of

movement of the change region, and a selected image of the change region. Selection is carried out so as to optimize the selected image, for example so that a detected person is facing and close to the video camera. The camera unit is network-ready (14), so that a remote workstation (13) can access the images and other information saved in the camera unit.

FIG. 1

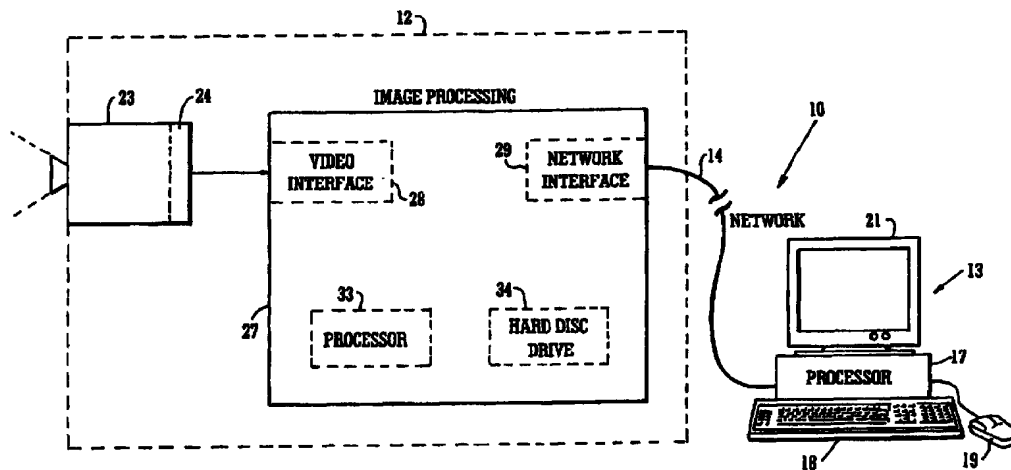

EP 0 967 584 A2

## Description

### TECHNICAL FIELD OF THE INVENTION

[0001] This invention relates in general to monitoring systems and, more particularly, to a method and apparatus for mapping the physical position of an object from a video image to a map of a monitored area.

### BACKGROUND OF THE INVENTION

[0002] A surveillance or monitoring system may include a video camera which generates images of a monitored area or region, and a computer which receives and processes the images from the video camera. The computer includes a digitized map, and monitors the detected video images in order to determine the presence in the monitored area of an object of interest, such as a human. Then an object of interest is identified through analysis of the detected images, the location of the object is mapped from the image to the map.

[0003] It is also common to record the output of each camera on a time-lapse video cassette recorder (VCR). In the event of a problem or security incident, the resulting recording can then be examined. It is also possible to use a video or infrared motion detector, so that the VCR does not record anything except when there is motion in the observed area. This reduces the consumption of tape and makes it easier to find footage of interest. Nevertheless, it does not eliminate the need for the VCR, which is a relatively complex and expensive component that is subject to mechanical failure and that requires periodic maintenance, such as cleaning of the video heads. Moreover, infrared motion detectors have a tendency to produce false detections.

[0004] Another known approach is to use an all-digital video imaging system, which converts each video image to a compressed digital form immediately upon capture. The digital data is then saved in a conventional database (such as a disk farm backed up by a tape juke box). This approach is relatively expensive, requires a substantial amount of storage space, and does nothing to help an operator find frames of interest.

[0005] Another approach uses a video camera and personal computer to detect and track people, and saves the first image that satisfies some alarm condition. However, this system makes no attempt to select a good view of the person, as a result of which the saved image may show the person with his or her back to the camera, rendering it difficult or impossible to identify the particular person. Another known system displays a path of movement of a detected person who is in the observed area, but discards the path of movement after the person leaves the observed area.

[0006] All of these known approaches have been generally adequate for their intended purposes, but they have not been satisfactory in all respects. For example, they involve hardware which is relatively expensive and

not particularly compact. They often use a VCR, which is subject to mechanical failure and requires periodic maintenance. Some systems store all incoming video information, which uses a substantial amount of storage capacity, and makes it difficult to find of events of interest.

[0007] This known system includes a computer-aided drafting (CAD) model of the environment or monitored area, which serves as the basis for the map. Further, in order to accurately determine the location on the map of an object identified in the detected images, parameters of the camera must be determined, and must be introduced into the computer. The camera parameters include not only internal parameters such as focal length and the number of millimeters per pixel, but also external parameters such as the location and the orientation of the camera.

[0008] When this known system is in operation, the location on the map of an object in a video image is determined using a formula derived by inverting equations that describe image formation geometry. The necessary set up and initialization for this system is complex and time consuming. Determining all of the pertinent internal and external parameters of the camera, and entering them into the computer system, is a complex and time-consuming task. Also, preparing the CAD model of the monitored area can be a slow and time-consuming task.

[0009] In addition, even if care is exercised in the determination of the camera parameters and the preparation of the CAD model, errors can still occur. For example, an object which is visible to the camera, because it is on a side of a wall nearest the camera, may be incorrectly positioned on the map on the opposite side of that wall, where it would not actually be visible to the camera. Errors of this type become even more problematic if the camera parameters and CAD model are not carefully established.

[0010] There are now video cameras which can be coupled to a computer, and there are software programs capable of converting video images from such cameras into a document in hypertext mark-up language (HTML) format, or in other words a document compatible with the Internet standard known as the World Wide Web (WWW). Further, personal communication devices such as cellular phones, pagers and personal digital assistants are becoming increasingly popular commercial products, as wireless communication technology becomes widespread and affordable. In fact, there is now a portable phone which has a small video display, and which includes a WWW-compatible browser that permits the portable unit to download and display HTML documents from the Internet.

[0011] At the same time, home security systems have become more common. However, even the most sophisticated home security systems are limited by rudimentary provisions for remote access by the property owner. Further, false alarms are relatively common.

Even if the owner is made aware of the alarm, there is no convenient and cost-effective way for the owner to determine whether it is a false alarm. For example, existing systems may notify an owner of a possible break-in or other event through an automated phone call or page message, but the owner has no way of verifying whether there is a real problem or merely a false alarm.

**[0012]** While these existing monitoring systems have been generally adequate for their intended purposes, they have not been satisfactory in all respects. For example, and as mentioned above, even if an owner is notified by a page or telephone call of a problem or other event of interest, there is no convenient way for the owner to determine whether the event represents a true problem or just a false alarm, still less from virtually any remote location. Further, existing systems do not allow the camera operation to be adjusted from virtually any remote location.

SUMMARY OF THE INVENTION

**[0013]** From the foregoing, it may be appreciated that a need has arisen in the automatic monitoring field for a method and apparatus which are reliable, which intelligently save selected information that is meaningful but minimizes storage capacity, and which facilitate the location and review by an operator of events of interest. As to the apparatus, there is a need for physical compactness and low cost.

**[0014]** According to one form of the present invention, a method and apparatus are provided to address this need, and involve periodically detecting an image of the area, identifying and tracking a moving object in a succession of the detected images, automatically selecting an image of each identified object, and saving the selected image of each identified object.

**[0015]** A different form of the present invention involves periodically detecting an image of the area, identifying and tracking a moving object in a succession of the detected images, and automatically saving information which identifies the path and movement of the object, the information being retained after the object is no longer present in the detected images.

**[0016]** From the foregoing, it may be appreciated that a need has arisen for a method and apparatus for mapping an object in a detected image to a map of the monitored area, which permit the mapping function to be easily and rapidly defined with minimal possibility for error, while avoiding the need to obtain and input both internal and external camera parameters.

**[0017]** According to the present invention, a method and apparatus are provided to address this need, and involve: providing a map of a monitored area; detecting a reference image of the area; identifying a first region which corresponds to a selected portion of the area as viewed in the reference image; identifying a second region which corresponds to the selected portion as

viewed on the map; detecting a further image of the area; identifying a portion of the further image corresponding to an object of interest; selecting in the region of the lower end of the portion of the further image a first point which is within the first region; and carrying out a warp transformation of the first point from the first region to the second region, in order to identify within the second region a second point which corresponds to the first point and which identifies a position on the map of the object of interest.

**[0018]** From the foregoing, it may be appreciated that a need has arisen for a cost-effective method and apparatus for monitoring which permit access and/or control from virtually any remote location.

**[0019]** According to one form of the present invention, a detector periodically detects an image of a monitored area, a system receives the detected image, a portable unit has a display, and a wireless communication link facilitates communication between the system and the portable unit, including transmission of the detected image from the system to the portable unit. The portable unit presents the detected image on the display. The system detects an occurrence of an event of interest in the monitored area, and automatically transmits to the portable unit through the wireless communication link an indication of the occurrence of that event.

**[0020]** According to a different form of the present invention, a detector periodically detects an image of a monitored area, a system receives the detected image, a portable unit has a display and an operator input portion, and a wireless communication link facilitates communication between the system and the portable unit, including transmission of the detected image from the system to the portable unit. A control section is coupled to the system and can adjust a predetermined characteristic of the image detected by the detector. The portable unit presents the detected image on the display, permits an operator to use the operator input portion to specify a change in the predetermined characteristic, and transmits to the control section through the wireless communication link and system an indication of the specified change in the predetermined characteristic. The control section responds to the indication received from the portable unit by effecting the specified change in the predetermined characteristic.

**[0021]** According to yet another form of the present invention, a first detector periodically detects an image of a monitored area, a second detector periodically detects an image of a monitored area, a system receives the detected images from each of the detectors, a portable unit has a display and an operator input portion, and a wireless communication link facilitates communication between the system and the portable unit. The portable unit permits an operator to identify one of the first and second detectors as a currently selected detector, and transmits to the system through the wireless communication link an indication of the currently selected detector. The system responds to the



indication received from the portable unit by transmitting to the portable unit through the wireless communication link the detected image from the currently selected detector, and the portable unit presents on the display the detected image from the currently selected detector.

**[0022]** According to still another form of the present invention, a detector periodically detects an image of a monitored area, and a system receives and processes a detected image from the detector in order to obtain a processed image. A portable unit has a display, and a wireless communication link facilitates communication between the system and the portable unit, including transmission of each of the processed images from the system to the portable unit. The portable unit successively presents the processed images on the display, the processed images having a resolution which is less than a resolution of the detected images, and which corresponds to a resolution of the display.

#### BRIEF DESCRIPTION OF THE DRAWINGS

**[0023]** A better understanding of the present invention will be realized from the detailed description which follows, taken in conjunction with the accompanying drawings, in which:

FIGURE 1 is a diagrammatic view of an automatic monitoring system which embodies the present invention;

FIGURES 2A, 2B, 2C, 2D, 2E, 2F, 2G and 2H are diagrammatic views of two-dimensional images that represent successive steps carried out by the system of FIGURE 1 when processing images obtained from a video camera;

FIGURE 3 is a motion analysis diagram indicating how the motion of objects in a video image is analyzed by the system of FIGURE 1;

FIGURE 4 is a diagrammatic top view of part of a floor plan of a building in which the system of FIGURE 1 can be utilized;

FIGURE 5 is a diagrammatic view of a reference image provided by the system of FIGURE 1 for the building of FIGURE 4;

FIGURE 6 is a diagrammatic view of a video image which is similar to the image of FIGURE 5, but which shows the presence of a person;

FIGURE 7 is a diagrammatic view of a directory structure which is used on a hard disk drive in the system of FIGURE 1;

FIGURE 8 is a diagrammatic view of a display presented on the screen of a computer monitor which is a component of the system of FIGURE 1;

FIGURE 9 is a diagrammatic view similar to FIGURE 8 of a display presented on the screen of the computer monitor of FIGURE 1;

FIGURE 10 is a diagrammatic top view of part of a floor plan of a building in which the system of FIGURE 1 can be utilized;

FIGURE 11 is a diagrammatic view of a reference video image provided by the system of FIGURE 1 for the building of FIGURE 10;

FIGURE 12 is a diagrammatic view of part of a video display provided by the system of FIGURE 1 to permit an operator to define a mapping function between a detected video image of the monitored area and a map of the monitored area;

FIGURE 13 is a diagrammatic view similar to FIGURE 12 but showing an exemplary display generated by the system of FIGURE 1 during normal operation;

FIGURE 14 is a diagrammatic view of a monitoring apparatus which embodies the present invention, the monitoring apparatus including two video cameras, a system which processes video images from the cameras, and a portable unit which is coupled to the system through a wireless link;

FIGURE 15 is a high-level flowchart of image processing techniques used by the apparatus of FIGURE 14;

FIGURE 16 is a diagrammatic view of an exemplary screen image presented on a display of the portable unit of FIGURE 14;

FIGURES 17A-17C are respective diagrammatic views of video images, which demonstrate how video images are processed by the apparatus of FIGURE 14;

FIGURE 18 is a diagrammatic view of a region of interest shown in FIGURE 2G, superimposed on a reference image which is shown in FIGURE 2A;

FIGURE 19 is a diagrammatic view of the outline of a the region of interest shown in FIGURE 2G;

FIGURE 20 is a diagrammatic view of the outline of FIGURE 19, superimposed on the reference image which is shown in FIGURE 2A;

FIGURE 21 is a diagrammatic view of a region derived from the image of FIGURE 2B, one part of which includes gray scale information, and a further part of which does not; and

FIGURE 22 is a diagrammatic view representing the differences between two successively detected images.

#### DETAILED DESCRIPTION OF THE INVENTION

**[0024]** FIGURE 1 is a diagrammatic view of a monitoring system 10 which embodies the present invention, and which is used to monitor activity in a selected region or area. The monitoring system 10 includes a camera unit 12 and a workstation 13, which are operatively coupled through a network shown diagrammatically at 14. The network 14 may be a local area network, the Internet, some other type of network, a modem link, or a combination of such technologies. The workstation 13 may be a personal computer, including a processor 17, a keyboard 18, a mouse 19, and a display 21.

**[0025]** The camera unit 12 includes a video camera 23

which, in the disclosed embodiment, is a monochrome camera. However, the present invention is also suitable for use with a color video camera, or some other type of two-dimensional image detector, such as an infrared detector. Video camera 23 includes a detector 24, which

**[0026]** The camera unit 12 further includes an image processing section 27. The image processing section 27 includes a video interface circuit 28 which receives the output of the detector 24, and a network interface circuit 29 which facilitates communication across the network 14. The image processing section 27 could also include a modem, in addition to or in place of the interface circuit 29, in order to facilitate communication through telephone lines. The image processing section 27 further includes a processor 33, and a memory such as a hard disk drive 34. The hard disk drive 34 could optionally be replaced with some other type of suitable non-volatile memory, such as a flash memory, or a memory with battery backup.

**[0027]** In the disclosed embodiment, the image processing section 27 is physically disposed within the housing of the camera unit 12. Thus, the camera unit 12 is a standalone device which can coupled directly to a telephone line or a network, such as the network 14. However, it will be recognized that the image processing section 27 could alternatively be implemented with a personal computer which is physically separate from the video camera 23, which has a plug-in video capture card serving as the video interface circuit, and which has a plug-in network interface card serving as the network interface circuit. Further, although the disclosed system has just one video camera 23, it would be possible to use two or more video cameras with a single image processing section.

**[0028]** The initial processing of video images by workstation 13 will now be described with reference to FIGURES 2A-2H and FIGURE 3. More specifically, FIGURE 2A is a diagrammatic view of a video image produced by the video camera 12 when it is directed toward an area which, in this example, has arbitrarily been selected to be the corner of a room. The video image of FIGURE 2A is saved as a reference image. FIGURE 2B is a similar video image that was obtained from the camera 12 at a later point in time, after an object 41 has been introduced into the monitored area. In this case, the object 41 is a person, who has walked into the corner of the room and thus into the field of view of the video camera 12. The video camera 12 is stationary, and thus the single difference between the images of FIGURES 2A and 2B is the presence of the person 41 in FIGURE 2B. The presence and movement of the person 41 is detected in the following manner.

**[0029]** First, the gray-scale image of FIGURE 2B is subtracted from the gray-scale image of FIGURE 2A, on

a pixel-by-pixel basis. The absolute value of the difference for each pixel is then determined, and the result is the gray-scale difference image of FIGURE 2C. Then, the difference image of FIGURE 2C is sub-sampled in order to reduce the number of pixels, for example to a 128 by 128 or 256 by 256 pixel image. The resulting low-resolution image is shown in FIGURE 2D. It will be recognized that it is alternatively possible to sub-sample each of the images of FIGURES 2A and 2B before determining the difference and absolute value for each pixel, which reduces the number of pixels that need to be processed, and therefore reduces the amount of time needed to obtain the image of FIGURE 2D.

**[0030]** The low-resolution difference image of FIGURE 2D is then thresholded. In other words, the gray-scale value for each pixel in the image of FIGURE 2D is compared to a predetermined threshold, and the pixel is then set to be either on or off (black or white), depending on whether the value is above or below the threshold. The resulting threshold image is shown in FIGURE 2E. Each pixel in the threshold image of FIGURE 2E can be represented by a binary "1" or a binary "0", depending on whether the pixel is considered to be on or off.

**[0031]** Morphological processing is then carried out on each pixel of the threshold image of FIGURE 2E, by first performing a dilate operation, and then performing an erode operation. More specifically, each pixel is processed by viewing it as the center pixel in a three-by-three matrix of pixels. During the dilate operation for each pixel in the threshold image of FIGURE 2E, if any one of the eight neighboring pixels in that image is a logic "1", the pixel of interest is set to a logic "1". The resulting dilate image is shown in FIGURE 2F. During the subsequent erode operation for each pixel in the dilate image of FIGURE 2F, if any one of the eight neighboring pixels in that image is a logic "0", then the pixel of interest is set to a logic "0". The result is the erode image of FIGURE 2G.

**[0032]** The erode image of FIGURE 2G is then analyzed to identify each region of contiguous logic "1" pixels. Each such region of contiguous logic "1" pixels represents a change region, corresponding to an object which has been introduced into the image of FIGURE 2B and which was not present in the image of FIGURE 2A, such as the person 41. This analysis can be carried out using known techniques, such as run-length encoding followed by connected-component analysis.

**[0033]** With respect to each detected change region, the image processing section 27 determines a bounding box for the change region. An example of a bounding box is shown at 43 in FIGURE 2H. It will be noted that the bounding box 43 is a rectangular box, just large enough to contain the entire change region. That is, no pixel of the change region lies outside the box, but every side of the box touches at least one pixel of the change region.

**[0034]** The above-described image processing is car-

ried out for each image in a succession of images provided by the video camera 12. That is, each of these successive images is processed with respect to the reference image of FIGURE 2A, in the same manner that was described above for the image of FIGURE 2B.

**[0035]** The workstation 13 then carries out motion analysis, by tracking movement or non-movement of each identified change region through a succession of the frames or images from the video camera. For purposes of facilitating an understanding of the present invention, one known motion analysis technique will be briefly summarized with reference to FIGURE 3. Although it will be recognized that motion analysis in the video images is carried out in two dimensions, for purposes of convenience the diagram of FIGURE 3 shows just one dimension.

**[0036]** In FIGURE 3, the nineteen vertical lines F0 through F18 each represent a respective frame or image in a series of successive images from the video camera 12. In FIGURE 3, the horizontal dimension represents time, and the vertical dimension represents one dimension of movement of an object within a two-dimensional image. Then an object which was not previously present first appears, for example at 51 or 52, it is identified as an "entrance" or "enter" event. When an object which was previously present is found to no longer be present, for example at 53 or 54, it is designated an "exit" event. If an existing object splits into two objects, one of which is moving and the other of which is stationary, for example as at 57, it is designated a "deposit" event. This would occur, for example, when a person who is carrying a briefcase sets it down on a table, and then walks away.

**[0037]** If a moving object merges with a stationary object, and then continues to move while the stationary object disappears, as at 58, it is designated a "remove" event. This would correspond to a situation where a person walks to a notebook resting on a table, and then picks up the notebook and walks away. Three other types of events, which are not specifically illustrated in FIGURE 3, are a "rest" event, a "move" event, and a "lightsout" event. A rest event occurs when a moving object comes to a stop but continues to be present without moving. A practical example is a situation where the objects being monitored are vehicles in a parking lot, and a car pulls into a parking space and thereafter remains stationary. A move event occurs when a detected object which has been stationary begins moving again, for example when a car that has been parked begins moving. A "lightsout" event occurs when the entire detected image suddenly changes, for example when the lights in a monitored room are turned out and the room becomes dark. A "lightsout" event can be detected without all of the image processing described above in association with FIGURES 2 and 3.

**[0038]** It is optionally possible to also carry out an identification analysis, in an attempt to identify a detected object. For example, with a small amount of

knowledge about the topography of the monitored area, the workstation 13 can use the position in the image of the midpoint of the lower side of the object's bounding box in order to identify how far the object is from the camera. Then, knowing how tall a person that far from the camera would be, the workstation 13 can evaluate the vertical height of the bounding box in the image, in order to determine whether the object generating the change region is tall enough to be a person. If the object is sufficiently tall to be a person, it can be assumed that it is a person.

**[0039]** Alternatively, the workstation 13 could map the endpoints of the lower side of a bounding box from an image to a map of the scene viewed. Given the scale of the map, the workstation 13 could determine the distance between these two points on the map, which would also be the distance between them in the image, and would thus be the length of the lower side of the bounding box in the image. The computer could then determine the height of the bounding box in the image, and evaluate whether the object in question is tall enough to be a person. Again, if the object is sufficiently tall to be a person, the workstation 13 assumes that it is a person. This process will be further described below.

**[0040]** If the object is not sufficiently tall to be a person, then the workstation 13 can carry out an object analysis procedure, by analyzing the image of the object in an attempt to classify it as one of several common objects, such as a briefcase, a notebook, a box, or a computer monitor. If the object is not specifically identified through this approach, then it is ultimately identified as an "unknown" object.

**[0041]** In order to facilitate an understanding of one aspect of the present invention, a specific exemplary application for the system 10 of FIGURE 1 will now be disclosed. However, it will be recognized that there are numerous other applications and environments in which the system 10 of FIGURE 1 could be utilized. With respect to the exemplary application, FIGURE 4 is a diagrammatic top view of a portion of a building which has a long hallway 71 with an alcove 72 near one end. The camera unit 12 of FIGURE 1 is stationarily mounted just below the ceiling and at one end of the hallway 71, so that it looks down the hallway 71 and slightly to the right. The camera unit 12 can thus observe the hallway 71 and the alcove 72. At its far end, the hallway 71 dead-ends into a transverse further hallway 73. Yet another transverse hallway 74 extends off to the right from hallway 71, at a location intermediate the alcove 72 and the hallway 73. There are three doors 76, 77 and 78 disposed at spaced locations along the left side of the hallway 71. A single door 79 is provided along the right side of the hallway 71, adjacent the hallway 74 and on a side thereof nearest the camera unit 12.

**[0042]** FIGURE 5 is a diagrammatic view of a video image which was obtained from the camera unit 12 in the environment of FIGURE 4, and which thus shows the hallway 71 and the alcove 72. For purposes of dis-

cussion, it is assumed that the image of FIGURE 5 has been saved as a reference image, analogous to the reference image discussed above in association with FIGURE 2A. FIGURE 6 is a diagrammatic view of a further video image from the camera unit 12, but after the appearance in the monitored area of an object 86 which was not present in the reference image of FIGURE 5.

**[0043]** In this case, the object 86 is a person, who entered the hallway 71 at the far end, and then walked down the length of the hallway 71 to the alcove 72. After the camera unit generated the video image of FIGURE 6, the person 86 continued down the hallway 71 toward the camera unit 12, and then walked under the camera unit so as to disappear from the field of view of the camera unit. During the time that the person 86 was in the field of view of the camera unit 12, the camera unit generated a succession of video images as the person walked down the hall 71. A selected one of these video images is shown in FIGURE 6. Each of the video images in this succession of images was processed relative to the reference image of FIGURE 5, in a manner analogous to that described above in association with FIGURE 2. In association with the processing of each such image, the system determines for each image a bounding box around the change region which corresponds to the person 86. The bounding box for the person 86 in the image of FIGURE 6 is shown at 87.

**[0044]** The image processing section 27 of FIGURE 1 does not save each of the numerous images of the person 86 which are obtained while the person walks down the hallway 71. While some known systems do this, it requires an extensive amount of memory to store all this video information. Instead, the system 10 stores just selected information, as discussed below.

**[0045]** More specifically, the image processing section 27 has already stored on the hard disk drive 34 the reference image of FIGURE 5. In the disclosed embodiment, the reference image of FIGURE 5 is first subsampled, and then the resulting low-resolution version of the image is stored on the hard disk drive 34, in order to reduce the amount of storage space needed for each such reference image. Objects which enter the observed area are of primary interest, rather than the observed area itself, and a low-resolution image of the observed area is thus sufficient for most applications.

**[0046]** For each detected object such as the person 86, the image processing section 27 also determines the Cartesian coordinates within each image of the midpoint of the lower side of the bounding box for that detected object. This information is saved on the hard disk drive. In other words, for each detected object, a Cartesian coordinate pair for that object is saved for each video image in which the object is present. As to a given object, the set of Cartesian coordinate pairs for all of the images in which that object was present can serve as a trace of the movement of the object within the observed area, as will be discussed in more detail later.

**[0047]** The image processing section 27 also saves a selected image of each detected object. In the disclosed embodiment, this selected image is just a portion of the overall image from the video camera 23. In particular, it is the portion of the image which is located within the bounding box for the object of interest. Thus, if the selected image for the person 86 was derived from the video image of FIGURE 6, it would be the portion of that image within the bounding box 87. This selected image or image portion is stored at full resolution, in order to have a top-quality view of the detected object. This is because a top-quality view will often be useful at a later point in time, for example to facilitate identification of a particular individual. Since the selected image is just a portion of the overall video image, the amount of memory needed to store the selected image at full resolution is often less than the amount of memory which would be needed to store the overall video image at a reduced resolution.

**[0048]** The selection of the particular image to be saved is an automatic determination, which is effected with simple heuristics. In most applications, the objects of primary interest are humans, and it is therefore desirable to favor selection of an image in which the person is facing generally toward the camera unit 12, and is reasonably close to the camera unit 12. In this regard, if the lower side of the bounding box is moving downwardly in successive images, it is assumed that the person is moving toward and facing the camera. On the other hand, if the lower side of the bounding box is not moving downwardly or upwardly, the new view will nevertheless be favored over a prior view, if the subject appears to be larger, as reflected by an increase in the vertical size of the bounding box.

**[0049]** Thus, when an object such as a person first appears, the image processing system 27 temporarily saves the first video image containing the person, and tentatively designates this image as the selected image. Then, in each successive image, the image processing section 27 checks to see whether the lower side of the bounding box in the current image is lower than the lower side of the bounding box in the tentatively selected image. If it is, then the prior image is discarded and the current image is tentatively designated as the selected image.

**[0050]** On the other hand, if the lower side of the bounding box for the object is found to have the same vertical position in the current image as in the tentatively selected prior image, then the section 27 checks to see if the vertical height of the bounding box in the current image is larger than the vertical height of the bounding box in the tentatively selected image. If so, then the prior image is discarded and the current image is tentatively designated as the selected image.

**[0051]** Then the object eventually exits the observed area, the image processing section 27 takes the tentatively selected video image, and saves on the hard disk drive 34 the portion of that video image which is within

the bounding box. As discussed above, this portion of the image is saved at full resolution.

[0052] Although the disclosed embodiment uses the foregoing selection criteria in order to favor facial close-ups of humans, it will be recognized that other applications may require other selection criteria. For example, if the camera unit 12 was being used to monitor vehicles, and if it was desirable to favor close-ups of the rear license plates of the vehicles, the selection criteria could be adjusted to achieve this.

[0053] In association with each detected object, the image processing section 27 also saves on the hard disk drive 34 certain other information, including a human-readable timestamp which indicates the date and time that the object was detected, the name of the disk file containing the reference image which was in use while the object was present in the observed area, and a keyword indicating how the object entered the observed area. As to the latter, the allowable keywords in the disclosed embodiment are "enter", "deposit" and "other", but it will be recognized that there could be additional allowable keywords, or fewer allowable keywords.

[0054] Over time, changes may occur in the background of the observed area. For example, the ambient lighting may change, due to variations in the sunlight entering through windows, opening and closing of window blinds, opening and closing of interior doors, actuation and deactuation of interior lighting, and so forth. Similarly, people may deposit, remove or reposition objects in the observed area. Each such change creates a permanent region of difference between the original reference image and each current video image. Absent a periodic update of the reference image, the system will continue to track these difference or change regions as detected objects. Lighting changes would thus be treated as detected objects, resulting in the storage of images which are not really of interest, and which simply waste memory on the hard disk drive 34.

[0055] In order to avoid this, the image processing section 27 checks for a condition in which nothing in the observed area has changed for a specified time interval, such as twenty seconds. In response to detection of this condition, the image processing section 27 terminates the tracking of all detected objects which were being actively tracked, saves the current video image as a new reference image, and then resumes monitoring of the observed area using the new reference image. In general, humans almost never remain completely still for more than a second or two, and there is thus little risk of selecting as the reference image a video image which has a human in it.

[0056] With reference to FIGURE 1, the image processing section 27 of the camera unit 12 has been designed so that it is Internet-compatible, and in particular is compatible with Internet standards commonly known as the World Wide Web (WWW). As a result, the camera unit 12 can be coupled directly to the network 14, and the stored information which was discussed

above can be accessed and viewed by a person using a web browser on a remote unit such as the workstation 13. To facilitate this, the image processing section 27 stores the results of its monitoring activities on the hard disk drive 34 in a manner which will now be described with reference to FIGURE 7.

[0057] More specifically, FIGURE 7 shows the directory organization of a portion of the hard disk drive 34. In FIGURE 7, the rectangular boxes 91 to 96 are each a diagrammatic representation of respective directory. These directories store the information relating to monitoring activities of the image processing section 27. The directory 91 is a subdirectory of a not-illustrated root directory, the directories 92 to 94 are subdirectories of the subdirectory 91, and the directories 95 and 96 are subdirectories of the directory 94.

[0058] The subdirectory 91 contains a file MASTER.HTML, and the subdirectories 92 and at 93 each contain a respective file named LOGLIST.HTML. The MASTER.HTML and LOGLIST.HTML files are each a WWW-compatible file in hypertext mark-up language (HTML) format, and facilitate access to other information stored in the directory structure of FIGURE 7. The MASTER.HTML file has hypertext links to each of the LOGLIST.HTML files, and the LOGLIST.HTML files are each an HTML shell which invokes an applet that facilitates access to files within the directory containing that particular LOGLIST.HTML file.

[0059] The directory 92 corresponds to a single day in which the camera unit 12 of FIGURE 1 was operational. When the camera unit 12 first begins monitoring a given area, the subdirectory 91 exists, but the subdirectories 92 and 93 do not exist. During the first day of monitoring, the image processing section 27 creates the subdirectory 92, and uses it to store information from that day's monitoring activities. Upon commencing each subsequent day of monitoring, the image processing section 27 creates a similar additional subdirectory, one of which is shown at 93. The name of each such subdirectory is in the format MM.DD.YY, and identifies the month, day and year for which the directory contains information.

[0060] Each of the subdirectories 92 and 93 has therein the above-mentioned LOGLIST.HTML file. Further, each such subdirectory includes a LOGLIST file, which is a summary list identifying all the log entries for the day in question, each log entry corresponding to a respective detected object. Each subdirectory also includes, for each log entry in its LOGLIST file, a separate file with the name format ENTRYX, where X is an integer. Each ENTRYX file contains details associated with the specific detected object, including the name of the file which contains the reference image that was in effect when the object was present, the keyword indicating how the object entered the scene, the series of Cartesian coordinate pairs which trace the path of movement of the object within the image, the selected image of the object in a full-resolution image format, and

two Cartesian coordinate pairs which respectively identify the position in the video image of two opposite corners of the bounding box for the selected image.

**[0061]** The summary information in the LOGLIST file includes two elements for each detected object, namely a timestamp representing the date and time when the corresponding object was detected, and the name of the ENTRYX file containing details about that detected object. In the disclosed embodiment, this information in the LOGLIST file is in an ASCII format.

**[0062]** The subdirectories shown at 95 and 96 in FIGURE 7 each correspond to a respective day, and each contain all of the reference images used during that day. More specifically, when the camera unit 12 first begins monitoring a selected area, the subdirectory 94 will exist, but the subdirectories 95 and 96 will not yet exist. During the first day of monitoring, the subdirectory 95 is created, and is used to store all of the reference images for that day. At the beginning of each subsequent day of monitoring, a new subdirectory is created, one of which is shown at 96.

**[0063]** Each of the subdirectories 95 and 96 has a name format of MM.DD.YY, representing the date corresponding to the information stored in the subdirectory. Each of the subdirectories 95 and 96 contains a plurality of files with the name format REFIMGXX.PGM, where XX is a unique integer. Each REFIMGXX.PGM file contains a respective reference image. Each time a new reference image is saved during the day, a new REFIMGXX.PGM file is created, and is named using the next highest unused XX integer.

**[0064]** FIGURE 8 is a diagrammatic view of the display 21 of FIGURE 1 when an operator is using the workstation 13 to observe information stored on the hard disk drive 34 by the image processing section 27. In FIGURE 8, the operator is using a web browser program which is sold under the tradename NETSCAPE by Netscape Communications Corporation of Mountainview, California. However, it will be recognized that some other equivalent web browser could alternatively be used. In FIGURE 8, the user has invoked the WWW capabilities of the Internet to access the WWW-compatible file MASTER.HTML in the directory 91 (FIGURE 7), which in turn has used the various LOGLIST.HTML files in the subdirectories 92 and 93 to access information in each of the respective LOGLIST files. The MASTER.HTML file may optionally require an operator to provide a valid password before giving the operator access to the information stored on the hard disk drive 34.

**[0065]** At the top of the displayed web page is a title 101, which is provided by the MASTER.HTML file, and which reflects the particular installation or application. Along the left side of the page is a scroll box 102, in which the MASTER.HTML and LOGLIST.HTML files display a list of the timestamps from all of the LOGLIST files, each timestamp including both a date and a time. Vertical and horizontal scroll bars 103 and 104 are pro-

vided if the number of timestamp entries or the length of any single timestamp entry is larger than can be displayed at one time within the scroll box 102. In the scroll box 102, the operator has highlighted one entry, which corresponds to a detected object that was present at the specified time on February 15, 1997.

**[0066]** To the right of the scroll box 102, information from the ENTRYX file corresponding to the selected log entry is displayed. More specifically, a video image 111 is presented, which represents the event that was discussed above in association with FIGUREs 5 and 6, namely the detection and tracking of the person 86. The image 111 is created by first retrieving and displaying the REFIMGXX.PGM file corresponding to the selected log entry 107. Then, the selected image corresponding to the log entry 107 is retrieved from the ENTRYX file, sub-sampled so as to have the same resolution as the reference image, and displayed in place of the corresponding portion of the reference image. Thereafter, the bounding box 87 associated with the selected image is superimposed on image 111.

**[0067]** Then, using the series of Cartesian coordinate pairs stored in the corresponding ENTRYX file, a trace 113 of the movement of the detected object is overlaid on the image 111. As discussed above, the trace 113 represents the movement of the midpoint of the lower side of the bounding box 87, and thus is an accurate representation of where the person 86 walked. Then, labels are superimposed on the image 111, as at 116 and 117, based on the information stored in the ENTRYX file. In FIGURE 8, the label 116 is the word "ENTER", and indicates that the person 86 entered the observed area at approximately the location of this label, or in other words at the far end of the hallway 71. The label 117 is the word "EXIT", and indicates where the person 86 exited the observed area, in this case by continuing down the hallway 71 and underneath the camera unit 12. The bounding box 87, trace 113 and/or labels 116 and 117 may optionally be displayed in one or more different colors, so that they are more readily visible.

**[0068]** To the right of the scroll box 102, and below the image 111, the image processing section 27 displays a further image 121, which is smaller than the image 111. The image 121 corresponds to the portion of the image 111 within the bounding box 87, but is displayed at full resolution rather than at the lower resolution used for the larger image 111. Thus, if an attempt is being made to identify a particular person, the features of that person may be more clearly visible in the high resolution image 121 than in the reduced resolution image 111. Since the saved image 121 was selected using the criteria discussed above, which are intended to favor facial close-ups of humans, it will be noted that the face of the person 86 is visible, and that the person is closer to the camera than would have been the case if the system had simply stored the first image in which the person 86 had been detected, without attempting to apply any

selection criteria.

[0069] FIGURE 9 is a diagrammatic view similar to FIGURE 8, but showing a different web page provided by the MASTER.HTML file. This web page includes an image 131, which is the current reference image, for example the reference image shown in FIGURE 5. The user can then use a mouse to identify one or more regions in this image, for example the region 132. The user may define the region by using the mouse pointer to identify the corners of the region, while clicking on each corner. Each time the user defines a region, it is automatically given a label, which is a letter. For example, the region 132 in FIGURE 9 has been given the label "A". As discussed above, the image processing section 27 maintains a history of the movement of the midpoint of the lower side of the bounding box for each object. If this midpoint were to remain within a given region, such as the region 132, for a predefined period of time, it might represent loitering, and could be detected by the image processing section 27.

[0070] The web page of FIGURE 9 also includes an event selection box 136, which the operator can use to indicate that the imaging processing section 27 is to check for a specified event, and to indicate what action is to be taken if the specified event occurs. In this regard, the operator can use a mouse to select one of several events identified in box 136, including an enter event, an exit event, a loiter event, a deposit event, a remove event, a move event, a rest event, and a light-sout event. The event selection box 136 allows the user to optionally restrict the monitoring for the specified event to certain types of detected objects, including a person, a box, a briefcase, a notebook, a computer monitor, any type of object, or just an unknown object. Event selection box 136 also allows the user to restrict the monitoring event to a particular region by identifying its label letter, such as the region 132 identified by the label letter "A".

[0071] For certain events, the event selection box 136 allows the user to specify a time duration in seconds. For example, if the user is instructing the system to monitor for a loiter event within a specified region, the user may specify that the loiter event is to be detected only if the specified object remains within the specified region for a period of at least five seconds. The event selection box 136 also allows the operator to specify the action to be taken if the specified event occurs, including an audible beep, the creation of a log entry on the hard disk drive 34, a pop-up window on the display 21 of the workstation 13, or a synthesized voice announcement which indicates that the event of interest has occurred, such as a synthesized announcement of the word "loiter". It will be recognized that the event selection box 136 could be modified to allow the identification of other events, objects, conditions, or actions. For example, actions could also include making a phone call to a specified number such as that of a security agency, or sending an electronic mail message to a

specified electronic mail address.

[0072] This aspect of the present invention provides a number of technical advantages. One such advantage is that, by periodically saving reference images, by saving these reference images at a reduced resolution, by saving just selected images of objects of interest, and by saving just portions of the overall image, the amount of memory needed to store images is greatly reduced in comparison to known systems. A related advantage is that the amount of stored information which an operator would have to review in response to the occurrence of an event is greatly reduced in comparison to known systems. A further advantage is that the available information is presented with timestamp information, so that an operator can rapidly identify the events of interest within a time frame of interest, and can quickly and easily review those events.

[0073] Yet another advantage is the storage of a trace representing the movement of a detected object, so as to later provide a readily understandable visible image of the object's movement, without storing numerous video images corresponding to the entire time interval while the detected object was present in an observed area. Another advantage is that the use of a web browser to access information logged by the system permits a person to access the information from virtually anywhere that a computer is available, including a WWW-compatible cellular phone.

[0074] Another advantage results from the fact that the selection of an image to save is based on criteria which are intended to optimize the image, for example to make it likely that a detected person is facing and close to the camera. Another advantage is that the disclosed system can be a self-contained camera unit which is WWW-compatible. A further advantage is that the disclosed system is more reliable than certain known technologies, such as known systems having a video cassette recorder (VCR) that is subject to mechanical breakdowns and that has heads which need to be periodically cleaned.

[0075] In order to facilitate an understanding of a second aspect of the present invention, further a specific exemplary application for the system 10 of FIGURE 1 will now be disclosed. However, it will be recognized that there are numerous other applications and environments in which the system 10 of FIGURE 1 could be utilized. With respect to the exemplary application, FIGURE 10 is a diagrammatic top view of a portion of a room 171 within a building, including three walls 172, 173 and 174. A door 177 is provided in the wall 172 at a location near the wall 173, and swings into the room 171 when opened. Three tables 181 to 183 are provided in the room, the table 181 being adjacent the wall 173, the table 182 being adjacent the wall 174, and the table 183 having one end adjacent the wall 174. The video camera 12 is supported on the wall 172, and is directed toward the corner of the room which is defined by the intersection of walls 173 and 174.

**[0076]** FIGURE 11 is a diagrammatic view of a video image which was obtained from the video camera 12 in the environment of FIGURE 10, and which thus shows the door 177, and portions of the walls 173 and 174. The image of FIGURE 11 also shows the tables 181 and 182, and a portion of the table 183. For purposes of discussion, it is assumed that the image of FIGURE 11 has been saved as a reference image, analogous to the reference image discussed above in association with FIGURE 2A.

**[0077]** FIGURE 12 is a diagrammatic view of a portion of the screen of the display 21 (FIGURE 1). On the left is an image 184, which in FIGURE 12 is the reference image shown in FIGURE 11. On the right is a map 185, which is a digitized image of the top view of the room 171 from FIGURE 10. In the disclosed embodiment, the image 185 was introduced into the computer using a not illustrated scanner to digitize a blueprint or drawing. The workstation 13 is not cognizant of physical structure within the map 185, such as the walls 171 to 174 or the tables 181 to 183. Instead, the workstation 13 sees the map 185 as simply a two-dimensional image defined by an array of pixels.

**[0078]** The video image 184 and the map 185 are thus just respective arrays of pixels to the workstation 13. In order to give the computer a basis for interrelating them, a mapping is established between the image 184 and the map 185, in the following manner. With reference to FIGURE 12, an operator uses the mouse 19 (FIGURE 1) to define one or more quadrilateral regions on each of the image 184 and the map 185. Each quadrilateral region is used to designate an upwardly facing surface that can support a person or an object, such as the floor, or the top surface of a table.

**[0079]** For example, the operator may first draw a quadrilateral region 186 on the image 184 of FIGURE 12. The quadrilateral region 186 corresponds to most of the floor that is visible in the image 184. The operator may draw the quadrilateral region 186 by clicking the mouse at selected points on the image 184, in order to define the four corners of the quadrilateral region. An outline of the quadrilateral region 186 is overlaid on the displayed image 184. In FIGURE 12, the outline of the quadrilateral region 186 is represented by a broken line, but it could alternatively be a solid line, and/or could be displayed in a color so as to be easily visible on the gray-scale image 184.

**[0080]** The operator then assigns the quadrilateral region 186 a label, which in FIGURE 12 is the letter "A" shown in the middle of the quadrilateral region 186. Alternatively, the operator could have used the name "FLOOR" for the quadrilateral region 186, because it represents a portion of the floor. Then, as accurately as possible, the operator draws on the map 185 a corresponding quadrilateral region 187, which represents exactly the same portion of the floor. Although the quadrilateral regions 186 and 187 represent the same portion of the floor, they have different sizes and shapes,

due to the fact that the image 184 is a perspective view of the room, and the map 185 is a top view. The operator gives to the quadrilateral region 187 the same label "A" which was used for the quadrilateral region 186, so that the workstation 13 will recognize that the quadrilateral regions 186 and 187 correspond to each other. After a quadrilateral region has been drawn, the workstation 13 allows the operator to adjust the shape and/or size of the quadrilateral region, for example by using the mouse 19 to drag and drop a side or a corner of the quadrilateral region.

**[0081]** In a similar manner, the operator may draw additional pairs of quadrilateral regions. For example, in FIGURE 12, the operator has drawn on the image 184 a quadrilateral region 188, which designates the top surface of the table 181, and has drawn a corresponding quadrilateral region 189 on the map 185. The operator has given these two related quadrilateral regions the label "B". Further, the operator has drawn associated quadrilateral regions 191 and 192 in order to designate the top surface of the table 182, and has given them both the label "C". In addition, the operator has drawn on the image 184 a quadrilateral region 193, which represents the portion of the top surface of table 183 that is visible in the image 184, and has drawn a corresponding quadrilateral region 194 on the map 185. The quadrilateral regions 193 and 194 have been given a common label "D".

**[0082]** For each pair of corresponding quadrilateral regions drawn by the operator, the workstation 13 sets up a warp transformation which uses a known mathematical technique, and which translates a selected point in one of the quadrilateral regions of the pair to a corresponding point in the other quadrilateral region of the pair. In order to permit the system to determine this warp transformation, the workstation 13 must know which side of a given quadrilateral region in the image 184 corresponds to which side of an associated quadrilateral region on the map 185. In the disclosed embodiment, the workstation 13 allows the operator to identify the location of the camera 12 on the map 185. The workstation 13 then automatically associates the side of a quadrilateral region which is lowest in the image 184 to the side of the corresponding quadrilateral region on the map 185 which is closest to the camera 12. However, it would alternatively be possible to ask the operator to manually identify related sides of the quadrilateral regions of each pair, for example by using the mouse 19 to click on a selected side of one quadrilateral region, and then using the mouse to click on the corresponding side of the other quadrilateral region.

**[0083]** Although the present discussion refers to the use of quadrilateral regions, it will be recognized that outlines of other shapes could be used. For example, an outline could have the shape of some other polygon or a circle, or could be an irregular outline, so long as an appropriate warp transformation is provided to relate each point in one region to a point in the corresponding



region.

**[0084]** The operator may sometimes find it necessary to draw quadrilateral regions which overlap. For example, in FIGURE 12, the quadrilateral region 193 representing the top of table 183 overlaps with a portion of the quadrilateral region 186 designating the floor of the room. In the event that a particular point in the image 184 is disposed within both of these quadrilateral regions, the workstation 13 must know whether to map the point from the image 184 to the map 185 using the warp transformation for the quadrilateral regions 193 and 194, or the warp transformation for the quadrilateral regions 186 and 187. Therefore, wherever two quadrilateral regions overlap in the image 184, the workstation 13 needs to know which of the two quadrilateral regions is to be given priority over the other.

**[0085]** In the disclosed embodiment, the workstation 13 automatically assumes that the smallest quadrilateral region has priority. Thus, in the image 184 of FIGURE 12, the quadrilateral region 193 would be given priority over the quadrilateral region 186. In other words, if a given point fell within the overlap between the quadrilateral regions 193 and 186, the point would be translated to map 185 using the warp transformation for quadrilateral regions 193 and 194, rather than the warp transformation for quadrilateral regions 186 and 187. This default priority scheme works relatively well in practice, because a larger quadrilateral region (such as quadrilateral region 186) usually represents a portion of the floor, whereas a smaller quadrilateral region (such as quadrilateral region 193) usually represents a top surface of a table or some other object resting on the floor. The table top will normally be visible to the video camera, but will obscure a portion of the floor from the view of the camera. Thus, where two quadrilateral regions overlap, assigning the area of overlap to the smaller quadrilateral region, rather than the larger quadrilateral region, will normally achieve a result that corresponds to what is visible to the camera and what is not. However, there may be circumstances in which the operator may wish to specify a different priority as to a given region of quadrilateral region overlap, and workstation 13 permits the operator to manually enter prioritization information that takes precedence over the default prioritization.

**[0086]** After the operator has drawn at least one pair of corresponding quadrilateral regions in the image 184 and the map 185, and has defined the priority for any region of overlap, the system 10 may be placed in a mode of normal monitoring operation. Successive images from the video camera 12 are processed relative to the reference image of FIGURE 11, in a manner analogous to that described above in association with FIGURES 2 and 3. In this regard, FIGURE 13 is a diagrammatic view similar to FIGURE 12, except that the displayed video image is a current video image 201 rather than the stored reference image of FIGURE 11.

**[0087]** In FIGURE 13, the current video image 201

reflects that a person 206 entered the room while carrying an object 207, placed the object 207 on the top surface of the table 182, and then started to walk away from the object 207. The object 207 may, for example, be a briefcase or a box. The bounding box for the person 206 is shown at 211, and the bounding box for the object 207 is shown at 212. The midpoints of the lower sides of the bounding boxes 211 and 212 are respectively shown at points 213 and 214.

**[0088]** The midpoint 213 is disposed within the quadrilateral region 186, and the warp transformation for quadrilateral regions 186 and 187 is therefore used to map the point 213 from the quadrilateral region 186 into a corresponding point 218 within the quadrilateral region 187 of the map 185. A symbol such as a dot is displayed on the map 185 at the point 218, in order to provide on the map 185 a visible indication of where the person 206 is standing within the room. The midpoint 214 is disposed within the quadrilateral region 191, and the warp transformation associated with quadrilateral regions 191 and 192 is therefore used to map the point 214 to a corresponding point 219 on the map 185. A dot is displayed at the point 219 on the map 185, in order to indicate where on the map 185 the object 207 is located. As the person 206 moves around within the room, the dot 218 representing the person will move on the map 185, in order to provide an accurate indication where in the room the person is currently located.

**[0089]** If the person 206 moves to a location where the point 213 is outside each of the quadrilateral regions 186, 188, 191 and 193 in the image 201 of FIGURE 13, then the point 213 will not be mapped to the map 185 until it is again within one of these four quadrilateral regions. Consequently, the dot 218 will not be displayed on the map 85 so long as the point 213 is outside these quadrilateral regions on the image 201.

**[0090]** Referring back to FIGURE 12, the workstation 13 allows the operator to also define one or more additional quadrilateral regions, one of which is shown at 223 on the map 185. The quadrilateral region 223 appears only on the map 185, and has no corresponding quadrilateral region on the image 184. The operator gives the quadrilateral region 223 a unique label, for example the label "Z". Referring again to FIGURE 13, the quadrilateral region 223 can be used to check for certain events. For example, if the workstation 13 determines that the point 218 has moved to a location on the map which is within the quadrilateral region 223, the workstation 13 could take some special action, such as producing an audible alarm. In a variation of this example, the workstation 13 might not produce an audible alarm immediately after the point 218 enters the quadrilateral region 223, but only if the point 218 remains within the quadrilateral region 223 for a specified period of time, which may be referred to as a "loiter" event.

**[0091]** An event selection box 136, such as previously illustrated in Figure 9, can be presented on the display 21 of FIGURE 1 and used in conjunction with the por-

tion of the display screen which is shown in FIGURE 13. An operator can use the event selection box 136 to specify that the workstation 13 is to check for a certain event, and to indicate what action is to be taken if the specified event occurs. This process has been previously described above in conjunction with Figure 9.

**[0092]** Referring again to FIGURE 12, the workstation 13 allows the operator to also define one or more additional quadrilateral regions, one of which is shown at 241 on the reference image 184. The quadrilateral region 241 appears only on the reference image 184, and has no corresponding quadrilateral region on the map 185. The operator gives the quadrilateral region 241 a unique label, for example the label "Y". This type of quadrilateral region is used to limit mapping of points from the image 184 to the map 185. More specifically, if a detected change region falls completely within the quadrilateral region 241, the change region is completely ignored for all purposes, and thus no point is mapped from the image 184 to the map 185 as a result of that detected change region. On the other hand, if only a portion of a detected change region falls within the quadrilateral region 241, then that change region is handled in a normal manner, as previously described. This capability is provided to allow certain types of activity in a monitored area to be intentionally ignored.

**[0093]** More specifically, as one example, if a computer printer was located within the monitored area, each time the printer ejected a sheet of paper, the system 10 would normally detect and log this event. Similarly, if an unattended computer monitor was within the monitored area and had a screen-saver displayed, the system 10 would normally detect and log display changes caused by the screen saver program. By placing the quadrilateral region 241 around the printer, or around the computer monitor, all activity associated with the printer or monitor would occur entirely within the quadrilateral region 241, and would thus be ignored. Consequently, ejection of paper from the printer or changes in the display of the monitor would be ignored, so that the system 10 would not log numerous events which were of little or not interest. In FIGURE 12, the quadrilateral region 241 is within the quadrilateral region 186. If a detected change region is entirely within the quadrilateral region 241, it will be completely ignored even though it is also within the quadrilateral region 186.

**[0094]** This aspect of the present invention provides a number of technical advantages. One such technical advantage is that a system operator can rapidly and accurately define the mapping between a video image and a site map. So long as the operator is reasonably careful to draw accurate quadrilateral regions, mapping errors can be substantially eliminated. For example, an object detected in the video image will not be incorrectly located on the wrong side of a wall. A further advantage is that this can be accomplished without any need to define camera parameters, including internal parameters such as focal length and millimeters per pixel, and

external parameters such as the location and orientation of the camera. This is all automatically taken into account.

**[0095]** FIGURE 14 is a diagrammatic view of a monitoring apparatus 310 which embodies another aspect of the present invention. The monitoring apparatus 310 is used to monitor activities in one or more regions or areas of interest. For example, the monitoring apparatus 310 might be used at a residence to monitor activity in one or more rooms, in the yard, at the front door, and/or in the driveway. It could also be used for monitoring one or more areas in a commercial or industrial facility.

**[0096]** The monitoring apparatus 310 includes two image detectors 312 and 313, which in the disclosed embodiment are video cameras of a known type. The video cameras 312 and 313 each include a not illustrated charge coupled device (CCD) sensor, and a not illustrated zoom lens assembly for adjusting the field-of-view of the image focused on the CCD sensor. The video cameras 312 and 313 may provide different views of the same monitored area, or may each provide a view of a completely different monitored area.

**[0097]** The video cameras 312 and 313 each include a respective control section 316 or 317. The control sections 316 and 317 are each capable of automatically controlling the zoom setting of the zoom lens assembly in the associated video camera 312 or 313. Further, the control sections 316 and 317 each include a physical support for the associated video camera, which can effect automated adjustment of the physical orientation of the associated video camera 312 or 313. In other words, with reference to a detected image of the monitored area, the control sections 316 and 317 can each adjust the orientation of the associated camera 312 or 313 up, down, left or right, so that the detected image is adjusted upwardly, downwardly, leftwardly, or rightwardly within the monitored area.

**[0098]** The monitoring apparatus 310 also includes a sensor 319 that can detect an event of interest in an area monitored by at least one of the cameras 312 and 313. In the disclosed embodiment, the sensor 319 is similar to those used in systems which automatically open doors for customers at retail establishments. In particular, the sensor 319 is a passive infrared sensor capable of detecting a heat source within the area it monitors, including the presence of a human or animal.

**[0099]** The monitoring apparatus 310 further includes a system 322, which has therein a computer 324. The computer 324 may be a personal computer which includes a processor, and which includes a memory device such as a hard disk drive.

**[0100]** A video connection 326 is provided between the video camera 312 and the computer 324, in order to supply video images from the video camera 312 to the computer 324. A similar video connection 328 is provided from the video camera 313 to the computer 324. Control lines 327 are provided from the computer 324 to

the control section 316 of the video camera 312, in order to provide the control section 316 with information that determines how the control section 316 will position the video camera 312, and how the control section 316 will set the zoom factor of the zoom lens assembly in the camera 312. A similar set of control lines 329 is provided from the computer 324 to the control section 317 of the video camera 313. The infrared sensor 319 has an output 331 which is coupled to the computer 324.

**[0101]** The system 322 further includes a cellular base station 336 of a known type which is used for communicating with cellular (wireless) telephones. The computer 324 is operatively coupled to the base station 336 by a network 338 which includes the Internet, and which may include one or more other networks such as a local area network, a wide area network, and so forth. The network 338 is coupled to a not illustrated network interface card provided in the computer 324. Since the network 338 includes the Internet, it is capable of transmitting information in the Internet format known as the World Wide Web (WWW), where documents called web pages are transferred between computers in a standardized format known as hypertext mark-up language (HTML) format.

**[0102]** The system 322 also includes a telephone line or system 341, which is coupled at one end to a not illustrated modem in the computer 324, and at its other end to the cellular base station 336.

**[0103]** The monitoring apparatus 310 further includes a portable communication unit 346, which is a cellular (wireless) telephone, and which also includes some additional capability, as discussed below. The portable unit 346 in the disclosed embodiment may be a unit which is available under the tradename NOKIA 9000 from NOKIA in Irving, Texas. The portable unit 346 has an antenna 348, which facilitates wireless communication with the base station 336 through a radio frequency (RF) cellular telephone link 349.

**[0104]** The portable unit 346 has an LCD display 351 capable of displaying two-dimensional video images at a low resolution. Further, the portable unit 346 has a plurality of buttons or keys, one of which is indicated at 352. A operator can use these keys to input information into the portable unit 346. The keys include an alphanumeric keyboard which has a "QWERTY" format similar to that found on personal computers, and include several function keys.

**[0105]** The monitoring apparatus 310 has the capability to take a video image detected by one of the video cameras 312 or 313, carry out some image processing on the detected image within the computer 324, transmit the resulting processed image to the portable unit 346 through the network 338, the base station 336, and the wireless link 349, and present the processed image on the display 351 of the portable unit 346. In the disclosed embodiment, the image processing carried out by the computer 324 includes steps which are explained below with reference to FIGURE 15.

**[0106]** In this regard, each of the video cameras 312 and 313 is capable of producing successive images at a speed and resolution which represents more information than can be transmitted through the wireless link 349. For example, even an inexpensive video camera can generate 30 frames or images per second, which each have a resolution of 320 by 240 gray-scale pixels. To transmit the data representing all of these pixels, a throughput of about 18 million bits per second would be needed. Existing wireless cellular links, such as that at 349 in FIGURE 14, can sustain a nominal throughput of about 9600 bits per second, or in other words about 1/2000 of the total video information produced by the video camera.

**[0107]** A further consideration is that existing portable units, such as that shown at 346 in FIGURE 14, have low-resolution monochrome displays. That is, the resolution of a display such as that shown at 351 is limited to about 160 by 120 pixels for a video image, where each pixel is either on or off, or in other words is a selected one of two different colors such as black and white.

**[0108]** For these reasons, the images from the video cameras 312 and 313 in FIGURE 14 are subjected by the computer 324 to image processing, which is depicted diagrammatically in FIGURE 15. FIGURE 15 is a flowchart showing successive image processing steps 161 to 163. The first step 161 is temporal sampling, which involves selecting a subset of the images produced by a given video camera. For example, of the 30 or so frames or images produced by a video camera every second, two of these frames or images may be selected for image processing, and the others may be discarded.

**[0109]** Then, at block 362, spatial sampling is carried out. In other words, subsampling is carried out in order to reduce the resolution of each of the images selected at 361. For example, each frame or image may be reduced to about 80 by 60 pixels.

**[0110]** Then, at block 363, a dithering process is carried out, in order to reduce the data representing each pixel to a single bit. That is, the bit associated with each pixel indicates whether that pixel is on or off. Stated differently, each pixel has one of two different colors, such as black and white. The dithering process sets the state of each pixel of the processed image based on the states of several pixels of the spatially sampled image, using a known technique. In the disclosed embodiment, the sampling and dithering carried out at blocks 361 to 363 of FIGURE 15 will reduce the video output to 9600 bits per second.

**[0111]** In the disclosed embodiment, the computer 324 takes the images that are processed according to the techniques discussed above in association with FIGURE 15, and successively inserts these processed images into a document or web page which is in HTML format, and which can thus be accessed through the Internet. In this regard, the portable unit 346 includes a manufactured-installed browser program, which is

capable of accessing, downloading and displaying on the display 351 an HTML page or document obtained through the network 338 from the computer 324.

**[0112]** FIGURE 16 shows an example of how the display 351 of the portable unit 346 might present an HTML page generated by the computer 324. An image 371, which has been sampled and dithered according to steps 361 to 363 of FIGURE 15, is presented on the left side of the display 351. As discussed above, this is a monochrome (two-color) image, with a low resolution of 60 by 90 pixels. Nevertheless, it is sufficient to permit visual detection of the presence of a person in the field-of-view, for example the person indicated at 372 in the image 371.

**[0113]** To the right of the image 371, the HTML page includes eight icons, which are identified with reference numerals 381 to 388. To the right of each icon is a parenthetical expression in the form of "(FX)", where X is an integer. To the right of each parenthetical expression is a label identifying the function of the associated icon. Each parenthetical expression identifies on the portable unit 346 a function key which will cause the associated function to be effected. The icons 387 and 388 relate to the capability of the operator to select one of the two video cameras 312 and 313. If the operator presses the function key F7 associated with icon 387, an associated HTML link back to the WWW server program in computer 324 will cause the computer 324 to designate the first video camera 312 as the selected video camera. The computer 324 will then ignore the output of the second video camera 313, will subject only the output of the video camera 312 to the image processing described above in association with FIGURE 15, and will forward to the portable unit 346 only the processed images obtained from the selected video camera 312. On the other hand, if the operator pressed the function key F8 associated with the icon 388, the second video camera 313 will be designated as the selected camera, the video images from the camera 313 will be subjected to the image processing described above in association with FIGURE 15, and only the processed images from the camera 313 will be forwarded to the portable unit 346.

**[0114]** The icon 381 is an upwardly pointing arrowhead. If the operator pressed the function key F1 associated with the icon 381, an HTML link back to the WWW server program in the computer 324 will cause the computer 324 to output control signals at either 327 or 329 to the control section 316 or 317 in the currently selected video camera 312 or 313. These control signals will cause the control section 316 or 317 for the selected camera to tilt the orientation of the camera, so that the image associated with that camera moves upwardly in terms of its view of the area being monitored. Similarly, if the operator presses a respective one of the function keys F2, F3 or F4, which are respectively associated with icons 382 to 384, the selected camera 312 or 313 will be adjusted respectively down, right or

left.

**[0115]** If the operator presses the function key F5 associated with the icon 385, an associated HTML link will cause the computer 324 to output control signals at 327 or 329 to the control section 316 or 317 of the selected video camera. These control signals will cause the zoom lens assembly in the selected video camera 312 or 313 to increase its magnification level in a manner commonly known as a zoom-in function. Alternatively, if the operator presses the function key F6 associated with the icon 386, its HTML link will cause the zoom lens assembly in the selected video camera to decrease its magnification level, in a manner commonly known as a zoom-out function.

**[0116]** If the portable unit 446 has a mouse-like pointing device, such as a small trackball, the operator can use the pointing device to select and "click" on any one of the icons 381 to 388, in order to effect the associated function. Similarly, if the operator happens to be accessing this HTML page from some other remote computer, and if that computer has a mouse, the operator can click directly on the icons 381 to 388.

**[0117]** As discussed above, the infrared sensor 319 is capable of detecting the presence, within its field-of-view, of a heat source such as a human or animal. When the sensor 319 outputs a signal at 331 to indicate that it has detected the presence of such a heat source, the computer 324 responds by using its not illustrated modem to place a telephone call to the telephone in the portable unit 346, namely through the telephone line 341, the base station 336 and the wireless link 349. This notifies the person or operator possessing the portable unit 346 that something is happening in the remote area being monitored by the system 310 of FIGURE 14. The operator may then use the browser provided in the unit 346 to access and download the HTML page generated by the computer 324, in order to obtain a screen display like that shown in FIGURE 16, so that the operator can view the image 371 and determine what is happening in the monitored area.

**[0118]** Alternatively, it would be possible to omit the sensor 319, and to have the computer 324 detect the occurrence of an event of interest by appropriate processing of the raw video images received from either of the video cameras 312 and 313. For example, FIGURE 17A is a diagrammatic view of an image of a monitored area produced by the video camera 312. In this case, the monitored area happens to be the corner region of a room. FIGURE 17B is a subsequent image from the same camera, which was taken after a person 396 had walked into the monitored corner of the room.

**[0119]** The current image in FIGURE 17B can be compared to the prior reference image of FIGURE 17A, in order to determine whether the current image differs in any significant way from the reference image. For example, this comparison can be carried out on a pixel-by-pixel basis by first determining the absolute value of the difference between the gray-scale color values for each

pixel, and by then comparing the result to a threshold value. If the absolute value of the difference for a given pixel is less than the threshold value, then the pixel is turned off. On the other hand, if the absolute value of the difference is above the threshold value, then the pixel is turned on.

**[0120]** The result is a monochrome (two-color) image, such as that shown in FIGURE 17C. In FIGURE 17C, there are a group of pixels at 397 which correspond to the person 396, and which have been turned on to indicate that something has changed relative to the reference image of FIGURE 17A. This condition can be used to trigger a telephone call from the computer 324 to the portable unit 346. It should be evident that, while the infrared sensor 319 detects heat, the alternative approach described in association with FIGURE 17 detects motion or a change in the video image, rather than the presence or absence of heat.

**[0121]** In the disclosed embodiment, the image processing described in association with FIGURE 15 does not include the use of video compression techniques. However, it will be recognized that the computer 324 of FIGURE 14 could be provided with hardware and/or software capable of performing a known video compression technique, and that the portable unit 346 could be provided with the capability to decode the compressed video information for purposes of display. For example, video compression could be effected according to the standard known as MPEG-4. In the event that video compression was provided in this manner, it would increase the amount of video information which could be transmitted in real-time from the computer 324 to the portable unit 346. Consequently, the image processing described in association with FIGURE 15 could be adjusted to increase the number of images processed and transmitted per second, and/or to increase the resolution of the processed images.

**[0122]** This third aspect of the present invention provides a number of technical advantages. One such technical advantage is that the wireless link to a portable unit allows the monitored area to be viewed from almost any remote location and at any convenient time. Moreover, it allows the camera position and/or operation to be adjusted from that remote location. Another advantage is that the occurrence of an event of interest in the monitored area can be detected, and an indication of the detection of this event can be automatically sent to the portable unit. The person in possession of the portable unit can then access images from a camera in the monitored area, in order to determine whether there is in fact a problem which requires attention. If there is no problem, the person could make a telephone call, or otherwise use the portable unit to prevent the automatic transmission of a message to the police, the fire department, a security agency, or the like.

**[0123]** Still another advantage is that the information from the video cameras is provided in a document in HTML format, which can be easily accessed from the

portable unit, or from any convenient computer having a WWW-compatible browser. Yet another advantage results from the use of image processing techniques to conform the amount of video information to a level which is compatible with the available bandwidth of a wireless link and which is compatible with the available resolution of the portable unit, while still providing at the portable unit an image that has sufficient resolution to permit detection of the presence of a person or an object in the monitored area.

**[0124]** Although one embodiment has been illustrated and described in detail, it should be understood that various changes, substitutions and alterations can be made therein without departing from the scope of the present invention. For example, although the disclosed embodiment has two separate video cameras, it will be recognized that only one camera could be provided, or that more than two cameras could be provided. As another example, the disclosed embodiment uses gray-scale video cameras, but it will be recognized that color video cameras could also be used. Further, although the disclosed embodiment uses image detectors which are video cameras, it will be recognized that there may be applications where a different type of image detector would be appropriate, for example a two-dimensional staring array infrared detector.

**[0125]** As still another example, the supplemental sensor provided in the disclosed embodiment is an infrared sensor, but it could be some other type of sensor, such as a photocell, a microphone, or the like. Also, even though the disclosed embodiment responds to an output signal from the infrared sensor by placing a telephone call to the telephone in the portable unit, it will be recognized that this information could be transmitted to the portable unit in some alternative manner, for example by sending a pager message to a pager circuit in the portable unit. Other changes, substitutions and alterations are possible, without departing from the spirit and scope of the present invention, as defined by the following claims.

**[0126]** Although one embodiment has been illustrated and described in detail, it should be understood that various changes, substitutions and alterations can be made therein without departing from the scope of the present invention. For example, although the disclosed embodiment uses quadrilaterals to define regions of interest on the displayed image and/or map, it will be recognized that other shapes could alternatively be used to define regions. Also, the disclosed embodiment uses a video camera which has a detector responsive to visual light, but it will be recognized that other types of detectors could alternatively be used, such as a staring array infrared detector. Further, the foregoing disclosure discusses an exemplary application for the disclosed embodiment, but it will be recognized that there are numerous other applications and environments in which the disclosed system could also be used. Other changes, substitutions, and alterations are possible

without departing from the spirit and scope of the present invention, as defined by the following claims.

**[0127]** According to the present invention, video information from the image detector 12 may be compressed in the following manner in order to obtain compressed image information. This process could take place at image processing section 27 or at workstation 13 depending on the relative capacities of these computers. For this example this processing as well as the processing such as described with respect to FIGURE 2 are assumed to take place at image processing section 27. First, the image processing section 27 selects and saves a high-resolution video image provided by the image detector 12, which will thereafter serve as a reference image. For the sake of example, it is assumed here that the reference image is the reference image shown in FIGURE 2A. The image processing section 27 stores this reference image in a high-resolution format on the hard disk drive 34. For each subsequent video image produced by the image detector 12, the image processing section 27 carries out, relative to the saved reference image, processing which is analogous to that described above in association with FIGURES 2B-2G.

**[0128]** The image processing section 27 then saves on the hard disk drive 34 a selected portion of the erode image of FIGURE 2G, namely the portion which represents a change from the reference image of FIGURE 2A. In other words, the image processing section 27 saves just the portion of the erode image of FIGURE 2G which corresponds to the person 41 (FIGURE 2B). Further, since the portion of the erode image of FIGURE 2G which is saved corresponds to a single color, the amount of memory required to save the selected portion of the erode image is substantially reduced over the amount of memory which would be required to save the same portion of the erode image in a gray scale format. In fact, since the portion of the image which is being saved corresponds to a single color (black or white), it is possible to store only an identification of this portion of the image, without any contrast information, or in other words without any gray scale or color information.

**[0129]** Thus, for each video image generated subsequent to the saved reference image, the image processing section 27 will carry out processing analogous to that described in association with FIGURES 2B to 2G, and then will save only an identification of the portion of the resulting erode image which represents differences from the saved reference image. The saved reference image, and the saved identification of a change or motion portion of each subsequent image, collectively represent compressed image information.

**[0130]** In order to uncompress and display this compressed image information, which is stored on the hard disk drive 34, the image processing section 27 would reconstruct each video image by displaying the saved reference image (which in this example is the reference image of FIGURE 2A), and by then overlaying on the reference image a region in a single solid color which is

based on the saved information identifying a change region (which in this example was derived from the erode image of FIGURE 2G). The resulting reconstructed image could be displayed on the display 21 or workstation 13 as shown in FIGURE 18.

**[0131]** Since the compressed image information does not include gray scale or color information, except for the reference image, the person or other object will appear in the reconstructed image in a solid color such as black or white. Nevertheless, as successive images are reconstructed and displayed, it is possible to easily distinguish a person from some other object such as a briefcase, and to see the person walking or otherwise moving within the monitored area. In most cases, it is possible to determine with a relatively high degree of accuracy where the person went in the monitored area and what the person did. In many surveillance and/or security applications, this is more than adequate to satisfy the needs for which the system is provided.

**[0132]** As an example of the efficiency of this approach, consider a sequence of 243 frames or images, each of which has an uncompressed storage requirement of 16437 bytes. If the uncompressed, high-resolution information for every one of the 243 images was stored, it would require  $243 \times 16437 = 3,994,191$  bytes to store the entire sequence. In contrast, if the first of the 243 images was stored at full resolution, it would require 16437 bytes. By then storing only an identification of the portions of the other 242 images which are different from the reference image, the total amount of storage required for the change regions from all of the 242 images might be about 47610 bytes. Thus, the total memory required for the entire sequence would be about  $16437 + 47610 = 64047$  bytes. The resulting compression ratio for this particular example is thus 62:1. Of course, the exact compression ratio will vary from situation to situation, depending on how many subsequent images are associated with a given reference image, and depending on the extent to which the images subsequent to the reference image differ from the reference image. If the differences with respect to the reference image are infrequent and minimal, as is often the case in a surveillance context, the amount of information stored will be very minimal, and the effective compression ratio will be very high.

**[0133]** The compression ratio discussed above can be further improved by supplementing the compression technique according to invention with certain known compression techniques. For example, the reference image could be JPEG compressed from 16437 bytes to 3068 bytes, and the information for the other 242 images could be Lempel-Ziv compressed from 47610 bytes to 20777 bytes, for a total of  $3068 + 20777 = 23845$  bytes for the entire 243 frame sequence. This represents an effective overall compression ratio of 170:1 with respect to the raw video data of 3,994,191 bytes.

**[0134]** As an alternative to saving the identification of

the entire change region for an object, as discussed above in association with FIGURE 2G, it would be possible to save only a outline of this change region. For example, FIGURE 19 depicts the outline of the change region shown in FIGURE 2G. Existing MPEG-4 compression standards provide excellent efficiency in storing outlines. Then a particular image from the compressed image information on the hard disk drive 34 is subsequently reconstructed, by overlaying the outline over the high-resolution reference image, it will appear as shown in FIGURE 20. There is no gray scale or color information for any particular object or person, but it is still possible from the displayed outline to readily distinguish a person from some other object such as a briefcase, and to determine where the person moves and what the person does.

**[0135]** As discussed above, there are many applications in which the change region for a person or other object can be adequately represented without saving contrast information such as color or gray scale information. However, there are a few applications in which it may be advantageous to provide contrast information (color or gray scale information) for a limited portion of the region of interest. For example, where an object of interest is a person, it may be desirable to have a gray scale or color image of the person's face. As discussed above, the image processing section 27 has the capability to make a determination of whether or not an object is a person. If it is determined that an object is a person, then the image processing section 27 can save gray scale or color information only as to an upper portion of the change region corresponding to that object, and can save only an identification of the remainder of the change region, without gray scale or color information. In the present example, this would result in saving the information which is shown in FIGURE 21. Since a portion of this information is a gray scale image, it will require more storage space than simply identifying the change region indicated by the erode image of FIGURE 2G, or the outline of this change region shown in FIGURE 19. Nevertheless, it will still require substantially less storage space than would be needed to save the entire video image, or to save just the change region with contrast information for the entire change region.

**[0136]** As still another variation, the image processing section 27 could save a high-resolution reference image, but then compare each subsequent image only to the image immediately before it. The information saved for the current image would represent only the differences from the immediately preceding image, rather than all differences relative to the reference image. In the specific example shown in the drawings, if the person 41 in FIGURE 2B was slowly raising his right arm, but otherwise remaining motionless, the only difference between the current image and the immediately preceding image would be some changes associated with movement of the right arm, for example as shown in solid lines in FIGURE 22. Obviously, the information

required to define this change region is substantially less than the information that would be required to define the change region corresponding to the entire person. As a result, the overall amount of memory required to store the compressed image information is very small.

**[0137]** When this compressed image information is being reconstructed for display, a representation of the change region would be maintained in memory, and would be modified slightly as each successive image was decompressed for display. In the present example, the image of the change region being maintained in memory would at some point correspond generally to the region designated by broken lines in FIGURE 22. Then the information corresponding to the solid lines in FIGURE 22 was retrieved, the image maintained in memory would be modified based on the information shown in solid lines, after which the display of the current image would be effected by displaying the reference image of FIGURE 2A and by then using the information maintained in memory to overlay on the displayed reference image a region corresponding to the broken lines in FIGURE 22, in order to obtain an overall image which would appear much like FIGURE 18.

**[0138]** As previously described, under certain circumstances, it may be necessary to periodically save a new reference image. For example, with reference to FIGURE 2A, a person may walk into the room, deposit a briefcase or other object, then walk out. Absent a new reference image, the briefcase would be detected indefinitely as a change region relative to the reference image, requiring the storage of a substantial amount of information over time, in an attempt to monitor an object which no longer needs to be observed or monitored. Accordingly, if the image processing section 27 determines that there is an existing difference from the reference image but that there has been no change in the current images for a predetermined period of time, for example five minutes, then at the end of this predetermined time interval the image processing section 27 saves a new reference image, and then analyzes all subsequently detected images relative to the new reference image rather than the original reference image.

**[0139]** The techniques described above all rely solely on the video images produced by the image detector 12, which is a video camera. As discussed above, the system 300 illustrated in FIGURE 14 may optionally include a further image detector 319, which in the disclosed embodiment is an infrared image detector. The image detectors 312 and 319 are, of course, appropriately aligned, so that the images detected by each are in alignment with each other. A video image from the image detector 312 would be selected and saved on the hard disk drive 34, to serve as a video reference image. At the same time, an infrared image from the image detector 319 would be temporarily saved within the computer 324 as an infrared reference image, but would not necessarily be stored on an not-illustrates hard disk

drive as part of the compressed image information. Subsequent infrared images from the image detector 319 would then be compared to the reference infrared image, in a manner analogous to that described above for video images in association with FIGURES 2A-2G. Then infrared images are processed in this manner, the identified change regions are, of course, those corresponding to temperature differences, which most typically represent the presence of a human or animal, rather than some other type of object such as a briefcase.

**[0140]** Information identifying each detected change region in each infrared image is then stored on the hard disk drive. When the compressed image information is to be reconstructed, the saved reference image (which is a video image) is displayed, and then the saved information identifying the detected change region from the infrared image is used to reconstruct the change region and to overlay the change region on the reference video image. The resulting composite image will be very similar to the image shown in FIGURE 18.

**[0141]** The foregoing examples each discuss saving the compressed image information on the hard disk drive 34 of the image processing section 27. However, it will be recognized that the image processing section 27 could take some different action with this compressed image information. For example, the image processing section 27 could transmit the compressed image information across the network 14 to workstation 13, and the workstation 13 could then display the information on the display 21, and/or store the information on a non-illustrated hard disk drive.

**[0142]** The present invention provides a number of technical advantages. One such technical advantage is that the high-resolution reference image in the compressed image information provides a detailed context for surveillance, while the information saved from subsequent images provides high temporal resolution with the use of a relatively small number of bytes. The high temporal resolution permits a human to observe the reconstructed images, and to easily determine when a person is present in the monitored area, and what that person is doing. A further technical advantage is that decompression and display can be efficiently handled by a low-cost, general-purpose computer. Still another advantage is that the saved information which identifies change regions relative to the reference image contains sufficient information to permit automated motion analysis to be carried out using known techniques.

**[0143]** Although the foregoing disclosure presents several related techniques which are all encompassed by the present invention, it will be recognized that it is possible to make changes, substitutions and alterations in these techniques without departing from the spirit and scope of the present invention, as defined by the following claims.

**[0144]** An apparatus wherein said system includes a computer which integrates the detected image into a

hypertext markup language document, and includes a computer network operatively coupled to said computer, said wireless communication link communicating with said computer through said computer network; and wherein said portable unit includes a network browser which is operative to retrieve the hypertext markup language document from said computer through said wireless communication link and said computer network, and to present the document and the image therein on said display.

**[0145]** An apparatus further comprising:

a control section coupled to said system and operative to adjust a predetermined characteristic of the image detected by said detector;

said portable unit being operative to present the detected image on said display, being operative to permit an operator to use said operator input portion to specify a change in the predetermined characteristic, and being operative to transmit to said control section through said wireless communication link and said system an indication of the specified change in the predetermined characteristic; and

said control section being operative to respond to the indication received from said portable unit by effecting the specified change in the predetermined characteristic.

**[0146]** An apparatus further comprising:

said portable unit being operative to successively present the processed images on said display as they are received, said processed images having a resolution which is less than a resolution of the detected images and which corresponds to a resolution of said display.

**[0147]** An apparatus wherein said system is operative to select a subset of the detected images produced by said detector, and to carry out the image processing only on the detected images which are selected for said subset.

**[0148]** A method for compressing image information, comprising the steps of:

detecting a first image of selected subject matter; thereafter detecting a second image of the selected subject matter;

identifying a region of the second image which is of interest; and

preparing compressed image information which includes the first image, which includes information corresponding to the region of interest in the second image, and which excludes at least a portion of the second image, the information which corresponds to the region of interest in the second image being free of contrast information from a substantial



portion of the region of interest in the second image.

[0149] A method including the step of displaying the compressed image information by displaying the first image therefrom, and by modifying the displayed first image based on the information from the compressed image information which corresponds to the region of interest in the second image.

[0150] A method wherein said step of identifying a region of the second image which is of interest includes the step of identifying a portion of the second image which differs from the first image.

[0151] A method wherein the information corresponding to the region of interest in the second image is an outline of the region of interest of the second image.

[0152] A method wherein the information corresponding to the region of interest in the second image is contrast-free information representing only the region of interest.

[0153] A method wherein the information corresponding to the region of interest in the second image includes contrast information for part of the region of interest, and is free of contrast information from a remaining part of the region of interest.

#### Claims

1. A method of monitoring an area, comprising the steps of:
  - periodically detecting an image of the area;
  - identifying and tracking a moving object in a succession of the detected images;
  - automatically selecting an image of each identified object using selection criteria; and
  - saving the selected image of each identified object
  - saving one of the detected images as a reference image;
  - carrying out said step of identifying by evaluating images detected subsequent to the reference image in order to identify therein each change region where the evaluated image differs from the reference image; and
  - carrying out said step of tracking by tracing movement of each change region in successive evaluated images.
2. A method according to Claim 1, wherein said step of automatically selecting includes the steps of:
  - saving one of the detected images as a reference image;
  - carrying out said step of identifying by evaluating images detected subsequent to the reference image in order to identify therein each change region where the evaluated image dif-

fers from the reference image;

determining a bounding box for a given change region in each image of a set of images in which the given change region appears; and

selecting the selected image for the given change region by discarding images from the set in which a lowermost side of the bounding box is higher than in other images of the set, and by selecting from the remaining images of the set an image in which a size of the bounding box is larger than in the other remaining images of the set.

3. A method according to Claim 2, wherein said step of automatically selecting is carried out using image selection criteria which cause a current image to be selected over a prior image if a lowermost point of a detected change region is lower in the current image than in the prior image.
4. A method according to Claim 2, wherein said step of automatically selecting is carried out using image selection criteria which cause a current image to be selected over a prior image if a detected change region has increased in size relative to a prior image.
5. A method according to claim 1, further comprising the step of:
  - automatically saving information which identifies the path of movement of the object, said information being retained after the object is no longer present in newly detected images.
6. A method according to claim 1, further comprising the steps of:
  - detecting successive images of the monitored area;
  - evaluating the detected images in order to identify events of interest in the monitored area;
  - selecting and saving, for each event of interest, image information from the detected images;
  - saving identifying information for each event of interest;
  - presenting a list of the saved identifying information to a user;
  - permitting the user to select the identifying information corresponding to one of the events of interest; and
  - displaying for the user the saved image information for the event of interest that corresponds to the selected identifying information.
7. An apparatus, comprising:
  - a detector operative to periodically detect an

image of a monitored area;  
 a system operative to receive the detected image from said detector;  
 a portable unit having a display; and  
 a wireless communication link which includes portions of said system and said portable unit and which is operative to facilitate wireless communication between said system and said portable unit, including transmission of the detected image from said system to said portable unit;  
 said portable unit being operative to present the detected image on said display; and  
 said system being further operative to detect an occurrence of an event of interest in the monitored area, and to automatically transmit through said wireless communication link to said portable unit an indication of the occurrence of the event of interest.

8. An apparatus according to Claim 7, wherein the event of interest is detected through image processing of a succession of the images detected by said detector.

9. An apparatus according to Claim 7, wherein said system includes a computer which integrates the detected image into a hypertext markup language document, and includes a computer network operatively coupled to said computer, said wireless communication link communicating with said computer through said computer network; and wherein said portable unit includes a network browser which is operative to retrieve the hypertext markup language document from said computer through said wireless communication link and said computer network, and to present the document and the image therein on said display.

10. An apparatus according to claim 7, further comprising:

a control section coupled to said system and operative to adjust a predetermined characteristic of the image detected by said detector;  
 said portable unit being operative to present the detected image on said display, being operative to permit an operator to use said operator input portion to specify a change in the predetermined characteristic, and being operative to transmit to said control section through said wireless communication link and said system an indication of the specified change in the predetermined characteristic; and  
 said control section being operative to respond to the indication received from said portable unit by effecting the specified change in the predetermined characteristic.

11. An apparatus according to claim 7, further comprising:

said portable unit being operative to successively present the processed images on said display as they are received, said processed images having a resolution which is less than a resolution of the detected images and which corresponds to a resolution of said display.

12. An apparatus according to Claim 11, wherein said system is operative to select a subset of the detected images produced by said detector, and to carry out the image processing only on the detected images which are selected for said subset.

FIG. 1

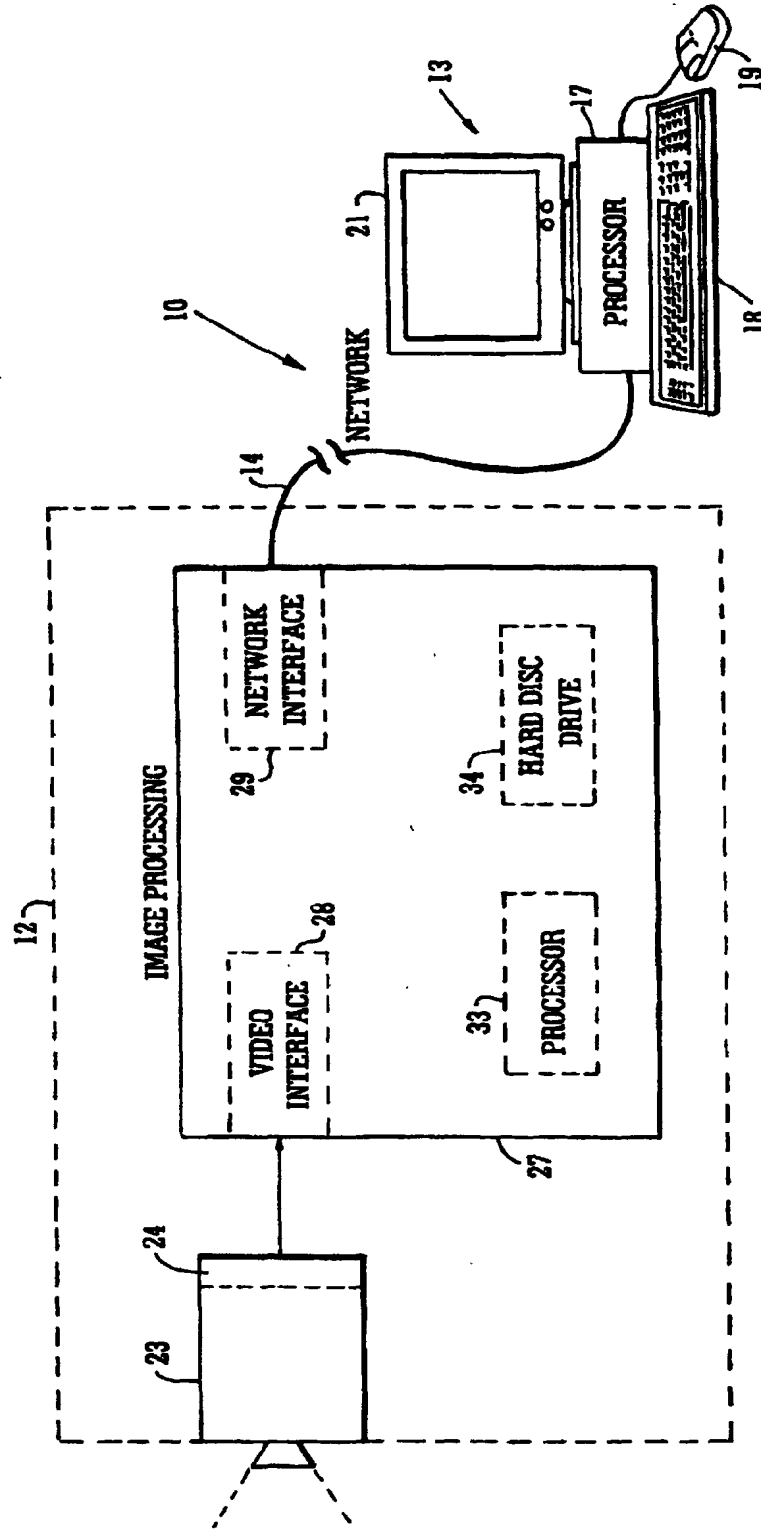

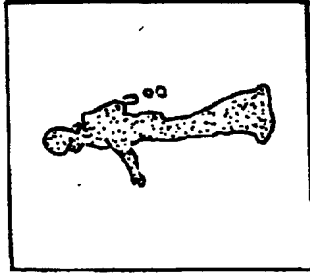

FIG. 2D

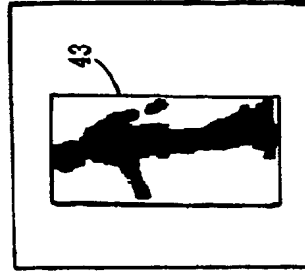

FIG. 2H

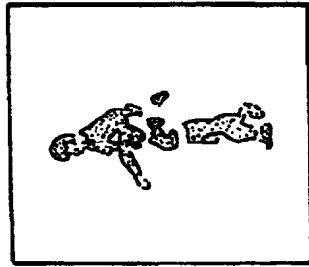

FIG. 2C

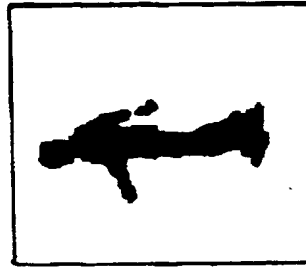

FIG. 2G

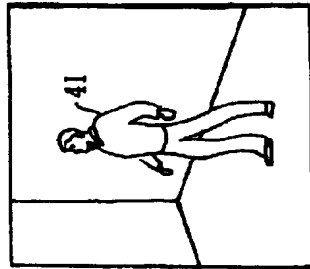

FIG. 2B

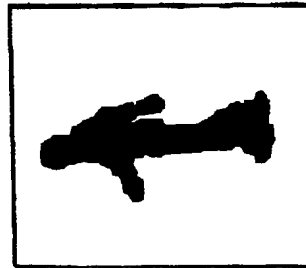

FIG. 2F

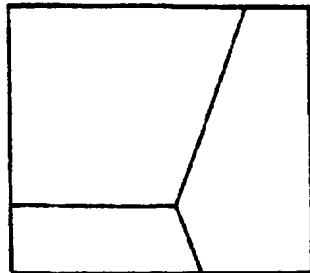

FIG. 2A



FIG. 2E

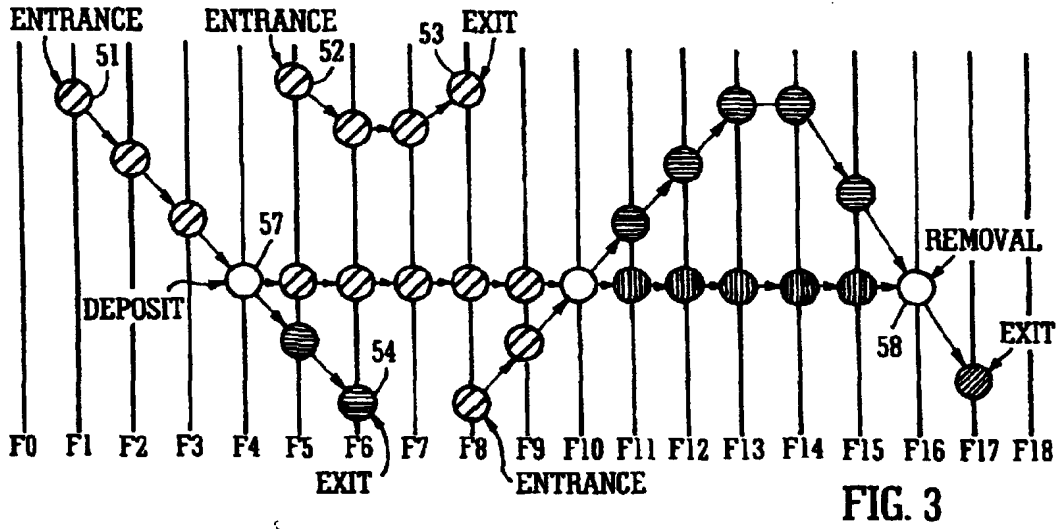

FIG. 3

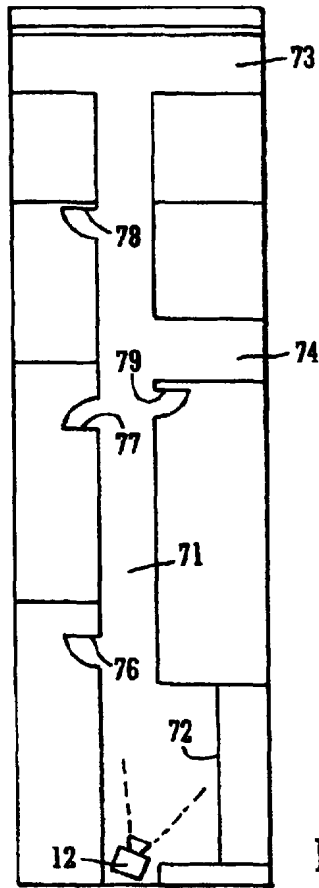

FIG. 4

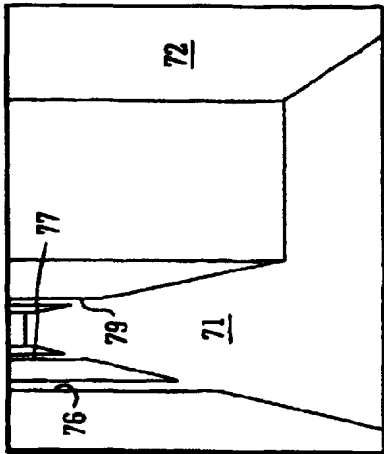

FIG. 5

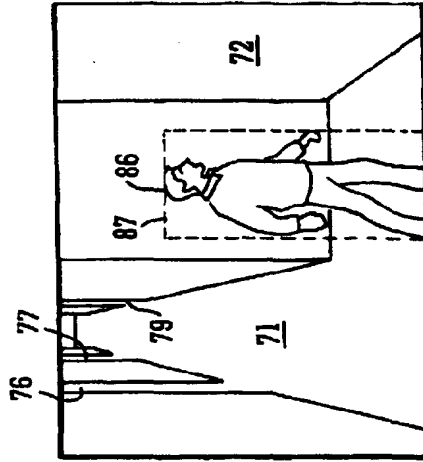

FIG. 6

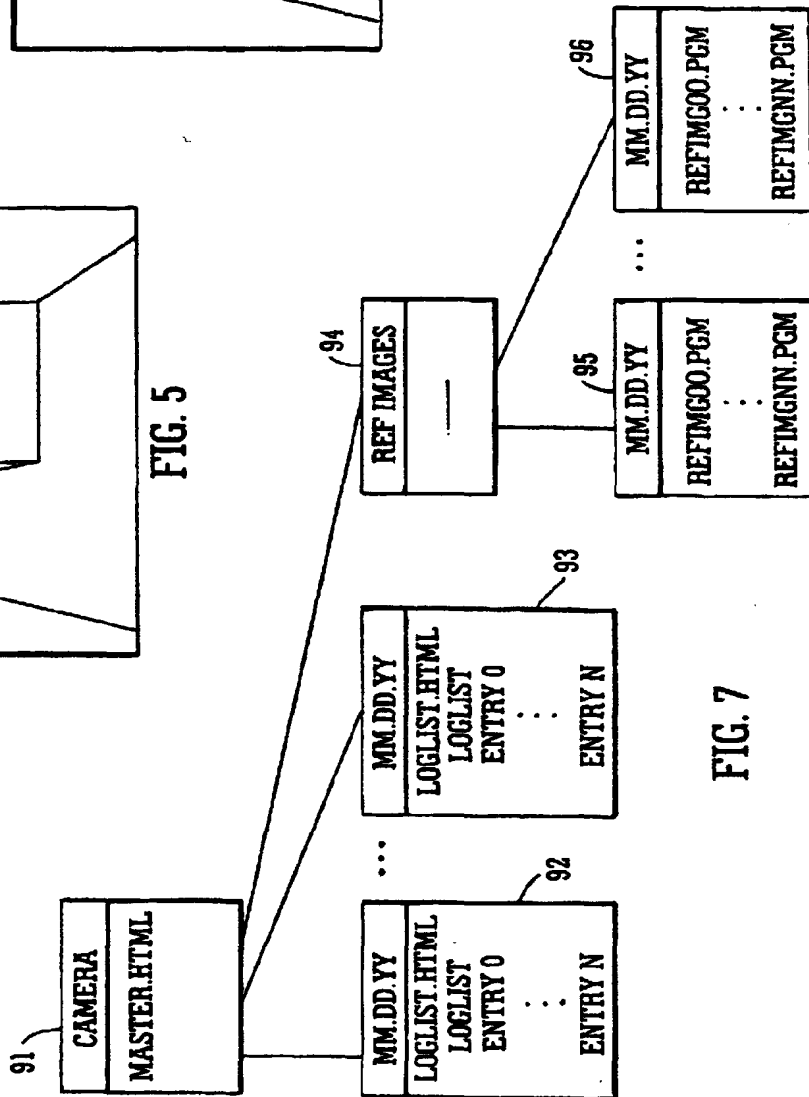

FIG. 7

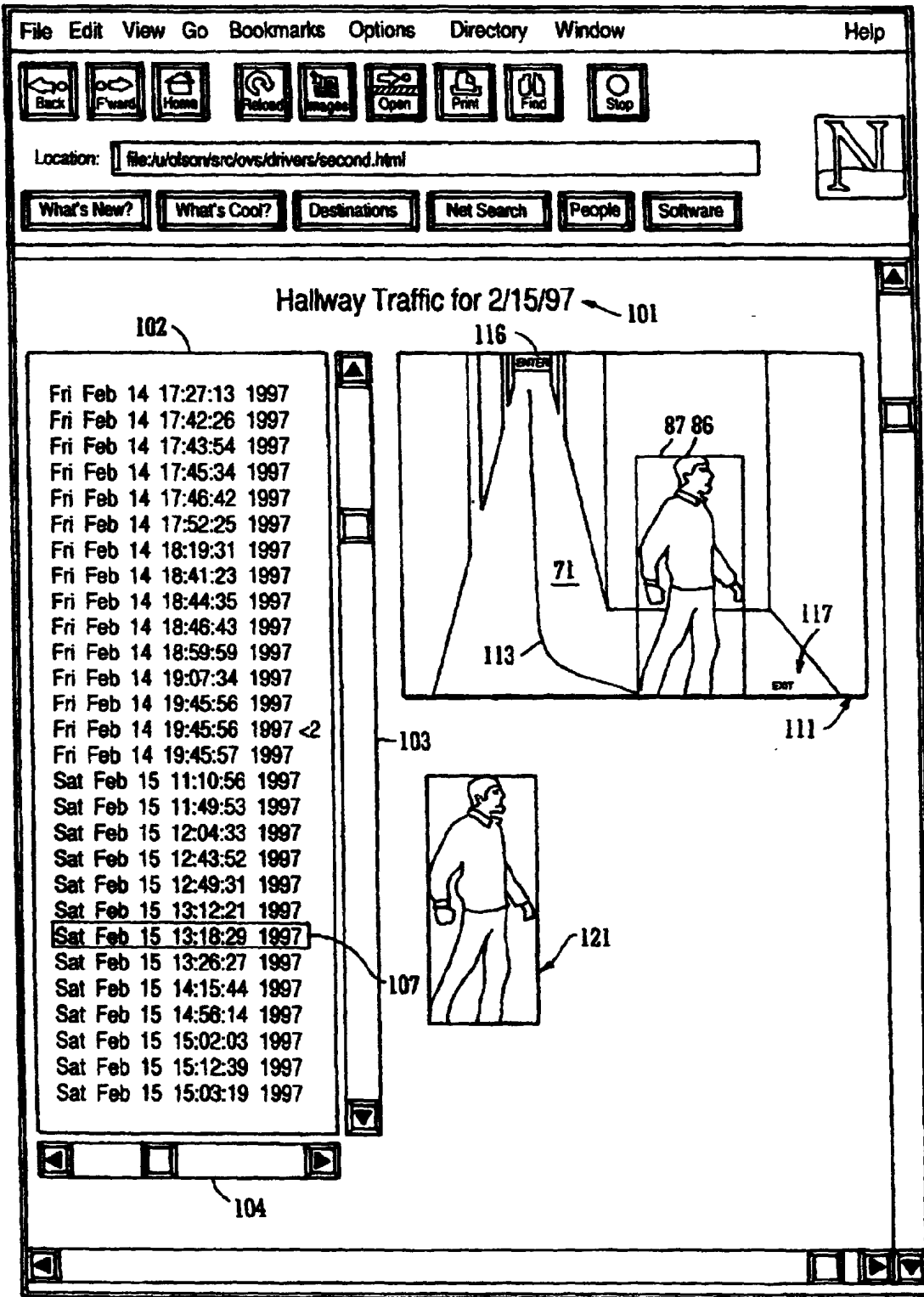

FIG. 8

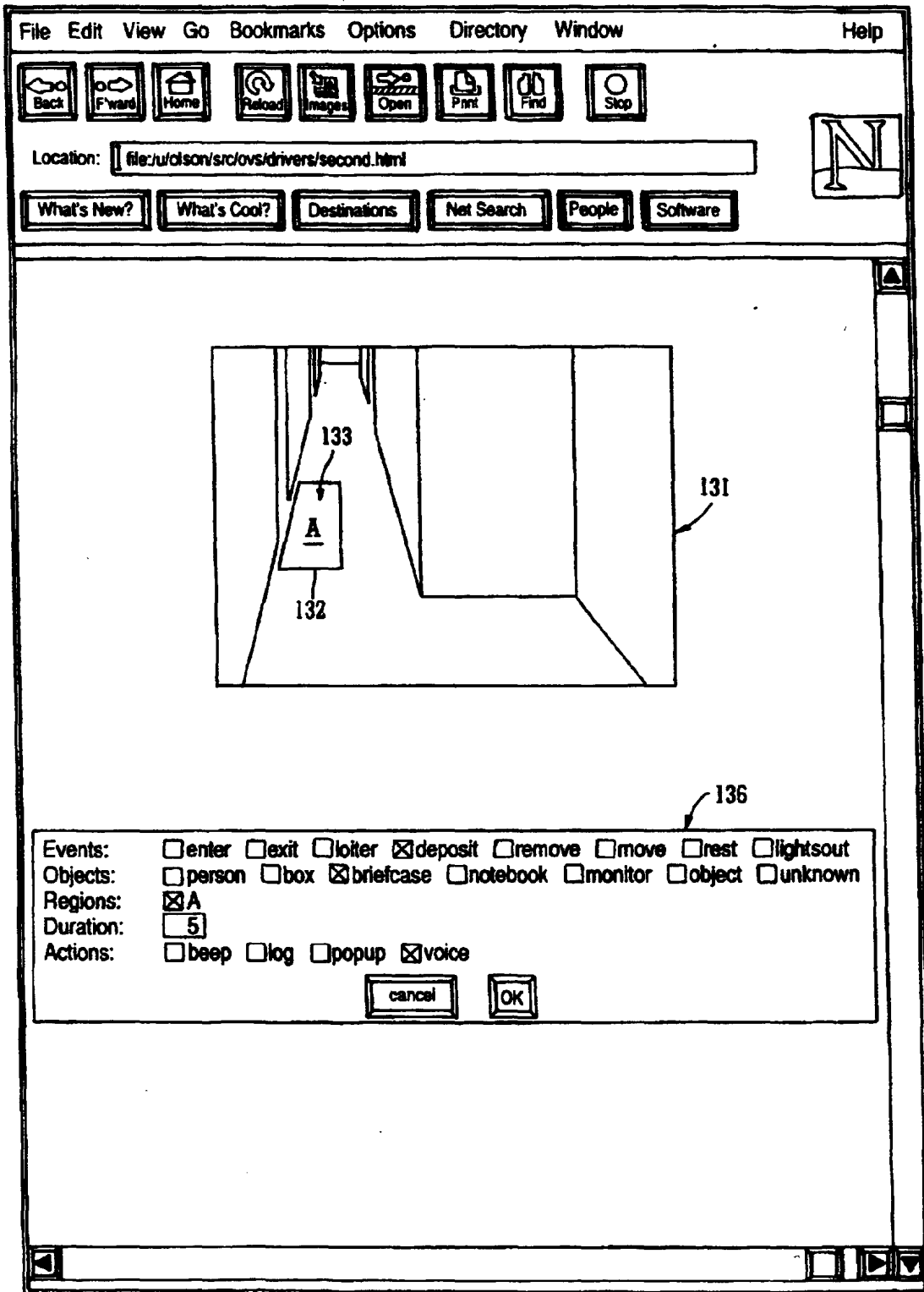

FIG. 9



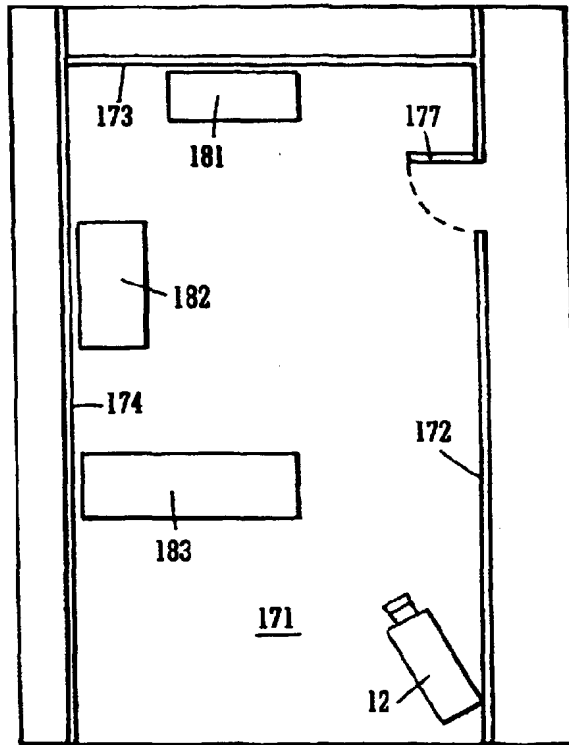

FIG. 10

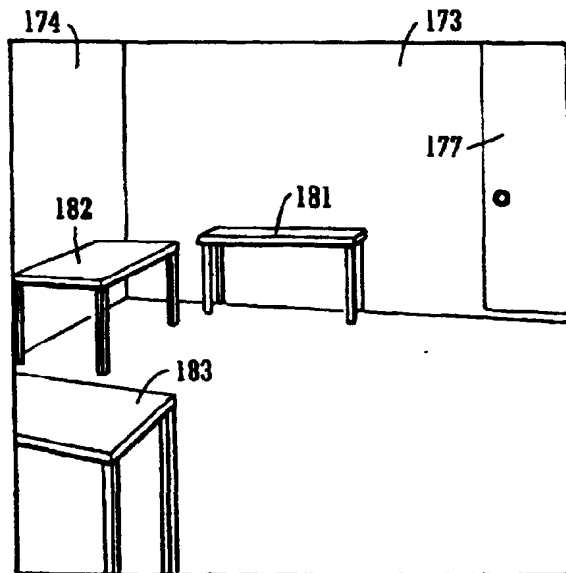

FIG. 11

FIG. 12

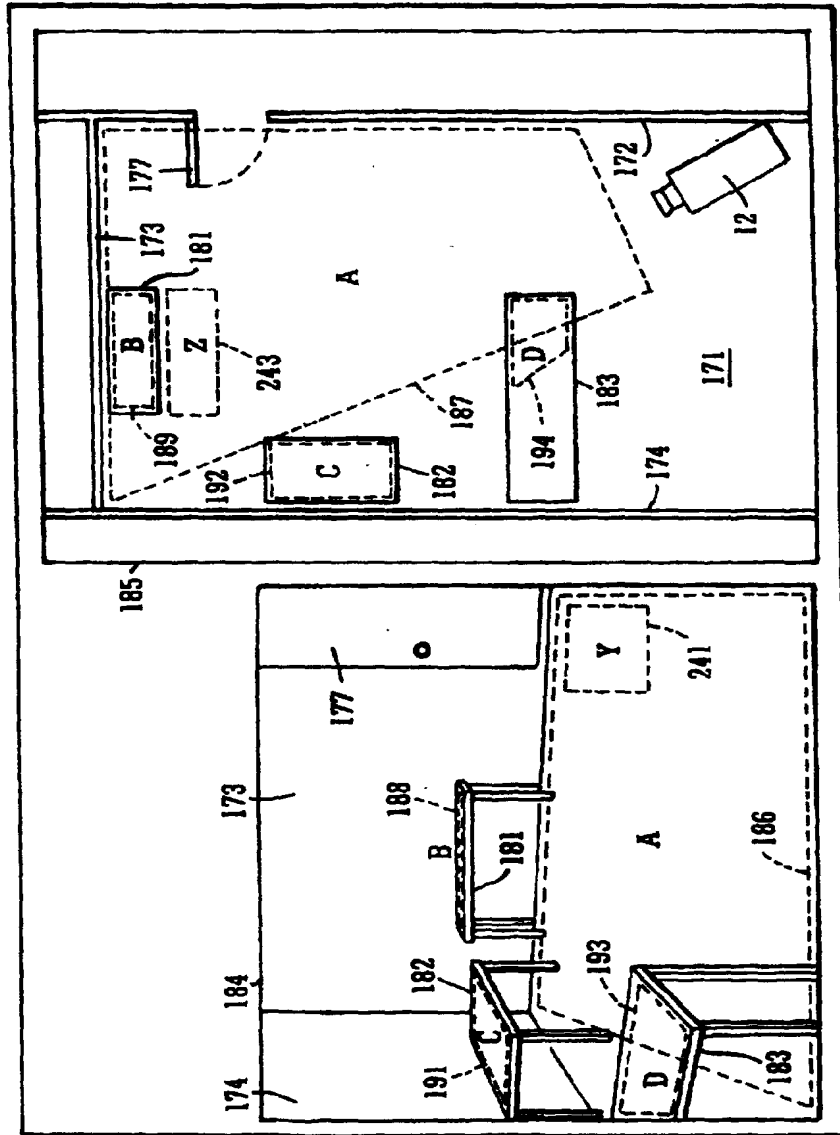
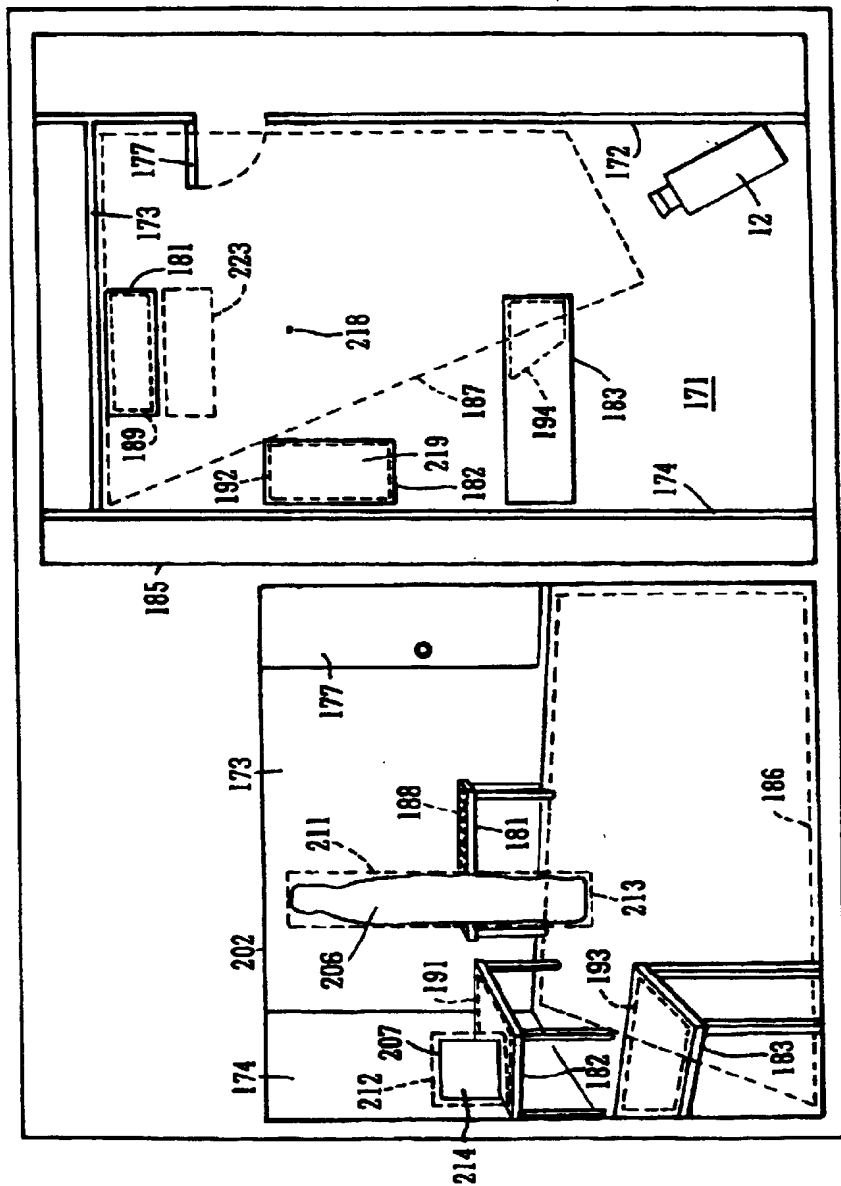

FIG. 13



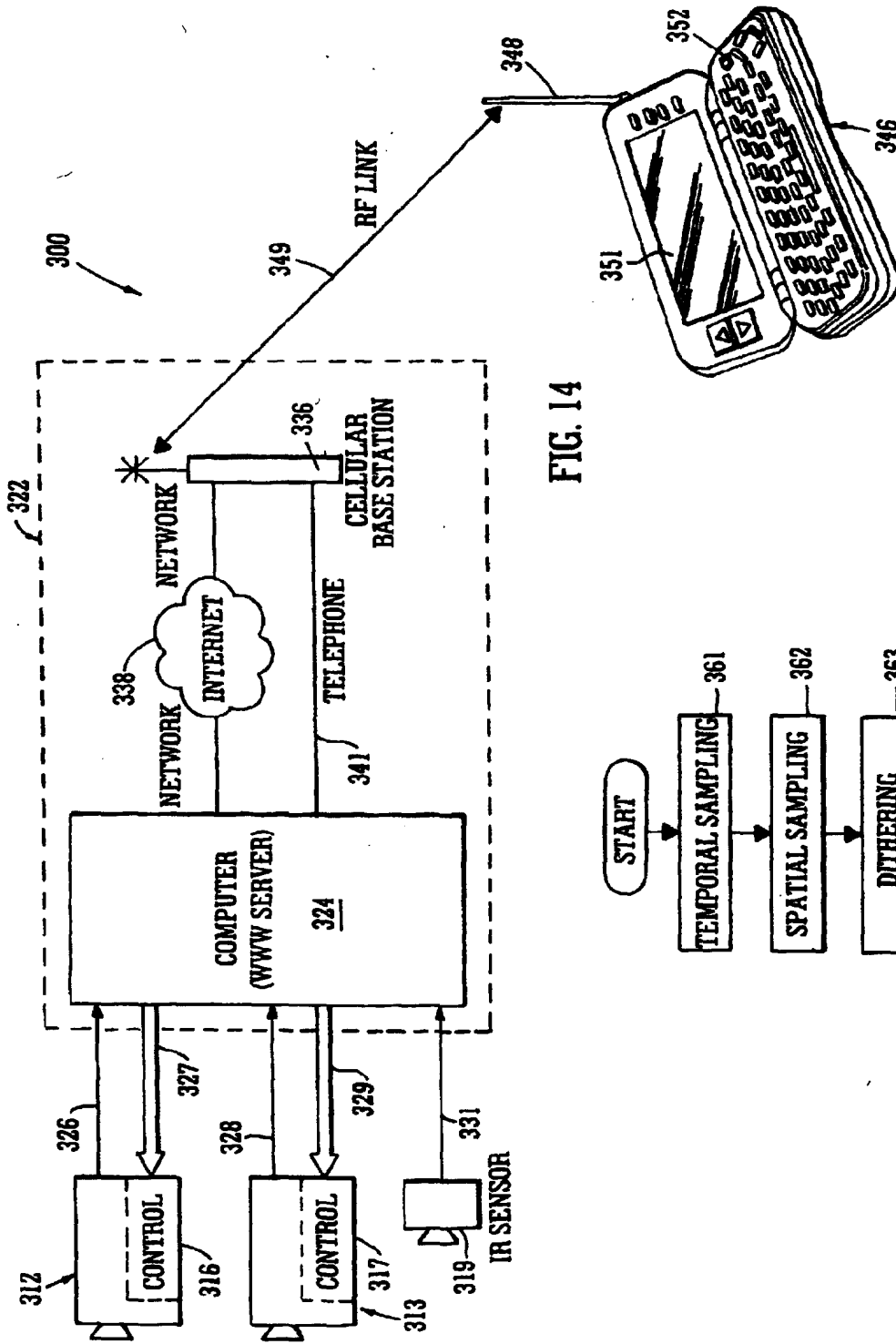

FIG. 14

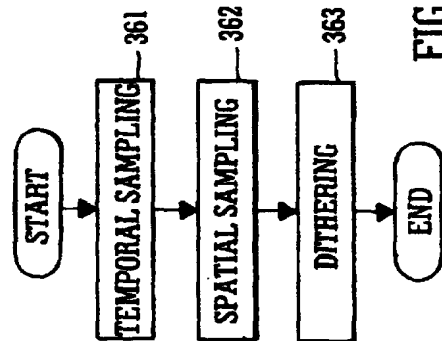

FIG. 15

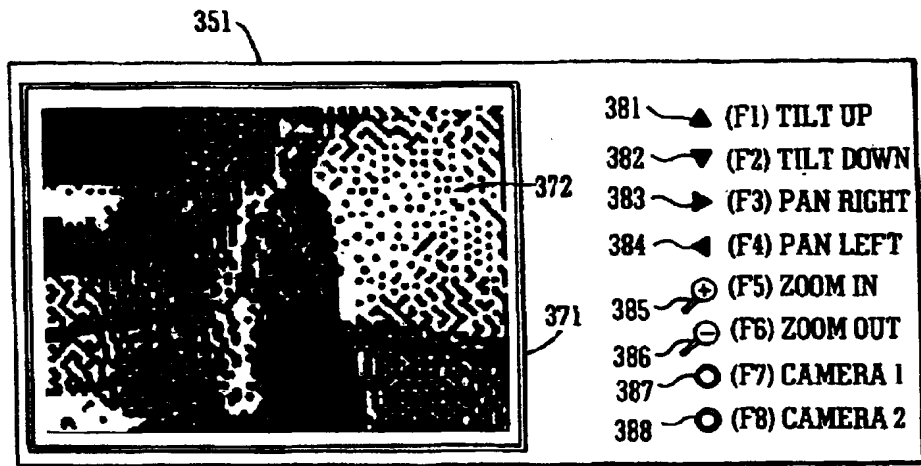

FIG. 16

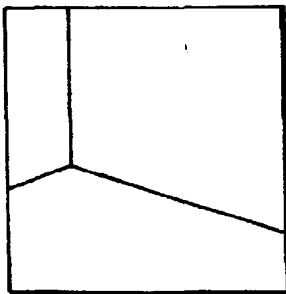

FIG. 17A

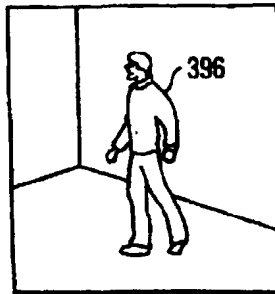

FIG. 17B

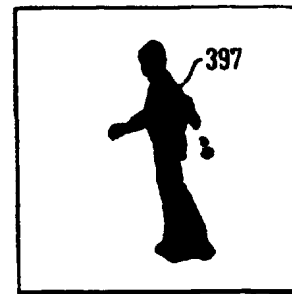

FIG. 17C

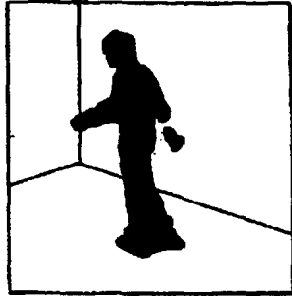

FIG. 18

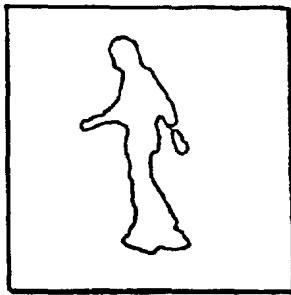

FIG. 19

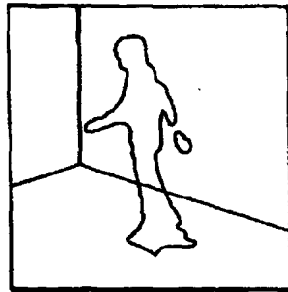

FIG. 20



FIG. 21

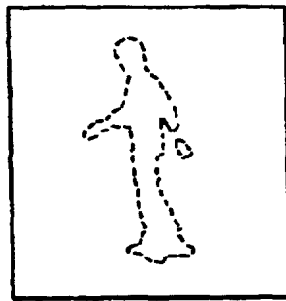

FIG. 22

(12) INTERNATIONAL APPLICATION PUBLISHED UNDER THE PATENT COOPERATION TREATY (PCT)

(19) World Intellectual Property Organization  
International Bureau



(43) International Publication Date  
30 May 2003 (30.05.2003)

PCT

(10) International Publication Number  
WO 03/044727 A1

(51) International Patent Classification<sup>7</sup>: G06K 9/62,  
H04N 7/18

(21) International Application Number: PCT/US02/22688

(22) International Filing Date: 17 July 2002 (17.07.2002)

(25) Filing Language: English

(26) Publication Language: English

(30) Priority Data:  
09/987,707 15 November 2001 (15.11.2001) US

(71) Applicant: DIAMONDBACK VISION, INC. [US/US];  
11600 Sunrise Valley Drive, Reston, VA 20191 (US).

(72) Inventors: LIPTON, Alan, J.; 2022 Peach Orchard Drive,  
#34, Falls Church, VA 22043 (US). STRAT, Thomas, M.;  
3227 Fox Vale Drive, Oakton, VA 22124 (US). VENE-  
TIANER, Peter, L.; 6623 Ivy Hill Drive, McLean, VA  
22101 (US). ALLMEN, Mark, C.; 6333 Starlight Drive,  
Morrison, CO 80465 (US). SEVERSON, William, E.;  
8085 South Franklin Court, Littleton, CO 80112 (US).  
HAERING, Niels; 911 North Barton Street, Arlington,  
VA 22201 (US). CHOSAK, Andrew, J.; 1581 Spring  
Gate Drive, #5309, McLean, VA 22102 (US). ZHANG,  
Zhong; 1122 Clinch Road, Herndon, VA 20170 (US).  
FRAZIER, Matthew, F.; 2500 Clarendon Boulevard,

#712, Arlington, VA 22201 (US). SFEKAS, James, S.;  
1211 South Eads Street, #1202, Arlington, VA 22202  
(US). HIRATA, Tasuki; 14409 Basingstake Lane, Silver  
Spring, MD 20905 (US). CLARK, John; 18604 Colston  
Court, Leesburg, VA 20176 (US).

(74) Agent: SARTORI, Michael, A.; VENABLE, BAETJER,  
HOWARD & CIVILETTI, LLP, 1201 New York Avenue,  
N.W., Suite 1000, P.O. Box 34385, Washington, DC 20043-  
9998 (US).

(81) Designated States (national): AE, AG, AL, AM, AT, AU,  
AZ, BA, BB, BG, BR, BY, BZ, CA, CH, CN, CO, CR, CU,  
CZ, DE, DK, DM, DZ, EC, EE, ES, FI, GB, GD, GE, GH,  
GM, HR, HU, ID, IL, IN, IS, JP, KE, KG, KP, KR, KZ, LC,  
LK, LR, LS, LT, LU, LV, MA, MD, MG, MK, MN, MW,  
MX, MZ, NO, NZ, OM, PH, PL, PT, RO, RU, SD, SE, SG,  
SI, SK, SL, TJ, TM, TN, TR, TT, TZ, UA, UG, UZ, VN,  
YU, ZA, ZM, ZW.

(84) Designated States (regional): ARIPO patent (GH, GM,  
KE, LS, MW, MZ, SD, SL, SZ, TZ, UG, ZM, ZW),  
Eurasian patent (AM, AZ, BY, KG, KZ, MD, RU, TJ, TM),  
European patent (AT, BE, BG, CH, CY, CZ, DE, DK, EE,  
ES, FI, FR, GB, GR, IE, IT, LU, MC, NL, PT, SE, SK,  
TR), OAPI patent (BF, BJ, CF, CG, CI, CM, GA, GN, GQ,  
GW, ML, MR, NE, SN, TD, TG).

Published:  
— with international search report

[Continued on next page]

(54) Title: VIDEO SURVEILLANCE SYSTEM EMPLOYING VIDEO PRIMITIVES

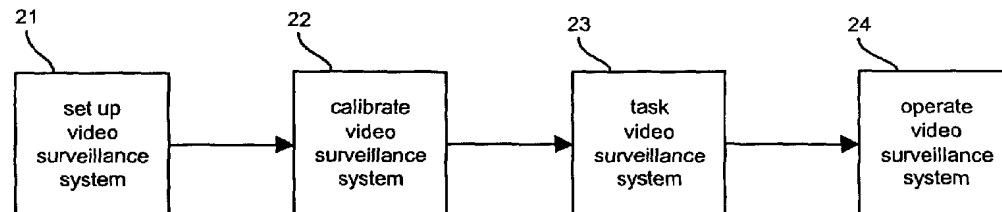
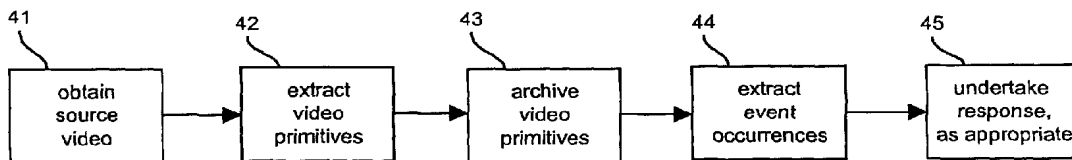

(57) Abstract: A video surveillance system is set up (21), calibrated (22), tasked (23), and operated (24). The system extracts video primitives (42) and extracts event occurrences (44) from the video primitives using event discriminators. The system can undertake a response (45) such as an alarm, based on extracted event occurrences.



WO 03/044727 A1



*For two-letter codes and other abbreviations, refer to the "Guidance Notes on Codes and Abbreviations" appearing at the beginning of each regular issue of the PCT Gazette.*



**VIDEO SURVEILLANCE SYSTEM EMPLOYING VIDEO PRIMITIVES**

5

**BACKGROUND OF THE INVENTION****Field of the Invention**

[1] The invention relates to a system for automatic video surveillance employing video primitives.

10

**References**

[2] For the convenience of the reader, the references referred to herein are listed below. In the specification, the numerals within brackets refer to respective references. The listed references are incorporated herein by reference.

[3] The following references describe moving target detection:

15

[4] {1} A. Lipton, H. Fujiyoshi and R. S. Patil, "Moving Target Detection and Classification from Real-Time Video," Proceedings of IEEE WACV '98, Princeton, NJ, 1998, pp. 8-14.

[5] {2} W.E.L. Grimson, et al., "Using Adaptive Tracking to Classify and Monitor Activities in a Site", CVPR, pp. 22-29, June 1998.

20

[6] {3} A.J. Lipton, H. Fujiyoshi, R.S. Patil, "Moving Target Classification and Tracking from Real-time Video," IUW, pp. 129-136, 1998.

[7] {4} T.J. Olson and F.Z. Brill, "Moving Object Detection and Event Recognition Algorithm for Smart Cameras," IUW, pp. 159-175, May 1997.

[8] The following references describe detecting and tracking humans:

25

[9] {5} A. J. Lipton, "Local Application of Optical Flow to Analyse Rigid Versus Non-Rigid Motion," International Conference on Computer Vision, Corfu, Greece, September 1999.

[10] {6} F. Bartolini, V. Cappellini, and A. Mecocci, "Counting people getting in and out of a bus by real-time image-sequence processing," IVC, 12(1):36-41, January 1994.

30

[11] {7} M. Rossi and A. Bozzoli, "Tracking and counting moving people," ICIP94, pp. 212-216, 1994.

[12] {8} C.R. Wren, A. Azarbayejani, T. Darrell, and A. Pentland, "Pfinder: Real-time tracking of the human body," Vismod, 1995.

[13] {9} L. Khoudour, L. Duvioubourg, J.P. Deparis, "Real-Time Pedestrian Counting by Active Linear Cameras," JEL, 5(4):452-459, October 1996.

5 [14] {10} S. Ioffe, D.A. Forsyth, "Probabilistic Methods for Finding People," IJCV, 43(1):45-68, June 2001.

[15] {11} M. Isard and J. MacCormick, "BraMBLe: A Bayesian Multiple-Blob Tracker," ICCV, 2001.

[16] The following references describe blob analysis:

10 [17] {12} D.M. Gavrila, "The Visual Analysis of Human Movement: A Survey," CVIU, 73(1):82-98, January 1999.

[18] {13} Niels Haering and Niels da Vitoria Lobo, "Visual Event Detection," Video Computing Series, Editor Mubarak Shah, 2001.

15 [19] The following references describe blob analysis for trucks, cars, and people:

[20] {14} Collins, Lipton, Kanade, Fujiyoshi, Duggins, Tsin, Tolliver, Enomoto, and Hasegawa, "A System for Video Surveillance and Monitoring: VSAM Final Report," Technical Report CMU-RI-TR-00-12, Robotics Institute, Carnegie Mellon University, May 2000.

20 [21] {15} Lipton, Fujiyoshi, and Patil, "Moving Target Classification and Tracking from Real-time Video," 98 Darpa IUW, Nov. 20-23, 1998.

[22] The following reference describes analyzing a single-person blob and its contours:

25 [23] {16} C.R. Wren, A. Azarbayejani, T. Darrell, and A.P. Pentland. "Pfinder: Real-Time Tracking of the Human Body," PAMI, vol 19, pp. 780-784, 1997.

[24] The following reference describes internal motion of blobs, including any motion-based segmentation:

30 [25] {17} M. Allmen and C. Dyer, "Long--Range Spatiotemporal Motion Understanding Using Spatiotemporal Flow Curves," Proc. IEEE CVPR, Lahaina, Maui, Hawaii, pp. 303-309, 1991.

[26] {18} L. Wixson, "Detecting Salient Motion by Accumulating Directionally Consistent Flow", IEEE Trans. Pattern Anal. Mach. Intell., vol. 22, pp. 774-781, Aug, 2000.

**Background of the Invention**

[27] Video surveillance of public spaces has become extremely widespread and accepted by the general public. Unfortunately, conventional video surveillance systems produce such prodigious volumes of data that an intractable problem results in the analysis of video surveillance data.

[28] A need exists to reduce the amount of video surveillance data so analysis of the video surveillance data can be conducted.

[29] A need exists to filter video surveillance data to identify desired portions of the video surveillance data.

**SUMMARY OF THE INVENTION**

[30] An object of the invention is to reduce the amount of video surveillance data so analysis of the video surveillance data can be conducted.

[31] An object of the invention is to filter video surveillance data to identify desired portions of the video surveillance data.

[32] An object of the invention is to produce a real time alarm based on an automatic detection of an event from video surveillance data.

[33] An object of the invention is to integrate data from surveillance sensors other than video for improved searching capabilities.

[34] An object of the invention is to integrate data from surveillance sensors other than video for improved event detection capabilities

[35] The invention includes an article of manufacture, a method, a system, and an apparatus for video surveillance.

[36] The article of manufacture of the invention includes a computer-readable medium comprising software for a video surveillance system, comprising code segments for operating the video surveillance system based on video primitives.

[37] The article of manufacture of the invention includes a computer-readable medium comprising software for a video surveillance system, comprising code segments for accessing archived video primitives, and code segments for extracting event occurrences from accessed archived video primitives.

[38] The system of the invention includes a computer system including a computer-readable medium having software to operate a computer in accordance with the invention.

[39] The apparatus of the invention includes a computer including a  
5 computer-readable medium having software to operate the computer in accordance with the invention.

[40] The article of manufacture of the invention includes a computer-readable medium having software to operate a computer in accordance with the invention.

[41] Moreover, the above objects and advantages of the invention are  
10 illustrative, and not exhaustive, of those that can be achieved by the invention. Thus, these and other objects and advantages of the invention will be apparent from the description herein, both as embodied herein and as modified in view of any variations which will be apparent to those skilled in the art.

## 15 **Definitions**

[42] A “video” refers to motion pictures represented in analog and/or digital form. Examples of video include: television, movies, image sequences from a video camera or other observer, and computer-generated image sequences.

[43] A “frame” refers to a particular image or other discrete unit within a  
20 video.

[44] An “object” refers to an item of interest in a video. Examples of an object include: a person, a vehicle, an animal, and a physical subject.

[45] An “activity” refers to one or more actions and/or one or more  
25 composites of actions of one or more objects. Examples of an activity include: entering; exiting; stopping; moving; raising; lowering; growing; and shrinking.

[46] A “location” refers to a space where an activity may occur. A location can be, for example, scene-based or image-based. Examples of a scene-based location include: a public space; a store; a retail space; an office; a warehouse; a hotel room; a hotel lobby; a lobby of a building; a casino; a bus station; a train station; an airport; a  
30 port; a bus; a train; an airplane; and a ship. Examples of an image-based location include: a video image; a line in a video image; an area in a video image; a rectangular section of a video image; and a polygonal section of a video image.

[47] An “event” refers to one or more objects engaged in an activity. The event may be referenced with respect to a location and/or a time.

[48] A “computer” refers to any apparatus that is capable of accepting a structured input, processing the structured input according to prescribed rules, and producing results of the processing as output. Examples of a computer include: a computer; a general purpose computer; a supercomputer; a mainframe; a super mini-computer; a mini-computer; a workstation; a micro-computer; a server; an interactive television; a hybrid combination of a computer and an interactive television; and application-specific hardware to emulate a computer and/or software. A computer can have a single processor or multiple processors, which can operate in parallel and/or not in parallel. A computer also refers to two or more computers connected together via a network for transmitting or receiving information between the computers. An example of such a computer includes a distributed computer system for processing information via computers linked by a network.

[49] A “computer-readable medium” refers to any storage device used for storing data accessible by a computer. Examples of a computer-readable medium include: a magnetic hard disk; a floppy disk; an optical disk, such as a CD-ROM and a DVD; a magnetic tape; a memory chip; and a carrier wave used to carry computer-readable electronic data, such as those used in transmitting and receiving e-mail or in accessing a network.

[50] “Software” refers to prescribed rules to operate a computer. Examples of software include: software; code segments; instructions; computer programs; and programmed logic.

[51] A “computer system” refers to a system having a computer, where the computer comprises a computer-readable medium embodying software to operate the computer.

[52] A “network” refers to a number of computers and associated devices that are connected by communication facilities. A network involves permanent connections such as cables or temporary connections such as those made through telephone or other communication links. Examples of a network include: an internet, such as the Internet; an intranet; a local area network (LAN); a wide area network (WAN); and a combination of networks, such as an internet and an intranet.

### **BRIEF DESCRIPTION OF THE DRAWINGS**

[53] Embodiments of the invention are explained in greater detail by way of the drawings, where the same reference numerals refer to the same features.

[54] Figure 1 illustrates a plan view of the video surveillance system of the invention.

[55] Figure 2 illustrates a flow diagram for the video surveillance system of the invention.

[56] Figure 3 illustrates a flow diagram for tasking the video surveillance system.

[57] Figure 4 illustrates a flow diagram for operating the video surveillance system.

[58] Figure 5 illustrates a flow diagram for extracting video primitives for the video surveillance system.

[59] Figure 6 illustrates a flow diagram for taking action with the video surveillance system.

[60] Figure 7 illustrates a flow diagram for semi-automatic calibration of the video surveillance system.

[61] Figure 8 illustrates a flow diagram for automatic calibration of the video surveillance system.

[62] Figure 9 illustrates an additional flow diagram for the video surveillance system of the invention.

[63] Figures 10-15 illustrate examples of the video surveillance system of the invention applied to monitoring a grocery store.

### **DETAILED DESCRIPTION OF THE INVENTION**

[64] The automatic video surveillance system of the invention is for monitoring a location for, for example, market research or security purposes. The system can be a dedicated video surveillance installation with purpose-built surveillance components, or the system can be a retrofit to existing video surveillance equipment that piggybacks off the surveillance video feeds. The system is capable of analyzing video data from live sources or from recorded media. The system can have a prescribed response to the analysis, such as record data, activate an alarm mechanism, or active another sensor system. The system is also capable of integrating with other surveillance

system components. The system produces security or market research reports that can be tailored according to the needs of an operator and, as an option, can be presented through an interactive web-based interface, or other reporting mechanism.

[65] An operator is provided with maximum flexibility in configuring the system by using event discriminators. Event discriminators are identified with one or more objects (whose descriptions are based on video primitives), along with one or more optional spatial attributes, and/or one or more optional temporal attributes. For example, an operator can define an event discriminator (called a "loitering" event in this example) as a "person" object in the "automatic teller machine" space for "longer than 15 minutes" and "between 10:00 p.m. and 6:00 a.m."

[66] Although the video surveillance system of the invention draws on well-known computer vision techniques from the public domain, the inventive video surveillance system has several unique and novel features that are not currently available. For example, current video surveillance systems use large volumes of video imagery as the primary commodity of information interchange. The system of the invention uses video primitives as the primary commodity with representative video imagery being used as collateral evidence. The system of the invention can also be calibrated (manually, semi-automatically, or automatically) and thereafter automatically can infer video primitives from video imagery. The system can further analyze previously processed video without needing to reprocess completely the video. By analyzing previously processed video, the system can perform inference analysis based on previously recorded video primitives, which greatly improves the analysis speed of the computer system.

[67] As another example, the system of the invention provides unique system tasking. Using equipment control directives, current video systems allow a user to position video sensors and, in some sophisticated conventional systems, to mask out regions of interest or disinterest. Equipment control directives are instructions to control the position, orientation, and focus of video cameras. Instead of equipment control directives, the system of the invention uses event discriminators based on video primitives as the primary tasking mechanism. With event discriminators and video primitives, an operator is provided with a much more intuitive approach over conventional systems for extracting useful information from the system. Rather than tasking a system with an equipment control directives, such as "camera A pan 45

degrees to the left,” the system of the invention can be tasked in a human-intuitive manner with one or more event discriminators based on video primitives, such as “a person enters restricted area A.”

[68] Using the invention for market research, the following are examples of the type of video surveillance that can be performed with the invention: counting people in a store; counting people in a part of a store; counting people who stop in a particular place in a store; measuring how long people spend in a store; measuring how long people spend in a part of a store; and measuring the length of a line in a store.

[69] Using the invention for security, the following are examples of the type of video surveillance that can be performed with the invention: determining when anyone enters a restricted area and storing associated imagery; determining when a person enters an area at unusual times; determining when changes to shelf space and storage space occur that might be unauthorized; determining when passengers aboard an aircraft approach the cockpit; determining when people tailgate through a secure portal; determining if there is an unattended bag in an airport; and determining if there is a theft of an asset.

[70] Figure 1 illustrates a plan view of the video surveillance system of the invention. A computer system 11 comprises a computer 12 having a computer-readable medium 13 embodying software to operate the computer 12 according to the invention. The computer system 11 is coupled to one or more video sensors 14, one or more video recorders 15, and one or more input/output (I/O) devices 16. The video sensors 14 can also be optionally coupled to the video recorders 15 for direct recording of video surveillance data. The computer system is optionally coupled to other sensors 17.

[71] The video sensors 14 provide source video to the computer system 11. Each video sensor 14 can be coupled to the computer system 11 using, for example, a direct connection (e.g., a firewire digital camera interface) or a network. The video sensors 14 can exist prior to installation of the invention or can be installed as part of the invention. Examples of a video sensor 14 include: a video camera; a digital video camera; a color camera; a monochrome camera; a camera; a camcorder, a PC camera; a webcam; an infra-red video camera; and a CCTV camera.

[72] The video recorders 15 receive video surveillance data from the computer system 11 for recording and/or provide source video to the computer system 11. Each video recorder 15 can be coupled to the computer system 11 using, for



example, a direct connection or a network. The video recorders 15 can exist prior to installation of the invention or can be installed as part of the invention. Examples of a video recorder 15 include: a video tape recorder; a digital video recorder; a video disk; a DVD; and a computer-readable medium.

5 [73] The I/O devices 16 provide input to and receive output from the computer system 11. The I/O devices 16 can be used to task the computer system 11 and produce reports from the computer system 11. Examples of I/O devices 16 include: a keyboard; a mouse; a stylus; a monitor; a printer; another computer system; a network; and an alarm.

10 [74] The other sensors 17 provide additional input to the computer system 11. Each other sensor 17 can be coupled to the computer system 11 using, for example, a direct connection or a network. The other sensors 17 can exist prior to installation of the invention or can be installed as part of the invention. Examples of another sensor 17 include: a motion sensor; an optical tripwire; a biometric sensor; and a card-based or  
15 keypad-based authorization system. The outputs of the other sensors 17 can be recorded by the computer system 11, recording devices, and/or recording systems.

[75] Figure 2 illustrates a flow diagram for the video surveillance system of the invention. Various aspects of the invention are exemplified with reference to Figures 10-15, which illustrate examples of the video surveillance system of the  
20 invention applied to monitoring a grocery store.

[76] In block 21, the video surveillance system is set up as discussed for Figure 1. Each video sensor 14 is orientated to a location for video surveillance. The computer system 11 is connected to the video feeds from the video equipment 14 and 15. The video surveillance system can be implemented using existing equipment or  
25 newly installed equipment for the location.

[77] In block 22, the video surveillance system is calibrated. Once the video surveillance system is in place from block 21, calibration occurs. The result of block 22 is the ability of the video surveillance system to determine an approximate absolute size and speed of a particular object (e.g., a person) at various places in the video image  
30 provided by the video sensor. The system can be calibrated using manual calibration, semi-automatic calibration, and automatic calibration. Calibration is further described after the discussion of block 24.

[78] In block 23 of Figure 2, the video surveillance system is tasked. Tasking occurs after calibration in block 22 and is optional. Tasking the video surveillance system involves specifying one or more event discriminators. Without tasking, the video surveillance system operates by detecting and archiving video primitives and associated video imagery without taking any action, as in block 45 in Figure 4.

[79] Figure 3 illustrates a flow diagram for tasking the video surveillance system to determine event discriminators. An event discriminator refers to one or more objects optionally interacting with one or more spatial attributes and/or one or more temporal attributes. An event discriminator is described in terms of video primitives. A video primitive refers to an observable attribute of an object viewed in a video feed. Examples of video primitives include the following: a classification; a size; a shape; a color; a texture; a position; a velocity; a speed; an internal motion; a motion; a salient motion; a feature of a salient motion; a scene change; a feature of a scene change; and a pre-defined model.

[80] A classification refers to an identification of an object as belonging to a particular category or class. Examples of a classification include: a person; a dog; a vehicle; a police car; an individual person; and a specific type of object.

[81] A size refers to a dimensional attribute of an object. Examples of a size include: large; medium; small; flat; taller than 6 feet; shorter than 1 foot; wider than 3 feet; thinner than 4 feet; about human size; bigger than a human; smaller than a human; about the size of a car; a rectangle in an image with approximate dimensions in pixels; and a number of image pixels.

[82] A color refers to a chromatic attribute of an object. Examples of a color include: white; black; grey; red; a range of HSV values; a range of YUV values; a range of RGB values; an average RGB value; an average YUV value; and a histogram of RGB values.

[83] A texture refers to a pattern attribute of an object. Examples of texture features include: self-similarity; spectral power; linearity; and coarseness.

[84] An internal motion refers to a measure of the rigidity of an object. An example of a fairly rigid object is a car, which does not exhibit a great amount of internal motion. An example of a fairly non-rigid object is a person having swinging arms and legs, which exhibits a great amount of internal motion.

[85] A motion refers to any motion that can be automatically detected. Examples of a motion include: appearance of an object; disappearance of an object; a vertical movement of an object; a horizontal movement of an object; and a periodic movement of an object.

5 [86] A salient motion refers to any motion that can be automatically detected and can be tracked for some period of time. Such a moving object exhibits apparently purposeful motion. Examples of a salient motion include: moving from one place to another; and moving to interact with another object.

[87] A feature of a salient motion refers to a property of a salient motion. Examples of a feature of a salient motion include: a trajectory; a length of a trajectory in image space; an approximate length of a trajectory in a three-dimensional representation of the environment; a position of an object in image space as a function of time; an approximate position of an object in a three-dimensional representation of the environment as a function of time; a duration of a trajectory; a velocity (e.g., speed and direction) in image space; an approximate velocity (e.g., speed and direction) in a three-dimensional representation of the environment; a duration of time at a velocity; a change of velocity in image space; an approximate change of velocity in a three-dimensional representation of the environment; a duration of a change of velocity; cessation of motion; and a duration of cessation of motion. A velocity refers to the speed and direction of an object at a particular time. A trajectory refers a set of (position, velocity) pairs for an object for as long as the object can be tracked or for a time period.

[88] A scene change refers to any region of a scene that can be detected as changing over a period of time. Examples of a scene change include: an stationary object leaving a scene; an object entering a scene and becoming stationary; an object changing position in a scene; and an object changing appearance (e.g. color, shape, or size).

[89] A feature of a scene change refers to a property of a scene change. Examples of a feature of a scene change include: a size of a scene change in image space; an approximate size of a scene change in a three-dimensional representation of the environment; a time at which a scene change occurred; a location of a scene change in image space; and an approximate location of a scene change in a three-dimensional representation of the environment.

[90] A pre-defined model refers to an *a priori* known model of an object. Examples of a pre-defined include: an adult; a child; a vehicle; and a semi-trailer.

[91] In block 31, one or more objects types of interests are identified in terms of video primitives or abstractions thereof. Examples of one or more objects include: an  
5 object; a person; a red object; two objects; two persons; and a vehicle.

[92] In block 32, one or more spatial areas of interest are identified. An area refers to one or more portions of an image from a source video or a spatial portion of a scene being viewed by a video sensor. An area also includes a combination of areas  
10 from various scenes and/or images. An area can be an image-based space (e.g., a line, a rectangle, a polygon, or a circle in a video image) or a three-dimensional space (e.g., a cube, or an area of floor space in a building).

[93] Figure 12 illustrates identifying areas along an aisle in a grocery store. Four areas are identified: coffee; soda promotion; chips snacks; and bottled water. The areas are identified via a point-and-click interface with the system.

[94] In block 33, one or more temporal attributes of interest are optionally  
15 identified. Examples of a temporal attribute include: every 15 minutes; between 9:00 p.m. to 6:30 a.m.; less than 5 minutes; longer than 30 seconds; over the weekend; and within 20 minutes of.

[95] In block 34, a response is optionally identified. Examples of a response  
20 includes the following: activating a visual and/or audio alert on a system display; activating a visual and/or audio alarm system at the location; activating a silent alarm; activating a rapid response mechanism; locking a door; contacting a security service; forwarding data (e.g., image data, video data, video primitives; and/or analyzed data) to another computer system via a network, such as the Internet; saving such data to a  
25 designated computer-readable medium; activating some other sensor or surveillance system; tasking the computer system 11 and/or another computer system; and directing the computer system 11 and/or another computer system.

[96] In block 35, one or more discriminators are identified by describing  
30 interactions between video primitives (or their abstractions), spatial areas of interest, and temporal attributes of interest. An interaction is determined for a combination of one or more objects identified in block 31, one or more spatial areas of interest identified in block 32, and one or more temporal attributes of interest identified in block

33. One or more responses identified in block 34 are optionally associated with each event discriminator.

[97] Examples of an event discriminator for a single object include: an object appears; a person appears; and a red object moves faster than 10m/s.

5 [98] Examples of an event discriminator for multiple objects include: two objects come together; a person exits a vehicle; and a red object moves next to a blue object.

[99] Examples of an event discriminator for an object and a spatial attribute include: an object crosses a line; an object enters an area; and a person crosses a line  
10 from the left.

[100] Examples of an event discriminator for an object and a temporal attribute include: an object appears at 10:00 p.m.; a person travels faster than 2m/s between 9:00 a.m. and 5:00 p.m.; and a vehicle appears on the weekend.

[101] Examples of an event discriminator for an object, a spatial attribute, and  
15 a temporal attribute include: a person crosses a line between midnight and 6:00 a.m.; and a vehicle stops in an area for longer than 10 minutes.

[102] An example of an event discriminator for an object, a spatial attribute, and a temporal attribute associated with a response include: a person enters an area between midnight and 6:00 a.m., and a security service is notified.

20 [103] In block 24 of Figure 2, the video surveillance system is operated. The video surveillance system of the invention operates automatically, detects and archives video primitives of objects in the scene, and detects event occurrences in real time using event discriminators. In addition, action is taken in real time, as appropriate, such as activating alarms, generating reports, and generating output. The reports and output can  
25 be displayed and/or stored locally to the system or elsewhere via a network, such as the Internet. Figure 4 illustrates a flow diagram for operating the video surveillance system.

[104] In block 41, the computer system 11 obtains source video from the video sensors 14 and/or the video recorders 15.

[105] In block 42, video primitives are extracted in real time from the source  
30 video. As an option, non-video primitives can be obtained and/or extracted from one or more other sensors 17 and used with the invention. The extraction of video primitives is illustrated with Figure 5.

[106] Figure 5 illustrates a flow diagram for extracting video primitives for the video surveillance system. Blocks 51 and 52 operate in parallel and can be performed in any order or concurrently. In block 51, objects are detected via movement. Any motion detection algorithm for detecting movement between frames at the pixel level can be used for this block. As an example, the three frame differencing technique can be used, which is discussed in {1}. The detected objects are forwarded to block 53.

[107] In block 52, objects are detected via change. Any change detection algorithm for detecting changes from a background model can be used for this block. An object is detected in this block if one or more pixels in a frame are deemed to be in the foreground of the frame because the pixels do not conform to a background model of the frame. As an example, a stochastic background modeling technique, such as dynamically adaptive background subtraction, can be used, which is described in {1} and U.S. Patent Application No. 09/694,712 filed October 24, 2000. The detected objects are forwarded to block 53.

[108] The motion detection technique of block 51 and the change detection technique of block 52 are complimentary techniques, where each technique advantageously addresses deficiencies in the other technique. As an option, additional and/or alternative detection schemes can be used for the techniques discussed for blocks 51 and 52. Examples of an additional and/or alternative detection scheme include the following: the Pfinder detection scheme for finding people as described in {8}; a skin tone detection scheme; a face detection scheme; and a model-based detection scheme. The results of such additional and/or alternative detection schemes are provided to block 53.

[109] As an option, if the video sensor 14 has motion (e.g., a video camera that sweeps, zooms, and/or translates), an additional block can be inserted before blocks 51 and 52 to provide input to blocks 51 and 52 for video stabilization. Video stabilization can be achieved by affine or projective global motion compensation. For example, image alignment described in U.S. Patent Application No. 09/609,919, filed July 3, 2000, which is incorporated herein by reference, can be used to obtain video stabilization.

[110] In block 53, blobs are generated. In general, a blob is any object in a frame. Examples of a blob include: a moving object, such as a person or a vehicle; and a consumer product, such as a piece of furniture, a clothing item, or a retail shelf item.

Blobs are generated using the detected objects from blocks 32 and 33. Any technique for generating blobs can be used for this block. An exemplary technique for generating blobs from motion detection and change detection uses a connected components scheme. For example, the morphology and connected components algorithm can be used, which is described in {1}.

[111] In block 54, blobs are tracked. Any technique for tracking blobs can be used for this block. For example, Kalman filtering or the CONDENSATION algorithm can be used. As another example, a template matching technique, such as described in {1}, can be used. As a further example, a multi-hypothesis Kalman tracker can be used, which is described in {5}. As yet another example, the frame-to-frame tracking technique described in U.S. Patent Application No. 09/694,712 filed October 24, 2000, can be used. For the example of a location being a grocery store, examples of objects that can be tracked include moving people, inventory items, and inventory moving appliances, such as shopping carts or trolleys.

[112] As an option, blocks 51-54 can be replaced with any detection and tracking scheme, as is known to those of ordinary skill. An example of such a detection and tracking scheme is described in {11}.

[113] In block 55, each trajectory of the tracked objects is analyzed to determine if the trajectory is salient. If the trajectory is insalient, the trajectory represents an object exhibiting unstable motion or represents an object of unstable size or color, and the corresponding object is rejected and is no longer analyzed by the system. If the trajectory is salient, the trajectory represents an object that is potentially of interest. A trajectory is determined to be salient or insalient by applying a salience measure to the trajectory. Techniques for determining a trajectory to be salient or insalient are described in {13} and {18}.

[114] In block 56, each object is classified. The general type of each object is determined as the classification of the object. Classification can be performed by a number of techniques, and examples of such techniques include using a neural network classifier {14} and using a linear discriminant classifier {14}. Examples of classification are the same as those discussed for block 23.

[115] In block 57, video primitives are identified using the information from blocks 51-56 and additional processing as necessary. Examples of video primitives identified are the same as those discussed for block 23. As an example, for size, the

system can use information obtained from calibration in block 22 as a video primitive. From calibration, the system has sufficient information to determine the approximate size of an object. As another example, the system can use velocity as measured from block 54 as a video primitive.

5 [116] In block 43, the video primitives from block 42 are archived. The video primitives can be archived in the computer-readable medium 13 or another computer-readable medium. Along with the video primitives, associated frames or video imagery from the source video can be archived.

10 [117] In block 44, event occurrences are extracted from the video primitives using event discriminators. The video primitives are determined in block 42, and the event discriminators are determined from tasking the system in block 23. The event discriminators are used to filter the video primitives to determine if any event occurrences occurred. For example, an event discriminator can be looking for a “wrong way” event as defined by a person traveling the "wrong way" into an area between  
15 9:00a.m. and 5:00p.m. The event discriminator checks all video primitives being generated according to Figure 5 and determines if any video primitives exist which have the following properties: a timestamp between 9:00a.m. and 5:00p.m., a classification of “person” or “group of people”, a position inside the area, and a “wrong” direction of motion.

20 [118] In block 45, action is taken for each event occurrence extracted in block 44, as appropriate. Figure 6 illustrates a flow diagram for taking action with the video surveillance system.

[119] In block 61, responses are undertaken as dictated by the event discriminators that detected the event occurrences. The response, if any, are identified  
25 for each event discriminator in block 34.

[120] In block 62, an activity record is generated for each event occurrence that occurred. The activity record includes, for example: details of a trajectory of an object; a time of detection of an object; a position of detection of an object, and a description or definition of the event discriminator that was employed. The activity record can include  
30 information, such as video primitives, needed by the event discriminator. The activity record can also include representative video or still imagery of the object(s) and/or area(s) involved in the event occurrence. The activity record is stored on a computer-readable medium.



[121] In block 63, output is generated. The output is based on the event occurrences extracted in block 44 and a direct feed of the source video from block 41. The output is stored on a computer-readable medium, displayed on the computer system 11 or another computer system, or forwarded to another computer system. As the system operates, information regarding event occurrences is collected, and the information can be viewed by the operator at any time, including real time. Examples of formats for receiving the information include: a display on a monitor of a computer system; a hard copy; a computer-readable medium; and an interactive web page.

[122] The output can include a display from the direct feed of the source video from block 41. For example, the source video can be displayed on a window of the monitor of a computer system or on a closed-circuit monitor. Further, the output can include source video marked up with graphics to highlight the objects and/or areas involved in the event occurrence.

[123] The output can include one or more reports for an operator based on the requirements of the operator and/or the event occurrences. Examples of a report include: the number of event occurrences which occurred; the positions in the scene in which the event occurrence occurred; the times at which the event occurrences occurred; representative imagery of each event occurrence; representative video of each event occurrence; raw statistical data; statistics of event occurrences (e.g., how many, how often, where, and when); and/or human-readable graphical displays.

[124] Figures 13 and 14 illustrate an exemplary report for the aisle in the grocery store of Figure 15. In Figures 13 and 14, several areas are identified in block 22 and are labeled accordingly in the images. The areas in Figure 13 match those in Figure 12, and the areas in Figure 14 are different ones. The system is tasked to look for people who stop in the area.

[125] In Figure 13, the exemplary report is an image from a video marked-up to include labels, graphics, statistical information, and an analysis of the statistical information. For example, the area identified as coffee has statistical information of an average number of customers in the area of 2/hour and an average dwell time in the area as 5 seconds. The system determined this area to be a "cold" region, which means there is not much commercial activity through this region. As another example, the area identified as sodas has statistical information of an average number of customers in the area of 15/hour and an average dwell time in the area as 22 seconds. The system

determined this area to be a “hot” region, which means there is a large amount of commercial activity in this region.

[126] In Figure 14, the exemplary report is an image from a video marked-up to include labels, graphics, statistical information, and an analysis of the statistical information. For example, the area at the back of the aisle has average number of customers of 14/hour and is determined to have low traffic. As another example, the area at the front of the aisle has average number of customers of 83/hour and is determined to have high traffic.

[127] For either Figure 13 or Figure 14, if the operator desires more information about any particular area or any particular area, a point-and-click interface allows the operator to navigate through representative still and video imagery of regions and/or activities that the system has detected and archived.

[128] Figure 15 illustrates another exemplary report for an aisle in a grocery store. The exemplary report includes an image from a video marked-up to include labels and trajectory indications and text describing the marked-up image. The system of the example is tasked with searching for a number of areas: length, position, and time of a trajectory of an object; time and location an object was immobile; correlation of trajectories with areas, as specified by the operator; and classification of an object as not a person, one person, two people, and three or more people.

[129] The video image of Figure 15 is from a time period where the trajectories were recorded. Of the three objects, two objects are each classified as one person, and one object is classified as not a person. Each object is assigned a label, namely Person ID 1032, Person ID 1033, and Object ID 32001. For Person ID 1032, the system determined the person spent 52 seconds in the area and 18 seconds at the position designated by the circle. For Person ID 1033, the system determined the person spent 1 minute and 8 seconds in the area and 12 seconds at the position designated by the circle. The trajectories for Person ID 1032 and Person ID 1033 are included in the marked-up image. For Object ID 32001, the system did not further analyze the object and indicated the position of the object with an X.

[130] Referring back to block 22 in Figure 2, calibration can be (1) manual, (2) semi-automatic using imagery from a video sensor or a video recorder, or (3) automatic using imagery from a video sensor or a video recorder. If imagery is required, it is

assumed that the source video to be analyzed by the computer system 11 is from a video sensor that obtained the source video used for calibration.

[131] For manual calibration, the operator provides to the computer system 11 the orientation and internal parameters for each of the video sensors 14 and the placement of each video sensor 14 with respect to the location. The computer system 11 can optionally maintain a map of the location, and the placement of the video sensors 14 can be indicated on the map. The map can be a two-dimensional or a three-dimensional representation of the environment. In addition, the manual calibration provides the system with sufficient information to determine the approximate size and relative position of an object.

[132] Alternatively, for manual calibration, the operator can mark up a video image from the sensor with a graphic representing the appearance of a known-sized object, such as a person. If the operator can mark up an image in at least two different locations, the system can infer approximate camera calibration information.

[133] For semi-automatic and automatic calibration, no knowledge of the camera parameters or scene geometry is required. From semi-automatic and automatic calibration, a lookup table is generated to approximate the size of an object at various areas in the scene, or the internal and external camera calibration parameters of the camera are inferred.

[134] For semi-automatic calibration, the video surveillance system is calibrated using a video source combined with input from the operator. A single person is placed in the field of view of the video sensor to be semi-automatic calibrated. The computer system 11 receives source video regarding the single person and automatically infers the size of person based on this data. As the number of locations in the field of view of the video sensor that the person is viewed is increased, and as the period of time that the person is viewed in the field of view of the video sensor is increased, the accuracy of the semi-automatic calibration is increased.

[135] Figure 7 illustrates a flow diagram for semi-automatic calibration of the video surveillance system. Block 71 is the same as block 41, except that a typical object moves through the scene at various trajectories. The typical object can have various velocities and be stationary at various positions. For example, the typical object moves as close to the video sensor as possible and then moves as far away from the video sensor as possible. This motion by the typical object can be repeated as necessary.

[136] Blocks 72-25 are the same as blocks 51-54, respectively.

[137] In block 76, the typical object is monitored throughout the scene. It is assumed that the only (or at least the most) stable object being tracked is the calibration object in the scene (i.e., the typical object moving through the scene). The size of the stable object is collected for every point in the scene at which it is observed, and this information is used to generate calibration information.

[138] In block 77, the size of the typical object is identified for different areas throughout the scene. The size of the typical object is used to determine the approximate sizes of similar objects at various areas in the scene. With this information, a lookup table is generated matching typical apparent sizes of the typical object in various areas in the image, or internal and external camera calibration parameters are inferred. As a sample output, a display of stick-sized figures in various areas of the image indicate what the system determined as an appropriate height. Such a stick-sized figure is illustrated in Figure 11.

[139] For automatic calibration, a learning phase is conducted where the computer system 11 determines information regarding the location in the field of view of each video sensor. During automatic calibration, the computer system 11 receives source video of the location for a representative period of time (e.g., minutes, hours or days) that is sufficient to obtain a statistically significant sampling of objects typical to the scene and thus infer typical apparent sizes and locations.

[140] Figure 8 illustrates a flow diagram for automatic calibration of the video surveillance system. Blocks 81-86 are the same as blocks 71-76 in Figure 7.

[141] In block 87, trackable regions in the field of view of the video sensor are identified. A trackable region refers to a region in the field of view of a video sensor where an object can be easily and/or accurately tracked. An untrackable region refers to a region in the field of view of a video sensor where an object is not easily and/or accurately tracked and/or is difficult to track. An untrackable region can be referred to as being an unstable or insalient region. An object may be difficult to track because the object is too small (e.g., smaller than a predetermined threshold), appear for too short of time (e.g., less than a predetermined threshold), or exhibit motion that is not salient (e.g., not purposeful). A trackable region can be identified using, for example, the techniques described in {13}.

[142] Figure 10 illustrates trackable regions determined for an aisle in a grocery store. The area at the far end of the aisle is determined to be insalient because too many confusers appear in this area. A confuser refers to something in a video that confuses a tracking scheme. Examples of a confuser include: leaves blowing; rain; a partially occluded object; and an object that appears for too short of time to be tracked accurately. In contrast, the area at the near end of the aisle is determined to be salient because good tracks are determined for this area.

[143] In block 88, the sizes of the objects are identified for different areas throughout the scene. The sizes of the objects are used to determine the approximate sizes of similar objects at various areas in the scene. A technique, such as using a histogram or a statistical median, is used to determine the typical apparent height and width of objects as a function of location in the scene. In one part of the image of the scene, typical objects can have a typical apparent height and width. With this information, a lookup table is generated matching typical apparent sizes of objects in various areas in the image, or the internal and external camera calibration parameters can be inferred.

[144] Figure 11 illustrates identifying typical sizes for typical objects in the aisle of the grocery store from Figure 10. Typical objects are assumed to be people and are identified by a label accordingly. Typical sizes of people are determined through plots of the average height and average width for the people detected in the salient region. In the example, plot A is determined for the average height of an average person, and plot B is determined for the average width for one person, two people, and three people.

[145] For plot A, the x-axis depicts the height of the blob in pixels, and the y-axis depicts the number of instances of a particular height, as identified on the x-axis, that occur. The peak of the line for plot A corresponds to the most common height of blobs in the designated region in the scene and, for this example, the peak corresponds to the average height of a person standing in the designated region.

[146] Assuming people travel in loosely knit groups, a similar graph to plot A is generated for width as plot B. For plot B, the x-axis depicts the width of the blobs in pixels, and the y-axis depicts the number of instances of a particular width, as identified on the x-axis, that occur. The peaks of the line for plot B correspond to the average width of a number of blobs. Assuming most groups contain only one person, the largest

peak corresponds to the most common width, which corresponds to the average width of a single person in the designated region. Similarly, the second largest peak corresponds to the average width of two people in the designated region, and the third largest peak corresponds to the average width of three people in the designated region.

5           [147] Figure 9 illustrates an additional flow diagram for the video surveillance system of the invention. In this additional embodiment, the system analyses archived video primitives with event discriminators to generate additional reports, for example, without needing to review the entire source video. Anytime after a video source has been processed according to the invention, video primitives for the source video are  
10 archived in block 43 of Figure 4. The video content can be reanalyzed with the additional embodiment in a relatively short time because only the video primitives are reviewed and because the video source is not reprocessed. This provides a great efficiency improvement over current state-of-the-art systems because processing video imagery data is extremely computationally expensive, whereas analyzing the small-  
15 sized video primitives abstracted from the video is extremely computationally cheap. As an example, the following event discriminator can be generated: "The number of people stopping for more than 10 minutes in area A in the last two months." With the additional embodiment, the last two months of source video does not need to be reviewed. Instead, only the video primitives from the last two months need to be  
20 reviewed, which is a significantly more efficient process.

[148] Block 91 is the same as block 23 in Figure 2.

[149] In block 92, archived video primitives are accessed. The video primitives are archived in block 43 of Figure 4.

[150] Blocks 93 and 94 are the same as blocks 44 and 45 in Figure 4.

25           [151] As an exemplary application, the invention can be used to analyze retail market space by measuring the efficacy of a retail display. Large sums of money are injected into retail displays in an effort to be as eye-catching as possible to promote sales of both the items on display and subsidiary items. The video surveillance system of the invention can be configured to measure the effectiveness of these retail displays.

30           [152] For this exemplary application, the video surveillance system is set up by orienting the field of view of a video sensor towards the space around the desired retail display. During tasking, the operator selects an area representing the space around the desired retail display. As a discriminator, the operator defines that he or she wishes to

monitor people-sized objects that enter the area and either exhibit a measurable reduction in velocity or stop for an appreciable amount of time.

[153] After operating for some period of time, the video surveillance system can provide reports for market analysis. The reports can include: the number of people  
5 who slowed down around the retail display; the number of people who stopped at the retail display; the breakdown of people who were interested in the retail display as a function of time, such as how many were interested on weekends and how many were interested in evenings; and video snapshots of the people who showed interest in the retail display. The market research information obtained from the video surveillance  
10 system can be combined with sales information from the store and customer records from the store to improve the analysts understanding of the efficacy of the retail display.

[154] The embodiments and examples discussed herein are non-limiting examples.

[155] The invention is described in detail with respect to preferred  
15 embodiments, and it will now be apparent from the foregoing to those skilled in the art that changes and modifications may be made without departing from the invention in its broader aspects, and the invention, therefore, as defined in the claims is intended to cover all such changes and modifications as fall within the true spirit of the invention.

CLAIMS

What is claimed is:

1. A computer-readable medium comprising software for a video surveillance system, comprising code segments for operating the video surveillance system based on video primitives.  
5
2. A computer-readable medium as in claim 1, wherein the code segments for operating the video surveillance system comprise:  
code segments for extracting video primitives; and  
10 code segments for extracting event occurrences from the video primitives.
3. A computer-readable medium as in claim 2, wherein the event occurrences are extracted using event discriminators.
- 15 4. A computer-readable medium as in claim 2, further comprising code segments for archiving the extracted video primitives.
5. A computer-readable medium as in claim 2, further comprising code segments for undertaking a response based on extracted event occurrences.  
20
6. A computer-readable medium as in claim 5, wherein the response comprises initiating another sensor system.
7. A computer-readable medium as in claim 1, further comprising code segments for calibrating the video surveillance system.  
25
8. A computer-readable medium as in claim 7, wherein the code segments for calibrating comprise code segments for self-calibrating the video surveillance system.
- 30 9. A computer-readable medium as in claim 8, wherein the code segments for self-calibrating comprise:  
code segments for detecting as least one object in a source video; and  
code segments for tracking the object.



10. A computer-readable medium as in claim 9, wherein the code segments for detecting at least one object comprise:

5 code segments for detecting at least one object via motion of the object; and  
code segments for detecting at least one object via change in a background model.

11. A computer-readable medium as in claim 7, wherein the code segments for self-calibrating comprise:

10 code segments for identifying trackable areas; and  
code segments for identifying typical sizes of typical objects.

12. A computer-readable medium as in claim 7, wherein the code segments for calibrating comprise:

15 code segments for manual calibration;  
code segments for semi-automatic calibration; and  
code segments for automatic calibration.

13. A computer-readable medium as in claim 1, further comprising code  
20 segments for tasking the video surveillance system with event discriminators.

14. A computer-readable medium as in claim 13, wherein the code segments for tasking comprise code segments for identifying at least one object.

25 15. A computer-readable medium as in claim 13, wherein the code segments for tasking comprise code segments for identifying at least one spatial area.

16. A computer-readable medium as in claim 13, wherein the code segments for tasking comprise code segments for identifying at least one temporal attribute.

30

17. A computer-readable medium as in claim 13, wherein the code segments for tasking identify at least one interaction.

18. A computer-readable medium as in claim 13, wherein the code segments for tasking identify at least one alarm.

5 19. A computer-readable medium as in claim 1, wherein the video primitives are from at least one of a video sensor and another sensor.

20. A computer-readable medium as in claim 1, wherein the video primitives are  
retrieved from an archive of video primitives.

10

21. A computer system comprising the computer-readable medium of claim 1.

22. A computer-readable medium comprising software for a video surveillance system, comprising:

15

code segments for accessing archived video primitives; and

code segments for extracting event occurrences from accessed archived video primitives.

20

23. A computer-readable medium as in claim 22, wherein the event occurrences are extracted using event discriminators.

24. A computer-readable medium as in claim 22, further comprising code segments for undertaking a response based on extracted event occurrences.

25

25. A method comprising the step of operating a video surveillance system based on video primitives.

26. A method comprising the steps of:

accessing archived video primitives; and

30

extracting event occurrences from accessed video primitives.

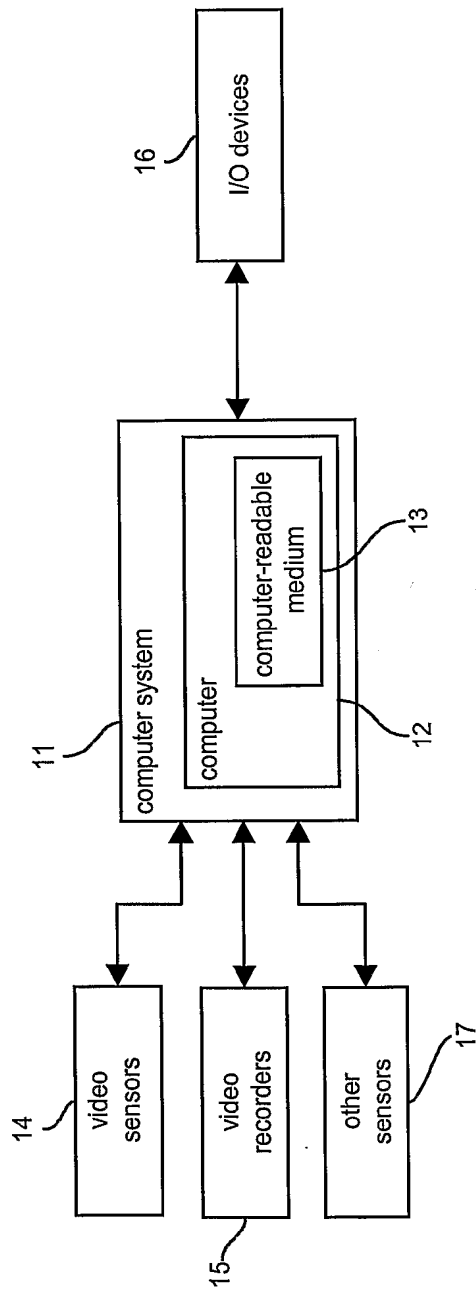

FIG. 1

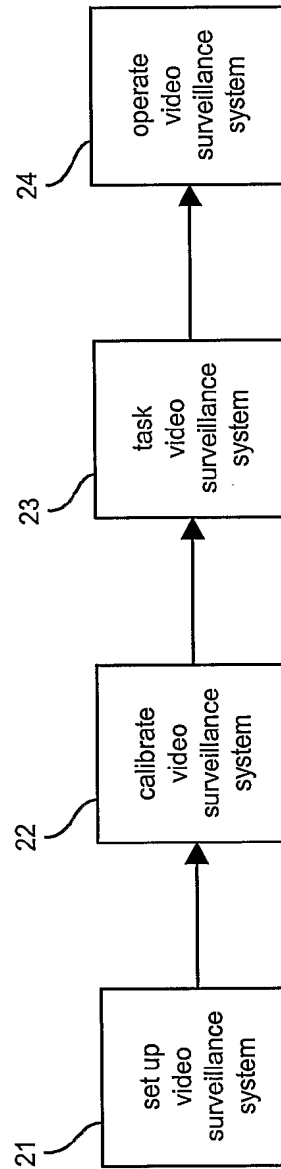

FIG. 2

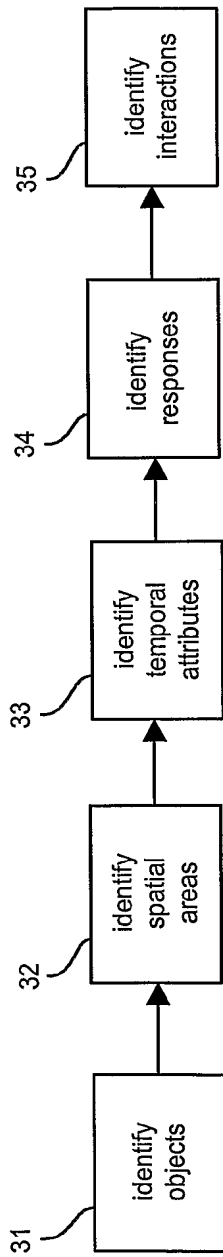

FIG. 3

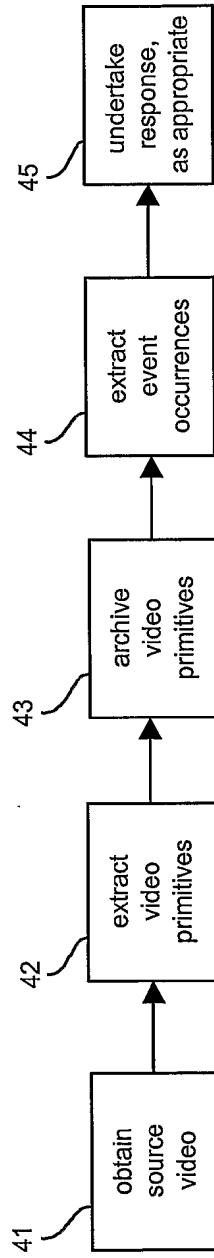

FIG. 4

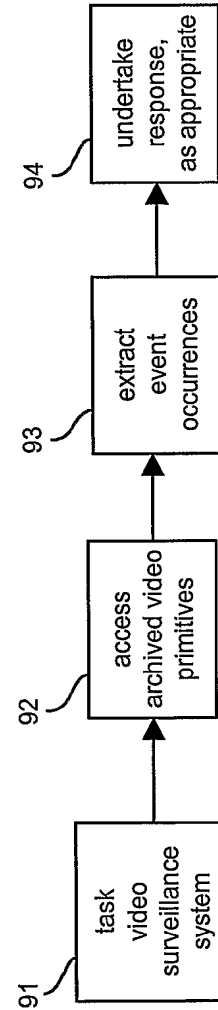

FIG. 9

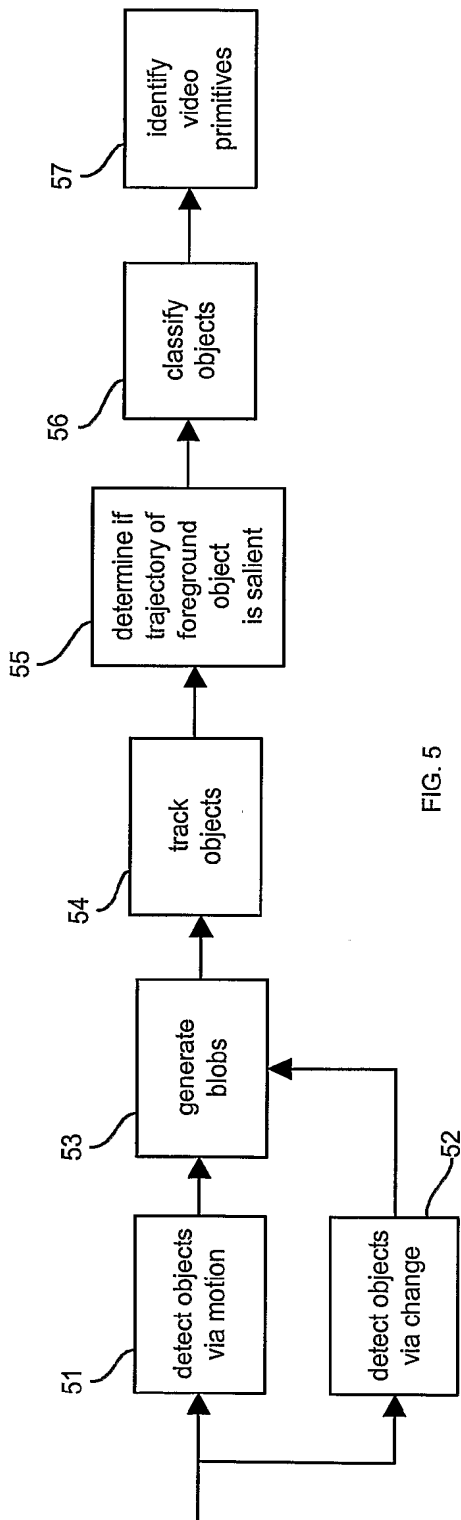

FIG. 5

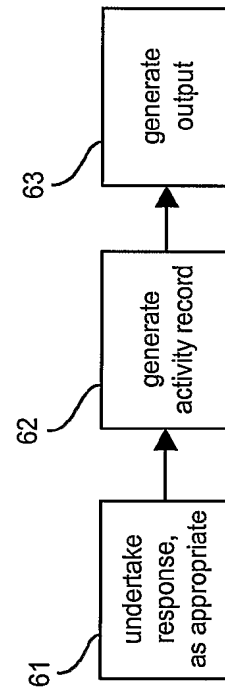

FIG. 6

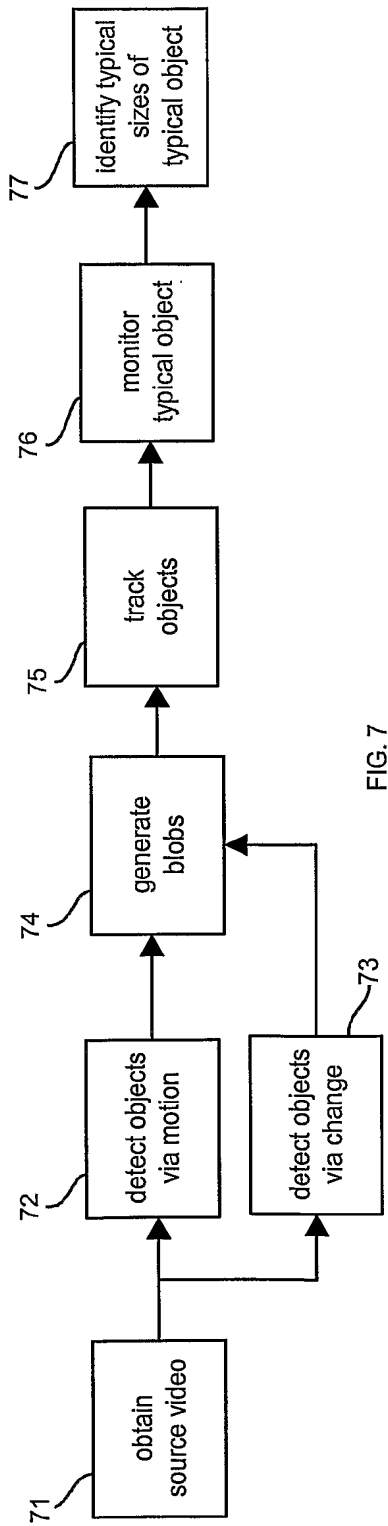

FIG. 7

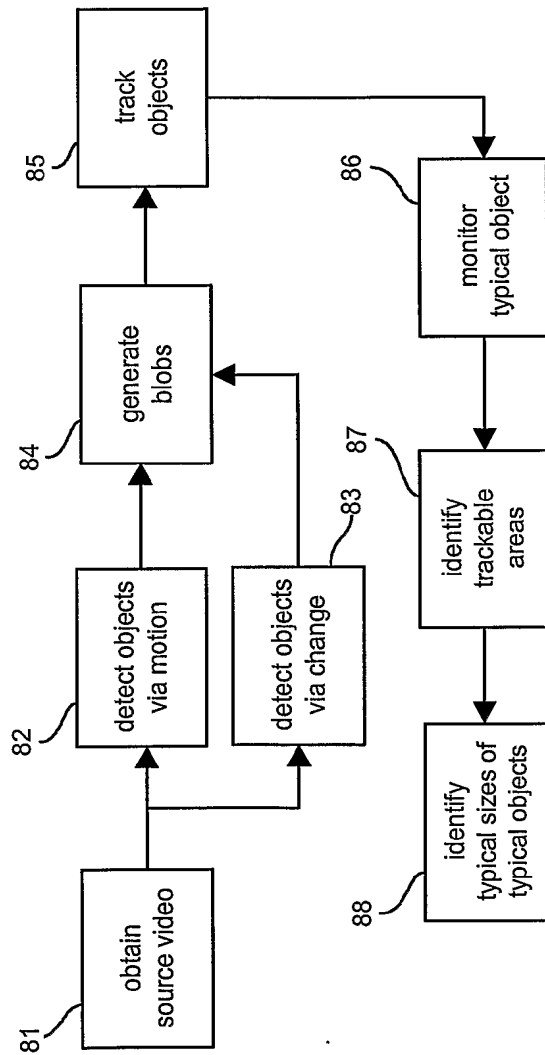

FIG. 8

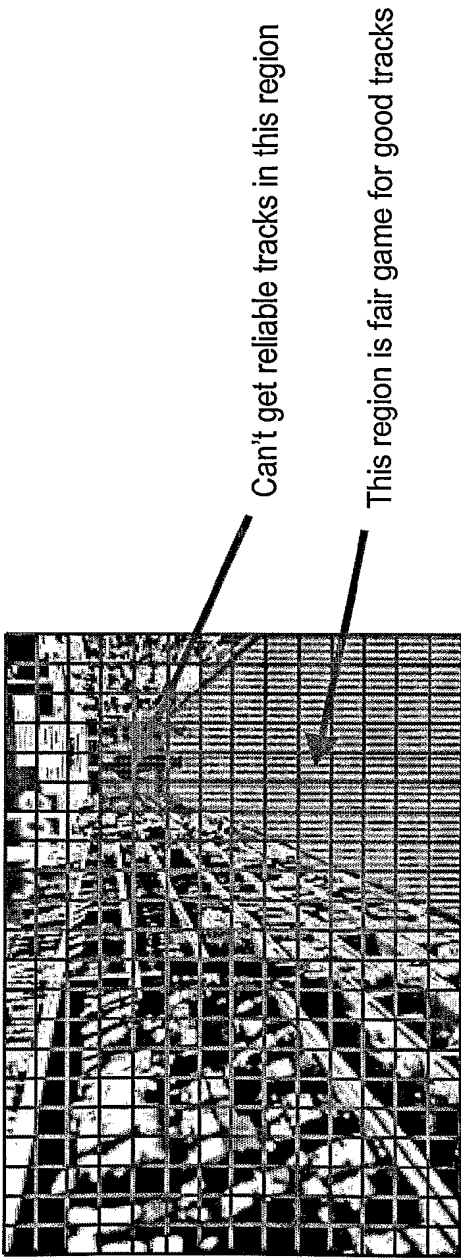

FIG. 10

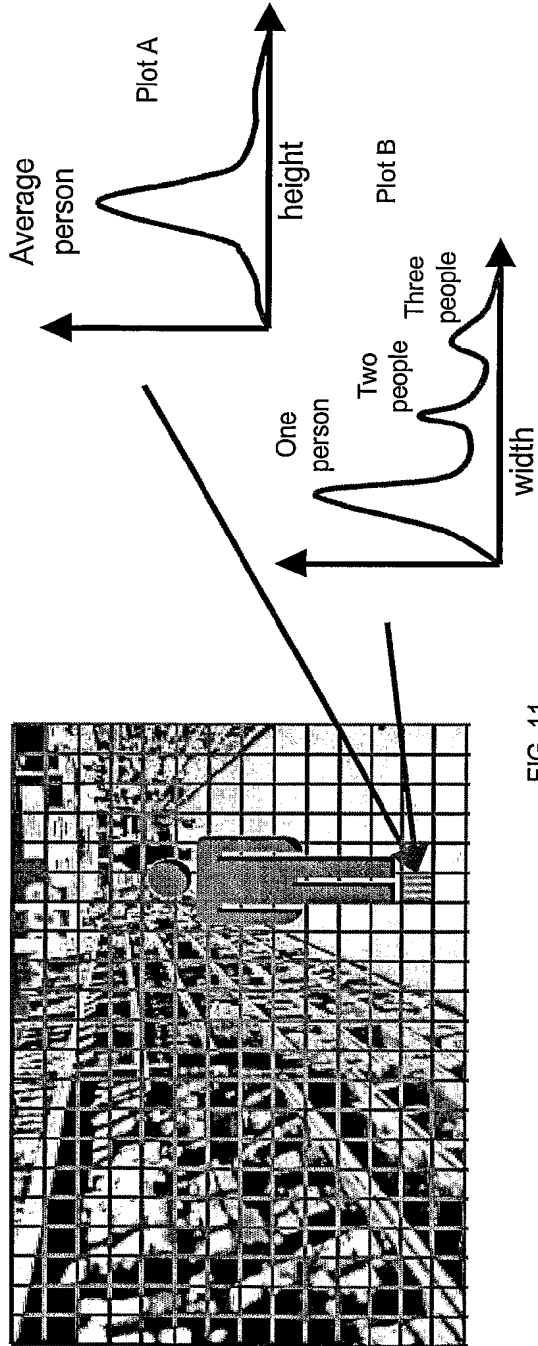

FIG. 11

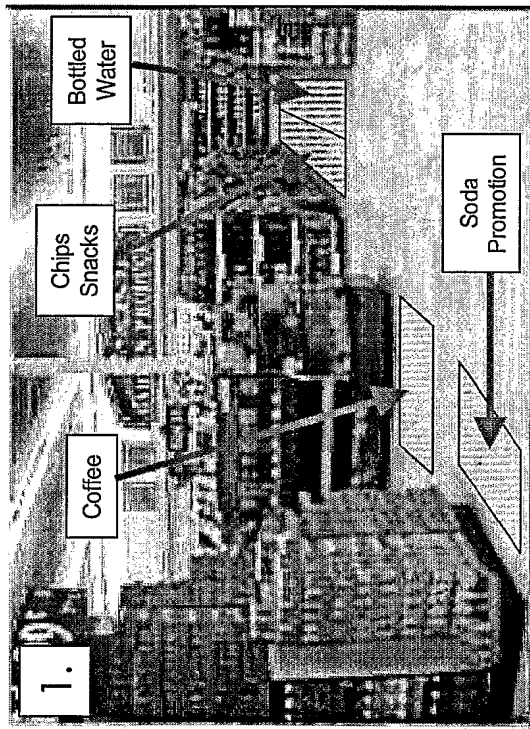

FIG. 12

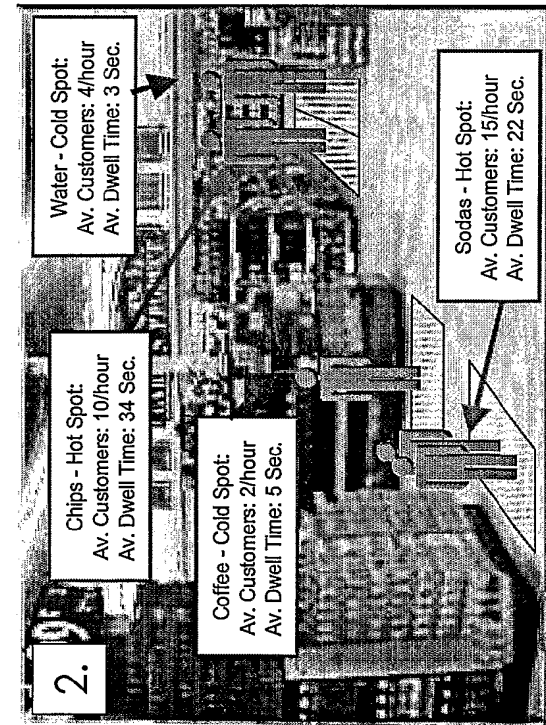

FIG. 13

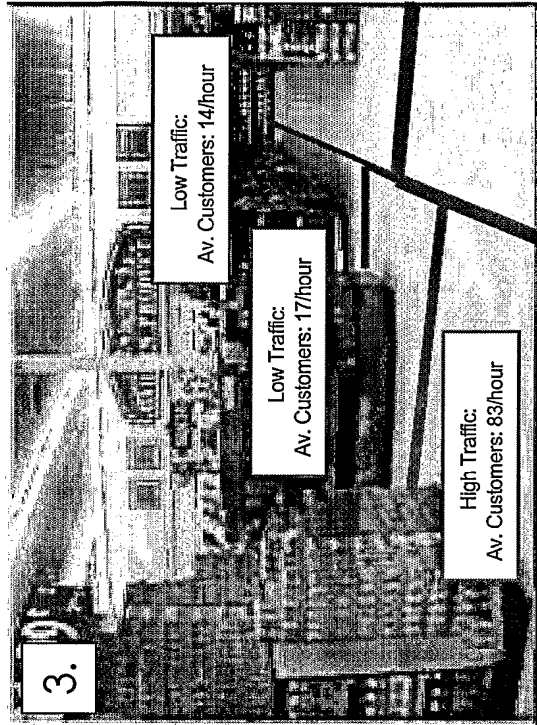
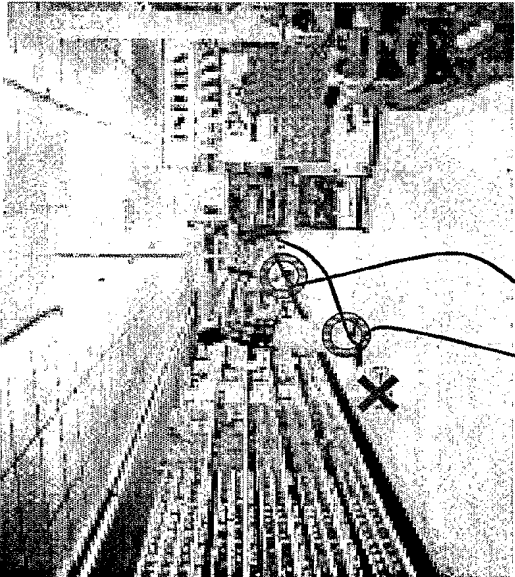

FIG. 14





- Person ID 1032:
  - Spent 52s in area
  - Spent 18s at point ○
- Person ID 1033:
  - Spent 1:08s in area
  - Spent 12s at point ○
- Object ID 32001:
  - Not a person

FIG. 15

**INTERNATIONAL SEARCH REPORT**

International application No.

PCT/US02/22688

<b>A. CLASSIFICATION OF SUBJECT MATTER</b>		
IPC(7) : G06K 9/62; H04N 7/18		
US CL : 348/143; 382/224; 707/104.1		
According to International Patent Classification (IPC) or to both national classification and IPC		
<b>B. FIELDS SEARCHED</b>		
Minimum documentation searched (classification system followed by classification symbols) U.S. : 348/143; 382/224; 707/104.1		
Documentation searched other than minimum documentation to the extent that such documents are included in the fields searched		
Electronic data base consulted during the international search (name of data base and, where practicable, search terms used)		
<b>C. DOCUMENTS CONSIDERED TO BE RELEVANT</b>		
Category *	Citation of document, with indication, where appropriate, of the relevant passages	Relevant to claim No.
A	US 6,014,461 A (HENNESSEY et al.) 11 January 2000 (11.01.2000), Fig. 2.	1-26
A	US 6,144,375 A (JAIN et al.) 07 November 2000 (07.11.2000), Fig. 3.	1-26
<input type="checkbox"/> Further documents are listed in the continuation of Box C. <input type="checkbox"/> See patent family annex.		
* Special categories of cited documents:		
"A"	document defining the general state of the art which is not considered to be of particular relevance	"T" later document published after the international filing date or priority date and not in conflict with the application but cited to understand the principle or theory underlying the invention
"E"	earlier application or patent published on or after the international filing date	"X" document of particular relevance; the claimed invention cannot be considered novel or cannot be considered to involve an inventive step when the document is taken alone
"L"	document which may throw doubts on priority claim(s) or which is cited to establish the publication date of another citation or other special reason (as specified)	"Y" document of particular relevance; the claimed invention cannot be considered to involve an inventive step when the document is combined with one or more other such documents, such combination being obvious to a person skilled in the art
"O"	document referring to an oral disclosure, use, exhibition or other means	
"P"	document published prior to the international filing date but later than the priority date claimed	"&" document member of the same patent family
Date of the actual completion of the international search 05 December 2002 (05.12.2002)		Date of mailing of the international search report <b>11 DEC 2002</b>
Name and mailing address of the ISA/US Commissioner of Patents and Trademarks Box PCT Washington, D.C. 20231 Facsimile No. (703)305-3230		Authorized officer Howard W. Britton <i>Rugenia Logan</i> Telephone No. 703-305-4700

Form PCT/ISA/210 (second sheet) (July 1998)

(19) World Intellectual Property  
Organization  
International Bureau



(43) International Publication Date  
15 January 2004 (15.01.2004)

PCT

(10) International Publication Number  
WO 2004/006184 A2

- (51) International Patent Classification<sup>7</sup>: G06T 7/00 CZ, DE, DK, DM, DZ, EC, EE, ES, FI, GB, GD, GE, GH, GM, HR, HU, ID, IL, IN, IS, JP, KE, KG, KP, KR, KZ, LC, LK, LR, LS, LT, LU, LV, MA, MD, MG, MK, MN, MW, MX, MZ, NI, NO, NZ, OM, PG, PH, PL, PT, RO, RU, SC, SD, SE, SG, SK, SL, SY, TJ, TM, TN, TR, TT, TZ, UA, UG, US, UZ, VC, VN, YU, ZA, ZM, ZW.
- (21) International Application Number: PCT/IL2003/000555
- (22) International Filing Date: 3 July 2003 (03.07.2003)
- (25) Filing Language: English
- (26) Publication Language: English
- (30) Priority Data: 60/394,205 5 July 2002 (05.07.2002) US
- (71) Applicants and
- (72) Inventors: TALMON, Gad [IL/IL]; 9/18 Yigal Alon Street, 55030 Kiryat Ono (IL). ASHANI, Zvi [IL/IL]; 16 HaCarmel Street, 55900 Ganei Tikva (IL).
- (81) Designated States (national): AE, AG, AL, AM, AT, AU, AZ, BA, BB, BG, BR, BY, BZ, CA, CH, CN, CO, CR, CU,
- (84) Designated States (regional): ARIPO patent (GH, GM, KE, LS, MW, MZ, SD, SL, SZ, TZ, UG, ZM, ZW), Eurasian patent (AM, AZ, BY, KG, KZ, MD, RU, TJ, TM), European patent (AT, BE, BG, CH, CY, CZ, DE, DK, EE, ES, FI, FR, GB, GR, HU, IE, IT, LU, MC, NL, PT, RO, SE, SI, SK, TR), OAPI patent (BF, BJ, CF, CG, CI, CM, GA, GN, GQ, GW, ML, MR, NE, SN, TD, TG).

**Published:**

— without international search report and to be republished upon receipt of that report

For two-letter codes and other abbreviations, refer to the "Guidance Notes on Codes and Abbreviations" appearing at the beginning of each regular issue of the PCT Gazette.



WO 2004/006184 A2

(54) Title: A METHOD AND SYSTEM FOR EFFECTIVELY PERFORMING EVENT DETECTION IN A LARGE NUMBER OF CONCURRENT IMAGE SEQUENCES

(57) Abstract: Method and system for performing event detection and object tracking in image streams by installing in field, a set of image acquisition devices, where each device includes a local programmable processor for converting the acquired image stream that consist of one or more images, to a digital format, and a local encoder for generating features from the image stream. These features are parameters that are related to attributes of objects in the image stream. The encoder also transmits a feature stream, whenever the motion features exceed a corresponding threshold. Each image acquisition device is connected to a data network through a corresponding data communication channel. An image processing server that determines the threshold and processes the feature stream is also connected to the data network. Whenever the server receives features from a local encoder through its corresponding data communication channel and the data network, the server provides indications regarding events in the image streams by processing the feature stream and transmitting these indications to an operator.

**A METHOD AND SYSTEM FOR EFFECTIVELY PERFORMING  
EVENT DETECTION IN A LARGE NUMBER OF CONCURRENT  
IMAGE SEQUENCES**

**Field of the Invention**

The present invention relates to the field of video processing. More particularly, the invention relates to a method and system for obtaining meaningful knowledge, in real time, from a plurality of concurrent compressed image sequences, by effective processing of a large number of concurrent incoming image sequences and/or features derived from the acquired images.

**Background of the Invention**

Many efforts have been spent to improve the ability to extract meaningful data out of images captured by video and still cameras. Such abilities are being used in several applications, such as consumer, industrial, medical, and business applications. Many cameras are deployed in the streets, airports, schools, banks, offices, residencies – as standard security measures. These cameras are used either for allowing an operator to remotely view security events in real time, or for recording and analyzing a security event at some later time.

The introduction of new technologies is shifting the video surveillance industry into new directions that significantly enhance the functionality of such systems. Several processing algorithms are used both for real-time and offline applications. These algorithms are implemented on a range of platforms from pure software to pure hardware, depending on the application. However, these platforms are usually designed to simultaneously process a relatively small number of incoming image

- 2 -

sequences, due to the substantial computational resources required for image processing. In addition, most of the common image processing systems are designed to process only uncompressed image data, such as the system disclosed in U.S. Patent 6,188,381. Modern networked video environments require efficient processing capability of a large number of compressed video streams, collected from a plurality of image sources.

Increasing operational demands, as well as cost constraints created the need for automation of event detection. Such event detection solutions provide a higher detection level, save manpower, replace other types of sensors and lower false alarm rates.

Although conventional solutions are available for automatic intruder detection, license plate identification, facial recognition, traffic violations detection and other image based applications, they usually support few simultaneous video sources, using expensive hardware platforms that require field installation, which implies high installation, maintenance and upgrade costs.

Conventional surveillance systems employ digital video networking technology and automatic event detection. Digital video networking is implemented by the development of Digital Video Compression technology and the availability of IP based networks. Compression standards, such as MPEG-4 and similar formats allow transmitting high quality images with a relatively narrow bandwidth.

A major limiting factor when using digital video networking is bandwidth requirements. Because it is too expensive to transmit all the cameras all

- 3 -

the time, networks are designed to concurrently transmit data, only from few cameras. The transmission of data only from cameras that are capturing important events at any given moment is crucial for establishing an efficient and cost-effective digital video network.

Automatic video-based event detection technology becomes effective for this purpose. This technology consists of a series of algorithms that are able to analyze the camera image in real time and provide notification of a special event, if it occurs. Currently available event-detection solutions use conventional image processing methods, which require heavy processing resources. Furthermore, they allocate a fixed processing power (usually one processor) per each camera input. Therefore, such systems either provide poor performance due to resources limitation or are extremely expensive.

As a result, the needs of large-scale digital surveillance installations – namely, reliable detection, effective bandwidth usage, flexible event definition, large-scale design and cost, cannot be met by any of the current automatic event detection solutions.

Video Motion Detection (VMD) methods are disclosed, for example, in U.S. Patent 6,349,114, WO 02/37429, in U.S. Patent Application Publication 2002,041,626, in U.S. Patent Application Publication No. 2002,054,210, in WO 01/63937, in EP1107609, in EP1173020, in U.S. Patent 6,384,862, in U.S. Patent 6,188,381, in U.S. Patent 6,130,707, and in U.S. Patent 6,069,655. However, all the methods described above have not yet provided satisfactory solutions to the problem of effectively obtaining meaningful knowledge, in real time, from a plurality of concurrent image sequences.

- 4 -

It is an object of the present invention to provide a method and system for obtaining meaningful knowledge, from a plurality of concurrent image sequences, in real time.

It is another object of the present invention to provide a method and system for obtaining meaningful knowledge, from a plurality of concurrent image sequences, which are cost effective.

It is a further object of the present invention to provide a method and system for obtaining meaningful knowledge, from a plurality of concurrent image sequences, with reduced amount of bandwidth resources.

It is still another object of the present invention to provide a method and system for obtaining meaningful knowledge, from a plurality of concurrent image sequences, which is reliable, and having high sensitivity in noisy environments.

It is yet another object of the present invention to provide a method and system for obtaining meaningful knowledge, from a plurality of concurrent image sequences, with reduced installation and maintenance costs.

Other objects and advantages of the invention will become apparent as the description proceeds.

#### **Summary of the Invention**

While these specifications discuss primarily video cameras, a person skilled in the art will recognize that the invention extends to any appropriate image source, such as still cameras, computer generated images, pre-recorded video data, and the like, and that image sources

- 5 -

should be equivalently considered. Similarly, the terms video and video stream, should be construed broadly to include video sequences, still pictures, computer generated graphics, or any other sequence of images provided or converted to an electronic format that may be processed by a computer.

The present invention is directed to a method for performing event detection and object tracking in image streams. A set of image acquisition devices is installed in field, such that each device comprises a local programmable processor for converting the acquired image stream, that consists of one or more images, to a digital format, and a local encoder, for generating features from the image stream. The features are parameters that are related to attributes of objects in the image stream. Each device transmits a feature stream, whenever the number and type of features exceed a corresponding threshold. Each image acquisition device is connected to a data network through a corresponding data communication channel. An image processing server connected to the data network determines the threshold and processes the feature stream. Whenever the server receives features from a local encoder through its corresponding data communication channel and the data network, the server obtains indications regarding events in the image streams by processing the feature stream and transmitting the indications to an operator.

The local encoder may be a composite encoder, which is a local encoder that further comprises circuitry for compressing the image stream. The composite encoder may operate in a first mode, during which it generates and transmits the features to the server, and in a second mode, during which it transmits to the server, in addition to the features, at least a portion of the image stream in a desired compression level, according to



- 6 -

commands sent from the server. Preferably, each composite encoder is controlled by a command sent from the server, to operate in its first mode. As long as the server receives features from a composite encoder, that composite encoder is controlled by a command sent from the server, to operate in its second mode. The server obtains indications regarding events in the image streams by processing the feature stream, and transmitting the indications and/or their corresponding image streams to an operator.

Whenever desired one or more compressed image streams containing events are decoded by the operator station, and the decoded image streams are transmitted to the display of an operator, for viewing. Compressed image streams obtained while their local encoder operates in its second mode may be recorded.

Preferably, additional image processing resources, in the server, are dynamically allocated to data communication channels that receive image streams. Feature streams obtained while operating in the first mode may comprise only a portion of the image.

A graphical polygon that encompasses an object of interest, being within the frame of an image or an AOI (Area Of Interest) in the image may be generated by the server and displayed to an operator for viewing. In addition, the server may generate and display a graphical trace indicating the history of movement of an object of interest, being within the frame of an image or an AOI in the image.

The image stream may be selected from the group of images that comprises video streams, still images, computer generated images, and pre-recorded digital, analog video data, or video streams, compressed

- 7 -

using MPEG format. The encoder may use different resolution and frame rate during operation in each mode.

Preferably, the features may include motion features, color, portions of the image, edge data and frequency related information.

The server may perform, using a feature stream, received from the local encoder of at least one image acquisition device, one or more of the following operations and/or any combination thereof:

- License Plate Recognition (LPR);
- Facial Recognition (FR);
- detection of traffic rules violations;
- behavior recognition;
- fire detection;
- traffic flow detection;
- smoke detection.

The present invention is also directed to a system for performing event detection and object tracking in image streams, that comprises:

- a) a set of image acquisition devices, installed in field, each of which includes:
  - a.1) a local programmable processor for converting the acquired image stream, to a digital format
  - a.2) a local encoder, for generating, from the image stream, features, being parameters related to attributes of objects in the image stream, and for transmitting a feature stream, whenever the motion features exceed a corresponding threshold;
- b) a data network, to which each image acquisition device is connected through a corresponding data communication channel;

- 8 -

c); and

d) an image processing server connected to the data network, the server being capable of determining the threshold, of obtaining indications regarding events in the image streams by processing the feature stream, and of transmitting the indications to an operator.

The system may further comprise an operator display, for receiving and displaying one or more image streams that contain events, as well as a network video recorder for recording one or more image streams, obtained while their local encoder operates in its first mode.

#### **Brief Description of the Drawings**

The above and other characteristics and advantages of the invention will be better understood through the following illustrative and non-limitative detailed description of preferred embodiments thereof, with reference to the appended drawings, wherein:

Fig. 1 schematically illustrates the structure of a surveillance system that comprises a plurality of cameras connected to a data network, according to a preferred embodiment of the invention;

Fig. 2 illustrates the use of AOFs (Area of Interest) for designating areas where event detection will be performed and for reducing the usage of system resources, according to a preferred embodiment of the invention; and

Figs. 3A to 3C illustrate the generation of an object of interest and its motion trace, according to a preferred embodiment of the invention.

#### **Detailed Description of Preferred Embodiments**

A significant saving in system resources can be achieved by applying novel data reduction techniques, proposed by the present invention. In a

- 9 -

situation where thousands of cameras are connected to a single server, only a small number of the cameras actually acquire important events that should be analyzed. A large-scale system can function properly only if it has the capability of identifying the inputs that may contain useful information and perform further processing only on such inputs. Such a filtering mechanism requires minimal processing and bandwidth resources, so that it is possible to apply it concurrently on a large number of image streams. The present invention proposes such a filtering mechanism, called Massively Concurrent Image Processing (MCIP) technology that is based on the analysis of incoming image sequences and/or feature streams, derived from the acquired images, so as to fulfill the need for automatic image detection capabilities in a large-scale digital video network environment.

MCIP technology combines diverse technologies such as large scale data reduction, effective server design and optimized image processing algorithms, thereby offering a platform that is mainly directed to the security market and is not rivaled by conventional solutions, particularly with vast numbers of potential users. MCIP is a networked solution for event detection in distributed installations, which is designed for large scale digital video surveillance networks that concurrently support thousands of camera inputs, distributed in an arbitrarily large geographical area and with real time performance. MCIP employs a unique feature transmission method that consumes narrow bandwidth, while maintaining high sensitivity and probability of detection. MCIP is a server-based solution that is compatible with modern monitoring and digital video recording systems and carries out complex detection algorithms, reduces field maintenance and provides improved scalability, high availability, low cost per channel and backup utilities. The same

- 10 -

system provides concurrently multiple applications such as VMD, LPR and FR. In addition, different detection applications may be associated with the same camera.

MCIP is composed of a server platform with various applications, camera encoders (either internal or external to the camera), a Network Video Recorder (NVR) and an operator station. The server contains a computer that includes proprietary hardware and software components. MCIP is based on the distribution of image processing algorithms between low-level feature extraction, which is performed by the encoders which are located in field (i.e., in the vicinity of a camera), and high-level processing applications, which are performed by a remote central server that collects and analyzes these features.

The MCIP system described hereafter solves not only the bandwidth problem but also reduces the load from the server and uses a unique type of data stream (not a digital video stream), and performs an effective process for detecting events at real time, in a large scale video surveillance environment.

A major element in MCIP is data reduction, which is achieved by the distribution of the image processing algorithms. Since all the video sources, which require event detection, transmit concurrently, the required network bandwidth is reduced by generating a reduced bandwidth feature stream in the vicinity of each camera. In order to detect and track moving objects in digitally transmitted video sources by analyzing the transmitted reduced bandwidth feature, there is no need to

- 11 -

transmit full video streams, but only partial data, which contains information regarding moving objects.

By doing so, a significantly smaller data bandwidth is used, which reduces the demands for both the network bandwidth and the event detection processing power. Furthermore, if only the shape, size, direction of movement and velocity should be detected, there is no need to transmit data regarding their intensity or color, and thus, a further bandwidth reduction is achieved. Another bandwidth optimization may be achieved if the encoder in the transmitting side filters out all motions which are under a motion threshold, determined by the remote central server. Such threshold may be the AC level of a moving object, motion distance or any combination thereof, and may be determined and changed dynamically, according to the attributes of the acquired image, such as resolution, AOI, compression level, etc. Moving objects which are under the threshold are considered either as noise, or non-interesting motions.

One method for extracting features at the encoder side is by slightly modifying and degrading existing temporal-based video compressors which were originally designed to transmit digital video. The features may also be generated by a specific feature extraction algorithm (such as any motion vector generating algorithm) that is not related to the video compression algorithm. When working in this reduced bandwidth mode, the output streams of these encoders are definitely not a video stream, and therefore cannot not be used by any receiving party to produce video images.

Fig. 1 schematically illustrates the structure of a surveillance system that comprises a plurality of cameras connected to a data network, according to a preferred embodiment of the invention. The system 100 comprises n

- 12 -

image sources (in this example, n cameras, CAM1,....,CAMn), each of which connected to a digital encoder ENC<sub>j</sub>, for converting the images acquired by CAM<sub>j</sub> to a compressed digital format. Each digital encoder ENC<sub>j</sub> is connected to a digital data network 101 at point p<sub>j</sub> and being capable of transmitting data, which may be a reduced bandwidth feature stream or a full compressed video stream, through its corresponding channel C<sub>j</sub>. The data network 101 collects the data transmitted from all channels and forwards them to the MCIP server 102, through data-bus 103. MCIP server 102 processes the data received from each channel and controls one or more cameras which transmit any combination of the reduced bandwidth feature stream and the full compressed video stream, which can be analyzed by MCIP server 102 in real time, or recorded by NVR 104 and analyzed by MCIP server 102 later. An operator station 105 is also connected to MCIP server 102, for real time monitoring of selected full compressed video streams. Operator station 105 can manually control the operation of MCIP server 102, whenever desired.

The MCIP (Massively Concurrent Image Processing) server is connected to the image sources (depicted as cameras in the drawing, but may also be any image source, such taped video, still cameras, video cameras, computer generated images or graphics, and the like.) through data-bus 103 and network 101, and receives features or images in a compressed format. In the broadest sense this is any type of network, wired or wireless. The images can be compressed using any type of compression. Practically, IP based networks are used, as well as compression schemes that use DCT, VideoLAN Client (VLC, which is a highly portable multimedia player for various audio and video formats as well as Digital Versatile Discs (DVDs), Video Compact Discs (VCDs), and various streaming protocols, disclosed in WO 01/63937) and motion estimation techniques such as MPEG.

- 13 -

The system 100 uses an optional load-balancing module that allows it to easily scale the number of inputs that can be processed and also creates the ability to remove a single point of failure, by creating backup MCIP servers. The system 100 also has a configuration component that is used for defining the type of processing that should be performed for each input and the destination of the processing results. The destination can be another computer, an email address, a monitoring application, or any other device that is able to receive textual and/or visual messages.

The system can optionally be connected to an external database to assist image processing. For example, a database of suspect, stolen cars, of license plate numbers can be used for identifying vehicles.

Fig. 2 illustrates the use of AOI's (Area of Interest) for reducing the usage of system resources, according to a preferred embodiment of the invention. An AOI is a polygon (in this Fig., an hexagon) that encloses the area where detection will occur. The rectangles indicate the estimated object size at various distances from the camera. In this example, the scene of interest comprises detection movement of a person in a field (shown in the first rectangle). It may be used in the filtering unit to decide if further processing is required. In this case, the filtering unit examines the feature data. The feature stream is analyzed to determine if enough significant features lie within the AOI. If the number of features that are located inside the AOI and comprise changes, exceeds the threshold, then this frame is designated as possibly containing an event and is transferred for further processing. Otherwise, the frame is dropped and no further processing is performed.



- 14 -

The MCIP server receives the reduced bandwidth feature stream (such a feature stream is not a video stream at all, and hence, no viewable image can be reconstructed thereof) from all the video sources which require event detection. When an event is detected within a reduced bandwidth stream that is transmitted from a specific video source, the central server may instruct this video source to change its operation mode to a **video stream mode**, in which that video source may operate as a regular video encoder and transmits a standard video stream, which may be decoded by the server or by any receiving party for observation, recording, further processing or any other purpose. Optionally the video encoder also continues transmitting the feature stream at the same time.

Working according to this scheme, most of the video sources remain in the **reduced bandwidth mode**, while transmitting a narrow bandwidth data stream, yet sufficient to detect events with high resolution and frame rate at the MCIP server. Only a very small portion of the sources (in which event is detected) are controlled to work concurrently in the **video stream mode**. This results in a total network bandwidth, which is significantly lower than the network bandwidth required for concurrently transmitting from all the video sources.

For example, if a conventional video surveillance installation that uses 1000 cameras, a bandwidth of about 500Kbp/s is needed by each camera, in order to transmit at an adequate quality. In the reduced bandwidth mode, only about 5Kbp/s is required by each camera for the transmission of information regarding moving objects at the same resolution and frame rate. Therefore, all the cameras working in this mode are using a total bandwidth of 5Kbp/s times 1000 = 5Mbp/s. Assuming that at steady state

- 15 -

suspected objects appear in 1% of the cameras (10 cameras) and they are working in video stream mode, extra bandwidth of 10 times 500Kbp/s = 5Mbp/s is required. Thus, the total required network bandwidth using the solution proposed by the present invention is 10Mbp/s. A total required network bandwidth of 500Mbp/s would be consumed by conventional systems, if all the 1000 cameras would concurrently transmit video streams.

The proposed solution may be applicable not only for high-level moving objects detection and tracking in live cameras but also in recorded video. Huge amounts of video footage are recorded by many surveillance systems. In order to detect interesting events in this recorded video, massive processing capabilities are needed. By converting recorded video, either digital or analog, to a reduced bandwidth stream according to the techniques described above, event detection becomes much easier, with lower processing requirements and faster operation.

The system proposed in the present invention comprises the following components:

1. One or more MCIP servers
2. One or more dual mode video encoders, which may be operated at reduced bandwidth mode or at video stream mode, according to remote instructions.
3. Digital network, LAN or WAN, IP or other, which establishes communication between the system components.
4. One or more operator stations, by which operators may define events criteria and other system parameters and manage events in real time.

- 16 -

5. An optional Network Video Recorder (NVR), which is able to record and play, on demand, any selected video source which is available on the network.

Implementation for security applications:

Following is a partial list of types of image processing applications which can be implemented very effectively using the method proposed by the present invention:

Video Motion Detection – for both indoor and outdoor applications. Such application is commonly used to detect intruders to protected zones. It is desired to ignore nuisances such as moving trees, dust and animals. In this embodiment of the present invention manipulates input images at the stream level in order to filter out certain images and image changes. Examples of such filtering are motion below a predetermined threshold, size or speed related filtering all preferably applied within the AOIs, thus reducing significantly the amount of required system resources for further processing. Since the system is server-based and there is no need for installation of equipment in the field (except the camera), this solution is very attractive for low budget application such as in the residential market.

Exceptional static objects detection -. this application is used to detect static objects where such objects may require an alarm, By way of example, such objects may comprise an unattended bag at the airport, a stopped car on a highway, a person stopped at a protected location and the like. In this embodiment the present invention manipulates the input images at the stream level and examines the motion vectors at the AOIs. Objects that stopped moving are further processed.

- 17 -

License Plate Recognition - this application is used for vehicles access control, stolen or suspected car detection and parking automation. In this embodiment, it is possible to detect wanted cars using hundreds or more cameras installed in the field, thus providing a practical detection solution.

Facial Recognition - this application is desired for biometric verification or detection device, for tasks such as locating criminals or terrorists and for personal access control purposes. Using this embodiment offers facial recognition capability to many cameras in the field. This is a very useful tool for large installations such as airports and public surveillance.

Smoke and flames detection - this application is used for fire detection. Using this embodiment of the invention, all the sites equipped with cameras may receive this service in addition to other application without any installation of smoke or flame detectors.

Traffic violations - this application detect a variety of traffic violation such as red light crossing, separation line crossing, parking or stopping at forbidden zone and the like. Using this embodiment, this functionality may be applied for many cameras located along roads and intersections, thus significantly optimizing police work.

Traffic flow analysis - this application is useful for traffic centers by automatically detecting any irregular traffic events such as traffic obstacles, accidents, too slow or too fast or too crowded traffic and the like. Using this embodiment, traffic centers may use many cameras located as desired at the covered area in order to provide a significantly better control level.

- 18 -

Suspicious vehicle or person tracking - this application is used to track objects of interest. This is needed to link a burglar to an escape car, locate a running suspect and more. Using this embodiment, this functionality may be associated with any selected camera or cameras in the field.

It should be noted that each of those applications or their combination may each be considered as a separate embodiment of the invention, all while using the basic structure contemplated herein, while specific embodiments may utilize specialized components. Selection of such component and the combination of features and applications provided herein is a matter of technical choice that will be clear to those skilled in the art.

Figs. 3A to 3C illustrate the generation of an object of interest and its motion trace, according to a preferred embodiment of the invention. Fig. 3A is an image of a selected AOI (in this example, an elongated zone, in which the presence of any person is forbidden), on which the MCIP server 102 generates an object, which is determined according to predefined size and motion parameters, received from the corresponding encoder. The object encompasses the body of a person, penetrating into the forbidden zone and walking from right to left. The motion parameters are continuously updated, such that the center of the object is tracked. The MCIP server 102 generates a trace (solid line) that provides a graphical indication regarding his motion within the forbidden zone. Fig. 3B is an image of the same selected AOI, on which the MCIP server 102 generates the object and the trace (solid line) that provides a graphical indication regarding his motion within the forbidden zone from left to right and more closely to the camera. Fig. 3C is an image of the same selected AOI, on which the MCIP server 102 generates the object and the trace (solid line) that provides a graphical indication regarding his motion within the

- 19 -

forbidden zone again from right to left and more closely to the camera. The filtration performed by the corresponding encoder prevents the generation of background movements, such as tree-tops and lower vegetation, which are considered as background noise.

The above examples and description have of course been provided only for the purpose of illustration, and are not intended to limit the invention in any way. As will be appreciated by the skilled person, the invention can be carried out in a great variety of ways, employing more than one technique from those described above, all without exceeding the scope of the invention.

- 20 -

### CLAIMS

1. Method for performing event detection and object tracking in image streams, comprising:

a) installing in field, a set of image acquisition devices, each of which comprising a local programmable processor for converting the acquired image stream, consisting of one or more images, to a digital format, and a local encoder, for generating, from said image stream, features, being parameters related to attributes of objects in said image stream, and for transmitting a feature stream, whenever said motion features exceed a corresponding threshold;

b) connecting each image acquisition device to a data network through a corresponding data communication channel;

c) connecting an image processing server to said data network, said server being capable of determining said threshold, and of processing said feature stream; and

d) whenever said server receives features from a local encoder through its corresponding data communication channel and said data network, obtaining indications regarding events in said image streams by processing, by said server, said feature stream, and transmitting said indications to an operator.

2. Method according to claim 1, wherein the local encoder is a composite encoder, being the local encoder that further comprises circuitry for compressing the image stream, said composite encoder being capable of operating in a first mode, during which it generates and transmits the features to the server, and in a second mode, during which it transmits to said server, in addition to said features, at least a portion of said image stream in a desired compression level, according to commands sent from said server.

- 21 -

3. Method according to claim 2, further comprising, controlling each composite encoder, by a command sent from said server, to operate in its first mode; as long as the server receives features from a composite encoder:
- a) controlling that composite encoder, by a command sent from said server, to operate in its second mode; and
  - b) obtaining indications regarding events in said image streams by processing, by said server, said feature stream, and transmitting said indications and/or their corresponding image streams to an operator.
4. Method according to claim 1 or 2, further comprising decoding one or more compressed image streams containing events by said server, and transmitting the decoded image streams to the display of an operator, for viewing.
5. Method according to claim 1 or 2, further comprising recording one or more compressed image streams obtained while their local encoder operates in its second mode.
6. Method according to claim 1 or 2, further comprising dynamically allocating additional image processing resources, in the server, to data communication channels that receive image streams.
7. Method according to claim 1 or 2, wherein one or more feature streams obtained while operating in the first mode, comprises only a portion of the image.
8. Method according to claim 6, further comprising generating and displaying a graphical polygon that encompasses an object of interest, being within the frame of an image or an AOI in said image.



- 22 -

9. Method according to claim 8, further comprising generating and displaying a graphical trace indicating the history of movement of an object of interest, being within the frame of an image or an AOI in said image.

10. Method according to claim 1 or 2, wherein the image stream is selected from the group of images that comprises video streams, still images, computer generated images, and pre-recorded digital or analog video data.

11. Method according to claim 1 or 2, wherein the image streams are video streams, compressed using MPEG format.

12. Method according to claim 1 or 2, wherein during each mode, the encoder uses different resolution and frame rate.

13. Method according to claim 1 or 2, wherein the features are selected from the following group:

- motion features;
- color;
- portion of the image;
- edge data; and
- frequency related information.

14. Method according to claim 1 or 2, further comprising performing, by the server, one or more of the following operations and/or any combination thereof:

- License Plate Recognition (LPR);

- 23 -

- Facial Recognition (FR);
- detection of traffic rules violations;
- behavior recognition;
- fire detection;
- traffic flow detection;
- smoke detection,

using a feature stream, received from the local encoder of at least one image acquisition device, through its data communication channel.

15. System for performing event detection and object tracking in image streams, comprising:

a) a set of image acquisition devices, installed in field, each of which includes:

a.1) a local programmable processor for converting the acquired image stream, to a digital format

a.2) a local encoder, for generating, from said image stream, features, being parameters related to attributes of objects in said image stream, and for transmitting a feature stream, whenever said motion features exceed a corresponding threshold;

b) a data network, to which each image acquisition device is connected through a corresponding data communication channel;

c); and

d) an image processing server connected to said data network, said server being capable of determining said threshold, of obtaining indications regarding events in said image streams by processing said feature stream, and of transmitting said indications to an operator.

16. System according to claim 15, in which the local encoder is a composite encoder, being the local encoder that further comprises circuitry for compressing the image stream, said composite encoder being capable of

- 24 -

operating in a first mode, during which it generates and transmits the features to the server, and in a second mode, during which it transmits to said server, in addition to said features, at least a portion of said image stream in a desired compression level, according to commands sent from said server.

17. System according to claim 15 or 16, further comprising an operator display, for receiving one or more image streams that are decoded by the server and contain events.

18. System according to claim 15 or 16, further comprising a network video recorder for recording one or more image streams, obtained while their local encoder operates in its first mode.

19. System according to claim 15 or 16, in which the server is capable of dynamically allocating additional image processing resources to data communication channels that receive image streams.

20. System according to claim 15 or 16, in which one or more image streams obtained while operating in the first mode, comprises only a portion of the image that corresponds to a desired AOI.

21. System according to claim 15 or 16, in which the server further comprises processing means for generating and displaying a graphical polygon that encompasses an object of interest, being within the frame of an image or an AOI in said image.

22. System according to claim 21, in which the server further comprises processing means for generating and displaying a graphical trace

- 25 -

indicating the history of movement of an object of interest, being within the frame of an image or an AOI in said image.

23. System according to claim 15 or 16, in which the image stream is selected from the group of images that comprises video streams, still images, computer generated images, and pre-recorded digital or analog video data.

24. System according to claim 15 or 16, in which the image streams are video streams, compressed using MPEG format.

25. System according to claim 15 or 16, in which during each mode, the encoder uses different resolution and frame rate.

26. System according to claim 15 or 16, in which the features are selected from the following group:

- motion features;
- color;
- portion of the image;
- edge data; and
- frequency related information.

27. System according to claim 15 or 16, in which the server further comprises processing means for performing one or more of the following operations and/or any combination thereof:

- License Plate Recognition (LPR);
- Facial Recognition (FR);
- detection of traffic rules violations;

- 26 -

- behavior recognition;
- fire detection;
- traffic flow detection;
- smoke detection,

using a feature stream, received from the local encoder of at least one image acquisition device, through its data communication channel.

28. Method for performing event detection and object tracking in image streams, substantially as described and illustrated.

29. System for performing event detection and object tracking in image streams, substantially as described and illustrated.

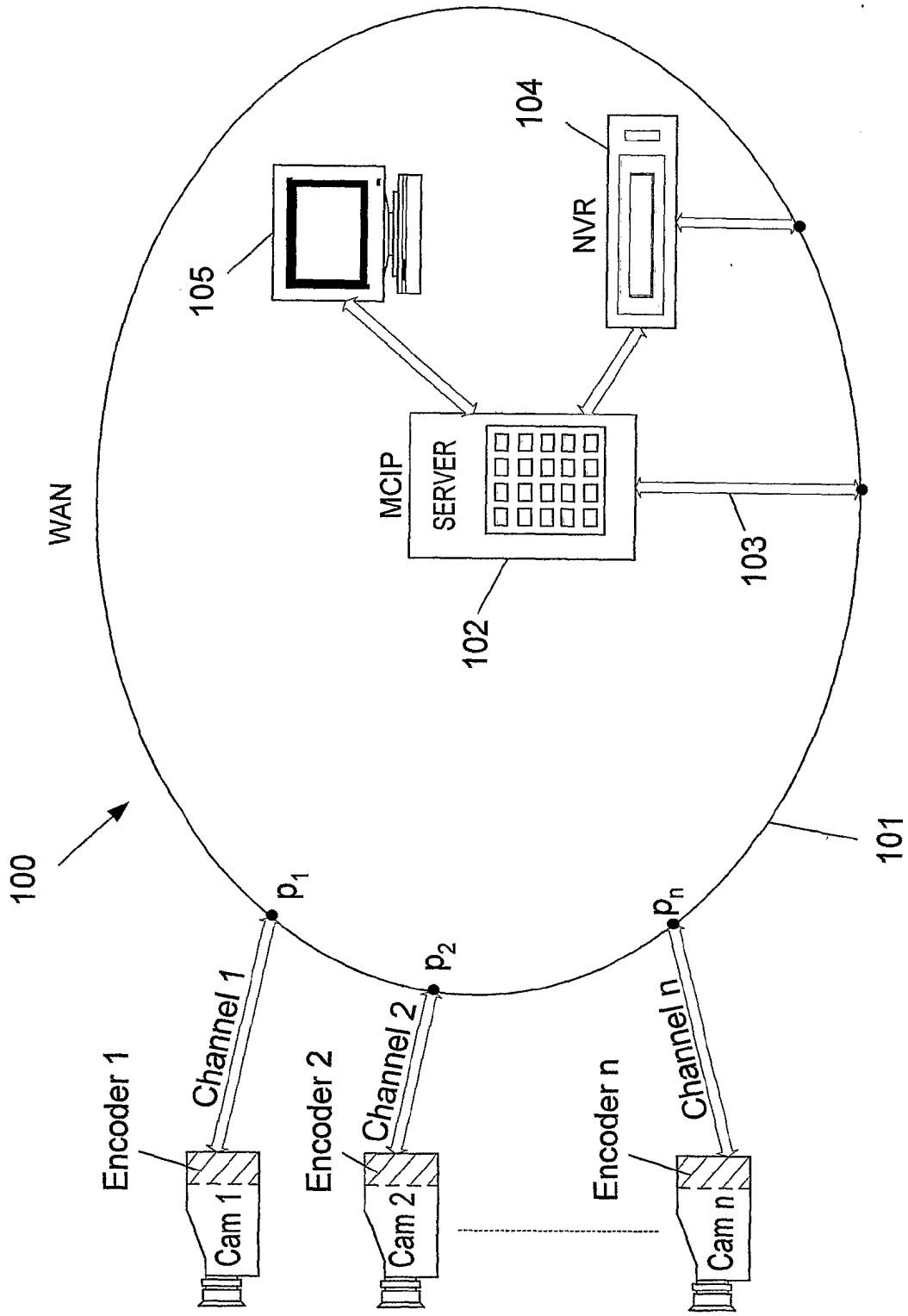

Fig. 1

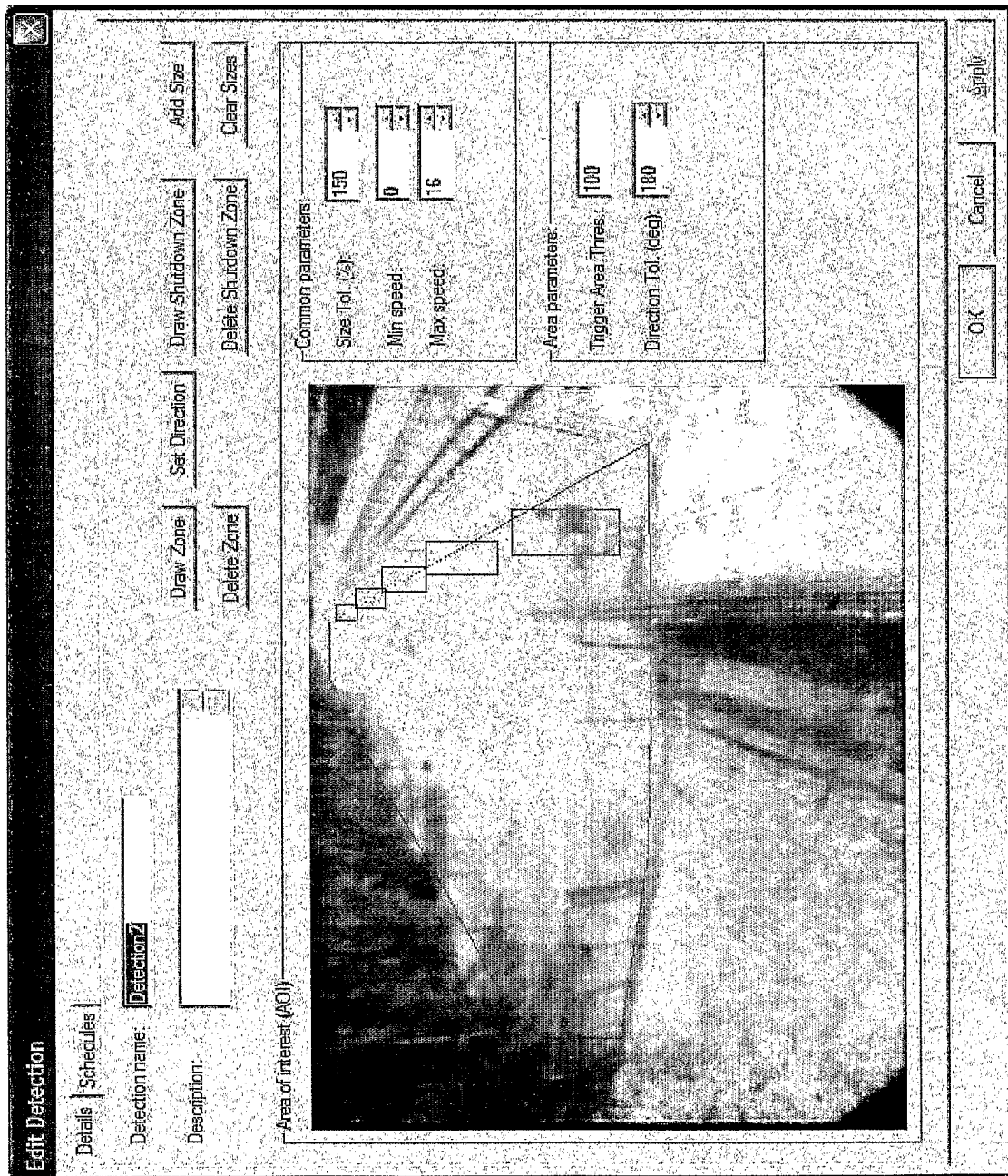

Fig. 2

3/5



Fig. 3A



4/5

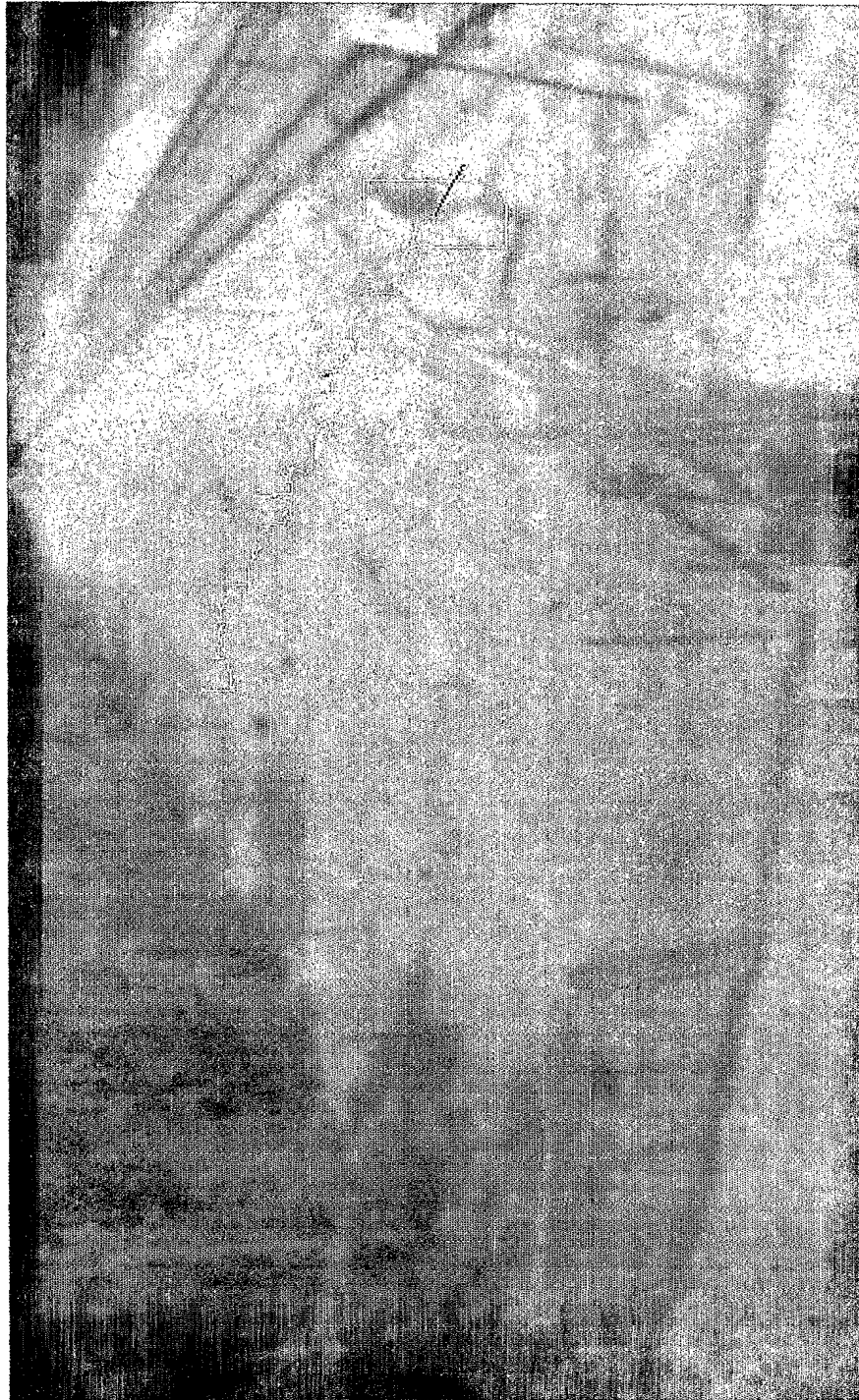

Fig. 3B

5/5

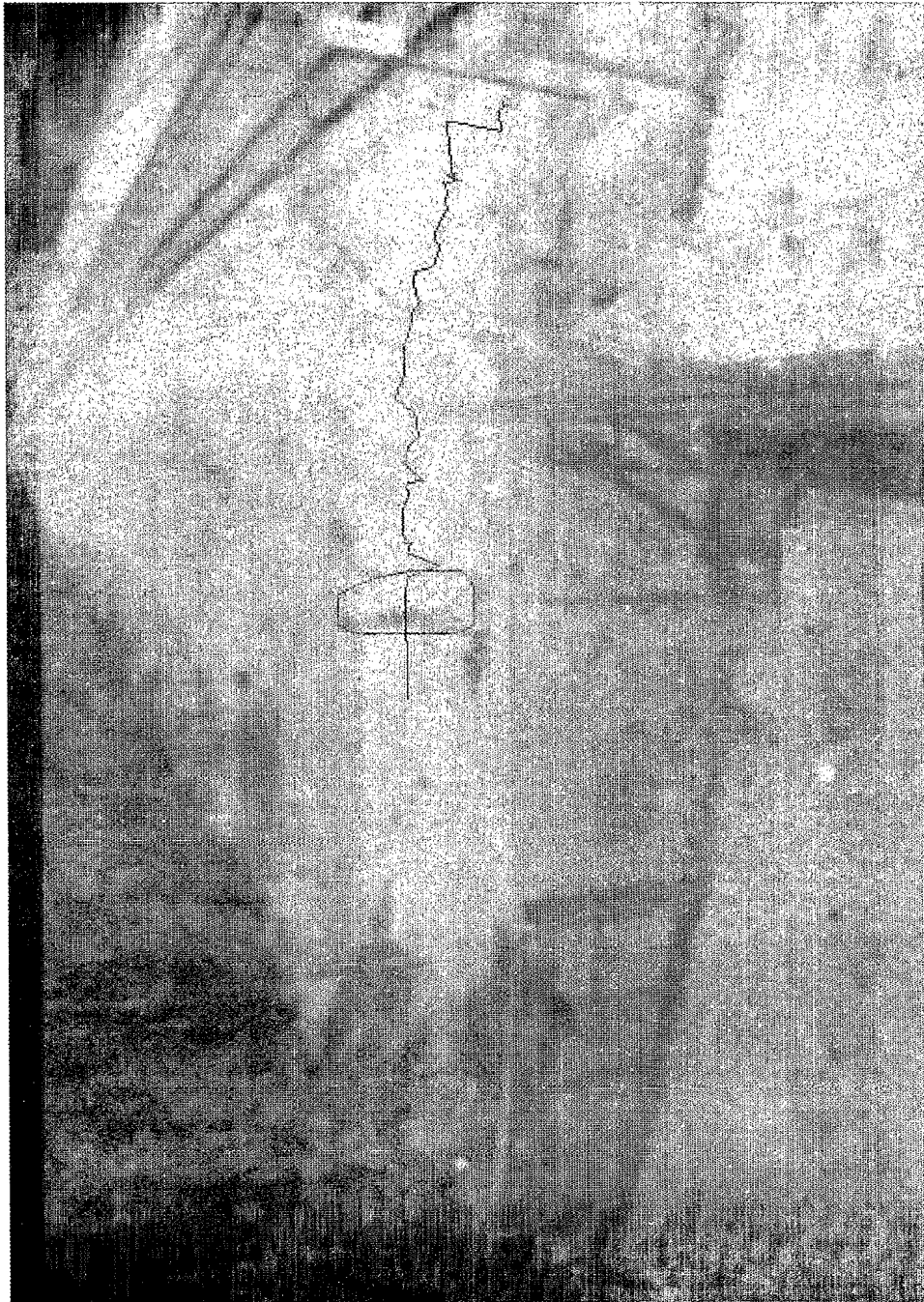

Fig. 3C

## Electronic Acknowledgement Receipt

<b>EFS ID:</b>	7739551
<b>Application Number:</b>	12569116
<b>International Application Number:</b>	
<b>Confirmation Number:</b>	7686
<b>Title of Invention:</b>	Video Surveillance System Employing Video Primitives
<b>First Named Inventor/Applicant Name:</b>	Alan J. Lipton
<b>Customer Number:</b>	74712
<b>Filer:</b>	Bradley E. Edelman
<b>Filer Authorized By:</b>	
<b>Attorney Docket Number:</b>	OV-101
<b>Receipt Date:</b>	03-JUN-2010
<b>Filing Date:</b>	29-SEP-2009
<b>Time Stamp:</b>	15:18:54
<b>Application Type:</b>	Utility under 35 USC 111(a)

### Payment information:

Submitted with Payment	no
------------------------	----

### File Listing:

Document Number	Document Description	File Name	File Size(Bytes)/ Message Digest	Multi Part /.zip	Pages (if appl.)
1	Transmittal Letter	OV_101_IDS_transmittal.pdf	63421 <small>e84aa2dabc6d329636358fa6729d1aa6bb8c7946</small>	no	2

### Warnings:

### Information:

2	Information Disclosure Statement (IDS) Filed (SB/08)	OV_101_IDS.pdf	87940 85ca99edda982c9e6b8d32b9008fb47ba20 81040	no	2
<b>Warnings:</b>					
<b>Information:</b>					
This is not an USPTO supplied IDS fillable form					
3	Foreign Reference	EP0967584A2.pdf	2191858 c826943c2b33a1c655727020b49a62a48e 8a157	no	33
<b>Warnings:</b>					
<b>Information:</b>					
4	Foreign Reference	WO03044727A1.pdf	2244009 4218d4c1c435e8fb867cc0052f156ec0c8be 4f85	no	36
<b>Warnings:</b>					
<b>Information:</b>					
5	Foreign Reference	WO2004006184A2.pdf	3482192 7ba406b3eb762ebf221e1be959631ad784 d3962	no	32
<b>Warnings:</b>					
<b>Information:</b>					
<b>Total Files Size (in bytes):</b>			8069420		
<p><b>This Acknowledgement Receipt evidences receipt on the noted date by the USPTO of the indicated documents, characterized by the applicant, and including page counts, where applicable. It serves as evidence of receipt similar to a Post Card, as described in MPEP 503.</b></p> <p><b><u>New Applications Under 35 U.S.C. 111</u></b>  If a new application is being filed and the application includes the necessary components for a filing date (see 37 CFR 1.53(b)-(d) and MPEP 506), a Filing Receipt (37 CFR 1.54) will be issued in due course and the date shown on this Acknowledgement Receipt will establish the filing date of the application.</p> <p><b><u>National Stage of an International Application under 35 U.S.C. 371</u></b>  If a timely submission to enter the national stage of an international application is compliant with the conditions of 35 U.S.C. 371 and other applicable requirements a Form PCT/DO/EO/903 indicating acceptance of the application as a national stage submission under 35 U.S.C. 371 will be issued in addition to the Filing Receipt, in due course.</p> <p><b><u>New International Application Filed with the USPTO as a Receiving Office</u></b>  If a new international application is being filed and the international application includes the necessary components for an international filing date (see PCT Article 11 and MPEP 1810), a Notification of the International Application Number and of the International Filing Date (Form PCT/RO/105) will be issued in due course, subject to prescriptions concerning national security, and the date shown on this Acknowledgement Receipt will establish the international filing date of the application.</p>					

**IN THE UNITED STATES PATENT AND TRADEMARK OFFICE**

In re the application of: Alan J. Lipton Attorney Docket No.: OV-101  
Serial No.: 12/569,116 Group Art Unit: 2621  
Filed: September 29, 2009 Examiner: Tung Vo  
Confirmation No.: 7686

Title: **VIDEO SURVEILLANCE SYSTEM EMPLOYING VIDEO PRIMITIVES**

INFORMATION DISCLOSURE STATEMENT UNDER 37 C.F.R. 1.97(b)

Commissioner for Patents  
P.O. Box 1450  
Alexandria, VA 22313

Dear Sir:

Pursuant to 37 C.F.R. 1.56 and 1.97(b), Applicant brings to the attention of the Examiner the listed documents on the attached SB/08 Form. This IDS is submitted, to the best of Applicant's knowledge, prior to the first office action on the merits of this application.

Applicant respectfully requests that the Examiner consider the listed documents and indicate that they were considered by making appropriate notations on the attached form.

This submission does not represent that a search has been made or that no better art exists and does not constitute an admission that each or all of the listed documents are material or constitute "prior art". If the Examiner applies any of the documents as prior art against any claim in the application and Applicant determines that the cited documents do

not constitute “prior art” under United States law, Applicant reserves the right to present to the U.S. Patent and Trademark Office the relevant facts and law regarding the appropriate status of such documents.

Applicant further reserves the right to take appropriate action to establish the patentability of the disclosed invention over the listed documents, should one or more of the documents be applied against the claims of the present application.

In the event any fees are required in connection with this paper, please charge the Deposit Account No. 50-4574.

Respectfully submitted,

/Bradley Edelman/, Reg. No. 57,648

Bradley Edelman

Registration No. 57,648

Tel: (703) 757-7880

MUIR PATENT CONSULTING, PLLC.  
9913 Georgetown Pike, Suite 200  
Great Falls, VA 22066  
Fax: (703) 757-7447

IDS Form PTO/SB/08: Substitute for form 1449A/PTO  <b>INFORMATION DISCLOSURE STATEMENT BY APPLICANT</b>  <i>(Use as many sheets as necessary)</i>			<b>Complete if Known</b>			
			Application Number		12/596,116	
			Filing Date		09-11-2009	
			First Named Inventor		Alan J. Lipton	
			Art Unit		2621	
			Examiner Name		Vo, Tung T.	
Sheet	1	of	1	Attorney Docket Number	OV-101	

U.S. PATENTS AND PUBLISHED U.S. PATENT APPLICATIONS						
Examiner Initials	Cite No. <sup>1</sup>	Document Number		Issue or Publication Date MM-DD-YYYY	Name of Patentee or Applicant of Cited Document	Pages, Columns, Lines, Where Relevant Passages or Relevant Figures Appear
		Number-Kind Code <sup>2</sup> (if known)				
	1	US-5,850,352 A		12-15-1998	Moezzi et al.	
	2	US-6,721,454 B1		04-13-2004	Qian et al.	
	3	US-7,660,439 B1		02-09-2010	Lu et al.	
	4					
	5					
	6					
	7					
	8					
	9					
	10					
	11					
	12					
	13					

**Note: Submission of copies of U.S. Patents and published U.S. Patent Applications is not required.**

FOREIGN PATENT DOCUMENTS							
Examiner Initials	Cite No. <sup>1</sup>	Foreign Patent Document		Publication Date MM-DD-YYYY	Name of Patentee or Applicant of Cited Document	Pages, Columns, Lines, Where Relevant Passages or Relevant Figures Appear	Translation <sup>6</sup>
		Country Code <sup>3</sup>	Number <sup>4</sup> Kind Code <sup>5</sup> (if known)				
	1						

NONPATENT LITERATURE DOCUMENTS			
Examiner Initials	Cite No. <sup>1</sup>	Include name of the author (in CAPITAL LETTERS), title of the article (when appropriate), title of the item (book, magazine, journal, serial, symposium, catalog, etc.), date, page(s), volume-issue number(s), publisher, city and/or country where published.	Translation <sup>6</sup>

Examiner Signature		Date Considered	
--------------------	--	-----------------	--

EXAMINER: Initial if reference considered, whether or not citation is in conformance with MPEP 609. Draw line through citation if not in conformance and not considered. Include copy of this form with next communication to applicant.

## Electronic Acknowledgement Receipt

<b>EFS ID:</b>	7356384
<b>Application Number:</b>	12569116
<b>International Application Number:</b>	
<b>Confirmation Number:</b>	7686
<b>Title of Invention:</b>	Video Surveillance System Employing Video Primitives
<b>First Named Inventor/Applicant Name:</b>	Alan J. Lipton
<b>Customer Number:</b>	74712
<b>Filer:</b>	Patrick Daniel Muir
<b>Filer Authorized By:</b>	
<b>Attorney Docket Number:</b>	OV-101
<b>Receipt Date:</b>	06-APR-2010
<b>Filing Date:</b>	29-SEP-2009
<b>Time Stamp:</b>	08:19:48
<b>Application Type:</b>	Utility under 35 USC 111(a)

### Payment information:

Submitted with Payment	no
------------------------	----

### File Listing:

Document Number	Document Description	File Name	File Size(Bytes)/ Message Digest	Multi Part /.zip	Pages (if appl.)
1	Transmittal Letter	OV_101_IDS_transmittal.pdf	60783 <small>e92bc63146243656fbd204c560df2c6ca9751216</small>	no	2

### Warnings:

### Information:



2	Information Disclosure Statement (IDS) Filed (SB/08)	OV-101_IDS2.pdf	79399  f11bd7666c3fce48bd5ea32097b07592ce4 179f4	no	1
---	---	-----------------	---	----	---

**Warnings:**

**Information:**

This is not an USPTO supplied IDS fillable form

<b>Total Files Size (in bytes):</b>	140182
-------------------------------------	--------

**This Acknowledgement Receipt evidences receipt on the noted date by the USPTO of the indicated documents, characterized by the applicant, and including page counts, where applicable. It serves as evidence of receipt similar to a Post Card, as described in MPEP 503.**

**New Applications Under 35 U.S.C. 111**

**If a new application is being filed and the application includes the necessary components for a filing date (see 37 CFR 1.53(b)-(d) and MPEP 506), a Filing Receipt (37 CFR 1.54) will be issued in due course and the date shown on this Acknowledgement Receipt will establish the filing date of the application.**

**National Stage of an International Application under 35 U.S.C. 371**

**If a timely submission to enter the national stage of an international application is compliant with the conditions of 35 U.S.C. 371 and other applicable requirements a Form PCT/DO/EO/903 indicating acceptance of the application as a national stage submission under 35 U.S.C. 371 will be issued in addition to the Filing Receipt, in due course.**

**New International Application Filed with the USPTO as a Receiving Office**

**If a new international application is being filed and the international application includes the necessary components for an international filing date (see PCT Article 11 and MPEP 1810), a Notification of the International Application Number and of the International Filing Date (Form PCT/RO/105) will be issued in due course, subject to prescriptions concerning national security, and the date shown on this Acknowledgement Receipt will establish the international filing date of the application.**

**IN THE UNITED STATES PATENT AND TRADEMARK OFFICE**

In re the application of: Alan J Lipton et al. Attorney Docket: OV-101  
Serial Number: 12/569,116 Group Art Unit: 2621  
Filed: September 29, 2009 Examiner: Tung Vo  
Confirmation Number: 7686  
Title: **VIDEO SURVEILLANCE SYSTEM EMPLOYING VIDEO PRIMITIVES**

INFORMATION DISCLOSURE STATEMENT UNDER 37 C.F.R. 1.97(b)

Commissioner for Patents  
P.O. Box 1450  
Alexandria, VA 22313

Dear Sir:

Pursuant to 37 C.F.R. 1.56 and 1.97(b), Applicant brings to the attention of the Examiner the listed documents on the attached SB/08 Form. This Information Disclosure Statement is being filed, to the best of Applicant's knowledge, before the mailing date of a first Office Action.

The present application is a continuation of Application Serial No. 09/987,707, filed November 15, 2001. Documents listed in this Information Disclosure Statement are those which were recently cited by the Examiner in related Application Serial No. 11/098,385 (also a continuation of Application Serial No. 09/987,707) that have not been previously submitted in the present application.

Applicants respectfully request that the Examiner consider the listed documents and indicate that they were considered by making appropriate notations on the attached form.

This submission does not represent that a search has been made or that no better art exists and does not constitute an admission that each or all of the listed documents are material or constitute "prior art". If the Examiner applies any of the documents as prior art against any claim in the application and Applicants determine that the cited documents do not constitute "prior art" under United States law, Applicants reserve the right to present to the U.S. Patent and Trademark Office the relevant facts and law regarding the appropriate status of such documents.

Applicants further reserve the right to take appropriate action to establish the patentability of the disclosed invention over the listed documents, should one or more of the documents be applied against the claims of the present application. In the event any fees are required in connection with this paper, please charge the Deposit Account No. 50-4574.

Respectfully submitted,

/Patrick D. Muir/ Reg. #37403

MUIR PATENT CONSULTING, PLLC.  
758 Walker Rd., Suite C  
Great Falls, VA 22066  
Fax: (703) 757-7447

---

Patrick D. Muir  
Attorney for Applicants,  
Registration No. 37,403  
Tel: (703) 757-7880



UNITED STATES PATENT AND TRADEMARK OFFICE

UNITED STATES DEPARTMENT OF COMMERCE
United States Patent and Trademark Office
Address: COMMISSIONER FOR PATENTS
P.O. Box 1450
Alexandria, Virginia 22313-1450
www.uspto.gov

Table with 4 columns: APPLICATION NUMBER (12/569,116), FILING OR 371(C) DATE (09/29/2009), FIRST NAMED APPLICANT (Alan J. Lipton), ATTY. DOCKET NO./TITLE (OV-101)

CONFIRMATION NO. 7686

PUBLICATION NOTICE

74712
MUIR PATENT CONSULTING, PLLC
758 WALKER RD
SUITE C
GREAT FALLS, VA 22066



Title:Video Surveillance System Employing Video Primitives

Publication No.US-2010-0013926-A1
Publication Date:01/21/2010

NOTICE OF PUBLICATION OF APPLICATION

The above-identified application will be electronically published as a patent application publication pursuant to 37 CFR 1.211, et seq. The patent application publication number and publication date are set forth above.

The publication may be accessed through the USPTO's publically available Searchable Databases via the Internet at www.uspto.gov. The direct link to access the publication is currently http://www.uspto.gov/patft/.

The publication process established by the Office does not provide for mailing a copy of the publication to applicant. A copy of the publication may be obtained from the Office upon payment of the appropriate fee set forth in 37 CFR 1.19(a)(1). Orders for copies of patent application publications are handled by the USPTO's Office of Public Records. The Office of Public Records can be reached by telephone at (703) 308-9726 or (800) 972-6382, by facsimile at (703) 305-8759, by mail addressed to the United States Patent and Trademark Office, Office of Public Records, Alexandria, VA 22313-1450 or via the Internet.

In addition, information on the status of the application, including the mailing date of Office actions and the dates of receipt of correspondence filed in the Office, may also be accessed via the Internet through the Patent Electronic Business Center at www.uspto.gov using the public side of the Patent Application Information and Retrieval (PAIR) system. The direct link to access this status information is currently http://pair.uspto.gov/. Prior to publication, such status information is confidential and may only be obtained by applicant using the private side of PAIR.

Further assistance in electronically accessing the publication, or about PAIR, is available by calling the Patent Electronic Business Center at 1-866-217-9197.

Office of Data Management, Application Assistance Unit (571) 272-4000, or (571) 272-4200, or 1-888-786-0101

<b>INFORMATION DISCLOSURE STATEMENT BY APPLICANT</b> ( Not for submission under 37 CFR 1.99)	Application Number		12596116
	Filing Date		2009-09-11
	First Named Inventor	Alan J. Lipton	
	Art Unit		2621
	Examiner Name	Tung Vo	
	Attorney Docket Number		OV-101

U.S.PATENTS							Remove
Examiner Initial*	Cite No	Patent Number	Kind Code <sup>1</sup>	Issue Date	Name of Patentee or Applicant of cited Document	Pages,Columns,Lines where Relevant Passages or Relevant Figures Appear	
	1	5912980	A	1999-06-15	Hunke, H. Martin		
	2	6025877	A	2001-02-15	Chang et al.		
	3	6097429	A	2000-08-01	Seeley et al.		
	4	6360234	B2	2002-03-19	Jain et al.		
	5	7197072	B1	2007-03-27	Hsu et al.		
	6	7227893	B1	2007-06-05	Srinivasa et al.		
	7	7356830	B1	2008-04-08	Dimitrova, Nevenka		
	8	7447331	B2	2008-11-04	Brown et al.		

**INFORMATION DISCLOSURE  
STATEMENT BY APPLICANT**  
( Not for submission under 37 CFR 1.99)

Application Number		12596116
Filing Date		2009-09-11
First Named Inventor	Alan J. Lipton	
Art Unit		2621
Examiner Name	Tung Vo	
Attorney Docket Number		OV-101

	9	5956081		1999-09-21	Katz et al.	
	10	3812287		1974-05-21	Lemelson	
	11	6226388		2001-05-01	Qian et al.	
	12	6177886		2001-01-23	Billington et al.	
	13	5623249		1997-04-22	Camire	
	14	6091771		2000-07-18	Seeley et al.	
	15	6075560		2000-06-13	Katz	
	16	5491511		1996-02-13	Odle	
	17	5801943		1998-09-01	Nasburg	
	18	5696503		1997-12-09	Nasburg	
	19	6201473		2001-03-13	Schaffer	

**INFORMATION DISCLOSURE  
STATEMENT BY APPLICANT**  
( Not for submission under 37 CFR 1.99)

Application Number		12596116
Filing Date		2009-09-11
First Named Inventor	Alan J. Lipton	
Art Unit		2621
Examiner Name	Tung Vo	
Attorney Docket Number		OV-101

20	5999189		1999-12-07	Kajiya et al.	
21	5987211		1999-11-16	Abecassis	
22	5886701		1999-03-23	Chauvin et al.	
23	5860086		1999-01-12	Crump et al	
24	5610653		1997-03-11	Abecassis	
25	5448315		1995-09-05	Sooahoo	
26	5959690		1999-09-28	Toebes, VIII et al.	
27	6014461		2000-01-11	Hennessey et al.	
28	6144375		2000-11-07	Jain et al	
29	4249207		1981-02-03	Harman et al.	
30	4257063		1981-03-17	Loughry et al.	

**INFORMATION DISCLOSURE  
STATEMENT BY APPLICANT**  
( Not for submission under 37 CFR 1.99)

Application Number		12596116
Filing Date		2009-09-11
First Named Inventor	Alan J. Lipton	
Art Unit		2621
Examiner Name	Tung Vo	
Attorney Docket Number		OV-101

	31	5926210		1999-07-20	Hackett et al.	
	32	6069653		2000-05-30	Hudson et al.	
	33	6297844		2001-10-02	Schatz et al.	
	34	6424370		2002-07-23	Courtney	
	35	6542840		2003-04-01	Shusaku et al.	
	36	6696945		2004-02-24	Venetianer et al.	
	37	6727938		2004-04-27	Randall	
	38	6738424		2004-05-18	Allmen et al.	
	39	6954498		2005-10-11	Lipton	
	40	6987883		2006-01-17	Lipton et al.	
	41	6351265	B1	2002-02-26	Bulman	



**INFORMATION DISCLOSURE  
STATEMENT BY APPLICANT**  
( Not for submission under 37 CFR 1.99)

Application Number	12596116
Filing Date	2009-09-11
First Named Inventor	Alan J. Lipton
Art Unit	2621
Examiner Name	Tung Vo
Attorney Docket Number	OV-101

42	6166744	A	2000-12-26	Jaszlics et al.	
----	---------	---	------------	-----------------	--

If you wish to add additional U.S. Patent citation information please click the Add button.

**U.S.PATENT APPLICATION PUBLICATIONS**

Examiner Initial*	Cite No	Publication Number	Kind Code <sup>1</sup>	Publication Date	Name of Patentee or Applicant of cited Document	Pages, Columns, Lines where Relevant Passages or Relevant Figures Appear
	1	20030231769	A1	2003-12-18	Bolle et al.	
	2	20040161133	A1	2004-08-19	Elazar et al.	
	3	20060279630	A1	2006-12-14	Aggarwal et al.	
	4	20060232673		2006-10-19	Lipton et al.	
	5	20070002141		2007-01-04	Lipton et al.	
	6	20070127774		2007-06-07	Zhang et al.	
	7	20070052803		2007-03-08	Chosak et al.	
	8	20030051255	A1	2003-03-13	Bulman et al.	

If you wish to add additional U.S. Published Application citation information please click the Add button.

**INFORMATION DISCLOSURE  
STATEMENT BY APPLICANT**  
( Not for submission under 37 CFR 1.99)

Application Number	12596116
Filing Date	2009-09-11
First Named Inventor	Alan J. Lipton
Art Unit	2621
Examiner Name	Tung Vo
Attorney Docket Number	OV-101

**FOREIGN PATENT DOCUMENTS**

[Remove](#)

Examiner Initial*	Cite No	Foreign Document Number <sup>3</sup>	Country Code <sup>2</sup> i	Kind Code <sup>4</sup>	Publication Date	Name of Patentee or Applicant of cited Document	Pages, Columns, Lines where Relevant Passages or Relevant Figures Appear	T <sup>5</sup>
	1	0293189	EP	B1	1994-07-13	Sony Corporation		<input type="checkbox"/>
	2	1024666	EP	A2	2000-08-02	Hitachi		<input type="checkbox"/>
	3	1120746	EP		2001-08-01	Matsushita Electric Ind. Co. Ltd		<input type="checkbox"/>
	4	1333682	EP	A1	2003-08-06	Samsung Electronics Co., Ltd.		<input type="checkbox"/>
	5	10-048008	JP		1998-02-20	Omron		<input type="checkbox"/>
	6	10-290449	JP		1998-10-27	Shimizu		<input type="checkbox"/>
	7	2000-175174	JP		2000-06-23	Mitsubishi		<input type="checkbox"/>
	8	2000-224542	JP		2000-11-08	Hitachi		<input type="checkbox"/>
	9	2000-339923	JP		2000-08-12	Mitsubishi		<input type="checkbox"/>

**INFORMATION DISCLOSURE  
STATEMENT BY APPLICANT**  
( Not for submission under 37 CFR 1.99)

Application Number		12596116
Filing Date		2009-09-11
First Named Inventor	Alan J. Lipton	
Art Unit		2621
Examiner Name	Tung Vo	
Attorney Docket Number		OV-101

10	2001-175868	JP		2001-06-29	Nippon Electric Co.	<input type="checkbox"/>
11	2001-285681	JP		2001-10-12	Matsushita Electric Ind. Co. Ltd.	<input type="checkbox"/>
12	2009-247654	JP	A	1997-09-19	Fujitsu General Ltd.	<input type="checkbox"/>
13	1994/003014	WO	A1	1994-02-03	Koz et al.	<input type="checkbox"/>
14	2001/62005	WO		2001-08-23	Wilson	<input type="checkbox"/>
15	0893923	EP	A1	1999-01-27	Texas Instruments France	<input type="checkbox"/>

If you wish to add additional Foreign Patent Document citation information please click the Add button

**NON-PATENT LITERATURE DOCUMENTS**

Examiner Initials*	Cite No	Include name of the author (in CAPITAL LETTERS), title of the article (when appropriate), title of the item (book, magazine, journal, serial, symposium, catalog, etc), date, pages(s), volume-issue number(s), publisher, city and/or country where published.	T <sup>5</sup>
	1	International Search Report for International Application No. PCT/US08/09073, dated November 3, 2008.	<input type="checkbox"/>
	2	Written Opinion for International Application No. PCT/US08/09073, dated November 3, 2008.	<input type="checkbox"/>
	3	A. SELINGER and L. WIXSON, "Classifying Moving Objects as Rigid or Non-Rigid Without Correspondences," Proceedings of DARPA Image Understanding Workshop, 1, November 1998, pp. 341-47.	<input type="checkbox"/>

**INFORMATION DISCLOSURE  
STATEMENT BY APPLICANT**  
( Not for submission under 37 CFR 1.99)

Application Number	12596116
Filing Date	2009-09-11
First Named Inventor	Alan J. Lipton
Art Unit	2621
Examiner Name	Tung Vo
Attorney Docket Number	OV-101

4	ALAN J. LIPTON, "Virtual Postman - An Illustrative Example of Virtual Video," International Journal of Robotics and Automation, Vol.15, No.1, January 2000, pp. 9-16.	<input type="checkbox"/>
5	ALAN J. LIPTON, "Virtual Postman - Real Time, Interactive Virtual Video," IASTED Conference on Computer Graphics and Imaging (CGIM '99), Palm Springs, October 25-27, 1999.	<input type="checkbox"/>
6	ROBERT T. COLLINS et al., "A System for Video Surveillance and Monitoring," Technical Report CMU-RI-TR-00-12, Robotics Institute, Carnegie Mellon University, May 2000.	<input type="checkbox"/>
7	Jemez Technology Corp., Variant iD Web-Site, www.variantid.com, printed August 25, 2003.	<input type="checkbox"/>
8	JP Office Action issued in PCT/US2002/22688 dated October 9, 2007	<input type="checkbox"/>
9	A. J. LIPTON et al., "Moving Target Classifications and Tracking from Real-time Video," IUW, pp. 159-175, May 1997.	<input type="checkbox"/>
10	A. J. LIPTON, "Local Application of Optic Flow to Analyze Rigid Versus Non-Rigid Motion," International Conference on Computer Vision, Corfu, Greece, September 1999.	<input type="checkbox"/>
11	A. J. LIPTON, H. FUJIYOSHI and R. S. PATIL, "Moving Target Classification and Tracking for Real-time Video," Proceedings of IEEE WACV'98, Princeton, NJ, 1998, pp. 8-14.	<input type="checkbox"/>
12	C. R. WREN et al., "Pfinder: Real-time Tracking of the Human Body," PAMI, vol.19, pp. 780-784, 1997.	<input type="checkbox"/>
13	C. R. WREN et al., "Pfinder: Real-time Tracking of the Human Body," Vismod, 1995.	<input type="checkbox"/>
14	CN Office Action for CN 02822772.7 on October 14, 2005	<input type="checkbox"/>

**INFORMATION DISCLOSURE  
STATEMENT BY APPLICANT**  
( Not for submission under 37 CFR 1.99)

Application Number		12596116
Filing Date		2009-09-11
First Named Inventor	Alan J. Lipton	
Art Unit		2621
Examiner Name	Tung Vo	
Attorney Docket Number		OV-101

15	D. M. GAVRILA, "The Visual Analysis of Human Movement: A Survey," CVIU, 73(1):82-98, January 1999.	<input type="checkbox"/>
16	F. BARTOLINI et al., "Counting People Getting In and Out of a Bus by Real-time Image-sequence Processing," IVC, 12(1):36-41, January 1994.	<input type="checkbox"/>
17	H. FUJIYOSHI and A. J. LIPTON, "Real-time Human Motion Analysis by Image Skeletonization," Proceedings of IEEE WACV'98, Princeton, NJ, 1998, pp. 15-21.	<input type="checkbox"/>
18	International Search Report for International Application No. PCT/2001/32614 on May 6, 2002.	<input type="checkbox"/>
19	International Search Report for International Application No. PCT/2006/25196, mailed January 16, 2008.	<input type="checkbox"/>
20	International Search Report for International Application No. PCT/US06/45625, mailed on September 24, 2007.	<input type="checkbox"/>
21	International Search Report for International Application No. PCT/US2002/22688 on December 11, 2002.	<input type="checkbox"/>
22	International Search Report for International Application No. PCT/US2006/012556, mailed on February 12, 2008.	<input type="checkbox"/>
23	International Search Report for International Application No. PCT/US2006/02700 dated April 13, 2007	<input type="checkbox"/>
24	J.P. DEPARIS et al., "A Device for Counting Passenger Making Use of Two Active Linear Cameras: Comparison of Algorithms," IEEE, pp. 1629-1634, 1996.	<input type="checkbox"/>
25	L. KHOUDOUR et al., "Real-time Pedestrian Counting by Active Linear Cameras," JEI, 5(4):452-459, October 1996.	<input type="checkbox"/>

**INFORMATION DISCLOSURE  
STATEMENT BY APPLICANT**  
( Not for submission under 37 CFR 1.99)

Application Number		12596116
Filing Date		2009-09-11
First Named Inventor	Alan J. Lipton	
Art Unit		2621
Examiner Name	Tung Vo	
Attorney Docket Number		OV-101

26	L. WIXSON et al., "Detecting Salient Motion by Accumulating Directionally-Consistent Flow," IEEE 1999	<input type="checkbox"/>
27	L. WIXSON et al., "Detecting Salient Motion by Accumulating Directionally-Consistent Flow," IEEE Trans Pattern Anal. Mach. Intell., vol.22, pp. 774-781, Aug, 2000.	<input type="checkbox"/>
28	M. ROSSI et al., "Tracking and Counting Moving People," ICIP94, pp. 212-216, 1994.	<input type="checkbox"/>
29	M. ALLMEN et al., "Long-Range Spatiotemporal Motion Understanding Using Spatiotemporal Flow Curves," Proc. IEEE CVPR, Lahaina, Maui, Hawaii, pp. 303-309, 1991.	<input type="checkbox"/>
30	M. ISARD et al., "BraMBLe: A Bayesian Multiple-Blob Tracker," ICCV, 2001.	<input type="checkbox"/>
31	N. HAERING et al., "Visual Event Detection," Video Computing Series, Editor Mubarak Shah, 2001.	<input type="checkbox"/>
32	Notification for IL Application No. 161777 issued February 21, 2008.	<input type="checkbox"/>
33	R. T. COLLINS, Y. TSIN, J. R. MILLER and A. J. LIPTON, "Using a DEM to Determine Geospatial Object Trajectories" CMU-RI-TR-98-19, 1998.	<input type="checkbox"/>
34	S. IOFFE et al., "Probabilistic Methods for Finding People," IJCV, 43(1):45-68, June 2001.	<input type="checkbox"/>
35	SHIO et al., "Segmentation of People in Motion," Proc. IEEE, 1991, vol.79, pp. 325-332	<input type="checkbox"/>
36	T.J. OLSEN et al., "Moving Object Detection and Event Recognition Algorithm for Smart Cameras," IUW, pp. 159-175, May 1997.	<input type="checkbox"/>

<b>INFORMATION DISCLOSURE STATEMENT BY APPLICANT</b> ( Not for submission under 37 CFR 1.99)	Application Number	12596116
	Filing Date	2009-09-11
	First Named Inventor	Alan J. Lipton
	Art Unit	2621
	Examiner Name	Tung Vo
	Attorney Docket Number	OV-101

37	W.E.L. GRIMSON et al., "Using Adaptive Tracking to Classify and Monitor Activities in a Site," CVPR, pp.22-29, June 1998.	<input type="checkbox"/>
38	Written Opinion for International Application No. PCT/US2006/25196, mailed on January 16, 2008.	<input type="checkbox"/>
39	Written Opinion issued in PCT Application No. PCT/US2006/012556, mailed on February 12, 2008.	<input type="checkbox"/>
40	Written Opinion of the International Searching Authority issued for PCT Application No. PCT/US2006/45625, mailed on September 24, 2007.	<input type="checkbox"/>
41	A. J. LIPTON et al., "Moving Target Classifications and Tracking from Real-time Video," IUW, pp. 129-136, 1998.	<input type="checkbox"/>

If you wish to add additional non-patent literature document citation information please click the Add button

**EXAMINER SIGNATURE**

Examiner Signature	Date Considered
--------------------	-----------------

\*EXAMINER: Initial if reference considered, whether or not citation is in conformance with MPEP 609. Draw line through a citation if not in conformance and not considered. Include copy of this form with next communication to applicant.

<sup>1</sup> See Kind Codes of USPTO Patent Documents at [www.USPTO.GOV](http://www.USPTO.GOV) or MPEP 901.04. <sup>2</sup> Enter office that issued the document, by the two-letter code (WIPO Standard ST.3). <sup>3</sup> For Japanese patent documents, the indication of the year of the reign of the Emperor must precede the serial number of the patent document. <sup>4</sup> Kind of document by the appropriate symbols as indicated on the document under WIPO Standard ST.16 if possible. <sup>5</sup> Applicant is to place a check mark here if English language translation is attached.

**INFORMATION DISCLOSURE  
STATEMENT BY APPLICANT**  
( Not for submission under 37 CFR 1.99)

Application Number	12596116
Filing Date	2009-09-11
First Named Inventor	Alan J. Lipton
Art Unit	2621
Examiner Name	Tung Vo
Attorney Docket Number	OV-101

**CERTIFICATION STATEMENT**

Please see 37 CFR 1.97 and 1.98 to make the appropriate selection(s):

That each item of information contained in the information disclosure statement was first cited in any communication from a foreign patent office in a counterpart foreign application not more than three months prior to the filing of the information disclosure statement. See 37 CFR 1.97(e)(1).

**OR**

That no item of information contained in the information disclosure statement was cited in a communication from a foreign patent office in a counterpart foreign application, and, to the knowledge of the person signing the certification after making reasonable inquiry, no item of information contained in the information disclosure statement was known to any individual designated in 37 CFR 1.56(c) more than three months prior to the filing of the information disclosure statement. See 37 CFR 1.97(e)(2).

See attached certification statement.

Fee set forth in 37 CFR 1.17 (p) has been submitted herewith.

None

**SIGNATURE**

A signature of the applicant or representative is required in accordance with CFR 1.33, 10.18. Please see CFR 1.4(d) for the form of the signature.

Signature	/Patrick D. Muir	Date (YYYY-MM-DD)	2009-12-31
Name/Print	Patrick D. Muir, Reg. #37403	Registration Number	37,403

This collection of information is required by 37 CFR 1.97 and 1.98. The information is required to obtain or retain a benefit by the public which is to file (and by the USPTO to process) an application. Confidentiality is governed by 35 U.S.C. 122 and 37 CFR 1.14. This collection is estimated to take 1 hour to complete, including gathering, preparing and submitting the completed application form to the USPTO. Time will vary depending upon the individual case. Any comments on the amount of time you require to complete this form and/or suggestions for reducing this burden, should be sent to the Chief Information Officer, U.S. Patent and Trademark Office, U.S. Department of Commerce, P.O. Box 1450, Alexandria, VA 22313-1450. **DO NOT SEND FEES OR COMPLETED FORMS TO THIS ADDRESS. SEND TO: Commissioner for Patents, P.O. Box 1450, Alexandria, VA 22313-1450.**



## Privacy Act Statement

The Privacy Act of 1974 (P.L. 93-579) requires that you be given certain information in connection with your submission of the attached form related to a patent application or patent. Accordingly, pursuant to the requirements of the Act, please be advised that: (1) the general authority for the collection of this information is 35 U.S.C. 2(b)(2); (2) furnishing of the information solicited is voluntary; and (3) the principal purpose for which the information is used by the U.S. Patent and Trademark Office is to process and/or examine your submission related to a patent application or patent. If you do not furnish the requested information, the U.S. Patent and Trademark Office may not be able to process and/or examine your submission, which may result in termination of proceedings or abandonment of the application or expiration of the patent.

The information provided by you in this form will be subject to the following routine uses:

1. The information on this form will be treated confidentially to the extent allowed under the Freedom of Information Act (5 U.S.C. 552) and the Privacy Act (5 U.S.C. 552a). Records from this system of records may be disclosed to the Department of Justice to determine whether the Freedom of Information Act requires disclosure of these records.
2. A record from this system of records may be disclosed, as a routine use, in the course of presenting evidence to a court, magistrate, or administrative tribunal, including disclosures to opposing counsel in the course of settlement negotiations.
3. A record in this system of records may be disclosed, as a routine use, to a Member of Congress submitting a request involving an individual, to whom the record pertains, when the individual has requested assistance from the Member with respect to the subject matter of the record.
4. A record in this system of records may be disclosed, as a routine use, to a contractor of the Agency having need for the information in order to perform a contract. Recipients of information shall be required to comply with the requirements of the Privacy Act of 1974, as amended, pursuant to 5 U.S.C. 552a(m).
5. A record related to an International Application filed under the Patent Cooperation Treaty in this system of records may be disclosed, as a routine use, to the International Bureau of the World Intellectual Property Organization, pursuant to the Patent Cooperation Treaty.
6. A record in this system of records may be disclosed, as a routine use, to another federal agency for purposes of National Security review (35 U.S.C. 181) and for review pursuant to the Atomic Energy Act (42 U.S.C. 218(c)).
7. A record from this system of records may be disclosed, as a routine use, to the Administrator, General Services, or his/her designee, during an inspection of records conducted by GSA as part of that agency's responsibility to recommend improvements in records management practices and programs, under authority of 44 U.S.C. 2904 and 2906. Such disclosure shall be made in accordance with the GSA regulations governing inspection of records for this purpose, and any other relevant (i.e., GSA or Commerce) directive. Such disclosure shall not be used to make determinations about individuals.
8. A record from this system of records may be disclosed, as a routine use, to the public after either publication of the application pursuant to 35 U.S.C. 122(b) or issuance of a patent pursuant to 35 U.S.C. 151. Further, a record may be disclosed, subject to the limitations of 37 CFR 1.14, as a routine use, to the public if the record was filed in an application which became abandoned or in which the proceedings were terminated and which application is referenced by either a published application, an application open to public inspections or an issued patent.
9. A record from this system of records may be disclosed, as a routine use, to a Federal, State, or local law enforcement agency, if the USPTO becomes aware of a violation or potential violation of law or regulation.

<b>INFORMATION DISCLOSURE STATEMENT BY APPLICANT</b> ( Not for submission under 37 CFR 1.99)	Application Number		12596116
	Filing Date		2009-09-11
	First Named Inventor	Alan J. Lipton	
	Art Unit		2621
	Examiner Name	Tung Vo	
	Attorney Docket Number		OV-101

U.S.PATENTS							Remove
Examiner Initial*	Cite No	Patent Number	Kind Code <sup>1</sup>	Issue Date	Name of Patentee or Applicant of cited Document	Pages,Columns,Lines where Relevant Passages or Relevant Figures Appear	
	1	6307885	B1	2001-10-23	Moon et al.		
	2	6351492	B1	2002-02-26	Kim		
	3	6151413	A	2000-11-21	Jang		
	4	6310916	B1	2001-10-30	Han		
	5	6326964	B1	2001-12-04	Snyder et al.		
	6	4737847		1988-12-04	Araki et al.		
	7	4908704		1990-03-13	Fujioka et al.		
	8	5802361		1998-09-01	Wang et al.		

**INFORMATION DISCLOSURE  
STATEMENT BY APPLICANT**  
( Not for submission under 37 CFR 1.99)

Application Number		12596116
Filing Date		2009-09-11
First Named Inventor	Alan J. Lipton	
Art Unit		2621
Examiner Name	Tung Vo	
Attorney Docket Number		OV-101

	9	5872865		1999-02-16	Normile et al.	
	10	6211907		2001-04-03	Scaman et al.	
	11	6542075		2003-04-01	Barker et al.	
	12	6123123		2000-09-26	Carder et al.	
	13	6552826		2003-04-22	Adler et al.	
	14	5963202		1999-10-05	Polish	
	15	7167519	B2	2007-01-23	Comaniciu et al.	
	16	7436887	B2	2008-10-14	Yeredor et al.	
	17	6865580	B1	2005-03-08	Bush	
	18	6741977		2004-05-25	Nagaya	
	19	6812835		2004-11-02	Ito et al.	

**INFORMATION DISCLOSURE  
STATEMENT BY APPLICANT**  
( Not for submission under 37 CFR 1.99)

Application Number		12596116
Filing Date		2009-09-11
First Named Inventor	Alan J. Lipton	
Art Unit		2621
Examiner Name	Tung Vo	
Attorney Docket Number		OV-101

	20	6940998		2005-09-06	Garoutte	
	21	6987528		2006-01-17	Nagahisa	
	22	7215795		2007-05-08	Ito et al.	
	23	7301536		2007-11-27	Ellenby	
	24	7307652		2007-12-11	Broemmelsiek	
	25	7479980		2009-01-20	Merheim et al.	
	26	5515453	A	1996-07-05	Hennessey et al.	
	27	5963203	A	1999-10-05	Goldberg et al.	
	28	5983147	A	1999-11-09	Krumm	
	29	6031573	A	2000-02-29	MacCormack et al.	
	30	6088484	A	2000-07-11	Mead	

**INFORMATION DISCLOSURE  
STATEMENT BY APPLICANT**  
( Not for submission under 37 CFR 1.99)

Application Number	12596116
Filing Date	2009-09-11
First Named Inventor	Alan J. Lipton
Art Unit	2621
Examiner Name	Tung Vo
Attorney Docket Number	OV-101

31	6404455	B1	2002-06-11	Ito et al.	
32	6411724	B1	2002-06-25	Vaithilingam et al.	
33	6504479	B1	2003-01-07	Lemons et al.	
34	6525658	B2	2003-02-25	Streetman et al	
35	6570608	B1	2003-05-27	Tserng	
36	6573907	B1	2003-06-03	Madrane	
37	6597800	B1	2003-07-22	Murray et al.	
38	6628835	B1	2003-09-30	Brill et al.	

If you wish to add additional U.S. Patent citation information please click the Add button.

**Add**

**U.S.PATENT APPLICATION PUBLICATIONS**

**Remove**

Examiner Initial*	Cite No	Publication Number	Kind Code <sup>1</sup>	Publication Date	Name of Patentee or Applicant of cited Document	Pages, Columns, Lines where Relevant Passages or Relevant Figures Appear
	1	20050146605		2005-07-07	Lipton et al.	

**INFORMATION DISCLOSURE  
STATEMENT BY APPLICANT**  
( Not for submission under 37 CFR 1.99)

Application Number		12596116
Filing Date		2009-09-11
First Named Inventor	Alan J. Lipton	
Art Unit		2621
Examiner Name	Tung Vo	
Attorney Docket Number		OV-101

2	20040113933	A1	2004-06-17	Guler	
3	20070013776		2007-01-18	Venetianer et al.	
4	20020191851	A1	2002-12-19	Keinan	
5	20030053659	A1	2003-03-20	Pavlidis et al.	
6	20080100704	A1	2008-05-01	Venetianer et al.	
7	20020008758	A1	2002-01-24	Broemmelsiek et al.	
8	20020082769		2002-06-27	Church et al.	
9	20050157169	A1	2005-07-21	Brodsky et al.	
10	20050162515		2005-07-28	Venetianer et al.	
11	20050168574		2005-08-04	Lipton et al.	
12	20050169367		2005-08-04	Venetianer et al.	

<b>INFORMATION DISCLOSURE STATEMENT BY APPLICANT</b> ( Not for submission under 37 CFR 1.99)	Application Number	12596116
	Filing Date	2009-09-11
	First Named Inventor	Alan J. Lipton
	Art Unit	2621
	Examiner Name	Tung Vo
	Attorney Docket Number	OV-101

If you wish to add additional U.S. Published Application citation information please click the Add button.

**FOREIGN PATENT DOCUMENTS**

Examiner Initial*	Cite No	Foreign Document Number <sup>3</sup>	Country Code <sup>2</sup> i	Kind Code <sup>4</sup>	Publication Date	Name of Patentee or Applicant of cited Document	Pages, Columns, Lines where Relevant Passages or Relevant Figures Appear	T <sup>5</sup>
	1							<input type="checkbox"/>

If you wish to add additional Foreign Patent Document citation information please click the Add button

**NON-PATENT LITERATURE DOCUMENTS**

Examiner Initials*	Cite No	Include name of the author (in CAPITAL LETTERS), title of the article (when appropriate), title of the item (book, magazine, journal, serial, symposium, catalog, etc), date, pages(s), volume-issue number(s), publisher, city and/or country where published.	T <sup>5</sup>
	1		<input type="checkbox"/>

If you wish to add additional non-patent literature document citation information please click the Add button

**EXAMINER SIGNATURE**

Examiner Signature	Date Considered
--------------------	-----------------

\*EXAMINER: Initial if reference considered, whether or not citation is in conformance with MPEP 609. Draw line through a citation if not in conformance and not considered. Include copy of this form with next communication to applicant.

<sup>1</sup> See Kind Codes of USPTO Patent Documents at [www.USPTO.GOV](http://www.USPTO.GOV) or MPEP 901.04. <sup>2</sup> Enter office that issued the document, by the two-letter code (WIPO Standard ST.3). <sup>3</sup> For Japanese patent documents, the indication of the year of the reign of the Emperor must precede the serial number of the patent document. <sup>4</sup> Kind of document by the appropriate symbols as indicated on the document under WIPO Standard ST.16 if possible. <sup>5</sup> Applicant is to place a check mark here if English language translation is attached.

<b>INFORMATION DISCLOSURE STATEMENT BY APPLICANT</b> ( Not for submission under 37 CFR 1.99)	Application Number	12596116
	Filing Date	2009-09-11
	First Named Inventor	Alan J. Lipton
	Art Unit	2621
	Examiner Name	Tung Vo
	Attorney Docket Number	OV-101

**CERTIFICATION STATEMENT**

Please see 37 CFR 1.97 and 1.98 to make the appropriate selection(s):

That each item of information contained in the information disclosure statement was first cited in any communication from a foreign patent office in a counterpart foreign application not more than three months prior to the filing of the information disclosure statement. See 37 CFR 1.97(e)(1).

**OR**

That no item of information contained in the information disclosure statement was cited in a communication from a foreign patent office in a counterpart foreign application, and, to the knowledge of the person signing the certification after making reasonable inquiry, no item of information contained in the information disclosure statement was known to any individual designated in 37 CFR 1.56(c) more than three months prior to the filing of the information disclosure statement. See 37 CFR 1.97(e)(2).

See attached certification statement.

Fee set forth in 37 CFR 1.17 (p) has been submitted herewith.

None

**SIGNATURE**

A signature of the applicant or representative is required in accordance with CFR 1.33, 10.18. Please see CFR 1.4(d) for the form of the signature.

Signature	/Patrick D. Muir/	Date (YYYY-MM-DD)	2009-12-31
Name/Print	Patrick D. Muir, Reg. #37403	Registration Number	37,403

This collection of information is required by 37 CFR 1.97 and 1.98. The information is required to obtain or retain a benefit by the public which is to file (and by the USPTO to process) an application. Confidentiality is governed by 35 U.S.C. 122 and 37 CFR 1.14. This collection is estimated to take 1 hour to complete, including gathering, preparing and submitting the completed application form to the USPTO. Time will vary depending upon the individual case. Any comments on the amount of time you require to complete this form and/or suggestions for reducing this burden, should be sent to the Chief Information Officer, U.S. Patent and Trademark Office, U.S. Department of Commerce, P.O. Box 1450, Alexandria, VA 22313-1450. **DO NOT SEND FEES OR COMPLETED FORMS TO THIS ADDRESS. SEND TO: Commissioner for Patents, P.O. Box 1450, Alexandria, VA 22313-1450.**



## Privacy Act Statement

The Privacy Act of 1974 (P.L. 93-579) requires that you be given certain information in connection with your submission of the attached form related to a patent application or patent. Accordingly, pursuant to the requirements of the Act, please be advised that: (1) the general authority for the collection of this information is 35 U.S.C. 2(b)(2); (2) furnishing of the information solicited is voluntary; and (3) the principal purpose for which the information is used by the U.S. Patent and Trademark Office is to process and/or examine your submission related to a patent application or patent. If you do not furnish the requested information, the U.S. Patent and Trademark Office may not be able to process and/or examine your submission, which may result in termination of proceedings or abandonment of the application or expiration of the patent.

The information provided by you in this form will be subject to the following routine uses:

1. The information on this form will be treated confidentially to the extent allowed under the Freedom of Information Act (5 U.S.C. 552) and the Privacy Act (5 U.S.C. 552a). Records from this system of records may be disclosed to the Department of Justice to determine whether the Freedom of Information Act requires disclosure of these records.
2. A record from this system of records may be disclosed, as a routine use, in the course of presenting evidence to a court, magistrate, or administrative tribunal, including disclosures to opposing counsel in the course of settlement negotiations.
3. A record in this system of records may be disclosed, as a routine use, to a Member of Congress submitting a request involving an individual, to whom the record pertains, when the individual has requested assistance from the Member with respect to the subject matter of the record.
4. A record in this system of records may be disclosed, as a routine use, to a contractor of the Agency having need for the information in order to perform a contract. Recipients of information shall be required to comply with the requirements of the Privacy Act of 1974, as amended, pursuant to 5 U.S.C. 552a(m).
5. A record related to an International Application filed under the Patent Cooperation Treaty in this system of records may be disclosed, as a routine use, to the International Bureau of the World Intellectual Property Organization, pursuant to the Patent Cooperation Treaty.
6. A record in this system of records may be disclosed, as a routine use, to another federal agency for purposes of National Security review (35 U.S.C. 181) and for review pursuant to the Atomic Energy Act (42 U.S.C. 218(c)).
7. A record from this system of records may be disclosed, as a routine use, to the Administrator, General Services, or his/her designee, during an inspection of records conducted by GSA as part of that agency's responsibility to recommend improvements in records management practices and programs, under authority of 44 U.S.C. 2904 and 2906. Such disclosure shall be made in accordance with the GSA regulations governing inspection of records for this purpose, and any other relevant (i.e., GSA or Commerce) directive. Such disclosure shall not be used to make determinations about individuals.
8. A record from this system of records may be disclosed, as a routine use, to the public after either publication of the application pursuant to 35 U.S.C. 122(b) or issuance of a patent pursuant to 35 U.S.C. 151. Further, a record may be disclosed, subject to the limitations of 37 CFR 1.14, as a routine use, to the public if the record was filed in an application which became abandoned or in which the proceedings were terminated and which application is referenced by either a published application, an application open to public inspections or an issued patent.
9. A record from this system of records may be disclosed, as a routine use, to a Federal, State, or local law enforcement agency, if the USPTO becomes aware of a violation or potential violation of law or regulation.

<b>INFORMATION DISCLOSURE STATEMENT BY APPLICANT</b> ( Not for submission under 37 CFR 1.99)	Application Number		12596116
	Filing Date		2009-09-11
	First Named Inventor	Alan J. Lipton	
	Art Unit		2621
	Examiner Name	Tung Vo	
	Attorney Docket Number		OV-101

U.S.PATENTS							Remove
Examiner Initial*	Cite No	Patent Number	Kind Code <sup>1</sup>	Issue Date	Name of Patentee or Applicant of cited Document	Pages,Columns,Lines where Relevant Passages or Relevant Figures Appear	
	1	6646676	B1	2003-11-11	DaGraca et al.		
	2	6707852	B1	2004-03-16	Wang		
	3	6724915	B1	2004-04-20	Toklu et al.		
	4	6801662	B1	2004-10-05	Owechko et al.		
	5	6816184	B1	2004-11-09	Brill et al.		
	6	6829371	B1	2004-12-07	Nichani et al.		
	7	6844818	B2	2005-01-18	Grech-Cini		
	8	6924801	B1	2005-08-02	Dorbie		

**INFORMATION DISCLOSURE  
STATEMENT BY APPLICANT**  
( Not for submission under 37 CFR 1.99)

Application Number	12596116
Filing Date	2009-09-11
First Named Inventor	Alan J. Lipton
Art Unit	2621
Examiner Name	Tung Vo
Attorney Docket Number	OV-101

9	7023469	B1	2006-04-04	Olson	
---	---------	----	------------	-------	--

If you wish to add additional U.S. Patent citation information please click the Add button.

[Add](#)

**U.S.PATENT APPLICATION PUBLICATIONS**

[Remove](#)

Examiner Initial*	Cite No	Publication Number	Kind Code <sup>1</sup>	Publication Date	Name of Patentee or Applicant of cited Document	Pages, Columns, Lines where Relevant Passages or Relevant Figures Appear
	1	20020051058	A1	2002-05-02	Ito et al.	
	2	20020135483	A1	2002-09-26	Merheim et al.	
	3	20020024446	A1	2002-02-28	Grech-Cini	
	4	20020163521	A1	2002-11-07	Ellenby	
	5	20020095490	A1	2002-07-18	Barker et al.	
	6	20010019357	A1	2001-09-06	Ito et al.	
	7	20010033330	A1	2001-10-25	Garoutte	
	8	20010035907	A1	2001-11-01	Broemmelsiek	

**INFORMATION DISCLOSURE  
STATEMENT BY APPLICANT**  
( Not for submission under 37 CFR 1.99)

Application Number	12596116
Filing Date	2009-09-11
First Named Inventor	Alan J. Lipton
Art Unit	2621
Examiner Name	Tung Vo
Attorney Docket Number	OV-101

9	20040240542	A1	2004-12-02	Yeredor et al.	
---	-------------	----	------------	----------------	--

If you wish to add additional U.S. Published Application citation information please click the Add button.

**FOREIGN PATENT DOCUMENTS**

Examiner Initial*	Cite No	Foreign Document Number <sup>3</sup>	Country Code <sup>2</sup> i	Kind Code <sup>4</sup>	Publication Date	Name of Patentee or Applicant of cited Document	Pages, Columns, Lines where Relevant Passages or Relevant Figures Appear	T <sup>5</sup>
	1							<input type="checkbox"/>

If you wish to add additional Foreign Patent Document citation information please click the Add button

**NON-PATENT LITERATURE DOCUMENTS**

Examiner Initials*	Cite No	Include name of the author (in CAPITAL LETTERS), title of the article (when appropriate), title of the item (book, magazine, journal, serial, symposium, catalog, etc), date, pages(s), volume-issue number(s), publisher, city and/or country where published.	T <sup>5</sup>
	1		<input type="checkbox"/>

If you wish to add additional non-patent literature document citation information please click the Add button

**EXAMINER SIGNATURE**

Examiner Signature	Date Considered
--------------------	-----------------

\*EXAMINER: Initial if reference considered, whether or not citation is in conformance with MPEP 609. Draw line through a citation if not in conformance and not considered. Include copy of this form with next communication to applicant.

<sup>1</sup> See Kind Codes of USPTO Patent Documents at [www.USPTO.GOV](http://www.USPTO.GOV) or MPEP 901.04. <sup>2</sup> Enter office that issued the document, by the two-letter code (WIPO Standard ST.3). <sup>3</sup> For Japanese patent documents, the indication of the year of the reign of the Emperor must precede the serial number of the patent document. <sup>4</sup> Kind of document by the appropriate symbols as indicated on the document under WIPO Standard ST.16 if possible. <sup>5</sup> Applicant is to place a check mark here if English language translation is attached.

<b>INFORMATION DISCLOSURE STATEMENT BY APPLICANT</b> ( Not for submission under 37 CFR 1.99)	Application Number	12596116
	Filing Date	2009-09-11
	First Named Inventor	Alan J. Lipton
	Art Unit	2621
	Examiner Name	Tung Vo
	Attorney Docket Number	OV-101

**CERTIFICATION STATEMENT**

Please see 37 CFR 1.97 and 1.98 to make the appropriate selection(s):

That each item of information contained in the information disclosure statement was first cited in any communication from a foreign patent office in a counterpart foreign application not more than three months prior to the filing of the information disclosure statement. See 37 CFR 1.97(e)(1).

**OR**

That no item of information contained in the information disclosure statement was cited in a communication from a foreign patent office in a counterpart foreign application, and, to the knowledge of the person signing the certification after making reasonable inquiry, no item of information contained in the information disclosure statement was known to any individual designated in 37 CFR 1.56(c) more than three months prior to the filing of the information disclosure statement. See 37 CFR 1.97(e)(2).

- See attached certification statement.
- Fee set forth in 37 CFR 1.17 (p) has been submitted herewith.
- None

**SIGNATURE**

A signature of the applicant or representative is required in accordance with CFR 1.33, 10.18. Please see CFR 1.4(d) for the form of the signature.

Signature	/Patrick D. Muir/	Date (YYYY-MM-DD)	2009-12-31
Name/Print	Patrick D. Muir, Reg. #37403	Registration Number	37,403

This collection of information is required by 37 CFR 1.97 and 1.98. The information is required to obtain or retain a benefit by the public which is to file (and by the USPTO to process) an application. Confidentiality is governed by 35 U.S.C. 122 and 37 CFR 1.14. This collection is estimated to take 1 hour to complete, including gathering, preparing and submitting the completed application form to the USPTO. Time will vary depending upon the individual case. Any comments on the amount of time you require to complete this form and/or suggestions for reducing this burden, should be sent to the Chief Information Officer, U.S. Patent and Trademark Office, U.S. Department of Commerce, P.O. Box 1450, Alexandria, VA 22313-1450. **DO NOT SEND FEES OR COMPLETED FORMS TO THIS ADDRESS. SEND TO: Commissioner for Patents, P.O. Box 1450, Alexandria, VA 22313-1450.**

## Privacy Act Statement

The Privacy Act of 1974 (P.L. 93-579) requires that you be given certain information in connection with your submission of the attached form related to a patent application or patent. Accordingly, pursuant to the requirements of the Act, please be advised that: (1) the general authority for the collection of this information is 35 U.S.C. 2(b)(2); (2) furnishing of the information solicited is voluntary; and (3) the principal purpose for which the information is used by the U.S. Patent and Trademark Office is to process and/or examine your submission related to a patent application or patent. If you do not furnish the requested information, the U.S. Patent and Trademark Office may not be able to process and/or examine your submission, which may result in termination of proceedings or abandonment of the application or expiration of the patent.

The information provided by you in this form will be subject to the following routine uses:

1. The information on this form will be treated confidentially to the extent allowed under the Freedom of Information Act (5 U.S.C. 552) and the Privacy Act (5 U.S.C. 552a). Records from this system of records may be disclosed to the Department of Justice to determine whether the Freedom of Information Act requires disclosure of these records.
2. A record from this system of records may be disclosed, as a routine use, in the course of presenting evidence to a court, magistrate, or administrative tribunal, including disclosures to opposing counsel in the course of settlement negotiations.
3. A record in this system of records may be disclosed, as a routine use, to a Member of Congress submitting a request involving an individual, to whom the record pertains, when the individual has requested assistance from the Member with respect to the subject matter of the record.
4. A record in this system of records may be disclosed, as a routine use, to a contractor of the Agency having need for the information in order to perform a contract. Recipients of information shall be required to comply with the requirements of the Privacy Act of 1974, as amended, pursuant to 5 U.S.C. 552a(m).
5. A record related to an International Application filed under the Patent Cooperation Treaty in this system of records may be disclosed, as a routine use, to the International Bureau of the World Intellectual Property Organization, pursuant to the Patent Cooperation Treaty.
6. A record in this system of records may be disclosed, as a routine use, to another federal agency for purposes of National Security review (35 U.S.C. 181) and for review pursuant to the Atomic Energy Act (42 U.S.C. 218(c)).
7. A record from this system of records may be disclosed, as a routine use, to the Administrator, General Services, or his/her designee, during an inspection of records conducted by GSA as part of that agency's responsibility to recommend improvements in records management practices and programs, under authority of 44 U.S.C. 2904 and 2906. Such disclosure shall be made in accordance with the GSA regulations governing inspection of records for this purpose, and any other relevant (i.e., GSA or Commerce) directive. Such disclosure shall not be used to make determinations about individuals.
8. A record from this system of records may be disclosed, as a routine use, to the public after either publication of the application pursuant to 35 U.S.C. 122(b) or issuance of a patent pursuant to 35 U.S.C. 151. Further, a record may be disclosed, subject to the limitations of 37 CFR 1.14, as a routine use, to the public if the record was filed in an application which became abandoned or in which the proceedings were terminated and which application is referenced by either a published application, an application open to public inspections or an issued patent.
9. A record from this system of records may be disclosed, as a routine use, to a Federal, State, or local law enforcement agency, if the USPTO becomes aware of a violation or potential violation of law or regulation.



Europäisches Patentamt  
 European Patent Office  
 Office européen des brevets



(11)

EP 0 893 923 A1

(12) **EUROPEAN PATENT APPLICATION**

(43) Date of publication:  
 27.01.1999 Bulletin 1999/04

(51) Int. Cl.<sup>6</sup>: H04N 7/26

(21) Application number: 97401772.5

(22) Date of filing: 23.07.1997

(84) Designated Contracting States:  
 AT BE CH DE DK ES FI FR GB GR IE IT LI LU MC  
 NL PT SE  
 Designated Extension States:  
 AL LT LV SI

(72) Inventor: **Thomas, David, Richard**  
 06650 Opio Cedex (FR)

(74) Representative:  
**Obolensky, Michel et al**  
 c/o CABINET LAVOIX  
 2, place d'Estienne d'Orves  
 75441 Paris Cédex 09 (FR)

(71) Applicant:  
**TEXAS INSTRUMENTS FRANCE**  
 06271 Villeneuve Loubet Cédex (FR)

(54) **Video communication system**

(57) The present invention provides a video communication system 100 and a method for operating a video communication system 100. An event is monitored with a video camera 112' to generate a sequence of frames of a video image. Video data is selected only from those regions of the video image in which motion exceeds a predetermined level. The selected video data and audio data corresponding to each frame of the video image are compressed before a signal comprising the compressed video data and the compressed audio data is generated and transmitted to a receiver 111". The receiver 111" decompresses the received signal to produce audio data and a first portion of said video data. A second portion of the video data for regions of a current frame of the video image that differ from a preceding frame of the video image is predicted from the decompressed audio data. The first and second portions of said video data are then combined to generate a display video image.

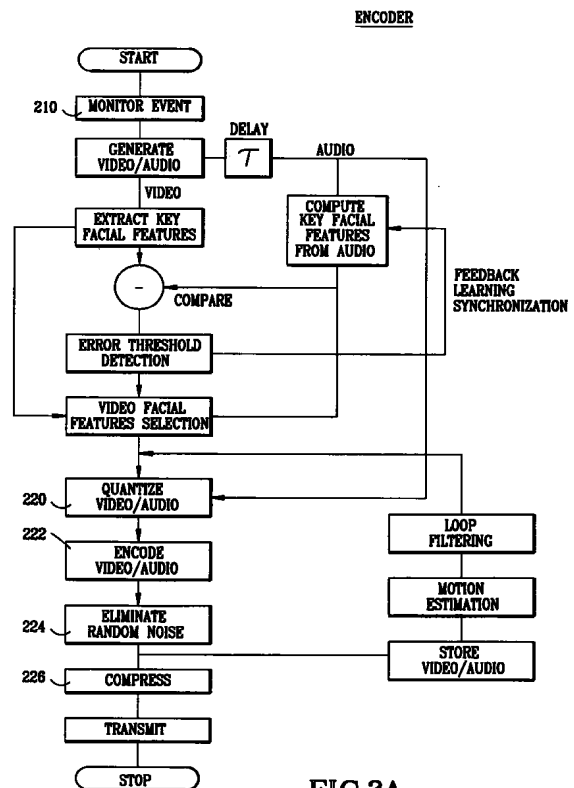

EP 0 893 923 A1

**Description**

**FIELD OF THE INVENTION**

The present invention relates generally to the compression of data in a signal having a video component and an audio component, and more particularly to a method and apparatus for reducing the data transmission requirements of signals transmitted between remote terminals of a video communication system.

**BACKGROUND OF THE INVENTION**

Recently, the use of video communication systems has become more prevalent. The more widespread acceptance of video communication systems has been restricted by the relatively poor quality of the displayed video images. This can largely be attributed to the use of the existing telecommunications infrastructure which was designed for the transmission of audio data only.

Current video communication systems generate poor quality video images providing small display areas, jerky motion, blurriness, blocky looking artefacts and in many instances the audio fails to fully synchronise with the video images. This is largely due to group delay introduced by the compression/decompression of the video signal for transmission.

The fundamental objective of recent developments in video communication systems has been to provide the best quality video image within the available data rate. Typically, video data is compressed prior to transmission and decompressed prior to generating an image following transmission.

Various national and international bodies have defined standards for the operation of video communication systems. One such standard is the H.320 video conferencing standard issued by the International Telecommunications Union (ITU).

The ITU H.320 standard supports a wide range of transmission data rates. Sophisticated, video communication systems provide greater levels of data to a single frame of the video image, generating an image having greater resolution. Commonly, the data rates used by video communication systems are 128K bits per second (known as baseband ISDN) and 384K bits per second (known as triple baseband ISDN). To date video communication systems using data rates substantially lower than 128/K bits per second have not been accepted due to the poor quality of the received image.

It should be noted that the audio component and the synchronisation component of the generated signal must be subtracted from these data rates. The most commonly used audio compression standard is the ITU G.728 standard that requires 16K bits per second.

Since the bandwidth is dictated by the available transmission medium, video communication systems requiring lower data rates generally require greater compression of the video image. Conventional com-

pression rates for video compression systems are in the range of 100-to-1 to 300-to-1. However, high compression of the video image will invariably result in a loss in the quality of the video image, particularly in sequences with significant changes from frame-to-frame. High compression of the video image also invariably results in increased group delay due to the computation time required in the coder and decoder.

Recent developments in video communication systems have attempted to alleviate some of the problems described by reducing the level of data required by the receiver for generating the display video image. This has been achieved by selecting and compressing video data only from those regions of the video image containing significant changes from frame-to-frame for transmission to the receiver. However, the quality of the display video image remains compromised where the monitored event comprises a situation where high levels of motion in separate regions of the video image occur, for example in a video conference situation where the monitored event comprises a group of users.

In video conferencing situations users derive a greater comfort factor from systems that are able to generate a display image in which the video component and the audio component are synchronised. Furthermore, it has been found that users are better able to comprehend audio data (speech) where the facial movements of other users are distinct. Therefore, it is desirable to maintain and even enhance the resolution of the display video image in regions comprising the facial features of the user.

**SUMMARY OF THE INVENTION**

The present invention provides a video communication system and method for operating a video communication system that reduce the levels of data required by the receiver for generating the display video image. This is achieved by transmitting only video data for regions of successive frames that contain "substantial" differences frame-to-frame. Video data corresponding to the facial region of the "active" user at any instant is predicted from the received audio data.

Since a large part of facial movement that takes place during a conversation is produced to generate spoken information, there is an inherent correlation between the generated speech and the facial features of the user at any instant. Therefore, it is possible to transmit the audio data (speech) to the receiver without the video data that corresponds to these facial features. The received audio data can then be used to predict pixels of the display video image that have changed from a preceding frame, in order that the current frame of the display video image can be reconstructed. This leads to a reduction in the data rate requirements of the video communication system.

Removing the duplication of audio data (speech) and video data corresponding to these facial features



reduces the data rate for transmission. Furthermore, since changes of these facial features are derived from the audio data (speech) it enables bidirectional and substantially synchronised audio and video data to be transmitted with a much reduced group delay when compared with conventional video communication systems.

Accordingly, a first aspect of the present invention provides a method for operating a video communication system comprising the steps of; monitoring an event with a video camera to generate a sequence of frames of a video image, selecting video data only from those regions of the video image comprising motion exceeding a predetermined level, compressing video data corresponding to said selected regions and compressing audio data for each of said frames of said video image, generating a signal comprising said compressed video data and compressed audio data and transmitting said signal to a receiver, at a receiver decompressing said received signal to produce audio data and a first portion of said video data, predicting a second portion of the video data for regions of a subsequent frame of the video image that differ from a preceding frame of the video image from said audio data, and combining said first and second portions of said video data to generate a display image.

According to a second aspect of the present invention there is provided a video communication system comprising; means for receiving an input from a video camera arranged for monitoring an event and for generating a sequence of frames of a video image, means for selecting video data only from those regions of the current video image including motion exceeding a predetermined level, a data compression module for compressing video data corresponding to said selected regions and audio data for each of said frames of said video image, means for generating a signal comprising said compressed video data and compressed audio data and transmitting said signal to a receiver, said receiver comprising a data decompression module for decompressing said received signal to produce audio data and a first portion of said video data, means for predicting a second portion of the video data for regions of the current frame of the video image that differ from a preceding frame of the video image from said audio data, and means for combining said first and second portions of said video data to generate a display image.

#### BRIEF DESCRIPTION OF THE DRAWINGS

For a more complete understanding of the present invention, and further features and advantages thereof, reference is now made, by way of example, to the following description taken in conjunction with the accompanying drawings, in which;

Figure 1 is a schematic block diagram of a conventional high-specification video communication system;

tem;

Figure 2a is a schematic block diagram of a transmission portion of a video communication system in accordance with the present invention;

Figure 2b is a schematic block diagram of a receiving portion of a video communication system in accordance with the present invention;

Figure 3a is a flow diagram illustrating a method of operating the transmitting portion of Figure 2a; and

Figure 3b is a flow diagram illustrating a method of operating the receiving portion of Figure 2b; and

Figure 4 shows example display video image from a conferencing situation illustrating the operation of the video communication system in accordance with the present invention.

For convenience like and corresponding features of the drawings will be referenced by like and corresponding reference numerals where possible.

#### DETAILED DESCRIPTION OF THE DRAWINGS

As previously described herein, resolution is lost from the generated video image due to the compression of the video data for transmission and its subsequent decompression. Video communication systems having greater processing power are more capable of implementing the ITU H.320 standard to produce greater quality video images.

Video communication systems using devices such as the TMS320C80 Multimedia Video Processor produced by Texas Instruments Inc. utilize a codec (coder/decoder) having H.320/MPEG-1/YPEG functionality for producing high quality video images. However, with so many variables the quality of the video image generated by the video communication systems can differ greatly. To provide the optimal quality of video image, a video communication system must provide an implementation of the ITU H.320 standard that is capable of determining bit allocation decisions to obtain the best quality video image within the available data rate and bandwidth.

The ITU H.320 standard is capable of supporting a range of compression techniques. Different compression techniques may be implemented to compress different portions of a single video frame according to the content of the video image. For example, a first compression technique may be used for compressing portions of the video data containing a background image that remains substantially constant from frame-to-frame, and a second compression technique may be used for compressing portions of the video data that comprise changes in the foreground image from frame-

to-frame as may occur with a user waving his hand or nodding his head.

Furthermore, the operating characteristics of the individual video communication system may effect the quality of the video image perceived by the user. These operating characteristics may make a particular video communication system inherently suitable for certain applications, while unsuitable for other applications.

Figure 1 shows a schematic block illustration of a typical high-specification video communication system 10. For convenience, the video communication system 10 will be described in terms of a transmitting portion 11' and a receiving portion 11". However, it will be understood by the skilled person that generally operation of the video communication will require both the portion 11' and the portion 11" to be capable of both generating and transmitting video data, and receiving and converting the video data to generate a video image.

The transmitting portion 11' includes a video camera 12', quantization module 14', coding module 15', pre-processing module 16', loop filtering circuit 17', motion estimation module 18', memory 19', and compression module 20'. Similarly, the receiving portion comprises a video display 12", dequantization module 14", decoding module 15", post-processing module 16", loop filtering circuit 17", motion estimation module 18", memory 19", and decompression module 20". It should be understood that various components described may perform dual functions dependant upon the portion 11' or the portion 11" operating in a transmitting or receiving mode of operation. It will should further be understood that the transmitting portion 11' and the receiving portion 11" are connected by a transmission medium 21, that may comprise a "hard-wired" electrical connection, a fibre optic connection, or a radio frequency connection.

The video camera 12' of the transmitting portion 11' is connected to the quantization module 14'. The quantization module 14' is capable of assigning each bit of the video data received from the video camera 12' to a predetermined quantization level. The quantisation module 14' is further connected to coding module 15' which receives the quantized video data and encodes each 16x16 pixel block in a frame using either an "inter-frame" or an "intraframe" coding technique. The "inter-frame" coding technique relies upon error terms used for correction of prediction data contained in a previous reference frame of the video image. Conversely, the "intraframe" coding technique relies upon actual pixel data. Selection of the appropriate coding technique will provide a greater quality video image, but use of the "interframe" coding technique is generally limited to video communication systems of greater complexity.

The pre-processing module 16' receives the encoded video data from the coding module 15' and eliminates the randomly generated noise that may cause single pixel errors originating from the video cam-

era 12'. Subsequent compression of this noise will increase the data transmission requirements of the system and waste data bandwidth of the transmission medium. Although simple low pass filtering can reduce the noise, it generally results in blurring of the resulting video image. Therefore, more complex filtering techniques are used (linear or non-linear filtering) in order that the noise generated by the video camera 12' is reduced, while preserving the resolution of the resulting video image.

The compression module 20' receives the encoded and preprocessed video data and performs a compression process on the video data. The compressed video data is then transmitted via the transmission medium 21 to the receiving module 11", but is also stored in memory 19' to assist with reducing the data content of subsequently transmitted frames of the video image.

At lower bandwidths and with sequences of frames of the video image that are not effectively compressed (i.e. those involving substantial motion), a reduction of the frame rate generally improves the quality of the video image. At relatively low data rates, as may be necessary due to the available bandwidth of standard transmission media, a frame rate that is too high will result in too few bits of the video image being provided to generate an adequate video image. Typically, video communication systems operating in accordance with the H.320 standard will provide a 128K data rate to produce between 7 and 15 frames per second. However, a lower frame rate may be required during sequences when there is substantial motion between subsequent frames of the video image.

In typical operational situations, the background and various features monitored by the video camera 12' remain substantially stationary from one frame period of the video image to the next frame period. However, movement of a feature between subsequent frame periods will cause pixels reproducing that feature to move as a block.

The encoded video data stored in memory 19' is used by motion estimation module 18' to generate motion vectors that estimate the position of the each pixel or block of pixels according to the position of that pixel or block of pixels in a preceding frame. Since motion between subsequent frame periods may be relatively complex (e.g. a rotating hand), motion vectors are only capable of providing rough approximations of the position of a pixel or block of pixels. Although additional data can be provided to improve the approximation of the position of the pixel (s), the provision of more accurate approximations of the position of the pixel(s) requires the transmission of less correcting data.

The methods for computing motion vectors vary widely between video communication systems since the ITU H.320 standard does not specify how these motion vectors should be obtained. Video communication systems providing limited motion estimation may comply with the H.320 standard, but will typically provide a rela-

tively poor quality video image. In more complex video communication systems utilising devices such as the TMS320C80, effective motion estimation is achieved through software implemented intelligent algorithms.

Following the generation of motion vectors by motion estimation module 18', a further improvement in the quality of the video image is obtained by reducing large errors in the prediction data and estimation vectors. This is achieved by loop filtering module 17' that performs a loop filtering process when using "intra-frame" coding techniques.

Referring now to the receiving portion 11", compressed and encoded video data is received from the transmitting portion 11' via the transmission medium 21. The received video data is decompressed at decompression module 20". However, the compression algorithms implemented by video communication systems may generate "mosquito noise" in the video data that causes artefacts in the resulting video image. Mosquito noise can be attributed to excessive quantization of the video data resulting in the elimination of important high frequency information along contours in the video image (e.g. the edge between a face and the background). Post-processing module 16" provides a reduction in the effects of "mosquito noise" by post-processing of the video data prior to the display of the video image.

Following post-processing the video data is passed via decoding module 15" and dequantization module 14" to video display 12" for generation of the video image.

It is preferred that motion estimation and loop filtering be performed by the transmitting module 11" in order that unnecessary bits of data do not utilize bandwidth that may be more effectively utilized by bits of data that change from frame-to-frame. However, motion estimation can also be performed at the receiving portion 11".

Furthermore, delays in the transmission of video data and in the generation of the video image result from the need to compress and decompress the video data, together with any inherent delays introduced by the transmission medium 21. Typically therefore, audio data is delayed in order that it may be synchronized with the video data. However, where a reduction in the data rate results in fewer frames of the video image being provided in a defined time period, as may occur where substantial motion occurs between subsequent frames of the video image, a loss of synchronisation may occur between the audio and video data. Therefore, the comfort factor for the user of the video communication system is greater where the delay due to compression of the video data is reduced.

Each of the previously described factors, and additional factors not detailed herein but recognizable to the skilled person, contribute to the quality of the video image perceived by the user of the video communication system. However, it should be understood that

although the present invention is described in terms of a video communication system complying with the ITU H.320 standard, the present invention is not limited to systems of the H.320 standard or to factors not specifically detailed herein.

Referring now to Figures 2a and 2b there are shown the transmitting portion 111' and the receiving portion 111" of a video communication system in accordance with the invention. The skilled person will clearly identify that many features of the conventional video communication system illustrated in Figure 1 are retained, and indeed perform like and corresponding functions to similarly identified features illustrated therein. For convenience the operation of portions 111' and 111" are described in terms of transmitting and receiving video signal respectively. However, in practise both portions 111' and 111" will be operable in either a transmitting mode of operation or a receiving mode of operation.

Figure 2a illustrates the transmitting portion 111' which differs from the corresponding transmitting portion 111' of Figure 1 merely by the addition of processor 130 between the coding module 115' and the pre-processing module 116', storage unit 132 connected to the processor 130, and by separate video quantization module 114' and audio quantization module 131'.

Similarly, Figure 2b illustrates the receiving portion 111" which differs from the corresponding receiving portion 111" of the Figure 1 merely by the addition of the processor 130' between post-processing module 116" and decoding module 115", storage unit 132' connected to the processor 130' and combining module 134.

Referring now to Figure 4, an example display video image from a video conferencing situation is illustrated. The display video image comprises the head and shoulder region of a user, monitored by the video camera 112'. The processor 130' selects integers corresponding to predetermined facial features (marked by crosses). For example, the selected integers in Figure 4 are the chin 312, opposing edges of the mouth 314' and 314" respectively, the nose 316, and the outer edge of each eye 318 and 320 respectively. Since the facial features around the region of the mouth vary substantially during speech these features are selected in more detail for example, around the position of the lips defined by 321, 322, 323 and 324. Details of this approach can be found in the paper "view based and modular eigen spaces for face recognition", Pentlan A. et al, IEEE Data Compression Conference, Utah, March 1995.

Preferably, the video image is divided into substantially triangular regions or blocks of pixels. Each of these regions is represented by an eigen feature. In regions where motion is likely to be less frequent (i.e. the background) but assist the user little in his comprehension of the audio data (speech), the regions comprise a larger area of pixels than regions from which the user gains

much assistance in comprehension of the audio data (e.g. mouth, chin, eyes, nose). Therefore, eigen features for video data corresponding to the region enclosed by the integers 312, 314, 316, 318, 320, 321, 322, 323 and 324 are representative of a smaller area of pixels than eigen features corresponding to an area of the video image that is external to the region enclosed by the integers.

#### TRANSMITTING PORTION

Operation of the transmitting portion 111' of Figure 2a will now be described in detail with reference to Figure 3a and Figure 4. For convenience, the operation of the transmitting portion 111' will be discussed for a situation where the video camera 112' monitors the head and shoulder region of an active user.

Referring firstly to Figure 3a, the transmitting portion 111' of the video communication system 110 monitors an event with video camera 112' (Block 210). Typically, the monitored event will comprise a video conferencing situation where a first user or group of users are monitored by the camera 112'. As is well known in the art, the video camera 112' is arranged to monitor the active user (i.e. the currently speaking user).

Quantization module 114' assigns each bit of the video data received from the video camera 112' to a predetermined quantization level. The processor 130' receives the quantized video data and identifies selected integers of the user facial features. For example, it is commonly known that the facial features which provide user's with the most assistance when comprehending speech are the regions around the eyes, nose, mouth and chin.

The processor 130' assigns each area of the video image to an eigen feature. Typically, eigen features that are representative of regions between the integers have a smaller area of pixels than regions not enclosed by the integers.

It will be appreciated by the skilled person that it is advantageous to assign eigen features representative of a smaller area of pixels to those regions of the video image in which significant motion is probable, and to assign eigen features representative of a greater area of pixels to those regions of the video image in which motion and/or the relevance of the information content of the video data are less. The use of an appropriate digital signal processor, such as the TMS320C6X manufactured by Texas Instruments Inc., will provide a system that is reactive to the information content of the video data at any instant.

The processor 130' synchronizes the corresponding speech patterns accompanying the video image by adding a fixed delay equivalent to any differences in delay occurring in the video quantization module 114' and audio quantization module 131'. The processor 130' then computes using an algorithm and/or look up table stored in the storage unit 132', the key eigen fea-

tures of the face corresponding to the quantized audio data. For example the location of the corners of the mouth (314' and 314''), the position of the top of the upper lip 321', the position of the lower part of the upper lip 324', the position of the upper part of the lower lip 323 and the position of the lower part of the lower lip 322 are dependent on the speech associated with a particular frame of video. In addition the position of the corners of the mouth (314' and 314'') relative to the chin 312 and nose 316 and the eyes (318 and 320) are again dependent on the speech associated with a particular frame of video.

The computed eigen features are compared to the features that have been determined by analysis of the data received from the video quantization module 114'. If the error between the eigen features computed from the data received from the audio quantization module 131' and the corresponding eigen features determined from the data obtained from the video quantization module are below a predefined limit the corresponding eigen features are not forwarded to the coding module 115'. To further reduce the data rate required for transmission of the video it is possible that the video communication system 110 could undergo a period of 'learning' where the parameters of the algorithm and/or look up table can be modified to reduce the error between the eigen features computed from the data received from the audio quantization module 131' and the corresponding eigen features determined from the data obtained from the video quantization module 114'. During the period of 'learning' synchronization of the receiver section of the video communication system 111' is achieved by transmission of information relating to the modifications to the algorithms and/or look up table that take place in the encoding section of the video communication system (110).

The coding module 115' receives the video data from the processor 130' and encodes residual eigen feature in a frame of the video image (Block 222).

The pre-processing module 116' receives the encoded video data from the coding module 115' and eliminates the randomly generated noise that may cause single pixel errors originating from the video camera 12' (Block 224).

Compression module 120' receives the encoded and pre-processed video data and performs a compression process on the video data (Block 226). The compressed video data is then transmitted via the transmission medium 121 to the receiving module 111'' (Block 228), but is also stored in memory 119' (Block 230) to assist with reducing the data content of subsequently transmitted frames of the video image.

In typical operational situations, the background and various features monitored by the video camera 112' remain substantially stationary from one frame period of the video image to the next frame period. The encoded video data stored in memory 119' is used by motion estimation module 118'' to generate motion vec-

tors that estimate the position of each residual eigen feature according to the position of that residual eigen feature in a preceding frame (Block 232). Since motion between subsequent frame periods may be relatively complex (e.g. a rotating hand), motion vectors are only capable of providing rough approximations of the position of an eigen feature. Although additional data can be provided to improve the approximation of the position of the eigen feature(s), the provision of more accurate approximations of the position of the eigen feature(s) requires the transmission of less correcting data.

Following the generation of motion vectors by motion estimation module 118', a further improvement in the quality of the video image is obtained by reducing large errors in the prediction data and estimation vectors. This is achieved by loop filtering module 117' that performs a loop filtering process using "intraframe" coding techniques (Block 234).

During an initial period of operation, video data corresponding to each residual eigen feature of the display video image is selected (Block 218), quantised (Block 220), encoded (Block 222), filtered to eliminate random noise (Block 224), compressed (Block 226), and transmitted to receiving portion 111" (Block 228). Similarly, the transmitting portion 111' operates in accordance with the initial period of operation for a new video image, as may occur where a new user becomes the active user. Operation of the transmitting portion 111' of the video communication system during this period substantially corresponds with the operation of the transmitting portion 11' of the prior art video communication system of Figure 2a.

During subsequent periods of operation, the processor 130' identifies regions between the selected integers (312, 314, 316, 318, 320) and determines whether the eigen features calculated from the audio quantized data are within predetermined limits of the eigen features extracted from the video quantized data. A substantial difference in the eigen features calculated and extracted from the video quantized data is indicative of the following; (i) the monitored user is speaking but the algorithm and/or tables need training to the specific eigen features of the speaker; (ii) the frame of the video image of the monitored active user differs from the preceding frame (i.e. motion of the active user); (iii) the monitored event has changed.

#### (i) Speech, No Motion

Processor 130' identifies for comparison eigen features of the display video image that substantially correspond with regions of the display video image that move with speed. For example, the head and shoulders of the monitored user may remain stationary for a sequence of frames although there will be motion of the regions around the eyes, nose and mouth as the monitored active user speaks.

For example, when expressing the syllable "Ahh"

the mouth is opened wide and consequently the chin drops, but eyes and nose remain substantially stationary.

Consequently by detecting the audio quantization data corresponding to the syllable "Ahh" one can predict the corresponding movement of the eigen features representing the chin (312) the corners of the mouth (314' and 314"), the top of the upper lip (321), the bottom of the upper lip (324), the top of the lower lip (323), the bottom of the lower lip (322) relative to the eyes (318 and 320) and the nose (316). The calculated movement of the eigen features is smoothed over a number of frames corresponding to the initial formation, duration of the syllable and transition to the next syllable.

#### (ii) Speech and Motion

Processor 130' identifies regions of the display video image that substantially correspond with regions of the preceding display video image. For example, the shoulders of the monitored user may remain stationary for a sequence of frames, but the user may change the orientation of his head and there may be motion of the regions around the eyes, nose and mouth as the monitored active user speaks.

Processor 130' selects those regions of the monitored video image where motion greater than a predetermined level is detected. This may be achieved by means of additional integer reference points selected by the processor 130', where a change in the position of eigen features between adjacent integers is indicative of motion.

For example, if the active user changes orientation of his/her head by looking to the right, the distance between the integers 320 and 318 and between 314' and 314" would decrease and the right ear would go out of display video image. Consequently the difference between the eigen features calculated by processor (130') from the audio quantized data and the eigen features extracted from the video quantized data would increase beyond the present limit. Under these conditions the eigen features extracted from the video quantized data are passed onto the coding module (115') and subsequently compressed and transmitted to the receiver. If the movement of the head to the right persists for a number of video frames the 'learning' synchronization at the coding module 115' of the video communication system will modify the algorithm and/or lookup tables to produce the corresponding eigen features to the head turned right position. During the 'learning' synchronization period the changes in the algorithm and/or lookup table are transmitted to the receiver of the video communication system. The net result is the gradual reduction of the difference between the eigen features calculated from the audio quantized data and those extracted from the video quantized data until they are within the preset limits such that the eigen features are not passed to the coding module (115') for subse-

quent transmission to the receiver of the video communication system.

However, in general use the head and shoulders of the monitored user may remain stationary for a sequence of frames while the user emphasizes his/her speech by hand motions. Therefore, all video data except that corresponding to the hand of the user may be excised for transmission, the eigen features being constructed at the receiver of the video communication system from the corresponding audio.

(iii) Monitored Event Changed

Operation of the transmitting portion where a change in the monitored event occurs, as for example a change of active user, will substantially correspond to the initial period of operation.

The eigen features of the active user are extracted from the video quantized data and sent to the coding module (115') for subsequent transmission to the receiver of the video communication system. As the active user starts to speak, the processor (130') calculates the eigen features from the audio quantized data using algorithms and/or lookup tables. The eigen features extracted from the video quantized data are compared to those that are calculated from the audio quantized data. If the error is above a preset limit the eigen features extracted from the video quantized data are forwarded to the coding module (115') for subsequent transmission to the receiver of the video communication system. During this initial period of operation the 'learning' synchronisation sequence modifies the algorithm and/or lookup tables are modified to reduce the error between the eigen features extracted from the video quantized data and that calculated by the processor (130') to be within the preset limits. During the 'learning' synchronization period the changes in the algorithm and/or lookup table are transmitted to the receiver of the video communication system.

RECEIVING PORTION

Operation of the receiving portion 111" of Figure 2b will now be described in detail with reference to Figure 3b and Figure 4.

Referring firstly to Figure 3b, the receiving portion 111" receives a video signal from the transmitting portion 111' corresponding to an event monitored with video camera 112' (Block 250).

Decompression module 120" decompresses video and audio data from the received signal (Block 252). The video and audio data is then filtered by the post processing module (116") to remove noise introduced by the compression (Block 254).

The filtered video and audio data and any information transmitted during the 'learning' synchronization period are received by the processor 130". The processor 130" reconstructs the eigen features from the audio

data either using an algorithm and/or a lookup table modified by information transmitted during the "learning" synchronization period.

In the case of the period when the encoder section of the video communication system is in the 'learning' synchronization period, the processor 130" insert only the eigen features reconstructed from the audio data that are not transmitted from the encoder with the video data.

For video frames where the active user is moving, for example if the active user changes orientation of his/her head by looking to the right, the distance between the integers 320 and 318 and between 314' and 314" would decrease and the right ear would go out of display video image. Consequently the difference between the eigen features calculated by processor (130") form the audio quantized data and the eigen features extracted from the video quantized data would increase beyond the preset limit. Under these conditions the eigen features extracted from the video quantized data are passed onto the decoding module (115")and subsequently decompressed and displayed. If the movement of the head to the right persists for a number of video frames the 'learning' synchronization at the coder of the video communication system will modify the algorithm and/or lookup tables to produce the corresponding eigen features to the head turned right position. The updated information is transmitted to the receiver enabling a new set of eigen features to be generated from the audio data by the processor (130") corresponding to the head turn right position and subsequently these eigen features are inserted into the video data after the 'learning' synchronization period has been completed.

For video frames where the active user is speaking and the head is deemed to be stationary and the system has been successfully through the 'learning' synchronization period all the eigen features reconstructed from the audio data can be inserted into the video data stream. Under these circumstances one achieves synchronization of the audio and video, minimal delays in transmission due to reduced data rates and a high frame refresh rate leading to an optimum comfort factor from the system.

Since the system only inserts eigen features that are reconstructed from the audio data when they are not present in the video data stream the receiver section of the video communication system is to all intense and purposes compatible with existing video telephony systems as outlined in Figure 1. The system will operate as if it is in the 'learning' synchronization period with reduced synchronization between audio and video, increased delay in transmission and lower frame refresh rates i.e. without the improved comfort factor for the user.

In addition one can store the video and audio data and any information transmitted during the 'learning' synchronization period within a memory for reconstruc-

tion at a later date.

Following the combination of the received and reconstructed portions of the video data, the video data is passed via coding module 15" (Block 262) and quantization module 14" (Block 264) to video display 12" for generation of the video image (Block 266).

Video data from the combined first and second portions of the video image may be stored in storage unit 132" prior to quantization (Block 268). The stored video data may be used for comparing eigen phases of a current frame of the video image with eigen phase of a preceding frame of the video image or may be used for refreshing eigen features of the current frame of the video image if required.

It is preferred that motion estimation and loop filtering be performed by the transmitting module 111' in order that unnecessary bits of data do not utilize bandwidth that may be more effectively utilized by bits of data that change from frame-to-frame. However, motion estimation can also be performed at the receiving portion 111".

Each of the previously described factors, and additional factors not detailed herein but recognizable to the skilled person, contribute to the quality of the video image perceived by the user of the video communication system. However, it should be understood that although the present invention is described in terms of a video communication system complying with the ITU H.320 standard, the present invention is not limited to systems of the H.320 standard or to factors not specifically detailed herein.

During an initial period of operation, video data corresponding to each eigen feature of the display video image is received from the transmitting portion 111' (Block 250). The receiving portion 111" operates in accordance with the initial period of operation for a new video image, as may occur where a new user becomes the active user. Operation of the receiving portion 111" of the video communication system during this period substantially corresponds with the operation of the receiving portion 11" of the prior art video communication system of Figure 2b.

#### (i) Speech, No Motion

The filtered video and audio data and any information transmitted during the 'learning' synchronization period are received by the processor 130". The processor 130" reconstructs the eigen features from the audio data either using an algorithm and/or a lookup table modified by information transmitted during the "learning" synchronization period.

In the case of the period when the encoder section of the video communication system is in the 'learning' synchronization period, the processor 130" insert only the eigen features reconstructed from the audio data that are not transmitted from the encoder with the video data.

For video frames where the active user is moving, for example if the active user changes orientation of his/her head by looking to the right, the distance between the integers 320 and 318 and between 314' and 314" would decrease and the right ear would go out of display video image. Consequently the difference between the eigen features calculated by processor (130") from the audio quantized data and the eigen features extracted from the video quantized data would increase beyond the preset limit. Under these conditions the eigen features extracted from the video quantized data are passed onto the decoding module (115") and subsequently decompressed and displayed. If the movement of the head to the right persists for a number of video frames the 'learning' synchronization at the coder of the video communication system will modify the algorithm and/or lookup tables to produce the corresponding eigen features to the head turned right position. The updated information is transmitted to the receiver enabling a new set of eigen features to be generated from the audio data by the processor (130") corresponding to the head turn right position and subsequently these eigen features are inserted into the video data after the 'learning' synchronization period has been completed.

For video frames where the active user is speaking and the head is deemed to be stationary and the system has been successfully through the 'learning' synchronization period all the eigen features reconstructed from the audio data can be inserted into the video data stream. Under these circumstances one achieves synchronization of the audio and video, minimal delays in transmission due to reduced data rates and a high frame refresh rate leading to an optimum comfort factor from the system.

Since the system only inserts eigen features that are reconstructed from the audio data when they are not present in the video data stream the receiver section of the video communication system is to all intense and purposes compatible with existing video telephony systems as outlined in Figure 1. The system will operate as if it is in the 'learning' synchronization period with reduced synchronization between audio and video, increased delay in transmission and lower frame refresh rates i.e. without the improved comfort factor for the user.

In addition one can store the video and audio data and any information transmitted during the 'learning' synchronization period within a memory for reconstruction at a later date.

For example, when expressing the syllable "Ahh" the mouth is opened wide and consequently the chin drops, but eyes and nose remain substantially stationary.

Consequently, the number of eigen phases between the chin (312) and each edge of the mouth (314',314"), and the nose (316), and between each edge of the mouth (314' ,314") and nose (316) will

increase. Therefore, the display video image generally corresponds with the preceding display video image where the users mouth is closed, except in those regions between the mouth, nose and chin.

(ii) Speech and Motion

The filtered video and audio data and any information transmitted during the 'learning' synchronization period are received by the processor 130". The processor 130" reconstructs the eigen features from the audio data either using an algorithm and/or a lookup table modified by information transmitted during the "learning" synchronization period.

In the case of the period when the encoder section of the video communication system is in the 'learning' synchronization period, the processor 130" insert only the eigen features reconstructed from the audio data that are not transmitted from the encoder with the video data.

For video frames where the active user is moving, for example if the active user changes orientation of his/her head by looking to the right, the distance between the integers 320 and 318 and between 314' and 314" would decrease and the right ear would go out of display video image. Consequently the difference between the eigen features calculated by processor (130") from the audio quantized data and the eigen features extracted from the video quantized data would increase beyond the preset limit. Under these conditions the eigen features extracted from the video quantized data are passed onto the decoding module (115") and subsequently decompressed and displayed. If the movement of the head to the right persists for a number of video frames the 'learning' synchronization at the coder of the video communication system will modify the algorithm and/or lookup tables to produce the corresponding eigen features to the head turned right position. The updated information is transmitted to the receiver enabling a new set of eigen features to be generated from the audio data by the processor (130") corresponding to the head turn right position and subsequently these eigen features are inserted into the video data after the 'learning' synchronization period has been completed.

For video frames where the active user is speaking and the head is deemed to be stationary and the system has been successfully through the 'learning' synchronization period all the eigen features reconstructed from the audio data can be inserted into the video data stream. Under these circumstances one achieves synchronization of the audio and video, minimal delays in transmission due to reduced data rates and a high frame refresh rate leading to an optimum comfort factor from the system.

Since the system only inserts eigen features that are reconstructed from the audio data when they are not present in the video data stream the receiver section of

the video communication system is to all intense and purposes compatible with existing video telephony systems as outlined in Figure 1. The system will operate as if it is in the 'learning' synchronisation period with reduced synchronization between audio and video, increased delay in transmission and lower frame refresh rates i.e. without the improved comfort factor for the user.

In addition one can store the video and audio data and any information transmitted during the 'learning' synchronization period within a memory for reconstruction at a later date.

Processor 130" receives video data for only those regions between selected integers where the number of eigen phases is different from the preceding display video image as described in reference to (i).

(iii) Monitored Event Changed

Operation of the receiving portion 111" where a change in the monitored event has occurred, as for example a change of active user, will substantially correspond to the initial period of operation. Video data corresponding to each eigen phase of the display video image is received from the transmitting portion 111' (Block 228).

While the present invention has been described by the foregoing detailed description, it will be understood by those skilled in the art that various changes, substitutions and alterations may be made to elements of the video communication system of the invention without departing from the spirit and scope of the invention.

**Claims**

1. A method of operating a video communication system comprising;

monitoring an event with a video camera to generate a sequence of frames for forming a video image;  
 selecting video data only from those regions of a current frame of the video image that are different from corresponding regions of a preceding frame of the video image;  
 compressing video data corresponding to said selected regions of the current frame of the video image and audio data for each of said frames of said video image;  
 generating a video signal comprising compressed video data and compressed audio data and transmitting said video signal to a receiver;  
 receiving said transmitted video signal at a receiver;  
 decompressing said received video signal to produce audio data and a first portion of said video data;



predicting a second portion of the video data for regions of a current frame of a video image that differ from a preceding frame of the video image from said audio data; and  
 combining said first and second portions of said video data to generate the current frame of a display video image.

- 2. The method as claimed in Claim 1 further comprising;

performing the step of identifying regions of the current frame of the video image that differ from a preceding frame of the video image.

- 3. The method as claimed in Claim 1 or Claim 2 further comprising;

generating an audio component from said audio data.

- 4. A video communication system comprising;

a video camera for monitoring an event and for generating a sequence of frames for forming a video image;

means for selecting video data only from those regions of a current frame of the video image that are different from corresponding regions of a preceding frame of the video image;

a data compression module for compressing video data corresponding to said selected regions of the current frame of the video image and audio data for each of said frames of said video image;

means for generating a video signal comprising said compressed video data and compressed audio data and transmitting said video signal to a receiver;

a data decompression module for decompressing a received video signal to produce audio data and a first portion of said video data;

means for predicting a second portion of the video data for regions of a subsequent frame of the video image that differ from a preceding frame of the video image from said audio data; and

means for combining said first and second portions of said video data to generate a display image.

- 5. The video communication system as claimed in Claim 4 further comprising;

means for performing the step of identifying regions of a subsequent frame of the video image that differ from a preceding frame of the video image.

- 6. The video communication system as claimed in Claim 4 or Claim 5 further comprising;

means for generating an audio component from said audio data.

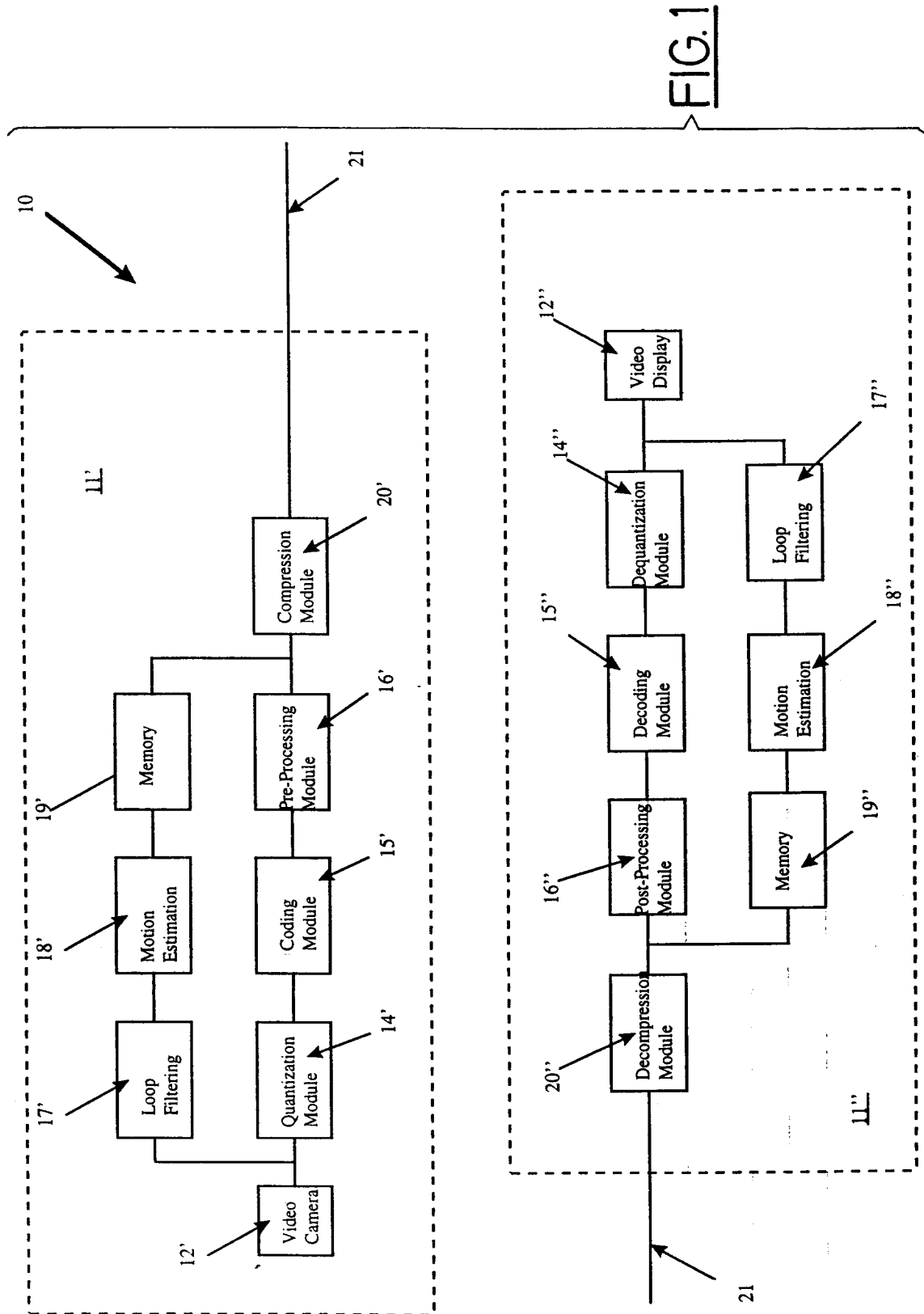

FIG. 1

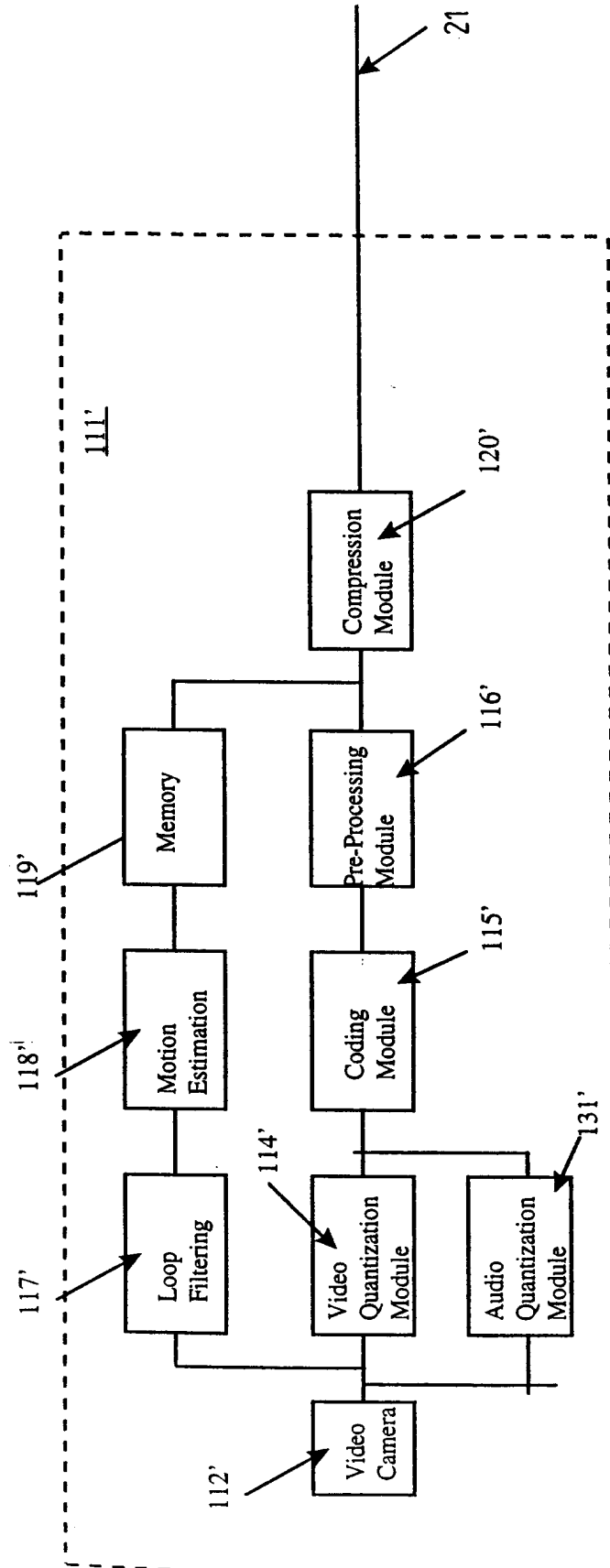

FIG. 2a

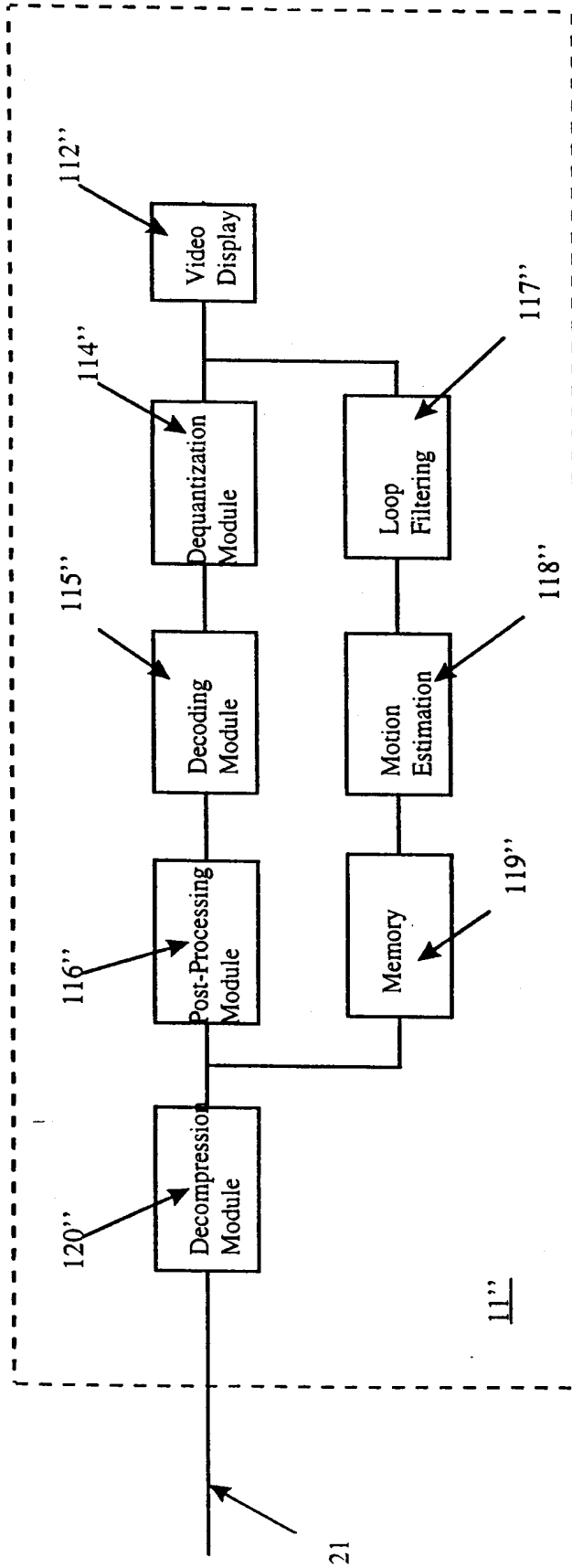

FIG. 2b

ENCODER

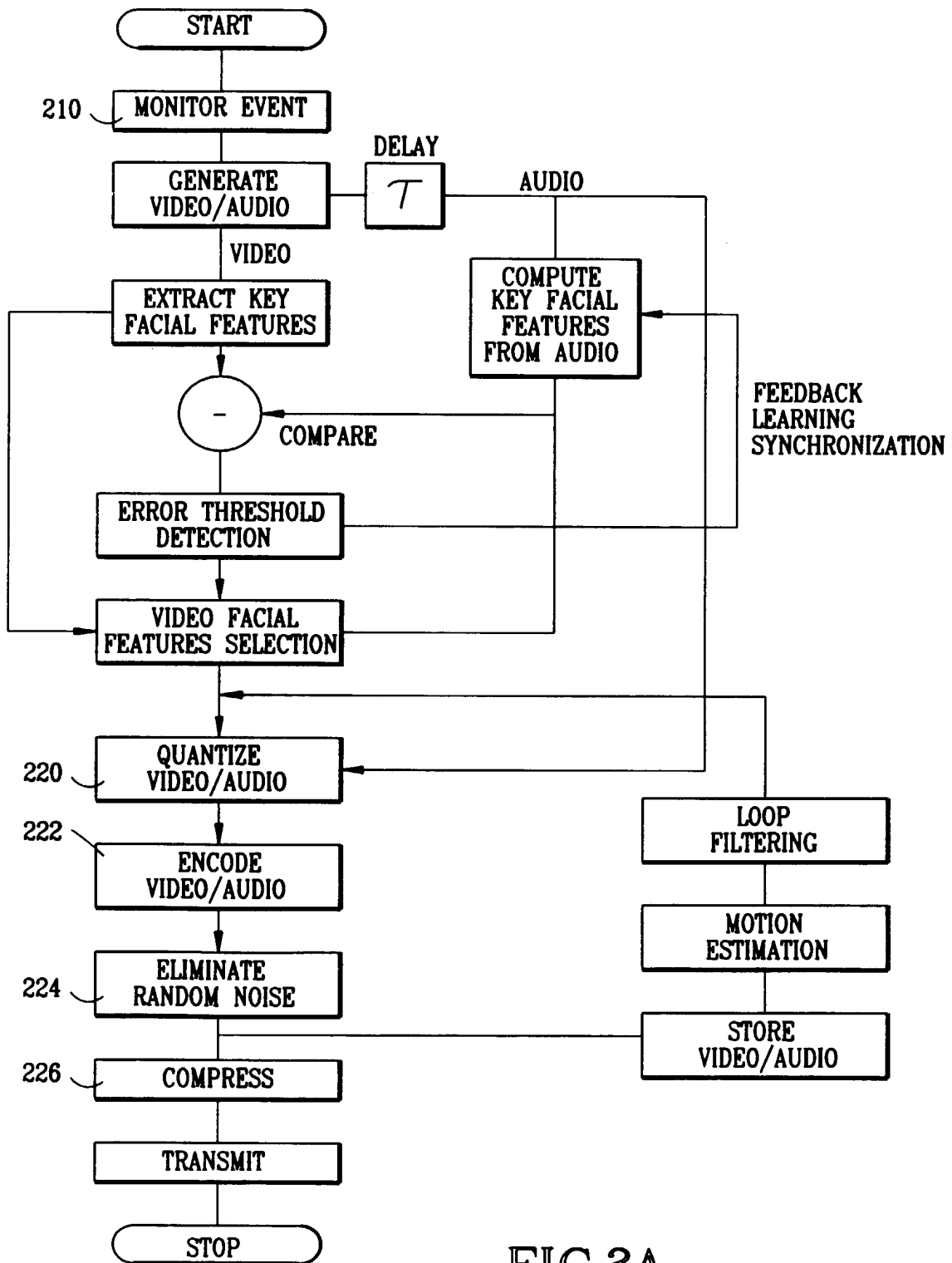

FIG.3A

DECODER

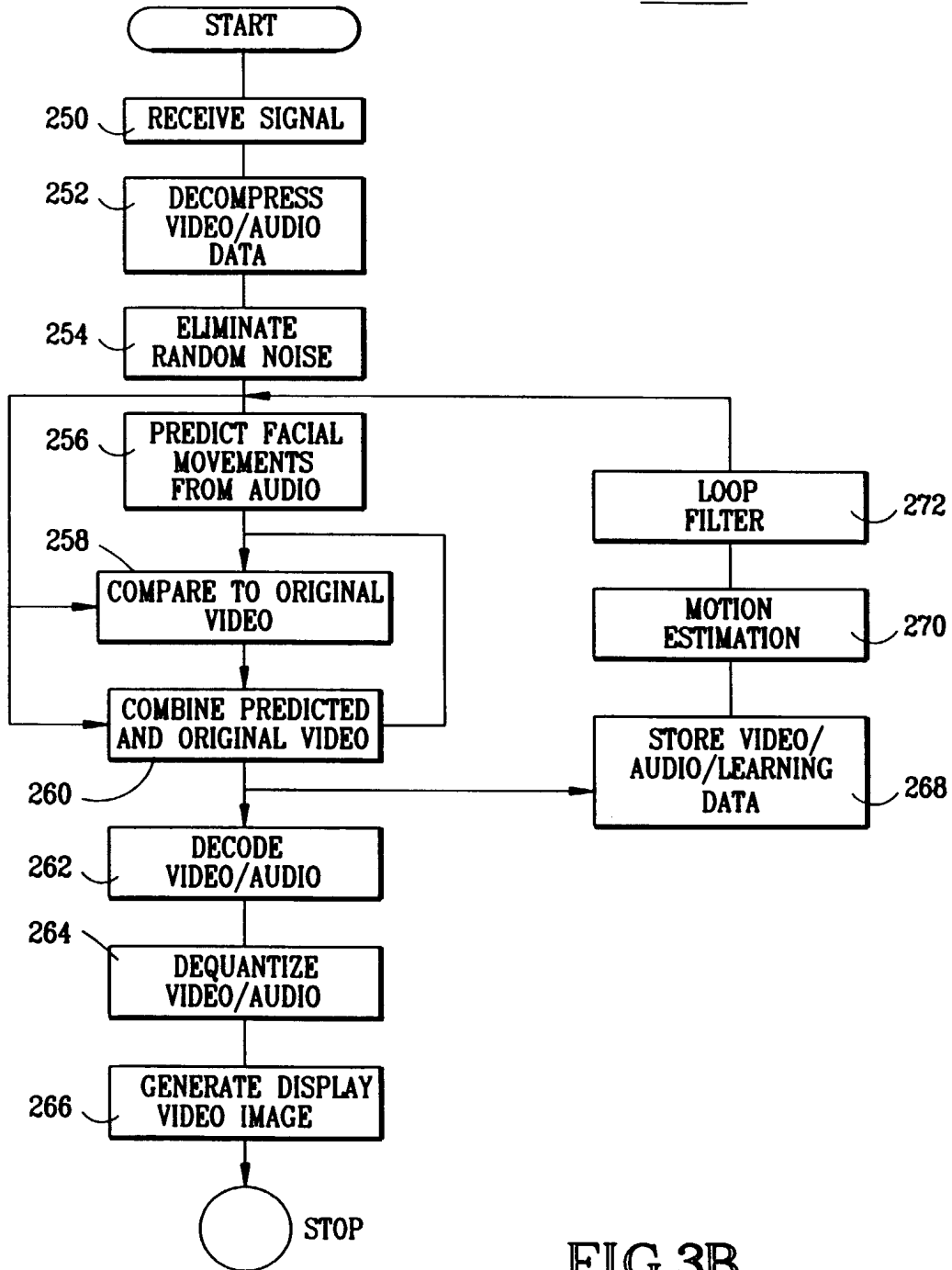
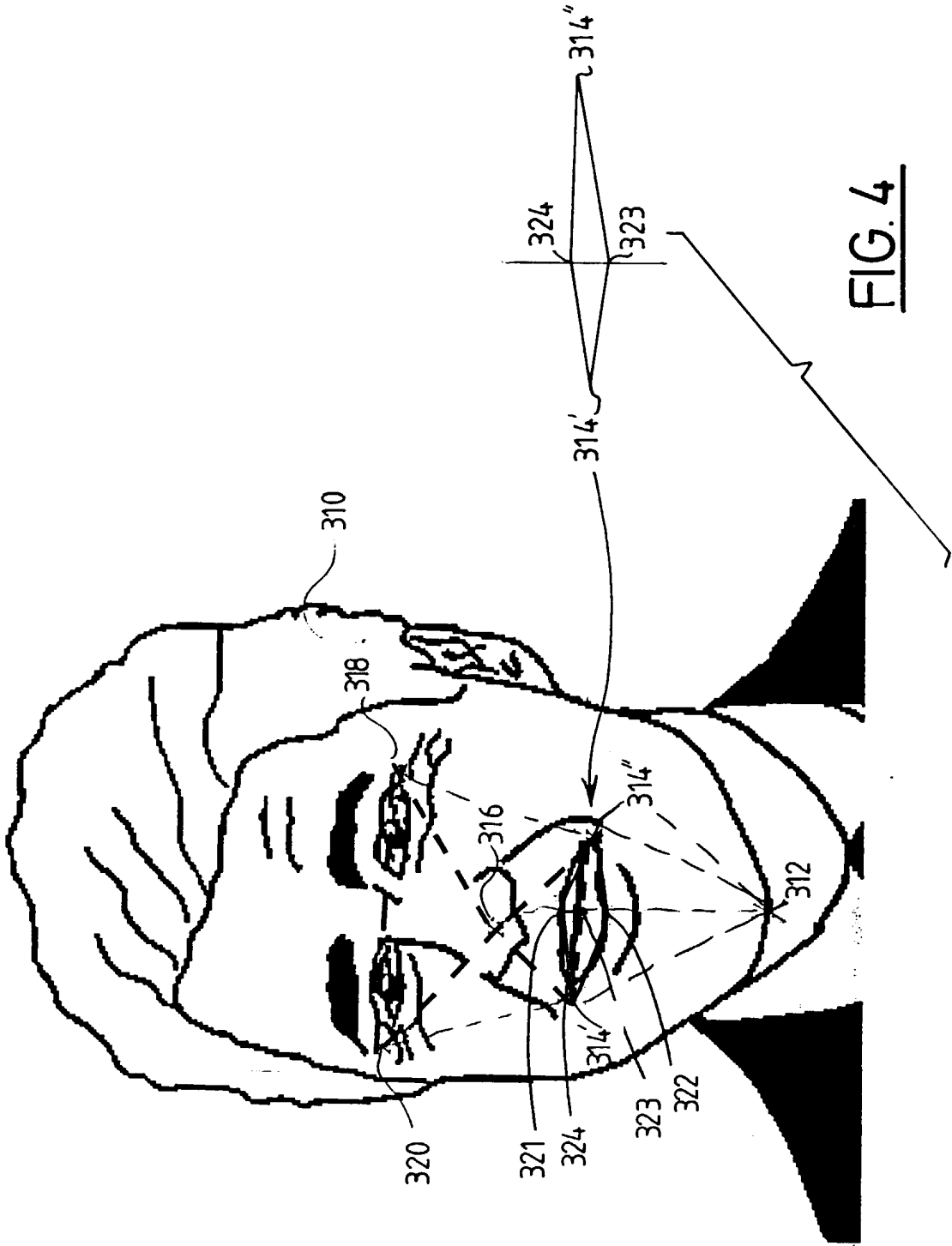

FIG.3B





European Patent Office

EUROPEAN SEARCH REPORT

Application Number  
EP 97 40 1772

DOCUMENTS CONSIDERED TO BE RELEVANT			
Category	Citation of document with indication, where appropriate, of relevant passages	Relevant to claim	CLASSIFICATION OF THE APPLICATION (Int.Cl.6)
X	EP 0 673 170 A (AT & T CORP) * the whole document * ---	1-6	H04N7/26
A	EP 0 676 899 A (AT & T CORP) * column 23, line 10 - line 36; figure 8 * ---	1-6	
A	US 5 426 460 A (ERVING RICHARD H ET AL) * abstract; figures 9,10 * ---	1-6	
A	US 5 057 940 A (MURAKAMI TOKUMICHI ET AL) * page 1, column 1, line 33 - column 2, line 14; figure 2 * ---	1-6	
A	US 4 841 575 A (WELSH WILLIAM J ET AL) * the whole document * ---	1-6	
A	GB 2 250 405 A (BRITISH TELECOMM) * abstract; figures 1,2 * -----	1-6	
The present search report has been drawn up for all claims			TECHNICAL FIELDS SEARCHED (Int.Cl.6)
			H04N
Place of search	Date of completion of the search	Examiner	
THE HAGUE	12 December 1997	Giannotti, P	
<p>CATEGORY OF CITED DOCUMENTS</p> <p>X : particularly relevant if taken alone                      Y : particularly relevant if combined with another document of the same category                      A : technological background                      O : non-written disclosure                      P : intermediate document</p> <p>T : theory or principle underlying the invention                      E : earlier patent document, but published on, or after the filing date                      D : document cited in the application                      L : document cited for other reasons</p> <p>.....                      &amp; : member of the same patent family, corresponding document</p>			

EPO FORM 1503 03 82 (P04C01)



## Electronic Acknowledgement Receipt

<b>EFS ID:</b>	6735204
<b>Application Number:</b>	12569116
<b>International Application Number:</b>	
<b>Confirmation Number:</b>	7686
<b>Title of Invention:</b>	Video Surveillance System Employing Video Primitives
<b>First Named Inventor/Applicant Name:</b>	Alan J. Lipton
<b>Customer Number:</b>	74712
<b>Filer:</b>	Patrick Daniel Muir/Melissa McGinn
<b>Filer Authorized By:</b>	Patrick Daniel Muir
<b>Attorney Docket Number:</b>	OV-101
<b>Receipt Date:</b>	31-DEC-2009
<b>Filing Date:</b>	29-SEP-2009
<b>Time Stamp:</b>	13:54:01
<b>Application Type:</b>	Utility under 35 USC 111(a)

### Payment information:

Submitted with Payment	no
------------------------	----

### File Listing:

Document Number	Document Description	File Name	File Size(Bytes)/ Message Digest	Multi Part /.zip	Pages (if appl.)
1	Transmittal Letter	OV_101_IDS_transmittal.pdf	61092 <small>88277dc651390d9858ad9c73ba30f28aca363545</small>	no	2

### Warnings:

### Information:

2	Information Disclosure Statement (IDS) Filed (SB/08)	OV_101_IDS_1.pdf	612900	no	13
			a7802e8ce608b7178e75fb19f3d5b21d4c1928cf		
<b>Warnings:</b>					
<b>Information:</b>					
3	Information Disclosure Statement (IDS) Filed (SB/08)	OV_101_IDS_2.pdf	609988	no	8
			90aaa85d17781fe3dd9e8d619cabf7a6b5b80cdb		
<b>Warnings:</b>					
<b>Information:</b>					
4	Information Disclosure Statement (IDS) Filed (SB/08)	OV_101_IDS_3.pdf	609037	no	5
			f38ae384b4e2f80e53a726c57545752ce96ac90		
<b>Warnings:</b>					
<b>Information:</b>					
5	Foreign Reference	EP0893923.pdf	175259	no	18
			028ff0b8046f32da8c4ba134839d85c160e27d87		
<b>Warnings:</b>					
<b>Information:</b>					
<b>Total Files Size (in bytes):</b>			2068276		

**This Acknowledgement Receipt evidences receipt on the noted date by the USPTO of the indicated documents, characterized by the applicant, and including page counts, where applicable. It serves as evidence of receipt similar to a Post Card, as described in MPEP 503.**

**New Applications Under 35 U.S.C. 111**

**If a new application is being filed and the application includes the necessary components for a filing date (see 37 CFR 1.53(b)-(d) and MPEP 506), a Filing Receipt (37 CFR 1.54) will be issued in due course and the date shown on this Acknowledgement Receipt will establish the filing date of the application.**

**National Stage of an International Application under 35 U.S.C. 371**

**If a timely submission to enter the national stage of an international application is compliant with the conditions of 35 U.S.C. 371 and other applicable requirements a Form PCT/DO/EO/903 indicating acceptance of the application as a national stage submission under 35 U.S.C. 371 will be issued in addition to the Filing Receipt, in due course.**

**New International Application Filed with the USPTO as a Receiving Office**

**If a new international application is being filed and the international application includes the necessary components for an international filing date (see PCT Article 11 and MPEP 1810), a Notification of the International Application Number and of the International Filing Date (Form PCT/RO/105) will be issued in due course, subject to prescriptions concerning national security, and the date shown on this Acknowledgement Receipt will establish the international filing date of the application.**

**IN THE UNITED STATES PATENT AND TRADEMARK OFFICE**

In re the application of: Alan J Lipton et al. Attorney Docket: OV-101  
Serial Number: 12/569,116 Group Art Unit: 2621  
Filed: September 29, 2009 Examiner: Tung Vo  
Confirmation Number: 7686

Title: **VIDEO SURVEILLANCE SYSTEM EMPLOYING VIDEO PRIMITIVES**

INFORMATION DISCLOSURE STATEMENT UNDER 37 C.F.R. 1.97(b)

Commissioner for Patents  
P.O. Box 1450  
Alexandria, VA 22313

Dear Sir:

Pursuant to 37 C.F.R. 1.56 and 1.97(b), Applicant brings to the attention of the Examiner the listed documents on the attached SB/08 Form. This Information Disclosure Statement is being filed, to the best of Applicant's knowledge, before the mailing date of a first Office Action.

This application is a continuation of Application Serial No. 09/987,707, filed November 15, 2001, which is a continuation-in-part of U.S. Application No. 09/694,712 (now U.S. Patent No. 6,954,498) filed October 24, 2000. Documents listed in this Information Disclosure Statement are either a U.S. patent, a U.S. patent publication, were previously submitted or cited by the United States Patent and Trademark Office in one or both of these previous applications (U.S. Application Nos. 09/987,707 and 09/694,712) or are submitted herewith.

Applicants respectfully request that the Examiner consider the listed documents and indicate that they were considered by making appropriate notations on the attached form.

This submission does not represent that a search has been made or that no better art exists and does not constitute an admission that each or all of the listed documents are material or constitute "prior art". If the Examiner applies any of the documents as prior art against any claim in the application and Applicants determine that the cited documents do not constitute "prior art" under United States law, Applicants reserve the right to present to the U.S. Patent and Trademark Office the relevant facts and law regarding the appropriate status of such documents.

Applicants further reserve the right to take appropriate action to establish the patentability of the disclosed invention over the listed documents, should one or more of the documents be applied against the claims of the present application. In the event any fees are required in connection with this paper, please charge the Deposit Account No. 50-4574.

Respectfully submitted,

/Patrick D. Muir/ Reg. #37403

MUIR PATENT CONSULTING, PLLC.  
758 Walker Rd., Suite C  
Great Falls, VA 22066  
Fax: (703) 757-7447

---

Patrick D. Muir  
Attorney for Applicants,  
Registration No. 37,403  
Tel: (703) 757-7880

**IN THE UNITED STATES PATENT AND TRADEMARK OFFICE**

In re the application of: Alan J Lipton et al. Attorney Docket: OV-101  
Serial Number: 12/569,116 Group Art Unit: 2621  
Filed: September 29, 2009 Examiner: Tung Vo  
Confirmation Number: 7686

Title: **VIDEO SURVEILLANCE SYSTEM EMPLOYING VIDEO PRIMITIVES**

PRELIMINARY AMENDMENT AND INTERVIEW SUMMARY

Commissioner for Patents  
P.O. Box 1450  
Alexandria, VA 22313

Dear Sir:

Prior to examination on the merits and calculation of relevant fees, please enter the following amendment.

**Amendments to the Claims:**

This listing of claims will replace all prior versions and listings of claims in the application:

**Listing of Claims:**

Claims 1-26 (Cancelled).

27. (New) A method comprising:

detecting an object in a video;

detecting a plurality of attributes of the object by analyzing the video, each attribute representing a characteristic of the detected object;

selecting a new user rule; and

after detecting the plurality of attributes, identifying an event of the object that is not one of the detected attributes of the object by applying the new user rule to the plurality of detected attributes;

wherein the plurality of attributes that are detected are independent of which event is identified.

28. (New) The method of claim 27, further comprising identifying the event without reprocessing the video.

29. (New) The method of claim 27, wherein selecting the new user rule comprises selecting a subset of the plurality of attributes for analysis.

30. (New) The method of claim 27, wherein the plurality of attributes that are detected are defined in a device prior to the selection of the subset of the plurality of attributes.

31. (New) The method of claim 27, wherein no analysis is performed on at least some of the detected attributes which are not the subset of the plurality of attributes.

32. (New) The method of claim 27, wherein the plurality of attributes include plural physical attributes and the method comprises applying the new user rule to a plural number of physical attributes.

33. (New) The method of claim 27, wherein the plurality of attributes include plural temporal attributes and the method comprises applying the new user rule to a plural number of temporal attributes.

34. (New) The method of claim 27, further comprising:  
storing the detected attributes in memory; and  
identifying the event of the object by analyzing only a subset of the attributes stored in the memory.

35. (New) The method of claim 27, further comprising:

detecting first and second objects in a video;

detecting a plurality of attributes of each of the detected first and second objects by analyzing the video, each attribute representing a characteristic of the respective detected object;

wherein the step of identifying an event comprises identifying an event of the first object interacting with the second object by analyzing the detected attributes of the first and second objects, the event not being one of the detected attributes.

36. (New) A video device comprising:

means for detecting an object in a video;

means for detecting a plurality of attributes of the object by analyzing the video, each attribute representing a characteristic of the detected object;

a memory storing the plurality of detected attributes; and

means for identifying an event of the object that is not one of the detected attributes of the object by applying a selected new user rule to the plurality of attributes stored in memory,

wherein the means for identifying an event is capable of identifying the event independent of when the attributes are stored in memory.

37. (New) The video device of claim 36, further comprising:

a video camera operable to obtain the video.

38. (New) The video device of claim 36, wherein the means for identifying an event of the object comprises means for identifying a first event of the object in real time



by analyzing, of the plurality of attributes, only a first selected subset of the plurality of attributes.

39. (New) The video device of claim 38, wherein the means for identifying an event of the object comprises means for identifying a second event of the object by analyzing, of the plurality of attributes, only a second selected subset of the plurality of attributes which have been archived.

40. (New) The video device of claim 36, wherein applying a selected new user rule comprises analyzing, of the plurality of attributes, only a selected subset of the plurality of attributes.

41. (New) The video device of claim 36,  
wherein the memory is capable of storing at least some of the plurality of attributes for at least two months, and  
wherein the means for identifying an event of the object is capable of identifying an event of the object by analyzing only a selected subset of the plurality of attributes including the at least some of the plurality of attributes stored for at least two months.

42. (New) The video device of claim 36, wherein the means for identifying an event is capable of identifying the event without reprocessing the video.

43. (New) The video device of claim 36, wherein the means for identifying an event is capable of identifying the event by analyzing at least two selected physical attributes of the plurality of attributes.

44. (New) The video device of claim 36, wherein the identifying means identifies an event by analyzing a selection of individual ones of the detected plural attributes.

45. (New) The video device of claim 36, wherein the plural attributes detected by the means for detecting are defined in the video device independent of a selection of the detected plural attributes.

46. (New) The video device of claim 36, wherein the video surveillance device is a computer system configured as a video surveillance device.

47. (New) The video device of claim 36, further comprising video sensors.

48. (New) A method comprising:  
providing a video device which detects an object upon analyzing a video and which detects plural attributes of the detected object upon analyzing the video; and  
then, selecting a rule, which is not a rule used to detect any individual attribute, as a new user rule, the new user rule providing an analysis of a combination of the attributes to detect an event that is not one of the detected attributes,  
wherein the attributes to be detected are independent of the event to be detected.

49. (New) The method of claim 48, further comprising:  
providing a video device which detects an object upon analyzing a video and which detects plural physical attributes and plural temporal attributes of the detected object upon analyzing the video; and  
then, selecting the new user rule to provide an analysis of a combination of the plural physical attributes and the plural temporal attributes to detect the event.

50. (New) A non-transitory computer-readable storage medium containing instructions that when executed by a computer system cause said computer system to implement the following method comprising:

detecting an object in a video;  
detecting a plurality of attributes of the object by analyzing the video, each attribute representing a characteristic of the detected object;  
selecting a new user rule; and  
after detecting the plurality of attributes, identifying an event of the object that is not one of the detected attributes of the object by applying the new user rule to the plurality of detected attributes;  
wherein the plurality of attributes that are detected are independent of which event is identified.

51. (New) The non-transitory computer-readable storage medium of claim 50, wherein the method implemented by the computer system further comprises identifying the event without reprocessing the video.

52. (New) The non-transitory computer-readable storage medium of claim 50, wherein selecting the new user rule comprises selecting a subset of the plurality of attributes for analysis.

53. (New) The non-transitory computer-readable storage medium of claim 50, wherein the plurality of attributes that are detected are defined in a device prior to the selection of the subset of the plurality of attributes.

54. (New) The non-transitory computer-readable storage medium of claim 50, wherein no analysis is performed on at least some of the detected attributes which are not the subset of the plurality of attributes.

55. (New) The non-transitory computer-readable storage medium of claim 50, wherein the plurality of attributes include plural physical attributes, and wherein the method implemented by the computer system further comprises applying the new user rule to a plural number of physical attributes.

56. (New) The non-transitory computer-readable storage medium of claim 50, wherein the plurality of attributes include plural temporal attributes, and wherein the method implemented by the computer system further comprises applying the new user rule to a plural number of temporal attributes.

57. (New) The non-transitory computer-readable storage medium of claim 50, wherein the method implemented by the computer system further comprises:

- storing the detected attributes in memory; and
- identifying the event of the object by analyzing only a subset of the attributes stored in the memory.

58. (New) The non-transitory computer-readable storage medium of claim 50, wherein the method implemented by the computer system further comprises:

- detecting first and second objects in a video;
- detecting a plurality of attributes of each of the detected first and second objects by analyzing the video, each attribute representing a characteristic of the respective detected object;

wherein the step of identifying an event comprises identifying an event of the first object interacting with the second object by analyzing the detected attributes of the first and second objects, the event not being one of the detected attributes.

### REMARKS

With this preliminary amendment, claims 1-26 have been cancelled and claims 27-58 have been added. Support for these new claims can be found throughout the disclosure, including without limitation, for example, Figures 1, 2, 3, 4 and 5 and the corresponding description. No new matter has been added.

The Applicant thanks Examiner Vo for his time during the personal interview of November 24, 2009. During the interview, the Applicant discussed draft claims 27-70 presented for the Examiner's consideration to help expedite allowance of this application. Applicant discussed distinguishing features of the invention, and how those features were attempted to be captured by the draft claim language.

It is believed that this application is in condition for allowance. Favorable consideration and prompt allowance are respectfully requested. In the event any fees are required in connection with this paper, please charge the Deposit Account No. 50-4574.

Respectfully submitted,

/Patrick D. Muir/ Reg. #37403

MUIR PATENT CONSULTING, PLLC.  
758 Walker Rd., Suite C  
Great Falls, VA 22066  
Fax: (703) 757-7447

---

Patrick D. Muir  
Attorney for Applicants,  
Registration No. 37,403  
Tel: (703) 757-7880

## Electronic Patent Application Fee Transmittal

<b>Application Number:</b>	12569116
<b>Filing Date:</b>	29-Sep-2009
<b>Title of Invention:</b>	Video Surveillance System Employing Video Primitives
<b>First Named Inventor/Applicant Name:</b>	Alan J. Lipton
<b>Filer:</b>	Patrick Daniel Muir
<b>Attorney Docket Number:</b>	OV-101

Filed as Small Entity

### Utility under 35 USC 111(a) Filing Fees

Description	Fee Code	Quantity	Amount	Sub-Total in USD(\$)
<b>Basic Filing:</b>				
<b>Pages:</b>				
<b>Claims:</b>				
Claims in excess of 20	2202	6	26	156

**Miscellaneous-Filing:**

**Petition:**

**Patent-Appeals-and-Interference:**

**Post-Allowance-and-Post-Issuance:**

**Extension-of-Time:**

Description	Fee Code	Quantity	Amount	Sub-Total in USD(\$)
<b>Miscellaneous:</b>				
<b>Total in USD (\$)</b>				<b>156</b>



## Electronic Acknowledgement Receipt

<b>EFS ID:</b>	6725702
<b>Application Number:</b>	12569116
<b>International Application Number:</b>	
<b>Confirmation Number:</b>	7686
<b>Title of Invention:</b>	Video Surveillance System Employing Video Primitives
<b>First Named Inventor/Applicant Name:</b>	Alan J. Lipton
<b>Customer Number:</b>	74712
<b>Filer:</b>	Patrick Daniel Muir
<b>Filer Authorized By:</b>	
<b>Attorney Docket Number:</b>	OV-101
<b>Receipt Date:</b>	30-DEC-2009
<b>Filing Date:</b>	29-SEP-2009
<b>Time Stamp:</b>	11:19:33
<b>Application Type:</b>	Utility under 35 USC 111(a)

### Payment information:

Submitted with Payment	yes
Payment Type	Deposit Account
Payment was successfully received in RAM	\$156
RAM confirmation Number	6507
Deposit Account	504574
Authorized User	

The Director of the USPTO is hereby authorized to charge indicated fees and credit any overpayment as follows:

Charge any Additional Fees required under 37 C.F.R. Section 1.17 (Patent application and reexamination processing fees)

Charge any Additional Fees required under 37 C.F.R. Section 1.19 (Document supply fees)

Charge any Additional Fees required under 37 C.F.R. Section 1.20 (Post Issuance fees)

Charge any Additional Fees required under 37 C.F.R. Section 1.21 (Miscellaneous fees and charges)

**File Listing:**

Document Number	Document Description	File Name	File Size(Bytes)/ Message Digest	Multi Part /.zip	Pages (if appl.)
1		12596166_prelim_amd_OV_101.pdf	84683 07dfb300c710501ba10fd6ea3e3c248172e452d3	yes	10
<b>Multipart Description/PDF files in .zip description</b>					
	<b>Document Description</b>		<b>Start</b>	<b>End</b>	
	Preliminary Amendment		1	1	
	Claims		2	9	
	Applicant Arguments/Remarks Made in an Amendment		10	10	

**Warnings:**

**Information:**

2	Fee Worksheet (PTO-875)	fee-info.pdf	29610 1997f958661c89629af0c37ce18ed1004a860e8	no	2
---	-------------------------	--------------	--	----	---

**Warnings:**

**Information:**

**Total Files Size (in bytes):** 114293

**This Acknowledgement Receipt evidences receipt on the noted date by the USPTO of the indicated documents, characterized by the applicant, and including page counts, where applicable. It serves as evidence of receipt similar to a Post Card, as described in MPEP 503.**

**New Applications Under 35 U.S.C. 111**

**If a new application is being filed and the application includes the necessary components for a filing date (see 37 CFR 1.53(b)-(d) and MPEP 506), a Filing Receipt (37 CFR 1.54) will be issued in due course and the date shown on this Acknowledgement Receipt will establish the filing date of the application.**

**National Stage of an International Application under 35 U.S.C. 371**

**If a timely submission to enter the national stage of an international application is compliant with the conditions of 35 U.S.C. 371 and other applicable requirements a Form PCT/DO/EO/903 indicating acceptance of the application as a national stage submission under 35 U.S.C. 371 will be issued in addition to the Filing Receipt, in due course.**

**New International Application Filed with the USPTO as a Receiving Office**

**If a new international application is being filed and the international application includes the necessary components for an international filing date (see PCT Article 11 and MPEP 1810), a Notification of the International Application Number and of the International Filing Date (Form PCT/RO/105) will be issued in due course, subject to prescriptions concerning national security, and the date shown on this Acknowledgement Receipt will establish the international filing date of the application.**

Under the Paperwork Reduction Act of 1995, no persons are required to respond to a collection of information unless it displays a valid OMB control number.

<b>PATENT APPLICATION FEE DETERMINATION RECORD</b> Substitute for Form PTO-875	Application or Docket Number <b>12/569,116</b>	Filing Date <b>09/29/2009</b>	<input type="checkbox"/> To be Mailed
---	---	----------------------------------	---------------------------------------

APPLICATION AS FILED – PART I			OTHER THAN SMALL ENTITY				
	(Column 1)	(Column 2)	SMALL ENTITY <input checked="" type="checkbox"/>	OR			
FOR	NUMBER FILED	NUMBER EXTRA	RATE (\$)	FEE (\$)	OR	RATE (\$)	FEE (\$)
<input type="checkbox"/> BASIC FEE <small>(37 CFR 1.16(a), (b), or (c))</small>	N/A	N/A	N/A			N/A	
<input type="checkbox"/> SEARCH FEE <small>(37 CFR 1.16(k), (l), or (m))</small>	N/A	N/A	N/A			N/A	
<input type="checkbox"/> EXAMINATION FEE <small>(37 CFR 1.16(o), (p), or (q))</small>	N/A	N/A	N/A			N/A	
TOTAL CLAIMS <small>(37 CFR 1.16(i))</small>	minus 20 =	*	X \$ =		OR	X \$ =	
INDEPENDENT CLAIMS <small>(37 CFR 1.16(h))</small>	minus 3 =	*	X \$ =			X \$ =	
<input type="checkbox"/> APPLICATION SIZE FEE <small>(37 CFR 1.16(s))</small>	If the specification and drawings exceed 100 sheets of paper, the application size fee due is \$250 (\$125 for small entity) for each additional 50 sheets or fraction thereof. See 35 U.S.C. 41(a)(1)(G) and 37 CFR 1.16(s).						
<input type="checkbox"/> MULTIPLE DEPENDENT CLAIM PRESENT <small>(37 CFR 1.16(j))</small>							
* If the difference in column 1 is less than zero, enter "0" in column 2.			TOTAL			TOTAL	

APPLICATION AS AMENDED – PART II					OTHER THAN SMALL ENTITY				
	(Column 1)	(Column 2)	(Column 3)						
AMENDMENT	<b>12/30/2009</b>	CLAIMS REMAINING AFTER AMENDMENT	HIGHEST NUMBER PREVIOUSLY PAID FOR	PRESENT EXTRA	RATE (\$)	ADDITIONAL FEE (\$)	OR	RATE (\$)	ADDITIONAL FEE (\$)
	Total <small>(37 CFR 1.16(i))</small>	* 26	Minus ** 26	= 0	X \$26 =	0	OR	X \$ =	
	Independent <small>(37 CFR 1.16(h))</small>	* 4	Minus ***4	= 0	X \$110 =	0	OR	X \$ =	
	<input type="checkbox"/> Application Size Fee <small>(37 CFR 1.16(s))</small>								
	<input type="checkbox"/> FIRST PRESENTATION OF MULTIPLE DEPENDENT CLAIM <small>(37 CFR 1.16(j))</small>						OR		
					TOTAL ADD'L FEE	0	OR	TOTAL ADD'L FEE	

	(Column 1)	(Column 2)	(Column 3)						
AMENDMENT		CLAIMS REMAINING AFTER AMENDMENT	HIGHEST NUMBER PREVIOUSLY PAID FOR	PRESENT EXTRA	RATE (\$)	ADDITIONAL FEE (\$)	OR	RATE (\$)	ADDITIONAL FEE (\$)
	Total <small>(37 CFR 1.16(i))</small>	*	Minus **	=	X \$ =		OR	X \$ =	
	Independent <small>(37 CFR 1.16(h))</small>	*	Minus ***	=	X \$ =		OR	X \$ =	
	<input type="checkbox"/> Application Size Fee <small>(37 CFR 1.16(s))</small>								
	<input type="checkbox"/> FIRST PRESENTATION OF MULTIPLE DEPENDENT CLAIM <small>(37 CFR 1.16(j))</small>						OR		
					TOTAL ADD'L FEE		OR	TOTAL ADD'L FEE	

\* If the entry in column 1 is less than the entry in column 2, write "0" in column 3.  
 \*\* If the "Highest Number Previously Paid For" IN THIS SPACE is less than 20, enter "20".  
 \*\*\* If the "Highest Number Previously Paid For" IN THIS SPACE is less than 3, enter "3".  
 The "Highest Number Previously Paid For" (Total or Independent) is the highest number found in the appropriate box in column 1.

Legal Instrument Examiner:  
 /KAREN VESTAL/

This collection of information is required by 37 CFR 1.16. The information is required to obtain or retain a benefit by the public which is to file (and by the USPTO to process) an application. Confidentiality is governed by 35 U.S.C. 122 and 37 CFR 1.14. This collection is estimated to take 12 minutes to complete, including gathering, preparing, and submitting the completed application form to the USPTO. Time will vary depending upon the individual case. Any comments on the amount of time you require to complete this form and/or suggestions for reducing this burden, should be sent to the Chief Information Officer, U.S. Patent and Trademark Office, U.S. Department of Commerce, P.O. Box 1450, Alexandria, VA 22313-1450. DO NOT SEND FEES OR COMPLETED FORMS TO THIS ADDRESS. **SEND TO: Commissioner for Patents, P.O. Box 1450, Alexandria, VA 22313-1450.**  
 If you need assistance in completing the form, call 1-800-PTO-9199 and select option 2.



UNITED STATES PATENT AND TRADEMARK OFFICE

UNITED STATES DEPARTMENT OF COMMERCE
United States Patent and Trademark Office
Address: COMMISSIONER FOR PATENTS
P.O. Box 1450
Alexandria, Virginia 22313-1450
www.uspto.gov

Table with 5 columns: APPLICATION NO., FILING DATE, FIRST NAMED INVENTOR, ATTORNEY DOCKET NO., CONFIRMATION NO.

12/569,116 09/29/2009 Alan J. Lipton OV-101 7686

74712 7590 12/02/2009
MUIR PATENT CONSULTING, PLLC
758 WALKER RD
SUITE C
GREAT FALLS, VA 22066

Table with 1 column: EXAMINER

Table with 2 columns: ART UNIT, PAPER NUMBER

2621

Table with 2 columns: MAIL DATE, DELIVERY MODE

12/02/2009 PAPER

Please find below and/or attached an Office communication concerning this application or proceeding.

The time period for reply, if any, is set in the attached communication.

<b>Interview Summary</b>	<b>Application No.</b> 12/569,116	<b>Applicant(s)</b> LIPTON ET AL.	
	<b>Examiner</b> Tung Vo	<b>Art Unit</b> 2621	

All participants (applicant, applicant's representative, PTO personnel):

- (1) Tung Vo. (3) Peter Venetianer.  
(2) Patrick Muir. (4) \_\_\_\_\_.

Date of Interview: 24 November 2009.

Type: a)  Telephonic b)  Video Conference  
c)  Personal [copy given to: 1)  applicant 2)  applicant's representative]

Exhibit shown or demonstration conducted: d)  Yes e)  No.  
If Yes, brief description: \_\_\_\_\_.

Claim(s) discussed: 27-70.

Identification of prior art discussed: \_\_\_\_\_.

Agreement with respect to the claims f)  was reached. g)  was not reached. h)  N/A.

Substance of Interview including description of the general nature of what was agreed to if an agreement was reached, or any other comments: The applicant discussed new claims 27-70.

(A fuller description, if necessary, and a copy of the amendments which the examiner agreed would render the claims allowable, if available, must be attached. Also, where no copy of the amendments that would render the claims allowable is available, a summary thereof must be attached.)

THE FORMAL WRITTEN REPLY TO THE LAST OFFICE ACTION MUST INCLUDE THE SUBSTANCE OF THE INTERVIEW. (See MPEP Section 713.04). If a reply to the last Office action has already been filed, APPLICANT IS GIVEN A NON-EXTENDABLE PERIOD OF THE LONGER OF ONE MONTH OR THIRTY DAYS FROM THIS INTERVIEW DATE, OR THE MAILING DATE OF THIS INTERVIEW SUMMARY FORM, WHICHEVER IS LATER, TO FILE A STATEMENT OF THE SUBSTANCE OF THE INTERVIEW. See Summary of Record of Interview requirements on reverse side or on attached sheet.

/Tung Vo/  
Primary Examiner, Art Unit 2621

## Summary of Record of Interview Requirements

### Manual of Patent Examining Procedure (MPEP), Section 713.04, Substance of Interview Must be Made of Record

A complete written statement as to the substance of any face-to-face, video conference, or telephone interview with regard to an application must be made of record in the application whether or not an agreement with the examiner was reached at the interview.

### Title 37 Code of Federal Regulations (CFR) § 1.133 Interviews Paragraph (b)

In every instance where reconsideration is requested in view of an interview with an examiner, a complete written statement of the reasons presented at the interview as warranting favorable action must be filed by the applicant. An interview does not remove the necessity for reply to Office action as specified in §§ 1.111, 1.135. (35 U.S.C. 132)

#### 37 CFR §1.2 Business to be transacted in writing.

All business with the Patent or Trademark Office should be transacted in writing. The personal attendance of applicants or their attorneys or agents at the Patent and Trademark Office is unnecessary. The action of the Patent and Trademark Office will be based exclusively on the written record in the Office. No attention will be paid to any alleged oral promise, stipulation, or understanding in relation to which there is disagreement or doubt.

The action of the Patent and Trademark Office cannot be based exclusively on the written record in the Office if that record is itself incomplete through the failure to record the substance of interviews.

It is the responsibility of the applicant or the attorney or agent to make the substance of an interview of record in the application file, unless the examiner indicates he or she will do so. It is the examiner's responsibility to see that such a record is made and to correct material inaccuracies which bear directly on the question of patentability.

Examiners must complete an Interview Summary Form for each interview held where a matter of substance has been discussed during the interview by checking the appropriate boxes and filling in the blanks. Discussions regarding only procedural matters, directed solely to restriction requirements for which interview recordation is otherwise provided for in Section 812.01 of the Manual of Patent Examining Procedure, or pointing out typographical errors or unreadable script in Office actions or the like, are excluded from the interview recordation procedures below. Where the substance of an interview is completely recorded in an Examiners Amendment, no separate Interview Summary Record is required.

The Interview Summary Form shall be given an appropriate Paper No., placed in the right hand portion of the file, and listed on the "Contents" section of the file wrapper. In a personal interview, a duplicate of the Form is given to the applicant (or attorney or agent) at the conclusion of the interview. In the case of a telephone or video-conference interview, the copy is mailed to the applicant's correspondence address either with or prior to the next official communication. If additional correspondence from the examiner is not likely before an allowance or if other circumstances dictate, the Form should be mailed promptly after the interview rather than with the next official communication.

The Form provides for recordation of the following information:

- Application Number (Series Code and Serial Number)
- Name of applicant
- Name of examiner
- Date of interview
- Type of interview (telephonic, video-conference, or personal)
- Name of participant(s) (applicant, attorney or agent, examiner, other PTO personnel, etc.)
- An indication whether or not an exhibit was shown or a demonstration conducted
- An identification of the specific prior art discussed
- An indication whether an agreement was reached and if so, a description of the general nature of the agreement (may be by attachment of a copy of amendments or claims agreed as being allowable). Note: Agreement as to allowability is tentative and does not restrict further action by the examiner to the contrary.
- The signature of the examiner who conducted the interview (if Form is not an attachment to a signed Office action)

It is desirable that the examiner orally remind the applicant of his or her obligation to record the substance of the interview of each case. It should be noted, however, that the Interview Summary Form will not normally be considered a complete and proper recordation of the interview unless it includes, or is supplemented by the applicant or the examiner to include, all of the applicable items required below concerning the substance of the interview.

A complete and proper recordation of the substance of any interview should include at least the following applicable items:

- 1) A brief description of the nature of any exhibit shown or any demonstration conducted,
- 2) an identification of the claims discussed,
- 3) an identification of the specific prior art discussed,
- 4) an identification of the principal proposed amendments of a substantive nature discussed, unless these are already described on the Interview Summary Form completed by the Examiner,
- 5) a brief identification of the general thrust of the principal arguments presented to the examiner,  
(The identification of arguments need not be lengthy or elaborate. A verbatim or highly detailed description of the arguments is not required. The identification of the arguments is sufficient if the general nature or thrust of the principal arguments made to the examiner can be understood in the context of the application file. Of course, the applicant may desire to emphasize and fully describe those arguments which he or she feels were or might be persuasive to the examiner.)
- 6) a general indication of any other pertinent matters discussed, and
- 7) if appropriate, the general results or outcome of the interview unless already described in the Interview Summary Form completed by the examiner.

Examiners are expected to carefully review the applicant's record of the substance of an interview. If the record is not complete and accurate, the examiner will give the applicant an extendable one month time period to correct the record.

### Examiner to Check for Accuracy

If the claims are allowable for other reasons of record, the examiner should send a letter setting forth the examiner's version of the statement attributed to him or her. If the record is complete and accurate, the examiner should place the indication, "Interview Record OK" on the paper recording the substance of the interview along with the date and the examiner's initials.



UNITED STATES PATENT AND TRADEMARK OFFICE

UNITED STATES DEPARTMENT OF COMMERCE
United States Patent and Trademark Office
Address: COMMISSIONER FOR PATENTS
P.O. Box 1450
Alexandria, Virginia 22313-1450
www.uspto.gov

Table with 7 columns: APPLICATION NUMBER, FILING or 371(c) DATE, GRP ART UNIT, FIL FEE REC'D, ATTY. DOCKET NO, TOT CLAIMS, IND CLAIMS. Row 1: 12/569,116, 09/29/2009, 2622, 728, OV-101, 26, 4

CONFIRMATION NO. 7686

74712
MUIR PATENT CONSULTING, PLLC
758 WALKER RD
SUITE C
GREAT FALLS, VA 22066

FILING RECEIPT



Date Mailed: 10/14/2009

Receipt is acknowledged of this non-provisional patent application. The application will be taken up for examination in due course. Applicant will be notified as to the results of the examination. Any correspondence concerning the application must include the following identification information: the U.S. APPLICATION NUMBER, FILING DATE, NAME OF APPLICANT, and TITLE OF INVENTION. Fees transmitted by check or draft are subject to collection. Please verify the accuracy of the data presented on this receipt. If an error is noted on this Filing Receipt, please submit a written request for a Filing Receipt Correction. Please provide a copy of this Filing Receipt with the changes noted thereon. If you received a "Notice to File Missing Parts" for this application, please submit any corrections to this Filing Receipt with your reply to the Notice. When the USPTO processes the reply to the Notice, the USPTO will generate another Filing Receipt incorporating the requested corrections

Applicant(s)

- Alan J. Lipton, Falls Church, VA;
Thomas M. Strat, Pakton, VA;
Peter L. Venetianer, McLean, VA;
Mark C. Allmen, Morrison, CO;
William E. Severson, Littleton, CO;
Niels Haering, Arlington, VA;
Andrew J. Chosak, McLean, VA;
Zhong Zhang, Herndon, VA;
Matthew F. Frazier, Arlington, VA;
James S. Seekas, Arlington, VA;
Tasuki Hirata, Silver Spring, MD;
John Clark, Leesburg, VA;

Power of Attorney: The patent practitioners associated with Customer Number 26694

Domestic Priority data as claimed by applicant

This application is a CON of 09/987,707 11/15/2001
which is a CIP of 09/694,712 10/24/2000 PAT 6,954,498

Foreign Applications

If Required, Foreign Filing License Granted: 10/09/2009

The country code and number of your priority application, to be used for filing abroad under the Paris Convention, is US 12/569,116

Projected Publication Date: 01/21/2010

**Non-Publication Request:** No

**Early Publication Request:** No

**\*\* SMALL ENTITY \*\***

**Title**

Video Surveillance System Employing Video Primitives

**Preliminary Class**

348

## **PROTECTING YOUR INVENTION OUTSIDE THE UNITED STATES**

Since the rights granted by a U.S. patent extend only throughout the territory of the United States and have no effect in a foreign country, an inventor who wishes patent protection in another country must apply for a patent in a specific country or in regional patent offices. Applicants may wish to consider the filing of an international application under the Patent Cooperation Treaty (PCT). An international (PCT) application generally has the same effect as a regular national patent application in each PCT-member country. The PCT process **simplifies** the filing of patent applications on the same invention in member countries, but **does not result** in a grant of "an international patent" and does not eliminate the need of applicants to file additional documents and fees in countries where patent protection is desired.

Almost every country has its own patent law, and a person desiring a patent in a particular country must make an application for patent in that country in accordance with its particular laws. Since the laws of many countries differ in various respects from the patent law of the United States, applicants are advised to seek guidance from specific foreign countries to ensure that patent rights are not lost prematurely.

Applicants also are advised that in the case of inventions made in the United States, the Director of the USPTO must issue a license before applicants can apply for a patent in a foreign country. The filing of a U.S. patent application serves as a request for a foreign filing license. The application's filing receipt contains further information and guidance as to the status of applicant's license for foreign filing.

Applicants may wish to consult the USPTO booklet, "General Information Concerning Patents" (specifically, the section entitled "Treaties and Foreign Patents") for more information on timeframes and deadlines for filing foreign patent applications. The guide is available either by contacting the USPTO Contact Center at 800-786-9199, or it can be viewed on the USPTO website at <http://www.uspto.gov/web/offices/pac/doc/general/index.html>.

For information on preventing theft of your intellectual property (patents, trademarks and copyrights), you may wish to consult the U.S. Government website, <http://www.stopfakes.gov>. Part of a Department of Commerce initiative, this website includes self-help "toolkits" giving innovators guidance on how to protect intellectual property in specific countries such as China, Korea and Mexico. For questions regarding patent enforcement issues, applicants may call the U.S. Government hotline at 1-866-999-HALT (1-866-999-4158).



**LICENSE FOR FOREIGN FILING UNDER**  
**Title 35, United States Code, Section 184**  
**Title 37, Code of Federal Regulations, 5.11 & 5.15**

**GRANTED**

The applicant has been granted a license under 35 U.S.C. 184, if the phrase "IF REQUIRED, FOREIGN FILING LICENSE GRANTED" followed by a date appears on this form. Such licenses are issued in all applications where the conditions for issuance of a license have been met, regardless of whether or not a license may be required as set forth in 37 CFR 5.15. The scope and limitations of this license are set forth in 37 CFR 5.15(a) unless an earlier license has been issued under 37 CFR 5.15(b). The license is subject to revocation upon written notification. The date indicated is the effective date of the license, unless an earlier license of similar scope has been granted under 37 CFR 5.13 or 5.14.

This license is to be retained by the licensee and may be used at any time on or after the effective date thereof unless it is revoked. This license is automatically transferred to any related applications(s) filed under 37 CFR 1.53(d). This license is not retroactive.

The grant of a license does not in any way lessen the responsibility of a licensee for the security of the subject matter as imposed by any Government contract or the provisions of existing laws relating to espionage and the national security or the export of technical data. Licensees should apprise themselves of current regulations especially with respect to certain countries, of other agencies, particularly the Office of Defense Trade Controls, Department of State (with respect to Arms, Munitions and Implements of War (22 CFR 121-128)); the Bureau of Industry and Security, Department of Commerce (15 CFR parts 730-774); the Office of Foreign Assets Control, Department of Treasury (31 CFR Parts 500+) and the Department of Energy.

**NOT GRANTED**

No license under 35 U.S.C. 184 has been granted at this time, if the phrase "IF REQUIRED, FOREIGN FILING LICENSE GRANTED" DOES NOT appear on this form. Applicant may still petition for a license under 37 CFR 5.12, if a license is desired before the expiration of 6 months from the filing date of the application. If 6 months has lapsed from the filing date of this application and the licensee has not received any indication of a secrecy order under 35 U.S.C. 181, the licensee may foreign file the application pursuant to 37 CFR 5.15(b).

Under the Paperwork Reduction Act of 1995, no persons are required to respond to a collection of information unless it displays a valid OMB control number.

<b>UTILITY PATENT APPLICATION TRANSMITTAL</b>  <i>(Only for new nonprovisional applications under 37 CFR 1.53(b))</i>	Attorney Docket No.	OV-101
	First Inventor	Alan J. Lipton
	Title	Video Surveillance System Employing
	Express Mail Label No.	

<b>APPLICATION ELEMENTS</b> <i>See MPEP chapter 600 concerning utility patent application contents.</i>	<b>ADDRESS TO:</b> Commissioner for Patents P.O. Box 1450 Alexandria VA 22313-1450
--	---

<p>1. <input type="checkbox"/> Fee Transmittal Form (e.g., PTO/SB/17)</p> <p>2. <input checked="" type="checkbox"/> Applicant claims small entity status. <i>See 37 CFR 1.27.</i></p> <p>3. <input checked="" type="checkbox"/> Specification [Total Pages <u>36</u>] Both the claims and abstract must start on a new page <i>(For information on the preferred arrangement, see MPEP 608.01(a))</i></p> <p>4. <input checked="" type="checkbox"/> Drawing(s) (35 U.S.C. 113) [Total Sheets <u>7</u>]</p> <p>5. Oath or Declaration [Total Sheets _____] a. <input type="checkbox"/> Newly executed (original or copy) b. <input checked="" type="checkbox"/> A copy from a prior application (37 CFR 1.63(d)) <i>(for continuation/divisional with Box 18 completed)</i> i. <input type="checkbox"/> DELETION OF INVENTOR(S) Signed statement attached deleting inventor(s) names in the prior application, see 37 CFR 1.63(d)(2) and 1.33(b).</p> <p>6. <input type="checkbox"/> Application Data Sheet. See 37 CFR 1.76</p> <p>7. <input type="checkbox"/> CD-ROM or CD-R in duplicate, large table or Computer Program (Appendix) <input type="checkbox"/> Landscape Table on CD</p> <p>8. Nucleotide and/or Amino Acid Sequence Submission <i>(if applicable, items a. - c. are required)</i> a. <input type="checkbox"/> Computer Readable Form (CRF) b. Specification Sequence Listing on: i. <input type="checkbox"/> CD-ROM or CD-R (2 copies); or ii. <input type="checkbox"/> Paper c. <input type="checkbox"/> Statements verifying identity of above copies</p>	<p style="text-align: center;"><b>ACCOMPANYING APPLICATION PARTS</b></p> <p>9. <input type="checkbox"/> Assignment Papers (cover sheet &amp; document(s)) Name of Assignee _____</p> <p>10. <input type="checkbox"/> 37 CFR 3.73(b) Statement <input type="checkbox"/> Power of Attorney <i>(when there is an assignee)</i></p> <p>11. <input type="checkbox"/> English Translation Document (if applicable)</p> <p>12. <input type="checkbox"/> Information Disclosure Statement (PTO/SB/05 or PTO-1449) <input type="checkbox"/> Copies of citations attached</p> <p>13. <input type="checkbox"/> Preliminary Amendment</p> <p>14. <input type="checkbox"/> Return Receipt Postcard (MPEP 503) <i>(Should be specifically itemized)</i></p> <p>15. <input type="checkbox"/> Certified Copy of Priority Document(s) <i>(if foreign priority is claimed)</i></p> <p>16. <input type="checkbox"/> Nonpublication Request under 35 U.S.C. 122(b)(2)(B)(i). Applicant must attach form PTO/SB/35 or equivalent.</p> <p>17. <input type="checkbox"/> Other: _____</p>
---	---

18. If a CONTINUING APPLICATION, check appropriate box, and supply the requisite information below and in the first sentence of the specification following the title, or in an Application Data Sheet under 37 CFR 1.76:

Continuation  Divisional  Continuation-in-part (CIP) of prior application No. 09/887,707

Prior application information: Examiner VO Tung Art Unit 2821

**19. CORRESPONDENCE ADDRESS**

The address associated with Customer Number 74,712 OR  Correspondence address below

Name			
Address			
City	State	Zip Code	
Country	Telephone	Email	

Signature		Date	9-23-2009
Name (Print/Type)	Patrick D. Muir	Registration No. (Attorney/Agent)	37,403

This collection of information is required by 37 CFR 1.53(b). The information is required to obtain or retain a benefit by the public which is to file (and by the USPTO to process) an application. Confidentiality is governed by 35 U.S.C. 122 and 37 CFR 1.11 and 1.14. This collection is estimated to take 12 minutes to complete, including gathering, preparing, and submitting the completed application form to the USPTO. Time will vary depending upon the individual case. Any comments on the amount of time you require to complete this form and/or suggestions for reducing this burden, should be sent to the Chief Information Officer, U.S. Patent and Trademark Office, U.S. Department of Commerce, P.O. Box 1450, Alexandria, VA 22313-1450. DO NOT SEND FEES OR COMPLETED FORMS TO THIS ADDRESS. SEND TO: Commissioner for Patents, P.O. Box 1450, Alexandria, VA 22313-1450.

*If you need assistance in completing the form, call 1-800-PTO-9199 and select option 2.*

## **VIDEO SURVEILLANCE SYSTEM EMPLOYING VIDEO PRIMITIVES**

### **CROSS-REFERENCE TO RELATED APPLICATIONS**

[1] This application claims the priority to U.S. Patent Application Serial No. 09/987,707, filed November 15, 2001, which claims priority to U.S. Patent Application Serial No. 09/694,712, now U.S. Patent No. 6,954,498, each of which is incorporated herein by reference in their entirety.

### **BACKGROUND OF THE INVENTION**

#### **Field of the Invention**

[2] The invention relates to a system for automatic video surveillance employing video primitives.

#### **References**

[3] For the convenience of the reader, the references referred to herein are listed below. In the specification, the numerals within brackets refer to respective references. The listed references are incorporated herein by reference.

[4] The following references describe moving target detection:

[5] {1} A. Lipton, H. Fujiyoshi and R.S. Patil, "Moving Target Detection and Classification from Real-Time Video," Proceedings of IEEE WACV'98, Princeton, NJ, 1998, pp. 8-14.

[6] {2} W.E.L. Grimson, et al., "Using Adaptive Tracking to Classify and Monitor Activities in a Site", CVPR, pp. 22-29, June 1998.

[7] {3} A.J. Lipton, H. Fujiyoshi, R.S. Patil, "Moving Target Classification and Tracking from Real-time Video," IJW, pp. 129-136, 1998

[8] {4} T.J. Olson and F.Z. Brill, "Moving Object Detection and Event Recognition Algorithm for Smart Cameras," IUW, pp. 159-175, May 1997.

[9] The following references describe detecting and tracking humans:

[10] {5} A. J. Lipton, "Local Application of Optical Flow to Analyse Rigid Versus  
5 Non-Rigid Motion," International Conference on Computer Vision, Corfu, Greece, September 1999.

[11] {6} F. Bartolini, V. Cappellini, and A. Mecocci, "Counting people getting in and out of a bus by real-time image-sequence processing," IVC, 12(1):36-41, January 1994.

[12] {7} M. Rossi and A. Bozzoli, "Tracking and counting moving people," ICIP94, pp. 212-216, 1994.

[13] {8} C.R. Wren, A. Azarbayejani, T. Darrell, and A. Pentland, "Pfinder: Real-time tracking of the human body," Vismod, 1995.

[14] {9} L. Khoudour, L. Duvieubourg, J.P. Deparis, "Real-Time Pedestrian Counting by Active Linear Cameras," JEI, 5(4):452-459, October 1996.

15 [15] {10} S. Ioffe, D.A. Forsyth, "Probabilistic Methods for Finding People," IJCV, 43(1):45-68, June 2001.

[16] {11} M. Isard and J. MacCormick, "BraMBLe: A Bayesian Multiple-Blob Tracker," ICCV, 2001.

[17] The following references describe blob analysis:

20 [18] {12} D.M. Gavrila, "The Visual Analysis of Human Movement: A Survey," CVIU, 73(1):82-98, January 1999.

[19] {13} Niels Haering and Niels da Vitoria Lobo, "Visual Event Detection," Video Computing Series, Editor Mubarak Shah, 2001.

[20] The following references describe blob analysis for trucks, cars, and people:

[21] {14} Collins, Lipton, Kanade, Fujiyoshi, Duggins, Tsin, Tolliver, Enomoto, and Hasegawa, "A System for Video Surveillance and Monitoring: VSAM Final Report," Technical Report CMU-RI-TR-00-12, Robotics Institute, Carnegie Mellon University, May 2000.

5 [22] {15} Lipton, Fujiyoshi, and Patil, "Moving Target Classification and Tracking from Real-time Video," 98 Darpa IUW, Nov. 20-23, 1998.

[23] The following reference describes analyzing a single-person blob and its contours:

[24] {16} C.R. Wren, A. Azarbayejani, T. Darrell, and A.P. Pentland. "Pfinder: Real-Time Tracking of the Human Body," PAMI, vol 19, pp. 780-784, 1997.

[25] The following reference describes internal motion of blobs, including any motion-based segmentation:

[26] {17} M. Allmen and C. Dyer, "Long--Range Spatiotemporal Motion Understanding Using Spatiotemporal Flow Curves," Proc. IEEE CVPR, Lahaina, Maui, Hawaii, pp. 303-309, 1991.

15 [27] {18} L. Wixson, "Detecting Salient Motion by Accumulating Directionally Consistent Flow", IEEE Trans. Pattern Anal. Mach. Intell., vol. 22, pp. 774-781, Aug, 2000.

### **Background of the Invention**

20 [28] Video surveillance of public spaces has become extremely widespread and accepted by the general public. Unfortunately, conventional video surveillance systems produce such prodigious volumes of data that an intractable problem results in the analysis of video surveillance data.

[29] A need exists to reduce the amount of video surveillance data so analysis of the video surveillance data can be conducted.

[30] A need exists to filter video surveillance data to identify desired portions of the video surveillance data.

5

**SUMMARY OF THE INVENTION**

[31] An object of the invention is to reduce the amount of video surveillance data so analysis of the video surveillance data can be conducted.

[32] An object of the invention is to filter video surveillance data to identify desired portions of the video surveillance data.

[33] An object of the invention is to produce a real time alarm based on an automatic detection of an event from video surveillance data.

[34] An object of the invention is to integrate data from surveillance sensors other than video for improved searching capabilities.

15 [35] An object of the invention is to integrate data from surveillance sensors other than video for improved event detection capabilities

[36] The invention includes an article of manufacture, a method, a system, and an apparatus for video surveillance.

20 [37] The article of manufacture of the invention includes a computer-readable medium comprising software for a video surveillance system, comprising code segments for operating the video surveillance system based on video primitives.

[38] The article of manufacture of the invention includes a computer-readable medium comprising software for a video surveillance system, comprising code segments for accessing

archived video primitives, and code segments for extracting event occurrences from accessed archived video primitives.

[39] The system of the invention includes a computer system including a computer-readable medium having software to operate a computer in accordance with the invention.

5 [40] The apparatus of the invention includes a computer including a computer-readable medium having software to operate the computer in accordance with the invention.

[41] The article of manufacture of the invention includes a computer-readable medium having software to operate a computer in accordance with the invention.

[42] Moreover, the above objects and advantages of the invention are illustrative, and not exhaustive, of those that can be achieved by the invention. Thus, these and other objects and advantages of the invention will be apparent from the description herein, both as embodied herein and as modified in view of any variations which will be apparent to those skilled in the art.

15 **Definitions**

[43] A “video” refers to motion pictures represented in analog and/or digital form. Examples of video include: television, movies, image sequences from a video camera or other observer, and computer-generated image sequences.

[44] A “frame” refers to a particular image or other discrete unit within a video.

20 [45] An “object” refers to an item of interest in a video. Examples of an object include: a person, a vehicle, an animal, and a physical subject.

[46] An “activity” refers to one or more actions and/or one or more composites of actions of one or more objects. Examples of an activity include: entering; exiting; stopping; moving; raising; lowering; growing; and shrinking.

[47] A “location” refers to a space where an activity may occur. A location can be, for  
5 example, scene-based or image-based. Examples of a scene-based location include: a public space; a store; a retail space; an office; a warehouse; a hotel room; a hotel lobby; a lobby of a building; a casino; a bus station; a train station; an airport; a port; a bus; a train; an airplane; and a ship. Examples of an image-based location include: a video image; a line in a video image; an area in a video image; a rectangular section of a video image; and a polygonal section of a video image.

[48] An “event” refers to one or more objects engaged in an activity. The event may be referenced with respect to a location and/or a time.

[49] A “computer” refers to any apparatus that is capable of accepting a structured input, processing the structured input according to prescribed rules, and producing results of the  
15 processing as output. Examples of a computer include: a computer; a general purpose computer; a supercomputer; a mainframe; a super mini-computer; a mini-computer; a workstation; a micro-computer; a server; an interactive television; a hybrid combination of a computer and an interactive television; and application-specific hardware to emulate a computer and/or software. A computer can have a single processor or multiple processors, which can operate in parallel  
20 and/or not in parallel. A computer also refers to two or more computers connected together via a network for transmitting or receiving information between the computers. An example of such a computer includes a distributed computer system for processing information via computers linked by a network.



[50] A “computer-readable medium” refers to any storage device used for storing data accessible by a computer. Examples of a computer-readable medium include: a magnetic hard disk; a floppy disk; an optical disk, such as a CD-ROM and a DVD; a magnetic tape; a memory chip; and a carrier wave used to carry computer-readable electronic data, such as those used in transmitting and receiving e-mail or in accessing a network.

[51] “Software” refers to prescribed rules to operate a computer. Examples of software include: software; code segments; instructions; computer programs; and programmed logic.

[52] A “computer system” refers to a system having a computer, where the computer comprises a computer-readable medium embodying software to operate the computer.

[53] A “network” refers to a number of computers and associated devices that are connected by communication facilities. A network involves permanent connections such as cables or temporary connections such as those made through telephone or other communication links. Examples of a network include: an internet, such as the Internet; an intranet; a local area network (LAN); a wide area network (WAN); and a combination of networks, such as an internet and an intranet.

### **BRIEF DESCRIPTION OF THE DRAWINGS**

[54] Embodiments of the invention are explained in greater detail by way of the drawings, where the same reference numerals refer to the same features.

[55] Figure 1 illustrates a plan view of the video surveillance system of the invention.

[56] Figure 2 illustrates a flow diagram for the video surveillance system of the invention.

[57] Figure 3 illustrates a flow diagram for tasking the video surveillance system.

[58] Figure 4 illustrates a flow diagram for operating the video surveillance system.

[59] Figure 5 illustrates a flow diagram for extracting video primitives for the video surveillance system.

5 [60] Figure 6 illustrates a flow diagram for taking action with the video surveillance system.

[61] Figure 7 illustrates a flow diagram for semi-automatic calibration of the video surveillance system.

[62] Figure 8 illustrates a flow diagram for automatic calibration of the video surveillance system.

[63] Figure 9 illustrates an additional flow diagram for the video surveillance system of the invention.

[64] Figures 10-15 illustrate examples of the video surveillance system of the invention applied to monitoring a grocery store.

15

### **DETAILED DESCRIPTION OF THE INVENTION**

[65] The automatic video surveillance system of the invention is for monitoring a location for, for example, market research or security purposes. The system can be a dedicated video surveillance installation with purpose-built surveillance components, or the system can be  
20 a retrofit to existing video surveillance equipment that piggybacks off the surveillance video feeds. The system is capable of analyzing video data from live sources or from recorded media. The system can have a prescribed response to the analysis, such as record data, activate an alarm mechanism, or active another sensor system. The system is also capable of integrating with

other surveillance system components. The system produces security or market research reports that can be tailored according to the needs of an operator and, as an option, can be presented through an interactive web-based interface, or other reporting mechanism.

[66] An operator is provided with maximum flexibility in configuring the system by using event discriminators. Event discriminators are identified with one or more objects (whose descriptions are based on video primitives), along with one or more optional spatial attributes, and/or one or more optional temporal attributes. For example, an operator can define an event discriminator (called a "loitering" event in this example) as a "person" object in the "automatic teller machine" space for "longer than 15 minutes" and "between 10:00 p.m. and 6:00 a.m."

[67] Although the video surveillance system of the invention draws on well-known computer vision techniques from the public domain, the inventive video surveillance system has several unique and novel features that are not currently available. For example, current video surveillance systems use large volumes of video imagery as the primary commodity of information interchange. The system of the invention uses video primitives as the primary commodity with representative video imagery being used as collateral evidence. The system of the invention can also be calibrated (manually, semi-automatically, or automatically) and thereafter automatically can infer video primitives from video imagery. The system can further analyze previously processed video without needing to reprocess completely the video. By analyzing previously processed video, the system can perform inference analysis based on previously recorded video primitives, which greatly improves the analysis speed of the computer system.

[68] As another example, the system of the invention provides unique system tasking. Using equipment control directives, current video systems allow a user to position video sensors

and, in some sophisticated conventional systems, to mask out regions of interest or disinterest. Equipment control directives are instructions to control the position, orientation, and focus of video cameras. Instead of equipment control directives, the system of the invention uses event discriminators based on video primitives as the primary tasking mechanism. With event

5 discriminators and video primitives, an operator is provided with a much more intuitive approach over conventional systems for extracting useful information from the system. Rather than tasking a system with an equipment control directives, such as “camera A pan 45 degrees to the

— left,” the system of the invention can be tasked in a human-intuitive manner with one or more event discriminators based on video primitives, such as “a person enters restricted area A.”

[69] Using the invention for market research, the following are examples of the type of video surveillance that can be performed with the invention: counting people in a store; counting people in a part of a store; counting people who stop in a particular place in a store; measuring how long people spend in a store; measuring how long people spend in a part of a store; and measuring the length of a line in a store.

15 [70] Using the invention for security, the following are examples of the type of video surveillance that can be performed with the invention: determining when anyone enters a restricted area and storing associated imagery; determining when a person enters an area at unusual times; determining when changes to shelf space and storage space occur that might be unauthorized; determining when passengers aboard an aircraft approach the cockpit; determining

20 when people tailgate through a secure portal; determining if there is an unattended bag in an airport; and determining if there is a theft of an asset.

[71] Figure 1 illustrates a plan view of the video surveillance system of the invention. A computer system 11 comprises a computer 12 having a computer-readable medium 13

embodying software to operate the computer 12 according to the invention. The computer system 11 is coupled to one or more video sensors 14, one or more video recorders 15, and one or more input/output (I/O) devices 16. The video sensors 14 can also be optionally coupled to the video recorders 15 for direct recording of video surveillance data. The computer system is  
5 optionally coupled to other sensors 17.

[72] The video sensors 14 provide source video to the computer system 11. Each video sensor 14 can be coupled to the computer system 11 using, for example, a direct connection (e.g., a firewire digital camera interface) or a network. The video sensors 14 can exist prior to installation of the invention or can be installed as part of the invention. Examples of a video sensor 14 include: a video camera; a digital video camera; a color camera; a monochrome camera; a camera; a camcorder, a PC camera; a webcam; an infra-red video camera; and a CCTV camera.

[73] The video recorders 15 receive video surveillance data from the computer system 11 for recording and/or provide source video to the computer system 11. Each video recorder 15  
15 can be coupled to the computer system 11 using, for example, a direct connection or a network. The video recorders 15 can exist prior to installation of the invention or can be installed as part of the invention. Examples of a video recorder 15 include: a video tape recorder; a digital video recorder; a video disk; a DVD; and a computer-readable medium.

[74] The I/O devices 16 provide input to and receive output from the computer system  
20 11. The I/O devices 16 can be used to task the computer system 11 and produce reports from the computer system 11. Examples of I/O devices 16 include: a keyboard; a mouse; a stylus; a monitor; a printer; another computer system; a network; and an alarm.

[75] The other sensors 17 provide additional input to the computer system 11. Each other sensor 17 can be coupled to the computer system 11 using, for example, a direct connection or a network. The other sensors 17 can exist prior to installation of the invention or can be installed as part of the invention. Examples of another sensor 17 include: a motion sensor; an optical tripwire; a biometric sensor; and a card-based or keypad-based authorization system. The outputs of the other sensors 17 can be recorded by the computer system 11, recording devices, and/or recording systems.

[76] Figure 2 illustrates a flow diagram for the video surveillance system of the invention. Various aspects of the invention are exemplified with reference to Figures 10-15, which illustrate examples of the video surveillance system of the invention applied to monitoring a grocery store.

[77] In block 21, the video surveillance system is set up as discussed for Figure 1. Each video sensor 14 is orientated to a location for video surveillance. The computer system 11 is connected to the video feeds from the video equipment 14 and 15. The video surveillance system can be implemented using existing equipment or newly installed equipment for the location.

[78] In block 22, the video surveillance system is calibrated. Once the video surveillance system is in place from block 21, calibration occurs. The result of block 22 is the ability of the video surveillance system to determine an approximate absolute size and speed of a particular object (e.g., a person) at various places in the video image provided by the video sensor. The system can be calibrated using manual calibration, semi-automatic calibration, and automatic calibration. Calibration is further described after the discussion of block 24.

[79] In block 23 of Figure 2, the video surveillance system is tasked. Tasking occurs after calibration in block 22 and is optional. Tasking the video surveillance system involves specifying one or more event discriminators. Without tasking, the video surveillance system operates by detecting and archiving video primitives and associated video imagery without  
5 taking any action, as in block 45 in Figure 4.

[80] Figure 3 illustrates a flow diagram for tasking the video surveillance system to determine event discriminators. An event discriminator refers to one or more objects optionally interacting with one or more spatial attributes and/or one or more temporal attributes. An event discriminator is described in terms of video primitives. A video primitive refers to an observable attribute of an object viewed in a video feed. Examples of video primitives include the following: a classification; a size; a shape; a color; a texture; a position; a velocity; a speed; an internal motion; a motion; a salient motion; a feature of a salient motion; a scene change; a feature of a scene change; and a pre-defined model.

[81] A classification refers to an identification of an object as belonging to a particular  
15 category or class. Examples of a classification include: a person; a dog; a vehicle; a police car; an individual person; and a specific type of object.

[82] A size refers to a dimensional attribute of an object. Examples of a size include: large; medium; small; flat; taller than 6 feet; shorter than 1 foot; wider than 3 feet; thinner than 4  
20 feet; about human size; bigger than a human; smaller than a human; about the size of a car; a rectangle in an image with approximate dimensions in pixels; and a number of image pixels.

[83] A color refers to a chromatic attribute of an object. Examples of a color include: white; black; grey; red; a range of HSV values; a range of YUV values; a range of RGB values; an average RGB value; an average YUV value; and a histogram of RGB values.

[84] A texture refers to a pattern attribute of an object. Examples of texture features include: self-similarity; spectral power; linearity; and coarseness.

[85] An internal motion refers to a measure of the rigidity of an object. An example of a fairly rigid object is a car, which does not exhibit a great amount of internal motion. An  
5 example of a fairly non-rigid object is a person having swinging arms and legs, which exhibits a great amount of internal motion.

[86] A motion refers to any motion that can be automatically detected. Examples of a motion include: appearance of an object; disappearance of an object; a vertical movement of an object; a horizontal movement of an object; and a periodic movement of an object.

[87] A salient motion refers to any motion that can be automatically detected and can be tracked for some period of time. Such a moving object exhibits apparently purposeful motion. Examples of a salient motion include: moving from one place to another; and moving to interact with another object.

[88] A feature of a salient motion refers to a property of a salient motion. Examples of  
15 a feature of a salient motion include: a trajectory; a length of a trajectory in image space; an approximate length of a trajectory in a three-dimensional representation of the environment; a position of an object in image space as a function of time; an approximate position of an object in a three-dimensional representation of the environment as a function of time; a duration of a trajectory; a velocity (e.g., speed and direction) in image space; an approximate velocity (e.g.,  
20 speed and direction) in a three-dimensional representation of the environment; a duration of time at a velocity; a change of velocity in image space; an approximate change of velocity in a three-dimensional representation of the environment; a duration of a change of velocity; cessation of motion; and a duration of cessation of motion. A velocity refers to the speed and direction of an



object at a particular time. A trajectory refers a set of (position, velocity) pairs for an object for as long as the object can be tracked or for a time period.

[89] A scene change refers to any region of a scene that can be detected as changing over a period of time. Examples of a scene change include: an stationary object leaving a scene; 5 an object entering a scene and becoming stationary; an object changing position in a scene; and an object changing appearance (e.g. color, shape, or size).

[90] A feature of a scene change refers to a property of a scene change. Examples of a feature of a scene change include: a size of a scene change in image space; an approximate size of a scene change in a three-dimensional representation of the environment; a time at which a scene change occurred; a location of a scene change in image space; and an approximate location of a scene change in a three-dimensional representation of the environment.

[91] A pre-defined model refers to an *a priori* known model of an object. Examples of a pre-defined include: an adult; a child; a vehicle; and a semi-trailer.

[92] In block 31, one or more objects types of interests are identified in terms of video 15 primitives or abstractions thereof. Examples of one or more objects include: an object; a person; a red object; two objects; two persons; and a vehicle.

[93] In block 32, one or more spatial areas of interest are identified. An area refers to one or more portions of an image from a source video or a spatial portion of a scene being viewed by a video sensor. An area also includes a combination of areas from various scenes 20 and/or images. An area can be an image-based space (e.g., a line, a rectangle, a polygon, or a circle in a video image) or a three-dimensional space (e.g., a cube, or an area of floor space in a building).

[94] Figure 12 illustrates identifying areas along an aisle in a grocery store. Four areas are identified: coffee; soda promotion; chips snacks; and bottled water. The areas are identified via a point-and-click interface with the system.

[95] In block 33, one or more temporal attributes of interest are optionally identified. 5 Examples of a temporal attribute include: every 15 minutes; between 9:00 p.m. to 6:30 a.m.; less than 5 minutes; longer than 30 seconds; over the weekend; and within 20 minutes of.

[96] In block 34, a response is optionally identified. Examples of a response includes the following: activating a visual and/or audio alert on a system display; activating a visual and/or audio alarm system at the location; activating a silent alarm; activating a rapid response mechanism; locking a door; contacting a security service; forwarding data (e.g., image data, video data, video primitives; and/or analyzed data) to another computer system via a network, such as the Internet; saving such data to a designated computer-readable medium; activating some other sensor or surveillance system; tasking the computer system 11 and/or another computer system; and directing the computer system 11 and/or another computer system.

15 [97] In block 35, one or more discriminators are identified by describing interactions between video primitives (or their abstractions), spatial areas of interest, and temporal attributes of interest. An interaction is determined for a combination of one or more objects identified in block 31, one or more spatial areas of interest identified in block 32, and one or more temporal attributes of interest identified in block 33. One or more responses identified in block 34 are 20 optionally associated with each event discriminator.

[98] Examples of an event discriminator for a single object include: an object appears; a person appears; and a red object moves faster than 10m/s.

[99] Examples of an event discriminator for multiple objects include: two objects come together; a person exits a vehicle; and a red object moves next to a blue object.

[100] Examples of an event discriminator for an object and a spatial attribute include: an object crosses a line; an object enters an area; and a person crosses a line from the left.

5 [101] Examples of an event discriminator for an object and a temporal attribute include: an object appears at 10:00 p.m.; a person travels faster than 2m/s between 9:00 a.m. and 5:00 p.m.; and a vehicle appears on the weekend.

[102] Examples of an event discriminator for an object, a spatial attribute, and a temporal attribute include: a person crosses a line between midnight and 6:00 a.m.; and a vehicle stops in an area for longer than 10 minutes.

[103] An example of an event discriminator for an object, a spatial attribute, and a temporal attribute associated with a response include: a person enters an area between midnight and 6:00 a.m., and a security service is notified.

15 [104] In block 24 of Figure 2, the video surveillance system is operated. The video surveillance system of the invention operates automatically, detects and archives video primitives of objects in the scene, and detects event occurrences in real time using event discriminators. In addition, action is taken in real time, as appropriate, such as activating alarms, generating reports, and generating output. The reports and output can be displayed and/or stored locally to the system or elsewhere via a network, such as the Internet. Figure 4 illustrates a flow  
20 diagram for operating the video surveillance system.

[105] In block 41, the computer system 11 obtains source video from the video sensors 14 and/or the video recorders 15.

[106] In block 42, video primitives are extracted in real time from the source video. As an option, non-video primitives can be obtained and/or extracted from one or more other sensors 17 and used with the invention. The extraction of video primitives is illustrated with Figure 5.

[107] Figure 5 illustrates a flow diagram for extracting video primitives for the video 5 surveillance system. Blocks 51 and 52 operate in parallel and can be performed in any order or concurrently. In block 51, objects are detected via movement. Any motion detection algorithm for detecting movement between frames at the pixel level can be used for this block. As an example, the three frame differencing technique can be used, which is discussed in {1}. The detected objects are forwarded to block 53.

[108] In block 52, objects are detected via change. Any change detection algorithm for detecting changes from a background model can be used for this block. An object is detected in this block if one or more pixels in a frame are deemed to be in the foreground of the frame because the pixels do not conform to a background model of the frame. As an example, a stochastic background modeling technique, such as dynamically adaptive background 15 subtraction, can be used, which is described in {1} and U.S. Patent Application No. 09/694,712 filed October 24, 2000. The detected objects are forwarded to block 53.

[109] The motion detection technique of block 51 and the change detection technique of block 52 are complimentary techniques, where each technique advantageously addresses deficiencies in the other technique. As an option, additional and/or alternative detection schemes 20 can be used for the techniques discussed for blocks 51 and 52. Examples of an additional and/or alternative detection scheme include the following: the Pfinder detection scheme for finding people as described in {8}; a skin tone detection scheme; a face detection scheme; and a model-

based detection scheme. The results of such additional and/or alternative detection schemes are provided to block 53.

[110] As an option, if the video sensor 14 has motion (e.g., a video camera that sweeps, zooms, and/or translates), an additional block can be inserted before blocks between blocks 51 and 52 to provide input to blocks 51 and 52 for video stabilization. Video stabilization can be achieved by affine or projective global motion compensation. For example, image alignment described in U.S. Patent Application No. 09/609,919, filed July 3, 2000, which is incorporated herein by reference, can be used to obtain video stabilization.

[111] In block 53, blobs are generated. In general, a blob is any object in a frame. Examples of a blob include: a moving object, such as a person or a vehicle; and a consumer product, such as a piece of furniture, a clothing item, or a retail shelf item. Blobs are generated using the detected objects from blocks 32 and 33. Any technique for generating blobs can be used for this block. An exemplary technique for generating blobs from motion detection and change detection uses a connected components scheme. For example, the morphology and connected components algorithm can be used, which is described in {1}.

[112] In block 54, blobs are tracked. Any technique for tracking blobs can be used for this block. For example, Kalman filtering or the CONDENSATION algorithm can be used. As another example, a template matching technique, such as described in {1}, can be used. As a further example, a multi-hypothesis Kalman tracker can be used, which is described in {5}. As yet another example, the frame-to-frame tracking technique described in U.S. Patent Application No. 09/694,712 filed October 24, 2000, can be used. For the example of a location being a grocery store, examples of objects that can be tracked include moving people, inventory items, and inventory moving appliances, such as shopping carts or trolleys.

[113] As an option, blocks 51-54 can be replaced with any detection and tracking scheme, as is known to those of ordinary skill. An example of such a detection and tracking scheme is described in {11}.

5 [114] In block 55, each trajectory of the tracked objects is analyzed to determine if the trajectory is salient. If the trajectory is insalient, the trajectory represents an object exhibiting unstable motion or represents an object of unstable size or color, and the corresponding object is rejected and is no longer analyzed by the system. If the trajectory is salient, the trajectory represents an object that is potentially of interest. A trajectory is determined to be salient or insalient by applying a salience measure to the trajectory. Techniques for determining a trajectory to be salient or insalient are described in {13} and {18}.

[115] In block 56, each object is classified. The general type of each object is determined as the classification of the object. Classification can be performed by a number of techniques, and examples of such techniques include using a neural network classifier {14} and using a linear discriminant classifier {14}. Examples of classification are the same as those  
15 discussed for block 23.

[116] In block 57, video primitives are identified using the information from blocks 51-56 and additional processing as necessary. Examples of video primitives identified are the same as those discussed for block 23. As an example, for size, the system can use information obtained from calibration in block 22 as a video primitive. From calibration, the system has  
20 sufficient information to determine the approximate size of an object. As another example, the system can use velocity as measured from block 54 as a video primitive.

[117] In block 43, the video primitives from block 42 are archived. The video primitives can be archived in the computer-readable medium 13 or another computer-readable

medium. Along with the video primitives, associated frames or video imagery from the source video can be archived.

[118] In block 44, event occurrences are extracted from the video primitives using event discriminators. The video primitives are determined in block 42, and the event discriminators are determined from tasking the system in block 23. The event discriminators are used to filter the video primitives to determine if any event occurrences occurred. For example, an event discriminator can be looking for a “wrong way” event as defined by a person traveling the "wrong way" into an area between 9:00a.m. and 5:00p.m. The event discriminator checks all video primitives being generated according to Figure 5 and determines if any video primitives exist which have the following properties: a timestamp between 9:00a.m. and 5:00p.m., a classification of “person” or “group of people”, a position inside the area, and a “wrong” direction of motion.

[119] In block 45, action is taken for each event occurrence extracted in block 44, as appropriate. Figure 6 illustrates a flow diagram for taking action with the video surveillance system.

[120] In block 61, responses are undertaken as dictated by the event discriminators that detected the event occurrences. The response, if any, are identified for each event discriminator in block 34.

[121] In block 62, an activity record is generated for each event occurrence that occurred. The activity record includes, for example: details of a trajectory of an object; a time of detection of an object; a position of detection of an object, and a description or definition of the event discriminator that was employed. The activity record can include information, such as video primitives, needed by the event discriminator. The activity record can also include

representative video or still imagery of the object(s) and/or area(s) involved in the event occurrence. The activity record is stored on a computer-readable medium.

[122] In block 63, output is generated. The output is based on the event occurrences extracted in block 44 and a direct feed of the source video from block 41. The output is stored  
5 on a computer-readable medium, displayed on the computer system 11 or another computer system, or forwarded to another computer system. As the system operates, information regarding event occurrences is collected, and the information can be viewed by the operator at any time, including real time. Examples of formats for receiving the information include: a display on a monitor of a computer system; a hard copy; a computer-readable medium; and an interactive web page.

[123] The output can include a display from the direct feed of the source video from block 41. For example, the source video can be displayed on a window of the monitor of a computer system or on a closed-circuit monitor. Further, the output can include source video marked up with graphics to highlight the objects and/or areas involved in the event occurrence.

15 [124] The output can include one or more reports for an operator based on the requirements of the operator and/or the event occurrences. Examples of a report include: the number of event occurrences which occurred; the positions in the scene in which the event occurrence occurred; the times at which the event occurrences occurred; representative imagery of each event occurrence; representative video of each event occurrence; raw statistical data;  
20 statistics of event occurrences (e.g., how many, how often, where, and when); and/or human-readable graphical displays.

[125] Figures 13 and 14 illustrate an exemplary report for the aisle in the grocery store of Figure 15. In Figures 13 and 14, several areas are identified in block 22 and are labeled



accordingly in the images. The areas in Figure 13 match those in Figure 12, and the areas in Figure 14 are different ones. The system is tasked to look for people who stop in the area.

[126] In Figure 13, the exemplary report is an image from a video marked-up to include labels, graphics, statistical information, and an analysis of the statistical information. For example, the area identified as coffee has statistical information of an average number of customers in the area of 2/hour and an average dwell time in the area as 5 seconds. The system determined this area to be a “cold” region, which means there is not much commercial activity through this region. As another example, the area identified as sodas has statistical information of an average number of customers in the area of 15/hour and an average dwell time in the area as 22 seconds. The system determined this area to be a “hot” region, which means there is a large amount of commercial activity in this region.

[127] In Figure 14, the exemplary report is an image from a video marked-up to include labels, graphics, statistical information, and an analysis of the statistical information. For example, the area at the back of the aisle has average number of customers of 14/hour and is determined to have low traffic. As another example, the area at the front of the aisle has average number of customers of 83/hour and is determined to have high traffic.

[128] For either Figure 13 or Figure 14, if the operator desires more information about any particular area or any particular area, a point-and-click interface allows the operator to navigate through representative still and video imagery of regions and/or activities that the system has detected and archived.

[129] Figure 15 illustrates another exemplary report for an aisle in a grocery store. The exemplary report includes an image from a video marked-up to include labels and trajectory indications and text describing the marked-up image. The system of the example is tasked with

searching for a number of areas: length, position, and time of a trajectory of an object; time and location an object was immobile; correlation of trajectories with areas, as specified by the operator; and classification of an object as not a person, one person, two people, and three or more people.

5 [130] The video image of Figure 15 is from a time period where the trajectories were recorded. Of the three objects, two objects are each classified as one person, and one object is classified as not a person. Each object is assigned a label, namely Person ID 1032, Person ID 1033, and Object ID 32001. For Person ID 1032, the system determined the person spent 52 seconds in the area and 18 seconds at the position designated by the circle. For Person ID 1033, the system determined the person spent 1 minute and 8 seconds in the area and 12 seconds at the position designated by the circle. The trajectories for Person ID 1032 and Person ID 1033 are included in the marked-up image. For Object ID 32001, the system did not further analyze the object and indicated the position of the object with an X.

15 [131] Referring back to block 22 in Figure 2, calibration can be (1) manual, (2) semi-automatic using imagery from a video sensor or a video recorder, or (3) automatic using imagery from a video sensor or a video recorder. If imagery is required, it is assumed that the source video to be analyzed by the computer system 11 is from a video sensor that obtained the source video used for calibration.

20 [132] For manual calibration, the operator provides to the computer system 11 the orientation and internal parameters for each of the video sensors 14 and the placement of each video sensor 14 with respect to the location. The computer system 11 can optionally maintain a map of the location, and the placement of the video sensors 14 can be indicated on the map. The map can be a two-dimensional or a three-dimensional representation of the environment. In

addition, the manual calibration provides the system with sufficient information to determine the approximate size and relative position of an object.

[133] Alternatively, for manual calibration, the operator can mark up a video image from the sensor with a graphic representing the appearance of a known-sized object, such as a person. If the operator can mark up an image in at least two different locations, the system can  
5 infer approximate camera calibration information.

[134] For semi-automatic and automatic calibration, no knowledge of the camera parameters or scene geometry is required. From semi-automatic and automatic calibration, a lookup table is generated to approximate the size of an object at various areas in the scene, or the internal and external camera calibration parameters of the camera are inferred.

[135] For semi-automatic calibration, the video surveillance system is calibrated using a video source combined with input from the operator. A single person is placed in the field of view of the video sensor to be semi-automatic calibrated. The computer system 11 receives source video regarding the single person and automatically infers the size of person based on this data. As the number of locations in the field of view of the video sensor that the person is viewed is increased, and as the period of time that the person is viewed in the field of view of the video sensor is increased, the accuracy of the semi-automatic calibration is increased.

[136] Figure 7 illustrates a flow diagram for semi-automatic calibration of the video surveillance system. Block 71 is the same as block 41, except that a typical object moves  
20 through the scene at various trajectories. The typical object can have various velocities and be stationary at various positions. For example, the typical object moves as close to the video sensor as possible and then moves as far away from the video sensor as possible. This motion by the typical object can be repeated as necessary.

[137] Blocks 72-25 are the same as blocks 51-54, respectively.

[138] In block 76, the typical object is monitored throughout the scene. It is assumed that the only (or at least the most) stable object being tracked is the calibration object in the scene (i.e., the typical object moving through the scene). The size of the stable object is collected for every point in the scene at which it is observed, and this information is used to generate calibration information.

[139] In block 77, the size of the typical object is identified for different areas throughout the scene. The size of the typical object is used to determine the approximate sizes of similar objects at various areas in the scene. With this information, a lookup table is generated matching typical apparent sizes of the typical object in various areas in the image, or internal and external camera calibration parameters are inferred. As a sample output, a display of stick-sized figures in various areas of the image indicate what the system determined as an appropriate height. Such a stick-sized figure is illustrated in Figure 11.

[140] For automatic calibration, a learning phase is conducted where the computer system 11 determines information regarding the location in the field of view of each video sensor. During automatic calibration, the computer system 11 receives source video of the location for a representative period of time (e.g., minutes, hours or days) that is sufficient to obtain a statistically significant sampling of objects typical to the scene and thus infer typical apparent sizes and locations.

[141] Figure 8 illustrates a flow diagram for automatic calibration of the video surveillance system. Blocks 81-86 are the same as blocks 71-76 in Figure 7.

[142] In block 87, trackable regions in the field of view of the video sensor are identified. A trackable region refers to a region in the field of view of a video sensor where an

object can be easily and/or accurately tracked. An untrackable region refers to a region in the field of view of a video sensor where an object is not easily and/or accurately tracked and/or is difficult to track. An untrackable region can be referred to as being an unstable or insalient region. An object may be difficult to track because the object is too small (e.g., smaller than a predetermined threshold), appear for too short of time (e.g., less than a predetermined threshold), or exhibit motion that is not salient (e.g., not purposeful). A trackable region can be identified using, for example, the techniques described in {13}.

[143] Figure 10 illustrates trackable regions determined for an aisle in a grocery store. The area at the far end of the aisle is determined to be insalient because too many confusers appear in this area. A confuser refers to something in a video that confuses a tracking scheme. Examples of a confuser include: leaves blowing; rain; a partially occluded object; and an object that appears for too short of time to be tracked accurately. In contrast, the area at the near end of the aisle is determined to be salient because good tracks are determined for this area.

[144] In block 88, the sizes of the objects are identified for different areas throughout the scene. The sizes of the objects are used to determine the approximate sizes of similar objects at various areas in the scene. A technique, such as using a histogram or a statistical median, is used to determine the typical apparent height and width of objects as a function of location in the scene. In one part of the image of the scene, typical objects can have a typical apparent height and width. With this information, a lookup table is generated matching typical apparent sizes of objects in various areas in the image, or the internal and external camera calibration parameters can be inferred.

[145] Figure 11 illustrates identifying typical sizes for typical objects in the aisle of the grocery store from Figure 10. Typical objects are assumed to be people and are identified by a

label accordingly. Typical sizes of people are determined through plots of the average height and average width for the people detected in the salient region. In the example, plot A is determined for the average height of an average person, and plot B is determined for the average width for one person, two people, and three people.

5 [146] For plot A, the x-axis depicts the height of the blob in pixels, and the y-axis depicts the number of instances of a particular height, as identified on the x-axis, that occur. The peak of the line for plot A corresponds to the most common height of blobs in the designated region in the scene and, for this example, the peak corresponds to the average height of a person standing in the designated region.

[147] Assuming people travel in loosely knit groups, a similar graph to plot A is generated for width as plot B. For plot B, the x-axis depicts the width of the blobs in pixels, and the y-axis depicts the number of instances of a particular width, as identified on the x-axis, that occur. The peaks of the line for plot B correspond to the average width of a number of blobs. Assuming most groups contain only one person, the largest peak corresponds to the most  
15 common width, which corresponds to the average width of a single person in the designated region. Similarly, the second largest peak corresponds to the average width of two people in the designated region, and the third largest peak corresponds to the average width of three people in the designated region.

[148] Figure 9 illustrates an additional flow diagram for the video surveillance system  
20 of the invention. In this additional embodiment, the system analyses archived video primitives with event discriminators to generate additional reports, for example, without needing to review the entire source video. Anytime after a video source has been processed according to the invention, video primitives for the source video are archived in block 43 of Figure 4. The video

content can be reanalyzed with the additional embodiment in a relatively short time because only the video primitives are reviewed and because the video source is not reprocessed. This provides a great efficiency improvement over current state-of-the-art systems because processing video imagery data is extremely computationally expensive, whereas analyzing the small-sized video primitives abstracted from the video is extremely computationally cheap. As an example, the following event discriminator can be generated: “The number of people stopping for more than 10 minutes in area A in the last two months.” With the additional embodiment, the last two months of source video does not need to be reviewed. Instead, only the video primitives from the last two months need to be reviewed, which is a significantly more efficient process.

[149] Block 91 is the same as block 23 in Figure 2.

[150] In block 92, archived video primitives are accessed. The video primitives are archived in block 43 of Figure 4.

[151] Blocks 93 and 94 are the same as blocks 44 and 45 in Figure 4.

[152] As an exemplary application, the invention can be used to analyze retail market space by measuring the efficacy of a retail display. Large sums of money are injected into retail displays in an effort to be as eye-catching as possible to promote sales of both the items on display and subsidiary items. The video surveillance system of the invention can be configured to measure the effectiveness of these retail displays.

[153] For this exemplary application, the video surveillance system is set up by orienting the field of view of a video sensor towards the space around the desired retail display. During tasking, the operator selects an area representing the space around the desired retail display. As a discriminator, the operator defines that he or she wishes to monitor people-sized

objects that enter the area and either exhibit a measurable reduction in velocity or stop for an appreciable amount of time.

[154] After operating for some period of time, the video surveillance system can provide reports for market analysis. The reports can include: the number of people who slowed  
5 down around the retail display; the number of people who stopped at the retail display; the breakdown of people who were interested in the retail display as a function of time, such as how many were interested on weekends and how many were interested in evenings; and video snapshots of the people who showed interest in the retail display. The market research information obtained from the video surveillance system can be combined with sales information from the store and customer records from the store to improve the analysts understanding of the efficacy of the retail display.

[155] The embodiments and examples discussed herein are non-limiting examples.

[156] The invention is described in detail with respect to preferred embodiments, and it will now be apparent from the foregoing to those skilled in the art that changes and modifications  
15 may be made without departing from the invention in its broader aspects, and the invention, therefore, as defined in the claims is intended to cover all such changes and modifications as fall within the true spirit of the invention.



**CLAIMS**

What is claimed is:

1. A computer-readable medium comprising software for a video surveillance system, comprising code segments for operating the video surveillance system based on video primitives.

5

2. A computer-readable medium as in claim 1, wherein the code segments for operating the video surveillance system comprise:

code segments for extracting video primitives; and

code segments for extracting event occurrences from the video primitives.

3. A computer-readable medium as in claim 2, wherein the event occurrences are extracted using event discriminators.

4. A computer-readable medium as in claim 2, further comprising code segments for archiving the extracted video primitives.

15

5. A computer-readable medium as in claim 2, further comprising code segments for undertaking a response based on extracted event occurrences.

6. A computer-readable medium as in claim 5, wherein the response comprises initiating another sensor system.

20

7. A computer-readable medium as in claim 1, further comprising code segments for calibrating the video surveillance system.

8. A computer-readable medium as in claim 7, wherein the code segments for calibrating  
5 comprise code segments for self-calibrating the video surveillance system.

9. A computer-readable medium as in claim 8, wherein the code segments for self-calibrating comprise:

code segments for detecting as least one object in a source video; and  
code segments for tracking the object.

10. A computer-readable medium as in claim 9, wherein the code segments for detecting at least one object comprise:

code segments for detecting at least one object via motion of the object; and  
15 code segments for detecting at least one object via change in a background model.

11. A computer-readable medium as in claim 7, wherein the code segments for self-calibrating comprise:

code segments for identifying trackable areas; and  
20 code segments for identifying typical sizes of typical objects.

12. A computer-readable medium as in claim 7, wherein the code segments for calibrating comprise:

code segments for manual calibration;  
code segments for semi-automatic calibration; and  
code segments for automatic calibration.

5           13. A computer-readable medium as in claim 1, further comprising code segments for  
tasking the video surveillance system with event discriminators.

14. A computer-readable medium as in claim 13, wherein the code segments for tasking  
comprise code segments for identifying at least one object.

15. A computer-readable medium as in claim 13, wherein the code segments for tasking  
comprise code segments for identifying at least one spatial area.

15           16. A computer-readable medium as in claim 13, wherein the code segments for tasking  
comprise code segments for identifying at least one temporal attribute.

17. A computer-readable medium as in claim 13, wherein the code segments for tasking  
identify at least one interaction.

20           18. A computer-readable medium as in claim 13, wherein the code segments for tasking  
identify at least one alarm.

19. A computer-readable medium as in claim 1, wherein the video primitives are from at least one of a video sensor and another sensor.

20. A computer-readable medium as in claim 1, wherein the video primitives are  
5 retrieved from an archive of video primitives.

21. A computer system comprising the computer-readable medium of claim 1.

22. A computer-readable medium comprising software for a video surveillance system,  
comprising:

code segments for accessing archived video primitives; and

code segments for extracting event occurrences from accessed archived video primitives.

23. A computer-readable medium as in claim 22, wherein the event occurrences are  
15 extracted using event discriminators.

24. A computer-readable medium as in claim 22, further comprising code segments for undertaking a response based on extracted event occurrences.

20 25. A method comprising the step of operating a video surveillance system based on video primitives.

26. A method comprising the steps of:

accessing archived video primitives; and

extracting event occurrences from accessed video primitives.

**ABSTRACT OF THE DISCLOSURE**

A video surveillance system is set up, calibrated, tasked, and operated. The system extracts video primitives and extracts event occurrences from the video primitives using event discriminators. The system can undertake a response, such as an alarm, based on extracted event  
5 occurrences.

1 of 7

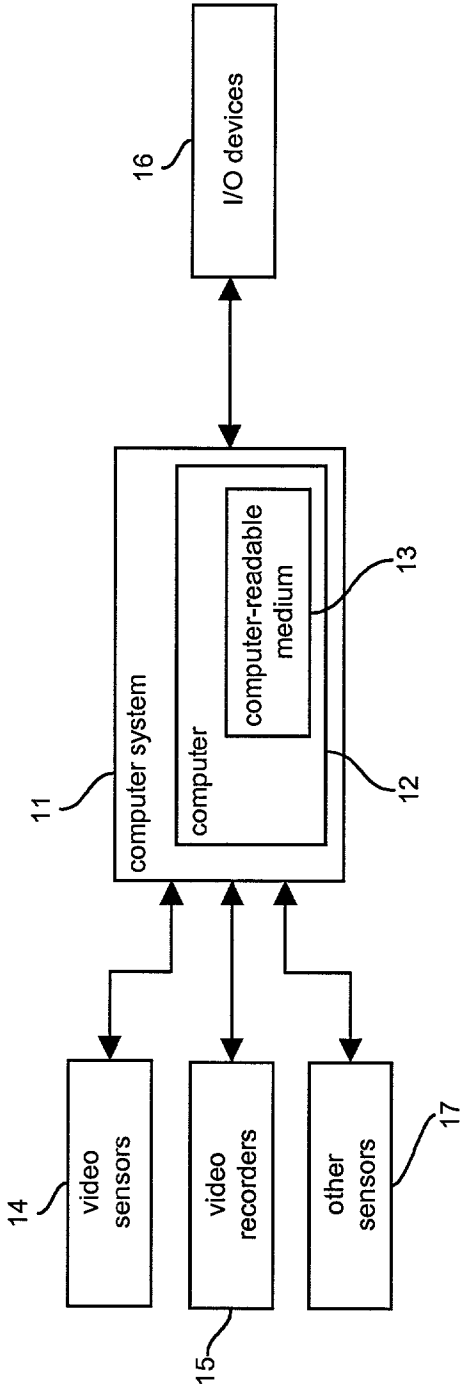

FIG. 1

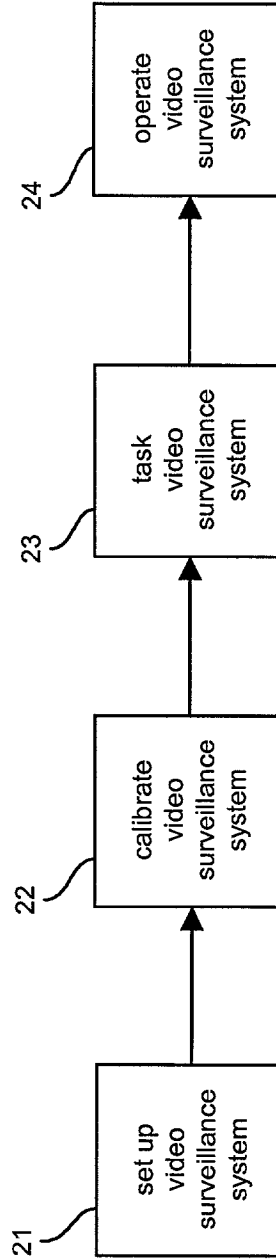

FIG. 2

2 of 7

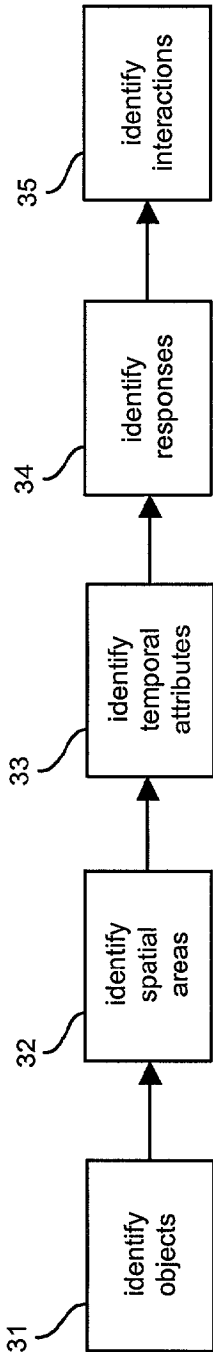

FIG. 3

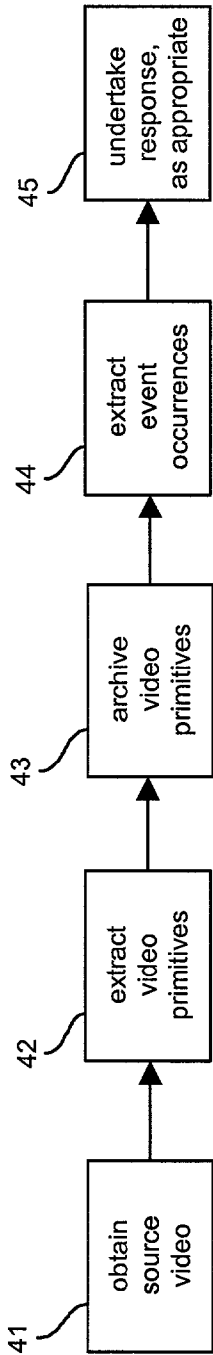

FIG. 4

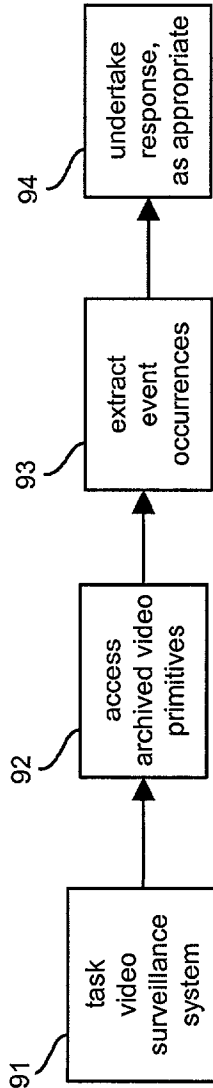

FIG. 9



3 of 7

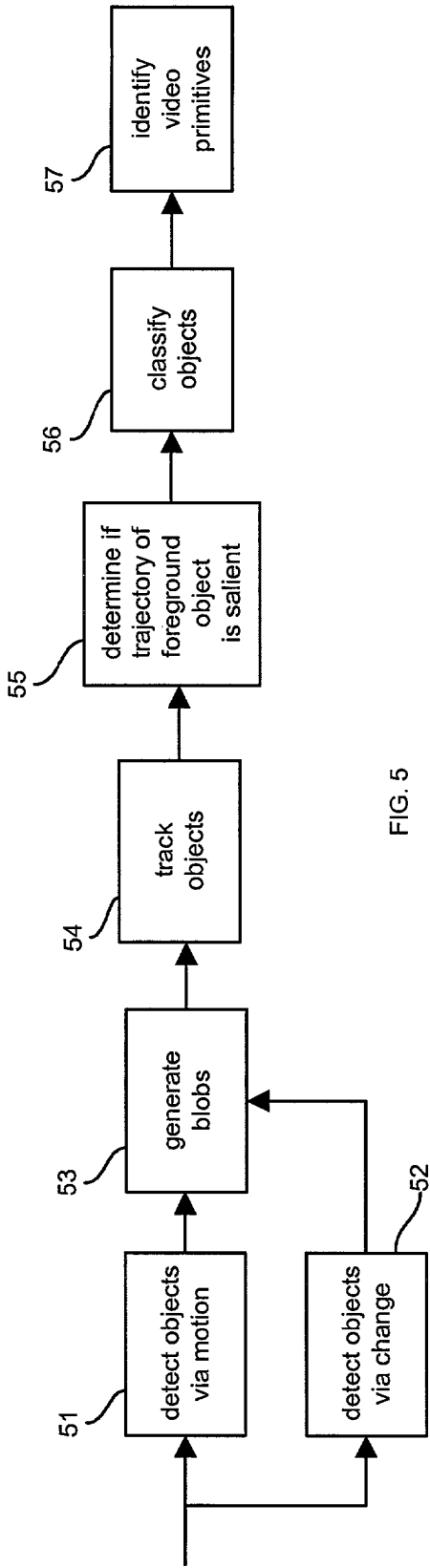

FIG. 5

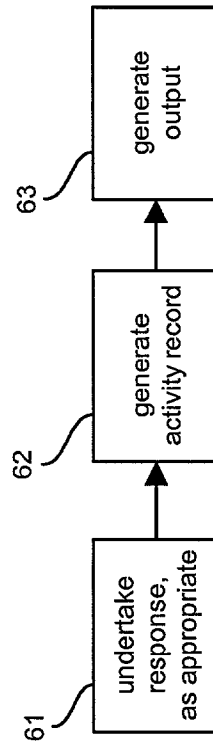

FIG. 6

4 of 7

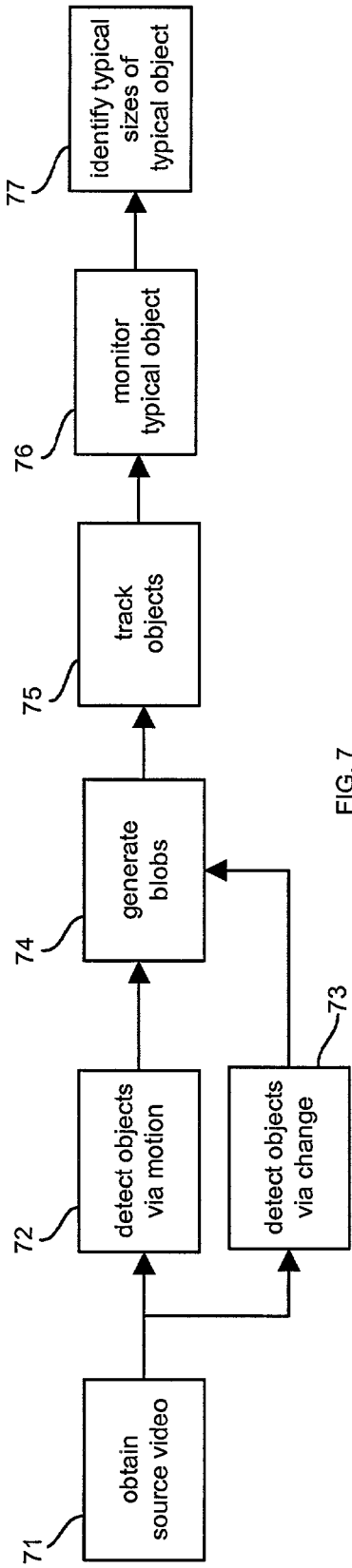

FIG. 7

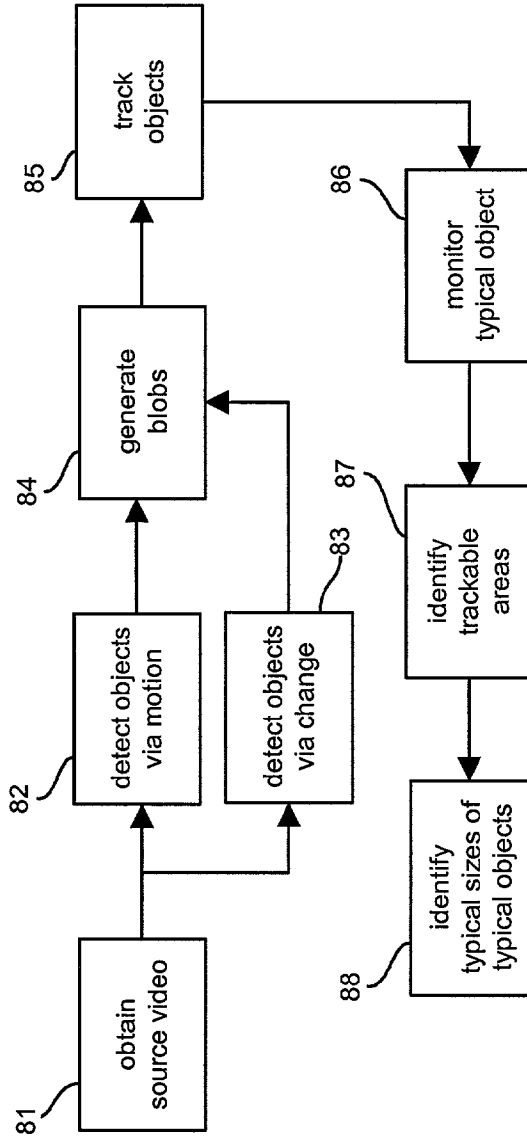
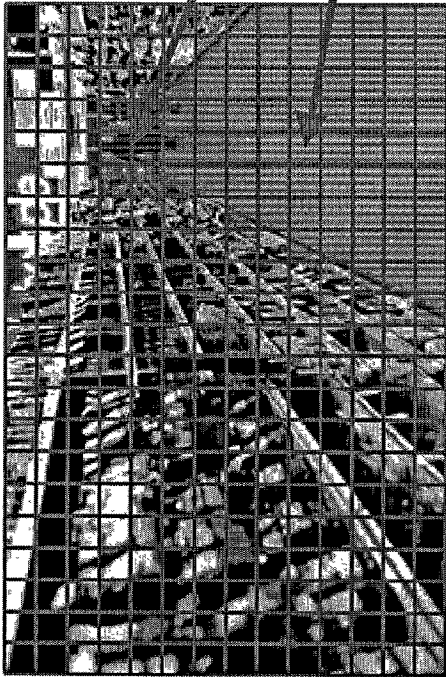

FIG. 8

5 of 7



Can't get reliable tracks in this region

This region is fair game for good tracks

FIG. 10

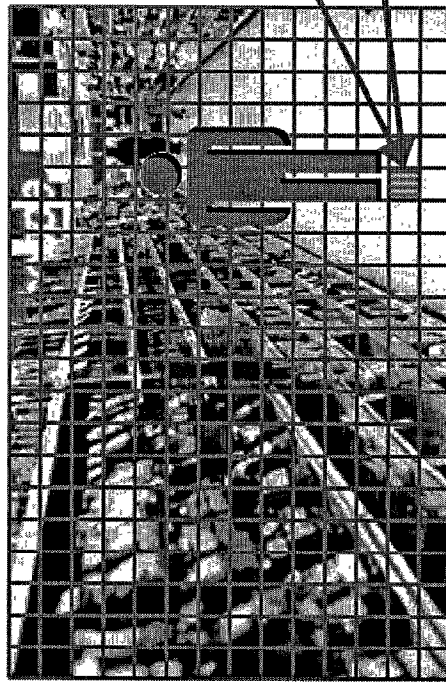
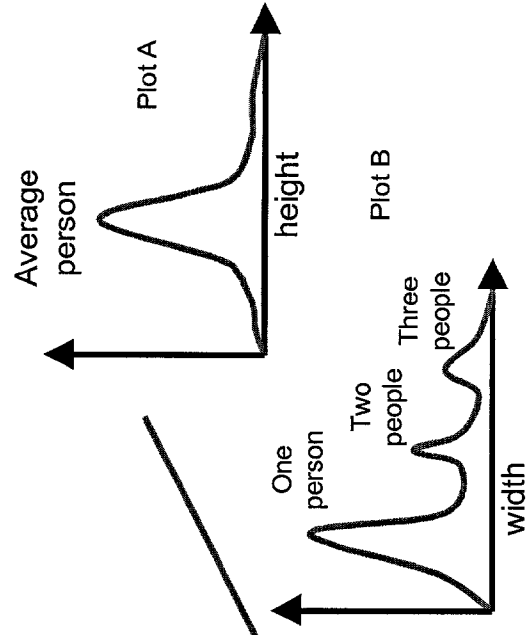

FIG. 11



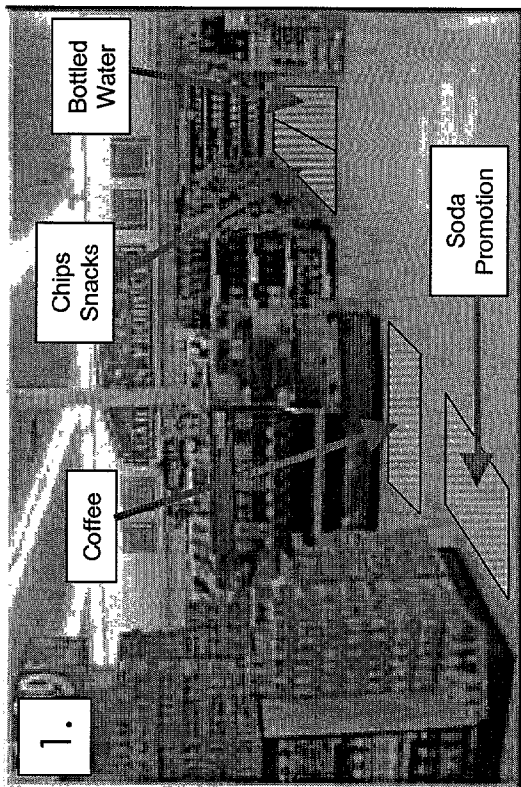

FIG. 12

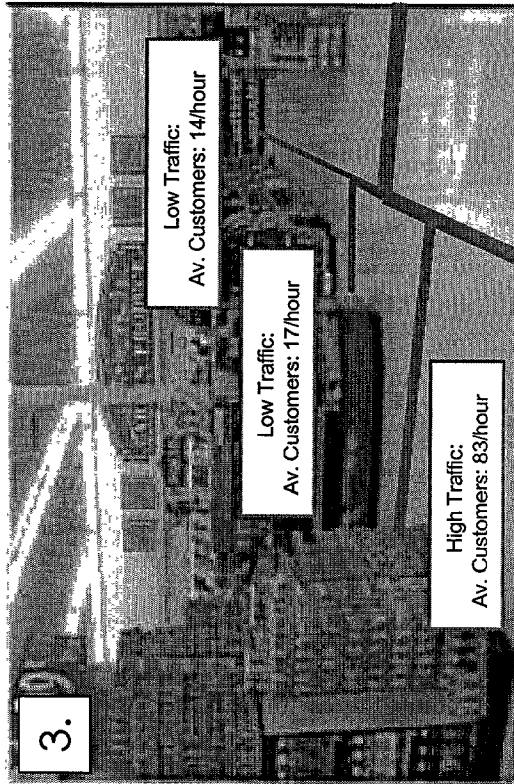

FIG. 14

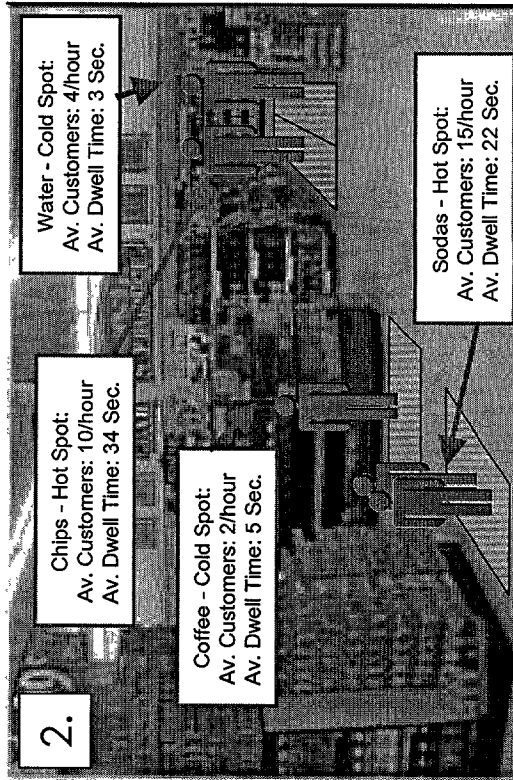
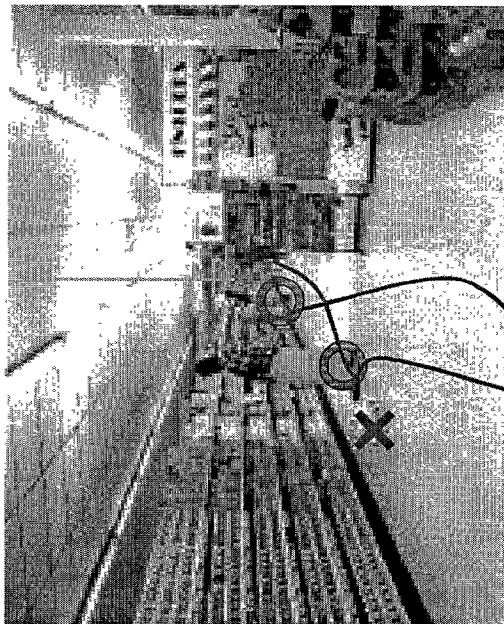
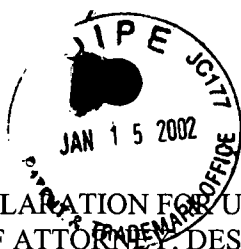

FIG. 13



- Person ID 1032:
  - Spent 52s in area
  - Spent 18s at point ○
- Person ID 1033:
  - Spent 1:08s in area
  - Spent 12s at point ○
- Object ID 32001:
  - Not a person

FIG. 15



3

DECLARATION FOR UNITED STATES PATENT APPLICATION  
 POWER OF ATTORNEY, DESIGNATION OF CORRESPONDENCE ADDRESS

Attorney Docket  
**37112-175340**

Page 1 of 3

As a below named inventor, I hereby declare that my residence, post office address and citizenship are as stated below next to my name, and that I believe I am the original, first and sole inventor (if only one name is listed below) or an original, first and joint inventor (if plural names are listed below) of the subject matter which is claimed and for which a patent is sought on the invention entitled VIDEO SURVEILLANCE SYSTEM EMPLOYING VIDEO PRIMITIVES, the specification of which

is attached hereto.

was filed on November 15, 2001, as Application Serial No. \_\_\_\_\_, and was amended on \_\_\_\_\_ [if applicable].

was filed under the Patent Cooperation Treaty on \_\_\_\_\_ Serial No. \_\_\_\_\_ the United States of America being designated, and was amended on \_\_\_\_\_ [if applicable].

I hereby state that I have reviewed and understand the contents of the above identified specification, including the claims, as amended by any amendment referred to above.

I acknowledge the duty to disclose to the Patent and Trademark Office all information known to me to be material to patentability as defined in Title 37, Code of Federal Regulations, 1.56.

I HEREBY CLAIM foreign priority benefits under Title 35, United States Code §119(a)-(d) of §365(b) of any foreign application(s) for patent or inventor's certificate, or §365(a) of any PCT international application which designated at least one country other than the United States of America, listed below and have also identified below any foreign application for patent or inventor's certificate or of any PCT international application having a filing date before that of the application on which priority is claimed.

Prior Foreign Application Number	Country	Foreign Filing Date	Priority Claimed

I HEREBY CLAIM the benefit under Title 35, United States Code §119(e) of any United States provisional application(s) listed below.

U.S. Provisional Application Number	Filing Date

I HEREBY CLAIM the benefit under Title 35, United States Code, §120 of any United States application(s), or §365(c) of any PCT International application designating the United States of America, listed below and, insofar as the subject matter of each of the claims of this application is not disclosed in the prior United States or PCT International application in the manner provided by the first paragraph of Title 35, United States Code §112, I acknowledge the duty to disclose information which is material to patentability as defined in Title 37, Code of Federal Regulations, §1.56 which became available between the filing date of the prior application and the national or PCT International filing date of this application.

U.S. Patent Application Number	PCT Patent Application Number	Patent Filing Date	Parent Patent Number
09/694,712		October 24, 2000	



DECLARATION FOR UNITED STATES PATENT APPLICATION  
POWER OF ATTORNEY, DESIGNATION OF CORRESPONDENCE ADDRESS

I hereby appoint the registered attorneys and agents of VENABLE associated with the following customer number to prosecute this application and to transact all business in the Patent and Trademark Office connected therewith:



26694

PATENT TRADEMARK OFFICE

VENABLE is located at Suite 1000, 1201 New York Avenue, N.W., Washington, D.C. 20005-3917, Telephone: (202) 962-4800, Telefax: (202) 962-8300. Address all correspondence to VENABLE, Post Office Box 34385, Washington, D.C. 20043-9998.

The undersigned hereby authorizes the registered U.S. attorneys and agents identified herein to accept and follow instructions from the undersigned's assignee, if any, and/or, if the undersigned is not a resident of the United States, the undersigned's domestic attorney, patent attorney or patent agent, as to any action to be taken in the Patent and Trademark Office regarding this application without direct communication between U.S. attorneys and the undersigned. In the event of a change in the person(s) from whom instructions may be taken, the registered U.S. attorneys and agents identified herein will be so notified by the undersigned.

I hereby declare that all statements made herein of my own knowledge are true and that all statements made on information and belief are believed to be true; and further that these statements were made with the knowledge that willful false statements and the like so made are punishable by fine or imprisonment, or both, under 1001 of Title 18 of the United States Code and that such willful false statements may jeopardize the validity of the application or any patent issued thereon.

Signature: [Signature]  
First/Sole Inventor: Alan J. LIPTON  
Citizenship: AUSTRALIAN  
Residence and Post Office Address: 2022 PEACH ORCHARD BR #34  
FALLS CHURCH, VA, 22043

Date: 5, Dec, 2001.

Signature: [Signature]  
Second Inventor: Thomas M. STRAT  
Citizenship: USA  
Residence and Post Office Address: 3227 Fox Vale Dr  
Parkton, VA 22124

Date: 5 Dec, 2001.

Signature: [Signature]  
Third Inventor: Peter L. VENETIANER  
Citizenship: Hungary  
Residence and Post Office Address: 6623 Ivy Hill Dr  
McLean, VA 22101

Date: Dec 5, 2001.

Signature: [Signature]  
Fourth Inventor: Mark C. ALLMEN  
Citizenship: USA  
Residence and Post Office Address: 6333 Starlight Dr  
Morrison, CO 80465

Date: Dec 17, 2001.

DECLARATION FOR UNITED STATES PATENT APPLICATION  
POWER OF ATTORNEY, DESIGNATION OF CORRESPONDENCE ADDRESS

Signature: William E. Severson  
Fifth Inventor: William E. SEVERSON  
Citizenship: US  
Residence and Post Office Address: 8085 SOUTH FRANKLIN COURT  
LITTLETON CO 80112

Date: Dec 11, 2001.

Signature: Niels Haering  
Sixth Inventor: Niels HAERING  
Citizenship: GERMAN  
Residence and Post Office Address: 911 N. BARTON ST.  
ARLINGTON, VA 22201

Date: Dec 11, 2001.

Signature: Andrew J. Chosak  
Seventh Inventor: Andrew J. CHOSAK  
Citizenship: US  
Residence and Post Office Address: 1581 Spring Gate Dr #5309  
McLean VA 22102

Date: 12/5, 2001.

Signature: Zhong Zhang  
Eight Inventor: Zhong ZHANG  
Citizenship: P. R. China  
Residence and Post Office Address: 1122 Clinch Rd.  
Herndon, VA 20170

Date: 12/5, 2001.

Signature: Matthew F. Frazier  
Ninth Inventor: Matthew F. FRAZIER  
Citizenship: US  
Residence and Post Office Address: 2500 Clamton Blvd Apt 712  
Arlington, VA 22201

Date: 5-12, 2001.

Signature: James S. Seekas  
Tenth Inventor: James S. SEEKAS  
Citizenship: USA  
Residence and Post Office Address: 1211 S. Eads St. #1202  
Arlington, VA 22202

Date: 12-5, 2001.

Signature: Tasuki Hirata  
Eleventh Inventor: Tasuki HIRATA  
Citizenship: Japan  
Residence and Post Office Address: 14409 Busingsfoke Lane  
Silver Spring, MD 20905

Date: 12/05, 2001.

Signature: John Clark  
Twelfth Inventor: John CLARK  
Citizenship: CANADIAN  
Residence and Post Office Address: 18604 COLSTON CT  
LEESBURG VA 20176

Date: 12/05, 2001.



## Electronic Patent Application Fee Transmittal

<b>Application Number:</b>				
<b>Filing Date:</b>				
<b>Title of Invention:</b>	Video Surveillance System Employing Video Primitives			
<b>First Named Inventor/Applicant Name:</b>	Alan J. Lipton			
<b>Filer:</b>	Patrick Daniel Muir/Melissa McGinn			
<b>Attorney Docket Number:</b>	OV-101			
Filed as Small Entity				
<b>Utility under 35 USC 111(a) Filing Fees</b>				
<b>Description</b>	<b>Fee Code</b>	<b>Quantity</b>	<b>Amount</b>	<b>Sub-Total in USD(\$)</b>
<b>Basic Filing:</b>				
Utility filing Fee (Electronic filing)	4011	1	82	82
Utility Search Fee	2111	1	270	270
Utility Examination Fee	2311	1	110	110
<b>Pages:</b>				
<b>Claims:</b>				
Claims in excess of 20	2202	6	26	156
Independent claims in excess of 3	2201	1	110	110
<b>Miscellaneous-Filing:</b>				

Description	Fee Code	Quantity	Amount	Sub-Total in USD(\$)
<b>Petition:</b>				
<b>Patent-Appeals-and-Interference:</b>				
<b>Post-Allowance-and-Post-Issuance:</b>				
<b>Extension-of-Time:</b>				
<b>Miscellaneous:</b>				
			<b>Total in USD (\$)</b>	<b>728</b>

## Electronic Acknowledgement Receipt

<b>EFS ID:</b>	6166428
<b>Application Number:</b>	12569116
<b>International Application Number:</b>	
<b>Confirmation Number:</b>	7686
<b>Title of Invention:</b>	Video Surveillance System Employing Video Primitives
<b>First Named Inventor/Applicant Name:</b>	Alan J. Lipton
<b>Customer Number:</b>	74712
<b>Filer:</b>	Patrick Daniel Muir/Melissa McGinn
<b>Filer Authorized By:</b>	Patrick Daniel Muir
<b>Attorney Docket Number:</b>	OV-101
<b>Receipt Date:</b>	29-SEP-2009
<b>Filing Date:</b>	
<b>Time Stamp:</b>	14:55:48
<b>Application Type:</b>	Utility under 35 USC 111(a)

### Payment information:

Submitted with Payment	yes
Payment Type	Deposit Account
Payment was successfully received in RAM	\$728
RAM confirmation Number	1291
Deposit Account	504574
Authorized User	

### File Listing:

Document Number	Document Description	File Name	File Size(Bytes)/ Message Digest	Multi Part (.zip)	Pages (if appl.)
-----------------	----------------------	-----------	-------------------------------------	-------------------	------------------

1	Transmittal of New Application	app_transmittal.pdf	398154 1e8ee848e4cdf25aac41cfaa2bdeed7406108f002	no	1
<b>Warnings:</b>					
<b>Information:</b>					
2		OV_101_application.pdf	3719517 5a772e57e1a518d1b54db85ed1c71d7ec26a4191	yes	43
	<b>Multipart Description/PDF files in .zip description</b>				
	<b>Document Description</b>		<b>Start</b>	<b>End</b>	
	Specification		1	30	
	Claims		31	35	
	Abstract		36	36	
	Drawings-only black and white line drawings		37	43	
<b>Warnings:</b>					
<b>Information:</b>					
3	Oath or Declaration filed	declaration.pdf	165389 cd4c8825f09dc97a00334fe55e9d7c97c7acc8c	no	3
<b>Warnings:</b>					
<b>Information:</b>					
4	Fee Worksheet (PTO-875)	fee-info.pdf	37892 32fef6027b774d2b62668cfaa79f973446206b4e	no	2
<b>Warnings:</b>					
<b>Information:</b>					
<b>Total Files Size (in bytes):</b>			4320952		

**This Acknowledgement Receipt evidences receipt on the noted date by the USPTO of the indicated documents, characterized by the applicant, and including page counts, where applicable. It serves as evidence of receipt similar to a Post Card, as described in MPEP 503.**

**New Applications Under 35 U.S.C. 111**

**If a new application is being filed and the application includes the necessary components for a filing date (see 37 CFR 1.53(b)-(d) and MPEP 506), a Filing Receipt (37 CFR 1.54) will be issued in due course and the date shown on this Acknowledgement Receipt will establish the filing date of the application.**

**National Stage of an International Application under 35 U.S.C. 371**

**If a timely submission to enter the national stage of an international application is compliant with the conditions of 35 U.S.C. 371 and other applicable requirements a Form PCT/DO/EO/903 indicating acceptance of the application as a national stage submission under 35 U.S.C. 371 will be issued in addition to the Filing Receipt, in due course.**

**New International Application Filed with the USPTO as a Receiving Office**

**If a new international application is being filed and the international application includes the necessary components for an international filing date (see PCT Article 11 and MPEP 1810), a Notification of the International Application Number and of the International Filing Date (Form PCT/RO/105) will be issued in due course, subject to prescriptions concerning national security, and the date shown on this Acknowledgement Receipt will establish the international filing date of the application.**

## Electronic Acknowledgement Receipt

<b>EFS ID:</b>	6166428
<b>Application Number:</b>	12569116
<b>International Application Number:</b>	
<b>Confirmation Number:</b>	7686
<b>Title of Invention:</b>	Video Surveillance System Employing Video Primitives
<b>First Named Inventor/Applicant Name:</b>	Alan J. Lipton
<b>Customer Number:</b>	74712
<b>Filer:</b>	Patrick Daniel Muir/Melissa McGinn
<b>Filer Authorized By:</b>	Patrick Daniel Muir
<b>Attorney Docket Number:</b>	OV-101
<b>Receipt Date:</b>	29-SEP-2009
<b>Filing Date:</b>	
<b>Time Stamp:</b>	14:55:48
<b>Application Type:</b>	Utility under 35 USC 111(a)

### Payment information:

Submitted with Payment	yes
Payment Type	Deposit Account
Payment was successfully received in RAM	\$728
RAM confirmation Number	1291
Deposit Account	504574
Authorized User	

### File Listing:

Document Number	Document Description	File Name	File Size(Bytes)/ Message Digest	Multi Part (.zip)	Pages (if appl.)
-----------------	----------------------	-----------	-------------------------------------	-------------------	------------------

1	Transmittal of New Application	app_transmittal.pdf	398154 1e8ee848e4cdf25aac41cfaa2bded7406108f002	no	1
<b>Warnings:</b>					
<b>Information:</b>					
2		OV_101_application.pdf	3719517 5a772e57e1a518d1b54db85ed1c71d7ec26a4191	yes	43
	<b>Multipart Description/PDF files in .zip description</b>				
	<b>Document Description</b>		<b>Start</b>	<b>End</b>	
	Specification		1	30	
	Claims		31	35	
	Abstract		36	36	
	Drawings-only black and white line drawings		37	43	
<b>Warnings:</b>					
<b>Information:</b>					
3	Oath or Declaration filed	declaration.pdf	165389 cd4c8825f09dc97a00334fe55e9d7c97c7acc8c	no	3
<b>Warnings:</b>					
<b>Information:</b>					
4	Fee Worksheet (PTO-875)	fee-info.pdf	37892 32fef6027b774d2b62668cfaa79f973446206b4e	no	2
<b>Warnings:</b>					
<b>Information:</b>					
<b>Total Files Size (in bytes):</b>			4320952		

**This Acknowledgement Receipt evidences receipt on the noted date by the USPTO of the indicated documents, characterized by the applicant, and including page counts, where applicable. It serves as evidence of receipt similar to a Post Card, as described in MPEP 503.**

**New Applications Under 35 U.S.C. 111**

**If a new application is being filed and the application includes the necessary components for a filing date (see 37 CFR 1.53(b)-(d) and MPEP 506), a Filing Receipt (37 CFR 1.54) will be issued in due course and the date shown on this Acknowledgement Receipt will establish the filing date of the application.**

**National Stage of an International Application under 35 U.S.C. 371**

**If a timely submission to enter the national stage of an international application is compliant with the conditions of 35 U.S.C. 371 and other applicable requirements a Form PCT/DO/EO/903 indicating acceptance of the application as a national stage submission under 35 U.S.C. 371 will be issued in addition to the Filing Receipt, in due course.**

**New International Application Filed with the USPTO as a Receiving Office**

**If a new international application is being filed and the international application includes the necessary components for an international filing date (see PCT Article 11 and MPEP 1810), a Notification of the International Application Number and of the International Filing Date (Form PCT/RO/105) will be issued in due course, subject to prescriptions concerning national security, and the date shown on this Acknowledgement Receipt will establish the international filing date of the application.**



Filing Date: 09/29/09

Approved for use through 7/31/2006. OMB 0651-0032  
U.S. Patent and Trademark Office; U.S. DEPARTMENT OF COMMERCE

Under the Paperwork Reduction Act of 1995, no persons are required to respond to a collection of information unless it displays a valid OMB control number.

PATENT APPLICATION FEE DETERMINATION RECORD Substitute for Form PTO-875					Application or Docket Number <b>12/569,116</b>					
<b>APPLICATION AS FILED – PART I</b> (Column 1) (Column 2)					<b>SMALL ENTITY</b>		OR	<b>OTHER THAN SMALL ENTITY</b>		
	FOR	NUMBER FILED	NUMBER EXTRA		RATE (\$)	FEE (\$)		RATE (\$)	FEE (\$)	
	BASIC FEE (37 CFR 1.16(a), (b), or (c))	N/A	N/A		N/A	<b>82</b>		N/A		
	SEARCH FEE (37 CFR 1.16(k), (l), or (m))	N/A	N/A		N/A	<b>270</b>		N/A		
	EXAMINATION FEE (37 CFR 1.16(o), (p), or (q))	N/A	N/A		N/A	<b>110</b>		N/A		
	TOTAL CLAIMS (37 CFR 1.16(j))	<b>26</b>	minus 20 =	<b>6</b>	x\$26	<b>156</b>	OR	x\$52		
	INDEPENDENT CLAIMS (37 CFR 1.16(h))	<b>4</b>	minus 3 =	<b>* 1</b>	x\$110	<b>110</b>		x\$220		
	APPLICATION SIZE FEE (37 CFR 1.16(s))	If the specification and drawings exceed 100 sheets of paper, the application size fee due is \$270 (\$135 for small entity) for each additional 50 sheets or fraction thereof. See 35 U.S.C. 41(a)(1)(G) and 37 CFR								
	MULTIPLE DEPENDENT CLAIM PRESENT (37 CFR 1.16(j))				195			390		
					<b>TOTAL</b>	<b>728</b>		<b>TOTAL</b>		
* If the difference in column 1 is less than zero, enter "0" in column 2.										
<b>APPLICATION AS AMENDED – PART II</b> (Column 1) (Column 2) (Column 3)					<b>SMALL ENTITY</b>		OR	<b>OTHER THAN SMALL ENTITY</b>		
AMENDMENT A		CLAIMS REMAINING AFTER AMENDMENT		HIGHEST NUMBER PREVIOUSLY PAID FOR	PRESENT EXTRA	RATE (\$)	ADDITIONAL FEE (\$)		RATE (\$)	ADDITIONAL FEE (\$)
	Total (37 CFR 1.16(i))	*	Minus	**	=	X	=	OR	X	=
	Independent (37 CFR 1.16(h))	*	Minus	***	=	X	=	OR	X	=
	Application Size Fee (37 CFR 1.16(s))							OR		
	FIRST PRESENTATION OF MULTIPLE DEPENDENT CLAIM (37 CFR 1.16(j))					N/A		OR	N/A	
					<b>TOTAL</b>	<b>ADD'T FEE</b>		<b>TOTAL</b>	<b>ADD'T FEE</b>	
					<b>SMALL ENTITY</b>		OR	<b>OTHER THAN SMALL ENTITY</b>		
AMENDMENT B		CLAIMS REMAINING AFTER AMENDMENT		HIGHEST NUMBER PREVIOUSLY PAID FOR	PRESENT EXTRA	RATE (\$)	ADDITIONAL FEE (\$)		RATE (\$)	ADDITIONAL FEE (\$)
	Total (37 CFR 1.16(i))	*	Minus	**	=	X	=	OR	X	=
	Independent (37 CFR 1.16(h))	*	Minus	***	=	X	=	OR	X	=
	Application Size Fee (37 CFR 1.16(s))							OR		
	FIRST PRESENTATION OF MULTIPLE DEPENDENT CLAIM (37 CFR 1.16(j))					N/A		OR	N/A	
					<b>TOTAL</b>	<b>ADD'T FEE</b>		<b>TOTAL</b>	<b>ADD'T FEE</b>	
<p>* If the entry in column 1 is less than the entry in column 2, write "0" in column 3.</p> <p>** If the "Highest Number Previously Paid For" IN THIS SPACE is less than 20, enter "20".</p> <p>*** If the "Highest Number Previously Paid For" IN THIS SPACE is less than 3, enter "3". The "Highest Number Previously Paid For" (Total or Independent) is the highest number found in the appropriate box in column 1.</p>										

This collection of information is required by 37 CFR 1.16. The information is required to obtain or retain a benefit by the public which is to file (and by the USPTO to process) an application. Confidentiality is governed by 35 U.S.C. 122 and 37 CFR 1.14. This collection is estimated to take 12 minutes to complete, including gathering, preparing, and submitting the completed application form to the USPTO. Time will vary depending upon the individual case. Any comments on the amount of time you require to complete this form and/or suggestions for reducing this burden, should be sent to the Chief Information Officer, U.S. Patent and Trademark Office, U.S. Department of Commerce, P.O. Box 1450, Alexandria, VA 22313-1450. DO NOT SEND FEES OR COMPLETED FORMS TO THIS ADDRESS. SEND TO: Commissioner for Patents, P.O. Box 1450, Alexandria, VA 22313-1450.

If you need assistance in completing the form, call 1-800-PTO-9199 and select option 2.