



UNITED STATES PATENT AND TRADEMARK OFFICE

UNITED STATES DEPARTMENT OF COMMERCE
United States Patent and Trademark Office
Address: COMMISSIONER FOR PATENTS
P. O. Box 1450
Alexandria, Virginia 22313-1450
www.uspto.gov

Table with 5 columns: APPLICATION NO., ISSUE DATE, PATENT NO., ATTORNEY DOCKET NO., CONFIRMATION NO.
Values: 09/876,515, 09/08/2009, 7587207, CA0419, 9201

3624 759 08/19/2009
VOLPE AND KOENIG, P.C.
UNITED PLAZA, SUITE 1600
30 SOUTH 17TH STREET
PHILADELPHIA, PA 19103

ISSUE NOTIFICATION

The projected patent number and issue date are specified above.

Determination of Patent Term Adjustment under 35 U.S.C. 154 (b)
(application filed on or after May 29, 2000)

The Patent Term Adjustment is 1859 day(s). Any patent to issue from the above-identified application will include an indication of the adjustment on the front page.

If a Continued Prosecution Application (CPA) was filed in the above-identified application, the filing date that determines Patent Term Adjustment is the filing date of the most recent CPA.

Applicant will be able to obtain more detailed information by accessing the Patent Application Information Retrieval (PAIR) WEB site (http://pair.uspto.gov).

Any questions regarding the Patent Term Extension or Adjustment determination should be directed to the Office of Patent Legal Administration at (571)-272-7702. Questions relating to issue and publication fee payments should be directed to the Customer Service Center of the Office of Patent Publication at (571)-272-4200.

APPLICANT(s) (Please see PAIR WEB site http://pair.uspto.gov for additional applicants):

Robert J. Davies, Horley, UNITED KINGDOM;
Saul R. Dooley, Reigate, UNITED KINGDOM;

**PART B - FEE(S) TRANSMITTAL**

Complete and send this form, together with applicable fee(s), to: **Mail** Mail Stop ISSUE FEE  
**Commissioner for Patents**  
**P.O. Box 1450**  
**Alexandria, Virginia 22313-1450**  
 or **Fax** (571)-273-2885

**INSTRUCTIONS:** This form should be used for transmitting the ISSUE FEE and PUBLICATION FEE (if required). Blocks 1 through 5 should be completed where appropriate. All further correspondence including the Patent, advance orders and notification of maintenance fees will be mailed to the current correspondence address as indicated unless corrected below or directed otherwise in Block 1, by (a) specifying a new correspondence address; and/or (b) indicating a separate "FEE ADDRESS" for maintenance fee notifications.

CURRENT CORRESPONDENCE ADDRESS (Note: Use Block 1 for any change of address)

Note: A certificate of mailing can only be used for domestic mailings of the Fee(s) Transmittal. This certificate cannot be used for any other accompanying papers. Each additional paper, such as an assignment or formal drawing, must have its own certificate of mailing or transmission.

3624 7590 04/29/2009

**VOLPE AND KOENIG, P.C.**  
**UNITED PLAZA, SUITE 1600**  
**30 SOUTH 17TH STREET**  
**PHILADELPHIA, PA 19103**

**Certificate of Mailing or Transmission**

I hereby certify that this Fee(s) Transmittal is being deposited with the United States Postal Service with sufficient postage for first class mail in an envelope addressed to the Mail Stop ISSUE FEE address above, or being facsimile transmitted to the USPTO (571) 273-2885, on the date indicated below.

|                           |                    |
|---------------------------|--------------------|
| Thomas A. Mattioli        | (Depositor's name) |
| <i>Thomas A. Mattioli</i> | (Signature)        |
| July 28, 2009             | (Date)             |

| APPLICATION NO. | FILING DATE | FIRST NAMED INVENTOR | ATTORNEY DOCKET NO. | CONFIRMATION NO. |
|-----------------|-------------|----------------------|---------------------|------------------|
| 09/876,515      | 06/07/2001  | Robert J. Davies     | CA0419              | 9201             |

TITLE OF INVENTION: DATA DELIVERY THROUGH BEACONS

| APPLN. TYPE    | SMALL ENTITY | ISSUE FEE DUE | PUBLICATION FEE DUE | PREV. PAID ISSUE FEE | TOTAL FEE(S) DUE | DATE DUE   |
|----------------|--------------|---------------|---------------------|----------------------|------------------|------------|
| nonprovisional | NO           | \$1510        | \$300               | \$0                  | \$1810           | 07/29/2009 |

| EXAMINER    | ART UNIT | CLASS-SUBCLASS |
|-------------|----------|----------------|
| LE, KAREN L | 2614     | 455-456100     |

1. Change of correspondence address or indication of "Fee Address" (37 CFR 1.363).
- Change of correspondence address (or Change of Correspondence Address form PTO/SB/122) attached.
  - "Fee Address" indication (or "Fee Address" Indication form PTO/SB/47; Rev 03-02 or more recent) attached. Use of a Customer Number is required.
2. For printing on the patent front page, list
- |                                                                                                                                                                                                  |                          |
|--------------------------------------------------------------------------------------------------------------------------------------------------------------------------------------------------|--------------------------|
| (1) the names of up to 3 registered patent attorneys or agents OR, alternatively,                                                                                                                | 1 Volpe and Koenig, P.C. |
| (2) the name of a single firm (having as a member a registered attorney or agent) and the names of up to 2 registered patent attorneys or agents. If no name is listed, no name will be printed. | 2 _____                  |
|                                                                                                                                                                                                  | 3 _____                  |

3. ASSIGNEE NAME AND RESIDENCE DATA TO BE PRINTED ON THE PATENT (print or type)

PLEASE NOTE: Unless an assignee is identified below, no assignee data will appear on the patent. If an assignee is identified below, the document has been filed for recordation as set forth in 37 CFR 3.11. Completion of this form is NOT a substitute for filing an assignment.

(A) NAME OF ASSIGNEE: **IPG Electronics 503 Limited**

(B) RESIDENCE: (CITY and STATE OR COUNTRY) **St. Peter Port, Guernsey**

Please check the appropriate assignee category or categories (will not be printed on the patent):  Individual  Corporation or other private group entity  Government

- 4a. The following fee(s) are submitted:
- Issue Fee
  - Publication Fee (No small entity discount permitted)
  - Advance Order - # of Copies \_\_\_\_\_
- 4b. Payment of Fee(s): (Please first reapply any previously paid issue fee shown above)
- A check is enclosed.
  - Payment by credit card. Form PTO-2038 is attached.
  - The Director is hereby authorized to charge the required fee(s), any deficiency, or credit any overpayment, to Deposit Account Number **22-0493** (enclose an extra copy of this form).

5. Change in Entity Status (from status indicated above)

- a. Applicant claims SMALL ENTITY status. See 37 CFR 1.27.
- b. Applicant is no longer claiming SMALL ENTITY status. See 37 CFR 1.27(g)(2).

NOTE: The Issue Fee and Publication Fee (if required) will not be accepted from anyone other than the applicant; a registered attorney or agent; or the assignee or other party in interest as shown by the records of the United States Patent and Trademark Office.

Authorized Signature *Thomas A. Mattioli* Date July 28, 2009

Typed or printed name Thomas A. Mattioli Registration No. 56,773

This collection of information is required by 37 CFR 1.311. The information is required to obtain or retain a benefit by the public which is to file (and by the USPTO to process) an application. Confidentiality is governed by 35 U.S.C. 122 and 37 CFR 1.14. This collection is estimated to take 12 minutes to complete, including gathering, preparing, and submitting the completed application form to the USPTO. Time will vary depending upon the individual case. Any comments on the amount of time you require to complete this form and/or suggestions for reducing this burden, should be sent to the Chief Information Officer, U.S. Patent and Trademark Office, U.S. Department of Commerce, P.O. Box 1450, Alexandria, Virginia 22313-1450. DO NOT SEND FEES OR COMPLETED FORMS TO THIS ADDRESS. SEND TO: Commissioner for Patents, P.O. Box 1450, Alexandria, Virginia 22313-1450.

Under the Paperwork Reduction Act of 1995, no persons are required to respond to a collection of information unless it displays a valid OMB control number.

## Electronic Patent Application Fee Transmittal

|                                             |                                 |
|---------------------------------------------|---------------------------------|
| <b>Application Number:</b>                  | 09876515                        |
| <b>Filing Date:</b>                         | 07-Jun-2001                     |
| <b>Title of Invention:</b>                  | DATA DELIVERY THROUGH BEACONS   |
| <b>First Named Inventor/Applicant Name:</b> | Robert J. Davies                |
| <b>Filer:</b>                               | Thomas A Mattioli/Yolanda Lopez |
| <b>Attorney Docket Number:</b>              | CA0419                          |

Filed as Large Entity

### Utility under 35 USC 111(a) Filing Fees

| Description                              | Fee Code | Quantity | Amount | Sub-Total in USD(\$) |
|------------------------------------------|----------|----------|--------|----------------------|
| <b>Basic Filing:</b>                     |          |          |        |                      |
| <b>Pages:</b>                            |          |          |        |                      |
| <b>Claims:</b>                           |          |          |        |                      |
| <b>Miscellaneous-Filing:</b>             |          |          |        |                      |
| Publ. Fee- early, voluntary, or normal   | 1504     | 1        | 300    | 300                  |
| <b>Petition:</b>                         |          |          |        |                      |
| <b>Patent-Appeals-and-Interference:</b>  |          |          |        |                      |
| <b>Post-Allowance-and-Post-Issuance:</b> |          |          |        |                      |
| Utility Appl issue fee                   | 1501     | 1        | 1510   | 1510                 |

| Description               | Fee Code | Quantity | Amount | Sub-Total in USD(\$) |
|---------------------------|----------|----------|--------|----------------------|
| <b>Extension-of-Time:</b> |          |          |        |                      |
| <b>Miscellaneous:</b>     |          |          |        |                      |
| <b>Total in USD (\$)</b>  |          |          |        | <b>1810</b>          |

## Electronic Acknowledgement Receipt

|                                             |                                 |
|---------------------------------------------|---------------------------------|
| <b>EFS ID:</b>                              | 5779976                         |
| <b>Application Number:</b>                  | 09876515                        |
| <b>International Application Number:</b>    |                                 |
| <b>Confirmation Number:</b>                 | 9201                            |
| <b>Title of Invention:</b>                  | DATA DELIVERY THROUGH BEACONS   |
| <b>First Named Inventor/Applicant Name:</b> | Robert J. Davies                |
| <b>Customer Number:</b>                     | 03624                           |
| <b>Filer:</b>                               | Thomas A Mattioli/Yolanda Lopez |
| <b>Filer Authorized By:</b>                 | Thomas A Mattioli               |
| <b>Attorney Docket Number:</b>              | CA0419                          |
| <b>Receipt Date:</b>                        | 28-JUL-2009                     |
| <b>Filing Date:</b>                         | 07-JUN-2001                     |
| <b>Time Stamp:</b>                          | 10:15:47                        |
| <b>Application Type:</b>                    | Utility under 35 USC 111(a)     |

### Payment information:

|                                          |                   |
|------------------------------------------|-------------------|
| Submitted with Payment                   | yes               |
| Payment Type                             | Credit Card       |
| Payment was successfully received in RAM | \$ 1810           |
| RAM confirmation Number                  | 7145              |
| Deposit Account                          | 220493            |
| Authorized User                          | MATTIOLI,THOMAS A |

The Director of the USPTO is hereby authorized to charge indicated fees and credit any overpayment as follows:  
Charge any Additional Fees required under 37 C.F.R. Section 1.17 (Patent application and reexamination processing fees)

**File Listing:**

| Document Number | Document Description        | File Name                                | File Size(Bytes)/ Message Digest                  | Multi Part /.zip | Pages (if appl.) |
|-----------------|-----------------------------|------------------------------------------|---------------------------------------------------|------------------|------------------|
| 1               | Issue Fee Payment (PTO-85B) | 20090728_CIPM_PH_CA0419_Form_PTOL_85.PDF | 28535<br>43b0aa9352b0b8202415e1d8a02b2a0a1a9bae5c | no               | 1                |

**Warnings:**

**Information:**

|   |                         |              |                                                 |    |   |
|---|-------------------------|--------------|-------------------------------------------------|----|---|
| 2 | Fee Worksheet (PTO-875) | fee-info.pdf | 32265<br>f377a4e9ab45faf7b170b1275f4ac4a1fe9d01 | no | 2 |
|---|-------------------------|--------------|-------------------------------------------------|----|---|

**Warnings:**

**Information:**

|                                     |       |
|-------------------------------------|-------|
| <b>Total Files Size (in bytes):</b> | 60800 |
|-------------------------------------|-------|

**This Acknowledgement Receipt evidences receipt on the noted date by the USPTO of the indicated documents, characterized by the applicant, and including page counts, where applicable. It serves as evidence of receipt similar to a Post Card, as described in MPEP 503.**

**New Applications Under 35 U.S.C. 111**

**If a new application is being filed and the application includes the necessary components for a filing date (see 37 CFR 1.53(b)-(d) and MPEP 506), a Filing Receipt (37 CFR 1.54) will be issued in due course and the date shown on this Acknowledgement Receipt will establish the filing date of the application.**

**National Stage of an International Application under 35 U.S.C. 371**

**If a timely submission to enter the national stage of an international application is compliant with the conditions of 35 U.S.C. 371 and other applicable requirements a Form PCT/DO/EO/903 indicating acceptance of the application as a national stage submission under 35 U.S.C. 371 will be issued in addition to the Filing Receipt, in due course.**

**New International Application Filed with the USPTO as a Receiving Office**

**If a new international application is being filed and the international application includes the necessary components for an international filing date (see PCT Article 11 and MPEP 1810), a Notification of the International Application Number and of the International Filing Date (Form PCT/RO/105) will be issued in due course, subject to prescriptions concerning national security, and the date shown on this Acknowledgement Receipt will establish the international filing date of the application.**



UNITED STATES PATENT AND TRADEMARK OFFICE

UNITED STATES DEPARTMENT OF COMMERCE
United States Patent and Trademark Office
Address: COMMISSIONER FOR PATENTS
P.O. Box 1450
Alexandria, Virginia 22313-1450
www.uspto.gov

Table with 5 columns: APPLICATION NO., FILING DATE, FIRST NAMED INVENTOR, ATTORNEY DOCKET NO., CONFIRMATION NO.
Row 1: 09/876,515, 06/07/2001, Robert J. Davies, CA0419, 9201
Row 2: 7590, 07/16/2009, VOLPE AND KOENIG, P.C., EXAMINER LE, KAREN L, ART UNIT 2614, PAPER NUMBER

DATE MAILED: 07/16/2009

PRIORITY ACKNOWLEDGMENT

- 1. Receipt is acknowledged of priority papers submitted under 35 U.S.C. 119. The papers have been placed of record in the file.
2. Applicant's claim for priority, based on papers filed in parent Application Number submitted under 35 U.S.C. 119, is acknowledged.
3. The priority papers, submitted, after payment of the issue fee are
- acknowledged
While the priority claim or certified copy filed will be placed in the file record, neither will be reviewed and the patent when published will not include the priority claim. See 37 CFR 1.55(a)(2).
- not acknowledged since the processing fee in 37 CFR 1.17(i) has not been received.
4. For utility and plant applications filed on or after November 29, 2000, the priority claim is not entered because the claim was not presented within the time limit required by 37 CFR 1.55(a)(1). A petition to accept a delayed claim for priority under 35 U.S.C. 119(a) - (d) or (f), or 365(a) may be filed. See 37 CFR 1.55(c) and MPEP 201.14(a).

Signature: Jennifer Mitchell, for
571-272-4200 or 1-888-786-0101
Application Assistance Unit
Office of Data Management

|                                                                                                          |                                            |                                                                 |
|----------------------------------------------------------------------------------------------------------|--------------------------------------------|-----------------------------------------------------------------|
| <b>Search Notes</b><br> | <b>Application/Control No.</b><br>09876515 | <b>Applicant(s)/Patent Under Reexamination</b><br>DAVIES ET AL. |
|                                                                                                          | <b>Examiner</b><br>KAREN L LE              | <b>Art Unit</b><br>2614                                         |

|                 |                   |             |                 |
|-----------------|-------------------|-------------|-----------------|
| <b>SEARCHED</b> |                   |             |                 |
| <b>Class</b>    | <b>Subclass</b>   | <b>Date</b> | <b>Examiner</b> |
| 455             | 456.1, 456.5, 457 | 4/06/09     | KL              |

|                          |             |                 |
|--------------------------|-------------|-----------------|
| <b>SEARCH NOTES</b>      |             |                 |
| <b>Search Notes</b>      | <b>Date</b> | <b>Examiner</b> |
| consulted with Tran Quoc | 4/06/09     | KL              |

|                                            |                 |             |                 |
|--------------------------------------------|-----------------|-------------|-----------------|
| <b>INTERFERENCE SEARCH</b>                 |                 |             |                 |
| <b>Class</b>                               | <b>Subclass</b> | <b>Date</b> | <b>Examiner</b> |
| See "Interference search" history here in. |                 | 4/06/09     | KL              |

|                                         |                                                       |
|-----------------------------------------|-------------------------------------------------------|
| /Karen L Le/<br>Examiner, Art Unit 2614 | /WALTER F. BRINEY III/<br>Acting SPE of Art Unit 2614 |
|-----------------------------------------|-------------------------------------------------------|





UNITED STATES PATENT AND TRADEMARK OFFICE

UNITED STATES DEPARTMENT OF COMMERCE
United States Patent and Trademark Office
Address: COMMISSIONER FOR PATENTS
P.O. Box 1450
Alexandria, Virginia 22313-1450
www.uspto.gov

Table with 5 columns: APPLICATION NO., FILING DATE, FIRST NAMED INVENTOR, ATTORNEY DOCKET NO., CONFIRMATION NO.
Row 1: 09/876,515, 06/07/2001, Robert J. Davies, CA0419, 9201
Row 2: 3624, 7500, 07/13/2009, VOLPE AND KOENIG, P.C., UNITED PLAZA, SUITE 1600, 30 SOUTH 17TH STREET, PHILADELPHIA, PA 19103
Row 3: EXAMINER, I.E, KAREN L.
Row 4: ART UNIT, PAPER NUMBER, 2614
Row 5: MAIL DATE, DELIVERY MODE, 07/13/2009, PAPER

Please find below and/or attached an Office communication concerning this application or proceeding.

The time period for reply, if any, is set in the attached communication.



**UNITED STATES DEPARTMENT OF COMMERCE**

**U.S. Patent and Trademark Office**

Address: COMMISSIONER FOR PATENTS

P.O. Box 14 50

Alexandria, Virginia 223 13 -14 50

|                                         |                    |                                                           |                            |
|-----------------------------------------|--------------------|-----------------------------------------------------------|----------------------------|
| <b>APPLICATION NO./<br/>CONTROL NO.</b> | <b>FILING DATE</b> | <b>FIRST NAMED INVENTOR /<br/>PATENT IN REEXAMINATION</b> | <b>ATTORNEY DOCKET NO.</b> |
| 09876515                                | 6/7/2001           | DAVIES ET AL.                                             | CA0419                     |

VOLPE AND KOENIG, P.C.  
UNITED PLAZA, SUITE 1600  
3 0SOUTH 17TH STREET  
PHILADELPHIA, PA 19 103

**EXAMINER**

KAREN L. LE

|                 |              |
|-----------------|--------------|
| <b>ART UNIT</b> | <b>PAPER</b> |
|-----------------|--------------|

2614

20090706

**DATE MAILED:**

**Please find below and/or attached an Office communication concerning this application or proceeding.**

**Commissioner for Patents**

A corrected field of search is provided.

/WALTER F. BRINEY III/  
Acting SPE of Art Unit 2614

/Karen L Le/  
Examiner, Art Unit 2614



UNITED STATES PATENT AND TRADEMARK OFFICE

UNITED STATES DEPARTMENT OF COMMERCE
United States Patent and Trademark Office
Address: COMMISSIONER FOR PATENTS
P.O. Box 1450
Alexandria, Virginia 22313-1450
www.uspto.gov

NOTICE OF ALLOWANCE AND FEE(S) DUE

3624 7590 04/29/2009
VOLPE AND KOENIG, P.C.
UNITED PLAZA, SUITE 1600
30 SOUTH 17TH STREET
PHILADELPHIA, PA 19103

EXAMINER

LE, KAREN L

ART UNIT PAPER NUMBER

2614

DATE MAILED: 04/29/2009

Table with 5 columns: APPLICATION NO., FILING DATE, FIRST NAMED INVENTOR, ATTORNEY DOCKET NO., CONFIRMATION NO.
09/876,515 06/07/2001 Robert J. Davies CA0419 9201

TITLE OF INVENTION: DATA DELIVERY THROUGH BEACONS

Table with 7 columns: APPLN. TYPE, SMALL ENTITY, ISSUE FEE DUE, PUBLICATION FEE DUE, PREV. PAID ISSUE FEE, TOTAL FEE(S) DUE, DATE DUE
nonprovisional NO \$1510 \$300 \$0 \$1810 07/29/2009

THE APPLICATION IDENTIFIED ABOVE HAS BEEN EXAMINED AND IS ALLOWED FOR ISSUANCE AS A PATENT. PROSECUTION ON THE MERITS IS CLOSED. THIS NOTICE OF ALLOWANCE IS NOT A GRANT OF PATENT RIGHTS. THIS APPLICATION IS SUBJECT TO WITHDRAWAL FROM ISSUE AT THE INITIATIVE OF THE OFFICE OR UPON PETITION BY THE APPLICANT. SEE 37 CFR 1.313 AND MPEP 1308.

THE ISSUE FEE AND PUBLICATION FEE (IF REQUIRED) MUST BE PAID WITHIN THREE MONTHS FROM THE MAILING DATE OF THIS NOTICE OR THIS APPLICATION SHALL BE REGARDED AS ABANDONED. THIS STATUTORY PERIOD CANNOT BE EXTENDED. SEE 35 U.S.C. 151. THE ISSUE FEE DUE INDICATED ABOVE DOES NOT REFLECT A CREDIT FOR ANY PREVIOUSLY PAID ISSUE FEE IN THIS APPLICATION. IF AN ISSUE FEE HAS PREVIOUSLY BEEN PAID IN THIS APPLICATION (AS SHOWN ABOVE), THE RETURN OF PART B OF THIS FORM WILL BE CONSIDERED A REQUEST TO REAPPLY THE PREVIOUSLY PAID ISSUE FEE TOWARD THE ISSUE FEE NOW DUE.

HOW TO REPLY TO THIS NOTICE:

I. Review the SMALL ENTITY status shown above.

If the SMALL ENTITY is shown as YES, verify your current SMALL ENTITY status:

- A. If the status is the same, pay the TOTAL FEE(S) DUE shown above.
B. If the status above is to be removed, check box 5b on Part B - Fee(s) Transmittal and pay the PUBLICATION FEE (if required) and twice the amount of the ISSUE FEE shown above, or

If the SMALL ENTITY is shown as NO:

- A. Pay TOTAL FEE(S) DUE shown above, or
B. If applicant claimed SMALL ENTITY status before, or is now claiming SMALL ENTITY status, check box 5a on Part B - Fee(s) Transmittal and pay the PUBLICATION FEE (if required) and 1/2 the ISSUE FEE shown above.

II. PART B - FEE(S) TRANSMITTAL, or its equivalent, must be completed and returned to the United States Patent and Trademark Office (USPTO) with your ISSUE FEE and PUBLICATION FEE (if required). If you are charging the fee(s) to your deposit account, section "4b" of Part B - Fee(s) Transmittal should be completed and an extra copy of the form should be submitted. If an equivalent of Part B is filed, a request to reapply a previously paid issue fee must be clearly made, and delays in processing may occur due to the difficulty in recognizing the paper as an equivalent of Part B.

III. All communications regarding this application must give the application number. Please direct all communications prior to issuance to Mail Stop ISSUE FEE unless advised to the contrary.

IMPORTANT REMINDER: Utility patents issuing on applications filed on or after Dec. 12, 1980 may require payment of maintenance fees. It is patentee's responsibility to ensure timely payment of maintenance fees when due.

**PART B - FEE(S) TRANSMITTAL**

Complete and send this form, together with applicable fee(s), to: **Mail** **Mail Stop ISSUE FEE**  
**Commissioner for Patents**  
**P.O. Box 1450**  
**Alexandria, Virginia 22313-1450**  
**or Fax (571)-273-2885**

**INSTRUCTIONS:** This form should be used for transmitting the ISSUE FEE and PUBLICATION FEE (if required). Blocks 1 through 5 should be completed where appropriate. All further correspondence including the Patent, advance orders and notification of maintenance fees will be mailed to the current correspondence address as indicated unless corrected below or directed otherwise in Block 1, by (a) specifying a new correspondence address; and/or (b) indicating a separate "FEE ADDRESS" for maintenance fee notifications.

CURRENT CORRESPONDENCE ADDRESS (Note: Use Block 1 for any change of address)

Note: A certificate of mailing can only be used for domestic mailings of the Fee(s) Transmittal. This certificate cannot be used for any other accompanying papers. Each additional paper, such as an assignment or formal drawing, must have its own certificate of mailing or transmission.

3624 7590 04/29/2009

**VOLPE AND KOENIG, P.C.**  
**UNITED PLAZA, SUITE 1600**  
**30 SOUTH 17TH STREET**  
**PHILADELPHIA, PA 19103**

**Certificate of Mailing or Transmission**

I hereby certify that this Fee(s) Transmittal is being deposited with the United States Postal Service with sufficient postage for first class mail in an envelope addressed to the Mail Stop ISSUE FEE address above, or being facsimile transmitted to the USPTO (571) 273-2885, on the date indicated below.

|                    |
|--------------------|
| (Depositor's name) |
| (Signature)        |
| (Date)             |

| APPLICATION NO. | FILING DATE | FIRST NAMED INVENTOR | ATTORNEY DOCKET NO. | CONFIRMATION NO. |
|-----------------|-------------|----------------------|---------------------|------------------|
| 09/876,515      | 06/07/2001  | Robert J. Davies     | CA0419              | 9201             |

TITLE OF INVENTION: DATA DELIVERY THROUGH BEACONS

| APPLN. TYPE    | SMALL ENTITY | ISSUE FEE DUE | PUBLICATION FEE DUE | PREV. PAID ISSUE FEE | TOTAL FEE(S) DUE | DATE DUE   |
|----------------|--------------|---------------|---------------------|----------------------|------------------|------------|
| nonprovisional | NO           | \$1510        | \$300               | \$0                  | \$1810           | 07/29/2009 |

| EXAMINER    | ART UNIT | CLASS-SUBCLASS |
|-------------|----------|----------------|
| LE, KAREN L | 2614     | 455-456100     |

1. Change of correspondence address or indication of "Fee Address" (37 CFR 1.363).

Change of correspondence address (or Change of Correspondence Address form PTO/SB/122) attached.

"Fee Address" indication (or "Fee Address" Indication form PTO/SB/47; Rev 03-02 or more recent) attached. **Use of a Customer Number is required.**

2. For printing on the patent front page, list

(1) the names of up to 3 registered patent attorneys or agents OR, alternatively, 1 \_\_\_\_\_

(2) the name of a single firm (having as a member a registered attorney or agent) and the names of up to 2 registered patent attorneys or agents. If no name is listed, no name will be printed. 2 \_\_\_\_\_

3 \_\_\_\_\_

3. ASSIGNEE NAME AND RESIDENCE DATA TO BE PRINTED ON THE PATENT (print or type)

PLEASE NOTE: Unless an assignee is identified below, no assignee data will appear on the patent. If an assignee is identified below, the document has been filed for recordation as set forth in 37 CFR 3.11. Completion of this form is NOT a substitute for filing an assignment.

(A) NAME OF ASSIGNEE \_\_\_\_\_ (B) RESIDENCE: (CITY and STATE OR COUNTRY) \_\_\_\_\_

Please check the appropriate assignee category or categories (will not be printed on the patent):  Individual  Corporation or other private group entity  Government

4a. The following fee(s) are submitted:

Issue Fee

Publication Fee (No small entity discount permitted)

Advance Order - # of Copies \_\_\_\_\_

4b. Payment of Fee(s): (**Please first reapply any previously paid issue fee shown above**)

A check is enclosed.

Payment by credit card. Form PTO-2038 is attached.

The Director is hereby authorized to charge the required fee(s), any deficiency, or credit any overpayment, to Deposit Account Number \_\_\_\_\_ (enclose an extra copy of this form).

5. Change in Entity Status (from status indicated above)

a. Applicant claims SMALL ENTITY status. See 37 CFR 1.27.  b. Applicant is no longer claiming SMALL ENTITY status. See 37 CFR 1.27(g)(2).

NOTE: The Issue Fee and Publication Fee (if required) will not be accepted from anyone other than the applicant; a registered attorney or agent; or the assignee or other party in interest as shown by the records of the United States Patent and Trademark Office.

Authorized Signature \_\_\_\_\_ Date \_\_\_\_\_

Typed or printed name \_\_\_\_\_ Registration No. \_\_\_\_\_

This collection of information is required by 37 CFR 1.311. The information is required to obtain or retain a benefit by the public which is to file (and by the USPTO to process) an application. Confidentiality is governed by 35 U.S.C. 122 and 37 CFR 1.14. This collection is estimated to take 12 minutes to complete, including gathering, preparing, and submitting the completed application form to the USPTO. Time will vary depending upon the individual case. Any comments on the amount of time you require to complete this form and/or suggestions for reducing this burden, should be sent to the Chief Information Officer, U.S. Patent and Trademark Office, U.S. Department of Commerce, P.O. Box 1450, Alexandria, Virginia 22313-1450. DO NOT SEND FEES OR COMPLETED FORMS TO THIS ADDRESS. SEND TO: Commissioner for Patents, P.O. Box 1450, Alexandria, Virginia 22313-1450.

Under the Paperwork Reduction Act of 1995, no persons are required to respond to a collection of information unless it displays a valid OMB control number.



UNITED STATES PATENT AND TRADEMARK OFFICE

UNITED STATES DEPARTMENT OF COMMERCE
United States Patent and Trademark Office
Address: COMMISSIONER FOR PATENTS
P.O. Box 1450
Alexandria, Virginia 22313-1450
www.uspto.gov

Table with columns: APPLICATION NO., FILING DATE, FIRST NAMED INVENTOR, ATTORNEY DOCKET NO., CONFIRMATION NO.
09/876,515 06/07/2001 Robert J. Davies CA0419 9201
3624 7590 04/29/2009
VOLPE AND KOENIG, P.C.
UNITED PLAZA, SUITE 1600
30 SOUTH 17TH STREET
PHILADELPHIA, PA 19103
EXAMINER
LE, KAREN L
ART UNIT PAPER NUMBER
2614
DATE MAILED: 04/29/2009

Determination of Patent Term Adjustment under 35 U.S.C. 154 (b)
(application filed on or after May 29, 2000)

The Patent Term Adjustment to date is 1600 day(s). If the issue fee is paid on the date that is three months after the mailing date of this notice and the patent issues on the Tuesday before the date that is 28 weeks (six and a half months) after the mailing date of this notice, the Patent Term Adjustment will be 1600 day(s).

If a Continued Prosecution Application (CPA) was filed in the above-identified application, the filing date that determines Patent Term Adjustment is the filing date of the most recent CPA.

Applicant will be able to obtain more detailed information by accessing the Patent Application Information Retrieval (PAIR) WEB site (http://pair.uspto.gov).

Any questions regarding the Patent Term Extension or Adjustment determination should be directed to the Office of Patent Legal Administration at (571)-272-7702. Questions relating to issue and publication fee payments should be directed to the Customer Service Center of the Office of Patent Publication at 1-(888)-786-0101 or (571)-272-4200.

|                               |                        |                     |  |
|-------------------------------|------------------------|---------------------|--|
| <b>Notice of Allowability</b> | <b>Application No.</b> | <b>Applicant(s)</b> |  |
|                               | 09/876,515             | DAVIES ET AL.       |  |
|                               | <b>Examiner</b>        | <b>Art Unit</b>     |  |
|                               | KAREN L. LE            | 2614                |  |

**-- The MAILING DATE of this communication appears on the cover sheet with the correspondence address--**

All claims being allowable, PROSECUTION ON THE MERITS IS (OR REMAINS) CLOSED in this application. If not included herewith (or previously mailed), a Notice of Allowance (PTOL-85) or other appropriate communication will be mailed in due course. **THIS NOTICE OF ALLOWABILITY IS NOT A GRANT OF PATENT RIGHTS.** This application is subject to withdrawal from issue at the initiative of the Office or upon petition by the applicant. See 37 CFR 1.313 and MPEP 1308.

1.  This communication is responsive to telephone interview on 4/06/2009.
2.  The allowed claim(s) is/are 1,2,4-9,11,12 and 14.
3.  Acknowledgment is made of a claim for foreign priority under 35 U.S.C. § 119(a)-(d) or (f).
  - a)  All    b)  Some\*    c)  None    of the:
    1.  Certified copies of the priority documents have been received.
    2.  Certified copies of the priority documents have been received in Application No. \_\_\_\_\_.
    3.  Copies of the certified copies of the priority documents have been received in this national stage application from the International Bureau (PCT Rule 17.2(a)).

\* Certified copies not received: \_\_\_\_\_.

Applicant has THREE MONTHS FROM THE "MAILING DATE" of this communication to file a reply complying with the requirements noted below. Failure to timely comply will result in ABANDONMENT of this application.  
**THIS THREE-MONTH PERIOD IS NOT EXTENDABLE.**

4.  A SUBSTITUTE OATH OR DECLARATION must be submitted. Note the attached EXAMINER'S AMENDMENT or NOTICE OF INFORMAL PATENT APPLICATION (PTO-152) which gives reason(s) why the oath or declaration is deficient.
5.  CORRECTED DRAWINGS ( as "replacement sheets") must be submitted.
  - (a)  including changes required by the Notice of Draftsperson's Patent Drawing Review ( PTO-948) attached
    - 1)  hereto or 2)  to Paper No./Mail Date \_\_\_\_\_.
  - (b)  including changes required by the attached Examiner's Amendment / Comment or in the Office action of Paper No./Mail Date \_\_\_\_\_.

**Identifying indicia such as the application number (see 37 CFR 1.84(c)) should be written on the drawings in the front (not the back) of each sheet. Replacement sheet(s) should be labeled as such in the header according to 37 CFR 1.121(d).**
6.  DEPOSIT OF and/or INFORMATION about the deposit of BIOLOGICAL MATERIAL must be submitted. Note the attached Examiner's comment regarding REQUIREMENT FOR THE DEPOSIT OF BIOLOGICAL MATERIAL.

**Attachment(s)**

- |                                                                                                                                                                                                                                                                                                                                                                                                                                                         |                                                                                                                                                                                                                                                                                                                                                                                                                                                            |
|---------------------------------------------------------------------------------------------------------------------------------------------------------------------------------------------------------------------------------------------------------------------------------------------------------------------------------------------------------------------------------------------------------------------------------------------------------|------------------------------------------------------------------------------------------------------------------------------------------------------------------------------------------------------------------------------------------------------------------------------------------------------------------------------------------------------------------------------------------------------------------------------------------------------------|
| <ol style="list-style-type: none"> <li>1. <input type="checkbox"/> Notice of References Cited (PTO-892)</li> <li>2. <input type="checkbox"/> Notice of Draftsperson's Patent Drawing Review (PTO-948)</li> <li>3. <input type="checkbox"/> Information Disclosure Statements (PTO/SB/08),<br/>Paper No./Mail Date _____</li> <li>4. <input type="checkbox"/> Examiner's Comment Regarding Requirement for Deposit<br/>of Biological Material</li> </ol> | <ol style="list-style-type: none"> <li>5. <input type="checkbox"/> Notice of Informal Patent Application</li> <li>6. <input checked="" type="checkbox"/> Interview Summary (PTO-413),<br/>Paper No./Mail Date <u>4/06/09.</u></li> <li>7. <input checked="" type="checkbox"/> Examiner's Amendment/Comment</li> <li>8. <input type="checkbox"/> Examiner's Statement of Reasons for Allowance</li> <li>9. <input type="checkbox"/> Other _____.</li> </ol> |
|---------------------------------------------------------------------------------------------------------------------------------------------------------------------------------------------------------------------------------------------------------------------------------------------------------------------------------------------------------------------------------------------------------------------------------------------------------|------------------------------------------------------------------------------------------------------------------------------------------------------------------------------------------------------------------------------------------------------------------------------------------------------------------------------------------------------------------------------------------------------------------------------------------------------------|

/Quoc D Tran/  
 Primary Examiner, Art Unit 2614

|                          |                        |                     |  |
|--------------------------|------------------------|---------------------|--|
| <b>Interview Summary</b> | <b>Application No.</b> | <b>Applicant(s)</b> |  |
|                          | 09/876,515             | DAVIES ET AL.       |  |
|                          | <b>Examiner</b>        | <b>Art Unit</b>     |  |
|                          | KAREN L. LE            | 2614                |  |

All participants (applicant, applicant's representative, PTO personnel):

(1) KAREN L. LE. (3)\_\_\_\_\_.

(2) Thomas A. Mattioli. (4)\_\_\_\_\_.

Date of Interview: 4/06/09.

Type: a)  Telephonic b)  Video Conference  
c)  Personal [copy given to: 1)  applicant 2)  applicant's representative]

Exhibit shown or demonstration conducted: d)  Yes e)  No.  
If Yes, brief description: \_\_\_\_\_.

Claim(s) discussed: 1-14.

Identification of prior art discussed: \_\_\_\_\_.

Agreement with respect to the claims f)  was reached. g)  was not reached. h)  N/A.

Substance of Interview including description of the general nature of what was agreed to if an agreement was reached, or any other comments: Mr. Thomas A. Mattioli agreed to add dependent claims 3 and 13 to independent claims 1 and 11 respectively and cancel claim 10..

(A fuller description, if necessary, and a copy of the amendments which the examiner agreed would render the claims allowable, if available, must be attached. Also, where no copy of the amendments that would render the claims allowable is available, a summary thereof must be attached.)

THE FORMAL WRITTEN REPLY TO THE LAST OFFICE ACTION MUST INCLUDE THE SUBSTANCE OF THE INTERVIEW. (See MPEP Section 713.04). If a reply to the last Office action has already been filed, APPLICANT IS GIVEN A NON-EXTENDABLE PERIOD OF THE LONGER OF ONE MONTH OR THIRTY DAYS FROM THIS INTERVIEW DATE, OR THE MAILING DATE OF THIS INTERVIEW SUMMARY FORM, WHICHEVER IS LATER, TO FILE A STATEMENT OF THE SUBSTANCE OF THE INTERVIEW. See Summary of Record of Interview requirements on reverse side or on attached sheet.

/Karen L Le/  
Examiner, Art Unit 2614

### EXAMINER'S AMENDMENT

1. An examiner's amendment to the record appears below. Should the changes and/or additions be unacceptable to applicant, an amendment may be filed as provided by 37 CFR 1.312. To ensure consideration of such an amendment, it MUST be submitted no later than the payment of the issue fee.

Authorization for this examiner's amendment was given in a telephone interview with Thomas A. Mattioli on 4/06/09.

The application has been amended as follows:

1. (Currently Amended) A communications system comprising at least one beacon device capable of wireless message transmission and at least one portable device capable of receiving such a message transmission, wherein the beacon is arranged to broadcast a series of inquiry messages each in the form of a plurality of predetermined data fields arranged according to a first communications protocol, wherein the beacon is further arranged to add to each inquiry message prior to transmission an additional data field, and wherein the beacon is further arranged to include an indication in one of said predetermined data fields, said indication denoting the presence of said additional data field, and wherein the at least one portable device is arranged to receive the transmitted inquiry messages and read data from said additional data field, the additional data field including location information.

2. (Original) A system as claimed in claim 1, wherein the beacon is arranged to add said additional data field at the end of a respective inquiry message.

3. Canceled.



Art Unit: 2614

4. (Original) A system as claimed in claim 1, wherein said first communications protocol comprises Bluetooth messaging.

5. (Original) A system as claimed in claim 4, wherein a special Dedicated Inquiry Access Code (DIAC) is used to indicate the presence of location information in the additional data field.

6. (Original) A system as claimed in claim 1, wherein the presence of location information in the additional data field is indicated with header information appearing in the additional data field.

7. (Original) A system in accordance with claim 1, wherein wireless messaging system employs frequency hopping, and further wherein location data is sent on each frequency used for inquiry message broadcasts.

8. (Original) A mobile communication device for use in the system of claim 1, the device comprising a receiver capable of receiving a short-range wireless inquiry message including a plurality of data fields according to a first communications protocol, means for determining when an additional data field including location information has been added to said plurality of data fields, and means for reading the location information data from such an additional data field.

9. (Original) A device as claimed in claim 8, wherein the receiver is configured to receive messages according to Bluetooth protocols.

10. Canceled.

11. (Currently Amended) A method for enabling the user of a portable communications device to receive broadcast messages wherein at least one beacon device broadcasts a series of inquiry messages each in the form of a plurality of

Art Unit: 2614

predetermined data fields arranged according to a first communications protocol, wherein the beacon adds to each inquiry message prior to transmission an additional data field carrying broadcast message data including location information, and wherein the beacon includes an indication in one of said predetermined data fields, said indication denoting the presence of said additional data field, and wherein the portable device receives the transmitted inquiry messages including the location information and reads the broadcast data from said additional data field.

12. (Original) A method as claimed in claim 11, wherein the beacon adds said additional data field at the end of a respective inquiry message.

13. Canceled.

14. (Original) A method as claimed in claim 11, wherein said first communications protocol comprises Bluetooth messaging.

2. Any inquiry concerning this communication or earlier communications from the examiner should be directed to KAREN L. LE whose telephone number is (571)272-7487. The examiner can normally be reached on Mon and Thurs: 8:30-5:00.

If attempts to reach the examiner by telephone are unsuccessful, the examiner's supervisor, Curtis A. Kuntz can be reached on 571-272-7499. The fax phone number for the organization where this application or proceeding is assigned is 571-273-8300.

Application/Control Number: 09/876,515

Page 5

Art Unit: 2614

Information regarding the status of an application may be obtained from the Patent Application Information Retrieval (PAIR) system. Status information for published applications may be obtained from either Private PAIR or Public PAIR. Status information for unpublished applications is available through Private PAIR only. For more information about the PAIR system, see <http://pair-direct.uspto.gov>. Should you have questions on access to the Private PAIR system, contact the Electronic Business Center (EBC) at 866-217-9197 (toll-free). If you would like assistance from a USPTO Customer Service Representative or access to the automated information system, call 800-786-9199 (IN USA OR CANADA) or 571-272-1000.

/Karen L Le/  
Examiner, Art Unit 2614

/Quoc D Tran/  
Primary Examiner, Art Unit 2614

|                                                                                                                 |                                                |                                                                     |
|-----------------------------------------------------------------------------------------------------------------|------------------------------------------------|---------------------------------------------------------------------|
| <b>Index of Claims</b><br><br> | <b>Application/Control No.</b><br><br>09876515 | <b>Applicant(s)/Patent Under Reexamination</b><br><br>DAVIES ET AL. |
|                                                                                                                 | <b>Examiner</b><br><br>KAREN L LE              | <b>Art Unit</b><br><br>2614                                         |

|   |                 |
|---|-----------------|
| ✓ | <b>Rejected</b> |
| = | <b>Allowed</b>  |

|   |                   |
|---|-------------------|
| - | <b>Cancelled</b>  |
| ÷ | <b>Restricted</b> |

|   |                     |
|---|---------------------|
| N | <b>Non-Elected</b>  |
| I | <b>Interference</b> |

|   |                 |
|---|-----------------|
| A | <b>Appeal</b>   |
| O | <b>Objected</b> |

Claims renumbered in the same order as presented by applicant
  CPA
  T.D.
  R.1.47

| CLAIM |          | DATE       |  |  |  |  |  |  |  |  |
|-------|----------|------------|--|--|--|--|--|--|--|--|
| Final | Original | 04/09/2009 |  |  |  |  |  |  |  |  |
| 1     | 1        | =          |  |  |  |  |  |  |  |  |
| 2     | 2        | =          |  |  |  |  |  |  |  |  |
|       | 3        | -          |  |  |  |  |  |  |  |  |
| 3     | 4        | =          |  |  |  |  |  |  |  |  |
| 4     | 5        | =          |  |  |  |  |  |  |  |  |
| 5     | 6        | =          |  |  |  |  |  |  |  |  |
| 6     | 7        | =          |  |  |  |  |  |  |  |  |
| 7     | 8        | =          |  |  |  |  |  |  |  |  |
| 8     | 9        | =          |  |  |  |  |  |  |  |  |
|       | 10       | -          |  |  |  |  |  |  |  |  |
| 9     | 11       | =          |  |  |  |  |  |  |  |  |
| 10    | 12       | =          |  |  |  |  |  |  |  |  |
|       | 13       | -          |  |  |  |  |  |  |  |  |
| 11    | 14       | =          |  |  |  |  |  |  |  |  |

**EAST Search History**

| Ref # | Hits | Search Query                                                                                                                                                                                                                                  | DBs             | Default Operator | Plurals | Time Stamp       |
|-------|------|-----------------------------------------------------------------------------------------------------------------------------------------------------------------------------------------------------------------------------------------------|-----------------|------------------|---------|------------------|
| S128  | 10   | communication and beacon and device and wireless and message and transmission and portable and broadcast and series and inquiry and predetermined and data and field and protocol and location and indication and denoting and presence.clm.  | US-PGPUB; USPAT | OR               | OFF     | 2009/04/11 09:22 |
| S129  | 10   | communication and beacon and device and wireless and messag\$3 and transmission and portable and broadcast and series and inquiry and predeter\$5 and data and field and protocol and location and indication and denot \$3 and presence.clm. | US-PGPUB; USPAT | OR               | OFF     | 2009/04/11 11:35 |

**4/ 11/ 2009 11:38:41 AM**

**C:\ Documents and Settings\ kle4\ My Documents\ EAST\ Workspaces\ 09876515.wsp**

|                                                                                                              |                                                                |                                                                                                     |
|--------------------------------------------------------------------------------------------------------------|----------------------------------------------------------------|-----------------------------------------------------------------------------------------------------|
| <b>Search Notes</b><br><br> | <b>Application/Control No.</b><br><br>098765151154229511141595 | <b>Applicant(s)/Patent Under Reexamination</b><br><br>DAVIES ET AL.SOMANI, ANAND<br>H.DEVITO ET AL. |
|                                                                                                              | <b>Examiner</b><br><br>KAREN L LEKAREN L LEKAREN L<br>LE       | <b>Art Unit</b><br><br>261426142614                                                                 |

| SEARCHED |                   |                        |          |
|----------|-------------------|------------------------|----------|
| Class    | Subclass          | Date                   | Examiner |
| 379EAST  | 93.05, 211.02     | 12/22/20088/3/2<br>008 | KLKL     |
| 379      | 210.01, 88.17     | 8/17/2008              | KL       |
| EAST455  | 456.1, 456.5, 457 | 3/01/094/06/09         | KLKL     |

| SEARCH NOTES                 |                        |          |
|------------------------------|------------------------|----------|
| Search Notes                 | Date                   | Examiner |
| EASTEAST                     | 12/22/20088/3/2<br>008 | KLKL     |
| EASTconsulted with Tran Quoc | 3/01/094/06/09         | KLKL     |

| INTERFERENCE SEARCH                        |          |         |          |
|--------------------------------------------|----------|---------|----------|
| Class                                      | Subclass | Date    | Examiner |
| See "Interference search" history here in. |          | 4/06/09 | KL       |

|                                         |  |
|-----------------------------------------|--|
| /Karen L Le/<br>Examiner, Art Unit 2614 |  |
|-----------------------------------------|--|

**Issue Classification**



**Application/Control No.**  
09876515

**Applicant(s)/Patent Under Reexamination**  
DAVIES ET AL.

**Examiner**  
KAREN L LE

**Art Unit**  
2614

| ORIGINAL                  |                                   |          |  |  | INTERNATIONAL CLASSIFICATION |   |   |   |                  |             |  |  |  |  |  |  |  |
|---------------------------|-----------------------------------|----------|--|--|------------------------------|---|---|---|------------------|-------------|--|--|--|--|--|--|--|
| CLASS                     |                                   | SUBCLASS |  |  | CLAIMED                      |   |   |   |                  | NON-CLAIMED |  |  |  |  |  |  |  |
| 455                       |                                   | 456.1    |  |  | H                            | 0 | 4 | W | 24 / 00 (2009.0) |             |  |  |  |  |  |  |  |
| <b>CROSS REFERENCE(S)</b> |                                   |          |  |  |                              |   |   |   |                  |             |  |  |  |  |  |  |  |
| CLASS                     | SUBCLASS (ONE SUBCLASS PER BLOCK) |          |  |  |                              |   |   |   |                  |             |  |  |  |  |  |  |  |
| 455                       | 456.5                             | 457      |  |  |                              |   |   |   |                  |             |  |  |  |  |  |  |  |
|                           |                                   |          |  |  |                              |   |   |   |                  |             |  |  |  |  |  |  |  |
|                           |                                   |          |  |  |                              |   |   |   |                  |             |  |  |  |  |  |  |  |
|                           |                                   |          |  |  |                              |   |   |   |                  |             |  |  |  |  |  |  |  |
|                           |                                   |          |  |  |                              |   |   |   |                  |             |  |  |  |  |  |  |  |
|                           |                                   |          |  |  |                              |   |   |   |                  |             |  |  |  |  |  |  |  |
|                           |                                   |          |  |  |                              |   |   |   |                  |             |  |  |  |  |  |  |  |
|                           |                                   |          |  |  |                              |   |   |   |                  |             |  |  |  |  |  |  |  |
|                           |                                   |          |  |  |                              |   |   |   |                  |             |  |  |  |  |  |  |  |
|                           |                                   |          |  |  |                              |   |   |   |                  |             |  |  |  |  |  |  |  |
|                           |                                   |          |  |  |                              |   |   |   |                  |             |  |  |  |  |  |  |  |
|                           |                                   |          |  |  |                              |   |   |   |                  |             |  |  |  |  |  |  |  |
|                           |                                   |          |  |  |                              |   |   |   |                  |             |  |  |  |  |  |  |  |
|                           |                                   |          |  |  |                              |   |   |   |                  |             |  |  |  |  |  |  |  |
|                           |                                   |          |  |  |                              |   |   |   |                  |             |  |  |  |  |  |  |  |
|                           |                                   |          |  |  |                              |   |   |   |                  |             |  |  |  |  |  |  |  |
|                           |                                   |          |  |  |                              |   |   |   |                  |             |  |  |  |  |  |  |  |

| <input type="checkbox"/> <b>Claims renumbered in the same order as presented by applicant</b> <input type="checkbox"/> <b>CPA</b> <input type="checkbox"/> <b>T.D.</b> <input type="checkbox"/> <b>R.1.47</b> |          |       |          |       |          |       |          |       |          |       |          |       |          |       |          |
|---------------------------------------------------------------------------------------------------------------------------------------------------------------------------------------------------------------|----------|-------|----------|-------|----------|-------|----------|-------|----------|-------|----------|-------|----------|-------|----------|
| Final                                                                                                                                                                                                         | Original | Final | Original | Final | Original | Final | Original | Final | Original | Final | Original | Final | Original | Final | Original |
| 1                                                                                                                                                                                                             | 1        |       |          |       |          |       |          |       |          |       |          |       |          |       |          |
| 2                                                                                                                                                                                                             | 2        |       |          |       |          |       |          |       |          |       |          |       |          |       |          |
|                                                                                                                                                                                                               | 3        |       |          |       |          |       |          |       |          |       |          |       |          |       |          |
| 3                                                                                                                                                                                                             | 4        |       |          |       |          |       |          |       |          |       |          |       |          |       |          |
| 4                                                                                                                                                                                                             | 5        |       |          |       |          |       |          |       |          |       |          |       |          |       |          |
| 5                                                                                                                                                                                                             | 6        |       |          |       |          |       |          |       |          |       |          |       |          |       |          |
| 6                                                                                                                                                                                                             | 7        |       |          |       |          |       |          |       |          |       |          |       |          |       |          |
| 7                                                                                                                                                                                                             | 8        |       |          |       |          |       |          |       |          |       |          |       |          |       |          |
| 8                                                                                                                                                                                                             | 9        |       |          |       |          |       |          |       |          |       |          |       |          |       |          |
|                                                                                                                                                                                                               | 10       |       |          |       |          |       |          |       |          |       |          |       |          |       |          |
| 9                                                                                                                                                                                                             | 11       |       |          |       |          |       |          |       |          |       |          |       |          |       |          |
| 10                                                                                                                                                                                                            | 12       |       |          |       |          |       |          |       |          |       |          |       |          |       |          |
|                                                                                                                                                                                                               | 13       |       |          |       |          |       |          |       |          |       |          |       |          |       |          |
| 11                                                                                                                                                                                                            | 14       |       |          |       |          |       |          |       |          |       |          |       |          |       |          |
|                                                                                                                                                                                                               |          |       |          |       |          |       |          |       |          |       |          |       |          |       |          |
|                                                                                                                                                                                                               |          |       |          |       |          |       |          |       |          |       |          |       |          |       |          |
|                                                                                                                                                                                                               |          |       |          |       |          |       |          |       |          |       |          |       |          |       |          |
|                                                                                                                                                                                                               |          |       |          |       |          |       |          |       |          |       |          |       |          |       |          |
|                                                                                                                                                                                                               |          |       |          |       |          |       |          |       |          |       |          |       |          |       |          |
|                                                                                                                                                                                                               |          |       |          |       |          |       |          |       |          |       |          |       |          |       |          |
|                                                                                                                                                                                                               |          |       |          |       |          |       |          |       |          |       |          |       |          |       |          |
|                                                                                                                                                                                                               |          |       |          |       |          |       |          |       |          |       |          |       |          |       |          |
|                                                                                                                                                                                                               |          |       |          |       |          |       |          |       |          |       |          |       |          |       |          |
|                                                                                                                                                                                                               |          |       |          |       |          |       |          |       |          |       |          |       |          |       |          |

|                                                 |  |            |  |                              |                   |
|-------------------------------------------------|--|------------|--|------------------------------|-------------------|
| /KAREN L LE/<br>Examiner.Art Unit 2614          |  | 4/10/09    |  | <b>Total Claims Allowed:</b> |                   |
| (Assistant Examiner)                            |  | (Date)     |  | 11                           |                   |
| /Quoc D Tran/<br>Primary Examiner.Art Unit 2614 |  | 04/11/2009 |  | O.G. Print Claim(s)          | O.G. Print Figure |
| (Primary Examiner)                              |  | (Date)     |  | 1                            | 1                 |

Under the Paperwork Reduction Act of 1995, no persons are required to respond to a collection of information unless it displays a valid OMB control number.

| <b>PATENT APPLICATION FEE DETERMINATION RECORD</b><br>Substitute for Form PTO-875                                               |                                                                                                                                                                                                                               |                                  |                                    |                                          | Application or Docket Number<br><b>09/876,515</b> | Filing Date<br><b>06/07/2001</b> | <input type="checkbox"/> To be Mailed |                 |                     |
|---------------------------------------------------------------------------------------------------------------------------------|-------------------------------------------------------------------------------------------------------------------------------------------------------------------------------------------------------------------------------|----------------------------------|------------------------------------|------------------------------------------|---------------------------------------------------|----------------------------------|---------------------------------------|-----------------|---------------------|
| <b>APPLICATION AS FILED – PART I</b>                                                                                            |                                                                                                                                                                                                                               |                                  |                                    |                                          | OTHER THAN                                        |                                  |                                       |                 |                     |
| (Column 1)                                                                                                                      |                                                                                                                                                                                                                               | (Column 2)                       |                                    | SMALL ENTITY <input type="checkbox"/> OR |                                                   | SMALL ENTITY                     |                                       |                 |                     |
| FOR                                                                                                                             | NUMBER FILED                                                                                                                                                                                                                  | NUMBER EXTRA                     | RATE (\$)                          | FEE (\$)                                 | OR                                                | RATE (\$)                        | FEE (\$)                              |                 |                     |
| <input type="checkbox"/> BASIC FEE<br><small>(37 CFR 1.16(a), (b), or (c))</small>                                              | N/A                                                                                                                                                                                                                           | N/A                              | N/A                                |                                          | OR                                                | N/A                              |                                       |                 |                     |
| <input type="checkbox"/> SEARCH FEE<br><small>(37 CFR 1.16(k), (j), or (m))</small>                                             | N/A                                                                                                                                                                                                                           | N/A                              | N/A                                |                                          | OR                                                | N/A                              |                                       |                 |                     |
| <input type="checkbox"/> EXAMINATION FEE<br><small>(37 CFR 1.16(o), (p), or (q))</small>                                        | N/A                                                                                                                                                                                                                           | N/A                              | N/A                                |                                          | OR                                                | N/A                              |                                       |                 |                     |
| TOTAL CLAIMS<br><small>(37 CFR 1.16(i))</small>                                                                                 | minus 20 =                                                                                                                                                                                                                    | *                                | X \$ =                             |                                          | OR                                                | X \$ =                           |                                       |                 |                     |
| INDEPENDENT CLAIMS<br><small>(37 CFR 1.16(h))</small>                                                                           | minus 3 =                                                                                                                                                                                                                     | *                                | X \$ =                             |                                          | OR                                                | X \$ =                           |                                       |                 |                     |
| <input type="checkbox"/> APPLICATION SIZE FEE<br><small>(37 CFR 1.16(s))</small>                                                | If the specification and drawings exceed 100 sheets of paper, the application size fee due is \$250 (\$125 for small entity) for each additional 50 sheets or fraction thereof. See 35 U.S.C. 41(a)(1)(G) and 37 CFR 1.16(s). |                                  |                                    |                                          | OR                                                |                                  |                                       |                 |                     |
| <input type="checkbox"/> MULTIPLE DEPENDENT CLAIM PRESENT <small>(37 CFR 1.16(j))</small>                                       |                                                                                                                                                                                                                               |                                  |                                    |                                          |                                                   |                                  |                                       |                 |                     |
| * If the difference in column 1 is less than zero, enter "0" in column 2.                                                       |                                                                                                                                                                                                                               |                                  |                                    |                                          |                                                   |                                  |                                       |                 |                     |
| <b>APPLICATION AS AMENDED – PART II</b>                                                                                         |                                                                                                                                                                                                                               |                                  |                                    |                                          | OTHER THAN                                        |                                  |                                       |                 |                     |
| (Column 1)                                                                                                                      |                                                                                                                                                                                                                               | (Column 2)                       |                                    | SMALL ENTITY OR                          |                                                   | SMALL ENTITY                     |                                       |                 |                     |
| AMENDMENT                                                                                                                       | 04/14/2009                                                                                                                                                                                                                    | CLAIMS REMAINING AFTER AMENDMENT | HIGHEST NUMBER PREVIOUSLY PAID FOR | PRESENT EXTRA                            | RATE (\$)                                         | ADDITIONAL FEE (\$)              | OR                                    | RATE (\$)       | ADDITIONAL FEE (\$) |
| Total <small>(37 CFR 1.16(j))</small>                                                                                           | *                                                                                                                                                                                                                             | 11                               | Minus                              | ** 20                                    | =                                                 | 0                                | OR                                    | X \$52=         | 0                   |
| Independent <small>(37 CFR 1.16(h))</small>                                                                                     | *                                                                                                                                                                                                                             | 2                                | Minus                              | *** 3                                    | =                                                 | 0                                | OR                                    | X \$220=        | 0                   |
| <input type="checkbox"/> Application Size Fee <small>(37 CFR 1.16(s))</small>                                                   |                                                                                                                                                                                                                               |                                  |                                    |                                          |                                                   |                                  |                                       |                 |                     |
| <input type="checkbox"/> FIRST PRESENTATION OF MULTIPLE DEPENDENT CLAIM <small>(37 CFR 1.16(j))</small>                         |                                                                                                                                                                                                                               |                                  |                                    |                                          |                                                   |                                  |                                       |                 |                     |
|                                                                                                                                 |                                                                                                                                                                                                                               |                                  |                                    |                                          | TOTAL ADD'L FEE                                   | OR                               |                                       | TOTAL ADD'L FEE | 0                   |
| (Column 1)                                                                                                                      |                                                                                                                                                                                                                               | (Column 2)                       |                                    | (Column 3)                               |                                                   | SMALL ENTITY OR                  |                                       | SMALL ENTITY    |                     |
| AMENDMENT                                                                                                                       |                                                                                                                                                                                                                               | CLAIMS REMAINING AFTER AMENDMENT | HIGHEST NUMBER PREVIOUSLY PAID FOR | PRESENT EXTRA                            | RATE (\$)                                         | ADDITIONAL FEE (\$)              | OR                                    | RATE (\$)       | ADDITIONAL FEE (\$) |
| Total <small>(37 CFR 1.16(j))</small>                                                                                           | *                                                                                                                                                                                                                             |                                  | Minus                              | **                                       | =                                                 |                                  | OR                                    | X \$ =          |                     |
| Independent <small>(37 CFR 1.16(h))</small>                                                                                     | *                                                                                                                                                                                                                             |                                  | Minus                              | ***                                      | =                                                 |                                  | OR                                    | X \$ =          |                     |
| <input type="checkbox"/> Application Size Fee <small>(37 CFR 1.16(s))</small>                                                   |                                                                                                                                                                                                                               |                                  |                                    |                                          |                                                   |                                  |                                       |                 |                     |
| <input type="checkbox"/> FIRST PRESENTATION OF MULTIPLE DEPENDENT CLAIM <small>(37 CFR 1.16(j))</small>                         |                                                                                                                                                                                                                               |                                  |                                    |                                          |                                                   |                                  |                                       |                 |                     |
|                                                                                                                                 |                                                                                                                                                                                                                               |                                  |                                    |                                          | TOTAL ADD'L FEE                                   | OR                               |                                       | TOTAL ADD'L FEE |                     |
| * If the entry in column 1 is less than the entry in column 2, write "0" in column 3.                                           |                                                                                                                                                                                                                               |                                  |                                    |                                          |                                                   |                                  |                                       |                 |                     |
| ** If the "Highest Number Previously Paid For" IN THIS SPACE is less than 20, enter "20".                                       |                                                                                                                                                                                                                               |                                  |                                    |                                          |                                                   |                                  |                                       |                 |                     |
| *** If the "Highest Number Previously Paid For" IN THIS SPACE is less than 3, enter "3".                                        |                                                                                                                                                                                                                               |                                  |                                    |                                          |                                                   |                                  |                                       |                 |                     |
| The "Highest Number Previously Paid For" (Total or Independent) is the highest number found in the appropriate box in column 1. |                                                                                                                                                                                                                               |                                  |                                    |                                          |                                                   |                                  |                                       |                 |                     |

Legal Instrument Examiner:  
/DAVINA G. BUTLER/

This collection of information is required by 37 CFR 1.16. The information is required to obtain or retain a benefit by the public which is to file (and by the USPTO to process) an application. Confidentiality is governed by 35 U.S.C. 122 and 37 CFR 1.14. This collection is estimated to take 12 minutes to complete, including gathering, preparing, and submitting the completed application form to the USPTO. Time will vary depending upon the individual case. Any comments on the amount of time you require to complete this form and/or suggestions for reducing this burden, should be sent to the Chief Information Officer, U.S. Patent and Trademark Office, U.S. Department of Commerce, P.O. Box 1450, Alexandria, VA 22313-1450. DO NOT SEND FEES OR COMPLETED FORMS TO THIS ADDRESS. SEND TO: Commissioner for Patents, P.O. Box 1450, Alexandria, VA 22313-1450.

If you need assistance in completing the form, call 1-800-PTO-9199 and select option 2.





UNITED STATES PATENT AND TRADEMARK OFFICE

UNITED STATES DEPARTMENT OF COMMERCE  
United States Patent and Trademark Office  
Address: COMMISSIONER FOR PATENTS  
P.O. Box 1450  
Alexandria, Virginia 22313-1450  
www.uspto.gov

| APPLICATION NUMBER | FILING OR 371(C) DATE | FIRST NAMED APPLICANT | ATTY. DOCKET NO./TITLE |
|--------------------|-----------------------|-----------------------|------------------------|
| 09/876,515         | 06/07/2001            | Robert J. Davies      | GB 000109              |

24737  
PHILIPS INTELLECTUAL PROPERTY & STANDARDS  
P.O. BOX 3001  
BRIARCLIFF MANOR, NY 10510

**CONFIRMATION NO. 9201**  
**POWER OF ATTORNEY NOTICE**



Date Mailed: 04/06/2009

**NOTICE REGARDING CHANGE OF POWER OF ATTORNEY**

This is in response to the Power of Attorney filed 03/31/2009.

- The Power of Attorney to you in this application has been revoked by the assignee who has intervened as provided by 37 CFR 3.71. Future correspondence will be mailed to the new address of record(37 CFR 1.33).

/sleutchit/

Office of Data Management, Application Assistance Unit (571) 272-4000, or (571) 272-4200, or 1-888-786-0101



UNITED STATES PATENT AND TRADEMARK OFFICE

UNITED STATES DEPARTMENT OF COMMERCE  
United States Patent and Trademark Office  
Address: COMMISSIONER FOR PATENTS  
P.O. Box 1450  
Alexandria, Virginia 22313-1450  
www.uspto.gov

| APPLICATION NUMBER | FILING OR 371(C) DATE | FIRST NAMED APPLICANT | ATTY. DOCKET NO./TITLE |
|--------------------|-----------------------|-----------------------|------------------------|
| 09/876,515         | 06/07/2001            | Robert J. Davies      | CA0419                 |

3624  
VOLPE AND KOENIG, P.C.  
UNITED PLAZA, SUITE 1600  
30 SOUTH 17TH STREET  
PHILADELPHIA, PA 19103

**CONFIRMATION NO. 9201**  
**POA ACCEPTANCE LETTER**



Date Mailed: 04/06/2009

**NOTICE OF ACCEPTANCE OF POWER OF ATTORNEY**

This is in response to the Power of Attorney filed 03/31/2009.

The Power of Attorney in this application is accepted. Correspondence in this application will be mailed to the above address as provided by 37 CFR 1.33.

/sleutchit/

Office of Data Management, Application Assistance Unit (571) 272-4000, or (571) 272-4200, or 1-888-786-0101

Under the Paperwork Reduction Act of 1995, no persons are required to respond to a collection of information unless it displays a valid OMB control number.

|                                                                                                                                                  |                               |                               |
|--------------------------------------------------------------------------------------------------------------------------------------------------|-------------------------------|-------------------------------|
| <b>POWER OF ATTORNEY<br/>OR<br/>REVOCAION OF POWER OF ATTORNEY<br/>WITH A NEW POWER OF ATTORNEY<br/>AND<br/>CHANGE OF CORRESPONDENCE ADDRESS</b> | <b>Application Number</b>     | 09/876515                     |
|                                                                                                                                                  | <b>Filing Date</b>            | 07-Jun-01                     |
|                                                                                                                                                  | <b>First Named Inventor</b>   | Robert J. Davies              |
|                                                                                                                                                  | <b>Title</b>                  | Data delivery through beacons |
|                                                                                                                                                  | <b>Art Unit</b>               | 2614                          |
|                                                                                                                                                  | <b>Examiner Name</b>          | LE, KAREN L                   |
|                                                                                                                                                  | <b>Attorney Docket Number</b> | CA0419                        |

I hereby revoke all previous powers of attorney given in the above-identified application.

A Power of Attorney is submitted herewith.

**OR**

I hereby appoint Practitioner(s) associated with the following Customer Number as my/our attorney(s) or agent(s) to prosecute the application identified above, and to transact all business in the United States Patent and Trademark Office connected therewith:

3624

**OR**

I hereby appoint Practitioner(s) named below as my/our attorney(s) or agent(s) to prosecute the application identified above, and to transact all business in the United States Patent and Trademark Office connected therewith:

| Practitioner(s) Name | Registration Number |
|----------------------|---------------------|
|                      |                     |
|                      |                     |
|                      |                     |
|                      |                     |

Please recognize or change the correspondence address for the above-identified application to:

The address associated with the above-mentioned Customer Number.

**OR**

The address associated with Customer Number:

Firm or Individual Name

Address

City State Zip

Country

Telephone Email

I am the:

Applicant/Inventor.

**OR**

Assignee of record of the entire interest. See 37 CFR 3.71. Statement under 37 CFR 3.73(b) (Form PTO/SB/96) submitted herewith or filed on \_\_\_\_\_.

**SIGNATURE of Applicant or Assignee of Record**

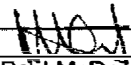
|                   |                                                                                     |
|-------------------|-------------------------------------------------------------------------------------|
| Signature         |  |
| Date              | 25/3/2009                                                                           |
| Name              | Paul McDonald                                                                       |
| Telephone         | +44 1481 745626                                                                     |
| Title and Company | Director, IPG Electronics 503 Limited                                               |

**NOTE:** Signatures of all the inventors or assignees of record of the entire interest or their representative(s) are required. Submit multiple forms if more than one signature is required. see below\*.

\*Total of 1 forms are submitted.

This collection of information is required by 37 CFR 1.31, 1.32 and 1.33. The information is required to obtain or retain a benefit by the public which is to file (and by the USPTO to process) an application. Confidentiality is governed by 35 U.S.C. 122 and 37 CFR 1.11 and 1.14. This collection is estimated to take 3 minutes to complete, including gathering, preparing, and submitting the completed application form to the USPTO. Time will vary depending upon the individual case. Any comments on the amount of time you require to complete this form and/or suggestions for reducing this burden, should be sent to the Chief Information Officer, U.S. Patent and Trademark Office, U.S. Department of Commerce, P.O. Box 1450, Alexandria, VA 22313-1450. DO NOT SEND FEES OR COMPLETED FORMS TO THIS ADDRESS. SEND TO: Commissioner for Patents, P.O. Box 1450, Alexandria, VA 22313-1450.

If you need assistance in completing the form, call 1-800-PTO-9199 and select option 2.

Under the Paperwork Reduction Act of 1995, no persons are required to respond to a collection of information unless it displays a valid OMB control number.

**STATEMENT UNDER 37 CFR 3.73(b)**

Applicant/Patent Owner: IPG ELECTRONICS 503 LIMITED

Application No./Patent No.: 09/876515

Filed/Issue Date: 06/07/2001

Titled: Data delivery through beacons

IPG ELECTRONICS 503 LIMITED, a Corporation

(Name of Assignee)

(Type of Assignee, e.g., corporation, partnership, university, government agency, etc.)

states that it is:

- 1.  the assignee of the entire right, title, and interest in;
- 2.  an assignee of less than the entire right, title, and interest in (The extent (by percentage) of its ownership interest is \_\_\_\_\_ %); or
- 3.  the assignee of an undivided interest in the entirety of (a complete assignment from one of the joint inventors was made)

the patent application/patent identified above, by virtue of either:

A.  An assignment from the inventor(s) of the patent application/patent identified above. The assignment was recorded in the United States Patent and Trademark Office at Reel \_\_\_\_\_, Frame \_\_\_\_\_, or for which a copy therefore is attached.

OR

B.  A chain of title from the inventor(s), of the patent application/patent identified above, to the current assignee as follows:

1. From: DAVIES, ROBERT J. To: KONINKLIJKE PHILIPS ELECTRONIC N.V.

The document was recorded in the United States Patent and Trademark Office at Reel 011893, Frame 0868, or for which a copy thereof is attached.

2. From: DAVIES, ROBERT J. and DOOLEY, SAUL R. To: KONINKLIJKE PHILIPS ELECTRONICS N.V.

The document was recorded in the United States Patent and Trademark Office at Reel 012276, Frame 0997, or for which a copy thereof is attached.

3. From: KONINKLIJKE PHILIPS ELECTRONICS N.V. To: IPG ELECTRONICS 503 LIMITED

The document was recorded in the United States Patent and Trademark Office at Reel 022203, Frame 0791, or for which a copy thereof is attached.

Additional documents in the chain of title are listed on a supplemental sheet(s).

As required by 37 CFR 3.73(b)(1)(i), the documentary evidence of the chain of title from the original owner to the assignee was, or concurrently is being, submitted for recordation pursuant to 37 CFR 3.11.

[NOTE: A separate copy (i.e., a true copy of the original assignment document(s)) must be submitted to Assignment Division in accordance with 37 CFR Part 3, to record the assignment in the records of the USPTO. See MPEP 302.08]

The undersigned (whose title is supplied below) is authorized to act on behalf of the assignee.

Signature

Date

Paul McDonald

Director

Printed or Typed Name

Title

This collection of information is required by 37 CFR 3.73(b). The information is required to obtain or retain a benefit by the public which is to file (and by the USPTO to process) an application. Confidentiality is governed by 35 U.S.C. 122 and 37 CFR 1.11 and 1.14. This collection is estimated to take 12 minutes to complete, including gathering, preparing, and submitting the completed application form to the USPTO. Time will vary depending upon the individual case. Any comments on the amount of time you require to complete this form and/or suggestions for reducing this burden, should be sent to the Chief Information Officer, U.S. Patent and Trademark Office, U.S. Department of Commerce, P.O. Box 1450, Alexandria, VA 22313-1450. DO NOT SEND FEES OR COMPLETED FORMS TO THIS ADDRESS. SEND TO: Commissioner for Patents, P.O. Box 1450, Alexandria, VA 22313-1450.

If you need assistance in completing the form, call 1-800-PTO-9199 and select option 2.

## Electronic Acknowledgement Receipt

|                                             |                                 |
|---------------------------------------------|---------------------------------|
| <b>EFS ID:</b>                              | 5068312                         |
| <b>Application Number:</b>                  | 09876515                        |
| <b>International Application Number:</b>    |                                 |
| <b>Confirmation Number:</b>                 | 9201                            |
| <b>Title of Invention:</b>                  | Data delivery through beacons   |
| <b>First Named Inventor/Applicant Name:</b> | Robert J. Davies                |
| <b>Customer Number:</b>                     | 24737                           |
| <b>Filer:</b>                               | Thomas A Mattioli/Yolanda Lopez |
| <b>Filer Authorized By:</b>                 | Thomas A Mattioli               |
| <b>Attorney Docket Number:</b>              | GB 000109                       |
| <b>Receipt Date:</b>                        | 31-MAR-2009                     |
| <b>Filing Date:</b>                         | 07-JUN-2001                     |
| <b>Time Stamp:</b>                          | 14:23:24                        |
| <b>Application Type:</b>                    | Utility under 35 USC 111(a)     |

### Payment information:

|                        |    |
|------------------------|----|
| Submitted with Payment | no |
|------------------------|----|

### File Listing:

| Document Number | Document Description | File Name                                       | File Size(Bytes)/<br>Message Digest                   | Multi Part /.zip | Pages (if appl.) |
|-----------------|----------------------|-------------------------------------------------|-------------------------------------------------------|------------------|------------------|
| 1               |                      | 20090331_CIPM_PH-<br>CA0419_PowerofAttorney.PDF | 84456<br>6fe1d4724d96a756d67f8304a073a97d224<br>c25e2 | yes              | 2                |

| <b>Multipart Description/PDF files in .zip description</b>                                                                                                                                                                                                                                                                                                                                                                                                                                                                                                                                                                                                                                                                                                                                                                                                                                                                                                                                                                                                                                                                                                                                                                                                                                                                                                                                                                                                                                                                                                                                                                                                                                                                                                                  |  |              |            |
|-----------------------------------------------------------------------------------------------------------------------------------------------------------------------------------------------------------------------------------------------------------------------------------------------------------------------------------------------------------------------------------------------------------------------------------------------------------------------------------------------------------------------------------------------------------------------------------------------------------------------------------------------------------------------------------------------------------------------------------------------------------------------------------------------------------------------------------------------------------------------------------------------------------------------------------------------------------------------------------------------------------------------------------------------------------------------------------------------------------------------------------------------------------------------------------------------------------------------------------------------------------------------------------------------------------------------------------------------------------------------------------------------------------------------------------------------------------------------------------------------------------------------------------------------------------------------------------------------------------------------------------------------------------------------------------------------------------------------------------------------------------------------------|--|--------------|------------|
| <b>Document Description</b>                                                                                                                                                                                                                                                                                                                                                                                                                                                                                                                                                                                                                                                                                                                                                                                                                                                                                                                                                                                                                                                                                                                                                                                                                                                                                                                                                                                                                                                                                                                                                                                                                                                                                                                                                 |  | <b>Start</b> | <b>End</b> |
| Power of Attorney                                                                                                                                                                                                                                                                                                                                                                                                                                                                                                                                                                                                                                                                                                                                                                                                                                                                                                                                                                                                                                                                                                                                                                                                                                                                                                                                                                                                                                                                                                                                                                                                                                                                                                                                                           |  | 1            | 1          |
| Assignee showing of ownership per 37 CFR 3.73(b).                                                                                                                                                                                                                                                                                                                                                                                                                                                                                                                                                                                                                                                                                                                                                                                                                                                                                                                                                                                                                                                                                                                                                                                                                                                                                                                                                                                                                                                                                                                                                                                                                                                                                                                           |  | 2            | 2          |
| <b>Warnings:</b>                                                                                                                                                                                                                                                                                                                                                                                                                                                                                                                                                                                                                                                                                                                                                                                                                                                                                                                                                                                                                                                                                                                                                                                                                                                                                                                                                                                                                                                                                                                                                                                                                                                                                                                                                            |  |              |            |
| <b>Information:</b>                                                                                                                                                                                                                                                                                                                                                                                                                                                                                                                                                                                                                                                                                                                                                                                                                                                                                                                                                                                                                                                                                                                                                                                                                                                                                                                                                                                                                                                                                                                                                                                                                                                                                                                                                         |  |              |            |
| <b>Total Files Size (in bytes):</b>                                                                                                                                                                                                                                                                                                                                                                                                                                                                                                                                                                                                                                                                                                                                                                                                                                                                                                                                                                                                                                                                                                                                                                                                                                                                                                                                                                                                                                                                                                                                                                                                                                                                                                                                         |  | 84456        |            |
| <p><b>This Acknowledgement Receipt evidences receipt on the noted date by the USPTO of the indicated documents, characterized by the applicant, and including page counts, where applicable. It serves as evidence of receipt similar to a Post Card, as described in MPEP 503.</b></p> <p><b><u>New Applications Under 35 U.S.C. 111</u></b><br/> <b>If a new application is being filed and the application includes the necessary components for a filing date (see 37 CFR 1.53(b)-(d) and MPEP 506), a Filing Receipt (37 CFR 1.54) will be issued in due course and the date shown on this Acknowledgement Receipt will establish the filing date of the application.</b></p> <p><b><u>National Stage of an International Application under 35 U.S.C. 371</u></b><br/> <b>If a timely submission to enter the national stage of an international application is compliant with the conditions of 35 U.S.C. 371 and other applicable requirements a Form PCT/DO/EO/903 indicating acceptance of the application as a national stage submission under 35 U.S.C. 371 will be issued in addition to the Filing Receipt, in due course.</b></p> <p><b><u>New International Application Filed with the USPTO as a Receiving Office</u></b><br/> <b>If a new international application is being filed and the international application includes the necessary components for an international filing date (see PCT Article 11 and MPEP 1810), a Notification of the International Application Number and of the International Filing Date (Form PCT/RO/105) will be issued in due course, subject to prescriptions concerning national security, and the date shown on this Acknowledgement Receipt will establish the international filing date of the application.</b></p> |  |              |            |



UNITED STATES PATENT AND TRADEMARK OFFICE

UNITED STATES DEPARTMENT OF COMMERCE  
United States Patent and Trademark Office  
Address: COMMISSIONER FOR PATENTS  
P.O. Box 1450  
Alexandria, Virginia 22313-1450  
www.uspto.gov

| APPLICATION NUMBER | FILING OR 371(C) DATE | FIRST NAMED APPLICANT | ATTY. DOCKET NO./TITLE |
|--------------------|-----------------------|-----------------------|------------------------|
| 09/876,515         | 06/07/2001            | Robert J. Davies      | GB 000109              |

24737  
PHILIPS INTELLECTUAL PROPERTY & STANDARDS  
P.O. BOX 3001  
BRIARCLIFF MANOR, NY 10510

**CONFIRMATION NO. 9201**  
**MISCELLANEOUS NOTICE**



Date Mailed: 02/02/2009

A communication which cannot be delivered in electronic form has been mailed to the applicant.



UNITED STATES PATENT AND TRADEMARK OFFICE

UNITED STATES DEPARTMENT OF COMMERCE
United States Patent and Trademark Office
Address: COMMISSIONER FOR PATENTS
P.O. Box 1450
Alexandria, Virginia 22313-1450
www.uspto.gov

Table with 5 columns: APPLICATION NO., FILING DATE, FIRST NAMED INVENTOR, ATTORNEY DOCKET NO., CONFIRMATION NO.
09/876,515 06/07/2001 Robert J. Davies GB 000109 9201

24737 7500 01/28/2009
PHILIPS INTELLECTUAL PROPERTY & STANDARDS
P.O. BOX 3001
BRIARCLIFF MANOR, NY 10510

EXAMINER

L.E, KAREN L

ART UNIT PAPER NUMBER

2614

MAIL DATE DELIVERY MODE

01/28/2009

PAPER

Please find below and/or attached an Office communication concerning this application or proceeding.

The time period for reply, if any, is set in the attached communication.





UNITED STATES DEPARTMENT OF COMMERCE

U.S. Patent and Trademark Office

Address: COMMISSIONER FOR PATENTS

P.O. Box 1450

Alexandria, Virginia 22313-1450

|                                         |                    |                                                           |                            |
|-----------------------------------------|--------------------|-----------------------------------------------------------|----------------------------|
| <b>APPLICATION NO./<br/>CONTROL NO.</b> | <b>FILING DATE</b> | <b>FIRST NAMED INVENTOR /<br/>PATENT IN REEXAMINATION</b> | <b>ATTORNEY DOCKET NO.</b> |
| 09876515                                | 6/7/2001           | DAVIES ET AL.                                             | GB 000109                  |

PHILIPS INTELLECTUAL PROPERTY & STANDARDS  
P.O. BOX 3001  
BRIARCLIFF MANOR, NY 10510

**EXAMINER**

KAREN L. LE

|                 |              |
|-----------------|--------------|
| <b>ART UNIT</b> | <b>PAPER</b> |
|-----------------|--------------|

2614

20090122

DATE MAILED:

**Please find below and/or attached an Office communication concerning this application or proceeding.**

**Commissioner for Patents**

The Board of Patent Appeals and Interferences affirmed the rejection(s) against independent claims [ 1, 8,10,11], but reversed all rejections against claims [ 3 and 13 ] dependent thereon. There are no allowed claims in the application. The independent claims are cancelled by the examiner in accordance with MPEP § 1214.06. Applicant is given a ONE MONTH TIME PERIOD from the mailing date of this letter in which to present the dependent claim(s) in independent form to avoid ABANDONMENT of the application. NO EXTENSIONS OF TIME UNDER 37 CFR 1.136(a) WILL BE GRANTED. Prosecution is otherwise closed.

/CURTIS KUNTZ/  
Supervisory Patent Examiner, Art Unit 2614

/Karen L Le/  
Examiner, Art Unit 2614



UNITED STATES PATENT AND TRADEMARK OFFICE

UNITED STATES DEPARTMENT OF COMMERCE
United States Patent and Trademark Office
Address: COMMISSIONER FOR PATENTS
P.O. Box 1450
Alexandria, Virginia 22313-1450
www.uspto.gov

Table with 4 columns: APPLICATION NUMBER (09/876,515), FILING DATE (06/07/2001), FIRST NAMED APPLICANT (Robert J. Davies), ATTY. DOCKET NO./TITLE (GB 000109)

24737
PHILIPS INTELLECTUAL PROPERTY & STANDARDS
P.O. BOX 3001
BRIARCLIFF MANOR, NY 10510

CONFIRMATION NO. 9201



Cc:VOLPE AND KOENIG, P.C.
UNITED PLAZA, SUITE 1600
30 SOUTH 17TH STREET
PHILADELPHIA, PA 19103

Date Mailed: 01/27/09

DENIAL OF REQUEST FOR POWER OF ATTORNEY

The request for Power of Attorney filed 01/21/09 is acknowledged. However, the request cannot be granted at this time for the reason stated below.

- Checkboxes for reasons of denial: 1. Not signed by applicant/assignee/attorney. 2. Power of Attorney from assignee, certificate not received. 3. Empowerment omitted. 4. Inventor without authority. 5. Signature of co-inventor omitted. 6. Attorney not registered.

Questions relating to this Notice should be directed to the Application Assistance Unit.

Handwritten signature

Office of Data Management, Application Assistance Unit (571) 272-4000, or (571) 272-4200, or 1-888-786-0101

**PATENT**

**IN THE UNITED STATES PATENT AND TRADEMARK OFFICE**

In the **PATENT APPLICATION** of:

Davies et al.

**Application No.:** 09/876,515

**Filed:** June 7, 2001

**Title:** DATA DELIVERY THROUGH  
BEACONS

Our File: CIPM-PH-CA0419

**REVOCATION OF POWER OF ATTORNEY AND  
POWER OF ATTORNEY**

Commissioner for Patents  
P.O. Box 1450  
Alexandria, VA 22313-1450

Sir:

United States Patent Application No. 09/876,515 is now owned by IPG Electronics 503 Limited. IPG Electronics 503 Limited hereby revokes all prior powers of attorney or authorizations of agent for this application and appoints the registered attorneys and agents associated with Volpe and Koenig, P.C., Customer No. 3624, as attorneys or agents to prosecute the application, and to transact all business in the United States Patent and Trademark Office connected therewith and request that all correspondence relating to this application be directed to **Customer No. 3624, namely, Volpe and Koenig, P.C.** The undersigned is authorized to act on behalf of the assignee.

Respectfully submitted,  
IPG Electronics 503 Limited

16 JANUARY 2009  
Date

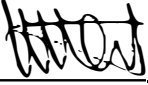
By   
Paul McDonald  
Director

## Electronic Acknowledgement Receipt

|                                             |                                 |
|---------------------------------------------|---------------------------------|
| <b>EFS ID:</b>                              | 4644971                         |
| <b>Application Number:</b>                  | 09876515                        |
| <b>International Application Number:</b>    |                                 |
| <b>Confirmation Number:</b>                 | 9201                            |
| <b>Title of Invention:</b>                  | Data delivery through beacons   |
| <b>First Named Inventor/Applicant Name:</b> | Robert J. Davies                |
| <b>Customer Number:</b>                     | 24737                           |
| <b>Filer:</b>                               | Thomas A Mattioli/Yolanda Lopez |
| <b>Filer Authorized By:</b>                 | Thomas A Mattioli               |
| <b>Attorney Docket Number:</b>              | GB 000109                       |
| <b>Receipt Date:</b>                        | 21-JAN-2009                     |
| <b>Filing Date:</b>                         | 07-JUN-2001                     |
| <b>Time Stamp:</b>                          | 11:35:33                        |
| <b>Application Type:</b>                    | Utility under 35 USC 111(a)     |

### Payment information:

|                        |    |
|------------------------|----|
| Submitted with Payment | no |
|------------------------|----|

### File Listing:

| Document Number | Document Description | File Name                                       | File Size(Bytes)/<br>Message Digest                       | Multi Part /.zip | Pages (if appl.) |
|-----------------|----------------------|-------------------------------------------------|-----------------------------------------------------------|------------------|------------------|
| 1               | Power of Attorney    | 20090121_CIPM_PH_CA0419_<br>PowerofAttorney.pdf | 24206<br><br>5ebb2#f105ce58c61b28e22b21a119b68e3<br>0498# | no               | 1                |

### Warnings:

### Information:

**Total Files Size (in bytes):**

24206

**This Acknowledgement Receipt evidences receipt on the noted date by the USPTO of the indicated documents, characterized by the applicant, and including page counts, where applicable. It serves as evidence of receipt similar to a Post Card, as described in MPEP 503.**

**New Applications Under 35 U.S.C. 111**

**If a new application is being filed and the application includes the necessary components for a filing date (see 37 CFR 1.53(b)-(d) and MPEP 506), a Filing Receipt (37 CFR 1.54) will be issued in due course and the date shown on this Acknowledgement Receipt will establish the filing date of the application.**

**National Stage of an International Application under 35 U.S.C. 371**

**If a timely submission to enter the national stage of an international application is compliant with the conditions of 35 U.S.C. 371 and other applicable requirements a Form PCT/DO/EO/903 indicating acceptance of the application as a national stage submission under 35 U.S.C. 371 will be issued in addition to the Filing Receipt, in due course.**

**New International Application Filed with the USPTO as a Receiving Office**

**If a new international application is being filed and the international application includes the necessary components for an international filing date (see PCT Article 11 and MPEP 1810), a Notification of the International Application Number and of the International Filing Date (Form PCT/RO/105) will be issued in due course, subject to prescriptions concerning national security, and the date shown on this Acknowledgement Receipt will establish the international filing date of the application.**



UNITED STATES PATENT AND TRADEMARK OFFICE

UNITED STATES DEPARTMENT OF COMMERCE
United States Patent and Trademark Office
Address: COMMISSIONER FOR PATENTS
P.O. Box 1450
Alexandria, Virginia 22313-1450
www.uspto.gov

Table with 5 columns: APPLICATION NO., FILING DATE, FIRST NAMED INVENTOR, ATTORNEY DOCKET NO., CONFIRMATION NO.
09/876,515 06/07/2001 Robert J. Davies GB 000109 9201

24737 7590 11/10/2008
PHILIPS INTELLECTUAL PROPERTY & STANDARDS
P.O. BOX 3001
BRIARCLIFF MANOR, NY 10510

EXAMINER

L.E, KAREN L

ART UNIT PAPER NUMBER

2614

MAIL DATE DELIVERY MODE

11/10/2008

PAPER

Please find below and/or attached an Office communication concerning this application or proceeding.

The time period for reply, if any, is set in the attached communication.

UNITED STATES PATENT AND TRADEMARK OFFICE

---

BEFORE THE BOARD OF PATENT APPEALS  
AND INTERFERENCES

---

*Ex parte* ROBERT J. DAVIES and SAUL R. DOOLEY

---

Appeal 2008-3403  
Application 09/876,515  
Technology Center 2600

---

Decided: November 10, 2008

---

Before JAMESON LEE, RICHARD TORCZON and SALLY C. MEDLEY,  
*Administrative Patent Judges.*

MEDLEY, *Administrative Patent Judge.*

DECISION ON APPEAL

**A. Statement of the Case**

Koninklijke Philips Electronics N.V. (“Philips”), the real party in interest, seeks review under 35 U.S.C. § 134(a) of a Final Rejection of claims 1-14. We have jurisdiction under 35 U.S.C. § 6(b). We affirm-in-part.

Philips' invention is related to a communication system that includes a beacon device and a portable device, such as a wireless telephone. The beacon device broadcasts a series of inquiry messages each in the form of a plurality of data fields according to a first communications protocol. The beacon device adds location information in an additional data field to each inquiry message before transmission. The portable device receives the transmitted inquiry messages that include the location information. Spec. Abs., 3.

Representative claim 1, reproduced from the Claim Appendix of the Appeal Brief, reads as follows:

A communications system comprising at least one beacon device capable of wireless message transmission and at least one portable device capable of receiving such a message transmission, wherein the beacon is arranged to broadcast a series of inquiry messages each in the form of a plurality of predetermined data fields arranged according to a first communications protocol, wherein the beacon is further arranged to add to each inquiry message prior to transmission an additional data field, and wherein the at least one portable device is arranged to receive the transmitted inquiry messages and read data from said additional data field, the additional data field including location information.

Claims App., App. Br. 12.

The Examiner relies on the following prior art in rejecting the claims on appeal:

|                      |           |               |
|----------------------|-----------|---------------|
| Whiteside            | 5,835,861 | Nov. 10, 1998 |
| King et al. ("King") | 6,169,498 | Jan. 2, 2001  |

The Examiner rejected claims 1-14 under 35 U.S.C. § 103(a) as unpatentable over Whiteside and King.



**B. Findings of Fact (“FF”)**

1. "Inquiry" is defined as a seeking for truth, information, or knowledge. THE RANDOM HOUSE COLLEGE DICTIONARY (Rev. Ed. 1975).
2. Whiteside describes a billboard 20 with an infrared transceiver 22 that continuously broadcasts a vendor's telephone number for receipt by a wireless telephone 10. Col. 2, ll. 9-16.
3. The broadcast carries the vendor's telephone number in data message 16. Col. 2, ll. 16-18
4. We take official notice that when placing a telephone call within the United States, a user enters the area code first as a first data field and enters the remainder of the number in one or more additional data fields.
5. We take official notice that the first data field of a U.S. telephone number is often distinguished from the additional data fields by use of parenthesis, a space or a hyphen.
6. We take official notice that when placing an international call, a user enters the country code in a first data field and enters the remainder of the number in one or more additional data fields.
7. We take official notice that area codes and country codes indicate a specific geographical location or region.
8. Whiteside describes that message 16 (broadcast from billboard 20) can also be used to convey other data such as a bank interest rate or current product cost. Col. 2, ll. 35-36.
9. Message 15 (transmitted from wireless telephone 10) can also be enhanced to make a more specific request for one of the items of information that can be supplied by the billboard. Col. 2, ll. 36-39.

10. Billboard 20 and wireless telephone 10 communicate via modulated infrared (IR) signals. Col. 1, ll. 36-40, 48-49.
11. The wireless telephone includes an IR receiver 14. Col. 1, ll. 59-64.
12. Billboard 20 and wireless telephone 10 can alternatively communicate via radio frequency links. Col. 2, l. 65-col. 3, l. 1.
13. When using radio frequency links, the IR transmitter 13 and IR receiver 14 are replaced in the wireless telephone by its existing RF circuitry and antenna. Col. 3, ll. 1-14.
14. Phillips does not challenge the Examiner's finding that Bluetooth is old and well known wireless technology that enables devices such as portable computers, cell phones, and portable handheld devices to connect to each other and the Internet. Final Rejection 3-4; Ans. 4; Br. 8, 10.

### **C. Principles of Law**

“In the patentability context, claims are to be given their broadest reasonable interpretations” *In re Van Geuns*, 988 F.2d 1181, 1184 (Fed. Cir. 1993) (citations omitted). “Absent claim language carrying a narrow meaning, the PTO should only limit the claim based on the specification or prosecution history when those sources expressly disclaim the broader definition.” *In re Bigio*, 381 F.3d 1320, 1325 (Fed. Cir. 2004).

“A person of ordinary skill is also a person of ordinary creativity, not an automaton.” *KSR Int'l Co. v. Teleflex Inc.*, 127 S.Ct. 1727, 1742 (2007).

A reference may be said to teach away when a person of ordinary skill, upon reading the reference, would be discouraged from following the path set out in the reference, or would be led in a direction divergent from the path that was taken by the applicant. The degree of teaching away will of course depend on the particular facts; in general, a reference

will teach away if it suggests that the line of development flowing from the reference's disclosure is unlikely to be productive of the result sought by the applicant.

*In re Gurley*, 27 F.3d 551, 553 (Fed. Cir. 1994).

“Section 103 forbids issuance of a patent when ‘the differences between the subject matter sought to be patented and the prior art are such that the subject matter as a whole would have been obvious at the time the invention was made to a person having ordinary skill in the art to which said subject matter pertains.’” *KSR Int'l Co. v. Teleflex Inc.*, 127 S.Ct. 1727, 1734 (2007).

In *KSR*, the Supreme Court explained that despite the enactment of Section 103 and the *Graham* analysis there still remains “the need for caution in granting a patent based on the combination of elements found in the prior art.” *Id.* at 1739. Based on its precedent, the Court reaffirmed the principle that “[t]he combination of familiar elements according to known methods is likely to be obvious when it does no more than yield predictable results.” *Id.*

The Court's opinion in *United States v. Adams*, 383 U.S. 39, 40 (1966) is illustrative of the application of this principle in the case where the claimed invention is a prior art structure altered by substituting one element in the structure for another known element. *Id.* at 1739-40. “The Court [in *Adams*] recognized that when a patent claims a structure already known in the prior art that is altered by the mere substitution of one element for another known in the field, the combination must do more than yield a predictable result.” *Id.* at 1740 (citation omitted) (The Court ultimately found unexpected results resulting from prior art warnings to be dispositive of nonobviousness).

## **D. Analysis**

### Claims 1, 8, 10 and 11.

Representative claim 1 recites “the beacon is arranged to broadcast a series of inquiry messages . . .”. Br. 12. Consistent with the dictionary definition of the term inquiry (FF<sup>1</sup> 1), we broadly construe an “inquiry message” as a message seeking information or knowledge. Philips does not direct us to an express disclaimer of a broader definition for an inquiry message.

Philips argues that Whiteside does not describe a beacon arranged to broadcast a series of inquiry messages. Br. 5. Philips argues that instead Whiteside describes continuously broadcasting a vendor’s telephone number or sending a message from a billboard in response to a message sent from a wireless telephone. Br. 5.

Whiteside describes a billboard 20 with an infrared transceiver 22 that *continuously* broadcasts a vendor’s telephone number. FF 2. The broadcast carries the vendor’s telephone number in data message 16. FF 3. The data message 16 that includes the vendor’s telephone number is an inquiry message because the message is implicitly seeking information (e.g., a response) from any potential message recipients to call the phone number provided. Whiteside’s vendor telephone number is continuously broadcasted. FF 2. Thus, the continuous broadcast of the vendor’s telephone number is a series of inquiry messages. For these reasons, we find that Whiteside describes a beacon that broadcasts a series of inquiry messages.

---

<sup>1</sup> FF denotes Finding of Fact.

Claim 1 also recites “a series of inquiry messages each in the form of a plurality of predetermined data fields arranged according to a first communications protocol . . .”. Br. 12.

Philips argues that Whiteside does not describe the inquiry messages being in the form of a plurality of predetermined data fields arranged according to a predetermined protocol. Br. 5. Philips also argues that Whiteside does not teach or suggest what types of structures and/or protocols are used to transmit information. Br. 5

As explained before, Whiteside describes continuously broadcasting a vendor’s telephone number. FF 2. It is well known that telephone numbers are divided into predetermined data fields. For example, when placing a telephone call within the United States, a user enters the area code first as a first data field and enters the remainder of the number in one or more additional data fields. FF 4. In this case, the first data field is often distinguished from the additional data fields by use of parenthesis, a space or a hyphen. FF 5. Likewise, for placing an international call, the user enters the country code in a first data field and enters the remainder of the number in one or more additional data fields. FF 6. It would have been obvious to one of ordinary skill that each instance of Whiteside’s broadcasted telephone number (i.e., each inquiry message) is in the form of a plurality of predetermined data fields arranged according to a first communications protocol, e.g., country code or area code in a first data field followed by the remainder of the telephone number in one or more additional data fields.

Claim 1 further recites that “the beacon is further arranged to add to each inquiry message prior to transmission an additional data field . . . the additional data field including location information . . .” Br. 12.

Philips argues that Whiteside is silent about adding an additional data field prior to transmission. Br. 6. Philips also argues that Whiteside and King do not teach that the additional data field is location information. Br. 6.

Whiteside describes continuously broadcasting a vendor's telephone number. FF 2. It is well known that telephone numbers are divided into predetermined data fields which include a data field for an area code or country code. FFs 4-6. The particular area code and/or country code of the telephone number indicates a specific geographical location or region. FF 7. Thus, Whiteside's continuously broadcasted vendor telephone number also includes location information in the area code and/or country code.

Alternatively, Whiteside further describes that message 16 can also be used to convey other data such as a bank interest rate or current product cost. FF 8. Whiteside describes sending a vendor's telephone number and also sending bank interest rates or product cost to a message recipient, which suggests that the message recipient may find further vendor information useful such as the vendor's address. Since each message 16 already includes the vendor's telephone number, it would have been obvious to one with ordinary skill to add the vendor's location information, e.g., vendor's address, to the message since this information may be useful to the message recipient. It would have also been obvious to one of ordinary skill to add an additional data field containing the vendor's location information to the inquiry message prior to transmission for the purpose of keeping the vendor's telephone number and location information in the same message. Adding an additional data field with the vendor location to the inquiry message containing the vendor telephone number ensures that message

recipients understand that the telephone number and location information correspond to the same vendor. Using an additional data field for the vendor's location information requires no more than ordinary skill in the art since the prior art already shows using a plurality of data fields for the telephone number.

For all these reasons we find that Philips has not sustained its burden of showing that the Examiner erred in rejecting claims 1, 8, 10 and 11 as unpatentable over Whiteside and King.

Claims 2 and 12

Claims 2 and 12 are dependent on claim 1 and 11 respectively. Br. 12, 14. Representative claim 2 recites "the beacon is arranged to add said additional data field at the end of a respective inquiry message." Br. 12.

Philips argues that Whiteside does not describe the aforementioned claim limitations. Br. 7.

Whiteside does not explicitly describe that an additional data field can be added at the end of the inquiry message. However, one with ordinary skill in the art would have recognized that the additional data field (i.e., vendor's location) could be added at the end of the message (i.e., vendor's telephone number) or could be added to the message at any other desirable position in the message, such as the beginning. "A person of ordinary skill is also a person of ordinary creativity, not an automaton." *KSR Int'l Co. v. Teleflex Inc.*, 127 S.Ct. 1727, 1742 (2007).

For this reason we find that Philips has not sustained its burden of showing that the Examiner erred in rejecting claims 2 and 12 as unpatentable over Whiteside and King.

Claims 3 and 13

Claims 3 and 13 are dependent on claim 1 and 11 respectively. Br. 12, 14. Representative claim 3 recites “the beacon is arranged to include an indication in one of said predetermined data fields, said indication denoting the presence of said additional data field.” Br. 12.

The Examiner and Philips disagree as to whether Whiteside describes the aforementioned claim limitations. Final Rejection 3; Ans. 4, citing Whiteside col. 2, ll. 35-39; Br. 7. Philips also argues that the citation to Whiteside provided by the Examiner is irrelevant. Br. 7.

The Whiteside citation provided by the Examiner describes that message 16 can also be used to convey other data such as a bank interest rate or current product cost and message 15 can also be enhanced to make a more specific request for one of the items of information that can be supplied by the billboard. FFs 8-9. The Examiner does not direct us to, and we can not find, where Whiteside or King describe including an indicator in one of the predetermined data fields that denotes the presence of the additional data field. Moreover, we do not find that one with ordinary skill would know to include an indicator in Whiteside’s broadcasted inquiry message (i.e., vendor’s telephone number) that denotes the presence of the additional data field (i.e., vendor’s location).

For all these reasons, we find that the Examiner erred in rejecting claims 3 and 13 as unpatentable over Whiteside and King.

Claims 4, 9 and 14

Representative claim 9 is dependent on claim 8 and further recites “wherein the receiver is configured to receive messages according to Bluetooth protocols.” Br. 13.



The Examiner finds that Bluetooth is old and well known wireless technology that enables devices such as portable computers, cell phones, and portable handheld devices to connect to each other and the Internet and Phillips does not contest this finding. FF 14.

Philips argues that Whiteside teaches away from a Bluetooth protocol because Whiteside teaches communications via an infrared signal instead of Bluetooth communication via short range radio frequency signals. Br. 8, 10.

Philips arguments are unpersuasive. Philips does not explain why a person of ordinary skill, upon reading the Whiteside reference, would be discouraged from following the path set out in the reference, or led in a direction divergent from the path that was taken by the inventors. Philips also does not dispute the Examiner's findings with respect to Bluetooth messaging being old and well known in the art. Moreover, contrary to Phillips' argument, Whiteside describes alternatively using radio frequency (RF) signals and RF receivers for communications. FFs 10-13. It would have been obvious to one with ordinary skill in the art at the time the invention was made to substitute a Bluetooth protocol and Bluetooth receiver for Whiteside's RF signals and RF receiver. The Supreme Court reaffirmed the principle that "when a [application] claims a structure already known in the prior art that is altered by the mere substitution of one element for another known in the field, the combination must do more than yield a predictable result." *KSR Int'l Co. v. Teleflex Inc.*, 127 S.Ct. 1727, 1734 (2007). Philips does not present evidence that substituting Bluetooth protocol and associated Bluetooth receiver for Whiteside's RF communication signals and associated RF receiver yields an unpredictable result.

For all these reasons we find that Philips has not sustained its burden of showing that the Examiner erred in rejecting claims 4 and 14 as unpatentable over Whiteside and King.

Claims 5 and 7

Claims 5 and 7 are dependent on claims 4 and 1, respectively. Claim 5 recites “a special Dedicated Inquiry Access Code (DIAC) is used to indicate the presence of location information in the additional data field.” Br. 12. Claim 7 recites the “wireless messaging system employs frequency hopping, and . . . location data is sent on each frequency used for inquiry message broadcasts.” Br. 13.

Philips argues that Whiteside does not describe the aforementioned limitations of claims 5 and 7. Br. 8-9. Philips also argues that the Whiteside citation provided by the Examiner to support the rejection is irrelevant. Br. 8-9.

We are not persuaded by Philips arguments. Contrary to Philips arguments, the Examiner does not provide a citation to Whiteside to support the rejection. In fact, the Examiner acknowledges that Whiteside does not describe a Dedicated Inquiry Access Code (DIAC) and frequency hopping. Final Rejection 4, Ans. 4. In addition, Philips does not dispute the Examiner’s findings that (1) DIAC is old and well known according to the Bluetooth specification; (2) a unit adapted to communicate according to the Bluetooth specification receives an inquiry message including a general inquiry access code (GIAC) or an appropriate DIAC and may respond by sending an inquiry response message; and (3) the inquiry response message is a frequency hop synchronization message. Final Rejection 4, Ans. 4. Philips also does not dispute the Examiner’s determination that it would

have been obvious to one with ordinary skill in the art at the time the invention was made to include the DIAC to indicate the presence of location information in the additional data field. Final Rejection 4, Ans. 4.

For all these reasons we find that Philips has not sustained its burden of showing that the Examiner erred in rejecting claims 5 and 7 as unpatentable over Whiteside and King.

Claim 6

Claim 6 is dependent on claim 1 and recites “wherein the presence of location information in the additional data field is indicated with header information appearing in the additional data field.”

Philips argues that Whiteside and King do not teach or suggest the disputed claim limitations. Br. 9-10. Philips also argues that the Examiner’s citation to King is irrelevant. Br. 9-10.

As explained before, Whiteside describes that message 16 can also convey bank interest rate or current product cost (FF 8) which suggests that the message recipient may find additional vendor information useful such as the vendor’s address. Since each message 16 already includes the vendor’s telephone number, it would have been obvious to one with ordinary skill to add the vendor’s location information, e.g. vendor’s address, to the message since this information may be useful to the message recipient. It would further would have been obvious to one of ordinary skill to include header information, e.g., “Location”, “Interest Rate”, “Product Cost”, in the additional data field to ensure that the message recipient will understand the context of the data contained in the additional data field.

Appeal 2008-3403  
Application 09/876,515

For all these reasons, we find that Philips has not sustained its burden of showing that the Examiner erred in rejecting claim 6 as unpatentable over Whiteside and King.

**E. Decision**

Upon consideration of the appeal, and for the reasons given herein:

the decision of the Examiner rejecting claims 1-2, 4-12 and 14 under 35 U.S.C. § 103(a) as unpatentable over Whiteside and King is affirmed; and

the decision of the Examiner rejecting claims 3 and 13 under 35 U.S.C. § 103(a) as unpatentable over Whiteside and King is reversed.

No time period for taking any subsequent action in connection with this appeal may be extended under 37 C.F.R. § 1.136(a).

AFFIRMED IN-PART

rvb

PHILIPS INTELLECTUAL PROPERTY & STANDARDS  
P.O. BOX 3001  
BRIARCLIFF MANOR NY 10510



UNITED STATES PATENT AND TRADEMARK OFFICE

UNITED STATES DEPARTMENT OF COMMERCE
United States Patent and Trademark Office
Address: COMMISSIONER FOR PATENTS
P.O. Box 1450
Alexandria, Virginia 22313-1450
www.uspto.gov

Table with 5 columns: APPLICATION NO., FILING DATE, FIRST NAMED INVENTOR, ATTORNEY DOCKET NO., CONFIRMATION NO.
09/876,515 06/07/2001 Robert J. Davies GB 000109 9201

24737 7590 05/12/2008
PHILIPS INTELLECTUAL PROPERTY & STANDARDS
P.O. BOX 3001
BRIARCLIFF MANOR, NY 10510

EXAMINER

L.E, KAREN L

ART UNIT PAPER NUMBER

2614

MAIL DATE DELIVERY MODE

05/12/2008

PAPER

Please find below and/or attached an Office communication concerning this application or proceeding.

The time period for reply, if any, is set in the attached communication.



**United States Patent and Trademark Office**

**Under Secretary of Commerce for Intellectual Property and  
Director of the United States Patent and Trademark Office**  
P.O. Box 1450  
Alexandria, Virginia 22313-1450  
[www.uspto.gov](http://www.uspto.gov)

PHILIPS INTELLECTUAL PROPERTY & STANDARDS  
P.O. BOX 3001  
BRIARCLIFF MANOR, NY 10510

Appeal No: 2008-3403  
Application: 09/876,515  
Appellant: Robert J. Davies et al.

**Board of Patent Appeals and Interferences  
Docketing Notice**

Application 09/876,515 was received from the Technology Center at the Board on April 02, 2008 and has been assigned Appeal No: 2008-3403.

A review of the file indicates that the following documents have been filed by appellant:

Appeal Brief filed on: January 16, 2007  
Reply Brief filed on: NONE  
Request for Hearing filed on: NONE

In all future communications regarding this appeal, please include both the application number and the appeal number.

The mailing address for the Board is:

**BOARD OF PATENT APPEALS AND INTERFERENCES  
UNITED STATES PATENT AND TRADEMARK OFFICE  
P.O. BOX 1450  
ALEXANDRIA, VIRGINIA 22313-1450**

The facsimile number of the Board is 571-273-0052. Because of the heightened security in the Washington D.C. area, facsimile communications are recommended. Telephone inquiries can be made by calling 571-272-9797 and should be directed to a Program and Resource Administrator.

By order of the Board of Patent Appeals and Interferences



UNITED STATES PATENT AND TRADEMARK OFFICE

UNITED STATES DEPARTMENT OF COMMERCE  
United States Patent and Trademark Office  
Address: COMMISSIONER FOR PATENTS  
P.O. Box 1450  
Alexandria, Virginia 22313-1450  
www.uspto.gov

| APPLICATION NO. | FILING DATE | FIRST NAMED INVENTOR | ATTORNEY DOCKET NO. | CONFIRMATION NO. |
|-----------------|-------------|----------------------|---------------------|------------------|
| 09/876,515      | 06/07/2001  | Robert J. Davies     | GB 000109           | 9201             |

24737 7590 12/27/2007  
PHILIPS INTELLECTUAL PROPERTY & STANDARDS  
P.O. BOX 3001  
BRIARCLIFF MANOR, NY 10510

EXAMINER

LE, KAREN L

| ART UNIT | PAPER NUMBER |
|----------|--------------|
| 2614     |              |

| MAIL DATE  | DELIVERY MODE |
|------------|---------------|
| 12/27/2007 | PAPER         |

**Please find below and/or attached an Office communication concerning this application or proceeding.**

The time period for reply, if any, is set in the attached communication.



**UNITED STATES DEPARTMENT OF COMMERCE  
U.S. Patent and Trademark Office**

Address: COMMISSIONER FOR PATENTS  
P.O. Box 1450  
Alexandria, Virginia 22313-1450

| APPLICATION NO./<br>CONTROL NO. | FILING DATE | FIRST NAMED INVENTOR /<br>PATENT IN REEXAMINATION | ATTORNEY DOCKET NO. |
|---------------------------------|-------------|---------------------------------------------------|---------------------|
| 09876515                        | 6/7/01      | DAVIES ET AL.                                     | GB 000109           |

PHILIPS INTELLECTUAL PROPERTY & STANDARDS  
P.O. BOX 3001  
BRIARCLIFF MANOR, NY 10510

EXAMINER

Karen L. Le

| ART UNIT | PAPER    |
|----------|----------|
| 2614     | 20071217 |

DATE MAILED:

**Please find below and/or attached an Office communication concerning this application or proceeding.**

**Commissioner for Patents**

Examiner has considered the IDS filed on June 7, 2001

Attachment PTO-1449.

*Ahmad F. Matar*  
**AHMAD F. MATAR  
 SUPERVISORY PATENT EXAMINER  
 TECHNOLOGY CENTER 2700**



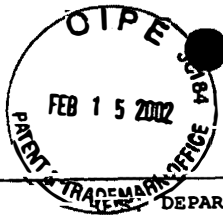

Form PTO-1449 DEPARTMENT OF COMMERCE (REV. 7-80) PATENT AND TRADEMARK OFFICE

Atty. Docket No. GB 000109 Serial No. 09/876,515

Applicant ROBERT J. DAVIES ET AL.

Filing Date 6/7/01 Group ~~2602~~ 2614

RECEIVED  
FEB 26 2002  
Technology Center 2600

**INFORMATION DISCLOSURE CITATION**  
(Use several sheets if necessary)

**U.S. PATENT DOCUMENTS**

| Ex. Int | Document Number | Date | Name | Class | Sub-class | Filing Date If Approp. |
|---------|-----------------|------|------|-------|-----------|------------------------|
| AA      |                 |      |      |       |           |                        |
| AB      |                 |      |      |       |           |                        |
| AC      |                 |      |      |       |           |                        |
| AD      |                 |      |      |       |           |                        |
| AE      |                 |      |      |       |           |                        |
| AF      |                 |      |      |       |           |                        |

**FOREIGN PATENT DOCUMENTS**

|         | Document Number   | Date   | Country | Class | Sub-class | Trans. |    |
|---------|-------------------|--------|---------|-------|-----------|--------|----|
|         |                   |        |         |       |           | Yes    | No |
| /KL/ AG | 0 7 5 2 7 9 3 A 2 | 8/1/97 | EUROPE  | H04Q  | 7/32      |        |    |
| /KL/ AH | 1 0 0 6 6 8 4 A 2 | 7/6/00 | EUROPE  | H04H  | 1/00      |        |    |
| AI      |                   |        |         |       |           |        |    |
| AJ      |                   |        |         |       |           |        |    |
| AK      |                   |        |         |       |           |        |    |

**OTHER (Including Author, Title, Date, Pertinent Pages, Etc.)**

|    |  |
|----|--|
| AL |  |
| AM |  |
| AN |  |

Examiner /Karen Le/ Date Considered 12/11/2007

EXAMINER: Initial if reference considered, whether or not citation is in conformance with MPEP 609; Draw line through citation if not in conformance and not considered. Include a copy of this form with next communication to applicant.

| Form PTO-1449<br>U.S. DEPARTMENT OF COMMERCE (REV.7-80) PATENT AND<br>TRADEMARK OFFICE                                                                                                                                                   |    |                                                                                                                                                                                                                                     |    |   |   |   |   |   |          | Atty. Docket No.<br>GB 000109       |         | Serial No. |           |                        |  |  |  |
|------------------------------------------------------------------------------------------------------------------------------------------------------------------------------------------------------------------------------------------|----|-------------------------------------------------------------------------------------------------------------------------------------------------------------------------------------------------------------------------------------|----|---|---|---|---|---|----------|-------------------------------------|---------|------------|-----------|------------------------|--|--|--|
|                                                                                                                                                                                                                                          |    |                                                                                                                                                                                                                                     |    |   |   |   |   |   |          | Applicant<br>ROBERT J. DAVIES ET AL |         |            |           |                        |  |  |  |
| INFORMATION DISCLOSURE CITATION<br>(Use several sheets if necessary)                                                                                                                                                                     |    |                                                                                                                                                                                                                                     |    |   |   |   |   |   |          | Filing Date<br>CONCURRENTLY         |         | Group      |           |                        |  |  |  |
| <b>U.S. PATENT DOCUMENTS</b>                                                                                                                                                                                                             |    |                                                                                                                                                                                                                                     |    |   |   |   |   |   |          |                                     |         |            |           |                        |  |  |  |
| Ex. Int.                                                                                                                                                                                                                                 |    | Document Number                                                                                                                                                                                                                     |    |   |   |   |   |   |          | Date                                | Name    | Class      | Sub-class | Filing Date If Approp. |  |  |  |
|                                                                                                                                                                                                                                          |    | 5                                                                                                                                                                                                                                   | 8  | 3 | 5 | 8 | 6 | 1 |          |                                     |         |            |           |                        |  |  |  |
| /KL/                                                                                                                                                                                                                                     | AA |                                                                                                                                                                                                                                     |    |   |   |   |   |   | 11/10/98 | Whiteside                           | 455     | 466        |           |                        |  |  |  |
|                                                                                                                                                                                                                                          | AB |                                                                                                                                                                                                                                     |    |   |   |   |   |   |          |                                     |         |            |           |                        |  |  |  |
|                                                                                                                                                                                                                                          | AC |                                                                                                                                                                                                                                     |    |   |   |   |   |   |          |                                     |         |            |           |                        |  |  |  |
|                                                                                                                                                                                                                                          | AD |                                                                                                                                                                                                                                     |    |   |   |   |   |   |          |                                     |         |            |           |                        |  |  |  |
|                                                                                                                                                                                                                                          | AE |                                                                                                                                                                                                                                     |    |   |   |   |   |   |          |                                     |         |            |           |                        |  |  |  |
|                                                                                                                                                                                                                                          | AF |                                                                                                                                                                                                                                     |    |   |   |   |   |   |          |                                     |         |            |           |                        |  |  |  |
| <b>FOREIGN PATENT DOCUMENTS</b>                                                                                                                                                                                                          |    |                                                                                                                                                                                                                                     |    |   |   |   |   |   |          |                                     |         |            |           |                        |  |  |  |
|                                                                                                                                                                                                                                          |    | Document Number                                                                                                                                                                                                                     |    |   |   |   |   |   |          | Date                                | Country | Class      | Sub-class | Trans.                 |  |  |  |
|                                                                                                                                                                                                                                          |    | Yes                                                                                                                                                                                                                                 | No |   |   |   |   |   |          |                                     |         |            |           |                        |  |  |  |
|                                                                                                                                                                                                                                          | AG |                                                                                                                                                                                                                                     |    |   |   |   |   |   |          |                                     |         |            |           |                        |  |  |  |
|                                                                                                                                                                                                                                          | AH |                                                                                                                                                                                                                                     |    |   |   |   |   |   |          |                                     |         |            |           |                        |  |  |  |
|                                                                                                                                                                                                                                          | AI |                                                                                                                                                                                                                                     |    |   |   |   |   |   |          |                                     |         |            |           |                        |  |  |  |
|                                                                                                                                                                                                                                          | AJ |                                                                                                                                                                                                                                     |    |   |   |   |   |   |          |                                     |         |            |           |                        |  |  |  |
|                                                                                                                                                                                                                                          | AK |                                                                                                                                                                                                                                     |    |   |   |   |   |   |          |                                     |         |            |           |                        |  |  |  |
| OTHER (Including Author, Title, Date, Pertinent Pages, Etc.)                                                                                                                                                                             |    |                                                                                                                                                                                                                                     |    |   |   |   |   |   |          |                                     |         |            |           |                        |  |  |  |
|                                                                                                                                                                                                                                          | AL | Publication Hp "Cooltown": < <a href="http://www.cooltown.hp.com/papers/webpres/Webpresence.htm">http://www.cooltown.hp.com/papers/webpres/Webpresence.htm</a> >; "People, Places, Things: Web Presence for the Real World pp. 1-20 |    |   |   |   |   |   |          |                                     |         |            |           |                        |  |  |  |
|                                                                                                                                                                                                                                          | AM |                                                                                                                                                                                                                                     |    |   |   |   |   |   |          |                                     |         |            |           |                        |  |  |  |
|                                                                                                                                                                                                                                          | AN |                                                                                                                                                                                                                                     |    |   |   |   |   |   |          |                                     |         |            |           |                        |  |  |  |
| Examiner                                                                                                                                                                                                                                 |    |                                                                                                                                                                                                                                     |    |   |   |   |   |   |          | /Karen Le/                          |         |            |           | Date Considered        |  |  |  |
|                                                                                                                                                                                                                                          |    |                                                                                                                                                                                                                                     |    |   |   |   |   |   |          | 12/11/2007                          |         |            |           |                        |  |  |  |
| EXAMINER: Initial if reference considered, whether or not citation is in conformance with MPEP 609; Draw li through citation if not in conformance and not considered. Include a copy of this form with next communication to applicant. |    |                                                                                                                                                                                                                                     |    |   |   |   |   |   |          |                                     |         |            |           |                        |  |  |  |

1-903 U.S. PTO  
 09/876515  
 06/07/01

UNITED STATES PATENT AND TRADEMARK OFFICE

---

BEFORE THE BOARD OF PATENT APPEALS  
AND INTERFERENCES

---

Ex parte ROBERT J. DAVIES  
AND SAUL R. DOOLEY

---

Application No. 09/876,515

---

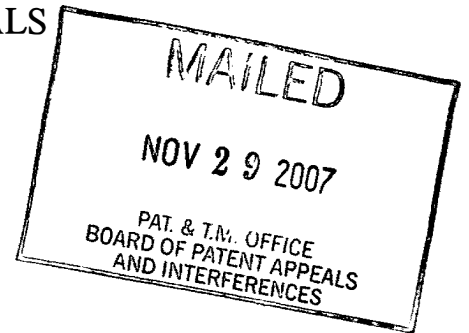

ORDER RETURNING UNDOCKETED APPEAL TO EXAMINER

---

This application was received electronically at the Board of Patent Appeals and Interferences on November 19, 2007. A review of the application has revealed that the application is not ready for docketing as an appeal. Accordingly, the application is herewith being returned to the examiner. The matter requiring attention prior to docketing is identified below.

An Information Disclosure Statement (IDS) was filed on June 7, 2001. A review of the Image File Wrapper reveals that the examiner has not considered the IDS. According to MPEP § 609 which states:

. Application No. 09/876,515

“ . . . The Examiner must also fill in his or her name and the date the information was considered in blocks at the bottom of the PTO-1449 or PTO/SB/08A and 08B form.”

Accordingly, it is

**ORDERED** that the application is returned to the Examiner for consideration of the IDS, written notification to the applicant of such consideration and for further action as may be appropriate.

BOARD OF PATENT APPEALS  
AND INTERFERENCES

By:   
PATRICK J. NOLAN  
Deputy Chief Appeals Administrator  
(571) 272-9797

PJN/dal

cc: PHILIPS INTELLECTUAL PROPERTY  
& STANDARDS  
P.O. BOX 3001  
BRIARCLIFF MANOR, NY 10510



UNITED STATES PATENT AND TRADEMARK OFFICE

UNITED STATES DEPARTMENT OF COMMERCE  
United States Patent and Trademark Office  
Address: COMMISSIONER FOR PATENTS  
P.O. Box 1450  
Alexandria, Virginia 22313-1450  
www.uspto.gov

| APPLICATION NO. | FILING DATE | FIRST NAMED INVENTOR | ATTORNEY DOCKET NO. | CONFIRMATION NO. |
|-----------------|-------------|----------------------|---------------------|------------------|
| 09/876,515      | 06/07/2001  | Robert J. Davies     | GB 000109           | 9201             |

24737 7590 05/16/2007  
PHILIPS INTELLECTUAL PROPERTY & STANDARDS  
P.O. BOX 3001  
BRIARCLIFF MANOR, NY 10510

EXAMINER

LE, KAREN L

ART UNIT PAPER NUMBER

2614

MAIL DATE DELIVERY MODE

05/16/2007

PAPER

**Please find below and/or attached an Office communication concerning this application or proceeding.**

The time period for reply, if any, is set in the attached communication.



UNITED STATES PATENT AND TRADEMARK OFFICE

---

Commissioner for Patents  
United States Patent and Trademark Office  
P.O. Box 1450  
Alexandria, VA 22313-1450  
[www.uspto.gov](http://www.uspto.gov)

**MAILED**  
**MAY 18 2007**  
**Technology Center 2600**

**BEFORE THE BOARD OF PATENT APPEALS  
AND INTERFERENCES**

Application Number: 09/876,515  
Filing Date: June 07, 2001  
Appellant(s): DAVIES ET AL.

---

DAVIES ET AL.  
For Appellant

**EXAMINER'S ANSWER**

This is in response to the appeal brief filed 1/16/07 appealing from the Office action mailed 8/11/06.

**(1) Real Party in Interest**

A statement identifying by name the real party in interest is contained in the brief.

**(2) Related Appeals and Interferences**

The examiner is not aware of any related appeals, interferences, or judicial proceedings which will directly affect or be directly affected by or have a bearing on the Board's decision in the pending appeal.

**(3) Status of Claims**

The statement of the status of claims contained in the brief is correct.

**(4) Status of Amendments After Final**

The appellant's statement of the status of amendments after final rejection contained in the brief is correct.

**(5) Summary of Claimed Subject Matter**

The summary of claimed subject matter contained in the brief is correct.

**(6) Grounds of Rejection to be Reviewed on Appeal**

The appellant's statement of the grounds of rejection to be reviewed on appeal is correct.

**(7) Claims Appendix**

The copy of the appealed claims contained in the Appendix to the brief is correct.

**(8) Evidence Relied Upon**

|           |               |         |
|-----------|---------------|---------|
| 6,782,253 | Shteyn et al. | 8-2004  |
| 6,311,060 | Evans et al.  | 10-2001 |

|           |            |         |
|-----------|------------|---------|
| 5,835,861 | Whiteside  | 11-1998 |
| 6,169,498 | King et al | 1-2001  |

**(9) Grounds of Rejection**

The following ground(s) of rejection are applicable to the appealed claims:

1. Claims 1-14 are rejected under 35 U.S.C. 103(a) as being unpatentable over Whiteside (U. S. 5,835,861) in view of King et al (U.S. 6,169,498).

Regarding claims 1, 6, 8, 10 and 11, Whiteside teaches a communications system comprising at least one beacon device (Fig. 1, billboard 20) capable of wireless message transmission (Col. 2, lines 14-18) and at least one portable device (Fig. 1, wireless telephone 10) capable of receiving such a message transmission (Col. 2, lines 54-55 and lines 35-39), wherein the beacon is arranged to broadcast a series of inquiry messages each in the form of a plurality of predetermined data fields arranged according to a first communications protocol (Col. 2, lines 35-39). The beacon is further arranged to add to each inquiry message prior to transmission an additional data field, and wherein the at least one portable device is arranged to receive the transmitted inquiry messages and read data from said additional data field (Col. 2, lines 35-39).

Whiteside does not teach the additional data field including location information. However King teaches the additional data field including location information (Col. 3, lines 54-56). King teaches a method for communicating location-specific messages that have a content that is related to a particular geographical location within a facility. Thus, it would have been obvious to one of ordinary skill in the art at the time the invention



was made to incorporate King's location information into Whiteside's messages in order to provide additional data field including location information. This feature is old and popular in telecommunication system. Whiteside messages may have any type of data without departing from the spirit of Whiteside's invention. The location information represents helpful and useful data.

Regarding claims 2-3 and 12-13, Whiteside teaches the beacon is arranged to add said additional data field at the end of a respective inquiry message wherein the beacon is arranged to include an indication in one of said predetermined data fields, said indication denoting the presence of said additional data field (col. 2, lines 35-39).

Regarding claims 4, 9 and 14, Whiteside does not teach a system wherein said first communications protocol comprises Bluetooth messaging. However, Bluetooth is extremely old and well known in the wireless technology. Bluetooth enables devices such as portable computers, cell phones, and portable handheld devices to connect to each other and to the Internet. It would have been obvious to one of ordinary skill in the art at the time the invention was made to include the Bluetooth to enable data delivery through beacons.

Regarding claims 5 and 7, Whiteside does not teach a system wherein a special Dedicated Inquiry Access Code (DIAC) is used to indicate the presence of location information in the additional data field. Wireless messaging system employs frequency

Art Unit: 2614

hopping, and further wherein location data is sent on each frequency used for inquiry message broadcasts. However, DIAC is old and well known in the Bluetooth specification. Normally, a unit adapted to communicate according to the Bluetooth specification receiving an inquiry message, including a general inquiry access code (GIAC) or an appropriate Dedicated Inquiry Access Code (DIAC), may respond by sending an inquiry response message. The inquiry response message is actually a frequency hop synchronization packet. It would have been obvious to one of ordinary skill in the art at the time the invention was made to include the DIAC to indicate the present of location information in the additional data field.

#### **(10) Response to Argument**

Regarding Appellant's statement (Brief, page 5 and 7) that "Whiteside does not teach or suggest a beacon arranged to broadcast a series or inquiry messages that are in the form of plurality of predetermined data field arranged according to a first communications protocol" or that "the beacon is further arranged to add to each inquiry message prior to transmission an additional data field". Examiner respectfully submits that Whiteside does teach broadcast inquiry messages in addition to broadcast advertising information and teaches the inquiry messages being in the form of a plurality of predetermined data fields such as a bank interest rate and current production cost (Col. 2, lines 35-36). King teaches a method for communicating location-specific messages that have a content related to a particular geographical location within a facility. Whiteside teaches broadcast bank interest rate and current production cost in

addition to advertising information. Thus, location message of King is simply one of the items in Whiteside's broadcasting information. King is the secondary reference and it does not have to be bodily incorporated in the primary reference. The claims are mainly functional or descriptive language and therefore read on the prior art. For example, claim one is a system claim and only requires a system with a beacon that transmits a message and a mobile unit that can receive the message. The remainder of the claim recites only the content of the message. Therefore, the claim reads on many systems that have those two components and the functionality. The claimed invention does not recite any special components that form a special message other than those components included in the claim.

Regarding Appellant's statement (Brief, page 8) that Whiteside does not teach or suggest "communication protocol comprises Bluetooth messaging". Examiner respectfully submits that Bluetooth is extremely old and well known in the wireless technology, also known as IEEE 802.15.1, that enables devices such as portable computers, cell phone, and portable handheld devices to connect to each other and to the Internet. Thus, it would have been obvious to one of ordinary skill in the art at the time the invention was made to include Bluetooth into Whiteside's system to enable data delivery through beacons. Applicant did not invent the Bluetooth technology which may be used for any short range wireless communications. See Appellant's argument which refers to IEEE 802.15.1 (Brief, page 8, line 9).

Regarding Appellant's statement (Brief, pages 8 and 9, claims 5 and 7) that Whiteside does not teach or suggest " a special Dedicated Inquiry Access Code (DIAC)

is use to indicate the presence of location information in the additional data field”.

Examiner respectfully submits that DIAC is old and well known in the Bluetooth specification. Normally, a unit adapted to communicate according to the Bluetooth specification receiving an inquiry message, including a general inquiry access code (GIAC) or an appropriate Dedicated Inquiry Access Code (DIAC), may respond by sending an inquiry response message. The inquiry response message is actually a frequency hop synchronization packet. It would have been obvious to one of ordinary skill in the art at the time the invention was made to include the DIAC to indicate the present of location information in the additional data field. Also, numerous other arrangements may be devised by one of ordinary skill in the art without departing from the scope of Whiteside. It is noted that Appellant argued that the use of Bluetooth and DIAC is not taught by the references, but Appellant has not challenged the Examiner’s position that such is old and well known. Again, IEEE.15.1 is referenced in the Appeal brief (page 8, line 9).

Regarding Appellant’s statement (Brief, page 9, claim 6) that Whiteside does not teach or suggest, “The presence of location information in the additional data field is indicated with header information appearing in the additional data field”. Examiner respectfully submits that this is only descriptive language that explains how to arrange the message and what is included in the message.

Regarding Appellant’s statement (Brief, page 10, claim 9) that Whiteside does not teach “the receiver is configured to receive messages according to Bluetooth protocols”. Examiner respectfully submits that Numerous other arrangements may be

Art Unit: 2614

devised by one of ordinary skill in the art without departing from the scope of Whiteside. For example, infrared receiver would be replace in the wireless telephone by its RF circuitry and antenna (See Col. 3, lines -9). Again, Bluetooth is extremely old and well known in the wireless technology. Thus, it would have been obvious to one of ordinary skill in the art at the time the invention was made to include Bluetooth into Whiteside's system to enable data delivery through beacons.

**(11) Related Proceeding(s) Appendix**

No decision rendered by a court or the Board is identified by the examiner in the Related Appeals and Interferences section of this examiner's answer.

For the above reasons, it is believed that the rejections should be sustained.

Respectfully submitted,

Karen Le



May 9, 2007

Conferees:

Ahmad Matar

Supervisory Patent Examiner



**AHMAD F. MATAR**  
SUPERVISORY PATENT EXAMINER  
TECHNOLOGY CENTER 2700

Corsaro Nick



**NICK CORSARO**  
SUPERVISORY PATENT EXAMINER  
TECHNOLOGY CENTER 2600

**IN THE UNITED STATES PATENT AND TRADEMARK OFFICE  
BEFORE THE BOARD OF PATENT APPEALS AND INTERFERENCES**

In re Application of : DAVIES et al.  
Serial No.: : 09/876,515  
 :  
Filed : 06/07/2001  
 :  
Art Unit : 2614  
 :  
Examiner : Karen L. Le  
 :  
Att. Docket : GB 000109  
 :  
Confirmation No. : 9201

Mail Stop Appeal Brief - Patents  
Commissioner for Patents  
P.O. Box 1450  
Alexandria, VA 22313-1450

**APPEAL BRIEF**

Sir:

Enclosed is an Appeal Brief in the above-identified patent application. Please charge the fee of \$500.00 to Deposit Account No. 14-1270.

Respectfully submitted,

By           /LARRY LIBERCHUK/            
Larry Liberchuk, Reg. No. 40,352  
Senior IP Counsel  
Philips Electronics N.A. Corporation  
914-333-9602

**I. REAL PARTY IN INTEREST**

The real party in interest is Koninklijke Philips Electronics N.V. corporation, the assignee of record.

**II. RELATED APPEALS AND INTERFERENCES**

Appellant is not aware of any pending appeals, judicial proceedings, or interferences which may be related to, directly affect, be directly affected by, or have a bearing on the Board's decision in the pending appeal.

**III. STATUS OF CLAIMS**

Claims 1-14 are rejected.

**IV. STATUS OF AMENDMENTS**

All amendments prior to the Final Office Action were entered into the record.

**V. SUMMARY OF CLAIMED SUBJECT MATTER**

The present invention, as recited in independent claim 1, is related to a communications system comprising at least one beacon device (12, 14) capable of wireless message transmission and at least one portable device (10) capable of receiving such a message transmission. See page 6, lines 30-31; Fig. 1. The beacon is arranged to broadcast a series of inquiry messages, each in the form of a plurality of predetermined data fields arranged according to a first communications protocol. See page 8, lines 14-20; page 10, lines 5-20; page 10, line 31 through page 12, line 14; Fig. 1. The beacon is further arranged to add to each inquiry message, prior to transmission, an

additional data field. See page 12, lines 19-26; Fig. 5. The portable device is arranged to receive the transmitted inquiry messages and read data from the additional data field, the additional data field including location information. See page 16, line 1 through page 17, line 22.

The present invention, as recited in independent claim 10, is related to a beacon device capable of wireless message transmission and for use in a communications system comprising the beacon device and at least one portable device capable of receiving such a message transmission. See page 6, lines 30-31; Fig. 1. The beacon is configured to broadcast a series of inquiry messages, each in the form of a plurality of predetermined data fields arranged according to a first communications protocol. See page 8, lines 14-20; page 10, lines 5-20; page 10, line 31 through page 12, line 14; Fig. 1. The beacon is also configured to add to each inquiry message prior to transmission an additional data field. See page 12, lines 19-26; Fig. 5. The at least one portable device, arranged to receive the transmitted inquiry messages, is enabled to read data from the additional data field, the additional data field including location information. See page 16, line 1 through page 17, line 22.

The present invention, as recited in independent claim 11, is related to a method for enabling the user of a portable communications device to receive broadcast messages. See page 6, lines 30-31; Fig. 1. At least one beacon device broadcasts a series of inquiry messages, each in the form of a plurality of predetermined data fields arranged according to a first communications protocol. See page 8, lines 14-20; page 10, lines 5-20; page 10, line 31 through page 12, line 14; Fig. 1. The beacon adds to each inquiry message, prior to transmission, an additional data field carrying broadcast message data including location information. See page 12, lines 19-26; Fig. 5. The portable device receives the transmitted inquiry messages including



the location information and reads the broadcast data from said additional data field. See page 16, line 1 through page 17, line 22.

## **VI. GROUNDS OF REJECTION TO BE REVIEWED ON APPEAL**

Whether claims 1-14 are properly rejected under 35 U.S.C. §103(a) as being unpatentable over U.S. Patent 5,835,861 (hereinafter “Whiteside”) in view of U.S. Patent 6,169,498 (hereinafter “King”).

## **VII. ARGUMENT**

1) Claims 1, 8, 10 and 11 are not properly rejected under 35 U.S.C. §103(a) as being unpatentable over Whiteside in view of King.

To establish a *prima facie* case of obviousness, three basic criteria must be met.

First, there must be some suggestion or motivation, either in the references themselves or in the knowledge generally available to one of ordinary skill in the art, to modify the reference or to combine reference teachings. Second, there must be a reasonable expectation of success. Finally, the prior art reference (or references when combined) must teach or suggest all the claim limitations. The teaching or suggestion to make the claimed combination and the reasonable expectation of success must both be found in the prior art and not based on applicant’s disclosure. *In re Vaeck*, 947 F.2d 488, 20 USPQ2d 1438 (Fed. Cir. 1991). MPEP § 2143 - §2143.03 contain decisions pertinent to each of these criteria.

Applicant submits that the Examiner has not established a *prima facie* case of obviousness because the prior art references cited by the Examiner do not teach or suggest all the

claim limitations, as recited in independent claims 1, 10 and 11, or in any of their respective dependent claims.

Applicant respectfully submits that Whiteside does not teach or suggest a beacon “arranged to broadcast a series of inquiry messages” as recited in, e.g., claim 1. What Whiteside discloses is a method of transmitting advertising information from a billboard to a wireless telephone. Whiteside describes two embodiments. In a first embodiment, an “infrared transceiver simply broadcasts the telephone number of the vendor continuously.” See 2:13-16 of the patent. In a second embodiment, the method comprises: “receiving a signal transmitted from a wireless telephone at a billboard, said signal being other than the regular wireless frequency band and, in response to receiving said signal, automatically transmitting a second signal from said billboard that is to be received and stored by said wireless telephone.” See 3:22-32 and 2:26-30 of the patent. In other words, the billboard in Whiteside does not broadcast inquiry messages, but instead it either simply broadcasts advertising information continuously, or it sends back a signal that includes the advertising information in response to a signal received from a wireless telephone. There is no teaching or suggestion that the billboard in Whiteside would broadcast inquiry messages.

Furthermore, Applicant submits that Whiteside does not teach or suggest the inquiry messages being “in the form of a plurality of predetermined data fields arranged according to a first communications protocol,” or that “the beacon is further arranged to add to each inquiry message prior to transmission an additional data field,” as recited in claims 1, 10 and 11. What Whiteside discloses is just that the signal broadcast from the billboard to the wireless telephone “can also be used to convey other data, such as a bank interest rate, current product cost,” and that the message transmitted from the wireless telephone to the billboard “can also be enhanced

to make a more specific request for one of the items of information that can be supplied by the billboard.” See 2:35-39. In other words, Whiteside only describes the various types of information that can be exchanged between the wireless telephone and the billboard. Whiteside does not teach or suggest what kind of structures and/or protocols are used to transmit that information. In particular, Whiteside is silent about adding an additional data field prior to transmission, as recited in claims 1, 10 and 11.

The Examiner admits that “Whiteside does not teach the additional data field including location information,” and relies upon King for that feature. Applicant submits that King, not only fails to cure the deficiencies previously pointed out in Whiteside, but it also does not teach or suggest “the additional data field including location information” either. King is directed to a method for communicating location-specific messages. However, the method taught by King requires “storing a library of such messages within a portable device having a capability of randomly accessing the messages.” *See, e.g.,* Abstract, lines 1-4; and claims 1, 8 and 9 of King. In other words, the location-specific messages disclosed by King are already stored in the portable device: they are not sent from a beacon to the portable device, as recited in Applicant’s claims 1, 10 and 11.

Applicant, therefore, submits that the Examiner has failed to establish a *prima facie* case of obviousness because the prior art references cited by the Examiner do not teach or suggest all the claim limitations, as recited in independent claims 1, 10 and 11. Applicant also submits that claim 8, which depends from 1, is patentable over the cited art references for at least the reasons stated above in connection with claim 1. Accordingly, reconsideration and withdrawal of the rejection of claims 1, 8, 10 and 11 is respectfully requested.

2) Claims 2, 3, 12 and 13 are not properly rejected under 35 U.S.C. §103(a) as being unpatentable over Whiteside in view of King.

Claims 2-3 and 12-13 depend, respectively, from claims 1 and 11 and are, therefore, also patentable over the cited art references for at least the reasons stated above in connection with claims 1 and 11, as well as for the separately patentable subject matter recited therein. In particular, and contrary to the Examiner's assertion, Applicant submits that Whiteside does not teach or suggest "the beacon is arranged to add said additional data field at the end of a respective inquiry message," as recited in claims 2 and 12. Furthermore, there is absolutely no teaching or suggestion in Whiteside of a beacon "arranged to include an indication in one of said predetermined data fields, said indication denoting the presence of said additional data field," as recited in claims 3 and 13. Moreover, Applicant respectfully submits that the citation provided by the Examiner in support for the rejection is completely irrelevant. At column 2, lines 35-39, Whiteside only states that, "Message 16 can also be used to convey other data, such as a bank interest rate, current product cost; message 15 can also be enhanced to make a more specific request for one of the items of information that can be supplied by the billboard."

Applicant therefore submits that the Examiner has failed to establish a *prima facie* case of obviousness against the subject matter recited in claims 2-3 and 12-13 because the prior art references cited by the Examiner do not teach or suggest all the claim limitations. Accordingly, reconsideration and withdrawal of the rejection of claims 2-3 and 12-13 is respectfully requested.

3) Claims 4 and 14 are not properly rejected under 35 U.S.C. §103(a) as being unpatentable over Whiteside in view of King.

Claims 4 and 14 depend, respectively, from claims 1 and 11, and are therefore also patentable over the cited art references for at least the reasons stated above in connection with claims 1 and 11, as well as for the separately patentable subject matter recited therein. In particular, and contrary to the Examiner's assertion, Applicant submits that Whiteside does not teach or suggest "wherein said communications protocol comprises Bluetooth messaging," as recited in claims 4 and 14. What Whiteside teaches at column 1, lines 48-49 is that "Communications in both directions are via a modulated infrared signal," which teaches away from a Bluetooth protocol. Bluetooth is an industrial specification for wireless networks, also known as IEEE 802.15.1, that provides a way to connect and exchange information between devices via a short range radio frequency, whereas Whiteside teaches communications via an infrared signal.

Applicant, therefore, submits that the Examiner has failed to establish a *prima facie* case of obviousness against the subject matter recited in claims 4 and 14, because the prior art references cited by the Examiner do not teach or suggest all the claim limitations. Accordingly, reconsideration and withdrawal of the rejection of claims 4 and 14 is respectfully requested.

4) Claims 5 and 7 are not properly rejected under 35 U.S.C. §103(a) as being unpatentable over Whiteside in view of King.

Claims 5 and 7 depend, respectively, from claims 4 and 1 and are, therefore, also patentable over the cited art references for at least the reasons stated above in connection with claims 4 and 1, as well as for the separately patentable subject matter recited therein. In particular, and contrary to the Examiner's assertion, Applicant submits that Whiteside does not teach or suggest "a special Dedicated Inquiry Access Code (DIAC) is used to indicate the

presence of location information in the additional data field,” as recited in Applicant’s claim 5. Furthermore, there is absolutely no teaching or suggestion in Whiteside that the “wireless messaging system employs frequency hopping, and further wherein location data is sent on each frequency used for inquiry message broadcasts,” as recited in Applicant’s claim 7. Moreover, Applicant respectfully submits that the citation provided by the Examiner in support for this rejection is again completely irrelevant. At column 1, lines 48-49, Whiteside only states that, “Communications in both directions are via a modulated infrared signal.”

Applicant, therefore, submits that the Examiner has failed to establish a *prima facie* case of obviousness against the subject matter recited in claims 5 and 7, because the prior art references cited by the Examiner do not teach or suggest all the claim limitations. Accordingly, reconsideration and withdrawal of the rejection of claims 5 and 7 is respectfully requested.

5) Claim 6 is not properly rejected under 35 U.S.C. §103(a) as being unpatentable over Whiteside in view of King.

Claim 6 depends from claim 1 and is therefore also patentable over the cited art references for at least the reasons stated above in connection with claim 1, as well as for the separately patentable subject matter recited therein. In particular, and contrary to the Examiner’s assertion, Applicant submits that King does not teach or suggest “wherein the presence of location information in the additional data field is indicated with header information appearing in the additional data field,” as recited in Applicant’s claim 6. The Examiner already admitted that Whiteside does not teach this feature, and Applicant submits that there is absolutely no teaching or suggestion of this feature in King either. Once again, the citation provided by the Examiner in support for this rejection is completely irrelevant. What King discloses in the Abstract, lines 17-

22 is just that, “The fixed map information and the time-dependent information may then be accessed to locate a particular site specified by the time-dependent information. For example, the map information may include gate locations within an airport and the time-dependent information may include flight arrival and departure times.”

Applicant, therefore, submits that the Examiner has failed to establish a *prima facie* case of obviousness against the subject matter recited in Applicant’s claim 6, because the prior art references cited by the Examiner do not teach or suggest all the claim limitations. Accordingly, reconsideration and withdrawal of the rejection of claim 6 is respectfully requested.

6) Claim 9 is not properly rejected under 35 U.S.C. §103(a) as being unpatentable over Whiteside in view of King.

Claim 9 depends from claims 1 and 8 and is, therefore, also patentable over the cited art references for at least the reasons stated above in connection with claims 1 and 8, as well as for the separately patentable subject matter recited therein. In particular, and contrary to the Examiner’s assertion, Applicant submits that Whiteside does not teach or suggest “wherein the receiver is configured to receive messages according to Bluetooth protocols,” as recited in claim 9. What Whiteside teaches at column 1, lines 48-49 is that “Communications in both directions are via a modulated infrared signal,” which teaches away from a Bluetooth protocol. Bluetooth is an industrial specification for wireless networks, also known as IEEE 802.15.1, that provides a way to connect and exchange information between devices via a short range radio frequency, whereas Whiteside teaches communications via an infrared signal.

Applicant therefore submits that the Examiner has failed to establish a *prima facie* case of obviousness against the subject matter recited in Applicant’s claim 9, because the prior art

references cited by the Examiner do not teach or suggest all the claim limitations. Accordingly, reconsideration and withdrawal of the rejection of claim 9 is respectfully requested.

**VIII. CONCLUSION**

In light of the above, Applicant respectfully submits that the rejections of claims 1-14 are in error. The prior art references relied upon in the Final Office Action do not anticipate or render obvious Applicant 's claims. Thus, Applicant respectfully submits that the rejections are in error, legally and factually, and must be reversed.

Respectfully submitted,

By           /LARRY LIBERCHUK/            
Larry Liberchuk, Reg. No. 40,352  
Senior IP Counsel  
Philips Electronics N.A. Corporation  
914-333-9602



**IX. CLAIMS APPENDIX**

1. A communications system comprising at least one beacon device capable of wireless message transmission and at least one portable device capable of receiving such a message transmission, wherein the beacon is arranged to broadcast a series of inquiry messages each in the form of a plurality of predetermined data fields arranged according to a first communications protocol, wherein the beacon is further arranged to add to each inquiry message prior to transmission an additional data field, and wherein the at least one portable device is arranged to receive the transmitted inquiry messages and read data from said additional data field, the additional data field including location information.
2. A system as claimed in claim 1, wherein the beacon is arranged to add said additional data field at the end of a respective inquiry message.
3. A system as claimed in claim 1, wherein the beacon is arranged to include an indication in one of said predetermined data fields, said indication denoting the presence of said additional data field.
4. A system as claimed in claim 1, wherein said first communications protocol comprises Bluetooth messaging.
5. A system as claimed in claim 4, wherein a special Dedicated Inquiry Access Code (DIAC) is used to indicate the presence of location information in the additional data field.

6. A system as claimed in claim 1, wherein the presence of location information in the additional data field is indicated with header information appearing in the additional data field.

7. A system in accordance with claim 1, wherein wireless messaging system employs frequency hopping, and further wherein location data is sent on each frequency used for inquiry message broadcasts.

8. A mobile communication device for use in the system of claim 1, the device comprising a receiver capable of receiving a short-range wireless inquiry message including a plurality of data fields according to a first communications protocol, means for determining when an additional data field including location information has been added to said plurality of data fields, and means for reading the location information data from such an additional data field.

9. A device as claimed in claim 8, wherein the receiver is configured to receive messages according to Bluetooth protocols.

10. A beacon device capable of wireless message transmission and for use in a communications system comprising said beacon device and at least one portable device capable of receiving such a message transmission, wherein the beacon is configured to broadcast a series of inquiry messages each in the form of a plurality of predetermined data fields arranged according to a first communications protocol, and to add to each inquiry message prior to transmission an additional data field, such as to enable the at least one portable device arranged to receive the transmitted

inquiry messages to read data from said additional data field, the additional data field including location information.

11. A method for enabling the user of a portable communications device to receive broadcast messages wherein at least one beacon device broadcasts a series of inquiry messages each in the form of a plurality of predetermined data fields arranged according to a first communications protocol, wherein the beacon adds to each inquiry message prior to transmission an additional data field carrying broadcast message data including location information, and wherein the portable device receives the transmitted inquiry messages including the location information and reads the broadcast data from said additional data field.

12. A method as claimed in claim 11, wherein the beacon adds said additional data field at the end of a respective inquiry message.

13. A method as claimed in claim 11, wherein the beacon includes an indication in one of said predetermined data fields, said indication denoting the presence of said additional data field.

14. A method as claimed in claim 11, wherein said first communications protocol comprises Bluetooth messaging.

**X. EVIDENCE APPENDIX**

None.

**XI. RELATED PROCEEDINGS APPENDIX**

None.

## Electronic Patent Application Fee Transmittal

|                                          |                               |                 |               |                             |
|------------------------------------------|-------------------------------|-----------------|---------------|-----------------------------|
| <b>Application Number:</b>               | 09876515                      |                 |               |                             |
| <b>Filing Date:</b>                      | 07-Jun-2001                   |                 |               |                             |
| <b>Title of Invention:</b>               | Data delivery through beacons |                 |               |                             |
| First Named Inventor/Applicant Name:     | Robert J. Davies              |                 |               |                             |
| <b>Filer:</b>                            | Michael E. Marion/NOEMI CHAPA |                 |               |                             |
| <b>Attorney Docket Number:</b>           | GB 000109                     |                 |               |                             |
| Filed as Large Entity                    |                               |                 |               |                             |
| <b>Utility Filing Fees</b>               |                               |                 |               |                             |
| <b>Description</b>                       | <b>Fee Code</b>               | <b>Quantity</b> | <b>Amount</b> | <b>Sub-Total in USD(\$)</b> |
| <b>Basic Filing:</b>                     |                               |                 |               |                             |
| <b>Pages:</b>                            |                               |                 |               |                             |
| <b>Claims:</b>                           |                               |                 |               |                             |
| <b>Miscellaneous-Filing:</b>             |                               |                 |               |                             |
| <b>Petition:</b>                         |                               |                 |               |                             |
| <b>Patent-Appeals-and-Interference:</b>  |                               |                 |               |                             |
| Filing a brief in support of an appeal   | 1402                          | 1               | 500           | 500                         |
| <b>Post-Allowance-and-Post-Issuance:</b> |                               |                 |               |                             |
| <b>Extension-of-Time:</b>                |                               |                 |               |                             |

| Description              | Fee Code | Quantity | Amount | Sub-Total in USD(\$) |
|--------------------------|----------|----------|--------|----------------------|
| <b>Miscellaneous:</b>    |          |          |        |                      |
| <b>Total in USD (\$)</b> |          |          |        | <b>500</b>           |

## Electronic Acknowledgement Receipt

|                                             |                               |
|---------------------------------------------|-------------------------------|
| <b>EFS ID:</b>                              | 1439590                       |
| <b>Application Number:</b>                  | 09876515                      |
| <b>International Application Number:</b>    |                               |
| <b>Confirmation Number:</b>                 | 9201                          |
| <b>Title of Invention:</b>                  | Data delivery through beacons |
| <b>First Named Inventor/Applicant Name:</b> | Robert J. Davies              |
| <b>Customer Number:</b>                     | 24737                         |
| <b>Filer:</b>                               | Michael E. Marion/NOEMI CHAPA |
| <b>Filer Authorized By:</b>                 | Michael E. Marion             |
| <b>Attorney Docket Number:</b>              | GB 000109                     |
| <b>Receipt Date:</b>                        | 16-JAN-2007                   |
| <b>Filing Date:</b>                         | 07-JUN-2001                   |
| <b>Time Stamp:</b>                          | 09:43:19                      |
| <b>Application Type:</b>                    | Utility                       |

### Payment information:

|                                          |        |
|------------------------------------------|--------|
| Submitted with Payment                   | yes    |
| Payment was successfully received in RAM | \$ 500 |
| RAM confirmation Number                  | 2053   |
| Deposit Account                          | 141270 |

The Director of the USPTO is hereby authorized to charge indicated fees and credit any overpayment as follows:  
Charge any Additional Fees required under 37 C.F.R. Section 1.16 and 1.17

### File Listing:



| Document Number | Document Description | File Name                           | File Size(Bytes) | Multi Part /.zip | Pages (if appl.) |
|-----------------|----------------------|-------------------------------------|------------------|------------------|------------------|
| 1               | Appeal Brief Filed   | GB000109_appeal_brief_16-JAN-07.pdf | 137914           | no               | 16               |

**Warnings:**

**Information:**

|   |                        |              |      |    |   |
|---|------------------------|--------------|------|----|---|
| 2 | Fee Worksheet (PTO-06) | fee-info.pdf | 8141 | no | 2 |
|---|------------------------|--------------|------|----|---|

**Warnings:**

**Information:**

|                                     |        |
|-------------------------------------|--------|
| <b>Total Files Size (in bytes):</b> | 146055 |
|-------------------------------------|--------|

**This Acknowledgement Receipt evidences receipt on the noted date by the USPTO of the indicated documents, characterized by the applicant, and including page counts, where applicable. It serves as evidence of receipt similar to a Post Card, as described in MPEP 503.**

**New Applications Under 35 U.S.C. 111**

**If a new application is being filed and the application includes the necessary components for a filing date (see 37 CFR 1.53(b)-(d) and MPEP 506), a Filing Receipt (37 CFR 1.54) will be issued in due course and the date shown on this Acknowledgement Receipt will establish the filing date of the application.**

**National Stage of an International Application under 35 U.S.C. 371**

**If a timely submission to enter the national stage of an international application is compliant with the conditions of 35 U.S.C. 371 and other applicable requirements a Form PCT/DO/EO/903 indicating acceptance of the application as a national stage submission under 35 U.S.C. 371 will be issued in addition to the Filing Receipt, in due course.**

IN THE UNITED STATES PATENT AND TRADEMARK OFFICE  
BEFORE THE BOARD OF PATENT APPEALS AND INTERFERENCES

In re Application of : DAVIES, Robert J.  
Serial No. : 09/876,515  
Filed : June 7, 2001  
Atty. Docket : GB000109  
Group Art Unit : 2614  
Examiner : LE, Karen L.  
Conf. No. : 0201

**Mail Stop AF**

Commissioner for Patents  
Alexandria, VA 22313

**NOTICE OF APPEAL**

Sir:

Applicants hereby appeal to the Board of Patent Appeals and Interferences from the Examiner's decision dated August 11, 2006, finally rejecting claims 1-14.

[X] Please charge the fee of \$500.00 to Deposit Account No. 14-1270.

[ ] No additional fee is required, because the fee was paid in a prior appeal filed on October 3, 2005.

Respectfully submitted,

By /LARRY LIBERCHUK/  
Larry Liberchuk, Reg. 40,352  
Senior IP Counsel  
914-333-9602

November 13, 2006

## Electronic Patent Application Fee Transmittal

|                                          |                               |                 |               |                             |
|------------------------------------------|-------------------------------|-----------------|---------------|-----------------------------|
| <b>Application Number:</b>               | 09876515                      |                 |               |                             |
| <b>Filing Date:</b>                      | 07-Jun-2001                   |                 |               |                             |
| <b>Title of Invention:</b>               | Data delivery through beacons |                 |               |                             |
| First Named Inventor/Applicant Name:     | Robert J. Davies              |                 |               |                             |
| <b>Filer:</b>                            | Michael E. Marion/NOEMI CHAPA |                 |               |                             |
| <b>Attorney Docket Number:</b>           | GB 000109                     |                 |               |                             |
| Filed as Large Entity                    |                               |                 |               |                             |
| <b>Utility Filing Fees</b>               |                               |                 |               |                             |
| <b>Description</b>                       | <b>Fee Code</b>               | <b>Quantity</b> | <b>Amount</b> | <b>Sub-Total in USD(\$)</b> |
| <b>Basic Filing:</b>                     |                               |                 |               |                             |
| <b>Pages:</b>                            |                               |                 |               |                             |
| <b>Claims:</b>                           |                               |                 |               |                             |
| <b>Miscellaneous-Filing:</b>             |                               |                 |               |                             |
| <b>Petition:</b>                         |                               |                 |               |                             |
| <b>Patent-Appeals-and-Interference:</b>  |                               |                 |               |                             |
| Notice of appeal                         | 1401                          | 1               | 500           | 500                         |
| <b>Post-Allowance-and-Post-Issuance:</b> |                               |                 |               |                             |
| <b>Extension-of-Time:</b>                |                               |                 |               |                             |

| Description              | Fee Code | Quantity | Amount | Sub-Total in USD(\$) |
|--------------------------|----------|----------|--------|----------------------|
| <b>Miscellaneous:</b>    |          |          |        |                      |
| <b>Total in USD (\$)</b> |          |          |        | <b>500</b>           |

## Electronic Acknowledgement Receipt

|                                             |                               |
|---------------------------------------------|-------------------------------|
| <b>EFS ID:</b>                              | 1308730                       |
| <b>Application Number:</b>                  | 09876515                      |
| <b>International Application Number:</b>    |                               |
| <b>Confirmation Number:</b>                 | 9201                          |
| <b>Title of Invention:</b>                  | Data delivery through beacons |
| <b>First Named Inventor/Applicant Name:</b> | Robert J. Davies              |
| <b>Customer Number:</b>                     | 24737                         |
| <b>Filer:</b>                               | Michael E. Marion/NOEMI CHAPA |
| <b>Filer Authorized By:</b>                 | Michael E. Marion             |
| <b>Attorney Docket Number:</b>              | GB 000109                     |
| <b>Receipt Date:</b>                        | 13-NOV-2006                   |
| <b>Filing Date:</b>                         | 07-JUN-2001                   |
| <b>Time Stamp:</b>                          | 14:03:29                      |
| <b>Application Type:</b>                    | Utility                       |

### Payment information:

|                                          |        |
|------------------------------------------|--------|
| Submitted with Payment                   | yes    |
| Payment was successfully received in RAM | \$ 500 |
| RAM confirmation Number                  | 2797   |
| Deposit Account                          | 141270 |

The Director of the USPTO is hereby authorized to charge indicated fees and credit any overpayment as follows:  
 Charge any Additional Fees required under 37 C.F.R. Section 1.16 and 1.17

### File Listing:

| Document Number | Document Description   | File Name                     | File Size(Bytes) | Multi Part /.zip | Pages (if appl.) |
|-----------------|------------------------|-------------------------------|------------------|------------------|------------------|
| 1               | Notice of Appeal Filed | GB000109_Notice_of_Appeal.pdf | 55644            | no               | 1                |

**Warnings:**

**Information:**

|   |                         |              |      |    |   |
|---|-------------------------|--------------|------|----|---|
| 2 | Fee Worksheet (PTO-875) | fee-info.pdf | 8129 | no | 2 |
|---|-------------------------|--------------|------|----|---|

**Warnings:**

**Information:**

|                                     |       |
|-------------------------------------|-------|
| <b>Total Files Size (in bytes):</b> | 63773 |
|-------------------------------------|-------|

**This Acknowledgement Receipt evidences receipt on the noted date by the USPTO of the indicated documents, characterized by the applicant, and including page counts, where applicable. It serves as evidence of receipt similar to a Post Card, as described in MPEP 503.**

**New Applications Under 35 U.S.C. 111**

**If a new application is being filed and the application includes the necessary components for a filing date (see 37 CFR 1.53(b)-(d) and MPEP 506), a Filing Receipt (37 CFR 1.54) will be issued in due course and the date shown on this Acknowledgement Receipt will establish the filing date of the application.**

**National Stage of an International Application under 35 U.S.C. 371**

**If a timely submission to enter the national stage of an international application is compliant with the conditions of 35 U.S.C. 371 and other applicable requirements a Form PCT/DO/EO/903 indicating acceptance of the application as a national stage submission under 35 U.S.C. 371 will be issued in addition to the Filing Receipt, in due course.**

24



UNITED STATES PATENT AND TRADEMARK OFFICE

UNITED STATES DEPARTMENT OF COMMERCE  
United States Patent and Trademark Office  
Address: COMMISSIONER FOR PATENTS  
P.O. Box 1450  
Alexandria, Virginia 22313-1450  
www.uspto.gov

| APPLICATION NO. | FILING DATE | FIRST NAMED INVENTOR | ATTORNEY DOCKET NO. | CONFIRMATION NO. |
|-----------------|-------------|----------------------|---------------------|------------------|
| 09/876,515      | 06/07/2001  | Robert J. Davies     | GB 000109           | 9201             |

24737      7590      08/11/2006

PHILIPS INTELLECTUAL PROPERTY & STANDARDS  
P.O. BOX 3001  
BRIARCLIFF MANOR, NY 10510

EXAMINER

LE, KAREN L

| ART UNIT | PAPER NUMBER |
|----------|--------------|
| 2614     |              |

2614

DATE MAILED: 08/11/2006

Please find below and/or attached an Office communication concerning this application or proceeding.

|                              |                                      |                                      |  |
|------------------------------|--------------------------------------|--------------------------------------|--|
| <b>Office Action Summary</b> | <b>Application No.</b><br>09/876,515 | <b>Applicant(s)</b><br>DAVIES ET AL. |  |
|                              | <b>Examiner</b><br>Karen L. Le       | <b>Art Unit</b><br>2614              |  |

-- The MAILING DATE of this communication appears on the cover sheet with the correspondence address --

**Period for Reply**

A SHORTENED STATUTORY PERIOD FOR REPLY IS SET TO EXPIRE 3 MONTH(S) OR THIRTY (30) DAYS, WHICHEVER IS LONGER, FROM THE MAILING DATE OF THIS COMMUNICATION.

- Extensions of time may be available under the provisions of 37 CFR 1.136(a). In no event, however, may a reply be timely filed after SIX (6) MONTHS from the mailing date of this communication.
- If NO period for reply is specified above, the maximum statutory period will apply and will expire SIX (6) MONTHS from the mailing date of this communication.
- Failure to reply within the set or extended period for reply will, by statute, cause the application to become ABANDONED (35 U.S.C. § 133). Any reply received by the Office later than three months after the mailing date of this communication, even if timely filed, may reduce any earned patent term adjustment. See 37 CFR 1.704(b).

**Status**

- 1)  Responsive to communication(s) filed on 15 May 2006.
- 2a)  This action is **FINAL**.                      2b)  This action is non-final.
- 3)  Since this application is in condition for allowance except for formal matters, prosecution as to the merits is closed in accordance with the practice under *Ex parte Quayle*, 1935 C.D. 11, 453 O.G. 213.

**Disposition of Claims**

- 4)  Claim(s) 1-14 is/are pending in the application.
- 4a) Of the above claim(s) \_\_\_\_\_ is/are withdrawn from consideration.
- 5)  Claim(s) \_\_\_\_\_ is/are allowed.
- 6)  Claim(s) 1-14 is/are rejected.
- 7)  Claim(s) \_\_\_\_\_ is/are objected to.
- 8)  Claim(s) \_\_\_\_\_ are subject to restriction and/or election requirement.

**Application Papers**

- 9)  The specification is objected to by the Examiner.
- 10)  The drawing(s) filed on \_\_\_\_\_ is/are: a)  accepted or b)  objected to by the Examiner.  
    Applicant may not request that any objection to the drawing(s) be held in abeyance. See 37 CFR 1.85(a).  
    Replacement drawing sheet(s) including the correction is required if the drawing(s) is objected to. See 37 CFR 1.121(d).
- 11)  The oath or declaration is objected to by the Examiner. Note the attached Office Action or form PTO-152.

**Priority under 35 U.S.C. § 119**

- 12)  Acknowledgment is made of a claim for foreign priority under 35 U.S.C. § 119(a)-(d) or (f).
- a)  All    b)  Some \*    c)  None of:
1.  Certified copies of the priority documents have been received.
2.  Certified copies of the priority documents have been received in Application No. \_\_\_\_\_.
3.  Copies of the certified copies of the priority documents have been received in this National Stage application from the International Bureau (PCT Rule 17.2(a)).

\* See the attached detailed Office action for a list of the certified copies not received.

**Attachment(s)**

- |                                                                                                                        |                                                                                         |
|------------------------------------------------------------------------------------------------------------------------|-----------------------------------------------------------------------------------------|
| 1) <input type="checkbox"/> Notice of References Cited (PTO-892)                                                       | 4) <input type="checkbox"/> Interview Summary (PTO-413)<br>Paper No(s)/Mail Date. _____ |
| 2) <input type="checkbox"/> Notice of Draftsperson's Patent Drawing Review (PTO-948)                                   | 5) <input type="checkbox"/> Notice of Informal Patent Application (PTO-152)             |
| 3) <input type="checkbox"/> Information Disclosure Statement(s) (PTO-1449 or PTO/SB/08)<br>Paper No(s)/Mail Date _____ | 6) <input type="checkbox"/> Other: _____                                                |



### DETAILED ACTION

1. Applicant's amendment filed on May 15, 2006 has been entered. No claims have been amended. No claims have been cancelled. No claims have been added. Claims 1-14 are still pending in this application, with claims 1, 8, 10 and 11 being independent. **This action is made final.**

#### ***Claim Rejections - 35 USC § 103***

2. The following is a quotation of 35 U.S.C. 103(a) which forms the basis for all obviousness rejections set forth in this Office action:

(a) A patent may not be obtained though the invention is not identically disclosed or described as set forth in section 102 of this title, if the differences between the subject matter sought to be patented and the prior art are such that the subject matter as a whole would have been obvious at the time the invention was made to a person having ordinary skill in the art to which said subject matter pertains. Patentability shall not be negated by the manner in which the invention was made.

3. Claims 1-14 are rejected under 35 U.S.C. 103(a) as being unpatentable over Whiteside (U. S. 5,835,861) in view of King et al (U.S. 6,169,498).

Regarding claims 1, 6, 8, 10 and 11, Whiteside teaches a communications system comprising at least one beacon device (Fig. 1, item 20) capable of wireless message transmission (Col. 2, lines 14-18) and at least one portable device (Fig. 1, item 10) capable of receiving such a message transmission (Col. 2, lines 54-55 and lines 35-39), wherein the beacon is arranged to broadcast a series of inquiry messages each in the form of a plurality of predetermined data fields arranged according to a first

Art Unit: 2614

communications protocol (Col. 2, lines 35-39). The beacon is further arranged to add to each inquiry message prior to transmission an additional data field, and wherein the at least one portable device is arranged to receive the transmitted inquiry messages and read data from said additional data field (Col. 2, lines 35-39).

Whiteside does not teach the additional data field including location information. However King teaches the additional data field including location information (Col. 3, lines 54-56). Whiteside teaches a method for communicating location-specific messages that has a content that is related to a particular geographical location within a facility. Thus, it would have been obvious to one of ordinary skill in the art at the time the invention was made to incorporate King's location feature into Whiteside's system in order to provide additional data field including location information. This feature is old and popular in telecommunication system.

Regarding claims 2-3 and 12-13, Whiteside teaches the beacon is arranged to add said additional data field at the end of a respective inquiry message wherein the beacon is arranged to include an indication in one of said predetermined data fields, said indication denoting the presence of said additional data field (col. 2, lines 35-39).

Regarding claims 4, 9 and 14, Whiteside does not teaches a system wherein said first communications protocol comprises Bluetooth messaging. However, Bluetooth is extremely old and well known in the wireless technology that enable devices such as portable computers, cell phones, and portable handheld devices to

Art Unit: 2614

connect to each other and to the Internet. It would have been obvious to one of ordinary skill in the art at the time the invention was made to include the Bluetooth to enable data delivery through beacons.

Regarding claims 5 and 7, Whiteside does not teaches a system wherein a special Dedicated Inquiry Access Code (DIAC) is used to indicate the presence of location information in the additional data field. Wireless messaging system employs frequency hopping, and further wherein location data is sent on each frequency used for inquiry message broadcasts. However, DIAC is old and well known in the Bluetooth specification. Normally, a unit adapted to communicate according to the Bluetooth specification receiving an inquiry message, including a general inquiry access code (GIAC) or an appropriate Dedicated Inquiry Access Code (DIAC), may response by sending an inquiry response message. The inquiry response message is actually a frequency hop synchronization packet. It would have been obvious to one of ordinary skill in the art at the time the invention was made to include the DIAC to indicate the present of location information in the additional data field.

#### ***Response to Arguments***

4. Applicant's arguments with respect to claims 1-3, 6 and 8-14 have been fully considered but they are not persuasive.

As to Applicant's Remarks, Applicant mainly argues that the billboard in Whiteside does not broadcast inquiry messages but instead it simply broadcasts

Art Unit: 2614

advertising information continuously, does not teach the inquiry messages being in the form of a plurality of predetermined data fields arranged according to a first communications protocol. Applicant also argues that Whiteside does not teach the additional data field including location information and King does not cure the deficiency. Examiner respectfully disagree for the following reasons:

Whiteside does teach broadcast inquiry messages in addition to broadcast advertising information and teach the inquiry messages being in the form of a plurality of predetermined data fields such as a bank interest rate and current production cost (Col. 2, lines 35-36). King teaches a method for communicating location-specific messages that has a content related to a particular geographical location within a facility.

Whiteside teaches broadcast bank interest rate and current production cost in addition to advertising information. Thus, location message of King is simply one of items in Whiteside's broadcasting information. King is the secondary reference and it does not have to be bodily incorporated in the primary reference.

For the above reason, Whiteside and King are maintained for supporting the enclosed Examiner's non-final action.

### ***Conclusion***

Any inquiry concerning this communication or earlier communications from the examiner should be directed to Karen L. Le whose telephone number is 571-272-7487. The examiner can normally be reached on M-F 8:30-5:00.

Application/Control Number: 09/876,515  
Art Unit: 2614

Page 6

If attempts to reach the examiner by telephone are unsuccessful, the examiner's supervisor, Wing F. Chan can be reached on 571-272-7493. The fax phone number for the organization where this application or proceeding is assigned is 571-273-8300.

Information regarding the status of an application may be obtained from the Patent Application Information Retrieval (PAIR) system. Status information for published applications may be obtained from either Private PAIR or Public PAIR. Status information for unpublished applications is available through Private PAIR only. For more information about the PAIR system, see <http://pair-direct.uspto.gov>. Should you have questions on access to the Private PAIR system, contact the Electronic Business Center (EBC) at 866-217-9197 (toll-free). If you would like assistance from a USPTO Customer Service Representative or access to the automated information system, call 800-786-9199 (IN USA OR CANADA) or 571-272-1000.

Karen Le  
KLL



WING CHAN  
SUPERVISORY PATENT EXAMINER

August 4, 2006



**Index of Claims**



**Application No.**

09/876,515

**Examiner**

Karen L Le

**Applicant(s)**

DAVIES ET AL.

**Art Unit**

2642

|   |                 |
|---|-----------------|
| √ | <b>Rejected</b> |
| = | <b>Allowed</b>  |

|   |                                        |
|---|----------------------------------------|
| — | <b>(Through numeral)<br/>Cancelled</b> |
| ÷ | <b>Restricted</b>                      |

|   |                     |
|---|---------------------|
| N | <b>Non-Elected</b>  |
| I | <b>Interference</b> |

|   |                 |
|---|-----------------|
| A | <b>Appeal</b>   |
| O | <b>Objected</b> |

| Claim |          | Date    |          |        |        |
|-------|----------|---------|----------|--------|--------|
| Final | Original | 2/17/05 | 10/17/05 | 2/7/06 | 8/4/06 |
| 1     | √        | √       | √        | √      | √      |
| 2     | √        | √       | √        | √      | √      |
| 3     | √        | √       | √        | √      | √      |
| 4     | √        | √       | √        | √      | √      |
| 5     | √        | √       | √        | √      | √      |
| 6     | √        | √       | √        | √      | √      |
| 7     | √        | √       | √        | √      | √      |
| 8     | √        | √       | √        | √      | √      |
| 9     | √        | √       | √        | √      | √      |
| 10    | √        | √       | √        | √      | √      |
| 11    | √        | √       | √        | √      | √      |
| 12    | √        | √       | √        | √      | √      |
| 13    | √        | √       | √        | √      | √      |
| 14    | √        | √       | √        | √      | √      |
| 15    |          |         |          |        |        |
| 16    |          |         |          |        |        |
| 17    |          |         |          |        |        |
| 18    |          |         |          |        |        |
| 19    |          |         |          |        |        |
| 20    |          |         |          |        |        |
| 21    |          |         |          |        |        |
| 22    |          |         |          |        |        |
| 23    |          |         |          |        |        |
| 24    |          |         |          |        |        |
| 25    |          |         |          |        |        |
| 26    |          |         |          |        |        |
| 27    |          |         |          |        |        |
| 28    |          |         |          |        |        |
| 29    |          |         |          |        |        |
| 30    |          |         |          |        |        |
| 31    |          |         |          |        |        |
| 32    |          |         |          |        |        |
| 33    |          |         |          |        |        |
| 34    |          |         |          |        |        |
| 35    |          |         |          |        |        |
| 36    |          |         |          |        |        |
| 37    |          |         |          |        |        |
| 38    |          |         |          |        |        |
| 39    |          |         |          |        |        |
| 40    |          |         |          |        |        |
| 41    |          |         |          |        |        |
| 42    |          |         |          |        |        |
| 43    |          |         |          |        |        |
| 44    |          |         |          |        |        |
| 45    |          |         |          |        |        |
| 46    |          |         |          |        |        |
| 47    |          |         |          |        |        |
| 48    |          |         |          |        |        |
| 49    |          |         |          |        |        |
| 50    |          |         |          |        |        |

| Claim |          | Date |  |  |  |
|-------|----------|------|--|--|--|
| Final | Original |      |  |  |  |
| 51    |          |      |  |  |  |
| 52    |          |      |  |  |  |
| 53    |          |      |  |  |  |
| 54    |          |      |  |  |  |
| 55    |          |      |  |  |  |
| 56    |          |      |  |  |  |
| 57    |          |      |  |  |  |
| 58    |          |      |  |  |  |
| 59    |          |      |  |  |  |
| 60    |          |      |  |  |  |
| 61    |          |      |  |  |  |
| 62    |          |      |  |  |  |
| 63    |          |      |  |  |  |
| 64    |          |      |  |  |  |
| 65    |          |      |  |  |  |
| 66    |          |      |  |  |  |
| 67    |          |      |  |  |  |
| 68    |          |      |  |  |  |
| 69    |          |      |  |  |  |
| 70    |          |      |  |  |  |
| 71    |          |      |  |  |  |
| 72    |          |      |  |  |  |
| 73    |          |      |  |  |  |
| 74    |          |      |  |  |  |
| 75    |          |      |  |  |  |
| 76    |          |      |  |  |  |
| 77    |          |      |  |  |  |
| 78    |          |      |  |  |  |
| 79    |          |      |  |  |  |
| 80    |          |      |  |  |  |
| 81    |          |      |  |  |  |
| 82    |          |      |  |  |  |
| 83    |          |      |  |  |  |
| 84    |          |      |  |  |  |
| 85    |          |      |  |  |  |
| 86    |          |      |  |  |  |
| 87    |          |      |  |  |  |
| 88    |          |      |  |  |  |
| 89    |          |      |  |  |  |
| 90    |          |      |  |  |  |
| 91    |          |      |  |  |  |
| 92    |          |      |  |  |  |
| 93    |          |      |  |  |  |
| 94    |          |      |  |  |  |
| 95    |          |      |  |  |  |
| 96    |          |      |  |  |  |
| 97    |          |      |  |  |  |
| 98    |          |      |  |  |  |
| 99    |          |      |  |  |  |
| 100   |          |      |  |  |  |

| Claim |          | Date |  |  |  |
|-------|----------|------|--|--|--|
| Final | Original |      |  |  |  |
| 101   |          |      |  |  |  |
| 102   |          |      |  |  |  |
| 103   |          |      |  |  |  |
| 104   |          |      |  |  |  |
| 105   |          |      |  |  |  |
| 106   |          |      |  |  |  |
| 107   |          |      |  |  |  |
| 108   |          |      |  |  |  |
| 109   |          |      |  |  |  |
| 110   |          |      |  |  |  |
| 111   |          |      |  |  |  |
| 112   |          |      |  |  |  |
| 113   |          |      |  |  |  |
| 114   |          |      |  |  |  |
| 115   |          |      |  |  |  |
| 116   |          |      |  |  |  |
| 117   |          |      |  |  |  |
| 118   |          |      |  |  |  |
| 119   |          |      |  |  |  |
| 120   |          |      |  |  |  |
| 121   |          |      |  |  |  |
| 122   |          |      |  |  |  |
| 123   |          |      |  |  |  |
| 124   |          |      |  |  |  |
| 125   |          |      |  |  |  |
| 126   |          |      |  |  |  |
| 127   |          |      |  |  |  |
| 128   |          |      |  |  |  |
| 129   |          |      |  |  |  |
| 130   |          |      |  |  |  |
| 131   |          |      |  |  |  |
| 132   |          |      |  |  |  |
| 133   |          |      |  |  |  |
| 134   |          |      |  |  |  |
| 135   |          |      |  |  |  |
| 136   |          |      |  |  |  |
| 137   |          |      |  |  |  |
| 138   |          |      |  |  |  |
| 139   |          |      |  |  |  |
| 140   |          |      |  |  |  |
| 141   |          |      |  |  |  |
| 142   |          |      |  |  |  |
| 143   |          |      |  |  |  |
| 144   |          |      |  |  |  |
| 145   |          |      |  |  |  |
| 146   |          |      |  |  |  |
| 147   |          |      |  |  |  |
| 148   |          |      |  |  |  |
| 149   |          |      |  |  |  |
| 150   |          |      |  |  |  |



RECEIVED  
CENTRAL FAX CENTER

MAY 15 2006

**KRAMER | AMADO PC**

PATENT RESEARCH SERVICES  
INTELLECTUAL PROPERTY LAW

1725 DUKE STREET  
SUITE 240  
ALEXANDRIA, VIRGINIA 22314  
PHONE: (703) 519-9801  
FACSIMILE: (703) 519-9802  
WWW.KRAMERIP.COM

# Fax Memo

**TO:** Mail Stop Amendment  
USPTO

**FAX NO.:** (571) 273-8300

**FROM:** Terry W. Kramer  
KRAMER & AMADO, P.C.

**DATE:** May 15, 2006

**SUBJECT:** U.S. Patent Application  
Title: **DATA DELIVERY THROUGH BEACONS**  
Serial No.: 09/876,515  
Attorney Docket No.: GB 000109

**PAGES:** INCLUDING COVER PAGE (14)

THE INFORMATION CONTAINED HEREIN is intended only for the exclusive use of the individual or entity named above. This facsimile may contain information that is privileged, confidential, or otherwise exempt from disclosure under applicable law. If the reader of this information is NOT the intended recipient, you are hereby notified that any dissemination, distribution, copying or use of this information in any way is strictly prohibited. If you have received this communication in error, please call us immediately and return the original information to us via U.S. Postal Service.

Message: Submitted herewith are the following:

- Transmittal Form (1 page)
- Response (12 pages)

In the event that the fees submitted herewith are insufficient, please charge any remaining balance, or credit any overpayment, to our Deposit Account Number 50-0578.



PTO/SB/21 (09-04)  
 Approved for use through 07/31/2006. OMB 0651-0031  
 U.S. Patent and Trademark Office, U.S. DEPARTMENT OF COMMERCE

Under the Paperwork Reduction Act of 1995, no persons are required to respond to a collection of information unless it displays a valid OMB control number.

|                                                                                         |                        |                  |                                                                            |
|-----------------------------------------------------------------------------------------|------------------------|------------------|----------------------------------------------------------------------------|
| <b>TRANSMITTAL FORM</b><br><br>(to be used for all correspondence after initial filing) | Application Number     | 09/876,515       | <b>RECEIVED</b><br><br><b>CENTRAL FAX CENTER</b><br><br><b>MAY 15 2006</b> |
|                                                                                         | Filing Date            | June 7, 2001     |                                                                            |
|                                                                                         | First Named Inventor   | Robert J. Davies |                                                                            |
|                                                                                         | Art Unit               | 2642             |                                                                            |
|                                                                                         | Examiner Name          | Le, Karen L.     |                                                                            |
|                                                                                         | Attorney Docket Number | GB 000109        |                                                                            |
| Total Number of Pages in This Submission                                                | 13                     |                  |                                                                            |

| ENCLOSURES (Check all that apply)                                         |                                                                                         |                                                                                         |
|---------------------------------------------------------------------------|-----------------------------------------------------------------------------------------|-----------------------------------------------------------------------------------------|
| <input type="checkbox"/> Fee Transmittal Form                             | <input type="checkbox"/> Drawing(s)                                                     | <input type="checkbox"/> After Allowance Communication to TC                            |
| <input type="checkbox"/> Fee Attached                                     | <input type="checkbox"/> Licensing-related Papers                                       | <input type="checkbox"/> Appeal Communication to Board of Appeals and Interferences     |
| <input checked="" type="checkbox"/> Amendment/Reply                       | <input type="checkbox"/> Petition                                                       | <input type="checkbox"/> Appeal Communication to TC (Appeal Notice, Brief, Reply Brief) |
| <input type="checkbox"/> After Final                                      | <input type="checkbox"/> Petition to Convert to a Provisional Application               | <input type="checkbox"/> Proprietary Information                                        |
| <input type="checkbox"/> Affidavits/declaration(s)                        | <input type="checkbox"/> Power of Attorney, Revocation Change of Correspondence Address | <input type="checkbox"/> Status Letter                                                  |
| <input type="checkbox"/> Extension of Time Request                        | <input type="checkbox"/> Terminal Disclaimer                                            | <input type="checkbox"/> Other Enclosure(s) (please identify below):                    |
| <input type="checkbox"/> Express Abandonment Request                      | <input type="checkbox"/> Request for Refund                                             |                                                                                         |
| <input type="checkbox"/> Information Disclosure Statement                 | <input type="checkbox"/> CD, Number of CD(s) _____                                      |                                                                                         |
| <input type="checkbox"/> Certified Copy of Priority Document(s)           | <input type="checkbox"/> Landscape Table on CD                                          |                                                                                         |
| <input type="checkbox"/> Reply to Missing Parts/Incomplete Application    | <input type="text" value="Remarks"/>                                                    |                                                                                         |
| <input type="checkbox"/> Reply to Missing Parts under 37 CFR 1.52 or 1.53 |                                                                                         |                                                                                         |

| SIGNATURE OF APPLICANT, ATTORNEY, OR AGENT |                                                                                     |          |        |
|--------------------------------------------|-------------------------------------------------------------------------------------|----------|--------|
| Firm Name                                  | Kramer & Amado, P.C.                                                                |          |        |
| Signature                                  |  |          |        |
| Printed name                               | Terry W. Kramer                                                                     |          |        |
| Date                                       | May 15, 2006                                                                        | Reg. No. | 41,541 |

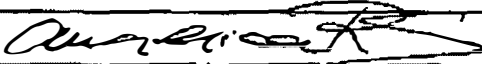
| CERTIFICATE OF TRANSMISSION/MAILING                                                                                                                                                                                                                                                                           |                                                                                     |         |
|---------------------------------------------------------------------------------------------------------------------------------------------------------------------------------------------------------------------------------------------------------------------------------------------------------------|-------------------------------------------------------------------------------------|---------|
| I hereby certify that this correspondence is being facsimile transmitted to the USPTO or deposited with the United States Postal Service with sufficient postage as first class mail in an envelope addressed to: Commissioner for Patents, P.O. Box 1450, Alexandria, VA 22313-1450 on the date shown below: |                                                                                     |         |
| Signature                                                                                                                                                                                                                                                                                                     |  |         |
| Typed or printed name                                                                                                                                                                                                                                                                                         | Angelica Rodriguez                                                                  | Date    |
|                                                                                                                                                                                                                                                                                                               |                                                                                     | 5/15/06 |

This collection of information is required by 37 CFR 1.5. The information is required to obtain or retain a benefit by the public which is to file (and by the USPTO to process) an application. Confidentiality is governed by 35 U.S.C. 122 and 37 CFR 1.11 and 1.14. This collection is estimated to 2 hours to complete, including gathering, preparing, and submitting the completed application form to the USPTO. Time will vary depending upon the individual case. Any comments on the amount of time you require to complete this form and/or suggestions for reducing this burden, should be sent to the Chief Information Officer, U.S. Patent and Trademark Office, U.S. Department of Commerce, P.O. Box 1450, Alexandria, VA 22313-1450. DO NOT SEND FEES OR COMPLETED FORMS TO THIS ADDRESS. SEND TO: Commissioner for Patents, P.O. Box 1450, Alexandria, VA 22313-1450.

If you need assistance in completing the form, call 1-800-PTO-9199 and select option 2.

RECEIVED  
CENTRAL FAX CENTER

MAY 15 2006

PATENT

IN THE UNITED STATES PATENT AND TRADEMARK OFFICE

|                      |   |                         |
|----------------------|---|-------------------------|
| In re Application of | : | Robert J. Davies et al. |
|                      | : |                         |
| For                  | : | DATA DELIVERY THROUGH   |
|                      | : | BEACONS                 |
|                      | : |                         |
| Serial No.:          | : | 09/876,515              |
|                      | : |                         |
| Filed                | : | June 7, 2001            |
|                      | : |                         |
| Art Unit             | : | 2642                    |
|                      | : |                         |
| Examiner             | : | Le, Karen L.            |
|                      | : |                         |
| Att. Docket          | : | GB 000109               |
|                      | : |                         |
| Confirmation No.     | : | 9201                    |

**RESPONSE under 37 C.F.R. §1.111**

Mail Stop Amendment  
Commissioner for Patents  
P.O. Box 1450  
Alexandria, VA 22313-1450

Sir:

In response to the Office Action dated February 24, 2006, the following is respectfully submitted:

**CLAIM LISTING** begins on page 2 of this paper.

**REMARKS/ARGUMENTS** begin on page 6 of this paper.

Application No: 09/876,515  
Attorney's Docket No: GB 000109

### CLAIM LISTING

This listing of claims will replace all prior versions and listings of claims in the application.

#### Listing of Claims

1. (Original) A communications system comprising at least one beacon device capable of wireless message transmission and at least one portable device capable of receiving such a message transmission, wherein the beacon is arranged to broadcast a series of inquiry messages each in the form of a plurality of predetermined data fields arranged according to a first communications protocol, wherein the beacon is further arranged to add to each inquiry message prior to transmission an additional data field, and wherein the at least one portable device is arranged to receive the transmitted inquiry messages and read data from said additional data field, the additional data field including location information.
2. (Original) A system as claimed in claim 1, wherein the beacon is arranged to add said additional data field at the end of a respective inquiry message.
3. (Original) A system as claimed in claim 1, wherein the beacon is arranged to include an indication in one of said predetermined data fields, said indication denoting the presence of said additional data field.

Application No: 09/876,515  
Attorney's Docket No: GB 000109

4. (Original) A system as claimed in claim 1, wherein said first communications protocol comprises Bluetooth messaging.
  
5. (Original) A system as claimed in claim 4, wherein a special Dedicated Inquiry Access Code (DIAC) is used to indicate the presence of location information in the additional data field.
  
6. (Original) A system as claimed in claim 1, wherein the presence of location information in the additional data field is indicated with header information appearing in the additional data field.
  
7. (Original) A system in accordance with claim 1, wherein wireless messaging system employs frequency hopping, and further wherein location data is sent on each frequency used for inquiry message broadcasts.
  
8. (Original) A mobile communication device for use in the system of claim 1, the device comprising a receiver capable of receiving a short-range wireless inquiry message including a plurality of data fields according to a first communications protocol, means for determining when an additional data field including location information has been added to said plurality of data fields, and means for reading the location information data from such an additional data field.

Application No: 09/876,515  
Attorney's Docket No: GB 000109

9. (Original) A device as claimed in claim 8, wherein the receiver is configured to receive messages according to Bluetooth protocols.

10. (Original) A beacon device capable of wireless message transmission and for use in a communications system comprising said beacon device and at least one portable device capable of receiving such a message transmission, wherein the beacon is configured to broadcast a series of inquiry messages each in the form of a plurality of predetermined data fields arranged according to a first communications protocol, and to add to each inquiry message prior to transmission an additional data field, such as to enable the at least one portable device arranged to receive the transmitted inquiry messages to read data from said additional data field, the additional data field including location information.

11. (Original) A method for enabling the user of a portable communications device to receive broadcast messages wherein at least one beacon device broadcasts a series of inquiry messages each in the form of a plurality of predetermined data fields arranged according to a first communications protocol, wherein the beacon adds to each inquiry message prior to transmission an additional data field carrying broadcast message data including location information, and wherein the portable device receives the transmitted inquiry messages including the location information and reads the broadcast data from said additional data field.

Application No: 09/876,515  
Attorney's Docket No: GB 000109

12. (Original) A method as claimed in claim 11, wherein the beacon adds said additional data field at the end of a respective inquiry message.
  
13. (Original) A method as claimed in claim 11, wherein the beacon includes an indication in one of said predetermined data fields, said indication denoting the presence of said additional data field.
  
14. (Original) A method as claimed in claim 11, wherein said first communications protocol comprises Bluetooth messaging.

Application No: 09/876,515  
Attorney's Docket No: GB 000109

### REMARKS

Applicant acknowledges receipt of the Final Office Action dated 02/24/2006. Claims 1-14 were pending in the application and are presented for reconsideration and further examination in view of the following remarks and arguments.

By this Response and Amendment the rejection of claims 1-14 under 35 U.S.C. § 103(a) is respectfully traversed.

#### **Rejections under 35 U.S.C. § 103**

The Examiner rejected claims 1-14 under 35 U.S.C. § 103(a) as being obvious over US Patent 5,835,861 to Whiteside, hereinafter noted "Whiteside," in view of US Patent 6,169,498 to King et al., hereinafter noted "King."

Applicant respectfully traverses these rejections.

Independent claims 1, 10 and 11 are directed to a communication system, a beacon device and a method for enabling data delivery through beacons. The system comprises the beacon device and at least one portable device. The beacon device broadcasts a series of inquiry messages in the form of a plurality of predetermined data fields arranged according to a communications protocol, and adds to each inquiry message an additional data field including location information. The portable device is arranged to receive the transmitted inquiry messages and read the additional data field including the location information. Dependent claim 8 depends from claim 1 and is directed to a mobile communication device such as the portable device recited in claim 1.

To establish a *prima facie* case of obviousness, three basic criteria must be met.

First, there must be some suggestion or motivation, either in the references themselves or in the knowledge generally available to one of ordinary skill in the art, to modify the reference or to combine reference teachings. Second, there must be a reasonable expectation of success. Finally, the prior art reference (or references when combined) must teach or suggest all the claim limitations. The teaching or suggestion to make the claimed combination and the reasonable

Application No: 09/876,515  
Attorney's Docket No: GB 000109

expectation of success must both be found in the prior art and not based on applicant's disclosure. *In re Vaeck*, 947 F.2d 488, 20 USPQ2d 1438 (Fed. Cir. 1991). See MPEP § 2143-§2143.03 for decisions pertinent to each of these criteria.

Applicant will show that the Examiner has not established a *prima facie* case of obviousness because the prior art references cited by the Examiner do not teach or suggest all the claim limitations, as recited in independent claims 1, 10 and 11, or in any of their respective dependent claims.

1. Claims 1, 8, 10 and 11:

Applicant respectfully submits that Whiteside does not teach or suggest a beacon "arranged to broadcast a series of inquiry messages" as recited in, e.g., claim 1. What Whiteside discloses is a method of transmitting advertising information from a billboard to a wireless telephone. Whiteside describes two embodiments. In a first embodiment, an "infrared transceiver simply broadcasts the telephone number of the vendor continuously." See Col. 2:13-16. In a second embodiment, the method comprises: "receiving a signal transmitted from a wireless telephone at a billboard, said signal being other than the regular wireless frequency band and, in response to receiving said signal, automatically transmitting a second signal from said billboard that is to be received and stored by said wireless telephone." See Col. 3:22-32 and Col. 2:26-30. In other words, the billboard in Whiteside does not broadcast inquiry messages, but instead it either simply broadcasts advertising information continuously, or it sends back a signal that includes the advertising information in response to a signal received from a wireless telephone. There is no teaching or suggestion that the billboard in Whiteside would broadcast inquiry messages.

Furthermore, Applicant submits that Whiteside does not teach or suggest the inquiry messages being "in the form of a plurality of predetermined data fields arranged according to a first communications protocol," or that "the beacon is further arranged to add to each inquiry message prior to transmission an additional data field," as recited in claims 1, 10 and 11. What Whiteside discloses is just that the signal broadcast from the billboard to the wireless telephone "can also be used to convey other data, such as a bank interest rate, current product cost," and



Application No: 09/876,515  
Attorney's Docket No: GB 000109

that the message transmitted from the wireless telephone to the billboard "can also be enhanced to make a more specific request for one of the items of information that can be supplied by the billboard." *See* Col. 2:35-39. In other words, Whiteside only describes the various types of information that can be exchanged between the wireless telephone and the billboard. Whiteside does not teach or suggest what kind of structures and/or protocols are used to transmit that information. In particular, Whiteside is silent about adding an additional data field prior to transmission, as recited in claims 1, 10 and 11.

The Examiner admits that "Whiteside does not teach the additional data field including location information," and relies upon King for that feature. Applicant submits that King, not only does not cure the other deficiencies previously pointed out in Whiteside, but it does not teach or suggest "the additional data field including location information" either. King is directed to a method for communicating location-specific messages. However, the method taught by King requires "storing a library of such messages within a portable device having a capability of randomly accessing the messages." *See, e.g.,* Abstract, lines 1-4; and claims 1, 8 and 9 of King. In other words, the location-specific messages disclosed by King are already stored in the portable device, they are not sent from a beacon to the portable device, as recited in claims 1, 10 and 11 of the application.

Applicant therefore submits that the Examiner has failed to establish a *prima facie* case of obviousness because the prior art references cited by the Examiner do not teach or suggest all the claim limitations, as recited in independent claims 1, 10 and 11. Applicant also submits that claim 8, which depends from 1, is patentable over the cited art references for at least the reasons stated above in connection with claim 1. Accordingly, reconsideration and withdrawal of the rejection of claims 1, 8, 10 and 11 is respectfully requested.

2. Claims 2-3 and 12-13:

Claims 2-3 and 12-13 depend, respectively, from claims 1 and 11, and are therefore also patentable over the cited art references for at least the reasons stated above in connection with claims 1 and 11, as well as for the separately patentable subject matter recited therein. In particular, and contrary to the Examiner's assertion, Applicant submits that Whiteside does not

Application No: 09/876,515  
Attorney's Docket No: GB 000109

teach or suggest "the beacon is arranged to add said additional data field at the end of a respective inquiry message," as recited in claims 2 and 12. Furthermore, there is absolutely no teaching or suggestion in Whiteside of a beacon "arranged to include an indication in one of said predetermined data fields, said indication denoting the presence of said additional data field," as recited in claims 3 and 13. Moreover, Applicant respectfully submits that the citation provided by the Examiner in support for the rejection is completely irrelevant. At column 2, lines 35-39, Whiteside only states that, "Message 16 can also be used to convey other data, such as a bank interest rate, current product cost; message 15 can also be enhanced to make a more specific request for one of the items of information that can be supplied by the billboard."

Applicant therefore submits that the Examiner has failed to establish a *prima facie* case of obviousness against the subject matter recited in claims 2-3 and 12-13 because the prior art references cited by the Examiner do not teach or suggest all the claim limitations. Accordingly, reconsideration and withdrawal of the rejection of claims 2-3 and 12-13 is respectfully requested.

### 3. Claims 4 and 14:

Claims 4 and 14 depend, respectively, from claims 1 and 11, and are therefore also patentable over the cited art references for at least the reasons stated above in connection with claims 1 and 11, as well as for the separately patentable subject matter recited therein. In particular, and contrary to the Examiner's assertion, Applicant submits that Whiteside does not teach or suggest "wherein said communications protocol comprises Bluetooth messaging," as recited in claims 4 and 14. What Whiteside teaches at column 1, lines 48-49 is that "Communications in both directions are via a modulated infrared signal," which teaches away from a Bluetooth protocol. Bluetooth is an industrial specification for wireless networks, also known as IEEE 802.15.1, that provides a way to connect and exchange information between devices via a short range **radio frequency**, whereas Whiteside teaches communications via an **infrared signal**.

Applicant therefore submits that the Examiner has failed to establish a *prima facie* case of obviousness against the subject matter recited in claims 4 and 14 because the prior art references

Application No: 09/876,515  
Attorney's Docket No: GB 000109

cited by the Examiner do not teach or suggest all the claim limitations. Accordingly, reconsideration and withdrawal of the rejection of claims 4 and 14 is respectfully requested.

4. Claims 5 and 7:

Claims 5 and 7 depend, respectively, from claims 4 and 1, and are therefore also patentable over the cited art references for at least the reasons stated above in connection with claims 4 and 1, as well as for the separately patentable subject matter recited therein. In particular, and contrary to the Examiner's assertion, Applicant submits that Whiteside does not teach or suggest "a special Dedicated Inquiry Access Code (DIAC) is used to indicate the presence of location information in the additional data field," as recited in claim 5. Furthermore, there is absolutely no teaching or suggestion in Whiteside that the "wireless messaging system employs frequency hopping, and further wherein location data is sent on each frequency used for inquiry message broadcasts," as recited in claim 7. Moreover, Applicant respectfully submits that the citation provided by the Examiner in support for this rejection is again completely irrelevant. At column 1, lines 48-49, Whiteside only states that, "Communications in both directions are via a modulated infrared signal."

Applicant therefore submits that the Examiner has failed to establish a *prima facie* case of obviousness against the subject matter recited in claims 5 and 7 because the prior art references cited by the Examiner do not teach or suggest all the claim limitations. Accordingly, reconsideration and withdrawal of the rejection of claims 5 and 7 is respectfully requested.

5. Claim 6:

Claim 6 depends from claim 1 and is therefore also patentable over the cited art references for at least the reasons stated above in connection with claim 1, as well as for the separately patentable subject matter recited therein. In particular, and contrary to the Examiner's assertion, Applicant submits that King does not teach or suggest "wherein the presence of location information in the additional data field is indicated with header information appearing in the additional data field," as recited in claim 6. The Examiner already admitted that Whiteside does not teach this feature, and Applicant submits that there is absolutely no teaching or suggestion of this feature in King either. Once again, the citation provided by the Examiner in

Application No: 09/876,515  
Attorney's Docket No: GB 000109

support for this rejection is completely irrelevant. What King discloses in the Abstract, lines 17-22 is just that, "The fixed map information and the time-dependent information may then be accessed to locate a particular site specified by the time-dependent information. For example, the map information may include gate locations within an airport and the time-dependent information may include flight arrival and departure times."

Applicant therefore submits that the Examiner has failed to establish a *prima facie* case of obviousness against the subject matter recited in claim 6 because the prior art references cited by the Examiner do not teach or suggest all the claim limitations. Accordingly, reconsideration and withdrawal of the rejection of claim 6 is respectfully requested.

6. Claim 9:

Claim 9 depends from claims 1 and 8 and is therefore also patentable over the cited art references for at least the reasons stated above in connection with claims 1 and 8, as well as for the separately patentable subject matter recited therein. In particular, and contrary to the Examiner's assertion, Applicant submits that Whiteside does not teach or suggest "wherein the receiver is configured to receive messages according to Bluetooth protocols," as recited in claim 9. What Whiteside teaches at column 1, lines 48-49 is that "Communications in both directions are via a modulated infrared signal," which teaches away from a Bluetooth protocol. Bluetooth is an industrial specification for wireless networks, also known as IEEE 802.15.1, that provides a way to connect and exchange information between devices via a short range radio frequency, whereas Whiteside teaches communications via an **infrared signal**.

Applicant therefore submits that the Examiner has failed to establish a *prima facie* case of obviousness against the subject matter recited in claim 9 because the prior art references cited by the Examiner do not teach or suggest all the claim limitations. Accordingly, reconsideration and withdrawal of the rejection of claim 9 is respectfully requested.

Application No: 09/876,515  
Attorney's Docket No: GB 000109

While we believe that the instant amendment places the application in condition for allowance, should the Examiner have any further comments or suggestions, it is respectfully requested that the Examiner telephone the undersigned attorney in order to expeditiously resolve any outstanding issues.

In the event that the fees submitted prove to be insufficient in connection with the filing of this paper, please charge our Deposit Account Number 50-0578 and please credit any excess fees to such Deposit Account.

Respectfully submitted,  
KRAMER & AMADO, P.C.

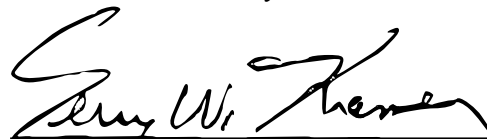

Terry W. Kramer  
Registration No.: 41,541

Date: May 15, 2006

KRAMER & AMADO, P.C.  
1725 Duke Street, Suite 240  
Alexandria, VA 22314  
Phone: 703-519-9801  
Fax: 703-519-9802

Under the Paperwork Reduction Act of 1995, no persons are required to respond to a collection of information unless it displays a valid OMB control number.

| <b>PATENT APPLICATION FEE DETERMINATION RECORD</b><br>Substitute for Form PTO-875                                               |                                                                                                                                                                                                                               |                                  |                                    |                                          | Application or Docket Number<br><b>09/876,515</b> | Filing Date<br><b>06/07/2001</b> | <input type="checkbox"/> To be Mailed |                 |                     |
|---------------------------------------------------------------------------------------------------------------------------------|-------------------------------------------------------------------------------------------------------------------------------------------------------------------------------------------------------------------------------|----------------------------------|------------------------------------|------------------------------------------|---------------------------------------------------|----------------------------------|---------------------------------------|-----------------|---------------------|
| <b>APPLICATION AS FILED – PART I</b>                                                                                            |                                                                                                                                                                                                                               |                                  |                                    |                                          | OTHER THAN                                        |                                  |                                       |                 |                     |
| (Column 1)                                                                                                                      |                                                                                                                                                                                                                               | (Column 2)                       |                                    | SMALL ENTITY <input type="checkbox"/> OR |                                                   | SMALL ENTITY                     |                                       |                 |                     |
| FOR                                                                                                                             | NUMBER FILED                                                                                                                                                                                                                  | NUMBER EXTRA                     | RATE (\$)                          | FEE (\$)                                 | OR                                                | RATE (\$)                        | FEE (\$)                              |                 |                     |
| <input type="checkbox"/> BASIC FEE<br><small>(37 CFR 1.16(a), (b), or (c))</small>                                              | N/A                                                                                                                                                                                                                           | N/A                              | N/A                                |                                          | OR                                                | N/A                              |                                       |                 |                     |
| <input type="checkbox"/> SEARCH FEE<br><small>(37 CFR 1.16(k), (j), or (m))</small>                                             | N/A                                                                                                                                                                                                                           | N/A                              | N/A                                |                                          | OR                                                | N/A                              |                                       |                 |                     |
| <input type="checkbox"/> EXAMINATION FEE<br><small>(37 CFR 1.16(o), (p), or (q))</small>                                        | N/A                                                                                                                                                                                                                           | N/A                              | N/A                                |                                          | OR                                                | N/A                              |                                       |                 |                     |
| TOTAL CLAIMS<br><small>(37 CFR 1.16(i))</small>                                                                                 | minus 20 =                                                                                                                                                                                                                    | *                                | X \$ =                             |                                          | OR                                                | X \$ =                           |                                       |                 |                     |
| INDEPENDENT CLAIMS<br><small>(37 CFR 1.16(h))</small>                                                                           | minus 3 =                                                                                                                                                                                                                     | *                                | X \$ =                             |                                          | OR                                                | X \$ =                           |                                       |                 |                     |
| <input type="checkbox"/> APPLICATION SIZE FEE<br><small>(37 CFR 1.16(s))</small>                                                | If the specification and drawings exceed 100 sheets of paper, the application size fee due is \$250 (\$125 for small entity) for each additional 50 sheets or fraction thereof. See 35 U.S.C. 41(a)(1)(G) and 37 CFR 1.16(s). |                                  |                                    |                                          | OR                                                |                                  |                                       |                 |                     |
| <input type="checkbox"/> MULTIPLE DEPENDENT CLAIM PRESENT <small>(37 CFR 1.16(j))</small>                                       |                                                                                                                                                                                                                               |                                  |                                    |                                          |                                                   |                                  |                                       |                 |                     |
| * If the difference in column 1 is less than zero, enter "0" in column 2.                                                       |                                                                                                                                                                                                                               |                                  |                                    |                                          |                                                   |                                  |                                       |                 |                     |
| <b>APPLICATION AS AMENDED – PART II</b>                                                                                         |                                                                                                                                                                                                                               |                                  |                                    |                                          | OTHER THAN                                        |                                  |                                       |                 |                     |
| (Column 1)                                                                                                                      |                                                                                                                                                                                                                               | (Column 2)                       |                                    | SMALL ENTITY OR                          |                                                   | SMALL ENTITY                     |                                       |                 |                     |
| AMENDMENT                                                                                                                       | 05/15/2006                                                                                                                                                                                                                    | CLAIMS REMAINING AFTER AMENDMENT | HIGHEST NUMBER PREVIOUSLY PAID FOR | PRESENT EXTRA                            | RATE (\$)                                         | ADDITIONAL FEE (\$)              | OR                                    | RATE (\$)       | ADDITIONAL FEE (\$) |
| Total <small>(37 CFR 1.16(j))</small>                                                                                           | *                                                                                                                                                                                                                             | 14                               | Minus                              | ** 20                                    | X \$ =                                            |                                  | OR                                    | X \$50=         | 0                   |
| Independent <small>(37 CFR 1.16(h))</small>                                                                                     | *                                                                                                                                                                                                                             | 3                                | Minus                              | ***3                                     | X \$ =                                            |                                  | OR                                    | X \$200=        | 0                   |
| <input type="checkbox"/> Application Size Fee <small>(37 CFR 1.16(s))</small>                                                   |                                                                                                                                                                                                                               |                                  |                                    |                                          |                                                   |                                  |                                       |                 |                     |
| <input type="checkbox"/> FIRST PRESENTATION OF MULTIPLE DEPENDENT CLAIM <small>(37 CFR 1.16(j))</small>                         |                                                                                                                                                                                                                               |                                  |                                    |                                          |                                                   |                                  |                                       |                 |                     |
|                                                                                                                                 |                                                                                                                                                                                                                               |                                  |                                    |                                          | TOTAL ADD'L FEE                                   |                                  | OR                                    | TOTAL ADD'L FEE | 0                   |
| (Column 1)                                                                                                                      |                                                                                                                                                                                                                               | (Column 2)                       |                                    | (Column 3)                               |                                                   |                                  |                                       |                 |                     |
| AMENDMENT                                                                                                                       |                                                                                                                                                                                                                               | CLAIMS REMAINING AFTER AMENDMENT | HIGHEST NUMBER PREVIOUSLY PAID FOR | PRESENT EXTRA                            | RATE (\$)                                         | ADDITIONAL FEE (\$)              | OR                                    | RATE (\$)       | ADDITIONAL FEE (\$) |
| Total <small>(37 CFR 1.16(j))</small>                                                                                           | *                                                                                                                                                                                                                             |                                  | Minus                              | **                                       | X \$ =                                            |                                  | OR                                    | X \$ =          |                     |
| Independent <small>(37 CFR 1.16(h))</small>                                                                                     | *                                                                                                                                                                                                                             |                                  | Minus                              | ***                                      | X \$ =                                            |                                  | OR                                    | X \$ =          |                     |
| <input type="checkbox"/> Application Size Fee <small>(37 CFR 1.16(s))</small>                                                   |                                                                                                                                                                                                                               |                                  |                                    |                                          |                                                   |                                  |                                       |                 |                     |
| <input type="checkbox"/> FIRST PRESENTATION OF MULTIPLE DEPENDENT CLAIM <small>(37 CFR 1.16(j))</small>                         |                                                                                                                                                                                                                               |                                  |                                    |                                          |                                                   |                                  |                                       |                 |                     |
|                                                                                                                                 |                                                                                                                                                                                                                               |                                  |                                    |                                          | TOTAL ADD'L FEE                                   |                                  | OR                                    | TOTAL ADD'L FEE |                     |
| * If the entry in column 1 is less than the entry in column 2, write "0" in column 3.                                           |                                                                                                                                                                                                                               |                                  |                                    |                                          |                                                   |                                  |                                       |                 |                     |
| ** If the "Highest Number Previously Paid For" IN THIS SPACE is less than 20, enter "20".                                       |                                                                                                                                                                                                                               |                                  |                                    |                                          |                                                   |                                  |                                       |                 |                     |
| *** If the "Highest Number Previously Paid For" IN THIS SPACE is less than 3, enter "3".                                        |                                                                                                                                                                                                                               |                                  |                                    |                                          |                                                   |                                  |                                       |                 |                     |
| The "Highest Number Previously Paid For" (Total or Independent) is the highest number found in the appropriate box in column 1. |                                                                                                                                                                                                                               |                                  |                                    |                                          |                                                   |                                  |                                       |                 |                     |

Legal Instrument Examiner:  
/DAVINA G. BUTLER/

This collection of information is required by 37 CFR 1.16. The information is required to obtain or retain a benefit by the public which is to file (and by the USPTO to process) an application. Confidentiality is governed by 35 U.S.C. 122 and 37 CFR 1.14. This collection is estimated to take 12 minutes to complete, including gathering, preparing, and submitting the completed application form to the USPTO. Time will vary depending upon the individual case. Any comments on the amount of time you require to complete this form and/or suggestions for reducing this burden, should be sent to the Chief Information Officer, U.S. Patent and Trademark Office, U.S. Department of Commerce, P.O. Box 1450, Alexandria, VA 22313-1450. DO NOT SEND FEES OR COMPLETED FORMS TO THIS ADDRESS. SEND TO: Commissioner for Patents, P.O. Box 1450, Alexandria, VA 22313-1450.

If you need assistance in completing the form, call 1-800-PTO-9199 and select option 2.



UNITED STATES PATENT AND TRADEMARK OFFICE

UNITED STATES DEPARTMENT OF COMMERCE  
United States Patent and Trademark Office  
Address: COMMISSIONER FOR PATENTS  
P.O. Box 1450  
Alexandria, Virginia 22313-1450  
www.uspto.gov

| APPLICATION NO.                                                                          | FILING DATE | FIRST NAMED INVENTOR | ATTORNEY DOCKET NO. | CONFIRMATION NO. |
|------------------------------------------------------------------------------------------|-------------|----------------------|---------------------|------------------|
| 09/876,515                                                                               | 06/07/2001  | Robert J. Davies     | GB 000109           | 9201             |
| 24737                                                                                    | 7590        | 02/24/2006           | EXAMINER            |                  |
| PHILIPS INTELLECTUAL PROPERTY & STANDARDS<br>P.O. BOX 3001<br>BRIARCLIFF MANOR, NY 10510 |             |                      | LE, KAREN L         |                  |
|                                                                                          |             |                      | ART UNIT            | PAPER NUMBER     |
|                                                                                          |             |                      | 2642                |                  |

DATE MAILED: 02/24/2006

Please find below and/or attached an Office communication concerning this application or proceeding.

|                              |                                      |                                      |  |
|------------------------------|--------------------------------------|--------------------------------------|--|
| <b>Office Action Summary</b> | <b>Application No.</b><br>09/876,515 | <b>Applicant(s)</b><br>DAVIES ET AL. |  |
|                              | <b>Examiner</b><br>Karen L. Le       | <b>Art Unit</b><br>2642              |  |

-- The MAILING DATE of this communication appears on the cover sheet with the correspondence address --

**Period for Reply**

A SHORTENED STATUTORY PERIOD FOR REPLY IS SET TO EXPIRE 3 MONTH(S) OR THIRTY (30) DAYS, WHICHEVER IS LONGER, FROM THE MAILING DATE OF THIS COMMUNICATION.

- Extensions of time may be available under the provisions of 37 CFR 1.136(a). In no event, however, may a reply be timely filed after SIX (6) MONTHS from the mailing date of this communication.
- If NO period for reply is specified above, the maximum statutory period will apply and will expire SIX (6) MONTHS from the mailing date of this communication.
- Failure to reply within the set or extended period for reply will, by statute, cause the application to become ABANDONED (35 U.S.C. § 133). Any reply received by the Office later than three months after the mailing date of this communication, even if timely filed, may reduce any earned patent term adjustment. See 37 CFR 1.704(b).

**Status**

- 1)  Responsive to communication(s) filed on 12/30/06.
- 2a)  This action is FINAL.                      2b)  This action is non-final.
- 3)  Since this application is in condition for allowance except for formal matters, prosecution as to the merits is closed in accordance with the practice under *Ex parte Quayle*, 1935 C.D. 11, 453 O.G. 213.

**Disposition of Claims**

- 4)  Claim(s) 1-14 is/are pending in the application.  
4a) Of the above claim(s) \_\_\_\_\_ is/are withdrawn from consideration.
- 5)  Claim(s) \_\_\_\_\_ is/are allowed.
- 6)  Claim(s) 1-14 is/are rejected.
- 7)  Claim(s) \_\_\_\_\_ is/are objected to.
- 8)  Claim(s) \_\_\_\_\_ are subject to restriction and/or election requirement.

**Application Papers**

- 9)  The specification is objected to by the Examiner.
- 10)  The drawing(s) filed on \_\_\_\_\_ is/are: a)  accepted or b)  objected to by the Examiner.  
Applicant may not request that any objection to the drawing(s) be held in abeyance. See 37 CFR 1.85(a).  
Replacement drawing sheet(s) including the correction is required if the drawing(s) is objected to. See 37 CFR 1.121(d).
- 11)  The oath or declaration is objected to by the Examiner. Note the attached Office Action or form PTO-152.

**Priority under 35 U.S.C. § 119**

- 12)  Acknowledgment is made of a claim for foreign priority under 35 U.S.C. § 119(a)-(d) or (f).  
a)  All    b)  Some \*    c)  None of:
1.  Certified copies of the priority documents have been received.
2.  Certified copies of the priority documents have been received in Application No. \_\_\_\_\_.
3.  Copies of the certified copies of the priority documents have been received in this National Stage application from the International Bureau (PCT Rule 17.2(a)).

\* See the attached detailed Office action for a list of the certified copies not received.

**Attachment(s)**

- |                                                                                                                        |                                                                                         |
|------------------------------------------------------------------------------------------------------------------------|-----------------------------------------------------------------------------------------|
| 1) <input checked="" type="checkbox"/> Notice of References Cited (PTO-892)                                            | 4) <input type="checkbox"/> Interview Summary (PTO-413)<br>Paper No(s)/Mail Date. _____ |
| 2) <input type="checkbox"/> Notice of Draftsperson's Patent Drawing Review (PTO-948)                                   | 5) <input type="checkbox"/> Notice of Informal Patent Application (PTO-152)             |
| 3) <input type="checkbox"/> Information Disclosure Statement(s) (PTO-1449 or PTO/SB/08)<br>Paper No(s)/Mail Date _____ | 6) <input type="checkbox"/> Other: _____                                                |



## DETAILED ACTION

### ***Claim Rejections - 35 USC § 103***

1. The following is a quotation of 35 U.S.C. 103(a) which forms the basis for all obviousness rejections set forth in this Office action:

(a) A patent may not be obtained though the invention is not identically disclosed or described as set forth in section 102 of this title, if the differences between the subject matter sought to be patented and the prior art are such that the subject matter as a whole would have been obvious at the time the invention was made to a person having ordinary skill in the art to which said subject matter pertains. Patentability shall not be negated by the manner in which the invention was made.

2. Claims 1-14 are rejected under 35 U.S.C. 103(a) as being unpatentable over Whiteside (U. S. 5,835,861) in view of King et al (U.S. 6,169,498).

Regarding claims 1, 8, 10 and 11, Whiteside teaches a communications system comprising at least one beacon device (Fig. 1, item 20) capable of wireless message transmission (Col. 2, lines 14-18) and at least one portable device (Fig. 1, item 10) capable of receiving such a message transmission (Col. 2, lines 54-55), wherein the beacon is arranged to broadcast a series of inquiry messages each in the form of a plurality of predetermined data fields arranged according to a first communications protocol (Col. 2, lines 35-39). The beacon is further arranged to add to each inquiry message prior to transmission an additional data field, and wherein the at least one portable device is arranged to receive the transmitted inquiry messages and read data from said additional data field (Col. 2, lines 35-39).

Whiteside does not teach the additional data field including location information. However King teaches the additional data field including location information (Col. 3, lines 54-56). Whiteside teaches a method for communicating location-specific messages that has a content that is related to a particular geographical location within a facility. Thus, it would have been obvious to one of ordinary skill in the art at the time the invention was made to incorporate King's location feature into Whiteside's system in order to provide additional data field including location information. This feature is old and popular in telecommunication system.

Regarding claims 2-3 and 12-13, Whiteside teaches the beacon is arranged to add said additional data field at the end of a respective inquiry message wherein the beacon is arranged to include an indication in one of said predetermined data fields, said indication denoting the presence of said additional data field (col. 2, lines 35-39).

Regarding claims 4 and 14, Whiteside further teaches a system as claimed in Claim 1, wherein said first communications protocol comprises Bluetooth messaging (Col. 1, lines 48-49).

Regarding claims 5 and 7, Whiteside further teaches a system as claimed in claim 4, wherein a special Dedicated Inquiry Access Code (DIAC) is used to indicate the presence of location information in the additional data field. Wireless messaging

Art Unit: 2642

system employs frequency hopping, and further wherein location data is sent on each frequency used for inquiry message broadcasts (Col. 1, lines 48-49).

Regarding claim 6, Whiteside does not teach a system as claimed in claim 1, wherein the presence of location information in the additional data field is indicated with header information appearing in the additional data field. However, King teaches wherein the presence of location information in the additional data field is indicated with header information appearing in the additional data field (Abstract, lines 17-22).

Regarding claim 9, Whiteside further teaches a device as claimed in Claim 8, wherein the receiver is configured to receive messages according to Bluetooth protocols (Col. 1, lines 48-49).

### ***Response to Arguments***

3. Applicant's arguments with respect to claims 1- 14 have been considered but are moot in view of the new ground of rejection.

### ***Conclusion***

Any inquiry concerning this communication or earlier communications from the examiner should be directed to Karen Le whose telephone number is 571-272-7487.

The examiner can normally be reached on 8am-5pm.

Application/Control Number: 09/876,515

Page 5

Art Unit: 2642

If attempts to reach the examiner by telephone are unsuccessful, the examiner's supervisor, Ahmad Matar can be reached on 571-272-7488. The fax phone number for the organization where this application or proceeding is assigned is 571-273-8300.

Information regarding the status of an application may be obtained from the Patent Application Information Retrieval (PAIR) system. Status information for published applications may be obtained from either Private PAIR or Public PAIR. Status information for unpublished applications is available through Private PAIR only. For more information about the PAIR system, see <http://pair-direct.uspto.gov>. Should you have questions on access to the Private PAIR system, contact the Electronic Business Center (EBC) at 866-217-9197 (toll-free).

Karen Le  
KLL  
February 17, 2006

  
AHMAD MATAR  
SUPERVISORY PATENT EXAMINER  
TECHNOLOGY CENTER 2600

|                                   |                                       |                                                             |             |
|-----------------------------------|---------------------------------------|-------------------------------------------------------------|-------------|
| <b>Notice of References Cited</b> | Application/Control No.<br>09/876,515 | Applicant(s)/Patent Under<br>Reexamination<br>DAVIES ET AL. |             |
|                                   | Examiner<br>Karen L. Le               | Art Unit<br>2642                                            | Page 1 of 1 |

**U.S. PATENT DOCUMENTS**

| * | Document Number<br>Country Code-Number-Kind Code | Date<br>MM-YYYY | Name             | Classification |
|---|--------------------------------------------------|-----------------|------------------|----------------|
| * | A US-5,835,861                                   | 11-1998         | Whiteside, Bruce | 455/466        |
| * | B US-6,169,498                                   | 01-2001         | King et al.      | 340/686.1      |
|   | C US-                                            |                 |                  |                |
|   | D US-                                            |                 |                  |                |
|   | E US-                                            |                 |                  |                |
|   | F US-                                            |                 |                  |                |
|   | G US-                                            |                 |                  |                |
|   | H US-                                            |                 |                  |                |
|   | I US-                                            |                 |                  |                |
|   | J US-                                            |                 |                  |                |
|   | K US-                                            |                 |                  |                |
|   | L US-                                            |                 |                  |                |
|   | M US-                                            |                 |                  |                |

**FOREIGN PATENT DOCUMENTS**

| * | Document Number<br>Country Code-Number-Kind Code | Date<br>MM-YYYY | Country | Name | Classification |
|---|--------------------------------------------------|-----------------|---------|------|----------------|
|   | N                                                |                 |         |      |                |
|   | O                                                |                 |         |      |                |
|   | P                                                |                 |         |      |                |
|   | Q                                                |                 |         |      |                |
|   | R                                                |                 |         |      |                |
|   | S                                                |                 |         |      |                |
|   | T                                                |                 |         |      |                |

**NON-PATENT DOCUMENTS**

| * | Include as applicable: Author, Title Date, Publisher, Edition or Volume, Pertinent Pages) |
|---|-------------------------------------------------------------------------------------------|
|   | U                                                                                         |
|   | V                                                                                         |
|   | W                                                                                         |
|   | X                                                                                         |

\*A copy of this reference is not being furnished with this Office action. (See MPEP § 707.05(a).)  
Dates in MM-YYYY format are publication dates. Classifications may be US or foreign.

**Index of Claims**



Application No.

09/876,515

Examiner

Karen L Le

Applicant(s)

DAVIES ET AL.

Art Unit

2642

|   |          |
|---|----------|
| √ | Rejected |
| = | Allowed  |

|   |                                |
|---|--------------------------------|
| - | (Through numeral)<br>Cancelled |
| + | Restricted                     |

|   |              |
|---|--------------|
| N | Non-Elected  |
| I | Interference |

|   |          |
|---|----------|
| A | Appeal   |
| O | Objected |

| Claim |          | Date    |          |        |  | Claim |          | Date |  |  |  | Claim |          | Date |  |  |  |
|-------|----------|---------|----------|--------|--|-------|----------|------|--|--|--|-------|----------|------|--|--|--|
| Final | Original | 2/17/05 | 10/17/05 | 2/7/06 |  | Final | Original |      |  |  |  | Final | Original |      |  |  |  |
|       | 1        | √       | √        | √      |  |       | 51       |      |  |  |  |       | 101      |      |  |  |  |
|       | 2        | √       | √        | √      |  |       | 52       |      |  |  |  |       | 102      |      |  |  |  |
|       | 3        | √       | √        | √      |  |       | 53       |      |  |  |  |       | 103      |      |  |  |  |
|       | 4        | √       | √        | √      |  |       | 54       |      |  |  |  |       | 104      |      |  |  |  |
|       | 5        | √       | √        | √      |  |       | 55       |      |  |  |  |       | 105      |      |  |  |  |
|       | 6        | √       | √        | √      |  |       | 56       |      |  |  |  |       | 106      |      |  |  |  |
|       | 7        | √       | √        | √      |  |       | 57       |      |  |  |  |       | 107      |      |  |  |  |
|       | 8        | √       | √        | √      |  |       | 58       |      |  |  |  |       | 108      |      |  |  |  |
|       | 9        | √       | √        | √      |  |       | 59       |      |  |  |  |       | 109      |      |  |  |  |
|       | 10       | √       | √        | √      |  |       | 60       |      |  |  |  |       | 110      |      |  |  |  |
|       | 11       | √       | √        | √      |  |       | 61       |      |  |  |  |       | 111      |      |  |  |  |
|       | 12       | √       | √        | √      |  |       | 62       |      |  |  |  |       | 112      |      |  |  |  |
|       | 13       | √       | √        | √      |  |       | 63       |      |  |  |  |       | 113      |      |  |  |  |
|       | 14       | √       | √        | √      |  |       | 64       |      |  |  |  |       | 114      |      |  |  |  |
|       | 15       |         |          |        |  |       | 65       |      |  |  |  |       | 115      |      |  |  |  |
|       | 16       |         |          |        |  |       | 66       |      |  |  |  |       | 116      |      |  |  |  |
|       | 17       |         |          |        |  |       | 67       |      |  |  |  |       | 117      |      |  |  |  |
|       | 18       |         |          |        |  |       | 68       |      |  |  |  |       | 118      |      |  |  |  |
|       | 19       |         |          |        |  |       | 69       |      |  |  |  |       | 119      |      |  |  |  |
|       | 20       |         |          |        |  |       | 70       |      |  |  |  |       | 120      |      |  |  |  |
|       | 21       |         |          |        |  |       | 71       |      |  |  |  |       | 121      |      |  |  |  |
|       | 22       |         |          |        |  |       | 72       |      |  |  |  |       | 122      |      |  |  |  |
|       | 23       |         |          |        |  |       | 73       |      |  |  |  |       | 123      |      |  |  |  |
|       | 24       |         |          |        |  |       | 74       |      |  |  |  |       | 124      |      |  |  |  |
|       | 25       |         |          |        |  |       | 75       |      |  |  |  |       | 125      |      |  |  |  |
|       | 26       |         |          |        |  |       | 76       |      |  |  |  |       | 126      |      |  |  |  |
|       | 27       |         |          |        |  |       | 77       |      |  |  |  |       | 127      |      |  |  |  |
|       | 28       |         |          |        |  |       | 78       |      |  |  |  |       | 128      |      |  |  |  |
|       | 29       |         |          |        |  |       | 79       |      |  |  |  |       | 129      |      |  |  |  |
|       | 30       |         |          |        |  |       | 80       |      |  |  |  |       | 130      |      |  |  |  |
|       | 31       |         |          |        |  |       | 81       |      |  |  |  |       | 131      |      |  |  |  |
|       | 32       |         |          |        |  |       | 82       |      |  |  |  |       | 132      |      |  |  |  |
|       | 33       |         |          |        |  |       | 83       |      |  |  |  |       | 133      |      |  |  |  |
|       | 34       |         |          |        |  |       | 84       |      |  |  |  |       | 134      |      |  |  |  |
|       | 35       |         |          |        |  |       | 85       |      |  |  |  |       | 135      |      |  |  |  |
|       | 36       |         |          |        |  |       | 86       |      |  |  |  |       | 136      |      |  |  |  |
|       | 37       |         |          |        |  |       | 87       |      |  |  |  |       | 137      |      |  |  |  |
|       | 38       |         |          |        |  |       | 88       |      |  |  |  |       | 138      |      |  |  |  |
|       | 39       |         |          |        |  |       | 89       |      |  |  |  |       | 139      |      |  |  |  |
|       | 40       |         |          |        |  |       | 90       |      |  |  |  |       | 140      |      |  |  |  |
|       | 41       |         |          |        |  |       | 91       |      |  |  |  |       | 141      |      |  |  |  |
|       | 42       |         |          |        |  |       | 92       |      |  |  |  |       | 142      |      |  |  |  |
|       | 43       |         |          |        |  |       | 93       |      |  |  |  |       | 143      |      |  |  |  |
|       | 44       |         |          |        |  |       | 94       |      |  |  |  |       | 144      |      |  |  |  |
|       | 45       |         |          |        |  |       | 95       |      |  |  |  |       | 145      |      |  |  |  |
|       | 46       |         |          |        |  |       | 96       |      |  |  |  |       | 146      |      |  |  |  |
|       | 47       |         |          |        |  |       | 97       |      |  |  |  |       | 147      |      |  |  |  |
|       | 48       |         |          |        |  |       | 98       |      |  |  |  |       | 148      |      |  |  |  |
|       | 49       |         |          |        |  |       | 99       |      |  |  |  |       | 149      |      |  |  |  |
|       | 50       |         |          |        |  |       | 100      |      |  |  |  |       | 150      |      |  |  |  |

**Search Notes**

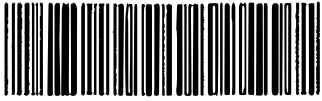

**Application No.**

09/876,515

**Examiner**

Karen L Le

**Applicant(s)**

DAVIES ET AL.

**Art Unit**

2642

**SEARCHED**

| Class  | Subclass    | Date       | Examiner |
|--------|-------------|------------|----------|
| 455    | 457         | 2/17/2005  | KL       |
| 455    | 456.1       | 2/17/2005  | KL       |
| update | search EAST | 10/17/2005 | KL       |
| Update | Search East | 2/17/2006  | K.L.     |
|        |             |            |          |
|        |             |            |          |
|        |             |            |          |
|        |             |            |          |
|        |             |            |          |
|        |             |            |          |
|        |             |            |          |
|        |             |            |          |
|        |             |            |          |
|        |             |            |          |
|        |             |            |          |
|        |             |            |          |
|        |             |            |          |

**INTERFERENCE SEARCHED**

| Class | Subclass | Date | Examiner |
|-------|----------|------|----------|
|       |          |      |          |
|       |          |      |          |
|       |          |      |          |
|       |          |      |          |
|       |          |      |          |

**SEARCH NOTES (INCLUDING SEARCH STRATEGY)**

|                                 | DATE       | EXMR |
|---------------------------------|------------|------|
| Consulted with Charles Appiah   | 12/23/04   | KL   |
|                                 | 10/17/2005 | KL   |
| Consulted with Nick, Vuong Hien | 2/17/06    | K.L. |
|                                 |            |      |
|                                 |            |      |
|                                 |            |      |
|                                 |            |      |
|                                 |            |      |
|                                 |            |      |
|                                 |            |      |
|                                 |            |      |
|                                 |            |      |
|                                 |            |      |
|                                 |            |      |
|                                 |            |      |
|                                 |            |      |
|                                 |            |      |
|                                 |            |      |
|                                 |            |      |
|                                 |            |      |
|                                 |            |      |
|                                 |            |      |

**PATENT  
IN THE UNITED STATES PATENT AND TRADEMARK OFFICE**

**RECEIVED  
CENTRAL FAX CENTER**

|                      |   |                                  |
|----------------------|---|----------------------------------|
| In re Application of | : | Davies, et al.                   |
|                      | : |                                  |
| For                  | : | DATA DELIVERY THROUGH<br>BEACONS |
|                      | : |                                  |
| Serial No.:          | : | 09/876,515                       |
|                      | : |                                  |
| Filed                | : | June 7, 2001                     |
|                      | : |                                  |
| Art Unit             | : | 2642                             |
|                      | : |                                  |
| Examiner             | : | Le, Karen L.                     |
|                      | : |                                  |
| Att. Docket          | : | GB 000109                        |
|                      | : |                                  |
| Confirmation No.     | : | 9201                             |

**DEC 30 2005**

**RESPONSE UNDER 37 C.F.R. § 1.111**

Mail Stop Amendment  
Commissioner for Patents  
P.O. Box 1450  
Alexandria, VA 22313-1450

Sir:

In response to the Office Action dated October 19, 2005, the following is respectfully submitted.

**REMARKS/ARGUMENTS** begin on page 2 of this paper.



Application No: 09/876,515  
Attorney's Docket No: GB 000109

### REMARKS/ARGUMENTS

Applicant acknowledges receipt of the Office Action dated October 19, 2005.

#### REQUEST FOR ACKNOWLEDGEMENT OF CLAIM OF PRIORITY

The subject application was filed June 7, 2001 and claimed priority under 35 U.S.C. § 119 of GB 0015454.2 (filed June 26, 2000) and GB 0020073.3 (filed August 15, 2000) by way of the originally filed Declaration. 37 C.F.R. § 1.55; M.P.E.P. § 201.13. Certified copies of both GB applications were originally filed with the subject application and are listed on the Official Filing Receipt.

The undersigned respectfully requests that the Examiner acknowledge the claim for priority by checking the appropriate boxes on the next Office Action Summary page.

#### REJECTION UNDER 35 U.S.C. § 103

Claims 1-16 stand rejected under 35 U.S.C. § 103 as being unpatentable over Shteyn et al., U.S. Patent No. 6,782,253 in view of Evan et al., U.S. Patent No. 6,311,060.

Shteyn et al. was published on August 24, 2004 and was filed on August 10, 2000. Shteyn et al. does not claim priority from any other application. Accordingly, Shteyn et al. is a reference under 35 U.S.C. § 102(e) as of its associated U.S. filing date of August 10, 2000.

The subject application properly claims priority from two British Applications, GB 0015454.2 (filed June 26, 2000) and GB 0020073.3 (filed August 15, 2000). Both applications set forth identical inventors.

The undersigned submits herewith two properly executed Declarations under 37 C.F.R. § 1.131 to establish a date of invention *at least* as of June 26, 2000, thereby antedating the Shteyn et al. reference. See M.P.E.P. § 715. Both Declarations properly set forth prior invention in a WTO country other than the United States on or after January 1, 1996.

Application No: 09/876,515  
Attorney's Docket No: GB 000109

Reconsideration and withdrawal of the outstanding obviousness rejection is therefore respectfully requested.

**CONCLUSION:**

While we believe that the instant amendment places the application in condition for allowance, should the Examiner have any further comments or suggestions, it is respectfully requested that the Examiner telephone the undersigned attorney in order to expeditiously resolve any outstanding issues.

In the event that the fees submitted prove to be insufficient in connection with the filing of this paper, please charge our Deposit Account Number 50-0578 and please credit any excess fees to such Deposit Account.

Respectfully submitted,  
KRAMER & AMADO, P.C.

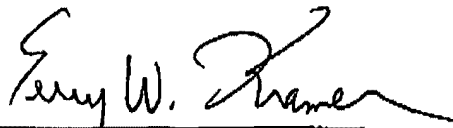

Terry W. Kramer  
Registration No.: 41,541

KRAMER & AMADO, P.C.  
1725 Duke Street, Suite 240  
Alexandria, VA 22314  
Phone: 703-519-9801  
Fax: 703-519-9802

Date: December 30, 2005

DEC 30 2005

PATENT

IN THE UNITED STATES PATENT AND TRADEMARK OFFICE

|                      |   |                               |
|----------------------|---|-------------------------------|
| In re Application of | : | Davies, et al.                |
|                      | : |                               |
| For                  | : | DATA DELIVERY THROUGH BEACONS |
|                      | : |                               |
| Serial No.:          | : | 09/876,515                    |
|                      | : |                               |
| Filed                | : | June 7, 2001                  |
|                      | : |                               |
| Art Unit             | : | 2642                          |
|                      | : |                               |
| Examiner             | : | Le, Karen L.                  |
|                      | : |                               |
| Att. Docket          | : | GB 000109                     |
|                      | : |                               |
| Confirmation No.     | : | 9201                          |

DECLARATION UNDER 37 C.F.R. § 1.131

Mail Stop Amendment  
Commissioner for Patents  
P.O. Box 1450  
Alexandria, VA 22313-1450

Sir:

The present Declaration is being submitted under 37 C.F.R. § 1.131 to establish a date of invention of the subject matter of claims 1-14 as originally filed, and claims 1-14 as are now pending before the U.S. Patent and Trademark Office. The present Declaration is further being submitted to establish a date of invention of the subject matter set forth in the specification and drawings as originally filed before the U.S. Patent and Trademark Office on June 7, 2001.

The above-referenced date of invention is at least as early as June 26, 2000.

The present application claims priority from two United Kingdom applications, namely GB 0015454.2 filed June 26, 2000 and GB 0020073.3 filed August 15, 2000. Although both priority documents were filed on different dates, approximately six weeks apart, the date of invention of the subject matter set forth in both applications was at least as of June 26, 2000.

Application No: 09/876,515  
Attorney's Docket No: GB 000109

Prior invention is established in the United States, in a NAFTA country other than the United States on or after December 8, 1993, or in a WTO country other than the United States on or after January 1, 1996.

Prior invention of the GB 0020073.3 United Kingdom patent application filed August 15, 2000 is established at least approximately six weeks prior, and at least as of June 26, 2000, because the undersigned inventors conceived of the present subject matter prior to June 26, 2000, then diligently submitted written invention disclosure materials to patent counsel with the intention of filing for patent protection.

I hereby declare that all statements made herein of my own knowledge are true and that all statements made on information and belief are believed to be true; and further that these statements were made with the knowledge that willful false statements and the like so made are punishable by fine or imprisonment, or both, under Section 1001 of Title 18 of the United States Code and that such willful false statements may jeopardize the validity of the application or any patent issued thereon.

Full Name of Inventor: Robert J. Davis Date: 2005/12/23  
Robert J. Davis

Full Name of Inventor: \_\_\_\_\_ Date: \_\_\_\_\_  
Saul R. Dooley

RECEIVED  
CENTRAL FAX CENTER

DEC 30 2005

PATENT

IN THE UNITED STATES PATENT AND TRADEMARK OFFICE

|                      |   |                               |
|----------------------|---|-------------------------------|
| In re Application of | : | Davies, et al.                |
|                      | : |                               |
| For                  | : | DATA DELIVERY THROUGH BEACONS |
|                      | : |                               |
| Serial No.:          | : | 09/876,515                    |
|                      | : |                               |
| Filed                | : | June 7, 2001                  |
|                      | : |                               |
| Art Unit             | : | 2642                          |
|                      | : |                               |
| Examiner             | : | Le, Karen L.                  |
|                      | : |                               |
| Att. Docket          | : | GB 000109                     |
|                      | : |                               |
| Confirmation No.     | : | 9201                          |

DECLARATION UNDER 37 C.F.R. § 1.131

Mail Stop Amendment  
Commissioner for Patents  
P.O. Box 1450  
Alexandria, VA 22313-1450

Sir:

The present Declaration is being submitted under 37 C.F.R. § 1.131 to establish a date of invention of the subject matter of claims 1-14 as originally filed, and claims 1-14 as are now pending before the U.S. Patent and Trademark Office. The present Declaration is further being submitted to establish a date of invention of the subject matter set forth in the specification and drawings as originally filed before the U.S. Patent and Trademark Office on June 7, 2001.

The above-referenced date of invention is at least as early as June 26, 2000.

The present application claims priority from two United Kingdom applications, namely GB 0015454.2 filed June 26, 2000 and GB 0020073.3 filed August 15, 2000. Although both priority documents were filed on different dates, approximately six weeks apart, the date of invention of the subject matter set forth in both applications was at least as of June 26, 2000.

Application No: 09/876,515  
Attorney's Docket No: GB 000109

Prior invention is established in the United States, in a NAFTA country other than the United States on or after December 8, 1993, or in a WTO country other than the United States on or after January 1, 1996.

Prior invention of the GB 0020073.3 United Kingdom patent application filed August 15, 2000 is established at least approximately six weeks prior, and at least as of June 26, 2000, because the undersigned inventors conceived of the present subject matter prior to June 26, 2000, then diligently submitted written invention disclosure materials to patent counsel with the intention of filing for patent protection.

I hereby declare that all statements made herein of my own knowledge are true and that all statements made on information and belief are believed to be true; and further that these statements were made with the knowledge that willful false statements and the like so made are punishable by fine or imprisonment, or both, under Section 1001 of Title 18 of the United States Code and that such willful false statements may jeopardize the validity of the application or any patent issued thereon.

Full Name of Inventor: \_\_\_\_\_  
Robert J. Davis

Date: \_\_\_\_\_

Full Name of Inventor: Saul R. Dooley  
Saul R. Dooley

Date: 13/12/2005



**KRAMER | AMADO**<sub>PC</sub>  
PATENT RESEARCH SERVICES  
INTELLECTUAL PROPERTY LAW

1725 DUKE STREET  
SUITE 240  
ALEXANDRIA, VIRGINIA 22314  
PHONE: (703) 519-9801  
FACSIMILE: (703) 519-9802  
WWW.KRAMERIP.COM

RECEIVED  
CENTRAL FAX CENTER

DEC 30 2005

# Fax Memo

**TO:** Mail Stop Amendment  
USPTO

**FAX NO.:** (571) 273-8300

**FROM:** Terry W. Kramer  
KRAMER & AMADO, P.C.

**DATE:** December 30, 2005

**SUBJECT:** U.S. Patent Application  
Title: DATA DELIVERY THROUGH BEACONS  
Serial No.: 09/876,515  
Attorney Docket No.: GB 000109

**PAGES:** INCLUDING COVER PAGE (9)

**THE INFORMATION CONTAINED HEREIN is intended only for the exclusive use of the individual or entity named above. This facsimile may contain information that is privileged, confidential, or otherwise exempt from disclosure under applicable law. If the reader of this information is NOT the intended recipient, you are hereby notified that any dissemination, distribution, copying or use of this information in any way is strictly prohibited. If you have received this communication in error, please call us immediately and return the original information to us via U.S. Postal Service.**

Message: Submitted herewith are the following:

- Transmittal Form
- Response under 37 CFR 1.111 (3 pages)
- Declaration (4 pages)

In the event that the fees submitted herewith are insufficient, please charge any remaining balance, or credit any overpayment, to our Deposit Account Number 50-0578.

PTO/SB/21 (02-04)

Approved for use through 07/31/2006. OMB 0651-0031

U.S. Patent and Trademark Office; U.S. DEPARTMENT OF COMMERCE

Under the Paperwork Reduction Act of 1995, no persons are required to respond to a collection of information unless it displays a valid OMB control number.

|                                                                                     |                        |                |
|-------------------------------------------------------------------------------------|------------------------|----------------|
| <b>TRANSMITTAL FORM</b><br>(to be used for all correspondence after initial filing) | Application Number     | 09/876,515     |
|                                                                                     | Filing Date            | June 7, 2001   |
|                                                                                     | First Named Inventor   | Davies, et al. |
|                                                                                     | Art Unit               | 2642           |
|                                                                                     | Examiner Name          | Le, Karen L.   |
|                                                                                     | Attorney Docket Number | GB 000109      |
| Total Number of Pages in This Submission                                            |                        | 8              |

| ENCLOSURES (Check all that apply)                                            |                                                                           |                                                                                         |
|------------------------------------------------------------------------------|---------------------------------------------------------------------------|-----------------------------------------------------------------------------------------|
| <input type="checkbox"/> Fee Transmittal Form                                | <input type="checkbox"/> Drawing(s)                                       | <input type="checkbox"/> After Allowance communication to Technology Center (TC)        |
| <input type="checkbox"/> Fee Attached                                        | <input type="checkbox"/> Licensing-related Papers                         | <input type="checkbox"/> Appeal Communication to Board of Appeals and Interferences     |
| <input checked="" type="checkbox"/> Amendment/Reply                          | <input type="checkbox"/> Petition                                         | <input type="checkbox"/> Appeal Communication to TC (Appeal Notice, Brief, Reply Brief) |
| <input type="checkbox"/> After Final                                         | <input type="checkbox"/> Petition to Convert to a Provisional Application | <input type="checkbox"/> Proprietary Information                                        |
| <input type="checkbox"/> Affidavits/declaration(s)                           | <input type="checkbox"/> Power of Attorney, Revocation                    | <input type="checkbox"/> Status Letter                                                  |
| <input type="checkbox"/> Extension of Time Request                           | <input type="checkbox"/> Change of Correspondence Address                 | <input type="checkbox"/> Other Enclosure(s) (please identify below):                    |
| <input type="checkbox"/> Express Abandonment Request                         | <input type="checkbox"/> Terminal Disclaimer                              |                                                                                         |
| <input type="checkbox"/> Information Disclosure Statement                    | <input type="checkbox"/> Request for Refund                               |                                                                                         |
| <input type="checkbox"/> Certified Copy of Priority Document(s)              | <input type="checkbox"/> CD, Number of CD(s)                              |                                                                                         |
| <input type="checkbox"/> Response to Missing Parts/Incomplete Application    | Remarks                                                                   |                                                                                         |
| <input type="checkbox"/> Response to Missing Parts under 37 CFR 1.52 or 1.53 |                                                                           |                                                                                         |

| SIGNATURE OF APPLICANT, ATTORNEY, OR AGENT |                                |
|--------------------------------------------|--------------------------------|
| Firm or Individual name                    | Kramer & Amado, P.C.           |
| Signature                                  | <i>[Handwritten Signature]</i> |
| Date                                       | December 30, 2005              |

| CERTIFICATE OF TRANSMISSION/MAILING                                                                                                                                                                                                                                                                           |  |      |
|---------------------------------------------------------------------------------------------------------------------------------------------------------------------------------------------------------------------------------------------------------------------------------------------------------------|--|------|
| I hereby certify that this correspondence is being facsimile transmitted to the USPTO or deposited with the United States Postal Service with sufficient postage as first class mail in an envelope addressed to: Commissioner for Patents, P.O. Box 1450, Alexandria, VA 22313-1450 on the date shown below. |  |      |
| Typed or printed name                                                                                                                                                                                                                                                                                         |  |      |
| Signature                                                                                                                                                                                                                                                                                                     |  | Date |

This collection of information is required by 37 CFR 1.5. The information is required to obtain or retain a benefit by the public which is to file (and by the USPTO to process) an application. Confidentiality is governed by 35 U.S.C. 122 and 37 CFR 1.14. This collection is estimated to 2 hours to complete, including gathering, preparing, and submitting the completed application form to the USPTO. Time will vary depending upon the individual case. Any comments on the amount of time you require to complete this form and/or suggestions for reducing this burden, should be sent to the Chief Information Officer, U.S. Patent and Trademark Office, U.S. Department of Commerce, P.O. Box 1450, Alexandria, VA 22313-1450. DO NOT SEND FEES OR COMPLETED FORMS TO THIS ADDRESS. SEND TO: Commissioner for Patents, P.O. Box 1450, Alexandria, VA 22313-1450.

If you need assistance in completing this form, call 1-800-PTO-9199 and select option 2.



IN THE UNITED STATES PATENT AND TRADEMARK OFFICE

PATENT  
RECEIVED  
CENTRAL FAX CENTER

DEC 30 2005

In re Application of : Davies, et al.  
: :  
For : DATA DELIVERY THROUGH  
: BEACONS  
: :  
Serial No.: : 09/876,515  
: :  
Filed : June 7, 2001  
: :  
Art Unit : 2642  
: :  
Examiner : Le, Karen L.  
: :  
Att. Docket : GB 000109  
: :  
Confirmation No. : 9201

RESPONSE UNDER 37 C.F.R. § 1.111

Mail Stop Amendment  
Commissioner for Patents  
P.O. Box 1450  
Alexandria, VA 22313-1450

Sir:

In response to the Office Action dated October 19, 2005, the following is respectfully submitted.

REMARKS/ARGUMENTS begin on page 2 of this paper.

Application No: 09/876,515  
Attorney's Docket No: GB 000109

**REMARKS/ARGUMENTS**

Applicant acknowledges receipt of the Office Action dated October 19, 2005.

**REQUEST FOR ACKNOWLEDGEMENT OF CLAIM OF PRIORITY**

The subject application was filed June 7, 2001 and claimed priority under 35 U.S.C. § 119 of GB 0015454.2 (filed June 26, 2000) and GB 0020073.3 (filed August 15, 2000) by way of the originally filed Declaration. 37 C.F.R. § 1.55; M.P.E.P. § 201.13. Certified copies of both GB applications were originally filed with the subject application and are listed on the Official Filing Receipt.

The undersigned respectfully requests that the Examiner acknowledge the claim for priority by checking the appropriate boxes on the next Office Action Summary page.

**REJECTION UNDER 35 U.S.C. § 103**

Claims 1-16 stand rejected under 35 U.S.C. § 103 as being unpatentable over Shteyn et al., U.S. Patent No. 6,782,253 in view of Evan et al., U.S. Patent No. 6,311,060.

Shteyn et al. was published on August 24, 2004 and was filed on August 10, 2000. Shteyn et al. does not claim priority from any other application. Accordingly, Shteyn et al. is a reference under 35 U.S.C. § 102(e) as of its associated U.S. filing date of August 10, 2000.

The subject application properly claims priority from two British Applications, GB 0015454.2 (filed June 26, 2000) and GB 0020073.3 (filed August 15, 2000). Both applications set forth identical inventors.

The undersigned submits herewith two properly executed Declarations under 37 C.F.R. § 1.131 to establish a date of invention *at least* as of June 26, 2000, thereby antedating the Shteyn et al. reference. See M.P.E.P. § 715. Both Declarations properly set forth prior invention in a WTO country other than the United States on or after January 1, 1996.

Application No: 09/876,515  
Attorney's Docket No: GB 000109

Reconsideration and withdrawal of the outstanding obviousness rejection is therefore respectfully requested.

CONCLUSION:

While we believe that the instant amendment places the application in condition for allowance, should the Examiner have any further comments or suggestions, it is respectfully requested that the Examiner telephone the undersigned attorney in order to expeditiously resolve any outstanding issues.

In the event that the fees submitted prove to be insufficient in connection with the filing of this paper, please charge our Deposit Account Number 50-0578 and please credit any excess fees to such Deposit Account.

Respectfully submitted,  
KRAMER & AMADO, P.C.

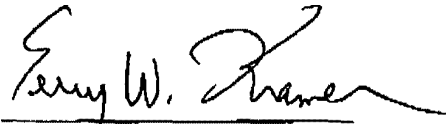

Terry W. Kramer  
Registration No.: 41,541

KRAMER & AMADO, P.C.  
1725 Duke Street, Suite 240  
Alexandria, VA 22314  
Phone: 703-519-9801  
Fax: 703-519-9802

Date: December 30, 2005

RECEIVED  
CENTRAL FAX CENTER

DEC 30 2005

PATENT

IN THE UNITED STATES PATENT AND TRADEMARK OFFICE

|                      |   |                               |
|----------------------|---|-------------------------------|
| In re Application of | : | Davies, et al.                |
|                      | : |                               |
| For                  | : | DATA DELIVERY THROUGH BEACONS |
|                      | : |                               |
| Serial No.:          | : | 09/876,515                    |
|                      | : |                               |
| Filed                | : | June 7, 2001                  |
|                      | : |                               |
| Art Unit             | : | 2642                          |
|                      | : |                               |
| Examiner             | : | Le, Karen L.                  |
|                      | : |                               |
| Att. Docket          | : | GB 000109                     |
|                      | : |                               |
| Confirmation No.     | : | 9201                          |

DECLARATION UNDER 37 C.F.R. § 1.131

Mail Stop Amendment  
Commissioner for Patents  
P.O. Box 1450  
Alexandria, VA 22313-1450

Sir:

The present Declaration is being submitted under 37 C.F.R. § 1.131 to establish a date of invention of the subject matter of claims 1-14 as originally filed, and claims 1-14 as are now pending before the U.S. Patent and Trademark Office. The present Declaration is further being submitted to establish a date of invention of the subject matter set forth in the specification and drawings as originally filed before the U.S. Patent and Trademark Office on June 7, 2001.

The above-referenced date of invention is at least as early as June 26, 2000.

The present application claims priority from two United Kingdom applications, namely GB 0015454.2 filed June 26, 2000 and GB 0020073.3 filed August 15, 2000. Although both priority documents were filed on different dates, approximately six weeks apart, the date of invention of the subject matter set forth in both applications was at least as of June 26, 2000.

Application No: 09/876,515  
Attorney's Docket No: GB 000109

Prior invention is established in the United States, in a NAFTA country other than the United States on or after December 8, 1993, or in a WTO country other than the United States on or after January 1, 1996.

Prior invention of the GB 0020073.3 United Kingdom patent application filed August 15, 2000 is established at least approximately six weeks prior, and at least as of June 26, 2000, because the undersigned inventors conceived of the present subject matter prior to June 26, 2000, then diligently submitted written invention disclosure materials to patent counsel with the intention of filing for patent protection.

I hereby declare that all statements made herein of my own knowledge are true and that all statements made on information and belief are believed to be true; and further that these statements were made with the knowledge that willful false statements and the like so made are punishable by fine or imprisonment, or both, under Section 1001 of Title 18 of the United States Code and that such willful false statements may jeopardize the validity of the application or any patent issued thereon.

Full Name of Inventor: Robert J. Davis  
Robert J. Davis

Date: 2005/12/23

Full Name of Inventor: \_\_\_\_\_  
Saul R. Dooley

Date: \_\_\_\_\_

RECEIVED  
CENTRAL FAX CENTER

DEC 30 2005

PATENT

IN THE UNITED STATES PATENT AND TRADEMARK OFFICE

|                      |   |                               |
|----------------------|---|-------------------------------|
| In re Application of | : | Davies, et al.                |
| For                  | : | DATA DELIVERY THROUGH BEACONS |
| Serial No.:          | : | 09/876,515                    |
| Filed                | : | June 7, 2001                  |
| Art Unit             | : | 2642                          |
| Examiner             | : | Le, Karen L.                  |
| Att. Docket          | : | GB 000109                     |
| Confirmation No.     | : | 9201                          |

DECLARATION UNDER 37 C.F.R. § 1.131

Mail Stop Amendment  
Commissioner for Patents  
P.O. Box 1450  
Alexandria, VA 22313-1450

Sir:

The present Declaration is being submitted under 37 C.F.R. § 1.131 to establish a date of invention of the subject matter of claims 1-14 as originally filed, and claims 1-14 as are now pending before the U.S. Patent and Trademark Office. The present Declaration is further being submitted to establish a date of invention of the subject matter set forth in the specification and drawings as originally filed before the U.S. Patent and Trademark Office on June 7, 2001.

The above-referenced date of invention is at least as early as June 26, 2000.

The present application claims priority from two United Kingdom applications, namely GB 0015454.2 filed June 26, 2000 and GB 0020073.3 filed August 15, 2000. Although both priority documents were filed on different dates, approximately six weeks apart, the date of invention of the subject matter set forth in both applications was at least as of June 26, 2000.

Application No: 09/876,515  
Attorney's Docket No: GB 000109

Prior invention is established in the United States, in a NAFTA country other than the United States on or after December 8, 1993, or in a WTO country other than the United States on or after January 1, 1996.

Prior invention of the GB 0020073.3 United Kingdom patent application filed August 15, 2000 is established at least approximately six weeks prior, and at least as of June 26, 2000, because the undersigned inventors conceived of the present subject matter prior to June 26, 2000, then diligently submitted written invention disclosure materials to patent counsel with the intention of filing for patent protection.

I hereby declare that all statements made herein of my own knowledge are true and that all statements made on information and belief are believed to be true; and further that these statements were made with the knowledge that willful false statements and the like so made are punishable by fine or imprisonment, or both, under Section 1001 of Title 18 of the United States Code and that such willful false statements may jeopardize the validity of the application or any patent issued thereon.

Full Name of Inventor: \_\_\_\_\_  
Robert J. Davis

Date: \_\_\_\_\_

Full Name of Inventor: Saul R. Dooley  
Saul R. Dooley

Date: 13/12/2005



**KRAMER | AMADO**<sub>PC</sub>  
PATENT RESEARCH SERVICES  
INTELLECTUAL PROPERTY LAW

1725 DUKE STREET  
SUITE 240  
ALEXANDRIA, VIRGINIA 22314  
PHONE: (703) 519-9801  
FACSIMILE: (703) 519-9802  
[WWW.KRAMERIP.COM](http://WWW.KRAMERIP.COM)

RECEIVED  
CENTRAL FAX CENTER  
DEC 30 2005

## Fax Memo

**TO:** Mail Stop Amendment  
USPTO

**FAX NO.:** (571) 273-8300

**FROM:** Terry W. Kramer  
KRAMER & AMADO, P.C.

**DATE:** December 30, 2005

**SUBJECT:** U.S. Patent Application  
Title: **DATA DELIVERY THROUGH BEACONS**  
Serial No.: 09/876,515  
Attorney Docket No.: GB 000109

**PAGES:** INCLUDING COVER PAGE (9)

THE INFORMATION CONTAINED HEREIN is intended only for the exclusive use of the individual or entity named above. This facsimile may contain information that is privileged, confidential, or otherwise exempt from disclosure under applicable law. If the reader of this information is NOT the intended recipient, you are hereby notified that any dissemination, distribution, copying or use of this information in any way is strictly prohibited. If you have received this communication in error, please call us immediately and return the original information to us via U.S. Postal Service.

Message: Submitted herewith are the following:

- Transmittal Form
- Response under 37 CFR 1.111 (3 pages)
- Declaration (4 pages)

In the event that the fees submitted herewith are insufficient, please charge any remaining balance, or credit any overpayment, to our Deposit Account Number 50-0578.



DEC 30 2005

PAGE 29 \* RCVD AT 12/30/2005 4:17:45 PM [Eastern Standard Time] \* SVR:USPTO-EFXRF-6/24 \* DNS:2738300 \* CSID:703 5199802 \* DURATION (mm-ss):02-06

PTO/SB/21 (02-04)

Approved for use through 07/31/2006. OMB 0651-0031  
U.S. Patent and Trademark Office; U.S. DEPARTMENT OF COMMERCE

Under the Paperwork Reduction Act of 1995, no persons are required to respond to a collection of information unless it displays a valid OMB control number.

|                                                                                                    |                      |                        |           |
|----------------------------------------------------------------------------------------------------|----------------------|------------------------|-----------|
| <b>TRANSMITTAL FORM</b><br><small>(to be used for all correspondence after initial filing)</small> | Application Number   | 09/876,515             |           |
|                                                                                                    | Filing Date          | June 7, 2001           |           |
|                                                                                                    | First Named Inventor | Davies, et al.         |           |
|                                                                                                    | Art Unit             | 2642                   |           |
|                                                                                                    | Examiner Name        | Le, Karen L.           |           |
| Total Number of Pages in This Submission                                                           | 8                    | Attorney Docket Number | GB 000109 |

| ENCLOSURES (Check all that apply)                                            |                                                                           |                                                                                         |
|------------------------------------------------------------------------------|---------------------------------------------------------------------------|-----------------------------------------------------------------------------------------|
| <input type="checkbox"/> Fee Transmittal Form                                | <input type="checkbox"/> Drawing(s)                                       | <input type="checkbox"/> After Allowance communication to Technology Center (TC)        |
| <input type="checkbox"/> Fee Attached                                        | <input type="checkbox"/> Licensing-related Papers                         | <input type="checkbox"/> Appeal Communication to Board of Appeals and Interferences     |
| <input checked="" type="checkbox"/> Amendment/Reply                          | <input type="checkbox"/> Petition                                         | <input type="checkbox"/> Appeal Communication to TC (Appeal Notice, Brief, Reply Brief) |
| <input type="checkbox"/> After Final                                         | <input type="checkbox"/> Petition to Convert to a Provisional Application | <input type="checkbox"/> Proprietary Information                                        |
| <input type="checkbox"/> Affidavits/declaration(s)                           | <input type="checkbox"/> Power of Attorney, Revocation                    | <input type="checkbox"/> Status Letter                                                  |
| <input type="checkbox"/> Extension of Time Request                           | <input type="checkbox"/> Change of Correspondence Address                 | <input type="checkbox"/> Other Enclosure(s) (please identify below):                    |
| <input type="checkbox"/> Express Abandonment Request                         | <input type="checkbox"/> Terminal Disclaimer                              |                                                                                         |
| <input type="checkbox"/> Information Disclosure Statement                    | <input type="checkbox"/> Request for Refund                               |                                                                                         |
| <input type="checkbox"/> Certified Copy of Priority Document(s)              | <input type="checkbox"/> CD, Number of CD(s) _____                        |                                                                                         |
| <input type="checkbox"/> Response to Missing Parts/Incomplete Application    | Remarks                                                                   |                                                                                         |
| <input type="checkbox"/> Response to Missing Parts under 37 CFR 1.52 or 1.53 |                                                                           |                                                                                         |

| SIGNATURE OF APPLICANT, ATTORNEY, OR AGENT |                        |
|--------------------------------------------|------------------------|
| Firm or Individual name                    | Kramer & Amado, P.C.   |
| Signature                                  | <i>Kerry W. Kramer</i> |
| Date                                       | December 30, 2005      |

| CERTIFICATE OF TRANSMISSION/MAILING                                                                                                                                                                                                                                                                           |  |      |
|---------------------------------------------------------------------------------------------------------------------------------------------------------------------------------------------------------------------------------------------------------------------------------------------------------------|--|------|
| I hereby certify that this correspondence is being facsimile transmitted to the USPTO or deposited with the United States Postal Service with sufficient postage as first class mail in an envelope addressed to: Commissioner for Patents, P.O. Box 1450, Alexandria, VA 22313-1450 on the date shown below. |  |      |
| Typed or printed name                                                                                                                                                                                                                                                                                         |  |      |
| Signature                                                                                                                                                                                                                                                                                                     |  | Date |

This collection of information is required by 37 CFR 1.5. The information is required to obtain or retain a benefit by the public which is to file (and by the USPTO to process) an application. Confidentiality is governed by 35 U.S.C. 122 and 37 CFR 1.14. This collection is estimated to 2 hours to complete, including gathering, preparing, and submitting the completed application form to the USPTO. Time will vary depending upon the individual case. Any comments on the amount of time you require to complete this form and/or suggestions for reducing this burden, should be sent to the Chief Information Officer, U.S. Patent and Trademark Office, U.S. Department of Commerce, P.O. Box 1450, Alexandria, VA 22313-1450. DO NOT SEND FEES OR COMPLETED FORMS TO THIS ADDRESS. SEND TO: Commissioner for Patents, P.O. Box 1450, Alexandria, VA 22313-1450.

If you need assistance in completing the form, call 1-800-PTO-9199 and select option 2.



**KRAMER | AMADO**<sub>PC</sub>  
PATENT RESEARCH SERVICES  
INTELLECTUAL PROPERTY LAW

1725 DUKE STREET  
SUITE 240  
ALEXANDRIA, VIRGINIA 22314  
PHONE: (703) 519-9801  
FACSIMILE: (703) 519-9802  
WWW.KRAMERIP.COM

RECEIVED  
CENTRAL FAX CENTER

DEC 30 2005

# Fax Memo

**TO:** Mail Stop Amendment  
USPTO

**FAX NO.:** (571) 273-8300

**FROM:** Terry W. Kramer  
KRAMER & AMADO, P.C.

**DATE:** December 30, 2005

**SUBJECT:** U.S. Patent Application  
Title: DATA DELIVERY THROUGH BEACONS  
Serial No.: 09/876,515  
Attorney Docket No.: GB 000109

**PAGES:** INCLUDING COVER PAGE (9)

THE INFORMATION CONTAINED HEREIN is intended only for the exclusive use of the individual or entity named above. This facsimile may contain information that is privileged, confidential, or otherwise exempt from disclosure under applicable law. If the reader of this information is NOT the intended recipient, you are hereby notified that any dissemination, distribution, copying or use of this information in any way is strictly prohibited. If you have received this communication in error, please call us immediately and return the original information to us via U.S. Postal Service.

Message: Submitted herewith are the following:

- Transmittal Form
- Response under 37 CFR 1.111 (3 pages)
- Declaration (4 pages)

In the event that the fees submitted herewith are insufficient, please charge any remaining balance, or credit any overpayment, to our Deposit Account Number 50-0578.

*Received 4 pages  
out of 9  
p.4 blank*

PTO/SB/21 (02-04)

Approved for use through 07/31/2006. OMB 0651-0031  
U.S. Patent and Trademark Office; U.S. DEPARTMENT OF COMMERCE

Under the Paperwork Reduction Act of 1995, no person is required to respond to a collection of information unless it displays a valid OMB control number.

|                                                                                         |                        |                |
|-----------------------------------------------------------------------------------------|------------------------|----------------|
| <b>TRANSMITTAL FORM</b><br><br>(to be used for all correspondence after initial filing) | Application Number     | 09/876,515     |
|                                                                                         | Filing Date            | June 7, 2001   |
|                                                                                         | First Named Inventor   | Davies, et al. |
|                                                                                         | Art Unit               | 2642           |
|                                                                                         | Examiner Name          | Le, Karen L.   |
|                                                                                         | Attorney Docket Number | GB 000109      |
| Total Number of Pages in This Submission                                                |                        | 8              |

| ENCLOSURES (Check all that apply)                                            |                                                                                         |                                                                                         |
|------------------------------------------------------------------------------|-----------------------------------------------------------------------------------------|-----------------------------------------------------------------------------------------|
| <input type="checkbox"/> Fee Transmittal Form                                | <input type="checkbox"/> Drawing(s)                                                     | <input type="checkbox"/> After Allowance communication to Technology Center (TC)        |
| <input type="checkbox"/> Fee Attached                                        | <input type="checkbox"/> Licensing-related Papers                                       | <input type="checkbox"/> Appeal Communication to Board of Appeals and Interferences     |
| <input checked="" type="checkbox"/> Amendment/Reply                          | <input type="checkbox"/> Petition                                                       | <input type="checkbox"/> Appeal Communication to TC (Appeal Notice, Brief, Reply Brief) |
| <input type="checkbox"/> After Final                                         | <input type="checkbox"/> Petition to Convert to a Provisional Application               | <input type="checkbox"/> Proprietary Information                                        |
| <input type="checkbox"/> Affidavits/declaration(s)                           | <input type="checkbox"/> Power of Attorney, Revocation Change of Correspondence Address | <input type="checkbox"/> Status Letter                                                  |
| <input type="checkbox"/> Extension of Time Request                           | <input type="checkbox"/> Terminal Disclaimer                                            | <input type="checkbox"/> Other Enclosure(s) (please identify below):                    |
| <input type="checkbox"/> Express Abandonment Request                         | <input type="checkbox"/> Request for Refund                                             |                                                                                         |
| <input type="checkbox"/> Information Disclosure Statement                    | <input type="checkbox"/> CD, Number of CD(s) _____                                      |                                                                                         |
| <input type="checkbox"/> Certified Copy of Priority Document(s)              | Remarks                                                                                 |                                                                                         |
| <input type="checkbox"/> Response to Missing Parts/Incomplete Application    |                                                                                         |                                                                                         |
| <input type="checkbox"/> Response to Missing Parts under 37 CFR 1.52 or 1.53 |                                                                                         |                                                                                         |

| SIGNATURE OF APPLICANT, ATTORNEY, OR AGENT |                          |
|--------------------------------------------|--------------------------|
| Firm or Individual name                    | Kramer & Amado, P.C.     |
| Signature                                  | <i>Kenneth W. Kramer</i> |
| Date                                       | December 30, 2005        |

| CERTIFICATE OF TRANSMISSION/MAILING                                                                                                                                                                                                                                                                           |  |      |
|---------------------------------------------------------------------------------------------------------------------------------------------------------------------------------------------------------------------------------------------------------------------------------------------------------------|--|------|
| I hereby certify that this correspondence is being facsimile transmitted to the USPTO or deposited with the United States Postal Service with sufficient postage as first class mail in an envelope addressed to: Commissioner for Patents, P.O. Box 1450, Alexandria, VA 22313-1450 on the date shown below. |  |      |
| Typed or printed name                                                                                                                                                                                                                                                                                         |  |      |
| Signature                                                                                                                                                                                                                                                                                                     |  | Date |

This collection of information is required by 37 CFR 1.5. The information is required to obtain or retain a benefit by the public which is to file (and by the USPTO to process) an application. Confidentiality is governed by 35 U.S.C. 122 and 37 CFR 1.14. This collection is estimated to 2 hours to complete, including gathering, preparing, and submitting the completed application form to the USPTO. Time will vary depending upon the individual case. Any comments on the amount of time you require to complete this form and/or suggestions for reducing this burden, should be sent to the Chief Information Officer, U.S. Patent and Trademark Office, U.S. Department of Commerce, P.O. Box 1450, Alexandria, VA 22313-1450. DO NOT SEND FEES OR COMPLETED FORMS TO THIS ADDRESS. SEND TO: Commissioner for Patents, P.O. Box 1450, Alexandria, VA 22313-1450.

If you need assistance in completing the form, call 1-800-PTO-9199 and select option 2.

**PATENT  
IN THE UNITED STATES PATENT AND TRADEMARK OFFICE**

In re Application of : Davies, et al.  
 :  
 For : DATA DELIVERY THROUGH  
 : BEACONS  
 :  
 Serial No.: : 09/876,515  
 :  
 Filed : June 7, 2001  
 :  
 Art Unit : 2642  
 :  
 Examiner : Le, Karen L.  
 :  
 Att. Docket : GB 000109  
 :  
 Confirmation No. : 9201

**RECEIVED  
CENTRAL FAX CENTER  
DEC 30 2005**

**RESPONSE UNDER 37 C.F.R. § 1.111**

Mail Stop Amendment  
 Commissioner for Patents  
 P.O. Box 1450  
 Alexandria, VA 22313-1450

Sir:

In response to the Office Action dated October 19, 2005, the following is respectfully submitted.

**REMARKS/ARGUMENTS** begin on page 2 of this paper.

**BEST AVAILABLE COPY**

**INVENTION APPLICATION FEE DETERMINATION RECORD**  
Effective October 1, 2000

Application or Docket Number

*6-000009*  
*09 187655*

**CLAIMS AS FILED - PART I**

|                                  | (Column 1)               | (Column 2)   |
|----------------------------------|--------------------------|--------------|
| TOTAL CLAIMS                     | 14                       |              |
| FOR                              | NUMBER FILED             | NUMBER EXTRA |
| TOTAL CHARGEABLE CLAIMS          | 14 minus 20 = 0          |              |
| INDEPENDENT CLAIMS               | 3 minus 3 = 0            |              |
| MULTIPLE DEPENDENT CLAIM PRESENT | <input type="checkbox"/> |              |

SMALL ENTITY TYPE

OR OTHER THAN SMALL ENTITY

| RATE      | FEE    |    | RATE      | FEE    |
|-----------|--------|----|-----------|--------|
| BASIC FEE | 355.00 | OR | BASIC FEE | 710.00 |
| X\$ 9=    |        | OR | X\$18=    |        |
| X40=      |        | OR | X80=      |        |
| +135=     |        | OR | +270=     |        |
| TOTAL     |        | OR | TOTAL     | 710    |

\* If the difference in column 1 is less than zero, enter "0" in column 2

**CLAIMS AS AMENDED - PART II**

7/20/07

|                                                | (Column 1)               | (Column 2)                         | (Column 3)    |
|------------------------------------------------|--------------------------|------------------------------------|---------------|
| CLAIMS REMAINING AFTER AMENDMENT               |                          | HIGHEST NUMBER PREVIOUSLY PAID FOR | PRESENT EXTRA |
| Total                                          | 14                       | 20                                 |               |
| Independent                                    | 3                        | 3                                  |               |
| FIRST PRESENTATION OF MULTIPLE DEPENDENT CLAIM | <input type="checkbox"/> |                                    |               |

SMALL ENTITY

OR OTHER THAN SMALL ENTITY

| RATE             | ADDITIONAL FEE |    | RATE             | ADDITIONAL FEE |
|------------------|----------------|----|------------------|----------------|
| X\$ 9=           |                | OR | X\$18=           |                |
| X40=             |                | OR | X80=             |                |
| +135=            |                | OR | +270=            |                |
| TOTAL ADDIT. FEE |                | OR | TOTAL ADDIT. FEE |                |

A, DVE  
12/30/05

AMENDMENT B

|                                                | (Column 1)               | (Column 2)                         | (Column 3)    |
|------------------------------------------------|--------------------------|------------------------------------|---------------|
| CLAIMS REMAINING AFTER AMENDMENT               |                          | HIGHEST NUMBER PREVIOUSLY PAID FOR | PRESENT EXTRA |
| Total                                          | 20                       | 20                                 |               |
| Independent                                    | 3                        | 3                                  |               |
| FIRST PRESENTATION OF MULTIPLE DEPENDENT CLAIM | <input type="checkbox"/> |                                    |               |

| RATE             | ADDITIONAL FEE |    | RATE             | ADDITIONAL FEE |
|------------------|----------------|----|------------------|----------------|
| X\$ 9=           |                | OR | X\$18=           |                |
| X40=             |                | OR | X80=             |                |
| +135=            |                | OR | +270=            |                |
| TOTAL ADDIT. FEE |                | OR | TOTAL ADDIT. FEE |                |

AMENDMENT C

|                                                | (Column 1)               | (Column 2)                         | (Column 3)    |
|------------------------------------------------|--------------------------|------------------------------------|---------------|
| CLAIMS REMAINING AFTER AMENDMENT               |                          | HIGHEST NUMBER PREVIOUSLY PAID FOR | PRESENT EXTRA |
| Total                                          |                          |                                    |               |
| Independent                                    |                          |                                    |               |
| FIRST PRESENTATION OF MULTIPLE DEPENDENT CLAIM | <input type="checkbox"/> |                                    |               |

| RATE             | ADDITIONAL FEE |    | RATE             | ADDITIONAL FEE |
|------------------|----------------|----|------------------|----------------|
| X\$ 9=           |                | OR | X\$18=           |                |
| X40=             |                | OR | X80=             |                |
| +135=            |                | OR | +270=            |                |
| TOTAL ADDIT. FEE |                | OR | TOTAL ADDIT. FEE |                |

- \* If the entry in column 1 is less than the entry in column 2, write "0" in column 3.
  - \*\* If the "Highest Number Previously Paid For" IN THIS SPACE is less than 20, enter "20."
  - \*\*\* If the "Highest Number Previously Paid For" IN THIS SPACE is less than 3, enter "3."
- The "Highest Number Previously Paid For" (Total or Independent) is the highest number found in the appropriate box in column 1.

BEST AVAILABLE COPY

Under the Paperwork Reduction Act of 1995, no persons are required to respond to a collection of information unless it displays a valid OMB control number.

| <b>PATENT APPLICATION FEE DETERMINATION RECORD</b><br>Substitute for Form PTO-875                                               |                                                                                                                                                                                                                               |                                  |                                    |                                          | Application or Docket Number<br><b>09/876,515</b> | Filing Date<br><b>06/07/2001</b> | <input type="checkbox"/> To be Mailed |                 |                     |
|---------------------------------------------------------------------------------------------------------------------------------|-------------------------------------------------------------------------------------------------------------------------------------------------------------------------------------------------------------------------------|----------------------------------|------------------------------------|------------------------------------------|---------------------------------------------------|----------------------------------|---------------------------------------|-----------------|---------------------|
| <b>APPLICATION AS FILED – PART I</b>                                                                                            |                                                                                                                                                                                                                               |                                  |                                    |                                          | OTHER THAN                                        |                                  |                                       |                 |                     |
| (Column 1)                                                                                                                      |                                                                                                                                                                                                                               | (Column 2)                       |                                    | SMALL ENTITY <input type="checkbox"/> OR |                                                   | SMALL ENTITY                     |                                       |                 |                     |
| FOR                                                                                                                             | NUMBER FILED                                                                                                                                                                                                                  | NUMBER EXTRA                     | RATE (\$)                          | FEE (\$)                                 | OR                                                | RATE (\$)                        | FEE (\$)                              |                 |                     |
| <input type="checkbox"/> BASIC FEE<br><small>(37 CFR 1.16(a), (b), or (c))</small>                                              | N/A                                                                                                                                                                                                                           | N/A                              | N/A                                |                                          | OR                                                | N/A                              |                                       |                 |                     |
| <input type="checkbox"/> SEARCH FEE<br><small>(37 CFR 1.16(k), (j), or (m))</small>                                             | N/A                                                                                                                                                                                                                           | N/A                              | N/A                                |                                          | OR                                                | N/A                              |                                       |                 |                     |
| <input type="checkbox"/> EXAMINATION FEE<br><small>(37 CFR 1.16(o), (p), or (q))</small>                                        | N/A                                                                                                                                                                                                                           | N/A                              | N/A                                |                                          | OR                                                | N/A                              |                                       |                 |                     |
| TOTAL CLAIMS<br><small>(37 CFR 1.16(i))</small>                                                                                 | minus 20 =                                                                                                                                                                                                                    | *                                | X \$ =                             |                                          | OR                                                | X \$ =                           |                                       |                 |                     |
| INDEPENDENT CLAIMS<br><small>(37 CFR 1.16(h))</small>                                                                           | minus 3 =                                                                                                                                                                                                                     | *                                | X \$ =                             |                                          | OR                                                | X \$ =                           |                                       |                 |                     |
| <input type="checkbox"/> APPLICATION SIZE FEE<br><small>(37 CFR 1.16(s))</small>                                                | If the specification and drawings exceed 100 sheets of paper, the application size fee due is \$250 (\$125 for small entity) for each additional 50 sheets or fraction thereof. See 35 U.S.C. 41(a)(1)(G) and 37 CFR 1.16(s). |                                  |                                    |                                          | OR                                                |                                  |                                       |                 |                     |
| <input type="checkbox"/> MULTIPLE DEPENDENT CLAIM PRESENT <small>(37 CFR 1.16(j))</small>                                       |                                                                                                                                                                                                                               |                                  |                                    |                                          |                                                   |                                  |                                       |                 |                     |
| * If the difference in column 1 is less than zero, enter "0" in column 2.                                                       |                                                                                                                                                                                                                               |                                  |                                    |                                          |                                                   |                                  |                                       |                 |                     |
| <b>APPLICATION AS AMENDED – PART II</b>                                                                                         |                                                                                                                                                                                                                               |                                  |                                    |                                          | OTHER THAN                                        |                                  |                                       |                 |                     |
| (Column 1)                                                                                                                      |                                                                                                                                                                                                                               | (Column 2)                       |                                    | SMALL ENTITY OR                          |                                                   | SMALL ENTITY                     |                                       |                 |                     |
| AMENDMENT                                                                                                                       | 12/30/2005                                                                                                                                                                                                                    | CLAIMS REMAINING AFTER AMENDMENT | HIGHEST NUMBER PREVIOUSLY PAID FOR | PRESENT EXTRA                            | RATE (\$)                                         | ADDITIONAL FEE (\$)              | OR                                    | RATE (\$)       | ADDITIONAL FEE (\$) |
| Total <small>(37 CFR 1.16(j))</small>                                                                                           | *                                                                                                                                                                                                                             | 14                               | Minus                              | ** 20                                    | =                                                 | 0                                | OR                                    | X \$50=         | 0                   |
| Independent <small>(37 CFR 1.16(h))</small>                                                                                     | *                                                                                                                                                                                                                             | 3                                | Minus                              | ***3                                     | =                                                 | 0                                | OR                                    | X \$200=        | 0                   |
| <input type="checkbox"/> Application Size Fee <small>(37 CFR 1.16(s))</small>                                                   |                                                                                                                                                                                                                               |                                  |                                    |                                          |                                                   |                                  |                                       |                 |                     |
| <input type="checkbox"/> FIRST PRESENTATION OF MULTIPLE DEPENDENT CLAIM <small>(37 CFR 1.16(j))</small>                         |                                                                                                                                                                                                                               |                                  |                                    |                                          |                                                   |                                  |                                       |                 |                     |
|                                                                                                                                 |                                                                                                                                                                                                                               |                                  |                                    |                                          | TOTAL ADD'L FEE                                   |                                  | OR                                    | TOTAL ADD'L FEE | 0                   |
| (Column 1)                                                                                                                      |                                                                                                                                                                                                                               | (Column 2)                       |                                    | (Column 3)                               |                                                   |                                  |                                       |                 |                     |
| AMENDMENT                                                                                                                       |                                                                                                                                                                                                                               | CLAIMS REMAINING AFTER AMENDMENT | HIGHEST NUMBER PREVIOUSLY PAID FOR | PRESENT EXTRA                            | RATE (\$)                                         | ADDITIONAL FEE (\$)              | OR                                    | RATE (\$)       | ADDITIONAL FEE (\$) |
| Total <small>(37 CFR 1.16(j))</small>                                                                                           | *                                                                                                                                                                                                                             |                                  | Minus                              | **                                       | =                                                 |                                  | OR                                    | X \$ =          |                     |
| Independent <small>(37 CFR 1.16(h))</small>                                                                                     | *                                                                                                                                                                                                                             |                                  | Minus                              | ***                                      | =                                                 |                                  | OR                                    | X \$ =          |                     |
| <input type="checkbox"/> Application Size Fee <small>(37 CFR 1.16(s))</small>                                                   |                                                                                                                                                                                                                               |                                  |                                    |                                          |                                                   |                                  |                                       |                 |                     |
| <input type="checkbox"/> FIRST PRESENTATION OF MULTIPLE DEPENDENT CLAIM <small>(37 CFR 1.16(j))</small>                         |                                                                                                                                                                                                                               |                                  |                                    |                                          |                                                   |                                  |                                       |                 |                     |
|                                                                                                                                 |                                                                                                                                                                                                                               |                                  |                                    |                                          | TOTAL ADD'L FEE                                   |                                  | OR                                    | TOTAL ADD'L FEE |                     |
| * If the entry in column 1 is less than the entry in column 2, write "0" in column 3.                                           |                                                                                                                                                                                                                               |                                  |                                    |                                          |                                                   |                                  |                                       |                 |                     |
| ** If the "Highest Number Previously Paid For" IN THIS SPACE is less than 20, enter "20".                                       |                                                                                                                                                                                                                               |                                  |                                    |                                          |                                                   |                                  |                                       |                 |                     |
| *** If the "Highest Number Previously Paid For" IN THIS SPACE is less than 3, enter "3".                                        |                                                                                                                                                                                                                               |                                  |                                    |                                          |                                                   |                                  |                                       |                 |                     |
| The "Highest Number Previously Paid For" (Total or Independent) is the highest number found in the appropriate box in column 1. |                                                                                                                                                                                                                               |                                  |                                    |                                          |                                                   |                                  |                                       |                 |                     |

Legal Instrument Examiner:  
/DAVINA G. BUTLER/

This collection of information is required by 37 CFR 1.16. The information is required to obtain or retain a benefit by the public which is to file (and by the USPTO to process) an application. Confidentiality is governed by 35 U.S.C. 122 and 37 CFR 1.14. This collection is estimated to take 12 minutes to complete, including gathering, preparing, and submitting the completed application form to the USPTO. Time will vary depending upon the individual case. Any comments on the amount of time you require to complete this form and/or suggestions for reducing this burden, should be sent to the Chief Information Officer, U.S. Patent and Trademark Office, U.S. Department of Commerce, P.O. Box 1450, Alexandria, VA 22313-1450. DO NOT SEND FEES OR COMPLETED FORMS TO THIS ADDRESS. **SEND TO: Commissioner for Patents, P.O. Box 1450, Alexandria, VA 22313-1450.**  
If you need assistance in completing the form, call 1-800-PTO-9199 and select option 2.



UNITED STATES PATENT AND TRADEMARK OFFICE

UNITED STATES DEPARTMENT OF COMMERCE  
United States Patent and Trademark Office  
Address: COMMISSIONER FOR PATENTS  
P.O. Box 1450  
Alexandria, Virginia 22313-1450  
www.uspto.gov

*Handwritten initials*

| APPLICATION NO. | FILING DATE | FIRST NAMED INVENTOR | ATTORNEY DOCKET NO. | CONFIRMATION NO. |
|-----------------|-------------|----------------------|---------------------|------------------|
| 09/876,515      | 06/07/2001  | Robert J. Davies     | GB 000109           | 9201             |

24737 7590 10/19/2005  
PHILIPS INTELLECTUAL PROPERTY & STANDARDS  
P.O. BOX 3001  
BRIARCLIFF MANOR, NY 10510

EXAMINER

LE, KAREN L

ART UNIT PAPER NUMBER

2642

DATE MAILED: 10/19/2005

Please find below and/or attached an Office communication concerning this application or proceeding.



|                              |                 |               |  |
|------------------------------|-----------------|---------------|--|
| <b>Office Action Summary</b> | Application No. | Applicant(s)  |  |
|                              | 09/876,515      | DAVIES ET AL. |  |
|                              | Examiner        | Art Unit      |  |
|                              | Karen L. Le     | 2642          |  |

-- The MAILING DATE of this communication appears on the cover sheet with the correspondence address --

**Period for Reply**

A SHORTENED STATUTORY PERIOD FOR REPLY IS SET TO EXPIRE 3 MONTH(S) OR THIRTY (30) DAYS, WHICHEVER IS LONGER, FROM THE MAILING DATE OF THIS COMMUNICATION.

- Extensions of time may be available under the provisions of 37 CFR 1.136(a). In no event, however, may a reply be timely filed after SIX (6) MONTHS from the mailing date of this communication.
- If NO period for reply is specified above, the maximum statutory period will apply and will expire SIX (6) MONTHS from the mailing date of this communication.
- Failure to reply within the set or extended period for reply will, by statute, cause the application to become ABANDONED (35 U.S.C. § 133). Any reply received by the Office later than three months after the mailing date of this communication, even if timely filed, may reduce any earned patent term adjustment. See 37 CFR 1.704(b).

**Status**

- 1)  Responsive to communication(s) filed on 18 July 2005.
- 2a)  This action is **FINAL**.
- 2b)  This action is non-final.
- 3)  Since this application is in condition for allowance except for formal matters, prosecution as to the merits is closed in accordance with the practice under *Ex parte Quayle*, 1935 C.D. 11, 453 O.G. 213.

**Disposition of Claims**

- 4)  Claim(s) 1-14 is/are pending in the application.
  - 4a) Of the above claim(s) \_\_\_\_\_ is/are withdrawn from consideration.
- 5)  Claim(s) \_\_\_\_\_ is/are allowed.
- 6)  Claim(s) 1-14 is/are rejected.
- 7)  Claim(s) \_\_\_\_\_ is/are objected to.
- 8)  Claim(s) \_\_\_\_\_ are subject to restriction and/or election requirement.

**Application Papers**

- 9)  The specification is objected to by the Examiner.
- 10)  The drawing(s) filed on \_\_\_\_\_ is/are: a)  accepted or b)  objected to by the Examiner.  
 Applicant may not request that any objection to the drawing(s) be held in abeyance. See 37 CFR 1.85(a).  
 Replacement drawing sheet(s) including the correction is required if the drawing(s) is objected to. See 37 CFR 1.121(d).
- 11)  The oath or declaration is objected to by the Examiner. Note the attached Office Action or form PTO-152.

**Priority under 35 U.S.C. § 119**

- 12)  Acknowledgment is made of a claim for foreign priority under 35 U.S.C. § 119(a)-(d) or (f).
  - a)  All    b)  Some \*    c)  None of:
  - 1.  Certified copies of the priority documents have been received.
  - 2.  Certified copies of the priority documents have been received in Application No. \_\_\_\_\_.
  - 3.  Copies of the certified copies of the priority documents have been received in this National Stage application from the International Bureau (PCT Rule 17.2(a)).

\* See the attached detailed Office action for a list of the certified copies not received.

**Attachment(s)**

- 1)  Notice of References Cited (PTO-892)
- 2)  Notice of Draftsperson's Patent Drawing Review (PTO-948)
- 3)  Information Disclosure Statement(s) (PTO-1449 or PTO/SB/08)  
 Paper No(s)/Mail Date \_\_\_\_\_.
- 4)  Interview Summary (PTO-413)  
 Paper No(s)/Mail Date \_\_\_\_\_.
- 5)  Notice of Informal Patent Application (PTO-152)
- 6)  Other: \_\_\_\_\_.

## DETAILED ACTION

### ***Claim Rejections - 35 USC § 103***

1. The following is a quotation of 35 U.S.C. 103(a) which forms the basis for all obviousness rejections set forth in this Office action:

(a) A patent may not be obtained though the invention is not identically disclosed or described as set forth in section 102 of this title, if the differences between the subject matter sought to be patented and the prior art are such that the subject matter as a whole would have been obvious at the time the invention was made to a person having ordinary skill in the art to which said subject matter pertains. Patentability shall not be negated by the manner in which the invention was made.

2. Claims 1-16 are rejected under 35 U.S.C. 103(a) as being unpatentable over Shteyn et al. (U. S. 6,782,253) in view of Evans et al (U.S. 6,311,060).

Regarding claims 1, 8, 10 and 11, Shteyn teaches a communications system comprising at least one beacon device (Fig. 1, item 104) capable of wireless message transmission and at least one portable device (Fig. 1, item 108) capable of receiving such a message transmission, wherein the beacon is arranged to broadcast a series of inquiry messages each in the form of a plurality of predetermined data fields arranged according to a first communications protocol (Col. 3, lines 1-9 and Col. 4, lines 6-12).

Shteyn does not teach the beacon is further arranged to add to each inquiry message prior to transmission an additional data field, and wherein the at least one portable device is arranged to receive the transmitted inquiry messages and read data from said additional data field, the additional data field including location information. However Evans teaches the beacon is further arranged to add to each inquiry message

Art Unit: 2642

prior to transmission an additional data field, and wherein the at least one portable device is arranged to receive the transmitted inquiry messages and read data from said additional data field, the additional data field including location information (Col. 17, lines 10-24 and Col. 4, lines 11-21). Evan teaches a method for triggering the registration of the location of a mobile cellular communications device and select expandable data acquired from various data sources. Different locations can be communicated to a single location. The data source includes long-haul truck tracking. The truck company desire to monitor various aspects of trucks that are in transit and are scattered all over the country. The data collection system could keep track of the truck's location at all times. The expandable data record includes an additional field to conventional data field. Thus it would have been obvious to one of ordinary skill in the art at the time the invention was made to incorporate Evan's additional data field feature into Shteyn's system in order to add to each inquiry message an additional location data field prior to transmission. This technology is very popular in communication field.

Regarding claims 2-3 and 12-13, Shteyn does not teach the beacon is arranged to add said additional data field at the end of a respective inquiry message wherein the beacon is arranged to include an indication in one of said predetermined data fields, said indication denoting the presence of said additional data field. However, Evan teaches the beacon is arranged to add said additional data field at the end of a respective inquiry message wherein the beacon is arranged to include an indication in one of said predetermined data fields (Col. 16, lines 59-65).

Regarding claims 4 and 14, Shteyn further teaches a system as claimed in Claim 1, wherein said first communications protocol comprises Bluetooth messaging (Col. 3, lines 50-51).

Regarding claims 5 and 7, Shteyn further teaches a system as claimed in claim 4, wherein a special Dedicated Inquiry Access Code (DIAC) is used to indicate the presence of location information in the additional data field. Wireless messaging system employs frequency hopping, and further wherein location data is sent on each frequency used for inquiry message broadcasts (Col. 3, lines 62- Col. 4, lines 17).

Regarding claim 6, Shteyn does not teach a system as claimed in claim 1, wherein the presence of location information in the additional data field is indicated with header information appearing in the additional data field. However, Evan teaches wherein the presence of location information in the additional data field is indicated with header information appearing in the additional data field (Col. 17, lines 18-24 and Col. 4, lines 19-21).

Regarding claim 9, Shteyn further teaches a device as claimed in Claim 8, wherein the receiver is configured to receive messages according to Bluetooth protocols (Col. 3, lines 36-39).

**Response to Arguments**

3. Applicant's arguments with respect to claims 1- 14 have been considered but are moot in view of the new ground(s) of rejection.

**Conclusion**

Any inquiry concerning this communication or earlier communications from the examiner should be directed to Karen Le whose telephone number is 571-272-7487. The examiner can normally be reached on 8am-5pm.

If attempts to reach the examiner by telephone are unsuccessful, the examiner's supervisor, Ahmad Matar can be reached on 571-272-7488. The fax phone number for the organization where this application or proceeding is assigned is 571-273-8300.

Information regarding the status of an application may be obtained from the Patent Application Information Retrieval (PAIR) system. Status information for published applications may be obtained from either Private PAIR or Public PAIR. Status information for unpublished applications is available through Private PAIR only. For more information about the PAIR system, see <http://pair-direct.uspto.gov>. Should you have questions on access to the Private PAIR system, contact the Electronic Business Center (EBC) at 866-217-9197 (toll-free).

Karen Le  
KLL  
October 17, 2005

  
AHMAD F. MATAR  
SUPERVISORY PATENT EXAMINER  
TECHNOLOGY CENTER 2700

|                                   |                                       |                                                             |             |
|-----------------------------------|---------------------------------------|-------------------------------------------------------------|-------------|
| <b>Notice of References Cited</b> | Application/Control No.<br>09/876,515 | Applicant(s)/Patent Under<br>Reexamination<br>DAVIES ET AL. |             |
|                                   | Examiner<br>Karen L. Le               | Art Unit<br>2642                                            | Page 1 of 1 |

**U.S. PATENT DOCUMENTS**

| * * * |   | Document Number<br>Country Code-Number-Kind Code | Date<br>MM-YYYY | Name         | Classification |
|-------|---|--------------------------------------------------|-----------------|--------------|----------------|
|       | A | US-6,311,060                                     | 10-2001         | Evans et al. | 455/426.1      |
|       | B | US-                                              |                 |              |                |
|       | C | US-                                              |                 |              |                |
|       | D | US-                                              |                 |              |                |
|       | E | US-                                              |                 |              |                |
|       | F | US-                                              |                 |              |                |
|       | G | US-                                              |                 |              |                |
|       | H | US-                                              |                 |              |                |
|       | I | US-                                              |                 |              |                |
|       | J | US-                                              |                 |              |                |
|       | K | US-                                              |                 |              |                |
|       | L | US-                                              |                 |              |                |
|       | M | US-                                              |                 |              |                |

**FOREIGN PATENT DOCUMENTS**

| * * * |   | Document Number<br>Country Code-Number-Kind Code | Date<br>MM-YYYY | Country | Name | Classification |
|-------|---|--------------------------------------------------|-----------------|---------|------|----------------|
|       | N |                                                  |                 |         |      |                |
|       | O |                                                  |                 |         |      |                |
|       | P |                                                  |                 |         |      |                |
|       | Q |                                                  |                 |         |      |                |
|       | R |                                                  |                 |         |      |                |
|       | S |                                                  |                 |         |      |                |
|       | T |                                                  |                 |         |      |                |

**NON-PATENT DOCUMENTS**

| * * * |   | Include as applicable: Author, Title Date, Publisher, Edition or Volume, Pertinent Pages) |
|-------|---|-------------------------------------------------------------------------------------------|
|       | U |                                                                                           |
|       | V |                                                                                           |
|       | W |                                                                                           |
|       | X |                                                                                           |

\*A copy of this reference is not being furnished with this Office action. (See MPEP § 707.05(a).)  
Dates in MM-YYYY format are publication dates. Classifications may be US or foreign.

**Index of Claims**

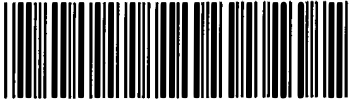

Application No.

09/876,515

Examiner

Karen L Le

Applicant(s)

DAVIES ET AL.

Art Unit

2642

|   |          |
|---|----------|
| √ | Rejected |
| = | Allowed  |

|   |                                |
|---|--------------------------------|
| - | (Through numeral)<br>Cancelled |
| + | Restricted                     |

|   |              |
|---|--------------|
| N | Non-Elected  |
| I | Interference |

|   |          |
|---|----------|
| A | Appeal   |
| O | Objected |

| Claim |          | Date    |          | Claim |          | Date  |          | Claim |          | Date |  |
|-------|----------|---------|----------|-------|----------|-------|----------|-------|----------|------|--|
| Final | Original | 2/17/05 | 10/17/05 | Final | Original | Final | Original | Final | Original |      |  |
| 1     | √        | √       |          | 51    |          | 101   |          |       |          |      |  |
| 2     | √        | √       |          | 52    |          | 102   |          |       |          |      |  |
| 3     | √        | √       |          | 53    |          | 103   |          |       |          |      |  |
| 4     | √        | √       |          | 54    |          | 104   |          |       |          |      |  |
| 5     | √        | √       |          | 55    |          | 105   |          |       |          |      |  |
| 6     | √        | √       |          | 56    |          | 106   |          |       |          |      |  |
| 7     | √        | √       |          | 57    |          | 107   |          |       |          |      |  |
| 8     | √        | √       |          | 58    |          | 108   |          |       |          |      |  |
| 9     | √        | √       |          | 59    |          | 109   |          |       |          |      |  |
| 10    | √        | √       |          | 60    |          | 110   |          |       |          |      |  |
| 11    | √        | √       |          | 61    |          | 111   |          |       |          |      |  |
| 12    | √        | √       |          | 62    |          | 112   |          |       |          |      |  |
| 13    | √        | √       |          | 63    |          | 113   |          |       |          |      |  |
| 14    | √        | √       |          | 64    |          | 114   |          |       |          |      |  |
| 15    |          |         |          | 65    |          | 115   |          |       |          |      |  |
| 16    |          |         |          | 66    |          | 116   |          |       |          |      |  |
| 17    |          |         |          | 67    |          | 117   |          |       |          |      |  |
| 18    |          |         |          | 68    |          | 118   |          |       |          |      |  |
| 19    |          |         |          | 69    |          | 119   |          |       |          |      |  |
| 20    |          |         |          | 70    |          | 120   |          |       |          |      |  |
| 21    |          |         |          | 71    |          | 121   |          |       |          |      |  |
| 22    |          |         |          | 72    |          | 122   |          |       |          |      |  |
| 23    |          |         |          | 73    |          | 123   |          |       |          |      |  |
| 24    |          |         |          | 74    |          | 124   |          |       |          |      |  |
| 25    |          |         |          | 75    |          | 125   |          |       |          |      |  |
| 26    |          |         |          | 76    |          | 126   |          |       |          |      |  |
| 27    |          |         |          | 77    |          | 127   |          |       |          |      |  |
| 28    |          |         |          | 78    |          | 128   |          |       |          |      |  |
| 29    |          |         |          | 79    |          | 129   |          |       |          |      |  |
| 30    |          |         |          | 80    |          | 130   |          |       |          |      |  |
| 31    |          |         |          | 81    |          | 131   |          |       |          |      |  |
| 32    |          |         |          | 82    |          | 132   |          |       |          |      |  |
| 33    |          |         |          | 83    |          | 133   |          |       |          |      |  |
| 34    |          |         |          | 84    |          | 134   |          |       |          |      |  |
| 35    |          |         |          | 85    |          | 135   |          |       |          |      |  |
| 36    |          |         |          | 86    |          | 136   |          |       |          |      |  |
| 37    |          |         |          | 87    |          | 137   |          |       |          |      |  |
| 38    |          |         |          | 88    |          | 138   |          |       |          |      |  |
| 39    |          |         |          | 89    |          | 139   |          |       |          |      |  |
| 40    |          |         |          | 90    |          | 140   |          |       |          |      |  |
| 41    |          |         |          | 91    |          | 141   |          |       |          |      |  |
| 42    |          |         |          | 92    |          | 142   |          |       |          |      |  |
| 43    |          |         |          | 93    |          | 143   |          |       |          |      |  |
| 44    |          |         |          | 94    |          | 144   |          |       |          |      |  |
| 45    |          |         |          | 95    |          | 145   |          |       |          |      |  |
| 46    |          |         |          | 96    |          | 146   |          |       |          |      |  |
| 47    |          |         |          | 97    |          | 147   |          |       |          |      |  |
| 48    |          |         |          | 98    |          | 148   |          |       |          |      |  |
| 49    |          |         |          | 99    |          | 149   |          |       |          |      |  |
| 50    |          |         |          | 100   |          | 150   |          |       |          |      |  |

**Search Notes**



**Application No.**

09/876,515

**Examiner**

Karen L Le

**Applicant(s)**

DAVIES ET AL.

**Art Unit**

2642

**SEARCHED**

| Class  | Subclass       | Date       | Examiner |
|--------|----------------|------------|----------|
| 455    | 457            | 2/17/2005  | KL       |
| 455    | 456.1          | 2/17/2005  | KL       |
| update | search<br>FAST | 10/17/2005 | KL       |
|        |                |            |          |
|        |                |            |          |
|        |                |            |          |
|        |                |            |          |
|        |                |            |          |
|        |                |            |          |
|        |                |            |          |
|        |                |            |          |
|        |                |            |          |
|        |                |            |          |
|        |                |            |          |
|        |                |            |          |
|        |                |            |          |
|        |                |            |          |
|        |                |            |          |

**SEARCH NOTES  
(INCLUDING SEARCH STRATEGY)**

|                               | DATE       | EXMR |
|-------------------------------|------------|------|
| Consulted with Charles Appiah | 12/23/04   | KL   |
|                               | 10/17/2005 | KL   |
|                               |            |      |
|                               |            |      |
|                               |            |      |
|                               |            |      |
|                               |            |      |
|                               |            |      |
|                               |            |      |
|                               |            |      |
|                               |            |      |
|                               |            |      |
|                               |            |      |
|                               |            |      |
|                               |            |      |
|                               |            |      |
|                               |            |      |

**INTERFERENCE SEARCHED**

| Class | Subclass | Date | Examiner |
|-------|----------|------|----------|
|       |          |      |          |
|       |          |      |          |
|       |          |      |          |
|       |          |      |          |
|       |          |      |          |
|       |          |      |          |
|       |          |      |          |
|       |          |      |          |
|       |          |      |          |



PATENT  
Amendment in Reply to Non-Final Office Action of February 23, 2005

Serial No. 09/876,515  
Confirmation No. 9201

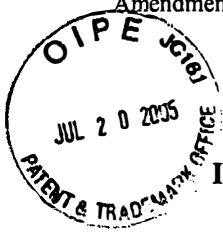

PATENT  
Atty. Docket [MS-168] PHGB000109

**IN THE UNITED STATES PATENT AND TRADEMARK OFFICE**

Applicant : ROBERT J. DAVIES ET AL. Examiner: Karen L. Lee  
Serial No. : 09/876,515 Group Art Unit: 2642  
Filed : June 7, 2001  
For : DATA DELIVERY THROUGH BEACONS

Commissioner for Patents  
P.O. Box 1450  
Alexandria, VA 22313-1450

**AMENDMENT UNDER 37 C.F.R. §1.111**

Sir:

In response to an Office Action of the U.S. Patent and Trademark Office mailed on February 23, 2005, please amend the subject application as follows:

**Claims** are reflected in the "Listing of Claims" which begins on page 2 of this paper

**Remarks/Arguments** begin on page 5 of this paper.

**Amendment to the Claims:**

A listing of the entire set of pending claims 1-14 is submitted herewith per 37 CFR §1.121. This listing of claims 1-14 will replace all prior versions, and listings, of claims in the application.

**Listing of Claims:**

1. (Original) A communications system comprising at least one beacon device capable of wireless message transmission and at least one portable device capable of receiving such a message transmission, wherein the beacon is arranged to broadcast a series of inquiry messages each in the form of a plurality of predetermined data fields arranged according to a first communications protocol, wherein the beacon is further arranged to add to each inquiry message prior to transmission an additional data field, and wherein the at least one portable device is arranged to receive the transmitted inquiry messages and read data from said additional data field, the additional data field including location information.
2. (Original) A system as claimed in claim 1, wherein the beacon is arranged to add said additional data field at the end of a respective inquiry message.
3. (Original) A system as claimed in claim 1, wherein the beacon is arranged to include an indication in one of said predetermined data fields, said indication denoting the presence of said additional data field.
4. (Original) A system as claimed in claim 1, wherein said first communications protocol comprises Bluetooth messaging.
5. (Original) A system as claimed in claim 4, wherein a special Dedicated Inquiry Access Code (DIAC) is used to indicate the presence of location information in the additional data field.

6. (Original) A system as claimed in claim 1, wherein the presence of location information in the additional data field is indicated with header information appearing in the additional data field.

7. (Original) A system in accordance with claim 1, wherein wireless messaging system employs frequency hopping, and further wherein location data is sent on each frequency used for inquiry message broadcasts.

8. (Original) A mobile communication device for use in the system of claim 1, the device comprising a receiver capable of receiving a short-range wireless inquiry message including a plurality of data fields according to a first communications protocol, means for determining when an additional data field including location information has been added to said plurality of data fields, and means for reading the location information data from such an additional data field.

9. (Original) A device as claimed in claim 8, wherein the receiver is configured to receive messages according to Bluetooth protocols.

10. (Original) A beacon device capable of wireless message transmission and for use in a communications system comprising said beacon device and at least one portable device capable of receiving such a message transmission, wherein the beacon is configured to broadcast a series of inquiry messages each in the form of a plurality of predetermined data fields arranged according to a first communications protocol, and to add to each inquiry message prior to transmission an additional data field, such as to enable the at least one portable device arranged to receive the transmitted inquiry messages to read data from said additional data field, the additional data field including location information.

11. (Original) A method for enabling the user of a portable communications device to receive broadcast messages wherein at least one beacon device broadcasts a series of inquiry messages each in the form of a plurality of predetermined data fields arranged

according to a first communications protocol, wherein the beacon adds to each inquiry message prior to transmission an additional data field carrying broadcast message data including location information, and wherein the portable device receives the transmitted inquiry messages including the location information and reads the broadcast data from said additional data field.

12. (Original) A method as claimed in claim 11, wherein the beacon adds said additional data field at the end of a respective inquiry message.

13. (Original) A method as claimed in claim 11, wherein the beacon includes an indication in one of said predetermined data fields, said indication denoting the presence of said additional data field.

14. (Original) A method as claimed in claim 11, wherein said first communications protocol comprises Bluetooth messaging.

**REMARKS**

This application has been reviewed in light of the Office Action mailed on February 23, 2005. Claims 1-14 are pending in the application. No new matter or issues are believed to be introduced by the amendments.

**35 U.S.C. §102(e)**

In the Office Action, Claims 1-14 were rejected under 35 U.S.C. §102(e) as being anticipated by U.S. Patent No. 6,782,253 – Shteyn et al (hereinafter Shteyn).

Applicants respectfully traverse the rejection of claims 1-14 under 35 U.S.C. §102(e). It is respectfully submitted that claims 1-14 are patentable over Shteyn for at least the following reasons.

The present invention relates to services offered to users of electronic equipment, especially but not exclusively to users of mobile communications devices such as portable telephones and suitably equipped PDA's (personal digital assistants).

Claim 1 recites, a communications system comprising at least one beacon device capable of wireless message transmission and at least one portable device capable of receiving such a message transmission, wherein the beacon is arranged to broadcast a series of inquiry messages each in the form of a plurality of predetermined data fields arranged according to a first communications protocol, wherein the beacon is further arranged to add to each inquiry message prior to transmission an additional data field, and wherein the at least one portable device is arranged to receive the transmitted inquiry

messages and read data from said additional data field, the additional data field including location information. These features are not shown (or suggested) in Shteyn.

The inquire message of claim 1 adds the additional field (suitably at the end of a respective inquiry message), so that a data broadcast may be carried on top of an existing inquiry process.

In contrast, Shteyn provides a method of enabling a user of a mobile communication device to receive a short-range wireless facilitation signal on the device. A beacon transmits a facilitating signal. When a user's device is within range of the beacon the facilitation signal initiates associating the facilitating signal with the service. The initiating leads conditionally to alerting the user to the service, depending on a user-profile, preferably stored at the mobile device. (Shteyn – Col. 3, lines 1 – 9)

Shteyn fails to teach (or suggest) the elements recited in independent Claim 1, that of, a beacon arranged to broadcast a series of inquiry messages each in the form of a plurality of predetermined data fields arranged according to a first communications protocol, wherein the beacon is further arranged to add to each inquiry message prior to transmission an additional data field, the additional data field including location information.

The system recited in independent claim 1 provides significant advantages. One advantage is that the usual delays that are incurred while an inquiry process is carried out prior to data transfer are avoided. Thus, the inquiry performance of a system can be improved by shortening the time to establish a connection for data exchange. A further advantage is that by placing the additional field at the end of a respective inquiry message in accordance with a communications protocol (preferably but not

essentially Bluetooth), those protocol-compatible devices not intended for reception of beacon signals can simply ignore the additional data without compromising operation according to protocol.

It is respectfully submitted that at least the limitations and/or features of Claim 1 is not anticipated by the disclosure of Shteyn.

Accordingly, withdrawal of the rejection under 35 U.S.C. §102(e) with respect to Claim 1 and allowance thereof is respectfully requested.

Claims 2-9 depend from independent Claim 1 and therefore contain the limitations of Claim 1 and are believed to be in condition for allowance for at least the same reasons given for Claim 1 above. Accordingly, withdrawal of the rejection under 35 U.S.C. §102(e) and allowance of Claims 2-9 is respectfully requested.

Independent Claims 10 and 11 recite similar subject matter as Claim 1 and therefore contain the limitations of Claim 1. Specifically, independent claim 10 recites a beacon device configured to broadcast a series of inquiry messages each in the form of a plurality of predetermined data fields arranged according to a first communications protocol, and to add to each inquiry message prior to transmission an additional data field, such as to enable the at least one portable device arranged to receive the transmitted inquiry messages to read data from said additional data field, the additional data field including location information.

Independent claim 11 recites a method for enabling a user of a portable communications device to receive broadcast messages wherein at least one beacon device broadcasts a series of inquiry messages each in the form of a plurality of predetermined data fields arranged according to a first communications protocol, wherein the beacon

adds to each inquiry message prior to transmission an additional data field carrying broadcast message data including location information, and wherein the portable device receives the transmitted inquiry messages including the location information and reads the broadcast data from said additional data field.

Hence, for at least the same reasons given for Claim 1, Claims 10 and 11 are believed to be allowable over Shteyn. Accordingly, withdrawal of the rejection under 35 U.S.C. §102(e) and allowance of Claims 10 and 11 is respectfully requested.

Claims 12-14 depend from independent Claim 11 and therefore contain the limitations of Claim 11 and are believed to be in condition for allowance for at least the same reasons given for Claim 11 above. Accordingly, withdrawal of the rejection under 35 U.S.C. §102(e) and allowance of Claims 12-14 is respectfully requested.

### Conclusion

In view of the foregoing amendments and remarks, it is respectfully submitted that all claims presently pending in the application, namely, Claims 1 – 14 are believed to be in condition for allowance and patentably distinguishable over the art of record.

Respectfully submitted,

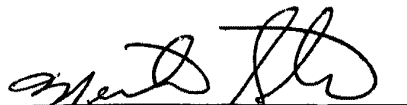

Michael A. Scaturro  
Reg. No. 51,356  
Attorney for Applicant

**Mailing Address:**  
**Intellectual Property Counsel**  
**Philips Electronics North America Corp.**



PATENT  
Amendment in Reply to Non-Final Office Action of February 23, 2005

Serial No. 09/876,515  
Confirmation No. 9201

**580 White Plains Road  
Tarrytown, New York 10591**

**Certificate of Mailing Under 37 C.F.R. 1.8**

I hereby certify that this correspondence is being deposited with the United States Postal Service as first class mail in an envelope addressed to: Assistant Commissioner for Patents, Washington, D.C.

20231, on 7-18 2005.



Michael A. Scaturro



*EP 26/02*

Atty. Docket [MS-168] PATENT  
PHGB000109

IN THE UNITED STATES PATENT AND TRADEMARK OFFICE

Applicant : ROBERT J. DAVIES ET AL. Examiner: Karen L. Lee  
Serial No.: 09/876,515 Group Art Unit: 2642  
Filed : June 7, 2001  
For : DATA DELIVERY THROUGH BEACONS

Commissioner for Patents  
P.O. Box 1450  
Alexandria, VA 22313-1450

PETITION FOR EXTENSION OF TIME UNDER 37 CFR 1.136(a)

Sir:

Applicants hereby petition for an extension of TWO (2) months to respond to the Office Action mailed on February 23, 2005.

Because of this extension the time period for response will expire on July 23, 2005. Filed herewith is an amendment. Please find enclosed form 2038 which covers the \$450.00 fee for this extension. Please charge any additional fees except for the Issue Fee, and credit any overpayment, to Deposit Account No. 14-1270.

Respectfully submitted,

By *[Signature]*  
Michael Scaturro, Reg. 51,356  
Attorney  
(516) 414-2007

~~07/20/2005 HOUTENAI 00000045 09879515~~  
~~01 FC:1252~~ ~~450.00 DP~~

CERTIFICATE OF MAILING

It is hereby certified that this correspondence is being deposited with the United States Postal Service as first-class mail in an envelope addressed to:  
COMMISSIONER OF PATENTS AND TRADEMARKS

P.O. Box 1450  
Alexandria, VA 22313-1450

On July 18, 2005  
By MICHAEL SCATURRO

Adjustment date: 07/21/2005 LWONDIM1  
07720/2005 HGUTENA1 00000045 09879515  
01 FC:1252 -450.00 DP

07/21/2005 LWONDIM1 00000001 09876515 450.00 DP  
01 FC:1252

**PATENT APPLICATION FEE DETERMINATION RECORD**  
Effective October 1, 2000

Application or Docket Number

~~6-0001-09~~  
09 187655

**CLAIMS AS FILED - PART I**

|                                  | (Column 1)               | (Column 2)   |
|----------------------------------|--------------------------|--------------|
| TOTAL CLAIMS                     | 14                       |              |
| FOR                              | NUMBER FILED             | NUMBER EXTRA |
| TOTAL CHARGEABLE CLAIMS          | 14 minus 20=             | *            |
| INDEPENDENT CLAIMS               | 3 minus 3 =              | *            |
| MULTIPLE DEPENDENT CLAIM PRESENT | <input type="checkbox"/> |              |

\* If the difference in column 1 is less than zero, enter "0" in column 2

**CLAIMS AS AMENDED - PART II**

7/20/07

|                                                                         | (Column 1)                       | (Column 2)                         | (Column 3)    |
|-------------------------------------------------------------------------|----------------------------------|------------------------------------|---------------|
| AMENDMENT A                                                             | CLAIMS REMAINING AFTER AMENDMENT | HIGHEST NUMBER PREVIOUSLY PAID FOR | PRESENT EXTRA |
|                                                                         | Total                            | • 14 Minus .. 20                   | =             |
|                                                                         | Independent                      | • 3 Minus ... 3                    | =             |
| FIRST PRESENTATION OF MULTIPLE DEPENDENT CLAIM <input type="checkbox"/> |                                  |                                    |               |

|                                                                         | (Column 1)                       | (Column 2)                         | (Column 3)    |
|-------------------------------------------------------------------------|----------------------------------|------------------------------------|---------------|
| AMENDMENT B                                                             | CLAIMS REMAINING AFTER AMENDMENT | HIGHEST NUMBER PREVIOUSLY PAID FOR | PRESENT EXTRA |
|                                                                         | Total                            | • Minus ..                         | =             |
|                                                                         | Independent                      | • Minus ...                        | =             |
| FIRST PRESENTATION OF MULTIPLE DEPENDENT CLAIM <input type="checkbox"/> |                                  |                                    |               |

|                                                                         | (Column 1)                       | (Column 2)                         | (Column 3)    |
|-------------------------------------------------------------------------|----------------------------------|------------------------------------|---------------|
| AMENDMENT C                                                             | CLAIMS REMAINING AFTER AMENDMENT | HIGHEST NUMBER PREVIOUSLY PAID FOR | PRESENT EXTRA |
|                                                                         | Total                            | • Minus ..                         | =             |
|                                                                         | Independent                      | • Minus ...                        | =             |
| FIRST PRESENTATION OF MULTI PLEDEPENDENT CLAIM <input type="checkbox"/> |                                  |                                    |               |

\* If the entry in column 1 is less than the entry in column 2, write "0" in column 3.

\*\* If the "Highest Number Previously Paid For" IN THIS SPACE is less than 20, enter "20."

\*\*\* If the "Highest Number Previously Paid For" IN THIS SPACE is less than 3, enter "3."

The "Highest Number Previously Paid For" (Total or Independent) is the highest number found in the appropriate box in column 1.

**SMALL ENTITY TYPE**  OR

**OTHER THAN SMALL ENTITY**

| RATE      | FEE    | OR | RATE      | FEE    |
|-----------|--------|----|-----------|--------|
| BASIC FEE | 355.00 |    | BASIC FEE | 710.00 |
| X\$ 9=    |        |    | X\$18=    |        |
| X40=      |        |    | X80=      |        |
| +135=     |        |    | +270=     |        |
| TOTAL     |        |    | TOTAL     | 710    |

**SMALL ENTITY** OR

**OTHER THAN SMALL ENTITY**

| RATE            | ADDITIONAL FEE | OR | RATE            | ADDITIONAL FEE |
|-----------------|----------------|----|-----------------|----------------|
| X\$ 9=          |                |    | X\$18=          |                |
| X40=            |                |    | X80=            |                |
| +135=           |                |    | +270=           |                |
| TOTAL ADDI. FEE |                |    | TOTAL ADDI. FEE |                |

| RATE            | ADDITIONAL FEE | OR | RATE            | ADDITIONAL FEE |
|-----------------|----------------|----|-----------------|----------------|
| X\$ 9=          |                |    | X\$18=          |                |
| X40=            |                |    | X80=            |                |
| +135=           |                |    | +270=           |                |
| TOTAL ADDI. FEE |                |    | TOTAL ADDI. FEE |                |

| RATE            | ADDITIONAL FEE | OR | RATE            | ADDITIONAL FEE |
|-----------------|----------------|----|-----------------|----------------|
| X\$ 9=          |                |    | X\$18=          |                |
| X40=            |                |    | X80=            |                |
| +135=           |                |    | +270=           |                |
| TOTAL ADDI. FEE |                |    | TOTAL ADDI. FEE |                |

BEST AVAILABLE COPY

21



UNITED STATES PATENT AND TRADEMARK OFFICE

UNITED STATES DEPARTMENT OF COMMERCE  
United States Patent and Trademark Office  
Address: COMMISSIONER FOR PATENTS  
P.O. Box 1450  
Alexandria, Virginia 22313-1450  
www.uspto.gov

| APPLICATION NO.                                                                          | FILING DATE | FIRST NAMED INVENTOR | ATTORNEY DOCKET NO. | CONFIRMATION NO. |
|------------------------------------------------------------------------------------------|-------------|----------------------|---------------------|------------------|
| 09/876,515                                                                               | 06/07/2001  | Robert J. Davies     | GB 000109           | 9201             |
| 24737                                                                                    | 7590        | 02/23/2005           | EXAMINER            |                  |
| PHILIPS INTELLECTUAL PROPERTY & STANDARDS<br>P.O. BOX 3001<br>BRIARCLIFF MANOR, NY 10510 |             |                      | LE, KAREN L         |                  |
|                                                                                          |             |                      | ART UNIT            | PAPER NUMBER     |
|                                                                                          |             |                      | 2642                |                  |

DATE MAILED: 02/23/2005

Please find below and/or attached an Office communication concerning this application or proceeding.

By

|                              |                                      |                                      |  |
|------------------------------|--------------------------------------|--------------------------------------|--|
| <b>Office Action Summary</b> | <b>Application No.</b><br>09/876,515 | <b>Applicant(s)</b><br>DAVIES ET AL. |  |
|                              | <b>Examiner</b><br>Karen L Le        | <b>Art Unit</b><br>2642              |  |

- The MAILING DATE of this communication appears on the cover sheet with the correspondence address -

**Period for Reply**

A SHORTENED STATUTORY PERIOD FOR REPLY IS SET TO EXPIRE 3 MONTH(S) FROM THE MAILING DATE OF THIS COMMUNICATION.

- Extensions of time may be available under the provisions of 37 CFR 1.136(a). In no event, however, may a reply be timely filed after SIX (6) MONTHS from the mailing date of this communication.
- If the period for reply specified above is less than thirty (30) days, a reply within the statutory minimum of thirty (30) days will be considered timely.
- If NO period for reply is specified above, the maximum statutory period will apply and will expire SIX (6) MONTHS from the mailing date of this communication.
- Failure to reply within the set or extended period for reply will, by statute, cause the application to become ABANDONED (35 U.S.C. § 133). Any reply received by the Office later than three months after the mailing date of this communication, even if timely filed, may reduce any earned patent term adjustment. See 37 CFR 1.704(b).

**Status**

- 1)  Responsive to communication(s) filed on 07 June 2001.
- 2a)  This action is **FINAL**.
- 2b)  This action is non-final.
- 3)  Since this application is in condition for allowance except for formal matters, prosecution as to the merits is closed in accordance with the practice under *Ex parte Quayle*, 1935 C.D. 11, 453 O.G. 213.

**Disposition of Claims**

- 4)  Claim(s) 1-14 is/are pending in the application.
  - 4a) Of the above claim(s) \_\_\_\_\_ is/are withdrawn from consideration.
- 5)  Claim(s) \_\_\_\_\_ is/are allowed.
- 6)  Claim(s) 1-14 is/are rejected.
- 7)  Claim(s) \_\_\_\_\_ is/are objected to.
- 8)  Claim(s) \_\_\_\_\_ are subject to restriction and/or election requirement.

**Application Papers**

- 9)  The specification is objected to by the Examiner.
- 10)  The drawing(s) filed on \_\_\_\_\_ is/are: a)  accepted or b)  objected to by the Examiner.  
Applicant may not request that any objection to the drawing(s) be held in abeyance. See 37 CFR 1.85(a).  
Replacement drawing sheet(s) including the correction is required if the drawing(s) is objected to. See 37 CFR 1.121(d).
- 11)  The oath or declaration is objected to by the Examiner. Note the attached Office Action or form PTO-152.

**Priority under 35 U.S.C. § 119**

- 12)  Acknowledgment is made of a claim for foreign priority under 35 U.S.C. § 119(a)-(d) or (f).
  - a)  All   b)  Some \*   c)  None of:
    - 1.  Certified copies of the priority documents have been received.
    - 2.  Certified copies of the priority documents have been received in Application No. \_\_\_\_\_.
    - 3.  Copies of the certified copies of the priority documents have been received in this National Stage application from the International Bureau (PCT Rule 17.2(a)).

\* See the attached detailed Office action for a list of the certified copies not received.

**Attachment(s)**

- 1)  Notice of References Cited (PTO-892)
- 2)  Notice of Draftsperson's Patent Drawing Review (PTO-948)
- 3)  Information Disclosure Statement(s) (PTO-1449 or PTO/SB/08)  
Paper No(s)/Mail Date \_\_\_\_\_.
- 4)  Interview Summary (PTO-413)  
Paper No(s)/Mail Date. \_\_\_\_\_.
- 5)  Notice of Informal Patent Application (PTO-152)
- 6)  Other: \_\_\_\_\_.

## DETAILED ACTION

### *Claim Rejections - 35 USC § 102*

1. The following is a quotation of the appropriate paragraphs of 35 U.S.C. 102 that form the basis for the rejections under this section made in this Office action:

A person shall be entitled to a patent unless –

(e) the invention was described in a patent granted on an application for patent by another filed in the United States before the invention thereof by the applicant for patent, or on an international application by another who has fulfilled the requirements of paragraphs (1), (2), and (4) of section 371(c) of this title before the invention thereof by the applicant for patent.

The changes made to 35 U.S.C. 102(e) by the American Inventors Protection Act of 1999 (AIPA) do not apply to the examination of this application as the application being examined was not (1) filed on or after November 29, 2000, or (2) voluntarily published under 35 U.S.C. 122(b). Therefore, this application is examined under 35 U.S.C. 102(e) prior to the amendment by the AIPA (pre-AIPA 35 U.S.C. 102(e)).

2. Claims 1-14 are rejected under 35 U.S.C. 102(e) as being anticipated by Shteyn et al. (U.S. 6,782,253).

Regarding claims 1 and 10, Shteyn teaches a communications system comprising at least one beacon device (Fig. 1, item 104) capable of wireless message transmission and at least one portable device (Fig. 1, item 108) capable of receiving such a message transmission, wherein the beacon is arranged to broadcast a series of inquiry messages each in the form of a plurality of predetermined data fields arranged according to a first communications protocol, wherein the

Art Unit: 2642

beacon is further arranged to add to each inquiry message prior to transmission an additional data field, and wherein the at least one portable device is arranged to receive the transmitted inquiry messages and read data from said additional data field, the additional data field including location information (Col. 3, lines 1-9 and Col. 4, lines 6-12).

Regarding claims 2-3 and 12-13, Shteyn further teaches the beacon is arranged to add said additional data field at the end of a respective inquiry message wherein the beacon is arranged to include an indication in one of said predetermined data fields, said indication denoting the presence of said additional data field (Col. 1, lines 48-62).

Regarding claims 4 and 14, Shteyn further teaches a system as claimed in Claim 1, wherein said first communications protocol comprises Bluetooth messaging (Col. 3, lines 50-51).

Regarding claims 5 and 7, Shteyn further teaches a system as claimed in claim 4, wherein a special Dedicated Inquiry Access Code (DIAC) is used to indicate the presence of location information in the additional data field. Wireless messaging system employs frequency hopping, and further wherein location data is sent on each frequency used for inquiry message broadcasts (Col. 3, lines 62- Col. 4, lines 17).

Regarding claim 6, Shteyn further teaches a system as claimed in claim 1, wherein the presence of location information in the additional data field is indicated with header information appearing in the additional data field (Col. 3, lines 62- Col. 4, lines 17).

Regarding claim 8, Shteyn further teaches a mobile communication device for use in the system of Claim 1, the device comprising a receiver capable of receiving a short-range wireless inquiry message including a plurality of data fields according to a first communications protocol, means for determining when an additional data field including location information has been added to said plurality of data fields, and means for reading the location information data from such an additional data field (Col. 6, lines 17-27).

Regarding claim 9, Shteyn further teaches a device as claimed in Claim 8, wherein the receiver is configured to receive messages according to Bluetooth protocols (Col. 3, lines 36-39).

Regarding claim 11, Shteyn further teaches a method for enabling the user of a portable communications device (Fig. 1, item 108) to receive broadcast messages wherein at least one beacon device (Fig. 1, item 104) broadcasts a series of inquiry messages each in the form of a plurality of predetermined data fields arranged according to a first communications protocol, wherein the beacon adds to each inquiry message prior to transmission an additional data field carrying broadcast message data including location information, and wherein the portable device receives the transmitted inquiry messages including the location information and reads the broadcast data from said additional data field (Col. 3, lines 1-9 and Col. 4, lines 6-12).



Application/Control Number: 09/876,515  
Art Unit: 2642

Page 5

***Conclusion***

Any inquiry concerning this communication or earlier communications from the examiner should be directed to Karen L Le whose telephone number is 703-308-4998. The examiner can normally be reached on M-F 8:30-5:00.

If attempts to reach the examiner by telephone are unsuccessful, the examiner's supervisor, Ahmad F Matar can be reached on 703-305-4731. The fax phone number for the organization where this application or proceeding is assigned is 703-872-9306.

Information regarding the status of an application may be obtained from the Patent Application Information Retrieval (PAIR) system. Status information for published applications may be obtained from either Private PAIR or Public PAIR. Status information for unpublished applications is available through Private PAIR only. For more information about the PAIR system, see <http://pair-direct.uspto.gov>. Should you have questions on access to the Private PAIR system, contact the Electronic Business Center (EBC) at 866-217-9197 (toll-free).

Karen Le  
KLL  
February 17, 2005

  
AHMAD MATAR  
SUPERVISORY PATENT EXAMINER  
TECHNOLOGY CENTER 2600

|                                   |                                       |                                                             |             |
|-----------------------------------|---------------------------------------|-------------------------------------------------------------|-------------|
| <b>Notice of References Cited</b> | Application/Control No.<br>09/876,515 | Applicant(s)/Patent Under<br>Reexamination<br>DAVIES ET AL. |             |
|                                   | Examiner<br>Karen L Le                | Art Unit<br>2642                                            | Page 1 of 1 |

**U.S. PATENT DOCUMENTS**

| * | Document Number<br>Country Code-Number-Kind Code | Date<br>MM-YYYY | Name          | Classification |
|---|--------------------------------------------------|-----------------|---------------|----------------|
| A | US-6,782,253                                     | 08-2004         | Shteyn et al. | 455/414.1      |
| B | US-                                              |                 |               |                |
| C | US-                                              |                 |               |                |
| D | US-                                              |                 |               |                |
| E | US-                                              |                 |               |                |
| F | US-                                              |                 |               |                |
| G | US-                                              |                 |               |                |
| H | US-                                              |                 |               |                |
| I | US-                                              |                 |               |                |
| J | US-                                              |                 |               |                |
| K | US-                                              |                 |               |                |
| L | US-                                              |                 |               |                |
| M | US-                                              |                 |               |                |

**FOREIGN PATENT DOCUMENTS**

| * | Document Number<br>Country Code-Number-Kind Code | Date<br>MM-YYYY | Country | Name | Classification |
|---|--------------------------------------------------|-----------------|---------|------|----------------|
| N |                                                  |                 |         |      |                |
| O |                                                  |                 |         |      |                |
| P |                                                  |                 |         |      |                |
| Q |                                                  |                 |         |      |                |
| R |                                                  |                 |         |      |                |
| S |                                                  |                 |         |      |                |
| T |                                                  |                 |         |      |                |

**NON-PATENT DOCUMENTS**

| * | Include as applicable: Author, Title Date, Publisher, Edition or Volume, Pertinent Pages) |
|---|-------------------------------------------------------------------------------------------|
| U |                                                                                           |
| V |                                                                                           |
| W |                                                                                           |
| X |                                                                                           |

\*A copy of this reference is not being furnished with this Office action. (See MPEP § 707.05(a).)  
Dates in MM-YYYY format are publication dates. Classifications may be US or foreign.



UNITED STATES PATENT AND TRADEMARK OFFICE

COMMISSIONER FOR PATENTS  
 UNITED STATES PATENT AND TRADEMARK OFFICE  
 WASHINGTON, D.C. 20231  
 www.uspto.gov



Bib Data Sheet

CONFIRMATION NO. 9201

|                                    |                                                 |                     |                               |                                         |
|------------------------------------|-------------------------------------------------|---------------------|-------------------------------|-----------------------------------------|
| <b>SERIAL NUMBER</b><br>09/876,515 | <b>FILING DATE</b><br>06/07/2001<br><b>RULE</b> | <b>CLASS</b><br>455 | <b>GROUP ART UNIT</b><br>2681 | <b>ATTORNEY DOCKET NO.</b><br>GB 000109 |
|------------------------------------|-------------------------------------------------|---------------------|-------------------------------|-----------------------------------------|

**APPLICANTS**  
 Robert J. Davies, Horley, UNITED KINGDOM;  
 Saul R. Dooley, Reigate, UNITED KINGDOM;

**\*\* CONTINUING DATA \*\*\*\*\*** None K.L.

**\*\* FOREIGN APPLICATIONS \*\*\*\*\*** yes. K.L.  
 UNITED KINGDOM 0015454.2 06/26/2000  
 UNITED KINGDOM 0020073.3 08/15/2000

**IF REQUIRED, FOREIGN FILING LICENSE GRANTED**  
**\*\* 08/07/2001**

|                                                                                          |                                                                                                                                                                                                                                                     |                                           |                            |                           |                                |
|------------------------------------------------------------------------------------------|-----------------------------------------------------------------------------------------------------------------------------------------------------------------------------------------------------------------------------------------------------|-------------------------------------------|----------------------------|---------------------------|--------------------------------|
| Foreign Priority claimed<br>35 USC 119 (a-d) conditions met<br>Verified and Acknowledged | <input checked="" type="checkbox"/> yes <input type="checkbox"/> no<br><input checked="" type="checkbox"/> yes <input type="checkbox"/> no <input type="checkbox"/> Met after Allowance<br>Examiner's Signature: <i>K. L.</i> Initials: <i>K.L.</i> | <b>STATE OR COUNTRY</b><br>UNITED KINGDOM | <b>SHEETS DRAWING</b><br>3 | <b>TOTAL CLAIMS</b><br>14 | <b>INDEPENDENT CLAIMS</b><br>3 |
|------------------------------------------------------------------------------------------|-----------------------------------------------------------------------------------------------------------------------------------------------------------------------------------------------------------------------------------------------------|-------------------------------------------|----------------------------|---------------------------|--------------------------------|

**ADDRESS**  
 Corporate Patent Counsel  
 U.S. Philips Corporation  
 580 White Plains Road  
 Tarrytown ,NY 10591

**TITLE**  
 Data delivery through beacons

|                                   |                                                                                                             |                                                                                                                                                                                                                                                                                 |
|-----------------------------------|-------------------------------------------------------------------------------------------------------------|---------------------------------------------------------------------------------------------------------------------------------------------------------------------------------------------------------------------------------------------------------------------------------|
| <b>FILING FEE RECEIVED</b><br>710 | FEES: Authority has been given in Paper No. _____ to charge/credit DEPOSIT ACCOUNT No. _____ for following: | <input type="checkbox"/> All Fees<br><input type="checkbox"/> 1.16 Fees ( Filing )<br><input type="checkbox"/> 1.17 Fees ( Processing Ext. of time )<br><input type="checkbox"/> 1.18 Fees ( Issue )<br><input type="checkbox"/> Other _____<br><input type="checkbox"/> Credit |
|-----------------------------------|-------------------------------------------------------------------------------------------------------------|---------------------------------------------------------------------------------------------------------------------------------------------------------------------------------------------------------------------------------------------------------------------------------|

**Index of Claims**

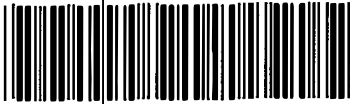

Application No.

09/876,515

Examiner

Karen L Le

Applicant(s)

DAVIES ET AL.

Art Unit

2642

|   |          |
|---|----------|
| √ | Rejected |
| = | Allowed  |

|   |                                |
|---|--------------------------------|
| - | (Through numeral)<br>Cancelled |
| + | Restricted                     |

|   |              |
|---|--------------|
| N | Non-Elected  |
| I | Interference |

|   |          |
|---|----------|
| A | Appeal   |
| O | Objected |

| Claim |          | Date |  |
|-------|----------|------|--|
| Final | Original |      |  |
|       | 1        | √    |  |
|       | 2        | √    |  |
|       | 3        | √    |  |
|       | 4        | √    |  |
|       | 5        | √    |  |
|       | 6        | √    |  |
|       | 7        | √    |  |
|       | 8        | √    |  |
|       | 9        | √    |  |
|       | 10       | √    |  |
|       | 11       | √    |  |
|       | 12       | √    |  |
|       | 13       | √    |  |
|       | 14       | √    |  |
|       | 15       |      |  |
|       | 16       |      |  |
|       | 17       |      |  |
|       | 18       |      |  |
|       | 19       |      |  |
|       | 20       |      |  |
|       | 21       |      |  |
|       | 22       |      |  |
|       | 23       |      |  |
|       | 24       |      |  |
|       | 25       |      |  |
|       | 26       |      |  |
|       | 27       |      |  |
|       | 28       |      |  |
|       | 29       |      |  |
|       | 30       |      |  |
|       | 31       |      |  |
|       | 32       |      |  |
|       | 33       |      |  |
|       | 34       |      |  |
|       | 35       |      |  |
|       | 36       |      |  |
|       | 37       |      |  |
|       | 38       |      |  |
|       | 39       |      |  |
|       | 40       |      |  |
|       | 41       |      |  |
|       | 42       |      |  |
|       | 43       |      |  |
|       | 44       |      |  |
|       | 45       |      |  |
|       | 46       |      |  |
|       | 47       |      |  |
|       | 48       |      |  |
|       | 49       |      |  |
|       | 50       |      |  |

| Claim |          | Date |  |
|-------|----------|------|--|
| Final | Original |      |  |
|       | 51       |      |  |
|       | 52       |      |  |
|       | 53       |      |  |
|       | 54       |      |  |
|       | 55       |      |  |
|       | 56       |      |  |
|       | 57       |      |  |
|       | 58       |      |  |
|       | 59       |      |  |
|       | 60       |      |  |
|       | 61       |      |  |
|       | 62       |      |  |
|       | 63       |      |  |
|       | 64       |      |  |
|       | 65       |      |  |
|       | 66       |      |  |
|       | 67       |      |  |
|       | 68       |      |  |
|       | 69       |      |  |
|       | 70       |      |  |
|       | 71       |      |  |
|       | 72       |      |  |
|       | 73       |      |  |
|       | 74       |      |  |
|       | 75       |      |  |
|       | 76       |      |  |
|       | 77       |      |  |
|       | 78       |      |  |
|       | 79       |      |  |
|       | 80       |      |  |
|       | 81       |      |  |
|       | 82       |      |  |
|       | 83       |      |  |
|       | 84       |      |  |
|       | 85       |      |  |
|       | 86       |      |  |
|       | 87       |      |  |
|       | 88       |      |  |
|       | 89       |      |  |
|       | 90       |      |  |
|       | 91       |      |  |
|       | 92       |      |  |
|       | 93       |      |  |
|       | 94       |      |  |
|       | 95       |      |  |
|       | 96       |      |  |
|       | 97       |      |  |
|       | 98       |      |  |
|       | 99       |      |  |
|       | 100      |      |  |

| Claim |          | Date |  |
|-------|----------|------|--|
| Final | Original |      |  |
|       | 101      |      |  |
|       | 102      |      |  |
|       | 103      |      |  |
|       | 104      |      |  |
|       | 105      |      |  |
|       | 106      |      |  |
|       | 107      |      |  |
|       | 108      |      |  |
|       | 109      |      |  |
|       | 110      |      |  |
|       | 111      |      |  |
|       | 112      |      |  |
|       | 113      |      |  |
|       | 114      |      |  |
|       | 115      |      |  |
|       | 116      |      |  |
|       | 117      |      |  |
|       | 118      |      |  |
|       | 119      |      |  |
|       | 120      |      |  |
|       | 121      |      |  |
|       | 122      |      |  |
|       | 123      |      |  |
|       | 124      |      |  |
|       | 125      |      |  |
|       | 126      |      |  |
|       | 127      |      |  |
|       | 128      |      |  |
|       | 129      |      |  |
|       | 130      |      |  |
|       | 131      |      |  |
|       | 132      |      |  |
|       | 133      |      |  |
|       | 134      |      |  |
|       | 135      |      |  |
|       | 136      |      |  |
|       | 137      |      |  |
|       | 138      |      |  |
|       | 139      |      |  |
|       | 140      |      |  |
|       | 141      |      |  |
|       | 142      |      |  |
|       | 143      |      |  |
|       | 144      |      |  |
|       | 145      |      |  |
|       | 146      |      |  |
|       | 147      |      |  |
|       | 148      |      |  |
|       | 149      |      |  |
|       | 150      |      |  |



|                                                                                       |                                      |            |
|---------------------------------------------------------------------------------------|--------------------------------------|------------|
| Form PTO-1449<br>DEPARTMENT OF<br>COMMERCE<br>(REV. 7-80) PATENT AND TRADEMARK OFFICE | Atty. Docket No.                     | Serial No. |
|                                                                                       | GB 000109                            | 09/876,515 |
|                                                                                       | Applicant<br>ROBERT J. DAVIES ET AL. |            |
| INFORMATION DISCLOSURE CITATION<br>(Use several sheets if necessary)                  | Filing Date                          | Group      |
|                                                                                       | 6/7/01                               | 2681       |

**RECEIVED**  
**FEB 22 2002**  
 Technology Center 2600

**U.S. PATENT DOCUMENTS**

| Ex. Int | Document Number | Date | Name | Class | Sub-class | Filing Date If Approp. |
|---------|-----------------|------|------|-------|-----------|------------------------|
| AA      |                 |      |      |       |           |                        |
| AB      |                 |      |      |       |           |                        |
| AC      |                 |      |      |       |           |                        |
| AD      |                 |      |      |       |           |                        |
| AE      |                 |      |      |       |           |                        |
| AF      |                 |      |      |       |           |                        |

**FOREIGN PATENT DOCUMENTS**

|       | Document Number   | Date   | Country | Class | Sub-class | Trans. |    |
|-------|-------------------|--------|---------|-------|-----------|--------|----|
|       |                   |        |         |       |           | Yes    | No |
| KL AG | 0 7 5 2 7 9 3 A 2 | 8/1/97 | EUROPE  | H04Q  | 7/32      |        |    |
| KL AH | 1 0 0 6 6 8 4 A 2 | 7/6/00 | EUROPE  | H04H  | 1/00      |        |    |
| AI    |                   |        |         |       |           |        |    |
| AJ    |                   |        |         |       |           |        |    |
| AK    |                   |        |         |       |           |        |    |

**OTHER (Including Author, Title, Date, Pertinent Pages, Etc.)**

|    |  |
|----|--|
| AL |  |
| AM |  |
| AN |  |

|                                                                                                                                                                                                                                             |                 |                 |                 |
|---------------------------------------------------------------------------------------------------------------------------------------------------------------------------------------------------------------------------------------------|-----------------|-----------------|-----------------|
| Examiner                                                                                                                                                                                                                                    | <i>Koren Le</i> | Date Considered | <i>12/23/04</i> |
| *EXAMINER: Initial if reference considered, whether or not citation is in conformance with MPEP 609; Draw line through citation if not in conformance and not considered. Include a copy of this form with next communication to applicant. |                 |                 |                 |





HO

#5  
2681  
23 28-32

|                                                                                                                                                                                                                                                                                                                   |                               |                         |
|-------------------------------------------------------------------------------------------------------------------------------------------------------------------------------------------------------------------------------------------------------------------------------------------------------------------|-------------------------------|-------------------------|
| <p align="center"><b>INFORMATION<br/>DISCLOSURE STATEMENT<br/>TRANSMITTAL</b></p> <p>To Commissioner For Patents<br/>Enclosed herewith is a Form PTO-1449, required copies of documents listed thereon, and a concise explanation of their relevance is described below or enclosed herewith per 37 CFR 1.97.</p> | <b>Application Number</b>     | 09/876,515              |
|                                                                                                                                                                                                                                                                                                                   | <b>Filing Date</b>            | JUNE 7, 2001            |
|                                                                                                                                                                                                                                                                                                                   | <b>First Named Inventor</b>   | ROBERT J. DAVIES ET AL. |
|                                                                                                                                                                                                                                                                                                                   | <b>Group Art Unit</b>         | 2681                    |
|                                                                                                                                                                                                                                                                                                                   | <b>Examiner Name</b>          |                         |
|                                                                                                                                                                                                                                                                                                                   | <b>Attorney Docket Number</b> | GB 000109               |

These documents may be relevant in that they have been:

considered in drafting the specification of the above-referenced application;

cited in the specification of the above-referenced application;

previously submitted or cited in U.S. patent application(s) \_\_\_\_\_ which are relied on for an earlier effective filing date under 35 U.S.C. 120 (no copy required); or

cited as an "X" or "Y" document in a foreign Patent Office search report on a foreign counterpart application, a copy of which report is also enclosed;

I hereby certify that these documents were first cited in any communication with a foreign Patent Office for a counterpart foreign application not more than three (3) months ago;

otherwise a concise explanation of the relevance of each document is append hereto.

I hereby certify that not one of these documents was cited in any communication with a foreign Patent Office nor was any known to any individual designated in §1.56(c) more than three (3) months ago.

**RECEIVED**  
**FEB 22 2002**  
Technology Center 2600

**SIGNATURE OF APPLICANT, ATTORNEY, OR AGENT REQUIRED**

|                          |                       |                                          |        |
|--------------------------|-----------------------|------------------------------------------|--------|
| <b>Name (Print Type)</b> | JACK D. SLOBOD        | <b>Registration No. (Attorney/Agent)</b> | 26,236 |
| <b>Signature</b>         | <i>Jack D. Slobod</i> | <b>Date</b>                              | 2/4/02 |

**CERTIFICATE OF MAILING OR TRANSMISSION**

I hereby certify that this is being deposited with the U.S. Postal Service with sufficient postage as first class mail in an envelope addressed to: Commissioner For Patents, Washington, DC 20231, or facsimile transmitted to the U.S. Patent and Trademark Office tel# \_\_\_\_\_ on the date below:

|                          |                        |
|--------------------------|------------------------|
| <b>Name (Print Type)</b> | Natale A. Manzo        |
| <b>Signature</b>         | <i>Natale A. Manzo</i> |
| <b>Date</b>              | 2/4/02                 |



|                                                                                       |                                   |                              |
|---------------------------------------------------------------------------------------|-----------------------------------|------------------------------|
| Form PTO-1449<br>DEPARTMENT OF<br>COMMERCE<br>(REV. 7-80) PATENT AND TRADEMARK OFFICE | Atty. Docket No.<br><br>GB 000109 | Serial No.<br><br>09/876,515 |
| <b>RECEIVED</b><br><b>FEB 22 2002</b><br>Technology Center 2600                       |                                   |                              |
| Applicant<br>ROBERT J. DAVIES ET AL.                                                  |                                   |                              |
| Filing Date<br>6/7/01                                                                 |                                   | Group<br>2681                |
| <b>INFORMATION DISCLOSURE CITATION</b><br>(Use several sheets if necessary)           |                                   |                              |

**U.S. PATENT DOCUMENTS**

| Ex. Int | Document Number | Date | Name | Class | Sub-class | Filing Date If Approp. |
|---------|-----------------|------|------|-------|-----------|------------------------|
| AA      |                 |      |      |       |           |                        |
| AB      |                 |      |      |       |           |                        |
| AC      |                 |      |      |       |           |                        |
| AD      |                 |      |      |       |           |                        |
| AE      |                 |      |      |       |           |                        |
| AF      |                 |      |      |       |           |                        |

**FOREIGN PATENT DOCUMENTS**

| Ex. Int | Document Number   | Date   | Country | Class | Sub-class | Trans. |    |
|---------|-------------------|--------|---------|-------|-----------|--------|----|
|         |                   |        |         |       |           | Yes    | No |
| AG      | 0 7 5 2 7 9 3 A 2 | 8/1/97 | EUROPE  | H04Q  | 7/32      |        |    |
| AH      | 1 0 0 6 6 8 4 A 2 | 7/6/00 | EUROPE  | H04H  | 1/00      |        |    |
| AI      |                   |        |         |       |           |        |    |
| AJ      |                   |        |         |       |           |        |    |
| AK      |                   |        |         |       |           |        |    |

**OTHER (Including Author, Title, Date, Pertinent Pages, Etc.)**

|    |  |
|----|--|
| AL |  |
| AM |  |
| AN |  |

Examiner \_\_\_\_\_ Date Considered \_\_\_\_\_

\*EXAMINER: Initial if reference considered, whether or not citation is in conformance with MPEP 609; Draw line through citation if not in conformance and not considered. Include a copy of this form with next communication to applicant.



PHGB  
000109 W<sup>o</sup>

MAT.  
DOSSIER



Europäisches Patentamt  
European Patent Office  
Office européen des brevets



(11) EP 0 752 793 A2

(12) EUROPEAN PATENT APPLICATION

(43) Date of publication:  
08.01.1997 Bulletin 1997/02

(51) Int. Cl.<sup>6</sup>: H04Q 7/32, H04Q 7/22

(21) Application number: 96304768.3

(22) Date of filing: 28.06.1996

(84) Designated Contracting States:  
DE FR GB SE

(74) Representative: Slingsby, Philip Roy et al  
NOKIA MOBILE PHONES,  
Patent Department,  
St. Georges Court,  
St. Georges Road,  
9 High Street  
Camberley, Surrey GU15 3QZ (GB)

(30) Priority: 07.07.1995 US 499165

(71) Applicant: NOKIA MOBILE PHONES LTD.  
24101 Salo (FI)

(72) Inventor: Alanärä, Seppo  
90800 Oulu (FI)

(54) Radiotelephone user interface for broadcast short message service

(57) This invention pertains to a method for operating a radiotelephone for receiving digitally encoded broadcast messages from a radio channel, and also to a radiotelephone that operates in accordance with the method. The method includes a first step of operating a user interface (19, 20, 22) for inputting information to a controller (20) of the radiotelephone, the information specifying at least one category of broadcast message to be received. In response to the inputted information,

a second step receives a broadcast message that belongs to the at least one category. A third step stores all or a portion of the received message in a memory (21) of the radiotelephone. A fourth step selectively displays (19) all or a portion of the stored message. In a presently preferred embodiment of this invention the message is received from a short message service broadcast channel.

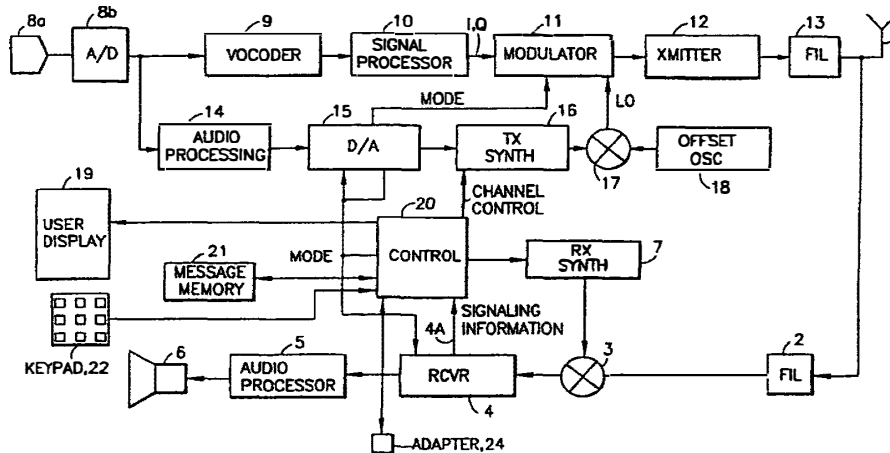

FIG. 1

EP 0 752 793 A2

## Description

This invention relates generally to radiotelephone receivers and, in particular, to radiotelephone that receives messages that are broadcast over a digital control channel (DCCH).

A Short Message Service Broadcast Channel (S-BCCH), in the IS-136 rev. 0 specification, is specified for use in sending short point-to-multipoint messages to mobile stations, such as radiotelephones. A maximum number of 15 slots per superframe may be assigned to the S-BCCH logical channel. The S-BCCH is considered as a continuous channel even if more than one slot is allocated to the S-BCCH. The IS-136 rev. 0 specification does not specify particulars of this mode of operation, except for the level 2 reservation of slots within a superframe.

One possible implementation for such a system is as follows. This implementation is similar to that originally set forth in the preliminary IS-136 rev. 0 specification.

The SMS frame can be defined as a sequence of 24 Superframes which are aligned with a Hyperframe (HF) counter. Thus, the number of slots assigned to the SMS frame are 0, 24, 48, 72, depending on how many slots per superframe are assigned to BCCH.

The Hyperframe (HF) counter and a Primary Superframe (SF) indicator can be provided in the BCCH. These two counters together ( $2 \cdot \text{HF Counter} + \text{Primary SF indicator}$ ) constitute a Superframe counter. A SMS frame is defined to be a single complete cycle (0 - 23) of the SF counter. The SMS frame is aligned to start at a HF counter value of 0, and also when the Primary Superframe indicator equals 0. The SF counter provides SMS frame synchronization information to the mobile station.

SMS subchannels are defined to allow different repetition cycles for different messages. Each subchannel has its own repetition cycle defined in terms of units of SMS frames. SMS frames are grouped into the SMS subchannels. Within each subchannel, a repetition cycle is defined (in units of SMS frames) with which the SMS broadcast message sequences contained in the SMS sub-channel are repeated. The SMS broadcast subchannel cycle may range from 1 to 64 SMS frames in length. Within each subchannel, the first S-BCCH slot within each SMS frame contains a header that describes the structure of the subchannel. Up to four subchannels may be defined. If more than one subchannel exists, the subchannels are time-multiplexed onto the S-BCCH channel on a SMS frame basis. If a SMS subchannel block is defined to consist of one SMS frame from each subchannel, placed in ascending order of subchannel number, then the multiplexed subchannels can be defined as the repetition of these subchannel blocks. The number of subchannels and the identity of the subchannel to which an SMS frame belongs are specified in the SMS frame header.

According to SMS header information found in the

first slot in any SMS frame, the set of messages in SMS(i) may span M(i) number of SMS frames before a cycle is completed. M(i) is the length of the sub-channel cycle. The SMS frame number within the subchannel cycle is referred to as the phase of the subchannel cycle.

A number of different BCCH message categories can be defined. These include Emergency Information messages, Time and Date messages, Overload Class messages, System Identity messages, and Broadcast messages. Each BCCH message typically includes a number of fields of information. These fields can include: a Protocol Discriminator field (2 bits), a Message Type field (6 bits), a SMS Message ID field (8 bits), and a Text Message Data field (8 to 2024 bits).

The Broadcast Message category field is coded to provide a number of different types of message category identifiers. These include, by example, emergency numbers and road-side information, toll gate information, airline departure/arrival information, weather-related information, news, and financial information.

As may be appreciated, it is important to provide a user of a radiotelephone an ability to specify what types of SMS Broadcast messages that the user is interested in receiving. It is also important to provide the user with other SMS Broadcast-related capabilities, such as an ability to selectively enable and disable the reception of these messages, an ability to generate with the radiotelephone different indications of message-related conditions, and an ability to control the storage and display of messages.

The foregoing problems may be overcome and by a method for operating a radiotelephone for receiving digitally encoded broadcast messages from a radio channel, and by a radiotelephone that operates in accordance with the method. The method includes a first step of operating a user interface for inputting information to a controller of the radiotelephone, the information specifying at least one category of broadcast message to be received. In response to the inputted information, a second step receives a broadcast message that belongs to the at least one category. A third step stores all or a portion of the received message in a memory of the radiotelephone. A fourth step selectively displays all or a portion of the stored message. In a presently preferred embodiment of this invention the message is received from a short message service broadcast channel.

Further in accordance with this invention the step of inputting includes a step of specifying whether or not to display a stored message, and the step of displaying displays all or a portion of the stored message only when the message is specified to be displayed.

Further in accordance with this invention the step of inputting includes a step of specifying whether or not to generate an audible tone upon a receipt by the radiotelephone of a new message of a specified at least one category of broadcast message, and a step of specifying whether or not to generate an audible tone upon the

storage by the radiotelephone of a received message of a specified at least one category of broadcast message.

Further in accordance with this invention the step of inputting includes a step of specifying a text string in conjunction with a specified at least one category of broadcast message, and the radiotelephone notifies the user of a receipt of a broadcast message that is within a specified category and that includes the specified text string.

Further in accordance with this invention the controller is responsive to input information for updating a stored message within a particular category only upon a receipt of a new message within the same category.

The above set forth and other features of the invention are made more apparent in the ensuing Detailed Description of the Invention when read in conjunction with the attached Drawings, wherein:

Figure 1 is block diagram of a radiotelephone that is constructed and operated in accordance with this invention; and

Figure 2 is a logical flow chart of a method in accordance with this invention.

This invention is described in the context of a radiotelephone or mobile terminal that operates in accordance with an analog (FM) mode and a Time Division Multiple Access (TDMA) digital mode of operation (dual-mode), as specified in the dual-mode Interim Standard IS-136 and its future revisions. However, it should be realized that the teaching of this invention may be employed in an all-digital radiotelephone, and may also be employed in a radiotelephone that operates with spread spectrum (SS) and Code Division Multiple Access (CDMA) techniques, such as that described in the IS-95 Standard.

Figure 1 illustrates a block diagram of a dual-mode mobile terminal (IS-136 compatible) that is constructed in accordance with the invention. An antenna (1) receives a signal from a base station (not shown). The received signal has a center frequency of 885 MHz. The received signal is fed through a bandpass filter (2) to a mixer (3). The receiver's first local oscillator signal is generated with an RX-synthesizer (7) which is tuned above the received frequency by an amount equal to, by example, 45 MHz. The receiver block (4) demodulates and processes the received signal and provides the processed received signal, for voice information, to an audio processing block (5). The required audio processing is accomplished digitally (using a digital to analog converter) or in an analog manner, depending on the operating mode. The output of the audio processor 5 drives a loudspeaker (6) whereby a user is enabled to hear the speech of another party during a conversation.

For the case where the Short Message Service Broadcast Channel (S-BCCH) is being received, the S-BCCH information is extracted from the received signal by the receiver block (4), and the extracted digital infor-

mation is input to a controller (20) on a path (4A). In this regard the controller (20) manages various counters to maintain synchronization with the Hyperframe and Superframe counters and indicators of the B-SMS, as described previously.

Having described the receiving side, a description is now given of the transmitting side of the dual-mode mobile terminal. A voice signal is fed from a microphone (8) to an analog to digital (A/D) converter (8a) and thence to a vocoder (9), in the digital mode, or to an audio processing block (14) for audio shaping and compressing in the analog mode. After audio processing, the analog signal is fed to a digital to analog converter (D/A) (15) for conversion back to an analog signal. The operation of the D/A converter (15) is controlled by the controller (20), preferably implemented as one or more microprocessors that operate under a control program.

In a presently preferred embodiment of this invention there are two microprocessors. One is a high speed digital signal processor (DSP) that manages the Layer 1 and Layer 2 real-time interface to the radio channel. The second microprocessor (MCU) is a slower speed device that is responsible for managing the user interface, via a keypad (22) and a user display (19), and also the Layer 3 and above real-time interface to the radio channel. The Layers 1, 2 and 3 are illustrated in, by example, Figures 2-1 and 2-2 of the IS-136 rev. 0 specification. For simplicity, the DSP and the MCU are collectively illustrated in Figure 1 as the controller (20).

In the digital mode of operation the controller (20) causes the output signal from the D/A converter (15) to assume a predetermined level, or to be switched out and replaced by a predetermined potential. In the analog mode of operation the controller (20) causes the output of the D/A converter (15) to be coupled to the input of a programmable oscillator of a transmitter synthesizer (Tx SYNTH) (16). That is, the output frequency of the TX-synthesizer (16) is varied in accordance with the input audio signal, thereby achieving a frequency modulation of the TX-synthesizer (16) output frequency. The controller (20) also operates to frequency modulate the TX-synthesizer (16) output frequency in accordance with signalling information to be transmitted. The TX-synthesizer (16) output frequency is also controlled to achieve channel switching.

The output frequency of the TX-synthesizer (16) is applied to a mixer (17) wherein it is mixed with the output of an offset oscillator (18) to generate a transmitter injection signal (LO) at the final transmitter frequency (840 Mhz). The offset oscillator (18) is typically set to 90 Mhz. A further oscillator (not shown) may provide a synchronizing frequency to the RX SYNTH (7), the TX SYNTH (16), and the offset oscillator (18).

It should be realized that the exact frequencies of the transmitter and receiver synthesizers (7) and (16) and the offset oscillator (18) are adjustable according to application specific requirements. The values given above are suitable for use in the dual-mode Interim Standard specified in IS-136, and are not intended to be

read in a limiting sense upon the practice of the invention.

As was indicated previously, the mobile terminal also includes the user display (19) and the keypad (22), each of which is coupled to the controller (20). Although the user display (19) and keypad (22) may be used in a conventional manner to place a call, their use is extended by the teaching of this invention to provide a novel interface for short message service (SMS) functions of a type referred to in the Background portion of the specification. A message memory (21) is also provided. The message memory (21) may be a part of the random access memory of the controller (20), and/or may be implemented with a non-volatile memory (e.g., EEPROM).

Referring to Figure 2, a user of the mobile terminal of Figure 1 employs the keypad (22) to enter information into the controller (20). This preferably occurs during a time that the controller (20) displays a B-SMS menu on the display (19).

At block A the user interface is initialized and the B-SMS menu is displayed. At block B a first menu function can be invoked by the user for enabling/disabling B-SMS reception. If this menu function is invoked control passes to block C where the controller (20) sets a flag to either enable or disable the reception of the B-SMS information. It may be desirable to disable the reception of the B-SMS information to maximize the battery life of the mobile terminal. Control then passes to the block labeled DONE.

Alternately, an enable/disable B-SMS display menu function can be enabled at block D. If this function is selected control passes to block E where the controller (20) sets a flag to selectively enable or disable the display of B-SMS message data on the user display (19).

Alternately, at block F an enable/disable of a first B-SMS audible tone is selected. If this function is enabled the controller (20) at block G sets a flag to enable or disable the generation of an audible tone on the occurrence of a new B-SMS message. The audible tone can be generated by the controller (20) by programming a digital to analog converter that forms a portion of the audio processor block (5). The audible tone is generated when, after all B-SMS channels have been scanned by the controller (20), a new message (with a new message ID) is located. The new message is then displayed if the display has not been disabled at block E. In this regard the controller (20) may store the header portion of all received messages. The stored header contains the start strings from all messages currently being transmitted on the B-SMS channels. The controller (20) may then monitor the B-SMS continuously and update the stored header information as appropriate. Deleted messages can be removed from the header list while new messages are added to the header list.

Alternately, at block H a scan for selected messages function can be enabled. If this function is enabled control passes to block I where the controller (20) sets a flag to enable or disable the scanning of the B-

SMS for selected message IDs. During the operation of this function, all message headers belonging to a user-selected category list (e.g., news information, financial information, etc.) are indicated to the controller (20). After selection of a specific message ID the controller (20) will receive and store the complete message and, optionally, also some predetermined number (e.g., 5) of subsequent messages. After the messages have been stored in the message memory 21, the user is enabled to read the stored messages using a scroll key function found on the keypad (22). This scroll key function forms a portion of the conventional user interface. Messages remain stored until the user chooses another message ID to be displayed.

Alternately, at block G an enable/disable second B-SMS audible tone can be enabled. If this function is enabled control passes to block K where the controller (20) sets a flag to enable or disable the generation of an audible tone to indicate when the controller (20) has received and stored a user selected message from the B-SMS channel. If the second audible tone is disabled the controller (20) instead displays the beginning of the received message without audibly notifying the user.

Alternately, at block L the user is enabled to select B-SMS scan categories for the controller (20). If enabled, the controller (20) displays a list of B-SMS category types and the user employs the keypad (22) to select one or more category types. In response, the controller (20) sets flags to enable only the selected B-SMS category types for reception. All messages that belong to a selected category will be either displayed or stored in the message memory (21). The second audible tone, if enabled at block K, is generated to alert the user that the controller (20) has received a message that matches one of the selected categories, after which the received message is displayed. In addition to the category selection menu a menu may also be displayed enabling keyword selection for messages that fall under the selected category. By example, if the financial message category is selected, the user may enter a keyword, such as the name of a particular company or stock. If the controller (20) receives a financial category message, and if the indicated keyword occurs within the message, then the message is displayed and the second audible tone generated, if enabled at block K.

If the broadcast B-SMS has been enabled on any combination of, or on all, SMS categories and channels, the controller (20) will receive all messages for this combination. These messages are then either displayed, stored, or discarded. After all messages on user selected channels and categories have been received once, the controller (20) will thereafter only respond to updated messages. In this mode the controller (20) displays as much of the new message as it is able to display to enable the user time to read the message. In this reception mode the display (19) is scrolled to show all messages being received. If more messages are received than can be displayed with enough time for the user to read the message (e.g., 2 seconds), the control-

ler (20) may truncate the messages before display. In this regard all messages can be truncated by some predetermined amount. Alternatively, selected message types can be prioritized by the user at block M, such as by the order of selection, and higher priority messages truncated less than lower priority messages.

If the mobile terminal is connected via an adapter (24) (Figure 1) to an external data processor or other device capable of message storage, all received messages can be output through the adapter (24) for storage and subsequent later display. In this regard it is noted that the above-described user interface functions illustrated in Figure 2 can also be accomplished through the adapter (24), wherein the display of an attached data processor is used in place of the display (19), and wherein the keyboard or pointing device of the attached data processor is used in place of the keypad (22). A command or a keystroke(s) sequence, if received by the controller (20) through the adapter (24), can be employed to cause the controller (20) to direct data to the adapter for external display, and to respond to information entered through the adapter (24).

It is noted that the B-SMS functions in a manner analogous to a videotext service, and periodically transmits all messages selected for broadcast. All broadcast messages are specified in a header type of message which gives the message ID and category. All changes to the contents of a broadcast cycle on any of the four B-SMS channels can thus be given in the header message information. In addition, all changes can be indicated by a change flag on a paging channel which the controller (20) constantly monitors.

In order to conserve battery power it is preferred that the mobile terminal read only once the unchanged content of the B-SMS, and thereafter only by request of the user. Thus, if the B-SMS has been enabled for certain categories of messages, the mobile terminal will only read the selected category messages once and thereafter only in the case where new or updated message is received in the user-selected category or categories.

Although not shown in Figure 2, a further menu function can be employed to control the scrolling of messages on the display 19.

While the invention has been particularly shown and described with respect to a preferred embodiment thereof, it will be understood by those skilled in the art that changes in form and details may be made therein without departing from the scope and spirit of the invention.

#### Claims

1. A method for operating a radiotelephone for receiving digitally encoded broadcast messages from a radio channel, comprising the steps of:

operating a user interface for inputting information to a controller of the radiotelephone, the

information specifying at least one category of broadcast message to be received;

in response to the inputted information, receiving a broadcast message that belongs to the at least one category;

storing at least a portion of the received message in a memory of the radiotelephone; and

displaying all or a portion of the stored message.

2. A method as set forth in claim 1 wherein the step of inputting includes a step of specifying whether to display a stored message, and wherein the step of displaying displays all or a portion of the stored message only when the message is specified to be displayed.
3. A method as set forth in claim 1 wherein the step of inputting includes a step of specifying whether to generate an audible tone upon a receipt by the radiotelephone of a new message of a specified at least one category of broadcast message.
4. A method as set forth in claim 1 wherein the step of inputting includes a step of specifying whether to generate an audible tone upon the storage by the radiotelephone of a received message of a specified at least one category of broadcast message.
5. A method as set forth in claim 1 wherein the step of inputting includes a step of specifying a text string in conjunction with a specified at least one category of broadcast message, and wherein the radiotelephone notifies the user of a receipt of a broadcast message that is within a specified category and that includes the specified text string.
6. A method as set forth in claim 1 wherein the controller is responsive to input information for updating a stored message within a particular category only upon a receipt of a new message within the same category.
7. A method as set forth in claim 1 wherein the message is received from a short message service broadcast channel.
8. A radiotelephone adapted for receiving digital broadcast messages from a radio channel, comprising:

an antenna;

a receiver having an input coupled to said antenna;

a controller having an input coupled to an output of said receiver, said controller receiving digital broadcast messages from said receiver;

a memory that is bidirectionally coupled to said controller for storing at least portions of received broadcast messages; and

a user interface including a display and a keypad for inputting information to said controller, the information specifying at least one category of broadcast message to be received;

wherein said controller is responsive to the inputted information for identifying a received broadcast message that belongs to the at least one category, for storing at least a portion of the received message in said memory, and for selectively displaying all or a portion of the stored message.

9. A radiotelephone as set forth in claim 8 wherein said controller is responsive to input information that specifies whether or not to display a stored message for displaying all or a portion of the stored message only when the message is specified to be displayed.

10. A radiotelephone as set forth in claim 8 wherein said radiotelephone further comprises means for generating an audible tone, and wherein said controller is responsive to input information that specifies whether or not to generate an audible tone upon a receipt of a new message of a specified at least one category of broadcast message, said controller being further responsive to input information for updating a stored message within a specified at least one category only upon a receipt of a new message within the same category.

11. A radiotelephone as set forth in claim 8 wherein said radiotelephone further comprises means for generating an audible tone, and wherein said controller is responsive to input information that specifies whether or not to generate an audible tone upon the storage by said controller of a received message of a specified at least one category of broadcast message.

12. A radiotelephone as set forth in claim 8 wherein said controller is responsive to input information that specifies a text string in conjunction with a specified at least one category of broadcast message for notifying the user of a receipt of a broadcast message that is within a specified category and that includes the specified text string.

13. A radiotelephone as set forth in claim 8 wherein the message is received from a short message service

broadcast channel.

14. A radiotelephone as set forth in claim 8 wherein the display and keypad form a portion of said radiotelephone.

15. A radiotelephone as set forth in claim 8 wherein the display and keypad are external to said radiotelephone.

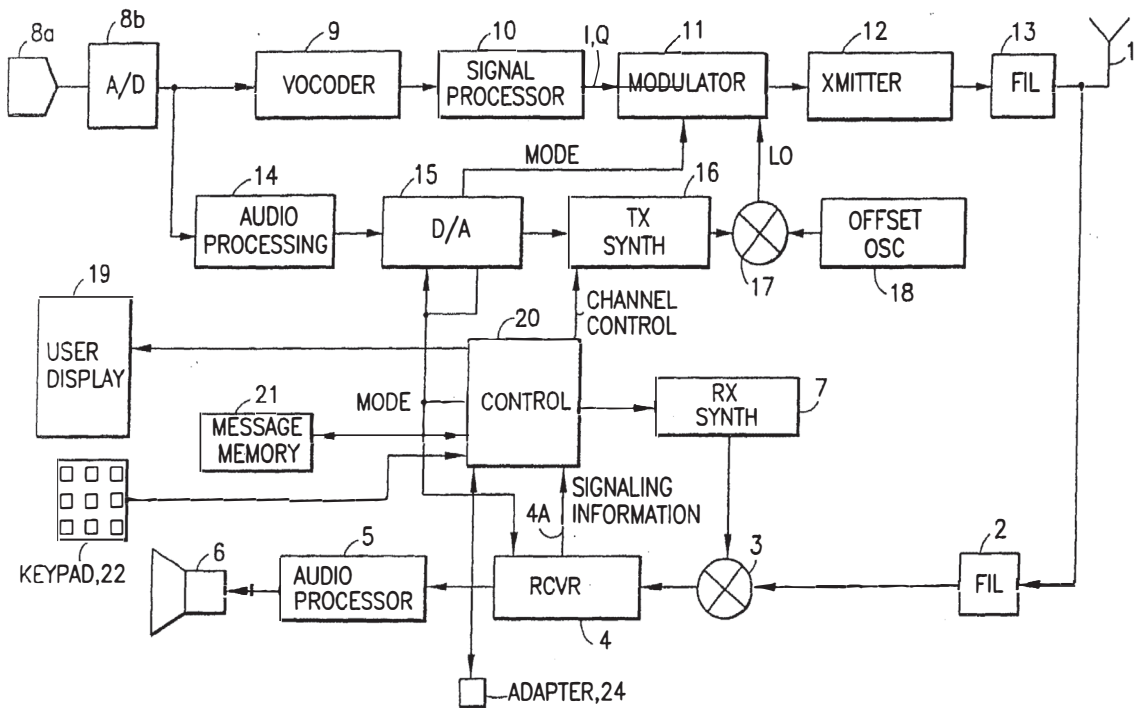

FIG. 1

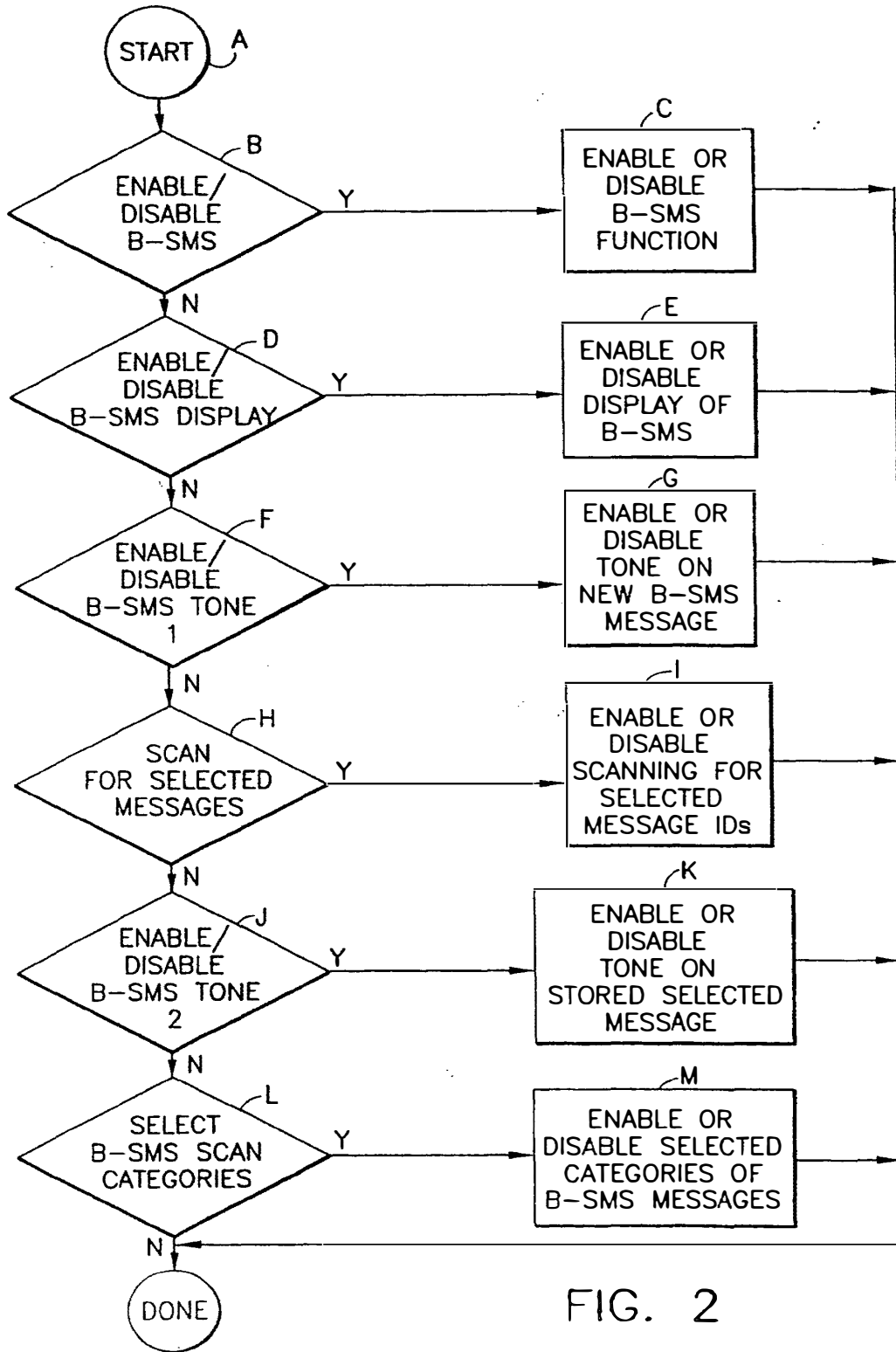

FIG. 2





(12) **EUROPEAN PATENT APPLICATION**

(88) Date of publication A3:  
**12.05.1999 Bulletin 1999/19**

(51) Int. Cl.<sup>6</sup>: **H04Q 7/32, H04Q 7/22**

(43) Date of publication A2:  
**08.01.1997 Bulletin 1997/02**

(21) Application number: **96304768.3**

(22) Date of filing: **28.06.1996**

(84) Designated Contracting States:  
**DE FR GB SE**

(30) Priority: **07.07.1995 US 499165**

(71) Applicant:  
**NOKIA MOBILE PHONES LTD.**  
**24101 Salo (FI)**

(72) Inventor: **Alanärä, Seppo**  
**90800 Oulu (FI)**

(74) Representative:  
**Slingsby, Philip Roy et al**  
**NOKIA MOBILE PHONES,**  
**Patent Department,**  
**St. Georges Court,**  
**St. Georges Road,**  
**9 High Street**  
**Camberley, Surrey GU15 3QZ (GB)**

(54) **Radiotelephone user interface for broadcast short message service**

(57) This invention pertains to a method for operating a radiotelephone for receiving digitally encoded broadcast messages from a radio channel, and also to a radiotelephone that operates in accordance with the method. The method includes a first step of operating a user interface (19, 20, 22) for inputting information to a controller (20) of the radiotelephone, the information specifying at least one category of broadcast message to be received. In response to the inputted information,

a second step receives a broadcast message that belongs to the at least one category. A third step stores all or a portion of the received message in a memory (21) of the radiotelephone. A fourth step selectively displays (19) all or a portion of the stored message. In a presently preferred embodiment of this invention the message is received from a short message service broadcast channel.

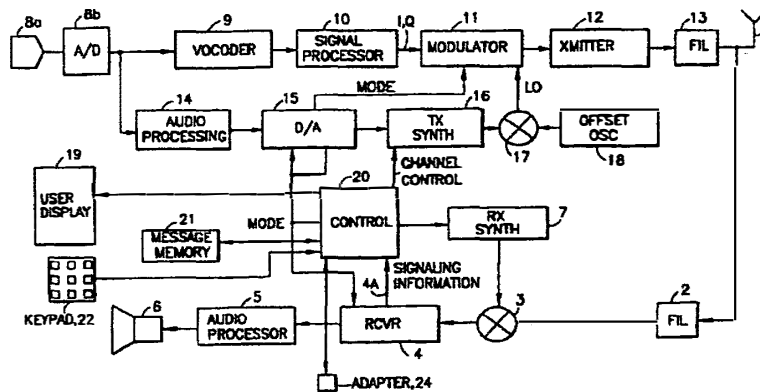

FIG. 1

EP 0 752 793 A3



European Patent Office

EUROPEAN SEARCH REPORT

Application Number  
EP 96 30 4768

| DOCUMENTS CONSIDERED TO BE RELEVANT                                                                                                                                                                                     |                                                                                                            |                                                                                                                                                                                                                                                                              |                                              |
|-------------------------------------------------------------------------------------------------------------------------------------------------------------------------------------------------------------------------|------------------------------------------------------------------------------------------------------------|------------------------------------------------------------------------------------------------------------------------------------------------------------------------------------------------------------------------------------------------------------------------------|----------------------------------------------|
| Category                                                                                                                                                                                                                | Citation of document with indication, where appropriate, of relevant passages                              | Relevant to claim                                                                                                                                                                                                                                                            | CLASSIFICATION OF THE APPLICATION (Int.Cl.6) |
| X                                                                                                                                                                                                                       | EP 0 583 064 A (NIPPON ELECTRIC CO)<br>16 February 1994                                                    | 1-3, 5, 6,<br>8-10, 12,<br>14                                                                                                                                                                                                                                                | H04Q7/32<br>H04Q7/22                         |
| Y                                                                                                                                                                                                                       | * column 4, line 29 - column 9, line 25 *<br>---                                                           | 7, 13                                                                                                                                                                                                                                                                        |                                              |
| Y                                                                                                                                                                                                                       | EP 0 652 680 A (ERICSSON TELEFON AB L M)<br>10 May 1995<br>* page 20, line 1 - page 21, line 33 *<br>----- | 7, 13                                                                                                                                                                                                                                                                        |                                              |
|                                                                                                                                                                                                                         |                                                                                                            |                                                                                                                                                                                                                                                                              | TECHNICAL FIELDS SEARCHED (Int.Cl.6)         |
|                                                                                                                                                                                                                         |                                                                                                            |                                                                                                                                                                                                                                                                              | H04Q<br>G08B                                 |
| The present search report has been drawn up for all claims                                                                                                                                                              |                                                                                                            |                                                                                                                                                                                                                                                                              |                                              |
| Place of search<br><b>THE HAGUE</b>                                                                                                                                                                                     |                                                                                                            | Date of completion of the search<br><b>23 March 1999</b>                                                                                                                                                                                                                     | Examiner<br><b>Kokkoraki, A</b>              |
| CATEGORY OF CITED DOCUMENTS                                                                                                                                                                                             |                                                                                                            | T : theory or principle underlying the invention<br>E : earlier patent document, but published on, or after the filing date<br>D : document cited in the application<br>L : document cited for other reasons<br>& : member of the same patent family, corresponding document |                                              |
| X : particularly relevant if taken alone<br>Y : particularly relevant if combined with another document of the same category<br>A : technological background<br>O : non-written disclosure<br>P : intermediate document |                                                                                                            |                                                                                                                                                                                                                                                                              |                                              |

EPO FORM 1503 03 82 (P04 Cat)

ANNEX TO THE EUROPEAN SEARCH REPORT  
ON EUROPEAN PATENT APPLICATION NO.

EP 96 30 4768

This annex lists the patent family members relating to the patent documents cited in the above-mentioned European search report. The members are as contained in the European Patent Office EDP file on  
The European Patent Office is in no way liable for these particulars which are merely given for the purpose of information.

23-03-1999

| Patent document cited in search report | Publication date | Patent family member(s) | Publication date |
|----------------------------------------|------------------|-------------------------|------------------|
| EP 0583064 A                           | 16-02-1994       | JP 6029907 A            | 04-02-1994       |
|                                        |                  | JP 6140982 A            | 20-05-1994       |
|                                        |                  | CN 1085028 A            | 06-04-1994       |
|                                        |                  | US 5764157 A            | 09-06-1998       |
| EP 0652680 A                           | 10-05-1995       | US 5603081 A            | 11-02-1997       |
|                                        |                  | AU 681730 B             | 04-09-1997       |
|                                        |                  | AU 1048095 A            | 23-05-1995       |
|                                        |                  | AU 680071 B             | 17-07-1997       |
|                                        |                  | AU 1048395 A            | 23-05-1995       |
|                                        |                  | AU 691850 B             | 28-05-1998       |
|                                        |                  | AU 1087495 A            | 23-05-1995       |
|                                        |                  | AU 685885 B             | 29-01-1998       |
|                                        |                  | AU 1087695 A            | 23-05-1995       |
|                                        |                  | AU 695892 B             | 27-08-1998       |
|                                        |                  | AU 2079997 A            | 24-07-1997       |
|                                        |                  | AU 2358897 A            | 14-08-1997       |
|                                        |                  | AU 690924 B             | 07-05-1998       |
|                                        |                  | AU 7757094 A            | 18-05-1995       |
|                                        |                  | AU 7865898 A            | 15-10-1998       |
|                                        |                  | AU 7865998 A            | 01-10-1998       |
|                                        |                  | AU 697210 B             | 01-10-1998       |
|                                        |                  | AU 8131394 A            | 23-05-1995       |
|                                        |                  | AU 681721 B             | 04-09-1997       |
|                                        |                  | AU 8131494 A            | 23-05-1995       |
|                                        |                  | BR 9404316 A            | 04-07-1995       |
|                                        |                  | BR 9405702 A            | 28-11-1995       |
|                                        |                  | BR 9405703 A            | 28-11-1995       |
|                                        |                  | BR 9405704 A            | 28-11-1995       |
|                                        |                  | BR 9405705 A            | 28-11-1995       |
|                                        |                  | BR 9405743 A            | 05-12-1995       |
|                                        |                  | BR 9405927 A            | 05-12-1995       |
|                                        |                  | CA 2134695 A            | 02-05-1995       |
|                                        |                  | CA 2152942 A            | 11-05-1995       |
|                                        |                  | CA 2152943 A            | 11-05-1995       |
|                                        |                  | CA 2152944 A            | 11-05-1995       |
|                                        |                  | CA 2152945 A            | 11-05-1995       |
|                                        |                  | CA 2152946 A            | 11-05-1995       |
| CA 2152947 A                           | 11-05-1995       |                         |                  |
| CN 1112345 A                           | 22-11-1995       |                         |                  |
| CN 1117329 A                           | 21-02-1996       |                         |                  |
| CN 1116888 A                           | 14-02-1996       |                         |                  |
| CN 1117330 A                           | 21-02-1996       |                         |                  |
| CN 1117331 A                           | 21-02-1996       |                         |                  |
| CN 1124074 A                           | 05-06-1996       |                         |                  |
| CN 1117332 A                           | 21-02-1996       |                         |                  |

EPO FORM P/0489

For more details about this annex : see Official Journal of the European Patent Office, No. 12/82

**ANNEX TO THE EUROPEAN SEARCH REPORT  
ON EUROPEAN PATENT APPLICATION NO.**

EP 96 30 4768

This annex lists the patent family members relating to the patent documents cited in the above-mentioned European search report. The members are as contained in the European Patent Office EDP file on The European Patent Office is in no way liable for these particulars which are merely given for the purpose of information.

23-03-1999

| Patent document cited in search report | Publication date | Patent family member(s) | Publication date |
|----------------------------------------|------------------|-------------------------|------------------|
| EP 0652680 A                           |                  | EP 0682829 A            | 22-11-1995       |
|                                        |                  | EP 0679304 A            | 02-11-1995       |
|                                        |                  | EP 0677222 A            | 18-10-1995       |
|                                        |                  | EP 0681766 A            | 15-11-1995       |
|                                        |                  | EP 0677223 A            | 18-10-1995       |
|                                        |                  | EP 0677224 A            | 18-10-1995       |
|                                        |                  | FI 953262 A             | 30-08-1995       |
|                                        |                  | FI 953263 A             | 30-06-1995       |
|                                        |                  | FI 953264 A             | 30-06-1995       |

EPO FORM P0459

For more details about this annex : see Official Journal of the European Patent Office, No. 12/82



Europäisches Patentamt  
European Patent Office  
Office européen des brevets



(11) EP 1 006 684 A2

(12) **EUROPÄISCHE PATENTANMELDUNG**

(43) Veröffentlichungstag:  
07.06.2000 Patentblatt 2000/23

(51) Int. Cl.<sup>7</sup>: H04H 1/00, H04Q 7/22,  
G08G 1/09

(21) Anmeldenummer: 99250413.4

(22) Anmeldetag: 23.11.1999

(84) Benannte Vertragsstaaten:  
AT BE CH CY DE DK ES FI FR GB GR IE IT LI LU  
MC NL PT SE  
Benannte Erstreckungsstaaten:  
AL LT LV MK RO SI

(72) Erfinder:  
• Möhlenkamp, Klaus, Dipl.-Ing.  
40545 Düsseldorf (DE)  
• Wichura, Torsten, Dipl.-Ing.  
40547 Düsseldorf (DE)

(30) Priorität: 04.12.1998 DE 19857782

(74) Vertreter:  
Meissner, Peter E., Dipl.-Ing. et al  
Meissner & Meissner,  
Patentanwaltsbüro,  
Hohenzollerndamm 89  
14199 Berlin (DE)

(71) Anmelder:  
MANNESMANN Aktiengesellschaft  
40213 Düsseldorf (DE)

(54) **Verfahren zum Übertragen von Tabelleninformationen von einer Zentrale an ein Endgerät über einen Übertragungskanal und Zentrale zum Durchführen des Verfahrens**

(57) Bei der Übertragung von Informationen, insbesondere Verkehrsinformationen von einer Zentrale an ein Endgerät wird der Umfang von im Endgerät zu speichernden Tabelleninformationen zur Dekodierung von codiert über einen Übertragungskanal übertragenen Informationen optimiert durch eine Zentrale und ein Verfahren zum Übertragen von Tabelleninformationen (10, 10a, 11) von einer Zentrale (7) an ein Endgerät (6) über einen Übertragungskanal (12), über welchen Übertragungskanal (12) auch Nutzinformationen (8, 9) codiert von der Zentrale (7) ("A", "E") an

das Endgerät (6) übertragen werden, wobei die Tabelleninformationen (10,11) im Endgerät (6) verwendbar sind zur Dekodierung (17) der zentralseitig mit Tabelleninformationen (10,11) codierten und derart codiert ("A", "E") an das Endgerät (6) übertragenen (12) Nutzinformationen (9a, 16; 8, 9), wobei zur Übertragung (12) von Tabelleninformationen (10,11) von der Zentrale (7) an das Endgerät (6) über den Übertragungskanal (12) mit Nutzinformationen (8,9) unbesetzte Lücken (10) verwendet werden.

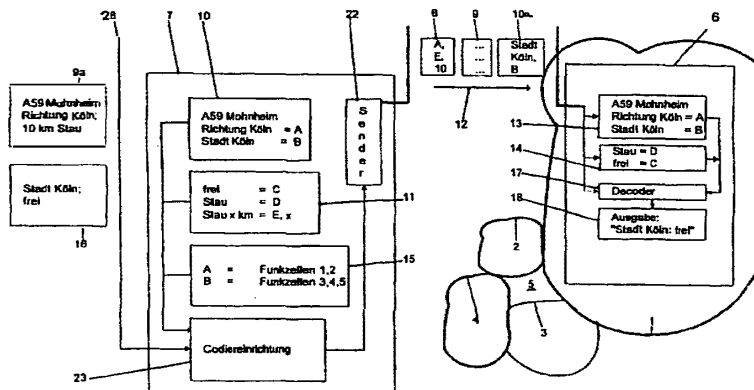

Fig.1

EP 1 006 684 A2

## Beschreibung

[0001] Die Erfindung betrifft ein Verfahren zum Übertragen von Tabelleninformationen von einer Zentrale an ein Endgerät über einen Übertragungskanal und eine Zentrale zum Durchführen des Verfahrens.

[0002] Zur Realisierung eines Informationssystems, insbesondere Verkehrsinformationssysteme, mit einer Informationen (insbesondere Verkehrsinformationen) über einen Übertragungskanal an ein Endgerät aussendenden Zentrale (insbesondere Verkehrsinformationszentrale) soll in der Zentrale eine Kodiertabelle mit Tabelleninformationen zum redundanzoptimierten Kodieren zu übertragender Nutzinformationen und im Endgerät eine Dekodiertabelle mit Tabelleninformationen zum Dekodieren der kodiert empfangenen Nutzinformationen vorgesehen werden.

[0003] Dem Fachmann bekannt ist die Übermittlung von Verkehrsinformationen über RDS/TMC, in welchem System im Endgerät Dekodiertabellen mit Meldungstexten und zugeordneten Ereignis-Codes für Ereignisse (wie beispielsweise Stau) sowie Dekodiertabellen mit Ortsinformationen (insbesondere Straßensegmente) und zugeordneten Orts-Codes verwendet werden.

[0004] Aufgabe der vorliegenden Erfindung ist die Schaffung eines Verfahrens bzw. einer Vorrichtung zum endgeräteseitigen Einbringen von Tabelleninformationen, insbesondere Verkehrsinformationen, welches bzw. welche den Umfang der im Endgerät zu speichernden Tabelleninformationen bei guter Aktualisierbarkeit der Tabelleninformationen minimiert. Die Aufgabe wird durch das Verfahren in dem unabhängigen Anspruch 1 und durch die Anordnung in dem unabhängigen Anspruch 16 gelöst.

[0005] Die Erfindung erlaubt die Ausbildung von Endgeräten mit relativ geringem Speicherumfang, da die für ein Endgerät relevanten Tabelleninformationen über den Übertragungskanal in Lücken (= sich ergebende oder reservierte freie Kapazitäten) zwischen Nutzinformationen übertragen werden. Das Endgerät ist an beliebigen Orten einsetzbar, da jeweils die erforderlichen Tabelleninformationen für die vor Ort relevanten Verkehrsinformationen eingebracht werden können. Überdies können die Tabelleninformationen im Endgerät auch einfach und schnell laufend aktualisiert werden. Das Verfahren bzw. die Zentrale arbeitet dabei ohne einen Rückkanal zur Anforderung von für das Endgerät relevanten Informationen, so daß das Verfahren alleine über Broadcast-Medien (= an mehr als einen Empfänger sendende Medien) effizient realisierbar ist.

[0006] Der Übertragungskanal kann insbesondere ein Mobilfunkkanal sein. Die Informationen können dabei insbesondere alphanumerisch über einen Kurznachrichtenkanal übertragen werden. Besonders geeignet ist ein Mobilfunk-Broadcast-Kanal, wie beispielsweise der GSM-SMS-CB-Kanal.

[0007] Die mit Nutzinformationen un belegten Lücken bei der Übertragung über den Übertragungskanal

können Zeit- und/oder Frequenz- und/oder Code-Lücken in Abhängigkeit vom verwendeten Übertragungskanal sein.

[0008] Die Lücken können zyklische, vorgegebene Lücken sein. Dies können beispielsweise zyklisch gesendete Kurznachrichten-Seiten oder Teile von Kurznachrichten-Seiten sein.

[0009] Nach einer anderen Ausgestaltung der Erfindung sind die Lücken variable Lücken, die sich jeweils im Einzelfall ergeben, wenn keine Nutzinformationen zu übertragen sind.

[0010] Im Falle zyklisch vorhandener variabler Lücken können diese beispielsweise jeweils nach einer vorgegebenen Anzahl zu sendender Pakete von Nutzinformationen auftreten, beispielsweise in jeder n-ten (z.B. dritten) Cellbroadcast-Seite (z.B. GSM-CB-SMS-Seite). Auch ist beispielsweise eine zyklische Übertragung in Zeitintervallen von z.B. ein bis zehn, insbesondere drei Minuten möglich.

Die Erfindung bezieht sich insbesondere auf Nutzinformationen in Form von Verkehrsinformationen (wie Stau-meldungen, Reisezeitenmeldungen, Durchschnittsgeschwindigkeiten-Meldungen), welche von einer Zentrale in Form einer Verkehrsinformationszentrale ausgesendet werden.

[0011] Die übertragenen Tabelleninformationen können (beispielsweise bei Verkehrsinformationen) insbesondere Ortsinformationen enthalten, wobei beispielsweise jeweils mindestens einem Orts-Code (der übertragen wird) jeweils mindestens ein Ort (z.B. der im Endgerät auszugebende Name des Ortes) zugeordnet sein kann. Alternativ oder zusätzlich können die übertragenen Tabelleninformationen auch Ereignis-Informationen enthalten; im Falle von Nutzinformationen in Form von Verkehrsinformationen können die Ereignisinformationen in den Tabelleninformationen beispielsweise Angaben über Staus, mittlere Reisezeiten, mittlere Geschwindigkeiten, Geisterfahrer etc. sein. Zur Übertragung einer auf Ereignisse bezogenen Tabelleninformation wird jeweils für eine Art von Ereignissen der Ereigniscode und die zugeordnete (insbesondere die am Endgerät auszugebende) Ereignisinformation übertragen (beispielsweise "D, Stau"). Zur Übertragung einer sich auf ein Ereignis beziehenden Nutzinformation kann auch z.B. nur der Ereignis-Code übertragen werden (hier D), worauf das Endgerät aus seinen Ereignis-Tabelleninformationen zugeordnete Ereignisinformationen, insbesondere auszugebende Texte ermitteln kann. Sowohl Tabelleninformationen als auch Nutzinformationen können also auf Orte und/oder Ereignisse bezogene Informationen beinhalten.

[0012] Hinsichtlich der Vorrichtung ist das Verfahren in einer Zentrale, insbesondere Verkehrsinformationszentrale, ausbildbar mit einer Sendeeinrichtung zum Senden von Nutzinformationen und Tabelleninformationen über einen Übertragungskanal, mit einer Kodiereinrichtung, mit einem Nutzinformationsspeicher und mit einem Code-Informationsspeicher versehen, wobei die

Sendeeinrichtung so ausgebildet ist, daß Tabelleninformationen von der Zentrale an das Endgerät über den Übertragungskanal in mit Nutzinformationen unbesetzten Lücken gesendet werden.

[0013] Die Einbringung der Tabelleninformationen in mit Nutzinformationen unbesetzten Lücken kann in Abhängigkeit vom Übertragungskanal in zeitlichen Lücken, Code-Lücken oder andere Lücken erfolgen durch geeignete Multiplexer für Nutzinformationen und Tabelleninformationen.

[0014] Tabelleninformationen können auch nur die innerhalb eines örtlichen Bereichs, beispielsweise eines Bereichs um eine Mobilfunkzelle, über die von der Zentrale übertragen wird, relevanten Tabelleninformationen sein.

[0015] Weitere Merkmale und Vorteile der Erfindung ergeben sich aus der nachfolgenden Beschreibung eines Ausführungsbeispiels anhand der Zeichnung. Dabei zeigt

Fig. 1 als Blockschaltbild die Übertragung von Tabelleninformationen von einer Zentrale an ein Endgerät und

Fig. 2 ein Beispiel einer Einfügung von Tabelleninformationen in eine Lücke zwischen zu übertragenden Nutzinformationen.

[0016] Figur 1 zeigt auszugsweise fünf Funkzellen 1 bis 5 eines Mobilfunknetzes. In der Funkzelle 1 befindet sich ein Endgerät 6 (hier ein Mobilfunkendgerät) zum Empfang von einer Zentrale 7 ausgesendeten Informationen 8, 9, 10.

[0017] Die Zentrale 7 sendet in unterschiedliche Funkzellen, hier in Gruppen von Funkzellen, unterschiedliche Informationen (Nutzinformationen und/oder Tabelleninformationen). So sendet sie in die Funkzelle 1, in welcher sich das Endgerät 6 befindet, die Nutzinformationen 8 und 9 sowie die Tabelleninformationen 10a. Die gleichen Informationen wie in die Zelle 1 werden auch in die Funkzelle 2 gesendet. In die Funkzellen 3, 4, 5 werden andere Informationen als in die Funkzellen 1, 2 gesendet. Welche Informationen jeweils in eine Funkzelle gesendet werden, hängt davon ab, welche Informationen regional in den Funkzellen bedeutsam sind. Die gesendeten Nutzinformationen (und/oder Tabelleninformationen) können insbesondere sich auf den Straßenverkehr beziehende Informationen, also Verkehrsinformationen, sein. Insbesondere in diesem Falle sind jeweils in eine Funkzelle Informationen zu senden, welche für sie örtlich und/oder zeitlich von Bedeutung sind, beispielsweise Staumeldungen in einer Umgebung von 30 km um eine Funkzelle etc.

[0018] In der Zentrale 7 gehen aus unterschiedlichen Quellen 28 Nutzdaten, hier Verkehrsdaten, ein. Nutzdaten können die Zentrale 7 bereits in fertiger zu versendender Form erreichen oder noch in der Zentrale 7 überarbeitet werden. Im Falle von Nutzinformationen

in Form von Verkehrsinformationen können die Quellen 8 insbesondere im Verkehr mitfahrende Fahrzeuge (FCD) und/oder stationäre Detektoren und/oder andere Quellen, wie Meldebehörden, sein.

[0019] In der Zentrale 7 liegen nach Eingang oder Aufbereitung die Nutzinformationen (hier Verkehrsinformationen) in Form von Daten vor, welche zumindest einen Ort und eine Art eines Ereignisses an diesem betreffen, beispielsweise eine Autobahnnummer und die Länge eines Staus darauf. Die Nutzinformationen können jedoch auch anstatt zweidimensional (Ort + Ereignis) nur eindimensional oder mehr als zweidimensional sein.

[0020] Zur optimalen Nutzung des Übertragungskanals sollen die Nutzinformationen codiert übertragen werden. Hierfür liegen für die (hier zweidimensionalen) Nutzinformationen Kodiertabellen vor für Orte und Ereignisse. Es können auch für weniger oder mehr als zwei Arten von Nutzinformations-Bestandteilen Tabellen vorliegen.

[0021] Im vorliegenden Fall ist die Nutzinformation 9a die Information "A59 Monheim, Richtung Köln; 10 km Stau".

[0022] Die Tabelle mit Tabelleninformationen 10 bezüglich der Orte umfaßt hier (neben einer Vielzahl weiterer Orte) die Orte "A59 Monheim Richtung Köln" mit dem zugeordneten Code "A" sowie den Ort "Stadt Köln" mit dem zugeordneten Code "B".

[0023] Ferner sind hier in einer Tabelle Tabelleninformationen 11 bezüglich bestimmter Ereignisse abgelegt. So ist für freie Fahrt, also "frei" der Code "C", für "Stau" der Code "D" und für "Stau x km" der Code "E, x" vorgesehen.

[0024] In den Tabelleninformationen 10, 11 sind also jeweils zu einer möglichen Nutzinformation (hinsichtlich eines Ortes bzw. Ereignisses) Codes A bis E vorgesehen, welche eine komprimierte Übertragung dieser Nutzinformationen über den Übertragungskanal 12 erlauben. Im Endgerät 6 werden die in Form von Codes A bis E (evtl. mit zusätzlichen Zahlenangaben) übertragenen Nutzinformationen wiederum mit Tabellen (13, 14) decodiert. Hierzu sind im Endgerät Tabelleninformationen 13 für Orte und Tabelleninformationen 14 für Ereignisse vorgesehen. Beispielsweise können, wie im vorliegenden Falle, mit der Tabelle 13 für Orte aus dem übertragenen Code "A" wieder der Text "A59 Monheim Richtung Köln" sowie mit der Tabelle 14 aus dem übertragenen Code "E, 10" die Information "10 km Stau" aus Tabelle 14 gewonnen werden, sobald die Tabelleninformation "E, x = Stau x km" im Endgerät eingebracht ist.

[0025] Die Erfindung sieht nun zur Optimierung der Nutzung des Übertragungskanals 12 vor, daß in mit Nutzinformationen (A, E) unbesetzten Lücken über den Übertragungskanal 12 ferner Tabelleninformationen 10a von der Zentrale 7 an das Endgerät 6 übertragen werden. Dies hat den Vorteil, daß im Endgerät 6 ein nur kleiner Speicher für Tabelleninformationen erforderlich

ist und daß Tabelleninformationen schnell, laufend und nur soweit örtlich relevant eingebracht werden können. Dabei können beispielsweise für Verkehrsinformationen nur Tabelleninformationen zu Orten (10, 13), nur Tabelleninformationen zu Ereignissen (11, 14) oder Tabelleninformationen zu Orten und Ereignissen übertragen werden. Insbesondere wenn die Tabelleninformationen zu Orten sehr umfangreich sind, kann es sinnvoll sein, nur Tabelleninformationen zu Orten von der Zentrale über den Übertragungskanal an das Endgerät 6 zu übertragen.

**[0026]** Um in der Zentrale 7 festzustellen, in welche örtlichen Bereiche (hier in welche Gruppen von Funkzellen 1, 2; 3, 4, 5) welche Verkehrsinformationen zu übertragen sind, ist eine weitere Tabelle 15 in der Zentrale vorgesehen, in welcher zu Gruppen von möglichen Orten (hier "A", "B" usw.) angegeben ist, in welche Funkzellen diese zu übertragen sind (hier in die Funkzellen 1, 2 oder die Funkzellen 3, 4, 5). Die Funkzellen können dabei in Form von Location-Codes angegeben sein. Die Auswahlinformationen (hier Ortsinformationen A, B) in der Tabelle 15 können in unterschiedlicher Form angegeben sein, beispielsweise in Form von vollständigen Texten, wie in der Meldung 9a, in Form von daraus gewonnenen Orts-Codes "A", "B" usw. anhand der Tabelle 10 etc. Allgemein ausgedrückt umfaßt die Tabelle 15 Auswahlkriterien zur Auswahl von Sendebereichen (hier Funkzellen eines Mobilfunknetzes) anhand der zu sendenden Informationen.

**[0027]** Im vorliegenden Fall wird entschieden, daß die Nutzinformatio- nen 9 aufgrund der Zuordnung in der Tabelle 10 zum Bereich "A" und aufgrund der Zuordnung der Tabelle 15 des Bereichs "A" zu den Funkzellen 1, 2 in den Funkzellen 1, 2 zu senden ist. Im vorliegenden Fall empfängt also das Endgerät 6 die Informationen, weil es sich derzeit in der Funkzelle 1 befindet. In die Funkzelle 2 werden die gleichen Informationen wie in die Funkzelle 1 übertragen. Hingegen werden andere Informationen ("B"-bezogene Informationen 16) in die Funkzellen 3, 4 und 5 gesendet. Die Sendung erfolgt als Mobilfunk-Kurznachrichten-Cellbroadcast-Sendung und ist in unterschiedlichen Funkzellen oder Gruppen von Funkzellen 1, 2; 3 bis 5 unterschiedlich.

**[0028]** Die Übertragung der Tabelleninformationen 10, 11 von der Zentrale 7 über den Übertragungskanal 12 in einen Speicher 13, 14 des Endgerätes 6 erfolgt in von Nutzinformatio- nen unbesetzten Lücken, also zeitlichen Lücken, Code-Lücken etc. Lücken sind dabei Zeiten, freie Codes etc. auf dem Übertragungskanal 12, welche aktuell nicht für Nutzinformatio- nen verwendet werden. Dabei können Lücken im Einzelfall verwendet werden, wenn aktuell keine Nutzinformatio- nen zu senden sind. Alternativ können Lücken zyklisch vorgesehen sein, beispielsweise alle 1 bis 10 Minuten, insbesondere alle drei Minuten oder in jeder n-ten (z. B. jeder dritten) Kurznachrichtenseite eines Mobilfunknetzes etc. Die von der Zentrale 7 über den Übertragungskanal 12 an das Endgerät 6 gesandten Tabelleninfor-

ationen 10 werden im Endgerät in Abhängigkeit davon, ob es sich um Nutzinformatio- nen oder Tabelleninformatio- nen handelt (was beispielsweise in einem Header in den Tabelleninformationen 10 angegeben sein kann) in einen Speicher für Tabelleninformationen 13, 14 für Orte (13) oder Ereignisse (14) geleitet und dort gespeichert. Wenn hingegen im Endgerät eine Nutzinformatio- n 10a eingeht, wird sie im Endgerät zu einer Dekodiereinrichtung 17 geleitet, welche auf die Speicher mit Tabelleninformationen 13 und/oder 14 zugreift. Von der Dekodiereinrichtung 17, werden dekodierte Nutzinformatio- nen in eine Ausgabereinrichtung 18 weitergeleitet, wo sie ausgegeben werden oder für eine spätere Ausgabe gespeichert werden.

**[0029]** Die Sendeeinrichtung der Zentrale 7 ist in Figur 1 als Block 22 dargestellt und kann einen Sender (im einfachsten Fall ein Mobilfunkgerät) oder einen Zugang zu einem Sender enthalten. Insbesondere kann sie ein Sender oder Zugang zu einem Sender für Mobilfunk beinhalten, über welchen (beispielsweise in Form von Kurznachrichten) alphanumerisch gesendet werden kann. Die Kodiereinrichtung ist in Figur 1 als Block 23 dargestellt, welcher eingehende Verkehrsinformatio- nen 9a, 16 anhand von Tabelleninformationen 10, 11 in der Zentrale und anhand der Orts-/Funkzellentabelle 15 jeweils denjenigen Funkzellen zuordnet, in welchen die Informationen gesendet werden sollen. Nach Auswahl der Funkzellen für zu sendende und codierte Informationen werden diese von der Kodiereinrichtung 23 an die Sendeeinrichtung 22 übermittelt.

**[0030]** Figur 2 zeigt anhand eines Mobilfunk-Cellbroadcast-Kurznachrichten-Blocks 19 die Einfügung von Tabelleninformationen in eine Lücke zwischen Nutzinformatio- nen. Im vorliegenden GSM-SMS-CB-Block 19 sind Informationsblöcke 8, 9, 20 mit Nutzinformatio- nen und ein Block 10 mit Tabelleninformationen vorgesehen. Im vorliegenden Falle wird also eine aktuell freie Lücke in Form von freiem Platz in einer Kurznachrichtenseite zur Einfügung von Tabelleninformatio- nen 10a verwendet.

#### Patentansprüche

1. Verfahren zum Übertragen von Tabelleninformatio- nen (10, 10a, 11) von einer Zentrale (7) an ein Endgerät (6) über einen Übertragungskanal (12), über welchen Übertragungskanal (12) auch Nutzinformatio- nen (8, 9) codiert von der Zentrale (7) ("A", "E") an das Endgerät (6) übertragen werden, wobei die Tabelleninformationen (10, 11) im Endgerät (6) verwendbar sind zur Dekodierung (17) der zentralseitig mit Tabelleninformationen (10, 11) codierten und derart codiert ("A", "E") an das Endgerät (6) übertragenen (12) Nutzinformatio- nen (9a, 16; 8, 9), wobei zur Übertragung (12) von Tabelleninformatio- nen (10, 11) von der Zentrale (7) an das Endgerät (6) über den Übertragungskanal (12) mit Nutzinfor-



- mationen (8,9) unbelegte Lücken (10a) verwendet werden.
2. Verfahren nach Anspruch 1, dadurch gekennzeichnet, daß der Übertragungskanal (12) ein Mobilfunkkanal ist. 5
  3. Verfahren nach einem der vorhergehenden Ansprüche, dadurch gekennzeichnet, daß der Übertragungskanal (12) ein an alle Teilnehmer in einem vorgegebenen örtlichen Bereich sendender alphanumerischer Kanal ist. 10
  4. Verfahren nach einem der vorhergehenden Ansprüche, dadurch gekennzeichnet, daß der Übertragungskanal (12) ein Mobilfunk-Kurznachrichten-Cellbroadcast-Kanal, insbesondere GSM-SMS-CB-Kanal, ist. 15 20
  5. Verfahren nach einem der vorhergehenden Ansprüche, dadurch gekennzeichnet, daß das Übertragungsverfahren auf dem Übertragungskanal (12) Lücken im Zeitbereich und/oder Frequenzbereich und/oder Code-Bereich in Form von Zeitslots, Frequenzslots oder Code-Slots zwischen Nutzinformationen zur Übertragung von Tabelleninformationen verwendet. 25 30
  6. Verfahren nach einem der vorhergehenden Ansprüche, dadurch gekennzeichnet, daß die Lücken variable Lücken sind, die sich jeweils für einen Zeitpunkt aus der Nicht-Belegung mit Nutzinformationen ergeben. 35
  7. Verfahren nach einem der Ansprüche, 1 bis 5, dadurch gekennzeichnet, daß die Lücken vorgegebene zyklische Lücken in mindestens einem zyklisch zu sendenden Informationsblock (19) sind. 40
  8. Verfahren nach einem der Ansprüche 1 bis 5 oder 7, dadurch gekennzeichnet, daß die Lücken eine Kurznachrichtenseite oder ein Teil einer Kurznachrichtenseite sind. 45
  9. Verfahren nach einem der Ansprüche 1 bis 5 oder 7 bis 8, dadurch gekennzeichnet, daß die Lücken bei zyklisch zu sendenden Paketen (8,9,10) jeweils nach einer vorgegebenen Anzahl von Paketen (8,9) in Form eines Paketes oder Teil eines Paketes (10) vorgesehen sind. 50 55
  10. Verfahren nach einem der Ansprüche 1 bis 5 oder 7 bis 8, dadurch gekennzeichnet, daß die Lücken nach bestimmten Zeitintervallen, insbesondere alle 1 bis 10, insbesondere alle drei Minuten vorgesehen sind.
  11. Verfahren nach einem der vorhergehenden Ansprüche, dadurch gekennzeichnet, daß die Nutzinformationen Verkehrsinfos sind.
  12. Verfahren nach einem der vorhergehenden Ansprüche, dadurch gekennzeichnet, daß in der Zentrale (7) für bestimmte Ortsbereiche, insbesondere Funkzellen oder Gruppen von Funkzellen (23, 15) relevante Informationen(8,9,10a) jeweils nur an eine Funkzelle oder eine Gruppe von Funkzellen (1,2; 3 bis 5) gesendet werden und/oder nur soweit sie zeitlich relevant sind, ausgesendet werden.
  13. Verfahren nach einem der vorhergehenden Ansprüche, dadurch gekennzeichnet, daß die Tabelleninformationen (10) Ortsinformationen ("A59 Monheim Richtung Köln") und zugeordnete, zu übertragende Codes ("A") umfassen.
  14. Verfahren nach einem der vorhergehenden Ansprüche, dadurch gekennzeichnet, daß die Informationen durch ein Empfangsgerät empfangen werden, daß dieses Empfangsgerät eine Speichervorrichtung zum Speichern der Tabelleninformation aufweist und daß bei nichtvorhandener oder ungültiger Tabelleninformation diese Tabelleninformation über den Übertragungskanal empfangen und gespeichert wird.
  15. Verfahren nach einem der vorhergehenden Ansprüche, dadurch gekennzeichnet, daß die Tabelleninformationen (11) Ereignisse ("frei", "Stau") und jeweils einem Ereignis zugeordnete zu übertragende Codes ("C", "D") enthalten.
  16. Zentrale, insbesondere Verkehrsinformationszentrale zur Durchführung des Verfahrens nach einem der vorhergehenden Ansprüche,
    - mit einer Sendeeinrichtung (22) zum Senden von Nutzinformationen (8) und Tabelleninformationen (10) über einen Übertragungskanal (12),
    - mit einer Kodiereinrichtung (23) zum Kodieren

- von mit der Sendeeinrichtung (22) über den Übertragungskanal (12) zu sendenden Nutzinformationen (9a, 16) unter Verwendung von in der Zentrale vorliegenden Tabelleninformationen (10,11),
- mit einem Nutzinformationsspeicher (9a, 16) für zu sendende Nutzinformationen,
  - mit einem Tabelleninformationsspeicher für zu sendende und/oder für zum Kodieren von zu sendenden Nutzinformationen zu verwendende Tabelleninformationen (10,11),
  - wobei die Kodiereinrichtung (23) und/oder die Sendeeinrichtung (22) so ausgebildet ist, daß zum Übertragen von Tabelleninformationen (10,11) von der Zentrale (7) an das Endgerät (6) über den Übertragungskanal (12) mit Nutzinformationen (8,9) unbesetzte Lücken (10a) verwendet werden.
- 5 23. Zentrale nach einem der Ansprüche 16 bis 22, dadurch gekennzeichnet, daß die Sendeeinrichtung zum Senden über einen Mobilfunk-Kurznachrichten-Cellbroadcast-Kanal ausgebildet ist.
- 10 24. Zentrale nach einem der Ansprüche 16 bis 22, dadurch gekennzeichnet, daß der Übertragungskanal ein Verkehrsradiokanal oder RDS- oder DAB- oder Pager- oder Internet-Kanal ist.
- 15
17. Zentrale nach Anspruch 16, dadurch gekennzeichnet, daß die Sendeeinrichtung der Zentrale einen Zeitmultiplexer aufweist, der so ausgebildet ist, daß Tabelleninformationen in zeitlichen Lücken zwischen Nutzinformationen gesendet werden. 20 25
18. Zentrale nach Anspruch 16 oder 17, dadurch gekennzeichnet, daß die Sendeeinrichtung einen Codemultiplexer aufweist, der so ausgebildet ist, daß Tabelleninformationen (10,11) in Code-Lücken zwischen Nutzinformationen gesendet werden. 30
19. Zentrale nach einem der Ansprüche 16 bis 18, dadurch gekennzeichnet, daß die Sendeeinrichtung so ausgebildet ist, daß Tabelleninformationen innerhalb eines zu übertragenden Datenpaketes, insbesondere innerhalb einer auch mit Nutzinformationen belegten Mobilfunk-Kurznachrichtenseite, übertragen werden. 35 40
20. Zentrale nach einem der Ansprüche 16 bis 18, dadurch gekennzeichnet, daß die Sendeeinrichtung der Zentrale so ausgebildet ist, daß Tabelleninformationen in einer eigenen Mobilfunk-Kurznachrichtenseite, insbesondere zyklisch, übertragen werden. 45
21. Zentrale nach einem der Ansprüche 16 bis 20, dadurch gekennzeichnet, daß die Zentrale eine der Sendeeinrichtung (22) vorgeschaltete Kodiereinrichtung (23) zum Auswählen oder Priorisieren von für ein Sendegebiet (Mobilfunkzellen 1, 3; 3 bis 5) örtlich relevanten Tabelleninformationen (10,11) aufweist. 50 55
22. Zentrale nach einem der Ansprüche 16 bis 21, dadurch gekennzeichnet,

daß sie eine Auswahleinrichtung (23) zum Auswählen oder Priorisieren von zeitlich aktuellen Tabelleninformationen aufweist.

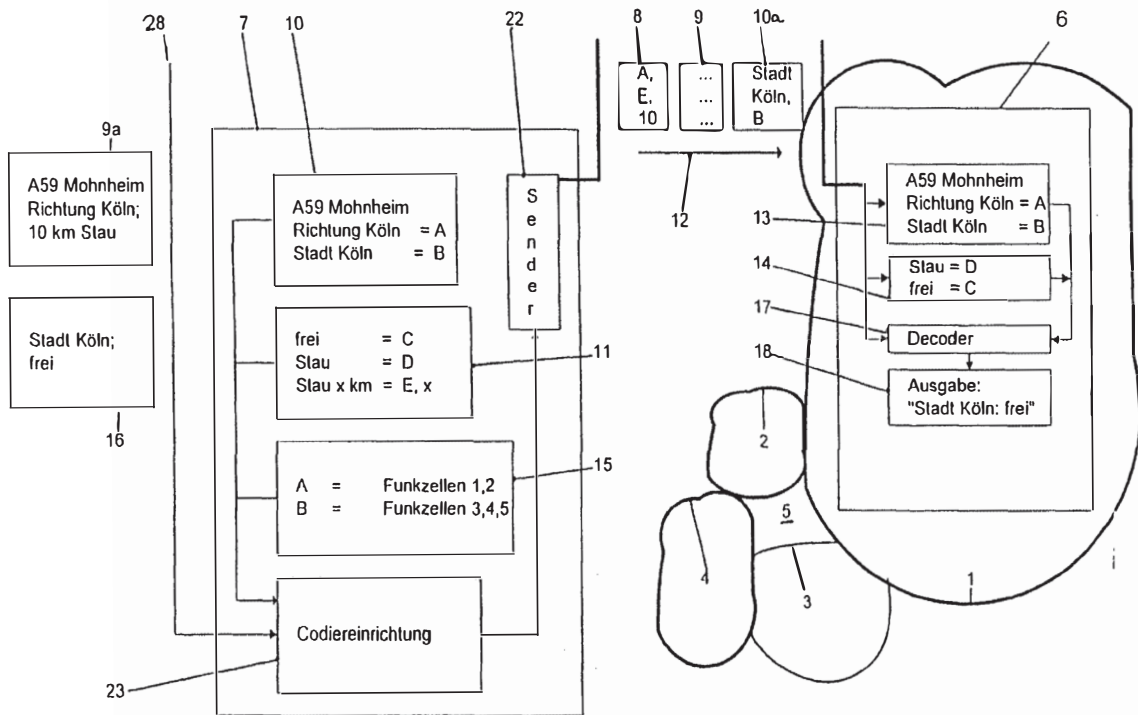
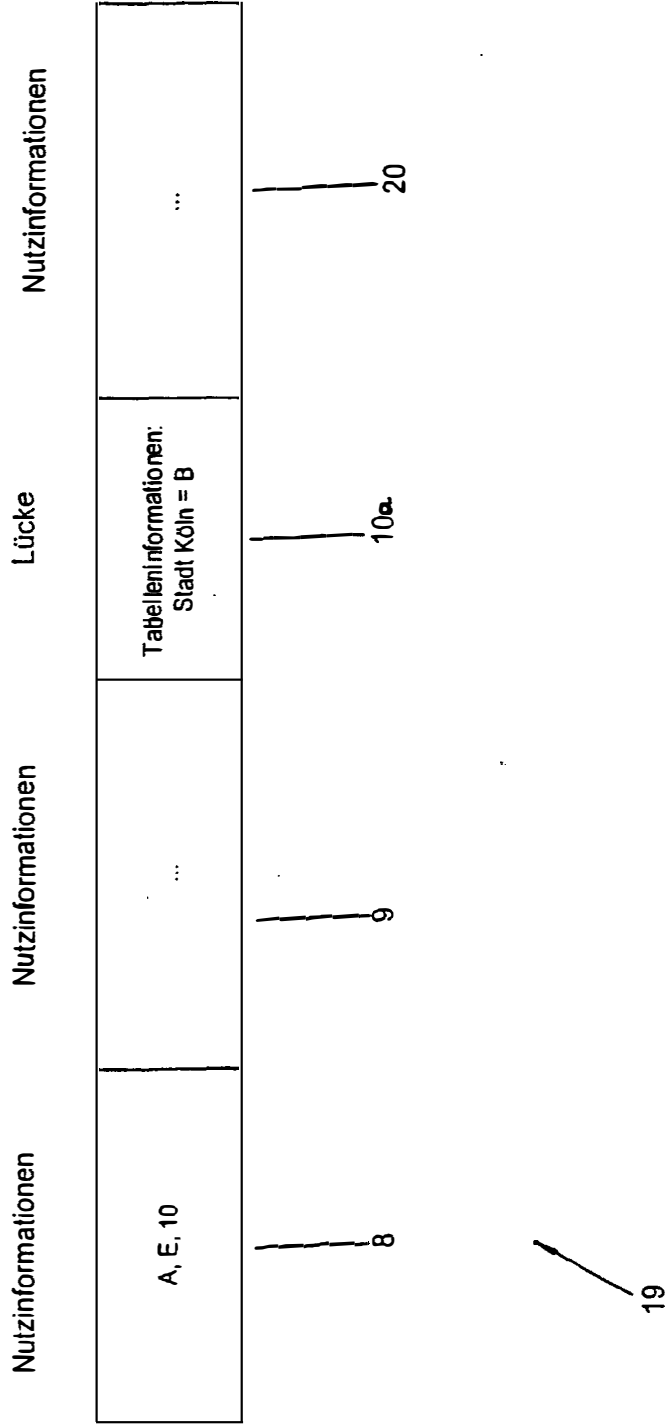

Fig. 1



**Fig. 2**

TC2100#4  
BT  
10-26-01

IN THE UNITED STATES PATENT AND TRADEMARK OFFICE

In re Application of

Atty. Docket

ROBERT J. DAVIES ET AL

GB 000109

Serial No. 09/876,515



Filed: JUNE 7, 2001

Group Art Unit 2681

Title: DATA DELIVERY THROUGH BEACONS

Commissioner for Patents  
Washington, D.C. 20231

RECEIVED  
OCT 19 2001  
Technology Center 2600

LETTER TO OFFICIAL DRAFTSMAN

Sir:

Enclosed are THREE (3) sheets of formal drawing  
for filing in the above-identified application.

Respectfully submitted,

By Jack D. Slobod  
Jack D. Slobod, Reg. 26,236  
Attorney  
(914) 333-9606

CERTIFICATE OF MAILING

I hereby certify that this correspondence is being  
deposited this date with the United States Postal Service as  
first-class mail in an envelope addressed to:

COMMISSIONER OF PATENTS AND TRADEMARKS  
Washington, D.C. 20231

On October 10, 2001  
(Mailing Date)

By Natasha O'Malley  
(Signature)

F:\WPDOCS\SL\GB000109frmlrdwg.sl.doc

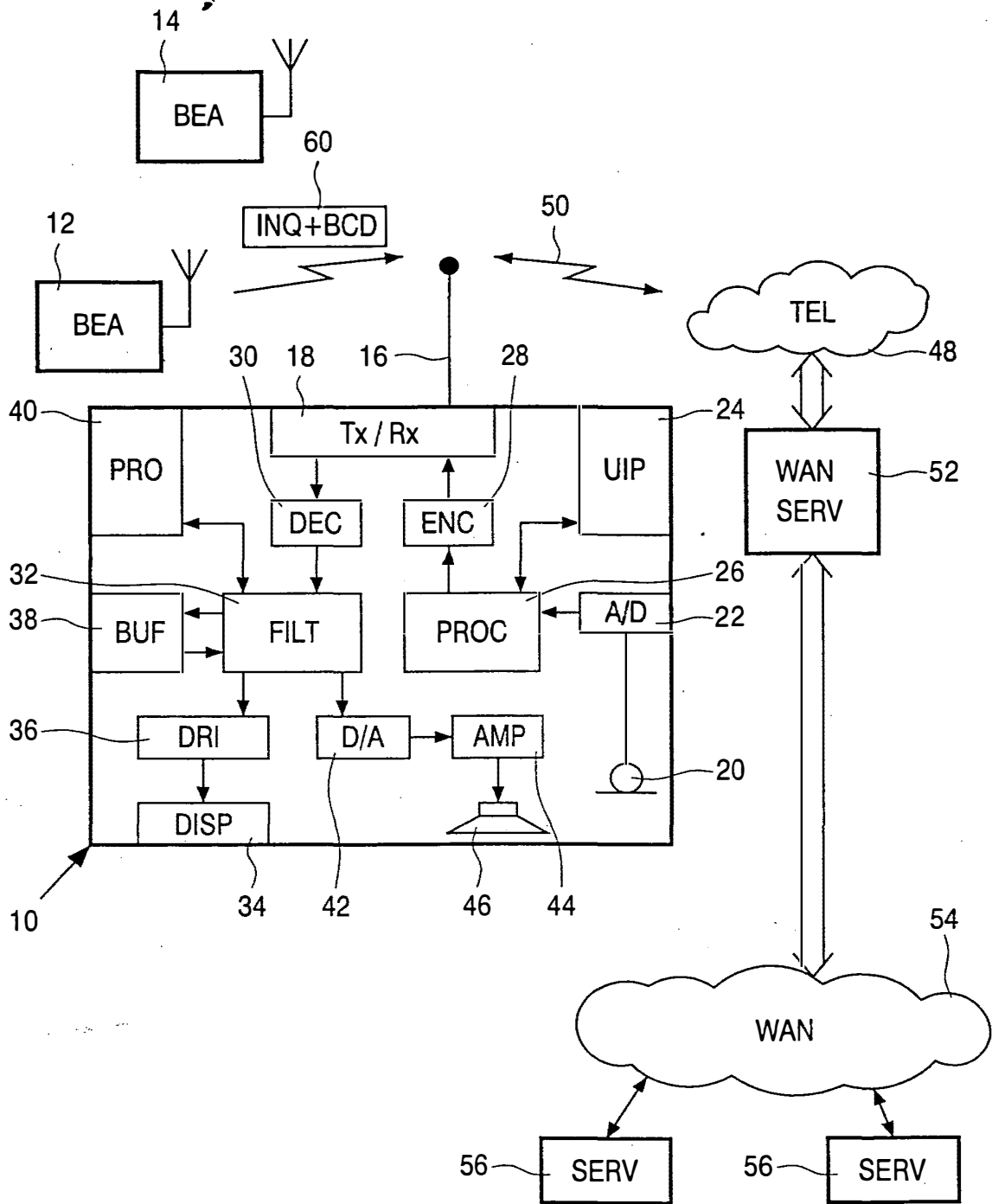

Fig.1

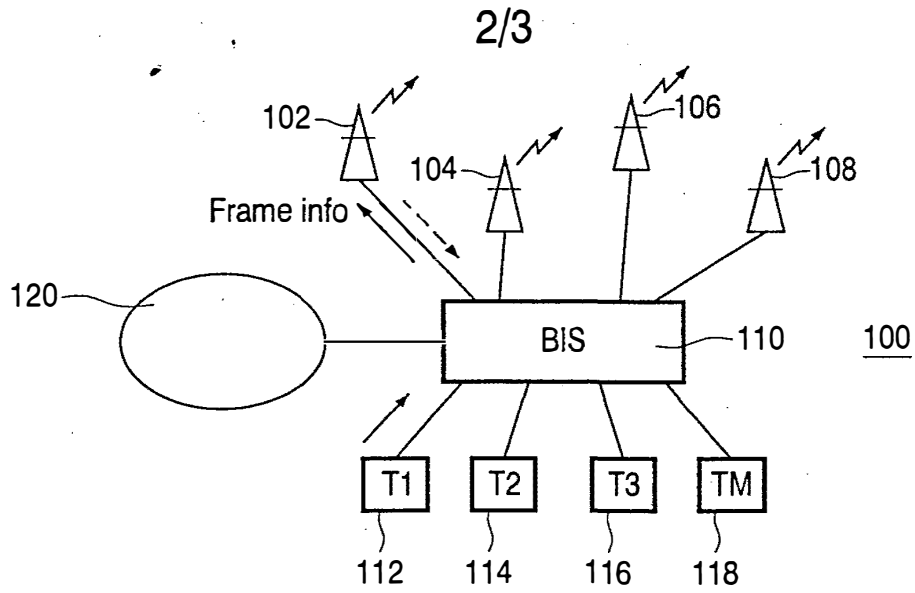

Fig.2

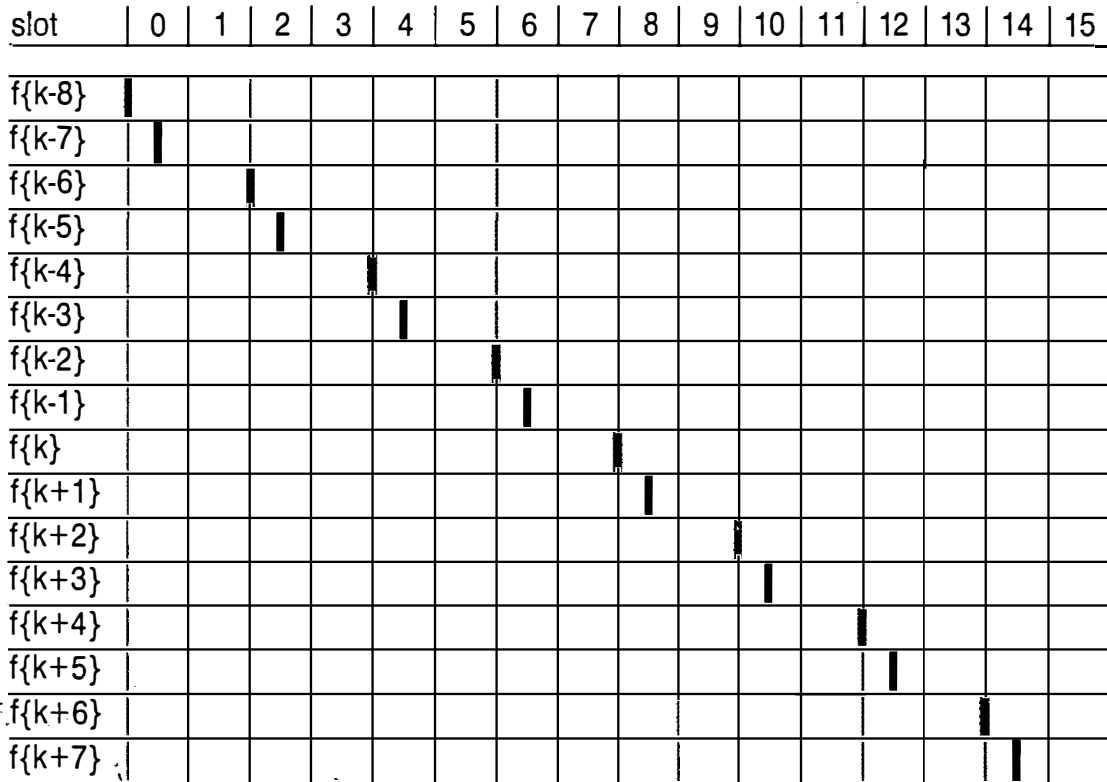

Fig.3

3/3

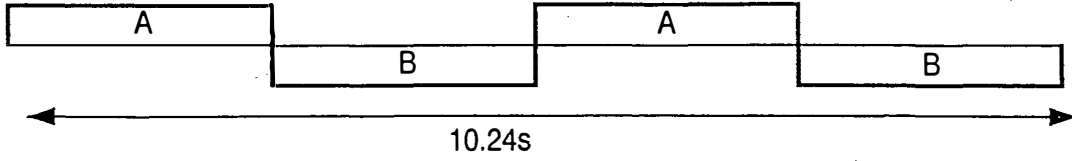

Fig.4

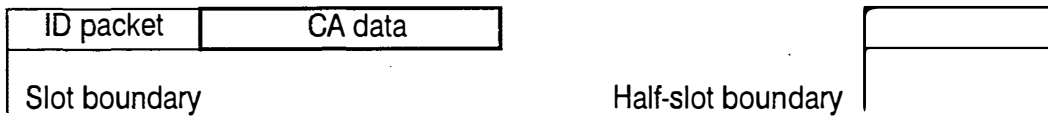

Fig.5

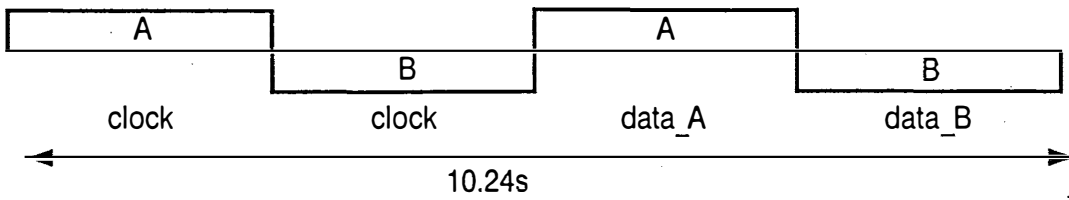

Fig.6

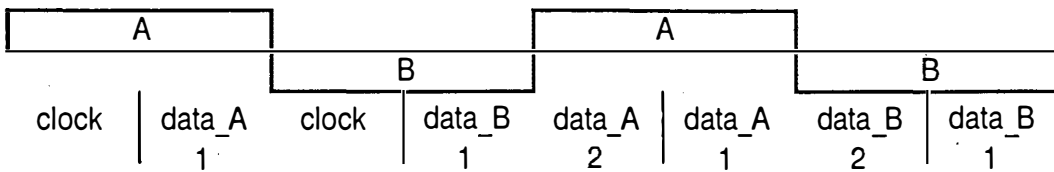

Fig.7



06-08-01 15

A

Case Docket No. GB 000109

THE COMMISSIONER FOR PATENTS, Washington, D.C. 20231

Enclosed for filing is the patent application of Inventor(s): Robert J. Davies; Saul R. Dooley

For: DATA DELIVERY THROUGH BEACONS

**ENCLOSED ARE:**

- Appointment of Associates;
- Information Disclosure Statement, Form PTO-1449 and copies of documents listed therein;
- Preliminary Amendment;
- Specification (23 Pages of Specification, Claims, & Abstract);
- Declaration and Power of Attorney: (1 Page of a  fully executed  unsigned Declaration);
- Drawing (3 sheets of  informal  formal sheets);
- Certified copy of BRITISH application Serial Nos. 0015454.2; 0020073.3;
- Authorization Pursuant to 37 CFR §1.136(a)(3)
- Other:
- Assignment to KONINKLIJKE PHILIPS ELECTRONICS N.V.

FEE COMPUTATION

| CLAIMS AS FILED                   |              |              |          |                      |
|-----------------------------------|--------------|--------------|----------|----------------------|
| FOR                               | NUMBER FILED | NUMBER EXTRA | RATE     | BASIC FEE - \$710.00 |
| Total Claims                      | 14 - 20 =    | 0            | X \$18 = | 0.00                 |
| Independent Claims                | 3 - 3 =      | 0            | X \$80 = | 0.00                 |
| Multiple Dependent Claims, if any |              |              | \$270 =  | 0.00                 |
| TOTAL FILING FEE . . . . .        |              |              |          | = \$710.00           |

Please charge Deposit Account No. 14-1270 in the amount of the total filing fee indicated above, plus any deficiencies. The Commissioner is also hereby authorized to charge any other fees which may be required, except the issue fee, or credit any overpayment to Account No. 14-1270.

Amend the specification by inserting before the first line as a centered heading --Cross Reference to Related Applications--; and insert below that as a new paragraph --This is a continuation-in-part of application Serial No. , filed , which is herein incorporated by reference--.

CERTIFICATE OF EXPRESS MAILING

Express Mail Mailing Label No. EZ666160503US

Date of Deposit 6-7-01

I hereby certify that this paper and/or fee is being deposited with the United States Postal Service "Express Mail Post Office to Addressee" service under 37 C.F.R. §1.10 on the date indicated above and is addressed to the Commissioner of Patents and Trademarks, Washington, D.C. 20231.

Jeanne Rusciano  
Typed Name

*Jeanne Rusciano*  
Signature

*Michael E. Marion*

Michael E. Marion, Reg. 32,266  
Attorney  
(914) 333-9641  
U.S. Philips Corporation  
580 White Plains Road  
Tarrytown, New York 10591

SASL\AMH06SLP0.RU0.doc

06/07/01  
jc961 U.S. PTO

jc903 U.S. PTO  
09/076515  
06/07/01

06/07/01 09:54:06

06-08-01 15

A

Case Docket No. GB 000109

THE COMMISSIONER FOR PATENTS, Washington, D.C. 20231

Enclosed for filing is the patent application of Inventor(s):  
Robert J. Davies; Saul R. Dooley

For: DATA DELIVERY THROUGH BEACONS

**ENCLOSED ARE:**

- Appointment of Associates;
- Information Disclosure Statement, Form PTO-1449 and copies of documents listed therein;
- Preliminary Amendment;
- Specification (23 Pages of Specification, Claims, & Abstract);
- Declaration and Power of Attorney:  
(1 Page of a  fully executed  unsigned Declaration);
- Drawing (3 sheets of  informal  formal sheets);
- Certified copy of BRITISH application Serial Nos. 0015454.2; 0020073.3;
- Authorization Pursuant to 37 CFR §1.136(a)(3)
- Other:
- Assignment to KONINKLIJKE PHILIPS ELECTRONICS N.V.

Jc903 U.S. PTO  
09/07/01



FEE COMPUTATION

| CLAIMS AS FILED                   |              |              |          |                         |
|-----------------------------------|--------------|--------------|----------|-------------------------|
| FOR                               | NUMBER FILED | NUMBER EXTRA | RATE     | BASIC FEE<br>- \$710.00 |
| Total Claims                      | 14 - 20 =    | 0            | X \$18 = | 0.00                    |
| Independent Claims                | 3 - 3 =      | 0            | X \$80 = | 0.00                    |
| Multiple Dependent Claims, if any |              |              | \$270 =  | 0.00                    |
| TOTAL FILING FEE . . . . .        |              |              |          | = \$710.00              |

Please charge Deposit Account No. 14-1270 in the amount of the total filing fee indicated above, plus any deficiencies. The Commissioner is also hereby authorized to charge any other fees which may be required, except the issue fee, or credit any overpayment to Account No. 14-1270.

Amend the specification by inserting before the first line as a centered heading --Cross Reference to Related Applications--; and insert below that as a new paragraph --This is a continuation-in-part of application Serial No. , filed , which is herein incorporated by reference--.

CERTIFICATE OF EXPRESS MAILING

Express Mail Mailing Label No. E2666160503US

Date of Deposit 6-7-01

I hereby certify that this paper and/or fee is being deposited with the United States Postal Service "Express Mail Post Office to Addressee" service under 37 C.F.R. §1.10 on the date indicated above and is addressed to the Commissioner of Patents and Trademarks, Washington, D.C. 20231.

Jeanne Rusciano  
Typed Name

*Jeanne Rusciano*  
Signature

Michael E. Marion, Reg. 32,266  
Attorney  
(914) 333-9641  
U.S. Philips Corporation  
580 White Plains Road  
Tarrytown, New York 10591

SASL\AMH06SLP0.RU0.doc

06/07/01  
Jc961 U.S. PTO

06/07/01

06/07/01  
3c961 U.S. PTO

DESCRIPTION

**DATA DELIVERY THROUGH BEACONS**

5           The present invention relates to services offered to users of electronic equipment, especially but not exclusively to users of mobile communications devices such as portable telephones and suitably equipped PDA's (personal digital assistants). The invention further relates to means for delivery of such services, and to portable devices for receiving them.

10           Recent years have seen a great increase in subscribers world-wide to mobile telephone networks and, through advances in technology and the addition of functionalities, cellular telephones have become personal, trusted devices. A result of this is that a mobile information society is developing, with  
15           personalised and localised services becoming increasingly more important. Such "Context-Aware" (CA) mobile telephones are used with low power, short range base stations in places like shopping malls to provide location-specific information. This information might include local maps, information on nearby shops and restaurants and so on. The user's CA terminal may be equipped to  
20           filter the information received according to pre-stored user preferences and the user is only alerted if an item of data of particular interest has been received.

          An example of a CA terminal is given in U.S. patent 5,835,861 which discloses the use of wireless telephones within the context of advertisement billboards. The user of a wireless telephone obtains the telephone number of a  
25           vendor by activating his/her wireless telephone to transmit a prompt signal to an active advertisement source and to receive from the advertisement source a response signal containing the telephone number of the advertising vendor. The telephone number can then be used to automatically place a call to that vendor via the public switched telephone network. Alternatively, the telephone  
30           number can be stored for use later on. This arrangement can be used to place a call to a vendor without having to either memorise the telephone number or

to write it down. The signals between the billboard and the caller can be transmitted as modulated infrared (IR) signals.

In another example, Hewlett-Packard has posted a publication on the Web at <http://www.cooltown.hp.com/papers/webpres/WebPresence.htm> about their "Cooltown" project. The convergence of Web technology, wireless networks and portable client devices provides design opportunities for computer/communications systems. In the Cooltown project, systems that are location-aware can be created using URL's for addressing, physical URL's for delivery via beacons and sensing of URL's for discovery, and localised web servers for directories. The systems are ubiquitous to support nomadic users. On top of this infrastructure the Internet connectivity can be leveraged to support communications services. Web presence bridges the World Wide Web and the physical world inhabited by the users, providing a model for supporting nomadic users without a central control point.

The Cooltown Museum and Bookstore offers visitors a Web-enhanced experience. As visitors tour the museum, their portable digital assistant (PDA) can receive Web URLs from wireless "beacons". These beacons are small infrared transceivers located close to pictures or sculptures; the URLs link into a Web of information about the items. Using the PDA's Web browser, visitors can read or hear about the artist or the work and about related art works in the museum. The URLs can also be stored as bookmarks for further study or they can be used to select reproductions of the artwork from the museum's online store.

It will be recognised that an important requirement for CA devices is that they quickly and efficiently gather data from beacons such that the user is not required to undertake actions such as staying close to a beacon whilst contact is established between portable device and beacon, nor having to specifically initiate interaction (as is the case with the above-mentioned system in US 5,835,861). A further requirement is that the portable device should be kept relatively simple insofar as the data gathering from beacons is concerned: in the Cooltown system, a full web browser and display capability is required to

support user navigation within the web page indicated by the URL being broadcast.

It is therefore an object of the invention to provide a system for the  
5 delivery of data via beacons whereby the amount of dedicated circuitry and  
operating procedure are kept to low levels.

In accordance with a first aspect of the present invention there is  
provided a communications system comprising at least one beacon device  
capable of wireless message transmission and at least one portable device  
10 capable of receiving such a message transmission, wherein the beacon is  
arranged to broadcast a series of inquiry messages each in the form of a  
plurality of predetermined data fields arranged according to a first  
communications protocol, wherein the beacon is further arranged to add to  
each inquiry message prior to transmission an additional data field, and  
15 wherein the at least one portable device is arranged to receive the transmitted  
inquiry messages and read data from said additional data field, the additional  
data field including location information. By adding the additional field (suitably  
at the end of a respective inquiry message), data broadcast may be carried on  
top of an existing inquiry process, such that the usual delays while such a  
20 process is carried out prior to data transfer are avoided. Furthermore, by  
placing the additional field at the end of those sent according to the  
communications protocol (preferably but not essentially Bluetooth), those  
protocol-compatible devices not intended for reception of beacon signals can  
simply ignore the additional data without compromising operation according to  
25 protocol.

Where the protocol is Bluetooth (or a similar frequency hopping  
arrangement) the beacon may be configured to broadcast a series of inquiry  
messages on a predetermined clocked succession or sequence of  
frequencies, with clock information for the beacon being carried by the  
30 additional data field. In one arrangement, the additional data field may carry at  
least 64 bits of data. As will be described in greater detail hereinafter with  
respect to embodiments of the invention, this can improve the inquiry

performance of a Bluetooth system, shortening the time to establish a connection for data exchange.

The beacon may be arranged to include an indication in one of said predetermined data fields (suitably in a currently unused or unassigned field),  
5 said indication denoting the presence of said additional data field, such that devices configured for reception of beacon data may be triggered to read from the additional data field.

Where the first communications protocol comprises Bluetooth messaging, a special Dedicated Enquiry Access Code (DIAC) may be used to  
10 indicate the presence of location information in the additional data field.

The presence of location information in the additional data field may be indicated by header information appearing in the additional data field.

The communications system may perform wireless message transmission and reception using a scheme which employs frequency hopping.  
15 In this case, location data may be sent on each frequency used for inquiry message broadcasts.

The beacon may be arranged to include in a message first comparison data, with the portable device further comprising storage means holding second comparison data and comparator means arranged to identify when  
20 there is a match between the first and second comparison data and present the data read from the additional data field, otherwise to not present the data. Such second comparison data may be predetermined and/or pre-stored, or it may be determined adaptively from user profiling of the portable device user.

That is, means may be provided for generating said second comparison  
25 data from user profiling of the portable device user.

The comparator means may be a programmable device operable to perform, in synchronous or overlapping manner, comparisons between respective sets of first and second comparison data.

Also in accordance with the present invention there is provided a mobile  
30 communication device for use in the system recited above, the device comprising a receiver capable of receiving a short-range wireless inquiry message including a plurality of data fields according to a first communications

protocol, means for determining when an additional data field including location information has been added to said plurality of data fields, and means for reading the location information data from such an additional data field.

Further in accordance with the present invention, there is provided a  
5 beacon device capable of wireless message transmission and for use in a  
communications system comprising said beacon device and at least one  
portable device capable of receiving such a message transmission, wherein  
the beacon is configured to broadcast a series of inquiry messages each in the  
form of a plurality of predetermined data fields arranged according to a first  
10 communications protocol, and to add to each inquiry message prior to  
transmission an additional data field, such as to enable the at least one  
portable device arranged to receive the transmitted inquiry messages to read  
data from said additional data field, the additional data field including location  
information. As described in relation to the system as a whole, the beacon  
15 device may be arranged to add said additional data field at the end of a  
respective inquiry message; it may be arranged to include an indication in one  
of said predetermined data fields, said indication denoting the presence of said  
additional data field; the first communications protocol may comprise Bluetooth  
messaging; and the device may be configured to broadcast a series of inquiry  
20 messages on a predetermined clocked succession of frequencies, with clock  
information for said beacon being included in data carried by said additional  
data field.

Still further in accordance with the present invention, there is provided a  
method for enabling the user of a portable communications device to receive  
25 broadcast messages wherein at least one beacon device broadcasts a series  
of inquiry messages each in the form of a plurality of predetermined data fields  
arranged according to a first communications protocol, wherein the beacon  
adds to each inquiry message prior to transmission an additional data field  
carrying broadcast message data, including location information, and wherein  
30 the portable device receives the transmitted inquiry messages, including the  
location information, and reads the broadcast data from said additional data  
field.

These and other aspects and optional features of the present invention appear in the appended claims, to which reference should now be made and the disclosure of which is incorporated herein by reference or will become apparent from reading the following description of the preferred embodiments of the invention.

Preferred embodiments of the invention will now be described, by way of example only, and with reference to the accompanying drawings, in which:

Figure 1 is a block schematic diagram of a beacon and portable device embodying the invention;

Figure 2 is a schematic diagram of a series of devices in a linked beacon infrastructure;

Figure 3 is a chart illustrating a portion of the transmission of a train of inquiry access codes centred on a given frequency ;

Figure 4 illustrates alternation between trains of inquiry messages over the duration of an inquiry broadcast;

Figure 5 illustrates the insertion of a packet of broadcast data within an existing transmission slot;

Figure 6 illustrates a first arrangement for sending beacon clock data in a sequence of inquiry message trains; and

Figure 7 illustrates an alternate arrangement to that of Figure 6 for the sending of beacon clock data.

In the following description we consider particularly a CA application which utilises Bluetooth protocols for communication of messages from beacon to portable device (whether telephone, PDA or other). As will be recognised, the general invention concept of including a broadcast channel as part of the inquiry procedure is not restricted to Bluetooth devices, and is applicable to other communications arrangements, in particular frequency hopping systems.

Figure 1 is a block schematic diagram of a CA mobile telephone in use with one or more low power, short range base stations or beacons. As mentioned previously, and discussed in greater detail below, such an



arrangement may be used in places like shopping malls to provide location-specific information such as local maps, information on nearby shops and restaurants and so on, with the beacon downloading information keys to a mobile device. As will be discussed in greater detail below, the arrangement  
5 may also be used to provide location information itself, for example mapping co-ordinates or the like. An information key is a small data object that provides a reference to a source of full information, and it is in the form of a number of predetermined fields, one of which may contain a short piece of descriptive text presented to a user. Another field will be a pointer or address of some  
10 form, for example a URL or telephone number. Other supplementary fields may control how the data is presented to a user and how the address may be exploited. The beacon will generally broadcast cyclically a number of these keys, each typically relating to a different service.

Issues relating to the beacon construction and configuration include the  
15 beacons range which will be dependent on output power (typical range being 1mW to 100mW), levels of local interference, and receiver sensitivity.

The user's CA terminal 10 comprises an aerial 16 coupled with transceiver stage 18 for the reception and transmission of messages. Outgoing messages result from user input to the telephone, either audio input  
20 via microphone 20 and A/D converter 22 or other data input via the keypad or other input means 24. These inputs are processed to message data format by signal and data processing stage 26 and converted to transmission format by encoder 28 before being supplied to the transceiver stage 18.

Messages received via the aerial 16 and transceiver 18 are passed via  
25 a decoding stage 30 to a filtering and signal processing stage 32. If the data carried by the message is for presentation on a display screen 34 of the telephone, the data will be passed to a display driver 36, optionally after buffering 38, with the driver formatting the display image. As will be recognised, the display 34 may be a relatively simple low-resolution device,  
30 and the conversion of received data to display data may be carried out as a subset of the processing stage 32 functionality, without the requirement for a dedicated display driver stage.

Where the message is carrying data from one or other of the beacons 12, 14, the telephone has the ability to filter the information received according to pre-stored 40 user preferences and the user is only alerted (i.e. the information will only be retained in buffer 38 and/or presented on screen 34) if  
5 comparison of stored preference data and subject matter indicators in the message indicate that an item of data of particular interest has been received.

For conventional audio messages, the audio data is output by the filter and processing stage 32, via D/A converter 42 and amplifier 44 to an earphone or speaker 46. Receipt of such messages from the telephone  
10 network 48 is indicated by arrow 50: the telephone network 48 also provides the link from the telephone 10 to a wide-area network (WAN) server 52 and, via the WAN 54 (which may be the internet), to one or more remote service providers 56 providing a source of data for the telephone 10.

Communication between the CA terminal (telephone 10) and the CA  
15 base station (beacon 12) takes two forms: 'push' and 'pull'. In 'push' mode, information is broadcast by the beacons 12, 14, to all portable terminals 10 in the form of short 'keys' indicated at 60. The keys will take various forms according to the application but will generally include a concise description of the information being sent and a pointer to fuller information, e.g. a URL  
20 identifying one of the service providers 56.

Keys are received by the terminal 10 'unconsciously', that is, without direct intervention by the user, and automatically filtered according to the user's pre-set preferences. This filtering may be done by a comparator function applied in processing stage 32. Suitably, the processing stage is  
25 operable to apply the comparator function in multiple simultaneous or overlapping copies such as to process in parallel the relatively large number of keys that may be received. Some will be discarded, some kept for further study, others might cause the user to be alerted immediately. By way of example, shops might choose to push details of special offers into passing  
30 terminals in the knowledge that users who have interest and have therefore set their filters 32 accordingly will be alerted by their terminal.

Sometimes the user will wish to obtain more information than is contained in the keys. Here, 'pull' mode allows a user to set up a connection with a server 56 (which need not necessarily be specially configured for CA use) and actively request information to pull down into the terminal 10. This mode is therefore typically interactive.

Whilst base stations or beacons will typically be independent of one another (in a shopping mall set up, each shop provides and maintains its own beacon without reference to any beacons provided by neighbouring shops), the beacons may be wholly or partially networked with at least some co-ordination as to their broadcast messages.

Figure 2 is a diagram of such a system 100 of linked beacons embodying the invention and providing an implementation of an infrastructure for use in, for example, department stores, shopping malls, theme parks, etc. The system 100 comprises a plurality of beacons 102, 104, 106, 108 distributed over a series of locales. Each of the beacons 102-108 broadcasts one or more short-range inquiry signals in a time-slot format as described in greater detail hereinafter. The beacons 102 - 108 are controlled by a beacon infrastructure server (BIS) 110, with one or more terminals 112, 114, 116, 118 being connected to the server 110. The terminals 112 - 118 enable service providers, i.e., the users of beacons 102 - 108, to author or edit allocated service slots in the form of added data piggy backed on inquiry facilitation signals transmitted by beacons 102 - 108. A service provider may lease a beacon or one of the beacon's service slots from the infrastructure provider. To this end, server 110 provides simple HTML templates for filling out by the user via one of terminals 112 - 118. Having filled out the template with, for example, a description of the service and other information for the data to be carried via the beacon broadcast, the template is returned to server 110, preferably via a secure link using, e.g., Secure HTTP (S-HTTP) or Secure Sockets Layer (SSL). SSL creates a secure link between a client and a server, over which any amount of data can be sent securely. S-HTTP is designed to transmit individual messages securely. Server 110 then creates the appropriate additional data package for appending to the inquiry signal of a relevant one of

the beacons 102 - 108 based on the information submitted with the template. The system 100 may further comprise an application server 120 to assist in carrying out various functions, as will be readily understood by the skilled reader.

5 Referring back to Figure 1, a strong candidate technology for the wireless link necessary for at least the 'push' mode of the above-described CA system is Bluetooth, on the grounds that it is expected to become a component part of a large number of mobile telephones 10. In analysing the Bluetooth protocol for CA broadcast or 'push' mode utilisation, a problem may  
10 be seen. In the ideal case, the terminal 10 will detect fixed beacons 12, 14 and extract basic information from them without the terminal 10 needing to transmit at all. However, this type of broadcast operation is not supported by the current Bluetooth specification.

In part, the incompatibility follows the frequency hopping nature of  
15 Bluetooth beacon systems which means that, in order for broadcast messages (or, indeed, any messages) to be received by a passing terminal, the terminal has to be synchronised to the beacon in both time and frequency. The portable device 10 has to synchronise its clock to the beacon clock and, from the beacons identity, deduce which of several hopping sequences is being  
20 employed.

To make this deduction, the portable device has conventionally been required to join – as a slave - the piconet administered by the beacon as piconet master. Two sets of procedures are used, namely “inquiry” and “page”. Inquiry allows a would-be slave to find a base station and issue a  
25 request to join the piconet. Page allows a base station to invite slaves of its choice to join the net. Analysis of these procedures indicates that the time taken to join a piconet and then be in a position to receive information from the master could be several tens of seconds, which is much too long for CA applications, where a user may move out of range of a beacon before joining  
30 could be completed.

The difficulty of receiving broadcast data from beacons is caused at least partially by the frequency-hopping nature of Bluetooth and similar

systems. The Bluetooth inquiry procedure has been proposed specifically to solve the problem of bringing together master and slave: the applicants have recognised that it is possible to piggy-back a broadcast channel on the inquiry messages issued by the master. Only CA terminals need read the broadcast channel messages and only CA base stations or beacons send them. In consequence, at the air interface, the mechanism is entirely compatible with conventional (non-CA) Bluetooth systems.

To illustrate how this is implemented, we first consider how the Inquiry procedures themselves operate, with reference to Figures 3 and 4. When a Bluetooth unit wants to discover other Bluetooth devices, it enters a so-called inquiry substate. In this mode, it issues an inquiry message containing a General Inquiry Access Code (GIAC) or a number of optional Dedicated Inquiry Access Codes (DIAC). This message transmission is repeated at several levels; first, it is transmitted on 16 frequencies from a total of 32 making up the inquiry hopping sequence. The message is sent twice on two frequencies in even timeslots with the following, odd timeslots used to listen for replies on the two corresponding inquiry response hopping frequencies. Sixteen frequencies and their response counterparts can therefore be covered in 16 timeslots, or 10ms. The chart of Figure 3 illustrates the transmission sequence on sixteen frequencies centred around  $f\{k\}$ , where  $f\{k\}$  represents the inquiry hopping sequence.

The next step is the repetition of the transmission sequence at least  $N_{\text{inquiry}}$  times. At the very least, this requires 256 repetitions of the entire sequence which constitutes a train of transmissions which we will refer to as inquiry transmission train A. Next, inquiry transmission train A is swapped for inquiry transmission train B consisting of a transmission sequence on the remaining 16 frequencies. Again, the train B is made up of 256 repetitions of the transmission sequence. Overall the inquiry transmissions cycle between transmissions of train A and train B. As shown by Figure 4, the specification states that this switch between trains must occur at least three times to ensure the collection of all responses in an error-free environment. This means that an inquiry broadcast could take at least 10.24 seconds.

One way to reduce this would be for the switch between inquiry transmission trains to be made more rapidly, i.e. without waiting until the 2.56 seconds for 256 repetitions of the 10ms to cover the 16 timeslots is up. This may suitably be accomplished by setting the systems to switch over if no inquiry message is detected after say 50ms, on the understanding that no such message will be detected in the remainder of the present train.

A portable device that wants to be discovered by a beacon enters the inquiry scan substate. Here, it listens for a message containing the GIAC or DIAC's of interest. It, too, operates in a cyclic way. It listens on a single hop frequency for an inquiry scan period of  $T_{w\_inquiry\_scan}$ . This must be long enough to cover the 16 inquiry frequencies used by the inquiry. The interval between the beginning of successive scans must be no greater than 1.28 seconds. The frequency chosen comes from the list of 32 making up the inquiry hopping sequence.

On hearing an inquiry containing an appropriate IAC, the portable device enters a so-called inquiry response substate and issues a number of inquiry response messages to the beacon. The beacon will then page the portable device, inviting it to join the piconet.

As mentioned above and shown in Figure 5, the applicants propose that the inquiry messages issued by the base station have an extra field appended to them, capable of carrying a user-defined payload (CA DATA). In the CA scenario, this payload is used to carry broadcast information, or keys, to CA terminals during the inquiry procedure. By adding the field to the end of the inquiry message, it will be appreciated that non-CA receivers can ignore it without modification. In addition, by using a CA-specific DIAC, CA receivers can be alerted to the presence of the extra information field.

The presence of the extra data field means that the guard space conventionally allowed at the end of a Bluetooth inquiry packet is reduced. However, this space - provided to give a frequency synthesiser time to change to a new hop frequency - will be generally unused otherwise, as current frequency synthesisers are capable of switching at speeds which do not need extension into the extra guard space. The standard inquiry packet is an ID

packet of length 68 bits. Since it is sent in a half-slot, the guard space allocated is  $(625/2 - 68) = 244.5 \mu\text{s}$  (625  $\mu\text{s}$  slot period, 1 Mbit/s signalling rate). Modern synthesisers can switch in much less time with figures of 100  $\mu\text{s}$  or lower considered routine by experts in the field. Applicants therefore propose allocation of 100 bits as a suitable size for this new field, although it will be readily understood that other field sizes are, of course, possible.

CA handsets can receive the broadcast data quickly without being required to run through a lengthy procedure to join a piconet. In addition, since there is no need for the handset to transmit any information whatsoever, there is a consequent power saving that will be particularly important in dense environments where many CA base stations may be present. Nevertheless, when the handset is in interactive mode and wishes to join a piconet in order to obtain more information, it may employ the default inquiry procedures as normal. There is no loss of functionality through supporting the additional data field.

In a typical embodiment, four of our 100 bits will be lost as trailer bits for the ID field; this is a consequence of it being read by a correlator. Of the 96 bits remaining, applicants preferred allocation is that 64 be used as data and 32 as a 2/3 FEC (forward error correction) checksum, although the checksum, any headers included, and other overheads may greatly reduce the number of bits available for data, perhaps to 10 bits or fewer in some circumstances. Each inquiry burst thus contains 8 bytes of broadcast data. In a most common scenario, by the second group of A and B trains the portable device has found the base station, understood it to be a CA beacon and is awaiting the broadcast data. Since it will be listening specifically, the portable device will at least be able to read 256 bursts of data twice (A and B), giving us two lots of 2 Kbytes, or 4 Kbytes in total.

At this stage, the portable device does not know the phase of the beacons clock because this information is not been transmitted. To assist the portable device, clock information is transmitted in at least some of the trains in the first A and B groups, as shown in Figure 6, together with some auxiliary information indicating when the next switches between A and B will occur.

This clock information will be transmitted in place of the CA broadcast data so means are provided to discriminate between the two data channels. Use of separate DIAC's is one possible method.

5 In the case where the portable device knows the timing of the beacon, the portable devices also knows how it will hop, which gives the ability to track all transmissions of a train. Since there are 16 transmissions in a frame, then the resultant CA channel has 16 times as much capacity and can convey 64 Kbytes of information.

10 Since the terminal wakes up every 1.28 seconds or less, it will generally have obtained the clocking information it needs by the half way mark in the first A or B periods. Switching from clock to data at these halfway marks, as illustrated in Figure 7, provides a number of useful advantages. Firstly, some data can be received in less than five seconds from the start of the inquiry procedure. Secondly, the terminal can still respond to an important key by 15 automatically issuing an inquiry response message to the base station (if that is the appropriate action for the terminal to take) even if the key appears comparatively late in the cycle. It will be noted that no increase in capacity is assumed.

20 In the foregoing, a portable device will receive all the additional data field packets on one of the 32 inquiry channels, thereby using only 1/32 of the available bandwidth. As will be recognised, if the uncertainty as to when a portable terminal (beacon slave) receives the first inquiry packet can be overcome, the predetermined nature of the hopping sequence may be accommodated and the full bandwidth therefore utilised. For a slave to 25 synchronise with a masters inquiry hopping sequence from the point where it received the first packet, the slave needs to know both the masters clock offset and the position of the first received packet in the masters hopping sequence. In the following example, it is assumed that the master follows the Bluetooth minimum enquiry procedure, which comprises 256 repetitions of the 16- 30 channel inquiry hopping sequences, with three train switches (as in Figure 4). Each sweep across the 16 channels takes 10ms.



An alternative method of synchronising the slave hopping is to transmit clocking data in every broadcast field. The additional data field (BCD; Fig. 1) carries 4 bytes containing the following information:

- Master clock offset (2 bytes);
- 5 • Number of full train repetitions (1 byte) – assuming that a full train consists of 256 repetitions of 10ms trains, the range of this parameter is 0-255 (before the inquiry switches to the next full train). This indicates to the slave when the master will next switch the full train.
- 10 • How many full train switches have been completed in the current inquiry cycle (1 byte) – this data indicates to the slave what the master is likely to do at the end of the current full train, i.e. whether it will switch over to another full train or whether the inquiry procedure will terminate.

15 As long as no channel repeats in the 10ms train, no field is required to indicate the position of the current channel in the hopping sequence as the slave is able to derive this from knowledge of the sequence.

From the foregoing it will be seen that, by adding 4 bytes to each additional field packet, the slave can then pick up all additional field packets to  
20 the end of the inquiry, whilst still having 4 bytes available (from our preferred assignment of 64 from 100 bits for data) to carry broadcast data.

Considering a complete beacon signal, it will be readily understood that it will need to be divided into a number of 4-byte packets with one being sent with each inquiry packet. Assuming a fixed length of beacon signal for the  
25 purposes of illustration, at 16kB the full signal can be accommodated on a single inquiry train (a train being 256 repetitions of the 16-channel hop sequence, giving  $256 \cdot 16 \cdot 4$  bytes = 16kB).

Extending this, by fixing that the first packet of a beacon signal goes on the first packet of an inquiry train, from the message indicator field for the  
30 number of repetitions for the current 16-channel hopping sequence in the message header, the slave is enabled to derive the position of the beacon packet it has received in the complete beacon signal.

Mobile CA devices may be provided with location aware applications. Such applications generally require actual location information, as opposed to just location specific information. Therefore we now discuss the issue of transferring such location information to a portable terminal.

5 In principle, by using a Bluetooth link, location information can be transferred over a short-range air interface allowing (Bluetooth enabled) location aware products to find out where they are. Such products can therefore establish their position using data originating from location establishing devices such as a GPS receiver, or other devices providing a source of location information. Therefore, the products themselves do not need to be equipped with potentially expensive and sometimes unreliable onboard location systems. Unfortunately, the transfer mechanism suffers from the above mentioned problems resulting from the fact that before information can be transferred, a Bluetooth link needs to be established. Establishing such a link requires a Bluetooth slave terminal (in this case the terminal making the location information request), to join the piconet administered by the Bluetooth master terminal (in this case the terminal responding to the enquires). The process of joining the piconet can take several tens of seconds. While this is happening the terminal does not know its current location and the operation of any location aware applications on the terminal will therefore be impaired. Therefore this approach is not ideal for providing location information to a context aware device – a mobile CA device may not spend enough time near a given beacon to establish a Bluetooth link. Furthermore, even if a device does carry out the establishment of a Bluetooth link, there will not necessarily be any location information available and the exercise will have been a wasted exercise.

We therefore propose that the presently described concept of establishing a broadcast channel from beacons for reception by CA devices, by adding data to inquiry transmissions should include the procedure of including location information as part of the information broadcast on that channel.

As described above, initial proposals assume that each inquiry burst can carry 8 bytes of broadcast data in the extended field. Some of this will be used for synchronisation purposes so that there will be in the order of 4 to 6 bytes remaining. A typical location information packet requires approximately  
5 12 to 15 bytes to convey basic service information, such as latitude / longitude co-ordinates and a few other parameters. For extended service purposes, the location information will typically require in the order of 15 to 300 bytes allowing information such as velocity information, optional auxiliary text and URL fields to be carried. In either case, the information may need to be  
10 spread over several packets. Basic service location information may be broadcast more often than extended service information. Optionally, extended service information may be retrieved over a normal Bluetooth connection in a 'client pull' type operation as a result of the basic broadcast indicating to the client that such extended service information is available.

15 In order to distinguish location information from other types of broadcast information (for example, other context aware mobile phone services or broadcast audio), two possible techniques include the following. The first is to use a special DIAC. A second, is to include a header somewhere in the additional data field to describe the information content type. In the presently  
20 described embodiment, we shall assume that the entire basic service location information burst is spread over four extended inquiry packets, although this is not to be interpreted as a limitation to the present invention.

The order of the inquiry transmissions from the master has already been discussed in some detail above, with two sets of sixteen frequencies  
25 being covered in 'trains' of inquiry transmission. In each train, all 16 frequencies in the set are covered in 10ms and this cycle is repeated 256 times (see Figures 4 and the relevant discussion above). Each train may be repeated twice.

30 Since the slave scans on a single frequency arbitrarily chosen from the set of 32 frequencies, it is useful to send location information on every frequency used for inquiry transmissions. Assuming that we require four

extended fields on each frequency, the location information burst will take 40 ms and about 1.6% of the total broadcast capacity to send.

For fast location acquisition, it is assumed that the beacon must be active continuously. Such activity would normally prevent conventional two-way links being set up but this obstacle can be overcome by employing two beacons operating in tandem, thereby providing fast access to the piconet and an unlimited two-way throughput capacity simultaneously. Such an arrangement is the subject of our pending UK patent application number GB0015452.6 entitled "Local Data Delivery through Beacons" filed on 26th June 2000.

The number of times location information is transmitted in a train can affect the access time to location information. By increasing the frequency of location information transmission in a train, speed of access to information can be improved. Assuming that one location information burst is sent per train, then the access time ranges from 0 to 5.12 seconds (the longer time results when the slave just misses the location information broadcast within the train and must wait for the duration of the remaining part of train A, all of train B and a portion of the next train A before it is possible to pick up the location information).

If it is known to a terminal receiver (slave receiver) that inquiry information is broadcast on each of 16 frequencies, say every 10ms, and it is monitoring those frequencies every 10ms, and after say 50ms the receiver has not managed to pick up any inquiry transmissions at all, it can choose to switch to monitoring those other 16 inquiry transmission frequencies associated with the other train.

If, in the absence of received inquiry transmissions on one of the inquiry transmission trains, the receiver is allowed to jump frequency to one in the other inquiry transmission train, access time to information carried in the additional data field, for example location information, might be reduced. The reduced time may be, for example in the order of 2.56 seconds. Transmitting the burst twice per frame brings this down to, say, 1.28 seconds maximum or 640 ms average.

It will be apparent that the location information may take a number of forms in both the format location information is represented and in the format it is broadcast. For example, the information may be represented in terms of mapping co-ordinates, Global Positioning System data, or any other suitable way. Location information may be absolute or relative. In the latter case location information may be expressed, for example, with reference to building room designations, vehicle identity (say, when a person is on a bus) or in other ways as will be apparent to the person skilled in the art.

From reading the present disclosure, other modifications will be apparent to persons skilled in the art. Such modifications may involve other features which are already known in the design, manufacture and use of fixed and portable communications systems, and systems and components for incorporation therein and which may be used instead of or in addition to features already described herein. As an example, rather than the foregoing scheme of having 4 clock and 4 data bytes in every broadcast packet, other arrangements may be used: an arrangement of 2 clock and 6 data bytes in 15 out of every 16 packets (with 4 clock and 4 data bytes in every sixteenth packet) improves the data carrying capability without necessarily detracting from the synchronisation performance.

FOR PUBLICATION

## CLAIMS:

1. A communications system comprising at least one beacon device capable of wireless message transmission and at least one portable device  
5 capable of receiving such a message transmission, wherein the beacon is arranged to broadcast a series of inquiry messages each in the form of a plurality of predetermined data fields arranged according to a first communications protocol, wherein the beacon is further arranged to add to each inquiry message prior to transmission an additional data field, and  
10 wherein the at least one portable device is arranged to receive the transmitted inquiry messages and read data from said additional data field, the additional data field including location information.
2. A system as claimed in Claim 1, wherein the beacon is arranged  
15 to add said additional data field at the end of a respective inquiry message.
3. A system as claimed in Claim 1, wherein the beacon is arranged to include an indication in one of said predetermined data fields, said indication denoting the presence of said additional data field.  
20
4. A system as claimed in Claim 1, wherein said first communications protocol comprises Bluetooth messaging.
5. A system as claimed in claim 4, wherein a special Dedicated Inquiry  
25 Access Code (DIAC) is used to indicate the presence of location information in the additional data field.
6. A system as claimed in claim 1, wherein the presence of location  
30 information in the additional data field is indicated with header information appearing in the additional data field.

7. A system in accordance with claim 1, wherein wireless messaging system employs frequency hopping, and further wherein location data is sent on each frequency used for inquiry message broadcasts.

5           8. A mobile communication device for use in the system of Claim 1, the device comprising a receiver capable of receiving a short-range wireless inquiry message including a plurality of data fields according to a first communications protocol, means for determining when an additional data field including location information has been added to said plurality of data fields,  
10 and means for reading the location information data from such an additional data field.

          9. A device as claimed in Claim 8, wherein the receiver is configured to receive messages according to Bluetooth protocols.

15           10. A beacon device capable of wireless message transmission and for use in a communications system comprising said beacon device and at least one portable device capable of receiving such a message transmission, wherein the beacon is configured to broadcast a series of inquiry messages  
20 each in the form of a plurality of predetermined data fields arranged according to a first communications protocol, and to add to each inquiry message prior to transmission an additional data field, such as to enable the at least one portable device arranged to receive the transmitted inquiry messages to read data from said additional data field, the additional data field including location  
25 information.

          11. A method for enabling the user of a portable communications device to receive broadcast messages wherein at least one beacon device broadcasts a series of inquiry messages each in the form of a plurality of  
30 predetermined data fields arranged according to a first communications protocol, wherein the beacon adds to each inquiry message prior to transmission an additional data field carrying broadcast message data

including location information, and wherein the portable device receives the transmitted inquiry messages including the location information and reads the broadcast data from said additional data field.

5           12.    A method as claimed in Claim 11, wherein the beacon adds said additional data field at the end of a respective inquiry message.

          13.    A method as claimed in Claim 11, wherein the beacon includes an indication in one of said predetermined data fields, said indication denoting  
10   the presence of said additional data field.

          14.    A method as claimed in Claim 11, wherein said first communications protocol comprises Bluetooth messaging.



## ABSTRACT

**DATA DELIVERY THROUGH BEACONS**

5           A communications system comprises at least one beacon device  
capable of wireless message transmission and at least one portable device  
capable of receiving such a message transmission. The beacon is arranged to  
broadcast a series of inquiry messages each in the form of a plurality of  
predetermined data fields arranged according to a first communications  
10   protocol, such as Bluetooth. For the delivery of additional data via broadcast,  
and in particular data including location information, the beacon adds to each  
inquiry message prior to transmission an additional data field carrying  
broadcast data, with the portable device receiving the transmitted inquiry  
messages including the location data and reading the broadcast data from the  
15   additional data field.

PHGB000109US

PHGB000109

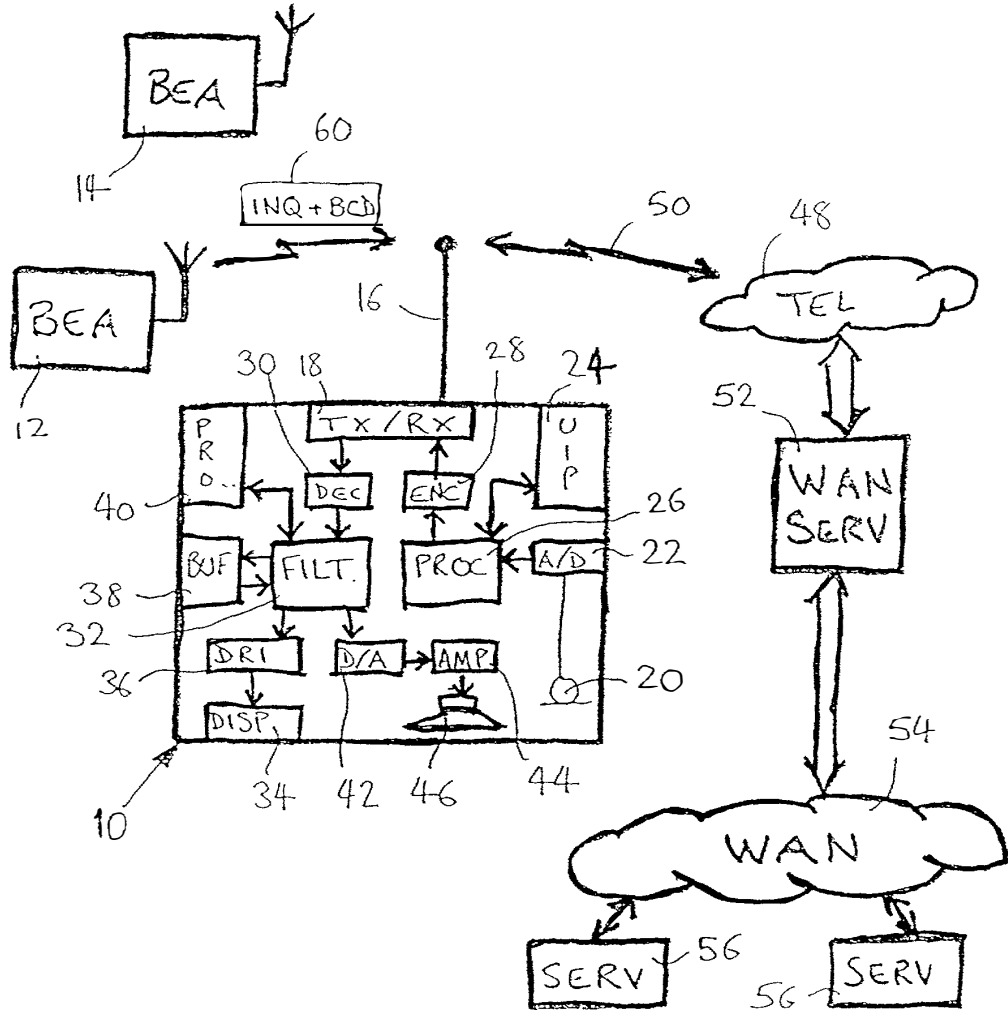

Fig. 1

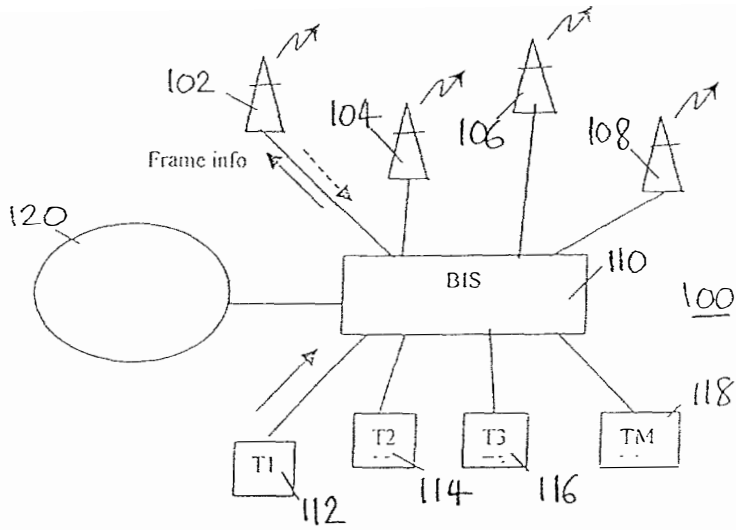

Fig. 2

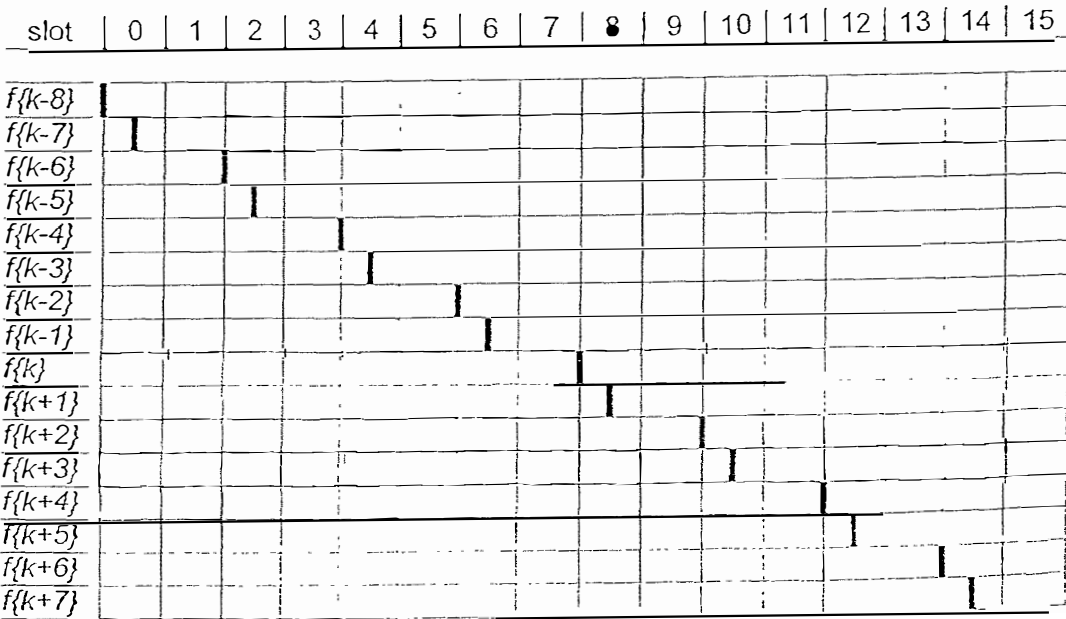
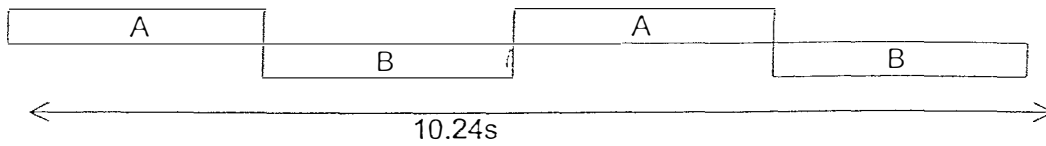
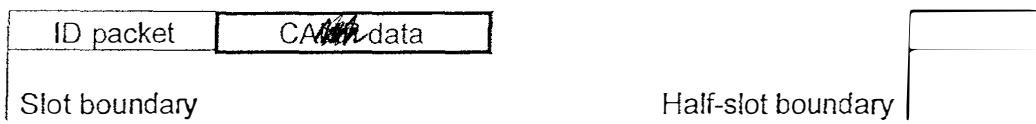

Fig. 3



**Fig. 4**



**Fig. 5**

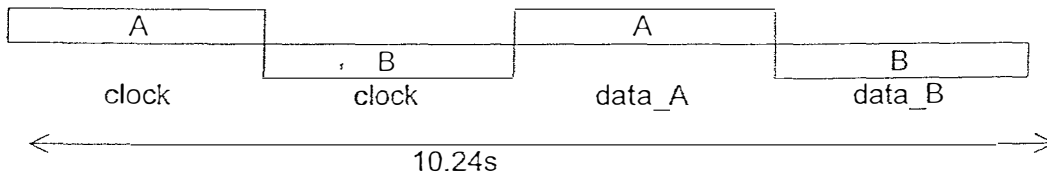

**Fig. 6**

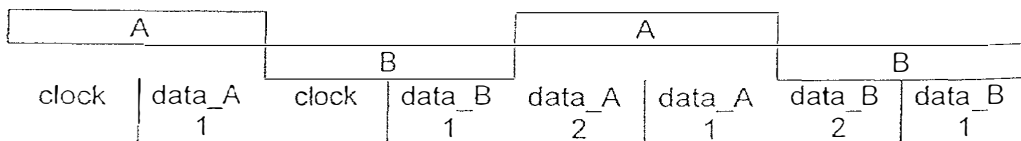

**Fig. 7**

# DECLARATION AND POWER OF ATTORNEY

Sole/Joint

Attorney's Docket No:  
PHGB 000109 US

As a below named inventor, I hereby declare that:

My residence, post office address and citizenship are as stated below next to my name

I believe I am the original, first and sole inventor (if only one name is listed below) or an original, first and joint inventor (if plural names are listed below) of the subject matter which is claimed and for which a patent is sought on the invention entitled

DATA DELIVERY THROUGH BEACONS

the specification of which (check one)

is attached hereto

was filed on

as Application Serial No: ..... and was amended on

..... (if applicable).

I hereby state that I have reviewed and understand the contents of the above-identified specification, including the claims, as amended by any amendment referred to above.

I acknowledge the duty to disclose information which is material to the examination of this application in accordance with Title 37, Code of Federal Regulations, §1.56 (a).

I hereby claim foreign priority benefits under Title 35, United States Code, §119 of any foreign application(s) for patent or inventor's certificate listed below and have also identified below any foreign application for patent or inventor's certificate having a filing date before that of the application on which priority is claimed.

### PRIOR FOREIGN APPLICATION(S)

| COUNTRY       | APPLICATION NUMBER | DATE OF FILING<br>(day, month, year) | PRIORITY<br>Claimed Under<br>35 U.S.C. 119 |                             |
|---------------|--------------------|--------------------------------------|--------------------------------------------|-----------------------------|
| GREAT BRITAIN | 0015454.2          | 26-06-2000                           | Yes <input checked="" type="checkbox"/>    | No <input type="checkbox"/> |
| GREAT BRITAIN | 0020073.3          | 15-08-2000                           | Yes <input checked="" type="checkbox"/>    | No <input type="checkbox"/> |

I hereby claim the benefit under Title 35, United States Code, §120 of any United States application(s) listed below and, insofar as the subject matter of each of the claims of this application is not disclosed in the prior United States application in the manner provided by the first paragraph of Title 35 United States Code §112, I acknowledge the duty to disclose material information as defined in Title 37, Code of Federal Regulations, §1.56(a) which occurred between the filing date of the prior application and the national or PCT international filing date of this application.

### PRIOR UNITED STATES APPLICATION(S)

| APPLICATION SERIAL NUMBER | FILING DATE | STATUS (PATENTED, PENDING, ABANDONED) |
|---------------------------|-------------|---------------------------------------|
|                           |             |                                       |

I hereby declare that all statements made herein of my own knowledge are true and that all statements made on information and belief are believed to be true; and further that these statements were made with the knowledge that willful false statements and the like so made are punishable by fine or imprisonment, or both, under Section 1001 of Title 18 of the United States Code and that such willful false statements may jeopardize the validity of the application or any patent issued thereon.

**POWER OF ATTORNEY:** As a named inventor, I hereby appoint the following attorney(s) and/or agent(s) to prosecute this application and transact all business in the Patent and Trademark Office connected therewith. (list name and registration number)

Jack E. Haken, Reg. No 26,902  
Algy Tamoshunas, Reg. No 27,677

|                                                                                                                                       |                                                                                 |
|---------------------------------------------------------------------------------------------------------------------------------------|---------------------------------------------------------------------------------|
| SEND CORRESPONDENCE TO:<br>Corporate Patent Counsel<br>U.S. Philips Corporation<br>580 White Plains Road<br>Tarrytown, New York 10591 | DIRECT TELEPHONE CALLS TO:<br>(Name and telephone number)<br><br>(914) 332-0222 |
|---------------------------------------------------------------------------------------------------------------------------------------|---------------------------------------------------------------------------------|

|                                  |                           |                                       |                                                  |
|----------------------------------|---------------------------|---------------------------------------|--------------------------------------------------|
| Dated: 18 <sup>th</sup> May 2001 |                           | Inventor's Signature: Robert J. Davis |                                                  |
| FULL NAME OF INVENTOR:           | Last name: DAVIES         | First Name: Robert                    | Middle Name: J.                                  |
| RESIDENCE & CITIZENSHIP:         | City: HORLEY              | State or Foreign Country: ENGLAND     | Country of Citizenship: GREAT BRITAIN            |
| POST OFFICE ADDRESS:             | Street & No: 7 WITHERDALE | City: HORLEY                          | State or Country: SURREY, U.K. Zip Code: RH6 8BW |

|                                  |                              |                                      |                                                  |
|----------------------------------|------------------------------|--------------------------------------|--------------------------------------------------|
| Dated: 21 <sup>st</sup> May 2001 |                              | Inventor's Signature: Paul R. Dooley |                                                  |
| FULL NAME OF INVENTOR:           | Last name: DOOLEY            | First Name: Saul                     | Middle Name: R.                                  |
| RESIDENCE & CITIZENSHIP:         | City: REIGATE                | State or Foreign Country: ENGLAND    | Country of Citizenship: GREAT BRITAIN            |
| POST OFFICE ADDRESS:             | Street & No: 38 GLOVERS ROAD | City: REIGATE                        | State or Country: SURREY, U.K. Zip Code: RH2 7LA |





UNITED STATES PATENT AND TRADEMARK OFFICE

COMMISSIONER FOR PATENTS  
 UNITED STATES PATENT AND TRADEMARK OFFICE  
 WASHINGTON, D.C. 20231  
 www.uspto.gov



Bib Data Sheet

CONFIRMATION NO. 9201

|                                    |                                                 |                     |                               |                                         |
|------------------------------------|-------------------------------------------------|---------------------|-------------------------------|-----------------------------------------|
| <b>SERIAL NUMBER</b><br>09/876,515 | <b>FILING DATE</b><br>06/07/2001<br><b>RULE</b> | <b>CLASS</b><br>455 | <b>GROUP ART UNIT</b><br>2681 | <b>ATTORNEY DOCKET NO.</b><br>GB 000109 |
|------------------------------------|-------------------------------------------------|---------------------|-------------------------------|-----------------------------------------|

**APPLICANTS**  
 Robert J. Davies, Horley, UNITED KINGDOM;  
 Saul R. Dooley, Reigate, UNITED KINGDOM;

**\*\* CONTINUING DATA \*\*\*\*\***

**\*\* FOREIGN APPLICATIONS \*\*\*\*\***  
 UNITED KINGDOM 0015454.2 06/26/2000  
 UNITED KINGDOM 0020073.3 08/15/2000

**IF REQUIRED, FOREIGN FILING LICENSE GRANTED**  
**\*\* 08/07/2001**

|                                                             |                                                                                                                                                                   |                                           |                            |                           |                                |
|-------------------------------------------------------------|-------------------------------------------------------------------------------------------------------------------------------------------------------------------|-------------------------------------------|----------------------------|---------------------------|--------------------------------|
| Foreign Priority claimed<br>35 USC 119 (a-d) conditions met | <input type="checkbox"/> yes <input type="checkbox"/> no<br><input type="checkbox"/> yes <input type="checkbox"/> no <input type="checkbox"/> Met after Allowance | <b>STATE OR COUNTRY</b><br>UNITED KINGDOM | <b>SHEETS DRAWING</b><br>3 | <b>TOTAL CLAIMS</b><br>14 | <b>INDEPENDENT CLAIMS</b><br>3 |
| Verified and Acknowledged                                   | Examiner's Signature _____<br>Initials _____                                                                                                                      |                                           |                            |                           |                                |

**ADDRESS**  
 Corporate Patent Counsel  
 U.S. Philips Corporation  
 580 White Plains Road  
 Tarrytown , NY 10591

**TITLE**  
 Data delivery through beacons

|                                   |                                                                                                             |                                                                                                                                                                                                                                                                                 |
|-----------------------------------|-------------------------------------------------------------------------------------------------------------|---------------------------------------------------------------------------------------------------------------------------------------------------------------------------------------------------------------------------------------------------------------------------------|
| <b>FILING FEE RECEIVED</b><br>710 | FEES: Authority has been given in Paper No. _____ to charge/credit DEPOSIT ACCOUNT No. _____ for following: | <input type="checkbox"/> All Fees<br><input type="checkbox"/> 1.16 Fees ( Filing )<br><input type="checkbox"/> 1.17 Fees ( Processing Ext. of time )<br><input type="checkbox"/> 1.18 Fees ( Issue )<br><input type="checkbox"/> Other _____<br><input type="checkbox"/> Credit |
|-----------------------------------|-------------------------------------------------------------------------------------------------------------|---------------------------------------------------------------------------------------------------------------------------------------------------------------------------------------------------------------------------------------------------------------------------------|

PATENT APPLICATION SERIAL NO. \_\_\_\_\_

U.S. DEPARTMENT OF COMMERCE  
PATENT AND TRADEMARK OFFICE  
FEE RECORD SHEET

06/12/2001 EFLDRES 00000097 141270 09876515

01 FC:101 710.00 CH

PTO-1556  
(5/87)



**PATENT APPLICATION FEE DETERMINATION RECORD**

Effective October 1, 2000

Application or Docket Number

~~60009109~~  
09 1876515

**CLAIMS AS FILED - PART I**

|                                                           | (Column 1)     | (Column 2)   |
|-----------------------------------------------------------|----------------|--------------|
| TOTAL CLAIMS                                              | 14             |              |
| FOR                                                       | NUMBER FILED   | NUMBER EXTRA |
| TOTAL CHARGEABLE CLAIMS                                   | 14 minus 20= * |              |
| INDEPENDENT CLAIMS                                        | 3 minus 3 = *  |              |
| MULTIPLE DEPENDENT CLAIM PRESENT <input type="checkbox"/> |                |              |

\* If the difference in column 1 is less than zero, enter "0" in column 2

SMALL ENTITY TYPE

OR OTHER THAN SMALL ENTITY

| RATE      | FEE    |
|-----------|--------|
| BASIC FEE | 355.00 |
| X\$ 9=    |        |
| X40=      |        |
| +135=     |        |
| TOTAL     |        |

| RATE      | FEE    |
|-----------|--------|
| BASIC FEE | 710.00 |
| X\$18=    |        |
| X80=      |        |
| +270=     |        |
| TOTAL     | 710    |

**CLAIMS AS AMENDED - PART II**

| AMENDMENT A                                                             | (Column 1)                       | (Column 2)                         | (Column 3)    |
|-------------------------------------------------------------------------|----------------------------------|------------------------------------|---------------|
|                                                                         | CLAIMS REMAINING AFTER AMENDMENT | HIGHEST NUMBER PREVIOUSLY PAID FOR | PRESENT EXTRA |
| Total                                                                   | *                                | Minus **                           | =             |
| Independent                                                             | *                                | Minus ***                          | =             |
| FIRST PRESENTATION OF MULTIPLE DEPENDENT CLAIM <input type="checkbox"/> |                                  |                                    |               |

SMALL ENTITY OR

OTHER THAN SMALL ENTITY

| RATE             | ADDITIONAL FEE |
|------------------|----------------|
| X\$ 9=           |                |
| X40=             |                |
| +135=            |                |
| TOTAL ADDIT. FEE |                |

| RATE             | ADDITIONAL FEE |
|------------------|----------------|
| X\$18=           |                |
| X80=             |                |
| +270=            |                |
| TOTAL ADDIT. FEE |                |

| AMENDMENT B                                                             | (Column 1)                       | (Column 2)                         | (Column 3)    |
|-------------------------------------------------------------------------|----------------------------------|------------------------------------|---------------|
|                                                                         | CLAIMS REMAINING AFTER AMENDMENT | HIGHEST NUMBER PREVIOUSLY PAID FOR | PRESENT EXTRA |
| Total                                                                   | *                                | Minus **                           | =             |
| Independent                                                             | *                                | Minus ***                          | =             |
| FIRST PRESENTATION OF MULTIPLE DEPENDENT CLAIM <input type="checkbox"/> |                                  |                                    |               |

| RATE             | ADDITIONAL FEE |
|------------------|----------------|
| X\$ 9=           |                |
| X40=             |                |
| +135=            |                |
| TOTAL ADDIT. FEE |                |

| RATE             | ADDITIONAL FEE |
|------------------|----------------|
| X\$18=           |                |
| X80=             |                |
| +270=            |                |
| TOTAL ADDIT. FEE |                |

| AMENDMENT C                                                             | (Column 1)                       | (Column 2)                         | (Column 3)    |
|-------------------------------------------------------------------------|----------------------------------|------------------------------------|---------------|
|                                                                         | CLAIMS REMAINING AFTER AMENDMENT | HIGHEST NUMBER PREVIOUSLY PAID FOR | PRESENT EXTRA |
| Total                                                                   | *                                | Minus **                           | =             |
| Independent                                                             | *                                | Minus ***                          | =             |
| FIRST PRESENTATION OF MULTIPLE DEPENDENT CLAIM <input type="checkbox"/> |                                  |                                    |               |

| RATE             | ADDITIONAL FEE |
|------------------|----------------|
| X\$ 9=           |                |
| X40=             |                |
| +135=            |                |
| TOTAL ADDIT. FEE |                |

| RATE             | ADDITIONAL FEE |
|------------------|----------------|
| X\$18=           |                |
| X80=             |                |
| +270=            |                |
| TOTAL ADDIT. FEE |                |

\* If the entry in column 1 is less than the entry in column 2, write "0" in column 3.

\*\* If the "Highest Number Previously Paid For" IN THIS SPACE is less than 20, enter "20."

\*\*\*If the "Highest Number Previously Paid For" IN THIS SPACE is less than 3, enter "3."

The "Highest Number Previously Paid For" (Total or Independent) is the highest number found in the appropriate box in column 1.

BEST AVAILABLE COPY

|              |                                                                                      |             |
|--------------|--------------------------------------------------------------------------------------|-------------|
| CLAIMS ONLY  | SERIAL NO.<br><span style="font-size: 1.2em; font-family: cursive;">098 76515</span> | FILING DATE |
| APPLICANT(S) |                                                                                      |             |

CLAIMS

|              | AS FILED |      | AFTER 1st AMENDMENT |      | AFTER 2nd AMENDMENT |      |  | *    |      | *    |      | *    |      |
|--------------|----------|------|---------------------|------|---------------------|------|--|------|------|------|------|------|------|
|              | IND.     | DEP. | IND.                | DEP. | IND.                | DEP. |  | IND. | DEP. | IND. | DEP. | IND. | DEP. |
| 1            |          |      |                     |      |                     |      |  |      |      |      |      |      |      |
| 2            |          |      |                     |      |                     |      |  |      |      |      |      |      |      |
| 3            |          |      |                     |      |                     |      |  |      |      |      |      |      |      |
| 4            |          |      |                     |      |                     |      |  |      |      |      |      |      |      |
| 5            |          |      |                     |      |                     |      |  |      |      |      |      |      |      |
| 6            |          |      |                     |      |                     |      |  |      |      |      |      |      |      |
| 7            |          |      |                     |      |                     |      |  |      |      |      |      |      |      |
| 8            |          |      |                     |      |                     |      |  |      |      |      |      |      |      |
| 9            |          |      |                     |      |                     |      |  |      |      |      |      |      |      |
| 10           |          |      |                     |      |                     |      |  |      |      |      |      |      |      |
| 11           |          |      |                     |      |                     |      |  |      |      |      |      |      |      |
| 12           |          |      |                     |      |                     |      |  |      |      |      |      |      |      |
| 13           |          |      |                     |      |                     |      |  |      |      |      |      |      |      |
| 14           |          |      |                     |      |                     |      |  |      |      |      |      |      |      |
| 15           |          |      |                     |      |                     |      |  |      |      |      |      |      |      |
| 16           |          |      |                     |      |                     |      |  |      |      |      |      |      |      |
| 17           |          |      |                     |      |                     |      |  |      |      |      |      |      |      |
| 18           |          |      |                     |      |                     |      |  |      |      |      |      |      |      |
| 19           |          |      |                     |      |                     |      |  |      |      |      |      |      |      |
| 20           |          |      |                     |      |                     |      |  |      |      |      |      |      |      |
| 21           |          |      |                     |      |                     |      |  |      |      |      |      |      |      |
| 22           |          |      |                     |      |                     |      |  |      |      |      |      |      |      |
| 23           |          |      |                     |      |                     |      |  |      |      |      |      |      |      |
| 24           |          |      |                     |      |                     |      |  |      |      |      |      |      |      |
| 25           |          |      |                     |      |                     |      |  |      |      |      |      |      |      |
| 26           |          |      |                     |      |                     |      |  |      |      |      |      |      |      |
| 27           |          |      |                     |      |                     |      |  |      |      |      |      |      |      |
| 28           |          |      |                     |      |                     |      |  |      |      |      |      |      |      |
| 29           |          |      |                     |      |                     |      |  |      |      |      |      |      |      |
| 30           |          |      |                     |      |                     |      |  |      |      |      |      |      |      |
| 31           |          |      |                     |      |                     |      |  |      |      |      |      |      |      |
| 32           |          |      |                     |      |                     |      |  |      |      |      |      |      |      |
| 33           |          |      |                     |      |                     |      |  |      |      |      |      |      |      |
| 34           |          |      |                     |      |                     |      |  |      |      |      |      |      |      |
| 35           |          |      |                     |      |                     |      |  |      |      |      |      |      |      |
| 36           |          |      |                     |      |                     |      |  |      |      |      |      |      |      |
| 37           |          |      |                     |      |                     |      |  |      |      |      |      |      |      |
| 38           |          |      |                     |      |                     |      |  |      |      |      |      |      |      |
| 39           |          |      |                     |      |                     |      |  |      |      |      |      |      |      |
| 40           |          |      |                     |      |                     |      |  |      |      |      |      |      |      |
| 41           |          |      |                     |      |                     |      |  |      |      |      |      |      |      |
| 42           |          |      |                     |      |                     |      |  |      |      |      |      |      |      |
| 43           |          |      |                     |      |                     |      |  |      |      |      |      |      |      |
| 44           |          |      |                     |      |                     |      |  |      |      |      |      |      |      |
| 45           |          |      |                     |      |                     |      |  |      |      |      |      |      |      |
| 46           |          |      |                     |      |                     |      |  |      |      |      |      |      |      |
| 47           |          |      |                     |      |                     |      |  |      |      |      |      |      |      |
| 48           |          |      |                     |      |                     |      |  |      |      |      |      |      |      |
| 49           |          |      |                     |      |                     |      |  |      |      |      |      |      |      |
| 50           |          |      |                     |      |                     |      |  |      |      |      |      |      |      |
| 51           |          |      |                     |      |                     |      |  |      |      |      |      |      |      |
| 52           |          |      |                     |      |                     |      |  |      |      |      |      |      |      |
| 53           |          |      |                     |      |                     |      |  |      |      |      |      |      |      |
| 54           |          |      |                     |      |                     |      |  |      |      |      |      |      |      |
| 55           |          |      |                     |      |                     |      |  |      |      |      |      |      |      |
| 56           |          |      |                     |      |                     |      |  |      |      |      |      |      |      |
| 57           |          |      |                     |      |                     |      |  |      |      |      |      |      |      |
| 58           |          |      |                     |      |                     |      |  |      |      |      |      |      |      |
| 59           |          |      |                     |      |                     |      |  |      |      |      |      |      |      |
| 60           |          |      |                     |      |                     |      |  |      |      |      |      |      |      |
| 61           |          |      |                     |      |                     |      |  |      |      |      |      |      |      |
| 62           |          |      |                     |      |                     |      |  |      |      |      |      |      |      |
| 63           |          |      |                     |      |                     |      |  |      |      |      |      |      |      |
| 64           |          |      |                     |      |                     |      |  |      |      |      |      |      |      |
| 65           |          |      |                     |      |                     |      |  |      |      |      |      |      |      |
| 66           |          |      |                     |      |                     |      |  |      |      |      |      |      |      |
| 67           |          |      |                     |      |                     |      |  |      |      |      |      |      |      |
| 68           |          |      |                     |      |                     |      |  |      |      |      |      |      |      |
| 69           |          |      |                     |      |                     |      |  |      |      |      |      |      |      |
| 70           |          |      |                     |      |                     |      |  |      |      |      |      |      |      |
| 71           |          |      |                     |      |                     |      |  |      |      |      |      |      |      |
| 72           |          |      |                     |      |                     |      |  |      |      |      |      |      |      |
| 73           |          |      |                     |      |                     |      |  |      |      |      |      |      |      |
| 74           |          |      |                     |      |                     |      |  |      |      |      |      |      |      |
| 75           |          |      |                     |      |                     |      |  |      |      |      |      |      |      |
| 76           |          |      |                     |      |                     |      |  |      |      |      |      |      |      |
| 77           |          |      |                     |      |                     |      |  |      |      |      |      |      |      |
| 78           |          |      |                     |      |                     |      |  |      |      |      |      |      |      |
| 79           |          |      |                     |      |                     |      |  |      |      |      |      |      |      |
| 80           |          |      |                     |      |                     |      |  |      |      |      |      |      |      |
| 81           |          |      |                     |      |                     |      |  |      |      |      |      |      |      |
| 82           |          |      |                     |      |                     |      |  |      |      |      |      |      |      |
| 83           |          |      |                     |      |                     |      |  |      |      |      |      |      |      |
| 84           |          |      |                     |      |                     |      |  |      |      |      |      |      |      |
| 85           |          |      |                     |      |                     |      |  |      |      |      |      |      |      |
| 86           |          |      |                     |      |                     |      |  |      |      |      |      |      |      |
| 87           |          |      |                     |      |                     |      |  |      |      |      |      |      |      |
| 88           |          |      |                     |      |                     |      |  |      |      |      |      |      |      |
| 89           |          |      |                     |      |                     |      |  |      |      |      |      |      |      |
| 90           |          |      |                     |      |                     |      |  |      |      |      |      |      |      |
| 91           |          |      |                     |      |                     |      |  |      |      |      |      |      |      |
| 92           |          |      |                     |      |                     |      |  |      |      |      |      |      |      |
| 93           |          |      |                     |      |                     |      |  |      |      |      |      |      |      |
| 94           |          |      |                     |      |                     |      |  |      |      |      |      |      |      |
| 95           |          |      |                     |      |                     |      |  |      |      |      |      |      |      |
| 96           |          |      |                     |      |                     |      |  |      |      |      |      |      |      |
| 97           |          |      |                     |      |                     |      |  |      |      |      |      |      |      |
| 98           |          |      |                     |      |                     |      |  |      |      |      |      |      |      |
| 99           |          |      |                     |      |                     |      |  |      |      |      |      |      |      |
| 100          |          |      |                     |      |                     |      |  |      |      |      |      |      |      |
| TOTAL IND.   | 3        |      |                     |      |                     |      |  |      |      |      |      |      |      |
| TOTAL DEP.   | 11       |      |                     |      |                     |      |  |      |      |      |      |      |      |
| TOTAL CLAIMS | 14       |      |                     |      |                     |      |  |      |      |      |      |      |      |

\* MAY BE USED FOR ADDITIONAL CLAIMS OR ADMMENDMENTS

BEST AVAILABLE COPY



PHGB 000 109

U.S.A.



I - II

INVESTOR IN PEOPLE

The Patent Office  
Concept House  
Cardiff Road  
Newport  
South Wales  
NP10 8QQ

JC903 U.S. PTO  
09/876515



I, the undersigned, being an officer duly authorised in accordance with Section 74(1) and (4) of the Deregulation & Contracting Out Act 1994, to sign and issue certificates on behalf of the Comptroller-General, hereby certify that annexed hereto is a true copy of the documents as originally filed in connection with the patent application identified therein.

In accordance with the Patents (Companies Re-registration) Rules 1982, if a company named in this certificate and any accompanying documents has re-registered under the Companies Act 1980 with the same name as that with which it was registered immediately before re-registration save for the substitution as, or inclusion as, the last part of the name of the words "public limited company" or their equivalents in Welsh, references to the name of the company in this certificate and any accompanying documents shall be treated as references to the name with which it is so re-registered.

In accordance with the rules, the words "public limited company", may be replaced by p.l.c., plc, P.L.C. or PLC.

Re-registration under the Companies Act does not constitute a new legal entity but merely subjects the company to certain additional company law rules.

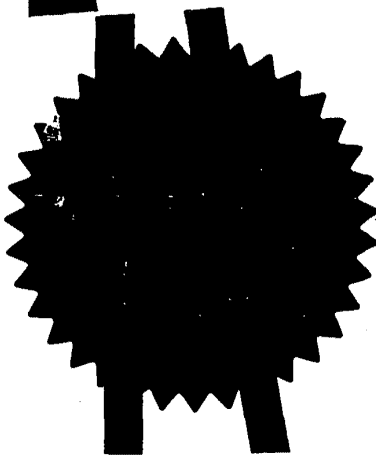

Signed

Dated -1 MAY 2001

**Request for grant of a patent**  
(See notes on the back of this form. You can also get an explanatory leaflet from the Patent Office to help you fill in this form)

THE PATENT OFFICE  
L  
26 JUN 2000  
NEWPORT

The Patent Office  
Cardiff Road  
Newport  
Gwent NP9 1RH

1. Your reference PHGB 000084

2. Patent application number (The Patent Office will fill in this part) **0015454.2** **26 JUN 2000**

3. Full name, address and postcode of the or of each applicant (underline all surnames)  
KONINKLIJKE PHILIPS ELECTRONICS N.V.  
GROENEWOUDSEWEG 1  
5621 BA EINDHOVEN  
THE NETHERLANDS  
Patents ADP Number (if you know it) 7586605002  
If the applicant is a corporate body, give the country/state of its incorporation THE NETHERLANDS

4. Title of the invention DATA DELIVERY THROUGH BEACONS

5. Name of your agent (if you have one) ANDREW GORDON WHITE  
"Address for service" in the United Kingdom Philips Corporate Intellectual Property  
to which all correspondence should be sent Cross Oak Lane  
(including the postcode) Redhill  
Surrey  
RH1 5HA  
Patents ADP number (if you know it) 7133473002

6. If you are declaring priority from one or more earlier patent applications, give the country and the date of filing of the or of each of these earlier applications and (if you know it) the or each application number

| Country | Priority Application number (if you know it) | Date of filing (day/month/year) |
|---------|----------------------------------------------|---------------------------------|
|---------|----------------------------------------------|---------------------------------|

7. If this application is divided or otherwise derived from an earlier UK application, give the number and the filing date of the earlier application

| Number of earlier application | Date of filing (day/month/year) |
|-------------------------------|---------------------------------|
|-------------------------------|---------------------------------|

8. Is a statement of inventorship and of right to grant of a patent required in support of this request? (Answer "Yes" if:  
a) any applicant named in part 3 is not an inventor, or  
b) there is an inventor who is not named as an applicant, or  
c) any named applicant is a corporate body. See note (d)) YES

9. Enter the number of sheets for any of the following items you are filing with this form. Do not count copies of the same document.

Continuation sheets of this form

|             |             |
|-------------|-------------|
| Description | 14          |
| Claims(s)   | 3           |
| Abstract    | 1           |
| Drawings    | 3 <i>AM</i> |

10. If you are also filing any of the following, state how many against each item:

Priority Documents

- Translations of priority documents
- Statement of inventorship and right to grant of a patent (*Patents Form 7/77*)
- Request for preliminary examination and search (*Patents Form 9/77*)
- Request for substantive examination (*Patents Form 10/77*)
- Any other documents (*Please specify*)

- 11.

I/We request the grant of a patent on the basis of this application.

Signature

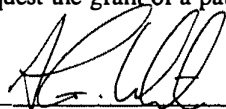

Date 23/6/2000

12. Name and daytime telephone number of person to contact in the United Kingdom

01293 815299

(A. G. WHITE)

**Warning**

After an application for a patent has been filed, the Comptroller of the Patent Office will consider whether publication or communication of the invention should be prohibited or restricted under Section 22 of the Patents Act 1977. You will be informed if it is necessary to prohibit or restrict your invention in this way. Furthermore, if you live in the United Kingdom, Section 23 of the Patents Act 1977 stops you from applying for a patent abroad without first getting written permission from the Patent Office unless an application has been filed at least 6 weeks beforehand in the United Kingdom for a patent for the same invention and either no direction prohibiting publication or communication has been given, or any such direction has been revoked.

**Notes**

- a) If you need help to fill in this form or you have any questions, please contact the Patent Office on 0645 500505.
- b) Write your answers in capital letters using black ink or you may type them.
- c) If there is not enough space for all the relevant details on any part of this form, please continue on a separate sheet of paper and write "see continuation sheet" in the relevant part(s). Any continuation sheet should be attached to this form.
- d) If you have answered "Yes" Patents Form 7/77 will need to be filed.
- e) Once you have filled in the form you must remember to sign and date it.
- f) For details of the fee and ways to pay please contact the Patent Office.

## DESCRIPTION

**DATA DELIVERY THROUGH BEACONS**

5           The present invention relates to services offered to users of electronic equipment, especially but not exclusively to users of mobile communications devices such as portable telephones and suitably equipped PDA's (personal digital assistants). The invention further relates to means for delivery of such services, and to portable devices for receiving them.

10

          Recent years have seen a great increase in subscribers world-wide to mobile telephone networks and, through advances in technology and the addition of functionalities, cellular telephones have become personal, trusted devices. A result of this is that a mobile information society is developing, with personalised and localised services becoming increasingly more important. Such "Context-Aware" (CA) mobile telephones are used with low power, short range base stations in places like shopping malls to provide location-specific information. This information might include local maps, information on nearby shops and restaurants and so on. The user's CA terminal may be equipped to filter the information received according to pre-stored user preferences and the user is only alerted if an item of data of particular interest has been received.

          An example of a CA terminal is given in U.S. patent 5,835,861 which discloses the use of wireless telephones within the context of advertisement billboards. The user of a wireless telephone obtains the telephone number of a vendor by activating his/her wireless telephone to transmit a prompt signal to an active advertisement source and to receive from the advertisement source a response signal containing the telephone number of the advertising vendor. The telephone number can then be used to automatically place a call to that vendor via the public switched telephone network. Alternatively, the telephone number can be stored for use later on. This arrangement can be used to place a call to a vendor without having to either memorise the telephone number or

30

to write it down. The signals between the billboard and the caller can be transmitted as modulated infrared (IR) signals.

In another example, Hewlett-Packard has posted a publication on the Web at <http://www.cooltown.hp.com/papers/webpres/WebPresence.htm> about their "Cooltown" project. The convergence of Web technology, wireless networks and portable client devices provides design opportunities for computer/communications systems. In the Cooltown project, systems that are location-aware can be created using URL's for addressing, physical URL's for delivery via beacons and sensing of URL's for discovery, and localised web servers for directories. The systems are ubiquitous to support nomadic users. On top of this infrastructure the Internet connectivity can be leveraged to support communications services. Web presence bridges the World Wide Web and the physical world inhabited by the users, providing a model for supporting nomadic users without a central control point.

The Cooltown Museum and Bookstore offers visitors a Web-enhanced experience. As visitors tour the museum, their portable digital assistant (PDA) can receive Web URLs from wireless "beacons". These beacons are small infrared transceivers located close to pictures or sculptures; the URLs link into a Web of information about the items. Using the PDA's Web browser, visitors can read or hear about the artist or the work and about related art works in the museum. The URLs can also be stored as bookmarks for further study or they can be used to select reproductions of the artwork from the museum's online store.

It will be recognised that an important requirement for CA devices is that they quickly and efficiently gather data from beacons such that the user is not required to undertake actions such as staying close to a beacon whilst contact is established between portable device and beacon, nor having to specifically initiate interaction (as is the case with the above-mentioned system in US 5,835,861). A further requirement is that the portable device should be kept relatively simple insofar as the data gathering from beacons is concerned: in the Cooltown system, a full web browser and display capability is required to

support user navigation within the web page indicated by the URL being broadcast.

5 It is therefore an object of the invention to provide a system for the delivery of data via beacons whereby the amount of dedicated circuitry and operating procedure are kept to low levels.

In accordance with a first aspect of the present invention there is provided a communications system comprising at least one beacon device capable of wireless message transmission and at least one portable device  
10 capable of receiving such a message transmission, wherein the beacon is arranged to broadcast a series of inquiry messages each in the form of a plurality of predetermined data fields arranged according to a first communications protocol, wherein the beacon is further arranged to add to each inquiry message prior to transmission an additional data field, and  
15 wherein the at least one portable device is arranged to receive the transmitted inquiry messages and read data from said additional data field. By adding the additional field (suitably at the end of a respective inquiry message), data broadcast may be carried on top of an existing inquiry process, such that the usual delays while such a process is carried out prior to data transfer are  
20 avoided. Furthermore, by placing the additional field at the end of those sent according to the communications protocol (preferably but not essentially Bluetooth), those protocol-compatible devices not intended for reception of beacon signals can simply ignore the additional data without compromising operation according to protocol.

25 Where the protocol is Bluetooth (or a similar frequency hopping arrangement) the beacon may be configured to broadcast a series of inquiry messages on a predetermined clocked sequence of frequencies, with clock information for the beacon being carried by the additional data field. As will be described in greater detail hereinafter with respect to embodiments of the  
30 invention, this can improve the inquiry performance of a Bluetooth system, shortening the time to establish a connection for data exchange.



The beacon may be arranged to include an indication in one of said predetermined data fields (suitably in a currently unused or unassigned field), said indication denoting the presence of said additional data field, such that devices configured for reception of beacon data may be triggered to read from the additional data field.

The beacon may be arranged to include in a message first comparison data, with the portable device further comprising storage means holding second comparison data and comparator means arranged to identify when there is a match between the first and second comparison data and present the data read from the additional data field, otherwise to not present the data. Such second comparison data may be predetermined and/or pre-stored, or it may be determined adaptively from user profiling of the portable device user.

Also in accordance with the present invention there is provided a mobile communication device for use in the system recited above, the device comprising a receiver capable of receiving a short-range wireless inquiry message including a plurality of data fields according to a first communications protocol, means for determining when an additional data field has been added to said plurality of data fields, and means for reading data from such an additional data field and presenting the same to a user.

Still further in accordance with the present invention, there is provided a method for enabling the user of a portable communications device to receive broadcast messages wherein at least one beacon device broadcasts a series of inquiry messages each in the form of a plurality of predetermined data fields arranged according to a first communications protocol, wherein the beacon adds to each inquiry message prior to transmission an additional data field carrying broadcast message data, and wherein the portable device receives the transmitted inquiry messages and reads the broadcast data from said additional data field.

Preferred embodiments of the invention will now be described, by way of example only, and with reference to the accompanying drawings, in which:

Figure 1 is a block schematic diagram of a beacon and portable device embodying the invention;

Figure 2 is a schematic diagram of a series of devices in a linked beacon infrastructure;

5 Figure 3 is a chart illustrating the transmission of a train of inquiry access codes centred on a given frequency ;

Figure 4 illustrates alternation between trains of inquiry messages over the duration of an inquiry broadcast;

10 Figure 5 illustrates the insertion of a packet of broadcast data within an existing transmission slot;

Figure 6 illustrates a first arrangement for sending beacon clock data in a sequence of inquiry message trains; and

Figure 7 illustrates an alternate arrangement to that of Figure 6 for the sending of beacon clock data.

15

In the following description we consider particularly a CA application which utilises Bluetooth protocols for communication of messages from beacon to portable device (whether telephone, PDA or other). As will be recognised, the general invention concept of including a broadcast channel as part of the inquiry procedure is not restricted to Bluetooth devices, and is applicable to other communications arrangements, in particular frequency hopping systems.

20 Figure 1 is a block schematic diagram of a CA mobile telephone 10 in use with one or more low power, short range base stations or beacons 12, 14. As mentioned previously, and discussed in greater detail below, such an arrangement may be used in places like shopping malls to provide location-specific information such as local maps, information on nearby shops and restaurants—and so on, with the beacon downloading information keys to a mobile device. An information key is a small data object that provides a reference to a source of full information, and it is in the form of a number of predetermined fields, one of which will contain a short piece of descriptive text presented to a user. Another field will be a pointer or address of some form,

30

for example a URL or telephone number. Other supplementary fields may control how the data is presented to a user and how the address may be exploited. The beacon will generally broadcast cyclically a number of these keys, each typically relating to a different service.

5 Issues relating to the beacon construction and configuration include the beacons range which will be dependent on output power (typical range being 1mW to 100mW), levels of local interference, and receiver sensitivity.

The user's CA terminal 10 comprises an aerial 16 coupled with transceiver stage 18 for the reception and transmission of messages. 10  
Outgoing messages result from user input to the telephone, either audio input via microphone 20 and A/D converter 22 or other data input via the keypad or other input means 24. These inputs are processed to message data format by signal and data processing stage 26 and converted to transmission format by encoder 28 before being supplied to the transceiver stage 18.

15 Messages received via the aerial 16 and transceiver 18 are passed via a decoding stage 30 to a filtering and signal processing stage 32. If the data carried by the message is for presentation on a display screen 34 of the telephone, the data will be passed to a display driver 36, optionally after buffering 38, with the driver formatting the display image. As will be 20  
recognised, the display 34 may be a relatively simple low-resolution device, and the conversion of received data to display data may be carried out as a subset of the processing stage 32 functionality, without the requirement for a dedicated display driver stage.

Where the message is carrying data from one or other of the beacons 25  
12, 14, the telephone has the ability to filter the information received according to pre-stored 40 user preferences and the user is only alerted (i.e. the information will only be retained in buffer 38 and/or presented on screen 34) if comparison of stored preference data and subject matter indicators in the message indicate that an item of data of particular interest has been received.

30 For conventional audio messages, the audio data is output by the filter and processing stage 32, via D/A converter 42 and amplifier 44 to an earphone or speaker 46. Receipt of such messages from the telephone

network 48 is indicated by arrow 50: the telephone network 48 also provides the link from the telephone 10 to a wide-area network (WAN) server 52 and, via the WAN 54 (which may be the internet), to one or more remote service providers 56 providing a source of data for the telephone 10.

5           Communication between the CA terminal (telephone 10) and the CA base station (beacon 12) takes two forms: 'push' and 'pull'. In 'push' mode, information is broadcast by the beacons 12, 14, to all portable terminals 10 in the form of short 'keys' indicated at 60. The keys will take various forms according to the application but will generally include a concise description of  
10 the information being sent and a pointer to fuller information, e.g. a URL identifying one of the service providers 56.

          Keys are received by the terminal 10 'unconsciously', that is, without direct intervention by the user, and automatically filtered according to the user's pre-set preferences. Some will be discarded, some kept for further  
15 study, others might cause the user to be alerted immediately. By way of example, shops might choose to push details of special offers into passing terminals in the knowledge that users who have interest and have therefore set their filters 32 accordingly will be alerted by their terminal.

          Sometimes the user will wish to obtain more information than is  
20 contained in the keys. Here, 'pull' mode allows a user to set up a connection with a server 56 (which need not necessarily be specially configured for CA use) and actively request information to pull down into the terminal 10. This mode is therefore typically interactive.

          Whilst base stations or beacons will typically be independent of one  
25 another (in a shopping mall set up, each shop provides and maintains its own beacon without reference to any beacons provided by neighbouring shops), the beacons may be wholly or partially networked with at least some co-ordination as to their broadcast messages.

          Figure 2 is a diagram of such a system 100 of linked beacons  
30 embodying the invention and providing an implementation of an infrastructure for use in, for example, department stores, shopping malls, theme parks, etc. The system 100 comprises a plurality of beacons 102, 104, 106, 108

distributed over a series of locales. Each of the beacons 102-108 broadcasts one or more short-range inquiry signals in a time-slot format as described in greater detail hereinafter. The beacons 102 - 108 are controlled by a beacon infrastructure server (BIS) 110, with one or more terminals 112, 114, 116, 118 being connected to the server 110. The terminals 112 - 118 enable service providers, i.e., the users of beacons 102 - 108, to author or edit allocated service slots in the form of added data piggy backed on inquiry facilitation signals transmitted by beacons 102 - 108. A service provider may lease a beacon or one of the beacon's service slots from the infrastructure provider. To this end, server 110 provides simple HTML templates for filling out by the user via one of terminals 112 - 118. Having filled out the template with, for example, a description of the service and other information for the data to be carried via the beacon broadcast, the template is returned to server 110, preferably via a secure link using, e.g., Secure HTTP (S-HTTP) or Secure Sockets Layer (SSL). SSL creates a secure link between a client and a server, over which any amount of data can be sent securely. S-HTTP is designed to transmit individual messages securely. Server 110 then creates the appropriate additional data package for appending to the inquiry signal of a relevant one of the beacons 102 - 108 based on the information submitted with the template. The system 100 may further comprise an application server 120 to assist in carrying out various functions, as will be readily understood by the skilled reader.

Referring back to Figure 1, a strong candidate technology for the wireless link necessary for at least the 'push' mode of the above-described CA system is Bluetooth, on the grounds that it is expected to become a component part of a large number of mobile telephones 10. In analysing the Bluetooth protocol for CA broadcast or 'push' mode utilisation, a problem may be seen. In the ideal case, the terminal 10 will detect fixed beacons 12, 14 and extract basic information from them without the terminal 10 needing to transmit at all. However, this type of broadcast operation is not supported by the current Bluetooth specification.

In part, the incompatibility follows the frequency hopping nature of Bluetooth beacon systems which means that, in order for broadcast messages (or, indeed, any messages) to be received by a passing terminal, the terminal has to be synchronised to the beacon in both time and frequency. The portable device 10 has to synchronise its clock to the beacon clock and, from the beacons identity, deduce which of several hopping sequences is being employed.

To make this deduction, the portable device has conventionally been required to join – as a slave - the piconet administered by the beacon as piconet master. Two sets of procedures are used, namely “inquiry” and “page”. Inquiry allows a would-be slave to find a base station and issue a request to join the piconet. Page allows a base station to invite slaves of its choice to join the net. Analysis of these procedures indicates that the time taken to join a piconet and then be in a position to receive information from the master could be several tens of seconds, which is much too long for CA applications, where a user may move out of range of a beacon before joining could be completed.

The difficulty of receiving broadcast data from beacons is caused at least partially by the frequency-hopping nature of Bluetooth and similar systems. The Bluetooth inquiry procedure has been proposed specifically to solve the problem of bringing together master and slave: the applicants have recognised that it is possible to piggy-back a broadcast channel on the inquiry messages issued by the master. Only CA terminals need read the broadcast channel messages and only CA base stations or beacons send them. In consequence, at the air interface, the mechanism is entirely compatible with conventional (non-CA) Bluetooth systems.

To illustrate how this is implemented, we first consider how the Inquiry procedures themselves operate, with reference to Figures 3 and 4. When a Bluetooth unit wants to discover other Bluetooth devices, it enters a so-called inquiry substate. In this mode, it issues an inquiry message containing a General Inquiry Access Code (GIAC) or a number of optional Dedicated Inquiry Access Codes (DIAC). This message is repeated at several levels;

first, it is repeated in a train A of 16 frequencies from a total of 32 making up the inquiry hopping sequence. The message is sent twice on two frequencies in even timeslots with the following, odd timeslots used to listen for replies on the two corresponding inquiry response hopping frequencies. Sixteen  
5 frequencies and their response counterparts can therefore be covered in 16 timeslots, or 10ms. The chart of Figure 3 illustrates the transmission of a single train on sixteen frequencies centred around  $f\{k\}$ , where  $f\{k\}$  represents the inquiry hopping sequence.

The next step is the repetition of the train at least  $N_{\text{inquiry}}$  times. At the  
10 very least, this means 256 repetitions of the entire train. Finally, the train A is swapped for the train B consisting of the remaining 16 frequencies and the cycle repeated. As shown by Figure 4, the specification states that this switch must occur at least three times to ensure the collection of all responses in an error-free environment. This means that an inquiry broadcast could take at  
15 least 10.24 seconds.

A portable device that wants to be discovered by a beacon enters the inquiry scan substate. Here, it listens for a message containing the GIAC or DIAC's of interest. It, too, operates in a cyclic way. It listens on a single hop frequency for an inquiry scan period of  $T_{w\_inquiry\_scan}$ . This must be long enough  
20 to cover the 16 inquiry frequencies used by the inquiry. The interval between the beginning of successive scans must be no greater than 1.28 seconds. The frequency chosen comes from the list of 32 making up the inquiry hopping sequence.

On hearing an inquiry containing an appropriate IAC, the portable  
25 device enters a so-called inquiry response substate and issues a number of inquiry response messages to the beacon. The beacon will then page the portable device, inviting it to join the piconet.

As mentioned above and shown in Figure 5, the applicants propose that the inquiry messages issued by the base station have an extra field appended  
30 to them, capable of carrying a user-defined payload (CA DATA). In the CA scenario, this payload is used to carry broadcast information, or keys, to CA terminals during the inquiry procedure. By adding the field to the end of the

inquiry message, it will be appreciated that non-CA receivers can ignore it without modification. In addition, by using a CA-specific DIAC, CA receivers can be alerted to the presence of the extra information field.

5 The presence of the extra data field means that the guard space conventionally allowed at the end of a Bluetooth inquiry packet is reduced. However, this space - provided to give a frequency synthesiser time to change to a new hop frequency - will be generally unused otherwise, as current frequency synthesisers are capable of switching at speeds which do not need extension into the extra guard space. The standard inquiry packet is an ID  
10 packet of length 68 bits. Since it is sent in a half-slot, the guard space allocated is  $(625/2 - 68) = 244.5 \mu\text{s}$  (625  $\mu\text{s}$  slot period, 1 Mbit/s signalling rate). Modern synthesisers can switch in much less time with figures of 100  $\mu\text{s}$  or lower considered routine by experts in the field. Applicants therefore propose allocation of 100 bits as a suitable size for this new field.

15 CA handsets can receive the broadcast data quickly without being required to run through a lengthy procedure to join a piconet. In addition, since there is no need for the handset to transmit any information whatsoever, there is a consequent power saving that will be particularly important in dense environments where many CA base stations may be present. Nevertheless,  
20 when the handset is in interactive mode and wishes to join a piconet in order to obtain more information, it may employ the default inquiry procedures as normal. There is no loss of functionality through supporting the additional data field.

In a typical embodiment, four of our 100 bits will be lost as trailer bits for  
25 the ID field; this is a consequence of it being read by a correlator. Of the 96 bits remaining, applicants preferred allocation is that 64 be used as data and 32 as a 2/3 FEC (forward error correction) checksum. Each inquiry burst thus contains 8 bytes of broadcast data. In a most common scenario, by the  
30 second group of A and B trains the portable device has found the base station, understood it to be a CA beacon and is awaiting the broadcast data. Since it will be listening specifically, the portable device will at least be able to read



256 bursts of data twice (A and B), giving us two lots of 2 Kbytes, or 4 Kbytes in total.

At this stage, the portable device does not know the phase of the beacons clock because this information is not been transmitted. To assist the portable device, clock information is transmitted in at least some of the trains in the first A and B groups, as shown in Figure 6, together with some auxiliary information indicating when the next switches between A and B will occur. This clock information will be transmitted in place of the CA broadcast data so means are provided to discriminate between the two data channels. Use of separate DIAC's is one possible method.

In the case where the portable device knows the timing of the beacon, the portable devices also knows how it will hop, which gives the ability to track all transmissions of a train. Since there are 16 transmissions in a frame, then the resultant CA channel has 16 times as much capacity and can convey 64 Kbytes of information.

Since the terminal wakes up every 1.28 seconds or less, it will generally have obtained the clocking information it needs by the half way mark in the first A or B periods. Switching from clock to data at these halfway marks, as illustrated in Figure 7, provides a number of useful advantages. Firstly, some data can be received in less than five seconds from the start of the inquiry procedure. Secondly, the terminal can still respond to an important key by automatically issuing an inquiry response message to the base station (if that is the appropriate action for the terminal to take) even if the key appears comparatively late in the cycle. It will be noted that no increase in capacity is assumed.

In the foregoing, a portable device will receive all the additional data field packets on one of the 32 inquiry channels, thereby using only 1/32 of the available bandwidth. As will be recognised, if the uncertainty as to when a portable terminal (beacon slave) receives the first inquiry packet can be overcome, the predetermined nature of the hopping sequence may be accommodated and the full bandwidth therefore utilised. For a slave to synchronise with a masters inquiry hopping sequence from the point where it

received the first packet, the slave needs to know both the masters clock offset and the position of the first received packet in the masters hopping sequence. In the following example, it is assumed that the master follows the Bluetooth minimum enquiry procedure, which comprises 256 repetitions of the 16-channel inquiry hopping sequences, with three train switches (as in Figure 4).  
5 Each sweep across the 16 channels takes 10ms.

To synchronise the slave hopping, the additional data field (BCD; Fig. 1) carries the following information:

- Master clock offset (2 bytes);
- 10 • Number of full train repetitions (1 byte) – assuming that a full train consists of 256 repetitions of 10ms trains, the range of this parameter is 0-255 (before the inquiry switches to the next full train). This indicates to the slave when the master will next switch the full train.
- 15 • How many full train switches have been completed in the current inquiry cycle (1 byte) – this data indicates to the slave what the master is likely to do at the end of the current full train, i.e. whether it will switch over to another full train or whether the inquiry procedure will terminate.

20 As long as no channel repeats in the 10ms train, no field is required to indicate the position of the current channel in the hopping sequence as the slave is able to derive this from knowledge of the sequence.

From the foregoing it will be seen that, by adding 4 bytes to each additional field packet, the slave can then pick up all additional field packets to the end of the inquiry, whilst still having 4 bytes available (from our preferred  
25 assignment of 64 from 100 bits for data) to carry broadcast data.

Considering a complete beacon signal, it will be readily understood that it will need to be divided into a number of 4-byte packets with one being sent with each inquiry packet. Assuming a fixed length of beacon signal for the  
30 purposes of illustration, at 16kB the full signal can be accommodated on a single inquiry train (a train being 256 repetitions of the 16-channel hop sequence, giving  $256 \times 16 \times 4$  bytes = 16kB).

Extending this, by fixing that the first packet of a beacon signal goes on the first packet of an inquiry train, from the message indicator field for the number of repetitions for the current 16-channel hopping sequence in the message header, the slave is enabled to derive the position of the beacon packet it has received in the complete beacon signal.

From reading the present disclosure, other modifications will be apparent to persons skilled in the art. Such modifications may involve other features which are already known in the design, manufacture and use of fixed and portable communications systems, and systems and components for incorporation therein and which may be used instead of or in addition to features already described herein.

## CLAIMS:

1. A communications system comprising at least one beacon device capable of wireless message transmission and at least one portable device  
5 capable of receiving such a message transmission, wherein the beacon is arranged to broadcast a series of inquiry messages each in the form of a plurality of predetermined data fields arranged according to a first communications protocol, wherein the beacon is further arranged to add to each inquiry message prior to transmission an additional data field, and  
10 wherein the at least one portable device is arranged to receive the transmitted inquiry messages and read data from said additional data field.
2. A system as claimed in Claim 1, wherein the beacon is arranged to add said additional data field at the end of a respective inquiry message.  
15
3. A system as claimed in Claim 1 or Claim 2, wherein the beacon is arranged to include an indication in one of said predetermined data fields, said indication denoting the presence of said additional data field.
- 20 4. A system as claimed in any of Claims 1 to 3, wherein said first communications protocol comprises Bluetooth messaging.
5. A system as claimed in Claim 4, wherein the beacon is configured to broadcast a series of inquiry messages on a predetermined  
25 clocked succession of frequencies, with clock information for said beacon being included in data carried by said additional data field.
6. A system as claimed in any of Claims 1 to 5, wherein said additional data field carries at least 64 bits of data.  
30
7. A system as claimed in Claim 1, wherein the beacon is arranged to include in a message first comparison data, the portable device further

comprising storage means holding second comparison data and comparator means arranged to identify when there is a match between the first and second comparison data and present the data read from the additional data field, otherwise to not present the data.

5

8. A system as claimed in Claim 7, further comprising means for generating said second comparison data from user profiling of the portable device user.

10

9. A mobile communication device for use in the system of any of Claims 1 to 8, the device comprising a receiver, capable of receiving a short-range wireless inquiry message including a plurality of data fields according to a first communications protocol, means for determining when an additional data field has been added to said plurality of data fields, and means for reading data from such an additional data field and presenting the same to a user.

15

10. A device as claimed in Claim 9, wherein the receiver is configured to receive messages according to Bluetooth protocols.

20

11. A method for enabling the user of a portable communications device to receive broadcast messages wherein at least one beacon device broadcasts a series of inquiry messages each in the form of a plurality of predetermined data fields arranged according to a first communications protocol, wherein the beacon adds to each inquiry message prior to transmission an additional data field carrying broadcast message data, and wherein the portable device receives the transmitted inquiry messages and reads the broadcast data from said additional data field.

25

12. A method as claimed in Claim 11, wherein the beacon adds said additional data field at the end of a respective inquiry message.

30

13. A method as claimed in Claim 11 or Claim 12, wherein the beacon includes an indication in one of said predetermined data fields, said indication denoting the presence of said additional data field.

5 14. A method as claimed in any of Claims 11 to 13, wherein said first communications protocol comprises Bluetooth messaging.

15. A communications system substantially as hereinbefore described with reference to the accompanying drawings.

10

16. A portable communications device substantially as hereinbefore described with reference to the accompanying drawings.

15 17. A method for enabling the user of a portable communications device to receive broadcast messages substantially as hereinbefore described with reference to the accompanying drawings.

## ABSTRACT

**DATA DELIVERY THROUGH BEACONS**

5           A communications system comprises at least one beacon device (12,  
14) capable of wireless message transmission and at least one portable device  
(10) capable of receiving such a message transmission. The beacon (12) is  
arranged to broadcast a series of inquiry messages (60) each in the form of a  
plurality of predetermined data fields (INQ) arranged according to a first  
10 communications protocol, such as Bluetooth. For the delivery of additional  
data via broadcast, the beacon (12) adds to each inquiry message prior to  
transmission an additional data field (BCD) carrying broadcast data, with the  
portable device (10) receiving the transmitted inquiry messages and reading  
the broadcast data from the additional data field.

15

(Figure 1)

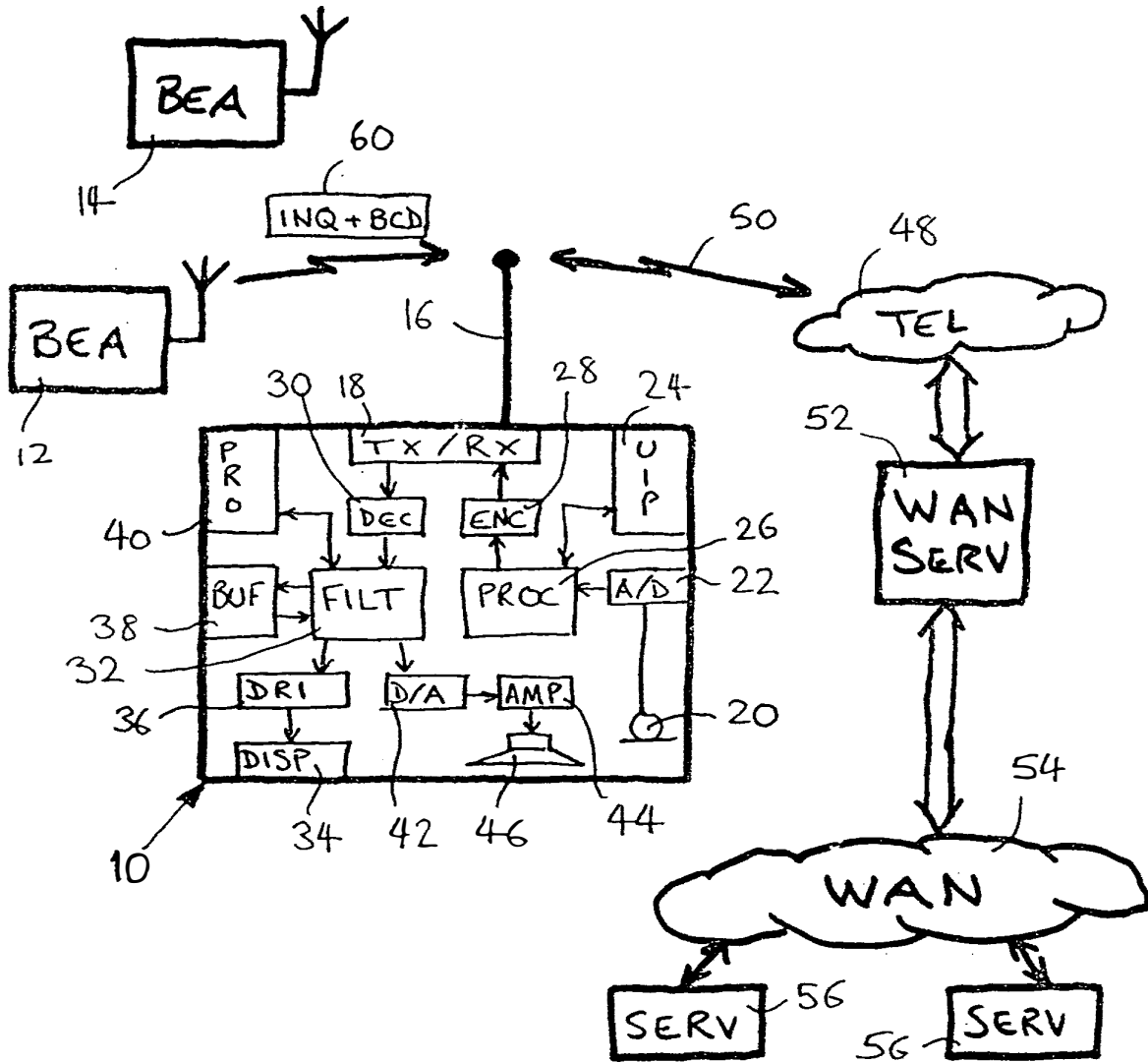

**Fig. 1**



2/3

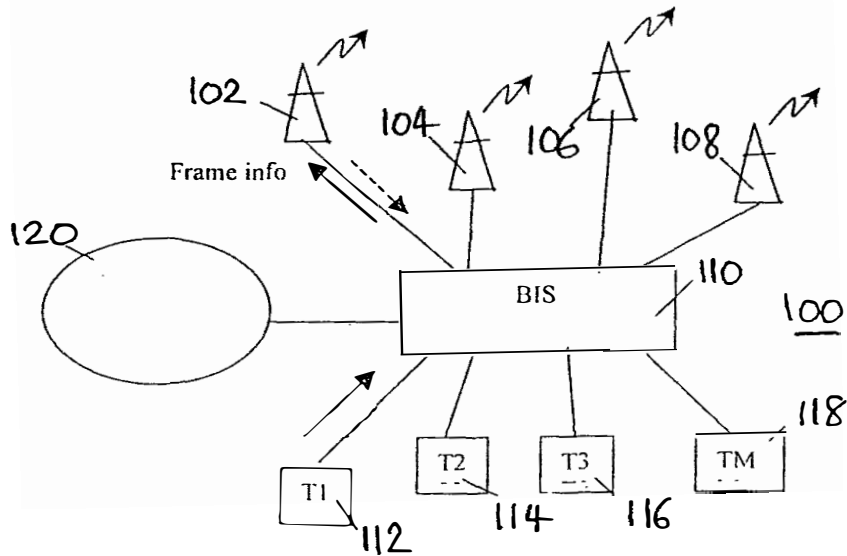

**Fig. 2**

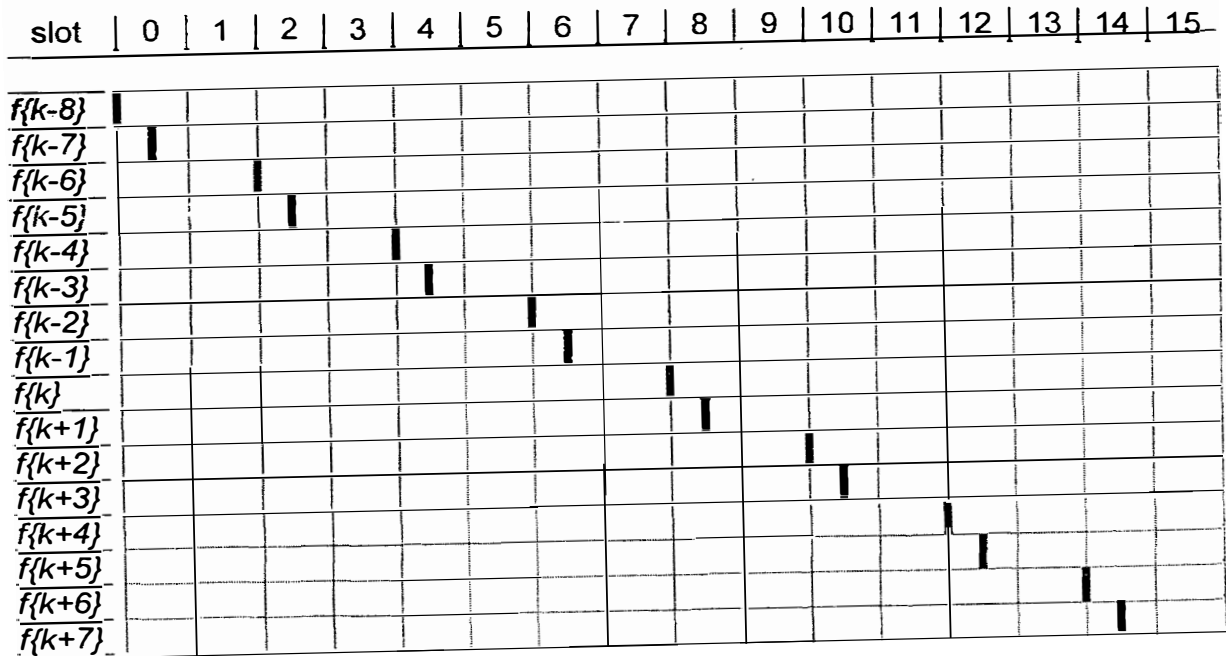

**Fig. 3**

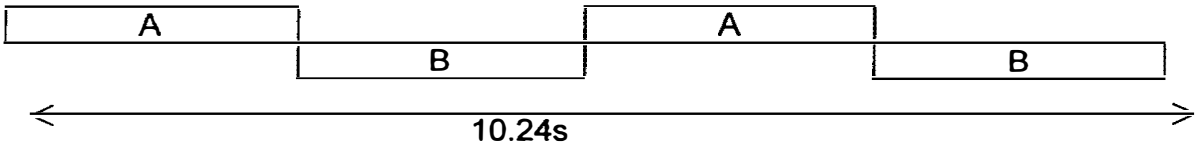

**Fig. 4**



**Fig. 5**

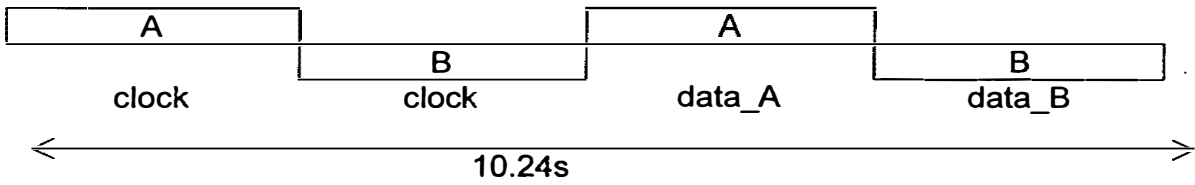

**Fig. 6**

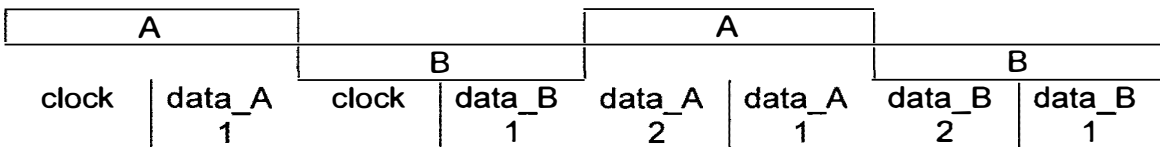

**Fig. 7**

IN THE UNITED STATES PATENT AND TRADEMARK OFFICE

In re Application of  
ROBERT J. DAVIES ET AL

Atty. Docket  
GB 000109

Serial No.

Group Art Unit

Filed: CONCURRENTLY

Ex.

Title: DATA DELIVERY THROUGH BEACONS

Commissioner for Patents  
Washington, D.C. 20231

Handwritten initials: *HA*  
1c903 U.S. PTO  
09/876515  
06/07/01

INFORMATION DISCLOSURE STATEMENT UNDER 37 C.F.R. 1.97

Sir:

Enclosed is a Form PTO-1449 and copies of documents listed thereon. These documents are considered to be relevant in that they have been:

- considered in drafting the specification of the above-referenced application;
  - cited in the specification of the above-referenced application; or
  - cited as an "X", "Y" or "A" document in a foreign Patent Office search report on a foreign counterpart application a copy of which report is also enclosed.
- I hereby certify that these documents were cited in said search report not more than three (3) months ago.
- Please charge any fee under 1.17(p) for this Information Disclosure Statement to be considered, not exceeding \$240.00, to Account No. 14-1270.

If readily available, English-language counterparts have been substituted for foreign-language patent documents. This disclosure is not an admission that any of these documents is material to or even prior art with respect to the above-referenced application.

Respectfully submitted,

*[Handwritten Signature]*  
By  
Michael E. Marion, Reg. 32,266  
Attorney  
(914) 333-9641

| Form PTO-1449<br>U.S. DEPARTMENT OF COMMERCE (REV.7-80) PATENT AND<br>TRADEMARK OFFICE                                                                                                                                                   |                  | Atty. Docket No.<br>GB 000109                                                                                                                                                                                                       |           | Serial No.      |           |                        |    |
|------------------------------------------------------------------------------------------------------------------------------------------------------------------------------------------------------------------------------------------|------------------|-------------------------------------------------------------------------------------------------------------------------------------------------------------------------------------------------------------------------------------|-----------|-----------------|-----------|------------------------|----|
|                                                                                                                                                                                                                                          |                  | Applicant<br>ROBERT J. DAVIES ET AL                                                                                                                                                                                                 |           |                 |           |                        |    |
|                                                                                                                                                                                                                                          |                  | Filing Date<br>CONCURRENTLY                                                                                                                                                                                                         |           | Group           |           |                        |    |
| <b>INFORMATION DISCLOSURE CITATION</b><br>(Use several sheets if necessary)                                                                                                                                                              |                  |                                                                                                                                                                                                                                     |           |                 |           |                        |    |
| <b>U.S. PATENT DOCUMENTS</b>                                                                                                                                                                                                             |                  |                                                                                                                                                                                                                                     |           |                 |           |                        |    |
| Ex. Int.                                                                                                                                                                                                                                 | Document Number  | Date                                                                                                                                                                                                                                | Name      | Class           | Sub-class | Filing Date If Approp. |    |
|                                                                                                                                                                                                                                          | AA 5 8 3 5 8 6 1 | 11/10/98                                                                                                                                                                                                                            | Whiteside | 455             | 466       |                        |    |
|                                                                                                                                                                                                                                          | AB               |                                                                                                                                                                                                                                     |           |                 |           |                        |    |
|                                                                                                                                                                                                                                          | AC               |                                                                                                                                                                                                                                     |           |                 |           |                        |    |
|                                                                                                                                                                                                                                          | AD               |                                                                                                                                                                                                                                     |           |                 |           |                        |    |
|                                                                                                                                                                                                                                          | AE               |                                                                                                                                                                                                                                     |           |                 |           |                        |    |
|                                                                                                                                                                                                                                          | AF               |                                                                                                                                                                                                                                     |           |                 |           |                        |    |
| <b>FOREIGN PATENT DOCUMENTS</b>                                                                                                                                                                                                          |                  |                                                                                                                                                                                                                                     |           |                 |           |                        |    |
|                                                                                                                                                                                                                                          | Document Number  | Date                                                                                                                                                                                                                                | Country   | Class           | Sub-class | Trans.                 |    |
|                                                                                                                                                                                                                                          |                  |                                                                                                                                                                                                                                     |           |                 |           | Yes                    | No |
|                                                                                                                                                                                                                                          | AG               |                                                                                                                                                                                                                                     |           |                 |           |                        |    |
|                                                                                                                                                                                                                                          | AH               |                                                                                                                                                                                                                                     |           |                 |           |                        |    |
|                                                                                                                                                                                                                                          | AI               |                                                                                                                                                                                                                                     |           |                 |           |                        |    |
|                                                                                                                                                                                                                                          | AJ               |                                                                                                                                                                                                                                     |           |                 |           |                        |    |
|                                                                                                                                                                                                                                          | AK               |                                                                                                                                                                                                                                     |           |                 |           |                        |    |
| OTHER (Including Author, Title, Date, Pertinent Pages, Etc.)                                                                                                                                                                             |                  |                                                                                                                                                                                                                                     |           |                 |           |                        |    |
|                                                                                                                                                                                                                                          | AL               | Publication Hp "Cooltown": < <a href="http://www.cooltown.hp.com/papers/webpres/Webpresence.htm">http://www.cooltown.hp.com/papers/webpres/Webpresence.htm</a> >; "People, Places, Things: Web Presence for the Real World pp. 1-20 |           |                 |           |                        |    |
|                                                                                                                                                                                                                                          | AM               |                                                                                                                                                                                                                                     |           |                 |           |                        |    |
|                                                                                                                                                                                                                                          | AN               |                                                                                                                                                                                                                                     |           |                 |           |                        |    |
| Examiner                                                                                                                                                                                                                                 |                  |                                                                                                                                                                                                                                     |           | Date Considered |           |                        |    |
| EXAMINER: Initial if reference considered, whether or not citation is in conformance with MPEP 609; Draw li through citation if not in conformance and not considered. Include a copy of this form with next communication to applicant. |                  |                                                                                                                                                                                                                                     |           |                 |           |                        |    |

09/17/01  
 09/17/01  
 06/07/01



PHGR000109 #3  
U.S.A.  
II - II

INVESTOR IN PEOPLE

The Patent Office  
Concept House  
Cardiff Road  
Newport  
South Wales  
NP10 8QQ



I, the undersigned, being an officer duly authorised in accordance with Section 74(1) and (4) of the Deregulation & Contracting Out Act 1994, to sign and issue certificates on behalf of the Comptroller-General, hereby certify that annexed hereto is a true copy of the documents as originally filed in connection with the patent application identified therein.

In accordance with the Patents (Companies Re-registration) Rules 1982, if a company named in this certificate and any accompanying documents has re-registered under the Companies Act 1980 with the same name as that with which it was registered immediately before re-registration save for the substitution as, or inclusion as, the last part of the name of the words "public limited company" or their equivalents in Welsh, references to the name of the company in this certificate and any accompanying documents shall be treated as references to the name with which it is so re-registered.

In accordance with the rules, the words "public limited company" may be replaced by p.l.c., plc, P.L.C. or PLC.

Re-registration under the Companies Act does not constitute a new legal entity but merely subjects the company to certain additional company law rules.

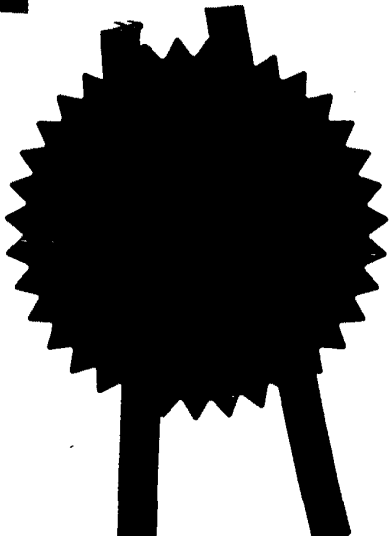

Signed *M. C. [Signature]*

Dated 14 MAY 2001

**CERTIFIED COPY OF  
PRIORITY DOCUMENT**

**This Page Blank (uspto)**

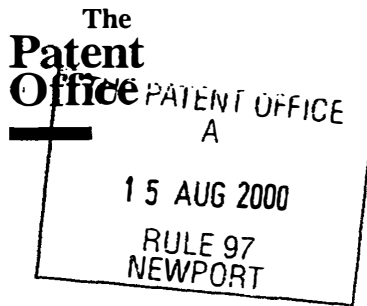

Request for grant of a patent  
(See notes on the back of this form. You can also get an explanatory leaflet from the Patent Office to help you fill in this form)

The Patent Office  
Cardiff Road  
Newport  
Gwent NP9 1RH

1. Your reference PHGB000109

2. Patent application number 0020073.3  
(The Patent Office will fill in this part)

15 AUG 2000

3. Full name, address and postcode of the or of each applicant (underline all surnames)

KONINKLIJKE PHILIPS ELECTRONICS N.V.  
GROENEWOUDSEWEG 1  
5621 BA EINDHOVEN  
THE NETHERLANDS

75 86605002

Patents ADP Number (if you know it)

If the applicant is a corporate body, give the country/state of its incorporation

THE NETHERLANDS

16AUG00 E561028-1 003008  
P01/7700 0.00-0020073.3

4. Title of the invention DATA DELIVERY THROUGH BEACONS

5. Name of your agent (if you have one)  
"Address for service" in the United Kingdom to which all correspondence should be sent (including the postcode)

Andrew G. White  
Philips Corporate Intellectual Property  
Cross Oak Lane  
Redhill  
Surrey RH1 5HA

Patents ADP number (if you know it)

7133473002

6. If you are declaring priority from one or more earlier patent applications, give the country and the date of filing of the or of each of these earlier applications and (if you know it) the or each application number

| Country | Priority Application number (if you know it) | Date of filing (day/month/year) |
|---------|----------------------------------------------|---------------------------------|
| GB      | 0015454.2                                    | 26 <sup>th</sup> June 2000      |

7. If this application is divided or otherwise derived from an earlier UK application, give the number and the filing date of the earlier application

| Number of earlier application | Date of filing (day/month/year) |
|-------------------------------|---------------------------------|
|                               |                                 |

8. Is a statement of inventorship and of right to grant of a patent required in support of this request? (Answer "Yes" if:

YES

- a) any applicant named in part 3 is not an inventor, or
  - b) there is an inventor who is not named as an applicant, or
  - c) any named applicant is a corporate body.
- See note (d))

Patents Form 1/77

9. Enter the number of sheets for any of the following items you are filing with this form. Do not count copies of the same document.

Continuation sheets of this form

|             |    |
|-------------|----|
| Description | 17 |
| Claims(s)   | 3  |
| Abstract    | 1  |
| Drawings    | 3  |

10. If you are also filing any of the following, state how many against each item:

Priority Documents

- Translations of priority documents
- Statement of inventorship and right to grant of a patent (*Patents Form 7/77*)
- Request for preliminary examination and search (*Patents Form 9/77*)
- Request for substantive examination (*Patents Form 10/77*)
- Any other documents (*Please specify*)

11. I/We request the grant of a patent on the basis of this application.

Signature

Date 14-8-2000

12. Name and daytime telephone number of person to contact in the United Kingdom      01293 815365      (D.Melbourne)

**Warning**

*After an application for a patent has been filed, the Comptroller of the Patent Office will consider whether publication or communication of the invention should be prohibited or restricted under Section 22 of the Patents Act 1977. You will be informed if it is necessary to prohibit or restrict your invention in this way. Furthermore, if you live in the United Kingdom, Section 23 of the Patents Act 1977 stops you from applying for a patent abroad without first getting written permission from the Patent Office unless an application has been filed at least 6 weeks beforehand in the United Kingdom for a patent for the same invention and either no direction prohibiting publication or communication has been given, or any such direction has been revoked.*

**Notes**

- a) *If you need help to fill in this form or you have any questions, please contact the Patent Office on 0645 500505.*
- b) *Write your answers in capital letters using black ink or you may type them.*
- c) *If there is not enough space for all the relevant details on any part of this form, please continue on a separate sheet of paper and write "see continuation sheet" in the relevant part(s). Any continuation sheet should be attached to this form.*
- d) *If you have answered "Yes" Patents Form 7/77 will need to be filed.*
- e) *Once you have filled in the form you must remember to sign and date it.*
- f) *For details of the fee and ways to pay please contact the Patent Office.*



## DESCRIPTION

**DATA DELIVERY THROUGH BEACONS**

5           The present invention relates to services offered to users of electronic equipment, especially but not exclusively to users of mobile communications devices such as portable telephones and suitably equipped PDA's (personal digital assistants). The invention further relates to means for delivery of such services, and to portable devices for receiving them.

10

          Recent years have seen a great increase in subscribers world-wide to mobile telephone networks and, through advances in technology and the addition of functionalities, cellular telephones have become personal, trusted devices. A result of this is that a mobile information society is developing, with  
15       personalised and localised services becoming increasingly more important. Such "Context-Aware" (CA) mobile telephones are used with low power, short range base stations in places like shopping malls to provide location-specific information. This information might include local maps, information on nearby shops and restaurants and so on. The user's CA terminal may be equipped to  
20       filter the information received according to pre-stored user preferences and the user is only alerted if an item of data of particular interest has been received.

          An example of a CA terminal is given in U.S. patent 5,835,861 which discloses the use of wireless telephones within the context of advertisement billboards. The user of a wireless telephone obtains the telephone number of a  
25       vendor by activating his/her wireless telephone to transmit a prompt signal to an active advertisement source and to receive from the advertisement source a response signal containing the telephone number of the advertising vendor. The telephone number can then be used to automatically place a call to that vendor via the public switched telephone network. Alternatively, the telephone  
30       number can be stored for use later on. This arrangement can be used to place a call to a vendor without having to either memorise the telephone number or

to write it down. The signals between the billboard and the caller can be transmitted as modulated infrared (IR) signals.

In another example, Hewlett-Packard has posted a publication on the Web at <http://www.cooltown.hp.com/papers/webpres/WebPresence.htm> about their "Cooltown" project. The convergence of Web technology, wireless networks and portable client devices provides design opportunities for computer/communications systems. In the Cooltown project, systems that are location-aware can be created using URL's for addressing, physical URL's for delivery via beacons and sensing of URL's for discovery, and localised web servers for directories. The systems are ubiquitous to support nomadic users. On top of this infrastructure the Internet connectivity can be leveraged to support communications services. Web presence bridges the World Wide Web and the physical world inhabited by the users, providing a model for supporting nomadic users without a central control point.

The Cooltown Museum and Bookstore offers visitors a Web-enhanced experience. As visitors tour the museum, their portable digital assistant (PDA) can receive Web URLs from wireless "beacons". These beacons are small infrared transceivers located close to pictures or sculptures; the URLs link into a Web of information about the items. Using the PDA's Web browser, visitors can read or hear about the artist or the work and about related art works in the museum. The URLs can also be stored as bookmarks for further study or they can be used to select reproductions of the artwork from the museum's online store.

It will be recognised that an important requirement for CA devices is that they quickly and efficiently gather data from beacons such that the user is not required to undertake actions such as staying close to a beacon whilst contact is established between portable device and beacon, nor having to specifically initiate interaction (as is the case with the above-mentioned system in US 5,835,861). A further requirement is that the portable device should be kept relatively simple insofar as the data gathering from beacons is concerned: in the Cooltown system, a full web browser and display capability is required to

support user navigation within the web page indicated by the URL being broadcast.

It is therefore an object of the invention to provide a system for the  
5 delivery of data via beacons whereby the amount of dedicated circuitry and  
operating procedure are kept to low levels.

In accordance with a first aspect of the present invention there is  
provided a communications system comprising at least one beacon device  
capable of wireless message transmission and at least one portable device  
10 capable of receiving such a message transmission, wherein the beacon is  
arranged to broadcast a series of inquiry messages each in the form of a  
plurality of predetermined data fields arranged according to a first  
communications protocol, wherein the beacon is further arranged to add to  
each inquiry message prior to transmission an additional data field, and  
15 wherein the at least one portable device is arranged to receive the transmitted  
inquiry messages and read data from said additional data field, the additional  
data field including location information. By adding the additional field (suitably  
at the end of a respective inquiry message), data broadcast may be carried on  
top of an existing inquiry process, such that the usual delays while such a  
20 process is carried out prior to data transfer are avoided. Furthermore, by  
placing the additional field at the end of those sent according to the  
communications protocol (preferably but not essentially Bluetooth), those  
protocol-compatible devices not intended for reception of beacon signals can  
simply ignore the additional data without compromising operation according to  
25 protocol.

Where the protocol is Bluetooth (or a similar frequency hopping  
arrangement) the beacon may be configured to broadcast a series of inquiry  
messages on a predetermined clocked succession or sequence of  
frequencies, with clock information for the beacon being carried by the  
30 additional data field. In one arrangement, the additional data field may carry at  
least 64 bits of data. As will be described in greater detail hereinafter with  
respect to embodiments of the invention, this can improve the inquiry

performance of a Bluetooth system, shortening the time to establish a connection for data exchange.

The beacon may be arranged to include an indication in one of said predetermined data fields (suitably in a currently unused or unassigned field), said indication denoting the presence of said additional data field, such that devices configured for reception of beacon data may be triggered to read from the additional data field.

The beacon may be arranged to include in a message first comparison data, with the portable device further comprising storage means holding second comparison data and comparator means arranged to identify when there is a match between the first and second comparison data and present the data read from the additional data field, otherwise to not present the data. Such second comparison data may be predetermined and/or pre-stored, or it may be determined adaptively from user profiling of the portable device user.

Also in accordance with the present invention there is provided a mobile communication device for use in the system recited above, the device comprising a receiver capable of receiving a short-range wireless inquiry message including a plurality of data fields according to a first communications protocol, means for determining when an additional data field including location information has been added to said plurality of data fields, and means for reading the location information data from such an additional data field.

Still further in accordance with the present invention, there is provided a method for enabling the user of a portable communications device to receive broadcast messages wherein at least one beacon device broadcasts a series of inquiry messages each in the form of a plurality of predetermined data fields arranged according to a first communications protocol, wherein the beacon adds to each inquiry message prior to transmission an additional data field carrying broadcast message data, including location information, and wherein the portable device receives the transmitted inquiry messages, including the location information, and reads the broadcast data from said additional data field.

Preferred embodiments of the invention will now be described, by way of example only, and with reference to the accompanying drawings, in which:

Figure 1 is a block schematic diagram of a beacon and portable device embodying the invention;

5 Figure 2 is a schematic diagram of a series of devices in a linked beacon infrastructure;

Figure 3 is a chart illustrating a portion of the transmission of a train of inquiry access codes centred on a given frequency ;

10 Figure 4 illustrates alternation between trains of inquiry messages over the duration of an inquiry broadcast;

Figure 5 illustrates the insertion of a packet of broadcast data within an existing transmission slot;

Figure 6 illustrates a first arrangement for sending beacon clock data in a sequence of inquiry message trains; and

15 Figure 7 illustrates an alternate arrangement to that of Figure 6 for the sending of beacon clock data.

In the following description we consider particularly a CA application which utilises Bluetooth protocols for communication of messages from beacon to portable device (whether telephone, PDA or other). As will be recognised, the general invention concept of including a broadcast channel as part of the inquiry procedure is not restricted to Bluetooth devices, and is applicable to other communications arrangements, in particular frequency hopping systems.

25 Figure 1 is a block schematic diagram of a CA mobile telephone 10 in use with one or more low power, short range base stations or beacons 12, 14. As mentioned previously, and discussed in greater detail below, such an arrangement may be used in places like shopping malls to provide location-specific information such as local maps, information on nearby shops and restaurants and so on, with the beacon downloading information keys to a mobile device. As will be discussed in greater detail below, the arrangement  
30 may also be used to provide location information itself, for example mapping

co-ordinates or the like. An information key is a small data object that provides a reference to a source of full information, and it is in the form of a number of predetermined fields, one of which may contain a short piece of descriptive text presented to a user. Another field will be a pointer or address of some form, for example a URL or telephone number. Other supplementary fields may control how the data is presented to a user and how the address may be exploited. The beacon will generally broadcast cyclically a number of these keys, each typically relating to a different service.

Issues relating to the beacon construction and configuration include the beacons range which will be dependent on output power (typical range being 1mW to 100mW), levels of local interference, and receiver sensitivity.

The user's CA terminal 10 comprises an aerial 16 coupled with transceiver stage 18 for the reception and transmission of messages. Outgoing messages result from user input to the telephone, either audio input via microphone 20 and A/D converter 22 or other data input via the keypad or other input means 24. These inputs are processed to message data format by signal and data processing stage 26 and converted to transmission format by encoder 28 before being supplied to the transceiver stage 18.

Messages received via the aerial 16 and transceiver 18 are passed via a decoding stage 30 to a filtering and signal processing stage 32. If the data carried by the message is for presentation on a display screen 34 of the telephone, the data will be passed to a display driver 36, optionally after buffering 38, with the driver formatting the display image. As will be recognised, the display 34 may be a relatively simple low-resolution device, and the conversion of received data to display data may be carried out as a subset of the processing stage 32 functionality, without the requirement for a dedicated display driver stage.

Where the message is carrying data from one or other of the beacons 12, 14, the telephone has the ability to filter the information received according to pre-stored 40 user preferences and the user is only alerted (i.e. the information will only be retained in buffer 38 and/or presented on screen 34) if

comparison of stored preference data and subject matter indicators in the message indicate that an item of data of particular interest has been received.

For conventional audio messages, the audio data is output by the filter and processing stage 32, via D/A converter 42 and amplifier 44 to an earphone or speaker 46. Receipt of such messages from the telephone network 48 is indicated by arrow 50: the telephone network 48 also provides the link from the telephone 10 to a wide-area network (WAN) server 52 and, via the WAN 54 (which may be the internet), to one or more remote service providers 56 providing a source of data for the telephone 10.

Communication between the CA terminal (telephone 10) and the CA base station (beacon 12) takes two forms: 'push' and 'pull'. In 'push' mode, information is broadcast by the beacons 12, 14, to all portable terminals 10 in the form of short 'keys' indicated at 60. The keys will take various forms according to the application but will generally include a concise description of the information being sent and a pointer to fuller information, e.g. a URL identifying one of the service providers 56.

Keys are received by the terminal 10 'unconsciously', that is, without direct intervention by the user, and automatically filtered according to the user's pre-set preferences. Some will be discarded, some kept for further study, others might cause the user to be alerted immediately. By way of example, shops might choose to push details of special offers into passing terminals in the knowledge that users who have interest and have therefore set their filters 32 accordingly will be alerted by their terminal.

Sometimes the user will wish to obtain more information than is contained in the keys. Here, 'pull' mode allows a user to set up a connection with a server 56 (which need not necessarily be specially configured for CA use) and actively request information to pull down into the terminal 10. This mode is therefore typically interactive.

Whilst base stations or beacons will typically be independent of one another (in a shopping mall set up, each shop provides and maintains its own beacon without reference to any beacons provided by neighbouring shops),

the beacons may be wholly or partially networked with at least some co-ordination as to their broadcast messages.

Figure 2 is a diagram of such a system 100 of linked beacons embodying the invention and providing an implementation of an infrastructure for use in, for example, department stores, shopping malls, theme parks, etc. The system 100 comprises a plurality of beacons 102, 104, 106, 108 distributed over a series of locales. Each of the beacons 102-108 broadcasts one or more short-range inquiry signals in a time-slot format as described in greater detail hereinafter. The beacons 102 - 108 are controlled by a beacon infrastructure server (BIS) 110, with one or more terminals 112, 114, 116, 118 being connected to the server 110. The terminals 112 - 118 enable service providers, i.e., the users of beacons 102 - 108, to author or edit allocated service slots in the form of added data piggy backed on inquiry facilitation signals transmitted by beacons 102 - 108. A service provider may lease a beacon or one of the beacon's service slots from the infrastructure provider. To this end, server 110 provides simple HTML templates for filling out by the user via one of terminals 112 - 118. Having filled out the template with, for example, a description of the service and other information for the data to be carried via the beacon broadcast, the template is returned to server 110, preferably via a secure link using, e.g., Secure HTTP (S-HTTP) or Secure Sockets Layer (SSL). SSL creates a secure link between a client and a server, over which any amount of data can be sent securely. S-HTTP is designed to transmit individual messages securely. Server 110 then creates the appropriate additional data package for appending to the inquiry signal of a relevant one of the beacons 102 - 108 based on the information submitted with the template. The system 100 may further comprise an application server 120 to assist in carrying out various functions, as will be readily understood by the skilled reader.

Referring back to Figure 1, a strong candidate technology for the wireless link necessary for at least the 'push' mode of the above-described CA system is Bluetooth, on the grounds that it is expected to become a component part of a large number of mobile telephones 10. In analysing the



Bluetooth protocol for CA broadcast or 'push' mode utilisation, a problem may be seen. In the ideal case, the terminal 10 will detect fixed beacons 12, 14 and extract basic information from them without the terminal 10 needing to transmit at all. However, this type of broadcast operation is not supported by  
5 the current Bluetooth specification.

In part, the incompatibility follows the frequency hopping nature of Bluetooth beacon systems which means that, in order for broadcast messages (or, indeed, any messages) to be received by a passing terminal, the terminal has to be synchronised to the beacon in both time and frequency. The  
10 portable device 10 has to synchronise its clock to the beacon clock and, from the beacons identity, deduce which of several hopping sequences is being employed.

To make this deduction, the portable device has conventionally been required to join – as a slave - the piconet administered by the beacon as  
15 piconet master. Two sets of procedures are used, namely "inquiry" and "page". Inquiry allows a would-be slave to find a base station and issue a request to join the piconet. Page allows a base station to invite slaves of its choice to join the net. Analysis of these procedures indicates that the time taken to join a piconet and then be in a position to receive information from the  
20 master could be several tens of seconds, which is much too long for CA applications, where a user may move out of range of a beacon before joining could be completed.

The difficulty of receiving broadcast data from beacons is caused at least partially by the frequency-hopping nature of Bluetooth and similar  
25 systems. The Bluetooth inquiry procedure has been proposed specifically to solve the problem of bringing together master and slave: the applicants have recognised that it is possible to piggy-back a broadcast channel on the inquiry messages issued by the master. Only CA terminals need read the broadcast channel messages and only CA base stations or beacons send them. In  
30 consequence, at the air interface, the mechanism is entirely compatible with conventional (non-CA) Bluetooth systems.

To illustrate how this is implemented, we first consider how the Inquiry procedures themselves operate, with reference to Figures 3 and 4. When a Bluetooth unit wants to discover other Bluetooth devices, it enters a so-called inquiry substate. In this mode, it issues an inquiry message containing a  
5 General Inquiry Access Code (GIAC) or a number of optional Dedicated Inquiry Access Codes (DIAC). This message transmission is repeated at several levels; first, it is transmitted on 16 frequencies from a total of 32 making up the inquiry hopping sequence. The message is sent twice on two frequencies in even timeslots with the following, odd timeslots used to listen for  
10 replies on the two corresponding inquiry response hopping frequencies. Sixteen frequencies and their response counterparts can therefore be covered in 16 timeslots, or 10ms. The chart of Figure 3 illustrates the transmission sequence on sixteen frequencies centred around  $f\{k\}$ , where  $f\{k\}$  represents the inquiry hopping sequence.

15 The next step is the repetition of the transmission sequence at least  $N_{\text{inquiry}}$  times. At the very least, this requires 256 repetitions of the entire sequence which constitutes a train of transmissions which we will refer to as inquiry transmission train A. Next, inquiry transmission train A is swapped for inquiry transmission train B consisting of a transmission sequence on the  
20 remaining 16 frequencies. Again, the train B is made up of 256 repetitions of the transmission sequence. Overall the inquiry transmissions cycle between transmissions of train A and train B. As shown by Figure 4, the specification states that this switch between trains must occur at least three times to ensure the collection of all responses in an error-free environment. This means that  
25 an inquiry broadcast could take at least 10.24 seconds.

A portable device that wants to be discovered by a beacon enters the inquiry scan substate. Here, it listens for a message containing the GIAC or DIAC's of interest. It, too, operates in a cyclic way. It listens on a single hop  
30 frequency for an inquiry scan period of  $T_{w\_inquiry\_scan}$ . This must be long enough to cover the 16 inquiry frequencies used by the inquiry. The interval between the beginning of successive scans must be no greater than 1.28 seconds. The

frequency chosen comes from the list of 32 making up the inquiry hopping sequence.

On hearing an inquiry containing an appropriate IAC, the portable device enters a so-called inquiry response substate and issues a number of inquiry response messages to the beacon. The beacon will then page the portable device, inviting it to join the piconet.

As mentioned above and shown in Figure 5, the applicants propose that the inquiry messages issued by the base station have an extra field appended to them, capable of carrying a user-defined payload (CA DATA). In the CA scenario, this payload is used to carry broadcast information, or keys, to CA terminals during the inquiry procedure. By adding the field to the end of the inquiry message, it will be appreciated that non-CA receivers can ignore it without modification. In addition, by using a CA-specific DIAC, CA receivers can be alerted to the presence of the extra information field.

The presence of the extra data field means that the guard space conventionally allowed at the end of a Bluetooth inquiry packet is reduced. However, this space - provided to give a frequency synthesiser time to change to a new hop frequency - will be generally unused otherwise, as current frequency synthesisers are capable of switching at speeds which do not need extension into the extra guard space. The standard inquiry packet is an ID packet of length 68 bits. Since it is sent in a half-slot, the guard space allocated is  $(625/2 - 68) = 244.5 \mu\text{s}$  (625  $\mu\text{s}$  slot period, 1 Mbit/s signalling rate). Modern synthesisers can switch in much less time with figures of 100  $\mu\text{s}$  or lower considered routine by experts in the field. Applicants therefore propose allocation of 100 bits as a suitable size for this new field.

CA handsets can receive the broadcast data quickly without being required to run through a lengthy procedure to join a piconet. In addition, since there is no need for the handset to transmit any information whatsoever, there is a consequent power saving that will be particularly important in dense environments where many CA base stations may be present. Nevertheless, when the handset is in interactive mode and wishes to join a piconet in order to obtain more information, it may employ the default inquiry procedures as

normal. There is no loss of functionality through supporting the additional data field.

In a typical embodiment, four of our 100 bits will be lost as trailer bits for the ID field; this is a consequence of it being read by a correlator. Of the 96 bits remaining, applicants preferred allocation is that 64 be used as data and 32 as a 2/3 FEC (forward error correction) checksum. Each inquiry burst thus contains 8 bytes of broadcast data. In a most common scenario, by the second group of A and B trains the portable device has found the base station, understood it to be a CA beacon and is awaiting the broadcast data. Since it will be listening specifically, the portable device will at least be able to read 256 bursts of data twice (A and B), giving us two lots of 2 Kbytes, or 4 Kbytes in total.

At this stage, the portable device does not know the phase of the beacons clock because this information is not been transmitted. To assist the portable device, clock information is transmitted in at least some of the trains in the first A and B groups, as shown in Figure 6, together with some auxiliary information indicating when the next switches between A and B will occur. This clock information will be transmitted in place of the CA broadcast data so means are provided to discriminate between the two data channels. Use of separate DIAC's is one possible method.

In the case where the portable device knows the timing of the beacon, the portable devices also knows how it will hop, which gives the ability to track all transmissions of a train. Since there are 16 transmissions in a frame, then the resultant CA channel has 16 times as much capacity and can convey 64 Kbytes of information.

Since the terminal wakes up every 1.28 seconds or less, it will generally have obtained the clocking information it needs by the half way mark in the first A or B periods. Switching from clock to data at these halfway marks, as illustrated in Figure 7, provides a number of useful advantages. Firstly, some data can be received in less than five seconds from the start of the inquiry procedure. Secondly, the terminal can still respond to an important key by automatically issuing an inquiry response message to the base station (if that

is the appropriate action for the terminal to take) even if the key appears comparatively late in the cycle. It will be noted that no increase in capacity is assumed.

In the foregoing, a portable device will receive all the additional data field packets on one of the 32 inquiry channels, thereby using only 1/32 of the available bandwidth. As will be recognised, if the uncertainty as to when a portable terminal (beacon slave) receives the first inquiry packet can be overcome, the predetermined nature of the hopping sequence may be accommodated and the full bandwidth therefore utilised. For a slave to synchronise with a masters inquiry hopping sequence from the point where it received the first packet, the slave needs to know both the masters clock offset and the position of the first received packet in the masters hopping sequence. In the following example, it is assumed that the master follows the Bluetooth minimum enquiry procedure, which comprises 256 repetitions of the 16-channel inquiry hopping sequences, with three train switches (as in Figure 4). Each sweep across the 16 channels takes 10ms.

To synchronise the slave hopping, the additional data field (BCD; Fig. 1) carries the following information:

- Master clock offset (2 bytes);
- Number of full train repetitions (1 byte) – assuming that a full train consists of 256 repetitions of 10ms trains, the range of this parameter is 0-255 (before the inquiry switches to the next full train). This indicates to the slave when the master will next switch the full train.
- How many full train switches have been completed in the current inquiry cycle (1 byte) – this data indicates to the slave what the master is likely to do at the end of the current full train, i.e. whether it will switch over to another full train or whether the inquiry procedure will terminate.

As long as no channel repeats in the 10ms train, no field is required to indicate the position of the current channel in the hopping sequence as the slave is able to derive this from knowledge of the sequence.

From the foregoing it will be seen that, by adding 4 bytes to each additional field packet, the slave can then pick up all additional field packets to the end of the inquiry, whilst still having 4 bytes available (from our preferred assignment of 64 from 100 bits for data) to carry broadcast data.

5        Considering a complete beacon signal, it will be readily understood that it will need to be divided into a number of 4-byte packets with one being sent with each inquiry packet. Assuming a fixed length of beacon signal for the purposes of illustration, at 16kB the full signal can be accommodated on a single inquiry train (a train being 256 repetitions of the 16-channel hop  
10 sequence, giving  $256 \times 16 \times 4$  bytes = 16kB).

Extending this, by fixing that the first packet of a beacon signal goes on the first packet of an inquiry train, from the message indicator field for the number of repetitions for the current 16-channel hopping sequence in the message header, the slave is enabled to derive the position of the beacon  
15 packet it has received in the complete beacon signal.

Mobile CA devices may be provided with location aware applications. Such applications generally require actual location information, as opposed to just location specific information. Therefore we now discuss the issue of transferring such location information to a portable terminal.

20        In principle, by using a Bluetooth link, location information can be transferred over a short-range air interface allowing (Bluetooth enabled) location aware products to find out where they are. Such products can therefore establish their position using data originating from location  
25 establishing devices such as a GPS receiver, or other devices providing a source of location information. Therefore, the products themselves do not need to be equipped with potentially expensive and sometimes unreliable onboard location systems. Unfortunately, the transfer mechanism suffers from the above mentioned problems resulting from the fact that before information  
30 such a link requires a Bluetooth slave terminal (in this case the terminal making the location information request), to join the piconet administered by the Bluetooth master terminal (in this case the terminal responding to the

enquires). The process of joining the piconet can take several tens of seconds. While this is happening the terminal does not know its current location and the operation of any location aware applications on the terminal will therefore be impaired. Therefore this approach is not ideal for providing location information to a context aware device – a mobile CA device may not spend enough time near a given beacon to establish a Bluetooth link. Furthermore, even if a device does carry out the establishment of a Bluetooth link, there will not necessarily be any location information available and the exercise will have been a wasted exercise.

We therefore propose that the presently described concept of establishing a broadcast channel from beacons for reception by CA devices, by adding data to inquiry transmissions should include the procedure of including location information as part of the information broadcast on that channel.

As described above, initial proposals assume that each inquiry burst can carry 8 bytes of broadcast data in the extended field. Some of this will be used for synchronisation purposes so that there will be in the order of 4 to 6 bytes remaining. A typical location information packet requires approximately 12 to 15 bytes to convey basic service information, such as latitude / longitude co-ordinates and a few other parameters. For extended service purposes, the location information will typically require in the order of 15 to 300 bytes allowing information such as velocity information, optional auxiliary text and URL fields to be carried. In either case, the information may need to be spread over several packets. Basic service location information may be broadcast more often than extended service information. Optionally, extended service information may be retrieved over a normal Bluetooth connection in a 'client pull' type operation as a result of the basic broadcast indicating to the client that such extended service information is available.

In order to distinguish location information from other types of broadcast information (for example, other context aware mobile phone services or broadcast audio), two possible techniques include the following. The first is to use a special DIAC. A second, is to include a header somewhere in the

additional data field to describe the information content type. In the presently described embodiment, we shall assume that the entire basic service location information burst is spread over four extended inquiry packets, although this is not to be interpreted as a limitation to the present invention.

5       The order of the inquiry transmissions from the master has already been discussed in some detail above, with two sets of sixteen frequencies being covered in 'trains' of inquiry transmission. In each train, all 16 frequencies in the set are covered in 10ms and this cycle is repeated 256 times (see Figures 4 and the relevant discussion above). Each train may be  
10       repeated twice.

      Since the slave scans on a single frequency arbitrarily chosen from the set of 32 frequencies, it is useful to send location information on every frequency used for inquiry transmissions. Assuming that we require four extended fields on each frequency, the location information burst will take 40  
15       ms and about 1.6% of the total broadcast capacity to send.

      For fast location acquisition, it is assumed that the beacon must be active continuously. Such activity would normally prevent conventional two-way links being set up but this obstacle can be overcome by employing two beacons operating in tandem, thereby providing fast access to the piconet and  
20       an unlimited two-way throughput capacity simultaneously. Such an arrangement is the subject of our pending UK patent application number GB0015452.6 entitled "Local Data Delivery through Beacons" filed on 26th June 2000.

      The number of times location information is transmitted in a train can  
25       affect the access time to location information. By increasing the frequency of location information transmission in a train, speed of access to information can be improved. Assuming that one location information burst is sent per train, then the access time ranges from 0 to 5.12 seconds (the longer time results when the slave just misses the location information broadcast within the train  
30       and must wait for the duration of the remaining part of train A, all of train B and a portion of the next train A before it is possible to pick up the location information).



If it is known to a terminal receiver (slave receiver) that inquiry information is broadcast on each of 16 frequencies, say every 10ms, and it is monitoring those frequencies every 10ms, and after say 50ms the receiver has not managed to pick up any inquiry transmissions at all, it can choose to switch  
5. to monitoring those other 16 inquiry transmission frequencies associated with the other train.

If, in the absence of received inquiry transmissions on one of the inquiry transmission trains, the receiver is allowed to jump frequency to one in the other inquiry transmission train, access time to information carried in the  
10 additional data field, for example location information, might be reduced. The reduced time may be, for example in the order of 2.56 seconds. Transmitting the burst twice per frame brings this down to, say, 1.28 seconds maximum or 640 ms average.

It will be apparent that the location information may take a number of  
15 forms in both the format location information is represented and in the format it is broadcast. For example, the information may be represented in terms of mapping co-ordinates, Global Positioning System data, or any other suitable way. Location information may be absolute or relative. In the latter case location information may be expressed, for example, with reference to building  
20 room designations, vehicle identity (say, when a person is on a bus) or in other ways as will be apparent to the person skilled in the art.

From reading the present disclosure, other modifications will be apparent to persons skilled in the art. Such modifications may involve other features which are already known in the design, manufacture and use of fixed  
25 and portable communications systems, and systems and components for incorporation therein and which may be used instead of or in addition to features already described herein.

## CLAIMS:

1. A communications system comprising at least one beacon device capable of wireless message transmission and at least one portable device capable of receiving such a message transmission, wherein the beacon is arranged to broadcast a series of inquiry messages each in the form of a plurality of predetermined data fields arranged according to a first communications protocol, wherein the beacon is further arranged to add to each inquiry message prior to transmission an additional data field, and wherein the at least one portable device is arranged to receive the transmitted inquiry messages and read data from said additional data field, the additional data field including location information.
2. A system as claimed in Claim 1, wherein the beacon is arranged to add said additional data field at the end of a respective inquiry message.
3. A system as claimed in Claim 1 or Claim 2, wherein the beacon is arranged to include an indication in one of said predetermined data fields, said indication denoting the presence of said additional data field.
4. A system as claimed in any of Claims 1 to 3, wherein said first communications protocol comprises Bluetooth messaging.
5. A system as claimed in claim 4, wherein a special Dedicated Inquiry Access Code (DIAC) is used to indicate the presence of location information in the additional data field.
6. A system as claimed in any one or more of claims 1 to 5 wherein the presence of location information in the additional data field is indicated with header information appearing in the additional data field.

7. A system in accordance with any one or more of claims 1 to 6, wherein wireless messaging system employs frequency hopping, and further wherein location data is sent on each frequency used for inquiry message broadcasts.

5

8. A mobile communication device for use in the system of any of Claims 1 to 7, the device comprising a receiver capable of receiving a short-range wireless inquiry message including a plurality of data fields according to a first communications protocol, means for determining when an additional data field including location information has been added to said plurality of data fields, and means for reading the location information data from such an additional data field.

9. A device as claimed in Claim 8, wherein the receiver is configured to receive messages according to Bluetooth protocols.

10. A method for enabling the user of a portable communications device to receive broadcast messages wherein at least one beacon device broadcasts a series of inquiry messages each in the form of a plurality of predetermined data fields arranged according to a first communications protocol, wherein the beacon adds to each inquiry message prior to transmission an additional data field carrying broadcast message data including location information, and wherein the portable device receives the transmitted inquiry messages including the location information and reads the broadcast data from said additional data field.

11. A method as claimed in Claim 10, wherein the beacon adds said additional data field at the end of a respective inquiry message.

12. A method as claimed in Claim 10 or Claim 11, wherein the beacon includes an indication in one of said predetermined data fields, said indication denoting the presence of said additional data field.

13. A method as claimed in any of Claims 10 to 12, wherein said first communications protocol comprises Bluetooth messaging.

5 14. A communications system substantially as hereinbefore described with reference to the accompanying drawings.

15. A portable communications device substantially as hereinbefore described with reference to the accompanying drawings.

10

16. A method for enabling the user of a portable communications device to receive broadcast messages substantially as hereinbefore described with reference to the accompanying drawings.

## ABSTRACT

**DATA DELIVERY THROUGH BEACONS**

5           A communications system comprises at least one beacon device (12,  
14) capable of wireless message transmission and at least one portable device  
(10) capable of receiving such a message transmission. The beacon (12) is  
arranged to broadcast a series of inquiry messages (60) each in the form of a  
plurality of predetermined data fields (INQ) arranged according to a first  
10       communications protocol, such as Bluetooth. For the delivery of additional  
data via broadcast, and in particular data including location information, the  
beacon (12) adds to each inquiry message prior to transmission an additional  
data field (BCD) carrying broadcast data, with the portable device (10)  
receiving the transmitted inquiry messages including the location data and  
15       reading the broadcast data from the additional data field.

(Figure 1)

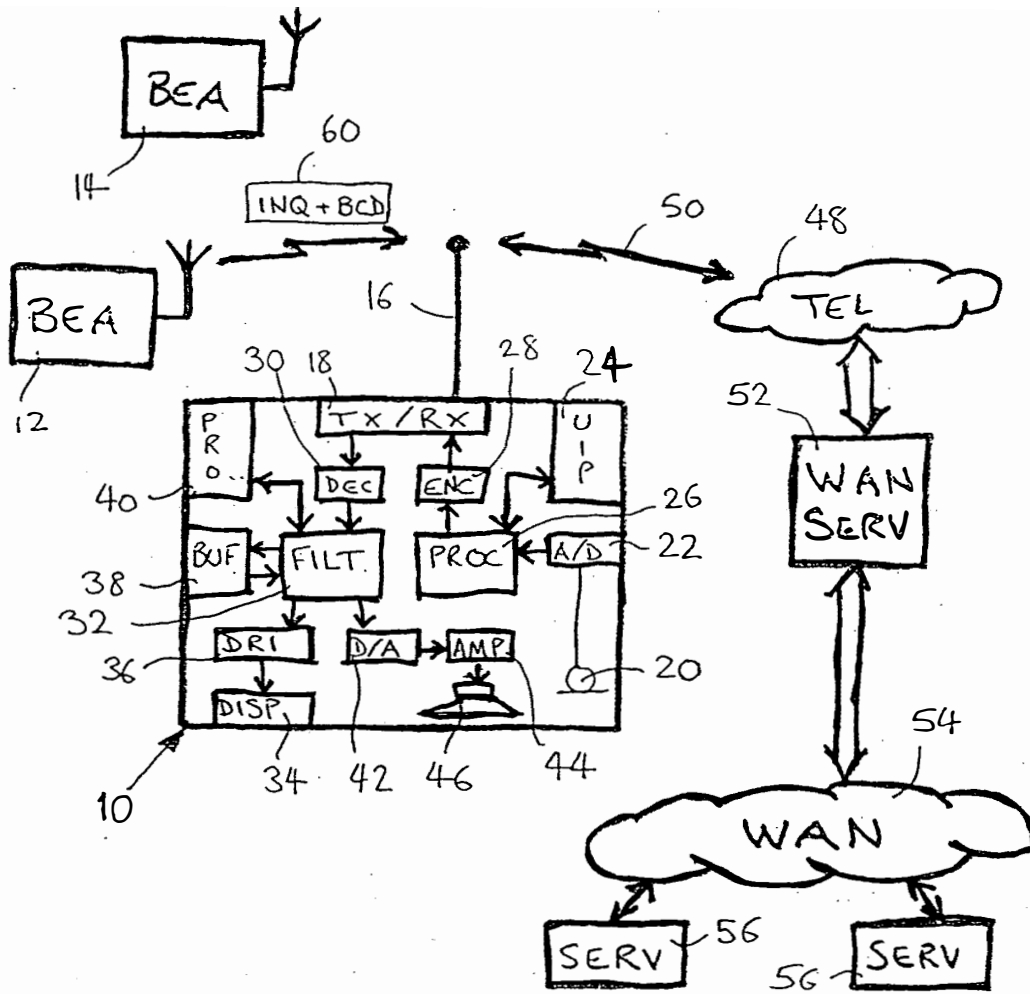

**Fig. 1**

PHGB000109

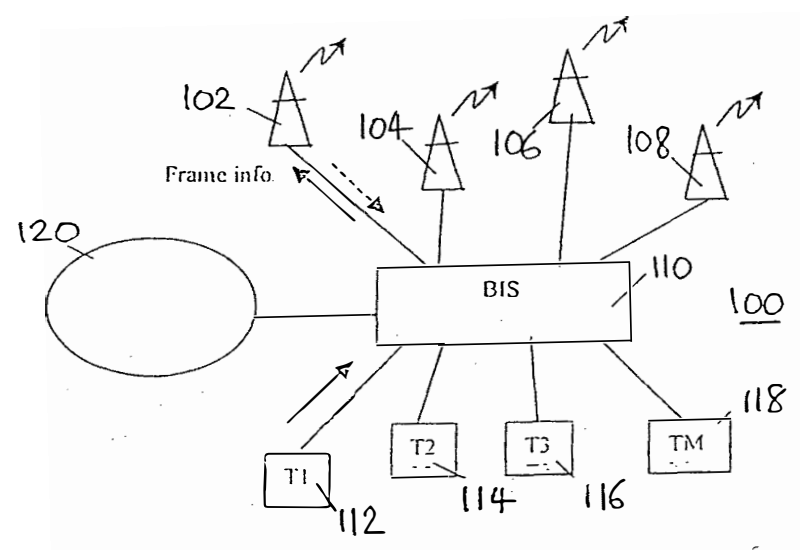

Fig. 2

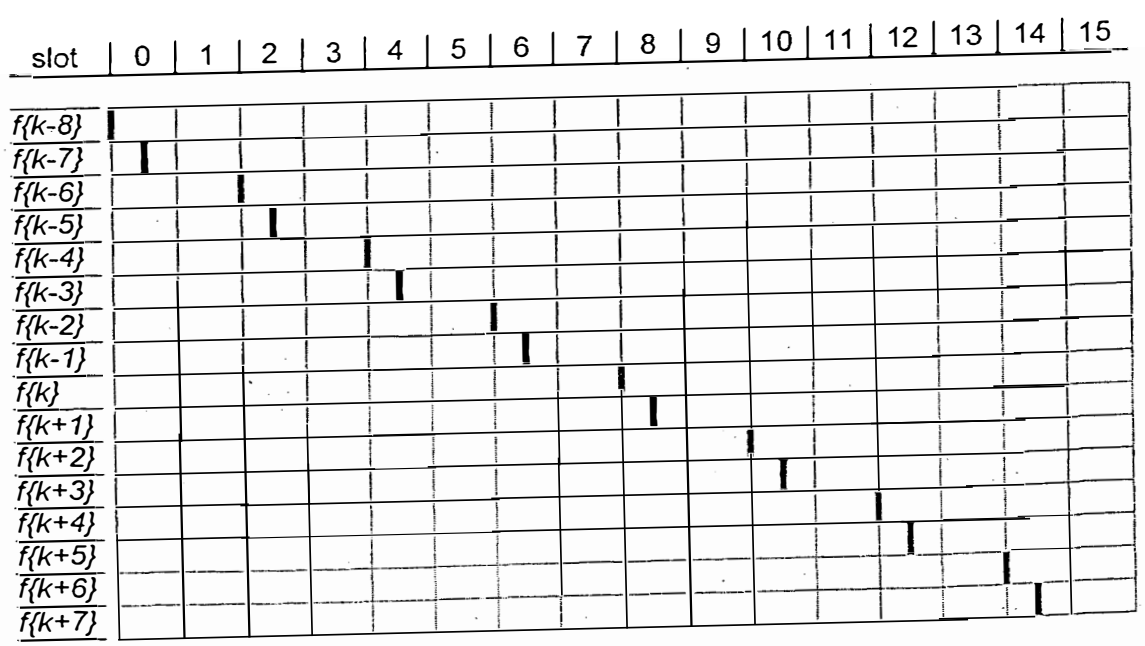
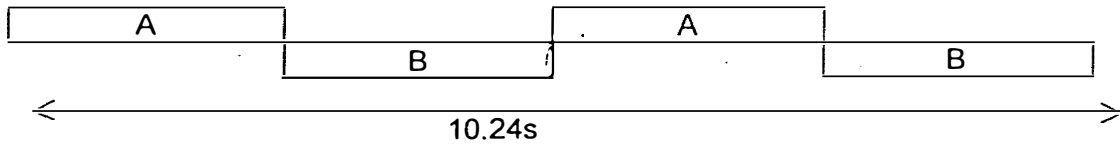
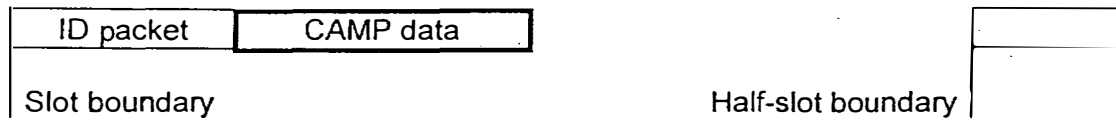

Fig. 3



**Fig. 4**



**Fig. 5**

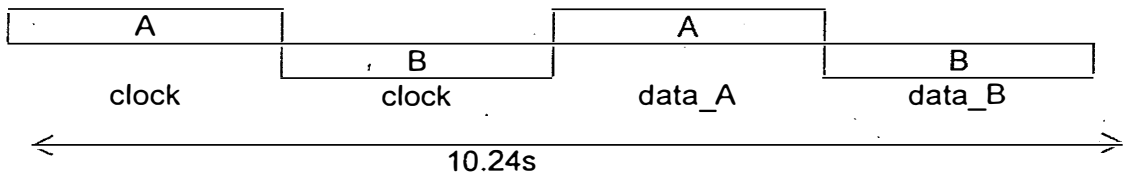

**Fig. 6**

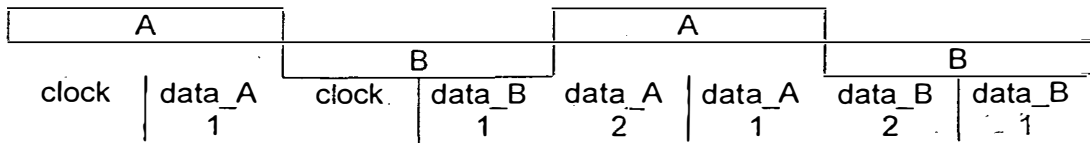

**Fig. 7**