



US006704293B1

(12) **United States Patent**
Larsson et al.

(10) **Patent No.:** **US 6,704,293 B1**
(45) **Date of Patent:** **Mar. 9, 2004**

- (54) **BROADCAST AS A TRIGGERING MECHANISM FOR ROUTE DISCOVERY IN AD-HOC NETWORKS**
- (75) Inventors: **Tony Larsson**, Stockholm (SE); **Johan Rune**, Lidingö (SE); **Johan Sörensen**, Eslöv (SE)
- (73) Assignee: **Telefonaktiebolaget LM Ericsson (publ)**, Stockholm (SE)
- (*) Notice: Subject to any disclaimer, the term of this patent is extended or adjusted under 35 U.S.C. 154(b) by 0 days.
- (21) Appl. No.: **09/455,460**
- (22) Filed: **Dec. 6, 1999**
- (51) **Int. Cl.⁷** **H04L 12/28**
- (52) **U.S. Cl.** **370/255; 370/351; 370/400**
- (58) **Field of Search** **370/351, 400, 370/401, 328, 254, 255**
- (56) **References Cited**

U.S. PATENT DOCUMENTS

5,051,984	A	9/1991	Mostafa et al.	
5,056,085	A	10/1991	Vu	
5,065,399	A	11/1991	Hasegawa et al.	
5,173,689	A	12/1992	Kusano	
5,235,599	A	8/1993	Nishimura et al.	
5,719,861	A	2/1998	Okanoue	
5,740,366	A	4/1998	Mahany et al.	
5,748,611	A	5/1998	Allen et al.	
5,987,011	A	* 11/1999	Toh	370/331
6,304,556	B1	* 10/2001	Haas	370/254

FOREIGN PATENT DOCUMENTS

EP	0599764	6/1994
EP	0883265	12/1998
EP	0913965	5/1999
WO	9911025	3/1999
WO	9923799	5/1999

OTHER PUBLICATIONS

W. Richard Stevens, "TCP/IP Illustrated, vol. 1, The Protocols," 1994, Addison-Wesley, pp. 53-64.*
 Pravin Bhagwat and Adrian Segall, "A Routing Vector Method (RVM) for Routing in Bluetooth Scatternets," IEEE 1999, pp. 375-379.*

Albrecht, M., et al., "IP Services over Bluetooth: Leading the Way to a New Mobility", Proceedings of the Conference on Local Computer Networks, Oct. 1999.
 Tode, H., et al., "A Routing Method Using a Tunable Cost Function to Obtain Required Communication Quality and Performance", Electronics and Communications in Japan, Part 1. Vol, 81, No. 5, 1998.
 Haartsen, J., "Bluetooth—The Universal Radio Interface for Ad Hoc, Wireless Connectivity", Ericsson Review No. 3 (1998), pp. 110-117.
 Takagi, Hideaki, "Queuing Analysis of Polling Models", ACM Computing Surveys, vol. 20, No. 1, Mar. 1988.
 Johansson, Per, et al., "Short Range Radio Based Ad-hoc Networking: Performance and Properties", Proceedings of International Conference on Communications (ICC '99), Jun. 6-10, 1999.
 "Specification of the Bluetooth System", Bluetooth SIG, vol. 10, pp. 35-40 and 121-122; Jul. 24, 1999.
 European Search Report Issued Jul. 28, 2000.

* cited by examiner

Primary Examiner—Chau Nguyen
Assistant Examiner—Keith M. George
 (74) *Attorney, Agent, or Firm*—Burns, Doane, Swecker & Mathis, LLP

(57) **ABSTRACT**

A method and/or an apparatus which places a broadcast message which the source expects a reply message in a broadcast message for route discovery. The combined message is broadcast throughout the ad-hoc network. When the combined broadcast message is received at the destination node, the destination node generates a response message including a reply message to the broadcast message that the source node expects a reply. The response message is sent back to the source node over the route which the combined broadcast message traveled to the destination node.

36 Claims, 11 Drawing Sheets

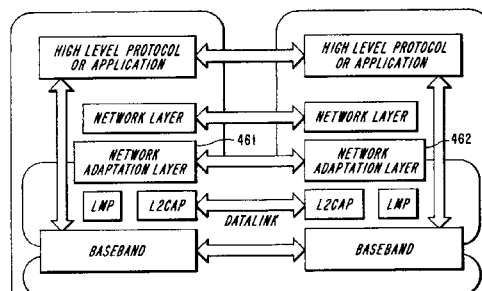

Fig. 1
Prior Art

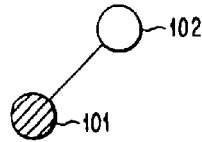

Fig. 2
Prior Art

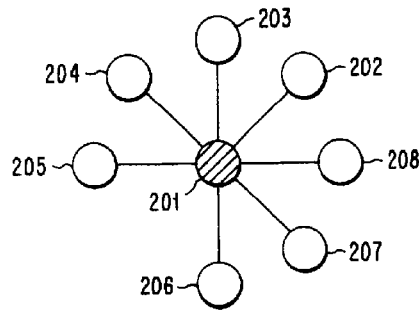

Fig. 3
Prior Art

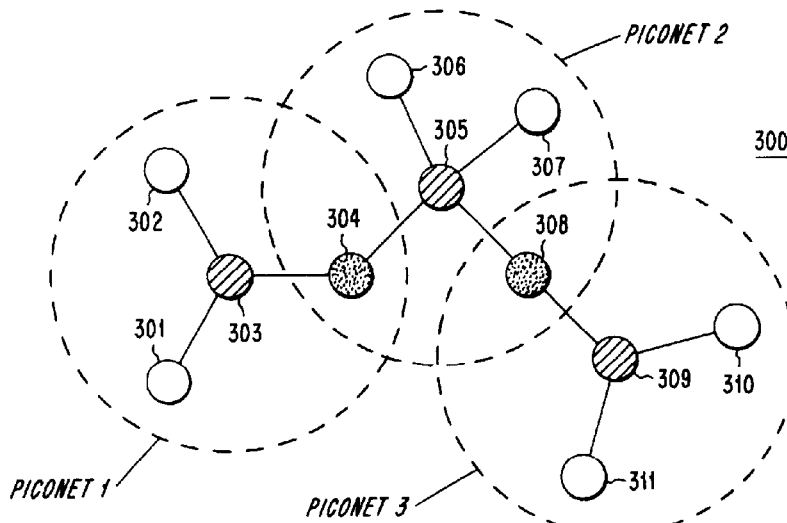

Fig. 4a
Prior Art

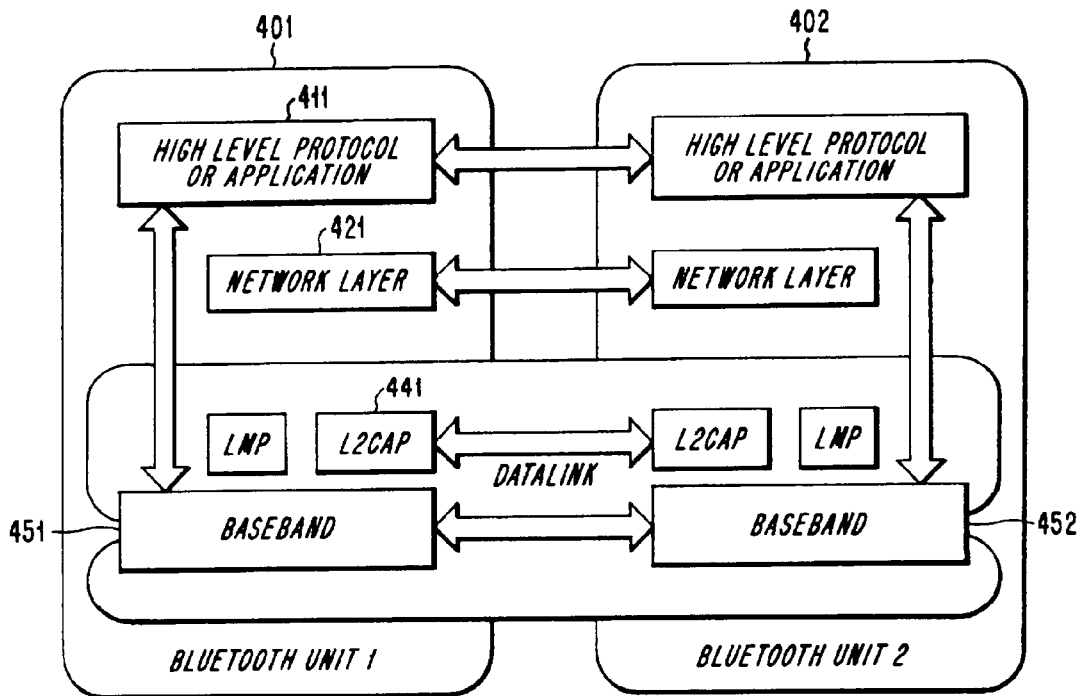

Fig. 4b

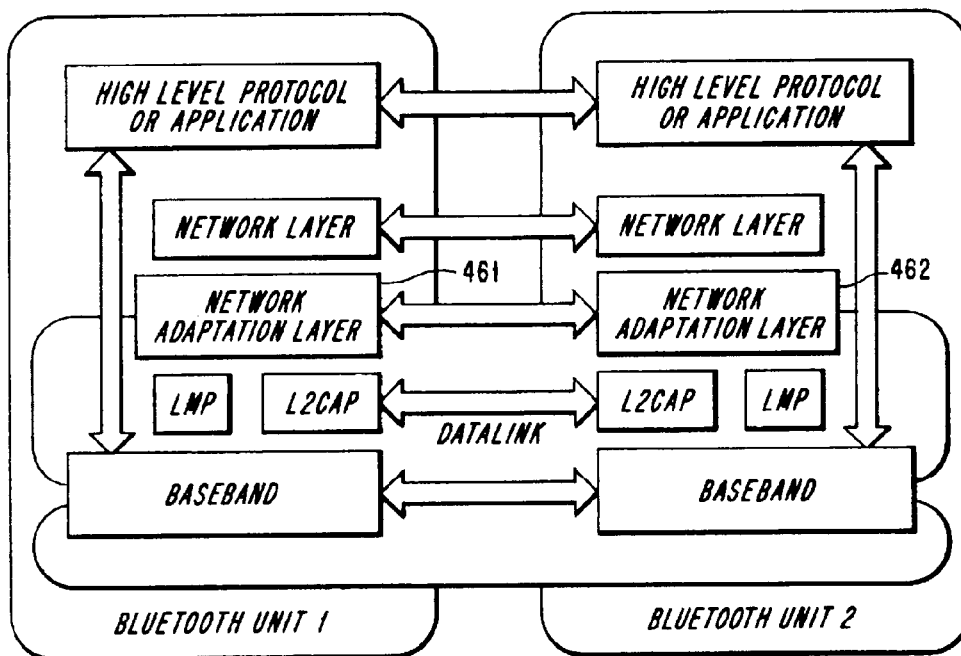

Fig. 5
Prior Art

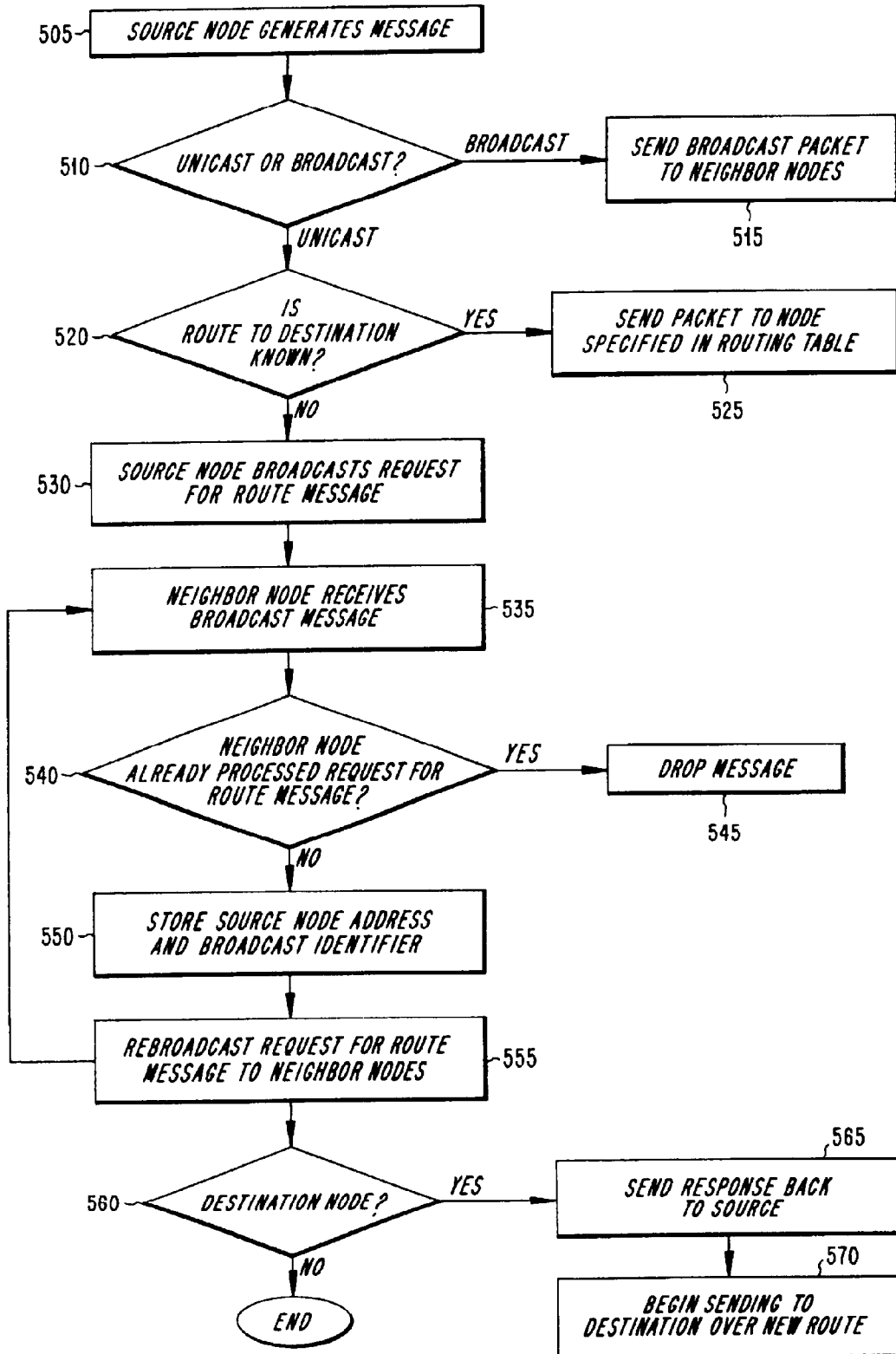
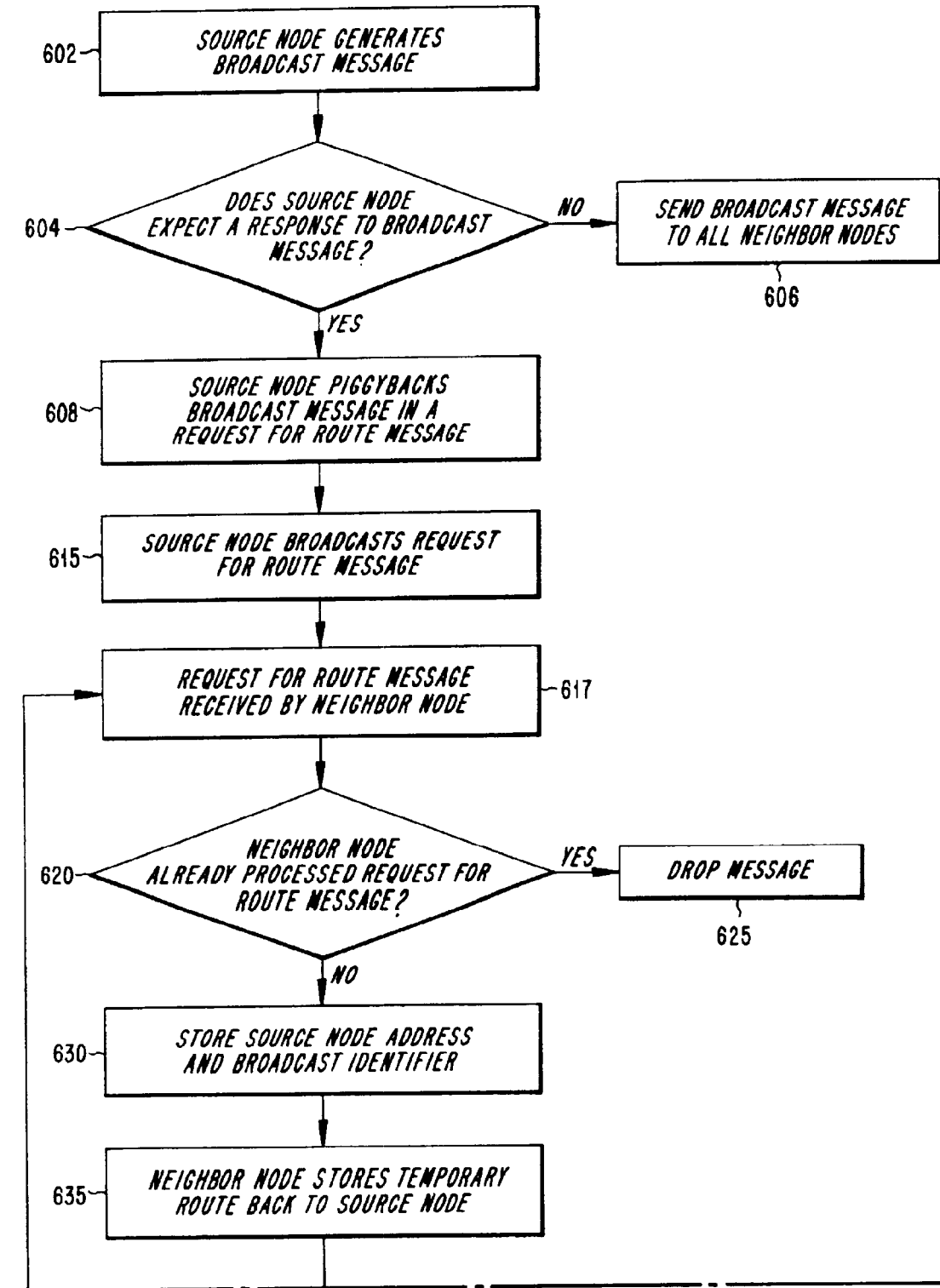

Fig. 6a



Explore Litigation Insights

Docket Alarm provides insights to develop a more informed litigation strategy and the peace of mind of knowing you're on top of things.

Real-Time Litigation Alerts



Keep your litigation team up-to-date with **real-time alerts** and advanced team management tools built for the enterprise, all while greatly reducing PACER spend.

Our comprehensive service means we can handle Federal, State, and Administrative courts across the country.

Advanced Docket Research



With over 230 million records, Docket Alarm's cloud-native docket research platform finds what other services can't. Coverage includes Federal, State, plus PTAB, TTAB, ITC and NLRB decisions, all in one place.

Identify arguments that have been successful in the past with full text, pinpoint searching. Link to case law cited within any court document via Fastcase.

Analytics At Your Fingertips



Learn what happened the last time a particular judge, opposing counsel or company faced cases similar to yours.

Advanced out-of-the-box PTAB and TTAB analytics are always at your fingertips.

API

Docket Alarm offers a powerful API (application programming interface) to developers that want to integrate case filings into their apps.

LAW FIRMS

Build custom dashboards for your attorneys and clients with live data direct from the court.

Automate many repetitive legal tasks like conflict checks, document management, and marketing.

FINANCIAL INSTITUTIONS

Litigation and bankruptcy checks for companies and debtors.

E-DISCOVERY AND LEGAL VENDORS

Sync your system to PACER to automate legal marketing.