

Express Mail No. EU 592640451US

PTO/SB/50 (08-03)  
Approved for use through 01/31/2004. OMB 0651-0033  
U.S. Patent and Trademark Office; U.S. DEPARTMENT OF COMMERCE

Under the Paperwork Reduction Act of 1995, no persons are required to respond to a collection of information unless it displays a valid OMB control number.

**REISSUE PATENT APPLICATION TRANSMITTAL**

Address to:  <b>Mail Stop Reissue Commissioner for Patents P.O. Box 1450 Alexandria, VA 22313-1450</b>	Attorney Docket No.	CHR 2001-79 (reissue)
	First Named Inventor	L. H. Hiltzik
	Original Patent Number	6,540,815
	Original Patent Issue Date (Month/Day/Year)	04/01/03
	Express Mail Label No.	EU592640451US

**APPLICATION FOR REISSUE OF:**  Utility Patent  Design Patent  Plant Patent  
(Check applicable box)

<p><b>APPLICATION ELEMENTS (37 CFR 1.173)</b></p> <ol style="list-style-type: none"> <li><input checked="" type="checkbox"/> Fee Transmittal Form (PTO/SB/56) (Submit an original, and a duplicate for fee processing)</li> <li><input type="checkbox"/> Applicant claims small entity status. See 37 CFR 1.27.</li> <li><input checked="" type="checkbox"/> Specification and Claims in double column copy of patent format (amended, if appropriate)</li> <li><input checked="" type="checkbox"/> Drawing(s) (proposed amendments, if appropriate) 33 pages</li> <li><input checked="" type="checkbox"/> Reissue Oath/Declaration (original or copy) (37 CFR 1.175) (PTO/SB/51 or 52)</li> <li><input checked="" type="checkbox"/> Power of Attorney (see PTO/SB/52)</li> <li><input checked="" type="checkbox"/> Original U.S. Patent currently assigned? <input checked="" type="checkbox"/> Yes <input type="checkbox"/> No (If Yes, check applicable box(es))                     <ul style="list-style-type: none"> <li><input checked="" type="checkbox"/> Written Consent of all Assignees (PTO/SB/53)</li> <li><input checked="" type="checkbox"/> 37 CFR 3.73(b) Statement (PTO/SB/96)</li> </ul> </li> <li><input type="checkbox"/> CD-ROM or CD-R in duplicate, Computer Program (Appendix) or large table</li> <li>9. Nucleotide and/or Amino Acid Sequence Submission (if applicable, all of the following are necessary)                     <ol style="list-style-type: none"> <li><input type="checkbox"/> Computer Readable Form (CFR)</li> <li>Specification Sequence Listing on:                             <ol style="list-style-type: none"> <li><input type="checkbox"/> CD-ROM (2 copies) or CD-R (2 copies); or</li> <li><input type="checkbox"/> paper</li> </ol> </li> <li><input type="checkbox"/> Statements verifying identity of above copies</li> </ol> </li> </ol>	<p><b>ACCOMPANYING APPLICATION PARTS</b></p> <ol style="list-style-type: none"> <li><input checked="" type="checkbox"/> Statement of status and support for all changes to the claims. See 37 CFR 1.173(c).</li> <li><input type="checkbox"/> Original Patent Grant                     <ul style="list-style-type: none"> <li><input type="checkbox"/> Ribbioned Original Patent Grant</li> <li><input type="checkbox"/> Statement of Loss (PTO/SB/55)</li> </ul> </li> <li><input type="checkbox"/> Foreign Priority Claim (35 U.S.C. 119) (if applicable)</li> <li><input checked="" type="checkbox"/> Information Disclosure Statement (IDS)/PTO-1449 <input checked="" type="checkbox"/> Copies of IDS Citations</li> <li><input type="checkbox"/> English Translation of Reissue Oath/Declaration (if applicable)</li> <li><input type="checkbox"/> Preliminary Amendment</li> <li><input checked="" type="checkbox"/> Return Receipt Postcard (MPEP 503) (Should be specifically itemized)</li> <li>17. Other: Certificate of Mailing; Statement in support changes Copy of Patent and Cert of Cor  Petition to Make Special &amp; Dec 1.131 Dec.</li> </ol>
---	---

**18. CORRESPONDENCE ADDRESS**

<input checked="" type="checkbox"/> Customer Number:	36876	OR	<input type="checkbox"/> Correspondence address below
Name	MeadWestvaco Corporation		
Address	5255 Virginia Avenue P. O. Box 118005		
City	Charleston	State	SC
Zip Code	29423-8005		
Country	United States of America	Telephone	843-746-8493
Fax	843-746-8494		

Name (Print/Type)	Terry B. McDaniel	Registration No. (Attorney/Agent)	28,444
Signature	<i>Terry B. McDaniel</i>	Date	10/21/03

This collection of information is required by 37 CFR 1.173. The information is required to obtain or retain a benefit by the public which is to file (and by the USPTO to process) an application. Confidentiality is governed by 35 U.S.C. 122 and 37 CFR 1.14. This collection is estimated to take 12 minutes to complete, including gathering, preparing, and submitting the completed application form to the USPTO. Time will vary depending upon the individual case. Any comments on the amount of time you require to complete this form and/or suggestions for reducing this burden, should be sent to the Chief Information Officer, U.S. Patent and Trademark Office, U.S. Department of Commerce, P.O. Box 1450, Alexandria, VA 22313-1450. DO NOT SEND FEES OR COMPLETED FORMS TO THIS ADDRESS. SEND TO: Mail Stop Reissue, Commissioner for Patents, P.O. Box 1450, Alexandria, VA 22313-1450.  
If you need assistance in completing the form, call 1-800-PTO-9199 and select option 2.

17513 U.S. PTO  
 10/690298  
 102103

Under the Paperwork Reduction Act of 1995, no persons are required to respond to a collection of information unless it displays a valid OMB control number.

<b>REISSUE APPLICATION FEE TRANSMITTAL FORM</b>							Docket Number (Optional)	
							CHR 2001-79 (reissue)	
Claims as Filed - Part 1								
	(1) Claims in Patent	(2) Number Filed in Reissue Application	(3) Number Extra	Small Entity		Other than a Small Entity		
				Rate	Fee	Rate	Fee	
Total Claims (37 CFR 1.16(j))	(A) 30	(B) 54	**** 24 =	x \$ _____ =		x \$ 18 =	612.00	
Independent claims (37 CFR 1.16(i))	(C) 2	(D) 4	* 1 =	x \$ _____ =		x \$ 86 =	86.00	
				Basic Fee (37 CFR 1.16(h))		\$ _____		
				Total Filing Fee		\$ _____		
						OR \$ 770.00		
						OR \$ 1468.00		
Claims as Amended - Part 2								
	(1) Claims Remaining After Amendment	(2) Highest Number Previously Paid For	(3) Extra Claims Present	Small Entity		Other than a Small Entity		
				Rate	Fee	Rate	Fee	
Total Claims (37 CFR 1.16(j))	*** 54	MINUS ** 30	* = 24	x \$ _____ =		x \$ 18 =	432.00	
Independent Claims (37 CFR 1.16(i))	*** 4	MINUS ***** 3	= 1	x \$ _____ =		x \$ 86 =	86.00	
				Total Additional Fee		\$ _____		
						OR \$ 1288.00		

\* If the entry in (D) is less than the entry in (C), Write "0" in column 3.

\*\* If the "Highest Number of Total Claims Previously Paid For" is less than 20, Write "20" in this space.

\*\*\* After any cancellation of claims.

\*\*\*\* If "A" is greater than 20, use (B - A); if "A" is 20 or less, use (B - 20).

\*\*\*\*\* "Highest Number of Independent Claims Previously Paid For" or Number of Independent Claims in Patent (C).

Applicant claims small entity status. See 37 CFR 1.27.

Please charge Deposit Account Number 23-1160 in the amount of \$1288.00.  
A duplicate copy of this sheet is enclosed.

The Director is hereby authorized to charge any additional fees under 37 CFR 1.16 or 1.17 which may be required, or credit any overpayment to Deposit Account Number 23-1160.  
A duplicate copy of this sheet is enclosed.

A check in the amount of \$ \_\_\_\_\_ to cover the filing/additional fee is enclosed.

Payment by credit card. Form PTO-2038 is attached.

**WARNING: Information on this form may become public. Credit card information should not be included on this form. Provide credit card information and authorization on PTO-2038.**

<p>October 21, 2003 Date</p> <p>28,444 Registration Number, if applicable</p>	 Signature of Applicant, Attorney or Agent of Record Terry B. McDaniel Typed or printed name
---	---

This collection of information is required by 37 CFR 1.16. The information is required to obtain or retain a benefit by the public which is to file (and by the USPTO to process) an application. Confidentiality is governed by 35 U.S.C. 122 and 37 CFR 1.14. This collection is estimated to take 12 minutes to complete, including gathering, preparing, and submitting the completed application form to the USPTO. Time will vary depending upon the individual case. Any comments on the amount of time you require to complete this form and/or suggestions for reducing this burden, should be sent to the Chief Information Officer, U.S. Patent and Trademark Office, U.S. Department of Commerce, P.O. Box 1450, Alexandria, VA 22313-1450. DO NOT SEND FEES OR COMPLETED FORMS TO THIS ADDRESS. SEND TO: **Commissioner for Patents, P.O. Box 1450, Alexandria, VA 22313-1450**

If you need assistance in completing the form, call 1-800-PTO-9199 and select option 2.



EXPRESS MAIL NO. EU592640451US  
Case Docket No. CHR 2001-79 Reissue

CERTIFICATE UNDER 37 C.F.R. 1.10(a)

I hereby certify that this correspondence is being deposited with the United States Postal Service as Express Mail in an envelope addressed to the Commissioner for Patents, P. O. Box 1450, Alexandria, VA 22313-1450, on October 21, 2003.

  
Terry B. McDaniel  
Attorney for the Applicants  
Registration No. 28,444



EXPRESS MAIL NO. EU592640451US  
Case Docket No. CHR 2001-79 Reissue

CERTIFICATE UNDER 37 C.F.R. 1.10(a)

I hereby certify that this correspondence is being deposited with the United States Postal Service as Express Mail in an envelope addressed to the Commissioner for Patents, P. O. Box 1450, Alexandria, VA 22313-1450, on October 21, 2003.

  
Terry B. McDanis  
Attorney for the Applicants  
Registration No. 28,444



EXPRESS MAIL NO. EU592640451US  
Case Docket No. CHR 2001-79 Reissue

CERTIFICATE UNDER 37 C.F.R. 1.10(a)

I hereby certify that this correspondence is being deposited with the United States Postal Service as Express Mail in an envelope addressed to the Commissioner for Patents, P. O. Box 1450, Alexandria, VA 22313-1450, on October 21, 2003.

  
\_\_\_\_\_  
Terry B. McDaniel  
Attorney for the Applicants  
Registration No. 28,444

EXPRESS MAIL NO. EU592640451US  
Case Docket No. CHR 2001-79 Reissue

CERTIFICATE UNDER 37 C.F.R. 1.10(a)

I hereby certify that this correspondence is being deposited with the United States Postal Service as Express Mail in an envelope addressed to the Commissioner for Patents, P. O. Box 1450, Alexandria, VA 22313-1450, on October 21, 2003.

  
Terry B. McDaniel  
Attorney for the Applicants  
Registration No. 28,444

EXPRESS MAIL NO. EU592640451US  
Case Docket No. CHR 2001-79 Reissue

CERTIFICATE UNDER 37 C.F.R. 1.10(a)

I hereby certify that this correspondence is being deposited with the United States Postal Service as Express Mail in an envelope addressed to the Commissioner for Patents, P. O. Box 1450, Alexandria, VA 22313-1450, on October 21, 2003.

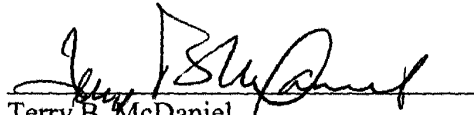
  
Terry B. McDaniel  
Attorney for the Applicants  
Registration No. 28,444

EXPRESS MAIL NO. EU592640451US  
Case Docket No. CHR 2001-79 Reissue

CERTIFICATE UNDER 37 C.F.R. 1.10(a)

I hereby certify that this correspondence is being deposited with the United States Postal Service as Express Mail in an envelope addressed to the Commissioner for Patents, P. O. Box 1450, Alexandria, VA 22313-1450, on October 21, 2003.

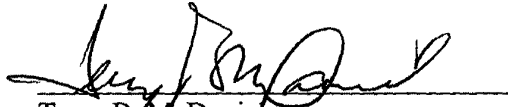
  
Terry B. McDaniel  
Attorney for the Applicants  
Registration No. 28,444

EXPRESS MAIL NO. EU592640451US  
Case Docket No. CHR 2001-79 Reissue

CERTIFICATE UNDER 37 C.F.R. 1.10(a)

I hereby certify that this correspondence is being deposited with the United States Postal Service as Express Mail in an envelope addressed to the Commissioner for Patents, P. O. Box 1450, Alexandria, VA 22313-1450, on October 21, 2003.

  
Terry B. McDaniel  
Attorney for the Applicants  
Registration No. 28,444

## METHOD FOR REDUCING EMISSIONS FROM EVAPORATIVE EMISSIONS CONTROL SYSTEMS

This application claims the benefit of U.S. Provisional Application No. 60/335,897 filed on Nov. 21, 2001.

### BACKGROUND OF THE INVENTION

#### 1. Field of the Invention

This invention relates to a method for reducing emissions from evaporative control systems including activated carbon particulate-filled canisters and adsorptive monolith-containing canisters, which monoliths include activated carbon, and to using said adsorbing canisters to remove volatile organic compounds, and other chemical agents from fluid streams. More particularly, this invention relates to using said vapor-adsorbing materials in hydrocarbon fuel consuming engines.

#### 2. Description of Related Art (Including Information Disclosed Under 37 CFR 1.97 and 37 CFR 1.98)

##### (a) Standard Working Capacity Adsorbents

Evaporation of gasoline from motor vehicle fuel systems is a major potential source of hydrocarbon air pollution. The automotive industry is challenged to design engine components and systems to contain, as much as possible, the almost one billion gallons of gasoline evaporated from fuel systems each year in the United States alone. Such emissions can be controlled by canister systems that employ activated carbon to adsorb and hold the vapor that evaporates. Under certain modes of engine operation, the adsorbed hydrocarbon vapor is periodically removed from the carbon by drawing air through the canister and burning the desorbed vapor in the engine. The regenerated carbon is then ready to adsorb additional vapor. Under EPA mandate, such control systems have been employed in the U.S. for about 30 years, and during that time government regulations have gradually reduced the allowable emission levels for these systems. In response, improvements in the control systems have been largely focused on improving the capacity of the activated carbon to hold hydrocarbon vapor. For example, current canister systems, containing activated carbon of uniform capacity, are readily capable of capturing and releasing 100 grams of vapor during adsorption and air purge regeneration cycling. These canister systems also must have low flow restrictions in order to accommodate the bulk flow of displaced air and hydrocarbon vapor from the fuel tank during refueling. Improvements in activated carbons for automotive emission control systems are disclosed in U.S. Pat. Nos.: 4,677,086; 5,204,310; 5,206,207; 5,250,491; 5,276,000; 5,304,527; 5,324,703; 5,416,056; 5,538,932; 5,691,270; 5,736,481; 5,736,485; 5,863,858; 5,914,294; 6,136,075; 6,171,373; 6,284,705.

A typical canister employed in a state of the art auto emission control system is shown in FIG. 1. Canister 1 includes support screen 2, dividing wall 3, a vent port 4 to the atmosphere (for when the engine is off), a vapor source connection 5 (from the fuel tank), a vacuum purge connection 6 (for when the engine is running), and adsorbent material fill 7.

Other basic auto emission control system canisters are disclosed in U.S. Pat. Nos. 5,456,236; 5,456,237; 5,460,136; and 5,477,836.

Typical carbons for evaporative emission canisters are characterized by standard measurements of bed packing density ("apparent density," g/mL), equilibrium saturation

capacity for 100% butane vapor ("butane activity," g/100 g-carbon), and purgeability ("butane ratio"), specifically, the proportion of adsorbed butane from the saturation step which can be recovered from the carbon by an air purge step. The multiplicative product of these three properties yields a measure of the carbon's effective butane "working capacity" ("BWC", g/dL), measured by ASTM D5228-92, which has been established in the art as a good predictor of the canister working capacity for gasoline vapors. Carbons that excel for this application have high BWC, typically 9 to 15+g/dL BWC, as a result of high saturation capacities on a volumetric-basis for butane (the product of density and butane activity), and high butane ratios (>0.85). In terms of isothermal equilibrium adsorption capacities across all vapor concentrations, these carbons characteristically have high incremental capacity as a function of increased vapor concentration (i.e., isotherm curved upward on a semi-log graph). This isotherm upward curve reflects the high working capacity performance feature of these carbons, in that gasoline vapors are adsorbed in high quantity at high concentrations but readily released in high concentration to an air purge stream. In addition, these carbons tend to be granular (somewhat irregularly shaped) or cylindrical pellet, typically of a size just about 1-3 mm in diameter. It has been found that somewhat larger sizes hinder diffusional transport of vapors into and out of the carbon particle during dynamic adsorb and purge cycles. On the other hand, somewhat smaller size particles have unacceptably high flow restriction for displaced air and hydrocarbon vapors during refueling.

##### (b) Diurnal Breathing Loss (DBL) Requirements

Recently, regulations have been promulgated that require a change in the approach with respect to the way in which vapors must be controlled. Allowable emission levels from canisters would be reduced to such low levels that the primary source of emitted vapor, the fuel tank, is no longer the primary concern, as current conventional evaporative emission control appears to have achieved a high efficiency of removal. Rather, the concern now is actually the hydrocarbon left on the carbon adsorbent itself as a residual "heel" after the regeneration (purge) step. Such emissions typically occur when a vehicle has been parked and subjected to diurnal temperature changes over a period of several days, commonly called "diurnal breathing losses." Now, the California Low Emission Vehicle Regulation makes it desirable for these diurnal breathing loss (DBL) emissions from the canister system to be below 10 mg ("PZEV") for a number of vehicles beginning with the 2003 model year and below 50 mg, typically below 20 mg, ("LEV-II") for a larger number of vehicles beginning with the 2004 model year. ("PZEV" and "LEV-II" are criteria of the California Low Emission Vehicle Regulation.)

While standard carbons used in the commercial canisters excel in terms of working capacity, these carbons are unable to meet DBL emission targets under normal canister operation. Furthermore, none of the standard measures of working capacity properties correlate with DBL emission performance. Nonetheless, one option for meeting emission targets is to significantly increase the volume of purge gas during regeneration in order to reduce the amount of residual hydrocarbon heel in the carbon bed and thereby reduce subsequent emissions. This strategy, however, has the drawback of complicating management of the fuel/air mixture to the engine during purge regeneration and tends to adversely affect tailpipe emissions, i.e., moving or redefining the problem rather than solving it. (See U.S. Pat. No. 4,894,072.)

3

Another option is to design the carbon bed so that there is a relatively low cross-sectional area on the vent-side of the canister system (the first portion of the bed to encounter purge air), either by redesign of the existing canister dimensions or by the installation of a supplemental, auxiliary vent-side canister of appropriate dimensions. This alternative has the effect of locally reducing residual hydrocarbon heel by increasing the intensity of purge for that vent-side portion of the bed, thereby improving its ability to retain vapors that would otherwise be emitted from the canister system under diurnal breathing conditions. The drawback is that there is a useful limit to which a portion of the bed can be elongated at reduced cross-sectional area without otherwise incurring excessive flow restriction by the canister system. In practice, this limit does not allow employing a sufficiently narrowed and elongated geometry to meet emission targets. (See U.S. Pat. No. 5,957,114.)

Another option for increasing the purge efficiency of a fuel vapor/air mixture fraction adsorbed in the pores of the adsorbent material is suggested by the teachings of U.S. Pat. Nos. 6,098,601 and 6,279,548 by providing a heating capability internal of the canister, or a section thereof, either to increase pressure in the vapor storage canister to expel hot vapor through the vapor/purge conduit back into the fuel tank where it condenses at the lower ambient temperature therein ('601) or to increase the purging efficiency of hydrocarbons from the heated adsorbent material and carry the purged fuel vapor to the induction system of an associated engine ('548). However, this increases the complexity of control system management, and there appears some inherent safety concerns in providing heating internal of a canister for trapping fuel vapors.

Thus, an acceptable remedy, which does not have drawbacks as the cited alternative approaches, is greatly desired. It is submitted that the invention disclosed and claimed herein provides the desired solution.

#### SUMMARY OF THE INVENTION

An invention is disclosed for sharply reducing diurnal breathing loss emissions from evaporative emissions canisters by the use of multiple layers, or stages, of adsorbents. On the fuel source-side of the canister, standard high working capacity carbons are preferred. On the vent-side, the preferred adsorbent volume exhibits a flat or flattened adsorbent isotherm on a volumetric basis in addition to certain characteristically desirable adsorptive properties across broad vapor concentrations, specifically relatively low incremental capacity at high concentration vapors compared with the fuel source-side adsorbent volume. Two approaches are described for attaining the preferred properties for the vent-side adsorbent volume. One approach is to use a filler and/or bed voidages as a volumetric diluent for flattening an isotherm. A second approach is to employ an adsorbent with the desired isotherm properties and to process it into an appropriate shape or form without necessarily requiring any special provision for dilution. Both such approaches provide a substantially lower emissions canister system without a significant loss in working capacity or an increase in flow restriction compared with prior art adsorbents used for automotive emissions control.

#### BRIEF DESCRIPTION OF THE DRAWINGS

FIG. 1 shows, in cross-section, a prior art canister system.

FIG. 2 shows, in cross-section, one embodiment of the invention canister comprising multiple adsorbents.

FIG. 3 shows butane isotherm properties for different activated carbon adsorbents.

4

#### DESCRIPTION OF THE PREFERRED EMBODIMENT(S)

The disclosed invention relates to the use of multiple beds (or layers, stages, or chambers) of adsorbent materials, which, in combination, significantly reduce DBL emissions while maintaining the high working capacity and low flow restriction properties of the canister system. (See FIG. 2.) These adsorbents include activated carbon from a variety of raw materials, including wood, peat, coal, coconut, synthetic or natural polymer, and a variety of processes, including chemical and/or thermal activation, as well as inorganic adsorbents, including molecular sieves, porous alumina, pillared clays, zeolites, and porous silica, and organic adsorbents, including porous polymers. The adsorbents may be in granular, spherical, or pelletized cylindrical shapes, or may be extruded into special thin-walled cross-sectional shapes, such as hollow-cylinder, star, twisted spiral, asterisk, configured ribbons, or other shapes within the technical capabilities of the art. In shaping, inorganic and/or organic binders may be used. The adsorbents may be formed into a monolith or honeycomb part. The adsorbents may be incorporated into a canister as one or more layers, or separate chambers, or they may be inserted in the fluid stream flow as auxiliary canister beds.

One common feature for all of these approaches is to have a vent-side adsorbent with a relatively flat-shaped isotherm. This isotherm shape is important for reasons related to purge efficiency across the adsorbent bed depth. For an adsorbent with a flat adsorption isotherm, the concentration of hydrocarbon vapor in equilibrium with adsorbed hydrocarbon, by definition, decreases further as the adsorbed hydrocarbon is removed compared with an adsorbent with a more steeply sloped isotherm. Thus, when such a material is employed as an adsorbent volume on the vent-side region of a canister, purge is able to reduce the vapor concentration in the area of the purge inlet to a very low level. Since it is the vapor near the purge inlet that eventually emerges as bleed, decreasing this concentration reduces the bleed emission level. The degree of removal of adsorbed hydrocarbon during purge is determined by the difference between the concentration of hydrocarbon picked up in the purge gas and the concentration in equilibrium with the adsorbent at any point in the bed. Thus, adsorbent in the immediate vicinity of the purge inlet will be most thoroughly regenerated. At points deeper in the adsorbent bed, less hydrocarbon will be removed because the purge gas will already contain hydrocarbon removed from previous points in the bed. An adsorbent with a flatter adsorption isotherm will give up less vapor into the purge stream and this purge will then be more efficient in reducing vapor concentrations deeper into the bed. Therefore, for a given quantity of purge gas, it will be possible to reduce the vapor concentration in a volume of adsorbent with a flat adsorption isotherm to a lower level than the concentration in the same volume of an adsorbent with a steep adsorption isotherm. Bleed emission from such a volume will therefore be lower when the adsorbent has a flatter adsorption isotherm.

A region within a canister containing particulate or in an adsorbent-containing monolith with the preferred adsorption isotherm properties for achieving low bleed emission levels will, however, have a relatively low adsorption working capacity compared to the activated carbons commonly used in automotive evaporative emission control. For example, the BWC of a low capacity adsorbent will be about 6 g/dL compared to the 9 g/dL to 15+g/dL range as used in typical automotive carbons. Therefore, in order to maintain the

5

required hydrocarbon capacity for normal emission control system operation, the low-bleed adsorbent will be used in a vent-side auxiliary region within the canister or outside the canister in combination with a fuel source-side region containing a volume of the high capacity carbon normally employed. When two different adsorbents are used, for example, system design will involve providing sufficient volume of the high capacity carbon in the main part, or fuel source-side, of an emission control canister to achieve the desired working capacity, and a sufficient volume of the low-bleed adsorbent to contain vapor emitted from the main bed to such an extent that such vapor does not materially affect the bleed emissions from the low-bleed adsorbent.

In the context of the invention, "monolith" is intended to include foams, woven and non-woven fibers, mats, blocks and bound aggregates of particulates.

It is notable that the emission of vapor from the main, high-capacity fuel source-side volume of adsorbent into the auxiliary lower capacity vent-side volume is significantly affected by the presence of that vent-side volume. During purge, a vent-side adsorbent volume having a flat adsorption isotherm will give up a relatively small hydrocarbon load into the purge gas. Therefore, the concentration of vapor carried by the purge gas will be low as it emerges from the low-bleed vent-side volume and enters the high-capacity, fuel source-side volume. This allows good regeneration of the high-capacity adsorbent in the vicinity of the junction of the two adsorbent volumes, and helps protect the vent-side volume from emissions from the fuel source-side region of the canister during diurnal breathing flow. Specifically, the greater regeneration efficiency of the fuel source-side volume reduces diurnal emissions by retarding the rate of bulk phase diffusion across the flow length of the canister system. Since bulk phase diffusion is a major mode of vapor transport during diurnal breathing conditions, by reducing the vapor concentration difference across the flow length of the canister system by enhanced regeneration, the redistribution of vapors within the canister system and subsequent emissions into the vent-side volume and out of the vent port are reduced.

Examples of adsorbents with isotherms having the preferred shape to provide low bleed performance are compared with standard canister-fill carbons (Westvaco Corporation's BAX 1100 and BAX 1500) in FIG. 3. It is important to note that, as shown in this figure, the isotherm properties must be defined in terms of volumetric capacity. On this basis, the preferred low-bleed adsorbent portion will have an incremental n-butane capacity of less than about 35 g/liter between 5 and 50 volume percent n-butane vapor concentration.

While in some instances, known adsorbents may have the preferred properties for the vent-side, these adsorbents would not be expected to be useful in an evaporative canister. In some cases, these materials have low purgeability (butane ratio less than 0.85) and low working capacity (BWC less than 9 g/dL) as measured by the standard BWC test for qualifying canister carbons. Common wisdom and experience in the art associate low butane ratio with high residual hydrocarbon heel, which is the potential source for high emissions. Furthermore, low BWC adsorbents were not considered useful for inclusion into a canister system as working capacity for gasoline vapors would be assumed impaired, with no expectation that there would be a utility for reducing emissions. In fact, one preferred embodiment of this invention, lower capacity adsorbents have BWC values preferably below 8 g/dL, which is well below the 9-15 g/dL BWC level normally deemed suitable for use in evaporative emission control canister systems. The preferred selection of

6

these low BWC materials for inclusion into a canister system as a vent-side layer to produce low emissions was only realized once the dynamics within the adsorbent bed were realized (i.e., the significance of low residual vapor concentration within the vent-side bed volume and the interactive effect that the vent-side bed volume has on the distribution and diffusion of vapor across the entire canister system during the diurnal breathing loss period).

Therefore, it has been found that the preferred vent-side adsorbent properties, in addition to a relatively low BWC, includes butane ratios between 0.40 and 0.98, which in total are substantially different properties compared with adsorbents previously conceived as useful for these canister systems.

The proposed alternative approaches described above are shown to be effective in canister bleed emission control in the following examples. One approach for preparing the vent-side adsorbent is to volumetrically dilute a high working capacity adsorbent so that its resulting isotherm is flattened on a volumetric basis. A second approach is to begin with an adsorbent that has the desired adsorption capacity and flat isotherm shape and process it into a shape or form, such as a pellet or honeycomb.

A particular preferred embodiment for a canister with multiple adsorbents is shown in FIG. 2. FIG. 2 shows a canister system comprising a primary canister body 1, a support screen 2, a dividing wall 3, a vent port 4 to the atmosphere, a vapor source connection 5, a vacuum purge connection 6, a fuel source-side region 7, vent-side canister regions 8-11 of varying low-capacities, supplemental canister body 12, and connecting hose 13 permitting fluid stream flow from the primary canister body 1 to the supplemental canister body 12. Additional embodiments, as discussed above, are also envisioned to be within the scope of the subject of the invention.

The desired results for the subject matter of the invention can be attained with a single vent-side uniform lower capacity adsorbent material as the subsequent adsorbent material. The option of multiples of lower capacity adsorbents with the desirable adsorptive properties across broad vapor concentrations is demonstrated merely as one embodiment.

The measures for gasoline working capacity (GWC) and emissions in the Table were derived from the Westvaco DBL test that uses a 2.1 L canister. The pellet examples were tested as a 300 mL vent-side layer within the canister, with the 1800 mL of BAX 1500 pellets as the remaining canister fill. The honeycomb was tested as an auxiliary bed canister that was placed in-line with the 2.1 L main canister of BAX 1500 pellets. For all examples, the canister system was uniformly first preconditioned by repetitive cycling of gasoline vapor adsorption and air purge (400 bed volumes air). This cycling generated the GWC value. Butane emissions were subsequently measured after a butane adsorption and an air purge step, specifically during a diurnal breathing loss period when the canister system was attached to a temperature-cycled fuel tank. The reported value is the 2<sup>nd</sup> day DBL emissions during an 11-hour period when the fuel tank was warmed and vapor-laden air was vented to the canister system and exhausted from the vent-side adsorbent where the emissions were measured. The procedure employed for measuring DBL emissions has been described in *SAE Technical Paper 2001-01-0733*, titled "Impact and Control of Canister Bleed Emissions," by R. S. Williams and C. R. Clontz.

Example 1: Microsphere Filler Pellets. These 2 mm pellets are an example of the volumetric dilution method by



adding a solid filler to the extrusion formulation. The pellets were prepared from an extrusion blend consisting of Westvaco SA-1500 powder (12.8 wt %), solid glass microsphere filler (79.7 wt % PQ Corporation A3000), bentonite clay (7.2 wt %), and phosphoric acid (0.3 wt %). The pellets were tumbled for four minutes, dried overnight at 105° C., and subsequently heat-treated in steam at 650° C. for 15 minutes. An appropriate non-adsorbing filler reduces adsorption capacities across all vapor concentrations, resulting in a flattened adsorption isotherm ("Example 1" in FIG. 3). Alternative methods for diluting the vent-side region are to co-mix adsorbent granules or pellets with inert filler particles of similar size, to form the extrusion paste into high voidage shapes such as hollow cylinders, asterisks, stars, or twisted, bent, or spiral ribbon pieces, or to place multiple thin layers of non-adsorbing particles or porous mats (e.g., foam), or simply trapped air space between layers of adsorbent.

Example 2: Ceramic-Bound Honeycomb. The 200 cpsi (cells per square inch) carbon-containing honeycomb is another example of the volumetric dilution method. The honeycomb in the Table was prepared according to the method described in U.S. Pat. No. 5,914,294, which discloses forming an adsorptive monolith comprising the steps of (a) extruding an extrudable mixture through an extrusion die such that a monolith is formed having a shape wherein the monolith has at least one passage therethrough and the extrudable mixture comprises activated carbon, a ceramic forming material, a flux material, and water, (b) drying the extruded monolith, and (c) firing the dried monolith at a temperature and for a time period sufficient to react the ceramic forming material together and form a ceramic

matrix. The extrudable mixture is capable of maintaining the shape of the monolith after extrusion and during drying of the monolith.

In this example, the extrusion formulation ingredients partially dilute the carbon adsorbent, and in addition, the adsorbent is further diluted by the open cell structure of the extruded part. These cells create more bed voidages within the part, compared with a similar bed volume of pellets (65 vol % voidages for the honeycomb versus 35 vol % for pellets or granules). The cell structure and high bed voidages have the added advantage of imposing minimal additional flow restriction compared with a bed of pellets, thereby allowing the honeycomb to be installed to the main canister as an add-on auxiliary device of greatly reduced cross-sectional area (see supplemental canister body 12 in FIG. 2).

Example 3: Special Precursor Pellets: These 2 mm pellets were prepared by selecting the adsorbent to be extruded according to its intrinsic flat isotherm adsorption properties. In this example, there was no special provision for filler in the formulation or bed voidage dilution from the extruded shape. The ingredients for the extrusion blend producing the tested activated carbon pellets consisted of SX 1 grade activated carbon produced by NORIT (93.2 wt %) and sodium carboxymethyl cellulose binder system (6.8 wt %). The pellets were tumbled for four minutes, dried overnight at 105° C., and subsequently heat-treated in air at 150° C. for three hours.

As noted above, the comparisons of these activated carbon containing materials, prepared as set forth in the examples, is shown in the following Table.

TABLE

Performance, Properties, and Formulations for Alternative Vent-Side Adsorbents

	Filled Pellet	Ceramic-Bound Honeycomb	Special Precursor Pellet	Prior Art: High Working Capacity Carbons	
Fuel source-side BAX 1500 Volume:	1800 mL	2100 mL	1800 mL	1800 mL	1800 mL
Vent-Side Adsorbent Type:	"Ex. 1"	"Ex. 2"	"Ex. 3"	BAX 1100	BAX 1500
Vent-Side Mode:	Layer	Auxiliary Bed	Layer	Layer	Layer
Vent-Side Adsorbent Volume:	300 mL	200 mL 41 mm diameter × 150 mm long, 200 cpsi	300 mL	300 mL	300 mL
Canister System Performance:					
<u>Westvaco DBL Test</u>					
Gasoline Working Capacity, g:	138	144	132	143	139
2 <sup>nd</sup> Day DBL Emissions, mg-C <sub>4</sub> :	29	10	13	88	221
Note:	(1)	(2)	(3)	(4)	(5)
<u>Vent-Side Properties (6)</u>					
<u>Incremental Adsorption At 25° C.</u>					
5-50 vol % butane vapor, g/L:	24	16	18	52	80
Apparent Density, g/mL:	0.869	0.355	0.453	0.358	0.284
Butane Activity, g/100 g:	7.0	13.1	18.5	39.0	64.7
BWC, g/dL:	5.7	4.0	5.0	11.9	16.0
Butane Ratio:	0.929	0.852	0.593	0.852	0.868

(1) Two DBL Test; Averaged data for GWC (400 bed volume purge) and DBL emissions (150 bed volume purge); 2.1L canister, 1500 mL fuel source-side chamber, 600 mL vent-side chamber, fuel source-side chamber cross-sectional area 2.5 times the vent-side cross-sectional area.

(2) Single DBL Test

(3) Average of three DBL Tests

(4) Average of three DBL Tests

(5) Average of six DBL Tests

(6) Density and BWC by ASTM standard techniques.

The Table shows data for the three examples of these two approaches compared with vent-side layers containing high working capacity carbons, BAX 1100 and BAX 1500. Compared with the state of the art BAX carbons (the FIG. 3), all three of the examples have significantly lower capacities for butane at high concentrations and considerably flatter isotherm curves.

As shown in the Table, the examples demonstrate reductions in emissions by factors of 3–22 over canisters consisting of only high working capacity carbons. There was either no loss or only a slight loss in GWC.

A further preferred embodiment of the invention method is presented in an evaporative emissions control system for a vehicle, the system comprising, in combination, a fuel tank for storing a volatile fuel, an engine having an air induction system and adapted to consume the fuel, a canister containing an initial volume of fuel vapor adsorbent material for temporarily adsorbing and storing fuel vapor from the tank, a conduit for conducting fuel vapor from the tank to a canister vapor inlet, a fuel vapor purge conduit from a canister purge outlet to the induction system of the engine, and a vent/air opening for venting the canister and for admission of air to the canister during operation of the engine induction system, wherein the canister defines a fuel vapor flow path via the canister vapor inlet through the initial volume of vapor adsorbent within a first region of the canister toward the vent/air opening, and an air flow path through a subsequent volume of adsorbent within a second region of the canister at the vent/air opening and the first region at the purge outlet, such that fuel vapor formed in the tank flows through the vapor inlet into the initial volume of adsorbent where it is adsorbed and, during operation of the engine induction system, ambient air flows in a path to and through the vent/air opening and along the air flow path in the canister through the initial volume and the purge outlet to the induction system of the engine, the flow of air removing a portion of the adsorbed fuel vapor but leaving a residue of fuel in the initial volume, wherein at least one subsequent volume of vapor adsorbent material comprises a volume of 1% to 100% of the first volume and is located either inside of the canister within the second region thereof or outside of the canister, and wherein the initial volume of vapor adsorbent material is characterized by an incremental adsorption capacity at 25° C. of greater than 35 g n-butane/L between vapor concentrations of 5 vol % and 50 vol % n-butane before routing the fluid stream through at least one subsequent volume of vapor adsorbent material wherein the subsequent volume of vapor adsorbent material is characterized by an incremental adsorption capacity at 25° C. of less than 35 g n-butane/L between vapor concentrations of 5 vol % and 50 vol % n-butane.

This invention method certainly includes an embodiment wherein the second volume of vapor adsorbent material is located outside the canister in a separate subsequent canister, but in the flow path of the ambient air to the vent/air inlet and the first region.

This invention method includes an embodiment wherein the initial volume of vapor adsorbent material and the subsequent volume of vapor adsorbent material are activated carbon derived from materials selected from the group consisting of wood, peat, coal, coconut, lignite, petroleum pitch, petroleum coke, coal tar pitch, fruit pits, nut shells, sawdust, wood flour, synthetic polymer, and natural polymer having been activated by a process selected from the group consisting of chemical, thermal, and combined chemical/thermal activation methods.

The invention method includes an embodiment wherein the initial volume of vapor adsorbent material and the

subsequent volume of vapor adsorbent material are inorganic materials selected from the group consisting of zeolites, porous silica, porous alumina, pillared clays, and molecular sieves.

The invention method includes an embodiment wherein the initial volume of vapor adsorbent material and the subsequent volume of vapor adsorbent material are porous polymers.

The invention method includes an embodiment wherein the subsequent volume of vapor adsorbent material exhibits adsorption capacities achieved by volumetric dilution.

The invention method further includes an embodiment wherein the volumetric dilution is accomplished by the addition of a non-adsorbing filler as a co-ingredient by an addition process selected from the group consisting of addition with the activated carbon raw material prior to activation, addition with the adsorbent before forming into a shaped particle or monolith, and a combination thereof.

The invention method further includes an embodiment wherein the volumetric dilution is accomplished by forming the adsorbent material into high voidage shapes selected from the group consisting of stars, hollow cylinders, asterisks, spirals, cylinders, configured ribbons, and other shapes within the capabilities of the art.

The method claimed herein includes an embodiment wherein the volumetric dilution is accomplished by forming the adsorbent into a honeycomb or monolith shape.

The method claimed herein includes an embodiment wherein the volumetric dilution is accomplished by the use of inert spacer particles, foams, fibers, and screens external to the vent-side adsorbent particles and monoliths.

The method claimed herein includes an embodiment wherein the non-adsorbing filler is a solid after processing.

Also, the method claimed herein includes an embodiment wherein the non-adsorbing filler is volatilized or combusted to form voidages larger than 50 Å width within the shaped particle or monolith.

The foregoing description relates to embodiments of the present invention, and changes and modifications may be made therein without departing from the scope of the invention as defined in the following claims.

We claim:

1. A method for reducing fuel vapor emissions in automotive evaporative emissions control systems comprising the steps of contacting the fuel vapor with an initial adsorbent volume having incremental adsorption capacity at 25° C. of greater than 35 g n-butane/L between vapor concentrations of 5 vol % and 50 vol % n-butane and at least one subsequent adsorbent volume having an incremental adsorption capacity of less than 35 g n-butane/L between vapor concentrations of 5 vol % and 50 vol % n-butane.

2. The method of claim 1 comprising a single subsequent adsorbent volume.

3. The method of claim 1 comprising multiple subsequent adsorbent volumes.

4. The method of claim 2 wherein the initial adsorbent volume and the subsequent adsorbent volume are located within a single automotive evaporative emission control canister.

5. The method of claim 3 wherein the initial adsorbent volume and the subsequent adsorbent volumes are located within a single automotive evaporative emission control canister.

6. The method of claim 2 wherein the initial adsorbent volume and the subsequent adsorbent volume are located in separate canisters that are connected to permit sequential contact by the fuel vapor.

11

7. The method of claim 3 wherein the initial adsorbent volume and at least one subsequent adsorbent volume are located in separate canisters that are connected to permit sequential contact by the fuel vapor.

8. The method of claim 1 wherein the initial adsorbent volume and the subsequent adsorbent volume are activated carbon derived from materials selected from the group consisting of wood, peat, coal, coconut, lignite, petroleum pitch, petroleum coke, coal tar pitch, fruit pits, nut shells, sawdust, wood flour, synthetic polymer, and natural polymer having been activated by a process selected from the group consisting of chemical, thermal, and combined chemical/thermal activation methods.

9. The method of claim 1 wherein the initial adsorbent volume and the subsequent adsorbent volume are inorganic materials selected from the group consisting of zeolites, porous silica, porous alumina, pillared clays, and molecular sieves.

10. The method of claim 1 wherein the initial adsorbent volume and the subsequent adsorbent volume are porous polymers.

11. The method of claim 1 wherein the subsequent adsorbent volume exhibits adsorption capacities achieved by volumetric dilution.

12. The method of claim 11 wherein the volumetric dilution is accomplished by the addition of a non-adsorbing filler as a co-ingredient by an addition process selected from the group consisting of addition with the activated carbon raw material prior to activation, addition with the adsorbent before forming into a shaped particle or monolith, and a combination thereof.

13. The method of claim 11 wherein the volumetric dilution is accomplished by forming the adsorbent into high voidage shapes selected from the group consisting of stars, hollow cylinders, asterisks, spirals, cylinders, and configured ribbons.

14. The method of claim 11 wherein the volumetric dilution is accomplished by forming the adsorbent into a honeycomb or monolith shape.

15. The method of claim 11 wherein the volumetric dilution is accomplished by the use of inert spacer particles, trapped air spaces, foams, fibers, and screens external to the adsorbent.

16. The method of claim 12 wherein the non-adsorbing filler is a solid after processing.

17. The method of claim 12 wherein the non-adsorbing filler is volatilized or combusted to form voidages larger than 50 Å width within the shaped particle or monolith.

18. In a method of reducing fuel vapor emissions in an automotive evaporative emissions control system comprising removing at least one volatile organic compound from a volatile organic compound-containing fuel vapor by routing the fuel vapor through a vapor adsorbent, the improvement comprising sequentially routing the fuel vapor through an initial adsorbent material-containing volume wherein the initial adsorbent material is characterized by an incremental adsorption capacity at 25° C. of greater than 35 g n-butane/L between vapor concentrations of 5 vol % and 50 vol %

12

n-butane before routing the fluid stream through at least one subsequent adsorbent-containing volume prior to venting to the atmosphere wherein the subsequent adsorbent-containing volume is characterized by an incremental adsorption capacity at 25° C. of less than 35 g n-butane/L between vapor concentrations of 5 vol % and 50 vol % n-butane.

19. The method of claim 18 wherein the initial adsorbent volume and the subsequent adsorbent volume are located in a single automotive evaporative emissions canister.

20. The method of claim 18 wherein the initial adsorbent volume and the subsequent adsorbent volume are located in separate canisters that are connected to permit sequential contact by the fuel vapor.

21. The method of claim 18 wherein the initial adsorbent volume and the subsequent adsorbent volume are activated carbon derived from materials selected from the group consisting of wood, peat, coal, coconut, lignite, petroleum pitch, petroleum coke, coal tar pitch, fruit pits, nut shells, sawdust, wood flour, synthetic polymer, and natural polymer and activated by chemical and/or thermal activation methods.

22. The method of claim 18 wherein the initial adsorbent volume and the subsequent adsorbent volume are inorganic materials selected from the group consisting of zeolites, porous silica, and molecular sieves.

23. The method of claim 18 wherein the initial adsorbent volume and the subsequent adsorbent volume are porous polymers.

24. The method of claim 18 wherein the subsequent adsorbent volume exhibits adsorption capacities achieved by volumetric dilution.

25. The method of claim 24 wherein the volumetric dilution is accomplished by the addition of a non-adsorbing filler as a co-ingredient by an addition process selected from the group consisting of addition with the activated carbon raw material prior to activation, addition with the adsorbent before forming into a shaped particle or monolith, and a combination thereof.

26. The method of claim 24 wherein the volumetric dilution is accomplished by forming the adsorbent into high voidage shapes selected from the group consisting of stars, hollow cylinders, asterisks, spirals, cylinders, and configured ribbons.

27. The method of claim 24 wherein the volumetric dilution is accomplished by forming the adsorbent into a honeycomb or monolith shape.

28. The method of claim 24 wherein the volumetric dilution is accomplished by the use of inert spacer particles, trapped air spaces, foams, fibers, and screens external to the adsorbent.

29. The method of claim 25 wherein the non-adsorbing filler is a solid after processing.

30. The method of claim 25 wherein the non-adsorbing filler is volatilized or combusted to form voidages larger than 50 Å width within the shaped particle or monolith.

\* \* \* \* \*

New Claims:

31. In an evaporative emissions control system for a vehicle comprising, in combination, a fuel tank for storing a volatile fuel, an engine having an air induction system and adapted to consume the fuel, a canister containing an initial volume of fuel vapor adsorbent material for temporarily adsorbing and storing fuel vapor from the tank, a conduit for conducting fuel vapor from the tank to a canister vapor inlet, a fuel vapor purge conduit from a canister purge outlet to the induction system of the engine, and a vent/air opening for venting the canister and for admission of air to the canister during operation of the engine induction system, wherein the canister is defined by a fuel vapor flow path via the canister vapor inlet through the initial volume of vapor adsorbent within a first region of the canister toward the vent/air opening, and an air flow path through a subsequent volume of adsorbent within a second region of the canister at the vent/air opening and the first region at the purge outlet, such that fuel vapor formed in the

tank flows through the vapor inlet into the initial volume of adsorbent where it is adsorbed and, during operation of the engine induction system, ambient air flows in a path to and through the vent/air opening and along the air flow path in the canister through the initial volume and the purge outlet to the induction system of the engine, the flow of air removing a portion of the adsorbed fuel vapor but leaving a residue of fuel in the initial volume,

the improvement wherein at least one subsequent volume of vapor adsorbent material comprises a volume of 1% to 100% of the first volume and is located either inside of the canister within the second region thereof or outside of the canister, and wherein the initial volume of vapor adsorbent material is characterized by an incremental adsorption capacity at 25°C of greater than 35 g n-butane/L-bed between vapor concentrations of 5 vol% and 50 vol% n-butane before routing the fluid stream through at

least one subsequent volume of vapor adsorbent material wherein the subsequent volume of vapor adsorbent material is characterized by an incremental adsorption capacity at 25°C of less than 35 g n-butane between vapor concentrations of 5 vol% and 50 vol% n-butane.

32. The system of claim 31 wherein the second volume of vapor adsorbent material is located outside the canister in a separate subsequent canister.

33. The system of claim 31 wherein the initial volume of vapor adsorbent material and the subsequent volume of vapor adsorbent material are activated carbon derived from materials selected from the group consisting of wood, peat, coal, coconut, lignite, petroleum pitch, petroleum coke, coal tar pitch, fruit pits, nut shells, sawdust, wood flour, synthetic polymer, and natural polymer having been activated by a process selected from the group consisting of chemical, thermal, and combined chemical/thermal activation methods.

34. The system of claim 31 wherein the initial volume of vapor adsorbent material and the subsequent volume of vapor adsorbent material are inorganic materials selected from the group consisting of zeolites, porous silica, porous alumina, pillared clays, and molecular sieves.

35. The system of claim 31 wherein the initial volume of vapor adsorbent material and the subsequent volume of vapor adsorbent material are porous polymers.

36. The system of claim 31 wherein the subsequent volume of vapor adsorbent material exhibits adsorption capacities achieved by volumetric dilution.

37. The system of claim 36 wherein the volumetric dilution is accomplished by the addition of a non-adsorbing filler as a co-ingredient by an addition process selected from the group consisting of addition with the activated carbon raw material prior to activation, addition with the adsorbent before forming into a shaped particle or monolith, and a combination thereof.

38. The system of claim 36 wherein the volumetric dilution is accomplished by

forming the adsorbent material into high voidage shapes selected from the group consisting of stars, hollow cylinders, asterisks, spirals, cylinders, and configured ribbons.

39. The system of claim 36 wherein the volumetric dilution is accomplished by forming the adsorbent into a honeycomb or monolith shape.

40. The system of claim 36 wherein the volumetric dilution is accomplished by the use of inert spacer particles, trapped air spaces, foams, and screens external to the adsorbent.

41. The system of claim 37 wherein the non-adsorbing filler is a solid after processing.

42. The system of claim 37 wherein the non-adsorbing filler is volatilized or combusted to form voidages larger than 50Å width within the shaped particle or monolith.

43. A canister operative for use in automotive systems for emission control defined by a canister vapor inlet to permit a fuel vapor flow path through an initial

volume of vapor adsorbent within a first region of the canister toward a canister vent/air opening to permit a continued air flow path through a subsequent volume of adsorbent within a second region of the canister at the vent/air opening and the first region at a canister purge outlet, such that fuel vapor formed in a tank for storing volatile fuel flows through the canister vapor inlet into the initial volume of adsorbent where it is adsorbed and, during operation of an engine induction system, ambient air is caused to flow in a path to and through the vent/air opening and along the air flow path in the canister through the initial volume and the purge outlet to the induction system of the engine, wherein the flow of air removing a portion of the adsorbed fuel vapor but leaving a residue of fuel in the initial volume, and wherein at least one subsequent volume of vapor adsorbent material comprises a volume of 1% to 100% of the initial volume and is located either inside of the canister within the second region thereof or outside of the canister, and wherein the initial volume of vapor adsorbent material is

characterized by an incremental adsorption capacity at 25°C of greater than 35 g n-butane/L-bed between vapor concentrations of 5 vol% and 50 vol% n-butane before routing the fluid stream [air flow?] through at least one subsequent volume of vapor adsorbent material wherein the subsequent volume of vapor adsorbent material is characterized by an incremental adsorption capacity at 25°C of less than 35 g n-butane between vapor concentrations of 5 vol% and 50 vol% n-butane.

44. The canister of claim 43 wherein the second volume of vapor adsorbent material is located outside the canister in a separate subsequent canister.

45. The canister of claim 43 wherein the initial volume of vapor adsorbent material and the subsequent volume of vapor adsorbent material are activated carbon derived from materials selected from the group consisting of wood, peat, coal, coconut, lignite, petroleum pitch, petroleum coke, coal tar pitch, fruit pits, nut shells, sawdust, wood flour, synthetic polymer, and natural polymer having been activated by a

process selected from the group consisting of chemical, thermal, and combined chemical/thermal activation methods.

46. The canister of claim 43 wherein the initial volume of vapor adsorbent material and the subsequent volume of vapor adsorbent material are inorganic materials selected from the group consisting of zeolites, porous silica, porous alumina, pillared clays, and molecular sieves.

47. The canister of claim 43 wherein the initial volume of vapor adsorbent material and the subsequent volume of vapor adsorbent material are porous polymers.

48. The canister of claim 43 wherein the subsequent volume of vapor adsorbent material exhibits adsorption capacities achieved by volumetric dilution.

49. The canister of claim 48 wherein the volumetric dilution is accomplished by the addition of a non-adsorbing filler as a co-ingredient by an addition process selected from the group consisting of addition with the activated carbon raw material prior to activation, addition with the adsorbent

before forming into a shaped particle or monolith, and a combination thereof.

50. The canister of claim 48 wherein the volumetric dilution is accomplished by forming the adsorbent material into high voidage shapes selected from the group consisting of stars, hollow cylinders, asterisks, spirals, cylinders, and configured ribbons.

51. The canister of claim 49 wherein the volumetric dilution is accomplished by an adsorbent formed into a honeycomb or monolith shape.

52. The canister of claim 48 wherein the volumetric dilution is accomplished by the inclusion of inert spacer particles, trapped air spaces, foams, and screens external to the adsorbent.

53. The canister of claim 49 wherein the non-adsorbing filler is a solid after processing.

54. The canister of claim 49 wherein the non-adsorbing filler is volatilized or combusted to form voidages larger than 50Å width within the shaped particle or monolith.





US006540815B1

(12) **United States Patent**  
Hiltzik et al.

(10) **Patent No.:** US 6,540,815 B1  
(45) **Date of Patent:** Apr. 1, 2003  
CHR 2001-79

(54) **METHOD FOR REDUCING EMISSIONS FROM EVAPORATIVE EMISSIONS CONTROL SYSTEMS**

(75) **Inventors:** Laurence H. Hiltzik, Charleston, SC (US); Jacek Z. Jagiello, Charleston, SC (US); Edward D. Tolles, Charleston, SC (US); Roger S. Williams, Lexington, VA (US)

(73) **Assignee:** MeadWestvaco Corporation, Stamford, CT (US)

(\*) **Notice:** Subject to any disclaimer, the term of this patent is extended or adjusted under 35 U.S.C. 154(b) by 0 days.

(21) **Appl. No.:** 10/100,362

(22) **Filed:** Mar. 18, 2002

**Related U.S. Application Data**

(60) Provisional application No. 60/335,897, filed on Nov. 21, 2001.

(51) **Int. Cl.<sup>7</sup>** ..... F02M 33/02; B01D 53/04

(52) **U.S. Cl.** ..... 95/146; 95/900; 123/519

(58) **Field of Search** ..... 95/90, 146, 148, 95/900-903; 96/132, 133, 147; 123/518, 519; 502/416

**References Cited**

**U.S. PATENT DOCUMENTS**

4,677,086 A	*	6/1987	McCue et al.	123/519
4,894,072 A	*	1/1990	Turner et al.	123/519
5,204,310 A	*	4/1993	Tolles et al.	123/519
5,206,207 A	*	4/1993	Tolles	502/423
5,207,808 A	*	5/1993	Haruta et al.	123/519
5,238,470 A	*	8/1993	Tolles et al.	95/143
5,250,491 A	*	10/1993	Yan	264/117
5,276,000 A	*	1/1994	Matthews et al.	502/424
5,304,527 A	*	4/1994	Dimitri	502/416
5,324,703 A	*	6/1994	McCue et al.	502/424
5,337,721 A	*	8/1994	Kasuya et al.	123/519

5,408,976 A	*	4/1995	Reddy	123/198 D
5,416,056 A	*	5/1995	Baker	502/425
5,456,236 A	*	10/1995	Wakashiro et al.	123/519

(List continued on next page.)

**FOREIGN PATENT DOCUMENTS**

EP	11 13163	7/2001
KR	2002012826 A	* 2/2002
WO	92/01585	9/1992
WO	01/62367	8/2001

*Primary Examiner*—David A. Simmons  
*Assistant Examiner*—Frank M. Lawrence

(74) *Attorney, Agent, or Firm*—Terry B. McDaniel; Daniel B. Reece, IV; Thomas A. Boshinski

**ABSTRACT**

(57) Disclosed is a method for sharply reducing diurnal breathing loss emissions from automotive evaporative emissions control systems by providing multiple layers, or stages, of adsorbents. On the fuel source-side of an emissions control system canister, high working capacity carbons are preferred in a first canister (adsorb) region. In subsequent canister region(s) on the vent-side, the preferred adsorbent should exhibit a flat or flattened adsorption isotherm on a volumetric basis and relatively lower capacity for high concentration vapors as compared with the fuel source-side adsorbent. Multiple approaches are described for attaining the preferred properties for the vent-side canister region. One approach is to use a filler and/or voidages as a volumetric diluent for flattening an adsorption isotherm. Another approach is to employ an adsorbent with the desired adsorption isotherm properties and to process it into an appropriate shape or form without necessarily requiring any special provision for dilution. The improved combination of high working capacity carbons on the fuel source-side and preferred lower working capacity adsorbent on the vent-side provides substantially lower diurnal breathing emissions without a significant loss in working capacity or increase in flow restriction compared with known adsorbents used in canister configurations for automotive emissions control systems.

**30 Claims, 3 Drawing Sheets**

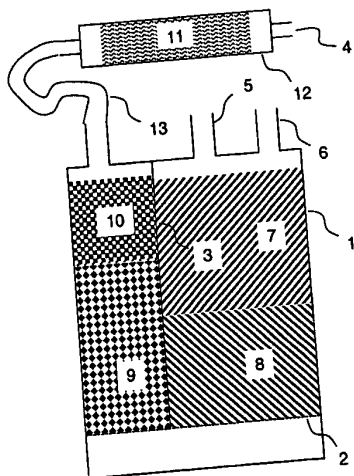

FIGURE 1

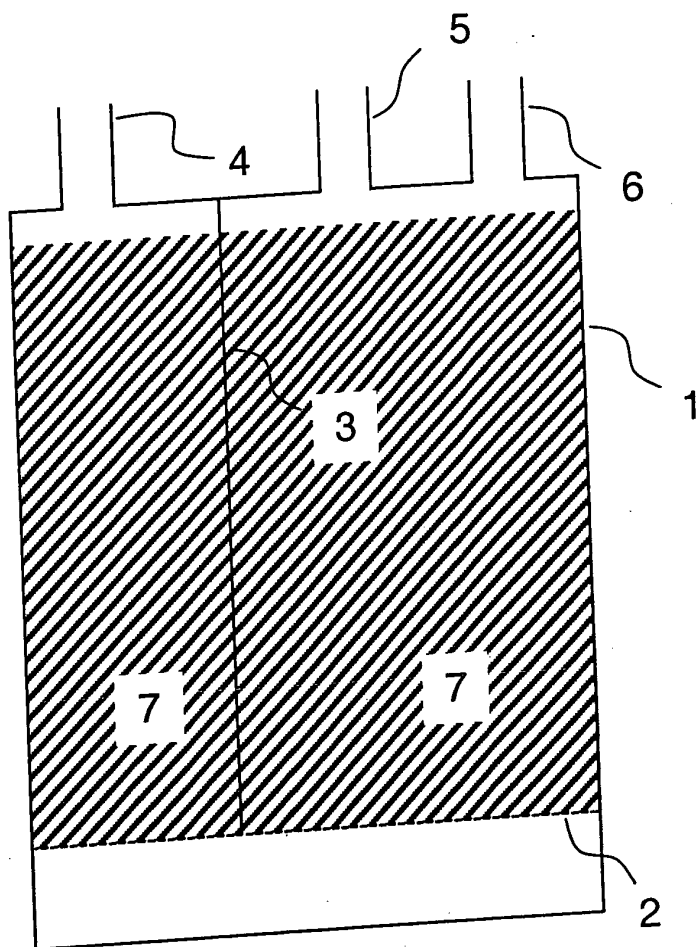

FIGURE 2

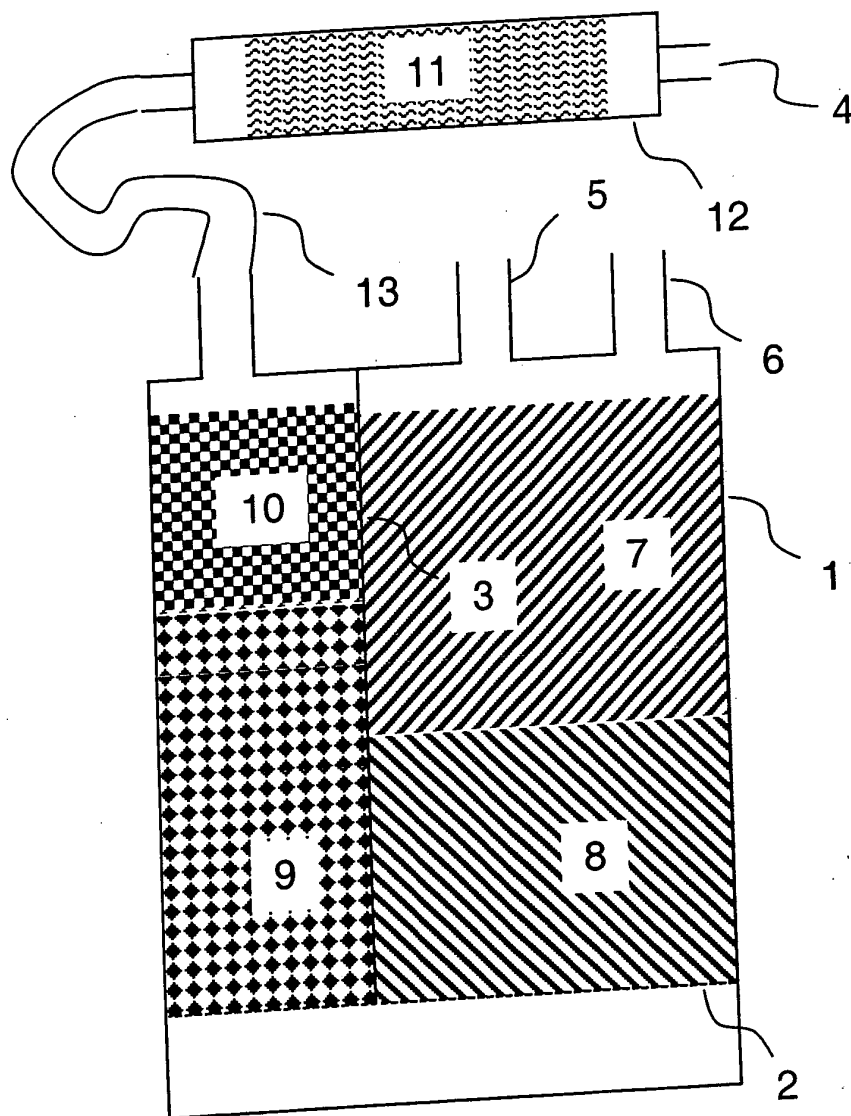
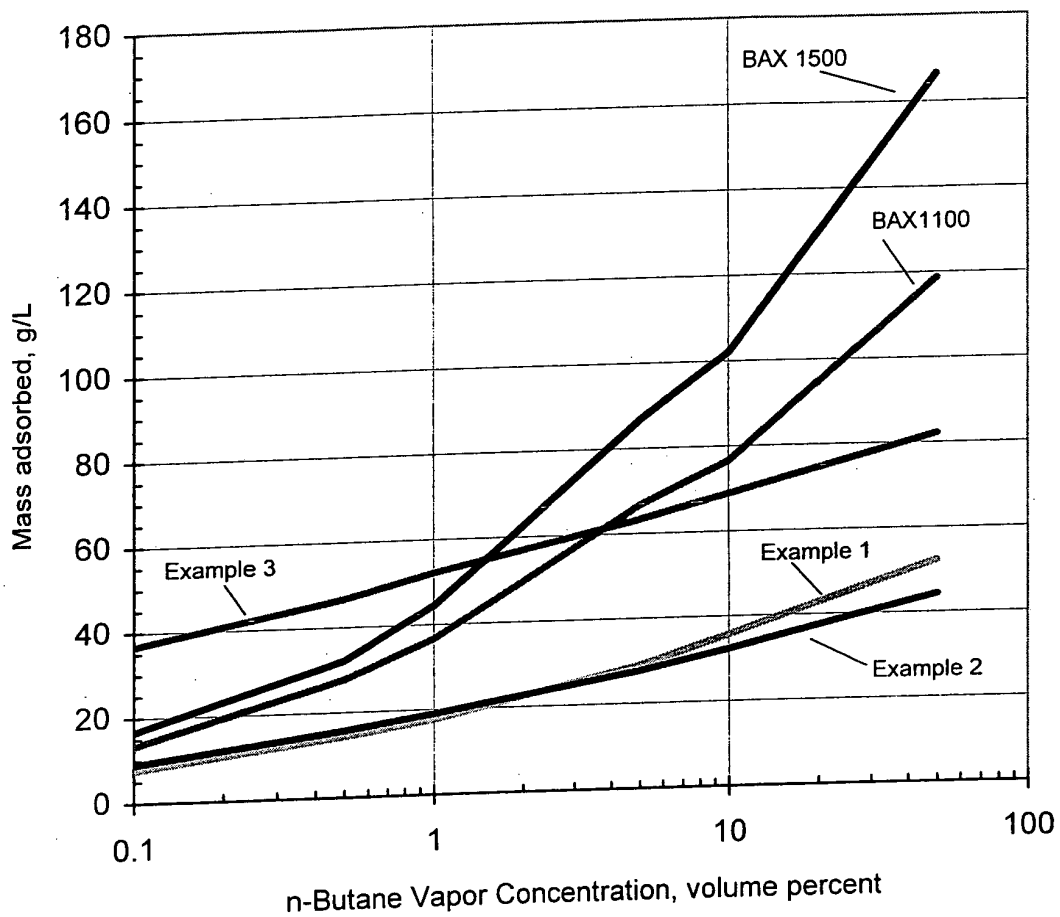

FIGURE 3

n-Butane Adsorption Isotherm at 25°C



IN THE UNITED STATES PATENT AND TRADEMARK OFFICE

Applicant: Laurence H. Hiltzik, Jacek Z. Jagiello, Edward D. Tolles, and  
Roger S. Williams

Group Art Unit: 1754

Serial No.: (To be assigned)

Filed: October 21, 2003

For: "Method for Reducing Emissions from Evaporative Emissions Control  
System"

Examiner: (To be assigned)

Commissioner for Patents  
United States Patent and Trademark Office  
Alexandria, VA 22313-1450

DECLARATION UNDER 37 CFR 1.131(a)

Dear Sir:

I, Terry B. McDaniel, declare as follows:

1. That I am the attorney for the applicants in the instant, above-identified  
reissue patent application and that I was the attorney for the same applicants in the patent  
application (SN 10/100,362), filed on March 18, 2002 (referencing benefit of the  
Provisional filing date of November 21, 2001) that issued as U.S. Patent No. 6,540,815  
on April 1, 2003, from which this reissue application is taken;

2. That I am familiar with the Abstract of the Japanese Published Patent  
Application Publication No. 2002-256989 titled "Canister" with the designated applicant  
Aisan Ind. Co. Ltd. and having a publication date of **September 11, 2002** (the "Aisan  
patent");

34

3. That both the provisional application filing date of SN 60/335,897 and the subsequent non-provisional filing date of U.S. Patent No. 6,540,815, from which this reissue application benefits for disclosure purposes, were **prior to September 11, 2002**, the critical date of the Aisan patent for consideration as prior art to a U.S. patent application;

4. That, pursuant to 37 C.F.R. 1.131(a), the disclosure of the Aisan patent cannot be considered as prior art in the examination of the instant reissue application: and

5. The undersigned declares further that all statements made herein of his own knowledge are true and that all statements made on information and belief are believed to be true; and further that these statements were made with the knowledge that willful false statements and the like so made are punishable by fine or imprisonment, or both, under section 1001 of Title 18 of the United States Code and that such willful false statements may jeopardize the validity of the application or any patent issuing thereon.

Date: October 21, 2003

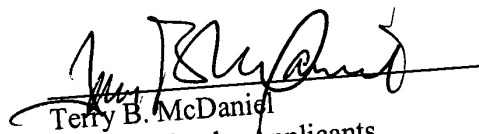
  
Terry B. McDaniel  
Attorney for the Applicants  
Registration No. 28,444

MeadWestvaco Corporation  
5255 Virginia Avenue  
Post Office Box 118005  
Charleston, SC 29423-8005  
Tel: (843) 740-2311  
Fax: (843) 746-8494

**REISSUE APPLICATION DECLARATION BY THE INVENTOR**

Docket Number (Optional)

CHR 2001-79 (reissue)

I hereby declare that:  
Each inventor's residence, mailing address and citizenship are stated below next to their name.  
I believe the inventors named below to be the original and first inventor(s) of the subject matter which is described and claimed in patent number 6,540,815, granted April 1, 2003 and for which a reissue patent is sought on the invention entitled Method For Reducing Emission From Evaporative Emission Control Systems

the specification of which

is attached hereto.

was filed on \_\_\_\_\_ as reissue application number \_\_\_\_\_ and was amended on \_\_\_\_\_ (if applicable).

I have reviewed and understand the contents of the above-identified specification, including the claims, as amended by any amendment referred to above.  
I acknowledge the duty to disclose information which is material to patentability as defined in 37 CFR 1.56.

I hereby claim foreign priority benefits under 35 U.S.C. 119(a)-(d) or (f), or 365(b). Attached is form PTO/SB/02B (or equivalent) listing the foreign applications.

I verily believe the original patent to be wholly or partly inoperative or invalid, for the reasons described below. (Check all boxes that apply.)

by reason of a defective specification or drawing.

by reason of the patentee claiming more or less than he had the right to claim in the patent.

by reason of other errors.

At least one error upon which reissue is based is described below. If the reissue is a broadening reissue, such must be stated with an explanation as to the nature of the broadening:

Submitted for reissue in order to gain benefit of previously disclosed but unclaimed subject matter related to a canister system for controlling auto emissions.

[Page 1 of 2]

This collection of information is required by 37 CFR 1.175. The information is required to obtain or retain a benefit by the public which is to file (and by the USPTO to process) an application. Confidentiality is governed by 35 U.S.C. 122 and 37 CFR 1.14. This collection is estimated to take 30 minutes to complete, including gathering, preparing, and submitting the completed application form to the USPTO. Time will vary depending upon the individual case. Any comments on the amount of time you require to complete this form and/or suggestions for reducing this burden, should be sent to the Chief Information Officer, U.S. Patent and Trademark Office, U.S. Department of Commerce, P.O. Box 1450, Alexandria, VA 22313-1450. DO NOT SEND FEES OR COMPLETED FORMS TO THIS ADDRESS. SEND TO: **Commissioner for Patents, P.O. Box 1450, Alexandria, VA 22313-1450.**

If you need assistance in completing the form, call 1-800-PTO-9199 and select option 2.

Docket Number (Optional)  
 CHR 2001-79 reissue

(REISSUE APPLICATION DECLARATION BY THE INVENTOR, page 2)

All errors corrected in this reissue application arose without any deceptive intention on the part of the applicant.  
 Note: To appoint a power of attorney, use form PTO/SB/81.

Correspondence Address: Direct all communications about the application to:

Customer Number: 36876

OR

Firm or Individual Name MeadWestvaco Corporation

Address

Address State Zip

City

Country Fax

Telephone

I hereby declare that all statements made herein of my own knowledge are true and that all statements made on information and belief are believed to be true; and further that these statements were made with the knowledge that willful false statements and the like so made are punishable by fine and imprisonment, or both, under 18 U.S.C. 1001, and that such willful false statements may jeopardize the validity of the application, any patent issuing thereon, or any patent to which this declaration is directed.

Full name of sole or first inventor (given name, family name)  
 Laurence H. Hiltzik

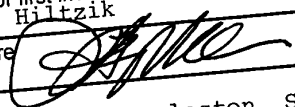
Inventor's signature  Date

Residence  
 191 Broad Street, Charleston, SC 29401

Mailing Address  
 191 Broad Street, Charleston, SC 29401

Citizenship  
 United States of America

Full name of second joint inventor (given name, family name)  
 Jacek Z. Jagiello

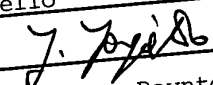
Inventor's signature  Date 10/13/2003

Residence  
 16212 Mahogany Drive, Boynton Beach FL

Mailing Address  
 16212 Mahogany Drive, Boynton Beach FL 33436

Citizenship  
 Poland

Full name of third joint inventor (given name, family name)  
 Edward Don Tolles

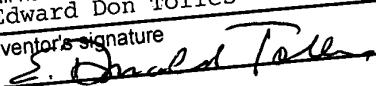
Inventor's signature  Date

Residence  
 2 Lampton Road, Charleston, SC 29407

Mailing Address  
 2 Lampton Road, Charleston, SC 29407

Citizenship  
 United States of America

Additional joint inventors or legal representative(s) are named on separately numbered sheets forms PTO/SB/02A or 02LR attached hereto.



03-10-21:21:27 HILTON NAGOYA EXECUTIVE LOUNGE  
2003E 10W17# 1100ERM MEADWESTVACO KOREA

Approved for use through 06/30/2003. OMB 0851-0032  
U.S. Patent and Trademark Office, U.S. DEPARTMENT OF COMMERCE

**DECLARATION**  
Under the Patent Reduction Act of 1996, no person is required to provide this information unless it contains a valid Omb control number.  
U.S. Patent and Trademark Office, U.S. DEPARTMENT OF COMMERCE  
Additional Inventor(s)  
Supplemental Sheet Page 1 of 1

Name of Additional Joint Inventor, if any:  
Given Name (first and middle (if any))  
Family Name or Surname  
Date 10/17/03  
USA Citizenship

Inventor's Signature: *Roger J. Williams*  
Residence: City  
Mailing Address: 800 Boyar Lane, Washington, VA State, USA Country  
Zip

Name of Additional Joint Inventor, if any:  
Given Name (first and middle (if any))  
Family Name or Surname  
Date  
USA Citizenship

Inventor's Signature  
Residence: City  
Mailing Address  
City  
State  
Zip  
Country

Name of Additional Joint Inventor, if any:  
Given Name (first and middle (if any))  
Family Name or Surname  
Date  
USA Citizenship

Inventor's Signature  
Residence: City  
Mailing Address  
City  
State  
Zip  
Country

This collection of information is required by 35 U.S.C. 115 and 37 CFR 1.117. The information is required to retain or obtain a benefit by the person which is to file (and by the USPTO to process) an application. Confidentiality is governed by 35 U.S.C. 122 and 37 CFR 1.14. This collection is estimated to take 28 minutes to complete, including gathering, preparing, and submitting the completed application form to the USPTO. Time will vary depending upon the individual case. Any comments on the amount of time you require to complete this form and/or suggestions for reducing this burden, should be sent to the Chief Information Officer, U.S. Patent and Trademark Office, U.S. Department of Commerce, P.O. Box 1450, Alexandria, VA 22313-1450. DO NOT SEND FEES OR COMPLETED FORMS TO THIS ADDRESS. See the Commissioner for Patents, P.O. Box 1450, Alexandria, VA 22313-1450 and select option 2.

If you need assistance in completing the form, call 1-800-PTO-9199 (1-800-778-9199) and select option 2.

0002

KOREA

MEADWESTVACO SBA

17/10 '03 FRI 10:19 FAX 862162754088

### REISSUE APPLICATION DECLARATION BY THE ASSIGNEE

Docket Number (optional)  
CHR 2001-79 (Reissue)

I hereby declare that:

The residence, mailing address and citizenship of the inventors are stated below.

I am authorized to act on behalf of the following assignee: MeadWestvaco Corporation

and the title of my position with said assignee is: Assistant Secretary

The entire title to the patent identified below is vested in said assignee.

Inventor Laurence H. Hiltzik

Citizenship  
United States of America

Residence/Mailing Address  
191 Broad Street, Charleston, SC 29401

Inventor Jacek Z. Jagiello

Citizenship  
Poland

Residence/Mailing Address  
16212 Mahogany Drive, Boynton Beach, FL 33436

Additional Inventors are named on separately numbered sheets attached hereto.

Date of Patent Issued  
April 1, 2003

Patent Number  
6,540,815

Title of Invention  
Method For Reducing Emissions From Evaporative Emissions Control Systems

I believe said inventor(s) to be the original and first inventor(s) of the subject matter which is described and claimed in said patent, for which a reissue patent is sought on the invention entitled:

Method For Reducing Emissions From Evaporative Emissions Control Systems

the specification of which

is attached hereto.

was filed on \_\_\_\_\_ as reissue application number \_\_\_\_\_ / \_\_\_\_\_  
and was amended on \_\_\_\_\_ (if applicable)

I have reviewed and understand the contents of the above identified specification, including the claims, as amended by any amendment referred to above.

I acknowledge the duty to disclose information which is material to patentability as defined in 37 CFR 1.56.

I hereby claim foreign priority benefits under 35 U.S.C. 119(a)-(d) or (f), or 365(b). Attached is form PTO/SB/02B (or equivalent) listing the foreign applications.

I verily believe the original patent to be wholly or partly inoperative or invalid, for the reasons described below. (Check all boxes that apply.)

by reason of a defective specification or drawing.

by reason of the patentee claiming more or less than he had the right to claim in the patent.

by reason of other errors.

[Page 1 of 2]

This collection of information is required by 37 CFR 1.175. The information is required to obtain or retain a benefit by the public which is to file (and by the USPTO to process) an application. Confidentiality is governed by 35 U.S.C. 122 and 37 CFR 1.14. This collection is estimated to take 30 minutes to complete, including gathering, preparing, and submitting the completed application form to the USPTO. Time will vary depending upon the individual case. Any comments on the amount of time you require to complete this form and/or suggestions for reducing this burden, should be sent to the Chief Information Officer, U.S. Patent and Trademark Office, U.S. Department of Commerce, P.O. Box 1450, Alexandria, VA 22313-1450. DO NOT SEND FEES OR COMPLETED FORMS TO THIS ADDRESS. SEND TO: Commissioner for Patents, P.O. Box 1450, Alexandria, VA 22313-1450.

If you need assistance in completing the form, call 1-800-PTO-9199 and select option 2.

Under the Paperwork Reduction Act of 1995, no persons are required to respond to a collection of information unless it displays a valid OMB control number.

Docket Number (Optional)  
CHR 2001-79 (reissue)

### REISSUE APPLICATION DECLARATION BY THE ASSIGNEE

At least one error upon which reissue is based is described as follows:  
Submitted for reissue in order to gain benefit of previously disclosed, but unclaimed subject matter related to a canister system for controlling auto emissions.

[Attach additional sheets, if needed.]

All errors corrected in this reissue application arose without any deceptive intention on the part of the applicant.  
I hereby appoint:

Practitioners at Customer Number:

OR

Practitioner(s) named below:

Name	Registration Number

as my/our attorney(s) or agent(s) to prosecute the application identified above, and to transact all business in the United States Patent and Trademark Office connected therewith.

Correspondence Address: Direct all communications about the application to:

Customer Number:

OR

Firm or Individual Name

MeadWestvaco Corporation

Address

Address

City

Country

Telephone

(843) 746-8493

Fax

(843) 746-8494

I hereby declare that all statements made herein of my own knowledge are true and that all statements made on information and belief are believed to be true; and further that these statements were made with the knowledge that willful false statements and the like so made are punishable by fine and imprisonment, or both, under 18 U.S.C. 1001, and that such willful false statements may jeopardize the validity of the application, any patent issuing thereon, or any patent to which this declaration is directed.

Full name of person signing (given name, family name)  
John J. Carrara

Signature *John J. Carrara*

Date *October 13, 2003*

Address of Assignee  
MeadWestvaco Corporation, One High Ridge Park, Stamford, CT 06905

Case Docket Number: CHR 2001-79 (reissue)  
Continuation of form PTO / SB / 52 – Reissue Application Declaration By The Assignee  
Page 1 of 1

Additional Inventors are named below:

Edward D. Tolles  
2 Lampton Road  
Charleston, SC 29407  
Citizenship: United States of America

Roger S. Williams  
900 Boyer Lane  
Lexington, VA 24450  
Citizenship: United States of America

Under the Paperwork Reduction Act of 1995, no persons are required to respond to a collection of information unless it displays a valid OMB control number.

STATEMENT UNDER 37 CFR 3.73(b)

Applicant/Patent Owner: MeadWestvaco Corporation
Application No./Patent No.: 10/100,362 / 6,540,815
Filed/Issue Date: March 18, 2002 / April 1, 2003

Entitled: Method For Reducing Emission From Evaporative Emissions Control Systems

MeadWestvaco Corporation, a Corporation
(Name of Assignee) (Type of Assignee, e.g., corporation, partnership, university, government agency, etc.)

states that it is:

- 1. [x] the assignee of the entire right, title, and interest; or
2. [ ] an assignee of less than the entire right, title and interest.
The extent (by percentage) of its ownership interest is \_\_\_\_\_ %
in the patent application/patent identified above by virtue of either:

A. [ ] An assignment from the inventor(s) of the patent application/patent identified above. The assignment was recorded in the United States Patent and Trademark Office at Reel \_\_\_\_\_, Frame \_\_\_\_\_, or for which a copy thereof is attached.

OR

B. [x] A chain of title from the inventor(s), of the patent application/patent identified above, to the current assignee as shown below: L.H. Hiltzik, J.Z. Jagiello,

1. From: E.D. Tolles, and R.S. Williams To: Westvaco Corporation

The document was recorded in the United States Patent and Trademark Office at Reel 12888, Frame 0474, or for which a copy thereof is attached.

2. From: Westvaco Corporation To: MeadWestvaco Corporation

The document was recorded in the United States Patent and Trademark Office at Reel 13922, Frame 0117, or for which a copy thereof is attached.

3. From: \_\_\_\_\_ To: \_\_\_\_\_

The document was recorded in the United States Patent and Trademark Office at Reel \_\_\_\_\_, Frame \_\_\_\_\_, or for which a copy thereof is attached.

[ ] Additional documents in the chain of title are listed on a supplemental sheet.

[x] Copies of assignments or other documents in the chain of title are attached.
[NOTE: A separate copy (i.e., the original assignment document or a true copy of the original document) must be submitted to Assignment Division in accordance with 37 CFR Part 3, if the assignment is to be recorded in the records of the USPTO. See MPEP 302.08]

The undersigned (whose title is supplied below) is authorized to act on behalf of the assignee.

October 13, 2003
Date

(203) 461-7502
Telephone number

John J. Carrara

Typed or printed name
Signature

Assistant Secretary

Title

This collection of information is required by 37 CFR 3.73(b). The information is required to obtain or retain a benefit by the public which is to file (and by the USPTO to process) an application. Confidentiality is governed by 35 U.S.C. 122 and 37 CFR 1.14. This collection is estimated to take 12 minutes to complete, including gathering, preparing, and submitting the completed application form to the USPTO. Time will vary depending upon the individual case. Any comments on the amount of time you require to complete this form and/or suggestions for reducing this burden, should be sent to the Chief Information Officer, U.S. Patent and Trademark Office, U.S. Department of Commerce, P.O. Box 1450, Alexandria, VA 22313-1450. DO NOT SEND FEES OR COMPLETED FORMS TO THIS ADDRESS. SEND TO: Commissioner for Patents, P.O. Box 1450, Alexandria, VA 22313-1450.

If you need assistance in completing the form, call 1-800-PTO-9199 and select option 2.



07-22-02 A10:52 IN

CHR 2001-79

JULY 16, 2002

PTAS

Chief Information Officer  
Washington, DC 20231  
www.uspto.gov

WESTVACO CORPORATION  
TERRY B. MCDANIEL  
5255 VIRGINIA AVENUE  
P.O. BOX 118005  
CHARLESTON, SC 29423-8005



\*102092281A\*

UNITED STATES PATENT AND TRADEMARK OFFICE  
NOTICE OF RECORDATION OF ASSIGNMENT DOCUMENT

THE ENCLOSED DOCUMENT HAS BEEN RECORDED BY THE ASSIGNMENT DIVISION OF THE U.S. PATENT AND TRADEMARK OFFICE. A COMPLETE MICROFILM COPY IS AVAILABLE AT THE ASSIGNMENT SEARCH ROOM ON THE REEL AND FRAME NUMBER REFERENCED BELOW.

PLEASE REVIEW ALL INFORMATION CONTAINED ON THIS NOTICE. THE INFORMATION CONTAINED ON THIS RECORDATION NOTICE REFLECTS THE DATA PRESENT IN THE PATENT AND TRADEMARK ASSIGNMENT SYSTEM. IF YOU SHOULD FIND ANY ERRORS OR HAVE QUESTIONS CONCERNING THIS NOTICE, YOU MAY CONTACT THE EMPLOYEE WHOSE NAME APPEARS ON THIS NOTICE AT 703-308-9723. PLEASE SEND REQUEST FOR CORRECTION TO: U.S. PATENT AND TRADEMARK OFFICE, ASSIGNMENT DIVISION, BOX ASSIGNMENTS, CG-4, 1213 JEFFERSON DAVIS HWY, SUITE 320, WASHINGTON, D.C. 20231.

RECORDATION DATE: 05/09/2002

REEL/FRAME: 012888/0474  
NUMBER OF PAGES: 3

BRIEF: ASSIGNMENT OF ASSIGNOR'S INTEREST (SEE DOCUMENT FOR DETAILS).

ASSIGNOR:  
HILTZIK, LAURENCE H.

DOC DATE: 03/26/2002

ASSIGNOR:  
JAGIELLO, JACEK Z.

DOC DATE: 03/28/2002

ASSIGNOR:  
TOLLES, EDWARD D.

DOC DATE: 03/28/2002

ASSIGNOR:  
WILLIAMS, ROGER S.

DOC DATE: 03/28/2002

ASSIGNEE:  
WESTVACO CORPORATION  
5255 VIRGINIA AVENUE  
P.O. BOX 118005  
CHARLESTON, SOUTH CAROLINA

29423-8005

012888/0474 PAGE 2

SERIAL NUMBER: 10100362  
PATENT NUMBER:

FILING DATE: 03/18/2002  
ISSUE DATE:

JOANN STEWART, EXAMINER  
ASSIGNMENT DIVISION  
OFFICE OF PUBLIC RECORDS

05-16-2002

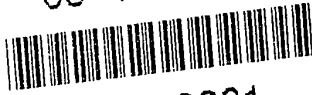

Express Mail No.: 370311201US  
Case Docket No. CHR 2001-79

Form PTO-1595  
(Rev. 03/01)  
OMB No. 0651-0027 (exp. 5/31/2002)

102092281

**PATENTS ONLY**

2 SHEET

U.S. DEPARTMENT OF COMMERCE  
U.S. Patent and Trademark Office

Tab settings ⇌ ⇌ ⇌  
To the Honorable Commissioner of Patents and Trademarks: Please record the attached original documents or copy thereof.

1. Name of conveying party(ies):

Laurence H. Hiltzik  
Jacek Z. Jagiello  
Edward D. Tolles  
Roger S. Williams

5.9.02

Additional name(s) of conveying party(ies) attached?  Yes  No

2. Name and address of receiving party(ies)

Name: Westvaco Corporation

Internal Address: P. O. Box 118005

Street Address: 5255 Virginia Avenue

City: Charleston State: SC Zip: 29423-8005

Additional name(s) & address(es) attached?  Yes  No

3. Nature of conveyance:

Assignment

Merger

Security Agreement

Change of Name

Other

Execution Date: 3/26/02 and 3/28/02

4. Application number(s) or patent number(s):

If this document is being filed together with a new application, the execution date of the application is: entitled  
Method for Reducing Emissions from Evaporative Emissions Control Systems  
A. Patent Application No.(s) 10/100,362  
B. Patent No.(s)

Filed 3/18/02

Additional numbers attached?  Yes  No

5. Name and address of party to whom correspondence concerning document should be mailed:

Name: Terry B. McDaniel

Internal Address: Westvaco Corporation

P. O. Box 118005

Street Address: 5255 Virginia Avenue

City: Charleston State: SC Zip: 29423-8005

6. Total number of applications and patents involved: 1

7. Total fee (37 CFR 3.41).....\$ 40.00

Enclosed

Authorized to be charged to deposit account

8. Deposit account number:

23-1160

OFFICE OF PUBLIC RECORDS  
2002 MAY -9 AM 8:48  
FINANCE SECTION

DO NOT USE THIS SPACE

9. Signature.

Terry B. McDaniel  
Name of Person Signing

*Terry B. McDaniel*  
Signature

May 9, 2002  
Date

Total number of pages including cover sheet, attachments, and documents: 4

Mail documents to be recorded with required cover sheet information to:  
Commissioner of Patents & Trademarks, Box Assignments  
Washington, D.C. 20231

5/15/2002 DBYRNE

00000266 10100362

40.00 OP

1 FC:581



ASSIGNMENT

WHEREAS, we, LAURENCE H. HILTZIK, residing at 191 Broad Street, Charleston, South Carolina 29401, JACEK Z. JAGIELLO, residing at 6240 Old Point Road, Apartment #41, Charleston, South Carolina 29406, EDWARD D. TOLLES, residing at 2 Lampton Road, Charleston, South Carolina 29407, and ROGER S. WILLIAMS, residing at 900 Boyer Lane, Lexington, Virginia 24450, have invented certain new and useful improvements in METHOD FOR REDUCING EMISSIONS FROM EVAPORATIVE EMISSIONS CONTROL SYSTEMS for which we have filed a United States Non-Provisional Patent Application Serial No. 10/100,362 on March 18, 2002;

NOW, THEREFORE, for good and valuable consideration paid to us by WESTVACO CORPORATION, a corporation of the State of Delaware, and having a place of business at Westvaco Corporation, Charleston Technical Center, 5255 Virginia Avenue, P. O. Box 118005, Charleston, South Carolina 29423-8005, the receipt of which is hereby acknowledged;

Effective March 18, 2002, WE DO HEREBY ASSIGN unto the said WESTVACO CORPORATION, its successors and assigns, all our right, title, and interest in and to said application and invention for the United States and all foreign countries, and any Letters Patent to be issued from a non-provisional patent application therefor in the United States and elsewhere. The Commissioner of Patents is requested to issue such Letters Patent in accordance herewith. And we agree to execute further instruments proper for effectuating the premises.

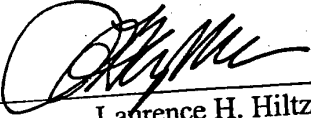
  
\_\_\_\_\_  
Laurence H. Hiltzik

Date: March 26, 2002

  
\_\_\_\_\_  
Jacek Z. Jagiello

Date: March 26, 2002

  
\_\_\_\_\_  
Edward D. Tolles

Date: March 26, 2002

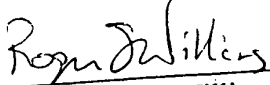
  
\_\_\_\_\_  
Roger S. Williams

Date: March 28, 2002

Case Docket No. CHR 2001-79  
U.S. Serial (Non-Provisional) No. 10/100,362

STATE OF SOUTH CAROLINA )  
 ) ss:  
COUNTY OF CHARLESTON

BEFORE ME, a Notary Public in and for said State, personally appeared Laurence H. Hiltzik, Jacek, Z. Jagiello, and Edward D. Tolles, to me known and known to be the persons described in and who executed the foregoing instrument, and they duly acknowledge it to be their act and deed.

WITNESS my hand and seal this 26th day of March 2002.

SEAL

Susan C. Harmon  
Notary Public  
My Commission expires: February 29, 2012

STATE OF VIRGINIA )  
 ) ss:  
City  
COUNTY OF Cornington

BEFORE ME, a Notary Public in and for said State, personally appeared Roger S. Williams, to me known and known to be the person described in and who executed the foregoing instrument, and he duly acknowledges it to be his act and deed.

WITNESS my hand and seal this 28 day of March 2002.

SEAL

Linda C. Stull  
Notary Public  
My Commission expires: 6-30-04

EXPRESS MAIL NO. EF370311201US  
Case Docket No. CHR 01-79  
Serial No.: 10/100,362  
File Date: 3/18/02

CERTIFICATE UNDER 37 C.F.R. 1.10(a)

I hereby certify that this correspondence is being deposited with the United States  
Postal Service as Express Mail in an envelope addressed to the Assistant Commissioner for  
Patents, Washington, DC 20231, on May 9, 2002.

  
Terry B. McDaniel  
Attorney for the Applicants  
Registration No. 28,444



UNITED STATES DEPARTMENT OF COMMERCE  
 Patent and Trademark Office  
 ASSISTANT SECRETARY AND COMMISSIONER  
 OF PATENTS AND TRADEMARKS  
 Washington, D.C. 20231

SEPTEMBER 02, 2003

PTAS



\*700042050A\*

MEADWESTVACO CORPORATION  
 THOMAS A. BOSHINSKI  
 4850 NORTH CHURCH LN. SE  
 SUITE D  
 SMYRNA, GA 30080

UNITED STATES PATENT AND TRADEMARK OFFICE  
 NOTICE OF RECORDATION OF ASSIGNMENT DOCUMENT

THE ENCLOSED DOCUMENT HAS BEEN RECORDED BY THE ASSIGNMENT DIVISION OF THE U.S. PATENT AND TRADEMARK OFFICE. A COMPLETE MICROFILM COPY IS AVAILABLE AT THE ASSIGNMENT SEARCH ROOM ON THE REEL AND FRAME NUMBER REFERENCED BELOW.

PLEASE REVIEW ALL INFORMATION CONTAINED ON THIS NOTICE. THE INFORMATION CONTAINED ON THIS RECORDATION NOTICE REFLECTS THE DATA PRESENT IN THE PATENT AND TRADEMARK ASSIGNMENT SYSTEM. IF YOU SHOULD FIND ANY ERRORS OR HAVE QUESTIONS CONCERNING THIS NOTICE, YOU MAY CONTACT THE EMPLOYEE WHOSE NAME APPEARS ON THIS NOTICE AT 703-308-9723. PLEASE SEND REQUEST FOR CORRECTION TO: U.S. PATENT AND TRADEMARK OFFICE, ASSIGNMENT DIVISION, BOX ASSIGNMENTS, CG-4, 1213 JEFFERSON DAVIS HWY, SUITE 320, WASHINGTON, D.C. 20231.

RECORDATION DATE: 08/28/2003

REEL/FRAME: 013922/0117  
 NUMBER OF PAGES: 11

BRIEF: MERGER (SEE DOCUMENT FOR DETAILS).

DOC DATE: 12/31/2002

ASSIGNOR:  
 WESTVACO CORPORATION

ASSIGNEE:  
 MEADWESTVACO CORPORATION  
 ONE HIGH RIDGE PARK  
 STAMFORD, CONNECTICUT 06905

SERIAL NUMBER: 09098991  
 PATENT NUMBER:

SERIAL NUMBER: 09140809  
 PATENT NUMBER: 6616981

SERIAL NUMBER: 09573160  
 PATENT NUMBER:

SERIAL NUMBER: 09803829  
 PATENT NUMBER:

FILING DATE: 06/17/1998  
 ISSUE DATE:

FILING DATE: 08/26/1998  
 ISSUE DATE: 09/09/2003

FILING DATE: 05/19/2000  
 ISSUE DATE:

FILING DATE: 03/12/2001  
 ISSUE DATE:

013922/0117 PAGE 2

SERIAL NUMBER: 09829917  
PATENT NUMBER:

SERIAL NUMBER: 09854367  
PATENT NUMBER:

SERIAL NUMBER: 09904224  
PATENT NUMBER:

SERIAL NUMBER: 09953983  
PATENT NUMBER:

SERIAL NUMBER: 09954467  
PATENT NUMBER:

SERIAL NUMBER: 09973088  
PATENT NUMBER:

SERIAL NUMBER: 09973089  
PATENT NUMBER:

SERIAL NUMBER: 09973369  
PATENT NUMBER:

SERIAL NUMBER: 09992902  
PATENT NUMBER:

SERIAL NUMBER: 09999294  
PATENT NUMBER:

SERIAL NUMBER: 10014710  
PATENT NUMBER:

SERIAL NUMBER: 10029360  
PATENT NUMBER:

SERIAL NUMBER: 10074729  
PATENT NUMBER:

SERIAL NUMBER: 10074731  
PATENT NUMBER:

SERIAL NUMBER: 10099670  
PATENT NUMBER:

SERIAL NUMBER: 10141158  
PATENT NUMBER:

SERIAL NUMBER: 10144201  
PATENT NUMBER:

SERIAL NUMBER: 10192277  
PATENT NUMBER:

FILING DATE: 04/11/2001  
ISSUE DATE:

FILING DATE: 05/11/2001  
ISSUE DATE:

FILING DATE: 07/12/2001  
ISSUE DATE:

FILING DATE: 09/17/2001  
ISSUE DATE:

FILING DATE: 09/17/2001  
ISSUE DATE:

FILING DATE: 10/10/2001  
ISSUE DATE:

FILING DATE: 10/10/2001  
ISSUE DATE:

FILING DATE: 10/09/2001  
ISSUE DATE:

FILING DATE: 11/14/2001  
ISSUE DATE:

FILING DATE: 11/15/2001  
ISSUE DATE:

FILING DATE: 12/11/2001  
ISSUE DATE:

FILING DATE: 12/20/2001  
ISSUE DATE:

FILING DATE: 04/23/2002  
ISSUE DATE:

FILING DATE: 02/13/2002  
ISSUE DATE:

FILING DATE: 03/15/2002  
ISSUE DATE:

FILING DATE: 05/08/2002  
ISSUE DATE:

FILING DATE: 05/10/2002  
ISSUE DATE:

FILING DATE: 07/10/2002  
ISSUE DATE:

013922/0117 PAGE 3

SERIAL NUMBER: 10214335  
PATENT NUMBER:

SERIAL NUMBER: 10228910  
PATENT NUMBER:

SERIAL NUMBER: 10247215  
PATENT NUMBER:

SERIAL NUMBER: 10247217  
PATENT NUMBER:

SERIAL NUMBER: 10268129  
PATENT NUMBER:

SERIAL NUMBER: 10287492  
PATENT NUMBER:

SERIAL NUMBER: 10287493  
PATENT NUMBER:

SERIAL NUMBER: 10291141  
PATENT NUMBER:

SERIAL NUMBER: 10324173  
PATENT NUMBER:

SERIAL NUMBER: 60416974  
PATENT NUMBER:

SERIAL NUMBER: 06877464  
PATENT NUMBER: 4740367

SERIAL NUMBER: 06942725  
PATENT NUMBER: 4744925

SERIAL NUMBER: 06713287  
PATENT NUMBER: 4801311

SERIAL NUMBER: 06745082  
PATENT NUMBER: 4802898

SERIAL NUMBER: 07754070  
PATENT NUMBER: 5136055

SERIAL NUMBER: 07821436  
PATENT NUMBER: 5137965

SERIAL NUMBER: 07723261  
PATENT NUMBER: 5152832

SERIAL NUMBER: 07312817  
PATENT NUMBER: 5160453

FILING DATE: 08/07/2002  
ISSUE DATE:

FILING DATE: 08/27/2002  
ISSUE DATE:

FILING DATE: 09/19/2002  
ISSUE DATE:

FILING DATE: 09/19/2002  
ISSUE DATE:

FILING DATE: 10/10/2002  
ISSUE DATE:

FILING DATE: 11/05/2002  
ISSUE DATE:

FILING DATE: 11/05/2002  
ISSUE DATE:

FILING DATE: 11/08/2002  
ISSUE DATE:

FILING DATE: 12/20/2002  
ISSUE DATE:

FILING DATE: 10/08/2002  
ISSUE DATE:

FILING DATE: 06/23/1986  
ISSUE DATE: 04/26/1988

FILING DATE: 12/17/1986  
ISSUE DATE: 05/17/1988

FILING DATE: 03/18/1985  
ISSUE DATE: 01/31/1989

FILING DATE: 06/17/1985  
ISSUE DATE: 02/07/1989

FILING DATE: 09/03/1991  
ISSUE DATE: 08/04/1992

FILING DATE: 01/15/1992  
ISSUE DATE: 08/11/1992

FILING DATE: 06/28/1991  
ISSUE DATE: 10/06/1992

FILING DATE: 02/21/1989  
ISSUE DATE: 11/03/1992

013922/0117 PAGE 4

SERIAL NUMBER: 07658208  
PATENT NUMBER: 5164446

SERIAL NUMBER: 07790757  
PATENT NUMBER: 5166245

SERIAL NUMBER: 07787408  
PATENT NUMBER: 5166256

SERIAL NUMBER: 07787269  
PATENT NUMBER: 5166257

SERIAL NUMBER: 07787412  
PATENT NUMBER: 5166258

SERIAL NUMBER: 07787268  
PATENT NUMBER: 5166262

SERIAL NUMBER: 07518267  
PATENT NUMBER: 5167694

SERIAL NUMBER: 07762959  
PATENT NUMBER: 5174913

SERIAL NUMBER: 07819084  
PATENT NUMBER: 5178674

SERIAL NUMBER: 07884916  
PATENT NUMBER: 5180424

SERIAL NUMBER: 07787270  
PATENT NUMBER: 5180774

SERIAL NUMBER: 07681916  
PATENT NUMBER: 5182326

SERIAL NUMBER: 07825533  
PATENT NUMBER: 5188665

SERIAL NUMBER: 07923543  
PATENT NUMBER: 5189090

SERIAL NUMBER: 07827705  
PATENT NUMBER: 5192361

SERIAL NUMBER: 07872195  
PATENT NUMBER: 5194840

SERIAL NUMBER: 07839597  
PATENT NUMBER: 5204310

SERIAL NUMBER: 07853133

FILING DATE: 02/19/1991  
ISSUE DATE: 11/17/1992

FILING DATE: 11/12/1991  
ISSUE DATE: 11/24/1992

FILING DATE: 11/04/1991  
ISSUE DATE: 11/24/1992

FILING DATE: 11/04/1991  
ISSUE DATE: 11/24/1992

FILING DATE: 11/04/1991  
ISSUE DATE: 11/24/1992

FILING DATE: 11/04/1991  
ISSUE DATE: 11/24/1992

FILING DATE: 05/04/1990  
ISSUE DATE: 12/01/1992

FILING DATE: 09/20/1991  
ISSUE DATE: 12/29/1992

FILING DATE: 01/09/1992  
ISSUE DATE: 01/12/1993

FILING DATE: 05/18/1992  
ISSUE DATE: 01/19/1993

FILING DATE: 11/04/1991  
ISSUE DATE: 01/19/1993

FILING DATE: 04/08/1991  
ISSUE DATE: 01/26/1993

FILING DATE: 01/24/1992  
ISSUE DATE: 02/23/1993

FILING DATE: 08/03/1992  
ISSUE DATE: 02/23/1993

FILING DATE: 01/27/1992  
ISSUE DATE: 03/09/1993

FILING DATE: 04/22/1992  
ISSUE DATE: 03/16/1993

FILING DATE: 02/21/1992  
ISSUE DATE: 04/20/1993

FILING DATE: 03/18/1992

PATENT NUMBER: 5206207

ISSUE DATE: 04/27/1993

013922/0117 PAGE 5

SERIAL NUMBER: 07904218  
PATENT NUMBER: 5208319

SERIAL NUMBER: 07891734  
PATENT NUMBER: 5212144

SERIAL NUMBER: 07885842  
PATENT NUMBER: 5212213

SERIAL NUMBER: 07868670  
PATENT NUMBER: 5216064

SERIAL NUMBER: 07967052  
PATENT NUMBER: 5216071

SERIAL NUMBER: 07909065  
PATENT NUMBER: 5238470

SERIAL NUMBER: 07929166  
PATENT NUMBER: 5250491

SERIAL NUMBER: 08017867  
PATENT NUMBER: 5264481

SERIAL NUMBER: 07961835  
PATENT NUMBER: 5270017

SERIAL NUMBER: 07967982  
PATENT NUMBER: 5276000

SERIAL NUMBER: 08046077  
PATENT NUMBER: 5292480

SERIAL NUMBER: 07977010  
PATENT NUMBER: 5304527

SERIAL NUMBER: 07987794  
PATENT NUMBER: 5306762

SERIAL NUMBER: 08362123  
PATENT NUMBER: 5603793

SERIAL NUMBER: 08055853  
PATENT NUMBER: 5312599

SERIAL NUMBER: 08121109  
PATENT NUMBER: 5320671

SERIAL NUMBER: 08095755  
PATENT NUMBER: 5324703

FILING DATE: 06/25/1992  
ISSUE DATE: 05/04/1993

FILING DATE: 06/01/1992  
ISSUE DATE: 05/18/1993

FILING DATE: 05/20/1992  
ISSUE DATE: 05/18/1993

FILING DATE: 04/15/1992  
ISSUE DATE: 06/01/1993

FILING DATE: 10/28/1992  
ISSUE DATE: 06/01/1993

FILING DATE: 07/02/1992  
ISSUE DATE: 08/24/1993

FILING DATE: 08/11/1992  
ISSUE DATE: 10/05/1993

FILING DATE: 02/16/1993  
ISSUE DATE: 11/23/1993

FILING DATE: 10/16/1992  
ISSUE DATE: 12/14/1993

FILING DATE: 10/28/1992  
ISSUE DATE: 01/04/1994

FILING DATE: 04/12/1993  
ISSUE DATE: 03/08/1994

FILING DATE: 11/16/1992  
ISSUE DATE: 04/19/1994

FILING DATE: 12/09/1992  
ISSUE DATE: 04/26/1994

FILING DATE: 12/22/1994  
ISSUE DATE: 02/18/1997

FILING DATE: 04/30/1993  
ISSUE DATE: 05/17/1994

FILING DATE: 09/14/1993  
ISSUE DATE: 06/14/1994

FILING DATE: 07/21/1993  
ISSUE DATE: 06/28/1994



SERIAL NUMBER: 08122004  
PATENT NUMBER: 5328505

FILING DATE: 09/14/1993  
ISSUE DATE: 07/12/1994

013922/0117 PAGE 6

SERIAL NUMBER: 08151360  
PATENT NUMBER: 5332435

SERIAL NUMBER: 07725422  
PATENT NUMBER: 5336438

SERIAL NUMBER: 08138994  
PATENT NUMBER: 5413930

SERIAL NUMBER: 08143551  
PATENT NUMBER: 5416056

SERIAL NUMBER: 08315548  
PATENT NUMBER: 5423908

SERIAL NUMBER: 08188718  
PATENT NUMBER: 5443902

SERIAL NUMBER: 08613270  
PATENT NUMBER: 5691270

SERIAL NUMBER: 08712281  
PATENT NUMBER: 5691405

SERIAL NUMBER: 08602371  
PATENT NUMBER: 5693702

SERIAL NUMBER: 08403390  
PATENT NUMBER: 5710092

SERIAL NUMBER: 08456757  
PATENT NUMBER: 5712164

SERIAL NUMBER: 08507779  
PATENT NUMBER: 5719795

SERIAL NUMBER: 08742636  
PATENT NUMBER: 5723020

SERIAL NUMBER: 08770980  
PATENT NUMBER: 5731191

SERIAL NUMBER: 08664936  
PATENT NUMBER: 5731203

SERIAL NUMBER: 08770960  
PATENT NUMBER: 5731204

SERIAL NUMBER: 08716105  
PATENT NUMBER: 5736481

FILING DATE: 11/12/1993  
ISSUE DATE: 07/26/1994

FILING DATE: 07/03/1991  
ISSUE DATE: 08/09/1994

FILING DATE: 10/21/1993  
ISSUE DATE: 05/09/1995

FILING DATE: 10/25/1993  
ISSUE DATE: 05/16/1995

FILING DATE: 09/30/1994  
ISSUE DATE: 06/13/1995

FILING DATE: 01/31/1994  
ISSUE DATE: 08/22/1995

FILING DATE: 03/08/1996  
ISSUE DATE: 11/25/1997

FILING DATE: 09/11/1996  
ISSUE DATE: 11/25/1997

FILING DATE: 02/16/1996  
ISSUE DATE: 12/02/1997

FILING DATE: 03/14/1995  
ISSUE DATE: 01/20/1998

FILING DATE: 06/01/1995  
ISSUE DATE: 01/27/1998

FILING DATE: 07/26/1995  
ISSUE DATE: 02/17/1998

FILING DATE: 11/01/1996  
ISSUE DATE: 03/03/1998

FILING DATE: 12/20/1996  
ISSUE DATE: 03/24/1998

FILING DATE: 06/14/1996  
ISSUE DATE: 03/24/1998

FILING DATE: 12/20/1996  
ISSUE DATE: 03/24/1998

FILING DATE: 09/19/1996  
ISSUE DATE: 04/07/1998

SERIAL NUMBER: 08716106  
PATENT NUMBER: 5736485

FILING DATE: 09/19/1996  
ISSUE DATE: 04/07/1998

013922/0117 PAGE 7

SERIAL NUMBER: 08712907  
PATENT NUMBER: 5749926

FILING DATE: 09/12/1996  
ISSUE DATE: 05/12/1998

SERIAL NUMBER: 08712906  
PATENT NUMBER: 5755830

FILING DATE: 09/12/1996  
ISSUE DATE: 05/26/1998

SERIAL NUMBER: 08854421  
PATENT NUMBER: 5759485

FILING DATE: 05/12/1997  
ISSUE DATE: 06/02/1998

SERIAL NUMBER: 08929837  
PATENT NUMBER: 5772749

FILING DATE: 09/15/1997  
ISSUE DATE: 06/30/1998

SERIAL NUMBER: 08695641  
PATENT NUMBER: 5776234

FILING DATE: 08/12/1996  
ISSUE DATE: 07/07/1998

SERIAL NUMBER: 08576447  
PATENT NUMBER: 5837376

FILING DATE: 12/21/1995  
ISSUE DATE: 11/17/1998

SERIAL NUMBER: 08835561  
PATENT NUMBER: 5856191

FILING DATE: 04/08/1997  
ISSUE DATE: 01/05/1999

SERIAL NUMBER: 08609632  
PATENT NUMBER: 5863858

FILING DATE: 03/12/1996  
ISSUE DATE: 01/26/1999

SERIAL NUMBER: 08814375  
PATENT NUMBER: 5871614

FILING DATE: 03/11/1997  
ISSUE DATE: 02/16/1999

SERIAL NUMBER: 08814680  
PATENT NUMBER: 5871663

FILING DATE: 03/11/1997  
ISSUE DATE: 02/16/1999

SERIAL NUMBER: 08898771  
PATENT NUMBER: 5905629

FILING DATE: 07/23/1997  
ISSUE DATE: 05/18/1999

SERIAL NUMBER: 08880754  
PATENT NUMBER: 5926361

FILING DATE: 06/23/1997  
ISSUE DATE: 07/20/1999

SERIAL NUMBER: 08324837  
PATENT NUMBER: 5965483

FILING DATE: 10/20/1994  
ISSUE DATE: 10/12/1999

SERIAL NUMBER: 09074751  
PATENT NUMBER: 5969071

FILING DATE: 05/08/1998  
ISSUE DATE: 10/19/1999

SERIAL NUMBER: 09074756  
PATENT NUMBER: 5973036

FILING DATE: 05/08/1998  
ISSUE DATE: 10/26/1999

SERIAL NUMBER: 09074760  
PATENT NUMBER: 6001904

FILING DATE: 05/08/1998  
ISSUE DATE: 12/14/1999

SERIAL NUMBER: 09074757

FILING DATE: 05/08/1998

OFFICE OF THE COMPTROLLER

PATENT NUMBER: 6007610

SERIAL NUMBER: 09093040

PATENT NUMBER: 6020399

ISSUE DATE: 12/28/1999

FILING DATE: 06/05/1998

ISSUE DATE: 02/01/2000

013922/0117 PAGE 8

SERIAL NUMBER: 08946718  
PATENT NUMBER: 6020401

SERIAL NUMBER: 09074755  
PATENT NUMBER: 6020405

SERIAL NUMBER: 08880755  
PATENT NUMBER: 6043183

SERIAL NUMBER: 09262468  
PATENT NUMBER: 6045606

SERIAL NUMBER: 09187448  
PATENT NUMBER: 6057462

SERIAL NUMBER: 09237339  
PATENT NUMBER: 6060424

SERIAL NUMBER: 09231064  
PATENT NUMBER: 6077888

SERIAL NUMBER: 09061557  
PATENT NUMBER: 6103780

SERIAL NUMBER: 09135945  
PATENT NUMBER: 6103802

SERIAL NUMBER: 09248735  
PATENT NUMBER: 6153693

SERIAL NUMBER: 09140582  
PATENT NUMBER: 6156384

SERIAL NUMBER: 09521437  
PATENT NUMBER: 6172149

SERIAL NUMBER: 09277244  
PATENT NUMBER: 6172174

SERIAL NUMBER: 09393549  
PATENT NUMBER: 6194471

SERIAL NUMBER: 08287866  
PATENT NUMBER: 6277780

SERIAL NUMBER: 09513032  
PATENT NUMBER: 6291075

SERIAL NUMBER: 09545668  
PATENT NUMBER: 6329068

SERIAL NUMBER: 09329842  
PATENT NUMBER: 6368457

FILING DATE: 10/08/1997  
ISSUE DATE: 02/01/2000

FILING DATE: 05/08/1998  
ISSUE DATE: 02/01/2000

FILING DATE: 06/23/1997  
ISSUE DATE: 03/28/2000

FILING DATE: 03/04/1999  
ISSUE DATE: 04/04/2000

FILING DATE: 11/06/1998  
ISSUE DATE: 05/02/2000

FILING DATE: 01/26/1999  
ISSUE DATE: 05/09/2000

FILING DATE: 01/14/1999  
ISSUE DATE: 06/20/2000

FILING DATE: 04/16/1998  
ISSUE DATE: 08/15/2000

FILING DATE: 08/18/1998  
ISSUE DATE: 08/15/2000

FILING DATE: 02/11/1999  
ISSUE DATE: 11/28/2000

FILING DATE: 08/26/1998  
ISSUE DATE: 12/05/2000

FILING DATE: 03/07/2000  
ISSUE DATE: 01/09/2001

FILING DATE: 03/26/1999  
ISSUE DATE: 01/09/2001

FILING DATE: 09/10/1999  
ISSUE DATE: 02/27/2001

FILING DATE: 08/09/1994  
ISSUE DATE: 08/21/2001

FILING DATE: 02/25/2000  
ISSUE DATE: 09/18/2001

FILING DATE: 04/07/2000  
ISSUE DATE: 12/11/2001

FILING DATE: 06/11/1999  
ISSUE DATE: 04/09/2002

013922/0117 PAGE 9

SERIAL NUMBER: 09426379  
PATENT NUMBER: 6376611

SERIAL NUMBER: 09427127  
PATENT NUMBER: 6409882

SERIAL NUMBER: 09738335  
PATENT NUMBER: 6429247

SERIAL NUMBER: 08890866  
PATENT NUMBER: 6433062

SERIAL NUMBER: 09637765  
PATENT NUMBER: 6437033

SERIAL NUMBER: 09661278  
PATENT NUMBER: 6437037

SERIAL NUMBER: 09832005  
PATENT NUMBER: 6472343

SERIAL NUMBER: 10027567  
PATENT NUMBER: 6476146

SERIAL NUMBER: 10027566  
PATENT NUMBER: 6479586

SERIAL NUMBER: 09537279  
PATENT NUMBER: 6503971

SERIAL NUMBER: 09318136  
PATENT NUMBER: 6518485

SERIAL NUMBER: 10171329  
PATENT NUMBER: 6521342

SERIAL NUMBER: 10194352  
PATENT NUMBER: 6521343

SERIAL NUMBER: 10100362  
PATENT NUMBER: 6540815

SERIAL NUMBER: 10117970  
PATENT NUMBER: 6540877

SERIAL NUMBER: 09167878  
PATENT NUMBER: 6541538

SERIAL NUMBER: 10147655  
PATENT NUMBER: 6572969

SERIAL NUMBER: 09832004  
PATENT NUMBER: 6573212

FILING DATE: 10/25/1999  
ISSUE DATE: 04/23/2002

FILING DATE: 10/22/1999  
ISSUE DATE: 06/25/2002

FILING DATE: 12/15/2000  
ISSUE DATE: 08/06/2002

FILING DATE: 07/10/1997  
ISSUE DATE: 08/13/2002

FILING DATE: 08/10/2000  
ISSUE DATE: 08/20/2002

FILING DATE: 09/14/2000  
ISSUE DATE: 08/20/2002

FILING DATE: 04/11/2001  
ISSUE DATE: 10/29/2002

FILING DATE: 12/20/2001  
ISSUE DATE: 11/05/2002

FILING DATE: 12/20/2001  
ISSUE DATE: 11/12/2002

FILING DATE: 03/29/2000  
ISSUE DATE: 01/07/2003

FILING DATE: 05/25/1999  
ISSUE DATE: 02/11/2003

FILING DATE: 06/12/2002  
ISSUE DATE: 02/18/2003

FILING DATE: 07/12/2002  
ISSUE DATE: 02/18/2003

FILING DATE: 03/18/2002  
ISSUE DATE: 04/01/2003

FILING DATE: 04/08/2002  
ISSUE DATE: 04/01/2003

FILING DATE: 10/07/1998  
ISSUE DATE: 04/01/2003

FILING DATE: 05/16/2002  
ISSUE DATE: 06/03/2003

FILING DATE: 04/11/2001  
ISSUE DATE: 06/03/2003

013922/0117 PAGE 10

SERIAL NUMBER: 08038539  
PATENT NUMBER: 5450892

SERIAL NUMBER: 08225637  
PATENT NUMBER: 5473006

SERIAL NUMBER: 08391603  
PATENT NUMBER: 5491090

SERIAL NUMBER: 08419920  
PATENT NUMBER: 5491215

SERIAL NUMBER: 08245486  
PATENT NUMBER: 5496653

SERIAL NUMBER: 08437626  
PATENT NUMBER: 5498661

SERIAL NUMBER: 08380341  
PATENT NUMBER: 5500191

SERIAL NUMBER: 08290153  
PATENT NUMBER: 5506136

SERIAL NUMBER: 08499113  
PATENT NUMBER: 5516826

SERIAL NUMBER: 08457876  
PATENT NUMBER: 5534433

SERIAL NUMBER: 08457026  
PATENT NUMBER: 5534434

SERIAL NUMBER: 08449811  
PATENT NUMBER: 5538932

SERIAL NUMBER: 08378474  
PATENT NUMBER: 5543110

SERIAL NUMBER: 08583782  
PATENT NUMBER: 5563198

FILING DATE: 03/29/1993  
ISSUE DATE: 09/19/1995

FILING DATE: 04/11/1994  
ISSUE DATE: 12/05/1995

FILING DATE: 02/21/1995  
ISSUE DATE: 02/13/1996

FILING DATE: 04/11/1995  
ISSUE DATE: 02/13/1996

FILING DATE: 05/18/1994  
ISSUE DATE: 03/05/1996

FILING DATE: 05/09/1995  
ISSUE DATE: 03/12/1996

FILING DATE: 02/03/1995  
ISSUE DATE: 03/19/1996

FILING DATE: 08/15/1994  
ISSUE DATE: 04/09/1996

FILING DATE: 07/06/1995  
ISSUE DATE: 05/14/1996

FILING DATE: 06/02/1995  
ISSUE DATE: 07/09/1996

FILING DATE: 06/02/1995  
ISSUE DATE: 07/09/1996

FILING DATE: 05/24/1995  
ISSUE DATE: 07/23/1996

FILING DATE: 01/26/1995  
ISSUE DATE: 08/06/1996

FILING DATE: 01/11/1996  
ISSUE DATE: 10/08/1996

JEEVON JONES, EXAMINER  
ASSIGNMENT DIVISION  
OFFICE OF PUBLIC RECORDS

08/28/2003  
700042050

**RECORDATION FORM COVER SHEET  
PATENTS ONLY**

U.S. DEPARTMENT OF COMMERCE  
U.S. Patent and Trademark Office

Form PTO-1595  
(Rev. 10/02)  
OMB No. 0651-0027 (exp. 6/30/2005)  
Tab settings

To the Honorable Commissioner of Patents and Trademarks: Please record the attached original documents or copy thereof.

<p>1. Name of conveying party(ies):  Westvaco Corporation</p> <p>Additional name(s) of conveying party(ies) attached? <input type="checkbox"/> Yes <input checked="" type="checkbox"/> No</p> <p>3. Nature of conveyance:  <input type="checkbox"/> Assignment  <input type="checkbox"/> Security Agreement  <input type="checkbox"/> Other _____  <input checked="" type="checkbox"/> Merger  <input type="checkbox"/> Change of Name</p> <p>Execution Date: 12/31/2002</p>	<p>2. Name and address of receiving party(ies) Name: MeadWestvaco Corporation</p> <p>Internal Address: _____</p> <p>Street Address: One High Ridge Park</p> <p>City: Stamford State: CT Zip: 06905</p> <p>Additional name(s) &amp; address(es) attached? <input type="checkbox"/> Yes <input checked="" type="checkbox"/> No</p>
<p>4. Application number(s) or patent number(s): If this document is being filed together with a new application, the execution date of the application is: _____</p> <p>A. Patent Application No.(s) 09/098,991</p> <p>B. Patent No.(s) 4740367</p> <p>Additional numbers attached? <input checked="" type="checkbox"/> Yes <input type="checkbox"/> No</p>	<p>6. Total number of applications and patents involved: 17</p> <p>7. Total fee (37 CFR 3.41)..... \$ 6,880.00</p> <p><input type="checkbox"/> Enclosed <input checked="" type="checkbox"/> Authorized to be charged to deposit account</p> <p>8. Deposit account number: 13-2512</p>
<p>5. Name and address of party to whom correspondence concerning document should be mailed: Name: MeadWestvaco Corporation</p> <p>Internal Address: Law Department</p> <p>Street Address: 4850 North Church Lane SE Suite D</p> <p>City: Smyrna State: GA Zip: 30080</p>	<p><b>DO NOT USE THIS SPACE</b></p>
<p>9. Signature.</p> <p style="text-align: center;"> Signature</p> <p style="text-align: right;">August 27, 2003 Date</p> <p>Thomas A. Boshinski, Reg. No. 30,611 Name of Person Signing</p>	

Total number of pages including cover sheet, attachments, and documents: 11

Mail documents to be recorded with required cover sheet information to:  
Commissioner of Patents & Trademarks, Box Assignments  
Washington, D.C. 20231

16686050 215251 0081 CH \$6520.00 132512 10500

MeadWestvaco Corporation  
U.S. Patented Docket

Patent No.	Case Docket No.
4740367	CHR 84-10 (CIP)
4744925	CHR 85-20 (CIP)
4801311	CHR 83-31
4802898	CHR 83-26
5136055	CHR 90-47
5137965	CHR 90-25 (CIP)
5152832	CHR 89-49 (CIP)
5160453	CHR 89-17
5164446	CHR 88-3
5166245	CHR 90-38 CIP
5166256	CHR 88-3 (DIV.) V
5166257	CHR 88-3 (DIV.)
5166258	CHR 88-3 (DIV.) IV
5166262	CHR 88-3 (DIV.) II
5167694	CHR 87-54 (CIP)
5174913	CHR 90-5
5178674	CHR 89-13 DIV. II (CIP)
5180424	CHR 91-17 DIV I
5180774	CHR 88-3 (DIV.) III
5182326	CHR 88-49
5188665	CHR 89-70
5189090	CHR 90-45 CIP
5192381	CHR 89-70 SP
5194640	CHR 91-9
5204310	CHR 91-42
5206207	CHR 91-42A
5208319	CHR 88-46 CIP
5212144	NACAR III



MeadWestvaco Corporation  
U.S. Patented Docket

Patent No.	Case Docket No.
5212213	CHR 89-51 CIP
5216084	CHR 90-33
5216071	CHR 90-45 CIP II
5238470	CHR 91-42 (DIV.)
5250491	CHR 91-42B
5264481	CHR 90-45 CIP III
5270017	NACAR III (DIV.)
5276000	CHR 91-42A (CIP)
5292480	CHR 90-5T CIP
5304527	CHR 91-42C
5306762	CHR 90-33A
5306793	CHR 91-47
5312599	NACAR III (CIP)
5320671	CHR 88-17B (CIP)
5324703	CHR 91-42B (CIP)
5328505	CHR 88-17A (CIP)
5332435	CHR 92-38A
5336438	CHR 87-43 CIP
5413930	FSL 92-3
5416056	CHR 93-35
5423908	CHR 93-45 CIP
5443902	CHR 93-5

MeadWestvaco Corporation  
U.S. Patented Docket

Patent No.	Case Docket No.
5691270	CHR 95-29
5691405	CHR 93-12 CIP
5693702	CHR 93-12
5710092	CHR 93-35 CIP III
5712164	FSL 93-3 CIP
5719795	FSL 88-1
5723020	CHR 95-30 CIP
5731191	FSL 96-2
5731203	FSL 94-2
5731204	FSL 96-2A
5736481	CHR 95-29A (CIP)
5736485	CHR 95-29 (CIP)
5749926	CHR 95-28B
5755830	CHR 95-28A
5759485	CHR 97-27
5772749	CHR 97-56
5776234	CHR 91-38
5837376	CHR 93-5 (CIP)2
5858191	FSL 95-3 CIP
5863858	CHR 95-29A
5871614	CHR 97-13A
5871663	CHR 97-13B

MeadWestvaco Corporation  
U.S. Patented Docket

Patent No.	Case Docket No.
5905629	CHR 94-18A CIP II
5926361	CHR 94-18 CIP II
5965483	CHR 93-35 CIP
5969071	CHR 97-30
5973036	CHR 97-96B
6001904	CHR 97-96
6007610	CHR 97-96A
6020399	CHR 97-32
6020401	CHR 95-55 DIV
6020405	CHR 97-96C
6043183	CHR 94-18 CIP I
6045606	CHR 98-6
6057462	CHR 98-35
6060424	CHR 94-18A CIP III
6077888	CHR 96-49 CIP II
6103780	CHR 97-33B
6103802	CHR 97-61
6153693	CHR 94-10 CIP
6156384	CHR 97-58
6172149	CHR 97-75A CIP
8172174	CHR 97-30 CIP
6194471	CHR 96-2 CIP
6277780	CHR 92-41 WV

MeadWestvaco Corporation  
U.S. Patented Docket

Patent No.	Case Docket No.
6291075	CHR 97-61 CIP
6329068	CHR 97-75C CIP
6368457	CHR (LRL 95-9 CIP)
6376611	CHR 97-32A DIV.
6409882	CHR 98-72
6429247	CHR 00-62
6433062	CHR 97-75 CIP
6437033	CHR 97-75 CIP II
6437037	CHR 97-82A
6444877	FSL 99-2
6472343	CHR 00-74 / COV 00-5
6476146	CHR 97-32A DIV. (DIV. of Divisional.)
6479586	CHR 97-32A DIV. (DIV. II of Divisional)
6503971	CHR 97-75B CIP
6518485	FSL 96-1 CPA
6521342	CHR 01-81
6521343	CHR 02-42 CIP
6540815	CHR 2001-79
6540877	CHR (LRL 95-9 CIP II)
6541538	CHR 97-58A CIP
6572969	CHR 02-42
6573212	CHR 00-74 / COV 00-5A

MeadWestvaco Corporation  
U.S. Applications Docket

Serial No.	Date Filed	Case Docket No.
09/098,991	06/17/98	CHR 97-32A
09/140,809	08/26/98	CHR 97-58B
09/573,160	05/19/00	FSL 99-11 CPA
09/803,829	03/12/01	CHR 01-34
09/829,917	04/11/01	CHR 00-74 / COV 00-5B
09/854,367	05/11/01	CHR 99-14 CIP I
09/904,224	07/12/01	CHR 00-63
09/953,983	09/17/01	CHR 00-80
09/954,467	09/17/01	CHR 01-75
09/973,088	10/10/01	FSL 00-07A
09/973,089	10/10/01	FSL 00-07B
09/973,369	10/09/01	FSL 00-03
09/992,902	11/14/01	CHR 00-77
09/999,294	11/15/01	FSL 98-2
10/014710	12/11/01	CHR 97-82 CIP
10/029,360	12/20/01	FSL 98-1 CIP
10/074,729	04/23/02	CHR 99-9 DIV.
10/074,731	02/13/02	CHR 95-14 (CIP) DIV.
10/099,670	03/15/02	CHR 02-34
10/141,158	05/08/02	CHR 01-76
10/144,201	05/10/02	CHR 01-76 CIP

MeadWestvaco Corporation  
U.S. Applications Docket

Serial No.	Date Filed	Case Docket No.
10/192,277	07/10/02	CHR 02-40
10/214,335	08/07/02	CHR 01-34 CIP
10/228,910	08/27/02	SCD 02-08
10/247,215	09/19/02	CHR 00-89 DIV
10/247,217	09/19/02	CHR 00-89 DIV II
10/268,129	10/10/02	CHR 98-70
10/287,492	11/05/02	CHR 99-38 CIP
10/287,493	11/05/02	CHR 99-38 CIP II
10/291,141	11/08/02	CHR 02-42 CIP II
10/324,173	12/20/02	SCD 02-04
60/416,974	10/08/02	CHR 02-38 PROV

8

MeadWestvaco Corporation  
U.S. Patented Docket

Patent No.	Case Docket No.
5450892	CHR 92-33
5473006	CHR 93-13
5491090	FSL 92-10 CIP
5491215	CHR 93-48B CIP
5498853	CHR 93-48B CIP DIV
5498661	CHR 94-31 CIP
5500191	CHR 94-41 (CIP)
5506136	FSL 92-3 CIP
5516826	CHR 92-8B CIP I
5534433	FSL 93-5A
5534434	FSL 93-5
5538932	CHR 91-42B (CIP)3
5543110	CHR 90-42 (CIP)2
5563198	CHR 92-8B CIP I DIV
5596032	CHR 93-23
5610051	FSL 91-3
5626637	CHR 93-35 (DIV.) CIP II
5656679	CHR 93-48A CIP
5667578	CHR 91-38A
5668197	CHR 92-3
5670562	CHR 91-38B
5677185	FSL 95-3

**REISSUE APPLICATION: CONSENT OF ASSIGNEE;  
 STATEMENT OF NON-ASSIGNMENT**

Docket Number (Optional)

CHR 2001-79 (reissue)

This is part of the application for a reissue patent based on the original patent identified below.

Name of Patentee(s)

MeadWestvaco Corporation

Patent Number

6,540,815

Date Patent Issued

April 1, 2003

Title of Invention

Method For Reducing Emission From Evaporative Emission Control Systems

1.  Filed herein is a statement under 37 CFR 3.73(b). (Form PTO/SB/96)

2.  Ownership of the patent is in the inventor(s), and no assignment of the patent is in effect.

One of boxes 1 or 2 above must be checked. If multiple assignees, complete this form for each assignee. If box 2 is checked, skip the next entry and go directly to "Name of Assignee".

The written consent of all assignees and inventors owning an undivided interest in the original patent is included in this application for reissue.

The assignee(s) owning an undivided interest in said original patent is/are MeadWestvaco Corporation and the assignee(s) consents to the accompanying application for reissue.

Name of assignee/inventor (if not assigned)

MeadWestvaco Corporation

Signature

*John J. Carrara*

Date

October 13, 2003

Typed or printed name and title of person signing for assignee (if assigned)

John J. Carrara  
 Assistant Secretary

This collection of information is required by 37 CFR 1.172. The information is required to obtain or retain a benefit by the public which is to file (and by the USPTO to process) an application. Confidentiality is governed by 35 U.S.C. 122 and 37 CFR 1.14. This collection is estimated to take 6 minutes to complete, including gathering, preparing, and submitting the completed application form to the USPTO. Time will vary depending upon the individual case. Any comments on the amount of time you require to complete this form and/or suggestions for reducing this burden, should be sent to the Chief Information Officer, U.S. Patent and Trademark Office, U.S. Department of Commerce, P.O. Box 1450, Alexandria, VA 22313-1450. DO NOT SEND FEES OR COMPLETED FORMS TO THIS ADDRESS. SEND TO: Commissioner for Patents, P.O. Box 1450, Alexandria, VA 22313-1450.

If you need assistance in completing the form, call 1-800-PTO-9199 and select option 2.

27



**STATEMENT UNDER 37 CFR 3.73(b)**

Applicant/Patent Owner: MeadWestvaco Corporation  
Application No./Patent No.: 10/100,362 Filed/Issue Date: March 18, 2002  
6,540,815 April 1, 2003  
Entitled: Method For Reducing Emission From Evaporative Emissions Control Systems  
MeadWestvaco Corporation, a Corporation  
(Name of Assignee) (Type of Assignee, e.g., corporation, partnership, university, government agency, etc.)

states that it is:

- 1.  the assignee of the entire right, title, and interest; or
- 2.  an assignee of less than the entire right, title and interest.  
The extent (by percentage) of its ownership interest is \_\_\_\_\_ %  
in the patent application/patent identified above by virtue of either:  
A. [ ] An assignment from the inventor(s) of the patent application/patent identified above. The assignment was recorded in the United States Patent and Trademark Office at Reel \_\_\_\_\_, Frame \_\_\_\_\_, or for which a copy thereof is attached.

OR

B.  A chain of title from the inventor(s), of the patent application/patent identified above, to the current assignee as shown below: L.H. Hiltzik, J.Z. Jagiello,  
E.D. Tolles, and R.S. Williams to Westvaco Corporation

- 1. From: E.D. Tolles, and R.S. Williams To: Westvaco Corporation  
The document was recorded in the United States Patent and Trademark Office at Reel 12888, Frame 0474, or for which a copy thereof is attached.
- 2. From: Westvaco Corporation To: MeadWestvaco Corporation  
The document was recorded in the United States Patent and Trademark Office at Reel 13922, Frame 0117, or for which a copy thereof is attached.
- 3. From: \_\_\_\_\_ To: \_\_\_\_\_  
The document was recorded in the United States Patent and Trademark Office at Reel \_\_\_\_\_, Frame \_\_\_\_\_, or for which a copy thereof is attached.

[ ] Additional documents in the chain of title are listed on a supplemental sheet.

Copies of assignments or other documents in the chain of title are attached.  
[NOTE: A separate copy (i.e., the original assignment document or a true copy of the original document) must be submitted to Assignment Division in accordance with 37 CFR Part 3, if the assignment is to be recorded in the records of the USPTO. See MPEP 302.08]

The undersigned (whose title is supplied below) is authorized to act on behalf of the assignee.

October 13, 2003  
Date  
(203) 461-7502  
Telephone number

John J. Carrara  
Typed or printed name  
John J. Carrara  
Signature  
Assistant Secretary  
Title

This collection of information is required by 37 CFR 3.73(b). The information is required to obtain or retain a benefit by the public which is to file (and by the USPTO to process) an application. Confidentiality is governed by 35 U.S.C. 122 and 37 CFR 1.14. This collection is estimated to take 12 minutes to complete, including gathering, preparing, and submitting the completed application form to the USPTO. Time will vary depending upon the individual case. Any comments on the amount of time you require to complete this form and/or suggestions for reducing this burden, should be sent to the Chief Information Officer, U.S. Patent and Trademark Office, U.S. Department of Commerce, P.O. Box 1450, Alexandria, VA 22313-1450. DO NOT SEND FEES OR COMPLETED FORMS TO THIS ADDRESS. SEND TO: Commissioner for Patents, P.O. Box 1450, Alexandria, VA 22313-1450.

If you need assistance in completing the form, call 1-800-PTO-9199 and select option 2.



UNITED STATES DEPARTMENT OF COMMERCE  
Patent and Trademark Office  
ASSISTANT SECRETARY AND COMMISSIONER  
OF PATENTS AND TRADEMARKS  
Washington, D.C. 20231

SEPTEMBER 02, 2003

PTAS



\*700042050\*

MEADWESTVACO CORPORATION  
THOMAS A. BOSHINSKI  
4850 NORTH CHURCH LN. SE  
SUITE D  
SMYRNA, GA 30080

UNITED STATES PATENT AND TRADEMARK OFFICE  
NOTICE OF RECORDATION OF ASSIGNMENT DOCUMENT

THE ENCLOSED DOCUMENT HAS BEEN RECORDED BY THE ASSIGNMENT DIVISION OF THE U.S. PATENT AND TRADEMARK OFFICE. A COMPLETE MICROFILM COPY IS AVAILABLE AT THE ASSIGNMENT SEARCH ROOM ON THE REEL AND FRAME NUMBER REFERENCED BELOW.

PLEASE REVIEW ALL INFORMATION CONTAINED ON THIS NOTICE. THE INFORMATION CONTAINED ON THIS RECORDATION NOTICE REFLECTS THE DATA PRESENT IN THE PATENT AND TRADEMARK ASSIGNMENT SYSTEM. IF YOU SHOULD FIND ANY ERRORS OR HAVE QUESTIONS CONCERNING THIS NOTICE, YOU MAY CONTACT THE EMPLOYEE WHOSE NAME APPEARS ON THIS NOTICE AT 703-308-9723. PLEASE SEND REQUEST FOR CORRECTION TO: U.S. PATENT AND TRADEMARK OFFICE, ASSIGNMENT DIVISION, BOX ASSIGNMENTS, CG-4, 1213 JEFFERSON DAVIS HWY, SUITE 320, WASHINGTON, D.C. 20231.

RECORDATION DATE: 08/28/2003

REEL/FRAME: 013922/0117  
NUMBER OF PAGES: 11

BRIEF: MERGER (SEE DOCUMENT FOR DETAILS).

DOC DATE: 12/31/2002

ASSIGNOR:  
WESTVACO CORPORATION

ASSIGNEE:  
MEADWESTVACO CORPORATION  
ONE HIGH RIDGE PARK  
STAMFORD, CONNECTICUT 06905

SERIAL NUMBER: 09098991  
PATENT NUMBER:

FILING DATE: 06/17/1998  
ISSUE DATE:

SERIAL NUMBER: 09140809  
PATENT NUMBER: 6616981

FILING DATE: 08/26/1998  
ISSUE DATE: 09/09/2003

SERIAL NUMBER: 09573160  
PATENT NUMBER:

FILING DATE: 05/19/2000  
ISSUE DATE:

SERIAL NUMBER: 09803829  
PATENT NUMBER:

FILING DATE: 03/12/2001  
ISSUE DATE:

013922/0117 PAGE 2

SERIAL NUMBER: 09829917  
PATENT NUMBER:

SERIAL NUMBER: 09854367  
PATENT NUMBER:

SERIAL NUMBER: 09904224  
PATENT NUMBER:

SERIAL NUMBER: 09953983  
PATENT NUMBER:

SERIAL NUMBER: 09954467  
PATENT NUMBER:

SERIAL NUMBER: 09973088  
PATENT NUMBER:

SERIAL NUMBER: 09973089  
PATENT NUMBER:

SERIAL NUMBER: 09973369  
PATENT NUMBER:

SERIAL NUMBER: 09992902  
PATENT NUMBER:

SERIAL NUMBER: 09999294  
PATENT NUMBER:

SERIAL NUMBER: 10014710  
PATENT NUMBER:

SERIAL NUMBER: 10029360  
PATENT NUMBER:

SERIAL NUMBER: 10074729  
PATENT NUMBER:

SERIAL NUMBER: 10074731  
PATENT NUMBER:

SERIAL NUMBER: 10099670  
PATENT NUMBER:

SERIAL NUMBER: 10141158  
PATENT NUMBER:

SERIAL NUMBER: 10144201  
PATENT NUMBER:

SERIAL NUMBER: 10192277  
PATENT NUMBER:

FILING DATE: 04/11/2001  
ISSUE DATE:

FILING DATE: 05/11/2001  
ISSUE DATE:

FILING DATE: 07/12/2001  
ISSUE DATE:

FILING DATE: 09/17/2001  
ISSUE DATE:

FILING DATE: 09/17/2001  
ISSUE DATE:

FILING DATE: 10/10/2001  
ISSUE DATE:

FILING DATE: 10/10/2001  
ISSUE DATE:

FILING DATE: 10/09/2001  
ISSUE DATE:

FILING DATE: 11/14/2001  
ISSUE DATE:

FILING DATE: 11/15/2001  
ISSUE DATE:

FILING DATE: 12/11/2001  
ISSUE DATE:

FILING DATE: 12/20/2001  
ISSUE DATE:

FILING DATE: 04/23/2002  
ISSUE DATE:

FILING DATE: 02/13/2002  
ISSUE DATE:

FILING DATE: 03/15/2002  
ISSUE DATE:

FILING DATE: 05/08/2002  
ISSUE DATE:

FILING DATE: 05/10/2002  
ISSUE DATE:

FILING DATE: 07/10/2002  
ISSUE DATE:

013922/0117 PAGE 3

SERIAL NUMBER: 10214335  
PATENT NUMBER:

SERIAL NUMBER: 10228910  
PATENT NUMBER:

SERIAL NUMBER: 10247215  
PATENT NUMBER:

SERIAL NUMBER: 10247217  
PATENT NUMBER:

SERIAL NUMBER: 10268129  
PATENT NUMBER:

SERIAL NUMBER: 10287492  
PATENT NUMBER:

SERIAL NUMBER: 10287493  
PATENT NUMBER:

SERIAL NUMBER: 10291141  
PATENT NUMBER:

SERIAL NUMBER: 10324173  
PATENT NUMBER:

SERIAL NUMBER: 60416974  
PATENT NUMBER:

SERIAL NUMBER: 06877464  
PATENT NUMBER: 4740367

SERIAL NUMBER: 06942725  
PATENT NUMBER: 4744925

SERIAL NUMBER: 06713287  
PATENT NUMBER: 4801311

SERIAL NUMBER: 06745082  
PATENT NUMBER: 4802898

SERIAL NUMBER: 07754070  
PATENT NUMBER: 5136055

SERIAL NUMBER: 07821436  
PATENT NUMBER: 5137965

SERIAL NUMBER: 07723261  
PATENT NUMBER: 5152832

SERIAL NUMBER: 07312817  
PATENT NUMBER: 5160453

FILING DATE: 08/07/2002  
ISSUE DATE:

FILING DATE: 08/27/2002  
ISSUE DATE:

FILING DATE: 09/19/2002  
ISSUE DATE:

FILING DATE: 09/19/2002  
ISSUE DATE:

FILING DATE: 10/10/2002  
ISSUE DATE:

FILING DATE: 11/05/2002  
ISSUE DATE:

FILING DATE: 11/05/2002  
ISSUE DATE:

FILING DATE: 11/08/2002  
ISSUE DATE:

FILING DATE: 12/20/2002  
ISSUE DATE:

FILING DATE: 10/08/2002  
ISSUE DATE:

FILING DATE: 06/23/1986  
ISSUE DATE: 04/26/1988

FILING DATE: 12/17/1986  
ISSUE DATE: 05/17/1988

FILING DATE: 03/18/1985  
ISSUE DATE: 01/31/1989

FILING DATE: 06/17/1985  
ISSUE DATE: 02/07/1989

FILING DATE: 09/03/1991  
ISSUE DATE: 08/04/1992

FILING DATE: 01/15/1992  
ISSUE DATE: 08/11/1992

FILING DATE: 06/28/1991  
ISSUE DATE: 10/06/1992

FILING DATE: 02/21/1989  
ISSUE DATE: 11/03/1992

013922/0117 PAGE 4

SERIAL NUMBER: 07658208  
PATENT NUMBER: 5164446

SERIAL NUMBER: 07790757  
PATENT NUMBER: 5166245

SERIAL NUMBER: 07787408  
PATENT NUMBER: 5166256

SERIAL NUMBER: 07787269  
PATENT NUMBER: 5166257

SERIAL NUMBER: 07787412  
PATENT NUMBER: 5166258

SERIAL NUMBER: 07787268  
PATENT NUMBER: 5166262

SERIAL NUMBER: 07518267  
PATENT NUMBER: 5167694

SERIAL NUMBER: 07762959  
PATENT NUMBER: 5174913

SERIAL NUMBER: 07819084  
PATENT NUMBER: 5178674

SERIAL NUMBER: 07884916  
PATENT NUMBER: 5180424

SERIAL NUMBER: 07787270  
PATENT NUMBER: 5180774

SERIAL NUMBER: 07681916  
PATENT NUMBER: 5182326

SERIAL NUMBER: 07825533  
PATENT NUMBER: 5188665

SERIAL NUMBER: 07923543  
PATENT NUMBER: 5189090

SERIAL NUMBER: 07827705  
PATENT NUMBER: 5192361

SERIAL NUMBER: 07872195  
PATENT NUMBER: 5194840

SERIAL NUMBER: 07839597  
PATENT NUMBER: 5204310

SERIAL NUMBER: 07853133

FILING DATE: 02/19/1991  
ISSUE DATE: 11/17/1992

FILING DATE: 11/12/1991  
ISSUE DATE: 11/24/1992

FILING DATE: 11/04/1991  
ISSUE DATE: 11/24/1992

FILING DATE: 11/04/1991  
ISSUE DATE: 11/24/1992

FILING DATE: 11/04/1991  
ISSUE DATE: 11/24/1992

FILING DATE: 11/04/1991  
ISSUE DATE: 11/24/1992

FILING DATE: 05/04/1990  
ISSUE DATE: 12/01/1992

FILING DATE: 09/20/1991  
ISSUE DATE: 12/29/1992

FILING DATE: 01/09/1992  
ISSUE DATE: 01/12/1993

FILING DATE: 05/18/1992  
ISSUE DATE: 01/19/1993

FILING DATE: 11/04/1991  
ISSUE DATE: 01/19/1993

FILING DATE: 04/08/1991  
ISSUE DATE: 01/26/1993

FILING DATE: 01/24/1992  
ISSUE DATE: 02/23/1993

FILING DATE: 08/03/1992  
ISSUE DATE: 02/23/1993

FILING DATE: 01/27/1992  
ISSUE DATE: 03/09/1993

FILING DATE: 04/22/1992  
ISSUE DATE: 03/16/1993

FILING DATE: 02/21/1992  
ISSUE DATE: 04/20/1993

FILING DATE: 03/18/1992

PATENT NUMBER: 5206207

013922/0117 PAGE 5

SERIAL NUMBER: 07904218  
PATENT NUMBER: 5208319

SERIAL NUMBER: 07891734  
PATENT NUMBER: 5212144

SERIAL NUMBER: 07885842  
PATENT NUMBER: 5212213

SERIAL NUMBER: 07868670  
PATENT NUMBER: 5216064

SERIAL NUMBER: 07967052  
PATENT NUMBER: 5216071

SERIAL NUMBER: 07909065  
PATENT NUMBER: 5238470

SERIAL NUMBER: 07929166  
PATENT NUMBER: 5250491

SERIAL NUMBER: 08017867  
PATENT NUMBER: 5264481

SERIAL NUMBER: 07961835  
PATENT NUMBER: 5270017

SERIAL NUMBER: 07967982  
PATENT NUMBER: 5276000

SERIAL NUMBER: 08046077  
PATENT NUMBER: 5292480

SERIAL NUMBER: 07977010  
PATENT NUMBER: 5304527

SERIAL NUMBER: 07987794  
PATENT NUMBER: 5306762

SERIAL NUMBER: 08362123  
PATENT NUMBER: 5603793

SERIAL NUMBER: 08055853  
PATENT NUMBER: 5312599

SERIAL NUMBER: 08121109  
PATENT NUMBER: 5320671

SERIAL NUMBER: 08095755  
PATENT NUMBER: 5324703

FILING DATE: 06/25/1992  
ISSUE DATE: 05/04/1993

FILING DATE: 06/01/1992  
ISSUE DATE: 05/18/1993

FILING DATE: 05/20/1992  
ISSUE DATE: 05/18/1993

FILING DATE: 04/15/1992  
ISSUE DATE: 06/01/1993

FILING DATE: 10/28/1992  
ISSUE DATE: 06/01/1993

FILING DATE: 07/02/1992  
ISSUE DATE: 08/24/1993

FILING DATE: 08/11/1992  
ISSUE DATE: 10/05/1993

FILING DATE: 02/16/1993  
ISSUE DATE: 11/23/1993

FILING DATE: 10/16/1992  
ISSUE DATE: 12/14/1993

FILING DATE: 10/28/1992  
ISSUE DATE: 01/04/1994

FILING DATE: 04/12/1993  
ISSUE DATE: 03/08/1994

FILING DATE: 11/16/1992  
ISSUE DATE: 04/19/1994

FILING DATE: 12/09/1992  
ISSUE DATE: 04/26/1994

FILING DATE: 12/22/1994  
ISSUE DATE: 02/18/1997

FILING DATE: 04/30/1993  
ISSUE DATE: 05/17/1994

FILING DATE: 09/14/1993  
ISSUE DATE: 06/14/1994

FILING DATE: 07/21/1993  
ISSUE DATE: 06/28/1994

SERIAL NUMBER: 08122004  
PATENT NUMBER: 5328505

FILING DATE: 09/14/1993  
ISSUE DATE: 07/12/1994

013922/0117 PAGE 6

SERIAL NUMBER: 08151360  
PATENT NUMBER: 5332435

SERIAL NUMBER: 07725422  
PATENT NUMBER: 5336438

SERIAL NUMBER: 08138994  
PATENT NUMBER: 5413930

SERIAL NUMBER: 08143551  
PATENT NUMBER: 5416056

SERIAL NUMBER: 08315548  
PATENT NUMBER: 5423908

SERIAL NUMBER: 08188718  
PATENT NUMBER: 5443902

SERIAL NUMBER: 08613270  
PATENT NUMBER: 5691270

SERIAL NUMBER: 08712281  
PATENT NUMBER: 5691405

SERIAL NUMBER: 08602371  
PATENT NUMBER: 5693702

SERIAL NUMBER: 08403390  
PATENT NUMBER: 5710092

SERIAL NUMBER: 08456757  
PATENT NUMBER: 5712164

SERIAL NUMBER: 08507779  
PATENT NUMBER: 5719795

SERIAL NUMBER: 08742636  
PATENT NUMBER: 5723020

SERIAL NUMBER: 08770980  
PATENT NUMBER: 5731191

SERIAL NUMBER: 08664936  
PATENT NUMBER: 5731203

SERIAL NUMBER: 08770960  
PATENT NUMBER: 5731204

SERIAL NUMBER: 08716105  
PATENT NUMBER: 5736481

FILING DATE: 11/12/1993  
ISSUE DATE: 07/26/1994

FILING DATE: 07/03/1991  
ISSUE DATE: 08/09/1994

FILING DATE: 10/21/1993  
ISSUE DATE: 05/09/1995

FILING DATE: 10/25/1993  
ISSUE DATE: 05/16/1995

FILING DATE: 09/30/1994  
ISSUE DATE: 06/13/1995

FILING DATE: 01/31/1994  
ISSUE DATE: 08/22/1995

FILING DATE: 03/08/1996  
ISSUE DATE: 11/25/1997

FILING DATE: 09/11/1996  
ISSUE DATE: 11/25/1997

FILING DATE: 02/16/1996  
ISSUE DATE: 12/02/1997

FILING DATE: 03/14/1995  
ISSUE DATE: 01/20/1998

FILING DATE: 06/01/1995  
ISSUE DATE: 01/27/1998

FILING DATE: 07/26/1995  
ISSUE DATE: 02/17/1998

FILING DATE: 11/01/1996  
ISSUE DATE: 03/03/1998

FILING DATE: 12/20/1996  
ISSUE DATE: 03/24/1998

FILING DATE: 06/14/1996  
ISSUE DATE: 03/24/1998

FILING DATE: 12/20/1996  
ISSUE DATE: 03/24/1998

FILING DATE: 09/19/1996  
ISSUE DATE: 04/07/1998

SERIAL NUMBER: 08716106  
PATENT NUMBER: 5736485

FILING DATE: 09/19/1996  
ISSUE DATE: 04/07/1998

013922/0117 PAGE 7

SERIAL NUMBER: 08712907  
PATENT NUMBER: 5749926

FILING DATE: 09/12/1996  
ISSUE DATE: 05/12/1998

SERIAL NUMBER: 08712906  
PATENT NUMBER: 5755830

FILING DATE: 09/12/1996  
ISSUE DATE: 05/26/1998

SERIAL NUMBER: 08854421  
PATENT NUMBER: 5759485

FILING DATE: 05/12/1997  
ISSUE DATE: 06/02/1998

SERIAL NUMBER: 08929837  
PATENT NUMBER: 5772749

FILING DATE: 09/15/1997  
ISSUE DATE: 06/30/1998

SERIAL NUMBER: 08695641  
PATENT NUMBER: 5776234

FILING DATE: 08/12/1996  
ISSUE DATE: 07/07/1998

SERIAL NUMBER: 08576447  
PATENT NUMBER: 5837376

FILING DATE: 12/21/1995  
ISSUE DATE: 11/17/1998

SERIAL NUMBER: 08835561  
PATENT NUMBER: 5856191

FILING DATE: 04/08/1997  
ISSUE DATE: 01/05/1999

SERIAL NUMBER: 08609632  
PATENT NUMBER: 5863858

FILING DATE: 03/12/1996  
ISSUE DATE: 01/26/1999

SERIAL NUMBER: 08814375  
PATENT NUMBER: 5871614

FILING DATE: 03/11/1997  
ISSUE DATE: 02/16/1999

SERIAL NUMBER: 08814680  
PATENT NUMBER: 5871663

FILING DATE: 03/11/1997  
ISSUE DATE: 02/16/1999

SERIAL NUMBER: 08898771  
PATENT NUMBER: 5905629

FILING DATE: 07/23/1997  
ISSUE DATE: 05/18/1999

SERIAL NUMBER: 08880754  
PATENT NUMBER: 5926361

FILING DATE: 06/23/1997  
ISSUE DATE: 07/20/1999

SERIAL NUMBER: 08324837  
PATENT NUMBER: 5965483

FILING DATE: 10/20/1994  
ISSUE DATE: 10/12/1999

SERIAL NUMBER: 09074751  
PATENT NUMBER: 5969071

FILING DATE: 05/08/1998  
ISSUE DATE: 10/19/1999

SERIAL NUMBER: 09074756  
PATENT NUMBER: 5973036

FILING DATE: 05/08/1998  
ISSUE DATE: 10/26/1999

SERIAL NUMBER: 09074760  
PATENT NUMBER: 6001904

FILING DATE: 05/08/1998  
ISSUE DATE: 12/14/1999

SERIAL NUMBER: 09074757

FILING DATE: 05/08/1998



OFFICE ASSIGNMENT

PATENT NUMBER: 6007610  
SERIAL NUMBER: 09093040  
PATENT NUMBER: 6020399

ISSUE DATE: 12/28/1999  
FILING DATE: 06/05/1998  
ISSUE DATE: 02/01/2000

013922/0117 PAGE 8

SERIAL NUMBER: 08946718  
PATENT NUMBER: 6020401

SERIAL NUMBER: 09074755  
PATENT NUMBER: 6020405

SERIAL NUMBER: 08880755  
PATENT NUMBER: 6043183

SERIAL NUMBER: 09262468  
PATENT NUMBER: 6045606

SERIAL NUMBER: 09187448  
PATENT NUMBER: 6057462

SERIAL NUMBER: 09237339  
PATENT NUMBER: 6060424

SERIAL NUMBER: 09231064  
PATENT NUMBER: 6077888

SERIAL NUMBER: 09061557  
PATENT NUMBER: 6103780

SERIAL NUMBER: 09135945  
PATENT NUMBER: 6103802

SERIAL NUMBER: 09248735  
PATENT NUMBER: 6153693

SERIAL NUMBER: 09140582  
PATENT NUMBER: 6156384

SERIAL NUMBER: 09521437  
PATENT NUMBER: 6172149

SERIAL NUMBER: 09277244  
PATENT NUMBER: 6172174

SERIAL NUMBER: 09393549  
PATENT NUMBER: 6194471

SERIAL NUMBER: 08287866  
PATENT NUMBER: 6277780

SERIAL NUMBER: 09513032  
PATENT NUMBER: 6291075

SERIAL NUMBER: 09545668  
PATENT NUMBER: 6329068

SERIAL NUMBER: 09329842  
PATENT NUMBER: 6368457

FILING DATE: 10/08/1997  
ISSUE DATE: 02/01/2000

FILING DATE: 05/08/1998  
ISSUE DATE: 02/01/2000

FILING DATE: 06/23/1997  
ISSUE DATE: 03/28/2000

FILING DATE: 03/04/1999  
ISSUE DATE: 04/04/2000

FILING DATE: 11/06/1998  
ISSUE DATE: 05/02/2000

FILING DATE: 01/26/1999  
ISSUE DATE: 05/09/2000

FILING DATE: 01/14/1999  
ISSUE DATE: 06/20/2000

FILING DATE: 04/16/1998  
ISSUE DATE: 08/15/2000

FILING DATE: 08/18/1998  
ISSUE DATE: 08/15/2000

FILING DATE: 02/11/1999  
ISSUE DATE: 11/28/2000

FILING DATE: 08/26/1998  
ISSUE DATE: 12/05/2000

FILING DATE: 03/07/2000  
ISSUE DATE: 01/09/2001

FILING DATE: 03/26/1999  
ISSUE DATE: 01/09/2001

FILING DATE: 09/10/1999  
ISSUE DATE: 02/27/2001

FILING DATE: 08/09/1994  
ISSUE DATE: 08/21/2001

FILING DATE: 02/25/2000  
ISSUE DATE: 09/18/2001

FILING DATE: 04/07/2000  
ISSUE DATE: 12/11/2001

FILING DATE: 06/11/1999  
ISSUE DATE: 04/09/2002

SERIAL NUMBER: 09426379  
PATENT NUMBER: 6376611

SERIAL NUMBER: 09427127  
PATENT NUMBER: 6409882

SERIAL NUMBER: 09738335  
PATENT NUMBER: 6429247

SERIAL NUMBER: 08890866  
PATENT NUMBER: 6433062

SERIAL NUMBER: 09637765  
PATENT NUMBER: 6437033

SERIAL NUMBER: 09661278  
PATENT NUMBER: 6437037

SERIAL NUMBER: 09832005  
PATENT NUMBER: 6472343

SERIAL NUMBER: 10027567  
PATENT NUMBER: 6476146

SERIAL NUMBER: 10027566  
PATENT NUMBER: 6479586

SERIAL NUMBER: 09537279  
PATENT NUMBER: 6503971

SERIAL NUMBER: 09318136  
PATENT NUMBER: 6518485

SERIAL NUMBER: 10171329  
PATENT NUMBER: 6521342

SERIAL NUMBER: 10194352  
PATENT NUMBER: 6521343

SERIAL NUMBER: 10100362  
PATENT NUMBER: 6540815

SERIAL NUMBER: 10117970  
PATENT NUMBER: 6540877

SERIAL NUMBER: 09167878  
PATENT NUMBER: 6541538

SERIAL NUMBER: 10147655  
PATENT NUMBER: 6572969

SERIAL NUMBER: 09832004  
PATENT NUMBER: 6573212

FILING DATE: 10/25/1999  
ISSUE DATE: 04/23/2002

FILING DATE: 10/22/1999  
ISSUE DATE: 06/25/2002

FILING DATE: 12/15/2000  
ISSUE DATE: 08/06/2002

FILING DATE: 07/10/1997  
ISSUE DATE: 08/13/2002

FILING DATE: 08/10/2000  
ISSUE DATE: 08/20/2002

FILING DATE: 09/14/2000  
ISSUE DATE: 08/20/2002

FILING DATE: 04/11/2001  
ISSUE DATE: 10/29/2002

FILING DATE: 12/20/2001  
ISSUE DATE: 11/05/2002

FILING DATE: 12/20/2001  
ISSUE DATE: 11/12/2002

FILING DATE: 03/29/2000  
ISSUE DATE: 01/07/2003

FILING DATE: 05/25/1999  
ISSUE DATE: 02/11/2003

FILING DATE: 06/12/2002  
ISSUE DATE: 02/18/2003

FILING DATE: 07/12/2002  
ISSUE DATE: 02/18/2003

FILING DATE: 03/18/2002  
ISSUE DATE: 04/01/2003

FILING DATE: 04/08/2002  
ISSUE DATE: 04/01/2003

FILING DATE: 10/07/1998  
ISSUE DATE: 04/01/2003

FILING DATE: 05/16/2002  
ISSUE DATE: 06/03/2003

FILING DATE: 04/11/2001  
ISSUE DATE: 06/03/2003

013922/0117 PAGE 10

SERIAL NUMBER: 08038539  
PATENT NUMBER: 5450892

SERIAL NUMBER: 08225637  
PATENT NUMBER: 5473006

SERIAL NUMBER: 08391603  
PATENT NUMBER: 5491090

SERIAL NUMBER: 08419920  
PATENT NUMBER: 5491215

SERIAL NUMBER: 08245486  
PATENT NUMBER: 5496653

SERIAL NUMBER: 08437626  
PATENT NUMBER: 5498661

SERIAL NUMBER: 08380341  
PATENT NUMBER: 5500191

SERIAL NUMBER: 08290153  
PATENT NUMBER: 5506136

SERIAL NUMBER: 08499113  
PATENT NUMBER: 5516826

SERIAL NUMBER: 08457876  
PATENT NUMBER: 5534433

SERIAL NUMBER: 08457026  
PATENT NUMBER: 5534434

SERIAL NUMBER: 08449811  
PATENT NUMBER: 5538932

SERIAL NUMBER: 08378474  
PATENT NUMBER: 5543110

SERIAL NUMBER: 08583782  
PATENT NUMBER: 5563198

FILING DATE: 03/29/1993  
ISSUE DATE: 09/19/1995

FILING DATE: 04/11/1994  
ISSUE DATE: 12/05/1995

FILING DATE: 02/21/1995  
ISSUE DATE: 02/13/1996

FILING DATE: 04/11/1995  
ISSUE DATE: 02/13/1996

FILING DATE: 05/18/1994  
ISSUE DATE: 03/05/1996

FILING DATE: 05/09/1995  
ISSUE DATE: 03/12/1996

FILING DATE: 02/03/1995  
ISSUE DATE: 03/19/1996

FILING DATE: 08/15/1994  
ISSUE DATE: 04/09/1996

FILING DATE: 07/06/1995  
ISSUE DATE: 05/14/1996

FILING DATE: 06/02/1995  
ISSUE DATE: 07/09/1996

FILING DATE: 06/02/1995  
ISSUE DATE: 07/09/1996

FILING DATE: 05/24/1995  
ISSUE DATE: 07/23/1996

FILING DATE: 01/26/1995  
ISSUE DATE: 08/06/1996

FILING DATE: 01/11/1996  
ISSUE DATE: 10/08/1996

JEEVON JONES, EXAMINER  
ASSIGNMENT DIVISION  
OFFICE OF PUBLIC RECORDS

08/28/2003  
700042050

RECORDATION FORM COVER SHEET PATENTS ONLY		U.S. DEPARTMENT OF COMMERCE U.S. Patent and Trademark Office	
Form PTO-1595 (Rev. 10/02) OMB No. 0651-0027 (exp. 6/30/2005) Tab settings			
To the Honorable Commissioner of Patents and Trademarks: Please record the attached original documents or copy thereof.			
1. Name of conveying party(ies):  Westvaco Corporation  Additional name(s) of conveying party(ies) attached? <input type="checkbox"/> Yes <input checked="" type="checkbox"/> No		2. Name and address of receiving party(ies) Name: <u>MeadWestvaco Corporation</u> Internal Address: _____ _____ Street Address: <u>One High Ridge Park</u> _____ City: <u>Stamford</u> State: <u>CT</u> Zip: <u>06905</u> Additional name(s) & address(es) attached? <input type="checkbox"/> Yes <input checked="" type="checkbox"/> No	
3. Nature of conveyance: <input type="checkbox"/> Assignment <input checked="" type="checkbox"/> Merger <input type="checkbox"/> Security Agreement <input type="checkbox"/> Change of Name <input type="checkbox"/> Other _____  Execution Date: <u>12/31/2002</u>		4. Application number(s) or patent number(s): If this document is being filed together with a new application, the execution date of the application is: _____ A. Patent Application No.(s) <u>09/098,991</u> B. Patent No.(s) <u>4740367</u> Additional numbers attached? <input checked="" type="checkbox"/> Yes <input type="checkbox"/> No	
5. Name and address of party to whom correspondence concerning document should be mailed: Name: <u>MeadWestvaco Corporation</u> Internal Address: <u>Law Department</u> _____ Street Address: <u>4850 North Church Lane SE</u> <u>Suite D</u> City: <u>Smyrna</u> State: <u>GA</u> Zip: <u>30080</u>		6. Total number of applications and patents involved: <u>172</u> 7. Total fee (37 CFR 3.41).....\$ <u>6,880.00</u> <input type="checkbox"/> Enclosed <input checked="" type="checkbox"/> Authorized to be charged to deposit account  8. Deposit account number: <u>13-2512</u>	
DO NOT USE THIS SPACE			
9. Signature.  <u>Thomas A. Boshinski, Reg. No. 30,611</u> Name of Person Signing		 Signature <u>August 27, 2003</u> Date	
Total number of pages including cover sheet, attachments, and documents: <u>11</u> Mail documents to be recorded with required cover sheet information to: Commissioner of Patents & Trademarks, Box Assignments Washington, D.C. 20231			

16680501 219761 00025593 CH

MeadWestvaco Corporation  
U.S. Patented Docket

Patent No.	Case Docket No.
4740367	CHR 84-10 (CIP)
4744925	CHR 85-20 (CIP)
4801311	CHR 83-31
4802898	CHR 83-26
5136055	CHR 90-47
5137965	CHR 90-25 (CIP)
5152832	CHR 89-49 (CIP)
5160453	CHR 89-17
5164446	CHR 88-3
5168245	CHR 90-38 CIP
5165256	CHR 88-3 (DIV.) V
5166257	CHR 88-3 (DIV.)
5166258	CHR 88-3 (DIV.) IV
5166262	CHR 88-3 (DIV.) II
5167694	CHR 87-54 (CIP)
5174913	CHR 90-5
5178674	CHR 89-13 DIV. II (CIP)
5180424	CHR 91-17 DIV I
5180774	CHR 88-3 (DIV.) III
5182326	CHR 88-49
5188665	CHR 89-70
5189090	CHR 90-45 CIP
5192361	CHR 89-70 SP
5194640	CHR 91-9
5204310	CHR 91-42
5206207	CHR 91-42A
5208319	CHR 88-46 CIP
5212144	NACAR III

MeadWestvaco Corporation  
U.S. Patented Docket

Patent No.	Case Docket No.
5212213	CHR 89-51 CIP
5216064	CHR 90-33
5216071	CHR 90-45 CIP II
5238470	CHR 91-42 (DIV.)
5250491	CHR 91-42B
5264481	CHR 90-45 CIP III
5270017	NACAR III (DIV.)
5276000	CHR 91-42A (CIP)
5292480	CHR 90-5T CIP
5304527	CHR 91-42C
5306762	CHR 90-33A
5306793	CHR 91-47
5312599	NACAR III (CIP)
5320671	CHR 88-17B (CIP)
5324703	CHR 91-42B (CIP)
5328505	CHR 88-17A (CIP)
5332436	CHR 92-38A
5336438	CHR 87-43 CIP
5413930	FSL 92-3
5416056	CHR 93-35
5423908	CHR 93-45 CIP
5443902	CHR 93-5

MeadWestvaco Corporation  
U.S. Patented Docket

Patent No.	Case Docket No.
5691270	CHR 95-29
5691405	CHR 93-12 CIP
5693702	CHR 93-12
5710092	CHR 93-35 CIP III
5712164	FSL 93-3 CIP
5719796	FSL 88-1
5723020	CHR 95-30 CIP
5731191	FSL 96-2
5731203	FSL 94-2
5731204	FSL 96-2A
5736481	CHR 95-29A (CIP)
5736485	CHR 95-29 (CIP)
5749926	CHR 95-28B
5755830	CHR 95-28A
5759485	CHR 97-27
5772749	CHR 97-56
5776234	CHR 91-38
5837376	CHR 93-5 (CIP)2
5856191	FSL 95-3 CIP
5863858	CHR 95-29A
5871614	CHR 97-13A
5871663	CHR 97-13B



MeadWestvaco Corporation  
U.S. Patented Docket

Patent No.	Case Docket No.
5905629	CHR 94-18A CIP II
5926361	CHR 94-18 CIP II
5965483	CHR 93-35 CIP
5969071	CHR 97-30
5973036	CHR 97-96B
6001904	CHR 97-96
6007610	CHR 97-96A
6020399	CHR 97-32
6020401	CHR 85-55 DIV
6020405	CHR 97-96C
6043183	CHR 94-18 CIP I
6045606	CHR 98-6
6057462	CHR 98-35
6060424	CHR 94-18A CIP III
6077888	CHR 96-49 CIP II
6103780	CHR 97-33B
6103802	CHR 97-61
6153693	CHR 94-10 CIP
6156384	CHR 97-5B
6172149	CHR 97-75A CIP
6172174	CHR 97-30 CIP
6194471	CHR 96-2 CIP
6277780	CHR 92-41 WV

MeadWestvaco Corporation  
U.S. Patented Docket

Patent No.	Case Docket No.
6291075	CHR 97-61 CIP
6329068	CHR 97-75C CIP
6368457	CHR (LRL 85-9 CIP)
6376611	CHR 97-32A DIV.
6409882	CHR 98-72
6429247	CHR 00-62
6433062	CHR 97-75 CIP
6437033	CHR 97-75 CIP II
6437037	CHR 97-82A
6444877	FSL 99-2
6472343	CHR 00-74 / COV 00-5
6476146	CHR 97-32A DIV. (DIV. of Divisional.)
6479586	CHR 97-32A DIV. (DIV. II of Divisional)
6503971	CHR 97-75B CIP
6518485	FSL 96-1 CPA
6521342	CHR 01-81
6521343	CHR 02-42 CIP
6540815	CHR 2001-79
6540877	CHR (LRL 95-9 CIP II)
6541538	CHR 97-58A CIP
6572969	CHR 02-42
6573212	CHR 00-74 / COV 00-5A

MeadWestvaco Corporation  
U.S. Applications Docket

Serial No.	Date Filed	Case Docket No.
09/098,991	06/17/98	CHR 97-32A
09/140,809	08/26/98	CHR 97-58B
09/573,160	05/19/00	FSL 99-11 CPA
09/803,829	03/12/01	CHR 01-34
09/829,917	04/11/01	CHR 00-74 / COV 00-5B
09/854,367	05/11/01	CHR 99-14 CIP I
09/904,224	07/12/01	CHR 00-63
09/953,983	09/17/01	CHR 00-60
09/954,467	09/17/01	CHR 01-75
09/973,088	10/10/01	FSL 00-07A
09/973,089	10/10/01	FSL 00-07B
09/973,369	10/09/01	FSL 00-03
09/992,902	11/14/01	CHR 00-77
09/999,294	11/15/01	FSL 98-2
10/014710	12/11/01	CHR 97-82 CIP
10/029,360	12/20/01	FSL 98-1 CIP
10/074,729	04/23/02	CHR 99-9 DIV.
10/074,731	02/13/02	CHR 95-14 (CIP) DIV.
10/099,670	03/15/02	CHR 02-34
10/141,158	05/08/02	CHR 01-76
10/144,201	05/10/02	CHR 01-76 CIP

MeadWestvaco Corporation  
U.S. Applications Docket

Serial No.	Date Filed	Case Docket N.
10/192,277	07/10/02	CHR 02-40
10/214,335	08/07/02	CHR 01-34 CIP
10/228,910	08/27/02	SCD 02-08
10/247,215	09/19/02	CHR 00-89 DIV
10/247,217	09/19/02	CHR 00-89 DIV II
10/268,129	10/10/02	CHR 98-70
10/287,492	11/05/02	CHR 99-38 CIP
10/287,493	11/05/02	CHR 99-38 CIP II
10/291,141	11/08/02	CHR 02-42 CIP II
10/324,173	12/20/02	SCD 02-04
60/416,974	10/08/02	CHR 02-38 PROV

8

MeadWestvaco Corporation  
U.S. Patented Docket

Patent No.	Case Docket No.
5450892	CHR 92-33
5473006	CHR 93-13
5491090	FSL 92-10 CIP
5491215	CHR 93-48B CIP
5498659	CHR 93-48B CIP DIV
5498661	CHR 94-31 CIP
5500191	CHR 94-41 (CIP)
5506136	FSL 92-3 CIP
5516826	CHR 92-8B CIP I
5534433	FSL 93-5A
5534434	FSL 93-5
5538932	CHR 91-42B (CIP)3
5543110	CHR 90-42 (CIP)2
5563198	CHR 92-8B CIP I DIV
5596032	CHR 93-23
5610051	FSL 91-3
5626637	CHR 93-35 (DIV.) CIP II
5656679	CHR 93-48A CIP
5667578	CHR 91-38A
5668197	CHR 92-3
5670562	CHR 91-38B
5677185	FSL 95-3

3

\*\* TOTAL PAGE.12 \*\*

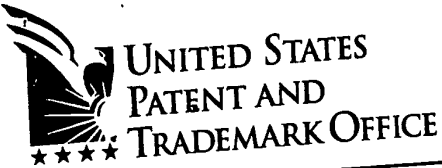

07-22-02 A10:52 IN

CHR 2001-79

JULY 16, 2002

PTAS

Chief Information Officer  
Washington, DC 20231  
www.uspto.gov

WESTVACO CORPORATION  
TERRY B. MCDANIEL  
5255 VIRGINIA AVENUE  
P.O. BOX 118005  
CHARLESTON, SC 29423-8005



\*102092281A\*

UNITED STATES PATENT AND TRADEMARK OFFICE  
NOTICE OF RECORDATION OF ASSIGNMENT DOCUMENT

THE ENCLOSED DOCUMENT HAS BEEN RECORDED BY THE ASSIGNMENT DIVISION OF THE U.S. PATENT AND TRADEMARK OFFICE. A COMPLETE MICROFILM COPY IS AVAILABLE AT THE ASSIGNMENT SEARCH ROOM ON THE REEL AND FRAME NUMBER REFERENCED BELOW.

PLEASE REVIEW ALL INFORMATION CONTAINED ON THIS NOTICE. THE INFORMATION CONTAINED ON THIS RECORDATION NOTICE REFLECTS THE DATA PRESENT IN THE PATENT AND TRADEMARK ASSIGNMENT SYSTEM. IF YOU SHOULD FIND ANY ERRORS OR HAVE QUESTIONS CONCERNING THIS NOTICE, YOU MAY CONTACT THE EMPLOYEE WHOSE NAME APPEARS ON THIS NOTICE AT 703-308-9723. PLEASE SEND REQUEST FOR CORRECTION TO: U.S. PATENT AND TRADEMARK OFFICE, ASSIGNMENT DIVISION, BOX ASSIGNMENTS, CG-4, 1213 JEFFERSON DAVIS HWY, SUITE 320, WASHINGTON, D.C. 20231.

RECORDATION DATE: 05/09/2002

REEL/FRAME: 012888/0474  
NUMBER OF PAGES: 3

BRIEF: ASSIGNMENT OF ASSIGNOR'S INTEREST (SEE DOCUMENT FOR DETAILS).

ASSIGNOR:  
HILTZIK, LAURENCE H.

DOC DATE: 03/26/2002

ASSIGNOR:  
JAGIELLO, JACEK Z.

DOC DATE: 03/28/2002

ASSIGNOR:  
TOLLES, EDWARD D.

DOC DATE: 03/28/2002

ASSIGNOR:  
WILLIAMS, ROGER S.

DOC DATE: 03/28/2002

ASSIGNEE:  
WESTVACO CORPORATION  
5255 VIRGINIA AVENUE  
P.O. BOX 118005  
CHARLESTON, SOUTH CAROLINA

29423-8005

012888/0474 PAGE 2

SERIAL NUMBER: 10100362  
PATENT NUMBER:

FILING DATE: 03/18/2002  
ISSUE DATE:

JOANN STEWART, EXAMINER  
ASSIGNMENT DIVISION  
OFFICE OF PUBLIC RECORDS

05-16-2002

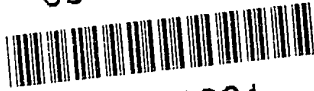

xpress Mail No.: 370311201US  
Case Docket No. CHR 2001-79

102092281  
**PATENTS ONLY**

FRONT SHEET

U.S. DEPARTMENT OF COMMERCE  
U.S. Patent and Trademark Office

Form PTO-1595  
(Rev. 03/01)

OMB No. 0651-0027 (exp. 5/31/2002)

Tab settings ⇌ ⇌ ⇌

To the Honorable Commissioner of Patents and Trademarks: Please record the attached original documents or copy thereof.

1. Name of conveying party(ies):

Laurence H. Hiltzik  
Jacek Z. Jagiello  
Edward D. Tolles  
Roger S. Williams

5.9.02

Additional name(s) of conveying party(ies) attached?  Yes  No

2. Name and address of receiving party(ies)

Name: Westvaco Corporation

Internal Address: P. O. Box 118005

Street Address: 5255 Virginia Avenue

City: Charleston State: SC Zip: 29423-8005

Additional name(s) & address(es) attached?  Yes  No

3. Nature of conveyance:

- Assignment  Merger
- Security Agreement  Change of Name
- Other \_\_\_\_\_

Execution Date: 3/26/02 and 3/28/02

4. Application number(s) or patent number(s):

If this document is being filed together with a new application, the execution date of the application is: entitled  
Method for Reducing Emissions from Evaporative Emissions Control Systems

A. Patent Application No.(s) 10/100,362

B. Patent No.(s) \_\_\_\_\_

Filed 3/18/02

Additional numbers attached?  Yes  No

5. Name and address of party to whom correspondence concerning document should be mailed:

Name: Terry B. McDaniel

Internal Address: Westvaco Corporation  
P. O. Box 118005

Street Address: 5255 Virginia Avenue

City: Charleston State: SC Zip: 29423-8005

6. Total number of applications and patents involved:

7. Total fee (37 CFR 3.41).....\$ 40.00

- Enclosed
- Authorized to be charged to deposit account

8. Deposit account number:

23-1160

OFFICE OF PUBLIC RECORDS  
2002 MAY -9 AM 8:18  
FINANCE SECTION

DO NOT USE THIS SPACE

9. Signature.

Terry B. McDaniel  
Name of Person Signing

*Terry B. McDaniel*  
Signature

May 9, 2002  
Date

Total number of pages including cover sheet, attachments, and documents:  4

Mail documents to be recorded with required cover sheet information to:  
Commissioner of Patents & Trademarks, Box Assignments  
Washington, D.C. 20231

05/15/2002 DBYRME 00000266 10100362  
01 FC:581 40.00 DP



ASSIGNMENT

WHEREAS, we, LAURENCE H. HILTZIK, residing at 191 Broad Street, Charleston, South Carolina 29401, JACEK Z. JAGIELLO, residing at 6240 Old Point Road, Apartment #41, Charleston, South Carolina 29406, EDWARD D. TOLLES, residing at 2 Lampton Road, Charleston, South Carolina 29407, and ROGER S. WILLIAMS, residing at 900 Boyer Lane, Lexington, Virginia 24450, have invented certain new and useful improvements in METHOD FOR REDUCING EMISSIONS FROM EVAPORATIVE EMISSIONS CONTROL SYSTEMS for which we have filed a United States Non-Provisional Patent Application Serial No. 10/100,362 on March 18, 2002;

NOW, THEREFORE, for good and valuable consideration paid to us by WESTVACO CORPORATION, a corporation of the State of Delaware, and having a place of business at Westvaco Corporation, Charleston Technical Center, 5255 Virginia Avenue, P. O. Box 118005, Charleston, South Carolina 29423-8005, the receipt of which is hereby acknowledged;

Effective March 18, 2002, WE DO HEREBY ASSIGN unto the said WESTVACO CORPORATION, its successors and assigns, all our right, title, and interest in and to said application and invention for the United States and all foreign countries, and any Letters Patent to be issued from a non-provisional patent application therefor in the United States and elsewhere. The Commissioner of Patents is requested to issue such Letters Patent in accordance herewith. And we agree to execute further instruments proper for effectuating the premises.

Date: March 26, 2002

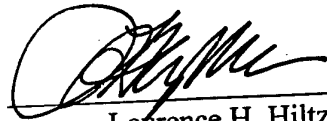

Laurence H. Hiltzik

Date: March 26, 2002

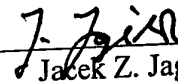

Jacek Z. Jagiello

Date: March 26, 2002

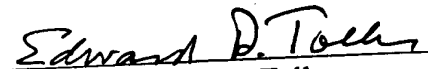

Edward D. Tolles

Date: March 28, 2002

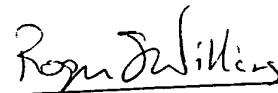

Roger S. Williams

STATE OF SOUTH CAROLINA )  
 ) ss:  
COUNTY OF CHARLESTON

BEFORE ME, a Notary Public in and for said State, personally appeared Laurence H. Hiltzik, Jacek, Z. Jagiello, and Edward D. Tolles, to me known and known to be the persons described in and who executed the foregoing instrument, and they duly acknowledge it to be their act and deed.

WITNESS my hand and seal this 26th day of March 2002.

SEAL

Susan C. Harrison  
Notary Public  
My Commission expires: February 29, 2012

STATE OF VIRGINIA )  
 ) ss:  
City  
COUNTY OF Covington )

BEFORE ME, a Notary Public in and for said State, personally appeared Roger S. Williams, to me known and known to be the person described in and who executed the foregoing instrument, and he duly acknowledges it to be his act and deed.

WITNESS my hand and seal this 28 day of March 2002.

SEAL

Linda C. Stull  
Notary Public  
My Commission expires: 6-30-04

IN THE UNITED STATES PATENT AND TRADEMARK OFFICE

Applicant: Laurence H. Hiltzik, Jacek Z. Jagiello, Edward D. Tolles, and  
Roger S. Williams

Serial No.: (To be assigned)

Group Art Unit: 1754

Filed: October 21, 2003

For: "Method for Reducing Emissions from Evaporative Emissions Control  
System"

Examiner: (To be assigned)

Commissioner for Patents  
P. O. Box 1450  
Alexandria, VA 22313-1450

**STATEMENT OF STATUS AND SUPPORT FOR ALL CHANGES TO THE CLAIMS**

Dear Sir:

The above-described application is an application for reissue of U.S. Patent No. 6,540,815 (the '815 patent), which issued with process claims 1-30 as originally filed, on April 1, 2003. This application was filed, under 35 U.S.C. §251, to correct an error in the '815 patent, which was made without any deceptive intention, where, as a result of the error, the patent may be deemed wholly or partly inoperative or invalid by reason of the patentee claiming more or less than he had a right to claim in the patent. The error in the patent arises out of an error in conduct, which error was made in the preparation of the application which became the '815 patent.

The specification of the patent discloses a process for sharply reducing diurnal breathing loss emissions from evaporative emissions control system canisters by the use of multiple layers, or stages, of adsorbents. The disclosed and claimed process specifies that on the fuel source-side of the canister, standard high working capacity carbons are preferred;

whereas, on the vent-side, the preferred adsorbent volume exhibits a flat or flattened adsorbent isotherm on a volumetric basis in addition to certain characteristically desirable adsorptive properties across broad vapor concentrations, specifically relatively low incremental capacity at high concentration vapors compared with the fuel source-side adsorbent volume. (See the Summary of the Invention at col. 3, lines 39-60.)

The discussion of the "Description of Related Art" beginning at col. 4, line 1 includes a review of state-of-the art methods and canisters for reducing auto emissions of volatile organics. It was shown that no prior art document either taught or suggested the method, as claimed, and/or the canister, as disclosed, to be included in prior art auto emission control systems. In particular, the prior art canisters taught adsorbents, whether of a single component or material or of a mixture of materials, of uniform character and properties. More particularly, a review of the prior art canisters using activated carbon as the adsorbent shows that increased adsorption (and retention) of volatile organics from the fuel (whether emanating from the gas tank or from the engine) to have been achieved by increasing the activity of the carbon adsorbent. Thus, it was surprising and unexpected to find, as did the applicants of the '815 patent and the instant reissue application, that providing a lower activity carbon adsorbent in the canister in an after-position (in relation to vapor flow through the canister) to the higher activity carbon adsorbent therein to effectively reduce the problem of diurnal bleeding of volatile organics from the emission control system canister.

In light of the applicants' disclosure in view of the prior art teaching, all of the original claims (1-30) were allowed and subsequently issued in the '815 patent.

It has now been appreciated that the patentees claimed less than they had a right to claim in the '815 patent, necessitating the instant application for reissue. Specifically, the

subject matter of the '815 patent and the application from which it sprang, as originally filed, disclosed more than the process as claimed. Throughout the application disclosure, novel and unobvious elements of the process were disclosed, but went unclaimed. In particular, the disclosure beginning at col. 9, line 12 through col. 10, line 41, which discloses a particular embodiment of the improved canister adsorbent configuration in the context of an improvement of the auto emissions control system (new claims 31 - 42) and, within such disclosure, one embodiment of the canister element in the disclosed auto emission induction system (new claims 43 - 54). This reissue application is made, under 35 U.S.C. §251, for the purpose of claiming such subject matter.

Therefore, newly added claims 31-42 claim the disclosed canister successive (or sequential) adsorbent orientation as an improvement in an auto emission control system, and newly added claims 43-54 claim the disclosed embodiment of the canister element of the subject matter of the invention. It is respectfully submitted that, for their patentability status as useful, novel, and unobvious over the prior art, as required in Title 35, U.S. Code, newly added claims 31-54 are in condition for allowance. Such action by the Examiner is earnestly solicited.

Respectfully submitted,

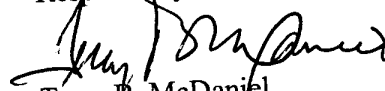

Terry B. McDaniel  
Attorney for the Applicants  
Registration No. 28,444

Date: October 21, 2003  
5255 Virginia Avenue  
Post Office Box 118005  
Charleston, SC 29423-8005  
Telephone (843) 740-2311  
Fax (843) 746-8494

UNITED STATES PATENT AND TRADEMARK OFFICE  
**CERTIFICATE OF CORRECTION**

Page 1 of 1

PATENT NO. : 6,540,815 B1  
DATED : April 1, 2003  
INVENTOR(S) : Laurence H. Hiltzik et al.

It is certified that error appears in the above-identified patent and that said Letters Patent is hereby corrected as shown below:

Title page,

Item [56], References Cited, U.S. PATENT DOCUMENTS, insert:

-- 5,957,114	9/1999	Johnson et al.
6,078,601	8/2000	Reddy --.

Drawings,

Sheet 1, beneath Figure 1 delete "Prior Art."

Column 8,

Table, Footnote 1, delete "Test" and insert therefor -- Tests --.

Signed and Sealed this

Twenty-sixth Day of August, 2003



A handwritten signature in black ink, appearing to read "James E. Rogan".

JAMES E. ROGAN  
Director of the United States Patent and Trademark Office



**IN THE UNITED STATES PATENT AND TRADEMARK OFFICE**

In re Application of: Laurence H. Hiltzik, Jacek Z. Jagiello, Edward D. Tolles, and  
Roger S. Williams

Provisional Filed: November 21, 2001  
Statutory Filed: March 18, 2002  
Reissue Filed: October 21, 2003

Provisional Serial No. 60/335,897  
Serial No.: 10/100,362

For: "Method for Reducing Emissions from Evaporative Emissions Control  
Systems"

Examiner: \_\_\_\_\_

Commissioner for Patents  
P. O. Box 1450  
Alexandria, VA 22313-1450

**PETITION TO MAKE SPECIAL UNDER 37 C.F.R. §1.102(c)  
FOR RESTORATION OR MAINTENANCE OF ENVIRONMENTAL QUALITY  
(MPEP §708.02, V)**

Dear Sir:

Applicants hereby petition to make this application special as being for an invention which will materially enhance the quality of the environment of mankind by contributing to the

- (a) \_\_\_ restoration of one of the basic life-sustaining natural elements – air, water, or soil.
- (b) X maintenance of one of the basic life-sustaining natural elements – air, water, or soil.

**1. Accompanying material**

Accompanying this petition is a declaration by

   applicant

  X   applicants' attorney

explaining how the invention materially contributes to category (a) or (b) set forth above.

**2. Fee**

In accordance with 37 C.F.R. §1.102(c), no fee is required for this petition.

Respectfully submitted,



Terry B. McDaniel  
Attorney for the Applicants  
Registration No. 28,444

October 21, 2003  
5255 Virginia Avenue  
P. O. Box 118005  
Charleston, South Carolina 29423-8005  
tel (843) 740-2311  
fax (843) 746-8494





IN THE UNITED STATES PATENT AND TRADEMARK OFFICE

---

In re Application of: Laurence H. Hiltzik, Jacek Z. Jagiello, Edward D. Tolles, and  
Roger S. Williams

Provisional Filed: November 21, 2001  
Statutory Filed: March 18, 2002  
Reissue Filed: October 21, 2003

Provisional Serial No. 60/335,897  
Serial No.: 10/100,362 - Patent No. 6,540,815, Issued 4/1/03

For: "Method for Reducing Emissions from Evaporative Emissions Control  
Systems"

Examiner:  
Customer Number: 36876

---

Commissioner for Patents  
P. O. Box 1450  
Alexandria, VA 22313-1450

DECLARATION IN SUPPORT OF  
PETITION TO MAKE SPECIAL UNDER 37 C.F.R. § 1.102(c)

Dear Sir:

I, Terry B. McDaniel, Esq., declare as follows:

(1) I am an attorney-of-record for applicants in the above-identified application and, having drafted the specification and claims thereof, am fully aware of the nature of the invention thereof and of its significance and, on implementation, of its ability to materially enhance the quality of the environment and prevent health hazards (which is a basis for granting a petition to make special under MPEP 708.02, V).

(2) The instant application describes a method for sharply reducing diurnal breathing loss emissions from automotive evaporative emissions control systems by providing multiple layers, or stages, of adsorbents. Evaporation of gasoline from motor vehicle fuel systems is a major potential source of hydrocarbon air pollution. The automotive industry is challenged to design engine components and systems to contain, as much as possible, the almost one billion gallons of gasoline evaporated from fuel systems each year in the United States alone. Such emissions can be controlled by canister systems that employ activated carbon to adsorb and hold the vapor that evaporates. Recently, regulations have been promulgated that require a change in

the approach with respect to the way in which vapors must be controlled. Allowable emission levels from canisters would be reduced to such low levels that the primary source of emitted vapor, the fuel tank, is no longer the regulatory focus, as current conventional evaporative emission control appears to have achieved a high efficiency of removal. Rather, the concern now is actually the hydrocarbon left on the carbon adsorbent itself as a residual "heel" after the regeneration (purge) step. Such emissions typically occur when a vehicle has been parked and subjected to diurnal temperature changes over a period of several days, commonly called "diurnal breathing losses." The invention improved combination of high working capacity carbons on the fuel source-side and preferred lower working capacity adsorbent on the vent-side provides substantially lower diurnal breathing emissions (without a significant loss in working capacity or increase in flow restriction) compared with known adsorbents used in canister configurations for automotive emissions control systems.

I declare further that all statements made herein of my own knowledge are true and that all statements made on information and belief are believed to be true and, further, that these statements were made with the knowledge that willful false statements and the like so made are punishable by fine or imprisonment, or both, under 18 USC § 1001 and that such false statements may jeopardize the validity of this document and the application to which it relates.

Signed at Charleston, South Carolina, this 21st day of October, 2003.

  
Terry B. McDaniel  
Attorney for the Applicants  
Registration No. 28,444

5255 Virginia Avenue  
P. O. Box 118005  
Charleston, SC 29423-8005  
Tel (843) 740-2311  
Fax (843) 746-8494

IN THE UNITED STATES PATENT AND TRADEMARK OFFICE

Applicant: L. H. Hiltzik, J. Z. Jagiello, E. D. Tolles, R. S. Williams  
Serial No.: (to be assigned) Group Art Unit: 1724  
Filed: October 21, 2003  
For: METHOD FOR REDUCING EMISSIONS FROM EVAPORATIVE EMISSION CONTROL SYSTEMS  
Examiner: (to be designated)  
Customer No.: 36876

---

Commissioner of Patents  
P. O. Box 1450  
Alexandria, VA 22313-1450

INFORMATION DISCLOSURE STATEMENT

Dear Sir:

In accordance with 37 C.F.R. 1.56, applicant wishes to call the attention of the Examiner to the following references:

<u>U.S. PATENT NO.</u>	<u>PATENTEE</u>	<u>ISSUE DATE</u>
4,677,086	McCue et al.	06/30/87
4,869,739	Kanome et al.	09/26/89
4,894,072	Turner et al.	01/16/90
5,204,310	Tolles et al.	04/20/93
5,206,207	Tolles	04/27/93
5,207,808	Haruta et al.	05/04/93
5,238,470	Tolles et al.	08/24/93
5,250,491	Yan	10/05/93
5,276,000	Matthews et al.	01/04/94
5,304,527	Dimitri	04/19/94

<u>U.S. PATENT NO.</u>	<u>PATENTEE</u>	<u>ISSUE DATE</u>
5,324,703	McCue et al.	06/28/94
5,337,721	Kasuyu et al.	08/16/94
5,355,861	Arai	10/18/94
5,377,644	Krohm	01/03/95
5,408,976	Reddy	04/25/95
5,416,056	Baker	05/16/95
5,456,236	Wakashiro et al.	10/10/95
5,456,237	Yamazaki et al.	10/10/95
5,460,136	Yamazaki et al.	10/24/95
5,477,836	Hyodo et al.	12/26/95
5,482,023	Hunt et al.	01/09/96
5,538,932	Yan et al.	07/23/96
5,564,398	Maeda et al.	10/15/96
5,687,697	Ishikawa	11/18/97
5,691,270	Miller	11/25/97
5,736,481	Miller	04/07/98
5,736,485	Miller	04/07/98
5,863,858	Miller et al.	01/26/99
5,914,294	Park et al.	06/22/99
5,914,457	Itakura et al.	06/22/99
5,931,141	Chino	08/03/99
5,957,114	Johnson et al.	09/28/99
6,098,601	Reddy	08/08/00
6,136,075	Bragg et al.	10/24/00
6,171,373	Park et al.	01/09/01
6,279,548	Reddy	08/28/01
6,284,705	Park et al.	09/04/01
6,488,748	Yamafuji et al.	12/03/02

OTHER DOCUMENTS

Williams, R. S. and C. R. Clontz. "Impact and Control of Canister Bleed Emissions" Covington, Virginia, *Society of Automotive Engineers, Inc. 2001.*

International Publication No. WO 92/01585, (Tennison, Stephen Robert et al.) "Apparatus and Process For Vapour Recovery," Publication date February 6, 1992.

Japanese Publication No. 10-339218, (Nakano, Masaru et al.) "Treatment Device Of Evaporative Fuel," Publication date December 22, 1998.

European Publication No. EP 1 094 032, (Uchino, Massachi et al.) "Formed Active Carbon and Process For Producing The Same," Publication Date April 25, 2001.

European Patent Application EP 1 113 163, (Uchino, Massahi et al.) "Fuel Vapor Treatment Canister," Publication date July 4, 2001.

International Publication No. WO 01/62367, (MacDowall, James Duff et al.) "Process For The Adsorption Of Organic Vapours From Gas Mixtures Containing Them," Publication date August 30, 2001.

Korean Publication No. KR 2002 012826, (OH, W.S.) "Diurnal Breathing Loss Control Canister Module System and Constructing Method Thereof," Publication Date February 20, 2002.

Japanese Publication No. 2002-256989 (Katsuhiko, Makino et al.) "Canister" Publication Date 11/9/02.

Copies of these references are submitted herewith along with form PTO-1449.

These references are cited as being representative of the state of the art in this area. All the above cited art have been previously addressed in the earlier prosecution of the U.S. Patent No. 6,540,815 except the following, which are individually addressed as follows:

U.S. Patent No. 4,869,739 to Kanome et al. teaches a fuel vapor collecting device comprising: an activated carbon receiving chamber and activated carbon particles contained in the activated carbon receiving chamber, each of the activated carbon particles containing heat accumulating solid fillers distributed therein and having a specific heat which is larger than that of an activated carbon. The patentees provide no disclosure or suggestion of separate beds of activated carbon adsorbents of differing activities. The applicants claim no "accumulating solid fillers" distributed within their activated carbon adsorbent particles.

U.S. Patent No. 5,238,470 to Tolles et al. teach the chemical activation of a carbonaceous material, preferably lignocellulosic material, with a chemical activation agent in a manner to produce a plastic intermediate product which is densified to effectively minimize the macropore structure of the activated carbonaceous material. Densification is followed by increasing the temperature of the shaped product at a controlled rate to from about 425° C. to about 650° C. The patentees teach their product to be a "high activity, high density gas-phase activated carbons produced are characterized by butane working capacities from above 15 to about g/100 cm<sup>3</sup>, but do not even suggest its use in an auto canister in conjunction with an activated carbon of reduced activation.

U.S. Patent No. 5,355,861 to Arai teaches an evaporative emission control system including a canister having an adsorbent accommodating chamber for accommodating an adsorbent therein, said canister includes: a vapor-liquid separation chamber formed in said canister; a liquefaction accelerating agent which is fibrous or long strip-shaped and filled in an upper portion of said vapor-liquid separation chamber; a fuel storage chamber disposed in a lower portion of said vapor-liquid separation chamber for storing a separated liquid fuel; and said vapor-liquid separation chamber communicating with said adsorbent accommodating chamber. The patent disclosure does not teach or suggest the applicants' claimed invention.

U.S. Patent No. 5,377,644 to Krohm teaches both method and apparatus for collecting and metering volatile fuel components for an engine, including a container with a regenerable storage device for collecting volatile fuel components from the fuel store. The storage device is connected to the engine fuel inlet through a metering valve, which is controlled to supply the previously collected components to optimize engine performance by a controlled feed of the volatile components into the fuel mixture according to the particular engine operating conditions. There is no suggestion by the patentee's disclosure of the applicants' claimed invention.

U.S. Patent No. 5,482,023 to Hunt et al. teaches a cold start fuel control system including a fuel vapor canister having an interior chamber filled with fuel absorbent material. This internal chamber of the canister is fluidly connected to the fuel tank. Additionally, a normally closed shut-off valve is fluidly connected between the canister and ambient air while a normally closed purge valve is fluidly connected in between the interior of the canister and the intake manifold. There ends the similarity to the applicants' claimed invention.

U.S. Patent No. 5,687,697 to Ishikawa teaches an apparatus for treating fuel vapor generated in a fuel tank of a vehicle is provided. The apparatus comprises a canister having a vapor inlet communicating with the tank, a vapor outlet communicating with the engine's air intake passage by way of a purge line, and an adsorbent. The adsorbent is taught to be "activated carbon or the like." In the disclosed configuration the canister is heated and the temperature of the adsorbent raised. This permits more efficient separation of the volatile compounds for separation from the exhausting gases. Although in system with two tailpipes it is suggested to provide separate canisters for each tailpipe, there is no suggestion of differing activations of adsorbents within the same canister. Thus, there is no suggestion of the applicants' claimed invention.

U.S. Patent No. 5,931,141 to Chino teaches a vapor treatment system incorporated with an automotive fuel storage tank for a gasoline. The vapor treatment system comprises a vapor adsorbent canister containing therein vapor adsorbent. The vapor adsorbent is taught to be "an inorganic vapor adsorbent such as activated carbon or ceramic, or organic vapor adsorbent such as high polymer vapor adsorbent. The vapor adsorbent S is granular, massive or honeycomb-shaped." (Of course, activated carbon is organic, not "inorganic.") Nevertheless, there is no teaching of a vapor adsorbent canister containing vapor adsorbents of differing activities.

EP 1094032 to Tennex Corp. teaches a formed activated carbon for a fuel vapor collecting device made by kneading activated powder with clay, a metal powder and/or a metal oxide powder, and a boron compound and/or a phosphorus compound, forming the mixture and firing the green body. This does teaching does not suggest the applicants' claimed invention.

JP 10339218 to Tennex Corp. teaches technology similar to EP 1094032 to Tennex (see above) with an aim to improve fuel adhesive and withdrawal performance. The adsorbent in a evaporative fuel device (canister) is taught to be active carbons produced by adhering heat accumulating particles comprising a metal or an inorganic material which has a higher heat transfer coefficient compared with activated carbon and a high heat capacity. When the heated evaporative fuel is adsorbed by the activated carbon, the heat generated is transferred to the heat accumulating particles so that the temperature rise of the activated carbon is suppressed. By suppressing the temperature rise of the activated carbon, when the adsorbed compounds are withdrawn by introducing air upon engine operation, a temperature decline of the activated carbons at such withdrawal time is also minimized, as the heat reduction occurs primarily in the heat accumulating particles.

JP 02256989 to Aisan Industries deals more directly with the problem addressed by the instant inventors/applicants in minimizing the diffusion phenomenon within the adsorbent material within a canister as an element within an automotive evaporative emission control system. The applicants of the Japanese published application provide, within the canister, a first layer of an activated carbon having a high adsorption and weak holding force and a second layer of an activated carbon having a middle adsorption and weak holding force, thereby having little remaining fuel after purging; thus, suppressing radiation of evaporated fuel to the atmosphere after leaving the canister under a high temperature. The canister configuration appears similar to that claimed by applicants, but the mechanism for reduced diurnal bleeding is not taught to be the same. The applicants' high activity carbon possess a relatively high holding force, and the suppression of diurnal bleeding of the evaporated volatile compounds results from the metering effect of the transference of said compounds from the high activity carbon to the lower activity carbon, before subsequent release to the atmosphere. Regardless of relevance or materiality, however, it is respectfully submitted that this reference document is removed as available prior art in denying the applicants' petition for patent by the attached Declaration Under 37 C.F.R. 131(a).

Express Mail No. EU592640451US  
Case Docket No. CHR 2001-79 (reissue)

As a matter of fact, none of the above citations constitute an admission that the references are relevant or material to the claims; they are cited only as constituting the closest art of which the applicant is aware.

Respectfully Submitted,

  
Terry B. McDaniel  
Attorney for the Applicants  
Registration No. 28,444

Attachments

Dated: October 21, 2003  
5255 Virginia Avenue  
Post Office Box 118005  
Charleston, SC 29423-8005  
Tel: (843) 740-2311  
Fax: (843) 746-8494



<b>Form PTO-1449</b> (REV. 8-83)  U.S. DEPT. OF COMMERCE PATENT AND TRADEMARK OFFICE  INFORMATION DISCLOSURE CITATION  (Use several sheets if necessary)	Atty. Docket No. <b>CHR 2001-79</b>	SERIAL NO.
	APPLICANT <b>L.H. Hiltzik, J.Z. Jagiello, E.D. Tolles, and R.S. Williams</b>	
	FILING DATE	GROUP <b>1725</b>

**U.S. PATENT DOCUMENTS**

*EXAMINER INITIAL	DOCUMENT NUMBER								DATE	NAME	CLASS	SUBCLASS	FILING DATE IF APPROPRIATE
	4	6	7	7	0	8	6	06/87	McCue et al.				
	4	8	6	9	7	3	9	09/89	Kanome et al.				
	4	8	9	4	0	7	2	01/90	Turner et al.				
	5	2	0	4	3	1	0	04/93	Tolles et al.				
	5	2	0	6	2	0	7	04/93	Tolles				
	5	2	0	7	8	0	8	05/93	Haruta et al.				
	5	2	3	8	4	7	0	08/93	Tolles et al.				
	5	2	5	0	4	9	1	10/93	Yan				
	5	2	7	6	0	0	0	01/94	Mathews et al.				
	5	3	0	4	5	2	7	04/94	Dimitri				
	5	3	2	4	7	0	3	06/94	McCue et al.				
	5	3	3	7	7	2	1	08/94	Kasuyu et al.				
	5	3	5	5	8	6	1	10/94	Arai				
	5	3	7	7	6	4	4	01/95	Krohm				
	5	4	0	8	9	7	6	04/95	Reddy				
	5	4	1	6	0	5	6	05/95	Baker				
	5	4	5	6	2	3	6	10/95	Wakashiro et al.				
	5	4	5	6	2	3	7	10/95	Yamazaki et al.				

**FOREIGN PATENT DOCUMENTS**

	DOCUMENT NUMBER								DATE	COUNTRY	CLASS	SUBCLASS	TRANSLATION	
													YES	NO
	WO	92	0	1	5	8	5	02/92	PCT Publication					
	JP	103	3	9	2	1	8	12/98	Japanese Publication					
	EP	11	1	3	1	6	3	07/01	European Patent Office Publication					
	WO	01	6	2	3	6	7	08/01	PCT Publication					
	KR	0	1	2	8	2	6	02/02	Korean Publication					
	EP	10	9	4	0	3	2	04/01	European Patent Office Publication					
	JP	022	5	6	9	8	9	11/02	Japanese Publication			X		

**OTHER DOCUMENTS (Including Author, Title, Date, Pertinent Pages, Etc.)**

	Williams, R. S. and C. R. Clontz "Impact and Control of Canister Bleed Emissions" Covington Virginia, Society of Automotive Engineers, Inc. 2001
EXAMINER	DATE CONSIDERED

\*EXAMINER: Initial if citation considered, whether or not citation is in conformance with MPEP 609; Draw line through citation if not in conformance and not considered. Include copy of this form with next communication with applicant.

<b>Form PTO-1449</b> (REV. 8-83)  U.S. DEPT. OF COMMERCE PATENT AND TRADEMARK OFFICE  <b>INFORMATION DISCLOSURE CITATION</b>  (Use several sheets if necessary)	Atty. Docket No. <b>CHR 2001-79</b>	SERIAL NO.  APPLICANT <b>L.H. Hiltzik, J.Z. Jagiello, E.D. Tolles, and R.S. Williams</b>  FILING DATE  GROUP <b>1725</b>
---	--	--

U.S. PATENT DOCUMENTS													
*EXAMINER INITIAL	DOCUMENT NUMBER								DATE	NAME	CLASS	SUBCLASS	FILING DATE IF APPROPRIATE
	5	4	6	0	1	3	6	10/95	Yamazaki et al.				
	5	4	7	7	8	3	6	12/95	Hyodo et al.				
	5	4	8	2	0	2	3	01/96	Hunt et al.				
	5	5	3	8	9	3	2	07/96	Yan et al.				
	5	5	6	4	3	9	8	10/96	Maeda et al.				
	5	6	8	7	6	9	7	11/97	Ishikawa				
	5	6	9	1	2	7	0	11/97	Miller				
	5	7	3	6	4	8	1	04/98	Miller				
	5	7	3	6	4	8	5	04/98	Miller				
	5	8	6	3	8	5	8	01/99	Miller et al.				
	5	9	1	4	2	9	4	06/99	Park et al.				
	5	9	1	4	4	5	7	06/99	Itakura et al.				
	5	9	3	1	1	4	1	08/99	Chino				
	5	9	5	7	1	1	4	09/99	Johnson et al.				
	6	0	9	8	6	0	1	08/00	Reddy				
	6	1	3	6	0	7	5	10/00	Bragg et al.				
	6	1	7	1	3	7	3	01/01	Park et al.				
	6	2	7	9	5	4	8	08/01	Reddy				
	6	2	8	4	7	0	5	09/01	Park et al.				
	6	4	8	8	7	4	8	12/02	Yamafuji et al.				

FOREIGN PATENT DOCUMENTS														
	DOCUMENT NUMBER								DATE	COUNTRY	CLASS	SUBCLASS	TRANSLATION	
													YES	NO

OTHER DOCUMENTS (Including Author, Title, Date, Pertinent Pages, Etc.)

EXAMINER	DATE CONSIDERED
*EXAMINER: Initial if citation considered, whether or not citation is in conformance with MPEP 609; Draw line through citation if not in conformance and not considered. Include copy of this form with next communication with applicant.	



PCT

WORLD INTELLECTUAL PROPERTY ORGANIZATION  
International Bureau

INTERNATIONAL APPLICATION PUBLISHED UNDER THE PATENT COOPERATION TREATY (PCT)

(51) International Patent Classification 5 : B60K 15/00, F02M 25/08	A1	(11) International Publication Number: WO 92/01585
		(43) International Publication Date: 6 February 1992 (06.02.92)

(21) International Application Number: PCT/GB91/01269	(74) Agent: RYAN, Edward, Terrence; BP International Limited, Patents & Agreements Division, Chertsey Road, Sunbury-on-Thames, Middlesex TW16 7LN (GB).
(22) International Filing Date: 26 July 1991 (26.07.91)	
(30) Priority data: 9016419.5                      26 July 1990 (26.07.90)                      GB	(81) Designated States: AT (European patent), AU, BE (European patent), BR, CA, CH (European patent), DE (European patent), DK (European patent), ES (European patent), FR (European patent), GB (European patent), GR (European patent), IT (European patent), JP, KR, LU (European patent), NL (European patent), SE (European patent), US.
(71) Applicant (for all designated States except US): THE BRITISH PETROLEUM COMPANY PLC [GB/GB]; Britanic House, 1 Finsbury Circus, London EC2M 7BA (GB).	
(72) Inventors: and (75) Inventors/Applicants (for US only): TENNISON, Stephen, Robert [GB/GB]; 62 Farleigh Road, New Haw, Weybridge, Surrey KT15 3HR (GB). FOSTER, Alan, Ivor [GB/GB]; 38 St. Leonard's Road, Amersham, Bucks, HB6 6DS (GB). NICHOLAS, David, Henry [GB/GB]; 8 Warner Road, Walthamstow, London E17 7DZ (GB). WEATHERHEAD, Richard, Henry [GB/GB]; 1 Cabbell Place, Adlestone, Weybridge, Surrey KT15 2XL (GB).	Published With international search report.

(54) Title: APPARATUS AND PROCESS FOR VAPOUR RECOVERY

(57) Abstract

A canister (1) for attachment to a vehicle fuel tank to reduce hydrocarbon emissions comprises a gas inlet (2), gas outlet (3) and vent (4) and contains a bed of adsorbent polymer (7) and a bed of carbon (8). The vent opens into the carbon bed and the gas inlet and outlet open into the polymer bed.

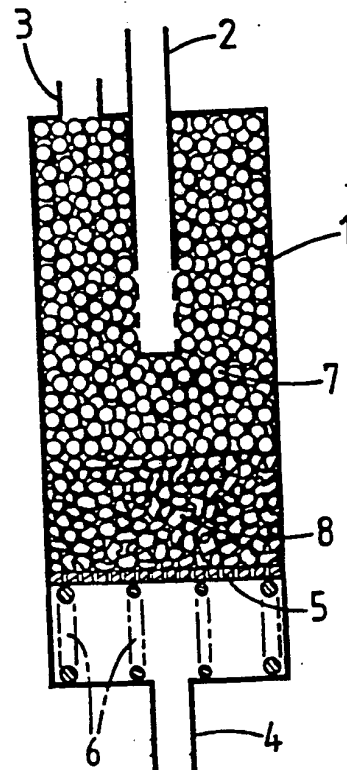

**FOR THE PURPOSES OF INFORMATION ONLY**

Codes used to identify States party to the PCT on the front pages of pamphlets publishing international applications under the PCT.

AT	Austria	ES	Spain	MG	Madagascar
AU	Australia	FI	Finland	ML	Mali
BB	Barbados	FR	France	MN	Mongolia
BE	Belgium	GA	Gabon	MR	Mauritania
BF	Burkina Faso	GB	United Kingdom	MW	Malawi
BG	Bulgaria	GN	Guinea	NL	Netherlands
BJ	Benin	GR	Greece	NO	Norway
BR	Brazil	HU	Hungary	PL	Poland
CA	Canada	IT	Italy	RO	Romania
CF	Central African Republic	JP	Japan	SD	Sudan
CC	Congo	KP	Democratic People's Republic of Korea	SE	Sweden
CH	Switzerland	KR	Republic of Korea	SN	Senegal
CI	Côte d'Ivoire	LI	Liechtenstein	SU <sup>+</sup>	Soviet Union
CM	Cameroon	LK	Sri Lanka	TD	Chad
CS	Czechoslovakia	LU	Luxembourg	TC	Togo
DE	Germany	MC	Monaco	US	United States of America
DK	Denmark				

+ It is not yet known for which States of the former Soviet Union any designation of the Soviet Union has effect.

APPARATUS AND PROCESS FOR VAPOUR RECOVERY

The present invention relates to the recovery of gasoline vapours from mixtures of gasoline vapour and air.

Gasoline vapour is emitted from motor vehicles powered by gasoline engines as a consequence of displacing gasoline vapour from the fuel tank during refuelling (refuelling losses). It is also emitted as a consequence of evaporation from the engine and fuel system either when the vehicle is in operation or when standing after use (diurnal losses). The emission of gasoline vapour is considered to be undesirable.

Manufacturers already fit carbon canisters to eliminate the diurnal losses and such an arrangement is disclosed for instance in GB 1 416 336. The carbon adsorbs the vapour emitted when the engine is stationary after use. The carbon canister is then regenerated by drawing air through the canister using the vacuum generated in the engine inlet manifold so that the gasoline vapour recovered from the canister is mixed with the normal air/fuel mixture to the engine. The vapour emission when the vehicle is stationary is quite small so that a canister having a capacity of about 1 litre is thought to be satisfactory. During normal vehicle operation the vapours emitted are continuously returned to the engine.

Refuelling an almost empty tank involves displacing a large amount of gas (corresponding to the volume of the fuel tank if it is being completely refilled) saturated with gasoline vapour although this only occurs approximately once every 600 km. This is equivalent to approximately 150-200 g of vapour for a typical

European car (60 L tank) depending on the composition of the vapour.

There are proposals both in the US and in Europe to impose legal restrictions on the amount of gasoline vapour which may be released into the atmosphere during refueling. One method proposed to meet such legal requirements is the recycling of the vapour from the fuel tank connected to the engine back to the storage tank from which the vehicle is refueled. This however is an expensive procedure in view of the complex equipment needed, and the work required at numerous refueling stations, often with underground storage tanks. It would be desirable to find a simple method of dealing with the problem by an extension of the use of adsorbent canisters mounted in vehicles. There is however a problem in trying to eliminate gasoline vapour emission during refuelling by the use of canisters carried in the vehicle. Although the overall weight of the gasoline vapour to be adsorbed is quite small the requirement to trap this during the 2-3 minutes that it takes to fill a normal saloon car tank would make it necessary to use as much as 5 litres of the carbons currently in use. Such large quantities of carbon can not be conveniently be provided in the restricted engine compartment of modern saloon cars.

One approach to reducing the size of the canister is to use a carbon with a high adsorptive capacity. However we have found that such carbons are not easily regenerated in use by drawing air through the carbon bed. They would adsorb a large quantity of gasoline vapour on the first cycle, but only small quantities thereafter. The optimum active carbon the adsorption of gasoline vapours is one which has a high pore volume with pores in the small mesopore range (approximately 2 nm diameter). This maximises both the adsorption capacity of the carbon and the regenerability resulting in the largest possible working capacity. However the working capacity for typical gasolines is still limited to approximately 5% weight predominantly by the difficulty of regenerating the bed.

GB 1 416 336 discusses some of the disadvantages of the use of carbon and proposes to overcome them by replacing the carbon by a

particulate macroreticular, substantially non-ionogenic, water-insoluble polymer having a specified surface area, porosity and average pore diameter. Among the polymers which may be used are polymers of divinyl benzene.

5           However we have found that such porous polymers are not satisfactory for use as gasoline adsorbents. The porous polymers have a good saturation capacity for gasoline vapour and are easily regenerated. However the lower molecular weight components of the gasoline vapour, such as propane and butane, are not held strongly  
10 enough on the polymer and thus break through the adsorbent bed and escape into the atmosphere after a comparatively short time thereby restricting the working capacity of the bed.

          In principle it is always preferably to prepare an adsorbent from a single material so as to simplify the manufacturing process.  
15 We have however found that the use of two different adsorbent materials give sufficiently marked advantages to justify the increased complexity.

          According to the present invention a canister for attachment to a vehicle fuel tank, said canister comprising a body adapted to  
20 receive an adsorbent, and having a gas inlet adapted to be connected to a gasoline storage tank, a gas outlet adapted to be connected to a gasoline engine, and a vent to the atmosphere, is characterised in that the canister contains a bed of adsorbent polymer and a bed of carbon arranged such that the vent opens into the bed of carbon and  
25 the gas inlet and gas outlet open into the bed of adsorbent polymer.

          The present invention further provides a motor vehicle with a gasoline engine having a canister defined as above.

          According to the present invention a method of adsorbing gasoline vapour from air comprises passing the mixture of air and  
30 gasoline vapour through a first bed of adsorbent polymer, and then through a bed of adsorbent carbon, and subsequently regenerating the adsorbent beds by passing a stripping gas first through the bed of adsorbent carbon and then through the bed of adsorbent polymer.

          According to another aspect of the present invention a process  
35 for operating a gasoline engine of a motor vehicle comprises passing

air displaced from the fuel tank while refueling the vehicle through a first bed of adsorbent polymer, and then through a bed of an adsorbent carbon so as to adsorb high molecular weight components of the gasoline on the polymer and lower molecular weight components of the gasoline on the carbon, and subsequently operating the engine so as to draw air through the bed of adsorbent carbon and then through the bed of adsorbent polymer before feeding the air to the engine.

The mixture of air and desorbed gasoline components will generally be blended with the normal gasoline/air fuel before the total mixture is passed to the engine.

The adsorbent carbon may be any of the conventional active carbons already proposed for use in gasoline engines. However the use of the carbon in conjunction with the polymer adsorbent bed in the layered bed canister allows the use of a wider variety of active carbons where the requirement for the majority of pores to be small mesopores can be relaxed. Using conventional premium European gasoline the best results in the layered bed canister have been obtained with a highly microporous coconut shell carbon.

Polymers which are suitable adsorbent polymers for gasoline vapour adsorption are disclosed in GB 1 416 336. This discloses the use of particulate macroreticular, substantially non-ionogenic, water-insoluble polymers having a specific surface area in the range 10 to 10000 m<sup>2</sup>/g, a porosity of 25% to 85%, and an average pore diameter of 2 nm to 2000 nm. Among specific polymers which may be used are those obtained by polymerising under macroreticular polymer producing conditions. The monomer charge is composed of ethylenically unsaturated monomer or monomers and containing from 2% to 100% by weight, based on the weight of the charge, of 1 or more of divinyl benzene, trivinyl benzene, alkyl vinyl benzenes having from 1 to 4 methyl or ethyl groups substituted in the benzene nucleus, and alkyl divinyl benzenes having from 1 to 3 methyl or ethyl groups substituted in the benzene nucleus.

We believe that the surface area of the polymer is preferably in the range 200 to 2000 m<sup>2</sup>/g, and that the polymer should contain a significant volume of pores in the range 1 nm to 50 nm for



adsorption purposes, as well as larger pores for gas transfer.

A particularly preferred polymer is a copolymer of a mixture containing a major amount of divinyl benzene and a minor amount of ethyl styrene which is sold under the designation "Ambersorb XAD4" by Rohm & Haas Inc.

5 The quantities of adsorbent used will depend on the working adsorbing capacity of the polymer, the working adsorbing capacity of the active carbon, the quantity of gasoline vapour to be adsorbed between each regeneration period and the time available for  
10 regeneration. For use in a canister useable in a normal size family car the total volume of adsorbent may be in the range 500 ml to 5 litres.

The optimum amount of the two different adsorbents to be used will depend on the design of the canister. The designated ratios  
15 refer to the volume of adsorbent between the gasoline vapour inlet and the vent to atmosphere. This can be seen by reference to figures 1 and 2. In figure 1 which shows a canister with the vapour inlet (2) in the centre of the bed the polymer:carbon ratio refers  
20 to the volume of adsorbent between the vapour inlet (2) and the vent to atmosphere (4). In the canister shown in figure 2 the ratio refers to the total volume of adsorbent in the canister between the vapour inlet (12) and the vent to atmosphere (14). The optimum  
25 ratio of polymer to carbon will vary with the type of gasoline to be used but may be in the range 3:7 to 7:3, or preferably in the range 4:6 to 6:4, more preferably 4.5:5.5 to 5.5:4.5.

The relative volumes of the two adsorbents may be adjusted to optimise the performance of the canister system for different types  
of gasoline used in different regions of the world. For the higher  
30 volatility fuels typically used in Europe a volume ratio of polymer to carbon of about 1:1 is preferred. For lower volatility fuels it is believed that polymer to carbon volume ratios of greater than 1:1 (ie larger relative amounts of polymer) will be desirable.

Depending on the design of the canister and the disposition of  
the inlet and vent, the ratios described above may correspond to a  
35 canister having a relatively large bed of adsorbent polymer and a

relatively small bed of carbon. However this will not necessarily correspond to the most efficient use of the adsorbents.

The invention will now be illustrated with reference to the drawings and the following experiments.

In the drawings:

5 Figure 1 is a diagrammatic cross-sectional view of one form of a gasoline adsorbing canister for use in the present invention, and Figure 2 is a cross-sectional diagrammatic view of an alternative form of gasoline canister according to the invention.

10 Referring to Figure 1 a cylindrical canister (1) is provided with a gas inlet (2) extending downwardly into the body of the canister and opening into the canister through slots at its lower end. A vapour outlet (3) is provided at the top of the canister. A vent (4), which may allow air to both enter or leave the canister is provided at the lower end. A perforated plate (5) is mounted above  
15 springs (6) which serves to urge the plate (5) upwards so as to keep any adsorbent material in the upper part of the canister compressed into its packed state. The upper part of the canister between the connection to the vehicle inlet manifold (3) and the vapour inlet  
20 (2) is filled with a bed (7) of adsorbent polymer particles. The lower part of the canister is filled with two layers. The upper layer (1) is of the porous polymeric adsorbent whilst the lower layer (8), closest to the atmospheric vent (4) is filled with carbon adsorbent such that the volume ratio of the volume of bed (1) to bed  
25 (8) is most preferably in the ratio 4.5:5.5 to 5.5:4.5.

In use in a motor vehicle the inlet (2) is connected by piping and appropriate valves to the vehicle's fuel tank connected by piping and appropriate valves to the vehicles fuel tank and to the vents from the vehicles fuel inlet system and crankcase. The outlet  
30 (3) is connected by piping and an appropriate valve to the engine, for example it may be connected as a bleed to a carburettor. The vent (4) provides for the inlet or outlet of gas to the outside air. When the motor vehicle is refueled gas displaced from the fuel tank enters the canister through inlet (2). Outlet (3) can be  
35 closed so that no air is drawn through it to the engine but this is

not essential. Gasoline vapour evaporating from the fuel tank will pass through inlet (2) into the canister. It will initially contact the adsorbent polymer and then diffuse through this into the adsorbent carbon. When the motor is running air will be drawn in through the vent (4) and will sweep adsorbed gasoline vapour components out of the adsorbent carbon. The air will then pass through the adsorbent polymer to the engine by way of outlet (3) so regenerating the adsorbent materials in the canister.

Figure 2 shows an alternative design of canister for use particularly in reducing emissions during the refueling of motor vehicles. The canister (11) is provided with a gas inlet (12) and a gas outlet (13) together with a vent (14). These are all provided at the top of the canister. A metal divider (15) covered with an asbestos insulating sheet (16) divides canister (11) so that an elongated flow path is provided between the inlet (12) and outlet (13) on the one hand and the vent (14) on the other. The canister is filled with two types of adsorbent material, namely a bed of adsorbent polymer (17), and a similar bed of adsorbent carbon (18). Wire mesh or perforated plates (19) and glass fibre (20) hold the adsorbent particles in position.

In use air containing gasoline vapour displaced from a motor vehicle fuel tank during refueling passes into the canister through inlet (12) and passes through the bed of adsorbent polymer (17) and then the bed of adsorbent carbon (18) to the vent (14) through which it is discharged to the atmosphere. When the canister is to be regenerated the connection to the fuel tank can be closed by a valve (not shown) and a connection is opened to the engine through outlet (13) by which air will be drawn into the canister through vent (14) so as to displace adsorbed gasoline vapour from the adsorbent particles and to transport it through outlet (13) to the engine.

In the experiments set out below experiments identified by number are examples of the invention and experiments identified by letter are comparative tests not according to the invention.

#### Comparative Test A

Tests were carried out on a Volkswagen car supplied fitted with

a carbon adsorbent canister of the type shown in Figure 1 having a capacity of 1.1 litre and filled with a commercial particulate carbon adsorbent. The engine was subjected to cycles of (a) running, in which air was drawn through the canister into the engine and (b) standing, in which gasoline vapour from the fuel tank passed through the canister before air from the tank was vented to the atmosphere. After use for a considerable number of cycles so as to give a fully aged carbon, tests were carried out over six cycles to determine the working capacity for gasoline adsorption of the carbon. This was done by measuring weight increase during the period of gasoline adsorption. The result is shown in the Table.

Comparative Test B

An experiment was carried out as in Comparative Test A except that the carbon particles were removed from the canister which was then loaded with a gasoline adsorbing polymer (1.1 litre packed volume) which was a polymer of divinyl benzene containing some ethyl styrene sold under the commercial designation "Ambersorb XAD4". The working capacity of the polymer was determined as in Comparative Test A.

Example 1

An experiment was carried out as in Comparative Test B, except that the lower part of the canister connected to the fuel tank and the air feed to the engine was loaded with the carbon of Test A, while the upper part was loaded with the adsorbent polymer of Test B. Both adsorbents were fully aged.

The relative quantities of gasoline-adsorbing polymer and adsorbent carbon were 3:1 by packed volume.

The working capacity of the mixture was determined as the mean of six cycles of the operation with a standard deviation of 3.54 g. The result is given in the Table.

For comparison a predicted value of the working capacity was determined based on the measured capacities from Tests A and B and the relative amounts of carbon and polymer used in example 1. The results are given in Table 1.

TABLE

EXPERIMENT	WORKING CAPACITY (g)
Test A	20
Test B	22
Example 1	29.2
Example 1 (predicted)	21.5

In addition to these tests with typical vehicle canisters, laboratory tests were carried out with the equipment described below. The two adsorbent beds (1 and 2) were contained in steel vessels that could be separated and weighed individually after each adsorption and desorption cycle. Each vessel was 4 cm in diameter and could hold up to 80 ml of adsorbent held in place between plugs of glass wool. The two beds were contained in a water bath maintained at 53C. The adsorption cycle was simulated by passing gasoline vapour, produced by bubbling 83 ml min of nitrogen through 200 ml Eurograde unleaded 95/85 gasoline held at 200C in a water bath, through the polymer bed and then the carbon bed in series. The temperature in the centre of each bed and the total flow from the second carbon bed was recorded as a function of time. The composition of the effluent gas was analysed by mass spectrometer. The adsorption cycle was assumed to be complete when the 29 peak in the mass spectrometer (mainly due to propane) reached  $1 \times 10^{-8}$  unts, ie partial breakthrough. The gas flow was then stopped and the two beds were isolated and weighed. The two beds were then returned to the water bath.

Desorption was carried out by reversing the nitrogen flow through the two beds. An average flow rate of 485 ml/minutes was used for a fixed time of 40 minutes for the desorption cycle. After the 40 minutes the two beds were again removed from the water bath and weighed.

#### Comparative Tests C and D

Tests C and D (table 2) are not according to the present invention and show the breakthrough time in minutes and the working capacity in both % weight and g/litre for the tests where both vessels contained either 80 ml of the porous polymer, XAD4 (test C) or 80 mls of a typical extrudate active carbon recommended for use in evaporative loss canisters (test D).

#### Examples 2 to 7

Examples 2 to 7 (table 2) demonstrate the dramatic improvements in both the time to breakthrough and the working capacity when the first bed is filled with 80 ml of the porous polymer, XAD4, and the second bed with 80 ml of activated carbon. In Examples 2 the carbon is the recommended extrudate active carbon used in comparative test D. It can be seen from a comparison of tables 1 and 2 that the increase in the working capacity compared to both the polymer/polymer bed and the carbon/carbon beds is almost identical to that found in the vehicle tests whilst the actual working capacities are slightly higher for the laboratory test probably due to slight differences in the breakthrough criterion. This demonstrates the validity of the laboratory test method.

Examples 3 to 7 demonstrate the use of different activated carbons in the second adsorbent bed. These materials were not selected using the normal criterion for evaporative emission canister carbons of maximising the small mesopore (2nm) volume but were typical microporous active carbons. It can be seen that the best performance for the dual bed system was achieved with Sutcliffe Speakman AC610C, a highly microporous active carbon. The relative performance of the activated carbons in the dual bed system correlates better with the saturation butane capacity of the carbons than the working capacity which are also shown in table 2. These

results demonstrate a second benefit of the dual bed canister, namely that the carbon component can now be selected to maximise the butane adsorption capacity without the generally poorer regeneration capability of the microporous carbons influencing the working capacity.

5 Table 2 - Cyclic Performance of Laboratory Test - twin beds each of 80 ml capacity.

Test	Materials	Breakthrough time (minutes)	Working Capacity		Butane Adsorption	
			% weight	g/litre	Saturation % weight	Working g/L
C	XAD4/XAD4	21.8	7.0	27.6	32	98
C	AC1/AC1	26.0	6.8	29.1	33	63
2	XAD4/AC45	40.5	11.0	44.8	39	54
3	XAD4/610C	42.2	11.7	46.0	34	50
4	XAD4/GAC616G	38.0	9.2	42.2	30	81
5	XAD4/AS IV	36.0	10.9	41.7	33	63
6	XAD4/WS IV	33.0	9.9	37.9	33	75

Comparative Test E and Examples 7 and 8

The same test conditions as used for tests C and D and Examples 2 to 6 were used in the following examples of a less preferred form of the present invention. In examples 2 to 6 the ratio of polymer to carbon was 50:50. In examples 7 to 8 the volume of adsorbent in the second bed has been reduced to 16 ml. The polymer:carbon volume ratio in tests F and G was 83:17.

Table 3

Test time (minutes)	Materials	Breakthrough % weight	Working Capacity
E	XAD4/XAD4	10.8	5.3
7	XAD4/SS208C	12.5	5.9
8	XAD4/AC1	11.6	6.0

5

10

As the total bed volume has been reduced from 160 mls to 96 mls the breakthrough times and working capacities in table 3 cannot be compared directly with those shown in table 2.

15

20

25

30

35



## Claims:

1. A canister for attachment to a vehicle fuel tank, said canister comprising a body adapted to receive an adsorbent, and having a gas inlet adapted to be connected to a gasoline storage tank, a gas outlet adapted to be connected to a gasoline engine, and a vent to the atmosphere, is characterised in that the canister contains a bed of adsorbent polymer and a bed of carbon arranged such that the vent opens into the bed of carbon and the gas inlet and gas outlet open into the bed of adsorbent polymer.
2. A canister according to claim 1 wherein the volume ratio of adsorbent between the gasoline vapour inlet and the vent to atmosphere is in the range 3:7 to 7:3.
3. A canister according to Claim 2 wherein the volume ratio is in the range 4:5:5.5 to 5.5:4.5.
4. A canister according to claim 1 wherein the canister contains a relatively large bed of adsorbent polymer and a relatively small bed of carbon.
5. A canister according to anyone of the preceding claims wherein the adsorbent polymer is a particulate macroreticular substantially non-inorganic, water insoluble polymer having a specific surface area in the range 10 to 1000 m<sup>2</sup>/g, a porosity of 25% to 85%, and an average pore diameter of 2 nm to 2000 nm.
6. A canister according to any one of the preceding claims wherein the polymer has a surface area in the range 200 to 2000 m<sup>2</sup>/g and contains pores in the range 1 to 50 nm.
7. A canister according to any one of the preceding claims wherein the total volume of adsorbent is in the range 500 ml to 5 litres.

8. A motor vehicle with a gasoline engine equipped with a canister, which canister is according to any one of the preceding claims.

5 8. A method of adsorbing gasoline vapour from air comprises passing the mixture of air and gasoline vapour through a first bed of adsorbent polymer, and then through a bed of adsorbent carbon, and subsequently regenerating the adsorbent beds by passing a stripping gas first through the bed of adsorbent carbon and then through the bed of adsorbent polymer.

10 10. A process for operating a gasoline engine of a motor vehicle comprises passing air displaced from the fuel tank while refueling the vehicle through a first bed of adsorbent polymer, and then through a bed of an adsorbent carbon so as to adsorb high molecular weight components of the gasoline on the polymer and lower molecular weight components of the gasoline on the carbon, and subsequently  
15 operating the engine so as to draw air through the bed of adsorbent carbon and then through the bed of adsorbent polymer before feeding the air to the engine.

20

25

30

35

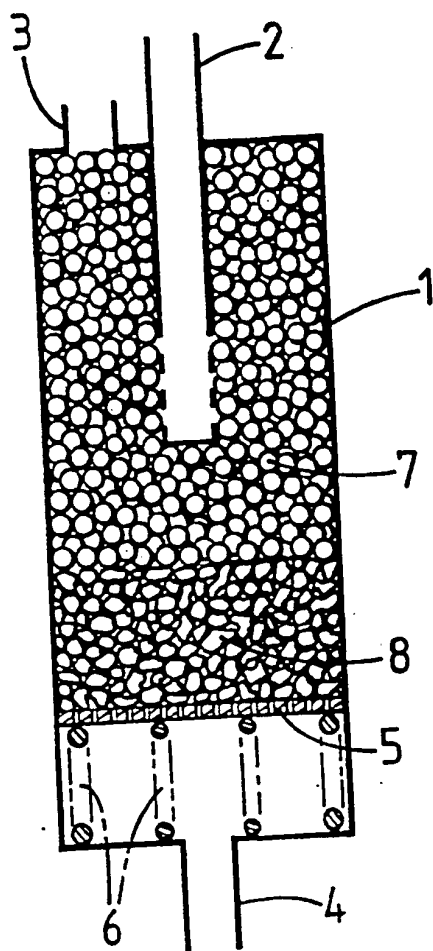

Fig. 1

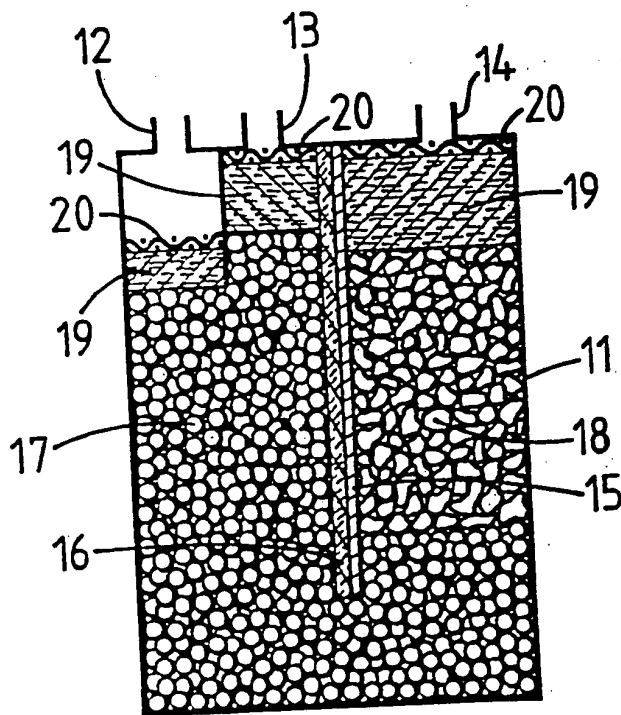

Fig. 2

# INTERNATIONAL SEARCH REPORT

PCT/GB 91/01269

International Application No

<b>I. CLASSIFICATION OF SUBJECT MATTER</b> (If several classification symbols apply, indicate all) <sup>6</sup> According to International Patent Classification (IPC) or to both National Classification and IPC Int.Cl. 5                      B60K15/00 ; F02M25/08																							
<b>II. FIELDS SEARCHED</b> <div style="text-align: right; font-size: small;">Minimum Documentation Searched<sup>7</sup></div> <table border="1" style="width: 100%; border-collapse: collapse;"> <tr> <td style="width: 30%; padding: 5px;">Classification System</td> <td style="padding: 5px;">Classification Symbols</td> </tr> <tr> <td style="padding: 5px;">Int.Cl. 5</td> <td style="padding: 5px;">B60K ; F02M</td> </tr> </table> <div style="text-align: center; font-size: x-small; margin-top: 5px;">Documentation Searched other than Minimum Documentation to the Extent that such Documents are Included in the Fields Searched<sup>8</sup></div>			Classification System	Classification Symbols	Int.Cl. 5	B60K ; F02M																	
Classification System	Classification Symbols																						
Int.Cl. 5	B60K ; F02M																						
<b>III. DOCUMENTS CONSIDERED TO BE RELEVANT<sup>9</sup></b> <table border="1" style="width: 100%; border-collapse: collapse;"> <thead> <tr> <th style="width: 10%; padding: 5px;">Category<sup>10</sup></th> <th style="width: 70%; padding: 5px;">Citation of Document, <sup>11</sup> with indication, where appropriate, of the relevant passages <sup>12</sup></th> <th style="width: 20%; padding: 5px;">Relevant to Claim No.<sup>13</sup></th> </tr> </thead> <tbody> <tr> <td style="text-align: center; vertical-align: top; padding: 5px;">A</td> <td style="padding: 5px;">US,A,4 684 382 (ABU-ISA) 4 August 1987 see the whole document ---</td> <td style="text-align: center; vertical-align: top; padding: 5px;">1-5,8-10</td> </tr> <tr> <td style="text-align: center; vertical-align: top; padding: 5px;">A</td> <td style="padding: 5px;">EP,A,0 330 864 (ADAM OPEL AG) 6 September 1989 see the whole document ---</td> <td style="text-align: center; vertical-align: top; padding: 5px;">1-3,5-8</td> </tr> <tr> <td style="text-align: center; vertical-align: top; padding: 5px;">A</td> <td style="padding: 5px;">US,A,4 308 841 (KINGSLEY) 5 January 1982 see abstract; claim 1; figure 1 see column 3, line 47 - line 56 ---</td> <td style="text-align: center; vertical-align: top; padding: 5px;">1-4,8-10</td> </tr> <tr> <td style="text-align: center; vertical-align: top; padding: 5px;">A</td> <td style="padding: 5px;">GB,A,1 416 336 (ROHM AND HAAS COMPANY) 3 December 1975 cited in the application see claims 1,11 ---</td> <td style="text-align: center; vertical-align: top; padding: 5px;">1,5,6,8, 9</td> </tr> <tr> <td style="text-align: center; vertical-align: top; padding: 5px;">A</td> <td style="padding: 5px;">US,A,3 838 673 (CSICSERY ET AL) 1 October 1974 see the whole document ---</td> <td style="text-align: center; vertical-align: top; padding: 5px;">1,4,8-10</td> </tr> <tr> <td colspan="3" style="text-align: center; padding: 5px;">-/-</td> </tr> </tbody> </table>			Category <sup>10</sup>	Citation of Document, <sup>11</sup> with indication, where appropriate, of the relevant passages <sup>12</sup>	Relevant to Claim No. <sup>13</sup>	A	US,A,4 684 382 (ABU-ISA) 4 August 1987 see the whole document ---	1-5,8-10	A	EP,A,0 330 864 (ADAM OPEL AG) 6 September 1989 see the whole document ---	1-3,5-8	A	US,A,4 308 841 (KINGSLEY) 5 January 1982 see abstract; claim 1; figure 1 see column 3, line 47 - line 56 ---	1-4,8-10	A	GB,A,1 416 336 (ROHM AND HAAS COMPANY) 3 December 1975 cited in the application see claims 1,11 ---	1,5,6,8, 9	A	US,A,3 838 673 (CSICSERY ET AL) 1 October 1974 see the whole document ---	1,4,8-10	-/-		
Category <sup>10</sup>	Citation of Document, <sup>11</sup> with indication, where appropriate, of the relevant passages <sup>12</sup>	Relevant to Claim No. <sup>13</sup>																					
A	US,A,4 684 382 (ABU-ISA) 4 August 1987 see the whole document ---	1-5,8-10																					
A	EP,A,0 330 864 (ADAM OPEL AG) 6 September 1989 see the whole document ---	1-3,5-8																					
A	US,A,4 308 841 (KINGSLEY) 5 January 1982 see abstract; claim 1; figure 1 see column 3, line 47 - line 56 ---	1-4,8-10																					
A	GB,A,1 416 336 (ROHM AND HAAS COMPANY) 3 December 1975 cited in the application see claims 1,11 ---	1,5,6,8, 9																					
A	US,A,3 838 673 (CSICSERY ET AL) 1 October 1974 see the whole document ---	1,4,8-10																					
-/-																							
<div style="font-size: x-small;"> <p>* Special categories of cited documents: <sup>10</sup></p> <p>*A* document defining the general state of the art which is not considered to be of particular relevance</p> <p>*E* earlier document but published on or after the international filing date</p> <p>*L* document which may throw doubts on priority claim(s) or which is cited to establish the publication date of another citation or other special reason (as specified)</p> <p>*O* document referring to an oral disclosure, use, exhibition or other means</p> <p>*P* document published prior to the international filing date but later than the priority date claimed</p> <p>*T* later document published after the international filing date or priority date and not in conflict with the application but cited to understand the principle or theory underlying the invention</p> <p>*X* document of particular relevance; the claimed invention cannot be considered novel or cannot be considered to involve an inventive step</p> <p>*Y* document of particular relevance; the claimed invention cannot be considered to involve an inventive step when the document is combined with one or more other such documents, such combination being obvious to a person skilled in the art.</p> <p>*R* document member of the same patent family</p> </div>																							
<b>IV. CERTIFICATION</b> Date of the Actual Completion of the International Search <div style="text-align: center; font-size: large;">25 OCTOBER 1991</div>		Date of Mailing of this International Search Report <div style="text-align: center; font-size: large;">19. 11. 91</div>																					
International Searching Authority <div style="text-align: center;">EUROPEAN PATENT OFFICE</div>		Signature of Authorized Officer <div style="text-align: center;">S. TOPP-BORN <i>TOPP-BORN</i></div>																					

III. DOCUMENTS CONSIDERED TO BE RELEVANT (CONTINUED FROM THE SECOND SHEET)		Relevant to Claim No.
Category	Citation of Document, with indication, where appropriate, of the relevant passages	
A	US,A,3 844 739 (ALFRY, JR.) 29 October 1974 see the whole document	1,4,8-10
A	US,A,4 289 513 (BROWNHILL ET AL.) 15 September 1981 see column 2, line 41 - column 3, line 36 see column 4, line 66 - column 5, line 15 see column 5, line 61 - column 10, line 47; claims 1-3; figures 1-6	1,5,9,10
A	DE,A,3 842 994 (AUDI AG) 5 July 1990 see the whole document	1,2
A	PATENT ABSTRACTS OF JAPAN vol. 9, no. 103 (M-377)(1826) 8 May 1985 & JP,A,59 226 263 ( TOYOTA ) 19 December 1984 see abstract	1,2

**ANNEX TO THE INTERNATIONAL SEARCH REPORT  
ON INTERNATIONAL PATENT APPLICATION NO.**

GB 9101269  
SA 49947

This annex lists the patent family members relating to the patent documents cited in the above-mentioned international search report. The members are as contained in the European Patent Office EDP file on The European Patent Office is in no way liable for these particulars which are merely given for the purpose of information. 25/10/91

Patent document cited in search report	Publication date	Patent family member(s)	Publication date
US-A-4684382	04-08-87	None	
EP-A-0330864	06-09-89	DE-C- 3806252 JP-A- 1267350	27-07-89 25-10-89
US-A-4308841	05-01-82	None	
GB-A-1416336	03-12-75	US-A- 3805493 US-A- 3798876 CA-A- 990221 DE-A- 2258298 FR-A, B 2162081 JP-C- 979629 JP-A- 48063973 JP-B- 54012429	23-04-74 26-03-74 01-06-76 14-06-73 13-07-73 14-12-79 05-09-73 23-05-79
US-A-3838673	01-10-74	None	
US-A-3844739	29-10-74	None	
US-A-4289513	15-09-81	None	
DE-A-3842994	05-07-90	None	

EPC FORM P047

For more details about this annex : see Official Journal of the European Patent Office, No. 12/82

## PATENT ABSTRACTS OF JAPAN

(11)Publication number : 10-339218  
 (43)Date of publication of application : 22.12.1998

(51)Int.Cl. F02M 25/08

(21)Application number : 09-160677 (71)Applicant : TENNEX:KK  
 HONDA MOTOR CO LTD  
 (22)Date of filing : 04.06.1997 (72)Inventor : NAKANO MASARU  
 WAKASHIRO TERUO  
 YAMAZAKI KAZUMI  
 HARA TAKESHI

### (54) TREATMENT DEVICE OF EVAPORATIVE FUEL

#### (57)Abstract:

**PROBLEM TO BE SOLVED:** To improve fuel-adhesive and withdrawal performances of active carbons used in a treatment device of an evaporative fuel.

**SOLUTION:** An evaporative fuel generated in a fuel tank 9 or the like is introduced into a vessel 3 which constitutes a canister C at the time of an engine stop.

Granular adsorbents 18 of active carbons are packed in the vessel 3. The adsorbents 18 of active carbons are produced by adhering heat accumulating particles 18b comprising a metal or an inorganic material which has a higher heat transfer coefficient comparing with active carbons and a big heat capacity, almost uniformly, on the surface of a granular adsorptive base material 18a comprising active carbons. The evaporative fuel

introduced into the vessel 3 is adsorbed by the active carbons in the adsorbents 18. The heat generated by the active carbons at the time of the adsorption is transferred to the heat accumulating particles 18b, so a temperature rise of the active carbons is suppressed. The fuel adsorbed in the adsorbents 18 is withdrawn by introducing air from an air port 13 into the vessel 3 at an operation time of the engine, and sent to an intake pipe 12 of the engine and

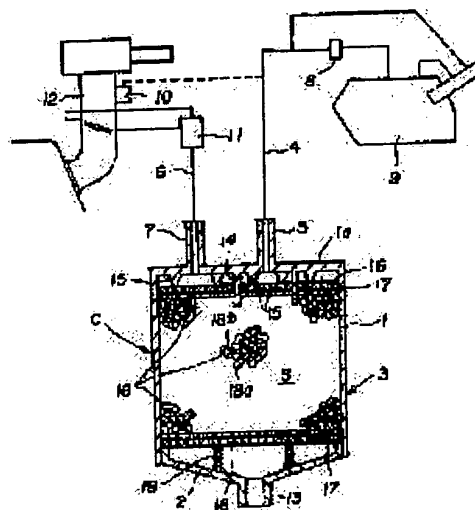

treated. A temperature decline of the active carbons at a withdrawal time of the fuel is prevented by taking away a retained heat of the heat accumulating particles 18b.

---

---

**LEGAL STATUS**

[Date of request for examination] 13.10.2000

[Date of sending the examiner's decision of rejection]

[Kind of final disposal of application other than the examiner's decision of rejection or application converted registration]

[Date of final disposal for application]

[Patent number] 3337398

[Date of registration] 09.08.2002

[Number of appeal against examiner's decision of rejection]

[Date of requesting appeal against examiner's decision of rejection]

[Date of extinction of right]

Copyright (C); 1998,2003 Japan Patent Office



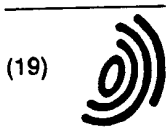

Europäisches Patentamt  
European Patent Office  
Office européen des brevets



(11) EP 1 113 163 A3

(12)

EUROPEAN PATENT APPLICATION

(88) Date of publication A3:  
09.01.2002 Bulletin 2002/02

(51) Int Cl.7: F02M 25/08

(43) Date of publication A2:  
04.07.2001 Bulletin 2001/27

(21) Application number: 00128191.4

(22) Date of filing: 21.12.2000

(84) Designated Contracting States:  
AT BE CH CY DE DK ES FI FR GB GR IE IT LI LU  
MC NL PT SE TR  
Designated Extension States:  
AL LT LV MK RO SI

(72) Inventors:  
• Uchino, Masashi  
Tsurugashima-shi, Saitama 350-2214 (JP)  
• Nakano, Masaru  
Sayama-shi, Saitama 350-1315 (JP)

(30) Priority: 19.12.2000 JP 2000386086  
28.12.1999 JP 37515199

(74) Representative:  
Grünecker, Kinkeldey, Stockmair &  
Schwanhäusser Anwaltssozietät  
Maximilianstrasse 58  
80538 München (DE)

(54) Fuel vapor treatment canister

(57) A fuel vapor treatment canister for controllably storing and releasing fuel vapor from a fuel tank and the like of an automotive vehicle. The fuel vapor treatment canister comprising a casing having first and second end walls between which an inside space is formed. The first end wall has a first opening in communication with a fuel tank, and a second opening in communication with an air intake passage of an engine. The second end wall has a third opening in communication with the atmosphere. The inside space includes first and second cham-

bers. The first chamber is located closer to the first end wall than the second chamber. A partition wall is disposed to divide the inside space into the first and second chambers. The partition wall structure has an air permeability and a heat insulating ability higher than that of metal. A first fuel vapor adsorbing material is disposed in the first chamber. A second fuel vapor adsorbing material and a heat-accumulative material are disposed in the second chamber. The heat-accumulative material is larger in specific heat than the second fuel vapor adsorbing material.

FIG.1A

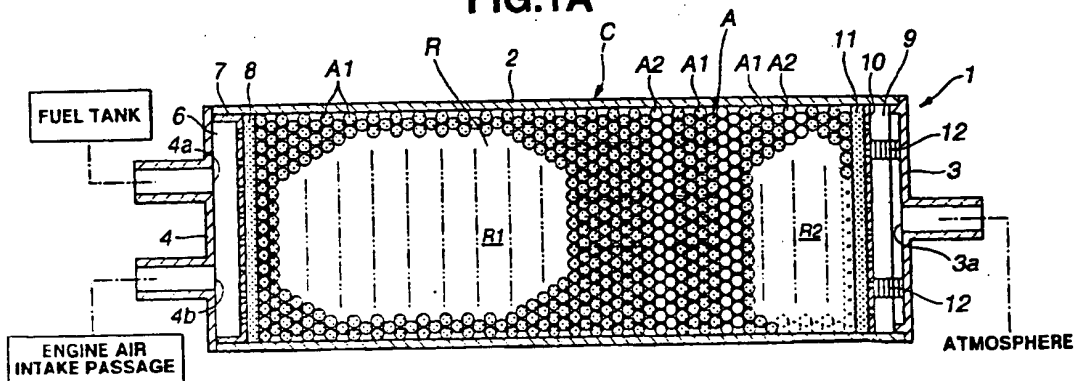

EP 1 113 163 A3

FIG.1B

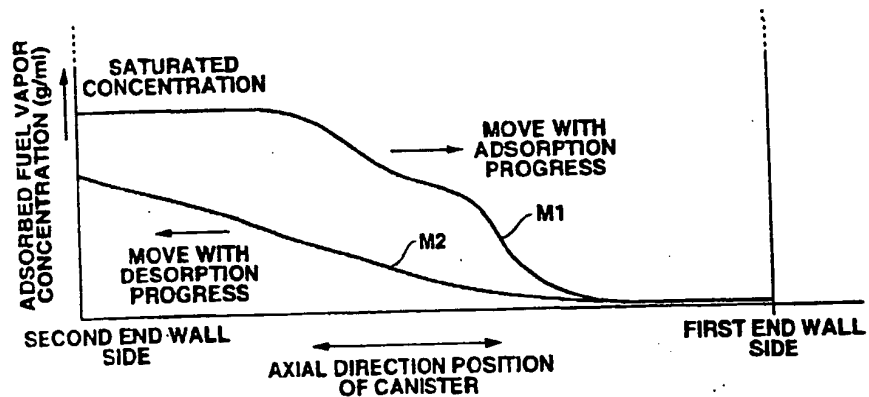

ANNEX TO THE EUROPEAN SEARCH REPORT  
ON EUROPEAN PATENT APPLICATION NO.

EP 00 12 8191

This annex lists the patent family members relating to the patent documents cited in the above-mentioned European search report. The members are as contained in the European Patent Office EDP file on The European Patent Office is in no way liable for these particulars which are merely given for the purpose of information.

15-11-2001

Patent document cited in search report		Publication date	Patent family member(s)	Publication date
US 5914457	A	22-06-1999	JP 9021360 A	21-01-1997
JP 10339218	A	22-12-1998	NONE	
JP 09112356	A	28-04-1997	NONE	
JP 07293365	A	07-11-1995	NONE	
JP 01036961	A	07-02-1989	NONE	
US 5992397	A	30-11-1999	NONE	

EPC FORM 1004/99

For more details about this annex : see Official Journal of the European Patent Office, No. 12/82



Europäisches Patentamt  
European Patent Office  
Office européen des brevets



(11) EP 1 113 163 A2

(12)

EUROPEAN PATENT APPLICATION

(43) Date of publication:  
04.07.2001 Bulletin 2001/27

(51) Int Cl.7: F02M 25/08

(21) Application number: 00128191.4

(22) Date of filing: 21.12.2000

(84) Designated Contracting States:  
AT BE CH CY DE DK ES FI FR GB GR IE IT LI LU  
MC NL PT SE TR  
Designated Extension States:  
AL LT LV MK RO SI

(72) Inventors:  
• Uchino, Masashi  
Tsurugashima-shi, Saitama 350-2214 (JP)  
• Nakano, Masaru  
Sayama-shi, Saitama 350-1315 (JP)

(30) Priority: 28.12.1999 JP 37515199  
19.12.2000 JP 2000386086  
28.12.1999 JP 37515199

(74) Representative: Grünecker, Kinkeldey,  
Stockmair & Schwanhäusser Anwaltssozietät  
Maximilianstrasse 58  
80538 München (DE)

(71) Applicant: Tennex Corporation  
Toshima-ku, Tokyo 171-0022 (JP)

(54) Fuel vapor treatment canister

(57) A fuel vapor treatment canister for controllably storing and releasing fuel vapor from a fuel tank and the like of an automotive vehicle. The fuel vapor treatment canister comprising a casing having first and second end walls between which an inside space is formed. The first end wall has a first opening in communication with a fuel tank, and a second opening in communication with an air intake passage of an engine. The second end wall has a third opening in communication with the atmosphere. The inside space includes first and second cham-

bers. The first chamber is located closer to the first end wall than the second chamber. A partition wall is disposed to divide the inside space into the first and second chambers. The partition wall structure has an air permeability and a heat insulating ability higher than that of metal. A first fuel vapor adsorbing material is disposed in the first chamber. A second fuel vapor adsorbing material and a heat-accumulative material are disposed in the second chamber. The heat-accumulative material is larger in specific heat than the second fuel vapor adsorbing material.

FIG.1A

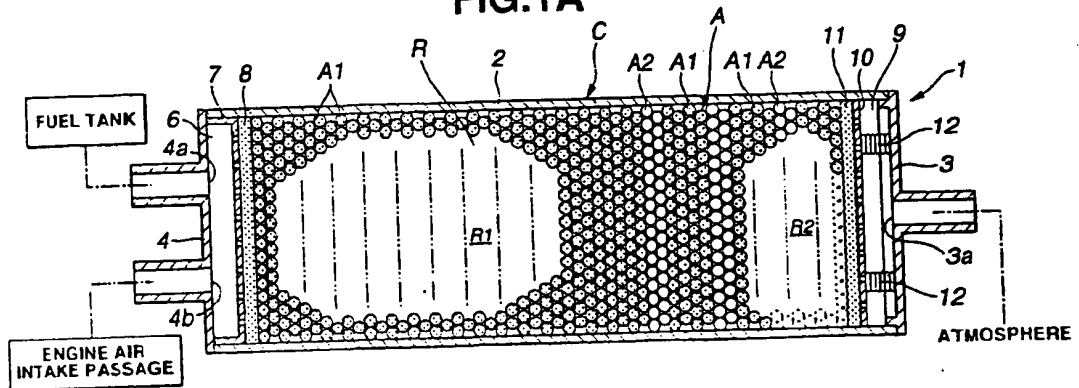

EP 1 113 163 A2

FIG.1B

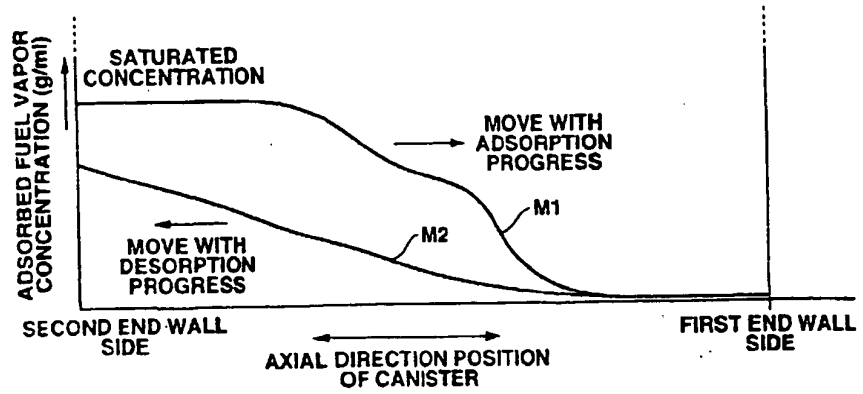

## Description

BACKGROUND OF THE INVENTION1. Field of the Invention

[0001] This invention relates to improvements in a fuel vapor treatment canister which is adapted to temporarily store therein fuel vapor generated in a fuel tank and the like and to release the stored fuel vapor at certain timings to be burnt in an engine in order to reduce the amount of fuel vapor emitted from the fuel tank and the like of a vehicle provided with the engine.

2. Description of the Prior Art

[0002] Hitherto most automotive vehicles are equipped with a fuel vapor treatment canister including fuel vapor adsorbing material (for example, crushed or granulated activated carbon) stored in a casing. Fuel vapor generated from a fuel tank is adsorbed by the fuel vapor adsorbing material, and then the adsorbed fuel vapor is desorbed from the fuel vapor adsorbing material at certain timings and carried to a combustion device (for example, combustion chambers of an engine, or a combustibles-burning device of a vehicle equipped with a fuel cell) under the action of air flowing through the fuel vapor adsorbing material. This prevents fuel vapor from being released into the atmosphere. It will be understood that fuel vapor is generated in the fuel tank, for example, in the following cases:

(a) When an automotive vehicle is allowed to stand, fuel vapor is generated at a high temperature in the daytime under a temperature change between day and night.

(b) When the vehicle is stopped after its cruising (particularly after its high speed cruising), heat of an engine at a high temperature is transmitted to the fuel tank or the like. At this time, the temperature of the fuel tank or the like abruptly rises so that fuel vapor is generated in the fuel tank or the like.

(c) When fuel is supplied into the fuel tank, fuel vapor is generated in the fuel tank.

[0003] A typical example of such a conventional fuel vapor treatment canister is disclosed in Japanese Patent Provisional Publication No. 9-112356 and will be discussed with reference to Fig. 13A.

[0004] The fuel vapor treatment canister 101 includes a casing 102C. The casing 102C includes a cylindrical casing body 102 which is provided at its one end with a first end wall 103, and at the other end with a second end wall 104. The first end wall 103 has a pipe defining therein a communication opening 103a which is in communication with the atmospheric. The second end wall 104 has an upper pipe defining therein a fuel vapor inlet opening 104a which is in communication with a fuel tank

so that fuel vapor is flown in through the opening 104a. The second end wall 104 further has a lower pipe defining therein a fuel vapor outlet opening 104b which is in communication with an air intake passage of an intake system of an internal combustion engine (not shown) so that fuel vapor is flown out through the opening 104b. A perforated dish-like plate 107 is disposed inside the casing body 102 and located adjacent the second end wall 104. The dish-like plate 107 is formed with a plurality of through-holes (not identified) and has a cylindrical flange section (not identified) which is fitted to the inner surface of the casing body 102 and in contact with the second end wall 104 so that a space 106 is defined between the dish-like plate 107 and the second end wall 104. A sheet-like filter 108 formed of a non-woven fabric of polyester or a sheet of polyurethane foam is disposed inside the dish-like plate 107 so as to be in contact with the dish-like plate 107.

[0005] A perforated plate 110 is disposed inside the casing body 102 and located adjacent the first end wall 103. Two compression springs 112, 112 are disposed between the perforated plate 110 and the first end wall 103 so as to define a space 109 inside the casing body 102. A filter 111 similar to the filter 108 is disposed and in contact with the perforated plate 110. A chamber or inside space Ra between the filter 108 and the filter 111. The chamber Ra is filled with a fuel vapor adsorbing material A1a and a heat-accumulative material A2a which is higher in heat conductivity and specific heat than the fuel vapor-adsorbing material A1a which are in a uniformly mixed state.

[0006] In operation, fuel vapor flowing in the canister 101 through the opening 104a is adsorbed by the fuel vapor adsorbing material A1a. At this time, the distribution of concentration of the adsorbed fuel is as shown in Fig. 13B in which the concentration of the fuel vapor is gradually saturated from a side near the second end wall 104 to a side near the first end wall 103. When the adsorption state has reached a level at which fuel vapor is adsorbed by a portion of the fuel vapor adsorbing material A1a located near the first end wall 103, fuel vapor is released in an amount according to the concentration of the adsorbed fuel vapor at the portion through the opening 103a. It is to be noted that heat is generated so as to raise the temperature of the fuel vapor adsorbing material A1a when fuel vapor is adsorbed by the fuel vapor adsorbing material A1a. A fuel vapor amount corresponding to fuel vapor adsorbing ability of the fuel vapor adsorbing material A1a increases as the temperature rises. However, the heat generated by the fuel vapor adsorbing material A1a is absorbed by the heat-accumulative material A2a thereby preventing the temperature of the fuel vapor adsorbing material A1a from rising. This prevents the fuel vapor amount corresponding to the fuel vapor adsorbing ability from being lowered.

[0007] In the intake stroke of an operational cycle of the engine, vacuum is generated in the air intake passage of the engine and transmitted through the opening

104b into the casing 102C. Accordingly, atmospheric air is introduced through the opening 103a into the casing 102C so as to develop air stream toward the opening 104b. Under the action of this air stream, fuel vapor (hydrocarbons) adsorbed by the fuel vapor adsorbing material A1a is desorbed and sucked through the opening 104b and the air intake passage into the engine to be combusted in the engine.

[0008] As shown in Fig. 14A, during desorption of the fuel vapor adsorbed by the fuel vapor adsorbing material A1a after fuel vapor adsorption indicated in Fig. 13B, the concentration of the adsorbed fuel vapor (or a fuel vapor residual level) takes a mode indicated by curves V1 which indicates the case where the fuel vapor adsorbing material A1a and the heat-accumulative material A2a are disposed in the chamber Ra. For reference, a curve V2 indicates a case where only the fuel vapor adsorbing material A1a such as activated carbon is disposed in the chamber Ra.

[0009] Additionally, as shown in Fig. 14B, during adsorption of fuel vapor by the fuel vapor adsorbing material A1a after fuel vapor desorption of Fig. 14A, the concentration of the adsorbed fuel vapor takes a mode indicated by a curve V3 which indicates the case where the fuel vapor adsorbing material A1a and the heat-accumulative material A2a are disposed in the chamber Ra. For reference, a curve V4 indicates a case where only the fuel vapor adsorbing material A1a such as activated carbon is disposed in the chamber Ra. Fig. 14B reveals that the fuel vapor residual level (the concentration of the adsorbed fuel vapor) at the respective positions in an axial direction of the canister is low in the case where the fuel vapor adsorbing material A1a and the heat-accumulative material A2a are disposed in the chamber Ra as compared with that in the case where only the fuel vapor adsorbing material A1a is disposed in the chamber Ra. This is because, in case that the fuel vapor adsorbing material A1a and the heat-accumulative material A2a are disposed in the chamber Ra, heat accumulated in the heat-accumulative material A2a is transmitted to the fuel vapor adsorbing material A1a during desorption of fuel vapor from the fuel vapor adsorbing material A1a, so that the temperature of the fuel vapor adsorbing material A1a is prevented from lowering thereby increasing the amount of fuel vapor desorbed from the fuel vapor adsorbing material A1a.

[0010] It will be understood that, in Fig. 14B, the difference between the concentration of adsorbed fuel vapor and the fuel vapor residual level at the side of the first end wall corresponds to the amount of fuel vapor desorbed from the fuel vapor adsorbing material A1a. Fig. 14B also reveals that the amount of fuel vapor adsorbed by the fuel vapor adsorbing material A1a at the respective positions in the flow direction of air and fuel vapor in the chamber R1a is large in the case where the fuel vapor adsorbing material A1a and the heat-accumulative material A2a are disposed in the chamber R as compared with that in the case where only the fuel

vapor adsorbing material A1a is disposed in the chamber Ra. As a result, the amount of fuel vapor released from the canister to the atmosphere increases at a time when the amount of fuel vapor adsorbed by the fuel vapor adsorbing material A1a is not so large, in the case where only the fuel vapor adsorbing material A1a is disposed in the chamber Ra as compared with that in case where the fuel vapor adsorbing material A1a and the heat-accumulative material A2a are disposed in the chamber Ra. This is because, in case where only the fuel vapor adsorbing material A1a is disposed in the chamber Ra, the temperature of the fuel vapor adsorbing material A1a increases owing to heat generation at adsorption of fuel vapor to the fuel vapor adsorbing material A1a thereby decreasing the fuel vapor amount corresponding to the fuel vapor adsorbing ability.

[0011] As appreciated from the above, it may be advantageous to use the fuel vapor adsorbing material A1a and the heat-accumulative material A2a in the chamber Ra in order that adsorption and desorption of fuel vapor in the canister is required to be quickly accomplished.

#### SUMMARY OF THE INVENTION

[0012] However, drawbacks have been encountered in the above conventional fuel vapor treatment canister, as discussed below. For example, when the engine is started and is operated at high speeds upon depression of an accelerator pedal under a condition in which a large amount of fuel vapor has been adsorbed in the fuel vapor adsorbing material in the canister provided with the fuel vapor adsorbing material and the heat-accumulative material in the whole inside space or chamber (Ra) thereof, fuel vapor adsorbed in the fuel vapor adsorbing material is abruptly desorbed from the fuel vapor adsorbing material. At this time, the fuel vapor adsorbing material makes its temperature lowering owing to rapid desorption of fuel vapor from the fuel vapor adsorbing material; however, the temperature lowering can be suppressed upon receiving heat released from the heat-accumulative material. Accordingly, in case that the heat-accumulative material is used mixed with the fuel vapor adsorbing material, the temperature of the fuel vapor adsorbing material can be kept high as compared with a case in which the heat-accumulative material does exist. As a result, a large amount of fuel vapor is abruptly desorbed so as to increase the fuel vapor concentration of intake air to be sucked into the combustion chambers of the engine. This invites disorder of the engine or ineffective combustion within the combustion chambers due to suction of excessive fuel (hydrocarbons) thereby releasing unburned combustion gas (hydrocarbons) into the atmosphere. Japanese Patent Provisional Publication No. 9-112356 discloses also a fuel vapor treatment canister which contains the fuel vapor adsorbing material in the form of a layer and the heat-accumulative material in the form of a layer, in which the

two layers are disposed alternate to each other. Such a conventional fuel vapor treatment canister also provides the same disadvantages as those in the above-discussed fuel vapor treatment canister shown in Fig. 13A.

[0013] In view of the above, it is an object of the present invention to provide an improved fuel vapor treatment canister which can overcome drawbacks encountered in conventional fuel vapor treatment canisters including ones disclosed in Japanese Patent Provisional Publication No. 9-112356.

[0014] Another object of the present invention is to provide an improved fuel vapor treatment canister which can effectively prevent an engine from becoming disordered and unburned hydrocarbons from being emitted to the atmosphere while increasing its fuel vapor adsorbing ability, thereby totally reducing emission of hydrocarbons to the atmosphere.

[0015] A further object of the present invention is to provide an improved fuel vapor treatment canister which can effectively prevent a large amount of fuel vapor from being abruptly sucked into an engine while increasing the amount of a fuel vapor adsorbing material disposed in the canister without enlarging the size of the canister.

[0016] A still further object of the present invention is to provide an improved fuel vapor treatment canister having a fuel vapor adsorption chamber and a heat accumulation and fuel vapor adsorption chamber, which is adapted to prevent heat generated in the fuel vapor adsorption chamber from being transmitted to the heat accumulation and fuel vapor adsorption chamber thereby preventing lowering in fuel vapor retaining ability of the fuel vapor adsorbing material in the heat accumulation and fuel vapor adsorption chamber which lowering is owing to temperature rise of the fuel vapor adsorbing material in the heat accumulation and fuel vapor adsorption chamber.

[0017] An aspect of the present invention resides in a fuel vapor treatment canister comprising a casing arrangement having first and second end walls between which first and second chambers are formed. The first end wall has a portion defining a first opening in communication with a fuel tank, and a portion defining a second opening in communication with an air intake passage of an engine. The second end wall has a portion defining a third opening in communication with atmosphere. The first chamber is located closer to the first end wall than the second chamber. A first fuel vapor adsorbing material is disposed in the first chamber, while a second fuel vapor adsorbing material and a heat-accumulative material are disposed in the second chamber. The heat-accumulative material is larger in specific heat than the second fuel vapor adsorbing material.

[0018] A second aspect of the present invention resides in a fuel vapor treatment canister comprising a casing having first and second end walls between which an inside space is formed. The first end wall has a portion defining a first opening in communication with a fuel tank, and a portion defining a second opening in communication with an air intake passage of an engine. The second end wall has a portion defining a third opening in communication with atmosphere. The inside space is formed between the first and second end walls. The first chamber is located closer to the first end wall than the second chamber. A first fuel vapor adsorbing material is disposed in the first chamber, while a second fuel vapor adsorbing material and a heat-accumulative material are disposed in the second chamber. The heat-accumulative material is larger in specific heat than the second fuel vapor adsorbing material.

[0019] A third aspect of the present invention resides in a fuel vapor treatment canister comprising a casing having first and second end walls between which an inside space is formed. The first end wall has a portion defining a first opening in communication with a fuel tank, and a portion defining a second opening in communication with an air intake passage of an engine. The second end wall has a portion defining a third opening in communication with atmosphere. The inside space includes first and second chambers. The first chamber is located closer to the first end wall than the second chamber. A first fuel vapor adsorbing material is disposed in the first chamber, while a second fuel vapor adsorbing material and a heat-accumulative material are disposed in the second chamber. The heat-accumulative material is larger in specific heat than the second fuel vapor adsorbing material.

[0020] A fourth aspect of the present invention resides in a fuel vapor treatment canister comprising a first casing having first and second end walls between which a first chamber is formed. The first end wall has a portion defining a first opening in communication with a fuel tank, and a portion defining a second opening. Additionally, a second casing is provided having third and fourth end walls between which a second chamber is formed. The third end wall has a portion defining a third opening in communication with the second opening of the first casing. The fourth end wall has a portion defining a fourth opening in communication with atmosphere. A first fuel vapor adsorbing material is disposed in the first chamber, while a second fuel vapor adsorbing material and a heat-accumulative material are disposed in the second chamber. The heat-accumulative material is larger in specific heat than the second fuel vapor adsorbing material.

[0021] In the drawings, like reference numerals designate like parts and elements throughout all figures, in which:

#### BRIEF DESCRIPTION OF THE DRAWINGS

[0021] In the drawings, like reference numerals designate like parts and elements throughout all figures, in which:

Fig. 1A is a longitudinal cross-sectional view of a



7

first embodiment of a fuel vapor treatment canister according to the present invention;  
 Fig. 1B is a graph showing the concentration of fuel vapor adsorbed in the canister of Fig. 1A in terms of the axial direction positions of the canister;  
 Fig. 2A is a longitudinal cross-sectional view of a second embodiment of the fuel vapor treatment canister according to the present invention;  
 Fig. 2B is a graph showing the concentration of fuel vapor adsorbed in the canister of Fig. 2A in terms of the axial direction positions of the canister;  
 Fig. 3 is a longitudinal cross-sectional view of a third embodiment of the fuel vapor treatment canister according to the present invention;  
 Fig. 4 is a cross-sectional view taken in the direction of arrows substantially along the line IV-IV of Fig. 3;  
 Fig. 5 is a cross-sectional view taken in the direction of arrows substantially along the line V-V of Fig. 3;  
 Fig. 6 is a cross-sectional view taken in the direction of arrows substantially along the line VI-VI of Fig. 5;  
 Fig. 7 is a longitudinal cross-sectional view of a fourth embodiment of the fuel vapor treatment canister according to the present invention;  
 Fig. 8 is a longitudinal cross-sectional view of a fifth embodiment of the fuel vapor treatment canister according to the present invention;  
 Fig. 9 is a longitudinal cross-sectional view of a sixth embodiment of the fuel vapor treatment canister according to the present invention;  
 Fig. 10 is a longitudinal cross-sectional view of a seventh embodiment of the fuel vapor treatment canister according to the present invention;  
 Fig. 11 is a longitudinal cross-sectional view of an eighth embodiment of the fuel vapor treatment canister according to the present invention;  
 Fig. 12 is a longitudinal cross-sectional view of a ninth embodiment of the fuel vapor treatment canister according to the present invention;  
 Fig. 13A is a longitudinal cross-sectional view of a conventional fuel vapor treatment canister;  
 Fig. 13B is a graph showing the concentration of fuel vapor adsorbed in the canister in terms of the axial direction positions of the canister of Fig. 13A;  
 Fig. 14A is a graph showing the concentration of fuel vapor adsorbed (or a fuel vapor residual level) in the canister in terms of the axial direction positions of the canister of Fig. 13A during desorption of fuel vapor; and  
 Fig. 14B is a graph showing the concentration of fuel vapor adsorbed in the canister axial direction positions in the canister of Fig. 13A during adsorption of fuel vapor.

#### DETAILED DESCRIPTION OF THE INVENTION

[0022] Referring now to Fig. 1A of the drawings, a first embodiment of an fuel vapor treatment canister is illustrated by the reference numeral 1. The canister 1 of this

embodiment is for an automotive vehicle and comprises a casing C formed of a plastic such as nylon or polypropylene. The casing C includes a casing body 2 having a circular cross-section. The casing body 2 is provided at its one end (right-side end in Fig. 1A) with a first end wall 3, and at the other end (left-side end in Fig. 1A) with a second end wall 4. The first end wall 3 has a pipe defining therein a communication opening 3a which is in communication with atmospheric air. The second end wall 4 has an upper pipe defining therein a fuel vapor inlet opening 4a which is in communication with a fuel tank so that fuel vapor is flown in through the opening 4a. The second end wall 4 further has a lower pipe defining therein a fuel vapor outlet opening 4b which is in communication with an air intake passage of an intake system of an internal combustion engine (not shown) so that fuel vapor is flown out through the opening 4b. It will be understood that intake air to be sucked into the engine flows through the air intake passage. Each of the first and second end walls 3, 4 is fixed to the casing 2 by means of vibration-welding.

[0023] A perforated dish-like plate 7 is disposed inside the casing body 2 and located adjacent the second end wall 4. The dish-like plate 7 is formed at its main body section with a plurality of through-holes (not identified) and has a cylindrical flange section (not identified) which is fitted to the inner surface of the casing body 2 and in contact with the second end wall 4 so that a space 6 is defined between the main body section (formed with the through-holes) of the dish-like plate 7 and the second end wall 4. A circular sheet-like filter 8 is formed of non-woven fabric of polyester and is disposed inside the dish-like plate 7 so as to be in contact with the main body section of the dish-like plate 7.

[0024] A circular perforated plate 10 formed of plastic is disposed inside the casing body 2 and located adjacent the first end wall 3 in such a manner that the periphery of the perforated plate 10 is in contact with the inner surface of the casing body 2. Two compression springs 12, 12 are disposed between the perforated plate 10 and the first end wall 3 so as to define a space 9 inside the casing body 2. A filter 11 similar to the filter 8 is disposed inside and in contact with the perforated plate 10. A chamber or inside space R between the filter 8 and the filter 11. The chamber R includes a vapor adsorption chamber R1 and a heat accumulation and vapor adsorption chamber R2. It will be understood that the volume of the chamber R2 is smaller than that of chamber R1.

[0025] The vapor adsorption chamber R1 is filled with a fuel vapor adsorbing material A1 formed of activated carbon particles. The heat accumulation and vapor adsorption chamber R2 is filled with a heat-accumulative and fuel vapor adsorbing material A which includes a fuel vapor adsorbing material A1 and a heat-accumulative material A2 which is higher in heat conductivity and specific heat than the fuel vapor-adsorbing material A1. In this embodiment, the fuel vapor adsorbing (granular)

material A1 and the heat-accumulative (granular) material A2 are respectively formed into circular layers and located alternate in the axial direction of the casing body 2 so that the vapor adsorbing material A1 is located between the layers of the heat-accumulative material A2. In other words, the heat-accumulative and fuel vapor adsorbing material A is constituted of alternate layers of the fuel vapor adsorbing material A1 and the heat-accumulative material A2. Each of the layers of the fuel vapor adsorbing material A1 and the heat-accumulative material A2 has its periphery in contact with the inner surface of the casing body 2 and extends perpendicular to the axis of the casing body 2. Examples of the heat-accumulative material A2 are aluminum, aluminum alloy, ceramic such as alumina, and stainless steel.

[0026] The perforated plate 10 is pressed leftward in Fig. 1A by the compression springs 12, 12 seated on the first end wall 3, and therefore the fuel vapor adsorbing material A1 and the heat-accumulative material A2 are kept in a tightly filled state under the bias of the compression springs 12, 12, in which the materials A1, A2 are pressed toward the perforated plate 7 at the side of the second end wall 4. A ratio in volume between the vapor adsorption chamber R1 and the heat accumulation and vapor adsorption chamber R2 is decided in accordance with kind, size, displacement, operating conditions and the like of the engine for the vehicle to which the fuel vapor treatment canister 1 is installed.

[0027] The manner of operation of the fuel vapor treatment canister 1 will be discussed.

[0028] Fuel vapor from the fuel tank is flown through the fuel vapor inlet opening 4a into the space 6 and then introduced through the dish-like plate 7 and the filter 8 into the vapor adsorption chamber R1 and the heat accumulation and vapor adsorption chamber R2 so that fuel vapor is adsorbed by the fuel vapor adsorbing material A1. In this case, fuel vapor is first adsorbed by the fuel vapor adsorbing material A1 located at a left-side (side of the second end wall 4) portion of the chamber R1 and then gradually adsorbed by the fuel vapor adsorbing material A1 located at a right-side (side of the first end wall 3) portion of the chamber R1.

[0029] Accordingly, as shown in Fig. 1B, a saturated portion (saturated with fuel vapor) of the fuel vapor adsorbing material A1 moves rightward or toward the first end wall 3 as adsorption of fuel vapor proceeds. More specifically, at the initial period of a process of fuel vapor adsorption, the fuel vapor adsorbing material A1 located near the first end wall 3 does not participate to fuel vapor adsorption; however, as the fuel vapor adsorption proceeds, the fuel vapor adsorbing material A1 gradually becomes participant to fuel vapor adsorption. When fuel vapor reaches the fuel vapor adsorbing material A1 located near the first end wall 3, fuel vapor can be released to the atmosphere even though the fuel vapor adsorption is not in a saturated state. Then, as fuel vapor adsorption in the fuel vapor adsorbing material A1 located near the first end wall 3 proceeds, release of fuel va-

por from the canister 1 gradually increases.

[0030] Within the heat accumulation and vapor adsorption chamber R2, the fuel vapor adsorbing material A1 and the heat-accumulative material A2 are alternately located. The heat-accumulative material A2 adsorbs heat generated from the fuel vapor adsorbing material A1 during adsorption of fuel vapor by the fuel vapor adsorbing material A2, thereby softening temperature rise of the fuel vapor adsorbing material A1 itself. This suppresses lowering in fuel vapor adsorbing ability of the fuel vapor adsorbing material A1. Consequently, fuel vapor which flows in from the side of the second end wall 4 can be effectively absorbed by the fuel vapor adsorbing material A1, thereby preventing fuel vapor (not adsorbed) from being released through the communication opening 3a to the atmosphere.

[0031] Additionally, when fuel vapor is released from the canister 1 under a condition where the fuel vapor has been adsorbed in the fuel vapor adsorbing material A1 within the vapor adsorption chamber R1 and the heat accumulation and vapor adsorption chamber R2, the fuel vapor is desorbed from the fuel vapor adsorbing material A1 under the influence of air flow from the communication opening 3a. At this time, owing to the heat releasing action of the heat-accumulative material A2 within the heat accumulation and vapor adsorption chamber R2, a temperature lowering of the fuel vapor adsorbing material A1 due to fuel vapor desorption from the fuel vapor adsorbing material A1 can be softened or suppressed. As a result, desorption of fuel vapor adsorbed in the fuel vapor adsorbing material A1 can be effectively accomplished, so that a desorption temperature (at which fuel vapor is desorbed from the fuel vapor adsorbing material A1) of the fuel vapor adsorbing material A1 is kept at a high level as compared with a case where only the fuel vapor adsorbing material A1 is stored in the chamber R of the canister 1, thus lowering a vapor residual level (at which fuel vapor remains not-desorbed in the fuel vapor adsorbing material A1).

[0032] Subsequently, when the thus desorbed fuel vapor flows toward the second end wall 4, it passes through the fuel vapor adsorbing material A1 within the vapor adsorption chamber R1. Here, only fuel vapor adsorbing material A1 is stored in the chamber R1, and therefore a temperature lowering is made in the fuel vapor adsorbing material A1 under desorption of fuel vapor from the fuel vapor adsorbing material A1 thereby increasing a fuel vapor adsorbing ability of the fuel vapor adsorbing material A1. This maintains a high vapor residual level, so that abrupt release of adsorbed fuel vapor cannot be made. It will be understood that abrupt desorption of fuel vapor from the chamber R2 is buffered during passage of the chamber R1, so that a change in concentration of fuel vapor to be sucked into the engine can be moderated.

[0033] As appreciated from the above, when air containing fuel vapor flows from the side of the second end wall 4 to the side of the first end wall 3 so that fuel vapor

is adsorbed in the canister 1, distribution of concentration of fuel vapor within the chamber R takes a mode indicated by a curve M1 as shown in Fig. 1B. It will be understood that the mode indicated by the curve M1 moves rightward in Fig. 1A or toward the first end wall 3 as adsorption of fuel vapor proceeds. When air introduced through the opening 3a flows from the side of the first end wall 3 to the side of the second end wall 4 so that fuel vapor adsorbed in the canister 1 is released from the canister, the distribution of concentration of fuel vapor within the chamber R takes a mode indicated by a curve M2. It will be understood that the mode indicated by the curve M2 moves leftward in Fig. 1 or toward the second end wall 3 as release of fuel vapor proceeds. The above-mentioned concentration means the weight of vapor (g) adsorbed per one ml of the fuel vapor adsorbing material A1.

[0034] In the fuel vapor treatment canister 1 of this embodiment, a gas-permeable partition wall (not shown) may be provided between the chambers R1 and R2, in which the partition wall is formed of a circular and porous metal, plastic or non-woven sheet. The partition wall is formed of a material having a low or high heat insulating ability.

[0035] Fig. 2A illustrates a second embodiment of the fuel vapor treatment canister 1 according to the present invention, which is similar to the first embodiment with the following exception: A circular sheet-like filter 14 similar to that 8 is disposed in the chamber R in such a manner that its periphery is in contact with the inner surface of the casing body 2. The sheet-like filter 14 divides the chamber R into the vapor adsorption chamber R1 and the heat accumulation and vapor adsorption chamber R2. The sheet-like filter 14 serving as a partition wall is thin and therefore is low in heat insulating ability.

[0036] In operation, heat generated within the fuel vapor adsorption chamber R1 during adsorption of fuel vapor is difficult to be transmitted to the heat accumulation and fuel vapor adsorption chamber R2 since the chambers R1, R2 are divided by the partition wall 14 having air permeability and heat insulating ability. Accordingly, when air containing fuel vapor introduced through the opening 4a flows from the side of the second end wall 4 to the side of the first end wall 1, the temperature within the chamber R1 is kept lower than that in case of the first embodiment. Consequently, as indicated by a mode indicated by a curve M3 in Fig. 2B, the fuel vapor adsorbing material A1 within the chamber R2 adjacent the filter 14 can adsorb much fuel vapor during adsorption of fuel vapor as compared with that (indicated by a dotted line in Fig. 2B) in case of the first embodiment. Additionally, when air introduced through the opening 3a flows from the side of the first end wall 3 and the side of the second end wall 4, the temperature within the chamber R2 adjacent the filter 14 is kept higher than that in case of the first embodiment. Consequently, as indicated by a mode indicated by a curve M4 in Fig. 2B, the fuel vapor adsorbing material A within the chamber R2

adjacent the filter 14 can desorb much fuel vapor during desorption of fuel vapor as compared with that (indicated by a dotted line in Fig. 2B) in case of the first embodiment. It will be understood that the same effects as those in the first embodiment can be obtained.

[0037] Figs. 3 to 6 illustrate a third embodiment of the fuel vapor treatment canister 1 according to the present invention, similar to the first embodiment generally with the exception that another vapor adsorption chamber R1A is formed in communication with the vapor adsorption chamber R1 and located parallel with the vapor adsorption chamber R1 and the heat accumulation and fuel vapor adsorption chamber R2. In this embodiment, the casing C and a casing C1 are formed of the same material as that of the casing C of the first embodiment. The casing C and the casing C1 are located parallel with each other and have a rectangular cross-section. The casing C and the casing C1 are fixedly connected with each other through a connecting wall 2c and an end connecting wall 2d. Additionally, the casing body 2 of the casing C and the casing body 2A of the casing C1 extend leftward over the end connecting wall 2d to form an extended section 2e. The cross-sectional area of the inside space of the casing body 2A is about 2 times of that of the casing body 2 as shown in Fig. 4.

[0038] The casing C1 includes the second end wall 4 which is located adjacent the first end wall 3. In this embodiment, the two compression springs 12, 12 are disposed between the second end wall 4 and the plate 7. The first and second end walls 3, 4 are respectively fixed to the casing body 2 and the casing body 2A by welding.

[0039] A bottom end wall 18 is fixed to the extended section 2e of the casing body 2 and the casing body 2A. The bottom end wall 18 is rectangular and formed with a plurality of embossments 19 having a rectangular cross-section. The embossments 19 are separate from each other to form a gas passage 20. A rectangular sheet-like filter 16 is disposed inside the extended section 2e in such a manner that its periphery is in contact with the inner surface of the extended section 2e. The filter 16 is supported by the embossments 19 of the bottom end wall 18 so as to contact with the end connecting wall 2d.

[0040] The fuel vapor adsorbing material A1 is filled in the fuel vapor adsorption chamber R1A defined between the filter 8 and the filter 16. Also in this embodiment, the fuel vapor adsorbing material A1 is filled in the fuel vapor adsorption chamber R1 defined between the filter 14 and the filter 16. The fuel vapor adsorption chambers R1, R1A are communicated with each other through the filter 16 and the gas passage 20.

[0041] It will be understood that, in this embodiment, the first and second end walls 3, 4, the plates 7, 10 and the filters 8, 11 and 14 are rectangular so that their peripheries are in contact with the inner surfaces of the casing bodies 2, 2A having the rectangular cross-section.

[0042] The manner of operation of the fuel vapor treat-

ment canister of the third embodiment will be discussed.

[0043] Fuel vapor generated in the fuel tank flows through the opening 4a, the fuel vapor adsorption chamber R1A, the gas passage 20, the fuel vapor adsorption chamber R1 in the order mentioned and reaches the heat accumulation and fuel vapor adsorption chamber R2. Accordingly, during adsorption of fuel vapor, flowing fuel vapor is adsorbed successively in the fuel vapor adsorbing material A1 located on the upstream side and the fuel vapor adsorbing material A1 on the downstream side relative to flow of fuel vapor.

[0044] In this embodiment, similarly to the first embodiment, the fuel vapor adsorbing material A1 and the heat-accumulative material A2 are stored in the heat accumulation and fuel vapor adsorption chamber R2 located adjacent the first end wall 3, and therefore the same effects as those in the first embodiment can be obtained during adsorption of fuel vapor and during desorption of fuel vapor.

[0045] Additionally the total space including the fuel vapor adsorption chambers R1, R1A is larger than the space of the heat accumulation and fuel vapor adsorption chamber R2 storing the fuel adsorbing material A1 and the heat-accumulative material A2, and therefore the amount of the heat-accumulative material A2 is less while the fuel vapor adsorbing material A1 are more in the whole chamber R similarly to in the first embodiment. As a result, it is made possible to absorb a large amount of fuel vapor which gradually evaporates in and flows into the canister 1 under temperature difference between day and night during a long period of time.

[0046] Fig. 7 illustrates a fourth embodiment of the fuel vapor treatment canister according to the present invention, which is similar to the second embodiment with the exception that the filter 14 as the partition wall is replaced with a partition wall arrangement S including two filters 14, 14 and an air chamber forming member 21.

[0047] In this embodiment, the chamber R is divided into the fuel vapor adsorption chamber R1 and the heat accumulation and fuel vapor adsorption chamber R2 by the partition wall arrangement S. The partition wall arrangement S includes the air chamber forming member 21 which is formed of the same plastic as that of the casing body 2. The air chamber forming member 21 includes a pair of perforated walls 21a, 21b which are disposed respectively on the side of the chamber R1 and the side of the chamber R2. The perforated walls 21a, 21b are spaced from each other by a space maintaining member 21c located between and integral with the perforated walls 21a, 21b. Each perforated wall 21a, 21b is formed with a plurality of openings through which air passes. The two filters 14, 14 are located respectively in contact with the perforated walls 21a, 21b in such a manner that the air chamber forming member 21 is located between the filters 14, 14. In other words, the chamber R1 and the chamber R2 are divided by the partition wall arrangement S having heat insulating ability and air permeability, while the chamber R1 and the

chamber R2 are divided by the filter 14 in the second embodiment.

[0048] In a conventional case that a sufficient amount of air for desorbing fuel vapor adsorbed in the canister 1 cannot be supplied through the opening 3a of the first end wall 3 in view of controlling engine exhaust gas, fuel vapor in an amount over a standard level is released through the opening 3a to the atmosphere. This is assumed to be caused from the following fact: Heat generated by adsorption of fuel vapor in the fuel adsorption chamber R1 during adsorption of fuel vapor is transmitted to the heat accumulation and fuel vapor adsorption chamber R2 thereby raising the temperature of the heat adsorbing material A1 in the chamber R2 so as to lower the fuel vapor retaining ability. As a result, fuel vapor remaining in the fuel vapor adsorbing material A1 within the chamber R1 and the chamber R2 is desorbed and released through the opening 3a when the amount of air for desorbing fuel vapor is insufficient.

[0049] However, in the fuel vapor treatment canister of this embodiment, the partition wall arrangement S possessing heat insulating ability and air permeability is disposed between the chamber R1 and the chamber R2 so as to allow gas to flow between the chamber R1 and the chamber R2 but to prevent heat from being transmitted between the chamber R1 and the chamber R2. Consequently, the temperature of the fuel vapor adsorbing material A1 within the chamber R2 can be prevented from rising while preventing the fuel vapor adsorbing material A1 within the chamber R2 from lowering in fuel vapor retaining ability. As a result, fuel vapor remaining in the fuel vapor adsorbing material A1 within the chamber R1 and the chamber R2 can be prevented from releasing through the opening 3a of the first end wall 3 in the event that the amount of air for desorbing fuel vapor is insufficient.

[0050] Fig. 8 illustrates a fifth embodiment of the fuel vapor treatment canister 1 according to the present invention, which is similar to the first embodiment with the exception that the heat accumulation and fuel vapor adsorption chamber R2 filled with the fuel vapor adsorbing material A1 and the heat-accumulative material A2 is removed from the casing C and formed in another casing C2 which is independent from the casing C.

[0051] In this embodiment, the casing C is formed with only the fuel vapor adsorption chamber R1 which is defined between the filter 8 and the filter 11 and filled with the fuel vapor adsorbing material A1. The casing C2 includes a casing body 2B which is provided with a first end wall 25 and a second end wall 26. The first end wall 25 is fixed to one (left-side) end of the casing body 2B and has a pipe defining a communication opening 25a which is in communication with the opening 3a of the first end wall 3 of the casing C through a pipe 27. The second end wall 26 is fixed to the other (right-side) end of the casing body 2B and has a pipe defining a communication opening 26a which is in communication with the atmosphere. The perforated plate 10 and the filter

11 are disposed adjacent the first end wall 25 in such a manner as to define a space between the perforated plate 10 and the first end wall 25. The peripheries of the perforated plate 10 and the filter 11 are in contact with the inner surface of the casing body 2B. Additionally, the perforated plate 7 and the filter 8 are disposed adjacent the second end wall 26 in such a manner as to define a space between the perforated plate 7 and the second end wall 26. The peripheries of the perforated plate 7 and the filter 8 are in contact with the inner surface of the casing body 2B. The heat accumulation and fuel vapor adsorption chamber R2 is defined between the filter 8 and the filter 11 and inside the casing body 2B. The chamber R2 is filled with the fuel vapor adsorbing material A1 and the heat-accumulative material A2 which are formed into the form of a layer and located alternate to each other.

[0052] In operation, since the casing C defining therein the chamber R1 and the casing C2 defining therein the chamber R2 are provided separate from each other, heat transmission between the chamber R1 and the chamber R2 can be prevented. Consequently, fuel vapor remaining in the fuel vapor adsorbing material A1 within the chamber R1 and the chamber R2 can be prevented from releasing through the communication opening 26a in case that the amount of air for desorbing fuel vapor is insufficient, similarly to in the fourth embodiment.

[0053] Fig. 9 illustrates a sixth embodiment of the fuel vapor treatment canister 1 according to the present invention, which is similar to the third embodiment with the exception that the filter 14 for separating the heat accumulation and fuel vapor adsorption chamber R2 from the fuel vapor adsorption chamber R1 has a thickness considerably larger than that of the filter 14 in the third embodiment. Thus, the filter 14 of this embodiment serves as a partition wall having heat insulating ability and air permeability. This can prevent heat transmission from the fuel vapor adsorption chamber R1 to the heat accumulation and fuel vapor adsorption chamber R2. Consequently, fuel vapor remaining in the fuel vapor adsorbing material A1 within the chamber R1 and the chamber R2 can be prevented from releasing through the communication opening 3a in case that the amount of air for desorbing fuel vapor is insufficient, similarly to in the fourth embodiment.

[0054] Fig. 10 illustrates a seventh embodiment of the fuel vapor treatment canister 1 according to the present invention, which is similar to the third embodiment with the exception that the filter 14 for dividing the fuel vapor adsorption chamber R1 and the heat accumulation and fuel vapor adsorption chamber R2 is replaced with the partition wall arrangement S used in the fourth embodiment.

[0055] In this embodiment, the partition wall arrangement S divides the inside space of the casing body 2A into the fuel vapor adsorption chamber R1 and the heat accumulation and fuel vapor adsorption chamber R2. As

shown, the fuel vapor adsorbing material A1 is filled in the chamber R1, while the fuel vapor adsorbing material A1 and the heat-accumulative material A2 is filled in a mixed state in the chamber R2. The partition wall arrangement S of this embodiment includes the air chamber forming member 21 which is formed of the same plastic as that of the casing body 2. The air chamber forming member 21 includes a pair of the perforated walls 21a, 21b which are disposed respectively on the sides of the chamber R1 and the chamber R2. The perforated walls 21a, 21b are spaced from each other by the space maintaining member 21c located between and integral with the perforated walls 21a, 21b. Each perforated wall 21a, 21b is formed with a plurality of openings through which air passes. The two filters 14, 14 are located respectively in contact with the perforated walls 21a, 21b in such a manner that the air chamber forming member 21 is located between the filters 14, 14.

[0056] Accordingly, also in this embodiment, heat transmission from the fuel vapor adsorption chamber R1 to the heat accumulation and fuel vapor adsorption chamber R2 can be prevented. Consequently, fuel vapor remaining in the fuel vapor adsorbing material A1 within the chamber R1 and the chamber R2 can be prevented from releasing through the communication opening 3a in case that the amount of air for desorbing fuel vapor is insufficient.

[0057] Fig. 11 illustrates an eighth embodiment of the fuel vapor treatment canister according to the present invention, which is similar to the third embodiment with the exception that only the heat accumulation and fuel vapor adsorption chamber R2 is formed inside the casing C without forming the fuel vapor adsorption chamber R1.

[0058] In this embodiment, the chamber R2 is formed between the filter 16 and the filter 11 and inside the casing C, and filled with the vapor fuel adsorbing material A1 and the heat-accumulative material A2 which are formed into a layer and located alternate to each other.

[0059] This embodiment prevents heat transmission from the fuel vapor adsorption chamber R1A to the heat accumulation and fuel vapor adsorption chamber R2 by a partition wall arrangement constituted by the bottom end wall 18 and the filter 16. Consequently, fuel vapor remaining in the fuel vapor adsorbing material A1 within the chamber R1A and the chamber R2 can be prevented from releasing through the communication opening 3a in case that the amount of air for desorbing fuel vapor is insufficient.

[0060] Fig. 12 illustrates a ninth embodiment of the fuel vapor treatment canister 1 according to the present invention, which is similar to the eighth embodiment with the exception that the heat accumulation and fuel vapor adsorption chamber R2 filled with the fuel vapor adsorbing material A1 and the heat-accumulative material A2 is replaced with a fuel vapor adsorption chamber R1B filled with the fuel vapor adsorbing material A1 and formed in another casing C3 which is independent from

the casing C.

[0061] In this embodiment, the casing C is formed with only the fuel vapor adsorption chamber R1B which is defined between the filter 11 and the filter 16 and filled with the fuel vapor adsorbing material A1. The casing C3 is similar to the casing 2B in the fifth embodiment and includes a casing body 2C which is provided with the first end wall 25 and the second end wall 26. The first end wall 25 is fixed to one (left-side) end of the casing body 2C and has the pipe defining the communication opening 25a which is in communication with the opening 3a of the first end wall 3 of the casing C through the pipe 27. The second end wall 26 is fixed to the other (right-side) end of the casing body 2C and has a pipe defining the communication opening 26a which is in communication with the atmosphere. The perforated plate 10 and the filter 11 are disposed adjacent the first end wall 25 in such a manner as to define the space between the perforated plate 10 and the first end wall 25. The peripheries of the perforated plate 10 and the filter 11 are in contact with the inner surface of the casing body 2C. Additionally, the perforated plate 7 and the filter 8 are disposed adjacent the second end wall 26 in such a manner as to define a space between the perforated plate 7 and the second end wall 26. The peripheries of the perforated plate 7 and the filter 8 are in contact with the inner surface of the casing body 2C. The heat accumulation and fuel vapor adsorption chamber R2 is defined between the filter 8 and the filter 11 and filled with the fuel vapor adsorbing material A1 and the heat-accumulative material A2 which are in a mixed state.

[0062] In operation, since the casing C defining therein the chamber R1B and the casing C3 defining therein the chamber R2 are provided separate from each other, heat transmission between the chamber R1B and the chamber R2 can be prevented. Consequently, fuel vapor remaining in the fuel vapor adsorbing material A1 within the chamber R1B and the chamber R2 can be prevented from releasing through the communication opening 26a in case that the amount of air for desorbing fuel vapor is insufficient, similarly to in the fourth embodiment.

[0063] The above-discussed embodiments may be modified as follows:

(1) While the first end wall 3, the second end wall 4 and the bottom end wall 18 have been shown and described as being fixedly connected, for example, by welding, it will be understood that at least of them may be formed integral with the casing body 2, 2A when the casing body is molded.

(2) While the fuel vapor inlet opening 4a and the fuel vapor outlet opening 4b are shown and described as being formed separate from each other, it will be understood that a single inlet-outlet opening serving as the fuel vapor inlet and outlet openings 4a, 4b may be formed in place of the separate openings 4a, 4b, in which a pipe connected to the inlet-outlet

opening is bifurcated to be connected to the fuel tank and the engine air intake passage.

(3) While the filter 14 has been shown and described as being used for dividing the inside space of the casing C into the fuel vapor adsorption chamber R1 and the heat accumulation and fuel vapor adsorption chamber R2 in some embodiments, it will be appreciated that the filter 14 may be omitted. In this regard, the chamber R1 and the chamber R2 may be divided by a perforated plate disposed between the chambers R1, R2 or formed integral with the casing body.

(4) While the fuel vapor adsorbing material A1 and the heat-accumulative material A2 in the state of layers have been shown and described as being disposed within the heat accumulation and fuel vapor adsorption chamber R2 in some embodiments, it will be appreciated that the materials A1, A2 may be replaced with a heat-accumulative and fuel vapor adsorbing material prepared by mixing the fuel vapor adsorbing material A1 and the heat-accumulative material A2, or with another heat-accumulative and fuel vapor adsorbing material prepared by mixing fuel vapor adsorbing material matrix particles or powder (such as activated carbon particles or powder) with heat-accumulative material particles or powder having high heat conductivity and high specific heat as compared with the fuel vapor adsorbing material matrix powder, and then by molding the mixed particles or powders into the form of pellets or the like. Examples of the heat-accumulative material particles or powder are aluminum or aluminum alloy particles or powder, and ceramic particles or powder.

[0064] Additionally, it will be appreciated that the materials A1, A2 may be replaced with a honeycomb-shaped heat-accumulative and fuel vapor adsorbing material prepared by mixing the fuel vapor adsorbing material matrix particles or powder (such as activated carbon particles or powder) with the heat-accumulative material particle or powder and binder, and then by molding the mixed particles or powders into the honeycomb shape, so that the fuel vapor adsorbing material matrix particles or powder and the heat-accumulative material particle or powder are contained in a dispersed state in the honeycomb-shaped heat-accumulative and fuel vapor adsorbing materials.

[0065] As appreciated from the above, according to the present invention, the fuel vapor treatment canister has the fuel vapor adsorption chamber and the heat accumulation and fuel vapor adsorption chamber which are located respectively at the side of fuel vapor inlet and outlet openings and the side of the communication opening in communication with the atmosphere. The fuel vapor adsorbing material is disposed in the fuel vapor adsorption chamber, while the fuel vapor adsorbing material and the heat-accumulative material are disposed

in the heat accumulation and fuel vapor adsorption chamber. Accordingly, during adsorption of fuel vapor in the canister, the fuel vapor adsorbing material within the heat accumulation and fuel vapor adsorption chamber is prevented from its temperature rise so that fuel vapor adsorption in the chamber can be securely accomplished, thereby effectively preventing release of fuel vapor to the atmosphere.

[0066] During desorption of fuel vapor in the canister, in the heat accumulation and fuel vapor adsorption chamber located at the side of the atmosphere-communication opening, the fuel vapor adsorbing material in the chamber is prevented from its temperature lowering owing to the heat release action of the heat-accumulative material in the chamber, so that desorption of fuel vapor from the fuel vapor adsorbing material can be effectively carried out thereby lowering the fuel vapor residual level after the fuel vapor desorption. Accordingly, adsorption of fuel vapor at the next operational (adsorption-desorption) cycle can be ensured. In the fuel vapor adsorption chamber through which air containing the fuel vapor desorbed from the fuel vapor adsorbing material in the heat accumulation and fuel adsorption chamber flows, fuel vapor is desorbed from the fuel vapor adsorbing material in the fuel vapor adsorption chamber, causing temperature lowering of the fuel vapor adsorbing material. This prevents abrupt desorption of fuel vapor from the fuel adsorbing material in the fuel vapor adsorption chamber, so that fuel vapor is gradually desorbed from the fuel vapor adsorbing material. As a result, a large amount of fuel vapor is prevented from being abruptly sucked into the engine. This effectively prevents disorder of the engine and considerable emission of hydrocarbons in exhaust gas from the engine due to excessive fuel (hydrocarbons) in air-fuel mixture to be sucked into the engine.

[0067] Additionally, since the heat-accumulative material is disposed only in the heat accumulation and fuel vapor adsorption chamber, the amount of the heat-accumulative material used in the canister can be reduced while increasing the amount of the fuel vapor adsorbing material used in the canister without increasing the size of the casing of the canister. Thus, the fuel vapor adsorbing ability of the canister can be increased without large-sizing the canister.

[0068] Further, the partition wall may be provided between the fuel vapor adsorption chamber and the heat accumulation and fuel vapor adsorption chamber, or otherwise the fuel vapor adsorption chamber and the heat accumulation and fuel vapor adsorption chamber may be formed respectively in the separate casings, so as to prevent heat transmission from the fuel vapor adsorption chamber to the heat accumulation and fuel vapor adsorption chamber. Consequently, the fuel vapor adsorbing material in the heat accumulation and fuel vapor adsorption chamber can be prevented from its temperature rise even though the temperature of the fuel vapor adsorbing material in the fuel vapor adsorption

chamber rises. This prevents a temperature rise of the fuel vapor adsorbing material in the heat accumulation and fuel vapor adsorption chamber while preventing lowering in the fuel vapor retaining ability of the fuel vapor adsorbing material in the heat accumulation and fuel vapor adsorption chamber. As a result, even in case that the amount of air for desorbing fuel vapor from the fuel vapor adsorbing material is insufficient, fuel vapor remaining in the fuel vapor adsorption chamber and the heat accumulation and fuel vapor adsorption chamber can be prevented from being released through the atmosphere-communication opening of the canister.

[0069] Although the invention has been described above by reference to certain embodiments of the invention, the invention is not limited to the embodiments described above. Modifications and variations of the embodiments described above will occur to those skilled in the art, in light of the above teachings. The scope of the invention is defined with reference to the following claims.

#### Claims

1. A fuel vapor treatment canister comprising:

a casing arrangement having first and second end walls between which first and second chambers are formed, said first end wall having a portion defining a first opening in communication with a fuel tank, and a portion defining a second opening in communication with an air intake passage of an engine, said second end wall having a portion defining a third opening in communication with atmosphere, said first chamber being located closer to said first end wall than said second chamber;  
a first fuel vapor adsorbing material disposed in said first chamber; and  
a second fuel vapor adsorbing material and a heat-accumulative material, disposed in said second chamber, said heat-accumulative material being larger in specific heat than said second fuel vapor adsorbing material.

2. A fuel vapor treatment canister as claimed in Claim 1, wherein at least one of said first and second fuel vapor adsorbing materials is granular.

3. A fuel vapor treatment canister as claimed in Claim 2, wherein said second fuel vapor adsorbing material and said heat-accumulative material form first and second layers, respectively, said first and second layers being located alternate to each other in a direction in which fuel vapor flows.

4. A fuel vapor treatment canister as claimed in Claim 3, wherein each of said first and second layers ex-

tends perpendicular to an axis of said second chamber.

- 5. A fuel vapor treatment canister as claimed in Claim 1, wherein said first and second fuel vapor adsorbing materials are activated carbon.
- 6. A fuel vapor treatment canister as claimed in Claim 1, wherein said heat-accumulative material is at least one selected from the group consisting of aluminum, aluminum alloy, ceramic, and stainless steel.
- 7. A fuel vapor treatment canister comprising:

a casing having first and second end walls between which an inside space is formed, said first end wall having a portion defining a first opening in communication with a fuel tank, and a portion defining a second opening in communication with an air intake passage of an engine, said second end wall having a portion defining a third opening in communication with atmosphere, said inside space including first and second chambers, said first chamber being located closer to said first end wall than said second chamber;

a first fuel vapor adsorbing material disposed in said first chamber; and

a second fuel vapor adsorbing material and a heat-accumulative material, disposed in said second chamber, said heat-accumulative material being larger in specific heat than said second fuel vapor adsorbing material.

- 8. A fuel vapor treatment canister comprising:

a casing having first and second end walls between which an inside space is formed, said first end wall having a portion defining a first opening in communication with a fuel tank, and a portion defining a second opening in communication with an air intake passage of an engine, said second end wall having a portion defining a third opening in communication with atmosphere, said inside space including first and second chambers, said first chamber being located closer to said first end wall than said second chamber;

a partition wall structure disposed to divide said inside space into said first and second chambers, said partition wall structure having an air permeability and a heat insulating ability higher than that of metal;

a first fuel vapor adsorbing material disposed in said first chamber; and

a second fuel vapor adsorbing material and a heat-accumulative material, disposed in said

second chamber, said heat-accumulative material being larger in specific heat than said second fuel vapor adsorbing material.

- 9. A fuel vapor treatment canister comprising:

a first casing having first and second end walls between which a first chamber is formed, said first end wall having a portion defining a first opening in communication with a fuel tank, and a second casing having third and fourth end walls between which a second chamber is formed, said third end wall having a portion defining a third opening in communication with said second opening of said first casing, said fourth end wall having a portion defining a fourth opening in communication with atmosphere;

a first fuel vapor adsorbing material disposed in said first chamber; and

a second fuel vapor adsorbing material and a heat-accumulative material, disposed in said second chamber, said heat-accumulative material being larger in specific heat than said second fuel vapor adsorbing material.



FIG.1A

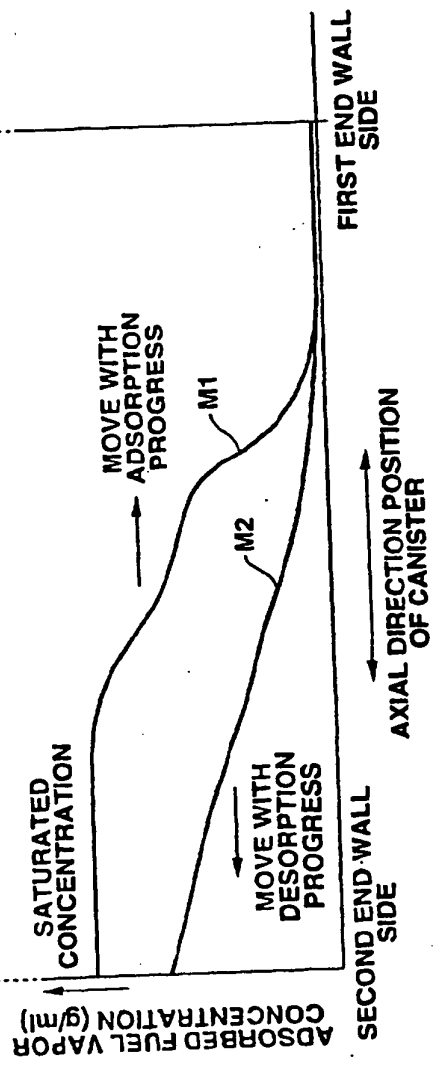
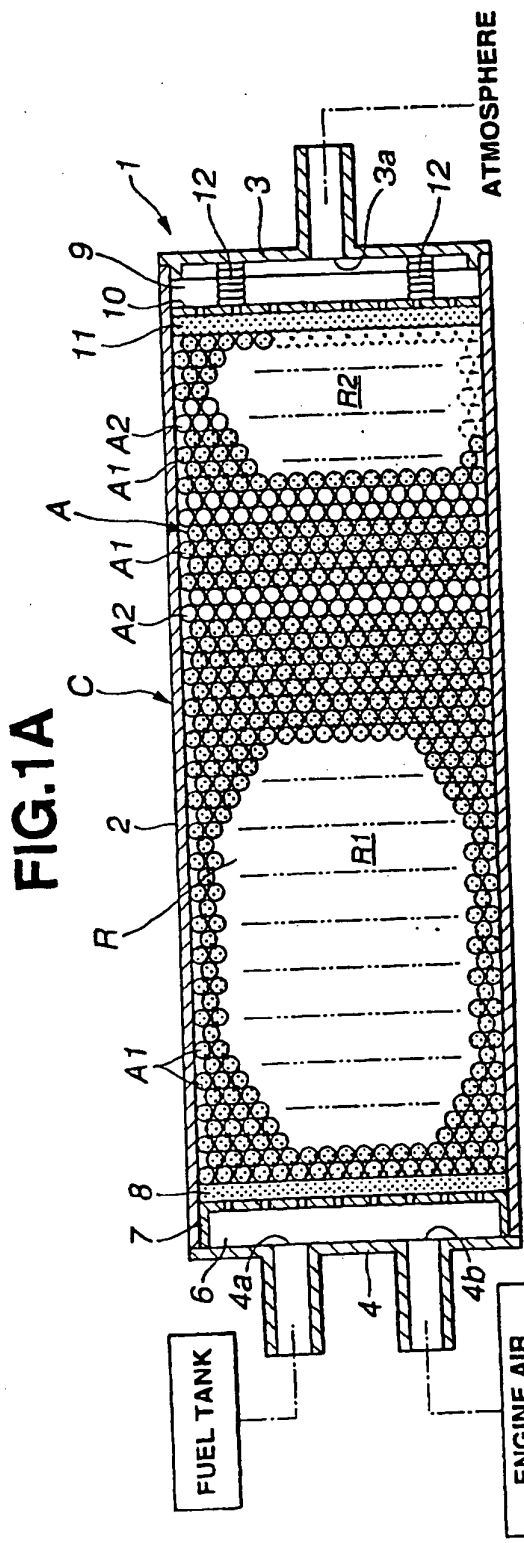

FIG.1B

FIG.2A

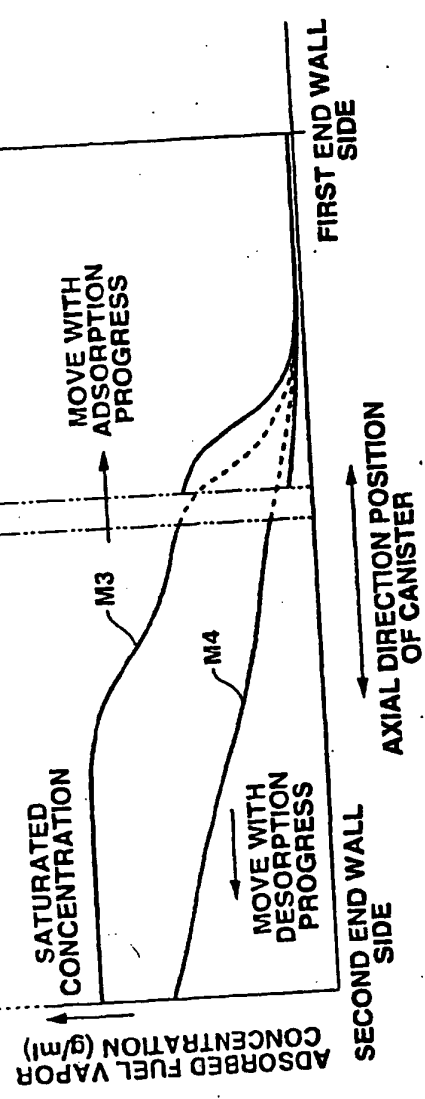
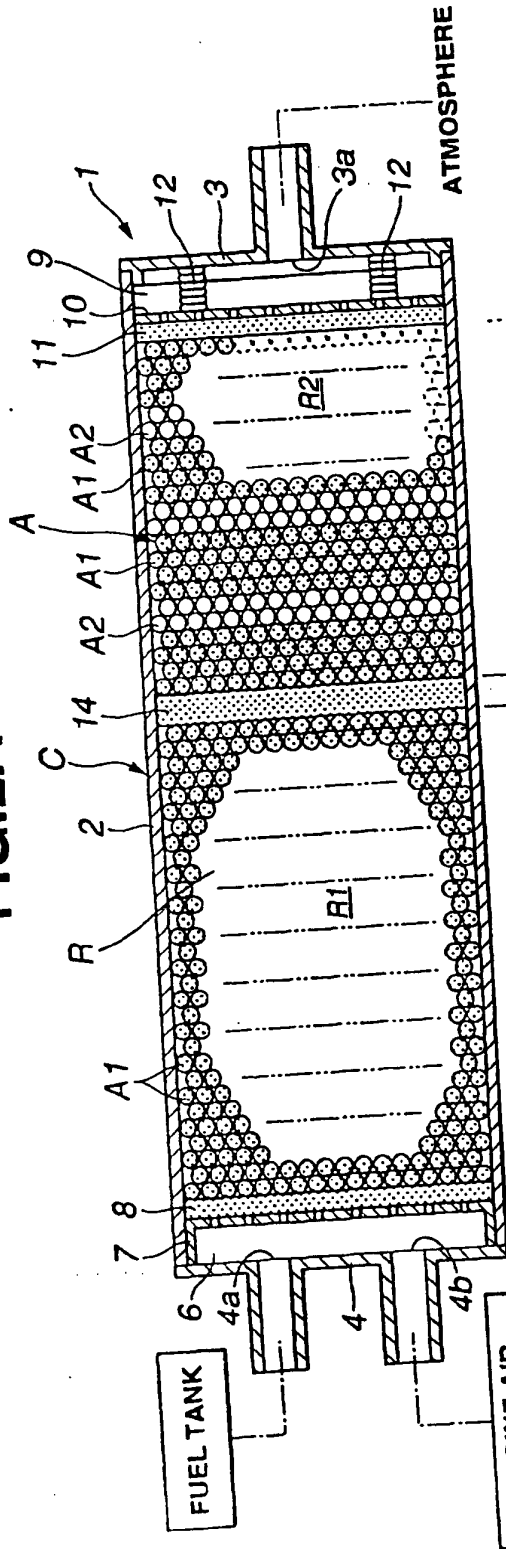

FIG.2B

FIG.3

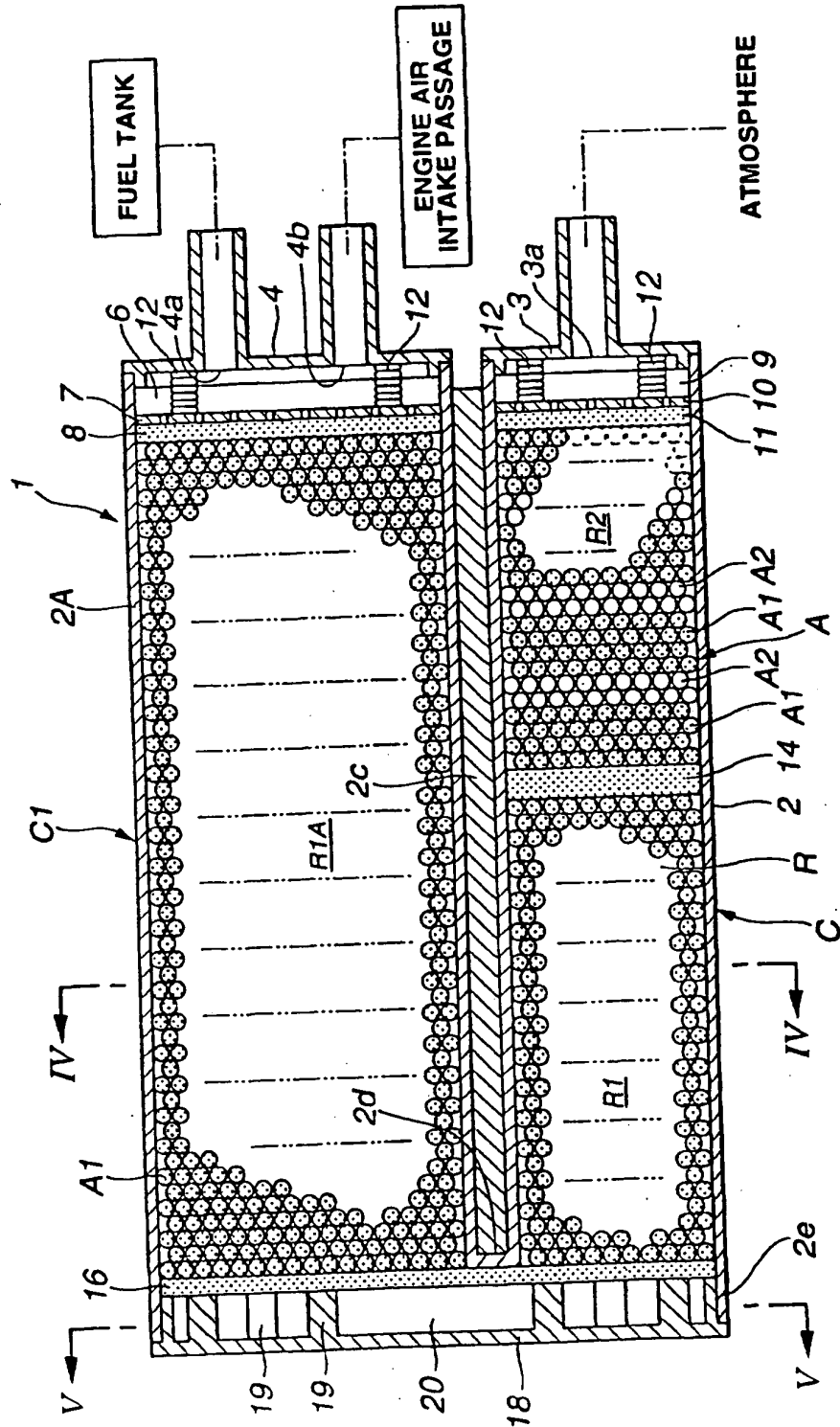

FIG.4

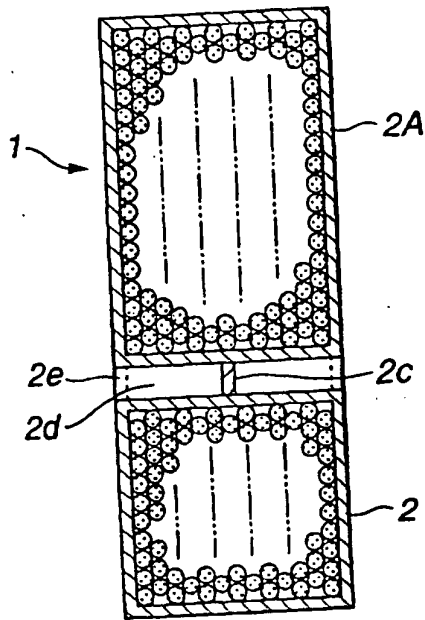

FIG.5

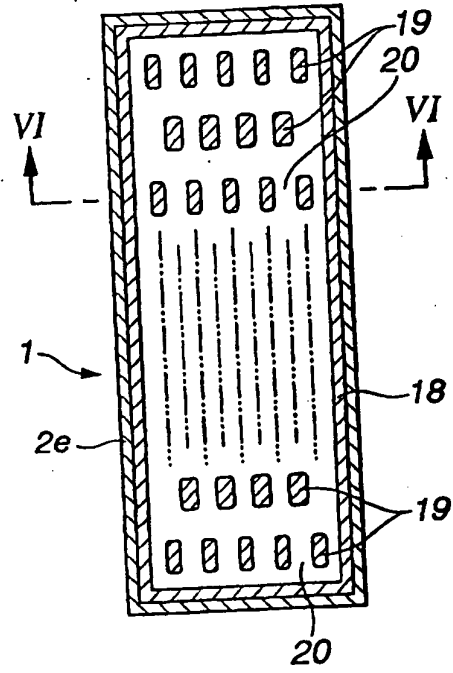

FIG.6

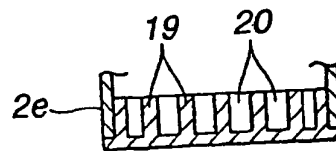

FIG.7

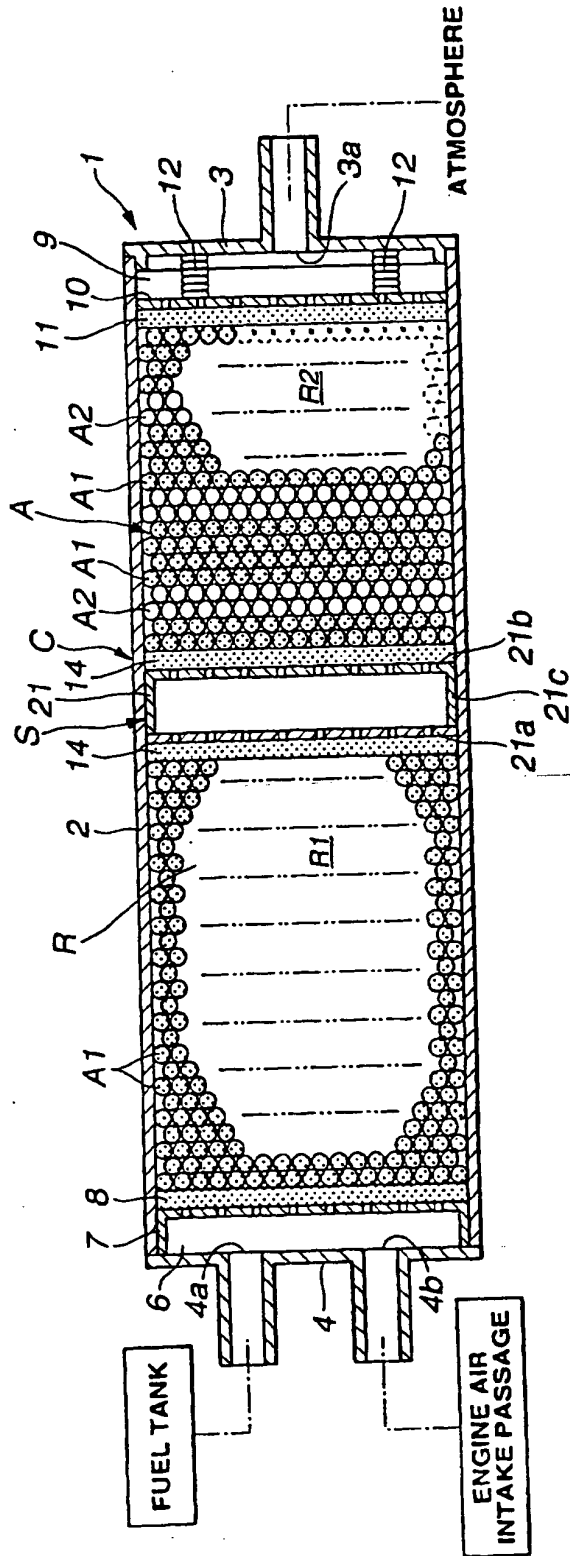



FIG.9

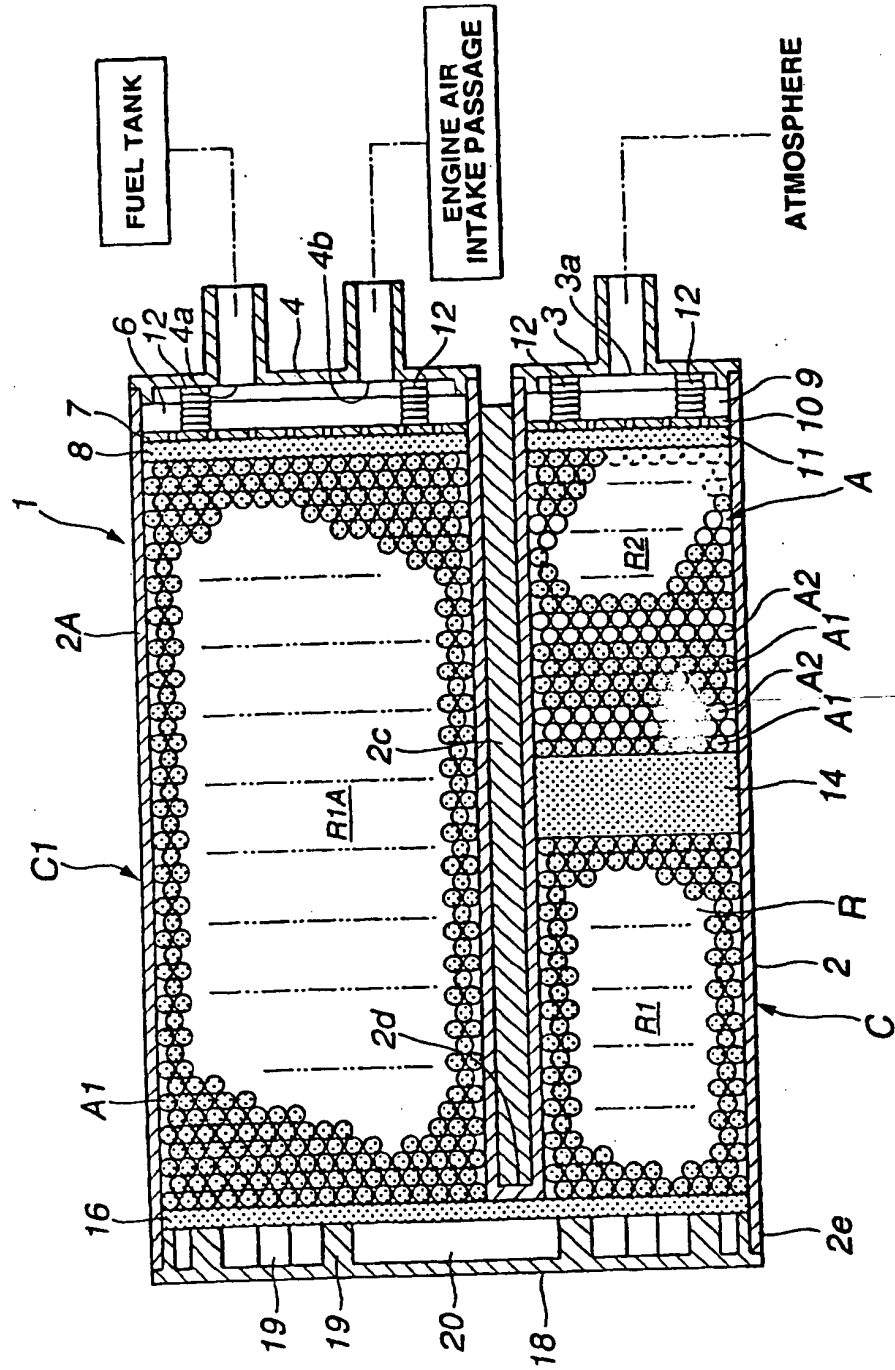

FIG.10

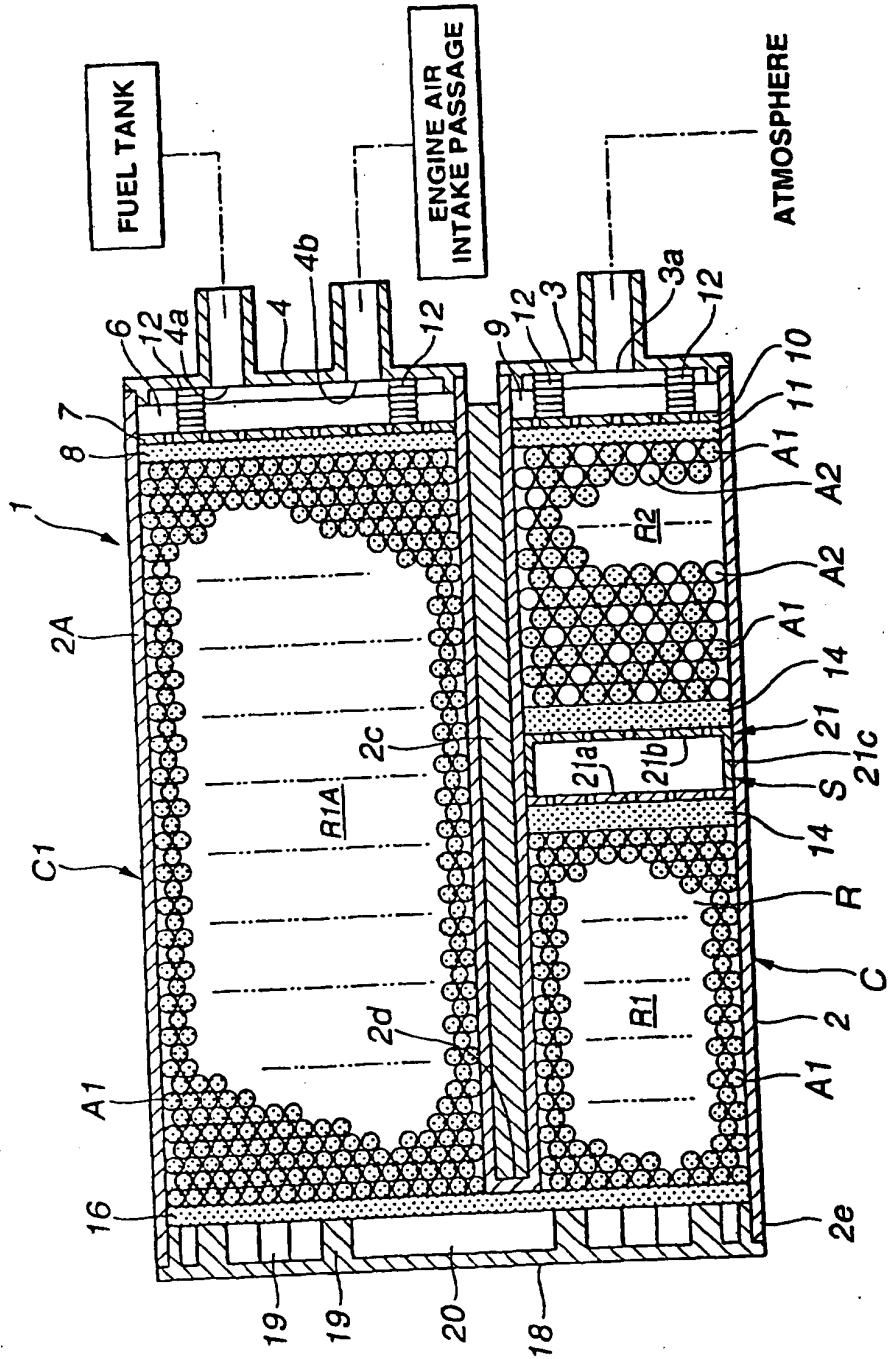
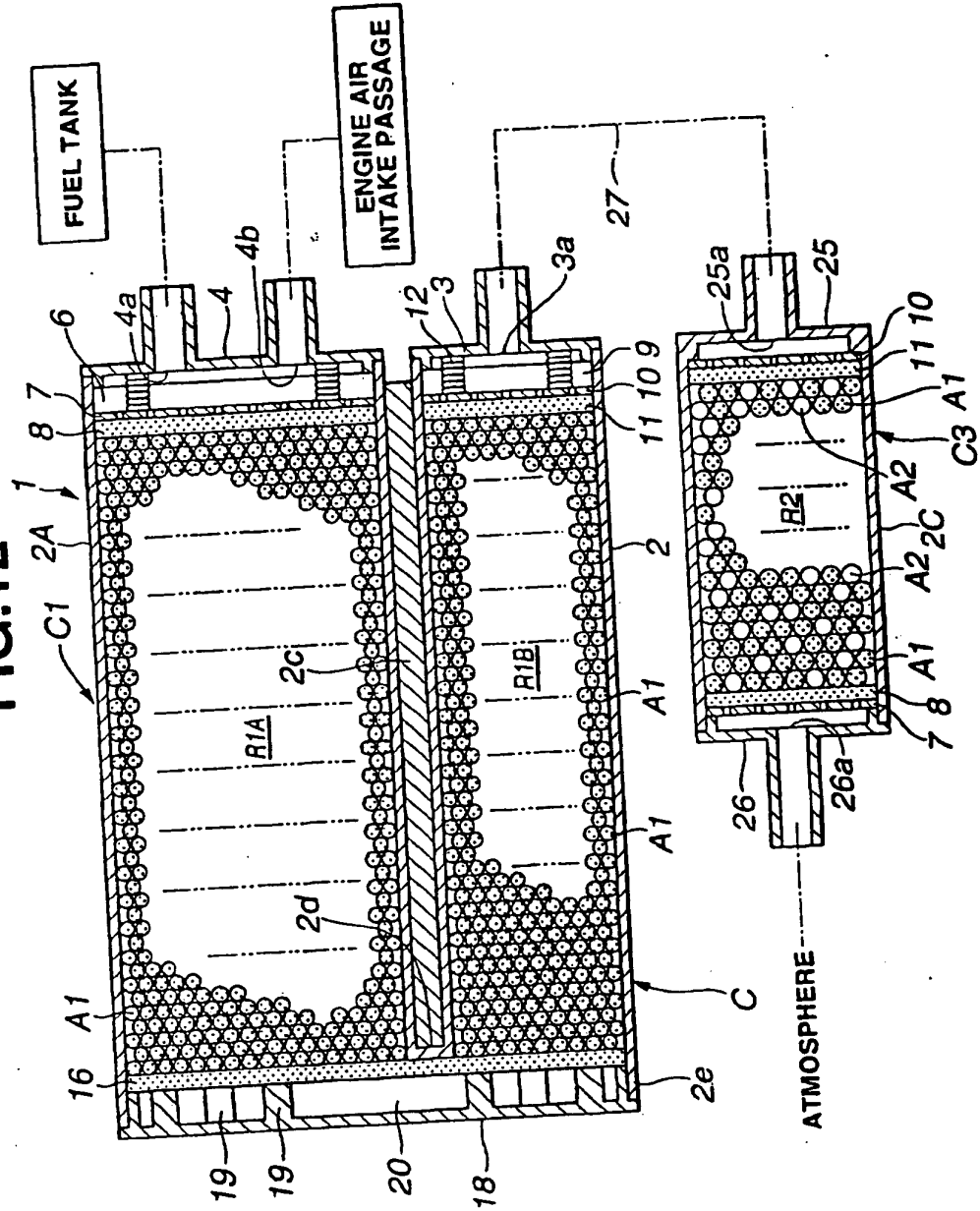
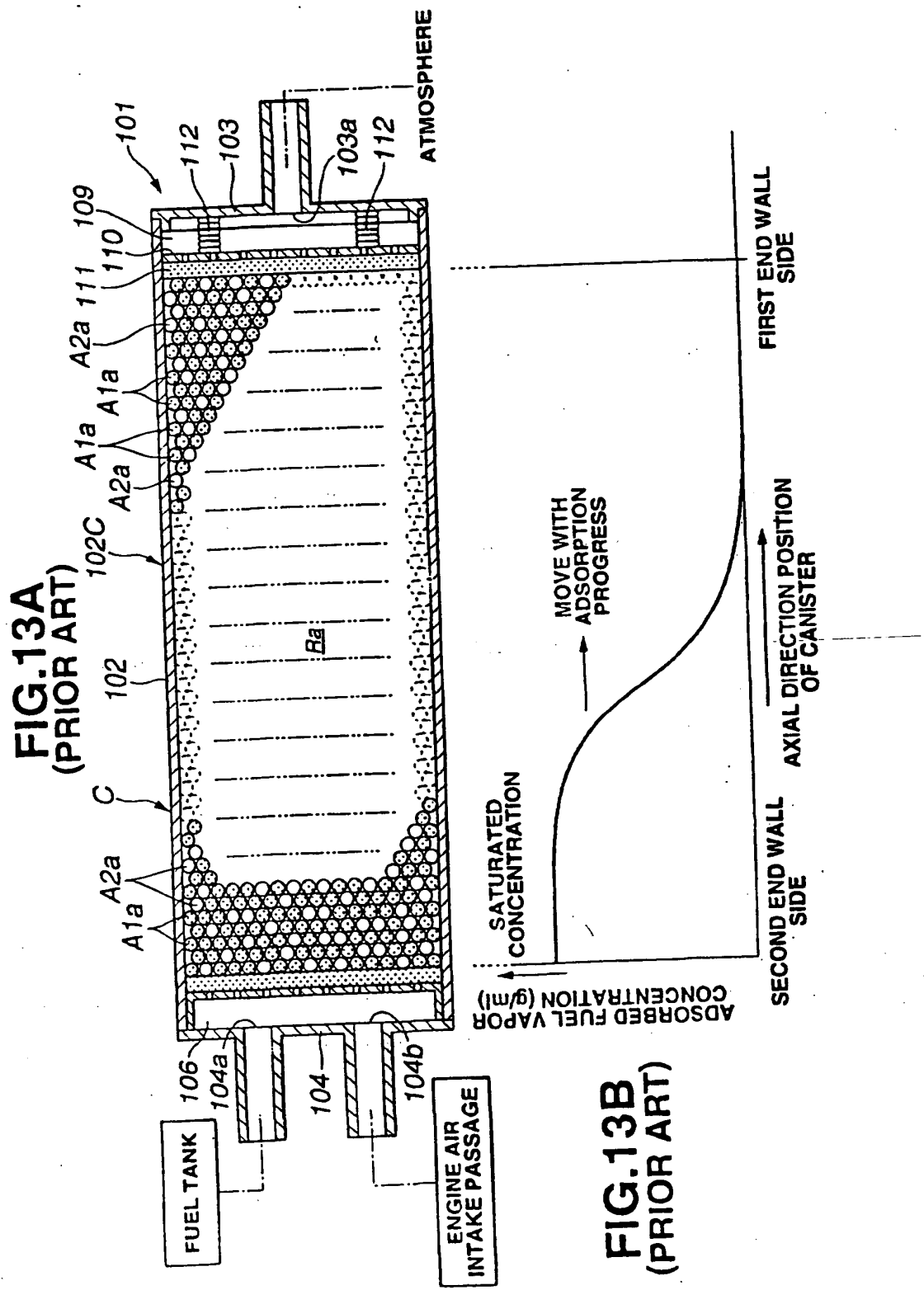

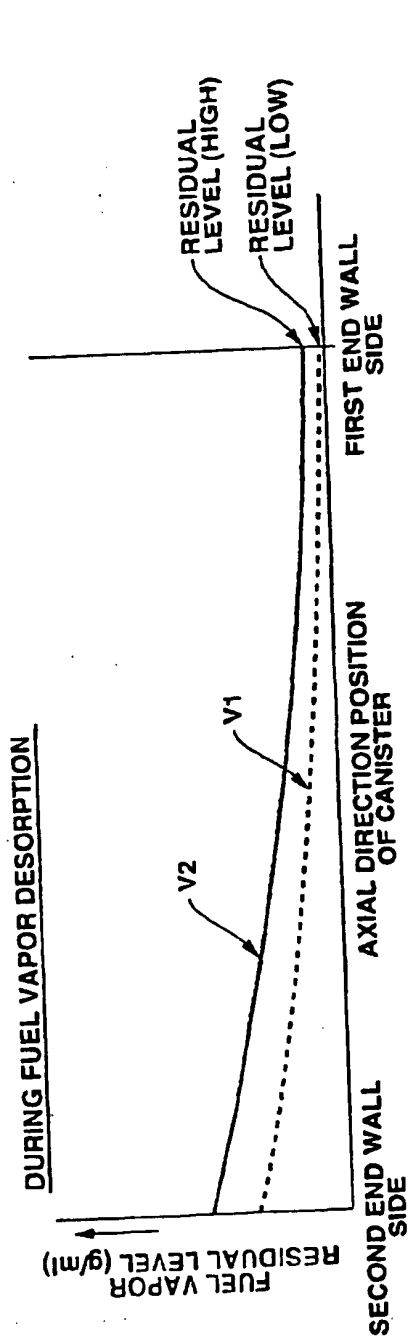



FIG.12







**FIG.14A**  
(PRIOR ART)

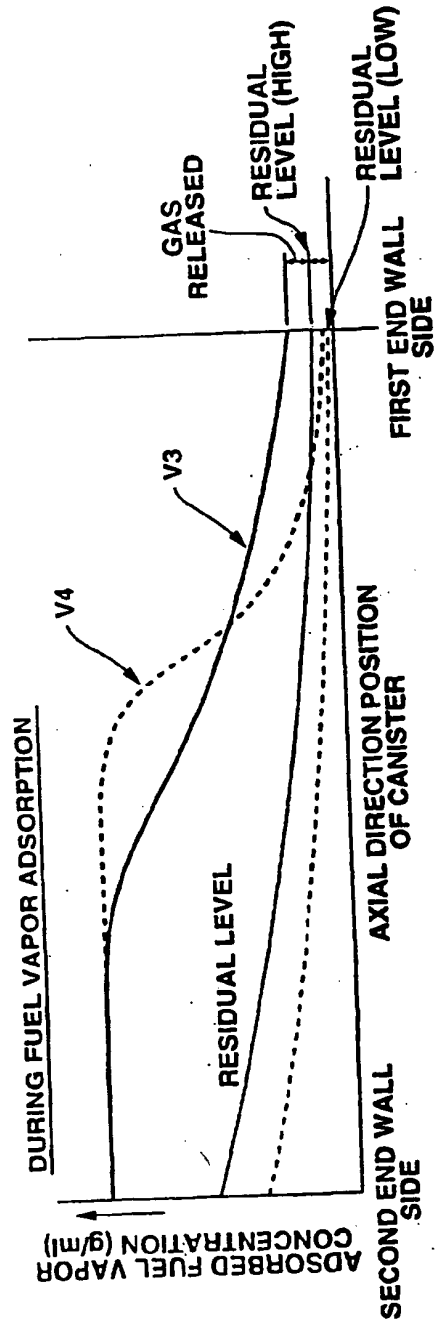

**FIG.14B**  
(PRIOR ART)

(12) INTERNATIONAL APPLICATION PUBLISHED UNDER THE PATENT COOPERATION TREATY (PCT)

(19) World Intellectual Property Organization  
International Bureau



(43) International Publication Date  
30 August 2001 (30.08.2001)

PCT

(10) International Publication Number  
WO 01/62367 A1

- (51) International Patent Classification<sup>7</sup>: B01D 53/04, (74) Agent: PRINS, A., W.; Vereenigde, Nieuwe Parklaan 97, B60K 15/035 NL-2587 BN The Hague (NL).
- (21) International Application Number: PCT/NL01/00146 (81) Designated States (*national*): AE, AG, AL, AM, AT, AU, AZ, BA, BB, BG, BR, BY, BZ, CA, CH, CN, CR, CU, CZ, DE, DK, DM, DZ, EE, ES, FI, GB, GD, GE, GH, GM, HR, HU, ID, IL, IN, IS, JP, KE, KG, KP, KR, KZ, LC, LK, LR, LS, LT, LU, LV, MA, MD, MG, MK, MN, MW, MX, MZ, NO, NZ, PL, PT, RO, RU, SD, SE, SG, SI, SK, SL, TJ, TM, TR, TT, TZ, UA, UG, US, UZ, VN, YU, ZA, ZW.
- (22) International Filing Date: 20 February 2001 (20.02.2001)
- (25) Filing Language: English
- (26) Publication Language: English
- (30) Priority Data: 00200608.8 22 February 2000 (22.02.2000) EP (84) Designated States (*regional*): ARIPO patent (GH, GM, KE, LS, MW, MZ, SD, SL, SZ, TZ, UG, ZW), Eurasian patent (AM, AZ, BY, KG, KZ, MD, RU, TJ, TM), European patent (AT, BE, CH, CY, DE, DK, ES, FI, FR, GB, GR, IE, IT, LU, MC, NL, PT, SE, TR), OAPI patent (BF, BJ, CF, CG, CI, CM, GA, GN, GW, ML, MR, NE, SN, TD, TG).
- (71) Applicant (*for all designated States except US*): NORIT NEDERLAND B.V. [NL/NL]; Nijverheidsweg N72, NL-3812 PM Amersfoort (NL).
- (72) Inventors; and
- (75) Inventors/Applicants (*for US only*): MACDOWALL, James, Duff [GB/GB]; 343 Kelvindale Road, Glasgow G12 0QU (GB). VAN DE KLEUT, Dirk [NL/NL]; Pastorielaan 125, NL-3828 EZ Hoogland (NL). KLEIJ, Michiel, Trijnisse [NL/NL]; Agnietenhove 13, NL-3834 XA Leusden (NL).

Published:

— with international search report

For two-letter codes and other abbreviations, refer to the "Guidance Notes on Codes and Abbreviations" appearing at the beginning of each regular issue of the PCT Gazette.



WO 01/62367 A1

(54) Title: PROCESS FOR THE ADSORPTION OF ORGANIC VAPOURS FROM GAS MIXTURES CONTAINING THEM

(57) Abstract: The invention is directed to a process for the adsorption of organic vapours from gas mixtures containing them onto activated carbon, said process comprising passing the gas mixture consecutively through at least a first and a second adsorption system, the first system consisting of activated carbon having a first adsorption rate for the said organic vapours and the second system consisting of an adsorbent having a second adsorption rate for the said organic vapours, the said second adsorption rate being higher than the said first adsorption rate, more in particular to such process when used in the operation of vehicle internal combustion engines.

Title: Process for the adsorption of organic vapours from gas mixtures containing them

The invention is directed to a process for the adsorption of organic vapours from gas mixtures containing them onto activated carbon.

Emission of organic vapours is harmful to the environment (smog). The emission from automotive sources is regulated by law worldwide, requiring car manufacturers to take measures to reduce the emission of fuel vapours from the fuel tanks during operation or refueling or during periods when the car is not driving, for example due to the temperature changes (day-night).

These emission reduction systems are based on activated carbon and are regenerated during vehicle operation, when combustion air is passed through the system, thereby removing the fuel from the activated carbon. These systems are known as evaporative loss control devices (ELCD-canister). Also it can be useful in stationary systems to apply activated carbon for removing organic vapours from gas mixtures. Examples are in the area of heating devices and such like.

Current emission limits have resulted in the use of special canisters containing specialised types of activated carbon, that are well suited to reduce the emission sufficiently. In the near future the emission limits will be reduced drastically; these levels cannot be met by current systems, especially not during refuelling. In that situation, not all vapours are adsorbed sufficiently fast and bleed through occurs. Increasing the adsorption capacity of the canister by increasing its size is not acceptable, since the available space for incorporating these canisters in a car is limited. Increase of the adsorption capacity per unit carbon volume can only be accomplished at high costs and still the adsorption rate will be insufficient.

A solution would be to increase the adsorption kinetics (adsorption rate), however, the common way to do that results in other problems. Usually this is done by decreasing the particle size of the adsorbent, but this results in an increase in pressure drop, which makes it difficult to properly refill the gasoline tank, i.e. without untimely stopping of the gasoline pump of the service station. An other alternative is to change the external surface area to volume ratio ( $S_v$ , with dimension of e.g.  $m^2/m^3$ ) of the adsorbent particles by selecting a different external shape. The consequence of this is a smaller amount of adsorbent in the same volume (i.e. a decrease in density), which is not acceptable, as the total adsorption capacity decreases.

Accordingly it is an object of the present invention to provide a process for the adsorption of organic vapours, in particular organic vapours (hydrocarbons) that are held responsible for smog formation, from gas mixtures containing them onto activated carbon, which process does not have the drawbacks described above. In the present description and claims, organic compounds that are held responsible for smog formation are gaseous compounds originating from fuels and are particularly defined as hydrocarbons having more than three carbon atoms. More in particular these compounds are present in the vapours of fuels such as gasoline, kerosene or fuel oil.

The process of the present invention should be suitable for application in ELCD-canisters. A further object is to provide for an improvement in this respect, i.e. to provide an ELCD-canister which enables a decrease of the emission of smog-forming hydrocarbons, without a significant increase in the pressure drop across the canister and without a significant decrease in the canister's adsorption capacity.

According to the invention the process comprises passing the gas mixture consecutively through at least a first and a second adsorption system, the first system consisting of activated carbon having a first adsorption rate for the said organic vapours and the second system consisting of an adsorbent

having a second adsorption rate for the said organic vapours, the said second adsorption rate being higher than the said first adsorption rate.

In a preferred embodiment said process is applied to automotive systems, wherein the adsorption system is operated in relation to an internal  
5 combustion engine.

The present invention is based on the surprising insight, that by the use of two consecutive adsorption systems with comparable adsorption capacities per unit volume, a first one having a limited adsorption rate and preferably a low pressure drop, and a second one having a higher adsorption  
10 rate, the emission can be decreased, without having to resort to other measures, such as increasing the size of the (standard) adsorption canisters, to eliminate the bleed through.

By the use of this system of at least two combined adsorbents having different adsorption kinetics, a better use of the available adsorption capacity  
15 is made, without an undue increase of canister size or pressure drop over the system.

According to the invention it was thus found that a canister containing a limited amount of adsorbent with fast adsorption kinetics at the outlet side of a regular canister already provides an improved reduction in  
20 emission. Apparently, the mass transfer zone obtained in the downstream adsorbent, preferably an activated carbon or zeolite bed, was reduced in size in this downstream section, thus increasing the efficiency.

In a preferred embodiment the present invention comprises the use of an activate carbon filter containing

25 1. activated carbon having a relatively low pressure drop and a high adsorption capacity per unit volume but limited adsorption kinetics, combined with

2. a second activated carbon with higher adsorption kinetics, for example by using smaller particles or other particle shapes.



The combining of both materials in a regular ELCD-canister ensures that the best aspects of both options are combined. The high adsorption capacity and low pressure drop of the regular carbon is combined with the fast kinetics of the downstream carbon. Since the carbon with the fast adsorption kinetics is placed at the outlet of the canister the bleeding of vapour is minimized. Accordingly, the amount of downstream carbon with higher adsorption kinetics is limited compared to the amount of regular carbon, thereby minimizing the pressure drop over the complete filter.

In the operation of the present invention there are various possibilities for the application thereof. In a first, preferred, embodiment, both adsorbents are placed in the same canister, either in direct contact with each other or separated by a grid, giving a single adsorbent bed, containing two different adsorbents with different properties as discussed above. It is also possible to place each adsorbent in a separate canister, the canisters being mutually connected all the time. In a third embodiment it is possible to place both adsorbents in separate canisters or separate sections of a single canister, which are connected to each other using valves which allow the gasoline vapours to enter the second, downstream canister or canister section only when required.

As indicated above, the present invention is based on the use of two different adsorbents, the first one being a regular activated carbon. As second adsorbent it is possible to use activated carbon, but one can also use other adsorbing materials which can be regenerated by passing the air that is used in the internal combustion engine through the adsorbent. Preferred materials are activated carbon and zeolites. In case of use of activated carbon as second adsorbent, it is to be noted that this must have different adsorption kinetics from the first carbon. This can for example be realized by using the same activated carbon as in the first adsorbent, but having different surface to volume ratio, thereby changing the diffusion characteristics of the activated carbon. One possibility is to make the particle size of the carbon smaller,

whereas another possibility is to change the outer shape, for example using specifically shaped extrudates or tablets. Another possibility to improve the adsorption kinetics is to select a carbon type with a more optimal pore size distribution, thus improving the diffusion characteristics. A third possibility is the use of fibrous activated carbon, e.g. activated carbon felts or cloths, or the use of activated carbon containing fibrous materials, which exhibit high adsorption kinetics combined with a low pressure drop and a relatively low adsorption capacity.

For practical purposes, it is preferred to use extruded activated carbon (EAC) as the particles having a low Sv and granular activated carbon (GAC) as the particles with the high Sv. Preferably, EAC having a Sv of about 1250-7000 m<sup>2</sup>/m<sup>3</sup>, more preferably 2000-3250 m<sup>2</sup>/m<sup>3</sup> is used. The Sv of the GAC particles is preferably from 2000-30 000 m<sup>2</sup>/m<sup>3</sup>, more preferably from 3000-12 000 m<sup>2</sup>/m<sup>3</sup>.

According to the invention, the amount of adsorbents is selected such, that the adsorption capacity for gasoline vapour of the first adsorption system is larger than the adsorption capacity of gasoline vapour of the second adsorption system. Generally, this means that the amount, by weight, of the second adsorbent will be lower than the amount, by weight, of the first adsorbent.

As indicated above, the present invention is applicable for the adsorption of organic vapours from gas mixtures, more in particular for the removal of gasoline or fuel oil vapours from gas mixtures originating in relation to the operation of vehicle internal combustion engines. Although the main application of the invention certainly lies in the so-called evaporative loss control devices (ELCD-canisters) which are designed to prevent emission of gasoline and fuel oil vapours caused by "breathing" of gasoline and fuel oil tanks, it is also possible to use the invention in relation to stationary tanks containing organic materials having a measurable vapour pressure at ambient temperature, such as tanks for gasoline, fuel oil, kerosene and naphtha.

### Brief description of the drawings

5 Figure 1 shows breakthrough curves of activated carbon beds containing EAC and GAC particles in ratios 95/5 and 90/10 (according to the invention) and 100/0 and 0/100 (reference), respectively.

10 Figure 2 shows hydrocarbons emission vs. outlet hydrocarbons concentration, as measured with activated carbon beds containing EAC and GAC particles in ratios 95/5 and 90/10 (according to the invention) and 100/0 and 0/100 (reference), respectively.

The present invention is now elucidated on the basis of three examples.

### 15 Comparative example

A standard evaporative loss control device canister, containing activated carbon, 2 mm/diameter extrudate was used and the emission in the "three day diurnal test" (US-EPA test procedure) was determined. The emission value obtained was set as 100%.

20

### Example 1

Using the same method as in the comparative example, the emission was determined of the same ELCD canister, containing 80% (by weight) activated carbon, 2 mm/diameter extrudates and 20% by weight granular  
25 activated carbon (sieve fraction 0.5-2.0 mm), downstream from the extrudate was used. In the same test procedure as used in the comparative example the emission was determined. The emission values obtained were 30% of the values obtained in the comparative example.

### Example 2

The performance of activated carbon for evaporative loss control was tested in a dedicated, automated test apparatus, in which a carbon bed is loaded with a model gasoline vapour and regenerated with air during various cycles. The applied test is a simulation of the conditions that are imposed on the carbon in an ELCD canister in practise.

The diameter of the test tube containing the carbon bed was 3.6 cm. The carbon bed height was always 15 cm, resulting in a total carbon volume of 153 cm<sup>3</sup>. The test tube was placed in a thermostatically controlled chamber at a temperature of 30 °C during the complete test.

The model gasoline vapour consisted of 50 vol% air, 33 vol% butane and 17 vol% of a mixture of various hydrocarbons (HC-mix). The composition of this HC-mix is presented in Table 1.

The contact time in the carbon bed was 75 seconds during each loading step. The total hydrocarbons concentration in the off-gas was measured every 10 seconds during the complete loading step using a flame ionisation detector (FID). The loading step was immediately stopped and the regeneration step was started once the measured FID-signal became higher than the FID-signal corresponding to 440 ppmv methane. The time required to reach this signal is taken as the loading time. The hydrocarbons concentration as measured by the FID is expressed as ppm methane equivalent, indicating the methane concentration giving the same FID-signal.

Regeneration was always performed in counter-flow (downstream) during 16 minutes, using 300 bed volumes of dry air.

Part of an extruded activated carbon sample (2 mm diameter) was crushed and sieved to obtain a sieve fraction containing particles between 1-2 mm in diameter. The surface to volume ratio (Sv) of these particles was 4000 m<sup>2</sup>/m<sup>3</sup>. This sieve fraction is indicated as granular activated carbon (GAC) hereafter. A multi-layer carbon bed was created by filling the test tube

with extruded activated carbon (EAC, having an Sv of 2400 m<sup>2</sup>/m<sup>3</sup>) first, after which an additional layer of GAC was added in such a way that the total activated carbon bed volume remained unchanged (153 cm<sup>3</sup>). The ratio EAC/GAC was varied as follows: 100/0, 95/5, 90/10, 0/100.

5 After the performance test the pressure drop in air over the carbon beds described above was measured at various linear flow rates.

By default, each carbon bed was tested for 75 loading and regeneration cycles under identical test conditions.

10 The gasoline working capacity (GWC) is defined as the effective adsorption capacity for hydrocarbons under the mentioned test conditions. The GWC was calculated for each cycle as follows:

$$\text{GWC} = \frac{(\text{Loading Time}) \cdot (\text{HC Supply Rate})}{1000 \cdot (\text{Carbon Volume})} \quad [\text{g}/100 \text{ ml}]$$

15 Due to ageing the GWC usually slightly decreases in time. The results obtained in cycle 75 are assumed to represent the performance after aging of the carbon and are the most close to a steady state situation in practise.

20 The outlet hydrocarbons concentration was registered as a function of time in order to establish the emitted amount of hydrocarbons during the loading step of the carbon. These data resulted in the so-called breakthrough curves for each loading step. By integration of the breakthrough curves the total amount of emitted hydrocarbons was established.

25 In Figure 1 the breakthrough curves in cycle 75 are presented for the various carbon beds described above, containing EAC/GAC in the ratios 100/0, 95/5, 90/10, and 0/100. Figure 1 clearly shows that the hydrocarbons concentration in the off-gas with EAC only is at a much higher level than that observed with GAC only, thus resulting in higher total emission values. It  
30 follows that the adsorption rate of the GAC particles is higher than the

adsorption rate of the EAC particles. Also the multi-layer carbon beds, containing a certain fraction GAC at the outlet side of the carbon bed, show a low hydrocarbons concentration in the off-gas. Furthermore, breakthrough of the 95/5 and 90/10 beds occurred later than with the 100/0 and 0/100 beds.

5           Table 2 contains the loading times in cycle 75 established using the mentioned carbon beds, relative to the loading time of the carbon bed containing EAC only. These data indicate that the total loading times of the multi-layer carbon beds are at least as long as that of the carbon bed containing EAC. This shows that the performance of the carbon bed (GWC) is  
10 not affected in a negative way by applying a multi-layer bed. The shorter loading time of the GAC bed primarily resulted from the lower packed density of this carbon compared to EAC, thus reducing the amount of activated carbon in the test tube.

          Figure 2 represents the test results of cycle 75 after integrating the  
15 breakthrough curves. It shows the cumulative hydrocarbons emission as a function of the outlet hydrocarbons concentration. From Figure 2 it follows that the hydrocarbons emission for a multi-layer carbon bed is at the same level as that of a bed filled with GAC only, and at a much lower level than that of a bed filled with EAC only.

20           Table 3 contains the pressure drop data in air over the carbon beds at various linear gas flow rates. These data indicate that the pressure drop of the multi-layer carbon bed is only slightly higher than that of a carbon bed containing only EAC, and considerably lower than that of a carbon bed containing GAC only.

25

Table 1 Composition of the HC-mix used to compose a model gasoline vapour.

Hydrocarbon Compound	Content in HC-mix [mole fraction]
n-pentane	0.579
n-hexane	0.077
1-hexene	0.050
benzene	0.013
toluene	0.053
2,3 di-methylpentane	0.017
iso-octane	0.043
ethylbenzene	0.017
o-xylene	0.014
nonane	0.006
MTBE	0.131

5 Table 2 Loading times during cycle 75 of carbon beds containing different amounts of EAC and GAC.

Carbon Bed Composition [ratio EAC/GAC]	Loading Time / Loading Time using EAC only [%]
100/0	100.0
95/5	100.7
90/10	100.4
0/100	96.1

Table 3 Pressure drop in air over carbons beds containing different amounts of EAC and GAC.

Linear Air Flow Rate [cm/sec]	Pressure Drop in Air [kPa/m]		
	EAC/GAC- ratio 100/0	EAC/GAC-ratio 90/10	EAC/GAC-ratio 0/100
7.7	0.4	0.5	1.2
15	1.3	1.7	3.1
23	2.4	3.0	5.4
31	3.7	4.6	8.5
38	5.7	6.9	12
46	7.7	9.2	17
54	11	12	21
61	14	17	27
69	17	20	34



Claims

1. Process for the adsorption of smog-forming hydrocarbon vapours from fuel gas mixtures containing them onto activated carbon, said process comprising passing the gas mixture consecutively through at least a first and a second adsorption system, the first system consisting of activated carbon  
5 having a first adsorption rate for the said organic vapours and the second system consisting of an adsorbent having a second adsorption rate for the said organic vapours, the said second adsorption rate being higher than the said first adsorption rate. *(this is reverse)*
2. Process according to claim 1, wherein the said second adsorption  
10 system contains an adsorbent selected from the group of activated carbon, zeolite, and modified zeolite.
3. process according to claim 2, wherein the said second adsorption system contains activated carbon.
4. Process according to claim 3, wherein the activated carbon in both  
15 adsorption systems is based on the same material, with different ratio of external surface to volume.
5. Process according to claims 2-4, wherein the particle size of the activated carbon in the said second adsorption system is smaller than the particle size of the activated carbon in the said first adsorption system.
- 20 6. Process according to claims 1-5, wherein the pressure drop per unit bed depth of the adsorbent in the said first adsorption system is lower than the pressure drop per unit bed depth of the adsorbent in the said second adsorption system.
7. Process according to claims 1-6, wherein the said fuel gas mixtures  
25 are selected from gases originating from gasoline, kerosine and fuel oil.
8. Process for the removal of gasoline or fuel oil vapours from gas mixtures originating in relation to the operation of vehicle internal combustion engines, said process comprising passing the gas mixture consecutively

- through at least a first and a second adsorption system, the first system consisting of activated carbon having a first adsorption rate for the said organic vapours and the second system consisting of an adsorbent having a second adsorption rate for the said organic vapours, the said second adsorption rate being higher than the said first adsorption rate.
- 5 9. Process according to claim 8, wherein the said second adsorption system contains an adsorbent selected from the group of activated carbon, zeolite, and modified zeolite.
- 10 10. process according to claim 9, wherein the said second adsorption system contains activated carbon.
11. Process according to claim 10, wherein the activated carbon in both adsorption systems is based on the same material, with different ratio of external surface to volume.
- 15 12. Process according to claims 9-11, wherein the particle size of the activated carbon in the said second adsorption system is smaller than the particle size of the activated carbon in the said first adsorption system.
13. Process according to claims 8-12, wherein the pressure drop over the adsorbent in the said first adsorption system is lower than the pressure drop over the adsorbent in the said second adsorption system.
- 20 14. Process according to claims 8-13, wherein the loaded adsorption systems are regenerated by passing combustion air through the adsorption systems.

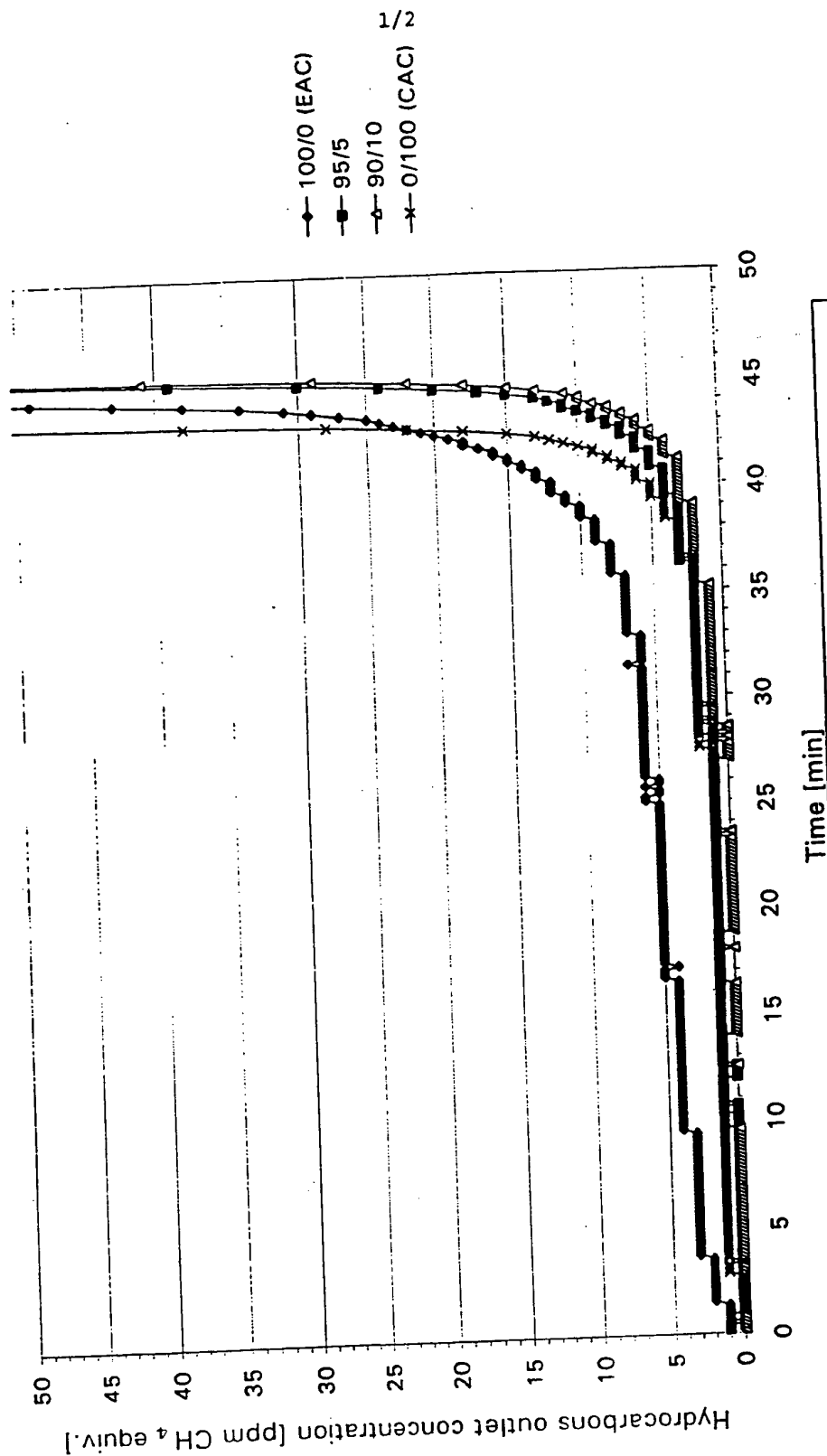

Figure 1 Breakthrough curves of activated carbon beds containing EAC/CAC in the ratios 100/0, 95/5, 90/10, and 0/100 (cycle 75).

- ◆ 100/0 (EAC)
- 95/5
- ▲ 90/10
- × 0/100 (CAC)

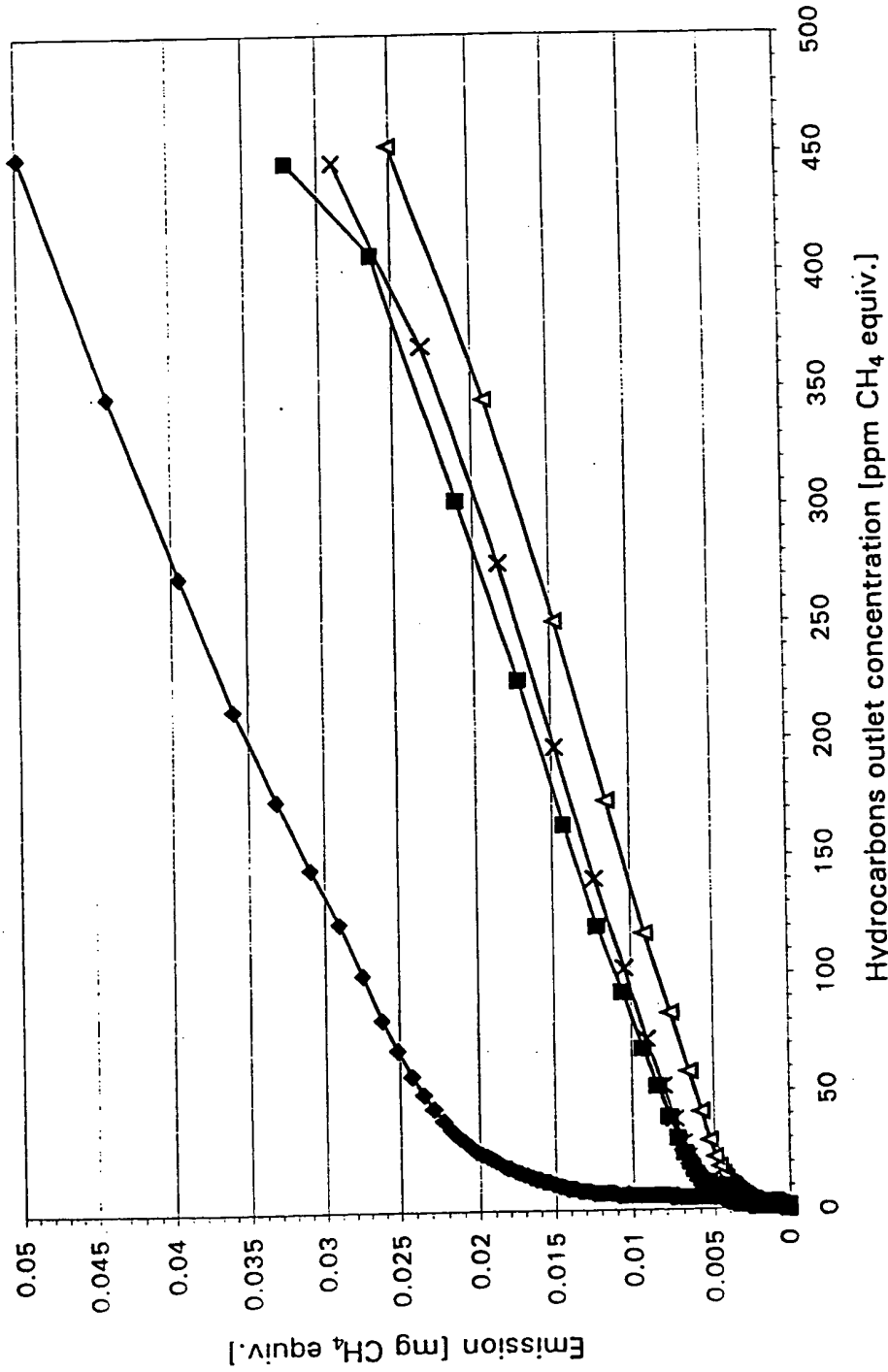

Figure 2 Hydrocarbons emission vs. outlet hydrocarbons concentration, as measured with activated carbon beds containing EAC/CAC in the ratios 100/0, 95/5, 90/10, and 0/100 (cycle 75).

# INTERNATIONAL SEARCH REPORT

International Application No

PCT/NL 01/00146

**A. CLASSIFICATION OF SUBJECT MATTER**  
 IPC 7 B01D53/04 B60K15/035

According to International Patent Classification (IPC) or to both national classification and IPC

**B. FIELDS SEARCHED**

Minimum documentation searched (classification system followed by classification symbols)  
 IPC 7 B01D B60K

Documentation searched other than minimum documentation to the extent that such documents are included in the fields searched

Electronic data base consulted during the international search (name of data base and, where practical, search terms used)  
 EPO-Internal, WPI Data

**C. DOCUMENTS CONSIDERED TO BE RELEVANT**

Category *	Citation of document, with indication, where appropriate, of the relevant passages	Relevant to claim No.
X	US 4 964 888 A (MILLER GEOFFREY Q) 23 October 1990 (1990-10-23) column 1, line 5 - line 10 column 1, line 13 - line 20 column 1, line 51 - column 2, line 2 column 3, line 60 - column 4, line 20 column 5, line 40 - line 49 ---	1-14
A	GB 2 300 577 A (BOC GROUP PLC) 13 November 1996 (1996-11-13) claims 1-16; figure ---	1-14
A	"Kirk-Othmer Encyclopedia of Chemical Technology. Fourth edition. Volume 4" 1992, JOHN WILEY & SONS, NEW YORK (USA) XP002143167 page 1030 -page 1031 ---	1-14

Further documents are listed in the continuation of box C.

Patent family members are listed in annex.

- \* Special categories of cited documents:
- \*A\* document defining the general state of the art which is not considered to be of particular relevance
  - \*E\* earlier document but published on or after the international filing date
  - \*L\* document which may throw doubts on priority claim(s) or which is cited to establish the publication date of another citation or other special reason (as specified)
  - \*O\* document referring to an oral disclosure, use, exhibition or other means
  - \*P\* document published prior to the international filing date but later than the priority date claimed
  - \*T\* later document published after the international filing date or priority date and not in conflict with the application but cited to understand the principle or theory underlying the invention
  - \*X\* document of particular relevance: the claimed invention cannot be considered novel or cannot be considered to involve an inventive step when the document is taken alone
  - \*Y\* document of particular relevance: the claimed invention cannot be considered to involve an inventive step when the document is combined with one or more other such documents, such combination being obvious to a person skilled in the art.
  - \*G\* document member of the same patent family

Date of the actual completion of the international search	Date of mailing of the international search report
29 May 2001	06/06/2001

Name and mailing address of the ISA European Patent Office, P.B. 5618 Patentlaan 2 NL - 2280 HV Rijswijk Tel. (+31-70) 340-2040. Tx. 31 651 epo nl. Fax: (+31-70) 340-3016	Authorized officer  <p style="text-align: center;">Cubas Alcaraz, J</p>
--	---

INTERNATIONAL SEARCH REPORT

International Application No  
PCT/NL 01/00146

C.(Continuation) DOCUMENTS CONSIDERED TO BE RELEVANT

Category *	Citation of document, with indication, where appropriate, of the relevant passages	Relevant to claim No.
A	WO 92 01585 A (BRITISH PETROLEUM CO PLC) 6 February 1992 (1992-02-06) page 1, line 1 - line 20 -----	1-14
A	US 3 844 739 A (ALFREY T) 29 October 1974 (1974-10-29) column 1, line 5 - line 10 column 1, line 37 - line 62 column 2, line 11 -column 3, line 26 column 4, line 64 -column 5, line 2; figure -----	1-14

1

# INTERNATIONAL SEARCH REPORT

Information on patent family members

International Application No

PCT/NL 01/00146

Patent document cited in search report	Publication date	Patent family member(s)	Publication date
US 4964888    A	23-10-1990	AU 6847090 A	04-07-1991
		BR 9006616 A	01-10-1991
		CA 2032613 A	28-06-1991
		CN 1052796 A	10-07-1991
		EP 0435156 A	03-07-1991
		JP 6304431 A	01-11-1994
		KR 9301608 B	06-03-1993
		NO 905512 A	28-06-1991
		ZA 9010402 A	30-10-1991
GB 2300577    A	13-11-1996	NONE	
WO 9201585    A	06-02-1992	AU 8281391 A	18-02-1992
US 3844739    A	29-10-1974	NONE	

# PATENT ABSTRACTS OF JAPAN

(11)Publication number : 2002-256989

(43)Date of publication of application : 11.09.2002

(51)Int.Cl.

F02M 25/08

(21)Application number : 2001-391571

(71)Applicant : AISAN IND CO LTD

(22)Date of filing : 25.12.2001

(72)Inventor : MAKINO KATSUHIKO  
KOSUGI TAKASHI  
TOKI TOMOZO

(30)Priority

Priority number : 2000404629    Priority date : 25.12.2000    Priority country : JP

## (54) CANISTER

(57)Abstract:

**PROBLEM TO BE SOLVED:** To provide a canister capable of suppressing blow-by of evaporated fuel to the atmosphere by minimizing a diffusion phenomenon within an adsorbing material layer of a canister and surely adsorbing the flowing evaporated fuel.

**SOLUTION:** This canister 1 is constituted by filling activated carbon A (5a) having much adsorbing amount of the evaporated fuel and weak holding force in a first adsorbing material layer 7 of the canister 1 and filling activated carbon B (5b) having middle adsorbing amount of evaporated fuel, weak holding force and thereby having a characteristic having little remaining amount of low boiling point component in evaporated fuel after purging. As a result, radiation of evaporated fuel to the atmosphere after leaving the canister 1 under a high temperature can be suppressed.

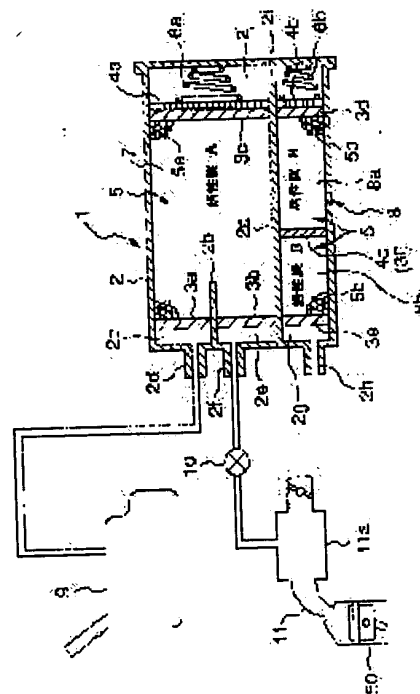



LEGAL STATUS

[Date of request for examination] 08.04.2003

[Date of sending the examiner's decision of rejection]

[Kind of final disposal of application other than the examiner's decision of rejection or application converted registration]

[Date of final disposal for application]

[Patent number]

[Date of registration]

[Number of appeal against examiner's decision of rejection]

[Date of requesting appeal against examiner's decision of rejection]

[Date of extinction of right]

Copyright (C); 1998,2003 Japan Patent Office

DERWENT-ACC-NO: 2002-544937  
DERWENT-WEEK: 200258  
COPYRIGHT 1999 DERWENT INFORMATION LTD

TITLE: Diurnal breathing loss control canister  
module system and constructing  
method thereof

INVENTOR: OH, W S

PATENT-ASSIGNEE: KOREA FUEL TECH CORP[KOFUN]

PRIORITY-DATA: 2000KR-0046045 (August 9, 2000)

PATENT-FAMILY:

PUB-NO	PAGES	PUB-DATE	MAIN-IPC	
KR 2002012826		February 20, 2002		N/A
001		B60K 015/10		

A

APPLICATION-DATA:

PUB-NO	APPL-DESCRIPTOR	APPL-NO
KR2002012826A	N/A	
2000KR-0046045	August 9, 2000	

INT-CL (IPC): B60K015/10

ABSTRACTED-PUB-NO: KR2002012826A

BASIC-ABSTRACT: NOVELTY - A constructing method of  
a DBL(Diurnal Breathing  
Loss) control canister module system is provided to  
cut down expenses and  
improve fuel efficiency by regulating DBL and  
preventing evaporative gas of  
fuel corresponding to exhaust gas regulation.

DETAILED DESCRIPTION - Hydrocarbon is discharged through a large canister(1), and collected to a DBL control canister(2). Activated carbon is filled in the DBL control canister with the volume of 250-1000CC.

A canister close valve(3) is connected between the DBL control canister and an air filter(4) to detect leakage of gas, and air is purified with the air filter. The DBL control canister is fixed with a bolt and a nut(17), or integrally formed in the large canister to prevent from being separated against impact and vibration. Gas is evaporated with increasing temperature of fuel in a tank, and evaporative gas is adsorbed in activated carbon of the canister. Evaporative hydrocarbon is adsorbed in the activated carbon of the DBL control canister, and burned with recycling to the engine by negative pressure of the engine. Fuel efficiency is improved with regulating exhaust gas.

CHOSEN-DRAWING: Dwg.1/10

TITLE-TERMS:  
DIURNAL BREATH LOSS CONTROL CANISTER MODULE SYSTEM  
CONSTRUCTION METHOD

DERWENT-CLASS: Q13

QTY	NG	PART NAME	RMKS
1	3	BC-1 NUT	
1	6	SPONGE	
1	6	DIFFUSION PLATE	
2	4	PAD	
1	3	PROTECTOR	
1	2	BAND-PROTECTOR	
1	1	ACTIVATED CARBON	
1	0	CLIP	
1	9	INSERT-PACKING	
1	8	HOSE-DIDL CANI. TO CVV	
1	7	HOSE-CANI. TO OBL CANISTER	
1	6	HOSE-CANI. TO VACUUM	
1	5	HOSE-CANI. TO TANK	
1	4	FILTER ASS'Y - AIR	
1	3	CANISTER CLOSE VALVE	
1	2	OBL CONTROL CANISTER	
1	1	CANISTER	

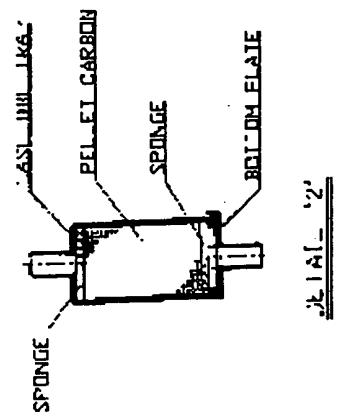
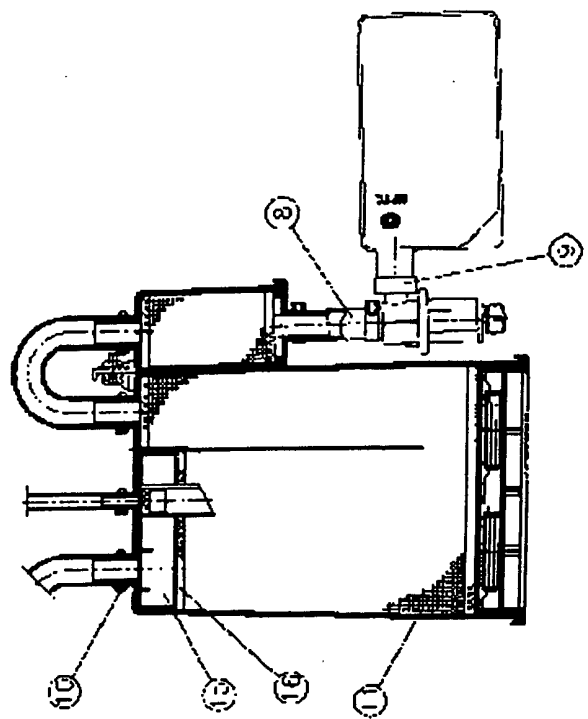
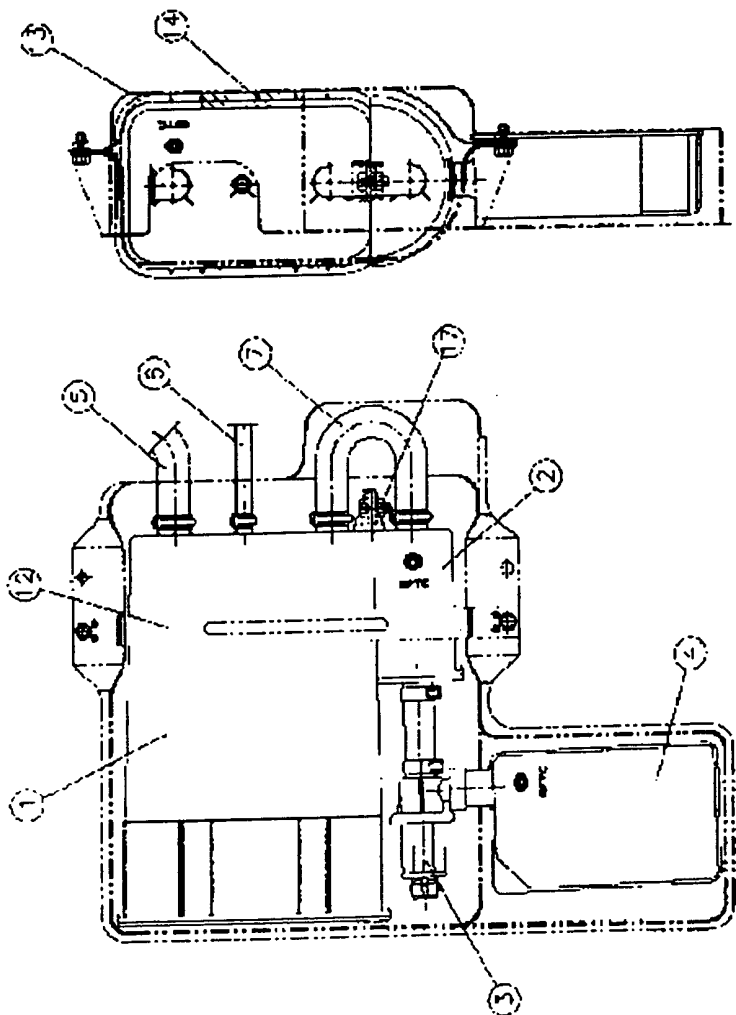

BEST AVAILABLE COPY

PATENT APPLICATION SERIAL NO. \_\_\_\_\_

U.S. DEPARTMENT OF COMMERCE  
PATENT AND TRADEMARK OFFICE  
FEE RECORD SHEET

10/24/2003 HLE333 00000032 231160 10690298

01 FC:1004	770.00 DA
02 FC:1204	86.00 DA
03 FC:1205	432.00 DA

PTO-1556  
(5/87)

(19)



Eur päisch s Patentamt

Eur pean Pat nt Office

Offi e europ n d s brevets



(11)

EP 1 094 032 A1

(12)

EUROPEAN PATENT APPLICATION

(43) Date of publication:  
25.04.2001 Bull tin 2001/17

(51) Int. Cl.7: C01B 31/08, C01B 31/14,  
B01D 53/02

(21) Application number: 00122313.0

(22) Date of filing: 20.10.2000

(84) Designated Contracting States:  
AT BE CH CY DE DK ES FI FR GB GR IE IT LI LU  
MC NL PT SE  
Designated Extension States:  
AL LT LV MK RO SI

(30) Priority: 21.10.1999 JP 29994499  
10.03.2000 JP 2000066762

(71) Applicants:  
• Tennex Corporation  
Toshima-ku, Tokyo (JP)  
• Mitsubishi Chemical Corporation  
Chiyoda-ku, Tokyo (JP)

(72) Inventors:  
• Uchino, Masachi  
Turugashima-shi, Saitama (JP)  
• Yamada, Eiiji  
Sakado-shi, Saitama (JP)

• Yamashita, Hiroshi,  
Chiyoda-ku, Tokyo (JP)  
• Matsuura, Kazushi,  
Mitsubishi Chemical Corporation  
Chiyoda-ku, Tokyo (JP)  
• Takeda, Yoshitaka,  
Mitsubishi Chemical Corporation  
Yokohama-shi, Kanagawa (JP)  
• Suzuki, Mitsuo,  
Mitsubishi Chemical Corporation  
Yokohama-shi, Kanagawa (JP)

(74) Representative:  
VOSSIUS & PARTNER  
Siebertstrasse 4  
81675 München (DE)

Remarks:

The application is published incomplete as filed  
(Article 93 (2) EPC).

(54) Formed active carbon and process for producing the same

(57) A formed activated carbon has a Kiya crushing  
strength of 1 kg or more and a specific heat of 0.4  
J/K • cc or more at 25°C.

EP 1 094 032 A1

## Description

[0001] This invention relates to formed activated carbon and process for producing the same. More particularly it relates to formed activated carbon for a fuel vapor collecting device, what is called "canister", and a process for producing the same.

[0002] An evaporative control system having a fuel vapor collecting device using activated carbon for preventing fuel vapor from dissipating in the air is known. This system is designed to have fuel vapor generated from a fuel system, such as a fuel tank, once adsorbed onto activated carbon of the fuel vapor collecting device and, when the engine is driven to introduce the air, the fuel vapor collecting device is purged with the air to desorb the fuel vapor, which is burnt in the engine.

[0003] The activated carbon exhibits higher adsorptivity for fuel vapor at a lower temperature, and higher desorptivity at a higher temperature. Adsorption of fuel vapor is an exothermic reaction, while desorption is an endothermic reaction. Therefore, with the progress of adsorption, the temperature of activated carbon elevates to gradually reduce the adsorptivity. Similarly, the temperature of activated carbon drops to reduce the desorptivity with the progress of desorption.

[0004] To solve this problem, JP-A-55-149622 proposes providing an activated carbon chamber with fin(s) for heat release to efficiently dissipate the generated heat thereby preventing temperature rise in adsorption or temperature drop in desorption to improve the adsorption and desorption efficiency.

[0005] JP-A-64-36962 proposes a fuel vapor collecting device packed with a collecting material comprising activated carbon having dispersed therein a heat accumulating solid filler having a higher specific heat than activated carbon. The fuel vapor collecting device is prepared by kneading coal powder and a heat accumulating solid filler together with a binder, forming, grinding, carbonizing, and activating.

[0006] According to JP-A-64-36962, however, since the heat accumulating solid filler is dispersed in activated carbon, the formed activated carbon hardly manifests a sufficiently increased specific heat, fails to have sufficient mechanical strength, and is still unsatisfactory in adsorptivity and desorptivity.

[0007] In the practice a treatment for increasing the bulk density is required for obtaining increased adsorptivity per unit volume. An activation treatment following forming has difficulty in securing sufficient mechanical strength or density consistently with high adsorptivity. A method comprising forming with an organic binder after activation (see JP-B-56-37164, JP-B-55-43402, and JP-B-52-13517) and a method comprising forming with an inorganic binder (see JP-B-45-12565 and JP-B-63-242343) have been proposed but are still insufficient in securing high adsorptivity and desorptivity.

[0008] Under these circumstances, activated carbon having moderate strength and enhanced adsorptivity and desorptivity has been sought. An object of the present invention is to provide activated carbon meeting such a demand.

[0009] The present inventors have conducted extensive studies to improve adsorptivity and desorptivity of activated carbon while retaining heat resistance, strength, and density. As a result, they have found that formed activated carbon which has sufficient forming strength and can take full advantage of the high specific heat of a heat accumulating solid filler can be obtained by kneading, forming and firing a mixture of activated carbon powder, a heat accumulating solid filler whose particle size is relatively close to that of the activated carbon powder, clay, and specific compounds.

[0010] The present invention provides formed activated carbon having a Kiya crushing strength (hereinafter defined) of 1 kg or more and a specific heat of 0.4 J/k $\cdot$ cc or more at 25°C.

[0011] The present invention also provides a process of producing formed activated carbon comprising kneading 100 parts by weight of activated carbon powder with (A) 10 to 100 parts by weight of clay, (B) 5 to 200 parts by weight of a metal powder and/or a metal oxide powder, and (C) 2 to 20 parts by weight of a boron compound and/or a phosphorus compound, forming the mixture (plastic body), and firing the green body.

[0012] The present invention further provides formed activated carbon produced by the above process.

[0013] In preferred embodiments of the invention, the Kiya crushing strength is that of formed activated carbon having a diameter of 2.5 mm and a length of 4 mm; the metal powder is aluminum powder and/or magnesium powder; the metal oxide powder is alumina powder and/or magnesium oxide powder; the boron compound is boric acid and/or diboron trioxide (B<sub>2</sub>O<sub>3</sub>); the formed activated carbon has an average particle size of 0.5 to 5 mm; the firing temperature is 500 to 900°C; and/or the formed activated carbon is for a fuel vapor collecting device.

[0014] The activated carbon powder which can be used in the invention includes various species obtained from coal, coconut shell, wood, lignin, etc. by activation with steam or chemicals, such as phosphoric acid, zinc chloride or an alkali metal. Phosphoric acid-activated wood-based carbon powder is preferred. From the standpoint of forming performance and formed body strength, the activated carbon powder usually has a particle size of 0.5 mm or smaller, preferably 0.05 to 0.15 mm. It is preferred for the activated carbon powder to comprise 200-mesh undersize particles in a proportion of 60 to 95%, particularly 60% or more of 100-mesh undersize particles and not more than 50% of 325-mesh undersize particles. It is still preferred that the activated carbon powder comprises 80% or more of 100-mesh undersize particles and not more than 40% of 325-mesh undersize particles, particularly 80 to 90% of 100-mesh undersize particles and 20 to 40% of 325-mesh undersize particles.

## Description

[0001] This invention relates to formed activated carbon and process for producing the same. More particularly it relates to formed activated carbon for a fuel vapor collecting device, what is called "canister", and a process for producing the same.

[0002] An evaporative control system having a fuel vapor collecting device using activated carbon for preventing fuel vapor from dissipating in the air is known. This system is designed to have fuel vapor generated from a fuel system, such as a fuel tank, once adsorbed onto activated carbon of the fuel vapor collecting device and, when the engine is driven to introduce the air, the fuel vapor collecting device is purged with the air to desorb the fuel vapor, which is burnt in the engine.

[0003] The activated carbon exhibits higher adsorptivity for fuel vapor at a lower temperature, and higher desorptivity at a higher temperature. Adsorption of fuel vapor is an exothermic reaction, while desorption is an endothermic reaction. Therefore, with the progress of adsorption, the temperature of activated carbon elevates to gradually reduce the adsorptivity. Similarly, the temperature of activated carbon drops to reduce the desorptivity with the progress of desorption.

[0004] To solve this problem, JP-A-55-149622 proposes providing an activated carbon chamber with fin(s) for heat release to efficiently dissipate the generated heat thereby preventing temperature rise in adsorption or temperature drop in desorption to improve the adsorption and desorption efficiency.

[0005] JP-A-64-36962 proposes a fuel vapor collecting device packed with a collecting material comprising activated carbon having dispersed therein a heat accumulating solid filler having a higher specific heat than activated carbon. The fuel vapor collecting device is prepared by kneading coal powder and a heat accumulating solid filler together with a binder, forming, grinding, carbonizing, and activating.

[0006] According to JP-A-64-36962, however, since the heat accumulating solid filler is dispersed in activated carbon, the formed activated carbon hardly manifests a sufficiently increased specific heat, fails to have sufficient mechanical strength, and is still unsatisfactory in adsorptivity and desorptivity.

[0007] In the practice a treatment for increasing the bulk density is required for obtaining increased adsorptivity per unit volume. An activation treatment following forming has difficulty in securing sufficient mechanical strength or density consistently with high adsorptivity. A method comprising forming with an organic binder after activation (see JP-B-56-37164, JP-B-55-43402, and JP-B-52-13517) and a method comprising forming with an inorganic binder (see JP-B-45-12565 and JP-B-63-242343) have been proposed but are still insufficient in securing high adsorptivity and desorptivity.

[0008] Under these circumstances, activated carbon having moderate strength and enhanced adsorptivity and desorptivity has been sought. An object of the present invention is to provide activated carbon meeting such a demand.

[0009] The present inventors have conducted extensive studies to improve adsorptivity and desorptivity of activated carbon while retaining heat resistance, strength, and density. As a result, they have found that formed activated carbon which has sufficient forming strength and can take full advantage of the high specific heat of a heat accumulating solid filler can be obtained by kneading, forming and firing a mixture of activated carbon powder, a heat accumulating solid filler whose particle size is relatively close to that of the activated carbon powder, clay, and specific compounds.

[0010] The present invention provides formed activated carbon having a Kiya crushing strength (hereinafter defined) of 1 kg or more and a specific heat of 0.4 J/k · cc or more at 25°C.

[0011] The present invention also provides a process of producing formed activated carbon comprising kneading 100 parts by weight of activated carbon powder with (A) 10 to 100 parts by weight of clay, (B) 5 to 200 parts by weight of a metal powder and/or a metal oxide powder, and (C) 2 to 20 parts by weight of a boron compound and/or a phosphorus compound, forming the mixture (plastic body), and firing the green body.

[0012] The present invention further provides formed activated carbon produced by the above process.

[0013] In preferred embodiments of the invention, the Kiya crushing strength is that of formed activated carbon having a diameter of 2.5 mm and a length of 4 mm; the metal powder is aluminum powder and/or magnesium powder; the metal oxide powder is alumina powder and/or magnesium oxide powder; the boron compound is boric acid and/or diboron trioxide ( $B_2O_3$ ); the formed activated carbon has an average particle size of 0.5 to 5 mm; the firing temperature is 500 to 900°C; and/or the formed activated carbon is for a fuel vapor collecting device.

[0014] The activated carbon powder which can be used in the invention includes various species obtained from coal, coconut shell, wood, lignin, etc. by activation with steam or chemicals, such as phosphoric acid, zinc chloride or an alkali metal. Phosphoric acid-activated wood-based carbon powder is preferred. From the standpoint of forming performance and formed body strength, the activated carbon powder usually has a particle size of 0.5 mm or smaller, preferably 0.05 to 0.15 mm. It is preferred for the activated carbon powder to comprise 200-mesh undersize particles in a proportion of 60 to 95%, particularly 60% or more of 100-mesh undersize particles and not more than 50% of 325-mesh undersize particles. It is still preferred that the activated carbon powder comprises 80% or more of 100-mesh undersize particles and not more than 40% of 325-mesh undersize particles, particularly 80 to 90% of 100-mesh undersize particles and 20 to 40% of 325-mesh undersize particles.



[0015] The activated carbon powder for use in the invention usually has a specific surface area of 500 to 2500 m<sup>2</sup>/g, preferably 1000 to 2000 m<sup>2</sup>/g, still preferably 1500 to 2000 m<sup>2</sup>/g. Activated carbon having too small a specific surface area tends to have insufficient adsorptivity, while one having too large a specific surface area tends to have insufficient strength.

5 [0016] The clay which can be used in the invention preferably includes bentonite, such as sodium bentonite and calcium bentonite, with sodium bentonite being particularly preferred. Sodium bentonite, having a particle size ranging from 1 to 100 μm, is not allowed to enter and clog the smaller pores than 300 Å of activated carbon which participate in gas or liquid adsorption and therefore secures high adsorptivity of activated carbon.

10 [0017] The heat accumulating solid filler which can be used in the invention includes powders of metals, such as iron, aluminum, magnesium, copper and lead (or alloys thereof), oxides or carbonates of one or more of these metals, ceramics, or glass. Preferred of them are powders of metals or metal oxides.

[0018] In order to suppress the temperature fall of activated carbon while purging fuel vapor from the activated carbon, it is desirable for the heat accumulating solid filler to have a higher specific heat than activated carbon. Such heat accumulating solid fillers include metal powders, e.g., aluminum powder, aluminum alloy powder, and magnesium powder; metal oxide powders, e.g., alumina powder, magnesium oxide powder, and boron oxide powder; and metal carbonate powders, e.g. calcium carbonate powder and magnesium carbonate powder. Preferred of them are aluminum powder, alumina powder, and magnesium oxide powder. These metal powders, metal oxide powders and metal carbonate powders can be used either individually or as a mixture of two or more thereof. Metal oxide powders are preferred for their chemical stability. From this viewpoint, alumina powder and magnesium oxide powder are the most preferred.

20 [0019] Alumina species of alumina powder includes α-alumina, β-alumina, γ-alumina, δ-alumina, χ-alumina, η-alumina, θ-alumina, and κ-alumina, with α-alumina being preferred.

[0020] The heat accumulating solid filler for use in the invention usually comprises about 95% of 60-mesh under-size particles and preferably has a particle size in the range of from 50 to 300 μm, particularly from 50 to 150 μm. Too large or too small a particle size of the heat accumulating solid filler tends to impair forming performance only to produce a formed body with a low strength or density, which is hard to handle. It is desirable that the particle size of the heat accumulating solid filler be relatively close to that of the activated carbon powder, for example, be within 0.1 to 10 times, particularly 0.5 to 3 times, the particle size of the activated carbon.

25 [0021] The boron compound which can be used in the present invention includes boranes, such as borane and diborane; acids, such as boric acids, borinic acid, and boronic acid; esters of these acids; organic boron compounds, such as boroxine and borazine derivatives having the hydrogen atoms displaced with an alkyl group having 1 to about 20 carbon atoms or an aryl group having 6 to about 20 carbon atoms; carboran; and diboron trioxide (B<sub>2</sub>O<sub>3</sub>). Preferred of them are boric acids and B<sub>2</sub>O<sub>3</sub>. Boric acids are still preferred. Of boric acids, which include orthoboric acid, metaboric acid, and tetraboric acid, orthoboric acid is preferred. The boron compound is preferably used as ground to have such a particle size distribution comprising about 95% of 100-mesh undersize particles.

35 [0022] The phosphorus compound which can be used in the invention includes phosphoric acids (orthophosphoric acid and polyphosphoric acids) and phosphoric acid salts, such as sodium phosphate, calcium phosphate and triphosphates, with phosphoric acids being preferred.

[0023] The boron compound and the phosphorus compound have an action of decreasing the temperature at which the clay changes its crystal form in firing the green body. That is, they are effective in lowering the firing temperature and developing the strength of formed activated carbon thereby to suppress contraction of pores due to the thermal history of the matrix activated carbon. It is believed therefore that these compounds contribute to a good balance between adsorptivity and strength.

40 [0024] The formed activated carbon according to the invention can be obtained from 100 parts by weight of the activated carbon powder compounded with 10 to 100 parts by weight, preferably 40 to 80 parts by weight, of the clay, 5 to 200 parts by weight, preferably 50 to 150 parts by weight, still preferably 100 to 150 parts by weight, of the heat accumulating solid filler, and 2 to 20 parts by weight, preferably 5 to 10 parts by weight, of the boron compound and/or the phosphorus compound. For example, the activated carbon powder, the clay, the heat accumulating solid filler, and the boron compound are mixed at a ratio of 10:6:10:1 by weight. Too much clay reduces adsorptivity, and too little clay reduces forming performance and strength. Use of too large an amount of the heat accumulating solid filler results in reduction in forming performance and strength of formed carbon. When used in too small an amount, the heat accumulating solid filler produces small effects on improvement of adsorptivity and desorptivity. The boron compound and/or the phosphorus compound, when used in too large an amount, reduces adsorptivity and desorptivity. If the amount is too small, the strength of formed carbon reduces.

50 [0025] The formed activated carbon of the invention can be obtained by kneading the above-described components together with an adequate amount of a plasticizer, such as water, forming the mixture, and firing the resulting green body. Kneading is usually conducted by means of a mixing machine, such as a kneader, at ambient temperature until the mixture develops such plasticity that the body may be held with hands. The amount of water to be added is such that the body may be held with hands, usually 50 to 200 parts by weight, preferably 100 to 150 parts by weight, per 100

parts by weight of the activated carbon powder.

[0026] The resulting plastic body is formed by an appropriate forming machine, e.g., an extruder or a press, into granules of desired shape, such as a cylindrical shape or a spherical shape. Preferably, the plastic body is granulated by extrusion. If desired, the granules are ground by means of an appropriate grinder and sized within a desired particle size range.

[0027] The granules or grinds are fired in an oxygen-free atmosphere at 400 to 1000°C, preferably 500 to 900°C, to obtain formed activated carbon of the invention.

[0028] It is preferable that the granules be subjected to rolling treatment with a rolling apparatus, such as a tumbler tester, before firing to make the surface smooth and thereby to increase the bulk density. The rolling treatment is usually performed at about 30 to 300 rpm, preferably about 50 to 100 rpm, for about 10 minutes to 10 hours, preferably about 30 minutes to 3 hours.

[0029] If desired, the firing treatment may be preceded or followed by washing or drying. Washing is carried out with a washing liquid giving no influence on the adsorption performance, usually deionized water or tap water, for several tens of seconds to several hours, preferably about 10 minutes to 1 hour. The washing system is heated appropriately, usually at 30 to 100°C, or boiled. Drying is conducted usually at about 50 to 200°C, preferably about 100 to 150°C, for about 0.5 to 50 hours, preferably about 1 to 10 hours.

[0030] The formed activated carbon according to the invention has a Kiya crushing strength of 1 kg or more, preferably 1 to 15 kg. The Kiya crushing strength is typically measured on a cylindrically formed activated carbon granule having a diameter of 2.5 mm and a length of 4 mm. The formed activated carbon of the invention is suited for use in a canister of automobiles. For this use, the formed activated carbon preferably has a Kiya crushing strength of 3 kg or more. Formed activated carbon having too small a Kiya crushing strength is readily powdered while being packed or used to have an increased permeation resistance (pressure loss).

[0031] The terminology "Kiya crushing strength" as used herein means a hardness measured as follows. A sample is placed on a mount and pressed down by a cylinder with its base facing down under a slowly increasing load. The applied load and the resistance of the sample are monitored, and the load at which the resistance falls to zero (i.e., at the time when the sample is crushed to break the contact between the sample and the base of the cylinder) is taken as a Kiya crushing strength. The measurement can easily be made with a commercially available Kiya type hardness tester. The Kiya crushing strength of the formed activated carbon according to the invention is 1 kg or more, preferably 3 to 15 kg, as measured on a granular sample of 2.5 mm in diameter and 4 mm in length.

[0032] The formed activated carbon of the invention desirably has a specific heat (25°C) of 0.4 J/k · cc or more, particularly 0.5 J/k · cc or more, which is preferred for preventing a temperature elevation during fuel vapor adsorption and for suppressing a temperature fall during fuel vapor desorption. If the specific heat is too low, the effects of adsorption and desorption are insubstantial. Considering the limited specific heat of the heat accumulating solid filler incorporated, the upper limit of the specific heat of the formed activated carbon would be about 0.8 J/k · cc.

[0033] The specific heat (25°C) can be measured in a usual manner. For example, it is obtained with a Perkin Elmer DSC7 equipped with Intracooler System using synthetic sapphire, etc. as a standard substance.

[0034] For use in canisters of automobiles, the formed activated carbon preferably has an average particle size of 0.5 to 5 mm, particularly 2 to 3 mm, and a length of about 0.5 to 10 mm, preferably about 3 to 5 mm. Too small particles increase permeation resistance, and too large particles have reduced packing density, leading to reduced performance.

[0035] Having the above-described physical properties, the formed activated carbon of the invention, as used at a packing density of 0.6 to 0.8 g/cc, exhibits such an ability of adsorbing and desorbing fuel vapor (e.g., gasoline vapor) as has a leak (second time) of about 0.009 to 0.012 g in a DBL test hereinafter described. It is therefore suitable for use as an adsorbent of a fuel vapor collecting device (canister) of an evaporative control system.

[0036] The present invention will now be illustrated in greater detail with reference to Examples, but it should be understood that the invention is not deemed to be limited thereto. Measurements were made in Examples as follows. Unless otherwise noted, all the parts and percents are by weight.

#### 1) DBL test

i. Gasoline vapor was passed through a canister filled with activated carbon until a breakthrough of 2 g, and the canister was then purged with a 400-fold amount of air.

ii. The above operation was repeated 10 cycles. After 11th adsorption, the canister was allowed to stand at ambient temperature for 1 day (soaking).

iii. After the canister was purged with a 400-fold amount of air, 50% butane was passed at a rate of 40 g/hr until a breakthrough of 2 g.

iv. After the canister was purged under conditions in conformity with the kind of the automobile (with an about 300-fold amount of air) and soaked, the following diurnal test was carried out.

v. The canister was connected to a gasoline tank, and a Tedlar bag for leak measurement was attached to the

outlet of the canister.

vi. The gasoline temperature was raised from 18°C up to 41°C over 12 hours, and the leak was measured (first leak).

vii. The gasoline temperature was dropped from 41°C to 18°C over 12 hours.

viii. The gasoline temperature was raised from 18°C to 41°C over 12 hours, and the leak was measured (second leak).

ix. The leak was obtained from (concentration of the gas in the Tedlar bag) x (volume of the Tedlar bag).

## 2) n-Butane adsorption

### 2-1)

i. A glass column was packed with 20 ml of activated carbon and kept at 25°C.

ii. 100% n-Butane was passed through the column at a rate of 105.4 ml/min for 20 minutes to measure a saturated adsorption.

iii. Nitrogen gas was passed through the column at a rate of 200 ml/min for 20 minutes at 25°C to measure a residual adsorption.

iv. An effective adsorption was obtained from [(saturated adsorption) - (residual adsorption)].

### 2-2)

i. A glass column was packed with 20 ml of activated carbon and kept at 25°C.

ii. 100% n-Butane was passed through the column at a rate of 105.4 ml/min for 15 minutes to measure a saturated adsorption.

iii. Nitrogen gas was passed through the column at a rate of 300 ml/min for 40 minutes at 25°C to measure a residual adsorption.

iv. An effective adsorption was obtained from [(saturated adsorption) - (residual adsorption)].

## 3) Specific heat

A Perkin Elmer DSC7 equipped with Intracooler System was used. Synthetic sapphire (specific heat at 25°C: 0.652 J · g · °C) was used as a standard substance. A sample (several cylindrical granules of formed activated carbon laid sideways on a mount) was maintained at 0°C for 5 minutes in a nitrogen atmosphere, heated at a rate of 10°C/min up to 50°C, at which it was maintained for 5 minutes, and the specific heat at 25°C was measured.

## 4) Kiya crushing strength

Kiya crushing strength of 25 formed activated carbon granules having a length of 3 to 5 mm was measured with a Kiya type hardness tester, and an average was obtained.

## EXAMPLE 1

[0037] Wood-based granular activated carbon (specific surface area: 1500 m<sup>2</sup>/g) was ground in a sample mill to such a degree that about 90% of particles had a 100-mesh undersize.

[0038] The resulting activated carbon powder (100 parts) was mixed with 63 parts of sodium bentonite (specific heat: 0.75 J/k · g), 10 parts of boric acid powder (100-mesh undersize), and 108 parts of aluminum powder (100-mesh undersize (about 75 to 150 μm); specific heat (25°C): 0.90 J/k · g) in a kneader for 15 minutes. To the mixture was added 125 parts of water, and kneading was continued for an additional 45 minute period.

[0039] The resulting plastic body was formed into cylinders having a diameter of about 2.5 mm and a length of about 4 mm by means of a disc pelleter, which were rolled in a tumbler tester at 50 rpm for 60 minutes.

[0040] The activated carbon pellets were dried in a hot-air drier at 115°C for 6 hours and then fired in a rotary kiln in a nitrogen atmosphere at 650°C for 1 hour. The fired carbon was boiled in 10 times as much deionized water as the carbon for 30 minutes to remove excess boric acid, followed by dewatering and drying at 115°C for 6 hours. The physical properties and performance of the resulting formed activated carbon are shown in Table 1 below.

## EXAMPLE 2

[0041] Formed activated carbon was prepared in the same manner as in Example 1, except for replacing the aluminum powder with 126 parts of α-alumina powder (particle size: 50 to 300 μm; average particle size: about 150 μm; specific heat (25°C): 0.77 J/k · g). The physical properties and performance of the resulting formed activated carbon are shown in Table 1.

EXAMPLE 3

[0042] Formed activated carbon was prepared in the same manner as in Example 1, except for replacing the aluminum powder with 108 parts of  $\alpha$ -alumina powder (particle size: 50 to 300  $\mu\text{m}$ ; average particle size; about 150  $\mu\text{m}$ ; specific heat (25°C):

5  
10  
15  
20  
25  
30  
35  
40  
45  
50  
55

5  
10  
15  
20  
25  
30  
35  
40  
45  
50  
55

TABLE 1

	Diameter (mm)	Packing Density (g/cc)	Klye Crushing Strength (kg)	n-Butane Adsorption*				Leak In DBL Test (g)		Specific Heat (J/k-g)	Specific Heat (J/k-cc)
				Saturated (g/dl)	Residual (g/dl)	Effective (g/dl)	Desorp-tivity (%)	1st	2nd		
Ex. 1	2.5	0.67	3	10.3	2.8	7.5	73	0.005	0.009	0.73	0.49
Ex. 2	2.5	0.77	4	11.1	1.3	9.8	88	0.006	0.012	0.69	0.53
Ex. 3	2.5	0.72	4	11.5	1.7	9.8	85	0.006	0.012	0.69	0.50
Ex. 4		0.68	3	10.4	1.5	8.9	86	0.004	0.011	0.74	0.50
Comp. Ex. 1	2.5	0.51	7	13.0	4.1	8.9	68	0.009	0.016	0.71	0.36
Comp. Ex. 2	2.5	0.61	10	11.0	3.7	7.3	66	0.012	0.023	-	-
Comp. Ex. 3	2.5	0.66	13	8.5	3.1	5.4	64	0.016	0.033	-	-
Comp. Ex. 4	2.2	0.34	3	12.6	3.8	8.8	70	0.007	0.017	-	-

\*: Method (2-1) was applied to Examples, and method (2-2) was applied to Comparative Examples.

[0043] The present invention provides activated carbon having moderate strength and improved adsorptivity and desorptivity and suited for use in canisters.

[0044] The entire disclosure of each and every foreign patent application from which the benefit of foreign priority has been claimed in the present application is incorporated herein by reference, as if fully set forth.

### Claims

- 5 1. A formed activated carbon having a Kiya crushing strength of 1 kg or more and a specific heat of 0.4 J/K • cc or more at 25°C.
- 10 2. The formed activated carbon according to claim 1, wherein the Kiya crushing strength is that of the formed activated carbon having a diameter of 2.5 mm and a length of 4 mm.
- 15 3. The formed activated carbon according to claim 1, which has a Kiya crushing strength of 1 to 15 kg in a formed activated carbon with a diameter of 2.5 mm and a length of 4 mm.
4. The formed activated carbon according to claim 1, which has a specific heat of 0.4 to 0.8 J/k • cc at 25°C.
5. The formed activated carbon according to claim 1, which has an average particle size of 0.5 to 5 mm.
- 20 6. The formed activated carbon according to any one of claims 1 to 5, which is obtained by a process comprising kneading 100 parts by weight of an activated carbon powder with (i) 10 to 100 parts by weight of clay, (ii) 5 to 200 parts by weight of a heat accumulating solid filler, and (iii) 2 to 20 parts by weight of a boron compound, a phosphorus compound or a mixture thereof, to prepare a plastic body, forming the resulting plastic body to prepare a green body, and firing the green body.
- 25 7. The formed activated carbon according to claim 6, wherein the heat accumulating solid filler has a higher specific heat than the activated carbon powder.
8. The formed activated carbon according to claim 6, wherein the heat accumulating solid filler is a metal powder, a metal oxide powder or a mixture thereof.
- 30 9. The formed activated carbon according to claim 8, wherein the metal powder is aluminum powder, magnesium powder or a mixture thereof.
10. The formed activated carbon according to claim 8, wherein the metal oxide powder is alumina powder, magnesium oxide powder or a mixture thereof.
- 35 11. The formed activated carbon according to claim 6, wherein the boron compound is boric acid, diboron trioxide ( $B_2O_3$ ) or a mixture thereof.
- 40 12. The formed activated carbon according to claim 6, wherein the firing is at 500 to 900°C.
13. The formed activated carbon according to claim 6, wherein the heat accumulating solid filler is used in an amount of 100 to 150 parts by weight per 100 parts by weight of the activated carbon powder.
- 45 14. The formed activated carbon according to claim 1, which is for a fuel vapor collecting device.
- 50 15. A formed activated carbon obtained by a process comprising kneading 100 parts by weight of an activated carbon powder with (A) 10 to 100 parts by weight of clay, (B) 5 to 200 parts by weight of a metal powder, a metal oxide powder or a mixture thereof, and (C) 2 to 20 parts by weight of a boron compound, a phosphorus compound or a mixture thereof, to prepare a plastic body, forming the resulting plastic body to prepare a green body, and firing the green body.
16. The formed activated carbon according to claim 15, wherein the metal powder and the metal oxide powder have a higher specific heat than the activated carbon powder.
- 55 17. The formed activated carbon according to claim 15, wherein the metal powder is aluminum powder, magnesium powder or a mixture thereof.

18. The formed activated carbon according to claim 15, wherein the metal oxide powder is alumina powder, magnesium oxide powder or a mixture thereof.
- 5 19. The formed activated carbon according to claim 15, wherein the boron compound is boric acid, diboron trioxide ( $B_2O_3$ ) or a mixture thereof.
20. The formed activated carbon according to claim 15, which has an average particle size of 0.5 to 5 mm.
21. The formed activated carbon according to claim 15, wherein the firing is at 500 to 900°C.
- 10 22. The formed activated carbon according to claim 15, wherein the heat accumulating solid filler is used in an amount of 100 to 150 parts by weight per 100 parts by weight of the activated carbon powder.
23. The formed activated carbon according to any one of claims 15 to 22, which is for a fuel vapor collecting device.
- 15 24. A process for producing a formed activated carbon, which comprises kneading 100 parts by weight of an activated carbon powder with (A) 10 to 100 parts by weight of clay, (B) 5 to 200 parts by weight of a metal powder, a metal oxide powder or a mixture thereof, and (C) 2 to 20 parts by weight of a boron compound, a phosphorus compound or a mixture thereof, to prepare a plastic body, forming the resulting plastic body to prepare a green body, and firing the green body.
- 20 25. A process for producing a formed activated carbon according to claim 24, wherein the firing is at 500 to 900°C.
26. A process for producing a formed activated carbon according to claim 24, wherein the green body is subjected to a rolling treatment, after the forming and before firing.
- 25

30

35

40

45

50

55



European Patent  
Office

### PARTIAL EUROPEAN SEARCH REPORT

Application Number

which under Rule 45 of the European Patent Convention shall be considered, for the purposes of subsequent proceedings, as the European search report

EP 00 12 2313

DOCUMENTS CONSIDERED TO BE RELEVANT			
Category	Citation of document with indication, where appropriate, of relevant passages	Relevant to claim	CLASSIFICATION OF THE APPLICATION (Int.Cl.7)
D, A	US 4 869 739 A (KANOME YOSHIHIRO ET AL) 26 September 1989 (1989-09-26)  * the whole document *	1,5-10, 13-18, 20,23	C01B31/08 C01B31/14 B01D53/02
A	US 4 963 519 A (OKABAYASHI SEIJI ET AL) 16 October 1990 (1990-10-16) * column 1, line 37 - column 5, line 44 * * table 4 * * claims; examples *	1,14,24	
A	DATABASE WPI Section Ch, Week 198847 Derwent Publications Ltd., London, GB; Class J01, AN 1988-333877 XP002158247 & JP. 63 246462 A (AISAN KOGYO KK), 13 October 1988 (1988-10-13) * abstract *	1,6,8,14	
A	US 5 324 703 A (MCCUE JOHN C ET AL) 28 June 1994 (1994-06-28) * table III * * claims; examples *	1,6,14, 24	TECHNICAL FIELDS SEARCHED (Int.Cl.7)  C01B B01D
-/--			
INCOMPLETE SEARCH			
<p>The Search Division considers that the present application, or one or more of its claims, does/do not comply with the EPC to such an extent that a meaningful search into the state of the art cannot be carried out, or can only be carried out partially, for these claims.</p> <p>Claims searched completely :</p> <p>Claims searched incompletely :</p> <p>Claims not searched :</p> <p>Reason for the limitation of the search: see sheet C</p>			
Place of search		Date of completion of the search	Examiner
THE HAGUE		24 January 2001	Puetz, C
CATEGORY OF CITED DOCUMENTS			
<p>X : particularly relevant if taken alone Y : particularly relevant if combined with another document of the same category A : technological background O : non-written disclosure P : intermediate document</p>		<p>T : theory or principle underlying the invention E : earlier patent document, but published on, or after the filing date D : document cited in the application L : document cited for other reasons &amp; : member of the same patent family, corresponding document</p>	

EPO FORM 1503 03/82 (P/M/07)





DOCUMENTS CONSIDERED TO BE RELEVANT		CLASSIFICATION OF THE APPLICATION (Int.Cl.7)
Category	Citation of document with indication, where appropriate, of relevant passages	Relevant to claim
A	CHEMICAL ABSTRACTS, vol. 86, no. 16, 18 April 1977 (1977-04-18) Columbus, Ohio, US; abstract no. 108665k, YAMABE ET AL.: "Articles from active carbon" XP002158246 * abstract * & JP 51 037091 A (TOMBOW PENCIL) 29 March 1976 (1976-03-29)	1,6-10
A	US 5 691 270 A (MILLER JAMES R) 25 November 1997 (1997-11-25) * claims *	1,6
		TECHNICAL FIELDS SEARCHED (Int.Cl.7)

EPO FORM 1503 03.82 (P04C10)



European Patent  
Office

INCOMPLETE SEARCH  
SHEET C

Application Number  
EP 00 12 2313

Claim(s) searched completely:  
6-13, 15-26

Claim(s) searched incompletely:  
1-5, 14

Reason for the limitation of the search:

Present claims 1-5 and 14 relate to a formed activated carbon product solely by reference to the following parameters:

P1: Kiya crushing strength

P2: specific heat

The use of these parameters in the present context is considered to lead to a lack of clarity within the meaning of Article 84 EPC. It is impossible to compare the parameters the applicant has chosen to employ with what is set out in the prior art. The lack of clarity is such as to render a meaningful complete search impossible. Consequently, the search has been restricted to compositions of products and processes of producing such products as mentioned in the description (s. page 3, line 18- page 4, line 1 and parts of the description where the different components are specified) and as prepared in examples 1-3.

ANNEX TO THE EUROPEAN SEARCH REPORT  
ON EUROPEAN PATENT APPLICATION NO.

EP 00 12 2313

This annex lists the patent family members relating to the patent documents cited in the above-mentioned European search report. The members are as contained in the European Patent Office EDP file on The European Patent Office is in no way liable for these particulars which are merely given for the purpose of information.

24-01-2001

Patent document cited in search report	Publication date	Patent family member(s)	Publication date
US 4869739 A	26-09-1989	JP 1036962 A	07-02-1989
US 4963519 A	16-10-1990	JP 1293134 A	27-11-1989
		JP 1897634 C	23-01-1995
		JP 6020548 B	23-03-1994
		CA 1331597 A	23-08-1994
		DE 68900410 D	12-12-1991
		EP 0343697 A	29-11-1989
		US 5049365 A	17-09-1991
JP 63246462 A	13-10-1988	NONE	
US 5324703 A	28-06-1994	US 5250491 A	05-10-1993
		US 5538932 A	23-07-1996
		CA 2092351 A,C	12-02-1994
		DE 583174 T	03-11-1994
		EP 0583174 A	16-02-1994
		JP 2618583 B	11-06-1997
		JP 6056416 A	01-03-1994
		MX 9301916 A	30-06-1994
JP 51037091 A	29-03-1976	NONE	
US 5691270 A	25-11-1997	US 5736485 A	07-04-1998

EPO FORM P0459

For more details about this annex : see Official Journal of the European Patent Office, No. 12/82

PATENT APPLICATION SERIAL NO. \_\_\_\_\_

U.S. DEPARTMENT OF COMMERCE  
PATENT AND TRADEMARK OFFICE  
FEE RECORD SHEET

10/24/2003 HLE333 00000032 231160 10690298

01 FC:1004	770.00 DA
02 FC:1204	85.00 DA
03 FC:1205	432.00 DA

12/05/2003 SDIRETR1 00000101 231160 10690298

01 FC:1204	66.00 DA
------------	----------

PTO-1556  
(5/87)

Access DB# 116052  
11/02/52

# SEARCH REQUEST FORM

Scientific and Technical Information Center

Requester's Full Name: Lawrence Frank Examiner #: 76035 Date: 3/8/04  
Art Unit: 1104 Phone Number: 30 Serial Number: \_\_\_\_\_  
Mail Box and Bldg/Room Location: 10511 Results Format Preferred (circle): PAPER DISK E-MAIL

If more than one search is submitted, please prioritize searches in order of need.

Please provide a detailed statement of the search topic, and describe as specifically as possible the subject matter to be searched. Include the elected species or structures, keywords, synonyms, acronyms, and registry numbers, and combine with the concept or utility of the invention. Define any terms that may have a special meaning. Give examples or relevant citations, authors, etc, if known. Please attach a copy of the cover sheet, pertinent claims, and abstract.

Title of Invention: \_\_\_\_\_

Inventors (please provide full names): \_\_\_\_\_

Earliest Priority Filing Date: \_\_\_\_\_

*\*For Sequence Searches Only\** Please include all pertinent information (parent, child, divisional, or issued patent numbers) along with the appropriate serial number.

PTO  
mail  
T.S. 6,540,815  
10/5/06

— NO REPORTED LITIGATION —

STAFF USE ONLY		Type of Search	Vendors and cost where applicable
Searcher: <u>24</u>	NA Sequence (#)	STN	
Searcher Phone #:	AA Sequence (#)	Dialog	\$15
Searcher Location:	Structure (#)	Questel/Orbit	\$15
Date Searcher Picked Up:	Bibliographic	Dr. Link	
Date Completed: <u>3-10-04</u>	Litigation <input checked="" type="checkbox"/>	Lexis/Nexis	\$40
Searcher Prep & Review Time: <u>5</u>	Fulltext	Sequence Systems	
Clerical Prep Time:	Patent Family	WWW/Internet	
Online Time: <u>12</u>	Other	Other (specify)	

*Lexis search*

PATNO IS 6540815

DATE: MARCH 10, 2004  
LIBRARY: PATENT  
FILE: ALL

Your search request is:  
PATNO IS 6540815

Number of PATENTS found with your search request through:  
LEVEL 1... 1

1ST PATENT of Level 1 printed in SEGMENTS format.

UNITED STATES PATENT AND TRADEMARK OFFICE GRANTED PATENT

6540815

April 1, 2003

Method for reducing emissions from evaporative emissions  
control systems

REISSUE: October 21, 2003 - Reissue Application filed Ex. Gp.: 1724; Re. S.N.  
10/690,298 (O.G. January 6, 2004)

CERT-CORRECTION: August 26, 2003 - a Certificate of Correction was issued for  
this patent (O.G. September 16, 2003)

APPL-NO: 100362 (10)

FILED-DATE: March 18, 2002

GRANTED-DATE: April 1, 2003

CORE TERMS: adsorbent, canister, vapor, emission, volume, carbon, vent-side,  
purge, fuel, isotherm ...

6,540,815 OR 6540815

Your search request has found no CASES.

To edit the above request, use the arrow keys. Be sure to move the cursor to the end of the request before you enter it.

To enter a new search request, type it and press the ENTER key.



\$%^Questel;HighlightOn=;HighlightOff=;

(C) QUESTEL 1994  
QUESTEL.ORBIT (TM) 1998  
Last connection: 10/03/04 18\*13\*57

10/03/04 18\*49\*23

?file lgst

Selected file: LGST

You are now connected to LGST ( INPADOC Legal Status and PRS )  
Covers select Legal Status Actions from over 40 Patenting Authorities  
Reloaded to reflect revised action coverage of EPO, enter: INFO LGST  
For Table of Actions kept / dropped by EPO, see website documentation  
Current thru weekly update (2004-10)

Search statement 1

?/pn us6540815

\*\* SS 1: Results 1

Search statement 2

?prt full pset 1

1/1 LGST - (C) EPO  
Patent Number -US6540815 B1 20030401 [US6540815]  
Application Number -US10036202 20020318 [2002US-0100362]  
Action Taken -20030826 US/CC-A  
CERTIFICATE OF CORRECTION  
-20040106 US/RF-A  
REISSUE APPLICATION FILED  
EFFECTIVE DATE: 20031021  
Update Code -2004-03

Search statement 2

?file lita

Selected file: LITA

You are now connected to LitAlert, (c) Derwent Information Ltd  
Covers 1970 thru weekly update (2004-09)  
For technical content information : see INFO LITA

Search statement . 1

?nbr /pn us6540815

1 1 US6538218  
2 2 US6538895  
3 1 US6539172  
4 2 US6539778  
5 1 US6540514

} no citations for '815  
in LITALERT  
97

6	2	US6540876
7	1	US6542751
8	1	US6543188
9	2	US6543261
10	1	US6543385
11	1	US6543551
12	1	US6543562
13	1	US6543835
14	1	US6544930
15	1	US6547502

Some: numbers / Continue: Y / None: N

\$%^Dialog;HighlightOn=;HighlightOff=;

File 345:Inpadoc/Fam.& Legal Stat 1968-2003/UD=200409  
(c) 2004 EPO

Set	Items	Description
S1	1	PN=US 6540815

1/9/1  
DIALOG(R)File 345:Inpadoc/Fam.& Legal Stat  
(c) 2004 EPO. All rts. reserv.

18776360  
Basic Patent (No,Kind,Date): US 6540815 BA 20030401 <No. of Patents: 002>

PATENT FAMILY:

UNITED STATES OF AMERICA (US)

Patent (No,Kind,Date): US 6540815 BA 20030401  
METHOD FOR REDUCING EMISSIONS FROM EVAPORATIVE EMISSIONS CONTROL  
SYSTEMS (English)  
Patent Assignee: MEADWESTVACO CORP (US)  
Author (Inventor): HILTZIK LAURENCE H (US); JAGIELLO JACEK Z (US);  
TOLLES EDWARD D (US); WILLIAMS ROGER S (US)  
Priority (No,Kind,Date): US 100362 A 20020318; US 335897 P  
20011121  
Applic (No,Kind,Date): US 100362 A 20020318  
National Class: \* 095146000; 095900000; 123519000  
IPC: \* F02M-033/02; B01D-053/04  
Language of Document: English

UNITED STATES OF AMERICA (US)

Legal Status (No,Type,Date,Code,Text):  
US 6540815 P 20011121 US AA PRIORITY (US PROVISIONAL  
APPLICATION)  
US 335897 P 20011121  
US 6540815 P 20020318 US AE APPLICATION DATA (PATENT)  
(APPL. DATA (PATENT))  
US 100362 A 20020318  
US 6540815 P 20030401 US BA PATENT (NO PREVIOUS  
PRE-GRANT PUBLICATION)  
US 6540815 P 20030826 US CC CERTIFICATE OF CORRECTION  
US 6540815 P 20040106 US RF REISSUE APPLICATION FILED  
(REISSUE APPL. FILED)  
DATE: 20031021

WORLD INTELLECTUAL PROPERTY ORGANIZATION, PCT (WO)

Patent (No,Kind,Date): WO 200346362 A1 20030605  
METHOD FOR REDUCING EMISSIONS FROM EVAPORATIVE EMISSIONS CONTROL  
SYSTEMS (English)  
Patent Assignee: WESTVACO CORP (US)  
Author (Inventor): HILTZIK LAURENCE H; JAGIELLO JACEK Z; TOLLES EDWARD  
D; WILLIAMS ROGER S  
Priority (No,Kind,Date): US 335897 P 20011121; US 100362 A  
20020318  
Applic (No,Kind,Date): WO 2002US21621 A 20020708  
Designated States: (National) AE; AG; AL; AM; AT; AU; AZ; BA; BB; BG;  
BR; BY; BZ; CA; CH; CN; CO; CR; CU; CZ; DE; DK; DM; DZ; EC; EE; ES;  
FI; GB; GD; GE; GH; GM; HR; HU; ID; IL; IN; IS; JP; KE; KG; KP; KR;  
KZ; LC; LK; LR; LS; LT; LU; LV; MA; MD; MG; MK; MN; MW; MX; MZ; NO;  
NZ; OM; PH; PL; PT; RO; RU; SD; SE; SG; SI; SK; SL; TJ; TM; TN; TR;  
TT; TZ; UA; UG; UZ; VN; YU; ZA; ZM; ZW (Regional) GH; GM; KE; LS;  
MW; MZ; SD; SL; SZ; TZ; UG; ZM; ZW; AM; AZ; BY; KG; KZ; MD; RU; TJ;  
TM; AT; BE; BG; CH; CY; CZ; DE; DK; EE; ES; FI; FR; GB; GR; IE; IT;

'LU; MC; NL; PT; SE; SK; TR; BF; BJ; CF; CG; CI; CM; GA; GN; GQ; GW;  
ML; MR; NE; SN; TD; TG  
Filing Details: WO 100000 With international search report  
IPC: \* F02M-025/08; B01D-053/04  
Language of Document: English

WORLD INTELLECTUAL PROPERTY ORGANIZATION, PCT (WO)

Legal Status (No, Type, Date, Code, Text):

WO 200346362	P	20011121	WO AA	PRIORITY CLAIMED
			US 335897	P 20011121
WO 200346362	P	20020318	WO AA	PRIORITY (PATENT)
			US 100362	A 20020318
WO 200346362	P	20020708	WO AE	APPLICATION DATA (APPL. DATA)
			WO 2002US21621	A 20020708
WO 200346362	P	20030605	WO AK	DESIGNATED STATES CITED IN A PUBLISHED APPLICATION WITH SEARCH REPORT (DESIGNATED STATES CITED IN A PUBLISHED APPL. WITH SEARCH REPORT)
			AE AG AL AM AT AU AZ BA BB BG BR BY BZ CA CH CN CO CR CU CZ DE DK DM DZ EC EE ES FI GB GD GE GH GM HR HU ID IL IN IS JP KE KG KP KR KZ LC LK LR LS LT LU LV MA MD MG MK MN MW MX MZ NO NZ OM PH PL PT RO RU SD SE SG SI SK SL TJ TM TN TR TT TZ UA UG UZ VN YU ZA ZM ZW	
WO 200346362	P	20030605	WO AL	DESIGNATED COUNTRIES FOR REGIONAL PATENTS CITED IN A PUBLISHED APPLICATION WITH SEARCH REPORT (DESIGNATED COUNTRIES FOR REGIONAL PATENTS CITED IN A PUBLISHED APPL. WITH SEARCH REPORT)
			GH GM KE LS MW MZ SD SL SZ TZ UG ZM ZW AM AZ BY KG KZ MD RU TJ TM AT BE BG CH CY CZ DE DK EE ES FI FR GB GR IE IT LU MC NL PT SE SK TR BF BJ CF CG CI CM GA GN GQ GW ML MR NE SN TD TG	
WO 200346362	P	20030605	WO A1	PUBLICATION OF THE INTERNATIONAL APPLICATION WITH THE INTERNATIONAL SEARCH REPORT (PUB. OF THE INTERNATIONAL APPL. WITH THE INTERNATIONAL SEARCH REPORT)
WO 200346362	P	20030730	WO 121	EP: THE EPO HAS BEEN INFORMED BY WIPO THAT EP WAS DESIGNATED IN THIS APPLICATION



UNITED STATES PATENT AND TRADEMARK OFFICE

UNITED STATES DEPARTMENT OF COMMERCE  
United States Patent and Trademark Office  
Address: COMMISSIONER FOR PATENTS  
P.O. Box 1450  
Alexandria, Virginia 22313-1450  
www.uspto.gov

APPLICATION NO.	FILING DATE	FIRST NAMED INVENTOR	ATTORNEY DOCKET NO.	CONFIRMATION NO.
10/690,298	10/21/2003	Laurence H. Hiltzik	CHR 2001-79 (reissue)	2091

36876 7590 03/19/2004  
MEADWESTVACO CORPORATION  
5255 VIRGINIA AVENUE  
P.O. BOX 118005  
CHARLESTON, SC 29423-8005

EXAMINER

LAWRENCE JR, FRANK M

ART UNIT PAPER NUMBER

1724

DATE MAILED: 03/19/2004

Please find below and/or attached an Office communication concerning this application or proceeding.

# Office Action Summary

<b>Application No.</b> 10/690,298	<b>Applicant(s)</b> HILTZIK ET AL.	
<b>Examiner</b> Frank M. Lawrence	<b>Art Unit</b> 1724	

-- The MAILING DATE of this communication appears on the cover sheet with the correspondence address --  
**Period for Reply**

A SHORTENED STATUTORY PERIOD FOR REPLY IS SET TO EXPIRE 2 MONTH(S) FROM THE MAILING DATE OF THIS COMMUNICATION.

- Extensions of time may be available under the provisions of 37 CFR 1.136(a). In no event, however, may a reply be timely filed after SIX (6) MONTHS from the mailing date of this communication.
- If the period for reply specified above is less than thirty (30) days, a reply within the statutory minimum of thirty (30) days will be considered timely.
- If NO period for reply is specified above, the maximum statutory period will apply and will expire SIX (6) MONTHS from the mailing date of this communication.
- Failure to reply within the set or extended period for reply will, by statute, cause the application to become ABANDONED (35 U.S.C. § 133). Any reply received by the Office later than three months after the mailing date of this communication, even if timely filed, may reduce any earned patent term adjustment. See 37 CFR 1.704(b).

## Status

- 1)  Responsive to communication(s) filed on 21 October 2003.
- 2a)  This action is **FINAL**.
- 2b)  This action is non-final.
- 3)  Since this application is in condition for allowance except for formal matters, prosecution as to the merits is closed in accordance with the practice under *Ex parte Quayle*, 1935 C.D. 11, 453 O.G. 213.

## Disposition of Claims

- 4)  Claim(s) 1-54 is/are pending in the application.
  - 4a) Of the above claim(s) \_\_\_\_\_ is/are withdrawn from consideration.
- 5)  Claim(s) 1-54 is/are allowed.
- 6)  Claim(s) \_\_\_\_\_ is/are rejected.
- 7)  Claim(s) \_\_\_\_\_ is/are objected to.
- 8)  Claim(s) \_\_\_\_\_ are subject to restriction and/or election requirement.

## Application Papers

- 9)  The specification is objected to by the Examiner.
- 10)  The drawing(s) filed on \_\_\_\_\_ is/are: a)  accepted or b)  objected to by the Examiner.  
Applicant may not request that any objection to the drawing(s) be held in abeyance. See 37 CFR 1.85(a).  
Replacement drawing sheet(s) including the correction is required if the drawing(s) is objected to. See 37 CFR 1.121(d).
- 11)  The oath or declaration is objected to by the Examiner. Note the attached Office Action or form PTO-152.

## Priority under 35 U.S.C. § 119

- 12)  Acknowledgment is made of a claim for foreign priority under 35 U.S.C. § 119(a)-(d) or (f).
    - a)  All b)  Some \* c)  None of:
      - 1.  Certified copies of the priority documents have been received.
      - 2.  Certified copies of the priority documents have been received in Application No. \_\_\_\_\_.
      - 3.  Copies of the certified copies of the priority documents have been received in this National Stage application from the International Bureau (PCT Rule 17.2(a)).
- \* See the attached detailed Office action for a list of the certified copies not received.

## Attachment(s)

- 1)  Notice of References Cited (PTO-892)
- 2)  Notice of Draftsperson's Patent Drawing Review (PTO-948)
- 3)  Information Disclosure Statement(s) (PTO-1449 or PTO/SB/08)  
Paper No(s)/Mail Date \_\_\_\_\_
- 4)  Interview Summary (PTO-413)  
Paper No(s)/Mail Date. \_\_\_\_\_
- 5)  Notice of Informal Patent Application (PTO-152)
- 6)  Other: \_\_\_\_\_

## **DETAILED ACTION**

### *Specification*

1. The disclosure is objected to because of the following informalities: There appears to be a typographical error in line 35 of claim 43. The recitation "air flow" is both bracketed and underlined and should be deleted.

Appropriate correction is required.

### *Reissue Applications*

2. The original patent, or a statement as to loss or inaccessibility of the original patent, must be received before this reissue application can be allowed. See 37 CFR 1.178.

### *Allowable Subject Matter*

3. Claims 1-54 are allowed.

4. The following is an examiner's statement of reasons for allowance: Claims 1-30 are unchanged and remain allowable for the reasons given in the notice of allowance office action mailed with the parent application. Claims 31-54 are allowable because the prior art fails to disclose or suggest an evaporative emissions control canister having the improvement of an initial adsorbent volume having incremental adsorption capacity at 25° C of greater than 35 g n-butane/L between vapor concentrations of 5 vol% and 50 vol% n-butane and at least one subsequent adsorbent volume having an incremental adsorption capacity of less than 35 g n-butane/L between vapor concentrations of 5 vol% and 50 vol% n-butane, as described in independent claims 31 and 43.

Any comments considered necessary by applicant must be submitted no later than the payment of the issue fee and, to avoid processing delays, should preferably accompany the issue

Art Unit: 1724

fee. Such submissions should be clearly labeled "Comments on Statement of Reasons for Allowance."

### *Conclusion*

5. This application is in condition for allowance except for the following formal matters:

The minor error in the claim and the lack of the original patent submission as described in paragraphs 1 and 2 above.

Prosecution on the merits is closed in accordance with the practice under *Ex parte Quayle*, 1935 C.D. 11, 453 O.G. 213.

A shortened statutory period for reply to this action is set to expire **TWO MONTHS** from the mailing date of this letter.

Any inquiry concerning this communication or earlier communications from the examiner should be directed to Frank M. Lawrence whose telephone number is 571-272-1161.

The examiner can normally be reached on Mon-Thurs 7:30-6:00.

If attempts to reach the examiner by telephone are unsuccessful, the examiner's supervisor, Blaine Copenheaver can be reached on 571-272-1156. The fax phone number for the organization where this application or proceeding is assigned is 703-872-9306.

Information regarding the status of an application may be obtained from the Patent Application Information Retrieval (PAIR) system. Status information for published applications may be obtained from either Private PAIR or Public PAIR. Status information for unpublished applications is available through Private PAIR only. For more information about the PAIR system, see <http://pair-direct.uspto.gov>. Should you have questions on access to the Private PAIR system, contact the Electronic Business Center (EBC) at 866-217-9197 (toll-free).



Application/Control Number: 10/690,298

Page 4

Art Unit: 1724

Frank M. Lawrence  
Primary Examiner  
Art Unit 1724

fl

*Frank Lawrence*  
*3-17-04*

<p><b>Form PTO-1449</b> (REV. 8-83)</p> <p style="text-align: center;"><b>U.S. DEPT. OF COMMERCE</b> PATENT AND TRADEMARK OFFICE</p> <p style="text-align: center;"><b>INFORMATION DISCLOSURE CITATION</b></p> <p style="text-align: center;">(Use several sheets if necessary)</p>	<p>Atty. Docket No. <b>CHR 2001-79</b></p> <p>SERIAL NO.</p> <hr/> <p>APPLICANT <b>L.H. Hiltzik, J.Z. Jagiello, E.D. Tolles, and R.S. Williams</b></p> <hr/> <p>FILING DATE</p> <p>GROUP <b>1725</b></p>
---	--

U.S. PATENT DOCUMENTS												
*EXAMINER INITIAL	DOCUMENT NUMBER							DATE	NAME	CLASS	SUBCLASS	FILING DATE IF APPROPRIATE
<i>JL</i>	4	6	7	7	0	8	6	06/87	McCue et al.			
	4	8	6	9	7	3	9	09/89	Kanome et al.			
	4	8	9	4	0	7	2	01/90	Turner et al.			
	5	2	0	4	3	1	0	04/93	Tolles et al.			
	5	2	0	6	2	0	7	04/93	Tolles			
	5	2	0	7	8	0	8	05/93	Haruta et al.			
	5	2	3	8	4	7	0	08/93	Tolles et al.			
	5	2	5	0	4	9	1	10/93	Yan			
	5	2	7	6	0	0	0	01/94	Matthews et al.			
	5	3	0	4	5	2	7	04/94	Dimitri			
	5	3	2	4	7	0	3	06/94	McCue et al.			
	5	3	3	7	7	2	1	08/94	Kasuyu et al.			
	5	3	5	5	8	6	1	10/94	Arai			
	5	3	7	7	6	4	4	01/95	Krohm			
	5	4	0	8	9	7	6	04/95	Reddy			
	5	4	1	6	0	5	6	05/95	Baker			
	5	4	5	6	2	3	6	10/95	Wakashiro et al.			
<i>JL</i>	5	4	5	6	2	3	7	10/95	Yamazaki et al.			

FOREIGN PATENT DOCUMENTS													
	DOCUMENT NUMBER							DATE	COUNTRY	CLASS	SUBCLASS	TRANSLATION	
												YES	NO
<i>JL</i>	WO	92	0	1	5	8	5	02/92	PCT Publication				
<i>JL</i>	JP	103	3	9	2	1	8	12/98	Japanese Publication				
<i>JL</i>	EP	11	1	3	1	6	3	07/01	European Patent Office Publication				
<i>JL</i>	WO	01	6	2	3	6	7	08/01	PCT Publication				
<i>JL</i>	KR	0	1	2	8	2	6	02/02	Korean Publication				
<i>JL</i>	EP	10	9	4	0	3	2	04/01	European Patent Office Publication				
<i>JL</i>	JP	022	5	6	9	8	9	11/02	Japanese Publication			X	

OTHER DOCUMENTS (Including Author, Title, Date, Pertinent Pages, Etc.)

<i>JL</i>	Williams, R. S. and C. R. Clontz "Impact and Control of Canister Bleed Emissions" Covington Virginia, Society of Automotive Engineers, Inc. 2001
-----------	--

EXAMINER <i>Leah Lawrence</i>	DATE CONSIDERED <b>3-17-04</b>
-------------------------------	--------------------------------

\*EXAMINER: Initial if citation considered, whether or not citation is in conformance with MPEP 609; Draw line through citation if not in conformance and not considered. Include copy of this form with next communication with applicant.

<b>Form PTO-1449</b> (REV. 8-83)  <b>U.S. DEPT. OF COMMERCE</b> PATENT AND TRADEMARK OFFICE  <b>INFORMATION DISCLOSURE CITATION</b>  (Use several sheets if necessary)		Atty. Docket No. CHR 2001-79		SERIAL NO.									
		APPLICANT L.H. Hiltzik, J.Z. Jagiello, E.D. Tolles, and R.S. Williams											
		FILING DATE		GROUP 1725									
<b>U.S. PATENT DOCUMENTS</b>													
*EXAMINER INITIAL	DOCUMENT NUMBER							DATE	NAME	CLASS	SUBCLASS	FILING DATE IF APPROPRIATE	
<i>JL</i>	5	4	6	0	1	3	6	10/95	Yamazaki et al.				
	5	4	7	7	8	3	6	12/95	Hyodo et al.				
	5	4	8	2	0	2	3	01/96	Hunt et al.				
	5	5	3	8	9	3	2	07/96	Yan et al.				
	5	5	6	4	3	9	8	10/96	Maeda et al.				
	5	6	8	7	6	9	7	11/97	Ishikawa				
	5	6	9	1	2	7	0	11/97	Miller				
	5	7	3	6	4	8	1	04/98	Miller				
	5	7	3	6	4	8	5	04/98	Miller				
	5	8	6	3	8	5	8	01/99	Miller et al.				
	5	9	1	4	2	9	4	06/99	Park et al.				
	5	9	1	4	4	5	7	06/99	Itakura et al.				
	5	9	3	1	1	4	1	08/99	Chino				
	5	9	5	7	1	1	4	09/99	Johnson et al.				
	6	0	9	8	6	0	1	08/00	Reddy				
	6	1	3	6	0	7	5	10/00	Bragg et al.				
	6	1	7	1	3	7	3	01/01	Park et al.				
	6	2	7	9	5	4	8	08/01	Reddy				
6	2	8	4	7	0	5	09/01	Park et al.					
<i>JL</i>	6	4	8	8	7	4	8	12/02	Yamafuji et al.				
<b>FOREIGN PATENT DOCUMENTS</b>													
	DOCUMENT NUMBER							DATE	COUNTRY	CLASS	SUBCLASS	TRANSLATION	
												YES	NO
<b>OTHER DOCUMENTS (Including Author, Title, Date, Pertinent Pages, Etc.)</b>													
EXAMINER <i>pub kenne</i>								DATE CONSIDERED <i>3-17-04</i>					
<small>*EXAMINER: Initial if citation considered, whether or not citation is in conformance with MPEP 609; Draw line through citation if not in conformance and not considered. Include copy of this form with next communication with applicant.</small>													



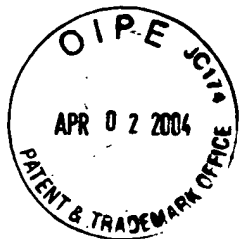

IN THE UNITED STATES PATENT AND TRADEMARK OFFICE

Appl. No. : 10/690,298 Confirmation No.: 2091  
Applicants : L. H. Hiltzik, J. Z. Jagiello, E. D. Tolles, and R. S. Williams  
Filed : October 21, 2003  
TC/A.U. : 1724  
Examiner : Frank M. Lawrence Jr.  
  
Docket No. : CHR 2001-79 (reissue)  
Customer No. : **36876**  
  
For: : Method For Reducing Emissions From Evaporative Emission Control  
Systems

Honorable Commissioner for Patents  
P. O. Box 1450  
Alexandria, VA 22313-1450

**AMENDMENT AND RESPONSE**

Dear Sir:

In response to the Office Action mailed March 19, 2004, having a shortened statutory period for response set to expire on May 19, 2004, reconsideration is respectfully requested in view of the following amendments and remarks.

**Amendments to the Claims** are reflected in the listing of claims which begins on page 2 of this paper.

**Remarks/Arguments** begin on page 10 of this paper.

**Amendments to the Claims:**

This listing of claims will replace all prior versions, and listings, of claims in the application:

**Listing of Claims:**

We claim:

1. (original): A method for reducing fuel vapor emissions in automotive evaporative emissions control systems comprising the steps of contacting the fuel vapor with an initial adsorbent volume having incremental adsorption capacity at 25°C of greater than 35 g n-butane/L between vapor concentrations of 5 vol% and 50 vol% n-butane and at least one subsequent adsorbent volume having an incremental adsorption capacity of less than 35 g n-butane/L between vapor concentrations of 5 vol% and 50 vol% n-butane.
2. (original): The method of claim 1 comprising a single subsequent adsorbent volume.
3. (original): The method of claim 1 comprising multiple subsequent adsorbent volumes.
4. (original): The method of claim 2 wherein the initial adsorbent volume and the subsequent adsorbent volume are located within a single automotive evaporative emission control canister.
5. (original): The method of claim 3 wherein the initial adsorbent volume and the subsequent adsorbent volumes are located within a single automotive evaporative emission control canister.
6. (original): The method of claim 2 wherein the initial adsorbent volume and the subsequent adsorbent volume are located in separate canisters that are connected to permit sequential contact by the fuel vapor.
7. (original): The method of claim 3 wherein the initial adsorbent volume and at least one subsequent adsorbent volume are located in separate canisters that are connected to permit sequential contact by the fuel vapor.
8. (original): The method of claim 1 wherein the initial adsorbent volume and the subsequent adsorbent volume are activated carbon derived from materials selected from

- the group consisting of wood, peat, coal, coconut, lignite, petroleum pitch, petroleum coke, coal tar pitch, fruit pits, nut shells, sawdust, wood flour, synthetic polymer, and natural polymer having been activated by a process selected from the group consisting of chemical, thermal, and combined chemical/thermal activation methods.
9. (original): The method of claim 1 wherein the initial adsorbent volume and the subsequent adsorbent volume are inorganic materials selected from the group consisting of zeolites, porous silica, porous alumina, pillared clays, and molecular sieves.
  10. (original): The method of claim 1 wherein the initial adsorbent volume and the subsequent adsorbent volume are porous polymers.
  11. (original): The method of claim 1 wherein the subsequent adsorbent volume exhibits adsorption capacities achieved by volumetric dilution.
  12. (original): The method of claim 11 wherein the volumetric dilution is accomplished by the addition of a non-adsorbing filler as a co-ingredient by an addition process selected from the group consisting of addition with the activated carbon raw material prior to activation, addition with the adsorbent before forming into a shaped particle or monolith, and a combination thereof.
  13. (original): The method of claim 11 wherein the volumetric dilution is accomplished by forming the adsorbent into high voidage shapes selected from the group consisting of stars, hollow cylinders, asterisks, spirals, cylinders, and configured ribbons.
  14. (original): The method of claim 11 wherein the volumetric dilution is accomplished by forming the adsorbent into a honeycomb or monolith shape.
  15. (original): The method of claim 11 wherein the volumetric dilution is accomplished by the use of inert spacer particles, trapped air spaces, foams, fibers, and screens external to the adsorbent.
  16. (original): The method of claim 12 wherein the non-adsorbing filler is a solid after processing.
  17. (original): The method of claim 12 wherein the non-adsorbing filler is volatilized or combusted to form voidages larger than 50Å width within the shaped particle or monolith.

18. (original): In a method of reducing fuel vapor emissions in an automotive evaporative emissions control system comprising removing at least one volatile organic compound from a volatile organic compound-containing fuel vapor by routing the fuel vapor through a vapor adsorbent, the improvement comprising sequentially routing the fuel vapor through an initial adsorbent material-containing volume wherein the initial adsorbent material is characterized by an incremental adsorption capacity at 25°C of greater than 35 g n-butane/L between vapor concentrations of 5 vol% and 50 vol% n-butane before routing the fluid stream through at least one subsequent adsorbent-containing volume prior to venting to the atmosphere wherein the subsequent adsorbent-containing volume is characterized by an incremental adsorption capacity at 25°C of less than 35 g n-butane/L between vapor concentrations of 5 vol% and 50 vol% n-butane.
19. (original): The method of claim 18 wherein the initial adsorbent volume and the subsequent adsorbent volume are located in a single automotive evaporative emissions canister.
20. (original): The method of claim 18 wherein the initial adsorbent volume and the subsequent adsorbent volume are located in separate canisters that are connected to permit sequential contact by the fuel vapor.
21. (original): The method of claim 18 wherein the initial adsorbent volume and the subsequent adsorbent volume are activated carbon derived from materials selected from the group consisting of wood, peat, coal, coconut, lignite, petroleum pitch, petroleum coke, coal tar pitch, fruit pits, nut shells, sawdust, wood flour, synthetic polymer, and natural polymer and activated by chemical and/or thermal activation methods.
22. (original): The method of claim 18 wherein the initial adsorbent volume and the subsequent adsorbent volume are inorganic materials selected from the group consisting of zeolites, porous silica, and molecular sieves.
23. (original): The method of claim 18 wherein the initial adsorbent volume and the subsequent adsorbent volume are porous polymers.
24. (original): The method of claim 18 wherein the subsequent adsorbent volume exhibits adsorption capacities achieved by volumetric dilution.



25. (original): The method of claim 24 wherein the volumetric dilution is accomplished by the addition of a non-adsorbing filler as a co-ingredient by an addition process selected from the group consisting of addition with the activated carbon raw material prior to activation, addition with the adsorbent before forming into a shaped particle or monolith, and a combination thereof.
26. (original): The method of claim 24 wherein the volumetric dilution is accomplished by forming the adsorbent into high voidage shapes selected from the group consisting of stars, hollow cylinders, asterisks, spirals, cylinders, and configured ribbons.
27. (original): The method of claim 24 wherein the volumetric dilution is accomplished by forming the adsorbent into a honeycomb or monolith shape.
28. (original): The method of claim 24 wherein the volumetric dilution is accomplished by the use of inert spacer particles, trapped air spaces, foams, fibers, and screens external to the adsorbent.
29. (original): The method of claim 25 wherein the non-adsorbing filler is a solid after processing.
30. (original): The method of claim 25 wherein the non-adsorbing filler is volatilized or combusted to form voidages larger than 50Å width within the shaped particle or monolith.
31. (currently amended) In an evaporative emissions control system for a vehicle comprising, in combination, a fuel tank for storing a volatile fuel, an engine having an air induction system and adapted to consume the fuel, a canister containing an initial volume of fuel vapor adsorbent material for temporarily adsorbing and storing fuel vapor from the tank, a conduit for conducting fuel vapor from the tank to a canister vapor inlet, a fuel vapor purge conduit from a canister purge outlet to the induction system of the engine, and a vent/air opening for venting the canister and for admission of air to the canister during operation of the engine induction system, wherein the canister is defined by a fuel vapor flow path via the canister vapor inlet through the initial volume of vapor adsorbent within a first region of the canister toward the vent/air opening, and an air flow path through a subsequent volume of adsorbent within a second region of the canister at the vent/air

opening and the first region at the purge outlet, such that fuel vapor formed in the tank flows through the vapor inlet into the initial volume of adsorbent where it is adsorbed and, during operation of the engine induction system, ambient air flows in a path to and through the vent/air opening and along the air flow path in the canister through the initial volume and the purge outlet to the induction system of the engine, the flow of air removing a portion of the adsorbed fuel vapor but leaving a residue of fuel in the initial volume,

the improvement wherein at least one subsequent volume of vapor adsorbent material comprises a volume of 1% to 100% of the first volume and is located either inside of the canister within the second region thereof or outside of the canister, and wherein the initial volume of vapor adsorbent material is characterized by an incremental adsorption capacity at 25°C of greater than 35 g n-butane/L-bed between vapor concentrations of 5 vol% and 50 vol% n-butane before routing the [fluid stream] air flow through at least one subsequent volume of vapor adsorbent material wherein the subsequent volume of vapor adsorbent material is characterized by an incremental adsorption capacity at 25°C of less than 35 g n-butane between vapor concentrations of 5 vol% and 50 vol% n-butane.

32. (previously presented) The system of claim 31 wherein the second volume of vapor adsorbent material is located outside the canister in a separate subsequent canister.
33. (previously presented) The system of claim 31 wherein the initial volume of vapor adsorbent material and the subsequent volume of vapor adsorbent material are activated carbon derived from materials selected from the group consisting of wood, peat, coal, coconut, lignite, petroleum pitch, petroleum coke, coal tar pitch, fruit pits, nut shells, sawdust, wood flour, synthetic polymer, and natural polymer having been activated by a process selected from the group consisting of chemical, thermal, and combined chemical/thermal activation methods.
34. (previously presented) The system of claim 31 wherein the initial volume of vapor adsorbent material and the subsequent volume of vapor adsorbent material are inorganic

- materials selected from the group consisting of zeolites, porous silica, porous alumina, pillared clays, and molecular sieves.
35. (previously presented) The system of claim 31 wherein the initial volume of vapor adsorbent material and the subsequent volume of vapor adsorbent material are porous polymers.
  36. (previously presented) The system of claim 31 wherein the subsequent volume of vapor adsorbent material exhibits adsorption capacities achieved by volumetric dilution.
  37. (previously presented) The system of claim 36 wherein the volumetric dilution is accomplished by the addition of a non-adsorbing filler as a co-ingredient by an addition process selected from the group consisting of addition with the activated carbon raw material prior to activation, addition with the adsorbent before forming into a shaped particle or monolith, and a combination thereof.
  38. (previously presented) The system of claim 36 wherein the volumetric dilution is accomplished by forming the adsorbent material into high voidage shapes selected from the group consisting of stars, hollow cylinders, asterisks, spirals, cylinders, and configured ribbons.
  39. (previously presented) The system of claim 36 wherein the volumetric dilution is accomplished by forming the adsorbent into a honeycomb or monolith shape.
  40. (previously presented) The system of claim 36 wherein the volumetric dilution is accomplished by the use of inert spacer particles, trapped air spaces, foams, and screens external to the adsorbent.
  41. (previously presented) The system of claim 37 wherein the non-adsorbing filler is a solid after processing.
  42. (previously presented) The system of claim 37 wherein the non-adsorbing filler is volatilized or combusted to form voidages larger than 50Å width within the shaped particle or monolith.
  43. (currently amended) A canister operative for use in automotive systems for emission control defined by a canister vapor inlet to permit a fuel vapor flow path through an initial volume of vapor adsorbent within a first region of the canister toward a canister

vent/air opening to permit a continued air flow path through a subsequent volume of adsorbent within a second region of the canister at the vent/air opening and the first region at a canister purge outlet, such that fuel vapor formed in a tank for storing volatile fuel flows through the canister vapor inlet into the initial volume of adsorbent where it is adsorbed and, during operation of an engine induction system, ambient air is caused to flow in a path to and through the vent/air opening and along the air flow path in the canister through the initial volume and the purge outlet to the induction system of the engine, wherein the flow of air removing a portion of the adsorbed fuel vapor but leaving a residue of fuel in the initial volume, and wherein at least one subsequent volume of vapor adsorbent material comprises a volume of 1% to 100% of the initial volume and is located either inside of the canister within the second region thereof or outside of the canister, and wherein the initial volume of vapor adsorbent material is characterized by an incremental adsorption capacity at 25°C of greater than 35 g n-butane/L-bed between vapor concentrations of 5 vol% and 50 vol% n-butane before routing the [fluid stream [air flow[?]] through at least one subsequent volume of vapor adsorbent material wherein the subsequent volume of vapor adsorbent material is characterized by an incremental adsorption capacity at 25°C of less than 35 g n-butane between vapor concentrations of 5 vol% and 50 vol% n-butane.

44. (previously presented) The canister of claim 43 wherein the second volume of vapor adsorbent material is located outside the canister in a separate subsequent canister.
45. (previously presented) The canister of claim 43 wherein the initial volume of vapor adsorbent material and the subsequent volume of vapor adsorbent material are activated carbon derived from materials selected from the group consisting of wood, peat, coal, coconut, lignite, petroleum pitch, petroleum coke, coal tar pitch, fruit pits, nut shells, sawdust, wood flour, synthetic polymer, and natural polymer having been activated by a process selected from the group consisting of chemical, thermal, and combined chemical/thermal activation methods.
46. (previously presented) The canister of claim 43 wherein the initial volume of vapor adsorbent material and the subsequent volume of vapor adsorbent material are inorganic

- materials selected from the group consisting of zeolites, porous silica, porous alumina, pillared clays, and molecular sieves.
47. (previously presented) The canister of claim 43 wherein the initial volume of vapor adsorbent material and the subsequent volume of vapor adsorbent material are porous polymers.
  48. (previously presented) The canister of claim 43 wherein the subsequent volume of vapor adsorbent material exhibits adsorption capacities achieved by volumetric dilution.
  49. (previously presented) The canister of claim 48 wherein the volumetric dilution is accomplished by the addition of a non-adsorbing filler as a co-ingredient by an addition process selected from the group consisting of addition with the activated carbon raw material prior to activation, addition with the adsorbent before forming into a shaped particle or monolith, and a combination thereof.
  50. (previously presented) The canister of claim 48 wherein the volumetric dilution is accomplished by forming the adsorbent material into high voidage shapes selected from the group consisting of stars, hollow cylinders, asterisks, spirals, cylinders, and configured ribbons.
  51. (previously presented) The canister of claim 49 wherein the volumetric dilution is accomplished by an adsorbent formed into a honeycomb or monolith shape.
  52. (previously presented) The canister of claim 48 wherein the volumetric dilution is accomplished by the inclusion of inert spacer particles, trapped air spaces, foams, and screens external to the adsorbent.
  53. (previously presented) The canister of claim 49 wherein the non-adsorbing filler is a solid after processing.
  54. (previously presented) The canister of claim 49 wherein the non-adsorbing filler is volatilized or combusted to form voidages larger than 50Å width within the shaped particle or monolith.

**REMARKS/ARGUMENTS**

Claims 1-54 remain in this application. Claims 1-54 have been allowed. The Examiner noted, however, the need for correction of an informal matter (a typo in claim 43) to place the claims in proper condition for allowance prior to issuance of the formal Notice of Allowance.

Thus, such correction has been made in the attached Listing of Claims.

Upon review of the newly presented claims of the instant reissue application, it was noted that the term "fluid stream" in independent claims 31 and 43 had no antecedent basis. Moreover, it was appreciated that the proper term describing the claimed subject matter was, in both instances, "air flow." In independent claim 31, written in Jepson claim format, the claim preamble includes the phrase "wherein the canister is defined by a fuel vapor flow path via the canister vapor inlet through the initial volume of vapor adsorbent within a first region of the canister toward the vent/air opening, and an air flow path through a subsequent volume of adsorbent within a second region of the canister at the vent/air opening and the first region at the purge outlet." In the subsequent description of the claimed invention improvement, the term "air flow" properly describes that part of the defined canister including the "subsequent volume of adsorbent." In independent claim 43, the same error occurred in the improper use of the term "fluid stream." In both instances, amendment of the claims corrects the error.

Applicant respectfully requests that a timely formal Notice of Allowance be issued in this case.

This explanation of the needed corrective action was discussed by the undersigned attorney with the Examiner by telephone on March 30, 2004. If the Examiner believes, for any reason, that further personal communication will expedite the prosecution of this application, the Examiner is invited to telephone the undersigned at the number provided.

In the Official Action Summary, to which this amendment is responsive, the Examiner noted the additional requirement for the reissue claims to be in condition for allowance is the submission of the original U.S. Patent No. 6,540,815. Therefore, please find enclosed herewith the ribbon copy of said U.S. Patent and the Certificate of Correction, dated August 26, 2003, issued therefore.

Appl. No. 10/690,298  
Amdt. Dated March 31, 2004  
Reply to Office action of March 19, 2004

Case Docket No. CHR 2001-79 (reissue)

No additional fees are believed to be due in connection with the filing of this amendment and response. Should it be determined that additional fees are due and payable, the Commissioner is authorized to charge any required fees or credit any overpayment to the assignee's Deposit Account No. 23-1160.

Respectfully submitted,

MEADWESTVACO CORPORATION

By   
Terry B. McDaniel  
Attorney for the Applicant  
Registration No. 28,444

Attachment

Date: March 31, 2004  
5255 Virginia Avenue  
Post Office Box 118005  
Charleston, SC 29423-8005  
Telephone (843) 740-2311



IN THE UNITED STATES PATENT & TRADEMARK OFFICE

Appl. No.	:	10/690,298	Confirmation No.:	<u>2091</u>
Applicants	:	L. H. Hiltzik, J. Z. Jagiello, E. D. Tolles, and R. S. Williams		
Filed	:	October 21, 2003		
TC/A.U.	:	1724		
Examiner	:	Frank M. Lawrence Jr.		
Docket No.	:	CHR 2001-79 (reissue)		
Customer No.	:	36876		
For	:	Method For Reducing Emissions From Evaporative Emission Control Systems		

Honorable Commissioner for Patents  
P.O. Box 1450  
Alexandria, VA 22313-1450

**SURRENDER OF ORIGINAL LETTERS PATENT**

Dear Sir:

Applicant hereby surrenders attached U.S. Patent No. 6,540,815 B1, in accordance with 35 U.S.C. 251 and 37 C.F.R. 1.178.

Also attached is an original Certificate of Correction that issued for U.S. Patent No. 6,540,815 B1 on August, 26, 2003.

Applicant respectfully requests that attention be made to the corrections set forth in the Certificate of Correction upon issuance of the reissue application.

Respectfully submitted

MEADWESTVACO CORPORATION

By   
 Terry B. McDaniel  
 Attorney for Applicant  
 Registration No. 28,444

Attachments: Original U.S. Letters Patent No. 6,540,815 B1.  
Original Certificate of Correction.

Date April 2, 2004  
5255 Virginia Avenue  
Post Office Box 118005  
Charleston, SC 29423-8005  
Telephone (843) 740-2311



UNITED STATES PATENT AND TRADEMARK OFFICE  
**CERTIFICATE OF CORRECTION**

PATENT NO. : 6,540,815 B1  
DATED : April 1, 2003  
INVENTOR(S) : Laurence H. Hiltzik et al.

Page 1 of 1

It is certified that error appears in the above-identified patent and that said Letters Patent is hereby corrected as shown below:

Title page,

Item [56], **References Cited**, U.S. PATENT DOCUMENTS, insert:

-- 5,957,114	9/1999	Johnson et al.
6,078,601	8/2000	Reddy --.

Drawings,

Sheet 1, beneath Figure 1 delete "Prior Art."

Column 8,

Table, Footnote 1, delete "Test" and insert therefor -- Tests --.

Signed and Sealed this

Twenty-sixth Day of August, 2003



A handwritten signature in black ink, appearing to read "James E. Rogan", written over a horizontal line.

JAMES E. ROGAN  
*Director of the United States Patent and Trademark Office*

### ARTIFACT SHEET

Enter artifact number below. Artifact number is application number + artifact type code (see list below) + sequential letter (A, B, C ...). The first artifact folder for an artifact type receives the letter A, the second B, etc..  
Examples: 59123456PA, 59123456PB, 59123456ZA, 59123456ZB

10 / 690 298 ZA

Indicate quantity of a single type of artifact received but not scanned. Create individual artifact folder/box and artifact number for each Artifact Type.

- CD(s) containing computer program listing  
Doc Code: Computer      Artifact Type Code: P
- Stapled Set(s) of Extra Color Drawings/Photographs  
Doc Code: Artifact      Artifact Type Code: C
- CD(s) containing pages of specification   
and/or sequence listing       Artifact Type Code: S  
Doc Code: Artifact
- CD(s) with content unspecified  
Doc Code: Artifact      Artifact Type Code: U
- Microfilm(s)  
Doc Code: Artifact      Artifact Type Code: F
- Video tape(s)  
Doc Code: Artifact      Artifact Type Code: V
- Model(s)  
Doc Code: Artifact      Artifact Type Code: M
- Bound Document(s)  
Doc Code: Artifact      Artifact Type Code: B
- Other, description: Patent Granted  
Doc Code: Artifact      Artifact Type Code: Z



UNITED STATES PATENT AND TRADEMARK OFFICE

UNITED STATES DEPARTMENT OF COMMERCE  
United States Patent and Trademark Office  
Address: COMMISSIONER FOR PATENTS  
P.O. Box 1450  
Alexandria, Virginia 22313-1450  
www.uspto.gov

APPLICATION NO.	FILING DATE	FIRST NAMED INVENTOR	ATTORNEY DOCKET NO.	CONFIRMATION NO.
10/690,298	10/21/2003	Laurence H. Hiltzik	CHR 2001-79 (reissue)	2091
36876	7590	04/13/2004	EXAMINER	
MEADWESTVACO CORPORATION 5255 VIRGINIA AVENUE P.O. BOX 118005 CHARLESTON, SC 29423-8005			LAWRENCE JR, FRANK M	
			ART UNIT	PAPER NUMBER
			1724	

DATE MAILED: 04/13/2004

Please find below and/or attached an Office communication concerning this application or proceeding.



**UNITED STATES DEPARTMENT OF COMMERCE**

**U.S. Patent and Trademark Office**

Address: COMMISSIONER FOR PATENTS

P.O. Box 1450

Alexandria, Virginia 22313-1450

APPLICATION NO./ CONTROL NO.	FILING DATE	FIRST NAMED INVENTOR / PATENT IN REEXAMINATION	ATTORNEY DOCKET NO. <sup>AC</sup>
---------------------------------	-------------	---	-----------------------------------

EXAMINER
----------

ART UNIT	PAPER
----------	-------

0404

DATE MAILED:

**Please find below and/or attached an Office communication concerning this application or proceeding.**

Commissioner for Patents

The amendment filed March 2, 2004 proposes amendments to the claims that do not comply with 37 CFR 1.173(b), which sets forth the manner of making amendments in reissue applications. A supplemental paper correctly amending the reissue application is required. Claims added to the patent must follow the number of the highest numbered patent claim (37 CFR 1.173(e)) and must be underlined in their entirety (37 CFR 1.173(d)).

A shortened statutory period for reply to this letter is set to expire ONE (1) MONTH or THIRTY (30) DAYS, whichever is longer, from the mailing date of this letter.



Frank M. Lawrence  
Primary Examiner  
Art Unit: 1724

4-8-04

RECEIVED  
CENTRAL FAX CENTER

MAY 13 2004

OFFICIAL

IN THE UNITED STATES PATENT AND TRADEMARK OFFICE

Appl. No. : 10/690,298 Confirmation No.: 2091  
 Applicants : L. H. Hiltzik, J. Z. Jagiello, E. D. Tolles, and R. S. Williams  
 Filed : October 21, 2003  
 TC/A.U. : 1724  
 Examiner : Frank M. Lawrence Jr.  
  
 Docket No. : CHR 2001-79 (reissue)  
 Customer No. : 36876  
  
 For: : Method For Reducing Emissions From Evaporative Emission Control Systems

Honorable Commissioner for Patents  
 P. O. Box 1450  
 Alexandria, VA 22313-1450

**SUPPLEMENTAL AMENDMENT AND RESPONSE**

Dear Sir:

In response to the Office Action mailed April 13, 2004, having a shortened statutory period for response set to expire on May 13, 2004, reconsideration is respectfully requested in view of the following amendments and remarks.

**Amendments to the Claims** are reflected in the listing of claims which begins on page 2 of this paper.

**Remarks/Arguments** begin on page 10 of this paper.

1724

Case Docket No. CHR 2001-79 (Reissue)  
U. S. Patent No. 6,540,815 (surrendered April 2, 2004)  
Examiner: Frank M. Lawrence Jr.  
Art Unit: 1724

Confirmation No. 2091  
U. S. Serial No. 10/690,298

OFFICIAL

RECEIVED  
CENTRAL FAX CENTER

MAY 18 2004

Certificate of Transmission under 37 CFR 1.8

I hereby certify that this correspondence is being facsimile transmitted to the United States Patent and Trademark Office

On May 13, 2004  
Date



Susan C. Harrison

Typed or printed name of person signing Certificate

Note: Each paper must have its own certificate of transmission, or this certificate must identify each submitted paper.

Supplemental Amendment and Response to Office Communication dated April 13, 2004  
regarding US Serial No. 10/690,298

Appl. No. 10/690,298  
Amdt. Dated May 13, 2004  
Reply to Office action of April 13, 2004

Case Docket No. CHR 2001-79 (reissue)

**Amendments to the Claims:**

This listing of claims will replace all prior versions, and listings, of claims in the application:

**Listing of Claims:**

We claim:

1. (original): A method for reducing fuel vapor emissions in automotive evaporative emissions control systems comprising the steps of contacting the fuel vapor with an initial adsorbent volume having incremental adsorption capacity at 25°C of greater than 35 g n-butane/L between vapor concentrations of 5 vol% and 50 vol% n-butane and at least one subsequent adsorbent volume having an incremental adsorption capacity of less than 35 g n-butane/L between vapor concentrations of 5 vol% and 50 vol% n-butane.
2. (original): The method of claim 1 comprising a single subsequent adsorbent volume.
3. (original): The method of claim 1 comprising multiple subsequent adsorbent volumes.
4. (original): The method of claim 2 wherein the initial adsorbent volume and the subsequent adsorbent volume are located within a single automotive evaporative emission control canister.
5. (original): The method of claim 3 wherein the initial adsorbent volume and the subsequent adsorbent volumes are located within a single automotive evaporative emission control canister.
6. (original): The method of claim 2 wherein the initial adsorbent volume and the subsequent adsorbent volume are located in separate canisters that are connected to permit sequential contact by the fuel vapor.
7. (original): The method of claim 3 wherein the initial adsorbent volume and at least one subsequent adsorbent volume are located in separate canisters that are connected to permit sequential contact by the fuel vapor.
8. (original): The method of claim 1 wherein the initial adsorbent volume and the subsequent adsorbent volume are activated carbon derived from materials selected from

Page 2 of 2



Appl. No. 10/690,298

Case Docket No. CHR 2001-79 (reissue)

Amdt. Dated May 13, 2004

Reply to Office action of April 13, 2004

- the group consisting of wood, peat, coal, coconut, lignite, petroleum pitch, petroleum coke, coal tar pitch, fruit pits, nut shells, sawdust, wood flour, synthetic polymer, and natural polymer having been activated by a process selected from the group consisting of chemical, thermal, and combined chemical/thermal activation methods.
9. (original): The method of claim 1 wherein the initial adsorbent volume and the subsequent adsorbent volume are inorganic materials selected from the group consisting of zeolites, porous silica, porous alumina, pillared clays, and molecular sieves.
  10. (original): The method of claim 1 wherein the initial adsorbent volume and the subsequent adsorbent volume are porous polymers.
  11. (original): The method of claim 1 wherein the subsequent adsorbent volume exhibits adsorption capacities achieved by volumetric dilution.
  12. (original): The method of claim 11 wherein the volumetric dilution is accomplished by the addition of a non-adsorbing filler as a co-ingredient by an addition process selected from the group consisting of addition with the activated carbon raw material prior to activation, addition with the adsorbent before forming into a shaped particle or monolith, and a combination thereof.
  13. (original): The method of claim 11 wherein the volumetric dilution is accomplished by forming the adsorbent into high voidage shapes selected from the group consisting of stars, hollow cylinders, asterisks, spirals, cylinders, and configured ribbons.
  14. (original): The method of claim 11 wherein the volumetric dilution is accomplished by forming the adsorbent into a honeycomb or monolith shape.
  15. (original): The method of claim 11 wherein the volumetric dilution is accomplished by the use of inert spacer particles, trapped air spaces, foams, fibers, and screens external to the adsorbent.
  16. (original): The method of claim 12 wherein the non-adsorbing filler is a solid after processing.
  17. (original): The method of claim 12 wherein the non-adsorbing filler is volatilized or combusted to form voidages larger than 50Å width within the shaped particle or monolith.

Appl. No. 10/690,298  
Amdt. Dated May 13, 2004  
Reply to Office action of April 13, 2004

Case Docket No. CHR 2001-79 (reissue)

18. (original): In a method of reducing fuel vapor emissions in an automotive evaporative emissions control system comprising removing at least one volatile organic compound from a volatile organic compound-containing fuel vapor by routing the fuel vapor through a vapor adsorbent, the improvement comprising sequentially routing the fuel vapor through an initial adsorbent material-containing volume wherein the initial adsorbent material is characterized by an incremental adsorption capacity at 25°C of greater than 35 g n-butane/L between vapor concentrations of 5 vol% and 50 vol% n-butane before routing the fluid stream through at least one subsequent adsorbent-containing volume prior to venting to the atmosphere wherein the subsequent adsorbent-containing volume is characterized by an incremental adsorption capacity at 25°C of less than 35 g n-butane/L between vapor concentrations of 5 vol% and 50 vol% n-butane.
19. (original): The method of claim 18 wherein the initial adsorbent volume and the subsequent adsorbent volume are located in a single automotive evaporative emissions canister.
20. (original): The method of claim 18 wherein the initial adsorbent volume and the subsequent adsorbent volume are located in separate canisters that are connected to permit sequential contact by the fuel vapor.
21. (original): The method of claim 18 wherein the initial adsorbent volume and the subsequent adsorbent volume are activated carbon derived from materials selected from the group consisting of wood, peat, coal, coconut, lignite, petroleum pitch, petroleum coke, coal tar pitch, fruit pits, nut shells, sawdust, wood flour, synthetic polymer, and natural polymer and activated by chemical and/or thermal activation methods.
22. (original): The method of claim 18 wherein the initial adsorbent volume and the subsequent adsorbent volume are inorganic materials selected from the group consisting of zeolites, porous silica, and molecular sieves.
23. (original): The method of claim 18 wherein the initial adsorbent volume and the subsequent adsorbent volume are porous polymers.
24. (original): The method of claim 18 wherein the subsequent adsorbent volume exhibits adsorption capacities achieved by volumetric dilution.

Appl. No. 10/690,298  
Amdt. Dated May 13, 2004  
Reply to Office action of April 13, 2004

Case Docket No. CHR 2001-79 (reissue)

25. (original): The method of claim 24 wherein the volumetric dilution is accomplished by the addition of a non-adsorbing filler as a co-ingredient by an addition process selected from the group consisting of addition with the activated carbon raw material prior to activation, addition with the adsorbent before forming into a shaped particle or monolith, and a combination thereof.
26. (original): The method of claim 24 wherein the volumetric dilution is accomplished by forming the adsorbent into high voidage shapes selected from the group consisting of stars, hollow cylinders, asterisks, spirals, cylinders, and configured ribbons.
27. (original): The method of claim 24 wherein the volumetric dilution is accomplished by forming the adsorbent into a honeycomb or monolith shape.
28. (original): The method of claim 24 wherein the volumetric dilution is accomplished by the use of inert spacer particles, trapped air spaces, foams, fibers, and screens external to the adsorbent.
29. (original): The method of claim 25 wherein the non-adsorbing filler is a solid after processing.
30. (original): The method of claim 25 wherein the non-adsorbing filler is volatilized or combusted to form voidages larger than 50Å width within the shaped particle or monolith.
31. (new) In an evaporative emissions control system for a vehicle comprising, in combination, a fuel tank for storing a volatile fuel, an engine having an air induction system and adapted to consume the fuel, a canister containing an initial volume of fuel vapor adsorbent material for temporarily adsorbing and storing fuel vapor from the tank, a conduit for conducting fuel vapor from the tank to a canister vapor inlet, a fuel vapor purge conduit from a canister purge outlet to the induction system of the engine, and a vent/air opening for venting the canister and for admission of air to the canister during operation of the engine induction system, wherein the canister is defined by a fuel vapor flow path via the canister vapor inlet through the initial volume of vapor adsorbent within a first region of the canister toward the vent/air opening, and an air flow path through a subsequent volume of adsorbent within a second region of the canister at the vent/air

Appl. No. 10/690,298  
Amdt. Dated May 13, 2004  
Reply to Office action of April 13, 2004

Case Docket No. CHR 2001-79 (reissue)

opening and the first region at the purge outlet, such that fuel vapor formed in the tank flows through the vapor inlet into the initial volume of adsorbent where it is adsorbed and, during operation of the engine induction system, ambient air flows in a path to and through the vent/air opening and along the air flow path in the canister through the initial volume and the purge outlet to the induction system of the engine, the flow of air removing a portion of the adsorbed fuel vapor but leaving a residue of fuel in the initial volume.

the improvement wherein at least one subsequent volume of vapor adsorbent material comprises a volume of 1% to 100% of the first volume and is located either inside of the canister within the second region thereof or outside of the canister, and wherein the initial volume of vapor adsorbent material is characterized by an incremental adsorption capacity at 25°C of greater than 35 g n-butane/L-bed between vapor concentrations of 5 vol% and 50 vol% n-butane before routing the air flow through at least one subsequent volume of vapor adsorbent material wherein the subsequent volume of vapor adsorbent material is characterized by an incremental adsorption capacity at 25°C of less than 35 g n-butane between vapor concentrations of 5 vol% and 50 vol% n-butane.

32. (new) The system of claim 31 wherein the second volume of vapor adsorbent material is located outside the canister in a separate subsequent canister.
33. (new) The system of claim 31 wherein the initial volume of vapor adsorbent material and the subsequent volume of vapor adsorbent material are activated carbon derived from materials selected from the group consisting of wood, peat, coal, coconut, lignite, petroleum pitch, petroleum coke, coal tar pitch, fruit pits, nut shells, sawdust, wood flour, synthetic polymer, and natural polymer having been activated by a process selected from the group consisting of chemical, thermal, and combined chemical/thermal activation methods.
34. (new) The system of claim 31 wherein the initial volume of vapor adsorbent material and the subsequent volume of vapor adsorbent material are inorganic materials selected from

Appl. No. 10/690,298

Amdt. Dated May 13, 2004

Reply to Office action of April 13, 2004

Case Docket No. CHR 2001-79 (reissue)

- the group consisting of zeolites, porous silica, porous alumina, pillared clays, and molecular sieves.
35. (new) The system of claim 31 wherein the initial volume of vapor adsorbent material and the subsequent volume of vapor adsorbent material are porous polymers.
36. (new) The system of claim 31 wherein the subsequent volume of vapor adsorbent material exhibits adsorption capacities achieved by volumetric dilution.
37. (new) The system of claim 36 wherein the volumetric dilution is accomplished by the addition of a non-adsorbing filler as a co-ingredient by an addition process selected from the group consisting of addition with the activated carbon raw material prior to activation, addition with the adsorbent before forming into a shaped particle or monolith, and a combination thereof.
38. (new) The system of claim 36 wherein the volumetric dilution is accomplished by forming the adsorbent material into high voidage shapes selected from the group consisting of stars, hollow cylinders, asterisks, spirals, cylinders, and configured ribbons.
39. (new) The system of claim 36 wherein the volumetric dilution is accomplished by forming the adsorbent into a honeycomb or monolith shape.
40. (new) The system of claim 36 wherein the volumetric dilution is accomplished by the use of inert spacer particles, trapped air spaces, foams, and screens external to the adsorbent.
41. (new) The system of claim 37 wherein the non-adsorbing filler is a solid after processing.
42. (new) The system of claim 37 wherein the non-adsorbing filler is volatilized or combusted to form voidages larger than 50Å width within the shaped particle or monolith.
43. (new) A canister operative for use in automotive systems for emission control defined by a canister vapor inlet to permit a fuel vapor flow path through an initial volume of vapor adsorbent within a first region of the canister toward a canister vent/air opening to permit a continued air flow path through a subsequent volume of adsorbent within a second region of the canister at the vent/air opening and the first region at a canister purge outlet, such that fuel vapor formed in a tank for storing volatile fuel flows through the canister vapor inlet into the initial volume of adsorbent where it is adsorbed and, during operation of an engine induction system, ambient air is caused to flow in a path to and through the

Appl. No. 10/690,298  
Amdt. Dated May 13, 2004  
Reply to Office action of April 13, 2004

Case Docket No. CHR 2001-79 (reissue)

vent/air opening and along the air flow path in the canister through the initial volume and the purge outlet to the induction system of the engine, wherein the flow of air removing a portion of the adsorbed fuel vapor but leaving a residue of fuel in the initial volume, and wherein at least one subsequent volume of vapor adsorbent material comprises a volume of 1% to 100% of the initial volume and is located either inside of the canister within the second region thereof or outside of the canister, and wherein the initial volume of vapor adsorbent material is characterized by an incremental adsorption capacity at 25°C of greater than 35 g n-butane/L-bed between vapor concentrations of 5 vol% and 50 vol% n-butane before routing the air flow through at least one subsequent volume of vapor adsorbent material wherein the subsequent volume of vapor adsorbent material is characterized by an incremental adsorption capacity at 25°C of less than 35 g n-butane between vapor concentrations of 5 vol% and 50 vol% n-butane.

44. (new) The canister of claim 43 wherein the second volume of vapor adsorbent material is located outside the canister in a separate subsequent canister.
45. (new) The canister of claim 43 wherein the initial volume of vapor adsorbent material and the subsequent volume of vapor adsorbent material are activated carbon derived from materials selected from the group consisting of wood, peat, coal, coconut, lignite, petroleum pitch, petroleum coke, coal tar pitch, fruit pits, nut shells, sawdust, wood flour, synthetic polymer, and natural polymer having been activated by a process selected from the group consisting of chemical, thermal, and combined chemical/thermal activation methods.
46. (new) The canister of claim 43 wherein the initial volume of vapor adsorbent material and the subsequent volume of vapor adsorbent material are inorganic materials selected from the group consisting of zeolites, porous silica, porous alumina, pillared clays, and molecular sieves.
47. (new) The canister of claim 43 wherein the initial volume of vapor adsorbent material and the subsequent volume of vapor adsorbent material are porous polymers.
48. (new) The canister of claim 43 wherein the subsequent volume of vapor adsorbent material exhibits adsorption capacities achieved by volumetric dilution.

Appl. No. 10/690,298  
Amdt. Dated May 13, 2004  
Reply to Office action of April 13, 2004

Case Docket No. CHR 2001-79 (reissue)

49. (new) The canister of claim 48 wherein the volumetric dilution is accomplished by the addition of a non-adsorbing filler as a co-ingredient by an addition process selected from the group consisting of addition with the activated carbon raw material prior to activation, addition with the adsorbent before forming into a shaped particle or monolith, and a combination thereof.
50. (new) The canister of claim 48 wherein the volumetric dilution is accomplished by forming the adsorbent material into high voidage shapes selected from the group consisting of stars, hollow cylinders, asterisks, spirals, cylinders, and configured ribbons.
51. (new) The canister of claim 49 wherein the volumetric dilution is accomplished by an adsorbent formed into a honeycomb or monolith shape.
52. (new) The canister of claim 48 wherein the volumetric dilution is accomplished by the inclusion of inert spacer particles, trapped air spaces, foams, and screens external to the adsorbent.
53. (new) The canister of claim 49 wherein the non-adsorbing filler is a solid after processing.
54. (new) The canister of claim 49 wherein the non-adsorbing filler is volatilized or combusted to form voidages larger than 50Å width within the shaped particle or monolith.

Appl. No. 10/690,298  
Amdt. Dated May 13, 2004  
Reply to Office action of April 13, 2004

Case Docket No. CHR 2001-79 (reissue)

**REMARKS/ARGUMENTS**

Claims 1-54 remain in this application. Claims 1-54 have been allowed in an Office communication mailed March 19, 2004, wherein the Examiner noted, however, the need for correction of an informal matter (a typo in claim 43) to place the claims in proper condition for allowance prior to issuance of the formal Notice of Allowance. Such correction was made in a response filed April 2, 2004.

In an Office communication mailed April 13, 2004, to which this supplemental amendment is responsive, and wherein the Examiner noted

The amendment filed March 2[?], 2004 proposes amendments to the claims that do not comply with 37 CFR 1.173(b), which sets forth the manner of making amendments in reissue applications. A supplemental paper correctly amending the reissue application is required. Claims added to the patent must follow the number of the highest numbered patent claim (37 CFR 1.173(e)) and must be underlined in their entirety (37 CFR 1.73(d)).

Review of the reissue application, filed October 21, 2003, shows it to have been filed according to 37 CFR 1.173(a), with amendments made in accordance with 37 CFR 1.173(b) wherein the amendments (*i.e.*, newly added claims) were physically incorporated into the specification with markings pursuant to 37 CFR 1.173(d), which requires matter to be omitted to be enclosed in brackets and matter to be added by reissue to be underlined. The reissue application, as filed, included no matter to be omitted and included newly added claims were all underlined. Moreover, the numbering of patent claims was preserved in the reissue application, as filed, according to 37 CFR 1.173(e). Therefore, the basis of the Examiner's concern raised in the Office communication to which this is responsive is not understood. The amendment filed on April 2, 2004, was not a "separate amendment paper" under 37 CFR 1.173(b). The List of Claims therein noted the status of each claim ("original," "currently amended," "previously presented," etc.). It is not the understanding of the undersigned attorney for the applicants that underlining of the entire claim is appropriate in a paper amending claims already introduced in the filed application with underlining.

Page 10 of 10



Appl. No. 10/690,298  
Amdt. Dated May 13, 2004  
Reply to Office action of April 13, 2004

Case Docket No. CHR 2001-79 (reissue)

In the event, however, the undersigned attorney is in error, the claims added by the reissue application filing on October 21, 2003 are submitted herein (as subsequently amended) as appropriately numbered and underlined, as requested by the Examiner.

Assuming that the claims have been properly presented in this application (and the original parent application having been earlier submitted), it is respectfully requested that a timely formal Notice of Allowance be issued in this case.

This explanation of the needed corrective action was discussed by the undersigned attorney with the Examiner by telephone on May 13, 2004. If the Examiner believes, for any reason, that further personal communication will expedite the prosecution of this application, the Examiner is invited to telephone the undersigned at the number provided.

No additional fees are believed to be due in connection with the filing of this amendment and response. Should it be determined that additional fees are due and payable, the Commissioner is authorized to charge any required fees or credit any overpayment to the assignee's Deposit Account No. 23-1160.

Respectfully submitted,

MEADWESTVACO CORPORATION

By

  
Terry B. McDaniel  
Attorney for the Applicant  
Registration No. 28,444

Date: May 13, 2004  
5255 Virginia Avenue  
Post Office Box 118005  
Charleston, SC 29423-8005  
Telephone (843) 740-2311

Page 11 of 11

10690298

PTO/ST/06 (08-03)

Approved for use through 7/31/2006. OMB 0651-0032

U.S. Patent and Trademark Office; U.S. DEPARTMENT OF COMMERCE

Under the Paperwork Reduction Act of 1995, no persons are required to respond to a collection of information unless it displays a valid OMB control number.

**PATENT APPLICATION FEE DETERMINATION RECORD**

Substitute for Form PTO-875

Application or Docket Number

**CLAIMS AS FILED - PART I**

(Column 1) (Column 2)

SMALL ENTITY

OR

OTHER THAN SMALL ENTITY

FOR	NUMBER FILED	NUMBER EXTRA
BASIC FEE (37 CFR 1.16(a))		
TOTAL CLAIMS (37 CFR 1.16(c))	54	minus 20 = *
INDEPENDENT CLAIMS (37 CFR 1.16(b))	4	minus 3 = *
MULTIPLE DEPENDENT CLAIM PRESENT (37 CFR 1.16(d))		

RATE	FEE
	\$ _____
X \$ _____ =	
X \$ _____ =	
+ \$ _____ =	
TOTAL	

RATE	FEE
	\$ _____
X \$ _____ =	
X \$ _____ =	
+ \$ _____ =	
TOTAL	

\* If the difference in column 1 is less than zero, enter "0" in column 2.

**CLAIMS AS AMENDED - PART II**

(Column 1) (Column 2) (Column 3)

SMALL ENTITY

OR

OTHER THAN SMALL ENTITY

AMENDMENT A

CLAIMS REMAINING AFTER AMENDMENT	HIGHEST NUMBER PREVIOUSLY PAID FOR	PRESENT EXTRA
Total (37 CFR 1.16(c))	Minus **	=
Independent (37 CFR 1.16(b))	Minus ***	=
FIRST PRESENTATION OF MULTIPLE DEPENDENT CLAIM (37 CFR 1.16(d))		

RATE	ADDITIONAL FEE
X \$ _____ =	
X \$ _____ =	
+ \$ _____ =	
TOTAL ADD'L FEE	

RATE	ADDITIONAL FEE
X \$ _____ =	
X \$ _____ =	
+ \$ _____ =	
TOTAL ADD'L FEE	

AMENDMENT B

CLAIMS REMAINING AFTER AMENDMENT	HIGHEST NUMBER PREVIOUSLY PAID FOR	PRESENT EXTRA
Total (37 CFR 1.16(c))	Minus **	=
Independent (37 CFR 1.16(b))	Minus ***	=
FIRST PRESENTATION OF MULTIPLE DEPENDENT CLAIM (37 CFR 1.16(d))		

RATE	ADDITIONAL FEE
X \$ _____ =	
X \$ _____ =	
+ \$ _____ =	
TOTAL ADD'L FEE	

RATE	ADDITIONAL FEE
X \$ _____ =	
X \$ _____ =	
+ \$ _____ =	
TOTAL ADD'L FEE	

AMENDMENT C

CLAIMS REMAINING AFTER AMENDMENT	HIGHEST NUMBER PREVIOUSLY PAID FOR	PRESENT EXTRA
Total (37 CFR 1.16(c))	Minus **	=
Independent (37 CFR 1.16(b))	Minus ***	=
FIRST PRESENTATION OF MULTIPLE DEPENDENT CLAIM (37 CFR 1.16(d))		

RATE	ADDITIONAL FEE
X \$ _____ =	
X \$ _____ =	
+ \$ _____ =	
TOTAL ADD'L FEE	

RATE	ADDITIONAL FEE
X \$ _____ =	
X \$ _____ =	
+ \$ _____ =	
TOTAL ADD'L FEE	

\* If the entry in column 1 is less than the entry in column 2, write "0" in column 3.  
 \*\* If the "Highest Number Previously Paid For" IN THIS SPACE is less than 20, enter "20".  
 \*\*\* If the "Highest Number Previously Paid For" IN THIS SPACE is less than 3, enter "3".

The "Highest Number Previously Paid For" (Total or Independent) is the highest number found in the appropriate box in column 1.

This collection of information is required by 37 CFR 1.16. The information is required to obtain or retain a benefit by the public which is to file (and by the USPTO to process) an application. Confidentiality is governed by 35 U.S.C. 122 and 37 CFR 1.14. This collection is estimated to take 12 minutes to complete, including gathering, preparing, and submitting the completed application form to the USPTO. Time will vary depending upon the individual case. Any comments on the amount of time you require to complete this form and/or suggestions for reducing this burden, should be sent to the Chief Information Officer, U.S. Patent and Trademark Office, U.S. Department of Commerce, P.O. Box 1450, Alexandria, VA 22313-1450. DO NOT SEND FEES OR COMPLETED FORMS TO THIS ADDRESS. SEND TO: Commissioner for Patents, P.O. Box 1450, Alexandria, VA 22313-1450.

If you need assistance in completing the form, call 1-800-PTO-9199 and select option 2.

5-13-04 4-2-04

IN THE UNITED STATES PATENT AND TRADEMARK OFFICE

Appl. No. : 10/690,298 Confirmation No.: 2091  
 Applicants : L. H. Hiltzik, J. Z. Jagiello, E. D. Tolles, and R. S. Williams  
 Filed : October 21, 2003  
 TC/A.U. : 1724  
 Examiner : Frank M. Lawrence Jr.  
  
 Docket No. : CHR 2001-79 (reissue)  
 Customer No. : 36876  
  
 For: : Method For Reducing Emissions From Evaporative Emission Control Systems

Honorable Commissioner for Patents  
 P. O. Box 1450  
 Alexandria, VA 22313-1450

**SUPPLEMENTAL AMENDMENT**

Dear Sir:

In response to the Examiner's voicemail of January 3, 2005, informing of the remaining requirement of a Supplemental Reissue Declaration, the attached, filled-in and signed (by the inventors) PTO Form SB-51S is provided herewith.

Applicant respectfully requests that a timely formal Notice of Allowance be issued in this case. Also, in view of the "special" status made of the instant application and of the extended delay in moving the application in conformance therewith, it is respectfully requested that attention be given the application's expedited status through prompt issuance as a patent.

No additional fees are believed to be due in connection with the filing of this amendment and response. Should it be determined that additional fees are due and payable, the Commissioner is authorized to charge any required fees or credit any overpayment to the assignee's Deposit Account No. 23-1160.

Respectfully submitted,

MEADWESTVACO CORPORATION

Attachment

Date: January 4, 2005  
 3950 Faber Place Drive  
 Post Office Box 118005  
 Charleston, SC 29423-8005  
 Telephone (843) 740-2311

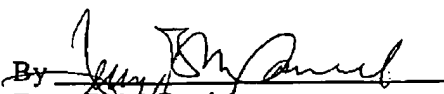
By   
 Terry B. McDaniel  
 Attorney for the Applicant  
 Registration No. 28,444

Case Docket No. CHR 2001-79 Reissue  
U. S. Application No. 10/690,298  
Customer Number 36876

Fax # 1-571-273-1161 (Frank M. Lawrence)

Certificate of Transmission under 37 CFR 1.8

I hereby certify that this correspondence is being facsimile transmitted to the United States Patent and Trademark Office

On January 4, 2005  
Date

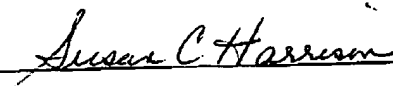
  
\_\_\_\_\_  
**Susan C. Harrison**  
\_\_\_\_\_  
Typed or printed name of person signing Certificate

Note: Each paper must have its own certificate of transmission, or this certificate must identify each submitted paper.

Supplemental Amendment (cover sheet)  
PTO/SB/51S (Supplemental Declaration For Reissue Patent Application to Correct "Error" Statement (37 CFR 1.175)

PROBABLE (P) OR  
 ASSIGNED FOR USE UNDER PATENT. ORN 001-14029  
 U.S. Patent and Trademark Office U.S. DEPARTMENT OF COMMERCE  
 MAILING SERVICE DIVISION 4000

<b>SUPPLEMENTAL DECLARATION          FOR REISSUE          PATENT APPLICATION          TO CORRECT "ERRORS" STATEMENT          (37 CFR 1.175)</b>	Priority Document Number	078 2001-79 Reissue
	First Named Inventor	L. H. Hiltzik
	COMPLETE Person	
	Application Number	10/690,299
	Filing Date	October 31, 2002
	Examiner Name	FRANK N. LAWRENCE

**(We hereby declare that:**

Every error in the patent which was corrected in the present reissue application, and which is not covered by the prior art(s) and/or declaration(s) submitted in this application, arose without any deceptive intention on the part of the applicant.

**(We hereby declare that all statements made herein of our/our own knowledge are true and that all statements made on information and belief are believed to be true; and further that these statements were made with the knowledge that willful false statements and the like or made in perjury by him or imprisonment, or both, under 18 U.S.C. 1001 and that such willful false statements may jeopardize the validity of the application or any patent issued thereon.**

Name of First Inventor		<input type="checkbox"/> A petition has been filed for this unsigned inventor	
Given Name (first and middle (if any))	Family Name or Surname		
Laurence M.	Hiltzik		
Inventor's Signature	Date	1/4/05	
Name of Second Inventor		<input type="checkbox"/> A petition has been filed for this unsigned inventor	
Given Name (first and middle (if any))	Family Name or Surname		
Jack Z.	Jagiello		
Inventor's Signature	Date	01/04/2005	
Name of Third Inventor		<input type="checkbox"/> A petition has been filed for this unsigned inventor	
Given Name (first and middle (if any))	Family Name or Surname		
Eduard Donald	Tollins		
Inventor's Signature	Date	1/4/05	
Name of Fourth Inventor		<input type="checkbox"/> A petition has been filed for this unsigned inventor	
Given Name (first and middle (if any))	Family Name or Surname		
Roger S.	Williams		
Inventor's Signature	Date	1/4/05	

Additional numbers of legal representatives are being added on this \_\_\_\_\_ (specify) phone \_\_\_\_\_ or other \_\_\_\_\_.

The collection of information is required by 37 CFR 1.175. The information is compiled to assist in the processing of reissues. This collection of information is subject to the terms and conditions of the USPTO's privacy policy, which can be found at [www.uspto.gov/privacy](http://www.uspto.gov/privacy). The information is used for the purposes of processing reissues and for statistical purposes. Any information collected is not to be used for any other purpose. If you have any questions regarding this information, please contact the U.S. Patent and Trademark Office, U.S. Department of Commerce, P.O. Box 1480, Alexandria, VA 22304-1480. DO NOT SEND FEES OR COMPLETED FORMS TO THIS ADDRESS. SEND TO: Commissioner for Patents, P.O. Box 1480, Alexandria, VA 22304-1480.

If you need assistance in completing this form, call 1-800-PTO-9199 and select option 2.





UNITED STATES DEPARTMENT OF COMMERCE
United States Patent and Trademark Office
Address: COMMISSIONER FOR PATENTS
P.O. Box 1450
Alexandria, Virginia 22313-1450
www.uspto.gov

NOTICE OF ALLOWANCE AND FEE(S) DUE

36876 7590 03/02/2005
MEADWESTVACO CORPORATION
REGIONAL OFFICE BUILDING
PO BOX 118005
CHARLESTON, SC 29423-8005

EXAMINER

LAWRENCE JR, FRANK M

ART UNIT PAPER NUMBER

1724

DATE MAILED: 03/02/2005

Table with 5 columns: APPLICATION NO., FILING DATE, FIRST NAMED INVENTOR, ATTORNEY DOCKET NO., CONFIRMATION NO.

10/690,298 10/21/2003 Laurence H. Hiltzik CHR 2001-79 (REISSUE) 2091

TITLE OF INVENTION: METHOD FOR REDUCING EMISSIONS FROM EVAPORATIVE EMISSIONS CONTROL SYSTEMS

Table with 6 columns: APPLN. TYPE, SMALL ENTITY, ISSUE FEE, PUBLICATION FEE, TOTAL FEE(S) DUE, DATE DUE

nonprovisional NO \$1400 \$0 \$1400 06/02/2005

THE APPLICATION IDENTIFIED ABOVE HAS BEEN EXAMINED AND IS ALLOWED FOR ISSUANCE AS A PATENT. PROSECUTION ON THE MERITS IS CLOSED. THIS NOTICE OF ALLOWANCE IS NOT A GRANT OF PATENT RIGHTS. THIS APPLICATION IS SUBJECT TO WITHDRAWAL FROM ISSUE AT THE INITIATIVE OF THE OFFICE OR UPON PETITION BY THE APPLICANT. SEE 37 CFR 1.313 AND MPEP 1308.

THE ISSUE FEE AND PUBLICATION FEE (IF REQUIRED) MUST BE PAID WITHIN THREE MONTHS FROM THE MAILING DATE OF THIS NOTICE OR THIS APPLICATION SHALL BE REGARDED AS ABANDONED. THIS STATUTORY PERIOD CANNOT BE EXTENDED. SEE 35 U.S.C. 151. THE ISSUE FEE DUE INDICATED ABOVE REFLECTS A CREDIT FOR ANY PREVIOUSLY PAID ISSUE FEE APPLIED IN THIS APPLICATION. THE PTOL-85B (OR AN EQUIVALENT) MUST BE RETURNED WITHIN THIS PERIOD EVEN IF NO FEE IS DUE OR THE APPLICATION WILL BE REGARDED AS ABANDONED.

HOW TO REPLY TO THIS NOTICE:

I. Review the SMALL ENTITY status shown above.

If the SMALL ENTITY is shown as YES, verify your current SMALL ENTITY status:

- A. If the status is the same, pay the TOTAL FEE(S) DUE shown above.
B. If the status above is to be removed, check box 5b on Part B - Fee(s) Transmittal and pay the PUBLICATION FEE (if required) and twice the amount of the ISSUE FEE shown above, or

If the SMALL ENTITY is shown as NO:

- A. Pay TOTAL FEE(S) DUE shown above, or
B. If applicant claimed SMALL ENTITY status before, or is now claiming SMALL ENTITY status, check box 5a on Part B - Fee(s) Transmittal and pay the PUBLICATION FEE (if required) and 1/2 the ISSUE FEE shown above.

II. PART B - FEE(S) TRANSMITTAL should be completed and returned to the United States Patent and Trademark Office (USPTO) with your ISSUE FEE and PUBLICATION FEE (if required). Even if the fee(s) have already been paid, Part B - Fee(s) Transmittal should be completed and returned. If you are charging the fee(s) to your deposit account, section "4b" of Part B - Fee(s) Transmittal should be completed and an extra copy of the form should be submitted.

III. All communications regarding this application must give the application number. Please direct all communications prior to issuance to Mail Stop ISSUE FEE unless advised to the contrary.

IMPORTANT REMINDER: Utility patents issuing on applications filed on or after Dec. 12, 1980 may require payment of maintenance fees. It is patentee's responsibility to ensure timely payment of maintenance fees when due.

**PART B - FEE(S) TRANSMITTAL**

Complete and send this form, together with applicable fee(s), to: **Mail**

**Mail Stop ISSUE FEE  
Commissioner for Patents  
P.O. Box 1450  
Alexandria, Virginia 22313-1450  
or Fax (703) 746-4000**

**INSTRUCTIONS:** This form should be used for transmitting the ISSUE FEE and PUBLICATION FEE (if required). Blocks 1 through 5 should be completed where appropriate. All further correspondence including the Patent, advance orders and notification of maintenance fees will be mailed to the current correspondence address as indicated unless corrected below or directed otherwise in Block 1, by (a) specifying a new correspondence address; and/or (b) indicating a separate "FEE ADDRESS" for maintenance fee notifications.

CURRENT CORRESPONDENCE ADDRESS (Note: Use Block 1 for any change of address)

36876                      7590                      03/02/2005

**MEADWESTVACO CORPORATION  
REGIONAL OFFICE BUILDING  
PO BOX 118005  
CHARLESTON, SC 29423-8005**

Note: A certificate of mailing can only be used for domestic mailings of the Fee(s) Transmittal. This certificate cannot be used for any other accompanying papers. Each additional paper, such as an assignment or formal drawing, must have its own certificate of mailing or transmission.

**Certificate of Mailing or Transmission**

I hereby certify that this Fee(s) Transmittal is being deposited with the United States Postal Service with sufficient postage for first class mail in an envelope addressed to the Mail Stop ISSUE FEE address above, or being facsimile transmitted to the USPTO (703) 746-4000, on the date indicated below.

(Depositor's name)
(Signature)
(Date)

APPLICATION NO.	FILING DATE	FIRST NAMED INVENTOR	ATTORNEY DOCKET NO.	CONFIRMATION NO.
-----------------	-------------	----------------------	---------------------	------------------

10/690,298                      10/21/2003                      Laurence H. Hiltzik                      CHR 2001-79 (REISSUE)                      2091

**TITLE OF INVENTION: METHOD FOR REDUCING EMISSIONS FROM EVAPORATIVE EMISSIONS CONTROL SYSTEMS**

APPLN. TYPE	SMALL ENTITY	ISSUE FEE	PUBLICATION FEE	TOTAL FEE(S) DUE	DATE DUE
-------------	--------------	-----------	-----------------	------------------	----------

nonprovisional                      NO                      \$1400                      \$0                      \$1400                      06/02/2005

EXAMINER	ART UNIT	CLASS-SUBCLASS
----------	----------	----------------

LAWRENCE JR, FRANK M                      1724                      095-146000

<p>1. Change of correspondence address or indication of "Fee Address" (37 CFR 1.363).</p> <p><input type="checkbox"/> Change of correspondence address (or Change of Correspondence Address form PTO/SB/122) attached.</p> <p><input type="checkbox"/> "Fee Address" indication (or "Fee Address" Indication form PTO/SB/47; Rev 03-02 or more recent) attached. Use of a Customer Number is required.</p>	<p>2. For printing on the patent front page, list</p> <p>(1) the names of up to 3 registered patent attorneys or agents OR, alternatively, _____ 1</p> <p>(2) the name of a single firm (having as a member a registered attorney or agent) and the names of up to 2 registered patent attorneys or agents. If no name is listed, no name will be printed. _____ 2</p> <p>_____ 3</p>
--	---

**3. ASSIGNEE NAME AND RESIDENCE DATA TO BE PRINTED ON THE PATENT (print or type)**

PLEASE NOTE: Unless an assignee is identified below, no assignee data will appear on the patent. If an assignee is identified below, the document has been filed for recordation as set forth in 37 CFR 3.11. Completion of this form is NOT a substitute for filing an assignment.

(A) NAME OF ASSIGNEE                      (B) RESIDENCE: (CITY and STATE OR COUNTRY)

Please check the appropriate assignee category or categories (will not be printed on the patent) :     Individual     Corporation or other private group entity     Government

<p>4a. The following fee(s) are enclosed:</p> <p><input type="checkbox"/> Issue Fee</p> <p><input type="checkbox"/> Publication Fee (No small entity discount permitted)</p> <p><input type="checkbox"/> Advance Order - # of Copies _____</p>	<p>4b. Payment of Fee(s):</p> <p><input type="checkbox"/> A check in the amount of the fee(s) is enclosed.</p> <p><input type="checkbox"/> Payment by credit card. Form PTO-2038 is attached.</p> <p><input type="checkbox"/> The Director is hereby authorized by charge the required fee(s), or credit any overpayment, to Deposit Account Number _____ (enclose an extra copy of this form).</p>
--	---

**5. Change in Entity Status (from status indicated above)**

a. Applicant claims SMALL ENTITY status. See 37 CFR 1.27.     b. Applicant is no longer claiming SMALL ENTITY status. See 37 CFR 1.27(g)(2).

The Director of the USPTO is requested to apply the Issue Fee and Publication Fee (if any) or to re-apply any previously paid issue fee to the application identified above. NOTE: The Issue Fee and Publication Fee (if required) will not be accepted from anyone other than the applicant; a registered attorney or agent; or the assignee or other party in interest as shown by the records of the United States Patent and Trademark Office.

Authorized Signature \_\_\_\_\_ Date \_\_\_\_\_

Typed or printed name \_\_\_\_\_ Registration No. \_\_\_\_\_

This collection of information is required by 37 CFR 1.311. The information is required to obtain or retain a benefit by the public which is to file (and by the USPTO to process) an application. Confidentiality is governed by 35 U.S.C. 122 and 37 CFR 1.14. This collection is estimated to take 12 minutes to complete, including gathering, preparing, and submitting the completed application form to the USPTO. Time will vary depending upon the individual case. Any comments on the amount of time you require to complete this form and/or suggestions for reducing this burden, should be sent to the Chief Information Officer, U.S. Patent and Trademark Office, U.S. Department of Commerce, P.O. Box 1450, Alexandria, Virginia 22313-1450. DO NOT SEND FEES OR COMPLETED FORMS TO THIS ADDRESS. SEND TO: Commissioner for Patents, P.O. Box 1450, Alexandria, Virginia 22313-1450.

Under the Paperwork Reduction Act of 1995, no persons are required to respond to a collection of information unless it displays a valid OMB control number.





UNITED STATES PATENT AND TRADEMARK OFFICE

UNITED STATES DEPARTMENT OF COMMERCE
United States Patent and Trademark Office
Address: COMMISSIONER FOR PATENTS
P.O. Box 1450
Alexandria, Virginia 22313-1450
www.uspto.gov

Table with 5 columns: APPLICATION NO., FILING DATE, FIRST NAMED INVENTOR, ATTORNEY DOCKET NO., CONFIRMATION NO.
10/690,298 10/21/2003 Laurence H. Hiltzik CHR 2001-79 (REISSUE) 2091

36876 7590 03/02/2005

MEADWESTVACO CORPORATION
REGIONAL OFFICE BUILDING
PO BOX 118005
CHARLESTON, SC 29423-8005

EXAMINER

LAWRENCE JR, FRANK M

ART UNIT PAPER NUMBER

1724

DATE MAILED: 03/02/2005

Determination of Patent Term Extension or Adjustment under 35 U.S.C. 154 (b)

A reissue patent is for "the unexpired part of the term of the original patent." See 35 U.S.C. 251. Accordingly, the above-identified reissue application is not eligible for Patent Term Extension or Adjustment under 35 U.S.C. 154(b).

Any questions regarding the Patent Term Extension or Adjustment determination should be directed to the Office of Patent Legal Administration at (571) 272-7702. Questions relating to issue and publication fee payments should be directed to the Customer Service Center of the Office of Patent Publication at (703) 305-8283.

<b>Notice of Allowability</b>	<b>Application No.</b>	<b>Applicant(s)</b>	
	10/690,298	HILTZIK ET AL.	
	<b>Examiner</b>	<b>Art Unit</b>	
	Frank M. Lawrence	1724	

**-- The MAILING DATE of this communication appears on the cover sheet with the correspondence address--**

All claims being allowable, PROSECUTION ON THE MERITS IS (OR REMAINS) CLOSED in this application. If not included herewith (or previously mailed), a Notice of Allowance (PTOL-85) or other appropriate communication will be mailed in due course. **THIS NOTICE OF ALLOWABILITY IS NOT A GRANT OF PATENT RIGHTS.** This application is subject to withdrawal from issue at the initiative of the Office or upon petition by the applicant. See 37 CFR 1.313 and MPEP 1308.

1.  This communication is responsive to the amendment filed May 13, 2004.
2.  The allowed claim(s) is/are 1-54.
3.  The drawings filed on 21 October 2003 are accepted by the Examiner.
4.  Acknowledgment is made of a claim for foreign priority under 35 U.S.C. § 119(a)-(d) or (f).
  - a)  All    b)  Some\*    c)  None    of the:
    1.  Certified copies of the priority documents have been received.
    2.  Certified copies of the priority documents have been received in Application No. \_\_\_\_\_.
    3.  Copies of the certified copies of the priority documents have been received in this national stage application from the International Bureau (PCT Rule 17.2(a)).

\* Certified copies not received: \_\_\_\_\_.

Applicant has THREE MONTHS FROM THE "MAILING DATE" of this communication to file a reply complying with the requirements noted below. Failure to timely comply will result in ABANDONMENT of this application.  
**THIS THREE-MONTH PERIOD IS NOT EXTENDABLE.**

5.  A SUBSTITUTE OATH OR DECLARATION must be submitted. Note the attached EXAMINER'S AMENDMENT or NOTICE OF INFORMAL PATENT APPLICATION (PTO-152) which gives reason(s) why the oath or declaration is deficient.
6.  CORRECTED DRAWINGS ( as "replacement sheets") must be submitted.
  - (a)  including changes required by the Notice of Draftperson's Patent Drawing Review ( PTO-948) attached
    - 1)  hereto or 2)  to Paper No./Mail Date \_\_\_\_\_.
  - (b)  including changes required by the attached Examiner's Amendment / Comment or in the Office action of Paper No./Mail Date \_\_\_\_\_.

Identifying indicia such as the application number (see 37 CFR 1.84(c)) should be written on the drawings in the front (not the back) of each sheet. Replacement sheet(s) should be labeled as such in the header according to 37 CFR 1.121(d).
7.  DEPOSIT OF and/or INFORMATION about the deposit of BIOLOGICAL MATERIAL must be submitted. Note the attached Examiner's comment regarding REQUIREMENT FOR THE DEPOSIT OF BIOLOGICAL MATERIAL.

**Attachment(s)**

- |   |   |
|---|---|
| 1. <input type="checkbox"/> Notice of References Cited (PTO-892)  | 5. <input type="checkbox"/> Notice of Informal Patent Application (PTO-152)                       |
| 2. <input type="checkbox"/> Notice of Draftperson's Patent Drawing Review (PTO-948)                                 | 6. <input checked="" type="checkbox"/> Interview Summary (PTO-413),<br>Paper No./Mail Date _____. |
| 3. <input type="checkbox"/> Information Disclosure Statements (PTO-1449 or PTO/SB/08),<br>Paper No./Mail Date _____ | 7. <input checked="" type="checkbox"/> Examiner's Amendment/Comment                               |
| 4. <input type="checkbox"/> Examiner's Comment Regarding Requirement for Deposit<br>of Biological Material          | 8. <input checked="" type="checkbox"/> Examiner's Statement of Reasons for Allowance              |
|   | 9. <input type="checkbox"/> Other _____.  |

Frank M. Lawrence  
 Primary Examiner  
 Art Unit: 1724

### EXAMINER'S AMENDMENT

1. An examiner's amendment to the record appears below. Should the changes and/or additions be unacceptable to applicant, an amendment may be filed as provided by 37 CFR 1.312. To ensure consideration of such an amendment, it **MUST** be submitted no later than the payment of the issue fee.

Authorization for this examiner's amendment was given in a telephone interview with Mr. Daniel Reece on March 8, 2004.

The application has been amended as follows:

In the Specification:

In footnote 1 of the Table in column 8, "Test" has been changed to ---Tests---

2. The following is an examiner's statement of reasons for allowance: The informalities detailed in the Quayle action have been corrected and the claims are allowable for reasons given in that office action.

Any comments considered necessary by applicant must be submitted no later than the payment of the issue fee and, to avoid processing delays, should preferably accompany the issue fee. Such submissions should be clearly labeled "Comments on Statement of Reasons for Allowance."

Any inquiry concerning this communication or earlier communications from the examiner should be directed to Frank M. Lawrence whose telephone number is 571-272-1161. The examiner can normally be reached on Mon-Thurs 7:30-6:00.

Application/Control Number: 10/690,298  
Art Unit: 1724

Page 3

If attempts to reach the examiner by telephone are unsuccessful, the examiner's supervisor, Blaine Copenheaver can be reached on 571-272-1156. The fax phone number for the organization where this application or proceeding is assigned is 703-872-9306.

Information regarding the status of an application may be obtained from the Patent Application Information Retrieval (PAIR) system. Status information for published applications may be obtained from either Private PAIR or Public PAIR. Status information for unpublished applications is available through Private PAIR only. For more information about the PAIR system, see <http://pair-direct.uspto.gov>. Should you have questions on access to the Private PAIR system, contact the Electronic Business Center (EBC) at 866-217-9197 (toll-free).

Frank M. Lawrence  
Primary Examiner  
Art Unit 1724

*Frank Lawrence*

5-20-04

fl

<b>Examiner-Initiated Interview Summary</b>	Application No. 10/690,298	Applicant(s) HILTZIK ET AL.	
	Examiner Frank M. Lawrence	Art Unit 1724	

**All Participants:**

(1) Frank M. Lawrence.

(2) Daniel Reece.

**Status of Application:** allowed

(3) \_\_\_\_\_.

(4) \_\_\_\_\_.

**Date of Interview:** 8 April 2004

**Time:** 10 am e.t.

**Type of Interview:**

- Telephonic  
 Video Conference  
 Personal (Copy given to:  Applicant  Applicant's representative)

Exhibit Shown or Demonstrated:  Yes  No

If Yes, provide a brief description:

**Part I.**

Rejection(s) discussed:

*none*

Claims discussed:

*none*

Prior art documents discussed:

*none*

**Part II.**

**SUBSTANCE OF INTERVIEW DESCRIBING THE GENERAL NATURE OF WHAT WAS DISCUSSED:**

*An examiner's amendment to the specification in order to correct a typographical error was discussed and agreed upon.*

**Part III.**



- It is not necessary for applicant to provide a separate record of the substance of the interview, since the interview directly resulted in the allowance of the application. The examiner will provide a written summary of the substance of the interview in the Notice of Allowability.  
 It is not necessary for applicant to provide a separate record of the substance of the interview, since the interview did not result in resolution of all issues. A brief summary by the examiner appears in Part II above.

\_\_\_\_\_  
(Examiner/SPE Signature)

\_\_\_\_\_  
(Applicant/Applicant's Representative Signature – if appropriate)





<b>Application Number</b>  	<b>Application No.</b> 10/690,298	<b>Applicant(s)</b> Hiltzik et al
	<b>Notice of Reissue Published in OG on</b> 1/6/04	
<b>Original Patent Number of Patent To Be Reissued is</b> 6,540,815		<b>The Maintenance fee status is:</b> <input type="checkbox"/> up to date. <input checked="" type="checkbox"/> not required.
<b>This reissue patent is subject to A Terminal Disclaimer that:</b> <input type="checkbox"/> was filed during the prosecution of the reissue application. <input type="checkbox"/> was of record prior to the filing of the reissue application.		
<b>Physical surrender of the letters patent</b> <input checked="" type="checkbox"/> was made. <input type="checkbox"/> was not made, but a statement of loss/inaccessibility was provided. <input type="checkbox"/> is not required		

<b>Final SPRE Review</b>
<u>          CST          </u> (INITIALS)
<u>          2/22/05          </u> (DATE)

U.S. Patent and Trademark Office



PART B - FEE(S) TRANSMITTAL

Complete and send this form, together with applicable fee(s), to: Mail

Mail Stop ISSUE FEE  
Commissioner for Patents  
P.O. Box 1450  
Alexandria, Virginia 22313-1450  
(703) 746-4000

or Fax

INSTRUCTIONS: This form should be used for transmitting the ISSUE FEE and PUBLICATION FEE (if required). Blocks 1 through 5 should be completed where appropriate. All further correspondence including the Patent, advance orders and notification of maintenance fees will be mailed to the current correspondence address as indicated unless corrected below or directed otherwise in Block 1, by (a) specifying a new correspondence address; and/or (b) indicating a separate "FEE ADDRESS" for maintenance fee notifications.

CURRENT CORRESPONDENCE ADDRESS (Note: Use Block 1 for any change of address)

36876 7590 03/02/2005

MEADWESTVACO CORPORATION  
REGIONAL OFFICE BUILDING  
PO BOX 118005  
CHARLESTON, SC 29423-8005



Note: A certificate of mailing can only be used for domestic mailings of the Fee(s) Transmittal. This certificate cannot be used for any other accompanying papers. Each additional paper, such as an assignment or formal drawing, must have its own certificate of mailing or transmission.

Certificate of Mailing or Transmission

I hereby certify that this Fee(s) Transmittal is being deposited with the United States Postal Service with sufficient postage for first class mail in an envelope addressed to the Mail Stop ISSUE FEE address above, or being facsimile transmitted to the USPTO (703) 746-4000, on the date indicated below.

Susan C. Harrison (Depositor's name)  
*Susan C. Harrison* (Signature)  
March 8, 2005 (Date)

01 FC:1501 1400.00 DA  
02 FC:8001 30.00 DA

03/09/2005 MGBREM2 00000006 231160 10690298

Table with 5 columns: APPLICATION NO., FILING DATE, FIRST NAMED INVENTOR, ATTORNEY DOCKET NO., CONFIRMATION NO.

TITLE OF INVENTION: METHOD FOR REDUCING EMISSIONS FROM EVAPORATIVE EMISSIONS CONTROL SYSTEMS

Table with 6 columns: APPLN. TYPE, SMALL ENTITY, ISSUE FEE, PUBLICATION FEE, TOTAL FEE(S) DUE, DATE DUE

Table with 3 columns: EXAMINER, ART UNIT, CLASS-SUBCLASS

1. Change of correspondence address or indication of "Fee Address" (37 CFR 1.363).  
2. For printing on the patent front page, list (1) the names of up to 3 registered patent attorneys or agents OR, alternatively, (2) the name of a single firm (having as a member a registered attorney or agent) and the names of up to 2 registered patent attorneys or agents. If no name is listed, no name will be printed.

3. ASSIGNEE NAME AND RESIDENCE DATA TO BE PRINTED ON THE PATENT (print or type)  
PLEASE NOTE: Unless an assignee is identified below, no assignee data will appear on the patent. If an assignee is identified below, the document has been filed for recordation as set forth in 37 CFR 3.11. Completion of this form is NOT a substitute for filing an assignment.  
(A) NAME OF ASSIGNEE: MeadWestvaco Corporation  
(B) RESIDENCE: (CITY and STATE OR COUNTRY) Stamford, Connecticut USA

Please check the appropriate assignee category or categories (will not be printed on the patent):  Individual  Corporation or other private group entity  Government

4a. The following fee(s) are enclosed:  
 Issue Fee  
 Publication Fee (No small entity discount permitted)  
 Advance Order - # of Copies 10 soft copies  
4b. Payment of Fee(s): \$1430.00 by Deposit Account  
 A check in the amount of the fee(s) is enclosed.  
 Payment by credit card. Form PTO-2038 is attached.  
 The Director is hereby authorized by charge the required fee(s), or credit any overpayment, to Deposit Account Number 23-1160 (enclose an extra copy of this form).

5. Change in Entity Status (from status indicated above)  
 a. Applicant claims SMALL ENTITY status. See 37 CFR 1.27.  b. Applicant is no longer claiming SMALL ENTITY status. See 37 CFR 1.27(g)(2).

The Director of the USPTO is requested to apply the Issue Fee and Publication Fee (if any) or to re-apply any previously paid issue fee to the application identified above. NOTE: The Issue Fee and Publication Fee (if required) will not be accepted from anyone other than the applicant; a registered attorney or agent; or the assignee or other party in interest as shown by the records of the United States Patent and Trademark Office.

Authorized Signature: *Terry B. McDaniel*  
Typed or printed name: Terry B. McDaniel  
Date: March 8, 2005  
Registration No.: 28,444

This collection of information is required by 37 CFR 1.311. The information is required to obtain or retain a benefit by the public which is to file (and by the USPTO to process) an application. Confidentiality is governed by 35 U.S.C. 122 and 37 CFR 1.14. This collection is estimated to take 12 minutes to complete, including gathering, preparing, and submitting the completed application form to the USPTO. Time will vary depending upon the individual case. Any comments on the amount of time you require to complete this form and/or suggestions for reducing this burden, should be sent to the Chief Information Officer, U.S. Patent and Trademark Office, U.S. Department of Commerce, P.O. Box 1450, Alexandria, Virginia 22313-1450. DO NOT SEND FEES OR COMPLETED FORMS TO THIS ADDRESS. SEND TO: Commissioner for Patents, P.O. Box 1450, Alexandria, Virginia 22313-1450.

Under the Paperwork Reduction Act of 1995, no persons are required to respond to a collection of information unless it displays a valid OMB control number.