



US00655622B1

(12) **United States Patent**
Narayanaswami

(10) **Patent No.:** **US 6,556,222 B1**
(45) **Date of Patent:** **Apr. 29, 2003**

(54) **BEZEL BASED INPUT MECHANISM AND USER INTERFACE FOR A SMART WATCH**

6,414,907 B1 * 7/2002 Pennington 368/10
6,443,614 B1 * 9/2002 Read 368/281

(75) Inventor: **Chandrasekhar Narayanaswami,**
Wilton, CT (US)

OTHER PUBLICATIONS

(73) Assignee: **International Business Machines Corporation,** Armonk, NY (US)

“The World’s Smallest PDA Computer Watch”, Hammacher Schlemmer Mid Summer 2000 Catalog, p. 3.

(*) Notice: Subject to any disclaimer, the term of this patent is extended or adjusted under 35 U.S.C. 154(b) by 425 days.

* cited by examiner

(21) Appl. No.: **09/607,594**

Primary Examiner—Kristine Kincaid
Assistant Examiner—Peng Ke

(22) Filed: **Jun. 30, 2000**

(74) *Attorney, Agent, or Firm*—Scully, Scott, Murphy & Presser; Gail H. Zarick, Esq.

(51) **Int. Cl.**⁷ **G09G 5/00; G04C 17/00**

(52) **U.S. Cl.** **345/786; 345/701; 368/69; 368/295**

(57) **ABSTRACT**

(58) **Field of Search** 345/786, 787, 345/828, 829, 830, 701, 700, 704, 810, 835, 839, 832, 853, 854, 964, 173, 174; 368/251, 244, 246, 248, 243, 10, 109, 247, 250, 262, 263, 267, 69, 295

A wearable mobile computing device/appliance (e.g., a wrist watch) with a high resolution display that is capable of wirelessly accessing information from the network and a variety of other devices. The mobile computing device/appliance includes a user interface employing a bezel-based input mechanism including a bezel ring which may be rotated and depressed for generating both rotation and wheel click events for enabling navigation, selection and entry of various displayed textual and graphical items.

(56) **References Cited**

U.S. PATENT DOCUMENTS

4,385,291 A * 5/1983 Piguet 345/173

42 Claims, 5 Drawing Sheets

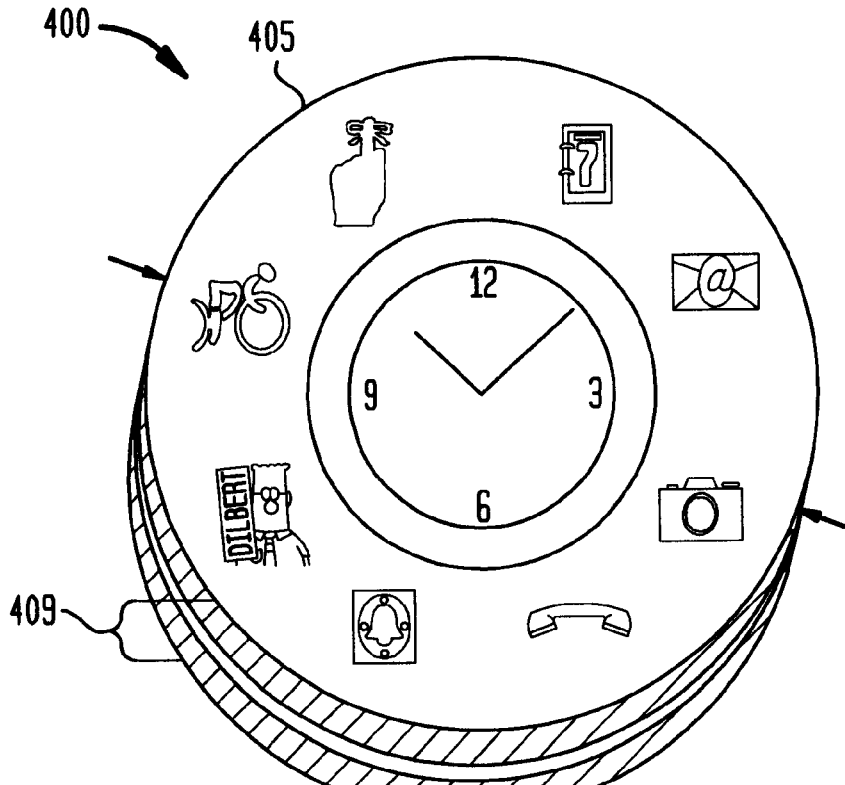

FIG. 1

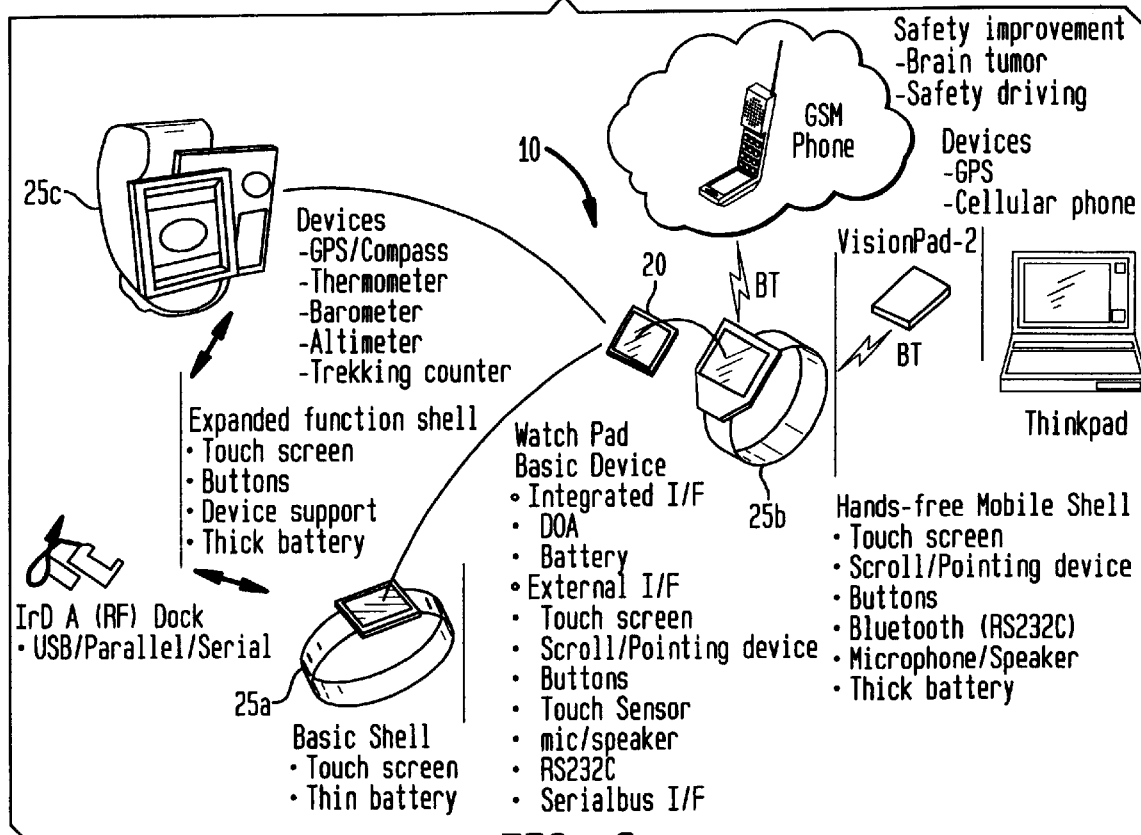

FIG. 3

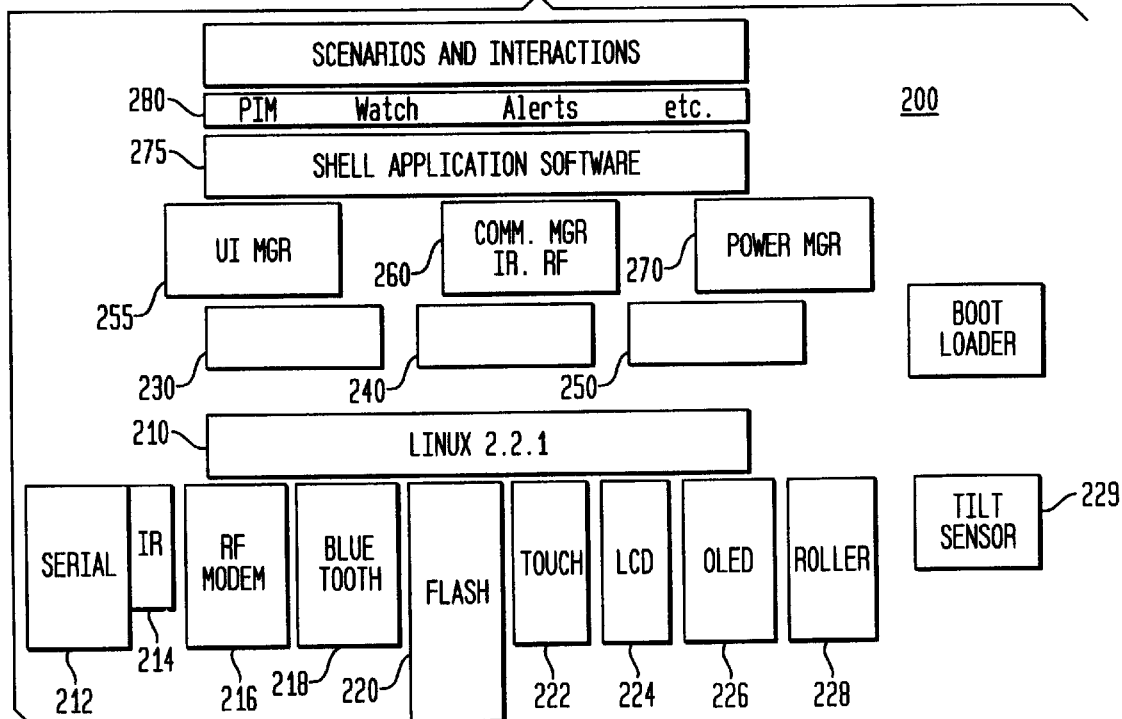

FIG. 2

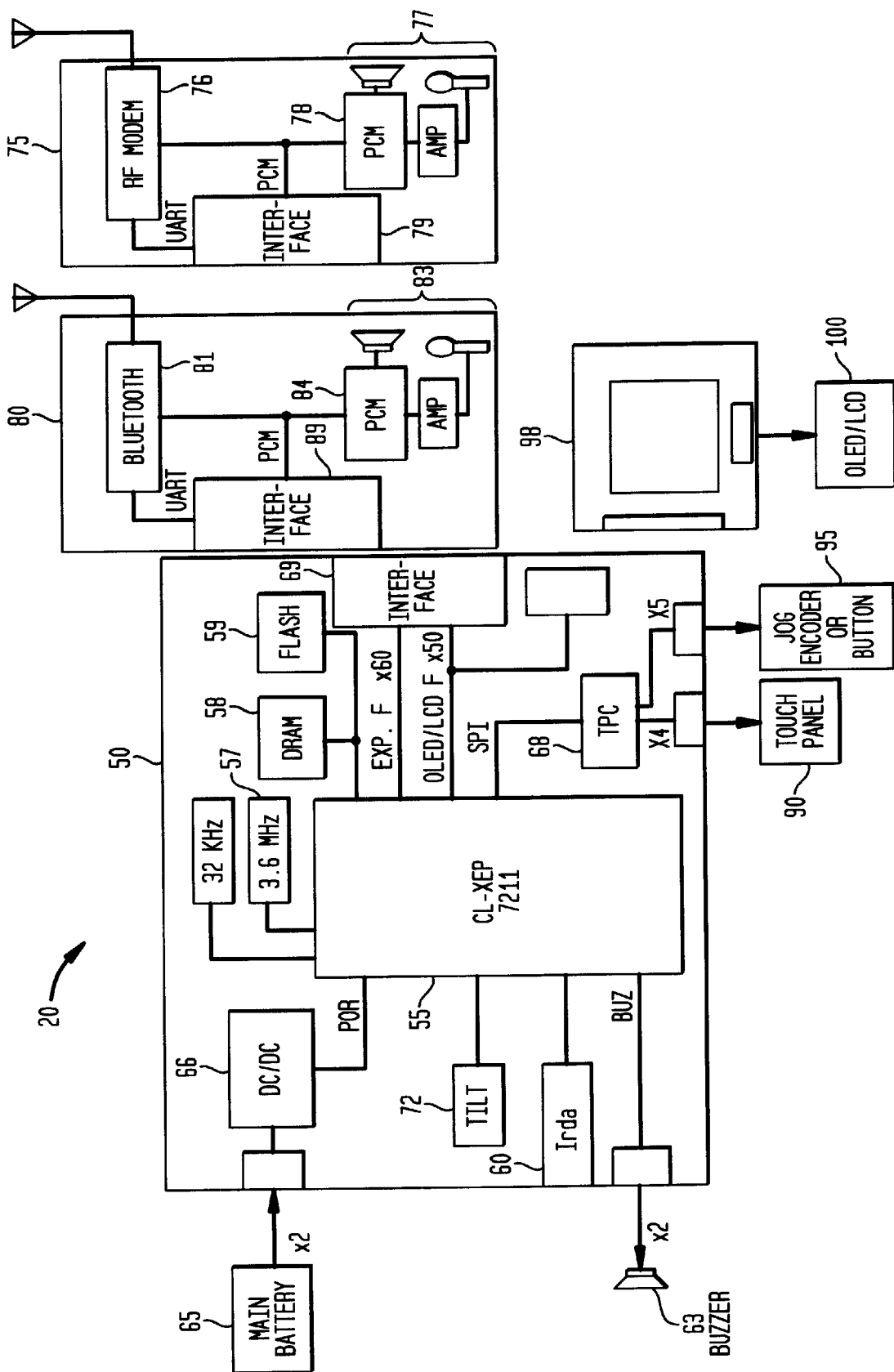

FIG. 4

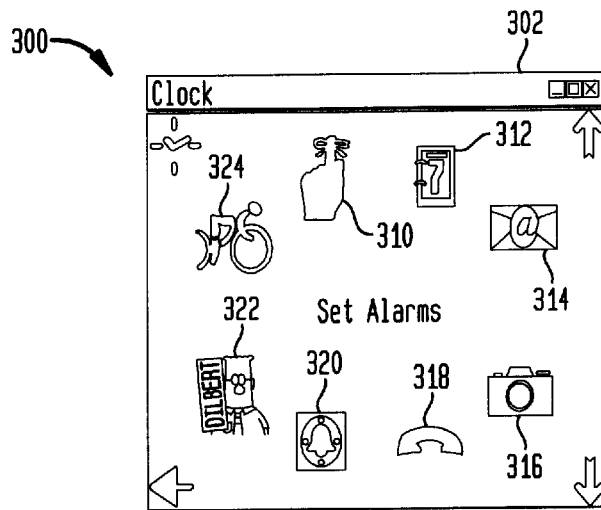

FIG. 5A

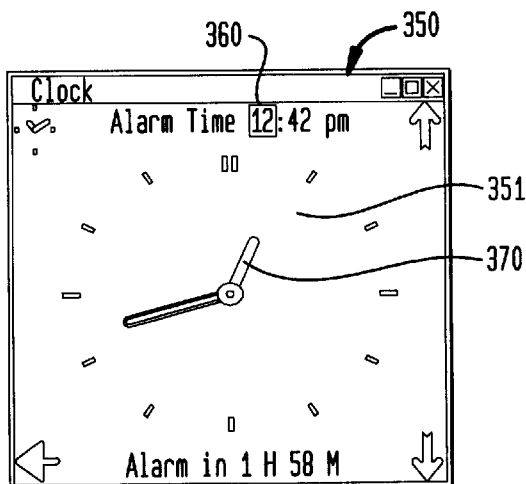

FIG. 5B

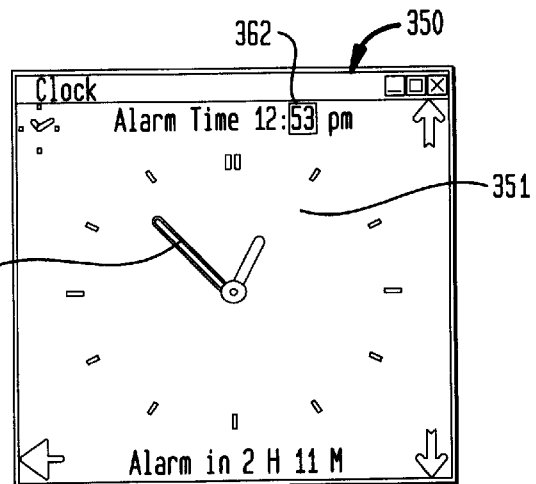

FIG. 6A

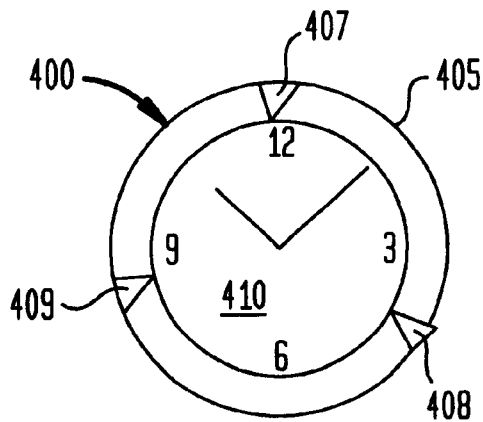

FIG. 6B

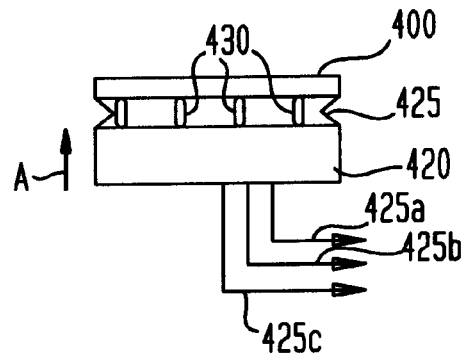
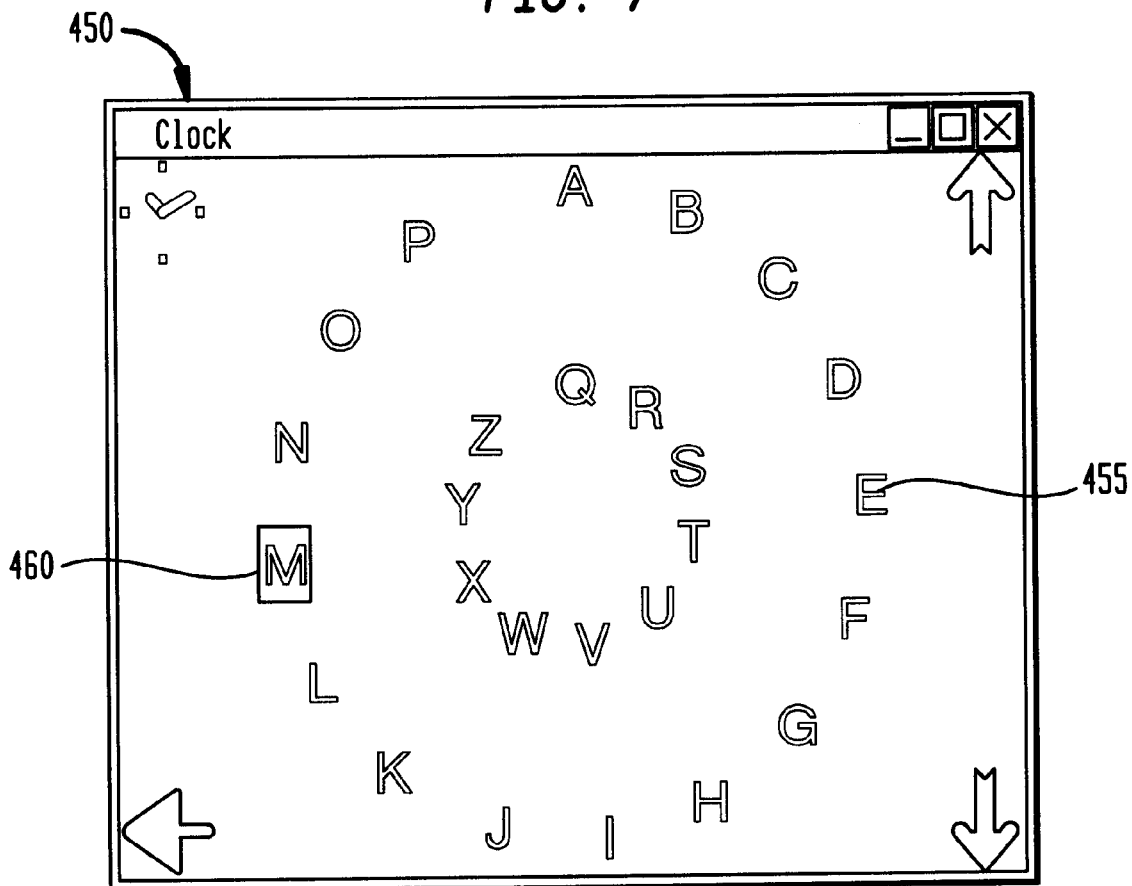

FIG. 7



Explore Litigation Insights

Docket Alarm provides insights to develop a more informed litigation strategy and the peace of mind of knowing you're on top of things.

Real-Time Litigation Alerts



Keep your litigation team up-to-date with **real-time alerts** and advanced team management tools built for the enterprise, all while greatly reducing PACER spend.

Our comprehensive service means we can handle Federal, State, and Administrative courts across the country.

Advanced Docket Research



With over 230 million records, Docket Alarm's cloud-native docket research platform finds what other services can't. Coverage includes Federal, State, plus PTAB, TTAB, ITC and NLRB decisions, all in one place.

Identify arguments that have been successful in the past with full text, pinpoint searching. Link to case law cited within any court document via Fastcase.

Analytics At Your Fingertips



Learn what happened the last time a particular judge, opposing counsel or company faced cases similar to yours.

Advanced out-of-the-box PTAB and TTAB analytics are always at your fingertips.

API

Docket Alarm offers a powerful API (application programming interface) to developers that want to integrate case filings into their apps.

LAW FIRMS

Build custom dashboards for your attorneys and clients with live data direct from the court.

Automate many repetitive legal tasks like conflict checks, document management, and marketing.

FINANCIAL INSTITUTIONS

Litigation and bankruptcy checks for companies and debtors.

E-DISCOVERY AND LEGAL VENDORS

Sync your system to PACER to automate legal marketing.