



US005422656A

United States Patent [19]
Allard et al.

[11] **Patent Number:** **5,422,656**
[45] **Date of Patent:** **Jun. 6, 1995**

[54] **PERSONAL COMMUNICATOR HAVING IMPROVED CONTRAST CONTROL FOR A LIQUID CRYSTAL, TOUCH SENSITIVE DISPLAY**

[75] Inventors: **David J. Allard**, Boynton Beach; **Brent A. Beatty**, Boca Raton; **Francis J. Canova, Jr.**, Boynton Beach; **Bradley J. DeBauche**, Delray Beach; **Danile M. Hsieh**, Coral Springs; **Debra A. G. Johnson**, Fort Lauderdale; **Charles S. Lanier**, Delray Beach; **James R. Lewis**, Coconut Creek; **Byron K. Tiller**, Boca Raton; **William Villafana**, Davie; **Raymond L. Yee**, Coral Springs, all of Fla.

[73] Assignee: **International Business Machines Corp.**, Armonk, N.Y.

[21] Appl. No.: **146,342**

[22] Filed: **Nov. 1, 1993**

[51] Int. Cl.⁶ **G09G 3/22**

[52] U.S. Cl. **345/173; 345/63; 345/147**

[58] Field of Search **345/77, 63, 89, 147, 345/173, 179; 178/18-20; 348/734, 738, 761, 790, 791, 794**

[56] **References Cited**

U.S. PATENT DOCUMENTS

5,029,982	7/1991	Nash	350/331 T
5,119,204	6/1992	Hashimoto et al.	348/794
5,148,155	9/1992	Martin et al.	345/179 X
5,166,666	11/1992	Tanaka	345/179
5,260,697	11/1993	Barrett et al.	345/179 X

FOREIGN PATENT DOCUMENTS

0354703	2/1990	European Pat. Off.
9104461	4/1991	WIPO

Primary Examiner—Ulysses Weldon
Attorney, Agent, or Firm—George E. Grosser; Douglas R. McKechnie

[57] **ABSTRACT**

A personal communicator has a touch sensitive overlay coupled with a liquid crystal display (LCD). The communicator has two external (non-screen) up/down buttons for adjusting the volume of a cellular phone speaker. These volume buttons are also used to allow the user to adjust contrast. In accordance with one operation, contrast is adjusted in response to the user touching a predetermined area of the screen at the same time as one of the up or down buttons is actuated. In accordance with another operation, contrast is adjusted in response to the user first pressing both speaker volume buttons to enter a contrast adjustment mode, and thereafter pressing one or the other of such buttons, to increase or decrease contrast as desired.

15 Claims, 5 Drawing Sheets

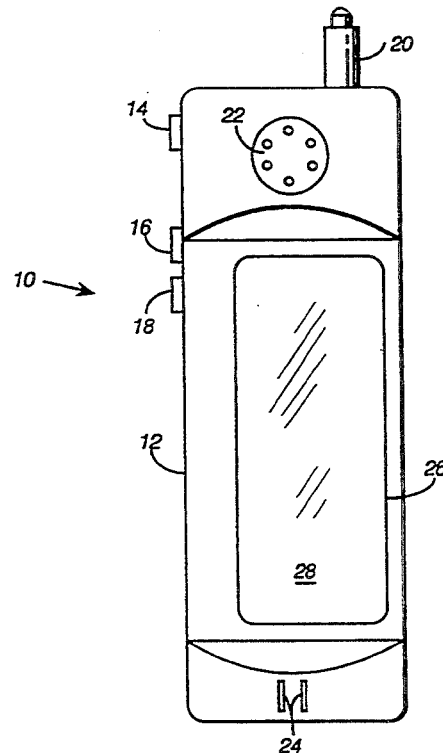

FIG. 1

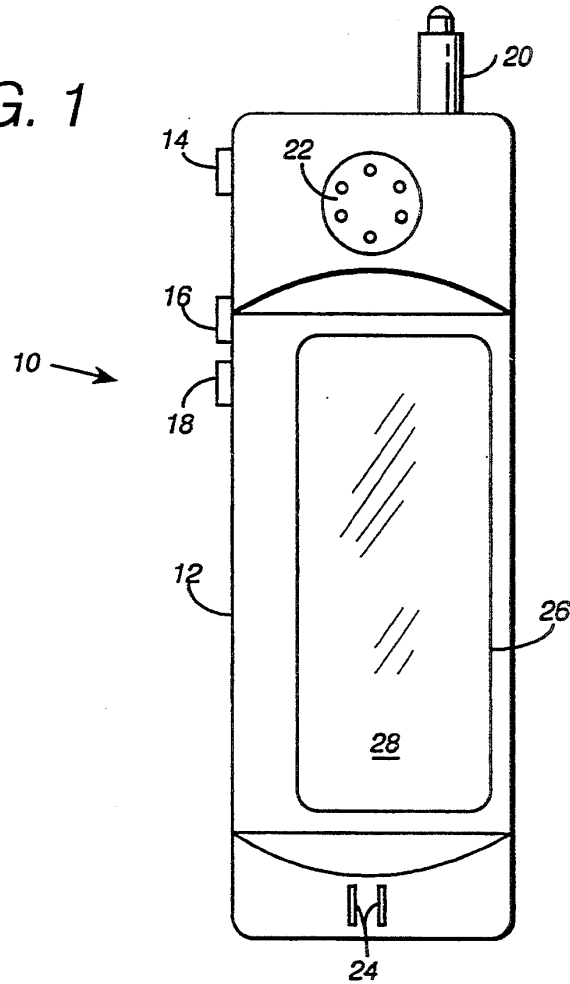

FIG. 2

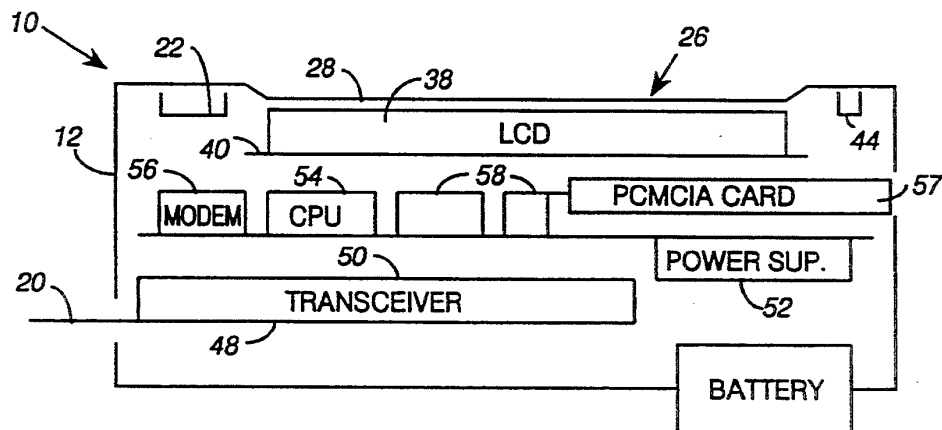

FIG. 3

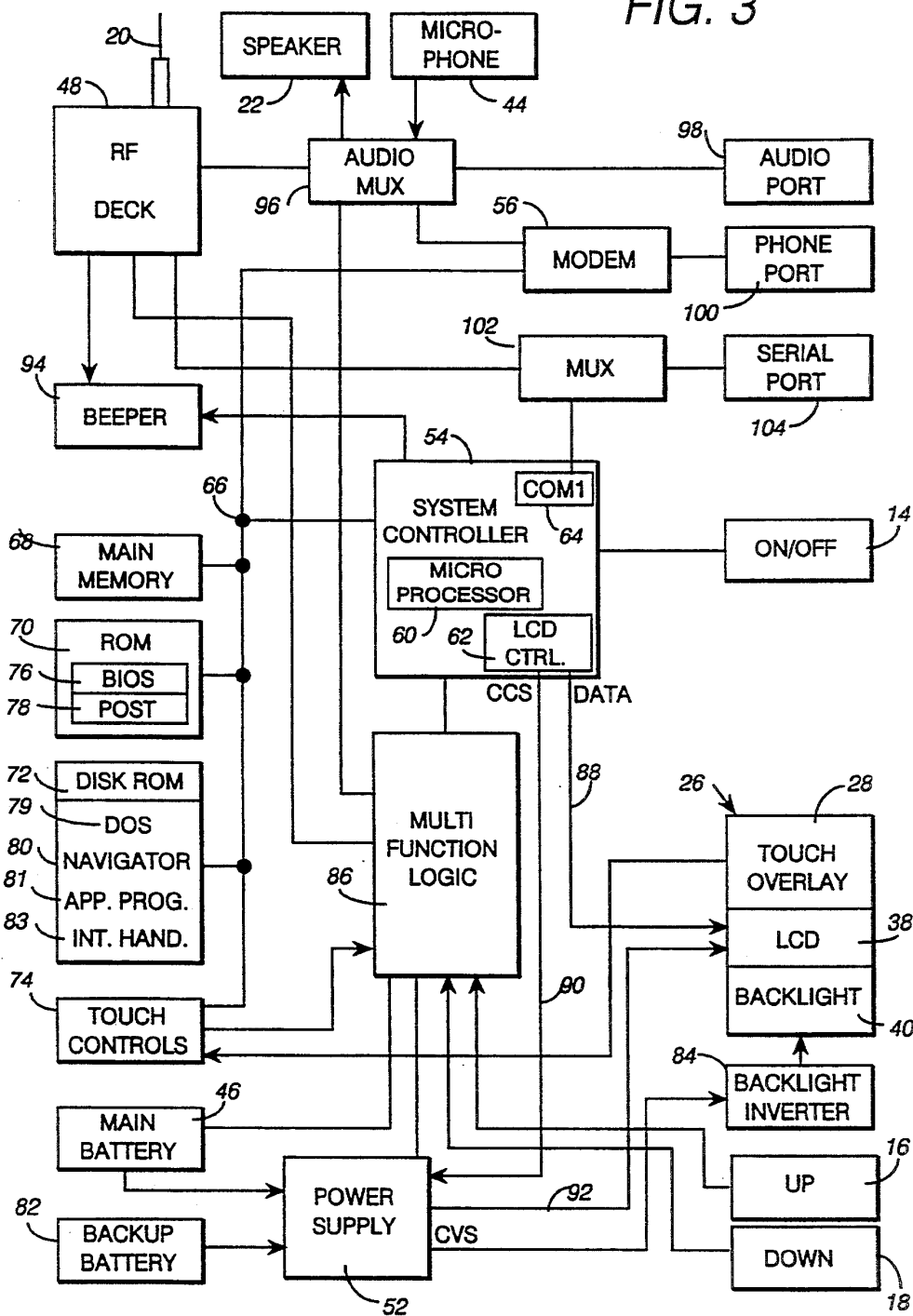

FIG. 4A

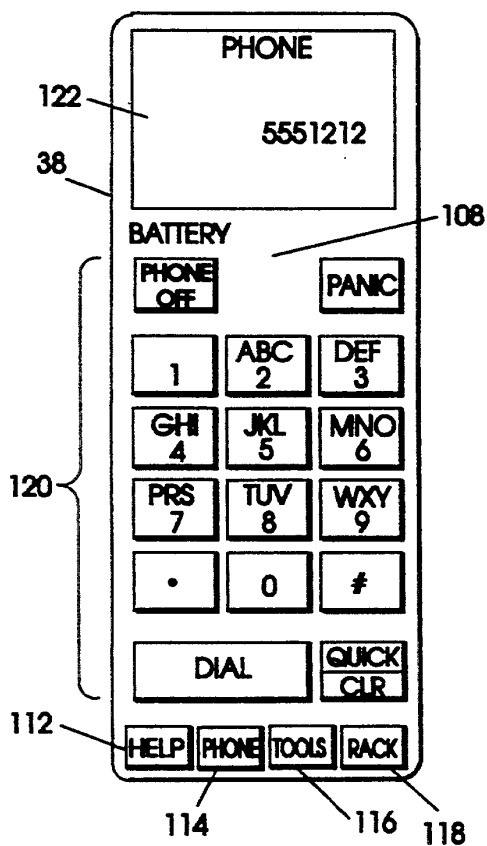

FIG. 4B

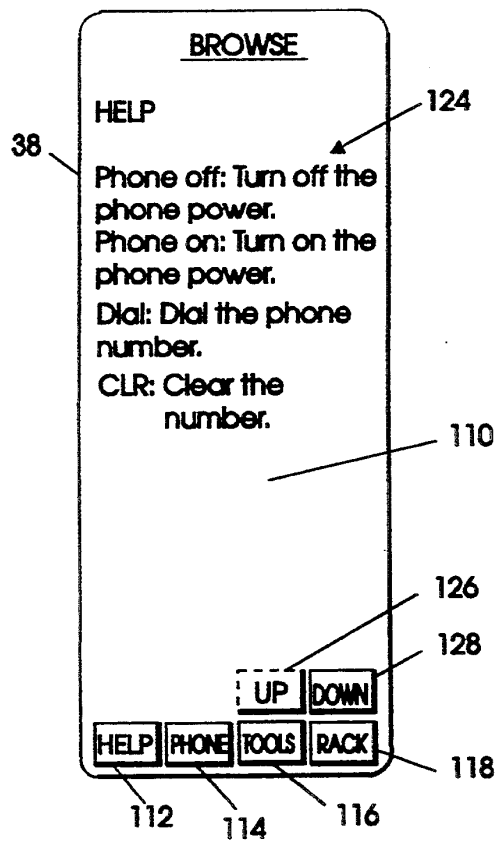
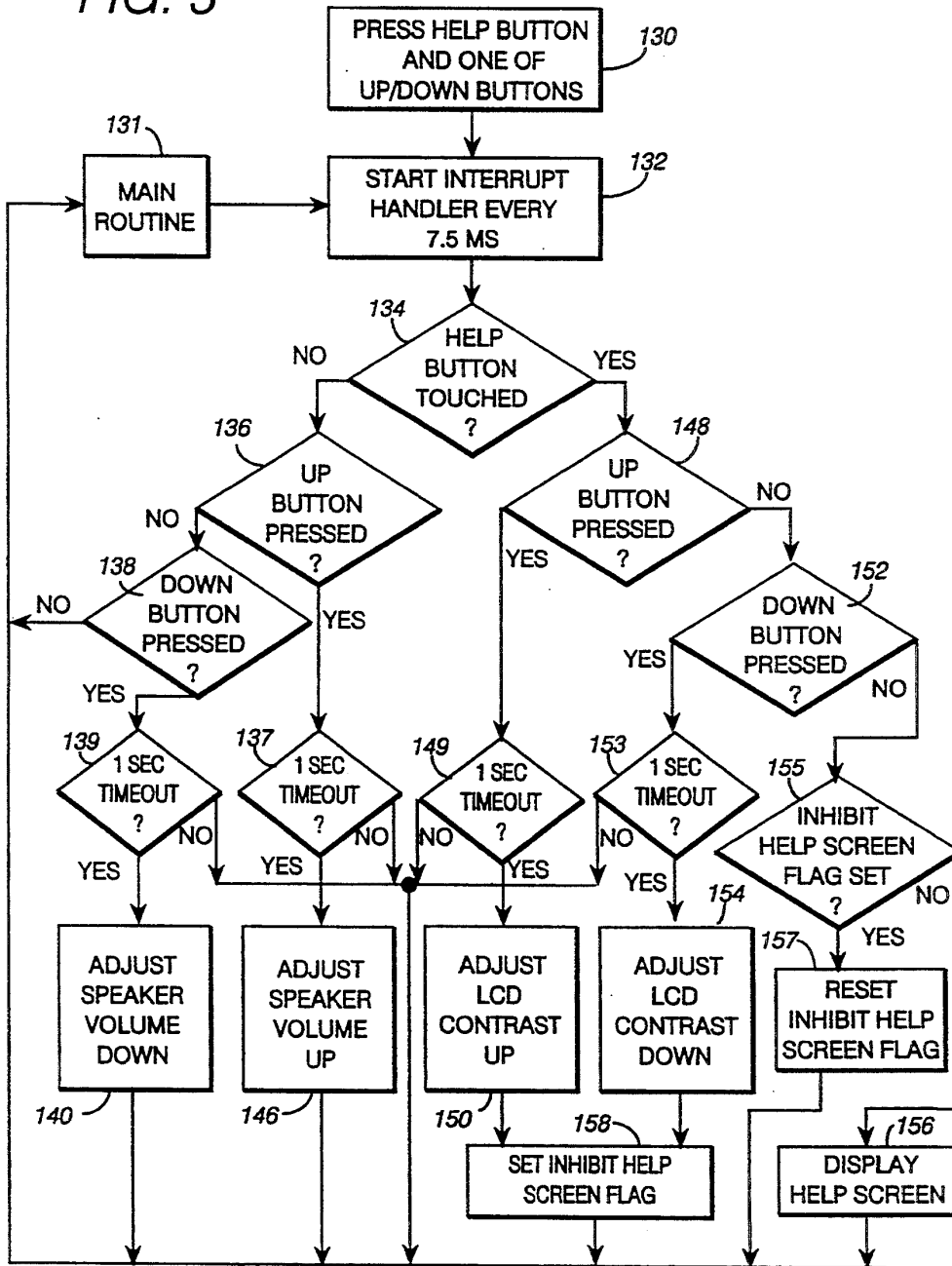

FIG. 5



Explore Litigation Insights

Docket Alarm provides insights to develop a more informed litigation strategy and the peace of mind of knowing you're on top of things.

Real-Time Litigation Alerts



Keep your litigation team up-to-date with **real-time alerts** and advanced team management tools built for the enterprise, all while greatly reducing PACER spend.

Our comprehensive service means we can handle Federal, State, and Administrative courts across the country.

Advanced Docket Research



With over 230 million records, Docket Alarm's cloud-native docket research platform finds what other services can't. Coverage includes Federal, State, plus PTAB, TTAB, ITC and NLRB decisions, all in one place.

Identify arguments that have been successful in the past with full text, pinpoint searching. Link to case law cited within any court document via Fastcase.

Analytics At Your Fingertips



Learn what happened the last time a particular judge, opposing counsel or company faced cases similar to yours.

Advanced out-of-the-box PTAB and TTAB analytics are always at your fingertips.

API

Docket Alarm offers a powerful API (application programming interface) to developers that want to integrate case filings into their apps.

LAW FIRMS

Build custom dashboards for your attorneys and clients with live data direct from the court.

Automate many repetitive legal tasks like conflict checks, document management, and marketing.

FINANCIAL INSTITUTIONS

Litigation and bankruptcy checks for companies and debtors.

E-DISCOVERY AND LEGAL VENDORS

Sync your system to PACER to automate legal marketing.