

USA  
214-932-6418  
Fax: 214-273-7483  
Email: Jcook@mcquirewoods.Com

Marshall Beil  
ATTORNEY TO BE NOTICED  
1345 Sixth Avenue 7th Floor  
New York , NY 10105  
USA  
212-548-7004  
Fax: 212-715-2319  
Email: Mbeil@mcquirewoods.Com

Shaun William Hassett  
PRO HAC VICE; ATTORNEY TO BE NOTICED  
McGuireWoods LLP  
2000 Mckinney Avenue Suite 1400  
Dallas , TX 75201  
USA  
214-932-6422  
Fax: 214-273-7475  
Email: Shassett@mcquirewoods.Com

Ixi Ip, Llc  
Counter-Defendant

John Joseph Higson  
LEAD ATTORNEY; PRO HAC VICE; ATTORNEY TO BE NOTICED  
Dilworth Paxson LLP  
1500 Market Street Suite 3500e  
Philadelphia , PA 19103  
USA  
215-575-7152  
Fax: 215-575-7200  
Email: Jhigson@dilworthlaw.Com

Joshua David Wolson  
LEAD ATTORNEY; PRO HAC VICE; ATTORNEY TO BE NOTICED  
Dilworth Paxson LLP  
1500 Market Street Suite 3500e  
Philadelphia , PA 19102  
USA  
215-575-7295  
Email: Jwolson@dilworthlaw.Com

Mark William Halderman  
LEAD ATTORNEY; PRO HAC VICE; ATTORNEY TO BE NOTICED  
Dilworth Paxson LLP  
1500 Market Street Suite 3500e  
Philadelphia , PA 19102  
USA  
215-575-7186  
Fax: 215-575-7200  
Email: Mwhalderman@dilworthlaw.Com

Thomas Steven Biemer  
LEAD ATTORNEY; PRO HAC VICE; ATTORNEY TO BE NOTICED  
Dilworth Paxson LLP (PA)  
1500 Market Street Suite 3500e  
Philadelphia , PA 19102-2101  
USA  
215-575-7025  
Fax: 215-575-7200  
Email: Tbiemer@dilworthlaw.Com

Jennifer S. Coleman  
ATTORNEY TO BE NOTICED  
Hopkins & Carley  
A Law Corporation The Letitia Building 70 South First Street  
P.O. Box 1469

San Jose , CA 95109-1469  
USA  
408-286-9800  
Fax: 408-998-4790  
Email: Jcoleman@hopkinscarley.Com

John V. Picone , III  
ATTORNEY TO BE NOTICED  
Hopkins & Carley  
A Law Corporation The Letitia Building 70 South First Street  
P.O. Box 1469  
San Jose , CA 95109-1469  
USA  
408-286-9800  
Fax: 408-998-4790  
Email: Jpicone@hopkinscarley.Com

Ixi Mobile (R&D) Ltd.  
Counter-Defendant

John Joseph Higson  
LEAD ATTORNEY; PRO HAC VICE; ATTORNEY TO BE NOTICED  
Dilworth Paxson LLP  
1500 Market Street Suite 3500e  
Philadelphia , PA 19103  
USA  
215-575-7152  
Fax: 215-575-7200  
Email: Jhigson@dilworthlaw.Com

Joshua David Wolson  
LEAD ATTORNEY; PRO HAC VICE; ATTORNEY TO BE NOTICED  
Dilworth Paxson LLP  
1500 Market Street Suite 3500e  
Philadelphia , PA 19102  
USA  
215-575-7295  
Email: Jwolson@dilworthlaw.Com

Mark William Halderman  
LEAD ATTORNEY; PRO HAC VICE; ATTORNEY TO BE NOTICED  
Dilworth Paxson LLP  
1500 Market Street Suite 3500e  
Philadelphia , PA 19102  
USA  
215-575-7186  
Fax: 215-575-7200  
Email: Mwhalderman@dilworthlaw.Com

Thomas Steven Biemer  
LEAD ATTORNEY; PRO HAC VICE; ATTORNEY TO BE NOTICED  
Dilworth Paxson LLP (PA)  
1500 Market Street Suite 3500e  
Philadelphia , PA 19102-2101  
USA  
215-575-7025  
Fax: 215-575-7200  
Email: Tbiemer@dilworthlaw.Com

Jennifer S. Coleman  
ATTORNEY TO BE NOTICED  
Hopkins & Carley  
A Law Corporation The Letitia Building 70 South First Street  
P.O. Box 1469  
San Jose , CA 95109-1469  
USA  
408-286-9800  
Fax: 408-998-4790  
Email: Jcoleman@hopkinscarley.Com

John V. Picone , III

ATTORNEY TO BE NOTICED  
 Hopkins & Carley  
 A Law Corporation The Letitia Building 70 South First Street  
 P.O. Box 1469  
 San Jose , CA 95109-1469  
 USA  
 408-286-9800  
 Fax: 408-998-4790  
 Email: Jpicone@hopkinscarley.Com

| Date       | # | Proceeding Text  | Source |
|------------|---|--|--------|
| 06/18/2014 | 1 | COMPLAINT against Blackberry Corporation, Blackberry Limited. (Filing Fee \$ 350.00, Receipt Number 1098194) Document filed by IXI Mobile (R&D) Ltd., IXI IP, LLC. (Attachments: # 1 Online, # 2 Online, # 3 Online, # 4 Online (Entered: 06/23/2014))   |        |
| 06/18/2014 |   | SUMMONS ISSUED as to Blackberry Corporation, Blackberry Limited. (moh) (Entered: 06/23/2014)   |        |
| 06/18/2014 |   | CASE REFERRED TO Judge Richard J. Sullivan as possibly related to 14-cv-4355. (moh) (Entered: 06/23/2014)  |        |
| 06/18/2014 |   | Case Designated ECF. (moh) (Entered: 06/23/2014)   |        |
| 06/18/2014 | 2 | CIVIL COVER SHEET filed. (moh) (Entered: 06/23/2014)   |        |
| 06/18/2014 | 3 | STATEMENT OF RELATEDNESS re: that this action be filed as related to 14-cv-4355. Document filed by IXI IP, LLC, IXI Mobile (R&D) Ltd..(moh) (Entered: 06/23/2014)  |        |
| 06/18/2014 | 4 | STANDING ORDER IN RE PILOT PROJECT REGARDING CASE MANAGEMENT TECHNIQUES FOR COMPLEX CIVIL CASES IN THE SOUTHERN DISTRICT OF NEW YORK (See M-10-468 Order filed November 1, 2011). This case is hereby designated for inclusion in the Pilot Project Regarding Case Management Techniques for Complex Civil Cases in the Southern District of New York (the Pilot Project), unless the judge to whom this case is assigned determines otherwise. This case is designated for inclusion in the Pilot Project because it is a class action, an MDL action, or is in one of the following Nature of Suit categories: 160, 245, 315, 355, 365, 385, 410, 830, 840, 850, 893, or 950. The presiding judge in a case that does not otherwise qualify for inclusion in the Pilot Project may nevertheless designate the case for inclusion in the Pilot Project by issuing an order directing that the case be included in the Pilot Project. The description of the Pilot Project, including procedures to be followed, is attached to this Order. (Signed by Judge Loretta A. Preska on 10/31/2011) (moh) (Main Document 4 replaced on 6/23/2014) (laq). (Entered: 06/23/2014) |        |
| 06/18/2014 |   | Case Eligible for Patent Pilot Program. (moh) (Entered: 06/23/2014)  |        |
| 06/18/2014 |   | Mailed notice to Commissioner of Patents and Trademarks to report the filing of this action. (moh) (Entered: 03/27/2015)   |        |
| 06/23/2014 | 5 | RULE 7.1 CORPORATE DISCLOSURE STATEMENT. No Corporate Parent. Document filed by IXI IP, LLC.(Biemer, Thomas) (Entered: 06/23/2014)   |        |
| 06/23/2014 | 6 | RULE 7.1 CORPORATE DISCLOSURE STATEMENT. No Corporate Parent. Document filed by IXI Mobile (R&D) Ltd..(Biemer, Thomas) (Entered: 06/23/2014)   |        |
| 06/26/2014 |   | CASE ACCEPTED AS RELATED. Create association to 1:14-cv-04355-RJS. Notice of Assignment to follow. (pgu) (Entered: 06/26/2014)   |        |
| 06/26/2014 |   | NOTICE OF CASE ASSIGNMENT to Judge Richard J. Sullivan. Judge Unassigned is no longer assigned to the case. (pgu) (Entered: 06/26/2014)  |        |
| 06/26/2014 |   | Magistrate Judge Debra C. Freeman is so designated. (pgu) (Entered: 06/26/2014)  |        |
| 06/27/2014 | 7 | AFFIDAVIT OF SERVICE of Summons and Complaint,. Blackberry Corporation served on 6/23/2014, answer due 7/14/2014. Service was accepted by Marie Garcia, Process Specialist for CT Corporation System as Registered Agent. Document filed by IXI Mobile (R&D) Ltd.; IXI IP, LLC. (Biemer, Thomas) (Entered: 06/27/2014)   |        |
| 06/30/2014 | 8 | ORDER: Initial Conference set for 8/26/2014 at 12:30 PM in Courtroom 905, 40 Centre Street, New York, NY 10007 before Judge Richard J. Sullivan, and as further set forth in this document. (Signed by Judge Richard J. Sullivan on 6/25/2014) (cd) (Entered: 07/01/2014)  |        |
| 07/08/2014 | 9 | SUPPLEMENTAL RULE 7.1 CORPORATE DISCLOSURE STATEMENT. Identifying Corporate Parent IXI Mobile Inc. for IXI Mobile (R&D) Ltd.. Document filed by IXI Mobile (R&D) Ltd..(Biemer, Thomas) (Entered: 07/08/2014)   |        |

- 07/08/2014 10 LETTER MOTION for Extension of Time To Respond to Plaintiffs' Complaint addressed to Judge Richard J. Sullivan from Thomas S. Biemer, Esquire dated 7/8/2014. Document filed by IXI IP, LLC, IXI Mobile (R&D) Ltd..(Biemer, Thomas) (Entered: 07/08/2014)
- 07/08/2014 11 ORDER granting 10 Letter Motion for Extension of Time. IT IS HEREBY ORDERED THAT Defendants time to answer, move against or otherwise respond to Plaintiffs' Complaint is extended to September 12, 2014. IT IS FURTHER ORDERED THAT the initial conference, currently scheduled for August 26, 2014, is ADJOURNED to October 7, 2014 at 12:30 p.m. IT IS FURTHER ORDERED that the parties shall submit the joint letter and proposed case management plan referenced in the Court's June 30, 2014 Order no later than September 30, 2014 at 4:00 p.m. (Signed by Judge Richard J. Sullivan on 7/8/2014) (cd) (Entered: 07/09/2014)
- 07/08/2014 Set/Reset Deadlines: Blackberry Corporation answer due 9/12/2014; Blackberry Limited answer due 9/12/2014. Set/Reset Hearings:(Initial Conference reset for 10/7/2014 at 12:30 PM before Judge Richard J. Sullivan.) (cd) (Entered: 07/09/2014)
- 07/22/2014 12 FILING ERROR - DEFICIENT DOCKET ENTRY - MOTION for Joshua D. Wolson to Appear Pro Hac Vice . Filing fee \$ 200.00, receipt number 0208-9915127. Motion and supporting papers to be reviewed by Clerk's Office staff. Document filed by IXI IP, LLC, IXI Mobile (R&D) Ltd.. (Attachments: # 1 Online, # 2 Online (Entered: 07/22/2014)
- 07/22/2014 13 FILING ERROR - DEFICIENT DOCKET ENTRY - MOTION for John Joseph Higson to Appear Pro Hac Vice . Filing fee \$ 200.00, receipt number 0208-9915198. Motion and supporting papers to be reviewed by Clerk's Office staff. Document filed by IXI IP, LLC, IXI Mobile (R&D) Ltd.. (Attachments: # 1 Online, # 2 Online (Entered: 07/22/2014)
- 07/23/2014 &gt;&gt;&gt;NOTICE REGARDING DEFICIENT MOTION TO APPEAR PRO HAC VICE. Notice regarding Document No. 12 MOTION for Joshua D. Wolson to Appear Pro Hac Vice . Filing fee \$ 200.00, receipt number 0208-9915127. Motion and supporting papers to be reviewed by Clerk's Office staff., 13 MOTION for John Joseph Higson to Appear Pro Hac Vice . Filing fee \$ 200.00, receipt number 0208-9915198. Motion and supporting papers to be reviewed by Clerk's Office staff.. Provide only one individual case number on the documents. (sdi) (Entered: 07/23/2014)
- 07/23/2014 14 MOTION for Joshua D. Wolson to Appear Pro Hac Vice (CORRECTED). Motion and supporting papers to be reviewed by Clerk's Office staff. Document filed by IXI IP, LLC, IXI Mobile (R&D) Ltd.. (Attachments: # 1 Online, # 2 Online (Entered: 07/23/2014)
- 07/23/2014 15 MOTION for John Joseph Higson to Appear Pro Hac Vice (CORRECTED). Motion and supporting papers to be reviewed by Clerk's Office staff. Document filed by IXI IP, LLC, IXI Mobile (R&D) Ltd.. (Attachments: # 1 Online, # 2 Online (Entered: 07/23/2014)
- 07/24/2014 &gt;&gt;&gt;NOTICE REGARDING PRO HAC VICE MOTION. Regarding Document No. 15 MOTION for John Joseph Higson to Appear Pro Hac Vice (CORRECTED). Motion and supporting papers to be reviewed by Clerk's Office staff., 14 MOTION for Joshua D. Wolson to Appear Pro Hac Vice (CORRECTED). Motion and supporting papers to be reviewed by Clerk's Office staff.. The document has been reviewed and there are no deficiencies. (wb) (Entered: 07/24/2014)
- 07/28/2014 16 ORDER granting 15 Motion for John J. Higson to Appear Pro Hac Vice. (Signed by Judge Richard J. Sullivan on 7/28/2014) (cd) (Entered: 07/28/2014)
- 07/28/2014 17 ORDER granting 14 Motion for Joshua D. Wolson to Appear Pro Hac Vice. (Signed by Judge Richard J. Sullivan on 7/28/2014) (cd) (Entered: 07/28/2014)
- 08/20/2014 18 FILING ERROR - DEFICIENT DOCKET ENTRY - MOTION to Appear Pro Hac Vice for Mark W. Halderman. Motion and supporting papers to be reviewed by Clerk's Office staff. Document filed by IXI IP, LLC, IXI Mobile (R&D) Ltd.. (Attachments: # 1 Online, # 2 Online (Entered: 08/20/2014)
- 08/20/2014 &gt;&gt;&gt;NOTICE REGARDING DEFICIENT MOTION TO APPEAR PRO HAC VICE. Notice regarding Document No. 18 MOTION to Appear Pro Hac Vice for Mark W. Halderman. Motion and supporting papers to be reviewed by Clerk's Office staff.. The filing is deficient for the following reason(s): Filing fee not paid.Missing Certificate of Good Standing. Certificate of Good Standing must be issued from the Supreme Court of Texas and not from a State Bar Association. Re-file the document as a Corrected Motion to Appear Pro Hac Vice and attach a valid Certificate of Good Standing, issued within the past 30 days and pay the filing fee. (bcu) (Entered: 08/20/2014)
- 08/25/2014 19 MOTION to Appear Pro Hac Vice for Mark Halderman. Filing fee \$ 200.00, receipt number 0208-10032239. Motion and supporting papers to be reviewed by Clerk's Office staff. Document filed by IXI IP, LLC, IXI Mobile (R&D) Ltd.. (Attachments: # 1 Online, # 2 Online (Entered: 08/25/2014)
- 08/25/2014 &gt;&gt;&gt;NOTICE REGARDING PRO HAC VICE MOTION. Regarding Document No. 19

- MOTION to Appear Pro Hac Vice for Mark Halderman. Filing fee \$ 200.00, receipt number 0208-10032239. Motion and supporting papers to be reviewed by Clerk's Office staff.. The document has been reviewed and there are no deficiencies. (wb) (Entered: 08/25/2014)
- 09/10/2014 20 NOTICE OF APPEARANCE by Marshall Beil on behalf of Blackberry Corporation, Blackberry Limited. (Beil, Marshall) (Entered: 09/10/2014)
- 09/10/2014 21 LETTER MOTION for Extension of Time to File Response/Reply addressed to Judge Richard J. Sullivan from Marshall Beil dated September 10, 2014. Document filed by Blackberry Corporation, Blackberry Limited.(Beil, Marshall) (Entered: 09/10/2014)
- 09/10/2014 22 ORDER granting 21 Letter Motion for Extension of Time to File Response/Reply. SO ORDERED. (Signed by Judge Richard J. Sullivan on 9/10/2014) (mro) (Entered: 09/11/2014)
- 09/10/2014 Set/Reset Deadlines: Blackberry Corporation answer due 9/26/2014; Blackberry Limited answer due 9/26/2014. (mro) (Entered: 09/11/2014)
- 09/26/2014 23 FILING ERROR - CORPORATE PARENT/OTHER AFFILIATE NOT ADDED - RULE 7.1 CORPORATE DISCLOSURE STATEMENT. No Corporate Parent. Document filed by Blackberry Corporation, Blackberry Limited.(Beil, Marshall) Modified on 9/29/2014 (lb). (Entered: 09/26/2014)
- 09/26/2014 24 ANSWER to 1 Complaint, with JURY DEMAND; COUNTERCLAIM against IXI Mobile (R&D) Ltd., IXI IP, LLC. Document filed by Blackberry Corporation, Blackberry Limited.(Beil, Marshall) Modified on 10/22/2014 (mro). (Entered: 09/26/2014)
- 09/29/2014 \*\*\* NOTE TO ATTORNEY TO RE-FILE DOCUMENT - DEFICIENT DOCKET ENTRY ERROR. Note to Attorney Marshall Beil to RE-FILE Document 23 Rule 7.1 Corporate Disclosure Statement,. ERROR(S): Corporate Parents were not added. Please re-file this document and when prompted: Are there any corporate parents or other affiliates?, select the YES radio button and enter the Corporate Parent(s) or Affiliate(s). YOU MUST SELECT THE SEARCH BUTTON. Select the correct name or create a new corporate parent. Add the Corporate Parent(s) or Affiliate(s) one party name at a time. (lb) (Entered: 09/29/2014)
- 09/29/2014 25 RULE 7.1 CORPORATE DISCLOSURE STATEMENT. Identifying Corporate Parent Blackberry Limited for Blackberry Corporation. Document filed by Blackberry Corporation, Blackberry Limited.(Beil, Marshall) (Entered: 09/29/2014)
- 09/30/2014 26 MOTION for Brian C. Riopelle to Appear Pro Hac Vice . Filing fee \$ 200.00, receipt number 0208-10156826. Motion and supporting papers to be reviewed by Clerk's Office staff. Document filed by Blackberry Corporation, Blackberry Limited.(Riopelle, Brian) (Entered: 09/30/2014)
- 09/30/2014 27 FILING ERROR - DEFICIENT DOCKET ENTRY - MOTION for Jason W. Cook to Appear Pro Hac Vice . Filing fee \$ 200.00, receipt number 0208-10156886. Motion and supporting papers to be reviewed by Clerk's Office staff. Document filed by Blackberry Corporation, Blackberry Limited.(Cook, Jason) Modified on 9/30/2014 (bcu). (Entered: 09/30/2014)
- 09/30/2014 &gt;&gt;&gt;NOTICE REGARDING PRO HAC VICE MOTION. Regarding Document No. 26 MOTION for Brian C. Riopelle to Appear Pro Hac Vice . Filing fee \$ 200.00, receipt number 0208-10156826. Motion and supporting papers to be reviewed by Clerk's Office staff.. The document has been reviewed and there are no deficiencies. (sdi) (Entered: 09/30/2014)
- 09/30/2014 &gt;&gt;&gt;NOTICE REGARDING DEFICIENT MOTION TO APPEAR PRO HAC VICE. Notice regarding Document No. 27 MOTION for Jason W. Cook to Appear Pro Hac Vice . Filing fee \$ 200.00, receipt number 0208-10156886. Motion and supporting papers to be reviewed by Clerk's Office staff.. The filing is deficient for the following reason(s): Missing Certificate of Good Standing. Certificate of Good Standing must be issued from the Supreme Court of Texas and not from a State Bar Association. Re-file the document as a Corrected Motion to Appear Pro Hac Vice and attach a valid Certificate of Good Standing, issued within the past 30 days. (bcu) (Entered: 09/30/2014)
- 09/30/2014 28 MOTION for Derek H. Swanson to Appear Pro Hac Vice . Filing fee \$ 200.00, receipt number 0208-10156919. Motion and supporting papers to be reviewed by Clerk's Office staff. Document filed by Blackberry Corporation, Blackberry Limited.(Swanson, Derek) (Entered: 09/30/2014)
- 09/30/2014 29 JOINT LETTER addressed to Judge Richard J. Sullivan from Thomas S. Biemer, Esquire dated September 30, 2014 re: Joint Letter per Court Order of 6-30-14 modified 7-8-14. Document filed by IXI IP, LLC, IXI Mobile (R&D) Ltd.. (Attachments: # 1 Online, # 2 Online) (Entered: 09/30/2014)
- 09/30/2014 &gt;&gt;&gt;NOTICE REGARDING PRO HAC VICE MOTION. Regarding Document No. 28 MOTION for Derek H. Swanson to Appear Pro Hac Vice . Filing fee \$ 200.00, receipt

- number 0208-10156919. Motion and supporting papers to be reviewed by Clerk's Office staff.. The document has been reviewed and there are no deficiencies. (sdi) (Entered: 09/30/2014)
- 10/01/2014 30 ORDER FOR ADMISSION PRO HAC VICE granting 26 Motion for Brian C. Riopelle to Appear Pro Hac Vice. (Signed by Judge Richard J. Sullivan on 10/1/2014) (kgo) (Entered: 10/01/2014)
- 10/01/2014 31 ORDER FOR ADMISSION PRO HAC VICE granting 28 Motion for Derek H. Swanson to Appear Pro Hac Vice. (Signed by Judge Richard J. Sullivan on 10/1/2014) (kgo) (Entered: 10/01/2014)
- 10/02/2014 32 MOTION for Jason W. Cook to Appear Pro Hac Vice . Motion and supporting papers to be reviewed by Clerk's Office staff. Document filed by Blackberry Corporation, Blackberry Limited.(Cook, Jason) (Entered: 10/02/2014)
- 10/02/2014 &gt;&gt;&gt;NOTICE REGARDING PRO HAC VICE MOTION. Regarding Document No. 32 MOTION for Jason W. Cook to Appear Pro Hac Vice . Motion and supporting papers to be reviewed by Clerk's Office staff.. The document has been reviewed and there are no deficiencies. (wb) (Entered: 10/02/2014)
- 10/03/2014 33 ORDER FOR ADMISSION PRO HAC VICE granting 32 Motion for Jason W. Cook to Appear Pro Hac Vice. (Signed by Judge Richard J. Sullivan on 10/3/2014) (kgo) (Entered: 10/03/2014)
- 10/07/2014 Minute Entry for proceedings held before Judge Richard J. Sullivan: Initial Pretrial Conference was held on 10/7/2014. Plaintiffs' counsel John Higson and Thomas Biemer were present. Defendant Samsung's counsel Todd Friedman and Greg Arovis were present. Defendant Blackberry's counsel Jason Cook and Marshal Beil were present. The parties are directed to confer with counsel for the defendant in the newly-filed related case and to submit a revised case management plan and joint letter no later than 11/7/14. (sc) (Entered: 10/08/2014)
- 10/08/2014 34 ORDER granting 19 Motion for Mark Halderman to Appear Pro Hac Vice. (Signed by Judge Richard J. Sullivan on 10/7/2014) (mro) (Entered: 10/08/2014)
- 10/17/2014 35 FILING ERROR - WRONG EVENT TYPE SELECTED FROM MENU - ANSWER to Complaint with JURY DEMAND. Document filed by IXI IP, LLC, IXI Mobile (R&D) Ltd.. (Attachments: # 1 Online (Entered: 10/17/2014)
- 10/21/2014 36 LETTER addressed to Judge Richard J. Sullivan from Marshall Beil dated October 21, 2014 re: Request for docket entry number 24 to be corrected. Document filed by Blackberry Corporation, Blackberry Limited. (Attachments: # 1 Online (Entered: 10/21/2014)
- 10/22/2014 37 MEMO ENDORSEMENT on re: 36 Letter, filed by Blackberry Limited, Blackberry Corporation. ENDORSEMENT: The Clerk of the Court is respectfully directed to correct docket entry 24 to reflect that Defendants Blackberry Limited and Blackberry Corporation filed an answer with counterclaims against Plaintiffs IXI Mobile (R&D) Ltd. and IXI IP, LLC. (Signed by Judge Richard J. Sullivan on 10/21/2014) (mro) (Entered: 10/22/2014)
- 11/07/2014 38 JOINT LETTER addressed to Judge Richard J. Sullivan from Thomas S. Biemer, Esquire dated 11/7/2014 re: Joint Submission Pursuant to Order during October 7, 2014 Conference. Document filed by IXI IP, LLC, IXI Mobile (R&D) Ltd.. (Attachments: # 1 Online, # 2 Online (Entered: 11/07/2014)
- 11/10/2014 39 LETTER addressed to Judge Richard J. Sullivan from Thomas S. Biemer, Esquire dated November 10, 2014 re: Response to Letter Dated November 7, 2014 from Defendant Apple, Inc. Document filed by IXI IP, LLC, IXI Mobile (R&D) Ltd..(Biemer, Thomas) (Entered: 11/10/2014)
- 12/01/2014 40 ORDER: The Court is in receipt of the parties' letters concerning disputes about the proposed case management plan. Having considered the parties' arguments, IT IS HEREBY ORDERED THAT, no later than December 8, 2014, the parties shall jointly submit a revised case management plan that reflects a 30-day extension of all contested dates. So Ordered (Signed by Judge Richard J. Sullivan on 12/1/2014) (js) Modified on 12/2/2014 (js). (Entered: 12/02/2014)
- 12/08/2014 41 JOINT LETTER addressed to Judge Richard J. Sullivan from Thomas S. Biemer, Esquire dated 12/8/2014 re: Proposed Case Management Plan and Scheduling Order. Document filed by IXI IP, LLC, IXI Mobile (R&D) Ltd.. (Attachments: # 1 Online (Entered: 12/08/2014)
- 12/12/2014 42 CASE MANAGEMENT PLAN AND SCHEDULING ORDER: All parties do not consent to disposition of this case by a Magistrate Judge, pursuant to 28 U.S.C. § 636(c). These cases are to be tried to juries. Plaintiffs' Claim Construction Brief shall be filed by: July 8, 2015. Defendants' Claim Construction Briefs shall be filed by: August 7, 2015. Plaintiffs'

Reply Claim Construction Brief shall be filed by: August 14, 2015. Depositions shall be completed by: 11/10/2015. Completion of Fact Discovery: 11/10/2015. The Court will conduct a post-discovery conference on 11/24/2015. Referral to a Magistrate Judge for settlement discussions. (Signed by Judge Richard J. Sullivan on 12/8/2014) (mro) (Entered: 12/15/2014)

- 12/12/2014 Set/Reset Deadlines: Brief due by 8/14/2015. (mro) (Entered: 12/15/2014)
- 12/16/2014 43 LETTER addressed to Judge Richard J. Sullivan from Marshall Beil dated December 16, 2014 re: Request to transfer action to the Northern District of California. Document filed by Blackberry Corporation, Blackberry Limited.(Beil, Marshall) (Entered: 12/16/2014)
- 12/19/2014 44 LETTER addressed to Judge Richard J. Sullivan from Thomas S. Biemer, Esquire dated 12/19/2014 re: Response to the Pre-Motion Letter from Blackberry, et al. dated 12-16-14. Document filed by IXI IP, LLC, IXI Mobile (R&D) Ltd..(Biemer, Thomas) (Entered: 12/19/2014)
- 12/22/2014 45 ORDER: The Court seeks input from Defendants Samsung Electronics Co., Ltd., et al. ("Samsung") as to their views concerning a potential 28 U.S.C. § 1404(a) motion to transfer Case No. 14-cv-4355 (RJS) to the Northern District of California. Accordingly, IT IS HEREBY ORDERED THAT Defendants Samsung shall submit a letter response to a potential 28 U.S.C. § 1404(a) motion to transfer to the Northern District of California by Tuesday, December 30, 2014. (Signed by Judge Richard J. Sullivan on 12/22/2014) (mro) (Entered: 12/22/2014)
- 01/05/2015 46 ORDER: After receiving pre-motion letters from the parties in Case Nos. 14-cv-7954 (RJS) and 14-cv-4428 (RJS) (Doc. Nos. 23, 24, No. 14-cv-7954 (RJS); Doc. Nos. 43, 44, No. 14-cv-4428 (RJS)), the Court, on December 22, 2014, issued an Order to Defendants Samsung Electronics Co., Ltd., et al. ("Samsung") in a related case, Case No. 14-cv-4355 (RJS), seeking input as to their views concerning a potential 28 U.S.C. § 1404(a) motion to transfer Case No. 14-cv-4355 (RJS) to the Northern District of California. (Doc. No. 39, No. 14-cv-4355 (RJS).) The Court is in receipt of Samsung's letter dated December 30, 2014, supporting Apple's and BlackBerry's motions to transfer but declining, at this time, to file their own motion to transfer. (Doc. No. 40, No. 14-cv-4355 (RJS).) Accordingly, IT IS HEREBY ORDERED THAT all of the above-captioned parties, including Samsung, shall appear for a conference on January 20, 2015 at 4:00 p.m. in Courtroom 905 at 40 Foley Square concerning the anticipated motions to transfer Case Nos. 14-cv-7954 (RJS) and 14-cv-4428 (RJS) to the Northern District of California pursuant to 28 U.S.C. § 1404(a). ( Status Conference set for 1/20/2015 at 04:00 PM in Courtroom 905, 40 Centre Street, New York, NY 10007 before Judge Richard J. Sullivan.) (Signed by Judge Richard J. Sullivan on 1/5/2015) (mro) (Entered: 01/05/2015)
- 02/03/2015 47 MOTION to Transfer Case . Document filed by Blackberry Corporation, Blackberry Limited. (Beil, Marshall) (Entered: 02/03/2015)
- 02/03/2015 48 MEMORANDUM OF LAW in Support re: 47 MOTION to Transfer Case . . Document filed by Blackberry Corporation, Blackberry Limited. (Beil, Marshall) (Entered: 02/03/2015)
- 02/03/2015 49 DECLARATION of Frank Geng in Support re: 47 MOTION to Transfer Case .. Document filed by Blackberry Corporation, Blackberry Limited. (Beil, Marshall) (Entered: 02/03/2015)
- 02/17/2015 50 BRIEF re: 47 MOTION to Transfer Case . Omnibus Brief In Opposition to Motion to Transfer. Document filed by IXI IP, LLC, IXI Mobile (R&D) Ltd..(Biemer, Thomas) (Entered: 02/17/2015)
- 02/17/2015 51 DECLARATION of John J. Higson in Opposition re: 47 MOTION to Transfer Case .. Document filed by IXI IP, LLC, IXI Mobile (R&D) Ltd.. (Attachments: # 1 Online, # 2 Online, # 3 Online, # 4 Online, # 5 Online, # 6 Online, # 7 Online, # 8 Online, # 9 Online, # 10 Online, # 11 Online, # 12 Online, # 13 Online, # 14 Online (Entered: 02/17/2015)
- 02/17/2015 52 DECLARATION of Zion Hadad in Opposition re: 47 MOTION to Transfer Case .. Document filed by IXI IP, LLC, IXI Mobile (R&D) Ltd.. (Biemer, Thomas) (Entered: 02/17/2015)
- 02/17/2015 53 DECLARATION of Steve Pedersen in Opposition re: 47 MOTION to Transfer Case .. Document filed by IXI IP, LLC, IXI Mobile (R&D) Ltd.. (Biemer, Thomas) (Entered: 02/17/2015)
- 02/20/2015 54 REPLY MEMORANDUM OF LAW in Support re: 47 MOTION to Transfer Case . . Document filed by Blackberry Corporation, Blackberry Limited. (Beil, Marshall) (Entered: 02/20/2015)
- 02/20/2015 55 DECLARATION of Derek H. Swanson in Support re: 47 MOTION to Transfer Case .. Document filed by Blackberry Corporation, Blackberry Limited. (Beil, Marshall) (Entered: 02/20/2015)

- 02/24/2015 56 LETTER addressed to Judge Richard J. Sullivan from Thomas S. Biemer, Esquire dated February 24, 2015 re: IXI Mobile (R&D), LTD., et al. v. Samsung Electronics Co., Blackberry, LTD, et al., and Apple, Inc. Transfer Venue Brief. Document filed by IXI IP, LLC, IXI Mobile (R&D) Ltd..(Biemer, Thomas) (Entered: 02/24/2015)
- 02/25/2015 57 ORDER: The Court is in receipt of Plaintiff's letter, dated February 24, 2015, requesting leave to file a sur-reply to Apple's reply brief. (Doc. No. 37, No. 14-cv-7954 (RJS).) The Court also is in receipt of Defendant Apple Inc.'s letter, dated February 24, 2015, responding to Plaintiff's letter and requesting "that IXI be required to provide the Court with the [IXI License Agreement]." (Doc. No. 38, No. 14-cv-7954 (RJS).) Because the Court finds that limited supplemental briefing as to whether IXI Mobile (R&D), Inc. lacks standing to be a Plaintiff in these actions would be helpful, IT IS HEREBY ORDERED THAT Plaintiff's request for leave to file a sur-reply is GRANTED. Plaintiff shall limit the sur-reply to three pages and submit the sur-reply by March 2, 2015. IT IS FURTHER ORDERED THAT Defendant Apple Inc.'s request "to respond to any new facts, evidence, or arguments introduced in the sur-reply" is GRANTED. Defendant Apple Inc. shall limit its response to three pages and submit the response by March 5, 2015. Finally, because the Court also finds that its review of the license referenced in the parties' briefing and letters would help the Court resolve the motion to transfer these actions to the Northern District of California pursuant to 28 U.S.C. § 1404(a), IT IS FURTHER ORDERED THAT Defendant Apple Inc.'s request "that IXI be required to provide the Court with the license" is GRANTED. ( Responses due by 3/5/2015, Surreplies due by 3/2/2015.) (Signed by Judge Richard J. Sullivan on 2/25/2015) (mro) (Entered: 02/26/2015)
- 02/27/2015 58 LETTER addressed to Judge Richard J. Sullivan from Thomas S. Biemer, Esquire dated February 27, 2015 re: IXI Mobile (R&D), LTD., et al. v. Samsung Electronics Co., Blackberry, LTD, et al., and Apple, Inc. Transfer Venue Sur-Reply. Document filed by IXI IP, LLC, IXI Mobile (R&D) Ltd..(Biemer, Thomas) (Entered: 02/27/2015)
- 02/27/2015 59 MEMO ENDORSEMENT on re: (54 in 1:14-cv-04355-RJS) Letter, filed by IXI IP,LLC, IXI Mobile (R&D) Ltd., (58 in 1:14-cv-04428-RJS) Letter, filed by IXI IP, LLC, IXI Mobile (R&D) Ltd., (40 in 1:14-cv-07954-RJS) Letter, filed by IXI IP,LLC, IXI Mobile (R&D) Ltd. ENDORSEMENT: There is a well-established presumption in the Second Circuit in favor of open court records. See *United States v. Amodeo*, 44 F.3d 141, 146 (2d Cir. 1995). To overcome this presumption, a party must demonstrate that sealing a judicial document is "essential to preserve higher values and is narrowly tailored to serve that interest." *United States v. Alcantara*, 396 F.3d 189, 199 (2d Cir. 2005); see also *Lugosch v. Pyramid Co. of Onondaga*, 435 F.3d 110, 119-20 (2d Cir. 2006) (" [D]ocuments may be sealed if specific, on the record findings are made demonstrating that closure is essential to preserve higher values and is narrowly tailored to serve that interest." (quotation marks and citations omitted)). Because Plaintiff represents that the license agreement between IXI IP and IXI Mobile contains "confidential information" and that the patent purchase agreement includes information relating to the strategy and financing of this litigation, the Court will allow Plaintiff to file the license and redacted patent purchase agreements under seal, and to submit the unredacted patent purchase agreement in camera. However, the Court may reach a different conclusion upon reviewing the materials in question and, at that time, will direct the parties to address whether the various documents should remain under seal. (Signed by Judge Richard J. Sullivan on 2/27/2015) (mro) (Entered: 03/02/2015)
- 03/02/2015 60 REPLY MEMORANDUM OF LAW in Opposition re: 47 MOTION to Transfer Case . PLAINTIFFS SUR-REPLY IN FURTHER OPPOSITION TO DEFENDANTS MOTIONS TO TRANSFER. Document filed by IXI IP, LLC, IXI Mobile (R&D) Ltd.. (Biemer, Thomas) (Entered: 03/02/2015)
- 03/02/2015 61 DECLARATION of STEVE PEDERSEN in Opposition re: 47 MOTION to Transfer Case .. Document filed by IXI IP, LLC, IXI Mobile (R&D) Ltd.. (Biemer, Thomas) (Entered: 03/02/2015)
- 03/02/2015 62 DECLARATION of John J. Higson in Opposition re: 47 MOTION to Transfer Case .. Document filed by IXI IP, LLC, IXI Mobile (R&D) Ltd.. (Attachments: # 1 Online, # 2 Online, # 3 Online, # 4 Online, # 5 Online, # 6 Online (Entered: 03/02/2015)
- 03/05/2015 63 RESPONSE in Support of Motion re: 47 MOTION to Transfer Case . Response to IXI's Sur-Reply to BlackBerrys Motion to Transfer. Document filed by Blackberry Corporation, Blackberry Limited. (Beil, Marshall) (Entered: 03/05/2015)
- 03/18/2015 64 MOTION for Shaun William Hassett to Appear Pro Hac Vice . Filing fee \$ 200.00, receipt number 0208-10716319. Motion and supporting papers to be reviewed by Clerk's Office staff. Document filed by Blackberry Corporation, Blackberry Limited.(Hassett, Shaun) (Entered: 03/18/2015)
- 03/19/2015 &gt;&gt;&gt;NOTICE REGARDING PRO HAC VICE MOTION. Regarding Document No. 64 MOTION for Shaun William Hassett to Appear Pro Hac Vice . Filing fee \$ 200.00, receipt



- number 0208-10716319. Motion and supporting papers to be reviewed by Clerk's Office staff.. The document has been reviewed and there are no deficiencies. (wb) (Entered: 03/19/2015)
- 03/20/2015 65 ORDER FOR ADMISSION PRO HAC VICE granting 64 Motion for Shaun W. Hassett to Appear Pro Hac Vice. (Signed by Judge Richard J. Sullivan on 3/20/2015) (kko) (Entered: 03/20/2015)
- 04/14/2015 66 AGREED PROTECTIVE ORDER REGARDING THE DISCLOSURE AND USE OF DISCOVERY MATERIALS...regarding procedures to be followed that shall govern the handling of confidential material... (Signed by Judge Richard J. Sullivan on 4/14/2015) (mro) (Entered: 04/15/2015)
- 04/14/2015 67 ORDER: This Addendum is an integral part of the Order of today's date granting confidentiality protection to certain materials. Notwithstanding any other provision, no document may be filed with the Clerk under seal without a further Order of this Court addressing the specific documents to be sealed. Any application to seal shall be accompanied by an affidavit or affidavits and a memorandum of law, demonstrating that the standards for sealing have been met and specifically addressing *Lugosch v. Pyramid Co. of Onondaga*, 435 F.3d 110, 119-20 (2d Cir. 2006) and any other controlling authority. Nothing herein is intended to alter or modify the applicability of Federal Rule of Civil Procedure 5.2 to this case. The redactions expressly authorized by Rule 5.2 may be made without further application to the Court. (Signed by Judge Richard J. Sullivan on 4/14/2015) (mro) (Entered: 04/15/2015)
- 05/04/2015 68 MOTION to Appear Pro Hac Vice for Gary D. Colby, Esquire. Filing fee \$ 200.00, receipt number 0208-10883370. Motion and supporting papers to be reviewed by Clerk's Office staff. Document filed by IXI IP, LLC, IXI Mobile (R&D) Ltd.. (Attachments: # 1 Online, # 2 Online) (Entered: 05/04/2015)
- 05/06/2015 69 ORDER granting 68 Motion for Gary D. Colby to Appear Pro Hac Vice. (Signed by Judge Richard J. Sullivan on 5/5/2015) (mro) (Entered: 05/06/2015)
- 05/11/2015 70 JOINT STIPULATION OF DISMISSAL OF CLAIMS AND COUNTERCLAIMS RELATED TO U.S. PATENT NO. 7,426,398: Plaintiffs IXI Mobile (R&D) Ltd. and IXI IP, LLC (collectively, "Plaintiffs") and Defendants BlackBerry Limited and BlackBerry Corporation (collectively "Defendants"); hereby stipulate and agree to the dismissal with prejudice of the Second Count for Relief in Plaintiffs' Complaint alleging infringement of U.S. Patent No. 7,426,398 ("the '398 Patent") in the above-captioned action, each party to bear its own costs and fees related to claims of infringement of the '398 Patent. Further, Plaintiffs and Defendants hereby stipulate and agree to the dismissal without prejudice of Defendants' counterclaims of invalidity and non-infringement of the '398 Patent, each party to bear its own costs and fees related to counterclaims of invalidity and non-infringement of the '398 Patent. (Signed by Judge Richard J. Sullivan on 5/11/2015) (kko) (Entered: 05/11/2015)
- 05/15/2015 71 JOINT LETTER addressed to Judge Richard J. Sullivan from Marshall Beil, Esq. dated 05/15/2015 re: mediation. Document filed by Blackberry Corporation, Blackberry Limited. (Beil, Marshall) (Entered: 05/15/2015)
- 05/15/2015 72 ORDER REFERRING CASE TO MAGISTRATE JUDGE. Order that case be referred to the Clerk of Court for assignment to a Magistrate Judge for Settlement: The parties shall contact Magistrate Judge Debra Freeman by May 19, 2015 to schedule a settlement conference. Referred to Magistrate Judge Debra C. Freeman. (Signed by Judge Richard J. Sullivan on 5/15/2015) (tn) (Entered: 05/18/2015)
- 05/28/2015 Minute Entry for proceedings held before Magistrate Judge Debra C. Freeman: Settlement Conference held via telephone on 5/28/2015. Telephone conference scheduled for 8/25/15 at 12:00 p.m. (aba) (Entered: 05/28/2015)
- 06/04/2015 73 LETTER addressed to Judge Richard J. Sullivan from Thomas S. Biemer, Esquire dated June 4, 2015 re: Claim Construction Technology Tutorial. Document filed by IXI IP, LLC, IXI Mobile (R&D) Ltd..(Biemer, Thomas) (Entered: 06/04/2015)
- 06/05/2015 74 AMENDED LETTER addressed to Judge Richard J. Sullivan from Thomas S. Biemer, Esquire dated June 5, 2015 re: Claim Construction Technology Tutorial. Document filed by IXI IP, LLC, IXI Mobile (R&D) Ltd..(Biemer, Thomas) (Entered: 06/05/2015)
- 06/08/2015 75 JOINT CLAIM CONSTRUCTION STATEMENT. Document filed by Blackberry Corporation, Blackberry Limited, IXI IP, LLC, IXI Mobile (R&D) Ltd..(Biemer, Thomas) (Entered: 06/08/2015)
- 06/15/2015 76 LETTER addressed to Judge Richard J. Sullivan from Thomas S. Biemer dated June 15, 2015 re: Pre-Motion Request to Strike Joint Claim Terms Chart. Document filed by IXI IP, LLC, IXI Mobile (R&D) Ltd..(Biemer, Thomas) (Entered: 06/15/2015)
- 06/18/2015 77 LETTER addressed to Judge Richard J. Sullivan from Harrison J. Frahn IV (on behalf of all

- Defendants) dated June 18, 2015 re: Response to IXI's Request for a Pre-motion Conference for a Motion to Strike. Document filed by Blackberry Corporation, Blackberry Limited.(Hassett, Shaun) (Entered: 06/18/2015)
- 07/02/2015 78 ENDORSED LETTER addressed to Judge Richard J. Sullivan from Thomas S. Biemer dated 7/2/2015 re: Plaintiffs respectfully request 5 additional pages for their Opening Claim Construction Brief due on July 8, 2015, as well as 5 additional pages for their supporting expert declaration. ENDORSEMENT: SO ORDERED. (Signed by Judge Richard J. Sullivan on 7/2/2015) (mro) (Entered: 07/06/2015)
- 07/08/2015 79 BRIEF Plaintiffs Opening Claim Construction Brief. Document filed by IXI IP, LLC, IXI Mobile (R&D) Ltd..(Biemer, Thomas) (Entered: 07/08/2015)
- 07/08/2015 80 DECLARATION re: 79 Brief Declaration of Mark W. Halderman. Document filed by IXI IP, LLC, IXI Mobile (R&D) Ltd.. (Attachments: # 1 Online, # 2 Online, # 3 Online, # 4 Online, # 5 Online, # 6 Online, # 7 Online, # 8 Online, # 9 Online, # 10 Online (Entered: 07/08/2015)
- 07/08/2015 81 DECLARATION re: 79 Brief Declaration of Joel R. Williams. Document filed by IXI IP, LLC, IXI Mobile (R&D) Ltd.. (Attachments: # 1 Online, # 2 Online, # 3 Online (Entered: 07/08/2015)
- 07/10/2015 82 LETTER addressed to Judge Richard J. Sullivan from Marshall Beil dated July 10, 2015 re: Request for pre-motion conference for a motion to stay. Document filed by Blackberry Corporation, Blackberry Limited.(Beil, Marshall) (Entered: 07/10/2015)
- 07/15/2015 83 LETTER addressed to Judge Richard J. Sullivan from Thomas S. Biemer, Esquire dated July 15, 2015 re: Response to pre-motion letter from Defendant Blackberry requesting a stay. Document filed by IXI IP, LLC, IXI Mobile (R&D) Ltd..(Biemer, Thomas) (Entered: 07/15/2015)
- 08/03/2015 84 LETTER addressed to Judge Richard J. Sullivan from Marshall Beil dated August 3, 2015 re: Request for additional pages and exhibits for Defendants' Responsive Claim Construction Brief. Document filed by Blackberry Corporation, Blackberry Limited.(Beil, Marshall) (Entered: 08/03/2015)
- 08/03/2015 85 MEMO ENDORSEMENT on re: (84 in 1:14-cv-04428-RJS) Letter, filed by Blackberry Limited, Blackberry Corporation, (77 in 1:14-cv-04355-RJS) Letter, filed by Samsung Electronics Co., Ltd., Samsung Electronics America, Inc. ENDORSEMENT: SO ORDERED. ( Brief due by 8/7/2015.) (Signed by Judge Richard J. Sullivan on 8/3/2015) (mro) (Entered: 08/04/2015)
- 08/06/2015 86 OPINION AND ORDER re: (27 in 1:14-cv-07954-RJS) MOTION to Transfer Case Apple Inc.'s Notice of Motion to Transfer Venue Pursuant to 28 U.S.C. § 1404(a). filed by Apple, Inc., (47 in 1:14-cv-04428-RJS) MOTION to Transfer Case . filed by Blackberry Limited, Blackberry Corporation, (44 in 1:14-cv-04355-RJS) MOTION to Transfer Case Samsung's Notice of Motion to Transfer Venue Pursuant to 28 U.S.C. § 1404(a). filed by Samsung Electronics Co., Ltd., Samsung Telecommunications America, LLC, Samsung Electronics America, Inc. Weighing the factors set forth above and having considered all the facts and circumstances before it, the Court determines that Defendants have demonstrated by clear and convincing evidence that transfer of these three actions is appropriate. Accordingly, IT IS HEREBY ORDERED THAT Defendants' motions to transfer these actions to the Northern District of California are GRANTED. The Clerk of the Court is respectfully directed to terminate the motions pending at docket entries 44 in case number 14--cv-4355 (RJS), 47 in case number 14--cv-4428 (RJS), and 27 in case number 14-cv-7954 (RJS), and to close these cases. SO ORDERED. (As further set forth within this Order.) (Signed by Judge Richard J. Sullivan on 8/6/2015) (ajs) (Entered: 08/07/2015)
- 08/06/2015 CASE TRANSFERRED OUT ELECTRONICALLY from the U.S.D.C. Southern District of New York to the United States District Court - Northern District of California. (ajs) (Entered: 08/14/2015)
- 08/12/2015 87 LETTER addressed to Judge Richard J. Sullivan from Thomas S. Biemer, Esquire dated August 12, 2015 re: Requesting Reconsideration of the Order entered August 7, 2015. Document filed by IXI IP, LLC, IXI Mobile (R&D) Ltd..(Biemer, Thomas) (Entered: 08/12/2015)
- 08/17/2015 88 Case transferred in from District of New York Southern; Case Number 1:14-cv-04428. Original file certified copy of transfer order and docket sheet received. Modified on 8/19/2015 (farS, COURT STAFF). (Entered: 08/19/2015)
- 08/19/2015 89 Initial Case Management Scheduling Order with ADR Deadlines: Case Management Statement due by 11/12/2015. Case Management Conference set for 11/19/2015 11:00 AM in Courtroom C, 15th Floor, San Francisco. (farS, COURT STAFF) (Filed on 8/19/2015) Modified on 8/19/2015 (farS, COURT STAFF). (Entered: 08/19/2015)

- 08/24/2015 90 NOTICE of Appearance by Jennifer S. Coleman (Coleman, Jennifer) (Filed on 8/24/2015) (Entered: 08/24/2015)
- 08/24/2015 91 CONSENT/DECLINATION to Proceed Before a US Magistrate Judge by IXI IP, LLC, IXI Mobile (R&D) Ltd... (Coleman, Jennifer) (Filed on 8/24/2015) (Entered: 08/24/2015)
- 08/25/2015 92 NOTICE of Appearance by John V. Picone, III (Picone, John) (Filed on 8/25/2015) (Entered: 08/25/2015)
- 08/25/2015 93 NOTICE of Appearance by Jeffrey Michael Ratinoff (Ratinoff, Jeffrey) (Filed on 8/25/2015) (Entered: 08/25/2015)
- 08/25/2015 94 NOTICE of Appearance by Aleksandr Korzh (Korzh, Aleksandr) (Filed on 8/25/2015) (Entered: 08/25/2015)
- 08/25/2015 95 CLERK'S NOTICE OF IMPENDING REASSIGNMENT TO A U.S. DISTRICT COURT JUDGE: The Clerk of this Court will now randomly reassign this case to a District Judge because either (1) a party has not consented to the jurisdiction of a Magistrate Judge, or (2) time is of the essence in deciding a pending judicial action for which the necessary consents to Magistrate Judge jurisdiction have not been secured. You will be informed by separate notice of the district judge to whom this case is reassigned. ALL HEARING DATES PRESENTLY SCHEDULED BEFORE THE CURRENT MAGISTRATE JUDGE ARE VACATED AND SHOULD BE RE-NOTICED FOR HEARING BEFORE THE JUDGE TO WHOM THIS CASE IS REASSIGNED. This is a text only docket entry; there is no document associated with this notice. (lsS, COURT STAFF) (Filed on 8/25/2015) (Entered: 08/25/2015)
- 08/25/2015 96 ORDER, Case reassigned to Hon. Richard Seeborg. Magistrate Judge Laurel Beeler no longer assigned to the case.. Signed by Executive Committee on 8/25/15. (ha, COURT STAFF) (Filed on 8/25/2015) (Entered: 08/25/2015)
- 08/26/2015 97 CLERK'S NOTICE SCHEDULING CASE MANAGEMENT CONFERENCE. Case Management Statement due by 11/12/2015. Case Management Conference set for 11/19/2015 at 10:00 AM in Courtroom 3, 17th Floor, San Francisco. (cl, COURT STAFF) (Filed on 8/26/2015) (Entered: 08/26/2015)
- 08/31/2015 98 NOTICE of Appearance by Franklin Devin Kang (Kang, Franklin) (Filed on 8/31/2015) (Entered: 08/31/2015)
- 09/09/2015 99 ORDER RELATING CASES 15-CV-3752-hsg AND 15-cv-3755-PJH. Signed by Judge Haywood S. Gilliam, Jr. on 9/9/2015. (ndrS, COURT STAFF) (Filed on 9/9/2015) (Entered: 09/09/2015)
- 09/15/2015 100 ORDER REASSIGNING CASE. Case reassigned to Judge Hon. Haywood S Gilliam, Jr for all further proceedings. Case reassigned to Judge Hon. Haywood S Gilliam, Jr. Judge Hon. Richard Seeborg no longer assigned to the case. Signed by Executive Committee on 9/15/15. (sv, COURT STAFF) (Filed on 9/15/2015) (Entered: 09/15/2015)
- 09/15/2015 101 CLERK'S NOTICE SETTING CASE MANAGEMENT CONFERENCE FOR REASSIGNED CIVIL CASE. Notice is hereby given that a Case Management Conference has been set for November 17, 2015, before Judge Haywood S. Gilliam, Jr., at 2:00 p.m., in Courtroom 15, 18th Floor, 450 Golden Gate Avenue, San Francisco, CA. Case Management Statement due by November 10, 2015. (This is a text only docket entry, there is no document associated with this notice.)(ndrS, COURT STAFF) (Filed on 9/15/2015) (Entered: 09/15/2015)
- 09/15/2015 102 CERTIFICATE OF SERVICE by IXI IP, LLC, IXI Mobile (R&D) Ltd. (Coleman, Jennifer) (Filed on 9/15/2015) (Entered: 09/15/2015)
- 09/16/2015 103 MOTION for leave to appear in Pro Hac Vice for Joshua D. Wolson ( Filing fee \$ 305, receipt number 0971-9841209.) filed by IXI IP, LLC, IXI Mobile (R&D) Ltd.. (Attachments: # 1 Online (Entered: 09/16/2015))
- 09/17/2015 104 MOTION for leave to appear in Pro Hac Vice for Thomas S. Biemer ( Filing fee \$ 305, receipt number 0971-9844116.) filed by IXI IP, LLC, IXI Mobile (R&D) Ltd.. (Attachments: # 1 Online (Entered: 09/17/2015))
- 09/17/2015 105 MOTION for leave to appear in Pro Hac Vice for Jason Cook ( Filing fee \$ 305, receipt number 0971-9844163.) filed by BlackBerry Corporation, BlackBerry Limited. (Attachments: # 1 Online (Entered: 09/17/2015))
- 09/17/2015 106 MOTION for leave to appear in Pro Hac Vice for John J. Higson ( Filing fee \$ 305, receipt number 0971-9844287.) filed by IXI IP, LLC, IXI Mobile (R&D) Ltd.. (Attachments: # 1 Online (Entered: 09/17/2015))
- 09/17/2015 107 MOTION for leave to appear in Pro Hac Vice for Shaun Hassett ( Filing fee \$ 305, receipt number 0971-9844303.) filed by BlackBerry Corporation, BlackBerry Limited. (Attachments: # 1 Online (Entered: 09/17/2015))

- 09/17/2015 108 MOTION for leave to appear in Pro Hac Vice for Gary D. Colby ( Filing fee \$ 305, receipt number 0971-9844709.) filed by IXI IP, LLC, IXI Mobile (R&D) Ltd.. (Attachments: # 1 Online (Entered: 09/17/2015))
- 09/17/2015 109 MOTION for leave to appear in Pro Hac Vice for Marie-Theres DiFillippo ( Filing fee \$ 305, receipt number 0971-9844885.) filed by IXI IP, LLC, IXI Mobile (R&D) Ltd.. (Attachments: # 1 Online (Entered: 09/17/2015))
- 09/17/2015 110 MOTION for leave to appear in Pro Hac Vice for Mark W. Halderman ( Filing fee \$ 305, receipt number 0971-9845169.) filed by IXI IP, LLC, IXI Mobile (R&D) Ltd.. (Attachments: # 1 Online (Entered: 09/17/2015))
- 09/24/2015 111 ORDER by Judge Haywood S. Gilliam, Jr. Granting 103 Motion for Pro Hac Vice for Joshua D. Wolson. (ndrS, COURT STAFF) (Filed on 9/24/2015) (Entered: 09/24/2015)
- 09/24/2015 112 ORDER by Judge Haywood S. Gilliam, Jr. Granting 104 Motion for Pro Hac Vice for Thomas S. Biemer (ndrS, COURT STAFF) (Filed on 9/24/2015) (Entered: 09/24/2015)
- 09/24/2015 113 ORDER by Judge Haywood S. Gilliam, Jr. Granting 105 Motion for Pro Hac Vice for Jason Cook (ndrS, COURT STAFF) (Filed on 9/24/2015) (Entered: 09/24/2015)
- 09/25/2015 114 ORDER by Judge Hyawood S. Gilliam, Jr. Granting 106 Motion for Pro Hac Vice for John J. Higson. (ndrS, COURT STAFF) (Filed on 9/25/2015) (Entered: 09/25/2015)
- 09/25/2015 115 ORDER by Judge Haywood S. Gilliam, Jr. Granting 107 Motion for Pro Hac Vice for Shaun Hassett. (ndrS, COURT STAFF) (Filed on 9/25/2015) (Entered: 09/25/2015)
- 09/25/2015 116 MOTION to Expedite Hearing Date of Case Management Conference filed by IXI IP, LLC, IXI Mobile (R&D) Ltd.. (Attachments: # 1 Online, # 2 Online (Entered: 09/25/2015))
- 09/28/2015 117 ORDER by Judge Haywood S. Gilliam, Jr. Granting 116 Motion to Expedite Hearing Date of Case Management Conference (ndrS, COURT STAFF) (Filed on 9/28/2015) (Entered: 09/28/2015)
- 09/28/2015 Reset Deadline/Hearing Pursuant to docket no. 117 : Case Management Statement due by 10/27/2015; Case Management Conference set for 11/3/2015 02:00 PM. (ndrS, COURT STAFF) (Filed on 9/28/2015) (Entered: 09/28/2015)
- 10/01/2015 118 ORDER by Judge Haywood S. Gilliam, Jr. Granting 108 Motion for Pro Hac Vice for Gary D. Colby (ndrS, COURT STAFF) (Filed on 10/1/2015) (Entered: 10/01/2015)
- 10/01/2015 119 ORDER by Judge Haywood S. Gilliam, Jr. Granting 109 Motion for Pro Hac Vice for Marie-Theres DiFillippo (ndrS, COURT STAFF) (Filed on 10/1/2015) (Entered: 10/01/2015)
- 10/01/2015 120 ORDER by Judge Haywood S. Gilliam, Jr. Granting 110 Motion for Pro Hac Vice for Mark W. Halderman (ndrS, COURT STAFF) (Filed on 10/1/2015) (Entered: 10/01/2015)
- 10/01/2015 121 MOTION to Stay Defendants' Motion to Stay Pending Inter Partes Review filed by BlackBerry Corporation, BlackBerry Limited. Motion Hearing set for 11/5/2015 02:00 PM in Courtroom 15, 18th Floor, San Francisco before Hon. Haywood S Gilliam Jr.. Responses due by 10/15/2015. Replies due by 10/22/2015. (Attachments: # 1 Online, # 2 Online, # 3 Online, # 4 Online, # 5 Online, # 6 Online, # 7 Online, # 8 Online, # 9 Online, # 10 Online (Entered: 10/01/2015))
- 10/01/2015 122 Certificate of Interested Entities by BlackBerry Corporation, BlackBerry Limited Rule 7.1 Corporate Disclosure Statement (Hassett, Shaun) (Filed on 10/1/2015) (Entered: 10/01/2015)
- 10/01/2015 123 Certificate of Interested Entities by BlackBerry Corporation, BlackBerry Limited (Hassett, Shaun) (Filed on 10/1/2015) (Entered: 10/01/2015)
- 10/05/2015 124 Certificate of Interested Entities by IXI IP, LLC, IXI Mobile (R&D) Ltd. identifying Corporate Parent IXI Mobile, Inc. for IXI Mobile (R&D) Ltd.. (Coleman, Jennifer) (Filed on 10/5/2015) (Entered: 10/05/2015)
- 10/06/2015 125 NOTICE of Appearance by Brian Charles Riopelle on behalf of Blackberry Limited et al. (Riopelle, Brian) (Filed on 10/6/2015) (Entered: 10/06/2015)
- 10/13/2015 126 Joint MOTION to Continue the Date of the Case Management Conference filed by BlackBerry Corporation, BlackBerry Limited. (Attachments: # 1 Online (Entered: 10/13/2015))
- 10/14/2015 127 ORDER by Judge Haywood S. Gilliam, Jr. Granting (126 in case 3:15-cv-03754-HSG; 110 in case 3:15-cv-03755-HSG; 121 in case 3:15-cv-03752-HSG Motion to Continue the Date of the Case Management Conference. (ndrS, COURT STAFF) (Filed on 10/14/2015) (Entered: 10/14/2015)
- 10/14/2015 Set Deadline/Hearing: Case Management Statement due by 10/29/2015; Case Management Conference set for 11/5/2015 02:00 PM. (ndrS, COURT STAFF) (Filed on

- 10/14/2015) (Entered: 10/14/2015)
- 10/15/2015 128 NOTICE of need for ADR Phone Conference (ADR L.R. 3-5 d) (Cook, Jason) (Filed on 10/15/2015) (Entered: 10/15/2015)
- 10/15/2015 129 ADR Certification (ADR L.R. 3-5 b) of discussion of ADR options (Cook, Jason) (Filed on 10/15/2015) (Entered: 10/15/2015)
- 10/15/2015 130 RESPONSE (re 121 MOTION to Stay Defendants' Motion to Stay Pending Inter Partes Review ) filed by IXI IP, LLC, IXI Mobile (R&D) Ltd.. (Attachments: # 1 Online, # 2 Online, # 3 Online, # 4 Online, # 5 Online (Entered: 10/15/2015)
- 10/16/2015 131 ADR Clerk's Notice Setting ADR Phone Conference on November 3, 2015 at 10:00 AM Pacific time. Please note that you must be logged into an ECF account of counsel of record in order to view this document. (cmf, COURT STAFF) (Filed on 10/16/2015) (Entered: 10/16/2015)
- 10/22/2015 132 REPLY (re 121 MOTION to Stay Defendants' Motion to Stay Pending Inter Partes Review ) filed by BlackBerry Corporation, BlackBerry Limited. (Attachments: # 1 Online, # 2 Online (Entered: 10/22/2015)
- 10/26/2015 133 ADR Certification (ADR L.R. 3-5 b) of discussion of ADR options (Coleman, Jennifer) (Filed on 10/26/2015) (Entered: 10/26/2015)
- 10/29/2015 134 JOINT CASE MANAGEMENT STATEMENT filed by IXI IP, LLC, IXI Mobile (R&D) Ltd.. (Picone, John) (Filed on 10/29/2015) (Entered: 10/29/2015)
- 11/03/2015 ADR Remark: ADR Phone Conference held on 11/3/2015 with Tamara Lange. (cmf, COURT STAFF) (Filed on 11/3/2015) (Entered: 11/03/2015)
- 11/03/2015 ADR Remark: The further ADR Phone Conference date of 12/2/2015 at 9:30 AM discussed during the 11/3/2015 ADR Phone Conference with Tamara Lange is off calendar. (cmf, COURT STAFF) (Filed on 11/3/2015) (Entered: 11/03/2015)
- 11/05/2015 135 Minute Entry for proceedings held before Hon. Haywood S. Gilliam, Jr.: Motion Hearing and Case Management Conference held on 11/5/2015 (Time: 12 minutes). Court Reporter Name Pam Batalo. Plaintiff Attorney Thomas Biemer; John Picone. Defendant Attorney Todd Friedman; Jason Cook; Elizabeth Gillen; Jessica Hannah; Buzz Frahn; Patrick King. Defendants' motions to stay (docket no. 119 in case no. 15-3752, docket no. 121 in case no. 15-3754, and docket no. 106 in case no. 15-3755) are argued and submitted by the parties, and taken under submission by the Court. (This is a text minute entry, there is no document associated with this entry.) (ndrS, COURT STAFF) (Date Entered: 11/9/2015) Modified on 11/10/2015 to correct file date (ndrS, COURT STAFF). (Entered: 11/09/2015)
- 11/12/2015 136 ORDER by Judge Haywood S. Gilliam, Jr. GRANTING(121 in case 3:15-cv-03754-HSG; 106 in case 3:15-cv-03755-HSG; and 119 in case 3:15-cv-03752-HSG MOTION TO STAY. (ndrS, COURT STAFF) (Filed on 11/12/2015) (Entered: 11/12/2015)
- 11/30/2015 137 Transcript of Proceedings held on 11/5/2015, before Judge Gilliam. Court Reporter Pamela A. Batalo, telephone number 626-688-7509; pamelabatalo@sbcglobal.net. Per General Order No. 59 and Judicial Conference policy, this transcript may be viewed only at the Clerk's Office public terminal or may be purchased through the Court Reporter/Transcriber until the deadline for the Release of Transcript Restriction. After that date it may be obtained through PACER. Any Notice of Intent to Request Redaction, if required, is due no later than 5 business days from date of this filing. (Re (121 in 3:15-cv-03755-HSG) Transcript Order ) Redaction Request due 12/21/2015. Redacted Transcript Deadline set for 12/31/2015. Release of Transcript Restriction set for 2/29/2016. (Batalo, Pam) (Filed on 11/30/2015) (Entered: 11/30/2015)
- 12/28/2015 138 NOTICE of Change In Counsel by Aleksandr Korzh (Korzh, Aleksandr) (Filed on 12/28/2015) (Entered: 12/28/2015)
- 01/05/2016 139 Letter from Thomas S. Biemer on behalf of parties, providing joint status report. (Picone, John) (Filed on 1/5/2016) (Entered: 01/05/2016)
- 01/07/2016 140 ORDER CONTINUING STAY. Signed by Judge Haywood S. Gilliam, Jr. on 1/7/2016. (ndrS, COURT STAFF) (Filed on 1/7/2016) (Entered: 01/07/2016)
- 12/28/2016 141 Letter from John V. Picone, III re Update on IPR. (Picone, John) (Filed on 12/28/2016) (Entered: 12/28/2016)

---

## US District Court Civil Docket

U.S. District - California Northern  
(San Francisco)

**3:15cv3755**

**Ixi Mobile (R&D) Ltd. et al v. Apple, Inc.**

This case was retrieved from the court on Tuesday, February 28, 2017

---

Date Filed: **08/17/2015**  
Assigned To: **Honorable Haywood S Gilliam, Jr**  
Referred To:  
Nature of suit: **Patent (830)**  
Cause: **Fed. Question**  
Lead Docket: **None**  
Other Docket: **3:15cv03752**  
**New York Southern, 1:14-cv-07954**  
Jurisdiction: **Federal Question**

Class Code: **OPEN**  
Closed:  
Statute: **28:1331**  
Jury Demand: **Both**  
Demand Amount: **\$0**  
NOS Description: **Patent**

---

| Litigants | Attorneys |
|-----------|-----------|
|-----------|-----------|

Ixi Mobile (R&D) Ltd.  
Plaintiff

Gary David Colby  
LEAD ATTORNEY; PRO HAC VICE; ATTORNEY TO BE NOTICED  
Dilworth Paxson, LLP  
1500 Market Street Suite 3500e  
Philadelphia, PA 19102  
USA  
215-575-7075  
Fax: 215-575-7200  
Email: Gcolby@dilworthlaw.Com

Gregory A Blue  
LEAD ATTORNEY; ATTORNEY TO BE NOTICED  
[Term: 08/20/2015]  
Dilworth Paxson LLP  
99 Park Avenue Suite 320  
New York, NY 10016  
USA  
212-975-4252  
Email: Gblue@dilworthlaw.Com

John Joseph Higson  
LEAD ATTORNEY; PRO HAC VICE; ATTORNEY TO BE NOTICED  
Dilworth Paxson LLP  
1500 Market Street Suite 3500e  
Philadelphia, PA 19103  
USA  
215-575-7152  
Fax: 215-575-7200  
Email: Jhigson@dilworthlaw.Com

Joshua David Wolson  
LEAD ATTORNEY; PRO HAC VICE; ATTORNEY TO BE NOTICED  
Dilworth Paxson LLP  
1500 Market Street Suite 3500e  
Philadelphia, PA 19102

USA  
215-575-7295  
Email: Jwolson@dilworthlaw.Com

Marie-Theres DiFillippo  
LEAD ATTORNEY; PRO HAC VICE; ATTORNEY TO BE NOTICED  
Dilworth Paxson LLP  
1500 Market Street Suite 3500e  
Philadelphia , PA 19102  
USA  
215-575-7120  
Fax: 215-575-7200  
Email: Mdifillippo@dilworthlaw.Com

Mark William Halderman  
LEAD ATTORNEY; PRO HAC VICE; ATTORNEY TO BE NOTICED  
Dilworth Paxswon LLP  
1500 Market Street Suite 3500e  
Philadelphia , PA 19102  
USA  
215-575-7186  
Fax: 215-575-7200  
Email: Mwhalderman@dilworthlaw.Com

Thomas Steven Biemer  
LEAD ATTORNEY; PRO HAC VICE; ATTORNEY TO BE NOTICED  
Dilworth Paxson LLP (PA)  
1500 Market Street Suite 3500e  
Philadelphia , PA 19102-2101  
USA  
215-575-7025  
Fax: 215-575-7200  
Email: Tbiemer@dilworthlaw.Com

Aleksandr Korzh  
[Term: 12/28/2015]  
70 So. First Street  
San Jose , CA 95113  
USA  
408-286-9800  
Fax: 408-998-4790  
Email: Akorzh@hopkinscarley.Com

Jeffrey Michael Ratinoff  
ATTORNEY TO BE NOTICED  
Hopkins & Carley  
70 S. First Street  
San Jose , CA 95113  
USA  
408-286-9800  
Fax: 408-998-4790  
Email: Jratinoff@hopkinscarley.Com

Jennifer S. Coleman  
ATTORNEY TO BE NOTICED  
Hopkins & Carley  
A Law Corporation The Letitia Building 70 South First Street  
P.O. Box 1469  
San Jose , CA 95109-1469  
USA  
408-286-9800  
Fax: 408-998-4790  
Email: Jcoleman@hopkinscarley.Com

John V. Picone , III  
ATTORNEY TO BE NOTICED  
Hopkins & Carley  
A Law Corporation The Letitia Building 70 South First Street  
P.O. Box 1469

Ixi Ip,Llc  
Plaintiff

San Jose , CA 95109-1469  
USA  
408-286-9800  
Fax: 408-998-4790  
Email: Jpicone@hopkinscarley.Com

Gary David Colby  
LEAD ATTORNEY; PRO HAC VICE; ATTORNEY TO BE NOTICED  
Dilworth Paxson, LLP  
1500 Market Street Suite 3500e  
Philadelphia , PA 19102  
USA  
215-575-7075  
Fax: 215-575-7200  
Email: Gcolby@dilworthlaw.Com

Gregory A Blue  
LEAD ATTORNEY; ATTORNEY TO BE NOTICED  
[Term: 08/20/2015]  
Dilworth Paxson LLP  
99 Park Avenue Suite 320  
New York , NY 10016  
USA  
212-975-4252  
Email: Gblue@dilworthlaw.Com

John Joseph Higson  
LEAD ATTORNEY; PRO HAC VICE; ATTORNEY TO BE NOTICED  
Dilworth Paxson LLP  
1500 Market Street Suite 3500e  
Philadelphia , PA 19103  
USA  
215-575-7152  
Fax: 215-575-7200  
Email: Jhigson@dilworthlaw.Com

Joshua David Wolson  
LEAD ATTORNEY; PRO HAC VICE; ATTORNEY TO BE NOTICED  
Dilworth Paxson LLP  
1500 Market Street Suite 3500e  
Philadelphia , PA 19102  
USA  
215-575-7295  
Email: Jwolson@dilworthlaw.Com

Marie-Theres DiFillippo  
LEAD ATTORNEY; PRO HAC VICE; ATTORNEY TO BE NOTICED  
Dilworth Paxson LLP  
1500 Market Street Suite 3500e  
Philadelphia , PA 19102  
USA  
215-575-7120  
Fax: 215-575-7200  
Email: MdiFillippo@dilworthlaw.Com

Mark William Halderman  
LEAD ATTORNEY; PRO HAC VICE; ATTORNEY TO BE NOTICED  
Dilworth Paxswon LLP  
1500 Market Street Suite 3500e  
Philadelphia , PA 19102  
USA  
215-575-7186  
Fax: 215-575-7200  
Email: Mwhalderman@dilworthlaw.Com

Thomas Steven Biemer  
LEAD ATTORNEY; PRO HAC VICE; ATTORNEY TO BE NOTICED  
Dilworth Paxson LLP (PA)



1500 Market Street Suite 3500e  
Philadelphia , PA 19102-2101  
USA  
215-575-7025  
Fax: 215-575-7200  
Email: Tbiemer@dilworthlaw.Com

Aleksandr Korzh  
[Term: 12/28/2015]  
70 So. First Street  
San Jose , CA 95113  
USA  
408-286-9800  
Fax: 408-998-4790  
Email: Akorzh@hopkinscarley.Com

Jeffrey Michael Ratinoff  
ATTORNEY TO BE NOTICED  
Hopkins & Carley  
70 S. First Street  
San Jose , CA 95113  
USA  
408-286-9800  
Fax: 408-998-4790  
Email: Jratinoff@hopkinscarley.Com

Jennifer S. Coleman  
ATTORNEY TO BE NOTICED  
Hopkins & Carley  
A Law Corporation The Letitia Building 70 South First Street  
P.O. Box 1469  
San Jose , CA 95109-1469  
USA  
408-286-9800  
Fax: 408-998-4790  
Email: Jcoleman@hopkinscarley.Com

John V. Picone , III  
ATTORNEY TO BE NOTICED  
Hopkins & Carley  
A Law Corporation The Letitia Building 70 South First Street  
P.O. Box 1469  
San Jose , CA 95109-1469  
USA  
408-286-9800  
Fax: 408-998-4790  
Email: Jpicone@hopkinscarley.Com

Apple Inc  
Defendant

Harrison J. Frahn , IV  
LEAD ATTORNEY; ATTORNEY TO BE NOTICED  
Simpson Thacher & Bartlett  
2475 Hanover Street  
Palo Alto , CA 94304  
USA  
(650)251-5025  
Fax: 650-251-5002  
Email: Hfrahn@stblaw.Com

Elizabeth Ann Gillen  
[Term: 06/21/2016]  
Simpson Thacher and Bartlett - Palo Alto  
2475 Hanover St  
Palo Alto , CA 94304  
USA  
(650)251-5000  
Fax: 650-251-5002  
Email: Egillen@stblaw.Com

Gregory Todd Chuebon  
 PRO HAC VICE; ATTORNEY TO BE NOTICED  
 Simpson Thacher and Bartlett  
 425 Lexington Avenue  
 Office 2222  
 New York , NY 10017  
 USA  
 212-455-3353  
 Email: Gchuebon@stblaw.Com

Patrick E. King  
 ATTORNEY TO BE NOTICED  
 Simpson Thacher & Bartlett LLP  
 2475 Hanover Street  
 650/-51-5000  
 Palo Alto , CA 94304  
 USA  
 Fax: 650-251-5002  
 Email: PKing@stblaw.Com

| Date       | # | Proceeding Text   | Source |
|------------|---|---|--------|
| 10/02/2014 | 1 |   |        |
| 10/02/2014 |   | SUMMONS ISSUED as to Apple, Inc.. (moh) (Entered: 10/03/2014)   |        |
| 10/02/2014 |   | CASE REFERRED TO Judge Richard J. Sullivan as possibly related to 14cv4355. (moh) (Entered: 10/03/2014)   |        |
| 10/02/2014 |   | Case Designated ECF. (moh) (Entered: 10/03/2014)  |        |
| 10/02/2014 | 2 | STATEMENT OF RELATEDNESS re: that this action be filed as related to 14cv4355. Document filed by IXI IP,LLC, IXI Mobile (R&D) Ltd..(moh) (moh). (Entered: 10/03/2014)   |        |
| 10/02/2014 | 3 | CIVIL COVER SHEET filed. (moh) (moh). (Entered: 10/03/2014)   |        |
| 10/02/2014 |   | Mailed notice to Commissioner of Patents and Trademarks to report the filing of this action. (moh) (Entered: 10/03/2014)  |        |
| 10/02/2014 | 4 | STANDING ORDER IN RE PILOT PROJECT REGARDING CASE MANAGEMENT TECHNIQUES FOR COMPLEX CIVIL CASES IN THE SOUTHERN DISTRICT OF NEW YORK (See M-10-468 Order filed November 1, 2011). This case is hereby designated for inclusion in the Pilot Project Regarding Case Management Techniques for Complex Civil Cases in the Southern District of New York (the Pilot Project), unless the judge to whom this case is assigned determines otherwise. This case is designated for inclusion in the Pilot Project because it is a class action, an MDL action, or is in one of the following Nature of Suit categories: 160, 245, 315, 355, 365, 385, 410, 830, 840, 850, 893, or 950. The presiding judge in a case that does not otherwise qualify for inclusion in the Pilot Project may nevertheless designate the case for inclusion in the Pilot Project by issuing an order directing that the case be included in the Pilot Project. The description of the Pilot Project, including procedures to be followed, is attached to this Order. (Signed by Judge Loretta A. Preska on 10/31/2011) (moh) (Entered: 10/03/2014) |        |
| 10/02/2014 |   | Case Eligible for Patent Pilot Program. (moh) (Entered: 10/08/2014)   |        |
| 10/07/2014 | 5 | MOTION to Appear Pro Hac Vice for Joshua D. Wolson. Filing fee \$ 200.00, receipt number 0208-10180198. Motion and supporting papers to be reviewed by Clerk's Office staff. Document filed by IXI IP,LLC, IXI Mobile (R&D) Ltd.. (Attachments: # 1 Online, # 2 Online (Entered: 10/07/2014)  |        |
| 10/07/2014 |   | &gt;&gt;&gt;NOTICE REGARDING PRO HAC VICE MOTION. Regarding Document No. 5 MOTION to Appear Pro Hac Vice for Joshua D. Wolson. Filing fee \$ 200.00, receipt number 0208-10180198. Motion and supporting papers to be reviewed by Clerk's Office staff.. The document has been reviewed and there are no deficiencies. (bcu) (Entered: 10/07/2014)  |        |
| 10/07/2014 | 6 | RULE 7.1 CORPORATE DISCLOSURE STATEMENT. No Corporate Parent. Document filed by IXI IP,LLC.(Biemer, Thomas) (Entered: 10/07/2014)   |        |
| 10/07/2014 | 7 | RULE 7.1 CORPORATE DISCLOSURE STATEMENT. Identifying Corporate Parent IXI Mobile Inc. for IXI Mobile (R&D) Ltd.. Document filed by IXI Mobile (R&D) Ltd.. (Biemer, Thomas) (Entered: 10/07/2014)  |        |

- 10/10/2014 CASE ACCEPTED AS RELATED. Create association to 1:14-cv-04355-RJS. Notice of Assignment to follow. (pgu) (Entered: 10/10/2014)
- 10/10/2014 NOTICE OF CASE ASSIGNMENT to Judge Richard J. Sullivan. Judge Unassigned is no longer assigned to the case. (pgu) (Entered: 10/10/2014)
- 10/10/2014 Magistrate Judge Debra C. Freeman is so designated. (pgu) (Entered: 10/10/2014)
- 10/13/2014 8 AFFIDAVIT OF SERVICE of Summons and Complaint,. Apple, Inc. served on 10/3/2014, answer due 10/24/2014. Service was accepted by Jan Lapinid, Registered Agent. Document filed by IXI Mobile (R&D) Ltd.; IXI IP,LLC. (Biemer, Thomas) (Entered: 10/13/2014)
- 10/22/2014 9 LETTER MOTION for Extension of Time to File Answer re: 1 Complaint, addressed to Judge Richard J. Sullivan from Greg Chuebon dated October 22, 2014. Document filed by Apple, Inc..(Chuebon, Gregory) (Entered: 10/22/2014)
- 10/22/2014 10 ORDER granting 9 Letter Motion for Extension of Time to Answer. SO ORDERED. Apple, Inc. answer due 11/24/2014. (Signed by Judge Richard J. Sullivan on 10/22/2014) (mro) (Entered: 10/23/2014)
- 10/27/2014 11 MOTION for John Joseph Higson to Appear Pro Hac Vice . Filing fee \$ 200.00, receipt number 0208-10245229. Motion and supporting papers to be reviewed by Clerk's Office staff. Document filed by IXI IP,LLC, IXI Mobile (R&D) Ltd.. (Attachments: # 1 Online, # 2 Online (Entered: 10/27/2014)
- 10/27/2014 &gt;&gt;&gt;NOTICE REGARDING PRO HAC VICE MOTION. Regarding Document No. 11 MOTION for John Joseph Higson to Appear Pro Hac Vice . Filing fee \$ 200.00, receipt number 0208-10245229. Motion and supporting papers to be reviewed by Clerk's Office staff.. The document has been reviewed and there are no deficiencies. (bcu) (Entered: 10/27/2014)
- 11/04/2014 12 ORDER granting 11 Motion for John Joseph Higson to Appear Pro Hac Vice. (Signed by Judge Richard J. Sullivan on 11/3/2014) (mro) (Entered: 11/04/2014)
- 11/07/2014 13 LETTER addressed to Judge Richard J. Sullivan from Harrison J. Frahn IV dated November 7, 2014 re: Apple's Letter regarding filings in IXI Mobile (R & D), LTD. v. Samsung Electronics Co. and IXI Mobile (R & D), LTD. v. Blackberry, LTD. Document filed by Apple, Inc..(Chuebon, Gregory) (Entered: 11/07/2014)
- 11/10/2014 14 NOTICE OF APPEARANCE by Harrison J. Frahn, IV on behalf of Apple, Inc.. (Frahn, Harrison) (Entered: 11/10/2014)
- 11/10/2014 15 LETTER addressed to Judge Richard J. Sullivan from Thomas S. Biemer, Esquire dated November 10, 2014 re: Response to Letter Dated November 7, 2014 from Defendant Apple, Inc. Document filed by IXI IP,LLC, IXI Mobile (R&D) Ltd..(Biemer, Thomas) (Entered: 11/10/2014)
- 11/10/2014 16 NOTICE OF APPEARANCE by Patrick E. King on behalf of Apple, Inc.. (King, Patrick) (Entered: 11/10/2014)
- 11/24/2014 17 RULE 7.1 CORPORATE DISCLOSURE STATEMENT. No Corporate Parent. Document filed by Apple, Inc..(Chuebon, Gregory) (Entered: 11/24/2014)
- 11/24/2014 18 ANSWER to 1 Complaint, with JURY DEMAND. Document filed by Apple, Inc..(Chuebon, Gregory) (Entered: 11/24/2014)
- 12/01/2014 19 ORDER: The Court is in receipt of the parties' letters concerning disputes about the proposed case management plan. Having considered the parties' arguments, IT IS HEREBY ORDERED THAT, no later than December 8, 2014, the parties shall jointly submit a revised case management plan that reflects a 30-day extension of all contested dates. So Ordered (Signed by Judge Richard J. Sullivan on 12/1/2014) (js) Modified on 12/2/2014 (js). (Entered: 12/02/2014)
- 12/03/2014 20 MOTION to Appear Pro Hac Vice for Mark W. Halderman, Esquire. Filing fee \$ 200.00, receipt number 0208-10371119. Motion and supporting papers to be reviewed by Clerk's Office staff. Document filed by IXI IP,LLC, IXI Mobile (R&D) Ltd.. (Attachments: # 1 Online, # 2 Online (Entered: 12/03/2014)
- 12/04/2014 &gt;&gt;&gt;NOTICE REGARDING PRO HAC VICE MOTION. Regarding Document No. 20 MOTION to Appear Pro Hac Vice for Mark W. Halderman, Esquire. Filing fee \$ 200.00, receipt number 0208-10371119. Motion and supporting papers to be reviewed by Clerk's Office staff.. The document has been reviewed and there are no deficiencies. (wb) (Entered: 12/04/2014)
- 12/08/2014 21 JOINT LETTER addressed to Judge Richard J. Sullivan from Thomas S. Biemer, Esquire dated 12/8/2014 re: Proposed Case Management Plan and Scheduling Order. Document filed by IXI IP,LLC, IXI Mobile (R&D) Ltd.. (Attachments: # 1 Online (Entered:

12/08/2014)

- 12/12/2014 22 CASE MANAGEMENT PLAN AND SCHEDULING ORDER: All parties do not consent to disposition of this case by a Magistrate Judge, pursuant to 28 U.S.C. § 636(c). These cases are to be tried to juries. Plaintiffs' Claim Construction Brief shall be filed by: July 8, 2015. Defendants' Claim Construction Briefs shall be filed by: August 7, 2015. Plaintiffs' Reply Claim Construction Brief shall be filed by: August 14, 2015. Depositions shall be completed by: 11/10/2015. Completion of Fact Discovery: 11/10/2015. The Court will conduct a post-discovery conference on 11/24/2015. Referral to a Magistrate Judge for settlement discussions. (Signed by Judge Richard J. Sullivan on 12/8/2014) (mro) (Entered: 12/15/2014)
- 12/12/2014 Set/Reset Deadlines: Brief due by 8/14/2015. (mro) (Entered: 12/15/2014)
- 12/15/2014 23 LETTER addressed to Judge Richard J. Sullivan from Patrick E. King dated 12/15/2014 re: Motion to Transfer. Document filed by Apple, Inc..(King, Patrick) (Entered: 12/15/2014)
- 12/18/2014 24 LETTER addressed to Judge Richard J. Sullivan from Thomas S. Biemer, Esquire dated December 18, 2014 re: Response to the Pre-Motion Letter from Apple Inc. dated 12-15-14. Document filed by IXI IP,LLC, IXI Mobile (R&D) Ltd..(Biemer, Thomas) (Entered: 12/18/2014)
- 12/22/2014 25 ORDER: The Court seeks input from Defendants Samsung Electronics Co., Ltd., et al. ("Samsung") as to their views concerning a potential 28 U.S.C. § 1404(a) motion to transfer Case No. 14-cv-4355 (RJS) to the Northern District of California. Accordingly, IT IS HEREBY ORDERED THAT Defendants Samsung shall submit a letter response to a potential 28 U.S.C. § 1404(a) motion to transfer to the Northern District of California by Tuesday, December 30, 2014. (Signed by Judge Richard J. Sullivan on 12/22/2014) (mro) (Entered: 12/22/2014)
- 01/05/2015 26 ORDER: After receiving pre-motion letters from the parties in Case Nos. 14-cv-7954 (RJS) and 14-cv-4428 (RJS) (Doc. Nos. 23, 24, No. 14-cv-7954 (RJS); Doc. Nos. 43, 44, No. 14-cv-4428 (RJS)), the Court, on December 22, 2014, issued an Order to Defendants Samsung Electronics Co., Ltd., et al. ("Samsung") in a related case, Case No. 14-cv-4355 (RJS), seeking input as to their views concerning a potential 28 U.S.C. § 1404(a) motion to transfer Case No. 14-cv-4355 (RJS) to the Northern District of California. (Doc. No. 39, No. 14-cv-4355 (RJS).) The Court is in receipt of Samsung's letter dated December 30, 2014, supporting Apple's and BlackBerry's motions to transfer but declining, at this time, to file their own motion to transfer. (Doc. No. 40, No. 14-cv-4355 (RJS).) Accordingly, IT IS HEREBY ORDERED THAT all of the above-captioned parties, including Samsung, shall appear for a conference on January 20, 2015 at 4:00 p.m. in Courtroom 905 at 40 Foley Square concerning the anticipated motions to transfer Case Nos. 14-cv-7954 (RJS) and 14-cv-4428 (RJS) to the Northern District of California pursuant to 28 U.S.C. § 1404(a). ( Status Conference set for 1/20/2015 at 04:00 PM in Courtroom 905, 40 Centre Street, New York, NY 10007 before Judge Richard J. Sullivan.) (Signed by Judge Richard J. Sullivan on 1/5/2015) (mro) (Entered: 01/05/2015)
- 01/20/2015 Minute Entry for proceedings held before Judge Richard J. Sullivan: Pre-Motion Conference was held on 1/20/2015. Plaintiffs' counsel, Thomas Biemer, was present. Defense counsel, Gregory Arovos, was present for Defendant Samsung. Marshall Beil was present for Defendant BlackBerry. Harrison (Buzz) Frahn and Elizabeth Gillen were present for Defendant Apple. The court reporter was present. Defendants' motions to transfer these actions to the Northern District of California are due on 2/3/15. Plaintiffs' responses are due on 2/17/15; and the defendants' replies are due on 2/20/15. (sc) (Entered: 01/22/2015)
- 02/03/2015 27 MOTION to Transfer Case Apple Inc.'s Notice of Motion to Transfer Venue Pursuant to 28 U.S.C. § 1404(a). Document filed by Apple, Inc..(King, Patrick) (Entered: 02/03/2015)
- 02/03/2015 28 MEMORANDUM OF LAW in Support re: 27 MOTION to Transfer Case Apple Inc.'s Notice of Motion to Transfer Venue Pursuant to 28 U.S.C. § 1404(a). . Document filed by Apple, Inc.. (King, Patrick) (Entered: 02/03/2015)
- 02/03/2015 29 DECLARATION of John William Van Dyke in Support re: 27 MOTION to Transfer Case Apple Inc.'s Notice of Motion to Transfer Venue Pursuant to 28 U.S.C. § 1404(a).. Document filed by Apple, Inc.. (King, Patrick) (Entered: 02/03/2015)
- 02/03/2015 30 DECLARATION of Elizabeth A. Gillen in Support re: 27 MOTION to Transfer Case Apple Inc.'s Notice of Motion to Transfer Venue Pursuant to 28 U.S.C. § 1404(a).. Document filed by Apple, Inc.. (Attachments: # 1 Online (Entered: 02/03/2015)
- 02/17/2015 31 BRIEF re: 27 MOTION to Transfer Case Apple Inc.'s Notice of Motion to Transfer Venue Pursuant to 28 U.S.C. § 1404(a). Omnibus Brief In Opposition to Motion to Transfer. Document filed by IXI IP,LLC, IXI Mobile (R&D) Ltd..(Biemer, Thomas) (Entered: 02/17/2015)

- 02/17/2015 32 DECLARATION of John J. Higson in Opposition re: 27 MOTION to Transfer Case Apple Inc.'s Notice of Motion to Transfer Venue Pursuant to 28 U.S.C. § 1404(a).. Document filed by IXI IP,LLC, IXI Mobile (R&D) Ltd.. (Attachments: # 1 Online, # 2 Online, # 3 Online, # 4 Online, # 5 Online, # 6 Online, # 7 Online, # 8 Online, # 9 Online, # 10 Online, # 11 Online, # 12 Online, # 13 Online, # 14 Online (Entered: 02/17/2015)
- 02/17/2015 33 DECLARATION of Zion Hadad in Opposition re: 27 MOTION to Transfer Case Apple Inc.'s Notice of Motion to Transfer Venue Pursuant to 28 U.S.C. § 1404(a).. Document filed by IXI IP,LLC, IXI Mobile (R&D) Ltd.. (Biemer, Thomas) (Entered: 02/17/2015)
- 02/17/2015 34 DECLARATION of Steve Pedersen in Opposition re: 27 MOTION to Transfer Case Apple Inc.'s Notice of Motion to Transfer Venue Pursuant to 28 U.S.C. § 1404(a).. Document filed by IXI IP,LLC, IXI Mobile (R&D) Ltd.. (Biemer, Thomas) (Entered: 02/17/2015)
- 02/20/2015 35 REPLY MEMORANDUM OF LAW in Support re: 27 MOTION to Transfer Case Apple Inc.'s Notice of Motion to Transfer Venue Pursuant to 28 U.S.C. § 1404(a).. Document filed by Apple, Inc.. (King, Patrick) (Entered: 02/20/2015)
- 02/20/2015 36 DECLARATION of Gregory T. Chuebon in Support re: 27 MOTION to Transfer Case Apple Inc.'s Notice of Motion to Transfer Venue Pursuant to 28 U.S.C. § 1404(a).. Document filed by Apple, Inc.. (Chuebon, Gregory) (Entered: 02/20/2015)
- 02/24/2015 37 LETTER addressed to Judge Richard J. Sullivan from Thomas S. Biemer, Esquire dated February 24, 2015 re: IXI Mobile (R&D), LTD., et al. v. Samsung Electronics Co., Blackberry, LTD, et al., and Apple, Inc. Transfer Venue Brief. Document filed by IXI IP,LLC, IXI Mobile (R&D) Ltd..(Biemer, Thomas) (Entered: 02/24/2015)
- 02/24/2015 38 LETTER addressed to Judge Richard J. Sullivan from Harrison J. Frahn IV dated February 24, 2015 re: Plaintiffs request for leave to file a sur-reply in connection with Motion to Transfer. Document filed by Apple, Inc..(Frahn, Harrison) (Entered: 02/24/2015)
- 02/25/2015 39 ORDER: The Court is in receipt of Plaintiff's letter, dated February 24, 2015, requesting leave to file a sur-reply to Apple's reply brief. (Doc. No. 37, No. 14-cv-7954 (RJS).) The Court also is in receipt of Defendant Apple Inc.'s letter, dated February 24, 2015, responding to Plaintiff's letter and requesting "that IXI be required to provide the Court with the [IXI License Agreement]." (Doc. No. 38, No. 14-cv-7954 (RJS).) Because the Court finds that limited supplemental briefing as to whether IXI Mobile (R&D), Inc. lacks standing to be a Plaintiff in these actions would be helpful, IT IS HEREBY ORDERED THAT Plaintiff's request for leave to file a sur-reply is GRANTED. Plaintiff shall limit the sur-reply to three pages and submit the sur-reply by March 2, 2015. IT IS FURTHER ORDERED THAT Defendant Apple Inc.'s request "to respond to any new facts, evidence, or arguments introduced in the sur-reply" is GRANTED. Defendant Apple Inc. shall limit its response to three pages and submit the response by March 5, 2015. Finally, because the Court also finds that its review of the license referenced in the parties' briefing and letters would help the Court resolve the motion to transfer these actions to the Northern District of California pursuant to 28 U.S.C. § 1404(a), IT IS FURTHER ORDERED THAT Defendant Apple Inc.'s request "that IXI be required to provide the Court with the license" is GRANTED. ( Responses due by 3/5/2015, Surreplies due by 3/2/2015.) (Signed by Judge Richard J. Sullivan on 2/25/2015) (mro) (Entered: 02/26/2015)
- 02/27/2015 40 LETTER addressed to Judge Richard J. Sullivan from Thomas S. Biemer, Esquire dated February 27, 2015 re: IXI Mobile (R&D), LTD., et al. v. Samsung Electronics Co., Blackberry, LTD, et al., and Apple, Inc. Transfer Venue Sur-Reply. Document filed by IXI IP,LLC, IXI Mobile (R&D) Ltd..(Biemer, Thomas) (Entered: 02/27/2015)
- 02/27/2015 41 MEMO ENDORSEMENT on re: (54 in 1:14-cv-04355-RJS) Letter, filed by IXI IP,LLC, IXI Mobile (R&D) Ltd., (58 in 1:14-cv-04428-RJS) Letter, filed by IXI IP, LLC, IXI Mobile (R&D) Ltd., (40 in 1:14-cv-07954-RJS) Letter, filed by IXI IP,LLC, IXI Mobile (R&D) Ltd. ENDORSEMENT: There is a well-established presumption in the Second Circuit in favor of open court records. See *United States v. Amodeo*, 44 F.3d 141, 146 (2d Cir. 1995). To overcome this presumption, a party must demonstrate that sealing a judicial document is "essential to preserve higher values and is narrowly tailored to serve that interest." *United States v. Alcantara*, 396 F.3d 189, 199 (2d Cir. 2005); see also *Lugosch v. Pyramid Co. of Onondaga*, 435 F.3d 110, 119-20 (2d Cir. 2006) (" [D]ocuments may be sealed if specific, on the record findings are made demonstrating that closure is essential to preserve higher values and is narrowly tailored to serve that interest." (quotation marks and citations omitted)). Because Plaintiff represents that the license agreement between IXI IP and IXI Mobile contains "confidential information" and that the patent purchase agreement includes information relating to the strategy and financing of this litigation, the Court will allow Plaintiff to file the license and redacted patent purchase agreements under seal, and to submit the unredacted patent purchase agreement in camera. However, the Court may reach a different conclusion upon reviewing the materials in question and, at that time, will direct the parties to address whether the various documents should remain under seal. (Signed by Judge Richard J.

- Sullivan on 2/27/2015) (mro) (Entered: 03/02/2015)
- 03/02/2015 42 REPLY MEMORANDUM OF LAW in Opposition re: 27 MOTION to Transfer Case Apple Inc.'s Notice of Motion to Transfer Venue Pursuant to 28 U.S.C. § 1404(a). PLAINTIFFS SUR-REPLY IN FURTHER OPPOSITION TO DEFENDANTS MOTIONS TO TRANSFER. Document filed by IXI IP,LLC, IXI Mobile (R&D) Ltd.. (Biemer, Thomas) (Entered: 03/02/2015)
- 03/02/2015 43 DECLARATION of STEVE PEDERSEN in Opposition re: 27 MOTION to Transfer Case Apple Inc.'s Notice of Motion to Transfer Venue Pursuant to 28 U.S.C. § 1404(a).. Document filed by IXI IP,LLC, IXI Mobile (R&D) Ltd.. (Biemer, Thomas) (Entered: 03/02/2015)
- 03/02/2015 44 DECLARATION of John J. Higson in Opposition re: 27 MOTION to Transfer Case Apple Inc.'s Notice of Motion to Transfer Venue Pursuant to 28 U.S.C. § 1404(a).. Document filed by IXI IP,LLC, IXI Mobile (R&D) Ltd.. (Attachments: # 1 Online, # 2 Online, # 3 Online, # 4 Online, # 5 Online, # 6 Online) (Entered: 03/02/2015)
- 03/05/2015 45 RESPONSE in Support of Motion re: 27 MOTION to Transfer Case Apple Inc.'s Notice of Motion to Transfer Venue Pursuant to 28 U.S.C. § 1404(a). Response to IXI's Sur-reply on Apple's Motion to Transfer. Document filed by Apple, Inc.. (Frahm, Harrison) (Entered: 03/05/2015)
- 04/14/2015 46 AGREED PROTECTIVE ORDER REGARDING THE DISCLOSURE AND USE OF DISCOVERY MATERIALS...regarding procedures to be followed that shall govern the handling of confidential material... (Signed by Judge Richard J. Sullivan on 4/14/2015) (mro) (Entered: 04/15/2015)
- 04/14/2015 47 ORDER: This Addendum is an integral part of the Order of today's date granting confidentiality protection to certain materials. Notwithstanding any other provision, no document may be filed with the Clerk under seal without a further Order of this Court addressing the specific documents to be sealed. Any application to seal shall be accompanied by an affidavit or affidavits and a memorandum of law, demonstrating that the standards for sealing have been met and specifically addressing *Lugosch v. Pyramid Co. of Onondaga*, 435 F.3d 110, 119-20 (2d Cir. 2006) and any other controlling authority. Nothing herein is intended to alter or modify the applicability of Federal Rule of Civil Procedure 5.2 to this case. The redactions expressly authorized by Rule 5.2 may be made without further application to the Court. (Signed by Judge Richard J. Sullivan on 4/14/2015) (mro) (Entered: 04/15/2015)
- 05/04/2015 48 MOTION to Appear Pro Hac Vice for Gary D. Colby, Esquire. Filing fee \$ 200.00, receipt number 0208-10883432. Motion and supporting papers to be reviewed by Clerk's Office staff. Document filed by IXI IP,LLC, IXI Mobile (R&D) Ltd.. (Attachments: # 1 Online, # 2 Online) (Entered: 05/04/2015)
- 05/04/2015 &gt;&gt;&gt;NOTICE REGARDING PRO HAC VICE MOTION. Regarding Document No. 48 MOTION to Appear Pro Hac Vice for Gary D. Colby, Esquire. Filing fee \$ 200.00, receipt number 0208-10883432. Motion and supporting papers to be reviewed by Clerk's Office staff.. The document has been reviewed and there are no deficiencies. (wb) (Entered: 05/04/2015)
- 05/06/2015 49 ORDER granting 48 Motion for Gary D. Colby to Appear Pro Hac Vice. (Signed by Judge Richard J. Sullivan on 5/5/2015) (mro) (Entered: 05/06/2015)
- 05/11/2015 50 JOINT STIPULATION OF DISMISSAL OF CLAIMS RELATED TO U.S. PATENT NO. 7,426,398: Plaintiffs IXI Mobile (R&D) Ltd. and IXI IP, LLC (collectively "Plaintiffs") and Defendant Apple Inc. hereby stipulate and agree to the dismissal with prejudice of the Second Count for Relief in Plaintiffs' Complaint, alleging infringement of U.S. Patent No. 7.426,398 (the "'398 Patent"), in the above-captioned action, each party to ear its own costs and fees related to claims of infringement of the '398 Patent. SO ORDERED. (Signed by Judge Richard J. Sullivan on 5/11/2015) (kko) (Entered: 05/11/2015)
- 05/15/2015 51 ORDER REFERRING CASE TO MAGISTRATE JUDGE. Order that case be referred to the Clerk of Court for assignment to a Magistrate Judge for Settlement: The parties shall contact Magistrate Judge Debra Freeman by May 19, 2015 to schedule a settlement conference. Referred to Magistrate Judge Debra C. Freeman. (Signed by Judge Richard J. Sullivan on 5/15/2015) (tn) (Entered: 05/18/2015)
- 05/20/2015 52 LETTER addressed to Judge Richard J. Sullivan from Harrison J. Frahn IV dated 5/20/2015 re: pre-motion conference for motion to dismiss IXI Mobile (R&D) Ltd. for lack of standing. Document filed by Apple, Inc..(Frahm, Harrison) (Entered: 05/20/2015)
- 05/26/2015 53 LETTER addressed to Judge Richard J. Sullivan from Thomas S. Biemer, Esquire dated May 26, 2015 re: IXI Mobile (R & D), LTD., et al. v. Apple, Inc. - Response to May 20, 2015 Pre-Motion Letter from Apple, Inc. Document filed by IXI IP,LLC, IXI Mobile (R&D) Ltd..(Biemer, Thomas) (Entered: 05/26/2015)

- 05/28/2015 Minute Entry for proceedings held before Magistrate Judge Debra C. Freeman: Settlement Conference held via telephone on 5/28/2015. Telephone conference scheduled for 8/25/15 at 12:00 p.m. (aba) (Entered: 05/28/2015)
- 06/04/2015 54 LETTER addressed to Judge Richard J. Sullivan from Thomas S. Biemer, Esquire dated June 4, 2015 re: Claim Construction Technology Tutorial. Document filed by IXI IP,LLC, IXI Mobile (R&D) Ltd..(Biemer, Thomas) (Entered: 06/04/2015)
- 06/05/2015 55 AMENDED LETTER addressed to Judge Richard J. Sullivan from Thomas S. Biemer, Esquire dated June 5, 2015 re: Claim Construction Technology Tutorial. Document filed by IXI IP,LLC, IXI Mobile (R&D) Ltd..(Biemer, Thomas) (Entered: 06/05/2015)
- 06/08/2015 56 JOINT CLAIM CONSTRUCTION STATEMENT. Document filed by Apple, Inc., IXI IP,LLC, IXI Mobile (R&D) Ltd..(Biemer, Thomas) (Entered: 06/08/2015)
- 06/15/2015 57 LETTER addressed to Judge Richard J. Sullivan from Thomas S. Biemer dated June 15, 2015 re: Pre-Motion Request to Strike Joint Claim Terms Chart. Document filed by IXI IP,LLC, IXI Mobile (R&D) Ltd..(Biemer, Thomas) (Entered: 06/15/2015)
- 06/18/2015 58 LETTER addressed to Judge Richard J. Sullivan from Harrison J. Frahn IV dated 06/18/2015 re: Response to IXI's Request for a Pre-motion Conference for a Motion to Strike. Document filed by Apple, Inc..(Frahn, Harrison) (Entered: 06/18/2015)
- 07/02/2015 59 LETTER addressed to Judge Richard J. Sullivan from Harrison J. Frahn IV dated 7/2/2015 re: pre-motion conference for motion to stay. Document filed by Apple, Inc..(Frahn, Harrison) (Entered: 07/02/2015)
- 07/02/2015 60 ENDORSED LETTER addressed to Judge Richard J. Sullivan from Thomas S. Biemer dated 7/2/2015 re: Plaintiffs respectfully request 5 additional pages for their Opening Claim Construction Brief due on July 8, 2015, as well as 5 additional pages for their supporting expert declaration. ENDORSEMENT: SO ORDERED. (Signed by Judge Richard J. Sullivan on 7/2/2015) (mro) (Entered: 07/06/2015)
- 07/08/2015 61 BRIEF Plaintiffs Opening Claim Construction Brief. Document filed by IXI IP,LLC, IXI Mobile (R&D) Ltd..(Biemer, Thomas) (Entered: 07/08/2015)
- 07/08/2015 62 DECLARATION re: 61 Brief Declaration of Mark W. Halderman. Document filed by IXI IP,LLC, IXI Mobile (R&D) Ltd.. (Attachments: # 1 Online, # 2 Online, # 3 Online, # 4 Online, # 5 Online, # 6 Online, # 7 Online, # 8 Online, # 9 Online, # 10 Online (Entered: 07/08/2015)
- 07/08/2015 63 DECLARATION re: 61 Brief Declaration of Joel R. Williams. Document filed by IXI IP,LLC, IXI Mobile (R&D) Ltd.. (Attachments: # 1 Online, # 2 Online, # 3 Online (Entered: 07/08/2015)
- 07/08/2015 64 LETTER addressed to Judge Richard J. Sullivan from Thomas S. Biemer, Esquire dated July 8, 2015 re: Response to pre-motion letter from Defendants Apple and Samsung requesting a stay. Document filed by IXI IP,LLC, IXI Mobile (R&D) Ltd..(Biemer, Thomas) (Entered: 07/08/2015)
- 07/24/2015 65 LETTER addressed to Judge Richard J. Sullivan from Harrison J. Frahn IV dated 7/24/2015 re: Apple's requests to transfer/stay. Document filed by Apple, Inc..(Frahn, Harrison) (Entered: 07/24/2015)
- 07/29/2015 66 LETTER addressed to Judge Richard J. Sullivan from Thomas S. Biemer, Esquire dated July 29, 2015 re: IXI Mobile, et al. v. Apple Inc. - Response to Letter from Apple Inc. dated July 24, 2015. Document filed by IXI IP,LLC, IXI Mobile (R&D) Ltd..(Biemer, Thomas) (Entered: 07/29/2015)
- 08/03/2015 67 MEMO ENDORSEMENT on re: (84 in 1:14-cv-04428-RJS) Letter, filed by Blackberry Limited, Blackberry Corporation, (77 in 1:14-cv-04355-RJS) Letter, filed by Samsung Electronics Co., Ltd., Samsung Electronics America, Inc. ENDORSEMENT: SO ORDERED. ( Brief due by 8/7/2015.) (Signed by Judge Richard J. Sullivan on 8/3/2015) (mro) (Entered: 08/04/2015)
- 08/04/2015 68 LETTER MOTION for Leave to File Excess Pages and Exhibits for Defendants' Responsive Claim Construction Brief addressed to Judge Richard J. Sullivan from Marshall Beil (on behalf of all Defendants) dated August 3, 2015. Document filed by Apple, Inc..(Chuebon, Gregory) (Entered: 08/04/2015)
- 08/04/2015 69 ORDER granting 5 Motion for Joshua D. Wolson to Appear Pro Hac Vice. (Signed by Judge Richard J. Sullivan on 8/4/2015) (mro) (Entered: 08/05/2015)
- 08/04/2015 70 ORDER granting 20 Motion for Mark W. Halderman to Appear Pro Hac Vice. (Signed by Judge Richard J. Sullivan on 8/4/2015) (mro) (Entered: 08/05/2015)
- 08/06/2015 71 OPINION AND ORDER re: (27 in 1:14-cv-07954-RJS) MOTION to Transfer Case Apple Inc.'s Notice of Motion to Transfer Venue Pursuant to 28 U.S.C. § 1404(a). filed by Apple,

Inc., (47 in 1:14-cv-04428-RJS) MOTION to Transfer Case . filed by Blackberry Limited, Blackberry Corporation, (44 in 1:14-cv-04355-RJS) MOTION to Transfer Case Samsung's Notice of Motion to Transfer Venue Pursuant to 28 U.S.C. § 1404(a). filed by Samsung Electronics Co., Ltd., Samsung Telecommunications America, LLC, Samsung Electronics America, Inc. Weighing the factors set forth above and having considered all the facts and circumstances before it, the Court determines that Defendants have demonstrated by clear and convincing evidence that transfer of these three actions is appropriate. Accordingly, IT IS HEREBY ORDERED THAT Defendants' motions to transfer these actions to the Northern District of California are GRANTED. The Clerk of the Court is respectfully directed to terminate the motions pending at docket entries 44 in case number 14--cv-4355 (RJS), 47 in case number 14--cv-4428 (RJS), and 27 in case number 14-cv-7954 (RJS), and to close these cases. SO ORDERED. (As further set forth within this Order.) (Signed by Judge Richard J. Sullivan on 8/6/2015) (ajs) (Entered: 08/07/2015)

- 08/06/2015 CASE TRANSFERRED OUT ELECTRONICALLY from the U.S.D.C. Southern District of New York to the United States District Court - Northern District of California. (ajs) (Entered: 08/14/2015)
- 08/12/2015 72 LETTER addressed to Judge Richard J. Sullivan from Thomas S. Biemer, Esquire dated August 12, 2015 re: Requesting Reconsideration of the Order entered August 7, 2015. Document filed by IXI IP,LLC, IXI Mobile (R&D) Ltd..(Biemer, Thomas) (Entered: 08/12/2015)
- 08/17/2015 73 Case transferred in from District of New York Southern; Case Number 1:14-cv-07954. Original file certified copy of transfer order and docket sheet received. Modified on 8/19/2015 (vlkS, COURT STAFF). (Entered: 08/19/2015)
- 08/19/2015 74 Initial Case Management Scheduling Order with ADR Deadlines: Case Management Statement due by 11/11/2015. Case Management Conference set for 11/18/2015 01:30 PM. (vlkS, COURT STAFF) (Filed on 8/19/2015) (Entered: 08/19/2015)
- 08/19/2015 75 CLERK'S NOTICE re Transfer of Case (vlkS, COURT STAFF) (Filed on 8/19/2015) (Entered: 08/19/2015)
- 08/21/2015 76 NOTICE of Change In Counsel by Gregory A Blue (Blue, Gregory) (Filed on 8/21/2015) (Entered: 08/21/2015)
- 08/24/2015 77 NOTICE of Appearance by Jennifer S. Coleman (Coleman, Jennifer) (Filed on 8/24/2015) (Entered: 08/24/2015)
- 08/24/2015 78 CONSENT/DECLINATION to Proceed Before a US Magistrate Judge by IXI IP,LLC, IXI Mobile (R&D) Ltd... (Coleman, Jennifer) (Filed on 8/24/2015) (Entered: 08/24/2015)
- 08/24/2015 79 CLERK'S NOTICE OF IMPENDING REASSIGNMENT TO A U.S. DISTRICT COURT JUDGE: The Clerk of this Court will now randomly reassign this case to a District Judge because either (1) a party has not consented to the jurisdiction of a Magistrate Judge, or (2) time is of the essence in deciding a pending judicial action for which the necessary consents to Magistrate Judge jurisdiction have not been secured. You will be informed by separate notice of the district judge to whom this case is reassigned. ALL HEARING DATES PRESENTLY SCHEDULED BEFORE THE CURRENT MAGISTRATE JUDGE ARE VACATED AND SHOULD BE RE-NOTICED FOR HEARING BEFORE THE JUDGE TO WHOM THIS CASE IS REASSIGNED. This is a text only docket entry; there is no document associated with this notice. (ig, COURT STAFF) (Filed on 8/24/2015) (Entered: 08/24/2015)
- 08/25/2015 80 ORDER REASSIGNING CASE. Case reassigned to Judge Hon. Phyllis J. Hamilton for all further proceedings. Magistrate Judge Donna M. Ryu no longer assigned to the case. Signed by the Executive Committee on August 25, 2015. (cjlS, COURT STAFF) (Filed on 8/25/2015) (Entered: 08/25/2015)
- 08/25/2015 81 NOTICE of Appearance by John V. Picone, III (Picone, John) (Filed on 8/25/2015) (Entered: 08/25/2015)
- 08/25/2015 82 NOTICE of Appearance by Jeffrey Michael Ratinoff (Ratinoff, Jeffrey) (Filed on 8/25/2015) (Entered: 08/25/2015)
- 08/25/2015 83 NOTICE of Appearance by Aleksandr Korzh (Korzh, Aleksandr) (Filed on 8/25/2015) (Entered: 08/25/2015)
- 09/03/2015 84 ORDER SETTING CASE MANAGEMENT CONFERENCE. Joint Case Management Statement due by 11/12/2015. Initial Case Management Conference set for 11/19/2015 02:00 PM in Courtroom 3, 3rd Floor, Oakland. Signed by Judge Phyllis J. Hamilton on 9/3/15. (napS, COURT STAFF) (Filed on 9/3/2015) (Entered: 09/03/2015)
- 09/09/2015 85 ORDER RELATING CASES 15-cv-3752-HSG and 15-cv-3754-RS. Signed by Judge Haywood S. Gilliam, Jr. on 9/9/2015. (ndrS, COURT STAFF) (Filed on 9/9/2015) (Entered: 09/09/2015)



- 09/10/2015 86 ORDER REASSIGNING CASE. Case reassigned to Judge Hon. Haywood S Gilliam, Jr for all further proceedings. Judge Hon. Phyllis J. Hamilton no longer assigned to the case. Signed by the Executive Committee on 9/10/2015. (vlkS, COURT STAFF) (Filed on 9/10/2015) (Entered: 09/10/2015)
- 09/11/2015 87 CLERK'S NOTICE SETTING CASE MANAGEMENT CONFERENCE FOR REASSIGNED CIVIL CASE. Notice is hereby given that a Case Management Conference has been set for November 17, 2015, before Judge Haywood S. Gilliam, Jr., at 2:00 p.m., in Courtroom 15, 18th Floor, 450 Golden Gate Avenue, San Francisco, CA. Case Management Statement due by November 10, 2015. (This is a text only docket entry, there is no document associated with this notice.)(ndr, COURT STAFF) (Filed on 9/11/2015) (Entered: 09/11/2015)
- 09/15/2015 88 CERTIFICATE OF SERVICE by IXI IP,LLC, IXI Mobile (R&D) Ltd. (Coleman, Jennifer) (Filed on 9/15/2015) (Entered: 09/15/2015)
- 09/16/2015 89 MOTION for leave to appear in Pro Hac Vice for Joshua D. Wolson ( Filing fee \$ 305, receipt number 0971-9841125.) filed by IXI IP,LLC, IXI Mobile (R&D) Ltd.. (Attachments: # 1 Online (Entered: 09/16/2015)
- 09/17/2015 90 MOTION for leave to appear in Pro Hac Vice for Thomas S. Biemer ( Filing fee \$ 305, receipt number 0971-9844144.) filed by IXI IP,LLC, IXI Mobile (R&D) Ltd.. (Attachments: # 1 Online (Entered: 09/17/2015)
- 09/17/2015 91 MOTION for leave to appear in Pro Hac Vice for John J. Higson ( Filing fee \$ 305, receipt number 0971-9844305.) filed by IXI IP,LLC, IXI Mobile (R&D) Ltd.. (Attachments: # 1 Online (Entered: 09/17/2015)
- 09/17/2015 92 MOTION for leave to appear in Pro Hac Vice for Gary D. Colby ( Filing fee \$ 305, receipt number 0971-9844722.) filed by IXI IP,LLC, IXI Mobile (R&D) Ltd.. (Attachments: # 1 Online (Entered: 09/17/2015)
- 09/17/2015 93 MOTION for leave to appear in Pro Hac Vice for Marie-Theres DiFillippo ( Filing fee \$ 305, receipt number 0971-9844964.) filed by IXI IP,LLC, IXI Mobile (R&D) Ltd.. (Attachments: # 1 Online (Entered: 09/17/2015)
- 09/17/2015 94 MOTION for leave to appear in Pro Hac Vice for Mark W. Halderman ( Filing fee \$ 305, receipt number 0971-9845191.) filed by IXI IP,LLC, IXI Mobile (R&D) Ltd.. (Attachments: # 1 Online (Entered: 09/17/2015)
- 09/25/2015 95 MOTION to Expedite Hearing Date of Case Management Conference filed by IXI IP,LLC, IXI Mobile (R&D) Ltd.. (Attachments: # 1 Online, # 2 Online (Entered: 09/25/2015)
- 09/28/2015 96 ORDER by Judge Haywood S. Gilliam, Jr. Granting 95 Motion to Expedite Hearing Date of Case Management Conference (ndrS, COURT STAFF) (Filed on 9/28/2015) (Entered: 09/28/2015)
- 09/28/2015 Reset Deadline/Hearing Pursuant to docket no. 96 : Case Management Statement due by 10/27/2015; Case Management Conference set for 11/3/2015 02:00 PM. (ndrS, COURT STAFF) (Filed on 9/28/2015) (Entered: 09/28/2015)
- 10/01/2015 97 ORDER by Judge Haywood S. Gilliam, Jr. Granting 89 Motion for Pro Hac Vice for Joshua D. Wolson (ndrS, COURT STAFF) (Filed on 10/1/2015) (Entered: 10/01/2015)
- 10/01/2015 98 ORDER by Judge Haywood S. Gilliam, Jr. Granting 90 Motion for Pro Hac Vice for Thomas S. Biemer (ndrS, COURT STAFF) (Filed on 10/1/2015) (Entered: 10/01/2015)
- 10/01/2015 99 ORDER by Judge Haywood S. Gilliam, Jr. Granting 91 Motion for Pro Hac Vice for John J. Higson (ndrS, COURT STAFF) (Filed on 10/1/2015) (Entered: 10/01/2015)
- 10/01/2015 100 ORDER by Judge Haywood S. Gilliam, Jr. Granting 92 Motion for Pro Hac Vice for Gary D. Colby (ndrS, COURT STAFF) (Filed on 10/1/2015) (Entered: 10/01/2015)
- 10/01/2015 101 ORDER by Judge Haywood S. Gilliam, Jr. Granting 93 Motion for Pro Hac Vice for Marie-Theres DiFillippo (ndrS, COURT STAFF) (Filed on 10/1/2015) (Entered: 10/01/2015)
- 10/01/2015 102 ORDER by Judge Haywood S. Gilliam, Jr. Granting 94 Motion for Pro Hac Vice for Mark W. Halderman (ndrS, COURT STAFF) (Filed on 10/1/2015) (Entered: 10/01/2015)
- 10/01/2015 103 Certificate of Interested Entities by Apple Inc Corporate Disclosure Statement (Frahm, Harrison) (Filed on 10/1/2015) (Entered: 10/01/2015)
- 10/01/2015 104 Certificate of Interested Entities by Apple Inc (Frahm, Harrison) (Filed on 10/1/2015) (Entered: 10/01/2015)
- 10/01/2015 105 NOTICE of Appearance by Elizabeth Ann Gillen for Defendant Apple Inc. (Gillen, Elizabeth) (Filed on 10/1/2015) (Entered: 10/01/2015)
- 10/01/2015 106 MOTION to Stay Defendants' Motion to Stay Pending Inter Partes Review filed by Apple

Inc. Motion Hearing set for 11/5/2015 02:00 PM in Courtroom 15, 18th Floor, San Francisco before Hon. Haywood S Gilliam Jr.. Responses due by 10/15/2015. Replies due by 10/22/2015. (Attachments: # 1 Online, # 2 Online, # 3 Online, # 4 Online, # 5 Online, # 6 Online, # 7 Online, # 8 Online, # 9 Online, # 10 Online (Entered: 10/01/2015))

- 10/05/2015 107 MOTION for leave to appear in Pro Hac Vice for Gregory T. Chuebon ( Filing fee \$ 305, receipt number 0971-9890450.) filed by Apple Inc. (Attachments: # 1 Online (Entered: 10/05/2015))
- 10/05/2015 108 Certificate of Interested Entities by IXI IP,LLC, IXI Mobile (R&D) Ltd. identifying Corporate Parent IXI Mobile, Inc. for IXI Mobile (R&D) Ltd.. (Coleman, Jennifer) (Filed on 10/5/2015) (Entered: 10/05/2015)
- 10/06/2015 109 ORDER by Judge Haywood S. Gilliam, Jr. Granting 107 Motion for Pro Hac Vice for Gregory T. Chuebon (ndrS, COURT STAFF) (Filed on 10/6/2015) (Entered: 10/06/2015)
- 10/14/2015 110 Joint MOTION to Continue the Date of the Case Management Conference filed by Apple Inc. (Attachments: # 1 Online (Entered: 10/14/2015))
- 10/14/2015 111 ADR Certification (ADR L.R. 3-5 b) of discussion of ADR options (Frahn, Harrison) (Filed on 10/14/2015) (Entered: 10/14/2015)
- 10/14/2015 112 ORDER by Judge Haywood S. Gilliam, Jr. Granting (126 in case 3:15-cv-03754-HSG; 110 in case 3:15-cv-03755-HSG; 121 in case 3:15-cv-03752-HSG Motion to Continue the Date of the Case Management Conference. (ndrS, COURT STAFF) (Filed on 10/14/2015) (Entered: 10/14/2015)
- 10/14/2015 Set Deadline/Hearing: Case Management Statement due by 10/29/2015; Case Management Conference set for 11/5/2015 02:00 PM. (ndrS, COURT STAFF) (Filed on 10/14/2015) (Entered: 10/14/2015)
- 10/15/2015 113 NOTICE of need for ADR Phone Conference (ADR L.R. 3-5 d) (Picone, John) (Filed on 10/15/2015) (Entered: 10/15/2015)
- 10/15/2015 114 RESPONSE (re 106 MOTION to Stay Defendants' Motion to Stay Pending Inter Partes Review ) filed by IXI IP,LLC, IXI Mobile (R&D) Ltd.. (Attachments: # 1 Online, # 2 Online, # 3 Online, # 4 Online, # 5 Online (Entered: 10/15/2015))
- 10/16/2015 115 ADR Clerk's Notice Setting ADR Phone Conference on November 3, 2015 at 10:00 AM Pacific time. Please note that you must be logged into an ECF account of counsel of record in order to view this document. (cmf, COURT STAFF) (Filed on 10/16/2015) (Entered: 10/16/2015)
- 10/22/2015 116 REPLY (re 106 MOTION to Stay Defendants' Motion to Stay Pending Inter Partes Review ) filed by Apple Inc. (Frahn, Harrison) (Filed on 10/22/2015) (Entered: 10/22/2015)
- 10/22/2015 117 Declaration of Elizabeth A. Gillen in Support of 116 Reply to Opposition/Response filed by Apple Inc. (Attachments: # 1 Online 116 ) (Gillen, Elizabeth) (Filed on 10/22/2015) (Entered: 10/22/2015)
- 10/26/2015 118 ADR Certification (ADR L.R. 3-5 b) of discussion of ADR options (Coleman, Jennifer) (Filed on 10/26/2015) (Entered: 10/26/2015)
- 10/29/2015 119 JOINT CASE MANAGEMENT STATEMENT filed by IXI IP,LLC, IXI Mobile (R&D) Ltd.. (Picone, John) (Filed on 10/29/2015) (Entered: 10/29/2015)
- 11/03/2015 ADR Remark: ADR Phone Conference held on 11/3/2015 with Tamara Lange. (cmf, COURT STAFF) (Filed on 11/3/2015) (Entered: 11/03/2015)
- 11/03/2015 ADR Remark: The further ADR Phone Conference date of 12/2/2015 at 9:30 AM discussed during the 11/3/2015 ADR Phone Conference with Tamara Lange is off calendar. (cmf, COURT STAFF) (Filed on 11/3/2015) (Entered: 11/03/2015)
- 11/05/2015 120 Minute Entry for proceedings held before Hon. Haywood S. Gilliam, Jr.: Motion Hearing and Case Management Conference held on 11/5/2015 (Time: 12 minutes).Court Reporter Name Pam Batalo. Plaintiff Attorney Thomas Biemer; John Picone. Defendant Attorney Todd Friedman; Jason Cook; Elizabeth Gillen; Jessica Hannah; Buzz Frahn; Patrick King. Defendants' motions to stay (docket no. 119 in case no. 15-3752, docket no. 121 in case no. 15-3754, and docket no. 106 in case no. 15-3755) are argued and submitted by the parties, and taken under submission by the Court.(This is a text minute entry, there is no document associated with this entry.)(ndrS, COURT STAFF) (Date Entered: 11/9/2015) Modified on 11/10/2015 to correct file date (ndrS, COURT STAFF). (Entered: 11/09/2015)
- 11/11/2015 121 TRANSCRIPT ORDER by Apple Inc for Court Reporter Pam Batalo. (Frahn, Harrison) (Filed on 11/11/2015) (Entered: 11/11/2015)
- 11/12/2015 122 ORDER by Judge Haywood S. Gilliam, Jr. GRANTING(121 in case 3:15-cv-03754-HSG; 106 in case 3:15-cv-03755-HSG; and 119 in case 3:15-cv-03752-HSG MOTION TO STAY.

- (ndrS, COURT STAFF) (Filed on 11/12/2015) (Entered: 11/12/2015)
- 11/30/2015 123 Transcript of Proceedings held on 11/5/2015, before Judge Gilliam. Court Reporter Pamela A. Batalo, telephone number 626-688-7509; pamel\_a\_batalo@sbcglobal.net. Per General Order No. 59 and Judicial Conference policy, this transcript may be viewed only at the Clerk's Office public terminal or may be purchased through the Court Reporter/Transcriber until the deadline for the Release of Transcript Restriction. After that date it may be obtained through PACER. Any Notice of Intent to Request Redaction, if required, is due no later than 5 business days from date of this filing. (Re (121 in 3:15-cv-03755-HSG) Transcript Order ) Redaction Request due 12/21/2015. Redacted Transcript Deadline set for 12/31/2015. Release of Transcript Restriction set for 2/29/2016. (Batalo, Pam) (Filed on 11/30/2015) (Entered: 11/30/2015)
- 12/28/2015 124 NOTICE of Change In Counsel by Aleksandr Korzh (Korzh, Aleksandr) (Filed on 12/28/2015) (Entered: 12/28/2015)
- 01/05/2016 125 Letter from Thomas S. Biemer on behalf of parties, providing joint status report. (Picone, John) (Filed on 1/5/2016) (Entered: 01/05/2016)
- 01/07/2016 126 ORDER CONTINUING STAY. Signed by Judge Haywood S. Gilliam, Jr. on 1/7/2016. (ndrS, COURT STAFF) (Filed on 1/7/2016) (Entered: 01/07/2016)
- 06/21/2016 127 NOTICE of Change In Counsel by Harrison J. Frahn, IV Notice of Withdrawal of Elizabeth A. Gillen (Frahn, Harrison) (Filed on 6/21/2016) (Entered: 06/21/2016)
- 12/28/2016 128 Letter from John V. Picone, III re Update on IPR. (Picone, John) (Filed on 12/28/2016) (Entered: 12/28/2016)

---

Copyright © 2017 LexisNexis CourtLink, Inc. All rights reserved.  
\*\*\* THIS DATA IS FOR INFORMATIONAL PURPOSES ONLY \*\*\*

---

## US District Court Civil Docket

U.S. District - California Northern  
(Oakland)

**4:15cv3755**

**Ixi Mobile (R&D) Ltd. et al v. Apple, Inc.**

This case was retrieved from the court on Wednesday, September 09, 2015

---

|   |                                |
|---|--------------------------------|
| <b>Date Filed: 08/17/2015</b>                         | <b>Class Code: OPEN</b>        |
| <b>Assigned To: Honorable Phyllis J. Hamilton</b>     | <b>Closed:</b>                 |
| <b>Referred To:</b>                                   | <b>Statute: 28:1331</b>        |
| <b>Nature of suit: Patent (830)</b>                   | <b>Jury Demand: Both</b>       |
| <b>Cause: Fed. Question</b>                           | <b>Demand Amount: \$0</b>      |
| <b>Lead Docket: None</b>                              | <b>NOS Description: Patent</b> |
| <b>Other Docket: New York Southern, 1:14-cv-07954</b> |                                |
| <b>Jurisdiction: Federal Question</b>                 |                                |

| Litigants | Attorneys |
|-----------|-----------|
|-----------|-----------|

Ixi Mobile (R&D) Ltd.  
Plaintiff

Gary David Colby  
LEAD ATTORNEY; ATTORNEY TO BE NOTICED  
Dilworth Paxson, LLP  
1500 Market Street  
Philadelphia, PA 19102  
USA  
(215)-575-7075  
Email: Gcolby@dilworthlaw.Com

Gregory A Blue  
LEAD ATTORNEY; ATTORNEY TO BE NOTICED  
[Term: 08/20/2015]  
Dilworth Paxson LLP  
99 Park Avenue Suite 320  
New York, NY 10016  
USA  
212-975-4252  
Email: Gblue@dilworthlaw.Com

John Joseph Higson  
LEAD ATTORNEY; PRO HAC VICE; ATTORNEY TO BE NOTICED  
Dilworth Paxson LLP  
1500 Market Street Suite 3500  
Philadelphia, PA 19103  
USA  
(212)575-7152  
Fax: (215)-575-7200  
Email: Jhigson@dilworthlaw.Com

Joshua D. Wolson  
LEAD ATTORNEY; PRO HAC VICE; ATTORNEY TO BE NOTICED  
Dilworth Paxson LLP (PA)  
1500 Market Street Suite 3500e  
Philadelphia, PA 19102-2101  
USA  
(215)-575-7295

Fax: (215)-575-7200  
Email: Jwolson@dilworthlaw.Com

Mark William Halderman  
LEAD ATTORNEY; ATTORNEY TO BE NOTICED  
Reed & Scardino LLP  
301 Congress Avenue, Suite 1250  
Austin , TX 78701  
USA  
512-474-2449  
Fax: 512-474-2622  
Email: Mwhalderman@dilworthlaw.Com

Thomas Steven Biemer  
LEAD ATTORNEY; ATTORNEY TO BE NOTICED  
Dilworth Paxson LLP (PA)  
1500 Market Street Suite 3500e  
Philadelphia , PA 19102-2101  
USA  
(215)-575-7025  
Fax: (215)-575-7200  
Email: Tbiemer@dilworthlaw.Com

Aleksandr Korzh  
ATTORNEY TO BE NOTICED  
70 So. First Street  
San Jose , CA 95113  
USA  
408-286-9800  
Fax: 408-998-4790  
Email: Akorzh@hopkinscarley.Com

Jeffrey Michael Ratinoff  
ATTORNEY TO BE NOTICED  
Hopkins & Carley  
70 S. First Street  
San Jose , CA 95113  
USA  
408-286-9800  
Fax: 408-998-4790  
Email: Jratinoff@hopkinscarley.Com

Jennifer S. Coleman  
ATTORNEY TO BE NOTICED  
Hopkins & Carley  
A Law Corporation The Letitia Building 70 South First Street  
P.O. Box 1469  
San Jose , CA 95109-1469  
USA  
408-286-9800  
Fax: 408-998-4790  
Email: Jcoleman@hopkinscarley.Com

John V. Picone , III  
ATTORNEY TO BE NOTICED  
Hopkins & Carley  
A Law Corporation The Letitia Building 70 South First Street  
P.O. Box 1469  
San Jose , CA 95109-1469  
USA  
408-286-9800  
Fax: 408-998-4790  
Email: Jpicone@hopkinscarley.Com

Ixi Ip,Llc  
Plaintiff

Gary David Colby  
LEAD ATTORNEY; ATTORNEY TO BE NOTICED  
Dilworth Paxson, LLP  
1500 Market Street

Philadelphia , PA 19102  
USA  
(215)-575-7075  
Email: Gcolby@dilworthlaw.Com

Gregory A Blue  
LEAD ATTORNEY; ATTORNEY TO BE NOTICED  
[Term: 08/20/2015]  
Dilworth Paxson LLP  
99 Park Avenue Suite 320  
New York , NY 10016  
USA  
212-975-4252  
Email: Gblue@dilworthlaw.Com

John Joseph Higson  
LEAD ATTORNEY; PRO HAC VICE; ATTORNEY TO BE NOTICED  
Dilworth Paxson LLP  
1500 Market Street Suite 3500  
Philadelphia , PA 19103  
USA  
(212)575-7152  
Fax: (215)-575-7200  
Email: Jhigson@dilworthlaw.Com

Joshua D. Wolson  
LEAD ATTORNEY; PRO HAC VICE; ATTORNEY TO BE NOTICED  
Dilworth Paxson LLP (PA)  
1500 Market Street Suite 3500e  
Philadelphia , PA 19102-2101  
USA  
(215)-575-7295  
Fax: (215)-575-7200  
Email: Jwolson@dilworthlaw.Com

Mark William Halderman  
LEAD ATTORNEY; ATTORNEY TO BE NOTICED  
Reed & Scardino LLP  
301 Congress Avenue, Suite 1250  
Austin , TX 78701  
USA  
512-474-2449  
Fax: 512-474-2622  
Email: Mwhalderman@dilworthlaw.Com

Thomas Steven Biemer  
LEAD ATTORNEY; ATTORNEY TO BE NOTICED  
Dilworth Paxson LLP (PA)  
1500 Market Street Suite 3500e  
Philadelphia , PA 19102-2101  
USA  
(215)-575-7025  
Fax: (215)-575-7200  
Email: Tbiemer@dilworthlaw.Com

Aleksandr Korzh  
ATTORNEY TO BE NOTICED  
70 So. First Street  
San Jose , CA 95113  
USA  
408-286-9800  
Fax: 408-998-4790  
Email: Akorzh@hopkinscarley.Com

Jeffrey Michael Ratnoff  
ATTORNEY TO BE NOTICED  
Hopkins & Carley  
70 S. First Street  
San Jose , CA 95113

USA  
 408-286-9800  
 Fax: 408-998-4790  
 Email: Jrationoff@hopkinscarley.Com

Jennifer S. Coleman  
 ATTORNEY TO BE NOTICED  
 Hopkins & Carley  
 A Law Corporation The Letitia Building 70 South First Street  
 P.O. Box 1469  
 San Jose , CA 95109-1469  
 USA  
 408-286-9800  
 Fax: 408-998-4790  
 Email: Jcoleman@hopkinscarley.Com

John V. Picone , III  
 ATTORNEY TO BE NOTICED  
 Hopkins & Carley  
 A Law Corporation The Letitia Building 70 South First Street  
 P.O. Box 1469  
 San Jose , CA 95109-1469  
 USA  
 408-286-9800  
 Fax: 408-998-4790  
 Email: Jpicone@hopkinscarley.Com

Apple Inc  
 Defendant

Harrison J. Frahn , IV  
 LEAD ATTORNEY; ATTORNEY TO BE NOTICED  
 Simpson Thacher & Bartlett  
 2475 Hanover Street  
 Palo Alto , CA 94304  
 USA  
 (650)251-5025  
 Fax: 650-251-5002  
 Email: Hfrahn@stblaw.Com

Gregory Todd Chuebon  
 ATTORNEY TO BE NOTICED  
 Simpson Thacher & Bartlett LLP (NY)  
 425 Lexington Avenue  
 New York , NY 10017  
 USA  
 (212)-455-3353  
 Fax: (212)-455-2502  
 Email: Gchuebon@stblaw.Com

Patrick E. King  
 ATTORNEY TO BE NOTICED  
 Simpson Thacher & Barlett LLP  
 2475 Hanover Street  
 650/-51-5000  
 Palo Alto , CA 94304  
 USA  
 Fax: 650-251-5002  
 Email: Pking@stblaw.Com

| Date       | # | Proceeding Text   | Source |
|------------|---|---|--------|
| 10/02/2014 | 1 | COMPLAINT against Apple, Inc.. (Filing Fee \$ 350.00, Receipt Number 465401106289) Document filed by IXI Mobile (R&D) Ltd., IXI IP,LLC.(moh) (Additional attachment(s) added on 10/6/2014: # 1 Exhibit A, # 2 Exhibit B, # 3 Exhibit C, # 4 Exhibit D) (moh). (Entered: 10/03/2014) |        |
| 10/02/2014 |   | SUMMONS ISSUED as to Apple, Inc.. (moh) (Entered: 10/03/2014)   |        |
| 10/02/2014 |   | CASE REFERRED TO Judge Richard J. Sullivan as possibly related to 14cv4355. (moh) (Entered: 10/03/2014)   |        |

10/02/2014 Case Designated ECF. (moh) (Entered: 10/03/2014)

10/02/2014 2 STATEMENT OF RELATEDNESS re: that this action be filed as related to 14cv4355. Document filed by IXI IP,LLC, IXI Mobile (R&D) Ltd..(moh) (moh). (Entered: 10/03/2014)

10/02/2014 3 CIVIL COVER SHEET filed. (moh) (moh). (Entered: 10/03/2014)

10/02/2014 Mailed notice to Commissioner of Patents and Trademarks to report the filing of this action. (moh) (Entered: 10/03/2014)

10/02/2014 4 STANDING ORDER IN RE PILOT PROJECT REGARDING CASE MANAGEMENT TECHNIQUES FOR COMPLEX CIVIL CASES IN THE SOUTHERN DISTRICT OF NEW YORK (See M-10-468 Order filed November 1, 2011). This case is hereby designated for inclusion in the Pilot Project Regarding Case Management Techniques for Complex Civil Cases in the Southern District of New York (the Pilot Project), unless the judge to whom this case is assigned determines otherwise. This case is designated for inclusion in the Pilot Project because it is a class action, an MDL action, or is in one of the following Nature of Suit categories: 160, 245, 315, 355, 365, 385, 410, 830, 840, 850, 893, or 950. The presiding judge in a case that does not otherwise qualify for inclusion in the Pilot Project may nevertheless designate the case for inclusion in the Pilot Project by issuing an order directing that the case be included in the Pilot Project. The description of the Pilot Project, including procedures to be followed, is attached to this Order. (Signed by Judge Loretta A. Preska on 10/31/2011) (moh) (Entered: 10/03/2014)

10/02/2014 Case Eligible for Patent Pilot Program. (moh) (Entered: 10/08/2014)

10/07/2014 5 MOTION to Appear Pro Hac Vice for Joshua D. Wolson. Filing fee \$ 200.00, receipt number 0208-10180198. Motion and supporting papers to be reviewed by Clerk's Office staff. Document filed by IXI IP,LLC, IXI Mobile (R&D) Ltd.. (Attachments: # Online, # Online (Entered: 10/07/2014)

10/07/2014 &gt;&gt;&gt;NOTICE REGARDING PRO HAC VICE MOTION. Regarding Document No. 5 MOTION to Appear Pro Hac Vice for Joshua D. Wolson. Filing fee \$ 200.00, receipt number 0208-10180198. Motion and supporting papers to be reviewed by Clerk's Office staff.. The document has been reviewed and there are no deficiencies. (bcu) (Entered: 10/07/2014)

10/07/2014 6 RULE 7.1 CORPORATE DISCLOSURE STATEMENT. No Corporate Parent. Document filed by IXI IP,LLC.(Biemer, Thomas) (Entered: 10/07/2014)

10/07/2014 7 RULE 7.1 CORPORATE DISCLOSURE STATEMENT. Identifying Corporate Parent IXI Mobile Inc. for IXI Mobile (R&D) Ltd.. Document filed by IXI Mobile (R&D) Ltd.. (Biemer, Thomas) (Entered: 10/07/2014)

10/10/2014 CASE ACCEPTED AS RELATED. Create association to 1:14-cv-04355-RJS. Notice of Assignment to follow. (pgu) (Entered: 10/10/2014)

10/10/2014 NOTICE OF CASE ASSIGNMENT to Judge Richard J. Sullivan. Judge Unassigned is no longer assigned to the case. (pgu) (Entered: 10/10/2014)

10/10/2014 Magistrate Judge Debra C. Freeman is so designated. (pgu) (Entered: 10/10/2014)

10/13/2014 8 AFFIDAVIT OF SERVICE of Summons and Complaint,. Apple, Inc. served on 10/3/2014, answer due 10/24/2014. Service was accepted by Jan Lapinid, Registered Agent. Document filed by IXI Mobile (R&D) Ltd.; IXI IP,LLC. (Biemer, Thomas) (Entered: 10/13/2014)

10/22/2014 9 LETTER MOTION for Extension of Time to File Answer re: 1 Complaint, addressed to Judge Richard J. Sullivan from Greg Chuebon dated October 22, 2014. Document filed by Apple, Inc..(Chuebon, Gregory) (Entered: 10/22/2014)

10/22/2014 10 ORDER granting 9 Letter Motion for Extension of Time to Answer. SO ORDERED. Apple, Inc. answer due 11/24/2014. (Signed by Judge Richard J. Sullivan on 10/22/2014) (mro) (Entered: 10/23/2014)

10/27/2014 11 MOTION for John Joseph Higson to Appear Pro Hac Vice . Filing fee \$ 200.00, receipt number 0208-10245229. Motion and supporting papers to be reviewed by Clerk's Office staff. Document filed by IXI IP,LLC, IXI Mobile (R&D) Ltd.. (Attachments: # Online, # Online (Entered: 10/27/2014)

10/27/2014 &gt;&gt;&gt;NOTICE REGARDING PRO HAC VICE MOTION. Regarding Document No. 11 MOTION for John Joseph Higson to Appear Pro Hac Vice . Filing fee \$ 200.00, receipt number 0208-10245229. Motion and supporting papers to be reviewed by Clerk's Office staff.. The document has been reviewed and there are no deficiencies. (bcu) (Entered: 10/27/2014)

11/04/2014 12 ORDER granting 11 Motion for John Joseph Higson to Appear Pro Hac Vice. (Signed by



- Judge Richard J. Sullivan on 11/3/2014) (mro) (Entered: 11/04/2014)
- 11/07/2014 13 LETTER addressed to Judge Richard J. Sullivan from Harrison J. Frahn IV dated November 7, 2014 re: Apple's Letter regarding filings in IXI Mobile (R & D), LTD. v. Samsung Electronics Co. and IXI Mobile (R & D), LTD. v. Blackberry, LTD. Document filed by Apple, Inc..(Chuebon, Gregory) (Entered: 11/07/2014)
- 11/10/2014 14 NOTICE OF APPEARANCE by Harrison J. Frahn, IV on behalf of Apple, Inc.. (Frahn, Harrison) (Entered: 11/10/2014)
- 11/10/2014 15 LETTER addressed to Judge Richard J. Sullivan from Thomas S. Biemer, Esquire dated November 10, 2014 re: Response to Letter Dated November 7, 2014 from Defendant Apple, Inc. Document filed by IXI IP,LLC, IXI Mobile (R&D) Ltd..(Biemer, Thomas) (Entered: 11/10/2014)
- 11/10/2014 16 NOTICE OF APPEARANCE by Patrick E. King on behalf of Apple, Inc.. (King, Patrick) (Entered: 11/10/2014)
- 11/24/2014 17 RULE 7.1 CORPORATE DISCLOSURE STATEMENT. No Corporate Parent. Document filed by Apple, Inc..(Chuebon, Gregory) (Entered: 11/24/2014)
- 11/24/2014 18 ANSWER to 1 Complaint, with JURY DEMAND. Document filed by Apple, Inc..(Chuebon, Gregory) (Entered: 11/24/2014)
- 12/01/2014 19 ORDER: The Court is in receipt of the parties' letters concerning disputes about the proposed case management plan. Having considered the parties' arguments, IT IS HEREBY ORDERED THAT, no later than December 8, 2014, the parties shall jointly submit a revised case management plan that reflects a 30-day extension of all contested dates. So Ordered (Signed by Judge Richard J. Sullivan on 12/1/2014) (js) Modified on 12/2/2014 (js). (Entered: 12/02/2014)
- 12/03/2014 20 MOTION to Appear Pro Hac Vice for Mark W. Halderman, Esquire. Filing fee \$ 200.00, receipt number 0208-10371119. Motion and supporting papers to be reviewed by Clerk's Office staff. Document filed by IXI IP,LLC, IXI Mobile (R&D) Ltd.. (Attachments: # Online, # Online (Entered: 12/03/2014)
- 12/04/2014 &gt;&gt;&gt;NOTICE REGARDING PRO HAC VICE MOTION. Regarding Document No. 20 MOTION to Appear Pro Hac Vice for Mark W. Halderman, Esquire. Filing fee \$ 200.00, receipt number 0208-10371119. Motion and supporting papers to be reviewed by Clerk's Office staff.. The document has been reviewed and there are no deficiencies. (wb) (Entered: 12/04/2014)
- 12/08/2014 21 JOINT LETTER addressed to Judge Richard J. Sullivan from Thomas S. Biemer, Esquire dated 12/8/2014 re: Proposed Case Management Plan and Scheduling Order. Document filed by IXI IP,LLC, IXI Mobile (R&D) Ltd.. (Attachments: # Online (Entered: 12/08/2014)
- 12/12/2014 22 CASE MANAGEMENT PLAN AND SCHEDULING ORDER: All parties do not consent to disposition of this case by a Magistrate Judge, pursuant to 28 U.S.C. § 636(c). These cases are to be tried to juries. Plaintiffs' Claim Construction Brief shall be filed by: July 8, 2015. Defendants' Claim Construction Briefs shall be filed by: August 7, 2015. Plaintiffs' Reply Claim Construction Brief shall be filed by: August 14, 2015. Depositions shall be completed by: 11/10/2015. Completion of Fact Discovery: 11/10/2015. The Court will conduct a post-discovery conference on 11/24/2015. Referral to a Magistrate Judge for settlement discussions. (Signed by Judge Richard J. Sullivan on 12/8/2014) (mro) (Entered: 12/15/2014)
- 12/12/2014 Set/Reset Deadlines: Brief due by 8/14/2015. (mro) (Entered: 12/15/2014)
- 12/15/2014 23 LETTER addressed to Judge Richard J. Sullivan from Patrick E. King dated 12/15/2014 re: Motion to Transfer. Document filed by Apple, Inc..(King, Patrick) (Entered: 12/15/2014)
- 12/18/2014 24 LETTER addressed to Judge Richard J. Sullivan from Thomas S. Biemer, Esquire dated December 18, 2014 re: Response to the Pre-Motion Letter from Apple Inc. dated 12-15-14. Document filed by IXI IP,LLC, IXI Mobile (R&D) Ltd..(Biemer, Thomas) (Entered: 12/18/2014)
- 12/22/2014 25 ORDER: The Court seeks input from Defendants Samsung Electronics Co., Ltd., et al. ("Samsung") as to their views concerning a potential 28 U.S.C. § 1404(a) motion to transfer Case No. 14-cv-4355 (RJS) to the Northern District of California. Accordingly, IT IS HEREBY ORDERED THAT Defendants Samsung shall submit a letter response to a potential 28 U.S.C. § 1404(a) motion to transfer to the Northern District of California by Tuesday, December 30, 2014. (Signed by Judge Richard J. Sullivan on 12/22/2014) (mro) (Entered: 12/22/2014)
- 01/05/2015 26 ORDER: After receiving pre-motion letters from the parties in Case Nos. 14-cv-7954 (RJS) and 14-cv-4428 (RJS) (Doc. Nos. 23, 24, No. 14-cv-7954 (RJS); Doc. Nos. 43, 44, No. 14-cv-4428 (RJS)), the Court, on December 22, 2014, issued an Order to Defendants

Samsung Electronics Co., Ltd., et al. ("Samsung") in a related case, Case No. 14-cv-4355 (RJS), seeking input as to their views concerning a potential 28 U.S.C. § 1404(a) motion to transfer Case No. 14-cv-4355 (RJS) to the Northern District of California. (Doc. No. 39, No. 14-cv-4355 (RJS).) The Court is in receipt of Samsung's letter dated December 30, 2014, supporting Apple's and BlackBerry's motions to transfer but declining, at this time, to file their own motion to transfer. (Doc. No. 40, No. 14-cv-4355 (RJS).) Accordingly, IT IS HEREBY ORDERED THAT all of the above-captioned parties, including Samsung, shall appear for a conference on January 20, 2015 at 4:00 p.m. in Courtroom 905 at 40 Foley Square concerning the anticipated motions to transfer Case Nos. 14-cv-7954 (RJS) and 14-cv-4428 (RJS) to the Northern District of California pursuant to 28 U.S.C. § 1404(a). ( Status Conference set for 1/20/2015 at 04:00 PM in Courtroom 905, 40 Centre Street, New York, NY 10007 before Judge Richard J. Sullivan.) (Signed by Judge Richard J. Sullivan on 1/5/2015) (mro) (Entered: 01/05/2015)

- 01/20/2015 Minute Entry for proceedings held before Judge Richard J. Sullivan: Pre-Motion Conference was held on 1/20/2015. Plaintiffs' counsel, Thomas Biemer, was present. Defense counsel, Gregory Arovas, was present for Defendant Samsung. Marshall Beil was present for Defendant BlackBerry. Harrison (Buzz) Frahn and Elizabeth Gillen were present for Defendant Apple. The court reporter was present. Defendants' motions to transfer these actions to the Northern District of California are due on 2/3/15. Plaintiffs' responses are due on 2/17/15; and the defendants' replies are due on 2/20/15. (sc) (Entered: 01/22/2015)
- 02/03/2015 27 MOTION to Transfer Case Apple Inc.'s Notice of Motion to Transfer Venue Pursuant to 28 U.S.C. § 1404(a). Document filed by Apple, Inc..(King, Patrick) (Entered: 02/03/2015)
- 02/03/2015 28 MEMORANDUM OF LAW in Support re: 27 MOTION to Transfer Case Apple Inc.'s Notice of Motion to Transfer Venue Pursuant to 28 U.S.C. § 1404(a).. Document filed by Apple, Inc.. (King, Patrick) (Entered: 02/03/2015)
- 02/03/2015 29 DECLARATION of John William Van Dyke in Support re: 27 MOTION to Transfer Case Apple Inc.'s Notice of Motion to Transfer Venue Pursuant to 28 U.S.C. § 1404(a).. Document filed by Apple, Inc.. (King, Patrick) (Entered: 02/03/2015)
- 02/03/2015 30 DECLARATION of Elizabeth A. Gillen in Support re: 27 MOTION to Transfer Case Apple Inc.'s Notice of Motion to Transfer Venue Pursuant to 28 U.S.C. § 1404(a).. Document filed by Apple, Inc.. (Attachments: # Online) (Entered: 02/03/2015)
- 02/17/2015 31 BRIEF re: 27 MOTION to Transfer Case Apple Inc.'s Notice of Motion to Transfer Venue Pursuant to 28 U.S.C. § 1404(a). Omnibus Brief In Opposition to Motion to Transfer. Document filed by IXI IP,LLC, IXI Mobile (R&D) Ltd..(Biemer, Thomas) (Entered: 02/17/2015)
- 02/17/2015 32 DECLARATION of John J. Higson in Opposition re: 27 MOTION to Transfer Case Apple Inc.'s Notice of Motion to Transfer Venue Pursuant to 28 U.S.C. § 1404(a).. Document filed by IXI IP,LLC, IXI Mobile (R&D) Ltd.. (Attachments: # Online, # Online, # Online, # Online, # Online, # Online, # Online, # Online, # Online, # Online, # Online, # Online, # Online, # Online) (Entered: 02/17/2015)
- 02/17/2015 33 DECLARATION of Zion Hadad in Opposition re: 27 MOTION to Transfer Case Apple Inc.'s Notice of Motion to Transfer Venue Pursuant to 28 U.S.C. § 1404(a).. Document filed by IXI IP,LLC, IXI Mobile (R&D) Ltd.. (Biemer, Thomas) (Entered: 02/17/2015)
- 02/17/2015 34 DECLARATION of Steve Pedersen in Opposition re: 27 MOTION to Transfer Case Apple Inc.'s Notice of Motion to Transfer Venue Pursuant to 28 U.S.C. § 1404(a).. Document filed by IXI IP,LLC, IXI Mobile (R&D) Ltd.. (Biemer, Thomas) (Entered: 02/17/2015)
- 02/20/2015 35 REPLY MEMORANDUM OF LAW in Support re: 27 MOTION to Transfer Case Apple Inc.'s Notice of Motion to Transfer Venue Pursuant to 28 U.S.C. § 1404(a).. Document filed by Apple, Inc.. (King, Patrick) (Entered: 02/20/2015)
- 02/20/2015 36 DECLARATION of Gregory T. Chuebon in Support re: 27 MOTION to Transfer Case Apple Inc.'s Notice of Motion to Transfer Venue Pursuant to 28 U.S.C. § 1404(a).. Document filed by Apple, Inc.. (Chuebon, Gregory) (Entered: 02/20/2015)
- 02/24/2015 37 LETTER addressed to Judge Richard J. Sullivan from Thomas S. Biemer, Esquire dated February 24, 2015 re: IXI Mobile (R&D), LTD., et al. v. Samsung Electronics Co., Blackberry, LTD, et al., and Apple, Inc. Transfer Venue Brief. Document filed by IXI IP,LLC, IXI Mobile (R&D) Ltd..(Biemer, Thomas) (Entered: 02/24/2015)
- 02/24/2015 38 LETTER addressed to Judge Richard J. Sullivan from Harrison J. Frahn IV dated February 24, 2015 re: Plaintiffs request for leave to file a sur-reply in connection with Motion to Transfer. Document filed by Apple, Inc..(Frahn, Harrison) (Entered: 02/24/2015)
- 02/25/2015 39 ORDER: The Court is in receipt of Plaintiff's letter, dated February 24, 2015, requesting leave to file a sur-reply to Apple's reply brief. (Doc. No. 37, No. 14-cv-7954 (RJS).) The

Court also is in receipt of Defendant Apple Inc.'s letter, dated February 24, 2015, responding to Plaintiff's letter and requesting "that IXI be required to provide the Court with the [IXI License Agreement]." (Doc. No. 38, No. 14-cv-7954 (RJS).) Because the Court finds that limited supplemental briefing as to whether IXI Mobile (R&D), Inc. lacks standing to be a Plaintiff in these actions would be helpful, IT IS HEREBY ORDERED THAT Plaintiff's request for leave to file a sur-reply is GRANTED. Plaintiff shall limit the sur-reply to three pages and submit the sur-reply by March 2, 2015. IT IS FURTHER ORDERED THAT Defendant Apple Inc.'s request "to respond to any new facts, evidence, or arguments introduced in the sur-reply" is GRANTED. Defendant Apple Inc. shall limit its response to three pages and submit the response by March 5, 2015. Finally, because the Court also finds that its review of the license referenced in the parties' briefing and letters would help the Court resolve the motion to transfer these actions to the Northern District of California pursuant to 28 U.S.C. § 1404(a), IT IS FURTHER ORDERED THAT Defendant Apple Inc.'s request "that IXI be required to provide the Court with the license" is GRANTED. ( Responses due by 3/5/2015, Surreplies due by 3/2/2015.) (Signed by Judge Richard J. Sullivan on 2/25/2015) (mro) (Entered: 02/26/2015)

- 02/27/2015 40 LETTER addressed to Judge Richard J. Sullivan from Thomas S. Biemer, Esquire dated February 27, 2015 re: IXI Mobile (R&D), LTD., et al. v. Samsung Electronics Co., Blackberry, LTD, et al., and Apple, Inc. Transfer Venue Sur-Reply. Document filed by IXI IP,LLC, IXI Mobile (R&D) Ltd..(Biemer, Thomas) (Entered: 02/27/2015)
- 02/27/2015 41 MEMO ENDORSEMENT on re: (54 in 1:14-cv-04355-RJS) Letter, filed by IXI IP,LLC, IXI Mobile (R&D) Ltd., (58 in 1:14-cv-04428-RJS) Letter, filed by IXI IP, LLC, IXI Mobile (R&D) Ltd., (40 in 1:14-cv-07954-RJS) Letter, filed by IXI IP,LLC, IXI Mobile (R&D) Ltd. ENDORSEMENT: There is a well-established presumption in the Second Circuit in favor of open court records. See *United States v. Amodeo*, 44 F.3d 141, 146 (2d Cir. 1995). To overcome this presumption, a party must demonstrate that sealing a judicial document is "essential to preserve higher values and is narrowly tailored to serve that interest." *United States v. Alcantara*, 396 F.3d 189, 199 (2d Cir. 2005); see also *Lugosch v. Pyramid Co. of Onondaga*, 435 F.3d 110, 119-20 (2d Cir. 2006) (" [D]ocuments may be sealed if specific, on the record findings are made demonstrating that closure is essential to preserve higher values and is narrowly tailored to serve that interest." (quotation marks and citations omitted)). Because Plaintiff represents that the license agreement between IXI IP and IXI Mobile contains "confidential information" and that the patent purchase agreement includes information relating to the strategy and financing of this litigation, the Court will allow Plaintiff to file the license and redacted patent purchase agreements under seal, and to submit the unredacted patent purchase agreement in camera. However, the Court may reach a different conclusion upon reviewing the materials in question and, at that time, will direct the parties to address whether the various documents should remain under seal. (Signed by Judge Richard J. Sullivan on 2/27/2015) (mro) (Entered: 03/02/2015)
- 03/02/2015 42 REPLY MEMORANDUM OF LAW in Opposition re: 27 MOTION to Transfer Case Apple Inc.'s Notice of Motion to Transfer Venue Pursuant to 28 U.S.C. § 1404(a). PLAINTIFFS SUR-REPLY IN FURTHER OPPOSITION TO DEFENDANTS MOTIONS TO TRANSFER. Document filed by IXI IP,LLC, IXI Mobile (R&D) Ltd.. (Biemer, Thomas) (Entered: 03/02/2015)
- 03/02/2015 43 DECLARATION of STEVE PEDERSEN in Opposition re: 27 MOTION to Transfer Case Apple Inc.'s Notice of Motion to Transfer Venue Pursuant to 28 U.S.C. § 1404(a).. Document filed by IXI IP,LLC, IXI Mobile (R&D) Ltd.. (Biemer, Thomas) (Entered: 03/02/2015)
- 03/02/2015 44 DECLARATION of John J. Higson in Opposition re: 27 MOTION to Transfer Case Apple Inc.'s Notice of Motion to Transfer Venue Pursuant to 28 U.S.C. § 1404(a).. Document filed by IXI IP,LLC, IXI Mobile (R&D) Ltd.. (Attachments: # Online, # Online, # Online, # Online, # Online, # Online) (Entered: 03/02/2015)
- 03/05/2015 45 RESPONSE in Support of Motion re: 27 MOTION to Transfer Case Apple Inc.'s Notice of Motion to Transfer Venue Pursuant to 28 U.S.C. § 1404(a). Response to IXI's Sur-reply on Apple's Motion to Transfer. Document filed by Apple, Inc.. (Frahm, Harrison) (Entered: 03/05/2015)
- 04/14/2015 46 AGREED PROTECTIVE ORDER REGARDING THE DISCLOSURE AND USE OF DISCOVERY MATERIALS...regarding procedures to be followed that shall govern the handling of confidential material... (Signed by Judge Richard J. Sullivan on 4/14/2015) (mro) (Entered: 04/15/2015)
- 04/14/2015 47 ORDER: This Addendum is an integral part of the Order of today's date granting confidentiality protection to certain materials. Notwithstanding any other provision, no document may be filed with the Clerk under seal without a further Order of this Court addressing the specific documents to be sealed. Any application to seal shall be accompanied by an affidavit or affidavits and a memorandum of law, demonstrating that the standards for sealing have been met and specifically addressing *Lugosch v. Pyramid*

Co. of Onondaga, 435 F.3d 110, 119-20 (2d Cir. 2006) and any other controlling authority. Nothing herein is intended to alter or modify the applicability of Federal Rule of Civil Procedure 5.2 to this case. The redactions expressly authorized by Rule 5.2 may be made without further application to the Court. (Signed by Judge Richard J. Sullivan on 4/14/2015) (mro) (Entered: 04/15/2015)

- 05/04/2015 48 MOTION to Appear Pro Hac Vice for Gary D. Colby, Esquire. Filing fee \$ 200.00, receipt number 0208-10883432. Motion and supporting papers to be reviewed by Clerk's Office staff. Document filed by IXI IP,LLC, IXI Mobile (R&D) Ltd.. (Attachments: # Online, # Online (Entered: 05/04/2015)
- 05/04/2015 &gt;&gt;&gt;NOTICE REGARDING PRO HAC VICE MOTION. Regarding Document No. 48 MOTION to Appear Pro Hac Vice for Gary D. Colby, Esquire. Filing fee \$ 200.00, receipt number 0208-10883432. Motion and supporting papers to be reviewed by Clerk's Office staff.. The document has been reviewed and there are no deficiencies. (wb) (Entered: 05/04/2015)
- 05/06/2015 49 ORDER granting 48 Motion for Gary D. Colby to Appear Pro Hac Vice. (Signed by Judge Richard J. Sullivan on 5/5/2015) (mro) (Entered: 05/06/2015)
- 05/11/2015 50 JOINT STIPULATION OF DISMISSAL OF CLAIMS RELATED TO U.S. PATENT NO. 7,426,398: Plaintiffs IXI Mobile (R&D) Ltd. and IXI IP, LLC (collectively "Plaintiffs") and Defendant Apple Inc. hereby stipulate and agree to the dismissal with prejudice of the Second Count for Relief in Plaintiffs' Complaint, alleging infringement of U.S. Patent No. 7.426,398 (the "'398 Patent"), in the above-captioned action, each party to ear its own costs and fees related to claims of infringement of the '398 Patent. SO ORDERED. (Signed by Judge Richard J. Sullivan on 5/11/2015) (kko) (Entered: 05/11/2015)
- 05/15/2015 51 ORDER REFERRING CASE TO MAGISTRATE JUDGE. Order that case be referred to the Clerk of Court for assignment to a Magistrate Judge for Settlement: The parties shall contact Magistrate Judge Debra Freeman by May 19, 2015 to schedule a settlement conference. Referred to Magistrate Judge Debra C. Freeman. (Signed by Judge Richard J. Sullivan on 5/15/2015) (tn) (Entered: 05/18/2015)
- 05/20/2015 52 LETTER addressed to Judge Richard J. Sullivan from Harrison J. Frahn IV dated 5/20/2015 re: pre-motion conference for motion to dismiss IXI Mobile (R&D) Ltd. for lack of standing. Document filed by Apple, Inc..(Frahn, Harrison) (Entered: 05/20/2015)
- 05/26/2015 53 LETTER addressed to Judge Richard J. Sullivan from Thomas S. Biemer, Esquire dated May 26, 2015 re: IXI Mobile (R & D), LTD., et al. v. Apple, Inc. - Response to May 20, 2015 Pre-Motion Letter from Apple, Inc. Document filed by IXI IP,LLC, IXI Mobile (R&D) Ltd..(Biemer, Thomas) (Entered: 05/26/2015)
- 05/28/2015 Minute Entry for proceedings held before Magistrate Judge Debra C. Freeman: Settlement Conference held via telephone on 5/28/2015. Telephone conference scheduled for 8/25/15 at 12:00 p.m. (aba) (Entered: 05/28/2015)
- 06/04/2015 54 LETTER addressed to Judge Richard J. Sullivan from Thomas S. Biemer, Esquire dated June 4, 2015 re: Claim Construction Technology Tutorial. Document filed by IXI IP,LLC, IXI Mobile (R&D) Ltd..(Biemer, Thomas) (Entered: 06/04/2015)
- 06/05/2015 55 AMENDED LETTER addressed to Judge Richard J. Sullivan from Thomas S. Biemer, Esquire dated June 5, 2015 re: Claim Construction Technology Tutorial. Document filed by IXI IP,LLC, IXI Mobile (R&D) Ltd..(Biemer, Thomas) (Entered: 06/05/2015)
- 06/08/2015 56 JOINT CLAIM CONSTRUCTION STATEMENT. Document filed by Apple, Inc., IXI IP,LLC, IXI Mobile (R&D) Ltd..(Biemer, Thomas) (Entered: 06/08/2015)
- 06/15/2015 57 LETTER addressed to Judge Richard J. Sullivan from Thomas S. Biemer dated June 15, 2015 re: Pre-Motion Request to Strike Joint Claim Terms Chart. Document filed by IXI IP,LLC, IXI Mobile (R&D) Ltd..(Biemer, Thomas) (Entered: 06/15/2015)
- 06/18/2015 58 LETTER addressed to Judge Richard J. Sullivan from Harrison J. Frahn IV dated 06/18/2015 re: Response to IXI's Request for a Pre-motion Conference for a Motion to Strike. Document filed by Apple, Inc..(Frahn, Harrison) (Entered: 06/18/2015)
- 07/02/2015 59 LETTER addressed to Judge Richard J. Sullivan from Harrison J. Frahn IV dated 7/2/2015 re: pre-motion conference for motion to stay. Document filed by Apple, Inc..(Frahn, Harrison) (Entered: 07/02/2015)
- 07/02/2015 60 ENDORSED LETTER addressed to Judge Richard J. Sullivan from Thomas S. Biemer dated 7/2/2015 re: Plaintiffs respectfully request 5 additional pages for their Opening Claim Construction Brief due on July 8, 2015, as well as 5 additional pages for their supporting expert declaration. ENDORSEMENT: SO ORDERED. (Signed by Judge Richard J. Sullivan on 7/2/2015) (mro) (Entered: 07/06/2015)

- 07/08/2015 61 BRIEF Plaintiffs Opening Claim Construction Brief. Document filed by IXI IP,LLC, IXI Mobile (R&D) Ltd..(Biemer, Thomas) (Entered: 07/08/2015)
- 07/08/2015 62 DECLARATION re: 61 Brief Declaration of Mark W. Halderman. Document filed by IXI IP,LLC, IXI Mobile (R&D) Ltd.. (Attachments: # Online, # Online, # Online, # Online, # Online, # Online, # Online, # Online, # Online, # Online, # Online, # Online (Entered: 07/08/2015)
- 07/08/2015 63 DECLARATION re: 61 Brief Declaration of Joel R. Williams. Document filed by IXI IP,LLC, IXI Mobile (R&D) Ltd.. (Attachments: # Online, # Online, # Online (Entered: 07/08/2015)
- 07/08/2015 64 LETTER addressed to Judge Richard J. Sullivan from Thomas S. Biemer, Esquire dated July 8, 2015 re: Response to pre-motion letter from Defendants Apple and Samsung requesting a stay. Document filed by IXI IP,LLC, IXI Mobile (R&D) Ltd..(Biemer, Thomas) (Entered: 07/08/2015)
- 07/24/2015 65 LETTER addressed to Judge Richard J. Sullivan from Harrison J. Frahn IV dated 7/24/2015 re: Apple's requests to transfer/stay. Document filed by Apple, Inc..(Frahn, Harrison) (Entered: 07/24/2015)
- 07/29/2015 66 LETTER addressed to Judge Richard J. Sullivan from Thomas S. Biemer, Esquire dated July 29, 2015 re: IXI Mobile, et al. v. Apple Inc. - Response to Letter from Apple Inc. dated July 24, 2015. Document filed by IXI IP,LLC, IXI Mobile (R&D) Ltd..(Biemer, Thomas) (Entered: 07/29/2015)
- 08/03/2015 67 MEMO ENDORSEMENT on re: (84 in 1:14-cv-04428-RJS) Letter, filed by Blackberry Limited, Blackberry Corporation, (77 in 1:14-cv-04355-RJS) Letter, filed by Samsung Electronics Co., Ltd., Samsung Electronics America, Inc. ENDORSEMENT: SO ORDERED. ( Brief due by 8/7/2015.) (Signed by Judge Richard J. Sullivan on 8/3/2015) (mro) (Entered: 08/04/2015)
- 08/04/2015 68 LETTER MOTION for Leave to File Excess Pages and Exhibits for Defendants' Responsive Claim Construction Brief addressed to Judge Richard J. Sullivan from Marshall Beil (on behalf of all Defendants) dated August 3, 2015. Document filed by Apple, Inc..(Chuebon, Gregory) (Entered: 08/04/2015)
- 08/04/2015 69 ORDER granting 5 Motion for Joshua D. Wolson to Appear Pro Hac Vice. (Signed by Judge Richard J. Sullivan on 8/4/2015) (mro) (Entered: 08/05/2015)
- 08/04/2015 70 ORDER granting 20 Motion for Mark W. Halderman to Appear Pro Hac Vice. (Signed by Judge Richard J. Sullivan on 8/4/2015) (mro) (Entered: 08/05/2015)
- 08/06/2015 71 OPINION AND ORDER re: (27 in 1:14-cv-07954-RJS) MOTION to Transfer Case Apple Inc.'s Notice of Motion to Transfer Venue Pursuant to 28 U.S.C. § 1404(a). filed by Apple, Inc., (47 in 1:14-cv-04428-RJS) MOTION to Transfer Case . filed by Blackberry Limited, Blackberry Corporation, (44 in 1:14-cv-04355-RJS) MOTION to Transfer Case Samsung's Notice of Motion to Transfer Venue Pursuant to 28 U.S.C. § 1404(a). filed by Samsung Electronics Co., Ltd., Samsung Telecommunications America, LLC, Samsung Electronics America, Inc. Weighing the factors set forth above and having considered all the facts and circumstances before it, the Court determines that Defendants have demonstrated by clear and convincing evidence that transfer of these three actions is appropriate. Accordingly, IT IS HEREBY ORDERED THAT Defendants' motions to transfer these actions to the Northern District of California are GRANTED. The Clerk of the Court is respectfully directed to terminate the motions pending at docket entries 44 in case number 14--cv-4355 (RJS), 47 in case number 14--cv-4428 (RJS), and 27 in case number 14-cv-7954 (RJS), and to close these cases. SO ORDERED. (As further set forth within this Order.) (Signed by Judge Richard J. Sullivan on 8/6/2015) (ajs) (Entered: 08/07/2015)
- 08/06/2015 CASE TRANSFERRED OUT ELECTRONICALLY from the U.S.D.C. Southern District of New York to the United States District Court - Northern District of California. (ajs) (Entered: 08/14/2015)
- 08/12/2015 72 LETTER addressed to Judge Richard J. Sullivan from Thomas S. Biemer, Esquire dated August 12, 2015 re: Requesting Reconsideration of the Order entered August 7, 2015. Document filed by IXI IP,LLC, IXI Mobile (R&D) Ltd..(Biemer, Thomas) (Entered: 08/12/2015)
- 08/17/2015 73 Case transferred in from District of New York Southern; Case Number 1:14-cv-07954. Original file certified copy of transfer order and docket sheet received. Modified on 8/19/2015 (vlkS, COURT STAFF). (Entered: 08/19/2015)
- 08/19/2015 74 Initial Case Management Scheduling Order with ADR Deadlines: Case Management Statement due by 11/11/2015. Case Management Conference set for 11/18/2015 01:30 PM. (vlkS, COURT STAFF) (Filed on 8/19/2015) (Entered: 08/19/2015)
- 08/19/2015 75 CLERK'S NOTICE re Transfer of Case (vlkS, COURT STAFF) (Filed on 8/19/2015) (Entered: 08/19/2015)

|            |     |   |                               |
|------------|-----|---|-------------------------------|
| 08/21/2015 | 76  | NOTICE of Change In Counsel by Gregory A Blue (Blue, Gregory) (Filed on 8/21/2015) (Entered: 08/21/2015)  |                               |
| 08/24/2015 | 77  | NOTICE of Appearance by Jennifer S. Coleman (Coleman, Jennifer) (Filed on 8/24/2015) (Entered: 08/24/2015)  |                               |
| 08/24/2015 | 78  | CONSENT/DECLINATION to Proceed Before a US Magistrate Judge by IXI IP,LLC, IXI Mobile (R&D) Ltd... (Coleman, Jennifer) (Filed on 8/24/2015) (Entered: 08/24/2015)   |                               |
| 08/24/2015 | 79  | CLERK'S NOTICE OF IMPENDING REASSIGNMENT TO A U.S. DISTRICT COURT JUDGE: The Clerk of this Court will now randomly reassign this case to a District Judge because either (1) a party has not consented to the jurisdiction of a Magistrate Judge, or (2) time is of the essence in deciding a pending judicial action for which the necessary consents to Magistrate Judge jurisdiction have not been secured. You will be informed by separate notice of the district judge to whom this case is reassigned. ALL HEARING DATES PRESENTLY SCHEDULED BEFORE THE CURRENT MAGISTRATE JUDGE ARE VACATED AND SHOULD BE RE-NOTICED FOR HEARING BEFORE THE JUDGE TO WHOM THIS CASE IS REASSIGNED. This is a text only docket entry; there is no document associated with this notice. (ig, COURT STAFF) (Filed on 8/24/2015) (Entered: 08/24/2015)   |                               |
| 08/25/2015 | 80  | ORDER REASSIGNING CASE. Case reassigned to Judge Hon. Phyllis J. Hamilton for all further proceedings. Magistrate Judge Donna M. Ryu no longer assigned to the case. Signed by the Executive Committee on August 25, 2015. (cjIS, COURT STAFF) (Filed on 8/25/2015) (Entered: 08/25/2015)   |                               |
| 08/25/2015 | 81  | NOTICE of Appearance by John V. Picone, III (Picone, John) (Filed on 8/25/2015) (Entered: 08/25/2015)   |                               |
| 08/25/2015 | 82  | NOTICE of Appearance by Jeffrey Michael Ratinoff (Ratinoff, Jeffrey) (Filed on 8/25/2015) (Entered: 08/25/2015)   |                               |
| 08/25/2015 | 83  | NOTICE of Appearance by Aleksandr Korzh (Korzh, Aleksandr) (Filed on 8/25/2015) (Entered: 08/25/2015)   |                               |
| 09/03/2015 | 84  | ORDER SETTING CASE MANAGEMENT CONFERENCE. Joint Case Management Statement due by 11/12/2015. Initial Case Management Conference set for 11/19/2015 02:00 PM in Courtroom 3, 3rd Floor, Oakland. Signed by Judge Phyllis J. Hamilton on 9/3/15. (napS, COURT STAFF) (Filed on 9/3/2015) (Entered: 09/03/2015)  |                               |
| 09/09/2015 | 85  | ORDER RELATING CASES 15-cv-3752-HSG and 15-cv-3754-RS. Signed by Judge Haywood S. Gilliam, Jr. on 9/9/2015. (ndrS, COURT STAFF) (Filed on 9/9/2015) (Entered: 09/09/2015)   |                               |
| 09/10/2015 | 86  | ORDER REASSIGNING CASE. Case reassigned to Judge Hon. Haywood S Gilliam, Jr for all further proceedings. Judge Hon. Phyllis J. Hamilton no longer assigned to the case. Signed by the Executive Committee on 9/10/2015. (vlkS, COURT STAFF) (Filed on 9/10/2015) (Entered: 09/10/2015)  | Events since last full update |
| 03/01/2017 | 129 | CLERKS NOTICE REGARDING CHANGE OF LOCATION FOR JUDGE GILLIAM: Effective March 2, 2017, Judge Haywood S. Gilliam, Jr.'s courtroom and chambers will be located in the Ronald V. Dellums Federal Building and United States Courthouse, Courtroom 2, 4th Floor, 1301 Clay Street, Oakland, CA 94612. On or after March 2, 2017, all filings for matters pending on Judge Gilliam's docket, all court appearances, and all deliveries of chambers copies of documents must be made at the Oakland Courthouse. The days and times for law and motion calendars and all currently scheduled proceedings remain unchanged. Please note that all of Judge Gilliam's case files will be moved to the Oakland Courthouse; therefore, all case numbers assigned to him will be changed slightly to reflect the correct location. Previously, all case numbers started with 3 to indicate the San Francisco office (Example: 3:15-cv-1129-HSG). As of March 2, 2017 all of Judge Gilliam's case files will begin with 4 to indicate the Oakland office, but everything else will stay the same (Example: 4:15-cv-1129-HSG). When e-filing, using the short case number format will always avoid problems when searching for the correct case: 12-12345 (YY-NNNNN). For information on the Oakland Courthouse please go to: <a href="http://cand.uscourts.gov/locations-oakland">http://cand.uscourts.gov/locations-oakland</a> (hdjS, COURT STAFF) (Filed on 3/1/2017) (Entered: 03/01/2017) | Events since last full update |
| 03/01/2017 | 130 | Letter from John V. Picone III re IPR Status. (Picone, John) (Filed on 3/1/2017) (Entered: 03/01/2017)  | Events since last full update |
| 03/17/2017 | 131 | ORDER CONTINUING STAY. Signed by Judge Haywood S. Gilliam, Jr. on 3/17/2017. (ndrS, COURT STAFF) (Filed on 3/17/2017) (Entered: 03/17/2017)   | Events since last full update |

Copyright © 2017 LexisNexis CourtLink, Inc. All rights reserved.  
\*\*\* THIS DATA IS FOR INFORMATIONAL PURPOSES ONLY \*\*\*

**United States Patent Trial and Appeals Board**

US Patent Trial and Appeals Board - Alexandria  
(Alexandria)

**IPR2015-01444**

**Samsung Electronics Co., Ltd. Vs. IXI IP, LLC**

This case was retrieved from the court on Tuesday, November 08, 2016

**Header**

Case Number: IPR2015-01444  
 Date Filed: 06/19/2015  
 Date Full Case Retrieved: 11/08/2016  
 Status: Open  
 Misc: Civil  
[\[ Summary \]](#) [\[ Participants \]](#) [\[ Proceedings \]](#)

**Summary**

Court Case Status: Trial Instituted  
 Case Type: IPR: Inter partes review  
 Date of Decision to Institute Case: 2015-12-30  
 Technical Center Number: 2600  
 Patent Application Number: 09850399  
 Patent Number: 7039033

**Participants**

**Litigants**

Samsung Electronics Co., Ltd.  
 Petitioner

Ixi Ip, Llc  
 PatentOwner

**Proceedings**

| <b><u>File Date</u></b> | <b><u>Details</u></b>            | <b><u>Document Type</u></b> | <b><u>Paper/ Exhibit No.</u></b> | <b><u>Filed By</u></b> | <b><u>Public?</u></b> |
|-------------------------|----------------------------------|-----------------------------|----------------------------------|------------------------|-----------------------|
| 06/19/2015              | Power of Attorney                | Paper                       | 1                                | petitioner             | Yes                   |
| 06/19/2015              | Petition for Inter Partes Review | Paper                       | 2                                | petitioner             | Yes                   |
| 06/19/2015              | Haller US7039033                 | Exhibits                    | 1001                             | petitioner             | Yes                   |
| 06/19/2015              | Bellovin Network Security        | Exhibits                    | 1002                             | petitioner             | Yes                   |
| 06/19/2015              | Kiaei Declaration                | Exhibits                    | 1003                             | petitioner             | Yes                   |
| 06/19/2015              | Kiaei CV                         | Exhibits                    | 1004                             | petitioner             | Yes                   |
| 06/19/2015              | Marchand WO2001076154            | Exhibits                    | 1005                             | petitioner             | Yes                   |
| 06/19/2015              | Marchand Application 09541529    | Exhibits                    | 1006                             | petitioner             | Yes                   |



|            |  |          |      |              |     |
|------------|--|----------|------|--------------|-----|
| 06/19/2015 | Handley RFC 2543   | Exhibits | 1007 | petitioner   | Yes |
| 06/19/2015 | Larsson US6836474  | Exhibits | 1008 | petitioner   | Yes |
| 06/19/2015 | Jini Specification Part 1  | Exhibits | 1009 | petitioner   | Yes |
| 06/19/2015 | Jini Specification Part 2  | Exhibits | 1009 | petitioner   | Yes |
| 06/19/2015 | Jini Specification Part 3  | Exhibits | 1009 | petitioner   | Yes |
| 06/19/2015 | Jini Specification Part 4  | Exhibits | 1009 | petitioner   | Yes |
| 06/19/2015 | Jini Specification Part 5  | Exhibits | 1009 | petitioner   | Yes |
| 06/19/2015 | Nurmann US6560642  | Exhibits | 1010 | petitioner   | Yes |
| 06/19/2015 | Vilander US6771635   | Exhibits | 1011 | petitioner   | Yes |
| 06/19/2015 | Claim Chart April 9, 2015  | Exhibits | 1012 | petitioner   | Yes |
| 06/19/2015 | Claim Chart March 27, 2015   | Exhibits | 1013 | petitioner   | Yes |
| 06/19/2015 | Rfc 2131   | Exhibits | 1014 | petitioner   | Yes |
| 06/19/2015 | Hoffman US6622017  | Exhibits | 1015 | petitioner   | Yes |
| 07/02/2015 | Notice of Filing Date Accorded to Petition   | Paper    | 3    | board        | Yes |
| 07/09/2015 | Power of Attorney  | Paper    | 4    | potential po | Yes |
| 07/09/2015 | Related Matters  | Paper    | 5    | potential po | Yes |
| 10/02/2015 | Patent Owner's Preliminary Response Pursuant to 37 C.F.R. Section 42.107               | Paper    | 6    | patentowner  | Yes |
| 11/04/2015 | Petitioners Updated Mandatory Notices  | Paper    | 7    | petitioner   | Yes |
| 12/30/2015 | Decision Institution of Inter Partes Review  | Paper    | 8    | board        | Yes |
| 12/30/2015 | Scheduling Order   | Paper    | 9    | board        | Yes |
| 01/13/2016 | Patent Owner's Objections to Petitioner's Evidence Pursuant to 37 C.F.R. Section 42.64 | Paper    | 10   | patentowner  | Yes |
| 02/04/2016 | Petitioners Notice of Additional Back-Up Counsel                                       | Paper    | 11   | petitioner   | Yes |
| 02/26/2016 | Notice of Deposition   | Paper    | 12   | patentowner  | Yes |
| 03/22/2016 | Notice of Joint Stipulation to Modify Schedule   | Paper    | 13   | patentowner  | Yes |
| 04/06/2016 | Patent Owner Response  | Paper    | 14   | patentowner  | Yes |
| 04/06/2016 | Expunged   | Exhibits | 2301 | patentowner  | Yes |
| 04/06/2016 | Exhibit 2302   | Exhibits | 2302 | patentowner  | Yes |
| 04/06/2016 | Exhibit 2303   | Exhibits | 2303 | patentowner  | Yes |
| 04/06/2016 | Exhibit 2304   | Exhibits | 2304 | patentowner  | Yes |
| 04/06/2016 | Exhibit 2305   | Exhibits | 2305 | patentowner  | Yes |
| 04/06/2016 | Exhibit 2306   | Exhibits | 2306 | patentowner  | Yes |
| 04/13/2016 | Notice of Objections to Evidence   | Paper    | 15   | petitioner   | Yes |
| 04/14/2016 | Ex. 2301   | Exhibits | 2301 | patentowner  | Yes |
| 05/05/2016 | Petitioner's Notice of Deposition  | Paper    | 16   | petitioner   | Yes |
| 05/17/2016 | Petitioners Notice of Designation of Additional Backup Counsel                         | Paper    | 17   | petitioner   | Yes |
| 06/21/2016 | Petitioners Reply  | Paper    | 18   | petitioner   | Yes |
| 06/21/2016 | A Programmers Guide toJini Technology  | Exhibits | 1016 | petitioner   | Yes |
| 06/21/2016 | Chadha US5963908   | Exhibits | 1017 | petitioner   | Yes |
| 06/21/2016 | Deposition Transcript of Dr. Mandayam, IPR2015-01443                                   | Exhibits | 1018 | petitioner   | Yes |
| 06/21/2016 | Deposition Transcript of Dr. Mandayam, IPR2015-01444                                   | Exhibits | 1019 | petitioner   | Yes |
| 06/28/2016 | Patent Owner's Objections to Evidence Relied Upon in the Reply                         | Paper    | 19   | patentowner  | Yes |
| 08/03/2016 | Patent Owner's Request for Oral Argument Under 37 C.F.R. Section 42.70                 | Paper    | 20   | patentowner  | Yes |
| 08/03/2016 | Patent Owner's Motion to Exclude Evidence  | Paper    | 21   | patentowner  | Yes |
| 08/03/2016 | Petitioners Request for Oral Argument  | Paper    | 22   | petitioner   | Yes |
| 08/10/2016 | Order - Request for Oral Hearing   | Paper    | 23   | board        | Yes |
| 08/17/2016 | Sheldon Hess Declaration Part 1  | Exhibits | 1020 | petitioner   | Yes |
| 08/17/2016 | Petitioners Opposition to Motion to Exclude  | Paper    | 24   | petitioner   | Yes |

|            |   |          |      |             |     |
|------------|---|----------|------|-------------|-----|
| 08/17/2016 | Sheldon Hess Declaration Part 2                               | Exhibits | 1020 | petitioner  | Yes |
| 08/31/2016 | Patent Owner's Reply in Support of Motion to Exclude Evidence | Paper    | 25   | patentowner | Yes |
| 10/20/2016 | Record of Oral Hearing  | Paper    | 26   | board       | Yes |

---

Copyright © 2017 LexisNexis CourtLink, Inc. All rights reserved.  
\*\*\* THIS DATA IS FOR INFORMATIONAL PURPOSES ONLY \*\*\*

---

**US District Court Civil Docket**

U.S. District - New York Southern  
(Foley Square)

**1:14cv7954**

**Ixi Mobile (R&D) Ltd. et al v. Apple, Inc.**

This case was retrieved from the court on Monday, February 27, 2017

---

Date Filed: **10/02/2014**

Assigned

To: **Judge Richard J. Sullivan**

Referred **Magistrate Judge Debra C. Freeman**

To: **(Settlement)**

Nature of

suit: **Patent (830)**

Cause: **Fed. Question**

Lead

Docket: **None**

Other

Docket: **1:14cv04355**

Jurisdiction: **Federal Question**

Class Code: **CLOSED**

Closed: **08/06/2015**

Statute: **28:1331**

Jury Demand: **Both**

Demand Amount: **\$0**

NOS Description: **Patent**

---

**Litigants**

Ixi Mobile (R&D) Ltd.  
Plaintiff

---

**Attorneys**

Gary David Colby  
LEAD ATTORNEY; ATTORNEY TO BE NOTICED  
Dilworth Paxson, LLP  
1500 Market Street  
Philadelphia, PA 19102  
USA  
(215)-575-7075  
Email: Gcolby@dilworthlaw.Com

Gregory A. Blue  
LEAD ATTORNEY; ATTORNEY TO BE NOTICED  
Dilworth Paxson LLP (NY)  
99 Park Avenue Suite 320  
New York, NY 10016  
USA  
(917)-675-4252  
Fax: (212) 208-6874  
Email: Gblue@dilworthlaw.Com

John Joseph Higson  
LEAD ATTORNEY; PRO HAC VICE; ATTORNEY TO BE NOTICED  
Dilworth Paxson LLP  
1500 Market Street Suite 3500  
Philadelphia, PA 19103  
USA  
(212)575-7152  
Fax: (215)-575-7200  
Email: Jhigson@dilworthlaw.Com

Joshua D. Wolson  
LEAD ATTORNEY; PRO HAC VICE; ATTORNEY TO BE NOTICED

Dilworth Paxson LLP (PA)  
1500 Market Street Suite 3500e  
Philadelphia , PA 19102-2101  
USA  
(215)-575-7295  
Fax: (215)-575-7200  
Email: Jwolson@dilworthlaw.Com

Mark William Halderman  
LEAD ATTORNEY; ATTORNEY TO BE NOTICED  
Dilworth Paxson LLP  
1500 Market Street, Suite 3500(E)  
Philadelphia , PA 19102  
USA  
(215)-575-7186  
Fax: (215)-575-7200  
Email: Mwhalderman@dilworthlaw.Com

Thomas Steven Biemer  
LEAD ATTORNEY; ATTORNEY TO BE NOTICED  
Dilworth Paxson LLP (PA)  
1500 Market Street Suite 3500e  
Philadelphia , PA 19102-2101  
USA  
(215)-575-7025  
Fax: (215)-575-7200  
Email: Tbiemer@dilworthlaw.Com

Ixi Ip, Llc  
Plaintiff

Gary David Colby  
LEAD ATTORNEY; ATTORNEY TO BE NOTICED  
Dilworth Paxson, LLP  
1500 Market Street  
Philadelphia , PA 19102  
USA  
(215)-575-7075  
Email: Gcolby@dilworthlaw.Com

Gregory A. Blue  
LEAD ATTORNEY; ATTORNEY TO BE NOTICED  
Dilworth Paxson LLP (NY)  
99 Park Avenue Suite 320  
New York , NY 10016  
USA  
(917)-675-4252  
Fax: (212) 208-6874  
Email: Gblue@dilworthlaw.Com

John Joseph Higson  
LEAD ATTORNEY; PRO HAC VICE; ATTORNEY TO BE NOTICED  
Dilworth Paxson LLP  
1500 Market Street Suite 3500  
Philadelphia , PA 19103  
USA  
(212)575-7152  
Fax: (215)-575-7200  
Email: Jhigson@dilworthlaw.Com

Joshua D. Wolson  
LEAD ATTORNEY; PRO HAC VICE; ATTORNEY TO BE NOTICED  
Dilworth Paxson LLP (PA)  
1500 Market Street Suite 3500e  
Philadelphia , PA 19102-2101  
USA  
(215)-575-7295  
Fax: (215)-575-7200  
Email: Jwolson@dilworthlaw.Com

Mark William Halderman

LEAD ATTORNEY; ATTORNEY TO BE NOTICED  
 Dilworth Paxson LLP  
 1500 Market Street, Suite 3500(E)  
 Philadelphia , PA 19102  
 USA  
 (215)-575-7186  
 Fax: (215)-575-7200  
 Email: Mwhalderman@dilworthlaw.Com

Thomas Steven Biemer  
 LEAD ATTORNEY; ATTORNEY TO BE NOTICED  
 Dilworth Paxson LLP (PA)  
 1500 Market Street Suite 3500e  
 Philadelphia , PA 19102-2101  
 USA  
 (215)-575-7025  
 Fax: (215)-575-7200  
 Email: Tbiemer@dilworthlaw.Com

Apple, Inc.  
 Defendant

Harrison J. Frahn , IV  
 LEAD ATTORNEY; ATTORNEY TO BE NOTICED  
 Simpson Thacher & Bartlett LLP (CA)  
 2475 Hanover Street  
 Palo Alto , CA 94304  
 USA  
 (650)-251-5065  
 Email: Hfrahn@stblaw.Com

Gregory Todd Chuebon  
 ATTORNEY TO BE NOTICED  
 Simpson Thacher & Bartlett LLP (NY)  
 425 Lexington Avenue  
 New York , NY 10017  
 USA  
 (212)-455-3353  
 Fax: (212)-455-2502  
 Email: Gchuebon@stblaw.Com

Patrick E. King  
 ATTORNEY TO BE NOTICED  
 Simpson Thacher & Bartlett LLP (CA)  
 2475 Hanover Street  
 Palo Alto , CA 94304  
 USA  
 (650) 251-5000  
 Email: Pking@stblaw.Com

| Date       | # | Proceeding Text   | Source |
|------------|---|---|--------|
| 10/02/2014 | 1 | COMPLAINT against Apple, Inc.. (Filing Fee \$ 350.00, Receipt Number 465401106289) Document filed by IXI Mobile (R&D) Ltd., IXI IP, LLC. (moh) (Additional attachment(s) added on 10/6/2014: # 1 Exhibit A, # 2 Exhibit B, # 3 Exhibit C, # 4 Exhibit D) (moh). (Entered: 10/03/2014) |        |
| 10/02/2014 |   | SUMMONS ISSUED as to Apple, Inc.. (moh) (Entered: 10/03/2014)   |        |
| 10/02/2014 |   | CASE REFERRED TO Judge Richard J. Sullivan as possibly related to 14cv4355. (moh) (Entered: 10/03/2014)   |        |
| 10/02/2014 |   | Case Designated ECF. (moh) (Entered: 10/03/2014)  |        |
| 10/02/2014 | 2 | STATEMENT OF RELATEDNESS re: that this action be filed as related to 14cv4355. Document filed by IXI IP, LLC, IXI Mobile (R&D) Ltd.. (moh) (moh). (Entered: 10/03/2014)   |        |
| 10/02/2014 | 3 | CIVIL COVER SHEET filed. (moh) (moh). (Entered: 10/03/2014)   |        |
| 10/02/2014 |   | Mailed notice to Commissioner of Patents and Trademarks to report the filing of this action. (moh) (Entered: 10/03/2014)  |        |
| 10/02/2014 | 4 | STANDING ORDER IN RE PILOT PROJECT REGARDING CASE MANAGEMENT TECHNIQUES   |        |

FOR COMPLEX CIVIL CASES IN THE SOUTHERN DISTRICT OF NEW YORK (See M-10-468 Order filed November 1, 2011). This case is hereby designated for inclusion in the Pilot Project Regarding Case Management Techniques for Complex Civil Cases in the Southern District of New York (the Pilot Project), unless the judge to whom this case is assigned determines otherwise. This case is designated for inclusion in the Pilot Project because it is a class action, an MDL action, or is in one of the following Nature of Suit categories: 160, 245, 315, 355, 365, 385, 410, 830, 840, 850, 893, or 950. The presiding judge in a case that does not otherwise qualify for inclusion in the Pilot Project may nevertheless designate the case for inclusion in the Pilot Project by issuing an order directing that the case be included in the Pilot Project. The description of the Pilot Project, including procedures to be followed, is attached to this Order. (Signed by Judge Loretta A. Preska on 10/31/2011) (moh) (Entered: 10/03/2014)

- 10/02/2014 Case Eligible for Patent Pilot Program. (moh) (Entered: 10/08/2014)
- 10/07/2014 5 MOTION to Appear Pro Hac Vice for Joshua D. Wolson. Filing fee \$ 200.00, receipt number 0208-10180198. Motion and supporting papers to be reviewed by Clerk's Office staff. Document filed by IXI IP,LLC, IXI Mobile (R&D) Ltd.. (Attachments: # 1 Online, # 2 Online (Entered: 10/07/2014)
- 10/07/2014 &gt;&gt;&gt;NOTICE REGARDING PRO HAC VICE MOTION. Regarding Document No. 5 MOTION to Appear Pro Hac Vice for Joshua D. Wolson. Filing fee \$ 200.00, receipt number 0208-10180198. Motion and supporting papers to be reviewed by Clerk's Office staff.. The document has been reviewed and there are no deficiencies. (bcu) (Entered: 10/07/2014)
- 10/07/2014 6 RULE 7.1 CORPORATE DISCLOSURE STATEMENT. No Corporate Parent. Document filed by IXI IP,LLC.(Biemer, Thomas) (Entered: 10/07/2014)
- 10/07/2014 7 RULE 7.1 CORPORATE DISCLOSURE STATEMENT. Identifying Corporate Parent IXI Mobile Inc. for IXI Mobile (R&D) Ltd.. Document filed by IXI Mobile (R&D) Ltd.. (Biemer, Thomas) (Entered: 10/07/2014)
- 10/10/2014 CASE ACCEPTED AS RELATED. Create association to 1:14-cv-04355-RJS. Notice of Assignment to follow. (pgu) (Entered: 10/10/2014)
- 10/10/2014 NOTICE OF CASE ASSIGNMENT to Judge Richard J. Sullivan. Judge Unassigned is no longer assigned to the case. (pgu) (Entered: 10/10/2014)
- 10/10/2014 Magistrate Judge Debra C. Freeman is so designated. (pgu) (Entered: 10/10/2014)
- 10/13/2014 8 AFFIDAVIT OF SERVICE of Summons and Complaint,. Apple, Inc. served on 10/3/2014, answer due 10/24/2014. Service was accepted by Jan Lapinid, Registered Agent. Document filed by IXI Mobile (R&D) Ltd.; IXI IP,LLC. (Biemer, Thomas) (Entered: 10/13/2014)
- 10/22/2014 9 LETTER MOTION for Extension of Time to File Answer re: 1 Complaint, addressed to Judge Richard J. Sullivan from Greg Chuebon dated October 22, 2014. Document filed by Apple, Inc..(Chuebon, Gregory) (Entered: 10/22/2014)
- 10/22/2014 10 ORDER granting 9 Letter Motion for Extension of Time to Answer. SO ORDERED. Apple, Inc. answer due 11/24/2014. (Signed by Judge Richard J. Sullivan on 10/22/2014) (mro) (Entered: 10/23/2014)
- 10/27/2014 11 MOTION for John Joseph Higson to Appear Pro Hac Vice . Filing fee \$ 200.00, receipt number 0208-10245229. Motion and supporting papers to be reviewed by Clerk's Office staff. Document filed by IXI IP,LLC, IXI Mobile (R&D) Ltd.. (Attachments: # 1 Online, # 2 Online (Entered: 10/27/2014)
- 10/27/2014 &gt;&gt;&gt;NOTICE REGARDING PRO HAC VICE MOTION. Regarding Document No. 11 MOTION for John Joseph Higson to Appear Pro Hac Vice . Filing fee \$ 200.00, receipt number 0208-10245229. Motion and supporting papers to be reviewed by Clerk's Office staff.. The document has been reviewed and there are no deficiencies. (bcu) (Entered: 10/27/2014)
- 11/04/2014 12 ORDER granting 11 Motion for John Joseph Higson to Appear Pro Hac Vice. (Signed by Judge Richard J. Sullivan on 11/3/2014) (mro) (Entered: 11/04/2014)
- 11/07/2014 13 LETTER addressed to Judge Richard J. Sullivan from Harrison J. Frahn IV dated November 7, 2014 re: Apple's Letter regarding filings in IXI Mobile (R & D), LTD. v. Samsung Electronics Co. and IXI Mobile (R & D), LTD. v. Blackberry, LTD. Document filed by Apple, Inc..(Chuebon, Gregory) (Entered: 11/07/2014)
- 11/10/2014 14 NOTICE OF APPEARANCE by Harrison J. Frahn, IV on behalf of Apple, Inc.. (Frahn, Harrison) (Entered: 11/10/2014)
- 11/10/2014 15 LETTER addressed to Judge Richard J. Sullivan from Thomas S. Biemer, Esquire dated November 10, 2014 re: Response to Letter Dated November 7, 2014 from Defendant

- Apple, Inc. Document filed by IXI IP,LLC, IXI Mobile (R&D) Ltd..(Biemer, Thomas) (Entered: 11/10/2014)
- 11/10/2014 16 NOTICE OF APPEARANCE by Patrick E. King on behalf of Apple, Inc.. (King, Patrick) (Entered: 11/10/2014)
- 11/24/2014 17 RULE 7.1 CORPORATE DISCLOSURE STATEMENT. No Corporate Parent. Document filed by Apple, Inc..(Chuebon, Gregory) (Entered: 11/24/2014)
- 11/24/2014 18 ANSWER to 1 Complaint, with JURY DEMAND. Document filed by Apple, Inc..(Chuebon, Gregory) (Entered: 11/24/2014)
- 12/01/2014 19 ORDER: The Court is in receipt of the parties' letters concerning disputes about the proposed case management plan. Having considered the parties' arguments, IT IS HEREBY ORDERED THAT, no later than December 8, 2014, the parties shall jointly submit a revised case management plan that reflects a 30-day extension of all contested dates. So Ordered (Signed by Judge Richard J. Sullivan on 12/1/2014) (js) Modified on 12/2/2014 (js). (Entered: 12/02/2014)
- 12/03/2014 20 MOTION to Appear Pro Hac Vice for Mark W. Halderman, Esquire. Filing fee \$ 200.00, receipt number 0208-10371119. Motion and supporting papers to be reviewed by Clerk's Office staff. Document filed by IXI IP,LLC, IXI Mobile (R&D) Ltd.. (Attachments: # 1 Online, # 2 Online (Entered: 12/03/2014)
- 12/04/2014 &gt;&gt;&gt;NOTICE REGARDING PRO HAC VICE MOTION. Regarding Document No. 20 MOTION to Appear Pro Hac Vice for Mark W. Halderman, Esquire. Filing fee \$ 200.00, receipt number 0208-10371119. Motion and supporting papers to be reviewed by Clerk's Office staff.. The document has been reviewed and there are no deficiencies. (wb) (Entered: 12/04/2014)
- 12/08/2014 21 JOINT LETTER addressed to Judge Richard J. Sullivan from Thomas S. Biemer, Esquire dated 12/8/2014 re: Proposed Case Management Plan and Scheduling Order. Document filed by IXI IP,LLC, IXI Mobile (R&D) Ltd.. (Attachments: # 1 Online (Entered: 12/08/2014)
- 12/12/2014 22 CASE MANAGEMENT PLAN AND SCHEDULING ORDER: All parties do not consent to disposition of this case by a Magistrate Judge, pursuant to 28 U.S.C. § 636(c). These cases are to be tried to juries. Plaintiffs' Claim Construction Brief shall be filed by: July 8, 2015. Defendants' Claim Construction Briefs shall be filed by: August 7, 2015. Plaintiffs' Reply Claim Construction Brief shall be filed by: August 14, 2015. Depositions shall be completed by: 11/10/2015. Completion of Fact Discovery: 11/10/2015. The Court will conduct a post-discovery conference on 11/24/2015. Referral to a Magistrate Judge for settlement discussions. (Signed by Judge Richard J. Sullivan on 12/8/2014) (mro) (Entered: 12/15/2014)
- 12/12/2014 Set/Reset Deadlines: Brief due by 8/14/2015. (mro) (Entered: 12/15/2014)
- 12/15/2014 23 LETTER addressed to Judge Richard J. Sullivan from Patrick E. King dated 12/15/2014 re: Motion to Transfer. Document filed by Apple, Inc..(King, Patrick) (Entered: 12/15/2014)
- 12/18/2014 24 LETTER addressed to Judge Richard J. Sullivan from Thomas S. Biemer, Esquire dated December 18, 2014 re: Response to the Pre-Motion Letter from Apple Inc. dated 12-15-14. Document filed by IXI IP,LLC, IXI Mobile (R&D) Ltd..(Biemer, Thomas) (Entered: 12/18/2014)
- 12/22/2014 25 ORDER: The Court seeks input from Defendants Samsung Electronics Co., Ltd., et al. ("Samsung") as to their views concerning a potential 28 U.S.C. § 1404(a) motion to transfer Case No. 14-cv-4355 (RJS) to the Northern District of California. Accordingly, IT IS HEREBY ORDERED THAT Defendants Samsung shall submit a letter response to a potential 28 U.S.C. § 1404(a) motion to transfer to the Northern District of California by Tuesday, December 30, 2014. (Signed by Judge Richard J. Sullivan on 12/22/2014) (mro) (Entered: 12/22/2014)
- 01/05/2015 26 ORDER: After receiving pre-motion letters from the parties in Case Nos. 14-cv-7954 (RJS) and 14-cv-4428 (RJS) (Doc. Nos. 23, 24, No. 14-cv-7954 (RJS); Doc. Nos. 43, 44, No. 14-cv-4428 (RJS)), the Court, on December 22, 2014, issued an Order to Defendants Samsung Electronics Co., Ltd., et al. ("Samsung") in a related case, Case No. 14-cv-4355 (RJS), seeking input as to their views concerning a potential 28 U.S.C. § 1404(a) motion to transfer Case No. 14-cv-4355 (RJS) to the Northern District of California. (Doc. No. 39, No. 14-cv-4355 (RJS).) The Court is in receipt of Samsung's letter dated December 30, 2014, supporting Apple's and BlackBerry's motions to transfer but declining, at this time, to file their own motion to transfer. (Doc. No. 40, No. 14-cv-4355 (RJS).) Accordingly, IT IS HEREBY ORDERED THAT all of the above-captioned parties, including Samsung, shall appear for a conference on January 20, 2015 at 4:00 p.m. in Courtroom 905 at 40 Foley Square concerning the anticipated motions to transfer Case Nos. 14-cv-7954 (RJS) and 14-cv-4428 (RJS) to the Northern District of California pursuant to 28 U.S.C. § 1404(a). (

Status Conference set for 1/20/2015 at 04:00 PM in Courtroom 905, 40 Centre Street, New York, NY 10007 before Judge Richard J. Sullivan.) (Signed by Judge Richard J. Sullivan on 1/5/2015) (mro) (Entered: 01/05/2015)

- 01/20/2015 Minute Entry for proceedings held before Judge Richard J. Sullivan: Pre-Motion Conference was held on 1/20/2015. Plaintiffs' counsel, Thomas Biemer, was present. Defense counsel, Gregory Arovas, was present for Defendant Samsung. Marshall Beil was present for Defendant BlackBerry. Harrison (Buzz) Frahn and Elizabeth Gillen were present for Defendant Apple. The court reporter was present. Defendants' motions to transfer these actions to the Northern District of California are due on 2/3/15. Plaintiffs' responses are due on 2/17/15; and the defendants' replies are due on 2/20/15. (sc) (Entered: 01/22/2015)
- 02/03/2015 27 MOTION to Transfer Case Apple Inc.'s Notice of Motion to Transfer Venue Pursuant to 28 U.S.C. § 1404(a). Document filed by Apple, Inc..(King, Patrick) (Entered: 02/03/2015)
- 02/03/2015 28 MEMORANDUM OF LAW in Support re: 27 MOTION to Transfer Case Apple Inc.'s Notice of Motion to Transfer Venue Pursuant to 28 U.S.C. § 1404(a). . Document filed by Apple, Inc.. (King, Patrick) (Entered: 02/03/2015)
- 02/03/2015 29 DECLARATION of John William Van Dyke in Support re: 27 MOTION to Transfer Case Apple Inc.'s Notice of Motion to Transfer Venue Pursuant to 28 U.S.C. § 1404(a).. Document filed by Apple, Inc.. (King, Patrick) (Entered: 02/03/2015)
- 02/03/2015 30 DECLARATION of Elizabeth A. Gillen in Support re: 27 MOTION to Transfer Case Apple Inc.'s Notice of Motion to Transfer Venue Pursuant to 28 U.S.C. § 1404(a).. Document filed by Apple, Inc.. (Attachments: # 1 Online (Entered: 02/03/2015)
- 02/17/2015 31 BRIEF re: 27 MOTION to Transfer Case Apple Inc.'s Notice of Motion to Transfer Venue Pursuant to 28 U.S.C. § 1404(a). Omnibus Brief In Opposition to Motion to Transfer. Document filed by IXI IP,LLC, IXI Mobile (R&D) Ltd..(Biemer, Thomas) (Entered: 02/17/2015)
- 02/17/2015 32 DECLARATION of John J. Higson in Opposition re: 27 MOTION to Transfer Case Apple Inc.'s Notice of Motion to Transfer Venue Pursuant to 28 U.S.C. § 1404(a).. Document filed by IXI IP,LLC, IXI Mobile (R&D) Ltd.. (Attachments: # 1 Online, # 2 Online, # 3 Online, # 4 Online, # 5 Online, # 6 Online, # 7 Online, # 8 Online, # 9 Online, # 10 Online, # 11 Online, # 12 Online, # 13 Online, # 14 Online (Entered: 02/17/2015)
- 02/17/2015 33 DECLARATION of Zion Hadad in Opposition re: 27 MOTION to Transfer Case Apple Inc.'s Notice of Motion to Transfer Venue Pursuant to 28 U.S.C. § 1404(a).. Document filed by IXI IP,LLC, IXI Mobile (R&D) Ltd.. (Biemer, Thomas) (Entered: 02/17/2015)
- 02/17/2015 34 DECLARATION of Steve Pedersen in Opposition re: 27 MOTION to Transfer Case Apple Inc.'s Notice of Motion to Transfer Venue Pursuant to 28 U.S.C. § 1404(a).. Document filed by IXI IP,LLC, IXI Mobile (R&D) Ltd.. (Biemer, Thomas) (Entered: 02/17/2015)
- 02/20/2015 35 REPLY MEMORANDUM OF LAW in Support re: 27 MOTION to Transfer Case Apple Inc.'s Notice of Motion to Transfer Venue Pursuant to 28 U.S.C. § 1404(a). . Document filed by Apple, Inc.. (King, Patrick) (Entered: 02/20/2015)
- 02/20/2015 36 DECLARATION of Gregory T. Chuebon in Support re: 27 MOTION to Transfer Case Apple Inc.'s Notice of Motion to Transfer Venue Pursuant to 28 U.S.C. § 1404(a).. Document filed by Apple, Inc.. (Chuebon, Gregory) (Entered: 02/20/2015)
- 02/24/2015 37 LETTER addressed to Judge Richard J. Sullivan from Thomas S. Biemer, Esquire dated February 24, 2015 re: IXI Mobile (R&D), LTD., et al. v. Samsung Electronics Co., Blackberry, LTD, et al., and Apple, Inc. Transfer Venue Brief. Document filed by IXI IP,LLC, IXI Mobile (R&D) Ltd..(Biemer, Thomas) (Entered: 02/24/2015)
- 02/24/2015 38 LETTER addressed to Judge Richard J. Sullivan from Harrison J. Frahn IV dated February 24, 2015 re: Plaintiffs request for leave to file a sur-reply in connection with Motion to Transfer. Document filed by Apple, Inc..(Frahn, Harrison) (Entered: 02/24/2015)
- 02/25/2015 39 ORDER: The Court is in receipt of Plaintiff's letter, dated February 24, 2015, requesting leave to file a sur-reply to Apple's reply brief. (Doc. No. 37, No. 14-cv-7954 (RJS).) The Court also is in receipt of Defendant Apple Inc.'s letter, dated February 24, 2015, responding to Plaintiff's letter and requesting "that IXI be required to provide the Court with the [IXI License Agreement]." (Doc. No. 38, No. 14-cv-7954 (RJS).) Because the Court finds that limited supplemental briefing as to whether IXI Mobile (R&D), Inc. lacks standing to be a Plaintiff in these actions would be helpful, IT IS HEREBY ORDERED THAT Plaintiff's request for leave to file a sur-reply is GRANTED. Plaintiff shall limit the sur-reply to three pages and submit the sur-reply by March 2, 2015. IT IS FURTHER ORDERED THAT Defendant Apple Inc.'s request "to respond to any new facts, evidence, or arguments introduced in the sur-reply" is GRANTED. Defendant Apple Inc. shall limit its response to three pages and submit the response by March 5, 2015. Finally, because



the Court also finds that its review of the license referenced in the parties' briefing and letters would help the Court resolve the motion to transfer these actions to the Northern District of California pursuant to 28 U.S.C. § 1404(a), IT IS FURTHER ORDERED THAT Defendant Apple Inc.'s request "that IXI be required to provide the Court with the license" is GRANTED. ( Responses due by 3/5/2015, Surreplies due by 3/2/2015.) (Signed by Judge Richard J. Sullivan on 2/25/2015) (mro) (Entered: 02/26/2015)

- 02/27/2015 40 LETTER addressed to Judge Richard J. Sullivan from Thomas S. Biemer, Esquire dated February 27, 2015 re: IXI Mobile (R&D), LTD., et al. v. Samsung Electronics Co., Blackberry, LTD, et al., and Apple, Inc. Transfer Venue Sur-Reply. Document filed by IXI IP,LLC, IXI Mobile (R&D) Ltd..(Biemer, Thomas) (Entered: 02/27/2015)
- 02/27/2015 41 MEMO ENDORSEMENT on re: (54 in 1:14-cv-04355-RJS) Letter, filed by IXI IP,LLC, IXI Mobile (R&D) Ltd., (58 in 1:14-cv-04428-RJS) Letter, filed by IXI IP, LLC, IXI Mobile (R&D) Ltd., (40 in 1:14-cv-07954-RJS) Letter, filed by IXI IP,LLC, IXI Mobile (R&D) Ltd. ENDORSEMENT: There is a well-established presumption in the Second Circuit in favor of open court records. See *United States v. Amodeo*, 44 F.3d 141, 146 (2d Cir. 1995). To overcome this presumption, a party must demonstrate that sealing a judicial document is "essential to preserve higher values and is narrowly tailored to serve that interest." *United States v. Alcantara*, 396 F.3d 189, 199 (2d Cir. 2005); see also *Lugosch v. Pyramid Co. of Onondaga*, 435 F.3d 110, 119-20 (2d Cir. 2006) (" [D]ocuments may be sealed if specific, on the record findings are made demonstrating that closure is essential to preserve higher values and is narrowly tailored to serve that interest." (quotation marks and citations omitted)). Because Plaintiff represents that the license agreement between IXI IP and IXI Mobile contains "confidential information" and that the patent purchase agreement includes information relating to the strategy and financing of this litigation, the Court will allow Plaintiff to file the license and redacted patent purchase agreements under seal, and to submit the unredacted patent purchase agreement in camera. However, the Court may reach a different conclusion upon reviewing the materials in question and, at that time, will direct the parties to address whether the various documents should remain under seal. (Signed by Judge Richard J. Sullivan on 2/27/2015) (mro) (Entered: 03/02/2015)
- 03/02/2015 42 REPLY MEMORANDUM OF LAW in Opposition re: 27 MOTION to Transfer Case Apple Inc.'s Notice of Motion to Transfer Venue Pursuant to 28 U.S.C. § 1404(a). PLAINTIFFS SUR-REPLY IN FURTHER OPPOSITION TO DEFENDANTS MOTIONS TO TRANSFER. Document filed by IXI IP,LLC, IXI Mobile (R&D) Ltd.. (Biemer, Thomas) (Entered: 03/02/2015)
- 03/02/2015 43 DECLARATION of STEVE PEDERSEN in Opposition re: 27 MOTION to Transfer Case Apple Inc.'s Notice of Motion to Transfer Venue Pursuant to 28 U.S.C. § 1404(a).. Document filed by IXI IP,LLC, IXI Mobile (R&D) Ltd.. (Biemer, Thomas) (Entered: 03/02/2015)
- 03/02/2015 44 DECLARATION of John J. Higson in Opposition re: 27 MOTION to Transfer Case Apple Inc.'s Notice of Motion to Transfer Venue Pursuant to 28 U.S.C. § 1404(a).. Document filed by IXI IP,LLC, IXI Mobile (R&D) Ltd.. (Attachments: # 1 Online, # 2 Online, # 3 Online, # 4 Online, # 5 Online, # 6 Online (Entered: 03/02/2015)
- 03/05/2015 45 RESPONSE in Support of Motion re: 27 MOTION to Transfer Case Apple Inc.'s Notice of Motion to Transfer Venue Pursuant to 28 U.S.C. § 1404(a). Response to IXI's Sur-reply on Apple's Motion to Transfer. Document filed by Apple, Inc.. (Frahm, Harrison) (Entered: 03/05/2015)
- 04/14/2015 46 AGREED PROTECTIVE ORDER REGARDING THE DISCLOSURE AND USE OF DISCOVERY MATERIALS...regarding procedures to be followed that shall govern the handling of confidential material... (Signed by Judge Richard J. Sullivan on 4/14/2015) (mro) (Entered: 04/15/2015)
- 04/14/2015 47 ORDER: This Addendum is an integral part of the Order of today's date granting confidentiality protection to certain materials. Notwithstanding any other provision, no document may be filed with the Clerk under seal without a further Order of this Court addressing the specific documents to be sealed. Any application to seal shall be accompanied by an affidavit or affidavits and a memorandum of law, demonstrating that the standards for sealing have been met and specifically addressing *Lugosch v. Pyramid Co. of Onondaga*, 435 F.3d 110, 119-20 (2d Cir. 2006) and any other controlling authority. Nothing herein is intended to alter or modify the applicability of Federal Rule of Civil Procedure 5.2 to this case. The redactions expressly authorized by Rule 5.2 may be made without further application to the Court. (Signed by Judge Richard J. Sullivan on 4/14/2015) (mro) (Entered: 04/15/2015)
- 05/04/2015 48 MOTION to Appear Pro Hac Vice for Gary D. Colby, Esquire. Filing fee \$ 200.00, receipt number 0208-10883432. Motion and supporting papers to be reviewed by Clerk's Office staff. Document filed by IXI IP,LLC, IXI Mobile (R&D) Ltd.. (Attachments: # 1 Online, # 2 Online (Entered: 05/04/2015)

- 05/04/2015 &&&NOTICE REGARDING PRO HAC VICE MOTION. Regarding Document No. 48 MOTION to Appear Pro Hac Vice for Gary D. Colby, Esquire. Filing fee \$ 200.00, receipt number 0208-10883432. Motion and supporting papers to be reviewed by Clerk's Office staff.. The document has been reviewed and there are no deficiencies. (wb) (Entered: 05/04/2015)
- 05/06/2015 49 ORDER granting 48 Motion for Gary D. Colby to Appear Pro Hac Vice. (Signed by Judge Richard J. Sullivan on 5/5/2015) (mro) (Entered: 05/06/2015)
- 05/11/2015 50 JOINT STIPULATION OF DISMISSAL OF CLAIMS RELATED TO U.S. PATENT NO. 7,426,398: Plaintiffs IXI Mobile (R&D) Ltd. and IXI IP, LLC (collectively "Plaintiffs") and Defendant Apple Inc. hereby stipulate and agree to the dismissal with prejudice of the Second Count for Relief in Plaintiffs' Complaint, alleging infringement of U.S. Patent No. 7.426,398 (the "'398 Patent"), in the above-captioned action, each party to ear its own costs and fees related to claims of infringement of the '398 Patent. SO ORDERED. (Signed by Judge Richard J. Sullivan on 5/11/2015) (kko) (Entered: 05/11/2015)
- 05/15/2015 51 ORDER REFERRING CASE TO MAGISTRATE JUDGE. Order that case be referred to the Clerk of Court for assignment to a Magistrate Judge for Settlement: The parties shall contact Magistrate Judge Debra Freeman by May 19, 2015 to schedule a settlement conference. Referred to Magistrate Judge Debra C. Freeman. (Signed by Judge Richard J. Sullivan on 5/15/2015) (tn) (Entered: 05/18/2015)
- 05/20/2015 52 LETTER addressed to Judge Richard J. Sullivan from Harrison J. Frahn IV dated 5/20/2015 re: pre-motion conference for motion to dismiss IXI Mobile (R&D) Ltd. for lack of standing. Document filed by Apple, Inc..(Frahn, Harrison) (Entered: 05/20/2015)
- 05/26/2015 53 LETTER addressed to Judge Richard J. Sullivan from Thomas S. Biemer, Esquire dated May 26, 2015 re: IXI Mobile (R & D), LTD., et al. v. Apple, Inc. - Response to May 20, 2015 Pre-Motion Letter from Apple, Inc. Document filed by IXI IP,LLC, IXI Mobile (R&D) Ltd..(Biemer, Thomas) (Entered: 05/26/2015)
- 05/28/2015 Minute Entry for proceedings held before Magistrate Judge Debra C. Freeman: Settlement Conference held via telephone on 5/28/2015. Telephone conference scheduled for 8/25/15 at 12:00 p.m. (aba) (Entered: 05/28/2015)
- 06/04/2015 54 LETTER addressed to Judge Richard J. Sullivan from Thomas S. Biemer, Esquire dated June 4, 2015 re: Claim Construction Technology Tutorial. Document filed by IXI IP,LLC, IXI Mobile (R&D) Ltd..(Biemer, Thomas) (Entered: 06/04/2015)
- 06/05/2015 55 AMENDED LETTER addressed to Judge Richard J. Sullivan from Thomas S. Biemer, Esquire dated June 5, 2015 re: Claim Construction Technology Tutorial. Document filed by IXI IP,LLC, IXI Mobile (R&D) Ltd..(Biemer, Thomas) (Entered: 06/05/2015)
- 06/08/2015 56 JOINT CLAIM CONSTRUCTION STATEMENT. Document filed by Apple, Inc., IXI IP,LLC, IXI Mobile (R&D) Ltd..(Biemer, Thomas) (Entered: 06/08/2015)
- 06/15/2015 57 LETTER addressed to Judge Richard J. Sullivan from Thomas S. Biemer dated June 15, 2015 re: Pre-Motion Request to Strike Joint Claim Terms Chart. Document filed by IXI IP,LLC, IXI Mobile (R&D) Ltd..(Biemer, Thomas) (Entered: 06/15/2015)
- 06/18/2015 58 LETTER addressed to Judge Richard J. Sullivan from Harrison J. Frahn IV dated 06/18/2015 re: Response to IXI's Request for a Pre-motion Conference for a Motion to Strike. Document filed by Apple, Inc..(Frahn, Harrison) (Entered: 06/18/2015)
- 07/02/2015 59 LETTER addressed to Judge Richard J. Sullivan from Harrison J. Frahn IV dated 7/2/2015 re: pre-motion conference for motion to stay. Document filed by Apple, Inc..(Frahn, Harrison) (Entered: 07/02/2015)
- 07/02/2015 60 ENDORSED LETTER addressed to Judge Richard J. Sullivan from Thomas S. Biemer dated 7/2/2015 re: Plaintiffs respectfully request 5 additional pages for their Opening Claim Construction Brief due on July 8, 2015, as well as 5 additional pages for their supporting expert declaration. ENDORSEMENT: SO ORDERED. (Signed by Judge Richard J. Sullivan on 7/2/2015) (mro) (Entered: 07/06/2015)
- 07/08/2015 61 BRIEF Plaintiffs Opening Claim Construction Brief. Document filed by IXI IP,LLC, IXI Mobile (R&D) Ltd..(Biemer, Thomas) (Entered: 07/08/2015)
- 07/08/2015 62 DECLARATION re: 61 Brief Declaration of Mark W. Halderman. Document filed by IXI IP,LLC, IXI Mobile (R&D) Ltd.. (Attachments: # 1 Online, # 2 Online, # 3 Online, # 4 Online, # 5 Online, # 6 Online, # 7 Online, # 8 Online, # 9 Online, # 10 Online (Entered: 07/08/2015)
- 07/08/2015 63 DECLARATION re: 61 Brief Declaration of Joel R. Williams. Document filed by IXI IP,LLC, IXI Mobile (R&D) Ltd.. (Attachments: # 1 Online, # 2 Online, # 3 Online (Entered: 07/08/2015)

- 07/08/2015 64 LETTER addressed to Judge Richard J. Sullivan from Thomas S. Biemer, Esquire dated July 8, 2015 re: Response to pre-motion letter from Defendants Apple and Samsung requesting a stay. Document filed by IXI IP,LLC, IXI Mobile (R&D) Ltd..(Biemer, Thomas) (Entered: 07/08/2015)
- 07/24/2015 65 LETTER addressed to Judge Richard J. Sullivan from Harrison J. Frahn IV dated 7/24/2015 re: Apple's requests to transfer/stay. Document filed by Apple, Inc..(Frahn, Harrison) (Entered: 07/24/2015)
- 07/29/2015 66 LETTER addressed to Judge Richard J. Sullivan from Thomas S. Biemer, Esquire dated July 29, 2015 re: IXI Mobile, et al. v. Apple Inc. - Response to Letter from Apple Inc. dated July 24, 2015. Document filed by IXI IP,LLC, IXI Mobile (R&D) Ltd..(Biemer, Thomas) (Entered: 07/29/2015)
- 08/03/2015 67 MEMO ENDORSEMENT on re: (84 in 1:14-cv-04428-RJS) Letter, filed by Blackberry Limited, Blackberry Corporation, (77 in 1:14-cv-04355-RJS) Letter, filed by Samsung Electronics Co., Ltd., Samsung Electronics America, Inc. ENDORSEMENT: SO ORDERED. ( Brief due by 8/7/2015.) (Signed by Judge Richard J. Sullivan on 8/3/2015) (mro) (Entered: 08/04/2015)
- 08/04/2015 68 LETTER MOTION for Leave to File Excess Pages and Exhibits for Defendants' Responsive Claim Construction Brief addressed to Judge Richard J. Sullivan from Marshall Beil (on behalf of all Defendants) dated August 3, 2015. Document filed by Apple, Inc..(Chuebon, Gregory) (Entered: 08/04/2015)
- 08/04/2015 69 ORDER granting 5 Motion for Joshua D. Wolson to Appear Pro Hac Vice. (Signed by Judge Richard J. Sullivan on 8/4/2015) (mro) (Entered: 08/05/2015)
- 08/04/2015 70 ORDER granting 20 Motion for Mark W. Halderman to Appear Pro Hac Vice. (Signed by Judge Richard J. Sullivan on 8/4/2015) (mro) (Entered: 08/05/2015)
- 08/06/2015 71 OPINION AND ORDER # 105941 re: (27 in 1:14-cv-07954-RJS) MOTION to Transfer Case Apple Inc.'s Notice of Motion to Transfer Venue Pursuant to 28 U.S.C. § 1404(a). filed by Apple, Inc., (47 in 1:14-cv-04428-RJS) MOTION to Transfer Case . filed by Blackberry Limited, Blackberry Corporation, (44 in 1:14-cv-04355-RJS) MOTION to Transfer Case Samsung's Notice of Motion to Transfer Venue Pursuant to 28 U.S.C. § 1404(a). filed by Samsung Electronics Co., Ltd., Samsung Telecommunications America, LLC, Samsung Electronics America, Inc. Weighing the factors set forth above and having considered all the facts and circumstances before it, the Court determines that Defendants have demonstrated by clear and convincing evidence that transfer of these three actions is appropriate. Accordingly, IT IS HEREBY ORDERED THAT Defendants' motions to transfer these actions to the Northern District of California are GRANTED. The Clerk of the Court is respectfully directed to terminate the motions pending at docket entries 44 in case number 14--cv-4355 (RJS), 47 in case number 14--cv-4428 (RJS), and 27 in case number 14-cv-7954 (RJS), and to close these cases. SO ORDERED. (As further set forth within this Order.) (Signed by Judge Richard J. Sullivan on 8/6/2015) (ajs) Modified on 10/13/2015 (ca). (Entered: 08/07/2015)
- 08/06/2015 CASE TRANSFERRED OUT ELECTRONICALLY from the U.S.D.C. Southern District of New York to the United States District Court - Northern District of California. (ajs) (Entered: 08/14/2015)
- 08/12/2015 72 LETTER addressed to Judge Richard J. Sullivan from Thomas S. Biemer, Esquire dated August 12, 2015 re: Requesting Reconsideration of the Order entered August 7, 2015. Document filed by IXI IP,LLC, IXI Mobile (R&D) Ltd..(Biemer, Thomas) (Entered: 08/12/2015)
- 08/19/2015 Received e-mail from the United States District Court - Northern District of California acknowledging receipt of transferred case. Assigned Case Number: 4:15-cv-03755, filed on 08/17/2015. (sjo) (Entered: 08/20/2015)
- 09/09/2015 73 ORDER: The Court is in receipt of a letter from Plaintiffs, dated August 12, 2015 (No. 14-cv-4355 (RJS), Doc. No. 80; No. 14-cv-4428 (RJS), Doc. No. 87; No. 14-cv- 7954 (RJS), Doc. No. 72), requesting that the Court reconsider its Opinion and Order, dated August 6, 2015, granting Defendants' motions to transfer these three related patent infringement actions to the Northern District of California pursuant to 28 U.S.C. § 1404(a). In sum, the Court finds that there is no "manifest injustice" here and that these actions bear little resemblance to the Eastern District of Texas decisions cited by Plaintiffs. Thus, Plaintiffs have failed to persuade the Court to reconsider its August 6, 2015 Opinion and Order. Accordingly, IT IS HEREBY ORDERED THAT Plaintiffs' motion for reconsideration is DENIED. (As further set forth in this Order.) (Signed by Judge Richard J. Sullivan on 9/9/2015) (kko) (Entered: 09/09/2015)
-

Copyright © 2017 LexisNexis CourtLink, Inc. All rights reserved.  
\*\*\* THIS DATA IS FOR INFORMATIONAL PURPOSES ONLY \*\*\*

---

**US District Court Civil Docket**

U.S. District - New York Southern  
(Foley Square)

**1:14cv4428**

**Ixi Mobile (R&D) Ltd. et al v. Blackberry Limited et al**

This case was retrieved from the court on Monday, February 27, 2017

---

Date Filed: **06/18/2014**

Assigned

To: **Judge Richard J. Sullivan**

Referred **Magistrate Judge Debra C. Freeman**

To: **(Settlement)**

Class Code: **CLOSED**

Closed: **08/06/2015**

Nature of

suit: **Patent (830)**

Statute: **35:145**

Cause: **Civil Action to Obtain Patent**

Jury Demand: **Both**

Lead

Demand Amount: **\$0**

Docket: **None**

NOS Description: **Patent**

Other

Docket: **1:14cv04355**

Jurisdiction: **Federal Question**

---

**Litigants**

---

**Attorneys**

Ixi Mobile (R&D) Ltd.  
Plaintiff

Gary David Colby  
LEAD ATTORNEY; ATTORNEY TO BE NOTICED  
Dilworth Paxson, LLP  
1500 Market Street  
Philadelphia, PA 19102  
USA  
(215)-575-7075  
Email: Gcolby@dilworthlaw.Com

John Joseph Higson  
LEAD ATTORNEY; PRO HAC VICE; ATTORNEY TO BE NOTICED  
Dilworth Paxson LLP  
3200 Mellon Bank Ctr 1735 Market Street  
Philadelphia, PA 19103  
USA  
(212)575-7152  
Fax: (215)-575-7200  
Email: Jhigson@dilworthlaw.Com

Joshua D. Wolson  
LEAD ATTORNEY; ATTORNEY TO BE NOTICED  
Dilworth Paxson LLP (PA)  
1500 Market Street Suite 3500e  
Philadelphia, PA 19102-2101  
USA  
(215)-575-7295  
Fax: (215)-575-7200  
Email: Jwolson@dilworthlaw.Com

Mark William Halderman  
LEAD ATTORNEY; ATTORNEY TO BE NOTICED

Dilworth Paxson LLP  
1500 Market Street, Suite 3500(E)  
Philadelphia , PA 19102  
USA  
(215)-575-7186  
Fax: (215)-575-7200  
Email: Mwhalderman@dilworthlaw.Com

Thomas Steven Biemer  
LEAD ATTORNEY; ATTORNEY TO BE NOTICED  
Dilworth Paxson LLP (PA)  
1500 Market Street Suite 3500e  
Philadelphia , PA 19102-2101  
USA  
(215)-575-7025  
Fax: (215)-575-7200  
Email: Tbiemer@dilworthlaw.Com

Ixi Ip, Llc  
Plaintiff

Gary David Colby  
LEAD ATTORNEY; ATTORNEY TO BE NOTICED  
Dilworth Paxson, LLP  
1500 Market Street  
Philadelphia , PA 19102  
USA  
(215)-575-7075  
Email: Gcolby@dilworthlaw.Com

John Joseph Higson  
LEAD ATTORNEY; PRO HAC VICE; ATTORNEY TO BE NOTICED  
Dilworth Paxson LLP  
3200 Mellon Bank Ctr 1735 Market Street  
Philadelphia , PA 19103  
USA  
(212)575-7152  
Fax: (215)-575-7200  
Email: Jhigson@dilworthlaw.Com

Joshua D. Wolson  
LEAD ATTORNEY; ATTORNEY TO BE NOTICED  
Dilworth Paxson LLP (PA)  
1500 Market Street Suite 3500e  
Philadelphia , PA 19102-2101  
USA  
(215)-575-7295  
Fax: (215)-575-7200  
Email: Jwolson@dilworthlaw.Com

Mark William Halderman  
LEAD ATTORNEY; ATTORNEY TO BE NOTICED  
Dilworth Paxson LLP  
1500 Market Street, Suite 3500(E)  
Philadelphia , PA 19102  
USA  
(215)-575-7186  
Fax: (215)-575-7200  
Email: Mwhalderman@dilworthlaw.Com

Thomas Steven Biemer  
LEAD ATTORNEY; ATTORNEY TO BE NOTICED  
Dilworth Paxson LLP (PA)  
1500 Market Street Suite 3500e  
Philadelphia , PA 19102-2101  
USA  
(215)-575-7025  
Fax: (215)-575-7200  
Email: Tbiemer@dilworthlaw.Com

Blackberry Limited  
Defendant

Brian Charles Riopelle  
LEAD ATTORNEY; PRO HAC VICE; ATTORNEY TO BE NOTICED  
McGuireWoods LLP (Richmond)  
Gate Way Plaza 800 East Canal Street  
Richmond , VA 23219  
USA  
(804) 775-1084  
Fax: (804) 698-2150  
Email: Briopelle@mcguirewoods.Com

Jason W. Cook  
LEAD ATTORNEY; ATTORNEY TO BE NOTICED  
McGuirewoods LLP  
2000 Mckinney Avenue, Suite 1400  
Dallas , TX 75201  
USA  
(214) 932-6418  
Email: Jcook@mcguirewoods.Com

Derek H. Swanson  
PRO HAC VICE; ATTORNEY TO BE NOTICED  
McGuireWoods LLP (Richmond)  
Gate Way Plaza 800 East Canal Street  
Richmond , VA 23219  
USA  
(804) 775-1081  
Email: Dswanson@mcguirewoods.Com

Marshall Beil  
ATTORNEY TO BE NOTICED  
McGuireWoods LLP (NYC)  
1345 Avenue Of The Americas 7th Floor  
New York , NY 10105  
USA  
212-548-7004  
Fax: 212-715-2319  
Email: Mbeil@mcguirewoods.Com

Shaun William Hassett  
ATTORNEY TO BE NOTICED  
McGuirewoods LLP  
2000 Mckinney Avenue, Suite 1400  
Dallas , TX 75201  
USA  
(214)-932-6422  
Fax: (214)-932-6499  
Email: Shassett@mcguirewoods.Com

Blackberry Corporation  
Defendant

Brian Charles Riopelle  
LEAD ATTORNEY; PRO HAC VICE; ATTORNEY TO BE NOTICED  
McGuireWoods LLP (Richmond)  
Gate Way Plaza 800 East Canal Street  
Richmond , VA 23219  
USA  
(804) 775-1084  
Fax: (804) 698-2150  
Email: Briopelle@mcguirewoods.Com

Jason W. Cook  
LEAD ATTORNEY; ATTORNEY TO BE NOTICED  
McGuirewoods LLP  
2000 Mckinney Avenue, Suite 1400  
Dallas , TX 75201  
USA  
(214) 932-6418  
Email: Jcook@mcguirewoods.Com

Derek H. Swanson

PRO HAC VICE; ATTORNEY TO BE NOTICED  
McGuireWoods LLP (Richmond)  
Gate Way Plaza 800 East Canal Street  
Richmond , VA 23219  
USA  
(804) 775-1081  
Email: Dswanson@mcguirewoods.Com

Marshall Beil  
ATTORNEY TO BE NOTICED  
McGuireWoods LLP (NYC)  
1345 Avenue Of The Americas 7th Floor  
New York , NY 10105  
USA  
212-548-7004  
Fax: 212-715-2319  
Email: Mbeil@mcguirewoods.Com

Shaun William Hassett  
ATTORNEY TO BE NOTICED  
McGuirewoods LLP  
2000 Mckinney Avenue, Suite 1400  
Dallas , TX 75201  
USA  
(214)-932-6422  
Fax: (214)-932-6499  
Email: Shassett@mcguirewoods.Com

Blackberry Corporation  
Counter Claimant

Brian Charles Riopelle  
LEAD ATTORNEY; PRO HAC VICE; ATTORNEY TO BE NOTICED  
McGuireWoods LLP (Richmond)  
One James Center 901 East Cary Street  
Richmond , VA 23219  
USA  
(804) 775-1084  
Fax: (804) 698-2150  
Email: Briopelle@mcguirewoods.Com

Jason W. Cook  
LEAD ATTORNEY; ATTORNEY TO BE NOTICED  
McGuirewoods LLP  
2000 Mckinney Avenue, Suite 1400  
Dallas , TX 75201  
USA  
(214) 932-6418  
Email: Jcook@mcguirewoods.Com

Derek H. Swanson  
PRO HAC VICE; ATTORNEY TO BE NOTICED  
McGuireWoods LLP (Richmond)  
One James Center 901 East Cary Street  
Richmond , VA 23219  
USA  
(804) 775-1081  
Email: Dswanson@mcguirewoods.Com

Marshall Beil  
ATTORNEY TO BE NOTICED  
McGuireWoods LLP (NYC)  
1345 Avenue Of The Americas 7th Floor  
New York , NY 10105  
USA  
212-548-7004  
Fax: 212-715-2319  
Email: Mbeil@mcguirewoods.Com

Blackberry Limited

Brian Charles Riopelle



Counter Claimant

LEAD ATTORNEY; PRO HAC VICE; ATTORNEY TO BE NOTICED  
McGuireWoods LLP (Richmond)  
Gate Way Plaza 800 East Canal Street  
Richmond , VA 23219  
USA  
(804) 775-1084  
Fax: (804) 698-2150  
Email: Briopelle@mcguirewoods.Com

Jason W. Cook  
LEAD ATTORNEY; ATTORNEY TO BE NOTICED  
McGuirewoods LLP  
2000 McKinney Avenue, Suite 1400  
Dallas , TX 75201  
USA  
(214) 932-6418  
Email: Jcook@mcguirewoods.Com

Derek H. Swanson  
PRO HAC VICE; ATTORNEY TO BE NOTICED  
McGuireWoods LLP (Richmond)  
Gate Way Plaza 800 East Canal Street  
Richmond , VA 23219  
USA  
(804) 775-1081  
Email: Dswanson@mcguirewoods.Com

Marshall Beil  
ATTORNEY TO BE NOTICED  
McGuireWoods LLP (NYC)  
1345 Avenue Of The Americas 7th Floor  
New York , NY 10105  
USA  
212-548-7004  
Fax: 212-715-2319  
Email: Mbeil@mcguirewoods.Com

Ixi Ip, Llc  
Counter Defendant

John Joseph Higson  
LEAD ATTORNEY; PRO HAC VICE; ATTORNEY TO BE NOTICED  
Dilworth Paxson LLP  
3200 Mellon Bank Ctr 1735 Market Street  
Philadelphia , PA 19103  
USA  
(212)575-7152  
Fax: (215)-575-7200  
Email: Jhigson@dilworthlaw.Com

Joshua D. Wolson  
LEAD ATTORNEY; ATTORNEY TO BE NOTICED  
Dilworth Paxson LLP (PA)  
1500 Market Street Suite 3500e  
Philadelphia , PA 19102-2101  
USA  
(215)-575-7295  
Fax: (215)-575-7200  
Email: Jwolson@dilworthlaw.Com

Mark William Halderman  
LEAD ATTORNEY; ATTORNEY TO BE NOTICED  
Dilworth Paxson LLP  
1500 Market Street, Suite 3500(E)  
Philadelphia , PA 19102  
USA  
(215)-575-7186  
Fax: (215)-575-7200  
Email: Mwhalderman@dilworthlaw.Com

Thomas Steven Biemer

LEAD ATTORNEY; ATTORNEY TO BE NOTICED  
 Dilworth Paxson LLP (PA)  
 1500 Market Street Suite 3500e  
 Philadelphia , PA 19102-2101  
 USA  
 (215)-575-7025  
 Fax: (215)-575-7200  
 Email: Tbiemer@dilworthlaw.Com

Ixi Mobile (R&D) Ltd.  
 Counter Defendant

John Joseph Higson  
 LEAD ATTORNEY; PRO HAC VICE; ATTORNEY TO BE NOTICED  
 Dilworth Paxson LLP  
 3200 Mellon Bank Ctr 1735 Market Street  
 Philadelphia , PA 19103  
 USA  
 (212)575-7152  
 Fax: (215)-575-7200  
 Email: Jhigson@dilworthlaw.Com

Joshua D. Wolson  
 LEAD ATTORNEY; ATTORNEY TO BE NOTICED  
 Dilworth Paxson LLP (PA)  
 1500 Market Street Suite 3500e  
 Philadelphia , PA 19102-2101  
 USA  
 (215)-575-7295  
 Fax: (215)-575-7200  
 Email: Jwolson@dilworthlaw.Com

Mark William Halderman  
 LEAD ATTORNEY; ATTORNEY TO BE NOTICED  
 Dilworth Paxson LLP  
 1500 Market Street, Suite 3500(E)  
 Philadelphia , PA 19102  
 USA  
 (215)-575-7186  
 Fax: (215)-575-7200  
 Email: Mwhalderman@dilworthlaw.Com

Thomas Steven Biemer  
 LEAD ATTORNEY; ATTORNEY TO BE NOTICED  
 Dilworth Paxson LLP (PA)  
 1500 Market Street Suite 3500e  
 Philadelphia , PA 19102-2101  
 USA  
 (215)-575-7025  
 Fax: (215)-575-7200  
 Email: Tbiemer@dilworthlaw.Com

| Date       | # | Proceeding Text   | Source |
|------------|---|---|--------|
| 06/18/2014 | 1 | COMPLAINT against Blackberry Corporation, Blackberry Limited. (Filing Fee \$ 350.00, Receipt Number 1098194) Document filed by IXI Mobile (R&D) Ltd., IXI IP, LLC. (Attachments: # 1 Online, # 2 Online, # 3 Online, # 4 Online (Entered: 06/23/2014) |        |
| 06/18/2014 |   | SUMMONS ISSUED as to Blackberry Corporation, Blackberry Limited. (moh) (Entered: 06/23/2014)  |        |
| 06/18/2014 |   | CASE REFERRED TO Judge Richard J. Sullivan as possibly related to 14-cv-4355. (moh) (Entered: 06/23/2014)   |        |
| 06/18/2014 |   | Case Designated ECF. (moh) (Entered: 06/23/2014)  |        |
| 06/18/2014 | 2 | CIVIL COVER SHEET filed. (moh) (Entered: 06/23/2014)  |        |
| 06/18/2014 | 3 | STATEMENT OF RELATEDNESS re: that this action be filed as related to 14-cv-4355. Document filed by IXI IP, LLC, IXI Mobile (R&D) Ltd..(moh) (Entered: 06/23/2014)   |        |
| 06/18/2014 | 4 | STANDING ORDER IN RE PILOT PROJECT REGARDING CASE MANAGEMENT TECHNIQUES FOR COMPLEX CIVIL CASES IN THE SOUTHERN DISTRICT OF NEW YORK (See M-10-468  |        |

Order filed November 1, 2011). This case is hereby designated for inclusion in the Pilot Project Regarding Case Management Techniques for Complex Civil Cases in the Southern District of New York (the Pilot Project), unless the judge to whom this case is assigned determines otherwise. This case is designated for inclusion in the Pilot Project because it is a class action, an MDL action, or is in one of the following Nature of Suit categories: 160, 245, 315, 355, 365, 385, 410, 830, 840, 850, 893, or 950. The presiding judge in a case that does not otherwise qualify for inclusion in the Pilot Project may nevertheless designate the case for inclusion in the Pilot Project by issuing an order directing that the case be included in the Pilot Project. The description of the Pilot Project, including procedures to be followed, is attached to this Order. (Signed by Judge Loretta A. Preska on 10/31/2011) (moh) (Main Document 4 replaced on 6/23/2014) (laq). (Entered: 06/23/2014)

- 06/18/2014 Case Eligible for Patent Pilot Program. (moh) (Entered: 06/23/2014)
- 06/18/2014 Mailed notice to Commissioner of Patents and Trademarks to report the filing of this action. (moh) (Entered: 03/27/2015)
- 06/23/2014 5 RULE 7.1 CORPORATE DISCLOSURE STATEMENT. No Corporate Parent. Document filed by IXI IP, LLC.(Biemer, Thomas) (Entered: 06/23/2014)
- 06/23/2014 6 RULE 7.1 CORPORATE DISCLOSURE STATEMENT. No Corporate Parent. Document filed by IXI Mobile (R&D) Ltd..(Biemer, Thomas) (Entered: 06/23/2014)
- 06/26/2014 CASE ACCEPTED AS RELATED. Create association to 1:14-cv-04355-RJS. Notice of Assignment to follow. (pgu) (Entered: 06/26/2014)
- 06/26/2014 NOTICE OF CASE ASSIGNMENT to Judge Richard J. Sullivan. Judge Unassigned is no longer assigned to the case. (pgu) (Entered: 06/26/2014)
- 06/26/2014 Magistrate Judge Debra C. Freeman is so designated. (pgu) (Entered: 06/26/2014)
- 06/27/2014 7 AFFIDAVIT OF SERVICE of Summons and Complaint,. Blackberry Corporation served on 6/23/2014, answer due 7/14/2014. Service was accepted by Marie Garcia, Process Specialist for CT Corporation System as Registered Agent. Document filed by IXI Mobile (R&D) Ltd.; IXI IP, LLC. (Biemer, Thomas) (Entered: 06/27/2014)
- 06/30/2014 8 ORDER: Initial Conference set for 8/26/2014 at 12:30 PM in Courtroom 905, 40 Centre Street, New York, NY 10007 before Judge Richard J. Sullivan, and as further set forth in this document. (Signed by Judge Richard J. Sullivan on 6/25/2014) (cd) (Entered: 07/01/2014)
- 07/08/2014 9 SUPPLEMENTAL RULE 7.1 CORPORATE DISCLOSURE STATEMENT. Identifying Corporate Parent IXI Mobile Inc. for IXI Mobile (R&D) Ltd.. Document filed by IXI Mobile (R&D) Ltd..(Biemer, Thomas) (Entered: 07/08/2014)
- 07/08/2014 10 LETTER MOTION for Extension of Time To Respond to Plaintiffs' Complaint addressed to Judge Richard J. Sullivan from Thomas S. Biemer, Esquire dated 7/8/2014. Document filed by IXI IP, LLC, IXI Mobile (R&D) Ltd..(Biemer, Thomas) (Entered: 07/08/2014)
- 07/08/2014 11 ORDER granting 10 Letter Motion for Extension of Time. IT IS HEREBY ORDERED THAT Defendants time to answer, move against or otherwise respond to Plaintiffs' Complaint is extended to September 12, 2014. IT IS FURTHER ORDERED THAT the initial conference, currently scheduled for August 26, 2014, is ADJOURNED to October 7, 2014 at 12:30 p.m. IT IS FURTHER ORDERED that the parties shall submit the joint letter and proposed case management plan referenced in the Court's June 30, 2014 Order no later than September 30, 2014 at 4:00 p.m. (Signed by Judge Richard J. Sullivan on 7/8/2014) (cd) (Entered: 07/09/2014)
- 07/08/2014 Set/Reset Deadlines: Blackberry Corporation answer due 9/12/2014; Blackberry Limited answer due 9/12/2014. Set/Reset Hearings:(Initial Conference reset for 10/7/2014 at 12:30 PM before Judge Richard J. Sullivan.) (cd) (Entered: 07/09/2014)
- 07/22/2014 12 FILING ERROR - DEFICIENT DOCKET ENTRY - MOTION for Joshua D. Wolson to Appear Pro Hac Vice . Filing fee \$ 200.00, receipt number 0208-9915127. Motion and supporting papers to be reviewed by Clerk's Office staff. Document filed by IXI IP, LLC, IXI Mobile (R&D) Ltd.. (Attachments: # 1 Online, # 2 Online (Entered: 07/22/2014)
- 07/22/2014 13 FILING ERROR - DEFICIENT DOCKET ENTRY - MOTION for John Joseph Higson to Appear Pro Hac Vice . Filing fee \$ 200.00, receipt number 0208-9915198. Motion and supporting papers to be reviewed by Clerk's Office staff. Document filed by IXI IP, LLC, IXI Mobile (R&D) Ltd.. (Attachments: # 1 Online, # 2 Online (Entered: 07/22/2014)
- 07/23/2014 &gt;&gt;&gt;NOTICE REGARDING DEFICIENT MOTION TO APPEAR PRO HAC VICE. Notice regarding Document No. 12 MOTION for Joshua D. Wolson to Appear Pro Hac Vice . Filing fee \$ 200.00, receipt number 0208-9915127. Motion and supporting papers to be reviewed by Clerk's Office staff., 13 MOTION for John Joseph Higson to Appear Pro Hac

- Vice . Filing fee \$ 200.00, receipt number 0208-9915198. Motion and supporting papers to be reviewed by Clerk's Office staff.. Provide only one individual case number on the documents. (sdi) (Entered: 07/23/2014)
- 07/23/2014 14 MOTION for Joshua D. Wolson to Appear Pro Hac Vice (CORRECTED). Motion and supporting papers to be reviewed by Clerk's Office staff. Document filed by IXI IP, LLC, IXI Mobile (R&D) Ltd.. (Attachments: # 1 Online, # 2 Online (Entered: 07/23/2014)
- 07/23/2014 15 MOTION for John Joseph Higson to Appear Pro Hac Vice (CORRECTED). Motion and supporting papers to be reviewed by Clerk's Office staff. Document filed by IXI IP, LLC, IXI Mobile (R&D) Ltd.. (Attachments: # 1 Online, # 2 Online (Entered: 07/23/2014)
- 07/24/2014 &gt;&gt;&gt;NOTICE REGARDING PRO HAC VICE MOTION. Regarding Document No. 15 MOTION for John Joseph Higson to Appear Pro Hac Vice (CORRECTED). Motion and supporting papers to be reviewed by Clerk's Office staff., 14 MOTION for Joshua D. Wolson to Appear Pro Hac Vice (CORRECTED). Motion and supporting papers to be reviewed by Clerk's Office staff.. The document has been reviewed and there are no deficiencies. (wb) (Entered: 07/24/2014)
- 07/28/2014 16 ORDER granting 15 Motion for John J. Higson to Appear Pro Hac Vice. (Signed by Judge Richard J. Sullivan on 7/28/2014) (cd) (Entered: 07/28/2014)
- 07/28/2014 17 ORDER granting 14 Motion for Joshua D. Wolson to Appear Pro Hac Vice. (Signed by Judge Richard J. Sullivan on 7/28/2014) (cd) (Entered: 07/28/2014)
- 08/20/2014 18 FILING ERROR - DEFICIENT DOCKET ENTRY - MOTION to Appear Pro Hac Vice for Mark W. Halderman. Motion and supporting papers to be reviewed by Clerk's Office staff. Document filed by IXI IP, LLC, IXI Mobile (R&D) Ltd.. (Attachments: # 1 Online, # 2 Online (Entered: 08/20/2014)
- 08/20/2014 &gt;&gt;&gt;NOTICE REGARDING DEFICIENT MOTION TO APPEAR PRO HAC VICE. Notice regarding Document No. 18 MOTION to Appear Pro Hac Vice for Mark W. Halderman. Motion and supporting papers to be reviewed by Clerk's Office staff.. The filing is deficient for the following reason(s): Filing fee not paid.Missing Certificate of Good Standing. Certificate of Good Standing must be issued from the Supreme Court of Texas and not from a State Bar Association. Re-file the document as a Corrected Motion to Appear Pro Hac Vice and attach a valid Certificate of Good Standing, issued within the past 30 days and pay the filing fee. (bcu) (Entered: 08/20/2014)
- 08/25/2014 19 MOTION to Appear Pro Hac Vice for Mark Halderman. Filing fee \$ 200.00, receipt number 0208-10032239. Motion and supporting papers to be reviewed by Clerk's Office staff. Document filed by IXI IP, LLC, IXI Mobile (R&D) Ltd.. (Attachments: # 1 Online, # 2 Online (Entered: 08/25/2014)
- 08/25/2014 &gt;&gt;&gt;NOTICE REGARDING PRO HAC VICE MOTION. Regarding Document No. 19 MOTION to Appear Pro Hac Vice for Mark Halderman. Filing fee \$ 200.00, receipt number 0208-10032239. Motion and supporting papers to be reviewed by Clerk's Office staff.. The document has been reviewed and there are no deficiencies. (wb) (Entered: 08/25/2014)
- 09/10/2014 20 NOTICE OF APPEARANCE by Marshall Beil on behalf of Blackberry Corporation, Blackberry Limited. (Beil, Marshall) (Entered: 09/10/2014)
- 09/10/2014 21 LETTER MOTION for Extension of Time to File Response/Reply addressed to Judge Richard J. Sullivan from Marshall Beil dated September 10, 2014. Document filed by Blackberry Corporation, Blackberry Limited.(Beil, Marshall) (Entered: 09/10/2014)
- 09/10/2014 22 ORDER granting 21 Letter Motion for Extension of Time to File Response/Reply. SO ORDERED. (Signed by Judge Richard J. Sullivan on 9/10/2014) (mro) (Entered: 09/11/2014)
- 09/10/2014 Set/Reset Deadlines: Blackberry Corporation answer due 9/26/2014; Blackberry Limited answer due 9/26/2014. (mro) (Entered: 09/11/2014)
- 09/26/2014 23 FILING ERROR - CORPORATE PARENT/OTHER AFFILIATE NOT ADDED - RULE 7.1 CORPORATE DISCLOSURE STATEMENT. No Corporate Parent. Document filed by Blackberry Corporation, Blackberry Limited.(Beil, Marshall) Modified on 9/29/2014 (lb). (Entered: 09/26/2014)
- 09/26/2014 24 ANSWER to 1 Complaint, with JURY DEMAND; COUNTERCLAIM against IXI Mobile (R&D) Ltd., IXI IP, LLC. Document filed by Blackberry Corporation, Blackberry Limited.(Beil, Marshall) Modified on 10/22/2014 (mro). (Entered: 09/26/2014)
- 09/29/2014 \*\*\* NOTE TO ATTORNEY TO RE-FILE DOCUMENT - DEFICIENT DOCKET ENTRY ERROR. Note to Attorney Marshall Beil to RE-FILE Document 23 Rule 7.1 Corporate Disclosure Statement,. ERROR(S): Corporate Parents were not added. Please re-file this document and when prompted: Are there any corporate parents or other affiliates?, select the YES

- radio button and enter the Corporate Parent(s) or Affiliate(s). YOU MUST SELECT THE SEARCH BUTTON. Select the correct name or create a new corporate parent. Add the Corporate Parent(s) or Affiliate(s) one party name at a time. (lb) (Entered: 09/29/2014)
- 09/29/2014 25 RULE 7.1 CORPORATE DISCLOSURE STATEMENT. Identifying Corporate Parent Blackberry Limited for Blackberry Corporation. Document filed by Blackberry Corporation, Blackberry Limited.(Beil, Marshall) (Entered: 09/29/2014)
- 09/30/2014 26 MOTION for Brian C. Riopelle to Appear Pro Hac Vice . Filing fee \$ 200.00, receipt number 0208-10156826. Motion and supporting papers to be reviewed by Clerk's Office staff. Document filed by Blackberry Corporation, Blackberry Limited.(Riopelle, Brian) (Entered: 09/30/2014)
- 09/30/2014 27 FILING ERROR - DEFICIENT DOCKET ENTRY - MOTION for Jason W. Cook to Appear Pro Hac Vice . Filing fee \$ 200.00, receipt number 0208-10156886. Motion and supporting papers to be reviewed by Clerk's Office staff. Document filed by Blackberry Corporation, Blackberry Limited.(Cook, Jason) Modified on 9/30/2014 (bcu). (Entered: 09/30/2014)
- 09/30/2014 &gt;&gt;&gt;NOTICE REGARDING PRO HAC VICE MOTION. Regarding Document No. 26 MOTION for Brian C. Riopelle to Appear Pro Hac Vice . Filing fee \$ 200.00, receipt number 0208-10156826. Motion and supporting papers to be reviewed by Clerk's Office staff.. The document has been reviewed and there are no deficiencies. (sdi) (Entered: 09/30/2014)
- 09/30/2014 &gt;&gt;&gt;NOTICE REGARDING DEFICIENT MOTION TO APPEAR PRO HAC VICE. Notice regarding Document No. 27 MOTION for Jason W. Cook to Appear Pro Hac Vice . Filing fee \$ 200.00, receipt number 0208-10156886. Motion and supporting papers to be reviewed by Clerk's Office staff.. The filing is deficient for the following reason(s): Missing Certificate of Good Standing. Certificate of Good Standing must be issued from the Supreme Court of Texas and not from a State Bar Association. Re-file the document as a Corrected Motion to Appear Pro Hac Vice and attach a valid Certificate of Good Standing, issued within the past 30 days. (bcu) (Entered: 09/30/2014)
- 09/30/2014 28 MOTION for Derek H. Swanson to Appear Pro Hac Vice . Filing fee \$ 200.00, receipt number 0208-10156919. Motion and supporting papers to be reviewed by Clerk's Office staff. Document filed by Blackberry Corporation, Blackberry Limited.(Swanson, Derek) (Entered: 09/30/2014)
- 09/30/2014 29 JOINT LETTER addressed to Judge Richard J. Sullivan from Thomas S. Biemer, Esquire dated September 30, 2014 re: Joint Letter per Court Order of 6-30-14 modified 7-8-14. Document filed by IXI IP, LLC, IXI Mobile (R&D) Ltd.. (Attachments: # 1 Online, # 2 Online) (Entered: 09/30/2014)
- 09/30/2014 &gt;&gt;&gt;NOTICE REGARDING PRO HAC VICE MOTION. Regarding Document No. 28 MOTION for Derek H. Swanson to Appear Pro Hac Vice . Filing fee \$ 200.00, receipt number 0208-10156919. Motion and supporting papers to be reviewed by Clerk's Office staff.. The document has been reviewed and there are no deficiencies. (sdi) (Entered: 09/30/2014)
- 10/01/2014 30 ORDER FOR ADMISSION PRO HAC VICE granting 26 Motion for Brian C. Riopelle to Appear Pro Hac Vice. (Signed by Judge Richard J. Sullivan on 10/1/2014) (kgo) (Entered: 10/01/2014)
- 10/01/2014 31 ORDER FOR ADMISSION PRO HAC VICE granting 28 Motion for Derek H. Swanson to Appear Pro Hac Vice. (Signed by Judge Richard J. Sullivan on 10/1/2014) (kgo) (Entered: 10/01/2014)
- 10/02/2014 32 MOTION for Jason W. Cook to Appear Pro Hac Vice . Motion and supporting papers to be reviewed by Clerk's Office staff. Document filed by Blackberry Corporation, Blackberry Limited.(Cook, Jason) (Entered: 10/02/2014)
- 10/02/2014 &gt;&gt;&gt;NOTICE REGARDING PRO HAC VICE MOTION. Regarding Document No. 32 MOTION for Jason W. Cook to Appear Pro Hac Vice . Motion and supporting papers to be reviewed by Clerk's Office staff.. The document has been reviewed and there are no deficiencies. (wb) (Entered: 10/02/2014)
- 10/03/2014 33 ORDER FOR ADMISSION PRO HAC VICE granting 32 Motion for Jason W. Cook to Appear Pro Hac Vice. (Signed by Judge Richard J. Sullivan on 10/3/2014) (kgo) (Entered: 10/03/2014)
- 10/07/2014 Minute Entry for proceedings held before Judge Richard J. Sullivan: Initial Pretrial Conference was held on 10/7/2014. Plaintiffs' counsel John Higson and Thomas Biemer were present. Defendant Samsung's counsel Todd Friedman and Greg Arovis were present. Defendant Blackberry's counsel Jason Cook and Marshal Beil were present. The parties are directed to confer with counsel for the defendant in the newly-filed related case and to submit a revised case management plan and joint letter no later than

- 11/7/14. (sc) (Entered: 10/08/2014)
- 10/08/2014 34 ORDER granting 19 Motion for Mark Halderman to Appear Pro Hac Vice. (Signed by Judge Richard J. Sullivan on 10/7/2014) (mro) (Entered: 10/08/2014)
- 10/17/2014 35 FILING ERROR - WRONG EVENT TYPE SELECTED FROM MENU - ANSWER to Complaint with JURY DEMAND. Document filed by IXI IP, LLC, IXI Mobile (R&D) Ltd.. (Attachments: # 1 Online (Entered: 10/17/2014))
- 10/21/2014 36 LETTER addressed to Judge Richard J. Sullivan from Marshall Beil dated October 21, 2014 re: Request for docket entry number 24 to be corrected. Document filed by Blackberry Corporation, Blackberry Limited. (Attachments: # 1 Online (Entered: 10/21/2014))
- 10/22/2014 37 MEMO ENDORSEMENT on re: 36 Letter, filed by Blackberry Limited, Blackberry Corporation. ENDORSEMENT: The Clerk of the Court is respectfully directed to correct docket entry 24 to reflect that Defendants Blackberry Limited and Blackberry Corporation filed an answer with counterclaims against Plaintiffs IXI Mobile (R&D) Ltd. and IXI IP, LLC. (Signed by Judge Richard J. Sullivan on 10/21/2014) (mro) (Entered: 10/22/2014)
- 11/07/2014 38 JOINT LETTER addressed to Judge Richard J. Sullivan from Thomas S. Biemer, Esquire dated 11/7/2014 re: Joint Submission Pursuant to Order during October 7, 2014 Conference. Document filed by IXI IP, LLC, IXI Mobile (R&D) Ltd.. (Attachments: # 1 Online, # 2 Online (Entered: 11/07/2014))
- 11/10/2014 39 LETTER addressed to Judge Richard J. Sullivan from Thomas S. Biemer, Esquire dated November 10, 2014 re: Response to Letter Dated November 7, 2014 from Defendant Apple, Inc. Document filed by IXI IP, LLC, IXI Mobile (R&D) Ltd..(Biemer, Thomas) (Entered: 11/10/2014)
- 12/01/2014 40 ORDER: The Court is in receipt of the parties' letters concerning disputes about the proposed case management plan. Having considered the parties' arguments, IT IS HEREBY ORDERED THAT, no later than December 8, 2014, the parties shall jointly submit a revised case management plan that reflects a 30-day extension of all contested dates. So Ordered (Signed by Judge Richard J. Sullivan on 12/1/2014) (js) Modified on 12/2/2014 (js). (Entered: 12/02/2014)
- 12/08/2014 41 JOINT LETTER addressed to Judge Richard J. Sullivan from Thomas S. Biemer, Esquire dated 12/8/2014 re: Proposed Case Management Plan and Scheduling Order. Document filed by IXI IP, LLC, IXI Mobile (R&D) Ltd.. (Attachments: # 1 Online (Entered: 12/08/2014))
- 12/12/2014 42 CASE MANAGEMENT PLAN AND SCHEDULING ORDER: All parties do not consent to disposition of this case by a Magistrate Judge, pursuant to 28 U.S.C. § 636(c). These cases are to be tried to juries. Plaintiffs' Claim Construction Brief shall be filed by: July 8, 2015. Defendants' Claim Construction Briefs shall be filed by: August 7, 2015. Plaintiffs' Reply Claim Construction Brief shall be filed by: August 14, 2015. Depositions shall be completed by: 11/10/2015. Completion of Fact Discovery: 11/10/2015. The Court will conduct a post-discovery conference on 11/24/2015. Referral to a Magistrate Judge for settlement discussions. (Signed by Judge Richard J. Sullivan on 12/8/2014) (mro) (Entered: 12/15/2014)
- 12/12/2014 Set/Reset Deadlines: Brief due by 8/14/2015. (mro) (Entered: 12/15/2014)
- 12/16/2014 43 LETTER addressed to Judge Richard J. Sullivan from Marshall Beil dated December 16, 2014 re: Request to transfer action to the Northern District of California. Document filed by Blackberry Corporation, Blackberry Limited.(Beil, Marshall) (Entered: 12/16/2014)
- 12/19/2014 44 LETTER addressed to Judge Richard J. Sullivan from Thomas S. Biemer, Esquire dated 12/19/2014 re: Response to the Pre-Motion Letter from Blackberry, et al. dated 12-16-14. Document filed by IXI IP, LLC, IXI Mobile (R&D) Ltd..(Biemer, Thomas) (Entered: 12/19/2014)
- 12/22/2014 45 ORDER: The Court seeks input from Defendants Samsung Electronics Co., Ltd., et al. ("Samsung") as to their views concerning a potential 28 U.S.C. § 1404(a) motion to transfer Case No. 14-cv-4355 (RJS) to the Northern District of California. Accordingly, IT IS HEREBY ORDERED THAT Defendants Samsung shall submit a letter response to a potential 28 U.S.C. § 1404(a) motion to transfer to the Northern District of California by Tuesday, December 30, 2014. (Signed by Judge Richard J. Sullivan on 12/22/2014) (mro) (Entered: 12/22/2014)
- 01/05/2015 46 ORDER: After receiving pre-motion letters from the parties in Case Nos. 14-cv-7954 (RJS) and 14-cv-4428 (RJS) (Doc. Nos. 23, 24, No. 14-cv-7954 (RJS); Doc. Nos. 43, 44, No. 14-cv-4428 (RJS)), the Court, on December 22, 2014, issued an Order to Defendants Samsung Electronics Co., Ltd., et al. ("Samsung") in a related case, Case No. 14-cv-4355 (RJS), seeking input as to their views concerning a potential 28 U.S.C. § 1404(a) motion

to transfer Case No. 14-cv-4355 (RJS) to the Northern District of California. (Doc. No. 39, No. 14-cv-4355 (RJS).) The Court is in receipt of Samsung's letter dated December 30, 2014, supporting Apple's and BlackBerry's motions to transfer but declining, at this time, to file their own motion to transfer. (Doc. No. 40, No. 14-cv-4355 (RJS).) Accordingly, IT IS HEREBY ORDERED THAT all of the above-captioned parties, including Samsung, shall appear for a conference on January 20, 2015 at 4:00 p.m. in Courtroom 905 at 40 Foley Square concerning the anticipated motions to transfer Case Nos. 14-cv-7954 (RJS) and 14-cv-4428 (RJS) to the Northern District of California pursuant to 28 U.S.C. § 1404(a). ( Status Conference set for 1/20/2015 at 04:00 PM in Courtroom 905, 40 Centre Street, New York, NY 10007 before Judge Richard J. Sullivan.) (Signed by Judge Richard J. Sullivan on 1/5/2015) (mro) (Entered: 01/05/2015)

- 02/03/2015 47 MOTION to Transfer Case . Document filed by Blackberry Corporation, Blackberry Limited. (Beil, Marshall) (Entered: 02/03/2015)
- 02/03/2015 48 MEMORANDUM OF LAW in Support re: 47 MOTION to Transfer Case . . Document filed by Blackberry Corporation, Blackberry Limited. (Beil, Marshall) (Entered: 02/03/2015)
- 02/03/2015 49 DECLARATION of Frank Geng in Support re: 47 MOTION to Transfer Case .. Document filed by Blackberry Corporation, Blackberry Limited. (Beil, Marshall) (Entered: 02/03/2015)
- 02/17/2015 50 BRIEF re: 47 MOTION to Transfer Case . Omnibus Brief In Opposition to Motion to Transfer. Document filed by IXI IP, LLC, IXI Mobile (R&D) Ltd..(Biemer, Thomas) (Entered: 02/17/2015)
- 02/17/2015 51 DECLARATION of John J. Higson in Opposition re: 47 MOTION to Transfer Case .. Document filed by IXI IP, LLC, IXI Mobile (R&D) Ltd.. (Attachments: # 1 Online, # 2 Online, # 3 Online, # 4 Online, # 5 Online, # 6 Online, # 7 Online, # 8 Online, # 9 Online, # 10 Online, # 11 Online, # 12 Online, # 13 Online, # 14 Online (Entered: 02/17/2015)
- 02/17/2015 52 DECLARATION of Zion Hadad in Opposition re: 47 MOTION to Transfer Case .. Document filed by IXI IP, LLC, IXI Mobile (R&D) Ltd.. (Biemer, Thomas) (Entered: 02/17/2015)
- 02/17/2015 53 DECLARATION of Steve Pedersen in Opposition re: 47 MOTION to Transfer Case .. Document filed by IXI IP, LLC, IXI Mobile (R&D) Ltd.. (Biemer, Thomas) (Entered: 02/17/2015)
- 02/20/2015 54 REPLY MEMORANDUM OF LAW in Support re: 47 MOTION to Transfer Case . . Document filed by Blackberry Corporation, Blackberry Limited. (Beil, Marshall) (Entered: 02/20/2015)
- 02/20/2015 55 DECLARATION of Derek H. Swanson in Support re: 47 MOTION to Transfer Case .. Document filed by Blackberry Corporation, Blackberry Limited. (Beil, Marshall) (Entered: 02/20/2015)
- 02/24/2015 56 LETTER addressed to Judge Richard J. Sullivan from Thomas S. Biemer, Esquire dated February 24, 2015 re: IXI Mobile (R&D), LTD., et al. v. Samsung Electronics Co., Blackberry, LTD, et al., and Apple, Inc. Transfer Venue Brief. Document filed by IXI IP, LLC, IXI Mobile (R&D) Ltd..(Biemer, Thomas) (Entered: 02/24/2015)
- 02/25/2015 57 ORDER: The Court is in receipt of Plaintiff's letter, dated February 24, 2015, requesting leave to file a sur-reply to Apple's reply brief. (Doc. No. 37, No. 14-cv-7954 (RJS).) The Court also is in receipt of Defendant Apple Inc.'s letter, dated February 24, 2015, responding to Plaintiff's letter and requesting "that IXI be required to provide the Court with the [IXI License Agreement]." (Doc. No. 38, No. 14-cv-7954 (RJS).) Because the Court finds that limited supplemental briefing as to whether IXI Mobile (R&D), Inc. lacks standing to be a Plaintiff in these actions would be helpful, IT IS HEREBY ORDERED THAT Plaintiff's request for leave to file a sur-reply is GRANTED. Plaintiff shall limit the sur-reply to three pages and submit the sur-reply by March 2, 2015. IT IS FURTHER ORDERED THAT Defendant Apple Inc.'s request "to respond to any new facts, evidence, or arguments introduced in the sur-reply" is GRANTED. Defendant Apple Inc. shall limit its response to three pages and submit the response by March 5, 2015. Finally, because the Court also finds that its review of the license referenced in the parties' briefing and letters would help the Court resolve the motion to transfer these actions to the Northern District of California pursuant to 28 U.S.C. § 1404(a), IT IS FURTHER ORDERED THAT Defendant Apple Inc.'s request "that IXI be required to provide the Court with the license" is GRANTED. ( Responses due by 3/5/2015, Surreplies due by 3/2/2015.) (Signed by Judge Richard J. Sullivan on 2/25/2015) (mro) (Entered: 02/26/2015)
- 02/27/2015 58 LETTER addressed to Judge Richard J. Sullivan from Thomas S. Biemer, Esquire dated February 27, 2015 re: IXI Mobile (R&D), LTD., et al. v. Samsung Electronics Co., Blackberry, LTD, et al., and Apple, Inc. Transfer Venue Sur-Reply. Document filed by IXI IP, LLC, IXI Mobile (R&D) Ltd..(Biemer, Thomas) (Entered: 02/27/2015)

- 02/27/2015 59 MEMO ENDORSEMENT on re: (54 in 1:14-cv-04355-RJS) Letter, filed by IXI IP,LLC, IXI Mobile (R&D) Ltd., (58 in 1:14-cv-04428-RJS) Letter, filed by IXI IP, LLC, IXI Mobile (R&D) Ltd., (40 in 1:14-cv-07954-RJS) Letter, filed by IXI IP,LLC, IXI Mobile (R&D) Ltd. ENDORSEMENT: There is a well-established presumption in the Second Circuit in favor of open court records. See *United States v. Amodeo*, 44 F.3d 141, 146 (2d Cir. 1995). To overcome this presumption, a party must demonstrate that sealing a judicial document is "essential to preserve higher values and is narrowly tailored to serve that interest." *United States v. Alcantara*, 396 F.3d 189, 199 (2d Cir. 2005); see also *Lugosch v. Pyramid Co. of Onondaga*, 435 F.3d 110, 119-20 (2d Cir. 2006) (" [D]ocuments may be sealed if specific, on the record findings are made demonstrating that closure is essential to preserve higher values and is narrowly tailored to serve that interest." (quotation marks and citations omitted)). Because Plaintiff represents that the license agreement between IXI IP and IXI Mobile contains "confidential information" and that the patent purchase agreement includes information relating to the strategy and financing of this litigation, the Court will allow Plaintiff to file the license and redacted patent purchase agreements under seal, and to submit the unredacted patent purchase agreement in camera. However, the Court may reach a different conclusion upon reviewing the materials in question and, at that time, will direct the parties to address whether the various documents should remain under seal. (Signed by Judge Richard J. Sullivan on 2/27/2015) (mro) (Entered: 03/02/2015)
- 03/02/2015 60 REPLY MEMORANDUM OF LAW in Opposition re: 47 MOTION to Transfer Case . PLAINTIFFS SUR-REPLY IN FURTHER OPPOSITION TO DEFENDANTS MOTIONS TO TRANSFER. Document filed by IXI IP, LLC, IXI Mobile (R&D) Ltd.. (Biemer, Thomas) (Entered: 03/02/2015)
- 03/02/2015 61 DECLARATION of STEVE PEDERSEN in Opposition re: 47 MOTION to Transfer Case .. Document filed by IXI IP, LLC, IXI Mobile (R&D) Ltd.. (Biemer, Thomas) (Entered: 03/02/2015)
- 03/02/2015 62 DECLARATION of John J. Higson in Opposition re: 47 MOTION to Transfer Case .. Document filed by IXI IP, LLC, IXI Mobile (R&D) Ltd.. (Attachments: # 1 Online, # 2 Online, # 3 Online, # 4 Online, # 5 Online, # 6 Online) (Entered: 03/02/2015)
- 03/05/2015 63 RESPONSE in Support of Motion re: 47 MOTION to Transfer Case . Response to IXI's Sur-Reply to BlackBerry's Motion to Transfer. Document filed by BlackBerry Corporation, BlackBerry Limited. (Beil, Marshall) (Entered: 03/05/2015)
- 03/18/2015 64 MOTION for Shaun William Hassett to Appear Pro Hac Vice . Filing fee \$ 200.00, receipt number 0208-10716319. Motion and supporting papers to be reviewed by Clerk's Office staff. Document filed by BlackBerry Corporation, BlackBerry Limited.(Hassett, Shaun) (Entered: 03/18/2015)
- 03/19/2015 >>>NOTICE REGARDING PRO HAC VICE MOTION. Regarding Document No. 64 MOTION for Shaun William Hassett to Appear Pro Hac Vice . Filing fee \$ 200.00, receipt number 0208-10716319. Motion and supporting papers to be reviewed by Clerk's Office staff.. The document has been reviewed and there are no deficiencies. (wb) (Entered: 03/19/2015)
- 03/20/2015 65 ORDER FOR ADMISSION PRO HAC VICE granting 64 Motion for Shaun W. Hassett to Appear Pro Hac Vice. (Signed by Judge Richard J. Sullivan on 3/20/2015) (kko) (Entered: 03/20/2015)
- 04/14/2015 66 AGREED PROTECTIVE ORDER REGARDING THE DISCLOSURE AND USE OF DISCOVERY MATERIALS...regarding procedures to be followed that shall govern the handling of confidential material... (Signed by Judge Richard J. Sullivan on 4/14/2015) (mro) (Entered: 04/15/2015)
- 04/14/2015 67 ORDER: This Addendum is an integral part of the Order of today's date granting confidentiality protection to certain materials. Notwithstanding any other provision, no document may be filed with the Clerk under seal without a further Order of this Court addressing the specific documents to be sealed. Any application to seal shall be accompanied by an affidavit or affidavits and a memorandum of law, demonstrating that the standards for sealing have been met and specifically addressing *Lugosch v. Pyramid Co. of Onondaga*, 435 F.3d 110, 119-20 (2d Cir. 2006) and any other controlling authority. Nothing herein is intended to alter or modify the applicability of Federal Rule of Civil Procedure 5.2 to this case. The redactions expressly authorized by Rule 5.2 may be made without further application to the Court. (Signed by Judge Richard J. Sullivan on 4/14/2015) (mro) (Entered: 04/15/2015)
- 05/04/2015 68 MOTION to Appear Pro Hac Vice for Gary D. Colby, Esquire. Filing fee \$ 200.00, receipt number 0208-10883370. Motion and supporting papers to be reviewed by Clerk's Office staff. Document filed by IXI IP, LLC, IXI Mobile (R&D) Ltd.. (Attachments: # 1 Online, # 2 Online) (Entered: 05/04/2015)



- 05/06/2015 69 ORDER granting 68 Motion for Gary D. Colby to Appear Pro Hac Vice. (Signed by Judge Richard J. Sullivan on 5/5/2015) (mro) (Entered: 05/06/2015)
- 05/11/2015 70 JOINT STIPULATION OF DISMISSAL OF CLAIMS AND COUNTERCLAIMS RELATED TO U.S. PATENT NO. 7,426,398: Plaintiffs IXI Mobile (R&D) Ltd. and IXI IP, LLC (collectively, "Plaintiffs") and Defendants BlackBerry Limited and BlackBerry Corporation (collectively "Defendants"); hereby stipulate and agree to the dismissal with prejudice of the Second Count for Relief in Plaintiffs' Complaint alleging infringement of U.S. Patent No. 7,426,398 ("the '398 Patent") in the above-captioned action, each party to bear its own costs and fees related to claims of infringement of the '398 Patent. Further, Plaintiffs and Defendants hereby stipulate and agree to the dismissal without prejudice of Defendants' counterclaims of invalidity and non-infringement of the '398 Patent, each party to bear its own costs and fees related to counterclaims of invalidity and non-infringement of the '398 Patent. (Signed by Judge Richard J. Sullivan on 5/11/2015) (kko) (Entered: 05/11/2015)
- 05/15/2015 71 JOINT LETTER addressed to Judge Richard J. Sullivan from Marshall Beil, Esq. dated 05/15/2015 re: mediation. Document filed by Blackberry Corporation, Blackberry Limited. (Beil, Marshall) (Entered: 05/15/2015)
- 05/15/2015 72 ORDER REFERRING CASE TO MAGISTRATE JUDGE. Order that case be referred to the Clerk of Court for assignment to a Magistrate Judge for Settlement: The parties shall contact Magistrate Judge Debra Freeman by May 19, 2015 to schedule a settlement conference. Referred to Magistrate Judge Debra C. Freeman. (Signed by Judge Richard J. Sullivan on 5/15/2015) (tn) (Entered: 05/18/2015)
- 05/28/2015 Minute Entry for proceedings held before Magistrate Judge Debra C. Freeman: Settlement Conference held via telephone on 5/28/2015. Telephone conference scheduled for 8/25/15 at 12:00 p.m. (aba) (Entered: 05/28/2015)
- 06/04/2015 73 LETTER addressed to Judge Richard J. Sullivan from Thomas S. Biemer, Esquire dated June 4, 2015 re: Claim Construction Technology Tutorial. Document filed by IXI IP, LLC, IXI Mobile (R&D) Ltd..(Biemer, Thomas) (Entered: 06/04/2015)
- 06/05/2015 74 AMENDED LETTER addressed to Judge Richard J. Sullivan from Thomas S. Biemer, Esquire dated June 5, 2015 re: Claim Construction Technology Tutorial. Document filed by IXI IP, LLC, IXI Mobile (R&D) Ltd..(Biemer, Thomas) (Entered: 06/05/2015)
- 06/08/2015 75 JOINT CLAIM CONSTRUCTION STATEMENT. Document filed by Blackberry Corporation, Blackberry Limited, IXI IP, LLC, IXI Mobile (R&D) Ltd..(Biemer, Thomas) (Entered: 06/08/2015)
- 06/15/2015 76 LETTER addressed to Judge Richard J. Sullivan from Thomas S. Biemer dated June 15, 2015 re: Pre-Motion Request to Strike Joint Claim Terms Chart. Document filed by IXI IP, LLC, IXI Mobile (R&D) Ltd..(Biemer, Thomas) (Entered: 06/15/2015)
- 06/18/2015 77 LETTER addressed to Judge Richard J. Sullivan from Harrison J. Frahn IV (on behalf of all Defendants) dated June 18, 2015 re: Response to IXI's Request for a Pre-motion Conference for a Motion to Strike. Document filed by Blackberry Corporation, Blackberry Limited.(Hassett, Shaun) (Entered: 06/18/2015)
- 07/02/2015 78 ENDORSED LETTER addressed to Judge Richard J. Sullivan from Thomas S. Biemer dated 7/2/2015 re: Plaintiffs respectfully request 5 additional pages for their Opening Claim Construction Brief due on July 8, 2015, as well as 5 additional pages for their supporting expert declaration. ENDORSEMENT: SO ORDERED. (Signed by Judge Richard J. Sullivan on 7/2/2015) (mro) (Entered: 07/06/2015)
- 07/08/2015 79 BRIEF Plaintiffs Opening Claim Construction Brief. Document filed by IXI IP, LLC, IXI Mobile (R&D) Ltd..(Biemer, Thomas) (Entered: 07/08/2015)
- 07/08/2015 80 DECLARATION re: 79 Brief Declaration of Mark W. Halderman. Document filed by IXI IP, LLC, IXI Mobile (R&D) Ltd.. (Attachments: # 1 Online, # 2 Online, # 3 Online, # 4 Online, # 5 Online, # 6 Online, # 7 Online, # 8 Online, # 9 Online, # 10 Online (Entered: 07/08/2015)
- 07/08/2015 81 DECLARATION re: 79 Brief Declaration of Joel R. Williams. Document filed by IXI IP, LLC, IXI Mobile (R&D) Ltd.. (Attachments: # 1 Online, # 2 Online, # 3 Online (Entered: 07/08/2015)
- 07/10/2015 82 LETTER addressed to Judge Richard J. Sullivan from Marshall Beil dated July 10, 2015 re: Request for pre-motion conference for a motion to stay. Document filed by Blackberry Corporation, Blackberry Limited.(Beil, Marshall) (Entered: 07/10/2015)
- 07/15/2015 83 LETTER addressed to Judge Richard J. Sullivan from Thomas S. Biemer, Esquire dated July 15, 2015 re: Response to pre-motion letter from Defendant Blackberry requesting a stay. Document filed by IXI IP, LLC, IXI Mobile (R&D) Ltd..(Biemer, Thomas) (Entered: 07/15/2015)

- 08/03/2015 84 LETTER addressed to Judge Richard J. Sullivan from Marshall Beil dated August 3, 2015 re: Request for additional pages and exhibits for Defendants' Responsive Claim Construction Brief. Document filed by Blackberry Corporation, Blackberry Limited.(Beil, Marshall) (Entered: 08/03/2015)
- 08/03/2015 85 MEMO ENDORSEMENT on re: (84 in 1:14-cv-04428-RJS) Letter, filed by Blackberry Limited, Blackberry Corporation, (77 in 1:14-cv-04355-RJS) Letter, filed by Samsung Electronics Co., Ltd., Samsung Electronics America, Inc. ENDORSEMENT: SO ORDERED. ( Brief due by 8/7/2015.) (Signed by Judge Richard J. Sullivan on 8/3/2015) (mro) (Entered: 08/04/2015)
- 08/06/2015 86 OPINION AND ORDER # 105941 re: (27 in 1:14-cv-07954-RJS) MOTION to Transfer Case Apple Inc.'s Notice of Motion to Transfer Venue Pursuant to 28 U.S.C. § 1404(a). filed by Apple, Inc., (47 in 1:14-cv-04428-RJS) MOTION to Transfer Case . filed by Blackberry Limited, Blackberry Corporation, (44 in 1:14-cv-04355-RJS) MOTION to Transfer Case Samsung's Notice of Motion to Transfer Venue Pursuant to 28 U.S.C. § 1404(a). filed by Samsung Electronics Co., Ltd., Samsung Telecommunications America, LLC, Samsung Electronics America, Inc. Weighing the factors set forth above and having considered all the facts and circumstances before it, the Court determines that Defendants have demonstrated by clear and convincing evidence that transfer of these three actions is appropriate. Accordingly, IT IS HEREBY ORDERED THAT Defendants' motions to transfer these actions to the Northern District of California are GRANTED. The Clerk of the Court is respectfully directed to terminate the motions pending at docket entries 44 in case number 14--cv-4355 (RJS), 47 in case number 14--cv-4428 (RJS), and 27 in case number 14-cv-7954 (RJS), and to close these cases. SO ORDERED. (As further set forth within this Order.) (Signed by Judge Richard J. Sullivan on 8/6/2015) (ajs) Modified on 10/13/2015 (ca). (Entered: 08/07/2015)
- 08/06/2015 CASE TRANSFERRED OUT ELECTRONICALLY from the U.S.D.C. Southern District of New York to the United States District Court - Northern District of California. (ajs) (Entered: 08/14/2015)
- 08/12/2015 87 LETTER addressed to Judge Richard J. Sullivan from Thomas S. Biemer, Esquire dated August 12, 2015 re: Requesting Reconsideration of the Order entered August 7, 2015. Document filed by IXI IP, LLC, IXI Mobile (R&D) Ltd..(Biemer, Thomas) (Entered: 08/12/2015)
- 08/19/2015 Received e-mail from the United States District Court - Northern District of California acknowledging receipt of transferred case. Assigned Case Number: 3:15-cv-03754, filed on 08/17/2015. (sjo) (Entered: 08/20/2015)
- 09/09/2015 88 ORDER: The Court is in receipt of a letter from Plaintiffs, dated August 12, 2015 (No. 14-cv-4355 (RJS), Doc. No. 80; No. 14-cv-4428 (RJS), Doc. No. 87; No. 14-cv-7954 (RJS), Doc. No. 72), requesting that the Court reconsider its Opinion and Order, dated August 6, 2015, granting Defendants' motions to transfer these three related patent infringement actions to the Northern District of California pursuant to 28 U.S.C. § 1404(a). In sum, the Court finds that there is no "manifest injustice" here and that these actions bear little resemblance to the Eastern District of Texas decisions cited by Plaintiffs. Thus, Plaintiffs have failed to persuade the Court to reconsider its August 6, 2015 Opinion and Order. Accordingly, IT IS HEREBY ORDERED THAT Plaintiffs' motion for reconsideration is DENIED. (As further set forth in this Order.) (Signed by Judge Richard J. Sullivan on 9/9/2015) (kko) (Entered: 09/09/2015)

---

**US District Court Civil Docket**

U.S. District - New York Southern  
(Foley Square)

**1:14cv4355**

**Ixi Mobile (R&D) Ltd. et al v. Samsung Electronics Co., Ltd. et al**

This case was retrieved from the court on Monday, February 27, 2017

---

Date Filed: **06/17/2014**

Assigned

To: **Judge Richard J. Sullivan**

Referred **Magistrate Judge Debra C. Freeman**

To: **(Settlement)**

Class Code: **CLOSED**

Closed: **08/06/2015**

Nature of

suit: **Patent (830)**

Statute: **35:145**

Cause: **Civil Action to Obtain Patent**

Jury Demand: **Both**

Lead

Demand Amount: **\$0**

Docket: **None**

NOS Description: **Patent**

Other **1:14cv04428**

Docket: **1:14cv07954**

Jurisdiction: **Federal Question**

---

**Litigants**

**Attorneys**

Ixi Mobile (R&D) Ltd.  
Plaintiff

Gary David Colby  
LEAD ATTORNEY; ATTORNEY TO BE NOTICED  
Dilworth Paxson, LLP  
1500 Market Street  
Philadelphia, PA 19102  
USA  
(215)-575-7075  
Email: Gcolby@dilworthlaw.Com

Gregory A. Blue  
LEAD ATTORNEY; ATTORNEY TO BE NOTICED  
Dilworth Paxson LLP (NY)  
99 Park Avenue Suite 320  
New York, NY 10016  
USA  
(917)-675-4252  
Fax: (212) 208-6874  
Email: Gblue@dilworthlaw.Com

John Joseph Higson  
LEAD ATTORNEY; PRO HAC VICE; ATTORNEY TO BE NOTICED  
Dilworth Paxson LLP  
3200 Mellon Bank Ctr 1735 Market Street  
Philadelphia, PA 19103  
USA  
(212)575-7152  
Fax: (215)-575-7200  
Email: Jhigson@dilworthlaw.Com

Joshua D. Wolson  
LEAD ATTORNEY; ATTORNEY TO BE NOTICED

Dilworth Paxson LLP (PA)  
1500 Market Street Suite 3500e  
Philadelphia , PA 19102-2101  
USA  
(215)-575-7295  
Fax: (215)-575-7200  
Email: Jwolson@dilworthlaw.Com

Mark William Halderman  
LEAD ATTORNEY; ATTORNEY TO BE NOTICED  
Dilworth Paxson LLP  
1500 Market Street, Suite 3500(E)  
Philadelphia , PA 19102  
USA  
(215)-575-7186  
Fax: (215)-575-7200  
Email: Mwhalderman@dilworthlaw.Com

Thomas Steven Biemer  
LEAD ATTORNEY; ATTORNEY TO BE NOTICED  
Dilworth Paxson LLP (PA)  
1500 Market Street Suite 3500e  
Philadelphia , PA 19102-2101  
USA  
(215)-575-7025  
Fax: (215)-575-7200  
Email: Tbiemer@dilworthlaw.Com

Ixi Ip, Llc  
Plaintiff

Gary David Colby  
LEAD ATTORNEY; ATTORNEY TO BE NOTICED  
Dilworth Paxson, LLP  
1500 Market Street  
Philadelphia , PA 19102  
USA  
(215)-575-7075  
Email: Gcolby@dilworthlaw.Com

Gregory A. Blue  
LEAD ATTORNEY; ATTORNEY TO BE NOTICED  
Dilworth Paxson LLP (NY)  
99 Park Avenue Suite 320  
New York , NY 10016  
USA  
(917)-675-4252  
Fax: (212) 208-6874  
Email: Gblue@dilworthlaw.Com

John Joseph Higson  
LEAD ATTORNEY; PRO HAC VICE; ATTORNEY TO BE NOTICED  
Dilworth Paxson LLP  
3200 Mellon Bank Ctr 1735 Market Street  
Philadelphia , PA 19103  
USA  
(212)575-7152  
Fax: (215)-575-7200  
Email: Jhigson@dilworthlaw.Com

Joshua D. Wolson  
LEAD ATTORNEY; ATTORNEY TO BE NOTICED  
Dilworth Paxson LLP (PA)  
1500 Market Street Suite 3500e  
Philadelphia , PA 19102-2101  
USA  
(215)-575-7295  
Fax: (215)-575-7200  
Email: Jwolson@dilworthlaw.Com

Mark William Halderman

LEAD ATTORNEY; ATTORNEY TO BE NOTICED  
Dilworth Paxson LLP  
1500 Market Street, Suite 3500(E)  
Philadelphia , PA 19102  
USA  
(215)-575-7186  
Fax: (215)-575-7200  
Email: Mwhalderman@dilworthlaw.Com

Thomas Steven Biemer  
LEAD ATTORNEY; ATTORNEY TO BE NOTICED  
Dilworth Paxson LLP (PA)  
1500 Market Street Suite 3500e  
Philadelphia , PA 19102-2101  
USA  
(215)-575-7025  
Fax: (215)-575-7200  
Email: Tbiemer@dilworthlaw.Com

Samsung Electronics Co., Ltd.  
Defendant

David Rokach  
ATTORNEY TO BE NOTICED  
Kirkland & Ellis LLP (IL)  
300 North LaSalle Street  
Chicago , IL 60654  
USA  
(312)-862-3169  
Fax: (312)-862-2200  
Email: David.Rokach@kirkland.Com

Gregory Steven Arovas  
ATTORNEY TO BE NOTICED  
Kirkland & Ellis LLP (NYC)  
601 Lexington Avenue  
New York , NY 10022  
USA  
(212) 446-4800 X4766  
Fax: (212) 446-4900  
Email: Greg.Arovas@kirkland.Com

James E. Marina  
ATTORNEY TO BE NOTICED  
Kirkland & Ellis LLP (NYC)  
601 Lexington Avenue  
New York , NY 10022  
USA  
(212)-446-4800  
Email: Jmarina@kirkland.Com

James Henry McConnell  
ATTORNEY TO BE NOTICED  
Kirkland & Ellis LLP  
601 Lexington Avenue  
New York , NY 10022  
USA  
(212) 446-4895  
Fax: (212) 446-4900  
Email: James.Mcconnell@kirkland.Com

Todd M. Friedman  
ATTORNEY TO BE NOTICED  
Kirkland & Ellis LLP (NYC)  
601 Lexington Avenue  
New York , NY 10022  
USA  
(212)446-4800 X.4786  
Fax: (212)446-4900  
Email: Todd.Friedman@kirkland.Com

Samsung Electronics America, Inc.  
Defendant

David Rokach  
ATTORNEY TO BE NOTICED  
Kirkland & Ellis LLP (IL)  
300 North LaSalle Street  
Chicago , IL 60654  
USA  
(312)-862-3169  
Fax: (312)-862-2200  
Email: David.Rokach@kirkland.Com

Gregory Steven Arovas  
ATTORNEY TO BE NOTICED  
Kirkland & Ellis LLP (NYC)  
601 Lexington Avenue  
New York , NY 10022  
USA  
(212) 446-4800 X4766  
Fax: (212) 446-4900  
Email: Greg.Arovas@kirkland.Com

James E. Marina  
ATTORNEY TO BE NOTICED  
Kirkland & Ellis LLP (NYC)  
601 Lexington Avenue  
New York , NY 10022  
USA  
(212)-446-4800  
Email: Jmarina@kirkland.Com

James Henry McConnell  
ATTORNEY TO BE NOTICED  
Kirkland & Ellis LLP  
601 Lexington Avenue  
New York , NY 10022  
USA  
(212) 446-4895  
Fax: (212) 446-4900  
Email: James.Mcconnell@kirkland.Com

Todd M. Friedman  
ATTORNEY TO BE NOTICED  
Kirkland & Ellis LLP (NYC)  
601 Lexington Avenue  
New York , NY 10022  
USA  
(212)446-4800 X.4786  
Fax: (212)446-4900  
Email: Todd.Friedman@kirkland.Com

Samsung Telecommunications America, Llc  
[Term: 03/06/2015]  
Defendant

David Rokach  
ATTORNEY TO BE NOTICED  
Kirkland & Ellis LLP (IL)  
300 North LaSalle Street  
Chicago , IL 60654  
USA  
(312)-862-3169  
Fax: (312)-862-2200  
Email: David.Rokach@kirkland.Com

Gregory Steven Arovas  
ATTORNEY TO BE NOTICED  
Kirkland & Ellis LLP (NYC)  
601 Lexington Avenue  
New York , NY 10022  
USA  
(212) 446-4800 X4766  
Fax: (212) 446-4900  
Email: Greg.Arovas@kirkland.Com

James E. Marina  
ATTORNEY TO BE NOTICED  
Kirkland & Ellis LLP (NYC)  
601 Lexington Avenue  
New York , NY 10022  
USA  
(212)-446-4800  
Email: Jmarina@kirkland.Com

James Henry McConnell  
ATTORNEY TO BE NOTICED  
Kirkland & Ellis LLP  
601 Lexington Avenue  
New York , NY 10022  
USA  
(212) 446-4895  
Fax: (212) 446-4900  
Email: James.Mcconnell@kirkland.Com

Todd M. Friedman  
ATTORNEY TO BE NOTICED  
Kirkland & Ellis LLP (NYC)  
601 Lexington Avenue  
New York , NY 10022  
USA  
(212)446-4800 X.4786  
Fax: (212)446-4900  
Email: Todd.Friedman@kirkland.Com

Samsung Electronics America, Inc.  
Counter Claimant

Todd M. Friedman  
ATTORNEY TO BE NOTICED  
Kirkland & Ellis LLP (NYC)  
601 Lexington Avenue  
New York , NY 10022  
USA  
(212)446-4800 X.4786  
Fax: (212)446-4900  
Email: Todd.Friedman@kirkland.Com

Samsung Electronics Co., Ltd.  
Counter Claimant

Todd M. Friedman  
ATTORNEY TO BE NOTICED  
Kirkland & Ellis LLP (NYC)  
601 Lexington Avenue  
New York , NY 10022  
USA  
(212)446-4800 X.4786  
Fax: (212)446-4900  
Email: Todd.Friedman@kirkland.Com

Samsung Telecommunications America, Llc  
[Term: 03/06/2015]  
Counter Claimant

Todd M. Friedman  
ATTORNEY TO BE NOTICED  
Kirkland & Ellis LLP (NYC)  
601 Lexington Avenue  
New York , NY 10022  
USA  
(212)446-4800 X.4786  
Fax: (212)446-4900  
Email: Todd.Friedman@kirkland.Com

Ixi Ip,Llc  
Counter Defendant

Gregory A. Blue  
LEAD ATTORNEY; ATTORNEY TO BE NOTICED  
Dilworth Paxson LLP (NY)  
99 Park Avenue Suite 320  
New York , NY 10016  
USA

(917)-675-4252  
Fax: (212) 208-6874  
Email: Gblue@dilworthlaw.Com

John Joseph Higson  
LEAD ATTORNEY; ATTORNEY TO BE NOTICED  
Dilworth Paxson LLP  
3200 Mellon Bank Ctr 1735 Market Street  
Philadelphia , PA 19103  
USA  
(212)575-7152  
Fax: (215)-575-7200  
Email: Jhigson@dilworthlaw.Com

Joshua D. Wolson  
LEAD ATTORNEY; ATTORNEY TO BE NOTICED  
Dilworth Paxson LLP (PA)  
1500 Market Street Suite 3500e  
Philadelphia , PA 19102-2101  
USA  
(215)-575-7295  
Fax: (215)-575-7200  
Email: Jwolson@dilworthlaw.Com

Mark William Halderman  
LEAD ATTORNEY; ATTORNEY TO BE NOTICED  
Dilworth Paxson LLP  
1500 Market Street, Suite 3500(E)  
Philadelphia , PA 19102  
USA  
(215)-575-7186  
Fax: (215)-575-7200  
Email: Mwhalderman@dilworthlaw.Com

Thomas Steven Biemer  
LEAD ATTORNEY; ATTORNEY TO BE NOTICED  
Dilworth Paxson LLP (PA)  
1500 Market Street Suite 3500e  
Philadelphia , PA 19102-2101  
USA  
(215)-575-7025  
Fax: (215)-575-7200  
Email: Tbiemer@dilworthlaw.Com

Ixi Mobile (R&D) Ltd.  
Counter Defendant

Gregory A. Blue  
LEAD ATTORNEY; ATTORNEY TO BE NOTICED  
Dilworth Paxson LLP (NY)  
99 Park Avenue Suite 320  
New York , NY 10016  
USA  
(917)-675-4252  
Fax: (212) 208-6874  
Email: Gblue@dilworthlaw.Com

John Joseph Higson  
LEAD ATTORNEY; ATTORNEY TO BE NOTICED  
Dilworth Paxson LLP  
3200 Mellon Bank Ctr 1735 Market Street  
Philadelphia , PA 19103  
USA  
(212)575-7152  
Fax: (215)-575-7200  
Email: Jhigson@dilworthlaw.Com

Joshua D. Wolson  
LEAD ATTORNEY; ATTORNEY TO BE NOTICED  
Dilworth Paxson LLP (PA)  
1500 Market Street Suite 3500e



Philadelphia , PA 19102-2101  
 USA  
 (215)-575-7295  
 Fax: (215)-575-7200  
 Email: Jwolson@dilworthlaw.Com

Mark William Halderman  
 LEAD ATTORNEY; ATTORNEY TO BE NOTICED  
 Dilworth Paxson LLP  
 1500 Market Street, Suite 3500(E)  
 Philadelphia , PA 19102  
 USA  
 (215)-575-7186  
 Fax: (215)-575-7200  
 Email: Mwhalderman@dilworthlaw.Com

Thomas Steven Biemer  
 LEAD ATTORNEY; ATTORNEY TO BE NOTICED  
 Dilworth Paxson LLP (PA)  
 1500 Market Street Suite 3500e  
 Philadelphia , PA 19102-2101  
 USA  
 (215)-575-7025  
 Fax: (215)-575-7200  
 Email: Tbiemer@dilworthlaw.Com

| Date       | # | Proceeding Text   | Source |
|------------|---|---|--------|
| 06/17/2014 | 1 | COMPLAINT against Samsung Electronics America, Inc., Samsung Electronics Co., Ltd., Samsung Telecommunications America, LLC. (Filing Fee \$ 350.00, Receipt Number 1097884) Document filed by IXI Mobile (R&D) Ltd., IXI IP, LLC. (moh) (Additional attachment(s) added on 6/19/2014: # 1 Exhibit Exhibit A, # 2 Exhibit Exhibit B, # 3 Exhibit Exhibit C, # 4 Exhibit Exhibit D) (moh). (Entered: 06/18/2014)  |        |
| 06/17/2014 |   | SUMMONS ISSUED as to Samsung Electronics America, Inc., Samsung Electronics Co., Ltd., Samsung Telecommunications America, LLC. (moh) (Entered: 06/18/2014)   |        |
| 06/17/2014 |   | Magistrate Judge Debra C. Freeman is so designated. (moh) (Entered: 06/18/2014)   |        |
| 06/17/2014 |   | Case Designated ECF. (moh) (Entered: 06/18/2014)  |        |
| 06/17/2014 | 2 | CIVIL COVER SHEET filed. (moh) (moh). (Entered: 06/18/2014)   |        |
| 06/17/2014 | 5 | STANDING ORDER IN RE PILOT PROJECT REGARDING CASE MANAGEMENT TECHNIQUES FOR COMPLEX CIVIL CASES IN THE SOUTHERN DISTRICT OF NEW YORK (See M-10-468 Order filed November 1, 2011). This case is hereby designated for inclusion in the Pilot Project Regarding Case Management Techniques for Complex Civil Cases in the Southern District of New York (the Pilot Project), unless the judge to whom this case is assigned determines otherwise. This case is designated for inclusion in the Pilot Project because it is a class action, an MDL action, or is in one of the following Nature of Suit categories: 160, 245, 315, 355, 365, 385, 410, 830, 840, 850, 893, or 950. The presiding judge in a case that does not otherwise qualify for inclusion in the Pilot Project may nevertheless designate the case for inclusion in the Pilot Project by issuing an order directing that the case be included in the Pilot Project. The description of the Pilot Project, including procedures to be followed, is attached to this Order. (Signed by Judge Loretta A. Preska on 10/31/2011) (moh) (Entered: 06/23/2014) |        |
| 06/17/2014 |   | Case Eligible for Patent Pilot Program. (moh) (Entered: 06/23/2014)   |        |
| 06/17/2014 |   | Mailed notice to Commissioner of Patents and Trademarks to report the filing of this action. (moh) (Entered: 03/26/2015)  |        |
| 06/19/2014 | 3 | RULE 7.1 CORPORATE DISCLOSURE STATEMENT. No Corporate Parent. Document filed by IXI IP, LLC. (Biemer, Thomas) (Entered: 06/19/2014)   |        |
| 06/19/2014 | 4 | RULE 7.1 CORPORATE DISCLOSURE STATEMENT. No Corporate Parent. Document filed by IXI Mobile (R&D) Ltd. (Biemer, Thomas) (Entered: 06/19/2014)  |        |
| 06/27/2014 | 6 | AFFIDAVIT OF SERVICE of Summons and Complaint, Samsung Telecommunications America, LLC served on 6/20/2014, answer due 7/11/2014. Service was accepted by Dion Miles, Agent in Charge of CSC Corporation Service Company. Document filed by IXI Mobile (R&D) Ltd.; IXI IP, LLC. (Biemer, Thomas) (Entered: 06/27/2014)  |        |

- 06/30/2014 7 ORDER: Initial Conference set for 8/26/2014 at 12:30 PM in Courtroom 905, 40 Centre Street, New York, NY 10007 before Judge Richard J. Sullivan, and as further set forth in this document. (Signed by Judge Richard J. Sullivan on 6/25/2014) (cd) (Entered: 07/01/2014)
- 07/02/2014 8 AFFIDAVIT OF SERVICE of Summons and Complaint,. Samsung Electronics America, Inc. served on 6/27/2014, answer due 7/18/2014. Service was accepted by Monica Reed, Corporate Operations Specialist, The Corporation Trust Company. Document filed by IXI Mobile (R&D) Ltd.; IXI IP,LLC. (Biemer, Thomas) (Entered: 07/02/2014)
- 07/08/2014 9 SUPPLEMENTAL RULE 7.1 CORPORATE DISCLOSURE STATEMENT. Identifying Corporate Parent IXI Mobile Inc. for IXI Mobile (R&D) Ltd.. Document filed by IXI Mobile (R&D) Ltd..(Biemer, Thomas) (Entered: 07/08/2014)
- 07/08/2014 10 LETTER MOTION for Extension of Time To Respond To Plaintiffs' Complaint addressed to Judge Richard J. Sullivan from Thomas S. Biemer, Esquire dated 7/8/2014. Document filed by IXI IP,LLC, IXI Mobile (R&D) Ltd..(Biemer, Thomas) (Entered: 07/08/2014)
- 07/08/2014 11 ORDER granting 10 Letter Motion for Extension of Time. IT IS HEREBY ORDERED THAT Defendants time to answer, move against or otherwise respond to Plaintiffs' Complaint is extended to September 12, 2014. IT IS FURTHER ORDERED THAT the initial conference, currently scheduled for August 26, 2014, is ADJOURNED to October 7, 2014 at 12:30 p.m. IT IS FURTHER ORDERED that the parties shall submit the joint letter and proposed case management plan referenced in the Court's June 30, 2014 Order no later than September 30, 2014 at 4:00 p.m. (Signed by Judge Richard J. Sullivan on 7/8/2014) (cd) (Entered: 07/09/2014)
- 07/08/2014 Set/Reset Deadlines: Samsung Electronics America, Inc. answer due 9/12/2014; Samsung Electronics Co., Ltd. answer due 9/12/2014; Samsung Telecommunications America, LLC answer due 9/12/2014. Set/Reset Hearings:(Initial Conference reset for 10/7/2014 at 12:30 PM before Judge Richard J. Sullivan.) (cd) (Entered: 07/09/2014)
- 07/22/2014 12 FILING ERROR - DEFICIENT DOCKET ENTRY - MOTION for Joshua D. Wolson to Appear Pro Hac Vice . Filing fee \$ 200.00, receipt number 0208-9915096. Motion and supporting papers to be reviewed by Clerk's Office staff. Document filed by IXI IP,LLC, IXI Mobile (R&D) Ltd.. (Attachments: # 1 Online, # 2 Online (Entered: 07/22/2014)
- 07/22/2014 13 FILING ERROR - DEFICIENT DOCKET ENTRY - MOTION for John Joseph Higson to Appear Pro Hac Vice . Filing fee \$ 200.00, receipt number 0208-9915160. Motion and supporting papers to be reviewed by Clerk's Office staff. Document filed by IXI IP,LLC, IXI Mobile (R&D) Ltd.. (Attachments: # 1 Online, # 2 Online (Entered: 07/22/2014)
- 07/23/2014 &gt;&gt;&gt;NOTICE REGARDING DEFICIENT MOTION TO APPEAR PRO HAC VICE. Notice regarding Document No. 13 MOTION for John Joseph Higson to Appear Pro Hac Vice . Filing fee \$ 200.00, receipt number 0208-9915160. Motion and supporting papers to be reviewed by Clerk's Office staff., 12 MOTION for Joshua D. Wolson to Appear Pro Hac Vice . Filing fee \$ 200.00, receipt number 0208-9915096. Motion and supporting papers to be reviewed by Clerk's Office staff.. Please put one Case number on the document. (wb) (Entered: 07/23/2014)
- 07/23/2014 14 MOTION for Joshua D. Wolson to Appear Pro Hac Vice (CORRECTED). Motion and supporting papers to be reviewed by Clerk's Office staff. Document filed by IXI IP,LLC, IXI Mobile (R&D) Ltd.. (Attachments: # 1 Online, # 2 Online (Entered: 07/23/2014)
- 07/23/2014 15 MOTION for John Joseph Higson to Appear Pro Hac Vice (CORRECTED). Motion and supporting papers to be reviewed by Clerk's Office staff. Document filed by IXI IP,LLC, IXI Mobile (R&D) Ltd.. (Attachments: # 1 Online, # 2 Online (Entered: 07/23/2014)
- 07/24/2014 &gt;&gt;&gt;NOTICE REGARDING PRO HAC VICE MOTION. Regarding Document No. 15 MOTION for John Joseph Higson to Appear Pro Hac Vice (CORRECTED). Motion and supporting papers to be reviewed by Clerk's Office staff.. The document has been reviewed and there are no deficiencies. (sdi) (Entered: 07/24/2014)
- 07/24/2014 &gt;&gt;&gt;NOTICE REGARDING PRO HAC VICE MOTION. Regarding Document No. 14 MOTION for Joshua D. Wolson to Appear Pro Hac Vice (CORRECTED). Motion and supporting papers to be reviewed by Clerk's Office staff.. The document has been reviewed and there are no deficiencies. (sdi) (Entered: 07/24/2014)
- 07/28/2014 16 ORDER granting 14 Application for Joshua D. Wolson to Appear Pro Hac Vice. (Signed by Judge Richard J. Sullivan on 7/28/2014) (cd) (Entered: 07/28/2014)
- 07/28/2014 17 ORDER granting 15 Motion for John J. Higson to Appear Pro Hac Vice. (Signed by Judge Richard J. Sullivan on 7/28/2014) (cd) (Entered: 07/28/2014)
- 08/20/2014 18 FILING ERROR - DEFICIENT DOCKET ENTRY - MOTION to Appear Pro Hac Vice for Mark W. Halderman. Motion and supporting papers to be reviewed by Clerk's Office staff. Document filed by IXI IP,LLC, IXI Mobile (R&D) Ltd.. (Attachments: # 1 Online, # 2

- Online (Entered: 08/20/2014)
- 08/20/2014 &gt;&gt;&gt;NOTICE REGARDING DEFICIENT MOTION TO APPEAR PRO HAC VICE. Notice regarding Document No. 18 MOTION to Appear Pro Hac Vice for Mark W. Halderman. Motion and supporting papers to be reviewed by Clerk's Office staff.. The filing is deficient for the following reason(s): Filing fee not paid.Missing Certificate of Good Standing. Certificate of Good Standing must be issued from the Supreme Court of Texas and not from a State Bar Association. Re-file the document as a Corrected Motion to Appear Pro Hac Vice and attach a valid Certificate of Good Standing, issued within the past 30 days and pay the filing fee. (bcu) (Entered: 08/20/2014)
- 08/25/2014 19 MOTION to Appear Pro Hac Vice for Mark Halderman. Filing fee \$ 200.00, receipt number 0208-10032281. Motion and supporting papers to be reviewed by Clerk's Office staff. Document filed by IXI IP,LLC, IXI Mobile (R&D) Ltd.. (Attachments: # 1 Online, # 2 Online (Entered: 08/25/2014)
- 08/25/2014 &gt;&gt;&gt;NOTICE REGARDING PRO HAC VICE MOTION. Regarding Document No. 19 MOTION to Appear Pro Hac Vice for Mark Halderman. Filing fee \$ 200.00, receipt number 0208-10032281. Motion and supporting papers to be reviewed by Clerk's Office staff.. The document has been reviewed and there are no deficiencies. (wb) (Entered: 08/25/2014)
- 08/26/2014 20 ORDER granting 19 Motion for Mark W. Halderman to Appear Pro Hac Vice. (Signed by Judge Richard J. Sullivan on 8/26/2014) (ajs) (Entered: 08/26/2014)
- 09/11/2014 21 LETTER MOTION for Extension of Time to File Answer addressed to Judge Richard J. Sullivan from Todd M. Friedman dated September 11, 2014. Document filed by Samsung Electronics America, Inc., Samsung Electronics Co., Ltd., Samsung Telecommunications America, LLC.(Friedman, Todd) (Entered: 09/11/2014)
- 09/11/2014 22 ORDER granting 21 Letter Motion for Extension of Time to Answer. SO ORDERED. Samsung Electronics America, Inc. answer due 9/26/2014; Samsung Electronics Co., Ltd. answer due 9/26/2014; Samsung Telecommunications America, LLC answer due 9/26/2014. (Signed by Judge Richard J. Sullivan on 9/11/2014) (mro) (Entered: 09/12/2014)
- 09/26/2014 23 FILING ERROR - CORPORATE PARENT/OTHER AFFILIATE NOT ADDED - RULE 7.1 CORPORATE DISCLOSURE STATEMENT. No Corporate Parent. Document filed by Samsung Electronics America, Inc., Samsung Electronics Co., Ltd., Samsung Telecommunications America, LLC.(Friedman, Todd) Modified on 9/29/2014 (lb). (Entered: 09/26/2014)
- 09/26/2014 24 ANSWER to 1 Complaint, with JURY DEMAND., COUNTERCLAIM against All Plaintiffs. Document filed by Samsung Electronics America, Inc., Samsung Electronics Co., Ltd., Samsung Telecommunications America, LLC.(Friedman, Todd) (Entered: 09/26/2014)
- 09/29/2014 \*\*\* NOTE TO ATTORNEY TO RE-FILE DOCUMENT - DEFICIENT DOCKET ENTRY ERROR. Note to Attorney Todd M. Friedman to RE-FILE Document 23 Rule 7.1 Corporate Disclosure Statement,. ERROR(S): Corporate Parents were not added. Please re-file this document and when prompted: Are there any corporate parents or other affiliates?, select the YES radio button and enter the Corporate Parent(s) or Affiliate(s). YOU MUST SELECT THE SEARCH BUTTON. Select the correct name or create a new corporate parent. Add the Corporate Parent(s) or Affiliate(s) one party name at a time. (lb) (Entered: 09/29/2014)
- 09/29/2014 25 RULE 7.1 CORPORATE DISCLOSURE STATEMENT. Identifying Other Affiliate Samsung Electronics America, Inc. for Samsung Telecommunications America, LLC; Corporate Parent Samsung Electronics Co., Ltd. for Samsung Electronics America, Inc.. Document filed by Samsung Electronics America, Inc., Samsung Electronics Co., Ltd., Samsung Telecommunications America, LLC.(Friedman, Todd) (Entered: 09/29/2014)
- 09/30/2014 26 JOINT LETTER addressed to Judge Richard J. Sullivan from Thomas S. Biemer, Esquire dated September 30, 2014 re: Joint Submission Pursuant to Court Order Dated June 30, 2014 modified 7-8-14. Document filed by IXI IP,LLC, IXI Mobile (R&D) Ltd.. (Attachments: # 1 Online, # 2 Online (Entered: 09/30/2014)
- 10/07/2014 Minute Entry for proceedings held before Judge Richard J. Sullivan: Initial Pretrial Conference was held on 10/7/2014. Plaintiffs' counsel John Higson and Thomas Biemer were present. Defendant Samsung's counsel Todd Friedman and Greg Arovis were present. Defendant Blackberry's counsel Jason Cook and Marshal Beil were present. The parties are directed to confer with counsel for the defendant in the newly-filed related case and to submit a revised case management plan and joint letter no later than 11/7/14. (sc) (Entered: 10/08/2014)
- 10/09/2014 27 NOTICE OF APPEARANCE by Gregory Steven Arovas on behalf of Samsung Electronics America, Inc., Samsung Electronics Co., Ltd., Samsung Telecommunications America,

- LLC. (Arovas, Gregory) (Entered: 10/09/2014)
- 10/09/2014 28 NOTICE OF APPEARANCE by Todd M. Friedman on behalf of Samsung Electronics America, Inc., Samsung Electronics Co., Ltd., Samsung Telecommunications America, LLC. (Friedman, Todd) (Entered: 10/09/2014)
- 10/09/2014 29 NOTICE OF APPEARANCE by James E. Marina on behalf of Samsung Electronics America, Inc., Samsung Electronics Co., Ltd., Samsung Telecommunications America, LLC. (Marina, James) (Entered: 10/09/2014)
- 10/17/2014 30 ANSWER to 24 Counterclaim. Document filed by IXI IP,LLC, IXI Mobile (R&D) Ltd.. (Attachments: # 1 Online (Entered: 10/17/2014))
- 11/03/2014 31 MOTION for David Rokach to Appear Pro Hac Vice . Filing fee \$ 200.00, receipt number 0208-10273866. Motion and supporting papers to be reviewed by Clerk's Office staff. Document filed by Samsung Electronics America, Inc., Samsung Electronics Co., Ltd., Samsung Telecommunications America, LLC. (Attachments: # 1 Online, # 2 Online (Entered: 11/03/2014))
- 11/04/2014 &gt;&gt;&gt;NOTICE REGARDING PRO HAC VICE MOTION. Regarding Document No. 31 MOTION for David Rokach to Appear Pro Hac Vice . Filing fee \$ 200.00, receipt number 0208-10273866. Motion and supporting papers to be reviewed by Clerk's Office staff.. The document has been reviewed and there are no deficiencies. (wb) (Entered: 11/04/2014)
- 11/06/2014 32 ORDER FOR ADMISSION PRO HAC VICE granting 31 Motion for David Rokach to Appear Pro Hac Vice. (Signed by Judge Richard J. Sullivan on 11/5/2014) (mro) (Entered: 11/07/2014)
- 11/07/2014 33 JOINT LETTER addressed to Judge Richard J. Sullivan from Thomas S. Biemer, Esquire dated 11/7/2014 re: Joint Submission Pursuant to Order during October 7, 2014 Conference. Document filed by IXI IP,LLC, IXI Mobile (R&D) Ltd.. (Attachments: # 1 Online, # 2 Online (Entered: 11/07/2014))
- 11/10/2014 34 LETTER addressed to Judge Richard J. Sullivan from Thomas S. Biemer, Esquire dated November 10, 2014 re: Response to Letter Dated November 7, 2014 from Defendant Apple, Inc. Document filed by IXI IP,LLC, IXI Mobile (R&D) Ltd..(Biemer, Thomas) (Entered: 11/10/2014)
- 11/26/2014 35 NOTICE OF APPEARANCE by James Henry McConnell on behalf of Samsung Electronics America, Inc., Samsung Electronics Co., Ltd., Samsung Telecommunications America, LLC. (McConnell, James) (Entered: 11/26/2014)
- 12/01/2014 36 ORDER: The Court is in receipt of the parties' letters concerning disputes about the proposed case management plan. Having considered the parties' arguments, IT IS HEREBY ORDERED THAT, no later than December 8, 2014, the parties shall jointly submit a revised case management plan that reflects a 30-day extension of all contested dates. So Ordered (Signed by Judge Richard J. Sullivan on 12/1/2014) (js) Modified on 12/2/2014 (js). (Entered: 12/02/2014)
- 12/08/2014 37 JOINT LETTER addressed to Judge Richard J. Sullivan from Thomas S. Biemer, Esquire dated 12/8/2014 re: Proposed Case Management Plan and Scheduling Order. Document filed by IXI IP,LLC, IXI Mobile (R&D) Ltd.. (Attachments: # 1 Online (Entered: 12/08/2014))
- 12/12/2014 38 CASE MANAGEMENT PLAN AND SCHEDULING ORDER: All parties do not consent to disposition of this case by a Magistrate Judge, pursuant to 28 U.S.C. § 636(c). These cases are to be tried to juries. Plaintiffs' Claim Construction Brief shall be filed by: July 8, 2015. Defendants' Claim Construction Briefs shall be filed by: August 7, 2015. Plaintiffs' Reply Claim Construction Brief shall be filed by: August 14, 2015. Depositions shall be completed by: 11/10/2015. Completion of Fact Discovery: 11/10/2015. The Court will conduct a post-discovery conference on 11/24/2015. Referral to a Magistrate Judge for settlement discussions. (Signed by Judge Richard J. Sullivan on 12/8/2014) (mro) (Entered: 12/15/2014)
- 12/12/2014 Set/Reset Deadlines: Brief due by 8/14/2015. (mro) (Entered: 12/15/2014)
- 12/22/2014 39 ORDER: The Court seeks input from Defendants Samsung Electronics Co., Ltd., et al. ("Samsung") as to their views concerning a potential 28 U.S.C. § 1404(a) motion to transfer Case No. 14-cv-4355 (RJS) to the Northern District of California. Accordingly, IT IS HEREBY ORDERED THAT Defendants Samsung shall submit a letter response to a potential 28 U.S.C. § 1404(a) motion to transfer to the Northern District of California by Tuesday, December 30, 2014. (Signed by Judge Richard J. Sullivan on 12/22/2014) (mro) (Entered: 12/22/2014)
- 12/30/2014 40 LETTER addressed to Judge Richard J. Sullivan from Todd M. Friedman dated December 30, 2014 re: Potential Motion to Transfer. Document filed by Samsung Electronics

- America, Inc., Samsung Electronics Co., Ltd., Samsung Telecommunications America, LLC.(Friedman, Todd) (Entered: 12/30/2014)
- 01/05/2015 41 ORDER: After receiving pre-motion letters from the parties in Case Nos. 14-cv-7954 (RJS) and 14-cv-4428 (RJS) (Doc. Nos. 23, 24, No. 14-cv-7954 (RJS); Doc. Nos. 43, 44, No. 14-cv-4428 (RJS)), the Court, on December 22, 2014, issued an Order to Defendants Samsung Electronics Co., Ltd., et al. ("Samsung") in a related case, Case No. 14-cv-4355 (RJS), seeking input as to their views concerning a potential 28 U.S.C. § 1404(a) motion to transfer Case No. 14-cv-4355 (RJS) to the Northern District of California. (Doc. No. 39, No. 14-cv-4355 (RJS).) The Court is in receipt of Samsung's letter dated December 30, 2014, supporting Apple's and BlackBerry's motions to transfer but declining, at this time, to file their own motion to transfer. (Doc. No. 40, No. 14-cv-4355 (RJS).) Accordingly, IT IS HEREBY ORDERED THAT all of the above-captioned parties, including Samsung, shall appear for a conference on January 20, 2015 at 4:00 p.m. in Courtroom 905 at 40 Foley Square concerning the anticipated motions to transfer Case Nos. 14-cv-7954 (RJS) and 14-cv-4428 (RJS) to the Northern District of California pursuant to 28 U.S.C. § 1404(a). ( Status Conference set for 1/20/2015 at 04:00 PM in Courtroom 905, 40 Centre Street, New York, NY 10007 before Judge Richard J. Sullivan.) (Signed by Judge Richard J. Sullivan on 1/5/2015) (mro) (Entered: 01/05/2015)
- 01/30/2015 42 TRANSCRIPT of Proceedings re: conference held on 1/20/2015 before Judge Richard J. Sullivan. Court Reporter/Transcriber: Khristine Sellin, (212) 805-0300. Transcript may be viewed at the court public terminal or purchased through the Court Reporter/Transcriber before the deadline for Release of Transcript Restriction. After that date it may be obtained through PACER. Redaction Request due 2/23/2015. Redacted Transcript Deadline set for 3/5/2015. Release of Transcript Restriction set for 5/4/2015.(McGuirk, Kelly) (Entered: 01/30/2015)
- 01/30/2015 43 NOTICE OF FILING OF OFFICIAL TRANSCRIPT Notice is hereby given that an official transcript of a conference proceeding held on 1/20/2015 has been filed by the court reporter/transcriber in the above-captioned matter. The parties have seven (7) calendar days to file with the court a Notice of Intent to Request Redaction of this transcript. If no such Notice is filed, the transcript may be made remotely electronically available to the public without redaction after 90 calendar days...(McGuirk, Kelly) (Entered: 01/30/2015)
- 02/03/2015 44 MOTION to Transfer Case Samsung's Notice of Motion to Transfer Venue Pursuant to 28 U.S.C. § 1404(a). Document filed by Samsung Electronics America, Inc., Samsung Electronics Co., Ltd., Samsung Telecommunications America, LLC.(Friedman, Todd) (Entered: 02/03/2015)
- 02/03/2015 45 MEMORANDUM OF LAW in Support re: 44 MOTION to Transfer Case Samsung's Notice of Motion to Transfer Venue Pursuant to 28 U.S.C. § 1404(a). . Document filed by Samsung Electronics America, Inc., Samsung Electronics Co., Ltd., Samsung Telecommunications America, LLC. (Friedman, Todd) (Entered: 02/03/2015)
- 02/03/2015 46 DECLARATION of Todd M. Friedman in Support re: 44 MOTION to Transfer Case Samsung's Notice of Motion to Transfer Venue Pursuant to 28 U.S.C. § 1404(a).. Document filed by Samsung Electronics America, Inc., Samsung Electronics Co., Ltd., Samsung Telecommunications America, LLC. (Attachments: # 1 Online, # 2 Online, # 3 Online, # 4 Online (Entered: 02/03/2015)
- 02/17/2015 47 BRIEF re: 44 MOTION to Transfer Case Samsung's Notice of Motion to Transfer Venue Pursuant to 28 U.S.C. § 1404(a). Omnibus Brief In Opposition to Motion to Transfer. Document filed by IXI IP,LLC, IXI Mobile (R&D) Ltd..(Biemer, Thomas) (Entered: 02/17/2015)
- 02/17/2015 48 DECLARATION of John J. Higson in Opposition re: 44 MOTION to Transfer Case Samsung's Notice of Motion to Transfer Venue Pursuant to 28 U.S.C. § 1404(a).. Document filed by IXI IP,LLC, IXI Mobile (R&D) Ltd.. (Attachments: # 1 Online, # 2 Online, # 3 Online, # 4 Online, # 5 Online, # 6 Online, # 7 Online, # 8 Online, # 9 Online, # 10 Online, # 11 Online, # 12 Online, # 13 Online, # 14 Online (Entered: 02/17/2015)
- 02/17/2015 49 DECLARATION of Zion Hadad in Opposition re: 44 MOTION to Transfer Case Samsung's Notice of Motion to Transfer Venue Pursuant to 28 U.S.C. § 1404(a).. Document filed by IXI IP,LLC, IXI Mobile (R&D) Ltd.. (Biemer, Thomas) (Entered: 02/17/2015)
- 02/17/2015 50 DECLARATION of Steve Pedersen in Opposition re: 44 MOTION to Transfer Case Samsung's Notice of Motion to Transfer Venue Pursuant to 28 U.S.C. § 1404(a).. Document filed by IXI IP,LLC, IXI Mobile (R&D) Ltd.. (Biemer, Thomas) (Entered: 02/17/2015)
- 02/20/2015 51 REPLY MEMORANDUM OF LAW in Support re: 44 MOTION to Transfer Case Samsung's Notice of Motion to Transfer Venue Pursuant to 28 U.S.C. § 1404(a). . Document filed by Samsung Electronics America, Inc., Samsung Electronics Co., Ltd., Samsung

- Telecommunications America, LLC. (Friedman, Todd) (Entered: 02/20/2015)
- 02/24/2015 52 LETTER addressed to Judge Richard J. Sullivan from Thomas S. Biemer, Esquire dated February 24, 2015 re: IXI Mobile (R&D), LTD., et al. v. Samsung Electronics Co., Blackberry, LTD, et al., and Apple, Inc. Venue Transfer Brief. Document filed by IXI IP,LLC, IXI Mobile (R&D) Ltd..(Biemer, Thomas) (Entered: 02/24/2015)
- 02/25/2015 53 ORDER: The Court is in receipt of Plaintiff's letter, dated February 24, 2015, requesting leave to file a sur-reply to Apple's reply brief. (Doc. No. 37, No. 14-cv-7954 (RJS).) The Court also is in receipt of Defendant Apple Inc.'s letter, dated February 24, 2015, responding to Plaintiff's letter and requesting "that IXI be required to provide the Court with the [IXI License Agreement]." (Doc. No. 38, No. 14-cv-7954 (RJS).) Because the Court finds that limited supplemental briefing as to whether IXI Mobile (R&D), Inc. lacks standing to be a Plaintiff in these actions would be helpful, IT IS HEREBY ORDERED THAT Plaintiff's request for leave to file a sur-reply is GRANTED. Plaintiff shall limit the sur-reply to three pages and submit the sur-reply by March 2, 2015. IT IS FURTHER ORDERED THAT Defendant Apple Inc.'s request "to respond to any new facts, evidence, or arguments introduced in the sur-reply" is GRANTED. Defendant Apple Inc. shall limit its response to three pages and submit the response by March 5, 2015. Finally, because the Court also finds that its review of the license referenced in the parties' briefing and letters would help the Court resolve the motion to transfer these actions to the Northern District of California pursuant to 28 U.S.C. § 1404(a), IT IS FURTHER ORDERED THAT Defendant Apple Inc.'s request "that IXI be required to provide the Court with the license" is GRANTED. ( Responses due by 3/5/2015, Surreplies due by 3/2/2015.) (Signed by Judge Richard J. Sullivan on 2/25/2015) (mro) (Entered: 02/26/2015)
- 02/27/2015 54 LETTER addressed to Judge Richard J. Sullivan from Thomas S. Biemer, Esquire dated February 27, 2015 re: IXI Mobile (R&D), LTD., et al. v. Samsung Electronics Co., Blackberry, LTD, et al., and Apple, Inc. Transfer Venue Sur-Reply. Document filed by IXI IP,LLC, IXI Mobile (R&D) Ltd..(Biemer, Thomas) (Entered: 02/27/2015)
- 02/27/2015 55 MEMO ENDORSEMENT on re: (54 in 1:14-cv-04355-RJS) Letter, filed by IXI IP,LLC, IXI Mobile (R&D) Ltd., (58 in 1:14-cv-04428-RJS) Letter, filed by IXI IP, LLC, IXI Mobile (R&D) Ltd., (40 in 1:14-cv-07954-RJS) Letter, filed by IXI IP,LLC, IXI Mobile (R&D) Ltd. ENDORSEMENT: There is a well-established presumption in the Second Circuit in favor of open court records. See *United States v. Amodeo*, 44 F.3d 141, 146 (2d Cir. 1995). To overcome this presumption, a party must demonstrate that sealing a judicial document is "essential to preserve higher values and is narrowly tailored to serve that interest." *United States v. Alcantara*, 396 F.3d 189, 199 (2d Cir. 2005); see also *Lugosch v. Pyramid Co. of Onondaga*, 435 F.3d 110, 119-20 (2d Cir. 2006) (" [D]ocuments may be sealed if specific, on the record findings are made demonstrating that closure is essential to preserve higher values and is narrowly tailored to serve that interest." (quotation marks and citations omitted)). Because Plaintiff represents that the license agreement between IXI IP and IXI Mobile contains "confidential information" and that the patent purchase agreement includes information relating to the strategy and financing of this litigation, the Court will allow Plaintiff to file the license and redacted patent purchase agreements under seal, and to submit the unredacted patent purchase agreement in camera. However, the Court may reach a different conclusion upon reviewing the materials in question and, at that time, will direct the parties to address whether the various documents should remain under seal. (Signed by Judge Richard J. Sullivan on 2/27/2015) (mro) (Entered: 03/02/2015)
- 03/02/2015 56 REPLY MEMORANDUM OF LAW in Opposition re: 44 MOTION to Transfer Case Samsung's Notice of Motion to Transfer Venue Pursuant to 28 U.S.C. § 1404(a). PLAINTIFFS SUR-REPLY IN FURTHER OPPOSITION TO DEFENDANTS MOTIONS TO TRANSFER. Document filed by IXI IP,LLC, IXI Mobile (R&D) Ltd.. (Biemer, Thomas) (Entered: 03/02/2015)
- 03/02/2015 57 DECLARATION of STEVE PEDERSEN in Opposition re: 44 MOTION to Transfer Case Samsung's Notice of Motion to Transfer Venue Pursuant to 28 U.S.C. § 1404(a).. Document filed by IXI IP,LLC, IXI Mobile (R&D) Ltd.. (Biemer, Thomas) (Entered: 03/02/2015)
- 03/02/2015 58 DECLARATION of JOHN J. HIGSON in Opposition re: 44 MOTION to Transfer Case Samsung's Notice of Motion to Transfer Venue Pursuant to 28 U.S.C. § 1404(a).. Document filed by IXI IP,LLC, IXI Mobile (R&D) Ltd.. (Attachments: # 1 Online, # 2 Online, # 3 Online, # 4 Online, # 5 Online, # 6 Online (Entered: 03/02/2015)
- 03/06/2015 59 STIPULATION OF DISMISSAL OF CLAIMS AGAINST SAMSUNG TELECOMMUNICATIONS AMERICA, LLC: IT IS HEREBY STIPULATED AND AGREED by the parties as follows: 1. Claims asserted by IXI against STA in the above-captioned action will be dismissed, without prejudice, pursuant to Rule 41(a) of the Federal Rules of Civil Procedure, and STA will no longer be a party to the above-captioned action. 2. SEA is STA's successor in interest for the purposes of this lawsuit and will assume any liability that STA bears in

- this lawsuit. 3. Nothing in this stipulation shall be construed as an admission or concession of liability by any defendant. (Signed by Judge Richard J. Sullivan on 3/6/2015) (mro) (Entered: 03/09/2015)
- 04/14/2015 60 AGREED PROTECTIVE ORDER REGARDING THE DISCLOSURE AND USE OF DISCOVERY MATERIALS...regarding procedures to be followed that shall govern the handling of confidential material... (Signed by Judge Richard J. Sullivan on 4/14/2015) (mro) (Entered: 04/15/2015)
- 04/14/2015 61 ORDER: This Addendum is an integral part of the Order of today's date granting confidentiality protection to certain materials. Notwithstanding any other provision, no document may be filed with the Clerk under seal without a further Order of this Court addressing the specific documents to be sealed. Any application to seal shall be accompanied by an affidavit or affidavits and a memorandum of law, demonstrating that the standards for sealing have been met and specifically addressing *Lugosch v. Pyramid Co. of Onondaga*, 435 F.3d 110, 119-20 (2d Cir. 2006) and any other controlling authority. Nothing herein is intended to alter or modify the applicability of Federal Rule of Civil Procedure 5.2 to this case. The redactions expressly authorized by Rule 5.2 may be made without further application to the Court. (Signed by Judge Richard J. Sullivan on 4/14/2015) (mro) (Entered: 04/15/2015)
- 05/04/2015 62 MOTION to Appear Pro Hac Vice for Gary D. Colby, Esquire. Filing fee \$ 200.00, receipt number 0208-10883328. Motion and supporting papers to be reviewed by Clerk's Office staff. Document filed by IXI IP,LLC, IXI Mobile (R&D) Ltd.. (Attachments: # 1 Online, # 2 Online) (Entered: 05/04/2015)
- 05/04/2015 &gt;&gt;&gt;NOTICE REGARDING PRO HAC VICE MOTION. Regarding Document No. 62 MOTION to Appear Pro Hac Vice for Gary D. Colby, Esquire. Filing fee \$ 200.00, receipt number 0208-10883328. Motion and supporting papers to be reviewed by Clerk's Office staff.. The document has been reviewed and there are no deficiencies. (wb) (Entered: 05/04/2015)
- 05/06/2015 63 ORDER granting 62 Motion for Gary D. Colby to Appear Pro Hac Vice. (Signed by Judge Richard J. Sullivan on 5/5/2015) (kl) (Entered: 05/06/2015)
- 05/11/2015 64 JOINT STIPULATION OF DISMISSAL OF CLAIMS RELATED TO U.S. PATENT NO. 7,426,398: Plaintiffs IXI Mobile (R&D) Ltd. and IXI IP, LLC (collectively, "Plaintiffs") and Defendants Samsung Electronics Co., Ltd. and Samsung Electronic America, Inc. (collectively "Defendants"); hereby stipulate and agree to the dismissal with prejudice of the Second Count for Relief in Plaintiffs' Complaint alleging infringement of U.S. Patent No. 7,426,398 ("the '398 Patent") in the above-captioned action, each party to bear its own costs and fees related to claims of infringement of the '398 Patent. Further, Plaintiffs and Defendants hereby stipulate and agree to the dismissal without prejudice of Defendants' counterclaims of invalidity and non-infringement of the '398 Patent, each party to bear its own costs and fees related to counterclaims of invalidity and non-infringement of the '398 Patent. SO ORDERED. (Signed by Judge Richard J. Sullivan on 5/11/2015) (kko) (Entered: 05/11/2015)
- 05/15/2015 65 ORDER REFERRING CASE TO MAGISTRATE JUDGE. Order that case be referred to the Clerk of Court for assignment to a Magistrate Judge for Settlement: The parties shall contact Magistrate Judge Debra Freeman by May 19, 2015 to schedule a settlement conference. Referred to Magistrate Judge Debra C. Freeman. (Signed by Judge Richard J. Sullivan on 5/15/2015) (tn) (Entered: 05/18/2015)
- 05/28/2015 Minute Entry for proceedings held before Magistrate Judge Debra C. Freeman: Settlement Conference held via telephone on 5/28/2015. Telephone conference scheduled for 8/25/15 at 12:00 p.m. (aba) (Entered: 05/28/2015)
- 06/04/2015 66 LETTER addressed to Judge Richard J. Sullivan from Thomas S. Biemer, Esquire dated June 4, 2015 re: Claim Construction Technology Tutorial. Document filed by IXI IP,LLC, IXI Mobile (R&D) Ltd..(Biemer, Thomas) (Entered: 06/04/2015)
- 06/05/2015 67 AMENDED LETTER addressed to Judge Richard J. Sullivan from Thomas S. Biemer, Esquire dated June 5, 2015 re: Claim Construction Technology Tutorial. Document filed by IXI IP,LLC, IXI Mobile (R&D) Ltd..(Biemer, Thomas) (Entered: 06/05/2015)
- 06/08/2015 68 JOINT CLAIM CONSTRUCTION STATEMENT. Document filed by IXI IP,LLC, IXI Mobile (R&D) Ltd., Samsung Electronics America, Inc., Samsung Electronics Co., Ltd.. (Biemer, Thomas) (Entered: 06/08/2015)
- 06/15/2015 69 LETTER addressed to Judge Richard J. Sullivan from Thomas S. Biemer dated June 15, 2015 re: Pre-Motion Request to Strike Joint Claim Terms Chart. Document filed by IXI IP,LLC, IXI Mobile (R&D) Ltd..(Biemer, Thomas) (Entered: 06/15/2015)
- 06/18/2015 70 LETTER addressed to Judge Richard J. Sullivan from Harrison J. Frahn IV (on behalf of all Defendants) dated June 18, 2015 re: Response to IXI's Request for a Pre-motion

- Conference for a Motion to Strike. Document filed by Samsung Electronics America, Inc., Samsung Electronics Co., Ltd..(Friedman, Todd) (Entered: 06/18/2015)
- 07/02/2015 72 ENDORSED LETTER addressed to Judge Richard J. Sullivan from Thomas S. Biemer dated 7/2/2015 re: Plaintiffs respectfully request 5 additional pages for their Opening Claim Construction Brief due on July 8, 2015, as well as 5 additional pages for their supporting expert declaration. ENDORSEMENT: SO ORDERED. (Signed by Judge Richard J. Sullivan on 7/2/2015) (mro) (Entered: 07/06/2015)
- 07/03/2015 71 LETTER addressed to Judge Richard J. Sullivan from Todd M. Friedman dated July 2, 2015 re: Pre-Motion Conference for Motion to Stay. Document filed by Samsung Electronics America, Inc., Samsung Electronics Co., Ltd..(Friedman, Todd) (Entered: 07/03/2015)
- 07/08/2015 73 BRIEF Plaintiffs Opening Claim Construction Brief. Document filed by IXI IP,LLC, IXI Mobile (R&D) Ltd..(Biemer, Thomas) (Entered: 07/08/2015)
- 07/08/2015 74 DECLARATION re: 73 Brief Declaration of Mark W. Halderman. Document filed by IXI IP,LLC, IXI Mobile (R&D) Ltd.. (Attachments: # 1 Online, # 2 Online, # 3 Online, # 4 Online, # 5 Online, # 6 Online, # 7 Online, # 8 Online, # 9 Online, # 10 Online (Entered: 07/08/2015)
- 07/08/2015 75 DECLARATION re: 73 Brief Declaration of Joel R. Williams. Document filed by IXI IP,LLC, IXI Mobile (R&D) Ltd.. (Attachments: # 1 Online, # 2 Online, # 3 Online (Entered: 07/08/2015)
- 07/08/2015 76 LETTER addressed to Judge Richard J. Sullivan from Thomas S. Biemer, Esquire dated July 8, 2015 re: Response to pre-motion letter from Defendants Apple and Samsung requesting a stay. Document filed by IXI IP,LLC, IXI Mobile (R&D) Ltd..(Biemer, Thomas) (Entered: 07/08/2015)
- 08/03/2015 77 LETTER addressed to Judge Richard J. Sullivan from Marshall Beil (on behalf of all Defendants) dated August 3, 2015 re: Request for additional pages and exhibits for Defendants' Responsive Claim Construction Brief. Document filed by Samsung Electronics America, Inc., Samsung Electronics Co., Ltd..(Friedman, Todd) (Entered: 08/03/2015)
- 08/03/2015 78 MEMO ENDORSEMENT on re: (84 in 1:14-cv-04428-RJS) Letter, filed by Blackberry Limited, Blackberry Corporation, (77 in 1:14-cv-04355-RJS) Letter, filed by Samsung Electronics Co., Ltd., Samsung Electronics America, Inc. ENDORSEMENT: SO ORDERED. (Brief due by 8/7/2015.) (Signed by Judge Richard J. Sullivan on 8/3/2015) (mro) (Entered: 08/04/2015)
- 08/06/2015 79 OPINION AND ORDER # 105941 re: (27 in 1:14-cv-07954-RJS) MOTION to Transfer Case Apple Inc.'s Notice of Motion to Transfer Venue Pursuant to 28 U.S.C. § 1404(a). filed by Apple, Inc., (47 in 1:14-cv-04428-RJS) MOTION to Transfer Case . filed by Blackberry Limited, Blackberry Corporation, (44 in 1:14-cv-04355-RJS) MOTION to Transfer Case Samsung's Notice of Motion to Transfer Venue Pursuant to 28 U.S.C. § 1404(a). filed by Samsung Electronics Co., Ltd., Samsung Telecommunications America, LLC, Samsung Electronics America, Inc. Weighing the factors set forth above and having considered all the facts and circumstances before it, the Court determines that Defendants have demonstrated by clear and convincing evidence that transfer of these three actions is appropriate. Accordingly, IT IS HEREBY ORDERED THAT Defendants' motions to transfer these actions to the Northern District of California are GRANTED. The Clerk of the Court is respectfully directed to terminate the motions pending at docket entries 44 in case number 14--cv-4355 (RJS), 47 in case number 14--cv-4428 (RJS), and 27 in case number 14-cv-7954 (RJS), and to close these cases. SO ORDERED. (As further set forth within this Order.) (Signed by Judge Richard J. Sullivan on 8/6/2015) (ajs) Modified on 10/13/2015 (ca). (Entered: 08/07/2015)
- 08/06/2015 CASE TRANSFERRED OUT ELECTRONICALLY from the U.S.D.C. Southern District of New York to the United States District Court - Northern District of California. (ajs) (Entered: 08/14/2015)
- 08/06/2015 Terminate Transcript Deadlines (ajs) (Entered: 08/14/2015)
- 08/12/2015 80 LETTER addressed to Judge Richard J. Sullivan from Thomas S. Biemer, Esquire dated August 12, 2015 re: Requesting Reconsideration of the Order entered August 7, 2015. Document filed by IXI IP,LLC, IXI Mobile (R&D) Ltd..(Biemer, Thomas) (Entered: 08/12/2015)
- 08/20/2015 Received e-mail from the United States District Court - Northern District of California acknowledging receipt of transferred case. Assigned Case Number: 3:15-cv-03752, filed on 08/17/2015. (sjo) (Entered: 08/21/2015)
- 09/09/2015 81 ORDER: The Court is in receipt of a letter from Plaintiffs, dated August 12, 2015 (No. 14-cv-4355 (RJS), Doc. No. 80; No. 14-cv-4428 (RJS), Doc. No. 87; No. 14-cv-7954 (RJS), Doc. No. 72), requesting that the Court reconsider its Opinion and Order, dated August 6,



2015, granting Defendants' motions to transfer these three related patent infringement actions to the Northern District of California pursuant to 28 U.S.C. § 1404(a). In sum, the Court finds that there is no "manifest injustice" here and that these actions bear little resemblance to the Eastern District of Texas decisions cited by Plaintiffs. Thus, Plaintiffs have failed to persuade the Court to reconsider its August 6, 2015 Opinion and Order. Accordingly, IT IS HEREBY ORDERED THAT Plaintiffs' motion for reconsideration is DENIED. (As further set forth in this Order.) (Signed by Judge Richard J. Sullivan on 9/9/2015) (kko) (Entered: 09/09/2015)

---

Copyright © 2017 LexisNexis CourtLink, Inc. All rights reserved.  
\*\*\* THIS DATA IS FOR INFORMATIONAL PURPOSES ONLY \*\*\*

850399 (09) 7039033 May 2, 2006

UNITED STATES PATENT AND TRADEMARK OFFICE GRANTED PATENT

7039033

Get Drawing Sheet 1 of 9  
Access PDF of Official Patent \*  
Order Patent File History / Wrapper from REEDFAX®  
Link to Claims Section

May 2, 2006

System, device and computer readable medium for providing a managed wireless network using short-range radio signals

**EXPIRATION:**

May 2, 2010 - due to failure to pay maintenance fees. , (O.G. June 22, 2010)

October 6, 2010 - REINSTATED due to acceptance of delayed payment of maintenance fee. , (O.G. November 2, 2010)

**REEXAM-LITIGATE:**

NOTICE OF LITIGATION

Ixi Mobile (R&D) Ltd. et al v. Samsung Electronics Co., Ltd. et al, Filed June 17, 2014, D.C. S.D. New York, Doc. No. 1:14cv4355

NOTICE OF LITIGATION

Ixi Mobile (R&D) Ltd. et al v. Blackberry Limited et al, Filed June 18, 2014, D.C. S.D. New York, Doc. No. 1:14cv4428

NOTICE OF LITIGATION

Ixi Mobile (R&D) Ltd. et al v. Apple, Inc., Filed October 2, 2014, D.C. S.D. New York, Doc. No. 1:14cv7954

NOTICE OF LITIGATION

Ixi Mobile (R&D) Ltd. et al v. Samsung Electronics Co., Ltd. et al, Filed August 17, 2015, D.C. N.D. California, Doc. No. 3:15cv3752

NOTICE OF LITIGATION

Ixi Mobile (R&D) Ltd. et al v. Blackberry Limited et al, Filed August 17, 2015, D.C. N.D. California, Doc. No. 3:15cv3754

NOTICE OF LITIGATION

Ixi Mobile (R&D) Ltd. et al v. Apple, Inc., Filed August 17, 2015, D.C. N.D. California, Doc. No. 3:15cv3755

NOTICE OF LITIGATION

Ixi Mobile (R&D) Ltd. et al v. Apple, Inc., Filed August 17, 2015, D.C. N.D. California, Doc. No. 4:15cv3755

**INVENTOR:** Haller, Amit - Belmont, California, United States of America (US), United States of America ( ) ; Fornell, Peter - Lake Oswego, Oregon, United States of America (US), United States of America ( ) ; Itzhak, Avraham - Ra'anana, State of Israel (IL), State of Israel ( ) ; Glick, Amir - Tel Aviv, State of Israel (IL), State of

Israel ( ) ; Haparnas, Ziv - Tel Aviv, State of Israel (IL), State of Israel ( )

**APPL-NO:** 850399 (09)

**FILED-DATE:** May 7, 2001

**GRANTED-DATE:** May 2, 2006

**PRIORITY:** May 7, 2001 - 09850399, United States of America (US)

**ASSIGNEE-PRE-ISSUE:**

September 13, 2002 - ASSIGNMENT OF ASSIGNORS INTEREST (SEE DOCUMENT FOR DETAILS)., IXI MOBILE (ISRAEL) LTD., HA'TIDHAR STREET, #3, RA'ANANA, ISRAEL ( ), 43654, Reel and Frame Number: 013273/0484

**ASSIGNEE-AT-ISSUE:**

IXI Mobile (israel) Ltd., Ra'Anana, State of Israel (IL), Foreign company or corporation (03)

**ASSIGNEE-AFTER-ISSUE:**

June 29, 2006 - SECURITY AGREEMENT, SOUTHPOINT MASTER FUND LP, SUITE 2503, 623 FIFTH AVENUE, NEW YORK, NEW YORK, UNITED STATES OF AMERICA (US), 10022, Reel and Frame Number: 017846/0872

April 17, 2012 - RELEASE BY SECURED PARTY (SEE DOCUMENT FOR DETAILS)., IXI MOBILE (R&D) LTD., 11 MOSHE LEVI STREET, RISHON LEZION, ISRAEL ( ), Reel and Frame Number: 028055/0575

February 11, 2014 - CHANGE OF NAME (SEE DOCUMENT FOR DETAILS)., IXI MOBILE (R & D) LTD., 11 MOSHE LEVI STREET, RISHON LEZION, ISRAEL ( ), Reel and Frame Number: 032239/0078

June 5, 2014 - ASSIGNMENT OF ASSIGNORS INTEREST (SEE DOCUMENT FOR DETAILS)., IXI IP, LLC, 405 LEXINGTON AVENUE, SUITE 726, THE CHRYSLER BUILDING, NEW YORK, NEW YORK, UNITED STATES OF AMERICA (US), 10174, Reel and Frame Number: 033042/0985

June 5, 2014 - SECURITY INTEREST, FORTRESS CREDIT CO LLC, 46TH FLOOR, 1345 AVENUE OF THE AMERICAS, NEW YORK, NEW YORK, UNITED STATES OF AMERICA (US), 10105, Reel and Frame Number: 033098/0056

September 11, 2014 - ASSIGNMENT OF ASSIGNORS INTEREST (SEE DOCUMENT FOR DETAILS)., FCO V CLO TRANSFEROR LLC, 46TH FLOOR, 1345 AVENUE OF THE AMERICAS, NEW YORK, NEW YORK, UNITED STATES OF AMERICA (US), 10105, Reel and Frame Number: 033718/0687

**LEGAL-REP:** Vierra Magen Marcus Harmon & DeNiro LLP

**PUB-TYPE:** May 2, 2006 - Patent with a pre-grant publication (B2)

**PUB-COUNTRY:** United States of America (US)

**LEGAL-STATUS:**

September 13, 2002 - ASSIGNMENT

June 29, 2006 - ASSIGNMENT

December 7, 2009 - MAINTENANCE FEE REMINDER MAILED

May 2, 2010 - REINSTATEMENT AFTER MAINTENANCE FEE PAYMENT CONFIRMED

June 22, 2010 - EXPIRED DUE TO FAILURE TO PAY MAINTENANCE FEE

July 23, 2010 - FEE PAYMENT

July 23, 2010 - SURCHARGE FOR LATE PAYMENT

October 4, 2010 - PATENT REINSTATED DUE TO THE ACCEPTANCE OF A LATE MAINTENANCE FEE

April 17, 2012 - ASSIGNMENT

December 13, 2013 - MAINTENANCE FEE REMINDER MAILED

February 11, 2014 - ASSIGNMENT

April 30, 2014 - FEE PAYMENT

April 30, 2014 - SURCHARGE FOR LATE PAYMENT

June 5, 2014 - ASSIGNMENT

June 5, 2014 - ASSIGNMENT

September 11, 2014 - ASSIGNMENT

July 28, 2015 - AIA TRIAL PROCEEDING FILED BEFORE THE PATENT AND APPEAL BOARD: INTER PARTES REVIEW

December 7, 2009 - Maintenance Fee Reminder Mailed.

May 2, 2010 - Patent Reinstated After Maintenance Fee Payment Confirmed.  
May 13, 2010 - Entity Status Set to Small  
July 23, 2010 - Surcharge, Petition to Accept Pymt After Exp, Unintentional.  
July 23, 2010 - Payment of Maintenance Fee, 4th Yr, Small Entity.  
July 23, 2010 - Petition Related to Maintenance Fees Filed.  
October 6, 2010 - Petition Related to Maintenance Fees Granted.  
July 18, 2013 - Payor Number Assigned.  
December 13, 2013 - Maintenance Fee Reminder Mailed.  
April 30, 2014 - Payment of Maintenance Fee, 8th Yr, Small Entity.  
April 30, 2014 - 7.5 yr surcharge - late pmt w/in 6 mo, Small Entity.  
June 4, 2015 - Payor Number Assigned.  
June 4, 2015 - Payer Number De-assigned.  
July 21, 2016 - Entity Status Set to Undiscounted

**FILING-LANG:** English (EN) (ENG)

**PUB-LANG:** English (EN) (ENG)

**REL-DATA:**

Prior Publication 20020163895, November 7, 2002

**US-MAIN-CL:** 370#338

**US-ADDL-CL:** 370#401, 370#466, 370#469

**CL:** 370

**SEARCH-FLD:** 370#259, 370#260, 370#320, 370#321, 370#328-339, 370#342, 370#347, 370#400-401, 370#395.5, 370#395.54, 370#465-649, 455#403, 455#422, 455#550, 455#556, 455#557, 709#203, 709#208

**IPC-MAIN-CL:** [8] G01R 031#08 (20060101) Advanced Inventive 20060502 (A F I B H US)

**IPC-ADDL-CL:** [8] H04L 012#46 (20060101) Advanced Inventive 20051220 (A F I R M JP)

**IPC-ADDL-CL:** [8] H04L 012#24 (20060101) Advanced Inventive 20051008 (A I R M EP)

**IPC-ADDL-CL:** [8] H04L 012#28 (20060101) Advanced Inventive 20051008 (A I R M EP)

**IPC-ADDL-CL:** [8] H04L 012#56 (20060101) Advanced Inventive 20051008 (A I R M EP)

**IPC-ADDL-CL:** [8] H04M 001#725 (20060101) Advanced Inventive 20051008 (A I R M EP)

**IPC-ADDL-CL:** [8] H04W 004#00 (20090101) Advanced Non-Inventive 20090105 (A N R M EP)

**IPC-ADDL-CL:** [8] H04W 084#04 (20090101) Advanced Non-Inventive 20090105 (A N R M EP)

**IPC-ADDL-CL:** [8] H04W 084#10 (20090101) Advanced Non-Inventive 20090105 (A N R M EP)

**IPC-ADDL-CL:** [8] H04W 084#18 (20090101) Advanced Non-Inventive 20090105 (A N R M EP)

**IPC-ADDL-CL:** [8] H04W 088#16 (20090101) Advanced Non-Inventive 20090105 (A N R M EP)

**PRIM-EXMR:** Duong, Frank

**REF-CITED:**

5442680, August 15, 1995, Schellinger et al., United States of America (US)

5457737, October 10, 1995, Wen, United States of America (US)

5572528, November 5, 1996, Shuen, United States of America (US)  
5742237, April 21, 1998, Biedsoe, United States of America (US)  
5771438, June 23, 1998, Palermo et al., United States of America (US)  
5774791, June 30, 1998, Strohallen et al., United States of America (US)  
5793763, August 11, 1998, Mayes et al., United States of America (US)  
5805166, September 8, 1998, Hall et al., United States of America (US)  
5838252, November 17, 1998, Kikinis, United States of America (US)  
5896369, April 20, 1999, Warsta et al., United States of America (US)  
5929848, July 27, 1999, Albuquerque et al., United States of America (US)  
5978386, November 2, 1999, Hamalainen et al., United States of America (US)  
5987011, November 16, 1999, Toh, United States of America (US)  
5987033, November 16, 1999, Boer et al., United States of America (US)  
6064734, May 16, 2000, Hasegawa et al., United States of America (US)  
6067291, May 23, 2000, Kamerman et al., United States of America (US)  
6069896, May 30, 2000, Borgstahl et al., United States of America (US)  
6078789, June 20, 2000, Bodenmann et al., United States of America (US)  
6085098, July 4, 2000, Moon et al., United States of America (US)  
6130602, October 10, 2000, O'Toole et al., United States of America (US)  
6151628, November 21, 2000, Xu et al., United States of America (US)  
6192257, February 20, 2001, Ray, United States of America (US)  
6198948, March 6, 2001, Sudo et al., United States of America (US)  
6218958, April 17, 2001, Eichstaedt et al., United States of America (US)  
6223029, April 24, 2001, Stenman et al., United States of America (US)  
6243581, June 5, 2001, Jawanda, United States of America (US)  
6265788, July 24, 2001, Davidson et al., United States of America (US)  
6282183, August 28, 2001, Harris et al., United States of America (US)  
6298443, October 2, 2001, Colligan et al., United States of America (US)  
6326926, December 4, 2001, Shooobridge et al., United States of America (US)  
6333973, December 25, 2001, Smith et al., United States of America (US)  
6343276, January 29, 2002, Barnett, United States of America (US)  
6405027, June 11, 2002, Bell, United States of America (US)  
6430408, August 6, 2002, Dorenbosch, United States of America (US)  
6434537, August 13, 2002, Grimes, United States of America (US)  
6446127, September 3, 2002, Schuster et al., United States of America (US)  
6452910, September 17, 2002, Vij et al., United States of America (US)  
6459882, October 1, 2002, Palermo et al., United States of America (US)  
6463078, October 8, 2002, Engstrom et al., United States of America (US)  
6487180, November 26, 2002, Borgstahl et al., United States of America (US)  
6519460, February 11, 2003, Haartsen, United States of America (US)  
6532366, March 11, 2003, Chung et al., United States of America (US)  
6600428, July 29, 2003, O'Toole et al., United States of America (US)  
6600734, July 29, 2003, Gernert, United States of America (US)  
6630925, October 7, 2003, &Ouml;stergaard et al., United States of America (US)  
6633759, October 14, 2003, Kobayashi, United States of America (US)  
6636489, October 21, 2003, Fingerhut, United States of America (US)  
6654616, November 25, 2003, Pope et al., United States of America (US)  
6665549, December 16, 2003, Reed, United States of America (US)  
6690929, February 10, 2004, Yeh, United States of America (US)  
6763012, July 13, 2004, Lord et al., United States of America (US)  
6763247, July 13, 2004, Hollstrom et al., United States of America (US)  
6871063, March 22, 2005, Schiffer, United States of America (US)  
20010047424, November 29, 2001, Alastalo et al., United States of America (US)  
20020010008, January 24, 2002, Bork et al., United States of America (US)  
20020010683, January 24, 2002, Aune, United States of America (US)  
20020037700, March 28, 2002, Dooley et al., United States of America (US)  
20020055333, May 9, 2002, Davies et al., United States of America (US)  
20020058502, May 16, 2002, Stanforth, United States of America (US)  
20020063472, May 30, 2002, Irvin, United States of America (US)  
20020065099, May 30, 2002, Bjorndahl, United States of America (US)  
20020065817, May 30, 2002, Ito et al., United States of America (US)

20020068559, June 6, 2002, Sharma et al., United States of America (US)  
20020068600, June 6, 2002, Chihara et al., United States of America (US)  
20020069037, June 6, 2002, Hendrickson et al., United States of America (US)  
20020082054, June 27, 2002, Keinonen et al., United States of America (US)  
20020086718, July 4, 2002, Bigwood et al., United States of America (US)  
20020091633, July 11, 2002, Proctor, United States of America (US)  
20020102974, August 1, 2002, Raith, United States of America (US)  
20020118663, August 29, 2002, Dorenbosch et al., United States of America (US)  
20020128051, September 12, 2002, Liebenow, United States of America (US)  
20020132610, September 19, 2002, Chaplin et al., United States of America (US)  
20020142762, October 3, 2002, Chmaytelli et al., United States of America (US)  
20020143952, October 3, 2002, Sugiarto et al., United States of America (US)  
20020155830, October 24, 2002, Iyer, United States of America (US)  
20020160764, October 31, 2002, Gorsuch, United States of America (US)  
20030013438, January 16, 2003, Darby, United States of America (US)  
20030017810, January 23, 2003, Janninck et al., United States of America (US)  
20030022699, January 30, 2003, Lin, United States of America (US)  
20030027563, February 6, 2003, Herle et al., United States of America (US)  
20030032417, February 13, 2003, Minear et al., United States of America (US)  
20030050058, March 13, 2003, Walsh et al., United States of America (US)  
20030054765, March 20, 2003, Botteck, United States of America (US)  
20030060188, March 27, 2003, Gidron, United States of America (US)  
20030060189, March 27, 2003, Minear et al., United States of America (US)  
20030078036, April 24, 2003, Chang et al., United States of America (US)  
20030091917, May 15, 2003, Davenport et al., United States of America (US)  
20030114105, June 19, 2003, Haller et al., United States of America (US)  
20030115351, June 19, 2003, Giobbi, United States of America (US)  
20030122856, July 3, 2003, Hubbard, United States of America (US)  
20030143992, July 31, 2003, Humphrey et al., United States of America (US)  
20030153280, August 14, 2003, Kopp et al., United States of America (US)  
20030187807, October 2, 2003, Matsubara et al., United States of America (US)  
20030214940, November 20, 2003, Takken, United States of America (US)  
20030224773, December 4, 2003, Deads, United States of America (US)  
20030232616, December 18, 2003, Gidron et al., United States of America (US)  
20040001467, January 1, 2004, Cromer et al., United States of America (US)  
20040048671, March 11, 2004, Rowe, United States of America (US)  
20040066769, April 8, 2004, Ahmavaara et al., United States of America (US)  
20040192384, September 30, 2004, Anastasakos et al., United States of America (US)  
20040196812, October 7, 2004, Barber, United States of America (US)  
3153213, April 3, 2001, Japan (JP)  
99048315, September, 1999, World Intellectual Property Organization (WIPO) (WO)  
00039967, July, 2000, World Intellectual Property Organization (WIPO) (WO)  
01048977, July, 2001, World Intellectual Property Organization (WIPO) (WO)

**NON-PATENT LITERATURE:**

Hardwick et al, Project P946-GI Smart Devices "When Things Start to Think", pp. 1-30, Jan. 2000.  
Guthery et al, The WebSIM- Clever Smartcards Listen to Port 80, pp. 1-16, Dec. 1999.  
Johansson et al, Short Range Radio Based Ad-hoc Networking: Performance and Properties, IEEE, pp. 1414-1420, 1999.  
Haartsen, BLUETHOOTH—The universal radio interface for ad hoc, wireless connectivity, Ericsson Review N. 3, pp. 110-117.  
Lee et al, Integrating Bluetooth with Wireless and Richocheting, IEEE, pp. 1310-1314, 2000.  
Karagiannis, Mobility support for ubiquitous Internet access, ERICSSON Open report, pp. 1-70, Dec. 21, 2000.  
Guthery et al., "The WebSIM—Clever Smartcards Listen to Port 80", version Dec. 15, 1999.  
Project P946-GI, Smart Devices "When Things Start to Think", Jan. 2000, 2000 EURESCOM Participants in Project P946-GI.  
Frodigh et al., "Wireless ad hoc networking—The art of networking without a network", Ericsson Review No. 4, 2000, pp. 248-263.  
Faruque et al, "Design and Analysis of Ad Hoc Wireless Networks for Battlefield Applications", Part of the SPIE Conference on Digitization of the Battlespace IV, Orlando, Florida, Apr., 1999, pp. 118-122.

Garcia-Luna-Aceves et al., "Wireless Internet Gateways (Wings)", 1997 IEEE, pp. 1271-1276.  
White Paper, Handheld Devices: Comparing the Major Platforms, www.dell.com/r&d, Dec. 2000.  
Miyatsu, Bluetooth Design Background and Its Technological Features, IEICE Trans, Fundamentals, vol. E83-A, No. 11, Nov. 2000.0034316020  
Parekh, Operating Systems on Wireless Handheld Devices, A Strategic Market Analysis, Massachusetts Institute of Technology, Sep. 28, 2000.  
Johansson, et al., Short Range Radio Based Ad-hoc Networking: Performance and Properties, IEEE, 1999.

**CORE TERMS:** terminal's, software, gateway, wireless, network, server, bluetooth, coupled, router, repository, cellular, processor, protocol, short-range, plug, layer, user, alternate, radio signals, communicate, abstraction, memory, accessing, storage, package, thin, operating system, technology, manager, backend

**ENGLISH-ABST:**

A system, a wireless hand-held device, and software component for accessing information responsive to short-range radio signals is provided. The system includes a wireless gateway device coupled to a network, such as a cellular network. The wireless gateway device includes a network manager software component for accessing information from the network responsive to a first short-range radio signal. The network may be a corporate, private or public network, such as the Internet. A first wireless device is coupled to the wireless gateway device. The first wireless device provides the first short-range radio signal. In an embodiment of the present invention, the first wireless device is a cellular telephone, personal digital assistant or thin terminal having a Bluetooth™ processor and transmitter. In an embodiment of the present invention, the network manager software component includes a plug and play software component for loading and executing software for the first wireless device. In an embodiment of the present invention, a second wireless device accesses information on the first wireless device using the wireless gateway device.

**NO-OF-CLAIMS:** 56

**EXMPL-CLAIM:** 1

**NO-OF-FIGURES:** 10

**NO-DRWNG-PP:** 9

**SUMMARY:**

**FIELD OF THE INVENTION**

[0001] This invention relates generally to wireless devices in a wireless network using short-range radio signals.

**BACKGROUND OF THE INVENTION**

[0002] A user has numerous wireless devices for accessing and processing information. For example, a user may have a cellular telephone for communicating with others, a personal digital assistant ("PDA") for storing contact information, a laptop computer for storing and processing files, a digital camera for obtaining images and a pager for being contacted. Each one of these devices also may access remote information on a private or public network, such as the Internet. However, this system suffers from several disadvantages.

[0003] First, typically only a single device originates and can access the Internet at a time.

[0004] Second, Internet protocol ("IP") addresses are held while connected to the Internet. This can be expensive and use scarce IP address resources.

[0005] Third, each device requires its own security management, such as a Virtual Private Network ("VPN") and firewall software component.

[0006] Fourth, there is no ability to share, add to or manage the services of the numerous wireless devices. In

particular, there is no communication between wireless devices. If a user obtains a wireless device having an additional service, such as extra persistence storage, other wireless devices typically are not capable of using the extra persistence storage.

[0007] Bluetooth™ technology (www.bluetooth.com) provides wireless communications between devices. Yet, Bluetooth™ technology also suffers from many disadvantages. Bluetooth™ technology does not allow for a "plug and play" capability at a wireless device application level. In other words, a wireless device cannot merely be turned on and Bluetooth™ technology recognizes it and establishes a communication protocol. If a user desires a wireless device to communicate with a Bluetooth™ technology device, the added wireless device must have software drivers and applications loaded to operate. Otherwise, the Bluetooth™ technology device is not able to communicate with the newly added wireless device. This makes it difficult to add new functionality or types of wireless devices. Bluetooth™ technology does not provide an open environment for software programmers to provide application software components for wireless devices. Further, Bluetooth™ technology does not allow devices to share information and resources at an application level.

[0008] Therefore, it is desirable to provide a system of wireless devices which can effectively communicate with each other and access information on the Internet. The system of wireless devices should efficiently use IP resources and security management. The wireless devices should effectively share and manage services and allow for seamless plug and play capability. The system should allow for new functionality and types of wireless devices.

#### SUMMARY OF THE INVENTION

[0009] A system, coupled to a cellular network, provides access to the Internet according to an embodiment of the present invention. The system comprises a wireless gateway device, coupled to the cellular network, having a network manager software component for accessing information from the Internet responsive to a first short-range radio signal. A first wireless device is coupled to the wireless gateway device. The first wireless device provides the first short-range radio signal.

[0010] According to an embodiment of the present invention, the first wireless device is selected from a group consisting of a desktop computer, a laptop computer, a personal digital assistant, a headset, a printer, a pager, a watch, digital camera and an equivalent thereof.

[0011] According to an embodiment of the present invention, the wireless gateway device is a cellular telephone using a Global System for Mobile communications ("GSM") protocol.

[0012] According to an embodiment of the present invention, the wireless gateway device is a cellular telephone using a Code Division Multiple Access ("CDMA") protocol.

[0013] According to an embodiment of the present invention, the wireless gateway device is a cellular telephone using a Time Division Multiple Access ("TDMA") protocol.

[0014] According to an embodiment of the present invention, the first wireless device is a thin terminal.

[0015] According to an embodiment of the present invention, the first wireless device includes a Bluetooth™ processor having a 2.4 GHz transmitter.

[0016] According to an embodiment of the present invention, the wireless gateway device includes a Bluetooth™ processor having a 2.4 GHz transmitter.

[0017] According to an embodiment of the present invention, the network manager software component includes a plug and play software component for loading and executing software for the first wireless device.

[0018] According to an embodiment of the present invention, the network manager software component includes a PIN number management software component for obtaining and supplying PIN numbers.

[0019] According to an embodiment of the present invention, the network manager software component includes a service repository software component for obtaining and providing an availability of a service from the first wireless device.



[0020] According to an embodiment of the present invention, the first wireless device includes an application software component for providing a service. The network manager software component includes a management software component for accessing the service.

[0021] According to an embodiment of the present invention, the system further comprises a second wireless device coupled to the wireless gateway device. The second wireless device provides a short-range signal. The first wireless device communicates with the second wireless device through the wireless gateway device.

[0022] According to an embodiment of the present invention, the system further comprises a second wireless device coupled to the wireless gateway device. The wireless gateway device provides access to the Internet for the first and second wireless devices.

[0023] According to an embodiment of the present invention, the network manager software component operates with an operating system software component.

[0024] According to an embodiment of the present invention, the operating system component is a Linux, EPOC or a PocketPC operating system.

[0025] According to an embodiment of the present invention, the wireless gateway device includes 1) an application software component for providing a service, and 2) an application server software component coupled to the network management software component.

[0026] According to an embodiment of the present invention, the wireless gateway device further includes a firewall software component.

[0027] According to an embodiment of the present invention, the wireless gateway device includes a VPN software component.

[0028] According to an embodiment of the present invention, a hand-held device for providing a personal area network is provided. The hand-held device comprises a storage device coupled to a processor. The storage device stores a software component for controlling the processor. The processor operates with the component to provide a short-range radio Internet protocol communication between the first hand-held wireless device and a second hand-held wireless device.

[0029] According to an embodiment of the present invention, a Bluetooth™ transmitter is coupled to the processor.

[0030] According to an embodiment of the present invention, a GSM transmitter is coupled to the processor.

[0031] According to an embodiment of the present invention, a wireless hand-held device accesses a router in a personal network. The wireless hand-held device comprises a storage device coupled to a processor. The storage device stores a software component for controlling the processor. The processor operates with the component to provide a first short-range radio signal to the router for accessing the Internet and a second short-range radio signal to the router for accessing another wireless hand-held device.

[0032] According to an embodiment of the present invention, an article of manufacture, including a computer readable medium is provided. The article of manufacture comprises an application software component for providing a service. An application server software component provides the application software component. The article of manufacture also includes an Internet protocol network manager software component and an operating system software component. Also, a short-range radio software component for providing a short-range radio signal and a cellular software component for providing a communications signal to a cellular network is included with the article of manufacture.

[0033] Other aspects and advantages of the present invention can be seen upon review of the figures, the detailed description, and the claims that follow.

**DRWDESC:**

## BRIEF DESCRIPTION OF THE FIGURES

[0034] FIG. 1 illustrates a system according to an embodiment of the present invention.

[0035] FIG. 2 illustrates thin terminals and a wireless gateway device according to an embodiment of the present invention.

[0036] FIGS. 3*a*–*b* are hardware block diagrams of a wireless gateway device and wireless hand held device according to an embodiment of the present invention.

[0037] FIGS. 4 and 5*a*–*b* are software block diagrams for a wireless gateway device according to an embodiment of the present invention.

[0038] FIG. 6 illustrates network management software interfaces according to an embodiment of the present invention.

[0039] FIG. 7 illustrates network management software components according to an embodiment of the present invention.

[0040] FIGS. 8*a*–*b* illustrate multiple wireless devices coupled to a wireless gateway device according to an embodiment of the present invention.

## DETDESC:

### DETAILED DESCRIPTION

#### I. System Overview

[0041] The following description and claims relate to a system that accesses information from a wide area network ("WAN"), such as the Internet, and local wireless devices in response to short-range radio signals. The network may also be an IP based public or private network, such as a corporate secured network using VPN.

[0042] FIG. 1 illustrates system **100** according to an embodiment of the present invention. System **100** includes terminals **107** coupled to wireless gateway device **106**. In an embodiment of the present invention, gateway device **106** and one or more terminals **107** communicate to form a personal area network ("PAN"). In an embodiment of the present invention, terminals **107** are coupled to gateway device **106** by short-range radio signals **110**. In an embodiment of the present invention, terminals **107** are a desktop computer, a laptop computer, a personal digital assistant, a headset, a pager, a printer, a watch, thin terminal, digital camera or an equivalent thereof. In an embodiment of the present invention, terminals **107** include a Bluetooth™ 2.4 GHz transmitter/receiver. Likewise, gateway device **106** includes a Bluetooth™ 2.4 GHz transmitter/receiver. In an alternate embodiment of the present invention, a Bluetooth™ 5.7 GHz transmitter/receiver is used. Gateway device **106** and terminals **107** hardware are illustrated in FIGS. 3*a*–*b*.

[0043] In alternate embodiments of the present invention, other local wireless technologies such as 802.11 or HomeRF signals are used to communicate between gateway device **106** and terminals **107**.

[0044] In an embodiment of the present invention, gateway device **106** is coupled to cellular network **105** by cellular signals **111** using a protocol, such as a Global and System for Mobile communications ("GSM") protocol. In alternate embodiments, a Code Division Multiple Access ("CDMA"), CDMA 2000 or Time Division Multiple Access ("TDMA"), or General Packet Radio Service ("GPRS") protocol is used.

[0045] In an alternate embodiment of the present invention, gateway device **106** is coupled to a landline network by an Ethernet, Digital Subscriber Line ("DSL"), or cable modem connection, singly or in combination.

[0046] In an embodiment of the present invention, gateway device **106** is a cellular telephone.

[0047] Cellular network **105** is coupled to a wireless carrier internal network or carrier backbone **104**. In an embodiment of the present invention, server **102** is coupled to carrier backbone **104**. In an alternate

embodiment of the present invention, carrier backbone **104** is coupled to Internet **103**. Server **101** is coupled to Internet **103**. In an embodiment of the present invention, servers **101** and **102** provide information, such as web pages or application software components to terminals **107** by way of gateway device **106**. In an embodiment of the present invention, terminals **107** share services and communicate by way of gateway device **106**.

## II. Gateway/Handheld Device Hardware

[0048] FIG. 2 illustrates terminals **107**. In an embodiment of the present invention, there are two types of terminals: 1) Smart terminals and 2) Thin terminals. Smart terminals have a relatively powerful central processor, operating system and applications. Their main needs from a PAN are access to a WAN through TCP/IP and other network services such as storage and execution. For example, a computer notebook and PDA are smart terminals. Thin terminals have a relatively low power central processor and operating system. They are mainly used as peripherals to an Application server in a PAN and their main task is user interaction, rendering output for a user and providing an Application server with a user's input. For example, a watch or a messaging terminal are thin terminals.

[0049] FIG. 2 illustrates thin terminals. Voice terminal **204** includes a display **204b** and a retractable keypad **204a**. Messaging Terminal **203** is illustrated in a closed position with a hinge **203a** used to open and close terminal **203**. Terminal **203** also includes a miniature QWERTY keyboard and display when opened. Gateway device **201** includes clip **202** for a belt.

[0050] In an embodiment, PMG device **201** is also illustrated in FIG. 2.

[0051] FIG. 3a illustrates a hardware block diagram of gateway device **106** in an embodiment of the present invention. Gateway device **106** includes both internal and removable memory. In particular, gateway device **106** includes internal FLASH (or Electrically Erasable Programmable Read-Only Memory ("EEPROM") and static Random Access Memory ("SRAM") memory **302** and **303**, respectively. Removable FLASH memory **304** is also used in an embodiment of the present invention. Memories **302**, **303** and **304** are coupled to bus **305**. In an embodiment of the present invention, bus **305** is an address and data bus. Application processor **301** is likewise coupled to bus **305**. In an embodiment of the present invention, processor **301** is a 32 bit processor.

[0052] Bluetooth™ processor **307** is also coupled to bus **305**. Bluetooth™ RF circuit **309** is coupled to Bluetooth™ processor **307** and antenna **313**. Processor **307**, RF circuit **309** and antenna **313** transmit and receive short-range radio signals to and from terminals **107** illustrated in FIG. 1, or device **350** illustrated in FIG. 3b.

[0053] Cellular, such as GSM, signals are transmitted and received using digital circuit **306**, analog circuit **308**, transmitter **310**, receiver **311** and antenna **312**. Digital circuit **306** is coupled to bus **305**. In alternate embodiments, gateway device **106** includes a display, a speaker, a microphone, a keypad and a touchscreen, singly or in combination thereof.

[0054] FIG. 3b illustrates device **350** that is a hand-held device in an embodiment of the present invention. Device **350**, in an embodiment of the present invention, is one of the terminals **107** illustrated in FIG. 1. Similar to gateway device **106**, device **350** includes SRAM and FLASH memory **351** and **352**, respectively. Memories **351** and **352** are coupled to bus **357**. In an embodiment of the present invention, bus **357** is an address and data bus. Keypad **353** is also coupled to bus **357**. Short-range radio signals are transmitted and received using Bluetooth™ processor **354** and Bluetooth™ RF circuit **355**. Antenna **356** is coupled to Bluetooth™ RF circuit **355**. In an embodiment of the present invention, antenna **356** transmits and receives short-range radio signals from gateway device **300**. In alternate embodiments, device **350** includes a display, a speaker, a microphone, a keypad and a touchscreen, singly or in combination thereof.

## III. Gateway Software

[0055] FIG. 4 illustrates a software architecture **400** for gateway device **106** illustrated in FIG. 3a according to an embodiment of the present invention. Gateway software **400** is stored in FLASH **302**. In an embodiment of the present invention, software components referenced in FIGS. 4-7 represent a software program, a software object, a software function, a software subroutine, a software method, a software instance, a code fragment, singly or in combination. In an alternate embodiment, functions performed by software components illustrated in FIGS. 4-7 are carried out completely or partially by hardware.

[0056] In an embodiment of the present invention, gateway software **400**, or components of gateway software **400**, is stored in an article of manufacture, such as a computer readable medium. For example, gateway software **400** is stored in a magnetic hard disk, an optical disk, a floppy disk, CD-ROM (Compact Disk ReadOnly Memory), RAM (Random Access Memory), ROM (Read-Only Memory), or other readable or writable data storage technologies, singly or in combination. In yet another embodiment, gateway software **400**, or components thereof, is downloaded from server **101** illustrated in FIG. 1.

[0057] Gateway software **400** includes telecommunication software or physical layer protocol stacks, in particular cellular communications software **401** and short-range radio communications software **402**. In an embodiment, communication software **401** is a GPRS baseband software component used with processor **306** to transmit and receive cellular signals. In an embodiment, communication software **402** is a Bluetooth™ baseband software component used with processor **307** to transmit and receive short-range radio signals.

[0058] In an embodiment of the present invention, operating system **403** is used to communicate with telecommunications software **401** and **402**. In an embodiment of the present invention, operating system **403** is a Linux operating system, EPOC operating system available from Symbian software of London, United Kingdom or a PocketPC or a Stinger operating system available from Microsoft of Redmond, Wash. Operating system **403** manages hardware and enables execution space for gateway device software components.

[0059] Network Management software **404** is used to provide a number of functions according to embodiments of the present invention: 1) routing, 2) device plug and play, 3) PIN number management, 4) network device management, and 5) service repository. In an embodiment of the present invention, network management software **404** is programmed in C++ software language.

[0060] Smart phone application software **405** communicates with operating system **403** and is used in a cellular telephone embodiment of the present invention.

[0061] 1st and 2nd software application components **406** communicate with management software **404** and provide additional services to a user. For example, application components **406** may include: 1) a stock quote application for providing stock quotes, 2) a personal information manager application including calendars, to do lists, emails, or contacts, 3) a synchronization software application for synchronizing databases, 4) a telephony application for providing telephone services, or 5) a location application for providing a current location of a gateway device.

[0062] Furthermore, Graphics User Interface ("GUI") **407** is provided to allow a user-friendly interface.

[0063] FIG. 5a illustrates detailed gateway software architecture **500**. In an embodiment of the present invention, network management software **404** illustrated in FIG. 4 includes three software components as illustrated in FIG. 5a: 1) PAN router **404c**; 2) PAN server **404b**; and 3) Application server **404a**. GPRS baseband **503** and Bluetooth™ baseband **502** are software components used to generate communication signals to a cellular network **105** and terminals **107** as illustrated in FIG. 1. In an alternate embodiment, other baseband software components **501** are used to generate communication signals. Media abstraction layer **504** allows operating system **403** to communicate with basebands **503**, **502**, and **501**, respectively. Media abstraction layer **504** and other abstraction layers, described herein, translate a particular communication protocol, such as GPRS, into a standard command set used by a gateway device and/or terminal. The purpose of an abstraction layer is to isolate the physical stacks from the rest of the gateway device software components. This enables future usage of different physical stacks without changing any of the upper layer software and allows the gateway device software to work with any communication protocol.

[0064] PAN router **404c** establishes a PAN network, implementing communication primitives, IP networking, IP services and similar tasks.

[0065] PAN server **404b** is responsible for implementing PAN oriented services such as plug and play, terminal enumeration, application loading, storage space and other services. In an embodiment, PAN server **404b** communicates directly with applications **406** using application drivers.

[0066] PAN application server **404a** is responsible for implementing user and terminal oriented services and enables thin terminals. In an embodiment of the present invention, PAN application server **404a** implements such applications as a GUI **407**, a remote terminal driver application, a location application, a telephony application or an equivalent thereof.

[0067] FIG. 5a, like FIG. 4, illustrates 1st and 2nd software component applications **406** and GUI **407**.

#### A. PAN Router

[0068] PAN router **404c** enables a fully meshed IP based network. In an embodiment of the present invention, each terminal can leverage the existing IP protocol, exchange data with other terminals and gain access to a WAN through PAN router **404c**.

[0069] FIG. 5b illustrates software components of PAN router **404c**. In an embodiment of the present invention, routing component **550**, Bluetooth™ LAN access Profile component **551**, Dynamic Host Configuration Protocol/Point-to-Point Protocol ("DHCP/PPP") component **552** and Network Address Translator ("NAT") component **553** are used in PAN router **404c**. In an alternate embodiment, Domain Naming Service ("DNS") component **554**, Tunneling and Optimization component **555** and Security component **556**, singly or in combination are used in PAN router **404c**.

#### 1. Routing Component

[0070] Routing component **550** is implemented in Router **404c** in order to realize a fully meshed IP network with access to a WAN. A routing component is responsible for imitating a fully meshed network based on a Master/Slave network.

[0071] Routing component **550** enables exchange of IP packets between two terminals, broadcasting of IP packets between all terminals on a PAN and routing of IP packets to and from a WAN.

#### 2. Bluetooth™ LAN Access Profile ("LAP") Component

[0072] A Bluetooth™ LAN Access Profile ("LAP") component **551** is used in order to enable terminals to seamlessly use IP base networking. LAP component **551** enables terminals to exchange IP packets between themselves and PAN router **404c**. LAP component **551** is implemented over a PPP serial Bluetooth™ connection. In an embodiment of the present invention, terminals, such as Smart terminals, include LAP chipsets.

#### 3. DHCP/PPP Component

[0073] DHCP and PPP components **552** are used in order to enable an IP network. PPP realizes an IP network layered over LAP component **551**.

[0074] DHCP component manages a PAN's IP address space and IP services, enabling terminals to get IP networking properties, such as an IP address for a terminal, an address of a DNS and an address of a default gateway device.

#### 4. NAT Component

[0075] NAT component **553** translates a private IP address to and from a real IP address. Since mobile networks are typically capable of only providing a single IP address, the terminals will have to use private IP addresses supplied by NAT component **553**.

#### 5. DNS Component

[0076] DNS component **554** translates services between human readable names and IP addresses. DNS component **554** enables a terminal to query another terminal's address based on the other terminal's name and to query for the IP address of a named service on a WAN.

#### 6. Tunneling and Optimization Component

[0077] Tunneling and Optimization component **555** allows terminals to use standard protocols. For example, accessing a WAN through a cellular GPRS/CDMA network using TCP/IP yields poor results because TCP/IP does not behave well over a bandwidth limited, high latency and high packet loss network, such as GPRS/CDMA.

[0078] Tunneling and Optimization component **555** is used to enable practical usage of IP in such networks. When using cellular, the tunnel will be between a mobile device having a PAN router and a landline operator's network. The tunneling and optimization network translates IP packets to more efficient transport methods for the specific access technology, and vice versa in a fully transparent fashion.

## 7. Security Component

[0079] Accessing a WAN can typically be done in two ways: unsecured when accessing a public network, such as the Internet, or secured when accessing a private network, such as an Enterprise network, file system or Exchange server.

[0080] Security component **556** is a centralized managed way for controlling access to a secured private WAN. In order to avoid each one of the terminals from implementing its own security scheme and methods, a centralized security component **556** is used. In an embodiment of the present invention, security component **556** is a firewall **556a**, VPN **556b** or URL filter **556c**, singly or in combination.

## 8. Usage Scenario

[0081] In this scenario, a user is a traveling professional, who has a PDA and needs to synchronize the PDA against a corporate Exchange server while on the road. This synchronization needs to be done securely as the only way to enter the corporate network is via a certified and an information technology ("IT") manager approved VPN.

[0082] The user has a gateway device enabled handset with an embedded PAN router **404c** and VPN client, which the IT manager installed.

[0083] As the user turns on the PDA, which is a Bluetooth™ equipped PDA with a LAP component **551**, the PDA connects to a gateway device handset via the LAP. The PDA receives a local PAN IP address.

[0084] The user loads the PDA synchronization software, which is configured to synchronize against the corporate Exchange server. When hitting the "Synchronize" button, the PDA opens a TCP connection to the IP address

[0085] The IP packets travel across the Bluetooth™ air interface to the handset using a PPP protocol. At the handset, the packets go through a NAT component and a local IP address is translated to a real Internet IP address. The real IP address goes to the VPN, which identifies the destination as the corporate LAN. The VPN packages the packet over its Internet tunnel, encrypts and signs it. The packet is then sent through the cellular air interface to the operator and the Internet, reaching the corporate VPN and Exchange servers. The PDA is totally unaware of this process.

## B. PAN Server

[0086] PAN server **404b** allows code to be downloaded to a PAN and executed in a central way. Similarly, PAN server **404b** shares and stores data in a centralized manner.

### 1. PAN Server Interfaces

[0087] FIG. 6 illustrates software interfaces for PAN server **404b** shown in FIG. 5a. PAN server **404b** provides application program interfaces ("API") to applications **406**. Applications **406** also queries PAN server **404b** for specific services and/or terminal attributes in a PAN. Applications **406** provide at least three types of information to PAN server **404b**. Applications **406** provide a Personal Identification Number ("PIN") number, network configuration information, service registration and unregistration information. PAN server **404a** provides services and devices enumeration information to applications **406**. In an embodiment of the present invention, a PIN

number is an authorization code to enable a terminal to connect to a PAN.

[0088] PAN server **404b** uses media abstraction layer **504** in order to communicate with terminals **107**. PAN server **404b** transfers services and devices enumerations to PAN router **404c**; while, a terminal ID number is provided to PAN server **404b** from PAN router **404c**. A terminal ID is a unique code for identifying a particular terminal. Finally, a PIN number is transferred from PAN server **404b** to PAN router **404c**.

[0089] In an embodiment of the present invention, PAN server **404b** loads an executable application software component to a selected terminal. Application server **404a** retrieves the application software component locally from gateway device **106** memory or from either server **102** or **103** as illustrated in FIG. 1.

[0090] Backend middleware **485** provides a PIN number to router **404c**. In an embodiment of the present invention, backend middleware **485** is stored on a server coupled to cellular network **105** shown in FIG. 1. In an embodiment of the present invention, backend middleware **485** is a software component for supplying PIN numbers and accessing application components for a particular terminal.

## 2. PAN Server Components

[0091] FIG. 7 illustrates software components of PAN server **404a** according to an embodiment of the present invention: 1) plug and play software component **701**, 2) PIN number management software component **702**, 3) management software component **703**, 4) service repository software component **704**, and 5) application loader **705**. In alternate embodiments, more or less components are used.

### a. Plug and Play Component

[0092] When a new terminal is introduced to a PAN, the software to support this terminal needs to be located, downloaded and executed. The Plug and Play component is responsible for identifying the introduction of the new terminal and deciding on the software needed to be downloaded.

[0093] An example of the Plug and Play usage is when a new thin terminal, like a messaging terminal, is introduced to a PAN. The terminal itself, being thin, has no embedded application code or data. The appropriate software package (messaging software in this case) needs to be found, downloaded and executed. The Plug and Play component will identify the messaging terminal and resolve the needed software to support it.

[0094] FIG. 7 illustrates the operation of Plug & Play component **701**. In response to a terminal ID from PAN router **404c**, Plug and Play component **701** will access the software package for a selected terminal from backend middleware **485** or locally from gateway device **106** memory. If the selected package is not locally available in gateway device **106** memory, a URL is provided from backend middleware **485** for accessing the package remotely. In an embodiment of the present invention, the selected package will install and run on different modules (typically but not necessarily a shell, service/terminal drivers and applications that can run on the terminal).

### b. Application Loader Component

[0095] Adding new capabilities to a PAN involves the loading of executable code to a PAN execution environment. Application loading can be a result of many events: plug and play component **701** can generate an application loading for supporting a new terminal on a PAN, a user can decide to actively load an application to a PAN or an operator on a cellular network can decide to load an application to a PAN. Application loader **705** is responsible for application software code transfer and execution.

### c. PIN Number Management Component

[0096] Whenever gateway device **106** and a terminal become aware of each other, a pairing process takes place between them. For example, gateway device **801** and terminal **802** are paired as illustrated in FIG. 8a. When this pairing takes place for a first time (or when the link key that they were sharing has been lost in one or both sides for any reason), a claimant side (for example, gateway device **801**) must know a PIN number of terminal

**802** in order to carry out a successful pairing. PAN server **404b** will supply PIN number information to PAN router **404c** for that purpose. A PIN number is used to generate an initialization key that is used as an encryption key for the exchange of initial parameters between a gateway device and terminals. In an embodiment of the present invention, PAN server **404b** must be able to supply PIN number information according to different criteria. For example, PAN server **404b** supplies PIN numbers for only those terminals that are associated with a certain terminal class or ID number.

[0097] PAN server **404b** will supply a PIN number upon an explicit request of another component, such as PAN router **404c**. In an alternate embodiment, Application server **404b** will supply PIN number information for terminals in order for them to establish a Bluetooth™ channel with other terminals without a gateway device **107** as a mediator.

[0098] In an embodiment of the present invention, PIN numbers are available from backend middleware **485**. In alternate embodiments of the present invention, applications **406** provide a PIN number. For example, an application may allow a user to enter a PIN number or an application may cause backend middleware **485** to generate a PIN number. In an embodiment of the present invention, an application that supplies a PIN number states its origin.

[0099] There are two methods for obtaining PIN numbers. First, a push method occurs when the source of the PIN number transfers the PIN number when it becomes available. Second, a query method occurs when router **404c** queries the source of the PIN number for a PIN number according to a certain criteria. A push method is preferred because it enables an immediate response to a request for a PIN number. However, if the PIN number is not available when a request arrives at the source of the PIN number, PAN server **404b** attempts to obtain the PIN number using the query method. When the push method is used, the stimulus comes from the PIN number information source.

[0100] PIN number management software component **702** maintains a local database of PIN numbers with some attributes. An attribute may include a terminal class or terminal ID. PIN number management software component **702** adds, deletes and retrieves PIN numbers from the database. PIN number software component **702** also may retrieve all PIN numbers associated with a screen terminal class. In an embodiment, PIN number management software component **702** will have a persistent database. In an alternate embodiment, PIN number management software component **702** will not have a persistent database.

[0101] In alternate embodiments of the present invention, PIN number management **702** is a central storage location for PAN databases and/or caching. The storage component supports implementation of a file system that can be accessed by a terminal. Also, a storage component may have automatic backup to a backend server or transparent storage.

#### d. Network Management Component

[0102] Management software component **703** provides functions to configure a PAN.

[0103] First, management software component **703** provides a disconnect service function that forces specific applications to disconnect from a specific service.

[0104] Second, management software component **703** provides a disconnect terminal function that forces specific applications to disconnect from all services of a specific terminal.

[0105] Third, management software component **703** provides a disable service function that halts any usage of a specific terminal's service.

[0106] Fourth, management software component **703** provides a disable terminal function that halts any usage of all services of a specific terminal.

[0107] The disconnecting functions described above allow a high priority application to obtain a service from an application using the service. The disabling functions allow for high priority applications to create personal area network restrictions.

[0108] Service repository software component **704** is used to cease offering services. PIN Number management



**702** is used to delete a PIN number and abstraction layer I/O is used to halt service's data traffic.

e. Enumeration or Service Repository Component

[0109]Service repository software component **704** allows applications **406**, which run on a gateway device **106** or terminals **107**, to discover what services are offered by a PAN, and to determine the characteristics of the available services. The service could be offered by remote terminal, such as an application in terminal **806** illustrated in FIG. 8*b*. For example, terminal **806** could be a printer having a printing service. Also, the service could be offered by an application stored on gateway device **106**, such as the application in gateway device **801** illustrated in FIG. 8*a*. For example, gateway device **801** is a cellular telephone having a telephony service provided by a cellular telephone application. Remote services are offered with the assistance of service logical drivers (SLDs) that are stored on gateway device **106**. Whenever an application is interested in using a terminal service, the terminal interoperates with the corresponding gateway device SLD. For example, an application on terminal **809**, shown in FIG. 8*b*, accesses a driver in gateway device **805** for a service provided by an application on terminal **806**. Therefore, from an application's point of view, the SLD of the remote service acts the same way as a local application.

[0110]Service repository software component **704** offers a plurality of functions.

[0111]First, service repository software component **704** provides service registration of a service offered by application, or a hardware capability offered by terminal driver.

[0112]Second, service repository software component **704** provides service unregistration that cancels a registered service.

[0113]Third, service repository software component **704** provides registered services that suit a specific class.

[0114]Fourth, service repository software component **704** also provides searching of services. This function describes whether listed terminals support listed services. This function enables an application to quickly locate a specific service. A search of a general class of service, such as a search for a printers may be performed. Likewise, a search for specific attributes associated with that service, for example laser or color, is provided. Further, a search for specific instance of a service, for example a HP LaserJet model GTI, is also provided.

[0115]Fifth, service repository software component **704** provides the capability of describing the participating terminals in a personal area network. The existence of these terminals is derived from a service registration function.

[0116]Sixth, service repository software component **704** provides a disabling function that ceases offering an unfriendly service.

[0117]Seventh, service repository software component **704** also provides an enabling function that cancels service disabling.

[0118]Eighth, service repository software component **704** provides a terminal disabling function that ceases offering all the services associated with an unfriendly terminal.

[0119]Ninth, service repository software component **704** provides a terminal enabling function that cancels terminal disabling.

[0120]In an embodiment, an application does not have to discover a service in order to connect with a terminal. If an application has previous knowledge of a terminal's service, the application needs to only search for the specific terminal.

[0121]In an embodiment of the present invention, service repository component **704** describes the terminals and the services that are available at a particular time, but service repository software component **704** does not describe the current status of the services. A service might be available in a PAN but not necessarily accessible since another application is exclusively using the service.

[0122]Since service repository software component **704** operates with local and remote applications, a uniform

interface is used. In an embodiment of the present invention, remote applications use a Bluetooth™ Service Discovery Protocol ("SDP") to discover what services gateway device **106** offers. Similarly, local applications use SDP in an embodiment of the present invention.

### C. Application Server

[0123] Application Server component **404a** illustrated in FIG. 5a allows for removing redundant capabilities from terminals and consolidating them in a centralized application server. This allows significant added value in minimizing the cost and complexity of the terminals in a PAN, as well as making their design intuitive and easy to use.

[0124] In an embodiment of the present invention, application server component **404a** includes two components: 1) an execution environment and 2) services for being able to successfully execute software on a multi-terminal PAN, such as a file system.

[0125] Thin terminals, being optimized for low cost will not include an IP capability in most cases. Instead, they will use the native protocols offered by the PAN's physical layer. This does not conflict with the PAN router **404c** since thin terminals are an extended remote I/O for applications running on a PAN application server **404a**. All the logic, protocols and standard compatibility is implemented in the application server, in which standard protocols like IP are implemented and used.

#### 1. Usage Scenario

[0126] In an embodiment of the present invention, a thin messaging terminal includes a color Liquid Crystal Display ("LCD"), QWERTY keypad, Bluetooth™ chipset and a small software stack for displaying graphical screens received over the Bluetooth™ air interface and transmit keypad actions back over the Bluetooth™ air interface.

[0127] When a terminal is turned on for the first time, a Plug and Play component **701** in the gateway device **106** identifies that this is a new terminal. Gateway device **106** communicates with Plug and Play component **701** in order to retrieve the needed software package to be executed on an application server **404a**. In an embodiment of the present invention, a Plug and Play component **701** contains a URL for a chatting application package.

[0128] Application loader **705** gets the URL and loads the new package to PAN application server **404a** in a gateway device **106** and executes the chatting software application. The chatting application software identifies the messaging device by enumerating a PAN for terminals and capabilities, and attaches itself to the right remote graphical driver and the remote keypad driver.

[0129] Now, all user interactions for the chatting application is displayed on the messaging terminal, and the keypad entries on the terminal are sent to the chatting application.

[0130] In this embodiment of the present invention, the terminal is used only for I/O and user interaction. The actual chatting logic is executed in application server **404a**, which is located in gateway device **106**.

### IV. Gateway Device/Terminal Operations

#### A. Terminal Joins Personal Area Network

[0131] First, PAN router **404c** requests a PIN number from PIN number management component **702**. Second, if a PIN number is available, PIN number management **702** transfers the PIN number to PAN router **404c**. Otherwise, PIN number management **702** attempts to obtain the PIN number from other sources, such as applications **406** or backend middleware **485**, and transfers the PIN number to PAN router **404c**. Third, PAN router **404c** notifies plug and play **701** that a pairing has ended and delivers a terminal ID to plug and play **701**. Fourth, plug and play **701** resolves the terminal package URL with backend middleware **485** if a package is not locally available; otherwise, the package is loaded and executed. Finally, if the package contains drivers, the driver's services are offered to service repository **704**.

#### B. Pin Number Received

[0132] Backend middleware **485** or an application acquires a PIN number. Second, the acquired PIN number is offered to PIN number management **702** by either backend middleware **485** or applications **406**. In an alternate embodiment of the present invention, a PIN number is offered with additional characteristics of the associated terminal. PIN number information is then accepted and stored with the attributes in a database of PIN number management **702**.

#### C. Gateway Device Application Queries for a Specific Service

[0133] There are two methods for a gateway device **106** application to inquire for a specific service. The first terminal method includes the application asking service repository **704** to describe the terminals in the current personal area network and to describe whether any of these terminals provide the requested service. In an embodiment of the present invention, an application sorts the available terminals in order of preference. The application then queries abstraction layer I/O whether the most preferred terminal's service is available.

[0134] The second service method includes an application querying service repository **704** to provide the registered services that suit a requested service class. The application then searches the registered services to determine which capabilities are provided by the registered services. In an embodiment of the present invention, an application sorts the available services in order of preference. The application then queries abstract layer I/O whether the most preferred service is available.

#### D. Terminal Application Queries for a Gateway Device Service

[0135] Media abstraction layer **504** obtains an SDP of a remote terminal application. Media abstraction layer **504** passes the SDP call to service repository **704**. Service repository **704** answers media abstraction layer **504**, using SDP, according to services that are registered. The abstraction layer **504** then sends the answers to an application on remote terminal.

[0136] In an alternate embodiment, service repository **704** pushes new services to a Bluetooth™ stack SDP database. The Bluetooth™ stack replies automatically and generates an SDP request.

#### E. High Priority Application Prevents Terminal Usage

[0137] In response to a network configuration signal from a high priority application in applications **406**, management component **703** generates a delete PIN number signal to PIN number management component **702** which deletes the PIN number associated with the selected terminal. Management component **703** generates a disable signal to service repository component **704** to cease offering all the services associated with the selected terminal. Management component **703** generates a disable service signal to abstraction layer I/O in order to halt all the transport to and from the selected terminal's services.

[0138] Abstraction layer I/O sends halt notifications to the applications that are currently using the selected terminal's services. Abstraction layer I/O then stops any data transport to and from the selected terminal's services.

#### V. Conclusion

[0139] The foregoing description of the preferred embodiments of the present invention has been provided for the purposes of illustration and description. It is not intended to be exhaustive or to limit the invention to the precise forms disclosed. Obviously, many modifications and variations will be apparent to practitioners skilled in the art. The embodiments were chosen and described in order to best explain the principles of the invention and its practical applications, thereby enabling others skilled in the art to understand the invention for various embodiments and with the various modifications as are suited to the particular use contemplated. It is intended that the scope of the invention be defined by the following claims and their equivalents.

#### ENGLISH-CLAIMS:

Return to Top of Patent

What is claimed is:

1. A system for providing access to the Internet, comprising:

• -

a first wireless device, in a short distance wireless network, having a software component to access information from the Internet by communicating with a cellular network in response to a first short-range radio signal, wherein the first wireless device communicates with the cellular network and receives the first short-range radio signal; and,

• -

a second wireless device, in the short distance wireless network, to provide the first short-range radio signal,

• -

wherein the software component includes a network address translator software component to translate between a first Internet Protocol ("IP") address provided to the first wireless device from the cellular network and a second address for the second wireless device provided by the first wireless device,

• -

wherein the software component includes a service repository software component to identify a service provided by the second wireless device.

2. The system of claim 1, wherein the second wireless device is selected from a group consisting of a desktop computer, a laptop computer, a personal digital assistant, a headset, a pager, a printer, a watch, and a digital camera.

3. The system of claim 1, wherein the first wireless device is a cellular telephone using a protocol selected from a group consisting of a Global System for Mobile Communications ("GSM") protocol, a Code Division Multiple Access ("CDMA") protocol, a cellular telephone using a CDMA 2000 protocol, and a Time Division Multiple Access ("TDMA") protocol.

4. The system of claim 1, wherein the service repository software component identifies whether the service is available at a particular time.

5. The system of claim 1, wherein the software component includes a domain naming service ("DNS") software component to translate between a human readable name and a second Internet Protocol ("IP") address.

6. The system of claim 1, wherein the software component includes a security software component to control access between the cellular network and the first wireless device.

7. The system of claim 1, wherein the second wireless device is a thin terminal.

8. The system of claim 1, wherein the second wireless device includes a Bluetooth™ processor and a 2.4 GHZ transmitter.

9. The system of claim 1, wherein the first wireless device includes a Bluetooth™ processor and a 2.4 GHZ transmitter.

10. The system of claim 1, wherein the second wireless device includes a Bluetooth™ processor and a 5.7 GHZ transmitter.

11. The system of claim 1, wherein the first wireless device includes a Bluetooth™ processor and a 5.7 GHZ transmitter.

12. The system of claim 1, wherein the software component includes a plug and play software component to load

and execute software for the second wireless device.

13. The system of claim 1, wherein the software component includes a PIN number management software component to obtain and provide PIN numbers.

14. The system of claim 1, wherein the second wireless device includes an application software component that registers an availability of the service with the service repository software component.

15. The system of claim 1, furthering comprising:

- -

- a third wireless device, in the short distance wireless network, having an application software component to obtain the service from the second wireless device.

16. The system of claim 15, wherein the first wireless device includes a service logical driver corresponding to the service, and wherein the application software component uses the service logical driver to obtain the service from the second wireless device.

17. The system of claim 1, wherein the software component operates with an operating system software component.

18. The system of claim 17, wherein the operating system software component is a Stinger operating system.

19. The system of claim 17, wherein the operating system software component is a Linux operating system.

20. The system of claim 17, wherein the operating system software component is a EPOC operating system.

21. The system of claim 17, wherein the operating system software component is a PocketPCoperating system.

22. The system of claim 1, wherein the service repository software component identifies a class, attribute and instance of the service.

23. The system of claim 1, wherein the first wireless device further includes a virtual private network ("VPN") software component.

24. The system of claim 1, wherein the first wireless device further includes a firewall software component.

25. A system for providing access to information on a cellular network, comprising:

- -

- a first wireless device, in a short distance wireless network, to provide a first short-range radio signal; and,

- -

- a second wireless device, in the short distance wireless network and the cellular network, to selectively transfer information, including Internet Protocol ("IP") data packets, between the first wireless device and the cellular network in response to a security software component,

- -

- wherein the second wireless device includes a service repository software component that identifies a plurality of services, in the short distance wireless network, associated with a plurality of wireless devices, and wherein the service repository software component searches for a service, in the plurality of services, to be used by an application software component stored in the first wireless device.

26. The system of claim 25, wherein the first wireless device provides execution space for executable software from the second wireless device.

27. The system of claim 25, wherein the security software component is a firewall software component to control access to the cellular network.

28. The system of claim 25, wherein the security software component is a virtual private network ("VPN") to control access to the cellular network.

29. The system of claim 25, wherein the security software component is a uniform resource locator ("URL") filter to control access to the cellular network.

30. The system of claim 25, wherein the first short-range radio signal is selected from a group consisting of a HomeRF signal, an 802.11 signal and Bluetooth™.

31. The system of claim 25, wherein the information is provided in the form of data packets.

32. The system of claim 25, wherein the second wireless device is coupled to the cellular network by a landline network.

33. The system of claim 25, wherein the second wireless device is coupled to the cellular network by either an Ethernet connection, DSL connection or a cable modem.

34. A handheld device for providing a short distance wireless network, comprising:

- -  
a storage device;
- -  
a processor, coupled to the storage device; and,
- -  
the storage device to store a software component; and, the processor operative with the software component to:
- -  
provide an Internet Protocol ("IP") data packet from the handheld device to a terminal using short-range radio signals,
- -  
control access between the short distance wireless network and a cellular network,
- -  
translate between a first IP address provided to the handheld device and a second IP address for the terminal provided by the handheld device in the short distance wireless network,
- -  
enumerate a list of services available from the handheld device and the terminal, wherein the handheld device and terminal register services available on the list, and
- -  
search the list of services for a service to be used by an application software component stored on the terminal.

35. The device of claim 34, wherein the software component includes a management software component.

36. The device of claim 34, wherein the application software component uses a service logical driver stored in the storage device to obtain a service available on the handheld device.

37. The device of claim 34, further comprising: a Bluetooth™ transmitter, coupled to the processor, to generate

the short-range radio signals.

38. The device of claim 34, further comprising: a GSM transmitter, coupled to the processor.

39. The device of claim 34, wherein the search includes searching the list of services by class, attribute or instance.

40. The device of claim 34, wherein the software component includes a plug and play software component to identify the terminal in the short distance wireless network and obtain the application software component for the terminal.

41. The device of claim 34, wherein the software component includes a PIN number management software component to provide a PIN number used in pairing the handheld device to the terminal in the short distance wireless network.

42. A first wireless handheld device, comprising:

- -

- a storage device;

- -

- a processor, coupled to the storage device; and,

- -

- the storage device to store a software component; and, the processor operative with the software component to:

- -

- access the Internet through a cellular network,

- -

- provide a first short-range radio signal to a second wireless handheld device and a second short-range radio signal to a third wireless handheld device,

- -

- control access between the Internet and the first, second and third wireless handheld devices,

- -

- translate between a first Internet Protocol ("IP") address provided to the first wireless handheld device from the cellular network and a second address for the second wireless handheld device provided by the first wireless handheld device, and a third address for the third wireless handheld device provided by the first wireless device,

- -

- enumerate a list of services available from the first, second and third wireless handheld devices, wherein the first, second and third wireless handheld devices register services available on the list, and

- -

- search the list of services for a class of service to be used by an application software component at a particular time, the application software component stored on the second wireless handheld device.

43. The first wireless handheld device of claim 42, wherein the first wireless handheld device includes a service logical driver corresponding to a service available from the third wireless device, and the application software component uses the service logical driver to obtain the service from the third wireless device.

44. The first wireless handheld device of claim 42, wherein the first wireless handheld device includes a 5.7 GHZ transmitter coupled to the processor.

45. The first wireless handheld device of claim 42, wherein the second wireless handheld device is selected from a group consisting of a desktop computer, a laptop computer, a personal digital assistant, a headset, a pager, a watch, and a thin terminal a digital camera.

46. The first wireless handheld device of claim 42, wherein the second wireless handheld device is a thin terminal.

47. The first wireless handheld device of claim 42, wherein the first wireless handheld device includes a 2.4 GHZ transmitter coupled to the processor.

48. An article of manufacture, including a computer readable medium, comprising:

• -

a short-range radio software component to communicate with a device in a short distance wireless network by using a short-range radio signal;

• -

a cellular software component to communicate with a cellular network by using a cellular signal;

• -

a network software component to selectively transfer an Internet Protocol ("IP") data packet between the device and the cellular network;

• -

a service repository software component to identify a plurality of available services from a plurality of devices in the short distance wireless network, the service repository software component having a uniform interface so that both a local application software component and a remote application software component identifies the plurality of available services; and

• -

a plurality of service logical drivers corresponding to the plurality of available services that are used to obtain the plurality of services, the plurality of service logical drivers are used in obtaining the plurality of services.

49. The article of manufacture of claim 48, wherein the cellular software component is a GSM component.

50. The article of manufacture of claim 48, wherein the short-range radio software component is a Bluetooth™ component.

51. The article of manufacture of claim 48, further comprising security software component to control access between the short distance wireless network and the cellular network.

52. The article of manufacture of claim 48, further comprising a network address translator software component to translate between a first Internet Protocol ("IP") address and a second IP address.

53. The article of manufacture of claim 48 further comprising a domain naming service ("DNS") software component to translate between a human readable name and an Internet Protocol ("IP") address.

54. The article of manufacture of claim 48, further comprising a plug and play software component to identify the terminal in the short distance wireless network and obtain an application software component for the terminal.

55. The article of manufacture of claim 48, wherein the article of manufacture is a memory storage device in a cellular telephone.

56. A handheld device for providing a short distance wireless network, comprising:

• -



- a storage device;
- -
- means for identifying an availability of a plurality of services to a plurality of application software components in the short distance wireless network;
- -
- means for selectively providing the plurality of services to the plurality of application software components in the short distance wireless network; and
- -
- means for selectively transferring an Internet Protocol ("IP") data packet between a cellular network and a selected application software component in the plurality of application software components in the short distance wireless network.

SYS-LOAD-DATE: May 10, 2017

---

Source: [Legal > Area of Law - By Topic > Patent Law > Find Patents > Utility, Design and Plant Patents](#) 

Terms: **patno=7039033** (Suggest Terms for My Search)

View: Full

Date/Time: Tuesday, May 16, 2017 - 11:14 AM EDT

---

2016 Pat. App. LEXIS 13292, \*

SAMSUNG ELECTRONICS CO., LTD., SAMSUNG ELECTRONICS AMERICA, INC., and APPLE INC.,  
Petitioner,  
v.  
IXI IP, LLC,  
Patent Owner.

Case IPR2015-01444, Paper No. 27

Patent 7,039,033 B2

Patent Trial and Appeal Board Representative Orders, Decisions and Notices

2016 Pat. App. LEXIS 13292

December 21, 2016, Decided

**CORE TERMS:** network, mobile, gateway, phone, software, wireless, terminal, artisan, skilled, piconet, recited, teach, proxy, teaching, printer, ad-hoc, reply, cellular, thin, laptop, skill, subject matter, handheld, server, recites, translator, preponderance, short-range, repository, maps

**NOTICE:**

[\* 1]

ROUTINE OPINION. Pursuant to the Patent Trial and Appeal Board Standard Operating Procedure 2, the opinion below has been designated a routine opinion.

Before KRISTINA M. KALAN, ROBERT J. WEINSCHENK, and JOHN A. HUDALLA, Administrative Patent Judges.

**COUNSEL:**

**PETITIONER:**

W. Karl Renner  
Kevin Greene  
FISH & RICHARDSON P.C.  
3200 RBC Plaza, 60 South Sixth Street  
Minneapolis, MN 55402  
IPR00035-0004IP1@fr.com

**PATENT OWNER:**

Andy H. Chan  
PEPPER HAMILTON LLP  
333 Twin Dolphin Drive, Suite 400  
Redwood City, CA 94065  
chana@pepperlaw.com

George S. Haight  
Andrew Schultz  
PEPPER HAMILTON LLP  
125 High Street, 19th Floor, High Street Tower  
Boston, MA 02110  
haightg@pepperlaw.com  
schuitza@pepperlaw.com

Tuhin Ganguly  
PEPPER HAMILTON LLP  
600 Fourteenth Street, N.W.  
Washington, DC 20005  
gangulyt@pepperlaw.com

**OPINIONBY:** JOHN A. HUDALLA

**OPINION:**

HUDALLA, Administrative Patent Judge.

FINAL WRITTEN DECISION

*35 U.S.C. § 318(a) and 37 C.F.R. § 42.73*

Samsung Electronics Co., Ltd., Samsung Electronics America, Inc., and Apple Inc. (collectively "Petitioner") filed a Petition ("Pet.") (Paper 2) to institute an *inter partes* review of claims 1, 4-7, 12, 14, 15, [\* 2] 22, 23, 25, 26, 34, 39, 40, 42, and 46 of U.S. Patent No. 7,039,033 B2 ("the '033 patent") (Ex. 1001) pursuant to 35 U.S.C. §§ 311-319. Patent Owner, IXI IP, LLC ("IXI"), filed a Preliminary Response ("Prelim. Resp.") (Paper 6) to the Petition. Taking into account the arguments presented in IXI's Preliminary Response, we determined that the information presented in the Petition established that there is a reasonable likelihood that Petitioner would prevail in challenging claims 1, 4-7, 12, 14, 15, 22, 23, 25, 28, 34, 39, 40, 42, and 46 of the '033 patent under 35 U.S.C. § 103(a). Pursuant to 35 U.S.C. § 314, we instituted this proceeding on December 30, 2015, as to these claims of the '033 patent. Paper 7 ("Dec. on Inst.").

During the course of trial, IXI filed a Patent Owner Response (Paper 14, "PO Resp."), and Petitioner filed a Reply to the Patent Owner Response (Paper 18, "Pet. Reply"). An oral hearing was held on September 15, 2016, and a transcript of the hearing [\* 3] is included in the record. Paper 26 ("Tr.").

Petitioner proffered a Declaration of Dr. Sayfe Kiaei (Ex. 1003) with its Petition, and IXI proffered a Declaration of Dr. Narayan Mandayam (Ex. 2301) with its Response. The parties also filed transcripts of the depositions of Dr. Kiaei (Exs. 2303-2305) and Dr. Mandayam (Exs. 1018, 1019).

IXI filed a Motion to Exclude (Paper 21) certain exhibits submitted by Petitioner. Petitioner filed an Opposition (Paper 24) and IXI filed a Reply (Paper 25).

We have jurisdiction under 35 U.S.C. § 6. This decision is a Final Written Decision under 35 U.S.C. § 318(a) as to the patentability of claims 1, 4-7, 12, 14, 15, 22, 23, 25, 28, 34, 39, 40, 42, and 46 of the '033 patent. For the reasons discussed below, Petitioner has demonstrated by a preponderance of the evidence that these claims are unpatentable under § 103(a).

## I. BACKGROUND

### A. Related Proceedings

The parties identify the following proceedings related to the '033 patent: *IXI Mobile (R&D) Ltd. v. Samsung Electronics Co.*, Case No. 3:15-cv-03752-HSG (N.D. Cal); *IXI Mobile (R&D) [\* 4] Ltd. v. Apple, Inc.*, Case No. 4:15-cv-03755-PJH (N.D. Cal); and *IXI Mobile (R&D) Ltd. v. Blackberry Ltd.*, Case No. 3:15-cv-03754-RS (N.D. Cal). Pet. 1-2; Paper 5, 1-2; Paper 7, 1-2.

### B. The '033 Patent

The '033 patent issued from an application filed on May 7, 2001. Ex. 1001, at [22]. The '033 patent is directed to "a system that accesses information from a wide area network ('WAN'), such as the Internet, and local wireless devices in response to short-range radio signals." *Id.* at 4:8-11. Figure 1 of the '033 patent is reproduced below:



Figure 1 illustrates an exemplary system 100 having a personal area network (PAN) and a wide area network. *Id.* at 4:8-19. The PAN is made up of gateway device 106 and one or more terminals 107, such as, for example, a laptop computer, a personal digital assistant (PDA), or a printer. *Id.* at 4:17-25. Gateway device 106 is coupled to cellular network 105, which in turn connects [**\* 5**] to Internet 103 through carrier backbone 104. *Id.* at 4:36-39, 49-55.

Software architecture 400 for gateway device 106 may include network management software 404 including, *inter alia*, PAN application server 404a. *Id.* at 5:61-6:5, 6:36-42; 6:58-63, Figs. 4, 5a. In turn, PAN application server 404a includes service repository software component 704, which "allows applications 406, which run on a gateway device 106 or terminals 107, to discover what services are offered by a PAN, and to determine the characteristics of the available services." *Id.* at 10:1-9, 12:9-14, Fig. 7; see also *id.* at 12:33-67 (enumerating the many functions of service repository software component 704).

### C. Illustrative Claim

Claims 1, 25, 34, and 42 of the '033 patent are independent. Claims 4-7, 12, 14, 15, 22, and 23 depend from claim 1; claim 28 depends from claim 25; claims 39 and 40 depend from claim 34; and claim 46 depends from claim 42. Independent claim 1 is illustrative of the challenged claims and is reproduced below:

1. A system for providing access to the Internet, comprising:

a first wireless device, in a short distance wireless network, having [**\* 6**] a software component to access information from the Internet by communicating with a cellular network in response to a first short-range radio signal, wherein the first wireless device communicates with the cellular network and receives the first short-range radio signal; and,

a second wireless device, in the short distance wireless network, to provide the first short-range radio signal,

wherein the software component includes a network address translator software component to translate between a first Internet Protocol ("IP") address provided to the first wireless device from the cellular network and a second address for the second wireless device provided by the first wireless device,

wherein the software component includes a service repository software component to identify a service provided by the second wireless device.

Ex. 1001, 15:40-59.

### D. The Prior Art

Petitioner relies on the following prior art: PCT Publication No. WO 01/76154 A2 to Marchand, published Oct. 11, 2001 (Ex. 1005, "Marchand"), which claims priority to U.S. Application No. 09/541,529, filed Apr. 3, 2000 (Ex. 1006, "Marchand Priority");

Handley et al., *Request For Comments 2543 SIP: Session Initiation [**\* 7**] Protocol*, The Internet Society, March 1999 (Ex. 1007, "RFC 2543");

U.S. Patent No. 6,836,474 B1 to Larsson, filed Aug. 31, 2000, issued Dec. 28, 2004 (Ex. 1008, "Larsson");

K. Arnold et al., *The Jini TM Specification*, Addison-Wesley, June 1, 1999 (Ex. 1009, "JINI Spec");

U.S. Patent No. 6,560,642 B1 to Nurmman, filed Oct. 23, 1999, issued May 6, 2003 (Ex. 1010, "Nurmman"); and

U.S. Patent No. 6,771,635 B1 to Vilander, filed Mar. 27, 2000, issued Aug. 3, 2004 (Ex. 1011, "Vilander").

### E. The Asserted Grounds

We instituted this proceeding on the following grounds of unpatentability (Dec. on Inst. 26):

| References                                     | Basis              | Claim (s)<br>Challenged              |
|--|--------------------|--------------------------------------|
| Marchand, Nurmman,<br>and Vilander             | 35 U.S.C. § 103(a) | 1, 4, 7, 14                          |
| Marchand, Nurmman,<br>Vilander, and RFC 2543   | 35 U.S.C. § 103(a) | 5                                    |
| Marchand, Nurmman,<br>Vilander, and Larsson    | 35 U.S.C. § 103(a) | 6, 23                                |
| Marchand, Nurmman,<br>Vilander, and JINI Spec. | 35 U.S.C. § 103(a) | 12, 15, 22,<br>34, 39, 40,<br>42, 46 |
| Marchand, Larsson, and<br>JINI Spec.           | 35 U.S.C. § 103(a) | 25, 28                               |

**[\* 8]**

*F. Claim Interpretation*

In an *inter partes* review, we construe claims by applying the broadest reasonable interpretation in light of the specification. 37 C.F.R. § 42.100(b); see *Cuozzo Speed Techs., LLC v. Lee*, 136 S. Ct. 2131, 2144-46 (2016). Under the broadest reasonable interpretation standard, and absent any special definitions, claim terms are given their ordinary and customary meaning, as would be understood by one of ordinary skill in the art in the context of the entire disclosure. See *In re Translogic Tech. Inc.*, 504 F.3d 1249, 1257 (Fed. Cir. 2007). Any special definitions for claim terms or phrases must be set forth "with reasonable clarity, deliberateness, and precision." *In re Paulsen*, 30 F.3d 1475, 1480 (Fed. Cir. 1994). Only those terms which are in controversy need be construed, and only to the extent necessary to resolve the controversy. *Vivid Techs., Inc. v. Am. Sci. & Eng'g, Inc.*, 200 F.3d 795, 803 (Fed. Cir. 1999).

In our Decision on Institution, we determined that no claim terms required construction. **[\* 9]** Dec. on Inst. 6-7. Based on our review of the complete record, we maintain our determination that no constructions are necessary, with the exception of the term "thin terminal" in claims 7 and 46.

The parties' arguments require us to consider whether a printer is commensurate with the broadest reasonable interpretation of "thin terminal." See Pet. 30-31; PO Resp. 42-43; Pet. Reply 18-20. The '033 patent describes "thin terminals" as having "a relatively low power central processor and operating system" and as being "mainly used as peripherals to an Application server in a PAN." Ex. 1001, 5:2-5. The main tasks of a thin terminal are described as "user interaction, rendering output for a user and providing an Application server with a user's input." *Id.* at 5:5-7. Examples of thin terminals provided in the '033 patent include a watch and a messaging terminal. *Id.* at 5:5-7. Furthermore, the '033 patent contrasts thin terminals with smart terminals having "a relatively powerful central processor, operating system and applications," such as "a computer notebook and PDA." *Id.* at 4:62-5:2. **[\* 10]** In describing a messaging terminal in one embodiment, the '033 patent states that the terminal "has no embedded application code or data." *Id.* at 10:18-21.

Petitioner contends a printer is a thin terminal because, at least, a printer "has a low power central processor and operating system relative to a laptop computer or PDA." Pet. 31 (citing Ex. 1003 125) (internal quotation omitted). We agree with Petitioner, and we additionally observe that a printer is a peripheral utilized for rendering user output, which is consistent with the Specification's description of a thin terminal. We also agree with Petitioner that the Specification's reference to "no embedded application code or data" (Ex. 1001, 10:18-21) does not preclude a printer with application code and/or data from being a thin terminal, because the '033 patent also describes the thin terminal locating, downloading, and executing software. Pet. 19 (citing Ex. 1001, 10:13-25). As such, we determine the "thin terminal" recited in claims 7 and 46 encompasses a printer. n1

----- Footnotes -----

n1 Although we acknowledge the different standards for claim interpretation before us and before the district courts, IXFs infringement contentions in the co-pending litigation provide additional extrinsic support for our

determination. See Pet. 31 (citing Ex. 1012, 20, 45; Ex. 1013, 35, 70). In particular, IXI contends that a printer is a type of "thin terminal" in its infringement case. See *id.*

----- End Footnotes----- [\* 11]

## II. ANALYSIS

### A. Obviousness Ground Based on *Marchand, Nurmman, and Vilander*

Petitioner contends claims 1, 4, 7, and 14 would have been obvious over the combination of *Marchand, Nurmman, and Vilander*. Pet. 11-29. IXI disputes Petitioner's contention. PO Resp. 16-43.

#### 1. Principles of Law

A claim is unpatentable under 35 U.S.C. § 103(a) n2 if the differences between the claimed subject matter and the prior art are such that the subject matter, as a whole, would have been obvious at the time the invention was made to a person having ordinary skill in the art to which said subject matter pertains. *KSR Int'l Co. v. Teleflex Inc.*, 550 U.S. 398, 406 (2007). The question of obviousness is resolved on the basis of underlying factual determinations, including: (1) the scope and content of the prior art; (2) any differences between the claimed subject matter and the prior art; (3) the level of skill in the art; and (4) where in evidence, so-called secondary considerations. *Graham v. John Deere Co.*, 383 U.S. 1, 17-18 (1966). We also recognize that prior art references must be "considered together with [\* 12] the knowledge of one of ordinary skill in the pertinent art." *Paulsen*, 30 F.3d at 1480 (citing *In re Samour*, 571 F.2d 559, 562 (CCPA 1978)). We analyze Petitioner's obviousness grounds with the principles identified above in mind.

----- Footnotes -----

n2 The Leahy-Smith America Invents Act, Pub. L. No. 112-29, 125 Stat. 284 (2011) ("AIA"), amended 35 U.S.C. §§ 102 and 103. Because the '033 patent has an effective filing date before the effective date of the applicable AIA amendments, throughout this Decision we refer to the pre-AIA versions of 35 U.S.C. §§ 102 and 103.

----- End Footnotes-----

#### 2. Level of Ordinary Skill in the Art

In determining the level of ordinary skill in the art, various factors may be considered, including the "type of problems encountered in the art; prior art solutions to those problems; rapidity [\* 13] with which innovations are made; sophistication of the technology; and educational level of active workers in the field." *In re GPAC, Inc.*, 57 F.3d 1573, 1579 (Fed. Cir. 1995) (citing *Custom Accessories, Inc. v. Jeffrey-Allan Indus., Inc.*, 807 F.2d 955, 962 (Fed. Cir. 1986)). In addition, the prior art of record in this proceeding--namely, *Marchand, Nurmman, Vilander, RFC 2543, Larsson, and JINI Spec.*--is indicative of the level of ordinary skill in the art. See *Okajima v. Bourdeau*, 261 F.3d 1350, 1355 (Fed. Cir. 2001); *GPAC*, 57 F.3d at 1579; *In re Oelrich*, 579 F.2d 86, 91 (CCPA 1978).

Petitioner contends a person of ordinary skill in the art would have had a Master[] of Science Degree (or a similar technical Master's Degree, or higher degree) in an academic area emphasizing electrical engineering, computer engineering, or computer science with a concentration in communication and networking systems or, alternatively, a Bachelor's Degree (or higher degree) in an academic area emphasizing electrical or computer engineering and [\* 14] having two or more years of experience in communication and networking systems.

Pet. 7-8. Petitioner's contention is supported by the testimony of Dr. Kiaei, who bases his testimony on his "experience working in industry and academia, with undergraduate and postgraduate students, with colleagues from academia, and with engineers practicing in industry." Ex. 1003 PP 15-16. IXI does not dispute Petitioner's definition of the level of ordinary skill in the art, and, in fact, IXI applies it in IXI's Patent Owner Response. PO Resp. 8; see also Ex. 2301 P 16 (IXI's declarant, Dr. Mandayam, applying same definition). Accordingly, we apply

Petitioner's definition of the level of ordinary skill in the art for purposes of this Decision. We further observe that Petitioner's proposed definition comports with the qualifications a person would need to understand and implement the teachings of the '033 patent and the prior art of record.

### 3. Marchand

Marchand is a published international patent application, and Petitioner asserts Marchand's priority date under 35 U.S.C. § 102(e) is April 3, 2000, the date of [\* 15] filing for a prior national application (i.e., Marchand Priority) in the United States. See Pet. 4-5. IXI does not contest Petitioner's priority date assertion. Therefore, for purposes of this decision, we find Marchand qualifies as prior art to the '033 patent under 35 U.S.C. § 102(e) because April 3, 2000, predates the May 7, 2001, filing date of the '033 patent.

Marchand relates to "an ad-hoc network and a gateway that provides an interface between external wireless IP networks and devices in the ad-hoc network." Ex. 1005, 1:5-7. Figure 3 of Marchand is reproduced below:



Figure 3 illustrates "an ad-hoc network 30 utilizing Bluetooth, IP [Internet Protocol], and JINI technologies ... to enable the use of a gateway mobile phone." *Id.* at 7:7-9. Ad-hoc network 30 (also called "Bluetooth Piconet (30)") includes laptop computer 31, printer 32, and mobile phone 33, which can communicate via Bluetooth radio link 34. *Id.* at Abstract, 7:9-11. Mobile phone [\* 16] 33 acts "as a gateway between the ad-hoc network and a 3G wireless IP network 35 such as the General Packet Radio Service (GPRS) network." *Id.* at 7:12-14. Regarding IP address translation, IP packets from the GPRS are received at mobile phone 33 through its public IP address, and then are forwarded to the private IP address of the device on ad-hoc network 30. *Id.* at 7:14-16. Address translation in the opposite direction is handled similarly. *Id.* at 7:16-17.

"JINI (Java) technology is utilized to publish and share services between the devices" in network 30, and this technology "provid[es] the capability for an application 21 to discover, join, and download services 22 from a JINI LUS [Lookup Service]." *Id.* at 6:3-4, 6:21-22. "The LUS contains a list of available services provided by other devices on the network." *Id.* at 3:11-12. Devices in the network "announce not only value-added services, but also their attributes and capabilities to the network," whereupon these services are published through the LUS. *Id.* at 3:12-15, 10:17-18. The LUS also provides interfaces for services that are available to the devices in the network. *Id.* at 3:13-14, 8:12-15.

Figure [\* 17] 4 of Marchand is reproduced below.



Figure 4 depicts "a simplified functional block diagram of a connection between two devices such as the laptop computer 31 and the mobile phone 33 utilizing the ad-hoc network 30 of FIG. 3." *Id.* at 7:26-28. Gateway mobile phone 33 publishes in the Bluetooth piconet the call control services that it offers utilizing JINI LUS 46.

### 4. Nurmam

Nurmam relates to establishing an "Internet Protocol ('IP') network with several IP hosts and with an IP gateway for connecting the IP network to the [I]nternet." Ex. 1010, 1:9-12. Acting as a Dynamic Host Configuration Protocol (DHCP) client, the IP gateway determines whether a DHCP server is present in the IP network. *Id.* at 2:62-67. If a DHCP server is present, "[t]he allocation of the IP addresses to the IP hosts functioning as DHCP clients takes place from the DHCP server." *Id.* at 2:6-27. "If there is no DHCP server[,] the IP gateway is activated automatically as [a] DHCP server," which "allocates IP addresses and IP network masks to the IP hosts in a [\* 18] standard manner." *Id.* at 2:50-57.

### 5. Vilander

Vilander relates to "the allocation of IP addresses to mobile terminals and in particular to the allocation of a host part of an IP address to a mobile terminal." Ex. 1011, 1:6-8. Vilander teaches that, when a mobile terminal requests Internet access, the request is directed to a Gateway General Packet Radio Service (GPRS) Switching Node (GGSN), which may act as an Internet Access Server. *Id.* at 1:48-52.

### 6. Claim 1

Petitioner argues Marchand teaches a "first wireless device, in a short distance wireless network, having a software component to access information from the Internet by communicating with a cellular network in response to a first short-range radio signal," as recited in claim 1. Pet. 21-23. Petitioner maps Marchand's mobile phone 33 to the recited "first wireless device," and Marchand's ad-hoc Bluetooth piconet to the recited "short distance wireless network." *Id.* at 21-22 (citing Ex. 1005, 1:29-31, 6:23-25, 7:12-14). Regarding the recited "second wireless device," Petitioner maps "[t]he devices in the ad-hoc Bluetooth Piconet network 30 [that] send signals to the mobile phone 33 over short-range radio links." **[\* 19]** *Id.* at 23-24 (citing Ex. 1003 PP 19, 25-27; Ex. 1005, 7:9-11, 7:18-21). As such, Petitioner maps Marchand's laptop computer 31 and/or printer 32 to the "second wireless device." *Id.*; Ex. 1005, 7:9-11, Fig. 3.

Regarding "access[ing] information from the Internet by communicating with a cellular network in response to a first short-range radio signal," Petitioner contends the IP packets sent among devices in Marchand's Bluetooth piconet over a short-range radio link correspond to the "first short-range radio signal." Pet. 22-23. Petitioner further contends Marchand's disclosure of connecting devices "to an IP-based network such as the Internet" and of "data going out of the Piconet to the GPRS network" teaches the recited Internet access. *Id.* at 22-24 (citing Ex. 1003 P 27; Ex. 1005, 7:14-17, 13:12-14).

According to Petitioner, "Marchand discloses a network address translator to translate between a first IP address and a second IP address" based on Marchand's description of translating and forwarding between public and private IP addresses. *Id.* at 24 (citing Ex. 1003 P 27; Ex. 1005, 7:14-17, 10:31-11:2). Petitioner contends **[\* 20]** an ordinarily skilled artisan would have modified Marchand in view of Vilander "such that the public IP address of the mobile phone gateway 33 was provided by the cellular network 35." *Id.* at 18 (citing Ex. 1003 P 46). In particular, Petitioner cites Vilander's implementation of a device on the cellular network, such as a GGSN, to allocate the public IP address to the gateway. *Id.* (citing Ex. 1011 at 1:48-52, 1:57-59). Petitioner further contends an ordinarily skilled artisan would have modified Marchand in view of Nurmman "such that the mobile gateway provides the private IP addresses to the devices on the network 30." *Id.* (citing Ex. 1003 P 47). Specifically, Petitioner proposes implementing Nurmman's DHCP server on Marchand's mobile phone 33 to accomplish IP addressing in Marchand's local network 30. *Id.* (citing Ex. 1010, 4:51-56). Petitioner associates these citations from Vilander and Nurmman with the recited "network address translator software component" of claim 1. *See id.* at 24-25.

Petitioner maps Marchand's JINI Lookup Service (LUS) to the recited "service repository software component [that] identifi[es] **[\* 21]** a service provided by the second wireless device" of claim 1. Pet. 25-26 (citing Ex. 1003 P 28; Ex. 1005, 3:11-12, 5:13-14). Claim 1 requires this "service repository software component" to be part of the "software component," which is itself part of the "first wireless device." Ex. 1001, 15:42-43, 15:57-59. Dr. Kiaei acknowledges "Marchand does not expressly state that the JINI LUS is located on mobile phone 33." Ex. 1003 P 37. Petitioner nonetheless contends an ordinarily skilled artisan "would appreciate that Marchand implicitly teaches an implementation in which the JINI LUS is located in the mobile phone 33." Pet. 26 (citing Ex. 1003 PP 37-41). In particular, Petitioner cites Marchand's description of the mobile phone having "an interface/Application Programming Interface (API). . . [that] is downloaded to the Bluetooth device involved in an external wireless call in order to have the device behave as a slave device toward the mobile phone which is the master." Ex. 1005, 6:27-31; *see also* Pet. 26-27 (citing same). Relying on testimony from Dr. Kiaei, Petitioner contends an ordinarily skilled artisan "would [have] underst[ood] **[\* 22]** that Marchand's API corresponds to a JINI proxy object" and that such "proxy objects are downloaded from a LUS" in JINI. Pet. 27 (citing Ex. 1003 P 38).

Petitioner also highlights Marchand's description "that all the devices in the ad-hoc Bluetooth Piconet network 30 publish their services when the mobile phone 33 connects to the ad-hoc Bluetooth Piconet network 30 and cellular network 35." *Id.* (citing Ex. 1003 P 39; Ex. 1005, 10:12-18). Because a LUS "identifies services provided by devices on the network 30," Petitioner contends an ordinarily skilled artisan would have concluded from this description that Marchand teaches a JINI LUS located on mobile phone 33. *Id.* at 27-28 (citing Ex. 1003 P 39). Petitioner additionally contends an ordinarily skilled artisan would have recognized that implementing Marchand's LUS in mobile phone 33--the gateway device to the cellular network--would best allow for the other devices in the ad-hoc Bluetooth piconet to join or leave without loss of connectivity between the piconet and the cellular network. Pet. 28 (citing Ex. 1003 P 40). **[\* 23]**

Thus, Petitioner has established that Marchand, Vilander, and Nurmman teach every limitation of claim 1. Petitioner, as supported by Dr. Kiaei's testimony, also has established that a person of ordinary skill in the art would have had reason to combine the teachings of Marchand, Vilander, and Nurmman to achieve the system recited in claim 1. *See* Pet. 17-20; Ex. 1003 PP 46-51. We now consider IXI's arguments in opposition to



Petitioner's obviousness analysis.

*a. How an Ordinarily Skilled Artisan Would Have Interpreted Marchand's Teachings Related to the LUS*

IXI disputes that Marchand teaches a LUS located on mobile phone 33, because IXI contends an ordinarily skilled artisan "would not understand Marchand to disclose that its JINI LUS is on Marchand's cellular-enabled mobile phone 33, and . . . would have no motivation to modify Marchand to place the JINI LUS on the mobile phone in contradistinction to Marchand's explicit teachings to the contrary." PO Resp. 26-27. In particular, IXI contends Petitioner and its declarant wrongly analyzed Marchand's Bluetooth piconet. *See id.* at 12-15, 27-36. IXI's contention is based on Dr. Mandayam's testimony regarding a Bluetooth [\* 24] scatternet, which is formed when a Bluetooth device participates concurrently in two or more piconets. *See Ex. 2301 PP 28-30.* Figure 4 from Dr. Mandayam's Declaration is reproduced below



*Id.* P 30. Figure 4 depicts separate piconets A (in blue) and B (in red) applied to the devices in Marchand's ad-hoc network. *Id.* P 31. Dr. Mandayam explains:

[T]he laptop computer is the master (M[A]) of piconet A, with the mobile phone (S[A]) and the printer (S[A]) as slave devices in piconet A. The mobile phone is the master of piconet B (M[B]), with only the laptop (S[B]) as its slave device. Both the laptop and the mobile phone simultaneously act as master and slave devices on independent piconets, with piconet B, being a "sub-piconet" within piconet A.

*Id.*

Applying Dr. Mandayam's explanation to Marchand, IXI contends an ordinarily skilled artisan "would [have] appreciate[d] that the JINI LUS 46 must be located on the master device of the Bluetooth piconet, which Marchand discloses is a laptop as clearly shown on Marchand's Figure [\* 25] 4." PO Resp. 28 (citing Ex. 2301 PP 54-55). IXI further contends "the gateway mobile phone is the master of a sub-piconet within Marchand's Bluetooth piconet." *Id.* at 27. This purported sub-piconet, in which "the gateway mobile phone acts as the master device with the requesting device as its slave," is formed "[w]hen a device, such as a laptop, seeks to use the call control service offered by Marchand's gateway mobile phone." *Id.* at 30 (citing Ex. 2301 PP 54-55). In this case, "the gateway mobile phone sends the requesting device an API which allows the gateway mobile phone to establish its own, independent Bluetooth piconet . . . within the main Bluetooth piconet that connects all of the devices in the network." *Id.* (citing Ex. 1005, 10:25-29; Ex. 2301 P 54). As such, IXI seeks to distinguish Marchand's teachings on publishing this call control API from Marchand's other teachings on publishing services to a JINI LUS upon entry of the mobile phone into the piconet. *Id.* at 32 (citing Ex. 2301 P 56).

IXI's arguments rely heavily on Marchand's Figure 4, which appears to dispose a LUS within [\* 26] the laptop computer. *Id.* at 28 (presenting annotated version of Marchand's Fig. 4). Based on this drawing figure, and in consideration of IXI's sub-piconet theory, IXI argues that an ordinarily skilled artisan would not have had a reason to dispose a LUS within Marchand's gateway mobile phone. *See id.* at 26-37. We do not agree Marchand's disclosure should be read so narrowly, however, particularly because obviousness is determined from the perspective of "a person having ordinary skill in the art to which said subject matter pertains." 35 U.S.C. § 103(a); *see also Dann v. Johnston*, 425 U.S. 219, 230 (1976) ("[T]he mere existence of differences between the prior art and an invention does not establish the invention's nonobviousness.").

Petitioner presents evidence showing that an ordinarily skilled artisan would have considered Marchand's call control API to be a JINI proxy object. *See Pet.* 26-27 (citing Ex. 1003 P 38; Ex. 1005, 6:27-7:2). In turn, Petitioner and Dr. Kiaei cite the JINI Spec. as teaching that such proxy objects are stored [\* 27] in a LUS for use when a client wants access to a service. *n3 See id.* (citing Ex. 1003 P 38; Ex. 1009, 5-12). Finally, Petitioner cites Marchand's claim 6 as explicitly reciting "a JINI call control API that is downloaded from the gateway to the other devices on the ad-hoc network." *See id.* at 27 (citing Ex. 1005, 15:25-27). Petitioner concludes an ordinarily skilled artisan would have understood Marchand "as implicitly describing an implementation in which the JINI LUS, which identifies services provided by devices on the network 30, is located on the mobile phone gateway 33." *Id.* (citing Ex. 1003 P 38). We are persuaded by this rationale, which establishes how an ordinarily

skilled artisan would have read Marchand.

----- Footnotes -----

n3 We may consider record evidence outside of the asserted ground, such as the JINI Spec., that demonstrates the knowledge and perspective of one of ordinary skill in the art, particularly when it explains why an ordinarily skilled artisan would have been motivated to combine or modify the cited references to arrive at the claimed invention. *See Ariosa Diagnostics v. Verinata Health, Inc.*, 805 F.3d 1359, 1365 (Fed. Cir. 2015); *Randall Mfg. v. Rea*, 733 F.3d 1355, 1362 (Fed. Cir. 2013).

----- End Footnotes----- [\* 28]

In addition, Marchand does not expressly prevent the LUS from being disposed on the gateway mobile phone. We agree with Petitioner's assessment that Marchand's Figure 4 is merely exemplary and that nothing in Marchand limits or precludes the inclusion of a LUS in the gateway mobile phone. *See* Pet. Reply 11-12. Furthermore, one of ordinary skill in the art would have known, at least, that it was possible to have multiple LUSs in a network. *See* Ex. 1009, 5 ("Each Jini system is built around *one or more* lookup services." (original emphasis omitted and emphasis added)). n4 If multiple LUSs are possible, and if a LUS must be disposed on a master device, as IXI contends (*see, e.g.*, PO Resp. 28 (citing Ex. 2301 PP 54-55)), then Marchand's teaching that a gateway mobile phone is a master (*see* Pet. 13-14 (citing Ex. 1005, 8:2-2); Pet. Reply 3 (citing Ex. 1005, 3:22-27, 7:26-31, 8:1-3)) supports Petitioner's contention that Marchand suggests disposing a LUS in the gateway mobile phone. We also are not persuaded by Dr. Mandayam's testimony and IXI's arguments that the LUS must be disposed on a device that is "intrinsic to the Piconet" and that is "not the gateway." Ex. 1019, [\* 29] 16:10-14; Tr. 81:1-86:2. The notion of an "intrinsic" device is not apt in Marchand, which is expressly directed to ad-hoc networks. *See, e.g.*, Ex. 1005, 7:7-11, Fig. 3 (including gateway mobile phone in discussion of described "ad-hoc network").

----- Footnotes -----

n4 Petitioner makes this point citing a reference that is subject to IXI's motion to exclude, *see* Pet. Reply 11-12 (citing Ex. 1016), but the same point is supported by the JINI Spec.

----- End Footnotes-----

Accordingly, based on the arguments before us, we determine that an ordinarily skilled artisan's understanding of Marchand would not have been limited by IXI's sub-piconet theory in the way suggested by IXI. Therefore, we determine that Marchand would have informed an ordinarily skilled artisan that the "service repository software component" may be disposed in the "first wireless device."

*b. Marchand's Teachings on a Network Address Translator*

IXI also disputes that Marchand teaches a "network address translator software component" located on mobile phone 33, as required by claim [\* 30] 1. PO Resp. 37. In particular, IXI contends that "Marchand discloses that an API should be used to translate between a public IP address and a private IP address." *Id.* (citing Ex. 1005, 11:17-12:3; 15:29-31). IXI cites Marchand's claim 7, which recites the "JINI call control API includes means for deconflicting public and private IP addresses when devices in the ad-hoc network are utilizing real-time applications over the wireless IP network." *Id.* (quoting Ex. 1005, 15:29-31). Dr. Mandayam testifies that an ordinarily skilled artisan "would have understood that the use of an API to translate between public and private addresses is significantly different than using a NAT [network address translator]." n5 Ex. 2301 P 64. IXI further contends Marchand discourages utilizing a NAT in the gateway mobile phone and encourages using an API translator to avoid the problem of IP address mismatch "for real-time applications such as VoIP [Voice over Internet Protocol]." PO Resp. 39 (quoting Ex. 1005, 11:26-12:2; citing Ex. 2301 P 66).

----- Footnotes -----

n5 Even though both parties reference a network address translator, Marchand actually uses the acronym "NAT"

to refer to a "National Access Translator." See Ex. 1005, 11:23. Given an opportunity at the oral hearing to explain if there were any meaningful differences in this terminology, IXI's counsel did not offer any. See Tr. 36:11-37:8.

----- End Footnotes----- [\* 31]

We do not agree with IXI's characterization of Marchand's teachings on address translation, however. As noted by Petitioner, Marchand describes forwarding IP packets received at the gateway mobile phone through a public IP address to a destination device in the piconet having a private IP address, and vice versa. Pet. 24 (citing Ex. 1003 P 27; Ex. 1005, 7:14-17, 10:31-11:2). In addition, Dr. Mandayam testifies that address translation is done at the gateway in Marchand. Pet. Reply 13 (citing Ex. 1018, 147:5-7, 152:25-153:1). Accordingly, and regardless of whether this address translation is performed by a NAT or an API translator, Marchand teaches a network address translator software component located on the gateway mobile phone. See Pet. Reply 14-15. Furthermore, we agree with Petitioner that the use of an API translator for certain real-time applications would have been viewed as "as a supplement to NAT [and] not a substitute for NAT." Pet. Reply 14 (citing Ex. 1003 P 27). For these reasons, Petitioner has established that Marchand teaches a "network address translator software component."

*c. Rationale for Modifying Marchand [\* 32] in View of Vilander and Nurmam*

IXI disputes Petitioner's contention that, in view of Vilander, an ordinarily skilled artisan "would have modified Marchand's system such that the public IP address of the mobile phone gateway 33 was provided by the cellular network 35." PO Resp. 40 (quoting Pet. 17-18). IXI argues that Marchand and Vilander do not indicate a need for the cellular network to provide a public IP address for the gateway mobile phone. *Id.* (citing Ex. 2301 P 70). Nevertheless, we agree with Petitioner that "using Vilander's address allocation in Marchand would have amounted to nothing more than the use of a known technique to improve similar devices in the same way or the combination of prior art elements according to known methods to yield predictable results." Pet. Reply 15 (citing, *inter alia*, *KSR v. Teleflex*, 550 U.S. 398, 417 (2007)); see also Pet. 19 (citing same). Although Marchand describes gateway mobile phone as having "a public IP address recognized in the wireless IP network," Marchand does not explicitly describe how the public IP address is assigned. Pet. Reply 16 (quoting Ex. 1005, 4:23-30).

[\* 33] In light of this, Petitioner identifies evidence that Vilander's GGSN would have improved Marchand by allocating the public IP address to Marchand's gateway mobile phone 33. Pet. 18 (citing Ex. 1003 P 46; Ex. 1011, 1:48-52, 1:57-59).

IXI likewise disputes Petitioner's contention that, in view of Nurmam, an ordinarily skilled artisan "would have modified [Marchand's] mobile gateway 33 such that the mobile gateway provides the private IP addresses to the devices on the network 30." PO Resp. 40 (quoting Pet. 18). According to IXI, a person of ordinary skill in the art "would have understood that the master device, containing the JINI LUS, . . . provide[s] the private IP addresses," so that person "would not have been motivated to require a slave device [i.e., the mobile gateway] in the network to assign private IP addresses." PO Resp. 40 (citing Ex. 2201 [sic, 2301] P 71). For the same reasons expressed above, however, we determine that an ordinarily skilled artisan would not have read Marchand to preclude the gateway from being a master device with a LUS. See *supra* § II.A.4.a.

*d. Secondary Considerations of Nonobviousness*

IXI did not put forth any [\* 34] evidence of secondary considerations of nonobviousness.

*e. Conclusion Regarding Claim 1*

Based on all of the evidence of record, we determine, by a preponderance of the evidence, that the subject matter of claim 1 would have been obvious over the combination of Marchand, Vilander, and Nurmam under 35 U.S.C. § 103(a).

*7. Claims 4, 7, and 14*

Claim 4 depends from claim 1 and recites "the service repository software component identifies whether the service is available at a particular time." Ex. 1001, 16:4-6. Building on Petitioner's analysis for claim 1, in which Marchand's LUS corresponds to the recited "service repository software component," Petitioner contends "Marchand teaches that "[t]he LUS contains a list of *available* services provided by other devices on the

network." Pet. 29 (quoting Ex. 1005, 3:11-12) (emphasis added by Petitioner).

Claim 7 depends from claim 1 and recites "the second wireless device is a thin terminal." Ex. 1001, 16:14-15. Mirroring its unpatentability contentions for claim 1, Petitioner maps Marchand's printer 32 to the recited "second wireless device" that is a "thin terminal." Pet. 30-31 (citing, *inter alia*, Ex. [\* 35] 1005, 7:9-11). As stated above, we determine a printer is a type of "thin terminal." See *supra* § I.F.

Claim 14 depends from claim 1 and recites "the second wireless device includes an application software component that registers an availability of the service with the service repository software component." Ex. 1001, 16:34-36. Petitioner cites Marchand for teaching that "[o]ther devices (e.g., printer 32) on [Marchand's] ad-hoc Bluetooth Piconet network 30 may use their respective Java and JNI layers 19 and 20 to discover, join, and download services 22 from [the] JNI LUS." Pet. 31-32 (citing Ex. 1005, 6:19-22, 7:23-25, 8:11-28) (internal quotation omitted). Petitioner contends an ordinarily skilled artisan "would [have] underst[ood] that one or more software elements, such as Marchand's Java technology layer 19, JNI technology layer 20, and any other application (e.g., application 21) in a network 30 device . . . help [to] implement registration of an availability of a service with the LUS." *Id.* at 32; Ex. 1003 PP 28, 32.

Therefore, having considered Petitioner's unpatentability contentions and supporting evidence, we are persuaded that Petitioner [\* 36] presents sufficient evidence to support a finding that these prior art references teach the claimed subject matter recited in claims 4, 7, and 14. For the same reasons as above with respect to claim 1, we also are satisfied that Petitioner has presented sufficient reasons for the combination, as supported by Dr. Kiaei's testimony. See Pet. 17-20; Ex. 1003 PP 46-51. Furthermore, regarding claims 4 and 14, IXI relies on its same arguments from claim 1 (see PO Resp. 41), which we do not find persuasive for the reasons mentioned above. For claim 7, IXI's arguments pertain to claim interpretation of the term "thin terminal," (see *id.* at 42-43), and we already have considered those arguments above. See *supra* § I.F. Therefore, based on the entire record before us, we conclude Petitioner has demonstrated by a preponderance of the evidence that the subject matter of claims 4, 7, and 14 would have been obvious over the combination of Marchand, Vilander, and Nurmman.

*B. Obviousness Ground Based on Marchand, Nurmman, Vilander, and RFC 2543*

Petitioner contends claim 5 would have been obvious over the combination of Marchand, Nurmman, Vilander, and [\* 37] RFC 2543. Pet. 32-35. IXI disputes Petitioner's contention. PO Resp. 43-45.

*1. RFC 2543*

RFC 2543 is an Internet standards document related to Session Initiation Protocol (SIP), which is "an application-layer control (signaling) protocol for creating, modifying and terminating sessions with one or more participants." Ex. 1007, 1. An SIP-capable "client queries the DNS [Domain Naming Service] server for address records for the host portion of the Request-URI [Uniform Resource Identifier]." *Id.* at 13. Such a client "MAY cache a successful DNS query result." *Id.*

*2. Claim 5*

Claim 5 depends from claim 1 and recites "the software component includes a domain naming service ('DNS') software component to translate between a human readable name and a second Internet Protocol ('IP') address." Ex. 1001, 16:7-10. Petitioner cites RFC 2543's teachings regarding a client querying a DNS server to obtain and cache an IP address corresponding to a human-readable name, such as "company.com." Pet. 33 (citing Ex. 1003 PP 54-55; Ex. 1007, 13, 146). Petitioner proposes adding "RFC 2543's disclosure of DNS query and response . . . with Marchand's SIP client in the combination of Marchand, [\* 38] Nurmman, and Vilander to implement full SIP capabilities (e.g., DNS) in Marchand's SIP client and comply with SIP standards." *Id.* at 34 (citing Ex. 1003 P 57). According to Petitioner, this would be useful when a device in Marchand's piconet requests "access to the Internet (e.g., a web page, online call)." *Id.* at 33-34 (citing Ex. 1003 P 56).

Supported by Dr. Mandayam's testimony, IXI argues that devices on Marchand's piconet access the cellular network through a call control client, and Marchand does not teach that the client provides access to a webpage. *Id.* at 44-45; Ex. 2301 PP 74-75. n6 IXI further notes that "Marchand does not teach that the devices in the Bluetooth piconet have human-readable names." *Id.* at 45 (drawing a contrast with Ex. 1001, 8:25-29). IXI also argues an ordinarily skilled artisan would not have been motivated to add such unnecessary functions. *Id.*

----- Footnotes -----

n6 Although IXI cites paragraphs 75-76 of Dr. Mandayam's declaration, the context makes clear that IXI intended to cite paragraphs 74-75.

----- End Footnotes----- [\* 39]

As noted by Petitioner, however, Marchand's gateway mobile phone includes a second interface/API, depicted as SIP client 42 in Figure 4, which enables the use of the full SIP client capabilities. Pet. 33; Pet. Reply 20 (both citing Ex. 1003 P 54; Ex. 1005, 8:5-7, 9:20-30). In light of this teaching, we are persuaded that an ordinarily skilled artisan would have known to implement RFC 2543's disclosure of DNS query, response, and caching in Marchand's SIP client 42. See Ex. 1003 PP 54, 57. We further agree with Petitioner that this amounts to using a known technique to improve similar devices in the same way to yield predictable results. See Pet. 34; Pet. Reply 21 (both citing *KSR*, 550 U.S. at 417).

For these reasons, we are satisfied that Petitioner has presented sufficient reasons for the combination of Marchand, Nurmman, Vilander, and RFC 2543. We also are persuaded that Petitioner presents sufficient evidence to support a finding that RFC 2543 teaches the additional limitation recited in claim 5. Finally, to the extent IXI again relies on its arguments for claim 1 (see PO Resp. 44), we do not find them persuasive [\* 40] for the same reasons mentioned above. Accordingly, based on the complete trial record, we conclude Petitioner has demonstrated by a preponderance of the evidence that the subject matter of claim 5 would have been obvious over the combination of Marchand, Vilander, Nurmman, and RFC 2543.

*C. Obviousness Ground Based on Marchand, Nurmman, Vilander, and Larsson*

Petitioner contends claims 6 and 23 would have been obvious over the combination of Marchand, Nurmman, Vilander, and Larsson. Pet. 35-39.

IXI disputes Petitioner's contention. PO Resp. 46-48.

*1. Larsson*

Larsson "relates to WAP [Wireless Application Protocol] sessions between a mobile terminal and a WAP gateway, and more particularly, to the organization of protocol layers in a WAP gateway." Ex. 1008, 1:25-27. Figure 1 of Larsson is reproduced below:



Figure 1 illustrates mobile terminal 10, i.e., "a portable laptop computer, personal digital assistant (PDA), mobile telephone, pager, etc.," accessing private network 15 via WAP gateway 30. *Id.* at 2:31-46. Private network 15 may [\* 41] be a corporate network or a virtual private network (VPN). *Id.* at 2:47-55. The mobile terminal 10 obtains access to access server 25 via wireless link 26 to Public Land Mobile Network (PLMN) 20. *Id.* at 2:40-44. The WAP gateway 30 includes first stage proxy 35 and second stage proxy 40, which are "functionally separated" by firewall 37. *Id.* at 2:62-64, 3:1-7.

*2. Claims 6 and 23*

Claim 6 depends from claim 1 and recites "the software component includes a security software component to control access between the cellular network and the first wireless device." Ex. 1001, 16:11-13. Petitioner proposes adding Larsson to the combination of Marchand, Nurmman, and Vilander for teaching the security software component. Pet. 37. Petitioner contends an ordinarily skilled artisan would have "include[d] security software components such as Larsson's firewall 37, first stage proxy 35, and second stage proxy 40 in Marchand's mobile phone gateway 33 which is situated between two networks (e.g., Marchand's cellular network 35 and ad-hoc Bluetooth Piconet network 30)." *Id.* (citing Ex. 1003 P 61). Petitioner also contends an ordinarily skilled artisan would [\* 42] have been motivated to add Larsson's firewall 37, first stage proxy 35, and second stage proxy 40 in Marchand's gateway 33 to provide secure access to Marchand's piconet from the cellular network. *Id.* (citing Ex. 1003 P 62). According to Petitioner, this would result in more efficient authentication because such authentication need only be performed once at the time of the first network access request. *Id.* at 37-38 (citing Ex. 1003 P 62; Ex. 1008, 2:8-15).

IXI contends Larsson does not teach "that the WAP gateway can be incorporated in the mobile terminal 10 or even that the WAP gateway is on a local area network with mobile terminal 10." PO Resp. 48 (citing Ex. 2201 P 78). We agree with Petitioner, however, that Petitioner's proposed combination seeks to add Larsson's security components to Marchand's gateway mobile phone, not Larsson's own mobile terminal 10. See Pet. Reply 22. As such, IXI misapprehends the proposed combination. Furthermore, we are persuaded by Petitioner's showing that Larsson and Marchand both involve a gateway situated between two networks [**\* 43**] such that an ordinarily skilled artisan would have known to apply Larsson's security features to Marchand's similar topology. See Pet. 37 (citing Ex. 1003 P 61); Pet. Reply 23 (citing Ex. 1003 PP 58-61; Ex. 1008, 1:8, 1:67-2:1, 2:30-54, Fig. 1). We are further persuaded by Petitioner's contention that an ordinarily skilled artisan would have been motivated by the efficiency gained through performing authentication only once at the time of the first request for network access. See Pet. 37-38 (citing Ex. 1003 P 62; Ex. 1008, 2:8-15).

Claim 23 depends from claim 1 and recites "the first wireless device further includes a virtual private network ('VPN') software component." Ex. 1001, 16:59-61. Regarding the recited VPN, Petitioner contends the asserted 4-way obviousness combination "discloses a second stage proxy that resides within the VPN side of a firewall in a gateway cellular phone, and authenticates access requests from users." Pet. 39 (citing Ex. 1003 P 59; Ex. 1008, 3:1-7; 4:13-22. This is supported by Larsson's teachings on private network 15 potentially being a VPN; because the second stage [**\* 44**] proxy interacts with the VPN, the second stage proxy acts as the recited "virtual private network . . . software component." See 1003 PP 58-59; Ex. 1008, 2:47-55, Fig. 1.

Finally, to the extent IXI relies on the same arguments from claim 1 relative to claims 6 and 23 (PO Resp. 46), we find them unpersuasive for the same reasons mentioned above.

Accordingly, we are persuaded that Petitioner presents sufficient evidence to support a finding that the combination of Marchand, Nurmman, Vilander, and Larsson teaches the subject matter recited in claims 6 and 23 (see Pet. 38-39), and that there are sufficient reasons for the combination (see *id.* at 37-38). Therefore, based on the entire record before us, we conclude Petitioner has demonstrated by a preponderance of the evidence that the subject matter of claims 6 and 23 would have been obvious over the combination of Marchand, Nurmman, Vilander, and Larsson.

#### *D. Obviousness Ground Based on Marchand, Nurmman, Vilander, and JINI Spec.*

Petitioner contends claims 12, 15, 22, 34, 39, 40, 42, and 46 would have been obvious over the combination of Marchand, Nurmman, Vilander, and JINI Spec. Pet. 39-55. [**\* 45**] IXI disputes Petitioner's contention. PO Resp. 48-56

##### *1. JINI Spec.*

The JINI Spec. is a textbook directed to the Jini architecture, which is "designed for deploying and using services in a network." Ex. 1009, xix. The JINI Spec. teaches a process by which a Lookup Service (LUS) is used to register proxy objects associated with available services. *Id.* at 5-12. A client wishing to use a service loads an appropriate proxy object from the LUS and executes the proxy object to access the service. *Id.* at 72-75; see also Ex. 1003 PP 63, 69 (explaining the use of proxy objects in the JINI Spec.).

##### *2. Claim 22, 34, and 39*

Independent claims 1 and 34 include some limitations that are similar in scope, so the parties' positions relative to claim 34 are similar to those in claim 1. Therefore, we focus on certain differences in the analyses between claims 1 and 34.

Petitioner maps Marchand's gateway mobile phone 33 to the recited "handheld device" of claim 34, and Petitioner maps Marchand's Bluetooth piconet to the recited "short distance wireless network." Pet. 44 (citing Ex. 1003 PP 24-26; Ex. 1005, 4:21-23, 6:16-29, 7:18-23, 8:11). For the recited "storage device," Petitioner [**\* 46**] cites Marchand's description of programming interfaces and protocol stack layers and contends that an ordinarily skilled artisan would have understood that a storage device would have been necessary to store software associated with these features in Marchand's gateway mobile phone. *Id.* at 45 (citing Ex. 1003 PP 33-36; Ex. 1005, 6:16-29). Petitioner likewise contends an ordinarily skilled artisan would have appreciated that software in the gateway, including software for "implement[ing] routing and communication over the cellular and local wireless networks," would require execution by a processor coupled to the storage device. *Id.* at 45-46 (citing Ex. 1003 PP 34-36; Ex. 1005, 2:14-16, 2:27-31, 6:18-20, 6:27-30).

Regarding claim 34's recitations on providing an IP data packet to a terminal and translating between first and second IP addresses, Petitioner cites Marchand's description of receiving IP data packets from a public IP network at the gateway and forwarding them to other devices in the Bluetooth piconet. *Id.* at 24-25, 46-48 (citing Ex. 1003 P 27; Ex. 1005, 7:14-17, 10:31-11:2). For "control[ing] access" between the networks, Petitioner [**\* 47**] cites this same teaching on IP data packets and also cites Marchand's description of the gateway functioning as "a call-control server for client devices in the ad-hoc network, and . . . as a call-control client for a server in the wireless IP network." *Id.* (citing Ex. 1003 PP 24, 25, 58-62; Ex. 1005, 4:23-27, 7:12-14). For enumerating and searching a list of services, Petitioner cites Marchand's teachings on listing services in a JINI LUS and on allowing devices to discover, join, and download services from the LUS. *Id.* at 48-49 (citing Ex. 1003 PP 28, 32; Ex. 1005, 6:19-22, 7:9-25, 8:11-28, 11:12-14). Petitioner also cites the JINI Spec. for teaching that the LUS can provide a proxy object to a requesting device so that the device may access the requested service. *Id.* (citing, *inter alia*, Ex. 1003 PP 38, 63, 68; Ex. 1009, 4-11, 72-75). Thus, Petitioner has established that Marchand, Vilander, Nurmman, and JINI Spec. teach every limitation of claim 34.

Claim 39 depends from claim 34 and recites "the search includes searching the list of services by class, attribute or instance." Ex. 1001, 18:3-4. Citing the JINI Spec., Petitioner contends [**\* 48**] "a JINI LUS stores information about a service's ID, its class or type, and its attributes," all of which can be searched. Pet. 50 (citing Ex. 1003 P 64; Ex. 1009, 9-11, 16-20, 73, 77-79, 217-230). Claim 22 depends from claim 1 and contains a similar limitation; Petitioner's analysis is nearly identical to that of claim 39. *See id.* at 43-44. Petitioner, therefore, has established that the combination of Marchand, Nurmman, Vilander, and JINI Spec. teaches the additional limitations in claims 22 and 39.

Building on its reasons for combining Marchand, Nurmman, and Vilander, Petitioner contends an ordinarily skilled artisan would have combined the JINI Spec. with these references "to fully implement and realize JINI technology in Marchand's ad-hoc Bluetooth Piconet network 30." *Id.* at 42 (citing Ex. 1003 P 70). According to Petitioner, this would allow each device in Marchand's piconet "to register, search for, and execute services in the [piconet] according to the JINI Spec." *Id.* (citing Ex. 1003 P 70). We agree with Petitioner that this amounts [**\* 49**] to nothing more than the use of a known technique to improve similar devices in the same way or the combination of prior art elements according to known methods to yield predictable results. *Id.* (citing *KSR*, 550 U.S. at 417). As such, Petitioner has established that a person of ordinary skill in the art would have had reason to combine the teachings of Marchand, Vilander, Nurmman, and JINI Spec. to achieve the system recited in claim 34.

With respect to claims 34 and 39, IXI argues Marchand cannot teach the recited enumerated list of services operative in the software component of the handheld device's processor because Marchand's LUS cannot be in gateway mobile phone 33. PO Resp. 53-54. IXI's reasoning behind this argument is the same as for the argument it made for claim 1. *See id.* Therefore, for the same reasons mentioned above with respect to claim 1, we are not persuaded by this argument. We also are unpersuaded by IXI's arguments for claim 22, which recapitulate arguments it made for claim 1. *See id.* at 52.

Accordingly, based on the entire trial record, we conclude Petitioner has demonstrated by a preponderance of the evidence that [**\* 50**] the subject matter of claims 22, 34, and 39 would have been obvious over the combination of Marchand, Nurmman, Vilander, and JINI Spec.

### 3. Claims 42 and 46

Claim 42 is an independent claim that shares many similar limitations to those in independent claim 34. *See* Ex. 1001, 18:14-40. Petitioner's mapping of prior art elements to claim 42 is nearly identical to that of claim 34. *See* Pet. 50-55. In contrast, however, claim 42 recites that the processor of a first handheld device provides short-range radio signals to second and third wireless handheld devices. *See* Ex. 1001, 18:14-40. Petitioner maps Marchand's network devices, such as a laptop computer, a printer, or a PDA, to the second and third wireless handheld devices. Pet. 52 (citing Ex. 1003 PP 25, 26; Ex. 1005, 6:23-27, 7:9-11, 10:18-21). In support of its mapping, Petitioner notes that non-asserted claim 45 from the '033 patent indicates that "a laptop computer [and] a personal digital assistant" are wireless handheld devices. *Id.* (citing Ex. 1001, 18:50-54). Petitioner also references the '033 patent's description of a "hand-held" device 350 in Figure [**\* 51**] 3b, which, in one embodiment, "is one of the terminals 107"; in turn, Petitioner references that a printer is one of the enumerated terminals 107 in the '033 patent. *Id.* at 52 (citing Ex. 1001, 4:17-25, 5:43-46). In light of this, Petitioner contends an ordinarily skilled artisan "would [have] consider[ed] any of Marchand's network 30 devices, such as the laptop computer, printer, or PDA, as corresponding to the second and third wireless handheld devices." Pet. 52 (citing Ex. 1001, 4:17-25; 5:43-46; Ex. 1003 P 26). Petitioner additionally notes that IXI mapped a printer to the "second wireless handheld device" limitation in its infringement contentions from the related district court

litigation. *Id.* at 52-53 (citing Ex. 1012, 45; Ex. 1013, 70).

IXI does not dispute Petitioner's evidence showing that an ordinarily skilled artisan would have understood Marchand's laptop computer, printer, and PDA as corresponding to the recited second and third wireless handheld devices. Nor does IXI dispute that Marchand's laptop computer, printer, and PDA are "handheld device[s]" commensurate with claim 42; [\* 52] indeed, IXI does not propose a construction of "handheld." IXI's only argument against Petitioner's analysis for claim 42 recapitulates its argument from claim 34, namely, that Marchand cannot teach a wireless handheld device that enumerates a list of services because Marchand's LUS cannot be in the gateway mobile phone. PO Resp. 53-55. As stated above, we do not agree that Marchand's teachings on the LUS are so limited. *See supra* § II.A.6.a. Accordingly, we determine that Marchand teaches the recited second and third "wireless handheld device[s]" of claim 42.

Claim 46 depends from claim 42 and further recites "the second wireless handheld device is a thin terminal." Ex. 1001, 18:55-57. As stated above, we determine a printer is a type of "thin terminal" (*see supra* § I.F.), and Petitioner maps Marchand's printer 32 to the second wireless handheld device. Pet. 55. IXI's arguments disputing Petitioner's analysis relate to claim interpretation (*see* PO Resp. 42-43, 56), which we have addressed above.

Therefore, having reviewed Petitioner's unpatentability contentions for claims 42 and 46 (*see id.* at 50-55), we determine Petitioner has established [\* 53] that Marchand, Vilander, Nurmman, and JINI Spec. teach every limitation of these claims. Petitioner's rationale for combining these references is also sufficient for the reasons stated above. Based on the entire trial record, we conclude Petitioner has demonstrated by a preponderance of the evidence that the subject matter of claims 42 and 46 would have been obvious over the combination of Marchand, Nurmman, Vilander, and JINI Spec.

#### 4. Claims 12, 15, and 40

Claim 12 recites "the software component includes a plug and play software component to load and execute software for the second wireless device." Ex. 1001, 16:27-29. Claim 40 recites "the software component includes a plug and play software component to identify the terminal in the short distance wireless network and obtain the application software component for the terminal." *Id.* at 18:5-9. Petitioner relies on Marchand and JINI Spec., as supported by Dr. Kiaei's testimony, for teaching these limitations. *See* Pet. 39-43, 50. Specifically, Petitioner contends "a network 30 device (e.g., printer 32) registers a service (e.g., printing service) with the JINI LUS in gateway mobile phone 33 by loading a proxy object corresponding [\* 54] to its service onto the JINI LUS." *Id.* at 39-42 (citing Ex. 1003 PP 63, 67; Ex. 1009, 4-11, 72-73, 217-230). According to Petitioner, when a request for a service is received, the proxy object is loaded and executed to allow access to the service. *Id.* at 41-43 (citing Ex. 1003 PP 38, 63, 68-69; Ex. 1009, 4-11, 16-20, 73-74, 77-79, 217-230).

As supported by Dr. Mandayam's testimony, IXI contends an ordinarily skilled artisan would not have understood JINI Spec.'s proxy object that is published to a LUS upon joining a network as constituting a "plug and play software component." PO Resp. 50 (citing Ex. 2301 P 84). Specifically, IXI contends "there is no disclosure of a software component that functions in a 'plug and play' manner." *Id.* IXI explains "the LUS does not *determine, find, or otherwise resolve* the software necessary to support the joining terminal, consistent with the plain and ordinary meaning of the term 'plug and play' and the specification of the -033 Patent." *Id.* at 50-51 (citing Ex. 2301 P 84).

Yet the JINI Spec. describes the concept [\* 55] of "[n]etwork plug-and-work" as being a goal of the JINI architecture: "You should be able to plug a service into the network and have it be visible and available to those who want to use it. Plugging something into a network should be all or almost all you need to do to deploy the service." Ex. 1009, 4. This is commensurate with the recited "plug and play" concept recited in claims 12 and 40. The JINI Spec. also describes downloading of code for a proxy object and "invoking methods on the proxy object" in response to a request for a service. *Id.* at 5-7, 9-10. This is commensurate with the recited "load[ing] and execut[ing]" of software in claim 12 and "obtain[ing] the application software component" in claim 40. We additionally agree with Petitioner (Pet. Reply 23-24) that certain of IXI's arguments turn on features not appearing in the claims, such as "determin[ing], find[ing], or otherwise resolv[ing] the software." *See* PO Resp. 50-51. These arguments are not persuasive.

Petitioner's obviousness analysis for claim 15 is similar to that for claim 12, and it likewise establishes that the asserted obviousness combination teaches the additional limitation in claim 15. *See* [\* 56] Pet. 43 (citing Ex. 1003 PP 38, 63, 67). Regarding claim 15, IXI again relies on its arguments for claim 1 (*see* PO Resp. 52), which are not persuasive for the same reasons mentioned above.



Based on all of the evidence of record, we determine, by a preponderance of the evidence, that the subject matter of claims 12, 15, and 40 would have been obvious over the combination of Marchand, Vilander, Nurmman, and JINI Spec. under 35 U.S.C. § 103(a).

*E. Obviousness Ground Based on Marchand, Larsson, and JINI Spec.*

Petitioner contends claims 25 and 28 would have been obvious over the combination of Marchand, Larsson, and JINI Spec. Pet. 55-60. IXI disputes Petitioner's contention. PO Resp. 56-57.

Petitioner's analysis for independent claim 25 incorporates elements of the analysis above for independent claim 34 and for dependent claim 6. In particular, Petitioner cites Marchand for teaching the basic Bluetooth system architecture, the transfer of IP data packets, and the use of a JINI LUS. Pet. 56-59. Petitioner cites Larsson for teaching the recited "security software component." *Id.* at 58-59. Petitioner cites the JINI Spec. for teaching details on registering [\* 57] and listing services with a LUS and using proxy objects to implement services. *Id.* at 59.

For claim 28, which depends from claim 25, Petitioner relies on the same analysis for claim 23, in which Petitioner cites Larsson for teaching staged proxies that are used with a VPN. *See id.* at 39, 60; *supra* § II.C.2.

Thus, for the same reasons discussed above, Petitioner establishes that the combination of Marchand, Larsson, and JINI Spec. teaches the subject matter recited in claims 25 and 28. Petitioner also presents sufficient reasons for combining Marchand, Larsson, and JINI Spec. that mirror those given with respect to other grounds discussed above. Pet. 56; *see supra* §§ II.C.2., II.D.2.

IXI again contends Marchand does not teach or suggest locating the JINI LUS and its service searching capabilities (i.e., the "service repository software component") on mobile phone 33, which corresponds to the recited "second wireless device" in claim 25. PO Resp. 57. For the same reasons discussed above, however, we are not persuaded by this argument.

Accordingly, based on the entire trial record, we conclude Petitioner has demonstrated by a preponderance of the evidence that the subject [\* 58] matter of claims 25 and 28 would have been obvious over the combination of Marchand, Larsson, and JINI Spec.

*F. Testimony of Dr. Kiaei*

IXI argues that "Dr. Kiaei's opinions are unreliable because they misunderstand and mischaracterize the inner workings of Marchand's network and devices." PO Resp. 12. Dr. Kiaei's "opinions regarding Bluetooth, the proposed modifications of Marchand, and the purported motivations for modifying Marchand should be entitled to little weight, if any," IXI argues, because of "Dr. Kiaei's lack of understanding Bluetooth and failure to consider the implications of Marchand's reliance on Bluetooth with respect to the proposed combinations." *Id.* at 15. IXI's arguments are rooted in IXI's sub-piconet theory discussed above. *See supra* § II.A.6.a.

Petitioner replies that the "portion of Marchand relied upon in the Petition does not rely on a device being connected in more than one piconet." Pet. Reply 25. Thus, IXI's sub-piconet theory is supported by hypothetical drawings and testimony of Dr. Mandayam, not by Marchand, according to Petitioner. *Id.* Moreover, Dr. Kiaei testified that the question of whether a device could be connected in more [\* 59] than one piconet was a hypothetical question that he could not answer without more information because it was outside of the scope of what he considered. *See id.* at 24-25 (quoting Ex. 2302, 98:2-3, 98:22-99:9). In sum, Petitioner argues that IXI's "attack on Dr. Kiaei's credibility is misguided and [is] not germane to any substantive issues involved in this proceeding." *Id.* at 25.

We have the discretion to determine the appropriate weight to be accorded to the evidence presented, including opinion testimony, based on the disclosure of the underlying facts or data upon which the opinion is based. *See, e.g., Yorkey v. Diab*, 601 F.3d 1279, 1284 (Fed. Cir. 2010) (holding the Board has discretion to credit one witness's testimony over another "unless no reasonable trier of fact could have done so"). In this instance, we are not persuaded by IXI's arguments that Dr. Kiaei's testimony as a whole should be given "little weight, if any." Specifically, we have considered IXI's and Dr. Mandayam's sub-piconet theory in detail, and we determine that it would not have limited an ordinarily skilled artisan's understanding of Marchand. *See supra* § II.A.6.a. [\* 60] Thus, we accord an appropriate weight to Dr. Kiaei's testimony as indicated in this Decision.

G. Motion to Exclude

IXI moves to exclude Exhibits 1002, 1014, and 1015 on the basis of relevance "because they are not referenced or explained at all in the Petition or the Reply." Paper 21, 10-11. In its Opposition, Petitioner contends Dr. Kiaei referenced these exhibits in his declaration. Paper 24, 2-3 (citing Ex. 1003 PP 35, 36, 42, 60). Because Dr. Kiaei relies on these exhibits in support of his testimony in this case, IXI has not shown that they are irrelevant under FRE 401 and 402. Accordingly, we deny IXI's motion to exclude Exhibits 1002, 1014, and 1015.

IXI also moves to exclude Exhibits 1016 and 1017 on the basis of relevance, hearsay, and authenticity. Paper 21, 5-9. IXI further contends Exhibits 1016 and 1017 constitute improper supplemental information that was submitted without authorization pursuant to 37 C.F.R. § 42.123. *Id.* at 2-5. Because we do not rely upon Exhibits 1016 and 1017 in rendering this Decision, we dismiss as moot IXI's motion to exclude [\* 61] these exhibits.

III. CONCLUSION

Petitioner has demonstrated, by a preponderance of the evidence, that

- (a) claims 1, 4, 7, and 14 are unpatentable over Marchand, Nurmman, and Vilander under 35 U.S.C. § 103(a);
- (b) claim 5 is unpatentable over Marchand, Nurmman, Vilander, and RFC 2543 under 35 U.S.C. § 103(a);
- (c) claims 6 and 23 are unpatentable over Marchand, Nurmman, Vilander, and Larsson under 35 U.S.C. § 103(a);
- (d) claims 12, 15, 22, 34, 39, 40, 42, and 46 are unpatentable over Marchand, Nurmman, Vilander, and JiNi Spec. under 35 U.S.C. § 103(a); and
- (e) claims 25 and 28 are unpatentable over Marchand, Larsson, and JiNi Spec. under 35 U.S.C. § 103(a).

IV. ORDER

In consideration of the foregoing, it is

ORDERED that claims 1, 4-7, 12, 14, 15, 22, 23, 25, 28, 34, 39, 40, 42, and 46 of the '033 patent are held unpatentable;

FURTHER ORDERED that IXI's motion to exclude Exhibits 1002, 1014, and 1015 is *denied*;

FURTHER ORDERED that IXI's motion to exclude Exhibits 1016 and 1017 is *dismissed as moot*; and

FURTHER ORDERED that [\* 62] because this is a Final Written Decision, parties to the proceeding seeking judicial review of the decision must comply with the notice and service requirements of 37 C.F.R. § 90.2.

---

Source: **Combined Source Set 3**  - Intellectual Property Cases, Administrative Decisions & Regulations

Terms: **7039033 or 7,039,033** (Suggest Terms for My Search)

View: Full

Date/Time: Tuesday, May 16, 2017 - 11:15 AM EDT

---



UNITED STATES PATENT AND TRADEMARK OFFICE

UNITED STATES DEPARTMENT OF COMMERCE
United States Patent and Trademark Office
Address: COMMISSIONER FOR PATENTS
P.O. Box 1450
Alexandria, Virginia 22313-1450
www.uspto.gov

Table with 3 columns: REEXAM CONTROL NUMBER (90/013,925), FILING OR 371 (c) DATE (03/24/2017), PATENT NUMBER (7039033)

41200
PK PATENT LAW
213 S. Payne Street
Alexandria, VA 22314

CONFIRMATION NO. 1027
REEXAMINATION REQUEST
NOTICE



Date Mailed: 03/29/2017

NOTICE OF REEXAMINATION REQUEST FILING DATE
(Patent Owner Requester)

Requester is hereby notified that the filing date of the request for reexamination is 03/24/2017, the date the required fee of \$12,000 was received. (See CFR 1.510(d)).

A decision on the request for reexamination will be mailed within three months from the filing date of the request for reexamination. (See 37 CFR 1.515(a)).

Pursuant to 37 CFR 1.33(c), future correspondence in this reexamination proceeding will be with the latest attorney or agent of the record in the patent file.

The paragraphs checked below are part of this communication:

- 1. The party receiving the courtesy copy is the latest attorney or agent of record in the patent file.
2. The person named to receive the correspondence in this proceeding has not been made the latest attorney or agent of record in the patent file because:
A. Requester's claim of ownership of the patent is not verified by the record.
B. The request papers are not signed with a real or apparent binding signature.
C. The mere naming of a correspondence addressee does not result in that person being appointed as the latest attorney or agent of record in the patent file.
3. Addressee is the latest attorney or agent of record in the patent file.
4. Other

/rbell/

Legal Instruments Examiner
Central Reexamination Unit 571-272-7705; FAX No. 571-273-9900



UNITED STATES PATENT AND TRADEMARK OFFICE

UNITED STATES DEPARTMENT OF COMMERCE
United States Patent and Trademark Office
Address: COMMISSIONER FOR PATENTS
P.O. Box 1450
Alexandria, Virginia 22313-1450
www.uspto.gov

Table with 3 columns: REEXAM CONTROL NUMBER (90/013,925), FILING OR 371 (c) DATE (03/24/2017), PATENT NUMBER (7039033)

41200
PK PATENT LAW
213 S. Payne Street
Alexandria, VA 22314

CONFIRMATION NO. 1027
REEXAM ASSIGNMENT NOTICE



Date Mailed: 03/29/2017

NOTICE OF ASSIGNMENT OF REEXAMINATION REQUEST

The above-identified request for reexamination has been assigned to Art Unit 3992. All future correspondence to the proceeding should be identified by the control number listed above and directed to the assigned Art Unit.

A copy of this Notice is being sent to the latest attorney or agent of record in the patent file or to all owners of record. (See 37 CFR 1.33(c)). If the addressee is not, or does not represent, the current owner, he or she is required to forward all communications regarding this proceeding to the current owner(s). An attorney or agent receiving this communication who does not represent the current owner(s) may wish to seek to withdraw pursuant to 37 CFR 1.36 in order to avoid receiving future communications. If the address of the current owner(s) is unknown, this communication should be returned within the request to withdraw pursuant to Section 1.36.

NOTICE OF USPTO EX PARTE REEXAMINATION PATENT OWNER STATEMENT WAIVER PROGRAM

The USPTO has implemented a pilot program where, after a reexamination proceeding has been granted a filing date and before the examiner begins his or her review, the patent owner may orally waive the right to file a patent owner's statement. See "Pilot Program for Waiver of Patent Owner's Statement in Ex Parte Reexamination Proceedings," 75 FR 47269 (August 5, 2010). One goal of the pilot program is to reduce the pendency of reexamination proceedings and improve the efficiency of the reexamination process.

Ordinarily when ex parte reexamination is ordered, the USPTO must wait until after the receipt of the patent owner's statement and the third party requester's reply, or after the expiration of the time period for filing the statement and reply (a period that can be as long as 5 to 6 months), before mailing a first determination of patentability. The USPTO's first determination of patentability is usually a first Office action on the merits or a Notice of Intent to Issue Reexamination Certificate (NIRC).

Under the pilot program, the patent owner's oral waiver allows the USPTO to act on the first determination of patentability immediately after determining that reexamination will be ordered, and in a suitable case issue the reexamination order and the first determination of patentability (which could be a NIRC if the claims under reexamination are confirmed) at the same time.

Benefits to the Patent Owner for participating in this pilot program include reduction in pendency.

To participate in this pilot program, Patent Owners may contact the USPTO's Central Reexamination Unit (CRU) at 571-272-7705. The USPTO will make the oral waiver of record in the reexamination file in an interview summary and a copy will be mailed to the patent owner and any third party requester.

cc: Third Party Requester(if any)

/rbell/

Legal Instruments Examiner
Central Reexamination Unit 571-272-7705; FAX No. 571-273-9900

# Patent Assignment Abstract of Title

## Total Assignments: 7

**Application #:** 09850399      **Filing Dt:** 05/07/2001      **Patent #:** 7039033      **Issue Dt:** 05/02/2006  
**PCT #:** NONE      **Intl Reg #:**      **Publication #:** US20020163895      **Pub Dt:** 11/07/2002  
**Inventors:** Amit Haller, Peter Fornell, Avraham Itzchak, Amir Glick, Ziv Haparnas  
**Title:** SYSTEM, DEVICE AND COMPUTER READABLE MEDIUM FOR PROVIDING A MANAGED WIRELESS NETWORK USING SHORT-RANGE RADIO SIGNALS

## Assignment: 1

**Reel/Frame:** 032239 / 0078      **Received:** 02/11/2014      **Recorded:** 02/11/2014      **Mailed:** 02/20/2014      **Pages:** 5

**Conveyance:** CHANGE OF NAME (SEE DOCUMENT FOR DETAILS).

**Assignor:** IXI MOBILE (ISRAEL) LTD.

**Exec Dt:** 11/28/2001

**Assignee:** IXI MOBILE (R & D) LTD.  
11 MOSHE LEVI STREET  
RISHON LEZION, ISRAEL

**Correspondent:** JMB DAVIS BEN-DAVID  
8 HARTOM STREET  
JERUSALEM, ISRAEL

## Assignment: 2

**Reel/Frame:** 013273 / 0484      **Received:** 09/13/2002      **Recorded:** 09/13/2002      **Mailed:** 12/02/2002      **Pages:** 7

**Conveyance:** ASSIGNMENT OF ASSIGNORS INTEREST (SEE DOCUMENT FOR DETAILS).

**Assignors:** HALLER, AMIT

**Exec Dt:** 01/07/2002

FORNELL, PETER

**Exec Dt:** 01/07/2002

ITZCHAK, AVRAHAM

**Exec Dt:** 06/05/2002

GLICK, AMIR

**Exec Dt:** 03/06/2002

HAPARNAS, ZIV

**Exec Dt:** 01/07/2002

**Assignee:** IXI MOBILE (ISRAEL) LTD.  
HA'TIDHAR STREET, #3  
RA'ANANA, ISRAEL 43654

**Correspondent:** VIERRA MAGEN MARCUS ET AL.  
KIRK J. DENIRO  
685 MARKET STREET, SUITE 540  
SAN FRANCISCO, CA 94105

## Assignment: 3

**Reel/Frame:** 017846 / 0872      **Received:** 06/29/2006      **Recorded:** 06/29/2006      **Mailed:** 06/30/2006      **Pages:** 10

**Conveyance:** SECURITY AGREEMENT

**Assignor:** IXI MOBILE (R&D) LTD.

**Exec Dt:** 06/19/2006

**Assignee:** SOUTHPOINT MASTER FUND LP  
623 FIFTH AVENUE  
SUITE 2503  
NEW YORK, NEW YORK 10022

**Correspondent:** AARON R. ETTELMAN [680454.0003]  
ONE COMMERCE SQUARE  
2005 MARKET STREET, SUITE 2200  
PHILADELPHIA, PA 19103-7013

## Assignment: 4

**Reel/Frame:** 028055 / 0575      **Received:** 04/17/2012      **Recorded:** 04/17/2012      **Mailed:** 04/18/2012      **Pages:** 5

**Conveyance:** RELEASE BY SECURED PARTY (SEE DOCUMENT FOR DETAILS).

**Assignor:** SOUTHPOINT MASTER FUND LP

**Exec Dt:** 03/21/2012

**Assignee:** IXI MOBILE (R&D) LTD.  
11 MOSHE LEVI STREET  
RISHON LEZION, ISRAEL

**Correspondent:** JMB DAVIS BEN-DAVID

1 HAMARPE STREET  
PO BOX 45087  
JERUSALEM, ISRAEL

**Assignment: 5**

**Reel/Frame:** 033042 / 0985    **Received:** 06/05/2014    **Recorded:** 06/05/2014    **Mailed:** 06/06/2014    **Pages:** 6

**Conveyance:** ASSIGNMENT OF ASSIGNORS INTEREST (SEE DOCUMENT FOR DETAILS).

**Assignor:** IXI MOBILE (R&D) LTD.

**Exec Dt:** 06/05/2014

**Assignee:** IXI IP, LLC

THE CHRYSLER BUILDING  
405 LEXINGTON AVENUE, SUITE 726  
NEW YORK, NEW YORK 10174

**Correspondent:** PERKINS COIE LLP  
1201 THIRD AVENUE, SUITE 4900  
SEATTLE, WA 98101

**Assignment: 6**

**Reel/Frame:** 033098 / 0056    **Received:** 06/05/2014    **Recorded:** 06/05/2014    **Mailed:** 06/16/2014    **Pages:** 5

**Conveyance:** SECURITY INTEREST

**Assignor:** IXI IP, LLC

**Exec Dt:** 06/05/2014

**Assignee:** FORTRESS CREDIT CO LLC

1345 AVENUE OF THE AMERICAS  
46TH FLOOR  
NEW YORK, NEW YORK 10105

**Correspondent:** PERKINS COIE LLP  
1201 THIRD AVENUE, SUITE 4900  
SEATTLE, WA 98101

**Assignment: 7**

**Reel/Frame:** 033718 / 0687    **Received:** 09/11/2014    **Recorded:** 09/11/2014    **Mailed:** 09/12/2014    **Pages:** 3

**Conveyance:** ASSIGNMENT OF ASSIGNORS INTEREST (SEE DOCUMENT FOR DETAILS).

**Assignor:** FORTRESS CREDIT CO DBDLLC

**Exec Dt:** 09/11/2014

**Assignee:** FCO V CLO TRANSFEROR LLC

1345 AVENUE OF THE AMERICAS  
46TH FLOOR  
NEW YORK, NEW YORK 10105

**Correspondent:** PERKINS COIE LLP  
1201 THIRD AVENUE, SUITE 4900  
SEATTLE, WA 98101

Search Results as of: 03/27/2017 01:46 PM

|   |                        |             |
|---|------------------------|-------------|
| <b>INFORMATION DISCLOSURE STATEMENT BY APPLICANT</b><br>( Not for submission under 37 CFR 1.99) | Application Number     |             |
|   | Filing Date            |             |
|   | First Named Inventor   | Amit HALLER |
|   | Art Unit               | N/A         |
|   | Examiner Name          | N/A         |
|   | Attorney Docket Number | 0909-010    |

| U.S.PATENTS       |         |               |                        |            |   | Remove   |
|-------------------|---------|---------------|------------------------|------------|---|--|
| Examiner Initial* | Cite No | Patent Number | Kind Code <sup>1</sup> | Issue Date | Name of Patentee or Applicant of cited Document | Pages,Columns,Lines where Relevant Passages or Relevant Figures Appear |
|                   | 1       | 6560642       | B1                     | 2003-05-06 | Nurmann   |  |
|                   | 2       | 6771635       | B1                     | 2004-08-03 | Vilander et al.                                 |  |
|                   | 3       | 6836474       | B1                     | 2004-12-28 | Larsson et al.                                  |  |

If you wish to add additional U.S. Patent citation information please click the Add button. Add

| U.S.PATENT APPLICATION PUBLICATIONS |         |                    |                        |                  |   | Remove   |
|-------------------------------------|---------|--------------------|------------------------|------------------|---|--|
| Examiner Initial*                   | Cite No | Publication Number | Kind Code <sup>1</sup> | Publication Date | Name of Patentee or Applicant of cited Document | Pages,Columns,Lines where Relevant Passages or Relevant Figures Appear |
|                                     | 1       |                    |                        |                  |   |  |

If you wish to add additional U.S. Published Application citation information please click the Add button. Add

| FOREIGN PATENT DOCUMENTS |         |                                      |                           |                        |                  |   | Remove   |                |
|--------------------------|---------|--------------------------------------|---------------------------|------------------------|------------------|---|--|----------------|
| Examiner Initial*        | Cite No | Foreign Document Number <sup>3</sup> | Country Code <sup>2</sup> | Kind Code <sup>4</sup> | Publication Date | Name of Patentee or Applicant of cited Document | Pages,Columns,Lines where Relevant Passages or Relevant Figures Appear | T <sup>5</sup> |
|                          | 1       | 2001076154                           | WO                        | A2                     | 2001-10-11       | Marchand  |  |                |

|   |                        |             |  |
|---|------------------------|-------------|--|
| <b>INFORMATION DISCLOSURE<br/>STATEMENT BY APPLICANT</b><br>( Not for submission under 37 CFR 1.99) | Application Number     |             |  |
|   | Filing Date            |             |  |
|   | First Named Inventor   | Amit HALLER |  |
|   | Art Unit               | N/A         |  |
|   | Examiner Name          | N/A         |  |
|   | Attorney Docket Number | 0909-010    |  |

If you wish to add additional Foreign Patent Document citation information please click the Add button

**NON-PATENT LITERATURE DOCUMENTS**

| Examiner Initials* | Cite No | Include name of the author (in CAPITAL LETTERS), title of the article (when appropriate), title of the item (book, magazine, journal, serial, symposium, catalog, etc), date, pages(s), volume-issue number(s), publisher, city and/or country where published. | T <sup>5</sup> |
|--------------------|---------|---|----------------|
|                    | 1       | Handley et al., "RFC 2543, SIP: Session Initiation Protocol," Network Working Group, Request for Comments: 2543, Standards Track, The Internet Society, March 1999.   |                |
|                    | 2       | K. Arnold et al., "The JINI™ Specification," Addison-Wesley, June 1, 1999.  |                |

If you wish to add additional non-patent literature document citation information please click the Add button

**EXAMINER SIGNATURE**

|                    |                      |                 |                      |
|--------------------|----------------------|-----------------|----------------------|
| Examiner Signature | <input type="text"/> | Date Considered | <input type="text"/> |
|--------------------|----------------------|-----------------|----------------------|

\*EXAMINER: Initial if reference considered, whether or not citation is in conformance with MPEP 609. Draw line through a citation if not in conformance and not considered. Include copy of this form with next communication to applicant.

<sup>1</sup> See Kind Codes of USPTO Patent Documents at [www.USPTO.GOV](http://www.USPTO.GOV) or MPEP 901.04. <sup>2</sup> Enter office that issued the document, by the two-letter code (WIPO Standard ST.3). <sup>3</sup> For Japanese patent documents, the indication of the year of the reign of the Emperor must precede the serial number of the patent document. <sup>4</sup> Kind of document by the appropriate symbols as indicated on the document under WIPO Standard ST.16 if possible. <sup>5</sup> Applicant is to place a check mark here if English language translation is attached.



|   |                        |             |  |
|---|------------------------|-------------|--|
| <b>INFORMATION DISCLOSURE<br/>STATEMENT BY APPLICANT</b><br>( Not for submission under 37 CFR 1.99) | Application Number     |             |  |
|   | Filing Date            |             |  |
|   | First Named Inventor   | Amit HALLER |  |
|   | Art Unit               | N/A         |  |
|   | Examiner Name          | N/A         |  |
|   | Attorney Docket Number | 0909-010    |  |

**CERTIFICATION STATEMENT**

Please see 37 CFR 1.97 and 1.98 to make the appropriate selection(s):

That each item of information contained in the information disclosure statement was first cited in any communication from a foreign patent office in a counterpart foreign application not more than three months prior to the filing of the information disclosure statement. See 37 CFR 1.97(e)(1).

**OR**

That no item of information contained in the information disclosure statement was cited in a communication from a foreign patent office in a counterpart foreign application, and, to the knowledge of the person signing the certification after making reasonable inquiry, no item of information contained in the information disclosure statement was known to any individual designated in 37 CFR 1.56(c) more than three months prior to the filing of the information disclosure statement. See 37 CFR 1.97(e)(2).

See attached certification statement.

The fee set forth in 37 CFR 1.17 (p) has been submitted herewith.

A certification statement is not submitted herewith.

**SIGNATURE**

A signature of the applicant or representative is required in accordance with CFR 1.33, 10.18. Please see CFR 1.4(d) for the form of the signature.

|            |                    |                     |            |
|------------|--------------------|---------------------|------------|
| Signature  | /Peter G Korytnyk/ | Date (YYYY-MM-DD)   | 2017-03-24 |
| Name/Print | Peter G Korytnyk   | Registration Number | 43400      |

This collection of information is required by 37 CFR 1.97 and 1.98. The information is required to obtain or retain a benefit by the public which is to file (and by the USPTO to process) an application. Confidentiality is governed by 35 U.S.C. 122 and 37 CFR 1.14. This collection is estimated to take 1 hour to complete, including gathering, preparing and submitting the completed application form to the USPTO. Time will vary depending upon the individual case. Any comments on the amount of time you require to complete this form and/or suggestions for reducing this burden, should be sent to the Chief Information Officer, U.S. Patent and Trademark Office, U.S. Department of Commerce, P.O. Box 1450, Alexandria, VA 22313-1450. **DO NOT SEND FEES OR COMPLETED FORMS TO THIS ADDRESS. SEND TO: Commissioner for Patents, P.O. Box 1450, Alexandria, VA 22313-1450.**

## Privacy Act Statement

The Privacy Act of 1974 (P.L. 93-579) requires that you be given certain information in connection with your submission of the attached form related to a patent application or patent. Accordingly, pursuant to the requirements of the Act, please be advised that: (1) the general authority for the collection of this information is 35 U.S.C. 2(b)(2); (2) furnishing of the information solicited is voluntary; and (3) the principal purpose for which the information is used by the U.S. Patent and Trademark Office is to process and/or examine your submission related to a patent application or patent. If you do not furnish the requested information, the U.S. Patent and Trademark Office may not be able to process and/or examine your submission, which may result in termination of proceedings or abandonment of the application or expiration of the patent.

The information provided by you in this form will be subject to the following routine uses:

1. The information on this form will be treated confidentially to the extent allowed under the Freedom of Information Act (5 U.S.C. 552) and the Privacy Act (5 U.S.C. 552a). Records from this system of records may be disclosed to the Department of Justice to determine whether the Freedom of Information Act requires disclosure of these records.
2. A record from this system of records may be disclosed, as a routine use, in the course of presenting evidence to a court, magistrate, or administrative tribunal, including disclosures to opposing counsel in the course of settlement negotiations.
3. A record in this system of records may be disclosed, as a routine use, to a Member of Congress submitting a request involving an individual, to whom the record pertains, when the individual has requested assistance from the Member with respect to the subject matter of the record.
4. A record in this system of records may be disclosed, as a routine use, to a contractor of the Agency having need for the information in order to perform a contract. Recipients of information shall be required to comply with the requirements of the Privacy Act of 1974, as amended, pursuant to 5 U.S.C. 552a(m).
5. A record related to an International Application filed under the Patent Cooperation Treaty in this system of records may be disclosed, as a routine use, to the International Bureau of the World Intellectual Property Organization, pursuant to the Patent Cooperation Treaty.
6. A record in this system of records may be disclosed, as a routine use, to another federal agency for purposes of National Security review (35 U.S.C. 181) and for review pursuant to the Atomic Energy Act (42 U.S.C. 218(c)).
7. A record from this system of records may be disclosed, as a routine use, to the Administrator, General Services, or his/her designee, during an inspection of records conducted by GSA as part of that agency's responsibility to recommend improvements in records management practices and programs, under authority of 44 U.S.C. 2904 and 2906. Such disclosure shall be made in accordance with the GSA regulations governing inspection of records for this purpose, and any other relevant (i.e., GSA or Commerce) directive. Such disclosure shall not be used to make determinations about individuals.
8. A record from this system of records may be disclosed, as a routine use, to the public after either publication of the application pursuant to 35 U.S.C. 122(b) or issuance of a patent pursuant to 35 U.S.C. 151. Further, a record may be disclosed, subject to the limitations of 37 CFR 1.14, as a routine use, to the public if the record was filed in an application which became abandoned or in which the proceedings were terminated and which application is referenced by either a published application, an application open to public inspections or an issued patent.
9. A record from this system of records may be disclosed, as a routine use, to a Federal, State, or local law enforcement agency, if the USPTO becomes aware of a violation or potential violation of law or regulation.

Under the Paperwork Reduction Act of 1995 no persons are required to respond to a collection of information unless it displays a valid OMB control number

|   |                       |                                      |
|---|-----------------------|--------------------------------------|
| <b>REEXAMINATION OR SUPPLEMENTAL EXAMINATION – PATENT OWNER POWER OF ATTORNEY OR REVOCATION OF POWER OF ATTORNEY WITH A NEW POWER OF ATTORNEY AND CHANGE OF CORRESPONDENCE ADDRESS FOR REEXAMINATION OR SUPPLEMENTAL EXAMINATION AND PATENT</b> | Control Number(s)     | Not Yet Assigned                     |
|   | Filing Date(s)        |                                      |
|   | First Named Inventor  | Amit Haller                          |
|   | Title                 | System, Device and Computer Readable |
|   | Patent Number         | 7,039,033                            |
|   | Examiner Name         | N/A                                  |
|   | Attorney Docket No(s) | IXI0101RX                            |

**I. Power of Attorney.** This form may be used to change the Power of Attorney in a reexamination or supplemental examination proceeding (or multiple proceedings where merged). This form may also be used to change the Power of Attorney in the patent file; in such a case, a copy of this form will be placed in both the patent file and the reexamination or supplemental examination proceeding.

A. Revocation of Previous Power of Attorney. I hereby revoke all previous patent owner powers of attorney, if any, given:

in the above-identified reexamination or supplemental examination proceeding control number(s) (more than one may be changed only if the proceedings are merged).

in the file of the above-identified patent.

**(check BOTH boxes if change in BOTH the patent file and the reexamination or supplemental examination proceeding is requested).**

B. Designation of Power of Attorney.

A Power of Attorney is submitted herewith.

OR

I hereby appoint Practitioner(s) associated with the Customer Number identified in the box at right as my/our attorney(s) or agent(s) to prosecute the proceeding(s)/patent identified above and selected in section I(A), and to transact all business in the United States Patent and Trademark Office connected therewith: 41200

OR

I hereby appoint Practitioner(s) named below as my/our attorney(s) or agent(s) to prosecute the proceeding(s) identified above, and to transact all business in the United States Patent and Trademark Office connected therewith:

| Practitioner(s) Name | Registration Number |
|----------------------|---------------------|
|                      |                     |
|                      |                     |
|                      |                     |
|                      |                     |

Authorization for the Power of Attorney is provided by the signature on page 2 of this form.

This collection of information is required by 37 CFR 1.31, 1.32, and 1.33. The information is required to obtain or retain a benefit by the public, which is to update (and by the USPTO to process) the file of a patent or reexamination proceeding. Confidentiality is governed by 35 U.S.C. 122 and 37 CFR 1.14. This collection is estimated to take 3 minutes to complete, including gathering, preparing, and submitting the completed application form to the USPTO. Time will vary depending upon the individual case. Any comments on the amount of time you require to complete this form and/or suggestions for reducing this burden, should be sent to the Chief Information Officer, U.S. Patent and Trademark Office, U.S. Department of Commerce, P.O. Box 1450, Alexandria, VA 22313-1450. DO NOT SEND FEES OR COMPLETED FORMS TO THIS ADDRESS. SEND TO: Commissioner for Patents, P.O. Box 1450, Alexandria, VA 22313-1450.

*If you need assistance in completing the form, call 1-800-PTO-9199 and select option 2.*

**II. Change of Correspondence Address**

Please recognize or change the correspondence address for the above-identified reexamination or supplemental examination proceeding control number(s) (more than one may be changed **only** if they are merged proceedings) **and for the file of the above-identified patent** to be:

The address associated with the above-identified Customer Number.

OR

The address associated with the Customer Number identified in the box at right:

|  |
|--|
|  |
|--|

Firm or Individual Name

Address

City

State

Zip

Country

Telephone

Email

**NOTE: THE CORRESPONDENCE ADDRESS FOR THE REEXAMINATION OR SUPPLEMENTAL EXAMINATION PROCEEDING CONTROL NUMBER(S) MUST BE THE SAME AS THAT FOR THE PATENT. SEE 37 CFR 1.33.**

**III. Authorization for Power of Attorney and (if selected) Change of Correspondence Address**

I am the:

Inventor, having ownership of the patent being reexamined.

OR

Patent owner.

Statement under 37 CFR 3.73(c) (Form PTO/AIA/96) submitted herewith or filed on \_\_\_\_\_.

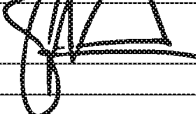
|                                       |                        |   |              |      |        |
|---------------------------------------|------------------------|---|--------------|------|--------|
| Signature of Inventor or Patent Owner |                        |  |              | Date | 3/9/17 |
| Name                                  | Steven Robert Pedersen | Telephone   | 212-634-7150 |      |        |
| Title and Company                     | Manager, IXI IP, LLC   |   |              |      |        |

**NOTE:** Signatures of all the inventors or patent owners of the entire interest or their representative(s) are required. If more than one signature is required, submit multiple forms, check the box below, and identify the total number of forms submitted in the blank below.

A total of \_\_\_\_\_ forms are submitted. *If you need assistance in completing the form, call 1-800-PTO-9199 and select option 2.*

09/850,399 SYSTEM, DEVICE AND COMPUTER READABLE MEDIUM  
 FOR PROVIDING A MANAGED WIRELESS NETWORK USING SHORT-RANGE RADIO SIGNALS IXIM-01003US1 03-07-  
 2017::14:26:40

### Patent Assignment Abstract of Title

#### Total Assignments: 7

Application #: 09850399 Filing Dt: 05/07/2001 Patent #: 7039033 Issue Dt: 05/02/2006  
 PCT #: NONE Intl Reg #: Publication #: US20020163895 Pub Dt: 11/07/2002  
 Inventors: Amit Haller, Peter Fornell, Avraham Itzchak, Amir Glick, Ziv Haparnas  
 Title: SYSTEM, DEVICE AND COMPUTER READABLE MEDIUM FOR PROVIDING A MANAGED WIRELESS NETWORK USING SHORT-RANGE RADIO SIGNALS

#### Assignment: 1

Reel/Frame: 032239 / 0078 Received: 02/11/2014 Recorded: 02/11/2014 Mailed: 02/20/2014 Pages: 5  
 Conveyance: CHANGE OF NAME (SEE DOCUMENT FOR DETAILS).  
 Assignor: IXI MOBILE (ISRAEL) LTD. Exec Dt: 11/28/2001  
 Assignee: IXI MOBILE (R & D) LTD.  
 11 MOSHE LEVI STREET  
 RISHON LEZION, ISRAEL  
 Correspondent: JMB DAVIS BEN-DAVID  
 8 HARTOM STREET  
 JERUSALEM, ISRAEL

#### Assignment: 2

Reel/Frame: 013273 / 0484 Received: 09/13/2002 Recorded: 09/13/2002 Mailed: 12/02/2002 Pages: 7  
 Conveyance: ASSIGNMENT OF ASSIGNORS INTEREST (SEE DOCUMENT FOR DETAILS).  
 Assignors: HALLER, AMIT Exec Dt: 01/07/2002  
 FORNELL, PETER Exec Dt: 01/07/2002  
 ITZCHAK, AVRAHAM Exec Dt: 06/05/2002  
 GLICK, AMIR Exec Dt: 03/06/2002  
 HAPARNAS, ZIV Exec Dt: 01/07/2002  
 Assignee: IXI MOBILE (ISRAEL) LTD.  
 HA'TIDHAR STREET, #3  
 RA'ANANA, ISRAEL 43654  
 Correspondent: VIERRA MAGEN MARCUS ET AL.  
 KIRK J. DENIRO  
 685 MARKET STREET, SUITE 540  
 SAN FRANCISCO, CA 94105

#### Assignment: 3

Reel/Frame: 017846 / 0872 Received: 06/29/2006 Recorded: 06/29/2006 Mailed: 06/30/2006 Pages: 10  
 Conveyance: SECURITY AGREEMENT  
 Assignor: IXI MOBILE (R&D) LTD. Exec Dt: 06/19/2006  
 Assignee: SOUTHPOINT MASTER FUND LP  
 623 FIFTH AVENUE  
 SUITE 2503  
 NEW YORK, NEW YORK 10022  
 Correspondent: AARON P. ETTELMAN (680454.0003)  
 ONE COMMERCE SQUARE  
 2005 MARKET STREET, SUITE 2200  
 PHILADELPHIA, PA 19103-7013

#### Assignment: 4

Reel/Frame: 028055 / 0575 Received: 04/17/2012 Recorded: 04/17/2012 Mailed: 04/18/2012 Pages: 5  
 Conveyance: RELEASE BY SECURED PARTY (SEE DOCUMENT FOR DETAILS).  
 Assignor: SOUTHPOINT MASTER FUND LP Exec Dt: 03/21/2012  
 Assignee: IXI MOBILE (R&D) LTD.  
 11 MOSHE LEVI STREET  
 RISHON LEZION, ISRAEL  
 Correspondent: JMB DAVIS BEN-DAVID  
 1 HAMARPE STREET  
 PO BOX 45087  
 JERUSALEM, ISRAEL

#### Assignment: 5

Reel/Frame: 033042 / 0985 Received: 06/05/2014 Recorded: 06/05/2014 Mailed: 06/06/2014 Pages: 6  
 Conveyance: ASSIGNMENT OF ASSIGNORS INTEREST (SEE DOCUMENT FOR DETAILS).  
 Assignor: IXI MOBILE (R&D) LTD. Exec Dt: 06/05/2014  
 Assignee: IXI IP, LLC  
 THE CHRYSLER BUILDING

405 LEXINGTON AVENUE, SUITE 726  
NEW YORK, NEW YORK 10174

**Correspondent:** PERKINS COIE LLP  
1201 THIRD AVENUE, SUITE 4900  
SEATTLE, WA 98101

**Assignment: 6**

**Reel/Frame:** 033098 / 0056      **Received:** 06/05/2014      **Recorded:** 06/05/2014      **Mailed:** 06/16/2014      **Pages:** 5

**Conveyance:** SECURITY INTEREST

**Assignor:** IXI IP, LLC

**Exec Dt:** 06/05/2014

**Assignee:** FORTRESS CREDIT CO LLC  
1345 AVENUE OF THE AMERICAS  
46TH FLOOR  
NEW YORK, NEW YORK 10105

**Correspondent:** PERKINS COIE LLP  
1201 THIRD AVENUE, SUITE 4900  
SEATTLE, WA 98101

**Assignment: 7**

**Reel/Frame:** 033718 / 0687      **Received:** 09/11/2014      **Recorded:** 09/11/2014      **Mailed:** 09/12/2014      **Pages:** 3

**Conveyance:** ASSIGNMENT OF ASSIGNORS INTEREST (SEE DOCUMENT FOR DETAILS).

**Assignor:** FORTRESS CREDIT CO DBDLLC

**Exec Dt:** 09/11/2014

**Assignee:** FCO V CLO TRANSFEROR LLC  
1345 AVENUE OF THE AMERICAS  
46TH FLOOR  
NEW YORK, NEW YORK 10105

**Correspondent:** PERKINS COIE LLP  
1201 THIRD AVENUE, SUITE 4900  
SEATTLE, WA 98101

Search Results as of: 05/07/2017 14:26:26 PM

**Disclaimer:**

***Assignment information on the assignment database reflects assignment documents that have been actually recorded. If the assignment for a patent was not recorded, the name of the assignee on the patent application publication or patent may be different.***

***if you have any comments or questions concerning the data displayed, contact OPR / Assignments at 571-272-3350***

[Close Window](#)

Under the Paperwork Reduction Act of 1995, no persons are required to respond to a collection of information unless it displays a valid OMB control number.

**STATEMENT UNDER 37 CFR 3.73(b)**

Applicant/Patent Owner: IXI IP, LLC

Application No./Patent No.: 7,039,033

Filed/Issue Date: May 2, 2006

Titled:

IXI IP, LLC

, a Corporation

(Name of Assignee)

(Type of Assignee, e.g., corporation, partnership, university, government agency, etc.)

states that it is:

- 1.  the assignee of the entire right, title, and interest in;
- 2.  an assignee of less than the entire right, title, and interest in  
(The extent (by percentage) of its ownership interest is \_\_\_\_\_ %); or
- 3.  the assignee of an undivided interest in the entirety of (a complete assignment from one of the joint inventors was made)

the patent application/patent identified above, by virtue of either:

A.  An assignment from the inventor(s) of the patent application/patent identified above. The assignment was recorded in the United States Patent and Trademark Office at Reel \_\_\_\_\_, Frame \_\_\_\_\_, or for which a copy therefore is attached.

OR

B.  A chain of title from the inventor(s), of the patent application/patent identified above, to the current assignee as follows:

1. From: Haller, Fornell, Itzchak, Glick and Haparnas To: IXI Mobile (ISRAEL) LTD.

The document was recorded in the United States Patent and Trademark Office at  
Reel 13273, Frame 00484, or for which a copy thereof is attached.

2. From: IXI Mobile (ISRAEL) LTD. To: IXI Mobile (R&D) LTD.

The document was recorded in the United States Patent and Trademark Office at  
Reel 32239, Frame 0078, or for which a copy thereof is attached.

3. From: IXI Mobile (R&D) LTD. To: IXI IP, LLC

The document was recorded in the United States Patent and Trademark Office at  
Reel 33042, Frame 00985, or for which a copy thereof is attached.

Additional documents in the chain of title are listed on a supplemental sheet(s).

As required by 37 CFR 3.73(b)(1)(i), the documentary evidence of the chain of title from the original owner to the assignee was, or concurrently is being, submitted for recordation pursuant to 37 CFR 3.11.

[NOTE: A separate copy (i.e., a true copy of the original assignment document(s)) must be submitted to Assignment Division in accordance with 37 CFR Part 3, to record the assignment in the records of the USPTO. See MPEP 302.08]

The undersigned (whose title is supplied below) is authorized to act on behalf of the assignee.

/Steven Robert Pedersen/

05/13/2015

Signature

Date

Steven Robert Pedersen

Manager

Printed or Typed Name

Title

This collection of information is required by 37 CFR 3.73(b). The information is required to obtain or retain a benefit by the public which is to file (and by the USPTO to process) an application. Confidentiality is governed by 35 U.S.C. 122 and 37 CFR 1.11 and 1.14. This collection is estimated to take 12 minutes to complete, including gathering, preparing, and submitting the completed application form to the USPTO. Time will vary depending upon the individual case. Any comments on the amount of time you require to complete this form and/or suggestions for reducing this burden, should be sent to the Chief Information Officer, U.S. Patent and Trademark Office, U.S. Department of Commerce, P.O. Box 1450, Alexandria, VA 22313-1450. DO NOT SEND FEES OR COMPLETED FORMS TO THIS ADDRESS. SEND TO: Commissioner for Patents, P.O. Box 1450, Alexandria, VA 22313-1450.

If you need assistance in completing the form, call 1-800-PTO-9199 and select option 2.

Under the Paperwork Reduction Act of 1995, no persons are required to respond to a collection of information unless it displays a valid OMB control number.

(Also referred to as FORM PTO-1465)

## REQUEST FOR *EX PARTE* REEXAMINATION TRANSMITTAL FORM

Address to:  
**Mail Stop *Ex Parte* Reexam  
Commissioner for Patents  
P.O. Box 1450  
Alexandria, VA 22313-1450**

Attorney Docket No.: 0909-010

Date: March 24, 2017

1.  This is a request for *ex parte* reexamination pursuant to 37 CFR 1.510 of patent number 7,039,033 issued May 2, 2006. The request is made by:  
 patent owner.  third party requester.
2.  The name and address of the person requesting reexamination is:  
\_\_\_\_\_  
\_\_\_\_\_  
\_\_\_\_\_
3. Requester asserts  small entity status (37 CFR 1.27) or  certifies micro entity status (37 CFR 1.29). Only a patent owner requester can certify micro entity status. Form PTO/SB/15A or B must be attached to certify micro entity status.
4.  a. A check in the amount of \$ \_\_\_\_\_ is enclosed to cover the reexamination fee, 37 CFR 1.20(c)(1);  
 b. The Director is hereby authorized to charge the fee as set forth in 37 CFR 1.20(c)(1) to Deposit Account No. 503318;  
 c. Payment by credit card. Form PTO-2038 is attached; or  
 d. Payment made via EFS-Web.
5.  Any refund should be made by  check or  credit to Deposit Account No. 503318. 37 CFR 1.26(c). If payment is made by credit card, refund must be to credit card account.
6.  A copy of the patent to be reexamined having a double column format on one side of a separate paper is enclosed. 37 CFR 1.510(b)(4).
7.  CD-ROM or CD-R in duplicate, Computer Program (Appendix) or large table  
 Landscape Table on CD
8.  Nucleotide and/or Amino Acid Sequence Submission  
*If applicable, items a. – c. are required.*
  - a.  Computer Readable Form (CRF)
  - b. Specification Sequence Listing on:
    - i.  CD-ROM (2 copies) or CD-R (2 copies); or
    - ii.  paper
  - c.  Statements verifying identity of above copies
9.  A copy of any disclaimer, certificate of correction or reexamination certificate issued in the patent is included.
10.  Reexamination of claim(s) 48, 56 is requested.
11.  A copy of every patent or printed publication relied upon is submitted herewith including a listing thereof on Form PTO/SB/08, PTO-1449, or equivalent.
12.  An English language translation of all necessary and pertinent non-English language patents and/or printed publications is included.

[Page 1 of 2]

This collection of information is required by 37 CFR 1.510. The information is required to obtain or retain a benefit by the public which is to file (and by the USPTO to process) a request for reexamination. Confidentiality is governed by 35 U.S.C. 122 and 37 CFR 1.11 and 1.14. This collection is estimated to take 18 minutes to complete, including gathering, preparing, and submitting the completed application form to the USPTO. Time will vary depending upon the individual case. Any comments on the amount of time you require to complete this form and/or suggestions for reducing this burden, should be sent to the Chief Information Officer, U.S. Patent and Trademark Office, U.S. Department of Commerce, P.O. Box 1450, Alexandria, VA 22313-1450. DO NOT SEND FEES OR COMPLETED FORMS TO THIS ADDRESS. **SEND TO: Mail Stop *Ex Parte* Reexam, Commissioner for Patents, P.O. Box 1450, Alexandria, VA 22313-1450.**

*If you need assistance in completing the form, call 1-800-PTO-9199 and select option 2.*



Under the Paperwork Reduction Act of 1995, no persons are required to respond to a collection of information unless it displays a valid OMB control number.

13.  The attached detailed request includes at least the following items:
- a. A statement identifying each substantial new question of patentability based on prior patents and printed publications. 37 CFR 1.510(b)(1).
  - b. An identification of every claim for which reexamination is requested, and a detailed explanation of the pertinency and manner of applying the cited art to every claim for which reexamination is requested. 37 CFR 1.510(b)(2).
14.  A proposed amendment is included (only where the patent owner is the requester). 37 CFR 1.510(e).
15.  It is certified that the statutory estoppel provisions of 35 U.S.C. 315(e)(1) or 35 U.S.C. 325(e)(1) do not prohibit requester from filing this *ex parte* reexamination request. 37 CFR 1.510(b)(6).
16.  a. It is certified that a copy of this request (if filed by other than the patent owner) has been served in its entirety on the patent owner as provided in 37 CFR 1.33(c).  
 The name and address of the party served and the date of service are:  
 \_\_\_\_\_  
 \_\_\_\_\_  
 Date of Service: \_\_\_\_\_; or
- b. A duplicate copy is enclosed since service on patent owner was not possible. An explanation of the efforts made to serve patent owner **is attached**. See MPEP 2220.

17. Correspondence Address: Direct all communication about the reexamination to:

- The address associated with Customer Number: 41200
- OR**
- Firm or Individual Name \_\_\_\_\_

Address

|           |       |     |
|-----------|-------|-----|
| City      | State | Zip |
| Country   |       |     |
| Telephone | Email |     |

18.  The patent is currently the subject of the following concurrent proceeding(s):
- a. Copending reissue Application No. \_\_\_\_\_
  - b. Copending reexamination Control No. \_\_\_\_\_
  - c. Copending Interference No. \_\_\_\_\_
  - d. Copending litigation styled:  
 See Section II.F of the Request concurrently herewith  
 \_\_\_\_\_

**WARNING: Information on this form may become public. Credit card information should not be included on this form. Provide credit card information and authorization on PTO-2038.**

/Peter G Korytnyk/ \_\_\_\_\_ March 24, 2017  
 Authorized Signature Date

Peter G. Korytnyk \_\_\_\_\_ 43400  For Patent Owner Requester  
 Typed/Printed Name Registration No.  For Third Party Requester

## Privacy Act Statement

The **Privacy Act of 1974 (P.L. 93-579)** requires that you be given certain information in connection with your submission of the attached form related to a patent application or patent. Accordingly, pursuant to the requirements of the Act, please be advised that: (1) the general authority for the collection of this information is 35 U.S.C. 2(b)(2); (2) furnishing of the information solicited is voluntary; and (3) the principal purpose for which the information is used by the U.S. Patent and Trademark Office is to process and/or examine your submission related to a patent application or patent. If you do not furnish the requested information, the U.S. Patent and Trademark Office may not be able to process and/or examine your submission, which may result in termination of proceedings or abandonment of the application or expiration of the patent.

The information provided by you in this form will be subject to the following routine uses:

1. The information on this form will be treated confidentially to the extent allowed under the Freedom of Information Act (5 U.S.C. 552) and the Privacy Act (5 U.S.C. 552a). Records from this system of records may be disclosed to the Department of Justice to determine whether disclosure of these records is required by the Freedom of Information Act.
2. A record from this system of records may be disclosed, as a routine use, in the course of presenting evidence to a court, magistrate, or administrative tribunal, including disclosures to opposing counsel in the course of settlement negotiations.
3. A record in this system of records may be disclosed, as a routine use, to a Member of Congress submitting a request involving an individual, to whom the record pertains, when the individual has requested assistance from the Member with respect to the subject matter of the record.
4. A record in this system of records may be disclosed, as a routine use, to a contractor of the Agency having need for the information in order to perform a contract. Recipients of information shall be required to comply with the requirements of the Privacy Act of 1974, as amended, pursuant to 5 U.S.C. 552a(m).
5. A record related to an International Application filed under the Patent Cooperation Treaty in this system of records may be disclosed, as a routine use, to the International Bureau of the World Intellectual Property Organization, pursuant to the Patent Cooperation Treaty.
6. A record in this system of records may be disclosed, as a routine use, to another federal agency for purposes of National Security review (35 U.S.C. 181) and for review pursuant to the Atomic Energy Act (42 U.S.C. 218(c)).
7. A record from this system of records may be disclosed, as a routine use, to the Administrator, General Services, or his/her designee, during an inspection of records conducted by GSA as part of that agency's responsibility to recommend improvements in records management practices and programs, under authority of 44 U.S.C. 2904 and 2906. Such disclosure shall be made in accordance with the GSA regulations governing inspection of records for this purpose, and any other relevant (*i.e.*, GSA or Commerce) directive. Such disclosure shall not be used to make determinations about individuals.
8. A record from this system of records may be disclosed, as a routine use, to the public after either publication of the application pursuant to 35 U.S.C. 122(b) or issuance of a patent pursuant to 35 U.S.C. 151. Further, a record may be disclosed, subject to the limitations of 37 CFR 1.14, as a routine use, to the public if the record was filed in an application which became abandoned or in which the proceedings were terminated and which application is referenced by either a published application, an application open to public inspection or an issued patent.
9. A record from this system of records may be disclosed, as a routine use, to a Federal, State, or local law enforcement agency, if the USPTO becomes aware of a violation or potential violation of law or regulation.

**IN THE UNITED STATES PATENT AND TRADEMARK OFFICE**

In re application of:

Haller et al.

Patent No.: 7,039,033

Control No.: N/A

Filed: March 24, 2017

For: SYSTEM, DEVICE AND COMPUTER READABLE MEDIUM  
FOR PROVIDING A MANAGED WIRELESS NETWORK  
USING SHORT-RANGE RADIO SIGNALS

Group Art Unit: N/A

Examiner: N/A

Request for Reexamination Under U.S.C  
§§ 302-307 and 37 C.F.R. §1.510

Attorney Docket No.: 0909-010

**PATENT OWNER REQUEST FOR *EX PARTE* REEXAMINATION  
OF U.S. PATENT NO. 7,039,033 INCLUDING AMENDMENT**

Mail Stop *Ex Parte* Reexamination  
Attn: Central Reexamination Unit  
Commissioner for Patents  
P.O. Box 1450  
Alexandria, VA 22313-1450

## Table of Contents

|   |     |
|---|-----|
| EXHIBIT LIST .....  | iii |
| I. Introduction.....  | 1   |
| II. Requirements for <i>Ex Parte</i> Reexamination Under 37 C.F.R. §1.510.....  | 2   |
| A. 37 C.F.R. §1.510(b)(1): Statement Pointing Out Each Substantial New<br>Question of Patentability.....  | 2   |
| B. 37 C.F.R. §1.510(b)(2): Detailed Explanation of the Pertinency and<br>Manner of Applying the Prior Art .....   | 2   |
| C. 37 C.F.R. §1.510(b)(3): Copy of Every Patent or Printed Publication Cited<br>Against the Claims.....   | 2   |
| D. 37 C.F.R. §1.510(b)(4): Copy of the Entire Patent .....  | 3   |
| E. 37 C.F.R. §1.510(a): Fee for Requesting Reexamination.....   | 3   |
| F. Related Matters .....  | 3   |
| III. Claim Construction .....   | 6   |
| A. Standard of Claim Construction.....  | 6   |
| B. Summary of Claim Construction Positions/Holdings.....  | 7   |
| IV. Prior Art .....   | 7   |
| A. Marchand .....   | 7   |
| B. Nurmann .....  | 15  |
| C. Vilander.....  | 15  |
| D. RFC 2543 .....   | 16  |
| E. Larsson.....   | 16  |
| F. JINI Spec.....   | 17  |
| V. Background of Wireless Technology.....   | 17  |
| VI. Overview of the ‘033 Patent .....   | 21  |
| A. Prosecution History.....   | 21  |
| B. Summary of the ‘033 Patent .....   | 23  |
| VII. 37 C.F.R. §1.510(b)(1): Statement Establishing Substantial New Questions of<br>Patentability (“SNQs”) of Claim 48 and 56 of the ‘033 Patent .....                  | 25  |
| A. Marchand in view of Nurmann, and Vilander establishes a substantial new<br>question of patentability with respect to independent claim 48 of the ‘033<br>patent..... | 25  |
| B. The ‘1444 IPR Art Does Not Render Claim 48 Unpatentable.....   | 28  |
| C. Marchand in view of Nurmann, and Vilander establishes a substantial new<br>question of patentability with respect to independent claim 56 of the ‘033<br>patent..... | 36  |
| D. The ‘1444 IPR Art Does Not Render Claim 56 Unpatentable.....   | 37  |
| VIII. Support for Proposed Amendments .....   | 45  |

|     |  |    |
|-----|--|----|
| IX. | Proposed Amendments are Patentably Distinct over Previously Asserted Grounds.....  | 45 |
| A.  | Ground 1 – Amended and New Claims 48 and 56-129 are not obvious under 35 U.S.C. § 103 with respect to Marchand, Nurmann, and Vilander .....              | 46 |
| B.  | Ground 2 – New and Amended Claims 48 and 56-129 are not obvious under 35 U.S.C. § 103 with respect to Marchand, Nurmann, Vilander and RFC2543 .....      | 54 |
| C.  | Ground 3 – New and Amended Claims 48 and 56-129 are not obvious under 35 U.S.C. § 103 with respect to Marchand, Nurmann, Vilander and Larsson.....       | 54 |
| D.  | Ground 4 – New and Amended Claims 48 and 56-129 are not obvious under 35 U.S.C. § 103 with respect to Marchand, Nurmann, Vilander and the JINI Spec..... | 55 |
| E.  | Ground 5 – New and Amended Claims 48 and 56-129 are not obvious under 35 U.S.C. § 103 with respect to Marchand, Larsson and the JINI Spec.....           | 57 |
| X.  | Objective Indicia Supports Nonobviousness .....  | 58 |
| XI. | Conclusion .....   | 61 |

**EXHIBIT LIST**

| <b>Exhibit No.</b> | <b>Description</b>                                    |
|--------------------|---|
| PAT-A              | U.S. Patent No. 7,039,033 Haller et al.               |
| PA-A               | International Publication No. WO 2001/076154 Marchand |
| PA-B               | U.S. Patent No. 6,560,642 Nurmman                     |
| PA-C               | U.S. Patent No. 6,771,635 Vilander et al.             |
| PA-D               | U.S. Patent No. 6,836,474 Larsson et al.              |
| PA-E               | RFC 2543  |
| PA-F               | JINI Spec   |
| SB08               | U.S. Patent and Trademark Office form SB08            |
| OTH-A              | Mandayam Declaration                                  |
| OTH-B              | Mandayam C.V.   |
| OTH-C              | Amended Claims  |
| OTH-D              | Support for proposed amendments                       |

**OTHER EXHIBITS AND SUPPORTING DOCUMENTATION**

| <b>Exhibit No.</b> | <b>Description</b>  | <b>Identifier</b>    |
|--------------------|---|----------------------|
| Ex. 1              | IPR2015-01444 Final Written Decision  | '1444 Final Decision |
| Ex. 2              | Reaching out to the Cell Phone with Jini  | Motorola             |
| Ex. 3              | The Evolution of Cell Phone Design Between 1983-2009  |                      |
| Ex. 4              | Blackberry – The Inside Story of Research In Motion   |                      |
| Ex. 5              | Losing the Signal – The Untold Story Behind The Extraordinary Rise And Spectacular Fall Of Blackberry | RIM                  |
| Ex. 6              | What's J2ME?  |                      |
| Ex. 7              | Java™ 2 Platform, Standard Edition (J2SE™)  | J2SE 2000            |
| Ex. 8              | J2ME: Step by step  |                      |
| Ex. 9              | PsiNaptic – The Application of Jini™ Technology to Enhance the Delivery of Mobile Services            | PsiNaptic            |
| Ex. 10             | IXI PMG System Specifications   |                      |
| Ex. 11             | The Personal Mobile Gateway (PMG) is a cool idea  | PMG is a cool idea   |
| Ex. 12             | Cautious Optimism at the 3GSM World Congress 2002   |                      |
| Ex. 13             | Consumer Gadgets – 50 Ways to Have Fun & Simplify Your Life with Today's Technology                   | Consumer Gadgets     |
| Ex. 14             | Samsung Introduces the World's First PMG (Personal Mobile Gateway) Phone at CeBIT                     | Brighthand Article   |

| <b>Exhibit No.</b> | <b>Description</b>  | <b>Identifier</b>        |
|--------------------|---|--------------------------|
| Ex. 15             | The Evolving Mobile User Interface: Strategies for the Wireless Internet  |                          |
| Ex. 16             | Deutsche Bank Securities Inc., Report   | Deutsche Bank            |
| Ex. 17             | PMGs Set to Explode in 2004   |                          |
| Ex. 18             | TNI Securities Equity Research  |                          |
| Ex. 19             | Handbook of Wireless Local Area Networks – Applications, Technology, Security, and Standards, p. 49   |                          |
| Ex. 20             | IXI Mobile Receives ‘Winning Technology’ Award from Tornado Insider   | Winning Technology Award |
| Ex. 21             | Handbook of Wireless Local Area Networks – Applications, Technology, Security, and Standards, p. 52   |                          |
| Ex. 22             | <p>Excerpt of Programmes After Market Services NHM-2/5nx.ny/6/9 Series Transceivers p. 34</p> <p>Excerpt of PAMS Technical Documentation NHM-7 Series Transceivers p. 27</p> <p>Ericsson R830 – The First Smartphone?</p> | Memory Requirements      |



## I. Introduction

IXI IP, LLC (“IXI”), Patent Owner, requests reexamination of claims 48 and 56 of U.S. Patent No. 7,039,033 (“’033 patent”) to amend the claims in light of substantial new questions of patentability raised by International Publication No. WO 2001/076154 (“Marchand”), U.S. Patent No. 6,560,642 (“Nurmann”), U.S. Patent No. 6,771,635 (“Vilander”), U.S. Patent No. 6,836,474 (“Larsson”), Handley et al., Request for Comments 2543 SIP: Session Initiation Protocol, The Internet Society, March, 1999 (“RFC 2543”), and K. Arnold et al., The JINI™ <sup>1</sup>Specification, Addison-Wesley, June 1, 1999 (“JINI Spec.”.)

Additionally, Patent Owner submits amended claims 48 and 56, which are patentably distinct over the prior art grounds raised in IPR2015-01444, NYSD-1-14-cv-04355-RJS, NYSD-1-14-cv-04428-RJS, NYSD-1-14-cv-07954-RJS, CAND-3-15-cv-03752-HSG, CAND-3-15-cv-03754-HSG and CAND-3-15-cv-03755-HSG, filed against the ‘033 patent.

While amendments were statutorily available to the patent owner during prosecution of the IPR, the PTAB has stated that patent owners may alternatively choose reexamination to amend claims:

If a patent owner desires a complete remodeling of its claim structure according to a different strategy, it may do so in another type of proceeding before the Office. For instance, **a patent owner may file a request for *ex parte* reexamination, relying on the Board’s conclusion of a petitioner having shown reasonable likelihood of success on certain alleged grounds of unpatentability as raising a substantial new question of patentability.**

*Idle Free Systems, Inc. v. Bergstrom, Inc.*, IPR2012-00027, Paper 26 at p. 6. (informative, boldface added.)

---

<sup>1</sup> “Jini” Trademark of Sun Microsystems

Accordingly, the patent owner requests reexamination of the '033 patent, specifically, that the Office find a substantial new question of patentability with respect to claims 48 and 56 of the original claims, order reexamination, and issue a notice of intent to issue a reexamination certificate that allows the amended claims submitted herewith.

**II. Requirements for *Ex Parte* Reexamination Under 37 C.F.R. §1.510**

Patent Owner satisfies each requirement for *ex parte* reexamination of the '033 Patent as stated below.

**A. 37 C.F.R. §1.510(b)(1): Statement Pointing Out Each Substantial New Question of Patentability**

A statement pointing out each substantial new question of patentability (“SNQ”) based on the cited patents in accordance with 37 C.F.R. §1.510 (b)(1) and (b)(2) is provided in Section VII.

**B. 37 C.F.R. §1.510(b)(2): Detailed Explanation of the Pertinency and Manner of Applying the Prior Art**

See Sections IV, VII and IX.

**C. 37 C.F.R. §1.510(b)(3): Copy of Every Patent or Printed Publication Cited Against the Claims**

Exhibits PA-A, PA-B, PA-C, PA-D, PA-E, and PA-F are Marchand, Nurmann, Vilander, Larsson, RFC 2543, and JINI Spec respectively:

PA-A Marchand

PA-B Nurmann

PA-C Vilander

PA-D Larsson

PA-E RFC 2543

PA-F JINI Spec

References PA-A through PA-F are also listed on Exhibit SB08 (i.e. Form PTO-SB/08.)

**D. 37 C.F.R. §1.510(b)(4): Copy of the Entire Patent**

A full copy of the 7,039,033 patent is submitted herein as Exhibit PAT-A in accordance with 37 C.F.R. §1.510(b)(4).

**E. 37 C.F.R. §1.510(a): Fee for Requesting Reexamination**

In accordance with 37 C.F.R. §1.510(a), the reexamination fee has been paid as part of the EFS-WEB submission. Any deficiency or overpayment may be debited/credited to Deposit Account No. 503318.

**F. Related Matters**

The following is a list of all the matters involving the '033 Patent:

| <b>Case No.</b>   | <b>Parties</b>   | <b>Venue</b>   | <b>Filed</b>      |
|-------------------|--|--|-------------------|
| 1-14-cv-04355-RJS | <i>IXI Mobile (R&amp;D) Ltd. et al v. Samsung Electronics Co., Ltd et al</i>                           | United States District Court Southern District of New York | June 17, 2014     |
| 1-14-cv-04428-RJS | <i>IXI Mobile (R&amp;D) Ltd. et al v. Blackberry Limited et al</i>                                     | United States District Court Southern District of New York | June 18, 2014     |
| 1-14-cv-07954-RJS | <i>IXI Mobile (R&amp;D) Ltd. et al v. Apple, Inc.</i>  | United States District Court Southern District of New York | October 2, 2014   |
| IPR2015-01444     | <i>Samsung Electronics Co., Ltd., Samsung Electronics America, Inc., and Apple Inc. v. IXI IP, LLC</i> | Patent Trial and Appeal Board                              | June 19, 2015     |
| 3-15-cv-03752-HSG | <i>IXI Mobile (R&amp;D) Ltd., et al v. Samsung Electronics Co., Ltd. et al</i>                         | United States District Court California Northern District  | August 17, 2015   |
| 3-15-cv-03754-HSG | <i>IXI Mobile (R&amp;D) Ltd., et al v. Blackberry Limited et al</i>                                    | United States District Court California Northern District  | August 17, 2015   |
| 3-15-cv-03755-HSG | <i>IXI Mobile (R&amp;D) Ltd., et al v. Apple Inc.</i>  | United States District Court California Northern District  | August 17, 2015   |
| 17-1665           | <i>IXI IP, LLC v. Samsung Electronics Co., Ltd</i>   | United States Court of Appeals for the Federal Circuit     | February 22, 2017 |

Case No. 1-14-cv-04355-RJS was filed by Plaintiff IXI Mobile (R&D) Ltd., and IXI IP, LLC (“IXI”), in the United States District Court for the Southern District of New York on June 17, 2014 (“’4355 Complaint”). The ’4355 Complaint was filed against Samsung Electronics Co., Ltd, Samsung Electronics America, Inc. and Samsung Telecommunications America, LLC (“Defendants”) for patent infringement of the ’033 patent, U.S. Patent No. 7,039,033, U.S. Patent No. 7,016,648, U.S. Patent No. 7,295,532, and U.S. Patent 7,426,398. The case was transferred to the United States District Court California Northern District on August 17, 2015 and assigned case no. 3-15-cv-03752-HSG. After the filing of IPR2015-01444, the ’3752 litigation was stayed.

Case No. 1-14-cv-004428-RJS was filed by Plaintiff IXI Mobile (R&D) Ltd., and IXI IP, LLC in the United States District Court for the Southern District of New York on June 18, 2014 (“’4428 Complaint”). The ’4428 Complaint was filed against Blackberry Limited and Blackberry Corporation (“Defendants”) for patent infringement of the ’033 patent, U.S. Patent No. 7,039,033, U.S. Patent No. 7,016,648, U.S. Patent No. 7,295,532, and U.S. Patent 7,426,398. The case was transferred to the United States District Court California Northern District on August 17, 2015 and assigned case no. 3-15-cv-03754-HSG. After the filing of IPR2015-01444, the ’3754 litigation was stayed.

Case 1-14-cv-07954-RJS was filed by Plaintiff IXI Mobile (R&D) Ltd., and IXI IP, LLC in the United States District Court for the Southern District of New York on October 2, 2014 (“’7954 Complaint”). The ’7954 Complaint was filed against Apple, Inc. (“Defendant”) for patent infringement of the ’033 patent, U.S. Patent No. 7,039,033, U.S. Patent No. 7,016,648, U.S. Patent No. 7,295,532, and U.S. Patent 7,426,398. The case was transferred to the United States District Court California Northern District on August 17, 2015 and assigned case no. 3-15-cv-03755-HSG. After the filing of IPR2015-01444, the ’3755 litigation was stayed.

On June 19, 2015, Samsung Electronics Co., Ltd., Samsung Electronics America, Inc., and Apple Inc. filed a petition for *inter partes* review of the ’033 patent before the Patent Trial and Appeal Board (“PTAB”), IPR2015-01444 (’1444 IPR”). The PTAB instituted the ’1444 IPR on December 30, 2015 and issued a Final Written Decision on December 21, 2016.

On February 21, 2017, IXI IP, LLC filed a Notice of Appeal in relation to the ’1444 Final Written Decision. On February 22, 2017, the U.S. Court of Appeals for the Federal Circuit docketed the Appeal and assigned case no. 17-1665.

Below is a summary of the grounds and Final Decision in the ’1444 IPR:

| <b>Grounds</b> | <b>Claims Challenged</b>           | <b>Challenged in the Petition (p. 3)</b>  | <b>Instituted (p. 26)</b>   | <b>Final Decision (p. 42)</b>   |
|----------------|------------------------------------|---|---|---|
| Ground 1       | 1, 4, 7, and 14                    | Invalid under 35 U.S.C. § 103(a) as obvious over Marchand in view of Nurmann and Vilander             | Claims 1, 4, 7, and 14 as obvious over Marchand, Nurmann, and Vilander under 35 U.S.C. § 103(a).                              | Claims 1, 4, 7, and 14 of U.S. Patent No. 7,039,033 are held to be unpatentable.                    |
| Ground 2       | 5                                  | Invalid under 35 U.S.C. § 103(a) as obvious over Marchand in view of Nurmann, Vilander, and RFC 2543  | Claim 5 as obvious over Marchand, Nurmann, Vilander, and RFC 2543 under 35 U.S.C. § 103(a).                                   | Claim 5 of U.S. Patent No. 7,039,033 are held to be unpatentable.                                   |
| Ground 3       | 6 and 23                           | Invalid under 35 U.S.C. § 103(a) as obvious over Marchand in view of Nurmann, Vilander, and Larsson   | Claim 6 and 23 as obvious over Marchand, Nurmann, Vilander, and Larsson under 35 U.S.C. § 103(a).                             | Claims 6 and 23 of U.S. Patent No. 7,039,033 are held to be unpatentable.                           |
| Ground 4       | 12, 15, 22, 34, 39, 40, 42, and 46 | Invalid under 35 U.S.C. § 103(a) as obvious over Marchand in view of Nurmann, Vilander, and JINI Spec | Claim 12, 15, 22, 34, 39, 40, 42, and 46 as obvious over Marchand, Nurmann, Vilander, and JINI Spec under 35 U.S.C. § 103(a). | Claims 12, 15, 22, 34, 39, 40, 42, and 46 of U.S. Patent No. 7,039,033 are held to be unpatentable. |
| Ground 5       | 25 and 28                          | Invalid under 35 U.S.C. § 103(a) as obvious over Marchand in view of Larsson and JINI Spec            | Claim 25 and 28 as obvious over Marchand, Larsson, and JINI Spec under 35 U.S.C. § 103(a).                                    | Claims 25 and 28 of U.S. Patent No. 7,039,033 are held to be unpatentable.                          |

### **III. Claim Construction**

#### **A. Standard of Claim Construction**

In an *ex parte* reexamination, claims are to be given their "broadest reasonable construction" consistent with the specification. MPEP §2111; *In re Swanson*, No. 07-1534 (Fed.

Cir. 2008). The constructions used in this request and during the reexamination can therefore be different from constructions based on the standard specified in *Phillips v. AWH Corp.* 415 F.3d 1303 (Fed. Cir. 2005).

**B. Summary of Claim Construction Positions/Holdings**

The following chart summarizes the claim construction positions and holdings for the '1444 IPR.

| <b>IPR2015-01444</b>   | <b>Board Institution</b>   | <b>Patent Owner</b>  | <b>Petitioner</b>  | <b>Final</b>  |
|--|--|--|--|---|
| “identifies whether the service is available at a particular time” | For purposes of this decision, we agree that the identified phrase from claim 4 does not need explicit construction at this time, because consideration of a service being registered does not bear on our analysis of Petitioner’s unpatentability contentions for this claim. Inst. 6. | Patent Owner contends this phrase does not need to be construed. Prelim. Resp. 9–10. | Petitioner contends this phrase should be construed broadly enough to encompass the service being registered. Pet. 9-10. | Maintained  |
| “thin terminal” presented by the Board in the Final Decision       |  |  |  | “thin terminal” recited in claims 7 and 46 encompasses a printer. Final Decision 8. |

**IV. Prior Art**

**A. Marchand**

Bluetooth is a local wireless technology that connects devices using short-range radio

signals. (Ex. PA-A, “Marchand” at 1:26-31.)<sup>2</sup> Bluetooth provides a point-to-point connection, if only two devices are connected, or a point-to-multipoint connection, if more than two devices are connected. When two or more devices are connected they share the same channel and form a piconet. (Ex. PA-A, “Marchand” at 2:17-25.)

When a piconet is first established, one device acts as a “master” device and the other devices (up to seven) act as “slave” devices for the duration of the network establishment so that all devices in the piconet are synchronized. (Ex. PA-A, “Marchand” at 2:17-25; *see also* Ex. OTH-A, “Mandayam Decl.” at ¶44.)

Marchand is directed to a Bluetooth piconet that has been extended into an Internet Protocol (IP) wireless local area network implementing JINI/Java technology in order to utilize the JINI technology to share services between devices in the piconet. (Ex. PA-A, “Marchand” at Abstract; 5:23-25; 6:25-27.) Additionally, a mobile phone connected to the piconet is configured to act as a gateway to provide a call control interface between the wireless IP network and other devices in the piconet. (Ex. PA-A, “Marchand” at Abstract.)

A person of ordinary skill in the art would have understood that the operation of the network and the devices described in Marchand are dependent on the underlying Bluetooth technology. Marchand makes it clear that the use of a Bluetooth piconet extended into an Internet Protocol (IP) wireless LAN implementing JINI/Java technology is essential to the operation of the network and devices of Marchand. (Ex. OTH-A, “Mandayam Decl.” at ¶46.) Specifically, Marchand explains that for devices in the Bluetooth piconet to share services, each device must be

---

<sup>2 2</sup> For each of the Marchand citations, the original pagination of the reference is being cited, not the pagination of the Exhibit.



“Bluetooth-compliant and JINI/Java capable” (Ex. PA-A, “Marchand” at 7:9-11.)

Marchand states that to be Bluetooth compliant, each device would include a Bluetooth chipset. (Ex. PA-A, “Marchand” at Abstract; 2:11-16.) Further, each device operates using a specific protocol stack, as defined and illustrated in Marchand’s Figure 2:

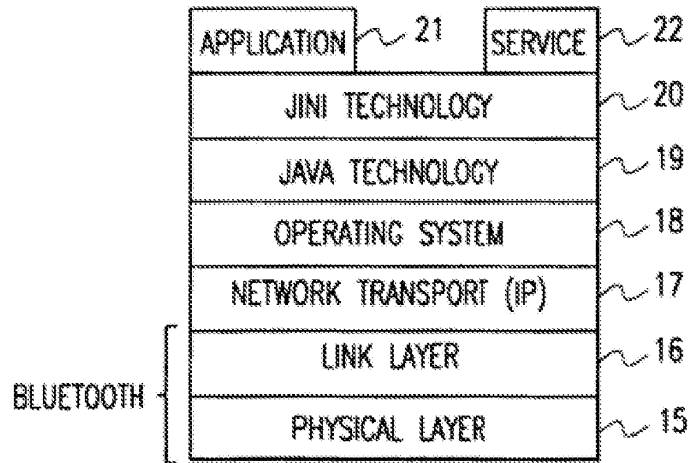

**FIG. 2**

(Ex. PA-A, “Marchand” at FIG. 2)

As shown above, each device in Marchand’s Bluetooth piconet includes a physical layer 15 and a link layer 16, which are identified as Bluetooth layers of the protocol stack. In addition, the protocol stack includes “a network transport (IP) layer 17”, “an operating system layer 18, a Java technology layer 19, and a JINI technology layer 20”. (Ex. PA-A, “Marchand” at 6:14-22.)

In Marchand, JINI technology is utilized to allow the Bluetooth-networked devices to share services. (Ex. OTH-A, “Mandayam Decl.” at ¶48.) Marchand describes JINI technology as “a Java-technology-centered, distributed software system for simplicity, flexibility and federation.” (Ex. PA-A, “Marchand” at 2:27-28.) “The JINI architecture provides mechanisms for machines or programs to enter into a federation where each machine or program offers resources to other members of the federation and uses resources as needed.” (Ex. PA-A, “Marchand” at 2:28-31.)

The JINI technology exploits the ability to move java language code from machine to machine and relies on the use of a JINI lookup service (LUS) to allow various connected devices to use services offered by other devices in the network. (Ex. PA-A, “Marchand” at 2:28-3:3; Ex. PA-F, “JINI Spec.” at p. 23; *see also* Ex. OTH-A, “Mandayam Decl.” at ¶49.) “The LUS contains a list of all services offered on a network” and allows devices to share those services. (Ex. PA-A, “Marchand” at 3:11-12.) Without the LUS, the devices on Marchand’s network would not be able to share and use services. (Ex. OTH-A, “Mandayam Decl.” at ¶49.)

Sharing of services among devices connected on a piconet more effectively utilizes the software and hardware resources of each device, such as memory, modems, and service software, as compared to duplicating these software and hardware resources across all devices, which is “inappropriate, expensive, and cumbersome” and “inefficient from the resource point of view to require loading a call control client such as H.323 (about 4 MB) in multiple devices on the Piconet.” (Ex. PA-A, “Marchand” at 4:1-9.) An application programming interface (API) may be transferred from a device having an available service to only the device requesting use of the service so that devices not using the service do not need to expend resources (memory, processing, etc.) for services that are not being used. (Ex. PA-A, “Marchand” at 6:27-7:2.)

When a device implementing JINI technology joins a JINI/Java network, the device undergoes a discovery and join process in which the joining device discovers the LUS and publishes the services that it can offer to the network. (Ex. PA-F, “JINI Spec Part 1” at p. 22.)<sup>3</sup> To publish its service, the joining device transfers java code (referred to as a proxy object or java

---

<sup>3</sup> For each of the JINI Spec citations, the original pagination of the reference is being cited, not the pagination of the Exhibit.

object) to the LUS. (*Id.*) This small amount of java code is used to identify the service(s) the joining device offers and to establish an interface with that service. (*See* Ex. PA-F, “JINI Spec Part 1” at p. 22-23; *see also* Ex. PA-A, “Marchand” at 3:13-14.) The LUS stores this java object and creates a list of the services available on the network. (Ex. PA-F, “JINI Spec Part 1” at pp. 22-23; Ex. PA-A, “Marchand” at 3:11-12.) For example, if a printer joins a network utilizing JINI technology, the printer will publish its printing service to the network by transferring java code to the LUS. (Ex. PA-F, “JINI Spec Part 1” at p. 22.) The java code includes the printer’s information and a method to implement its printer interface. (*Id.* at pp. 23-24; Ex. OTH-A, “Mandayam Decl.” at ¶51.)

When a JINI/Java capable device would like to use a service offered by another device in the network, it sends a request to the LUS, and the LUS then transfers the java code necessary to access that service. (Ex. PA-F, “JINI Spec Part 1” at p. 22.) Continuing the above example, when another device in the network needs to print, the device will ask the LUS if any printer services are available. (Ex. PA-F, “JINI Spec Part 1” at p. 22.) The LUS provides the printer’s java code to the requesting device, which will automatically download the code, if it was not previously downloaded. (Ex. PA-F, “JINI Spec Part 1” at p. 23.) The device can then send the print request by invoking the methods provided by the java code for implementing the printer interface. (*Id.*) That is, the proxy object, now contained on the device requesting the printing services, communicates with the printer to execute the print request. (Ex. PA-F, “JINI Spec Part 1” at p. 23.) JINI technology does not define the protocol between the proxy object on the device and the printer. Rather, the protocol is defined by the printer and its proxy object. (*Id.*) “Whoever writes the proxy object determines when it talks to whom to get what, constrained, of course, by the security environment in which it executes.” (*Id.* at 24.)

Operating in accordance with these underlying technologies, Marchand describes that the devices are able to connect to form a Bluetooth piconet, with each device including the protocol stack described above for extending the Bluetooth piconet into an IP wireless LAN and implementing JINI and Java technologies. (Ex. OTH-A, “Mandayam Decl.” at ¶53.) Through this method, the devices in Marchand can share services with one another. (*Id.*) “Though identifying other services that can be used, Marchand only particularly describes the protocol for implementing the call control service offered by the mobile phone 33.” (*Id.*) Specifically, Marchand provides that the mobile phone 33 can connect to the Bluetooth piconet and act as a gateway between the other devices and a wireless IP network. (Ex. PA-A, “Marchand” at 10:15-16; 12:6-10; 7:12-14.) This gateway mobile phone “publishes” its call control service to the LUS, thereby allowing other devices in the piconet to detect and subsequently utilize this service through request. (*Id.* at 8:11-20; Fig. 3.) For example, other Bluetooth devices on the piconet perform a JINI-defined add-in “discovery and join” protocol “to locate the LUS and upload all of its services’ interfaces, including call control services.” (*Id.* at 8:12-20.) After this “discovery and join” process, other Bluetooth devices are able to utilize the call control client of the gateway mobile phone to connect to the wireless IP network. (Ex. OTH-A, “Mandayam Decl.” at ¶53.)

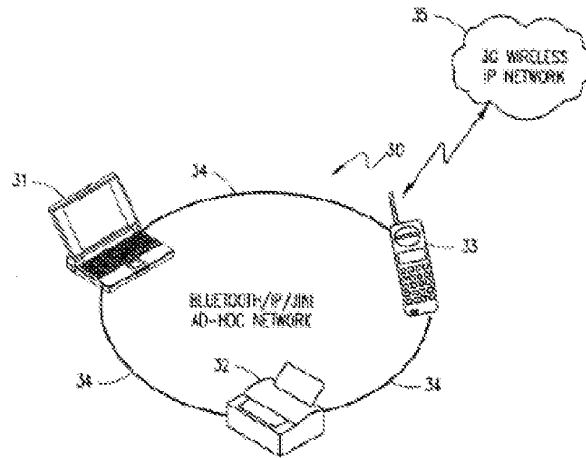

FIG. 3

(Ex. PA-A, “Marchand” at FIG. 3)

As shown in Figure 3 of Marchand above, the gateway mobile phone 33 has both a radio access modem and a Bluetooth chipset. (Ex. PA-A, “Marchand” at 7:12-25; 11:7.) The radio access modem provides an interface with a public IP address for accessing the wireless IP network and the Bluetooth chipset provides an interface with a private IP address for accessing the piconet. (*Id.* at 11:7-10.) When another device in the piconet uses the call control client of the mobile phone, the mobile phone pushes incoming IP packets received on its public IP address to the private IP address of the device in the piconet, and also translates IP packets in the other direction. (Ex. PA-A, “Marchand” at 7:14-17; 11:13-16.) The translation between public and private IP addresses is performed by an API sent from the mobile phone to the device requesting the call control service. (*Id.* at 11:17-18; 15:25-31.)

To act as a gateway for other devices in the Bluetooth piconet, the mobile phone includes “an interface/Application Programming Interface (API) which is an abstraction of a SIP and/or H.323 call control client.” (Ex. PA-A, “Marchand” at 6:27-29.) When a Bluetooth device in the piconet seeks to make a call through the gateway mobile phone, the API is downloaded into the

Bluetooth device to have the device behave as a slave device toward the mobile phone which acts as the master. (Ex. PA-A, “Marchand” at 6:29-31.) Figure 4, below, provides a simplified block diagram of a connection between a laptop computer and a mobile phone. (*Id.* at 7:26-27; FIG. 4.) Marchand establishes three new API interfaces, preferably implemented as JINI services: the first interface, call control client 41, enables any of the connected Bluetooth devices to behave as a slave toward the mobile phone; the second interface, SIP client 42, enables the full use of SIP client capabilities; and the third interface, H.323 client 44, enables the full use of H.323 client capabilities. (*Id.* at 7:29-31.)

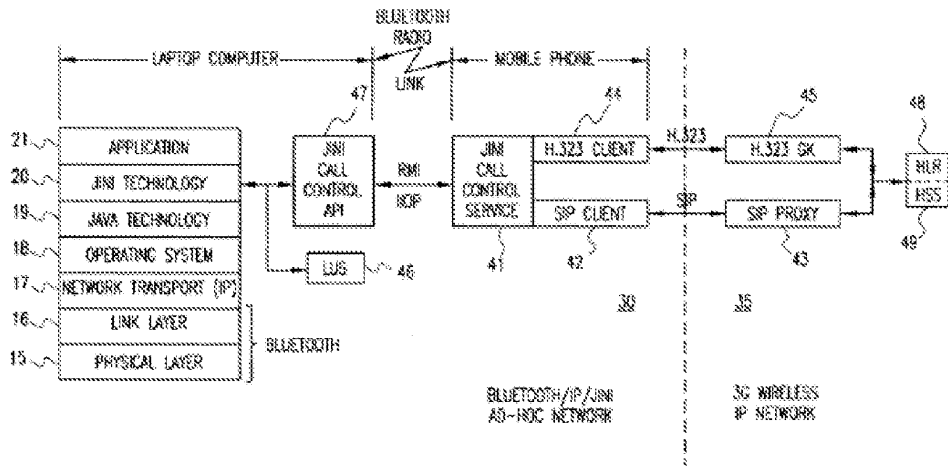

FIG. 4

(Ex. PA-A, “Marchand” at FIG. 4)

After a mobile phone lists its call control service as an available service on the piconet, a user can place a call from another device in the piconet. (*Id.* at 10:24-25.) When the call is initiated, “the SIP client in the mobile phone sends an API to the [device] that is used to route the call through the mobile phone to the wireless IP network. The SIP client in the mobile phone behaves as a server application for the piconet, and another API is downloaded to the [device] to connect to the server.” (*Id.* at 10:24-29.) “The phone acts as a server application toward the [device], and

acts as a client and gateway toward the wireless IP network.” (Ex. PA-A, “Marchand” at 10:29-30.)

**B. Nurmann**

Nurmann is directed to a method of assigning IP addresses to IP hosts in an IP network. (Ex. PA-B, “Nurmann” at Abstract.) The IP gateway first functions as a DHCP (Dynamic Host Configuration Protocol) client and determines whether a DHCP server is present in the IP network. (*Id.* at 2:62-67; 5:15-17.) If so, the DHCP server assigns IP addresses to the IP hosts. (*Id.*) If there is no DHCP present in the IP network, the IP gateway then functions as a DHCP server and allocates IP addresses to the IP hosts. (*Id.* at 2:46-60; 5:18-21.)

**C. Vilander**

Vilander is directed to a method for allocating IP addresses for mobile terminals. Vilander discloses that a mobile terminal conducts “a negotiation” with a mobile telecommunications network “to determine a host part of the IP address.” (Ex. PA-C, “Vilander” at 3:7-4:3.) The mobile terminal then “generate[s] an IP address” using the host part negotiated with the mobile telecommunications network. (*Id.*) In other words, the IP address of the mobile terminal is generated by the mobile terminal itself.

Specifically, Vilander discloses that a “suitable host part is negotiated between the mobile terminal 7 and the radio network 1 during the establishment of (lower) communication layers over the air interface[.]” (Ex. PA-C, “Vilander” at 4:60-67.) “The negotiation is initiated by the radio network proposing a suitable host part which it knows is unique within its coverage area.” (*Id.*) “[T]he mobile terminal receives the proposed host part and is able to combine this with the received routing prefix to form an IP address for use in subsequent Internet sessions.” (*Id.* at 5:7-10.) Alternatively, the mobile terminal can “generate a temporary host part upon registering with a

radio network.” (*Id.* at 5:20-25.)

**D. RFC 2543**

RFC 2543 (SIP: Session Initiation Protocol, RFC 2543) is directed to the Session Initiation Protocol (“SIP”), “an application-layer control protocol that can establish, modify and terminate multimedia sessions or calls.” (Ex. PA-E, “RFC 2543” at p. 7<sup>4</sup>.)

**E. Larsson**

Larsson is directed to a Wireless Session Protocol (WAP) gateway interconnecting a Public Land Mobile Network (PLMN) and a private network. (Ex. PA-D, “Larsson” at Abstract.) As shown in FIG. 1 below, a mobile terminal 10 (e.g., a laptop computer, personal digital assistant, mobile phone) coupled to the PLMN 20 may access a private network 15 (e.g., a corporate network) via the WAP gateway 30. (*Id.* at Fig. 1.)

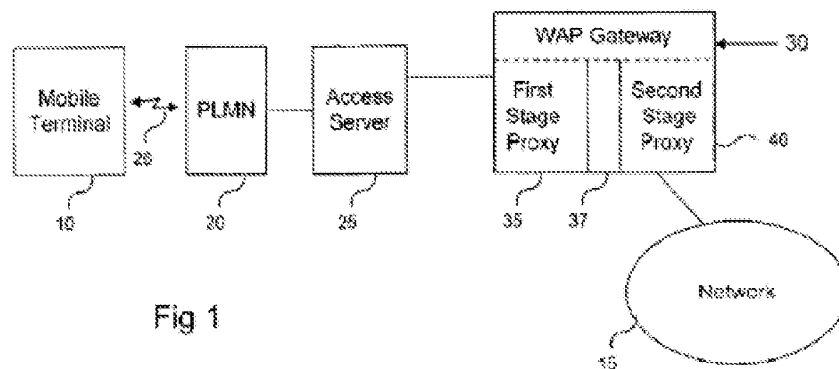

Fig 1

(Ex. PA-D, “Larsson” at Fig 1)

The WAP gateway 30 includes a first stage proxy 35 and a second stage proxy 40. (*Id.* at 2:62-3:1.) “The first stage proxy 35 includes the lowest layer of the WAP protocol stack and is

---

<sup>4</sup> For each of the RFC 2543 citations, the original pagination of the reference is being cited, not the pagination of the Exhibit.



responsible for granting access of a mobile terminal 10 to the private network 15. The second stage proxy 40 contains the remainder of the layers of the WAP protocol stack.” (*Id.*)

#### **F. JINI Spec**

The JINI Spec. provides “an overview of the JINI architecture, its design philosophy, and its application.” (Ex. PA-F, “JINI Spec Part 1 at p. xix.) “T[he] J[INI] architecture is designed for deploying and using services in a network.” (*Id.*) Through JINI, a device that wants to make services available on the network registers the service with the LUS and provides a proxy object to the LUS to store. (*Id.* at 5-12.) A client that wants access to a given service then searches the LUS for the service, and if available it receives the associated proxy object. (*Id.*) The proxy object implements the interface for the service and is thus used by the client to access the service. (*Id.*)

#### **V. Background of Wireless Technology**

As of the 2001 filing date of the ‘033 patent, several technical issues such as battery life, frequency interference, bandwidth, visual displays, memory, etc. led the wireless industry to consider convergence—combining multiple applications on a single device—as a “future” goal and instead researchers worked to actively develop individual user applications, such as a printer, pager, PDA, phone, etc. (*See* Ex. 2, “Motorola” at p. 9; Ex. OTH-A “Mandayam Decl.” at ¶18.)

In the context of mobile phones, the best-selling phones in 2001, by Ericsson and Nokia lacked Java and had an internal memory ranging from 512 kbyte to 2 Mbytes. (Ex. 22, “Memory Requirements” at pp. 2, 4, 8.) At that time, Nokia was the market leader and almost all of their devices included a similar hardware platform with a MAD2 CPU, running at 13 Mhz (approximately 13 MIPS). (Ex. 3, “The Evolution of Cell Phone Design Between 1983-2009” at pp. 17-23.)

In 2002, RIM, the manufacturer of the Blackberry smartphone combined cellular phone capability with e-mail messaging—which made them the undisputed “smartphone” leader for at least 5 years. (Ex. 4, “Blackberry: The Inside Story of Research in Motion” at p. 3; Ex. 5, “RIM” at p. 18.) When the iPhone launched on January 9, 2007, Steve Jobs announced he would “change everything” with three firsts: a touchscreen iPod, a mobile phone, and an Internet communications device, all on the same device. (Ex. 5, “RIM” at p. 19.) Thus, the “convergence” offered by the iPhone came 6 years after the filing date of the ‘033 patent. (Ex. OTH-A, “Mandayam Decl. at ¶20.)

Given the state of the industry, available platforms and market demand, convergence was not an industry-wide goal in 2001. (*Id.* at ¶21.) On the contrary, as documented in the book “Losing the Signal,” Lazaridis, the CEO of the smartphone market leader, RIM, expressed skepticism at full-scale convergence:

RIM decided to sit out the convergence dance. Lazaridis didn’t buy into the idea that the handset race would be won by smartphones combining computing, phone and Internet services. To him, that made no sense. All-purpose operating systems sucked batteries dry, hogged wireless bandwidth and were awkward to use with their tap-and-write touch screens or full, shrunken desktop keyboards. He and his engineers had spent years creating the world’s most efficient handheld device, focusing on a single, perfect-application: wireless e-mail. It was light on battery use and e-mails were dispatched so efficiently that an average month of messages consumed less network spectrum than one local telephone call.

(Ex. 5, “RIM” at pp. 9-10.)

Further, the limited processing and memory capabilities of mobile phones in 2001 prevented mobile phones from including software platforms such as Java or Jini. (Ex. OTH-A, “Mandayam Decl.” at ¶22.) Developed by Sun Microsystems, Java is a computer programming language that allows programs written in a particular Java class to run similarly on all platforms

that support that Java class without requiring recompilation. (*Id.* at ¶23.) Jini, also developed by Sun Microsystems, provides a network architecture that allows devices and services on a network to communicate, deploy and share services through a collection of Java-based programs. (Ex. PA-F “JINI Spec Part 1” at p. 21.) In Jini, the discovery of an available service on the network, such as a printer or fax, is done via a look-up service (LUS) that allows services to “advertise their availability” so they can be discovered and then shared with other devices on the network. (Ex. OTH-A, “Mandayam Decl.” at ¶¶24-25.)

Because Java is class-based, different Java applications are not interchangeable: “you cannot take a Java application written for one profile and run it on a machine that supports another profile. Likewise, you cannot take an application written for Java 2 Standard Edition (J2SE) or Java 2 Enterprise Edition (J2EE) and run it on a machine that supports J2ME [Java 2 Micro Edition]. You can only use the Java classes provided in the Java class library included in your target device’s profile.” (Ex. 6, “What’s J2ME?” at p. 1.)

To operate the full, mainstream Java application, Java SE (Standard Edition) in 2000 (Ex. 7, “J2SE 2000” at p. 1) the following system requirements were needed: 1) a CPU with at least 166 Mhz (equivalent to 166 Mips); and 2) an internal memory of a minimum of 32 Mbytes, although 48 Mbytes was recommended. (Ex. 7, “J2SE 2000” at p. 3.) Because Java SE could not operate on mobile phones, in 1999 Java launched Java 2 Micro Edition (J2ME) for mobile phones, reducing the memory and CPU requirements—instead of the 32 Mbytes requirement for Java SE the J2ME application required a “memory budget of 256 kilobytes.” (Ex. 8, “J2ME Step by step” at p. 4.) This stripped down J2ME mobile phone application however lacked the memory needs for Jini and specifically the LUS feature which by itself required “more than 3 megabytes of static and runtime storage”. (Ex. 9, “PsiNaptic” at p. 32; *see also* Ex. OTH-A, “Mandayam Decl.” at

¶30.)

The limitations of the J2ME application and specifically its inability to run Jini and the LUS feature were well known in 2001 (Ex. OTH-A, “Mandayam Decl.” at ¶31.) A 2001 article by PsiNaptic makes it clear that when designing the Jini LUS, Sun Microsystems “chose to sacrifice storage for speed; that is, their Jini technology implementation was optimized for access speed by using extra storage to maintain efficient data access structures. This is important if one assumes the Jini Lookup Service will host services from several (or many) devices in the network.” (Ex. 9, “PsiNaptic” at pp. 31-32.) Thus, “[t]he resulting Jini Lookup service implementation is too large (e.g., typically, requiring more than 3 megabytes of static and runtime storage. Many networked computing devices are task-specialized; they are very small, low power, low cost, (hence, resource-constrained) and often mobile—too small to support an RMI-based Jini.” (*Id.*)

In a 2002 article documenting the development of the Motorola Nextel phone, Motorola also made it clear that computing limitations in mobile phone platforms meant that “current technology should not be applied to CPU intensive activities.” (Ex. 2, “Motorola” at p. 8.) The article specifies that prevailing mobile phone platforms cannot support Jini: “The most limited devices run Java 2 Micro Edition [J2ME], CLDC[5], but this cannot support Jini as it lacks dynamic class loading and object serialization. So despite progress in downsizing Java, the value-proposition of Jini for [mobile phone] devices remains an unattained promise.” (Ex. 2, “Motorola” at p. 2.) As an alternative, the Motorola authors propose using an intermediary solution (similar to the one taught in the primary reference for IPR2015-01444, Marchand), in which Jini and the LUS feature are made available to the mobile phone through a surrogate PC on the network that hosts the “Jini Technology, since handheld devices are as yet unable to support Jini directly.” (Ex. 2, “Motorola” at p. 9; *see also* Ex. OTH-A, “Mandayam Decl.” at ¶33.)

Thus, as of the 2001 filing date of the '033 patent, mobile phones with at most 2 Mbytes of memory and 13 Mhz CPU, were unable to run Jini or its LUS technology directly. (Mandayam Decl. ¶37.)

## **VI. Overview of the '033 Patent**

### **A. Prosecution History**

U.S. Patent Application No. 09/850,399 (“the ‘399 application”) that resulted in the issuance of the ‘033 patent was filed on May 7, 2001.

In the first Non-Final Office Action, mailed on April 9, 2003, all claims 1-57 were rejected. Claims 1-18, 23-50 and 55-57 were rejected under §103(a) as being unpatentable over Rautiola et al., WO 99/48315, (“Rautiola”) in view of Hardwick et al. (Project P946-GI Smart Devices “When Things Start to Think” (“Hardwick”). (Non-Final Office Action dated April 9, 2003, p. 2.) Claims 19-22 and 51-54 were rejected under §103(a) “as being unpatentable over Rautiola in view of Hardwick further in view of Parekh” (Operating Systems on Wireless Handheld Devices, pages 1-8, September 28, 2000)” (“Parekh”). (Non-Final Office Action dated April 9, 2003, p. 20.) Claims 19-22 and 51-54 were rejected under §103(a) “as being unpatentable over Rautiola in view of Hardwick further in view of Dell (White Paper, Handheld Devices: Comparing The Major Platforms, pages 1-7)” (“Dell”). (Non-Final Office Action dated April 9, 2003, p. 22.)

In response to the Non-Final Office Action, applicant amended claims 1-18 and 23-54. Independent claim 1 was amended to state “*wherein the first wireless device is capable of communicating with the cellular network and receiving the first short-range radio signal concurrently*” which is not taught or suggested by Rautiola or Hardwick which limit concurrent operation (Amendment dated October 14, 2003, p. 17.)

In the subsequent Final Office Action dated January 5, 2004, all claims 1-57 were rejected.

Claims 1-25 were rejected under §112 first paragraph as failing to comply with the written description requirement. Claims 45-48 were rejected under §112 second paragraph as being indefinite for failing to particularly point out and distinctly claim the subject matter which applicant regards as the invention. Claims 1-18, 23-50, and 55-57 were rejected under §102(e) “as being anticipated by U.S. Publication No. 2002/0118663 (“Dorenbosch”). (Final Office Action dated January 5, 2004, p. 3.) Claims 19-22 and 51-54 were rejected under §103(a) as being unpatentable over Dorenbosch in view of Parekh. (Final Office Action dated January 5, 2004, pp. 16-17.) Claims 19-22 and 51-54 were rejected under §103(a) as being unpatentable over Dorenbosch in view of Dell. (Final Office Action dated January 5, 2004, p. 18.)

On January 28, 2004, a telephonic interview was conducted between the Examiner and the Applicant, but no agreement was reached. During the interview, the Examiner advised Applicant to file a response for consideration. (Examiner Interview Summary dated February 2, 2004, p. 3.)

In response to the Final Office Action, applicant submitted an amendment on April 9, 2004 amending claims 1, 3-6, 26-30, 36, 39-42, 44-49, 51-54 and adding claim 58. As part of that amendment, in relation to the rejection under §112 first paragraph, the term “concurrently” was removed from claim 1. In relation to the rejection under §112 second paragraph, claims 45-49 were amended to claim “the first wireless handheld device”. (Amendment dated April 9, 2004, p. 12.) Applicant additionally filed a Declaration of Amit Haller “swearing behind” Dorenbosch et al. reference to overcome the §102(e) rejection over Dorenbosch, the §103(a) rejection over Dorenbosch in view of Parekh and the §103(a) rejection over Dorenbosch in view of Dell. (Amendment dated April 9, 2004, pp. 12-13.)

In the subsequent Non-Final Office Action, mailed on July 7, 2004, all claims, 1-58, were rejected. Claims 3 and 30 were rejected under §112, second paragraph. Claims 1-58 were rejected

under §102(a) as “being anticipated by Karagiannis (Mobility support for ubiquitous Internet access, Ericsson Open report, pages 1-70, December 21, 2000). (“Karagiannis”). (Non-Final Office Action dated July 7, 2004, p. 3.) Claims 19-22 were rejected under §103(a) as being unpatentable over Karagiannis in view of Parekh. Claims 19-22 were rejected under §103(a) as being unpatentable over Karagiannis in view of Dell. (Non-Final Office Action dated July 7, 2004, pp. 17-18.)

In response to the Non-Final Office Action, applicant submitted an amendment on January 10, 2005, amending claims 1-3, 5-6, 12-17, 23, 26-30, 36-37, 44-45, 49-50, 53, 58 and canceling claims 4 and 32. (Amendment dated January 10, 2005, p. 12.)

In the subsequent Final Office Action dated May 25, 2005, all claims 1-58 were rejected. Claim 39 was rejected under §112, second paragraph. Claims 1-3, 5-18, 23-25, 26-31, 33-50 and 55-57 were rejected under §102(e) as being anticipated by Lord et al. U.S. Patent No. 6,763,012 (“Lord”). (Final Office Action dated May 25, 2005, pp. 2-3.) Claims 19-22 and 51-54 were rejected under §103(a) as being unpatentable over Lord in view of Parekh. (Final Office Action dated May 25, 2005, p. 16.) And, claims 19-22 and 51-54 were rejected under §103(a) as being unpatentable over Lord in view of Dell. (Final Office Action dated May 25, 2005, pp. 17-18.)

In response to the Final Office Action, applicant submitted an amendment on August 29, 2005, amending claims 1, 14-17, 23, 26, 36, 39-42, 44, 49-50 and 58. (Amendment dated August 29, 2005, p. 12.) Following this amendment, the Examiner issued a notice of allowance. (Notice of Allowance dated October 24, 2005, p. 1.)

#### **B. Summary of the ‘033 Patent**

The ‘033 Patent is directed to “a system that accesses information from a wide area network (‘WAN’), such as the Internet, and local wireless devices in response to short-range radio signals.”

(Ex. PAT-A, “’033 patent” at 4:8-11; Abstract.) The system includes a wireless gateway device that is coupled to the WAN and to a personal area network (“PAN”). (*Id.* at Abstract; FIG. 1.) The wireless gateway device allows devices connected on the PAN to connect to the WAN. The wireless gateway device also includes software components that allow devices on the PAN to communicate and share services, and includes the ability to provide security to the network.

Figure 1 provides an illustration of the system described in the ’033 Patent and is depicted below:

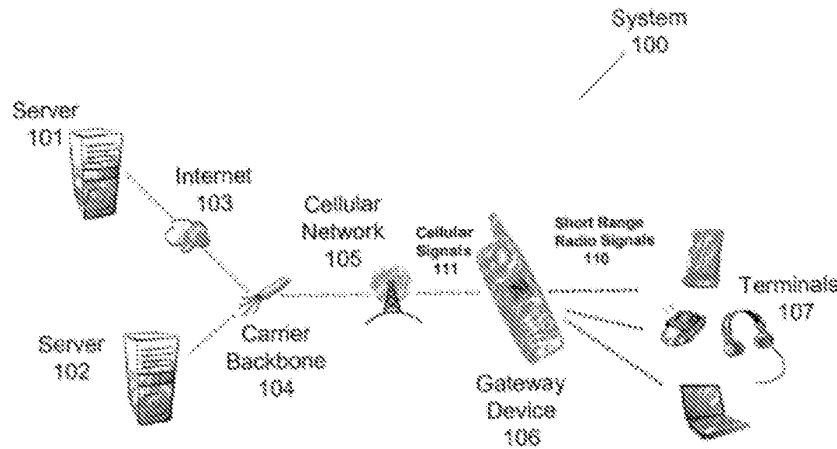

Fig. 1

(Ex. PAT-A, “’033 Patent”, Fig. 1)

The Gateway Device 106 communicates with one or more terminals 107 to form a personal area network (“PAN”) using short-range radio signals 110. (*Id.* at 4:16-21.) The PAN is implemented using local wireless technology such as Bluetooth or 802.11, which is commonly referred to as Wi-Fi. (*Id.* at 4:25-35.) The Gateway Device 106 is coupled to cellular network 105 and can communicate with, for example, Server 101 and Server 102 via carrier backbone 104. (*Id.* at 4:36-59.) In so doing, Servers 101 and 102 can provide information, such as web pages or



application software components, to terminals 107 in the WLAN by way of the Gateway Device 106. (*Id.* at 4:49-54.)

The software components described in the '033 patent are what enables the Gateway Device to connect the terminals on the PAN to the WAN and offer network management and security functions. As part of the architecture, the Gateway Device includes a “[s]ervice repository software component 704.” The service repository software component “allows applications 406, which run on a gateway device 106 or terminals 107, to discover what services are offered by a PAN, and to determine the characteristics of the available services.” (*Id.* at 12:11-14.)

The Gateway Device 106 also includes a “Plug and Play component.” The “Plug and Play” capability of Gateway Device 106 allows it to identify a new terminal and determine the necessary software required to support the new terminal. (*Id.* at 10:11-37; Fig. 7.) Terminals connecting to the PAN are not necessarily readily supported by the Gateway Device 106. For example, the '033 Patent identifies the introduction of “thin” terminals to the PAN as an example of utilizing the “Plug and Play” capability of the Gateway Device 106. (*Id.* at 10:18-35.) Thin terminals do not have embedded application code or data. *Id.* In order to support these types of devices, the “Plug and Play component” uses the terminals’ identification to find, download, and execute the software necessary for the Gateway Device 106 to support the terminal. (*Id.* at 10:11-37.)

**VII. 37 C.F.R. §1.510(b)(1): Statement Establishing Substantial New Questions of Patentability (“SNQs”) of Claim 48 and 56 of the ‘033 Patent**

**A. Marchand in view of Nurmman, and Vilander establishes a substantial new question of patentability with respect to independent claim 48 of the ‘033 patent.**

The combination of Marchand, Nurmman, and Vilander fails to render obvious claim 48 and thus while it raises a substantial new question of patentability it does not render the claim unpatentable.

Marchand in view of Nurmann and Vilander was applied against claim 1 in Ground 1 of the '1444 IPR. The PTAB instituted the '1444 IPR on December 30, 2015 and issued a Final Written Decision on December 21, 2016.

While Marchand in view of Nurmann and Vilander was applied against base claim 1 in the '1444 IPR, the combination was not considered in relation to claim 48 of the '033 patent, either by the PTAB or during prosecution of the application that led to the issuance of the '033 patent. Thus, as explained in detail below, Marchand in view of Nurmann and Vilander presents a substantial new question of patentability with respect to claim 48 that has not previously been presented to the Office prior to the instant request for reexamination. Moreover, and as explained in further detail below in reference to each limitation of claim 48, the combination of Marchand in view of Nurmann and Vilander does not rise to the level of unpatentability.

As seen in the table below, claim 1 and claim 48 have similar limitations and thus a person of ordinary skill in the art would consider that the combination of Marchand, Nurmann, and Vilander are important in the consideration of patentability. However, it is the position of the Patent Owner that while it may raise a substantial new question of patentability the combination does not render claim 48 unpatentable.

| Claim 1   | Claim 48   | Claim 56   |
|---|--|--|
| 1. A system for providing access to the Internet, comprising: | 48. An article of manufacture, including a computer readable medium, comprising: | 56. A handheld device for providing a short distance wireless network, comprising: |
| a first wireless device, in a short distance wireless         | a short-range radio software component to  | a storage device; means for identifying  |

| Claim 1   | Claim 48  | Claim 56   |
|---|---|--|
| <p>network, having a software component to access information from the Internet by communicating with a cellular network in response to a first short-range radio signal,</p>   | <p>communicate with a device in a short distance wireless network by using a short-range radio signal;</p>  | <p>an availability of a plurality of services to a plurality of application software components in the short distance wireless network;</p>  |
| <p>wherein the first wireless device communicates with the cellular network and receives the first short-range radio signal; and, a second wireless device, in the short distance wireless network, to provide the first short-range radio signal, wherein the software component includes a network address translator software component to translate between a first Internet Protocol (“IP”) address provided to the first wireless device from the</p> | <p>a cellular software component to communicate with a cellular network by using a cellular signal; a network software component to selectively transfer an Internet Protocol (“IP”) data packet between the device and the cellular network; a service repository software component to identify a plurality of available services from a plurality of devices in the short distance wireless network, the service repository software</p> | <p>means for selectively providing the plurality of services to the plurality of application software components in the short distance wireless network; and means for selectively transferring an Internet Protocol (“IP”) data packet between a cellular network and a selected application software component in the plurality of application software components in the short distance wireless network.</p> |

| Claim 1   | Claim 48  | Claim 56 |
|---|---|----------|
| cellular network and a second address for the second wireless device provided by the first wireless device, wherein the software component includes a providing the plurality of services component to identify a service provided by the second wireless device. | component having a uniform interface so that both a local application software component and a remote application software component identifies the plurality of available services; and a plurality of service logical drivers corresponding to the plurality of available services that are used to obtain the plurality of services, the plurality of service logical drivers are used in obtaining the plurality of services. |          |

**B. The ‘1444 IPR Art Does Not Render Claim 48 Unpatentable**

Below, relevant limitations of claim 48 will be reviewed in the context of the ‘1444 IPR art to establish that the claim is patentable over Ground 1 of the ‘1444 IPR. As the arguments presented below are not exhaustive of the applicable patentability grounds, Patent Owner reserves its right to present further arguments to the extent necessary.

**48. An article of manufacture, including a computer readable medium, comprising:**

*... a short-range radio software component to communicate with a device in a short distance wireless network by using a short-range radio signal;*

Marchand is directed to a Bluetooth piconet that has been extended into an Internet Protocol (IP) wireless local area network implementing JINI/Java technology to share services between devices in the piconet through the Jini technology. (Ex. PA-A, “Marchand” at Abstract; 5:23-25; 6:25-27.) Specifically, a mobile phone (article of manufacture in claim 48) connected to the Bluetooth (a short-range radio signal in claim 48) piconet is configured to serve as a gateway to provide a call control interface between the wireless IP network and other devices in the piconet. (Ex. PA-A, “Marchand” at Abstract; *see also* Ex. OTH-A, “Mandayam Decl.” at ¶45.)

*... a cellular software component to communicate with a cellular network by using a cellular signal; a network software component to selectively transfer an Internet Protocol (“IP”) data packet between the device and the cellular network*

In Figure 3 of Marchand the gateway mobile phone 33 has both a radio access modem (cellular software component in claim 48) and a Bluetooth chipset. (Ex. PA-A, “Marchand” at 7:12-25; 11:7.) The radio access modem provides an interface with a public IP address for accessing the wireless IP network and the Bluetooth chipset provides an interface with a private IP address for accessing the piconet. (*Id.* at 11:7-10.) When another device in the piconet uses the call control client of the mobile phone, the mobile phone pushes incoming IP packets received on its public IP address to the private IP address of the device in the piconet, and also translates IP packets in the other direction. (*Id.* at 7:14-17; 11:13-16.) The translation between public and private IP addresses is performed by an API sent from the mobile phone to the device requesting the call control service. (*Id.* at 11:17-18; 15: 25-31.) (Ex. OTH-A, “Mandayam Decl.” at ¶54.)

*... a service repository software component to identify a plurality of available services from a plurality of devices in the short distance wireless network, the service repository software component having a uniform interface so that both a local application software component and a remote application software component identifies the plurality of available services;*

The combination of Marchand, Nurmman, and Vilander proposed by Petitioner in the IPR fails to teach or disclose this limitation of claim 48. In Ground 1 of the IPR, Petitioner relied solely on the teachings of Marchand to suggest that the alleged combination of Marchand, Nurmman, and Vilander meets the “service repository software component” limitation. More particularly, Petitioner argued that Marchand teaches this claim element through its description of the JINI LUS. Petitioner’s arguments, however, are based on a fundamental misunderstanding of the underlying JINI technology in Marchand and are contrary to Marchand’s explicit teachings. A person of ordinary skill in the art (POSITA) would not understand Marchand to disclose that its JINI LUS is physically located on Marchand’s cellular-enabled mobile phone 33, and further, a POSITA would have no motivation to modify Marchand to place the JINI LUS on the mobile phone (article of manufacture in claim 48) in view of Marchand’s explicit teachings to the contrary. (Ex. OTH-A, “Mandayam Decl.” at ¶¶53-54.)

With respect to Ground 1 of IPR2015-01444, the PTAB acknowledged that by Petitioner’s own admission, the LUS of Marchand does not explicitly satisfy the “service repository software component” limitations of claims 1, 4, 7, and 14. (Ex. 1, “1444 Final Decision” at pp. 15-16.) The PTAB however determined that Marchand would have implicitly informed a person skilled in the art that the “service repository software component” may be disposed in the “first wireless device”. (*Id.* at p. 20.) The PTAB’s conclusion is incorrect for at least two reasons that were not originally presented in Patent Owner’s response: 1) Marchand teaches away from the PTAB’s reading of the

reference as Marchand describes several disadvantages associated with duplicating resources such as a JINI LUS or “service repository software component” on multiple devices within a piconet, and 2) available mobile phone technology in 2001 filing date of the ‘033 application was incapable of implementing JINI and/or the JINI LUS application. (Ex. OTH-A, “Mandayam Decl.” at ¶¶64, 72-76.) For these reasons, in addition to the positions presented in Patent Owner’s Response, there would be no motivation or rationale for a person skilled in the art to modify the previously established network of Marchand by either 1) duplicating the JINI LUS functionality and having it resident in both the laptop computer and the mobile phone gateway or 2) repositioning the LUS from the laptop computer to the mobile phone gateway. (*Id.*)

Regarding the first reason, Marchand teaches that it is “inefficient from the resource point of view” and “inappropriate, expensive, and cumbersome” to have the same hardware and software on all the devices in the piconet, such as a cellular radio modem (Ex. PA-A, “Marchand” at 4:1-9) or call control client (Ex. PA-A, “Marchand” at 6:31-7:2; *see also* Ex. OTH-A, “Mandayam Decl.” at ¶¶50, 65. (“The API is downloaded only to the device involved in the call since the other Bluetooth devices that are not making the call do not need this particular code.”)) Accordingly, Marchand does not support duplicating resources such as an LUS as a service repository component on both the laptop computer and the mobile phone gateway, as this “defeats the purpose of forming a piconet to share services among devices.” (Ex. OTH-A, “Mandayam Decl.” at ¶65.)

According to the explicit teachings in Marchand, JINI LUS is hosted by the laptop computer not the mobile phone gateway. (Ex. PA-A, “Marchand” at FIG. 4; *see also* Ex. OTH-A, “Mandayam Decl.” at ¶¶55, 66.) In Marchand, when a device joins an existing Bluetooth piconet, it can perform a “discovery and join” protocol to locate the LUS, hosted on the laptop computer, and publish its services to the LUS so those services are then made available to other devices on

the piconet. (Ex. PA-A, “Marchand” at 8:11-15.) Marchand explicitly defines where the list of available services is located: “[t]he services menu **on the laptop** indicates all services available on the Piconet.” (Ex. PA-A, “Marchand” at 10:24; boldface added.) It is also clear from Figure 4 which explicitly shows the LUS feature on the laptop computer and not any other device. Thus, the only explicit teachings in Marchand point to the network’s LUS being located on the laptop. (Ex. OTH-A, “Mandayam Decl.” at ¶¶55, 66).

Regarding the second reason, it is clear from Marchand, when viewed in the context of JINI functionality and prevailing limitations regarding hardware and software for mobile phones, that a POSITA in 2001 would not **infer** that JINI LUS could be implemented on the mobile phone gateway. (Ex. OTH-A, “Mandayam Decl.” at ¶73.) The implicit teachings advanced by the Petitioner and adopted by the PTAB in the Final Written Decision, are contrary to Marchand, how the JINI LUS feature functions and the limitations of wireless phone technology in 2001. (Ex. OTH-A, “Mandayam Decl.” at ¶¶72-78.) In its Final Written Decision the Board relied on Petitioner and their expert Dr. Kiaei’s argument that 1) Marchand’s call control API is a JINI proxy object and 2) a JINI call control API is downloaded from the gateway to the other devices on the ad-hoc network to support its conclusion that an ordinary skilled artisan “would have understood Marchand as implicitly describing an implementation in which the JINI LUS which identifies services provided by devices on the network 30, is located on the mobile phone gateway 33.” (Ex. 1, “1444 Final Decision” at pp. 14-15; 18-19.)

Per the JINI Spec, the purpose of an LUS is to provide a registry of services that can be registered and searched for within a piconet so that other devices can make use of the available services. (See Ex. PA-F, “JINI Spec Part 1” at pp. 22-23). As detailed in the background section above, once a device joins a JINI/Java network, the joining device transfers java code (referred to



as a proxy object or java object) to the LUS. (*Id.*) This small amount of java code is used to identify the service(s) the joining device offers and to establish an interface with that service. (*See* Ex. PA-F, “JINI Spec Part 1” at pp. 22-23; *see also* Ex. PA-A, “Marchand” at 3:13-14.) The LUS stores this java object and creates a list of the services available on the network. (Ex. PA-F, “JINI Spec Part 1” at pp. 21-22; Ex. PA-A, “Marchand” at 3:11-12.) For example, if a printer joins a network utilizing JINI technology, the printer will publish its printing service to the network by transferring java code to the LUS. (Ex. PA-F, “JINI Spec Part 1” at p. 22.) The java code includes the printer’s information and a method to implement its printer interface. (*Id.*)

While JINI technology defines an architecture for JINI/Java capable devices to publish and share services using the JINI LUS, it does not define how a device offering its services implements a given service or how the service is utilized by another device. (*See* Ex. OTH-A, “Mandayam Decl.” at ¶¶52-53.) Instead, JINI technology requires that the sharing device provide its own protocol to control the use of its shared service. (*Id.*) For example, in Marchand’s system, the gateway mobile device shares its call control service with other devices on the Bluetooth piconet through the LUS on the laptop, with the call control service defining the protocol for another device to utilize this service of Marchand’s mobile phone. (*Id.*) However, under the described protocol Marchand’s mobile phone merely provides a calling service” code much as the printer provides a “printing service” code to the LUS. (*Id.*)

It follows that regarding the mobile phone, once the call control service is published in the services menu of the laptop, the details of how the mobile phone shares its call control service—e.g. through specific API interfaces that are downloaded to each device as a proxy object—to become a gateway for other devices on the network is not part of the JINI LUS technology. (*Id.*) After the service code is published to the LUS, the other devices on the piconet can access the

published service code and interface method per its defined protocol and use the mobile phone as a gateway to the IP network. (Ex. PA-A, “Marchand” at 10:12-16; *see also* Ex. OTH-A, “Mandayam Decl.” at ¶66.) Thus, contrary to Petitioner’s arguments, the details of how the phone interacts with other devices as a gateway cannot be used to establish that the phone serves as the LUS—because these details are irrelevant to the workings of JINI’s LUS feature. Like the mobile phone, when other devices join the network, such as a PDA or printer, they first publish their service to the LUS and then may use the LUS to discover network services, e.g. the call control client code of the mobile phone to access its gateway services. (Ex. PA-A, “Marchand” at 10:18-20.) “For example, other BLUETOOTH devices on the piconet perform a JINI-defined add-in ‘discovery and join’ protocol ‘to locate the LUS and upload all of its services’ interfaces, including call control services. (*Id.* at 8:12-20.) The ability for the other devices, including the mobile phone, to send Java code to the rest of the network to facilitate the sharing of services in no way equates to the “discover and join” LUS feature itself, which provides the claimed “service repository software component” and per Marchand is located on the laptop computer. (Ex. OTH-A, “Mandayam Decl.” at ¶53)

Absent some teaching in Marchand that the LUS feature resides on the mobile phone, the Ground 1 argument advanced in the IPR fails. The ’033 Patent calls for the service “repository software component” to be located on the first wireless device-- the cellular device. In the case of claim 48, the “repository software component” is specifically located on the article of manufacture, the gateway device. Petitioner in the IPR relied on their expert Dr. Kiaei’s opinions to argue that Marchand implicitly teaches that its JINI LUS is located on Marchand’s gateway mobile phone. When the teachings of Marchand are properly considered from the perspective of a person of ordinary skill in the art, it is however clear that Marchand precludes the JINI LUS from being

located on its gateway mobile phone. (Ex. OTH-A, “Mandayam Decl.” at ¶¶72-78.)

Moreover, the JINI LUS relied on in Marchand required hardware resources (memory and processor) that exceeded the capabilities of mobile phones at the time (See Ex. 9, “PsiNaptic” at pp. 31-32; Ex. OTH-A, “Mandayam Decl.” at ¶67.) As described in the background section above, the hardware required to operate the JINI LUS—at least 3 megabytes of memory—was not available on mobile phones during the relevant 2001 time period. (Ex. OTH-A, “Mandayam Decl.” at ¶¶36-37). With a memory of at most 2 megabytes and 13 MHz CPU, mobile phones in 2000-2002 were not able to support the JINI application, let alone the LUS feature. (*Id.*) This limitation was recognized by the developer of the JINI/Java software platforms, Sun Microsystems, who developed an alternate, “micro” version of JINI, known as J2ME, that was streamlined for mobile phones but lacked the functionality required to support the LUS feature. (*Id.* at ¶¶28-29.) The limitations of the J2ME application and specifically its inability to run Jini and the LUS feature were well known in 2001 (Ex. OTH-A, “Mandayam Decl.” at ¶¶31-37.) Several articles in 2001-2002 documented the mismatch between the JINI requirements and mobile phone capabilities: “The resulting Jini LookUp Service implementation is too large (e.g., typically requiring more than 3 megabytes of static and running storage). Many networked computing devices are. . . mobile—too small to support an RMI based Jini”; “The most limited devices run Java 2 Micro Edition [J2ME], but this cannot support Jini as it lacks dynamic class loading and object serialization. So despite progress in downsizing Java, the value-proposition of Jini for mobile devices remains an unattained promise.” (*Id.* at ¶¶30-31; Ex. 9, “PsiNaptic” at pp. 31-32; Ex. 2, “Motorola” at p. 2).

Accordingly, a person skilled in the art, would not **infer** that the JINI LUS feature could be duplicated or repositioned from the laptop computer to the mobile phone as Petitioner argued

in the IPR. (Ex. OTH-A, “Mandayam Decl.” at ¶73). Moreover, even if the JINI LUS feature was moved to a mobile phone, it would have been **inoperable** on the mobile phones that existed during the relevant time-period as they lacked the required system requirements, such as memory and processing capabilities. As discussed in the background section, the developer of Java and Jini, Sun Microsystems, recognized that mobile phones could not run the full Java application and devised a lighter application J2ME for phones, but with its reduced memory and processing capabilities that version of Java was not able to support Jini or its LUS feature. (Ex. OTH-A, “Mandayam Decl.” at ¶73 citing Ex. 2, “Motorola” at p. 2.) While Marchand appears to recognize that consumer products such as laptops and PDAs may soon be modified to provide multimedia and telephony applications, (Ex. PA-A, “Marchand” at 7:2-6), there is no teaching or suggestion that mobile phones may be modified to include laptop computer applications or PDA applications. As Marchand relies on JINI and the LUS feature and in view of the limitations of mobile phones to support both platforms, it is not surprising that Marchand only teaches a surrogate approach, where JINI and LUS are placed on the laptop computer and the phone accesses the technology through the network. (Ex. OTH-A, “Mandayam Decl.” at ¶¶37-38).

Thus, in view of the above, one of ordinary skill in the art would not apply the combination of Marchand, Nurmann and Vilander to arrive at Claim 48, however the combination does rise to the level of a substantial new question of patentability that has not been previously presented to the Office for claim 48.

**C. Marchand in view of Nurmann, and Vilander establishes a substantial new question of patentability with respect to independent claim 56 of the ‘033 patent.**

The combination of Marchand, Nurmann, and Vilander fails to render obvious claim 56 and thus while it raises a substantial new question of patentability it does not render the claim

unpatentable. Marchand in view of Nurmman and Vilander was applied against claim 1 in Ground 1 of the '1444 IPR. The PTAB instituted the '1444 IPR on December 30, 2015 and issued a Final Written Decision on December 21, 2016.

While Marchand in view of Nurmman and Vilander was applied against base claim 1 in the '1444 IPR, the combination was neither considered by the PTAB nor the PTO during prosecution of the application against claim 56 of the '033 patent. Thus, as explained in detail below, Marchand in view of Nurmman and Vilander presents a substantial new question of patentability with respect to claim 56 that has not previously been presented to the Office prior to the instant request for reexamination. Moreover, and as explained in further detail below in reference to certain limitations of claim 56, the combination of Marchand in view of Nurmman and Vilander does not rise to the level of unpatentability.

As seen in the table on pp. 25-26, claim 1 and claim 56 have similar limitations and thus a person of ordinary skill in the art would consider that the combination of Marchand, Nurmman and Vilander are important in the consideration of patentability. However, it is the position of the Patent Owner that while it may raise a substantial new question of patentability the combination does not render claim 56 unpatentable. As the arguments presented below are not exhaustive of the applicable patentability grounds, Patent Owner reserves its right to present further arguments to the extent necessary.

**D. The '1444 IPR Art Does Not Render Claim 56 Unpatentable**

Below, relevant limitations of claim 56 will be reviewed in the context of the '1444 IPR art to establish that the claim is patentable over Ground 1 of the '1444 IPR.

**56. A handheld device for providing a short distance wireless network, comprising:**

*... a storage device;*

Marchand is directed to a Bluetooth piconet that has been extended into an Internet Protocol (IP) wireless local area network implementing JINI/Java technology to use the JINI technology to share services between devices in the piconet. (Ex. PA-A, “Marchand” at Abstract; 5:23-25; 6:25-27.) Moreover, a mobile phone connected to the piconet is configured to serve as a gateway to provide a call control interface between the wireless IP network and other devices in the piconet. (Ex. PA-A, “Marchand” at Abstract; *see also* Ex. OTH-A, “Mandayam Decl.” at ¶45.)

*... means for identifying an availability of a plurality of services to a plurality of application software components in the short distance wireless network;*

The combination of Marchand, Nurmman, and Vilander proposed by Petitioner fails to teach or disclose this limitation of claim 56. In Ground 1, Petitioner relied solely on the teachings of Marchand to suggest that the alleged combination of Marchand, Nurmman, and Vilander meets the “service repository software component” in claim 1. Support for construing the “means for identifying an availability of a plurality of services to a plurality of application software components in the short distance wireless network” limitation as the “service repository software component” under 35 U.S.C. § 112(6) can be found in the ‘033 patent. (Ex. PA-A, “’033 patent” at 12:11-14.)

More particularly, Petitioner argued that Marchand teaches this claim element through its description of the JINI LUS. Petitioner’s arguments, however, are based on a fundamental misunderstanding of the underlying JINI technology in Marchand and are contrary to Marchand’s explicit teachings. A person of ordinary skill in the art (POSITA) would not understand Marchand to disclose that its JINI LUS is physically located on Marchand’s cellular-enabled mobile phone 33, and further, a POSITA would have no motivation to modify Marchand to place the JINI LUS on the mobile phone (article of manufacture in claim 48) in view of Marchand’s explicit teachings

to the contrary. (Ex. OTH-A, “Mandayam Decl.” at ¶¶53-54.)

With respect to Ground 1 of IPR2015-01444, the PTAB acknowledged that by Petitioner’s own admission, the LUS of Marchand does not explicitly satisfy the “service repository software component” limitations of claims 1, 4, 7, and 14. (Ex. 1, “1444 Final Decision” at pp. 15-16.) The PTAB however determined that Marchand would have implicitly informed a person skilled in the art that the “service repository software component” may be disposed in the “first wireless device”. (*Id.* at p. 20.) The PTAB’s conclusion is incorrect for at least two reasons that were not originally presented in Patent Owner’s response: 1) Marchand teaches away from the PTAB’s reading of the reference as Marchand describes several disadvantages associated with duplicating resources such as a JINI LUS or “service repository component” on multiple devices within a piconet, and 2) available mobile phone technology in 2001 filing date of the ‘033 application was incapable of implementing JINI and/or the JINI LUS application. (Ex. OTH-A, “Mandayam Decl.” at ¶¶64, 72-76.) For these reasons, in addition to the positions presented in Patent Owner’s Response, there would be no motivation or rationale for a person skilled in the art to modify the previously established network of Marchand by either 1) duplicating the JINI LUS functionality and having it resident in both the laptop computer and the mobile phone gateway or 2) repositioning the LUS from the laptop computer to the mobile phone gateway. (*Id.*)

Regarding the first reason, Marchand teaches that it is “inefficient from the resource point of view” and “inappropriate, expensive, and cumbersome” to have the same hardware and software on all the devices in the piconet, such as a cellular radio modem (Ex. PA-A, “Marchand” at 4:1-9) or call control client (Ex. PA-A, “Marchand” at 6:31-7:2; *see also* Ex. OTH-A, “Mandayam Decl.” at ¶¶50, 65. (“The API is downloaded only to the device involved in the call since the other Bluetooth devices that are not making the call do not need this particular code.”) Accordingly,

Marchand does not support duplicating resources such as an LUS as a service repository component on both the laptop computer and the mobile phone gateway, as this “defeats the purpose of forming a piconet to share services among devices.” (Ex. OTH-A, “Mandayam Decl.” at ¶¶65.)

According to the explicit teachings in Marchand, JINI LUS is hosted by the laptop computer not the mobile phone gateway. (Ex. PA-A, “Marchand” at FIG. 4; *see also* Ex. OTH-A, “Mandayam Decl.” at ¶¶55, 66.) In Marchand, when a device joins an existing Bluetooth piconet, it can perform a “discovery and join” protocol to locate the LUS, hosted on the laptop computer, and publish its services to the LUS so those services are then made available to other devices on the piconet. (Ex. PA-A, “Marchand” at 8:11-15.) Marchand explicitly defines where the list of available services is located: “[t]he services menu **on the laptop** indicates all services available on the Piconet.” (Ex. PA-A, “Marchand” at 10:24; boldface added.) It is also clear from Figure 4 which explicitly shows the LUS feature on the laptop computer and not any other device. Thus, the only explicit teachings in Marchand point to the network’s LUS being located on the laptop. (Ex. OTH-A, “Mandayam Decl.” at ¶¶55, 66).

Regarding the second reason, it is clear from Marchand, when viewed in the context of JINI functionality and prevailing limitations regarding hardware and software for mobile phones, that a POSITA in 2001 would not **infer** that JINI LUS could be implemented on the mobile phone gateway. (Ex. OTH-A, “Mandayam Decl.” at ¶73.) The implicit teachings advanced by the Petitioner and adopted by the PTAB in the Final Written Decision, are contrary to Marchand, how the JINI LUS feature functions and the limitations of wireless phone technology in 2001. (Ex. OTH-A, “Mandayam Decl.” at ¶¶72-78.) In its Final Written Decision the Board relied on Petitioner and their expert Dr. Kiaei’s argument that 1) Marchand’s call control API is a JINI proxy object and 2) a JINI call control API is downloaded from the gateway to the other devices on the



ad-hoc network to support its conclusion that an ordinary skilled artisan “would have understood Marchand as implicitly describing an implementation in which the JINI LUS which identifies services provided by devices on the network 30, is located on the mobile phone gateway 33.” (Ex. 1, “1444 Final Decision” at pp. 14-15; 18-19.)

Per the JINI Spec, the purpose of an LUS is to provide a registry of services that can be registered and searched for within a piconet so that other devices can make use of the available services. (See Ex. PA-F, “JINI Spec Part 1” at pp. 22-23.) As detailed in the background section above, once a device joins a JINI/Java network, the joining device transfers java code (referred to as a proxy object or java object) to the LUS. (*Id.*) This small amount of java code is used to identify the service(s) the joining device offers and to establish an interface with that service. (See Ex. PA-F, “JINI Spec Part 1” at pp. 22-23; see also Ex. PA-A, “Marchand” at 3:13-14.) The LUS stores this java object and creates a list of the services available on the network. (Ex. PA-F, “JINI Spec Part 1” at pp. 22-23; Ex. PA-A, “Marchand” at 3:11-12.) For example, if a printer joins a network utilizing JINI technology, the printer will publish its printing service to the network by transferring java code to the LUS. (Ex. PA-F, “JINI Spec Part 1” at p. 22.) The java code includes the printer’s information and a method to implement its printer interface. (*Id.*)

While JINI technology defines an architecture for JINI/Java capable devices to publish and share services using the JINI LUS, it does not define how a device offering its services implements a given service or how the service is utilized by another device. (See Ex. OTH-A, “Mandayam Decl.” at ¶¶52-53.) Instead, JINI technology requires that the sharing device provide its own protocol to control the use of its shared service. (*Id.*) For example, in Marchand’s system, the gateway mobile device shares its call control service with other devices on the Bluetooth piconet through the LUS on the laptop, with the call control service defining the protocol for another device

to utilize this service of Marchand’s mobile phone. (*Id.*) However, under the described protocol Marchand’s mobile phone merely provides a calling service” code much as the printer provides a “printing service” code to the LUS. (*Id.*)

It follows that regarding the mobile phone, once the call control service is published in the services menu of the laptop, the details of how the mobile phone shares its call control service—e.g. through specific API interfaces that are downloaded to each device as a proxy object—to become a gateway for other devices on the network is not part of the JINI LUS technology. (*Id.*) After the service code is published to the LUS, the other devices on the piconet can access the published service code and interface method per its defined protocol and use the mobile phone as a gateway to the IP network. (Ex. PA-A, “Marchand” at 10:12-16; *see also* Ex. OTH-A, “Mandayam Decl.” at ¶66.) Thus, contrary to Petitioner’s arguments, the details of how the phone interacts with other devices as a gateway cannot be used to establish that the phone serves as the LUS—because these details are irrelevant to the workings of JINI’s LUS feature. Like the mobile phone, when other devices join the network, such as a PDA or printer, they first publish their service to the LUS and then may use the LUS to discover network services, e.g. the call control client code of the mobile phone to access its gateway services. (Ex. PA-A, “Marchand” at 10:18-20.) “For example, other BLUETOOTH devices on the piconet perform a JINI-defined add-in ‘discovery and join’ protocol ‘to locate the LUS and upload all of its services’ interfaces, including call control services. (*Id.* at 8:12-20.) The ability for the other devices, including the mobile phone, to send Java code to the rest of the network to facilitate the sharing of services in no way equates to the “discover and join” LUS feature itself, which provides the claimed “service repository software component” and per Marchand is located on the laptop computer. (Ex. OTH-A, “Mandayam Decl.” at ¶53)

Absent some teaching in Marchand that the LUS feature resides on the mobile phone, the Ground 1 argument advanced in the IPR fails. The '033 Patent calls for the service “repository software component” to be located on the first wireless device-- the cellular device. In the case of claim 56, the “means for identifying” limitation or “service repository software component” is specifically located on the handheld device or mobile phone. Petitioner in the IPR relied on their expert Dr. Kiaei’s opinions to argue that Marchand implicitly teaches that its JINI LUS is located on Marchand’s gateway mobile phone. (Ex. 1, “1444 Final Decision” at p. 15.) When the teachings of Marchand are properly considered from the perspective of a person of ordinary skill in the art, it is however clear that Marchand precludes the JINI LUS from being located on its gateway mobile phone. (Ex. OTH-A, “Mandayam Decl.” at ¶¶72-78.)

Moreover, the JINI LUS relied on in Marchand required hardware resources (memory and processor) that exceeded the capabilities of mobile phones at the time (See Ex. 9, “PsiNaptic” at pp. 31-32; Ex. OTH-A, “Mandayam Decl.” at ¶67.) As described in the background section above, the hardware required to operate the JINI LUS—at least 3 megabytes of memory—was not available on mobile phones during the relevant 2001 time period. (Ex. OTH-A, “Mandayam Decl.” at ¶¶36-37). With a memory of at most 2 megabytes and 13 MHz CPU, mobile phones in 2000-2002 were not able to support the JINI application, let alone the LUS feature. (*Id.*) This limitation was recognized by the developer of the JINI/Java software platforms, Sun Microsystems, who developed an alternate, “micro” version of JINI, known as J2ME, that was streamlined for mobile phones but lacked the functionality required to support the LUS feature. (*Id.* at ¶¶28-29.) The limitations of the J2ME application and specifically its inability to run Jini and the LUS feature were well known in 2001 (Ex. OTH-A, “Mandayam Decl.” at ¶¶31-37.) Several articles in 2001-2002 documented the mismatch between the JINI requirements and mobile phone capabilities:

“The resulting Jini LookUp Service implementation is too large (e.g., typically requiring more than 3 megabytes of static and running storage). Many networked computing devices are. . . mobile—too small to support an RMI based Jini”; “The most limited devices run Java 2 Micro Edition [J2ME], but this cannot support Jini as it lacks dynamic class loading and object serialization. So despite progress in downsizing Java, the value-proposition of Jini for mobile devices remains an unattained promise.” (*Id.* at ¶¶30-31; Ex. 9, “PsiNaptic” at pp. 31-32; Ex. 2, “Motorola” at p. 2).

Accordingly, a person skilled in the art, would not **infer** that the JINI LUS feature could be duplicated or repositioned from the laptop computer to the mobile phone as Petitioner argued in the IPR. (Ex. OTH-A, “Mandayam Decl.” at ¶73). Moreover, even if the JINI LUS feature was moved to a mobile phone, it would have been **inoperable** on the mobile phones that existed during the relevant time-period as they lacked the required system requirements, such as memory and processing capabilities. As discussed in the background section, the developer of Java and Jini, Sun Microsystems, recognized that mobile phones could not run the full Java application and devised a lighter application J2ME for phones, but with its reduced memory and processing capabilities that version of Java was not able to support Jini or its LUS feature. (Ex. OTH-A, “Mandayam Decl.” at ¶73 citing Ex. 2, “Motorola” at p. 2.) While Marchand appears to recognize that consumer products such as laptops and PDAs may soon be modified to provide multimedia and telephony applications, (Ex. PA-A, “Marchand” at 7:2-6), there is no teaching or suggestion that mobile phones may be modified to include laptop computer applications or PDA applications. As Marchand relies on JINI and the LUS feature and in view of the limitations of mobile phones to support both platforms, it is not surprising that Marchand only teaches a surrogate approach, where JINI and LUS are placed on the laptop computer and the phone accesses the technology

through the network. (Ex. OTH-A, “Mandayam Decl.” at ¶¶37-38).

Thus, in view of the above, one of ordinary skill in the art would not apply the combination of Marchand, Nurmam and Vilander to arrive at Claim 56, however the combination does not rise to the level of a substantial new question of patentability that has not been previously presented to the Office for claim 56.

### **VIII. Support for Proposed Amendments**

Please see Exhibit OTH-D for Proposed Amendments.

### **IX. 37 C.F.R. §1.510(b)(2): Detailed Explanation of the Pertinency and Manner of Applying the Prior Art. Proposed Amendments are Patentably Distinct over Previously Asserted Grounds.**

While new and amended Claims 48 and 56-129 include a number of features that were not addressed in any of the Grounds of IPR2015-01444 as noted below, claims 48 and 56-129 include a “service repository software component” or its equivalent function (such as enumerating and searching services) provided on a wireless device that wirelessly connects to both a cellular network and a short distance wireless network and are therefore not obvious in view of Marchand, Nurmam, and Vilander. (Ex. OTH-A, “Mandayam Decl.” at ¶78.)

As described below in relation to the arguments presented in Ground 1, the new and amended claims are patentably distinct as the proffered combination does not teach or suggest a mobile phone gateway including the claimed “service repository component.” Further, it would not have been obvious to move the “service repository component” from the laptop computer in Marchand to the mobile phone gateway, as that combination would have been inoperable in 2001, given the hardware and software limitations that existed at the time. As the arguments presented below are not exhaustive of the applicable patentability grounds, Patent Owner reserves its right to present further arguments to the extent necessary.

A number of features have been added by amendment to Claims 48 and 56, and have been included in new claims 57-129, that are not addressed by the grounds or references as applied in IPR2015-01444. These features provide separate bases for patentability of the amended and added claims. For example, features related to 802.11 (or Wi-Fi) technology used alone or in combination with Bluetooth technology (Ex. OTH-A, “Mandayam Decl.” at ¶87.), applications to provide email services, calendaring services and managing contacts (Ex. OTH-A, “Mandayam Decl.” at ¶88.), a location application that provides a current location of the wireless device (Ex. OTH-A, “Mandayam Decl.” at ¶89.), a tunneling and optimization component (Ex. OTH-A, “Mandayam Decl.” at ¶90.), software to establish the short-distance wireless network (Ex. OTH-A, “Mandayam Decl.” at ¶91.), and various network management functions performed by the handheld wireless device (Ex. OTH-A, “Mandayam Decl.” at ¶92.) further distinguish over the references as applied in the grounds of IPR2015-01444.

**A. Ground 1 – Amended and New Claims 48 and 56-129 are not obvious under 35 U.S.C. § 103 with respect to Marchand, Nurmman, and Vilander**

Ground 1 of IPR2015-01444 relied on the teachings Vilander and Nurmman with respect to a network address translator software component as claimed by the Patent Owner. Ground 1 did not rely on Vilander or Nurmman with respect to teaching a LUS or service repository software component, or a device to host a LUS or service repository.

While new and amended Claims 48 and 56-129 include a number of features that were not addressed in any of the Grounds of IPR2015-01444 as noted below, new and amended Claims 48 and 56-129 include a “service repository software component” or equivalent function (such as enumerating and searching services) provided on a wireless device that wirelessly connects to both a cellular network and a short distance wireless network and are therefore not obvious in view of

Marchand, Nurmann, and Vilander.

More particularly, Petitioner argued that Marchand teaches this claim element through its description of the JINI LUS. Petitioner's arguments, however, are based on a fundamental misunderstanding of the underlying JINI technology in Marchand and are contrary to Marchand's explicit teachings. A person of ordinary skill in the art (POSITA) would not understand Marchand to disclose that its JINI LUS is physically located on Marchand's cellular-enabled mobile phone 33, and further, a POSITA would have no motivation to modify Marchand to place the JINI LUS on the mobile phone (article of manufacture in claim 48) in view of Marchand's explicit teachings to the contrary. (Ex. OTH-A, "Mandayam Decl." at ¶¶53-54.)

With respect to Ground 1 of IPR2015-01444, the PTAB acknowledged that by Petitioner's own admission, the LUS of Marchand does not explicitly satisfy the "service repository software component" limitations of claims 1, 4, 7, and 14. (Ex. 1, "'1444 Final Decision" at pp. 15-16.) The PTAB however determined that Marchand would have implicitly informed a person skilled in the art that the "service repository software component" may be disposed in the "first wireless device". (*Id.* at p. 20.) The PTAB's conclusion is incorrect for at least two reasons that were not originally presented in Patent Owner's response: 1) Marchand teaches away from the PTAB's reading of the reference as Marchand describes several disadvantages associated with duplicating resources such as a JINI LUS or "service repository component" on multiple devices within a piconet, and 2) available mobile phone technology in 2001 filing date of the '033 application was incapable of implementing JINI and/or the JINI LUS application. (Ex. OTH-A, "Mandayam Decl." at ¶¶64, 72-76.) For these reasons, in addition to the positions presented in Patent Owner's Response, there would be no motivation or rationale for a person skilled in the art to modify the previously established network of Marchand by either 1) duplicating the JINI LUS functionality and having

it resident in both the laptop computer and the mobile phone gateway or 2) repositioning the LUS from the laptop computer to the mobile phone gateway. (*Id.*)

Regarding the first reason, Marchand teaches that it is “inefficient from the resource point of view” and “inappropriate, expensive, and cumbersome” to have the same hardware and software on all the devices in the piconet, such as a cellular radio modem (Ex. PA-A, “Marchand” at 4:1-9) or call control client (Ex. PA-A, “Marchand” at 6:31-7:2; *see also* Ex. OTH-A, “Mandayam Decl.” at ¶¶50, 65. (“The API is downloaded only to the device involved in the call since the other Bluetooth devices that are not making the call do not need this particular code.”) Accordingly, Marchand does not support duplicating resources such as an LUS as a service repository component on both the laptop computer and the mobile phone gateway, as this “defeats the purpose of forming a piconet to share services among devices.” (Ex. OTH-A, “Mandayam Decl.” at ¶65.)

According to the explicit teachings in Marchand, JINI LUS is hosted by the laptop computer not the mobile phone gateway. (Ex. PA-A, “Marchand” at FIG. 4; *see also* Ex. OTH-A, “Mandayam Decl.” at ¶¶55, 66.) In Marchand, when a device joins an existing Bluetooth piconet, it can perform a “discovery and join” protocol to locate the LUS, hosted on the laptop computer, and publish its services to the LUS so those services are then made available to other devices on the piconet. (Ex. PA-A, “Marchand” at 8:11-15.) Marchand explicitly defines where the list of available services is located: “[t]he services menu **on the laptop** indicates all services available on the Piconet.” (Ex. PA-A, “Marchand” at 10:24; boldface added.) It is also clear from Figure 4 which explicitly shows the LUS feature on the laptop computer and not any other device. Thus, the only explicit teachings in Marchand point to the network’s LUS being located on the laptop. (Ex. OTH-A, “Mandayam Decl.” at ¶¶55, 66).

Regarding the second reason, it is clear from Marchand, when viewed in the context of



JINI functionality and prevailing limitations regarding hardware and software for mobile phones, that a POSITA in 2001 would not **infer** that JINI LUS could be implemented on the mobile phone gateway. (Ex. OTH-A, “Mandayam Decl.” at ¶73.) The implicit teachings advanced by the Petitioner and adopted by the PTAB in the Final Written Decision, are contrary to Marchand, how the JINI LUS feature functions and the limitations of wireless phone technology in 2001. (Ex. OTH-A, “Mandayam Decl.” at ¶¶72-78.) In its Final Written Decision the Board relied on Petitioner and their expert Dr. Kiaei’s argument that 1) Marchand’s call control API is a JINI proxy object and 2) a JINI call control API is downloaded from the gateway to the other devices on the ad-hoc network to support its conclusion that an ordinary skilled artisan “would have understood Marchand as implicitly describing an implementation in which the JINI LUS which identifies services provided by devices on the network 30, is located on the mobile phone gateway 33.” (Ex. 1, “1444 Final Decision” at pp. 14-15; 18-19.)

Per the JINI Spec, the purpose of an LUS is to provide a registry of services that can be registered and searched for within a piconet so that other devices can make use of the available services. (See Ex. PA-F, “JINI Spec Part 1” at pp. 22-23.) As detailed in the background section above, once a device joins a JINI/Java network, the joining device transfers java code (referred to as a proxy object or java object) to the LUS. (*Id.*) This small amount of java code is used to identify the service(s) the joining device offers and to establish an interface with that service. (See Ex. PA-F, “JINI Spec Part 1” at pp. 22-23; *see also* Ex. PA-A, “Marchand” at 3:13-14.) The LUS stores this java object and creates a list of the services available on the network. (Ex. PA-F, “JINI Spec Part 1” at pp. 22-23; Ex. PA-A, “Marchand” at 3:11-12.) For example, if a printer joins a network utilizing JINI technology, the printer will publish its printing service to the network by transferring java code to the LUS. (Ex. PA-F, “JINI Spec Part 1” at p. 22.) The java code includes the printer’s

information and a method to implement its printer interface. (*Id.*)

While JINI technology defines an architecture for JINI/Java capable devices to publish and share services using the JINI LUS, it does not define how a device offering its services implements a given service or how the service is utilized by another device. (*See* Ex. PA-F, “JINI Spec Part 1” at p. 24; Ex. OTH-A, “Mandayam Decl.” at ¶¶52-53.) Instead, the sharing device provides its own protocol to control the use of its shared service. (*Id.*) For example, in Marchand’s system, the gateway mobile device shares its call control service with other devices on the Bluetooth piconet through the LUS on the laptop, with the call control service defining the protocol for another device to utilize this service of Marchand’s mobile phone. (*Id.*) However, under the described protocol Marchand’s mobile phone merely provides a calling service” code much as the printer provides a “printing service” code to the LUS. (*Id.*)

It follows that regarding the mobile phone, once the call control service is published in the services menu of the laptop, the details of how the mobile phone shares its call control service—e.g. through specific API interfaces that are downloaded to each device as a proxy object—to become a gateway for other devices on the network is not part of the JINI LUS technology. (*Id.*) After the service code is published to the LUS, the other devices on the piconet can access the published service code and interface method per its defined protocol and use the mobile phone as a gateway to the IP network. (Ex. PA-A, “Marchand” at 10:12-16; *see also* Ex. OTH-A, “Mandayam Decl.” at ¶66.) Thus, contrary to Petitioner’s arguments, the details of how the phone interacts with other devices as a gateway cannot be used to establish that the phone serves as the LUS—because these details are irrelevant to the workings of JINI’s LUS feature. (Ex. OTH-A, “Mandayam Decl.” at ¶52.) Like the mobile phone, when other devices join the network, such as a PDA or printer, they first publish their service to the LUS and then may use the LUS to discover

network services, e.g. the call control client code of the mobile phone to access its gateway services. (Ex. PA-A, “Marchand” at 10:18-20.) “For example, other BLUETOOTH devices on the piconet perform a JINI-defined add-in ‘discovery and join’ protocol ‘to locate the LUS and upload all of its services’ interfaces, including call control services. (*Id.* at 8:12-20.) The ability for the other devices, including the mobile phone, to send Java code to the rest of the network to facilitate the sharing of services in no way equates to the “discover and join” LUS feature itself, which provides the claimed “service repository software component” and per Marchand is located on the laptop computer. (Ex. OTH-A, “Mandayam Decl.” at ¶¶53)

Absent some teaching in Marchand that the LUS feature resides on the mobile phone, the Ground 1 argument advanced in the IPR fails. Other than including call control service feature 41 (Figure 4 of Marchand) on the mobile phone to access the JINI LUS application on the laptop, Marchand does not teach or suggest having the JINI LUS application resident on the mobile phone gateway. The ’033 Patent calls for the service “repository software component” to be located on the first wireless device-- the cellular device. In the case of claim 48, the “repository software component” is specifically located on the article of manufacture, the gateway device. Petitioner in the IPR relied on their expert Dr. Kiaei’s opinions to argue that Marchand implicitly teaches that its JINI LUS is located on Marchand’s gateway mobile phone. (Ex. 1, “’1444 Final Decision” at pp. 15-16.) When the teachings of Marchand are properly considered from the perspective of a person of ordinary skill in the art, it is however clear that Marchand precludes the JINI LUS from being located on its gateway mobile phone. (Ex. OTH-A, “Mandayam Decl.” at ¶¶72-78.)

Moreover, the JINI LUS relied on in Marchand required hardware resources (memory and processor) that exceeded the capabilities of mobile phones at the time (*See* Ex. 9, “PsiNaptic” at pp. 31-32; Ex. OTH-A, “Mandayam Decl.” at ¶¶67.) As described in the background section above,

the hardware required to operate the JINI LUS—at least 3 megabytes of memory—was not available on mobile phones during the relevant 2001 time period. (Ex. OTH-A, “Mandayam Decl.” at ¶¶36-37). With a memory of at most 2 megabytes and 13 MHz CPU, mobile phones in 2000-2002 were not able to support the JINI application, let alone the LUS feature. (*Id.*) This limitation was recognized by the developer of the JINI/Java software platforms, Sun Microsystems, who developed an alternate, “micro” version of JINI, known as J2ME, that was streamlined for mobile phones but lacked the functionality required to support the LUS feature. (*Id.* at ¶¶28-29.) The limitations of the J2ME application and specifically its inability to run Jini and the LUS feature were well known in 2001 (Ex. OTH-A, “Mandayam Decl.” at ¶¶31-37.) Several articles in 2001-2002 documented the mismatch between the JINI requirements and mobile phone capabilities: “The resulting Jini LookUp Service implementation is too large (e.g., typically requiring more than 3 megabytes of static and running storage). Many networked computing devices are. . . mobile—too small to support an RMI based Jini”; “The most limited devices run Java 2 Micro Edition [J2ME], but this cannot support Jini as it lacks dynamic class loading and object serialization. So despite progress in downsizing Java, the value-proposition of Jini for mobile devices remains an unattained promise.” (*Id.* at ¶¶30-31; Ex. 9, “PsiNaptic” at pp. 31-32; Ex. 2, “Motorola” at p. 2).

As described in the background section and above, the hardware required to operate JINI LUS—at least 3 megabytes of memory—was not available on mobile phones during the relevant 2001 time-period. *See* S. Hashman and S. Knudsen, “The Application of Jini Technology to enhance the Delivery of Mobile Services,” PsiNaptic, December 2001, pages 31-32. Moreover, even if the JINI LUS feature was moved to a mobile phone, it would have been inoperable on the mobile phones that existed during the relevant time-period as they lacked the required system

requirements, such as memory and processing capabilities. As discussed in the background section, the developer of Java and Jini, Sun Microsystems, recognized that mobile phones could not run the full Java application and devised a lighter application J2ME for phones, but with its reduced memory and processing capabilities that version of Java was not able to support Jini or its LUS feature. (Ex. OTH-A, “Mandayam Decl.” at ¶73 citing Ex. 2, “Motorola” at p. 2.) As established above, the industry was well-aware of both the system requirements to support Jini and its LUS feature and the hardware/software limitations in prevailing phones that prevented them from supporting the more robust Java Standard Edition software and Jini technology.

Accordingly, a person skilled in the art, would not **infer** that the JINI LUS feature could be duplicated or repositioned from the laptop computer to the mobile phone as Petitioner argued in the IPR. (Ex. OTH-A, “Mandayam Decl.” at ¶76). Moreover, even if the JINI LUS feature was moved to a mobile phone, it would have been **inoperable** on the mobile phones that existed during the relevant time-period as they lacked the required system requirements, such as memory and processing capabilities. (*Id.*) As discussed in the background section, the developer of Java and Jini, Sun Microsystems, recognized that mobile phones could not run the full Java application and devised a lighter application J2ME for phones, but with its reduced memory and processing capabilities that version of Java was not able to support Jini or its LUS feature. (Ex. OTH-A, “Mandayam Decl.” at ¶¶74-75 citing Ex. 2, “Motorola” at p. 2.) While Marchand appears to recognize that consumer products such as laptops and PDAs may soon be modified to provide multimedia and telephony applications, (Ex. PA-A, “Marchand” at 7:2-6), there is no teaching or suggestion that mobile phones may be modified to include laptop computer applications or PDA applications. As Marchand relies on JINI and the LUS feature and in view of the limitations of mobile phones to support both platforms, it is not surprising that Marchand only teaches a surrogate

approach, where JINI and LUS are placed on the laptop computer and the phone accesses the technology through the network. (Ex. OTH-A, “Mandayam Decl.” at ¶¶37-38).

**B. Ground 2 – New and Amended Claims 48 and 56-129 are not obvious under 35 U.S.C. § 103 with respect to Marchand, Nurmman, Vilander and RFC2543**

Ground 2 of IPR2015-01444 asserted that claim 5 of the ‘033 patent was obvious under 35 U.S.C. § 103 in view of Marchand, Nurmman, Vilander and RFC 2543. Claim 5 depends from Claim 1 and therefore includes the same limitations described above with respect to the service repository. Claim 5 adds a domain naming service (“DNS”) software component. The PTAB determined that claim 5 was unpatentable over the combination of Marchand, Nurmman, Vilander, and RFC2543 in that a person of ordinary skill in the art would have combined the DNS software component taught by RFC 2543 with the features of Marchand, Nurmman, and Vilander. However, RFC2543 provides no additional insight with respect to location of a JINI LUS within a Bluetooth piconet, or providing multiple devices in a Bluetooth piconet with a JINI LUS. (Ex. OTH-A, “Mandayam Decl.” at ¶77.)

While new and amended claims 48 and 56-129 include several features that were not addressed in any of the Grounds of IPR2015-01444 as noted below, new Claims 62, 85, 86, 96, 101, 108, 111 and 125 include DNS software like that present in claim 5 of the ‘033 patent. Because RFC2543 does not provide any insight with respect to a Jini LUS or service repository software component or equivalent function (such as enumerating and searching services) provided on the wireless device present in claims 48 and 56-129 that wirelessly connects to both a cellular network and a short distance wireless network, these claims are therefore not obvious in view of Marchand, Nurmman, Vilander and RFC2543. (Ex. OTH-A, “Mandayam Decl.” at ¶78.)

**C. Ground 3 – New and Amended Claims 48 and 56-129 are not obvious under 35 U.S.C. § 103 with respect to Marchand, Nurmman, Vilander**

**and Larsson.**

Ground 3 of IPR2015-01444 asserted that claims 6 and 23 of the '033 patent were obvious under 35 U.S.C. § 103 in view of Marchand, Nurmman, Vilander and Larsson. Claims 6 and 23 depend from Claim 1 and therefore include the same limitations described above with respect to the service repository. Claims 6 and 23 add a security software component and a virtual private network software component, respectively. The PTAB determined that claims 6 and 23 were unpatentable over the combination of Marchand, Nurmman, Vilander, and Larsson in that a person of ordinary skill in the art would have combined the security software component and VPN software component taught by Larsson with the features of Marchand, Nurmman, and Vilander. However, Vilander provides no additional insight with respect to location of a JINI LUS within a Bluetooth piconet, or providing multiple devices in a Bluetooth piconet with a JINI LUS. As such, these claims are patentable at least because of their dependency from Claim 1. (Ex. OTH-A, "Mandayam Decl." at ¶79.)

While new and amended claims 48 and 56-129 include many features that were not addressed in any of the Grounds of IPR2015-01444 as noted below, new Claims 63, 87, 88, 102, 104, 112, 115, and 126 include a security software component and/or a virtual private network software component, that was present in claims 6 and 23 of the '033 patent. Because Larsson does not add any insight with respect to the service repository software component or equivalent function (such as enumerating and searching services) being provided on the wireless device present in claims 48 and 56-129 that wirelessly connects to both a cellular network and a short distance wireless network, these claims not obvious in view of Marchand, Nurmman, Vilander and Larsson. (Ex. OTH-A, "Mandayam Decl." at ¶80.)

**D. Ground 4 – New and Amended Claims 48 and 56-129 are not obvious under 35 U.S.C. § 103 with respect to Marchand, Nurmman, Vilander**

**and the JINI Spec.**

Ground 4 of IPR2015-01444 asserted that claims 12, 15, 22, 34, 39, 40, 42, and 46 of the '033 patent were obvious under 35 U.S.C. § 103 in view of Marchand, Nurmman, Vilander and the JINI Spec. Claims 12, 15, and 22 depend from Claim 1 and therefore include the same limitations described above with respect to the service repository software component. Claims 34 and 42 are independent claims that include more specific service repository functions such as enumerating a list of services and searching the list of services, however these functions are performed by a handheld wireless device that controls access between a short distance wireless network and a cellular network like the first wireless device having the service repository software component as recited in Claim 1. Claims 39 and 40 depend from Claim 34. Claim 46 depends from Claim 42. (Ex. OTH-A, "Mandayam Decl." at ¶81.)

The PTAB relied on the JINI spec. for teachings with respect to the JINI LUS as storing information about a service's ID, class or type, and attributes, as well as searching the LUS, providing a plug and play feature, and having more than one LUS in a network, in combination with the reasoning with respect to Claim 1 for locating the JINI LUS on the mobile phone in - finding that Claims 12, 15, 22, 34, 39, 40, 42, and 46 unpatentable. (Ex. OTH-A, "Mandayam Decl." at ¶82.)

While new and amended claims 48 and 56-129 include several features that were not addressed in any of the Grounds of IPR2015-01444 as noted below, new claims 58, 64, 83, 88, 95, 100, 104, 106, 110, 115, and 128 include more specific service repository functions such as enumerating a list of services and searching the list of services that were present in one or more of claims 12, 15, 22, 34, 39, 40, 42, and 46 of the '033 patent. Because, the JINI Spec does not add any insight or features with respect to the service repository software component or equivalent



function (such as enumerating and searching services) provided on the wireless device present in claims 48 and 56-129 that wirelessly connects to both a cellular network and a short distance wireless network, these claims are therefore not obvious in view of Marchand, Nurmman, Vilander and the JINI Spec. (Ex. OTH-A, “Mandayam Decl.” at ¶83.)

**E. Ground 5 – New and Amended Claims 48 and 56-129 are not obvious under 35 U.S.C. § 103 with respect to Marchand, Larsson and the JINI Spec.**

Ground 5 of IPR2015-01444 asserted that claims 25 and 28 of the ‘033 patent were obvious under 35 U.S.C. § 103 in view of Marchand, Larsson and the JINI Spec. Claim 25 is an independent claim that includes a service repository software component on a wireless device in a short distance wireless network and a cellular network like the service repository software component of Claim 1. Claim 28 depends from Claim 25 and therefore includes the same limitations described above with respect to the service repository software component, but adds a security software VPN. The PTAB determined that claims 25 and 28 were unpatentable over the combination of Marchand, Larsson, and the JINI Spec. relying on the same reasoning relied upon with respect to Claims 1 and 34. (Ex. OTH-A, “Mandayam Decl.” at ¶84.)

While new and amended claims 48 and 56-129 include several features that were not addressed in any of the Grounds of IPR2015-01444 as noted below, new Claims 63, 87, 102, 112, and 126 add a security software or VPN feature, like that present in claims 25 and 28 of the ‘033 patent. Because Larsson does not provide any insight relative to the service repository software component or equivalent function (such as enumerating and searching services) provided on the wireless device present in claims 48 and 56-129 that wirelessly connects to both a cellular network and a short distance wireless network, these claims are therefore not obvious in view of Marchand in view of Larsson and JINI Spec. (Ex. OTH-A, “Mandayam Decl.” at ¶85.)

## X. Objective Indicia Supports Nonobviousness

Objective indicia, such as unexpected results, industry praise, teaching away and long-felt need, “can be the most probative evidence of non-obviousness in the record, and enable the court to avert the trap of hindsight.” *Crocs, Inc. v. ITC*, 598 F.3d 1294, 1310 (Fed. Cir. 2010). These objective criteria “turn back the clock and place the claims in the context that led to their invention.” *Mintz v. Dietz*, 679 F.3d 1372, 1378 (Fed. Cir. 2012). As such, the Federal Circuit requires consideration of these objective indicia because they “provide objective evidence of how the patented device is viewed in the marketplace, by those directly interested in the product.” (*Demaco Corp. v. F. Von Langsdorff Licensing Ltd.*, 851 F.2d 1387, 1391 (Fed. Cir. 1988) and *Spectralytics, Inc. v. Cordis Corp.*, 649 F.3d 1336, 1344 (Fed. Cir. 2011).

IXI’s Personal Mobile Gateway (PMG) embodies the ‘033 patented invention. (Ex. OTH-A, “Mandayam Decl.” at ¶97.) As illustrated in ¶97 of Dr. Mandayam’s declaration, IXI’s PMG product reads on claim 25 of the ‘033 patent. Objective evidence regarding how PMG has been received by the wireless industry is thus relevant to establish non-obviousness of the ‘033 patented invention.

Shortly after the launch of IXI’s PMG product, the industry began praising the invention and touted the claimed features of the ‘033 patent. (*Id.* at ¶¶100-104.) One article entitled “Cautious Optimism at the 3GSM World Congress” provided “IXI Mobile presented an **innovative** GSM/GPRS product called the Personal Mobile Gateway (PMG). . . IXI has an interesting approach to mobile devices, one that divorces the communications engine from the user interface.” (Ex. OTH-A, “Mandayam Decl.” at ¶101 citing Ex. 12, “Cautious Optimism at the 3GSM World Congress” at p. 12, boldface added.)

In an article entitled “Consumer Gadgets: 50 Ways to Have Fun & Simplify Your Life with Today’s Technology, Chapter 39 Using Many Devices with One Connection: Personal Mobile Gateways”, the author notes “The company offers a personal mobile gateway (PMG) that acts as a bridge between the devices and the wireless network. . . and serves as the gateway between the short-range personal area network (PAN). . . The PMG device acts as a pocket-sized microbridge and microrouter between the PAN and the wireless network. . . **Perhaps the most exciting thing is that all these devices will be able to communicate with one another and the Internet. . .**” (Ex. OTH-A, “Mandayam Decl.” at ¶102 citing Ex. 13, “Consumer Gadgets” at pp. 4-5, boldface added.)

In 2000, prior to the launch of IXI’s PMG, the industry and specifically the CEO of market leader RIM expressed skepticism at the idea of “combining computing, phone and Internet services. To him, that made no sense. All-purpose operating systems sucked batteries dry, hogged wireless bandwidth and were awkward to use.” (Ex. OTH-A, “Mandayam Decl.” at ¶103 citing Ex. 5, “RIM” at pp. 9-10.)

Approximately one year after IXI’s launch of its PMG, Samsung obtained a license for the PMG software for its “new breed of Samsung wireless phones,” Samsung SGH-X410. (Ex. OTH-A, “Mandayam Decl.” at ¶104 citing Ex. 14, “Brighthand” at p. 1.)

In addition to industry praise, IXI’s PMG addressed a long felt but unmet need. (Ex. OTH-A, “Mandayam Decl.” at ¶¶105-110.) In one article entitled “The Evolving Mobile User Interface\_Strategies for the Wireless Internet” the author states IXI’s PMG product provides an “**end-to-end solution**” and concludes that “the IXI Mobile **has identified a real problem and proposes a real solution.**” (Ex. OTH-A, “Mandayam Decl.” at ¶105 citing Ex. 15, “The Evolving

Mobile User Interface\_Strategies for the Wireless Internet<sup>5</sup>” at pp. 62, 48, boldface added.)

This unmet need is also captured in a report entitled “PMGs Set to Explode in 2004” that provided a “synopsis and forecast analysis of the emerging Personal Mobile Gateway or PMG, market” and estimated that **the market for PMG and PMG Companion devices could “exceed 110 Million units in 2007.”** (Ex. OTH-A, “Mandayam Decl.” at ¶107 citing Ex. 17, “PMGs Set to Explode in 2004 at pp. 1, 6, boldface added.)

In another report TNI Securities Equity Research outlines how IXI’s PMG is leading “first steps” towards a “**paradigm shift**” in connectivity that “combines wide area networking technologies such as GSM/GPRS, CDMA, etc. with short distance wireless such as Bluetooth or WiFi with micro-router and micro-server functionalities.” (Ex. OTH-A, “Mandayam Decl.” at ¶108 citing Ex. 18, “TNI Securities Equity Research” at pp. 1, 4-5, boldface added.)

IXI’s PMG was also the recipient of the Winning Technology Award “for its end-to-end software solutions that enable the introduction of a new category of wireless devices including the Personal Mobile Gateway (PMG). . . Industry recognition of the PMG is continuing to grow.” (Ex. OTH-A, “Mandayam Decl.” at ¶110 citing Ex. 20, “Winning Technology Award” at p. 1.)

And, Marchand’s surrogate approach in which the phone accesses a JINI LUS on the laptop constitutes a teaching away from the ‘033 claimed invention, where the phone serves as a bridge and router between other devices on the PAN. (Ex. OTH-A, “Mandayam Decl.” at ¶¶31, 111.)

Based on the above examples of industry praise, teaching away, and long felt but unmet need, there is sufficient objective evidence that the claimed invention as embodied in IXI’s PMG

---

<sup>5</sup> For each of “The Evolving Mobile User Interface\_Strategies for the Wireless Internet” citations, the original pagination of the reference is being cited, not the pagination of the Exhibit.

product was “not obvious during the relevant time frame and given the state of the industry at that time.” (Ex. OTH-A, “Mandayam Decl.” at ¶112.)

**XI. Conclusion**

The prior art documents presented in the above Request were either not previously considered by the Office or are now being presented in a new light pursuant to MPEP § 2242.

New and amended claims 48 and 56-129 of the ‘033 patent are patentable over the prior art documents cited herein. The prior art documents teach the subject matter of the ‘033 patent in a manner such that substantial new questions of patentability for those claims are raised by this Request. Accordingly, the Office is requested to grant this Request and to initiate reexamination with special dispatch.

Respectfully submitted,

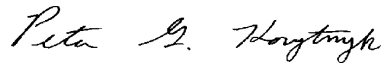

Dated: March 24, 2017

---

Peter G. Korytnyk (Reg. No. 43,400)  
Attorney for Applicant

213 S. Payne Street  
Alexandria, VA 22314  
703-892-5210 (telephone)

## Electronic Patent Application Fee Transmittal

|   |  |                 |               |                             |  |
|---|--|-----------------|---------------|-----------------------------|--|
| <b>Application Number:</b>                  |  |                 |               |                             |  |
| <b>Filing Date:</b>                         |  |                 |               |                             |  |
| <b>Title of Invention:</b>                  | SYSTEM, DEVICE AND COMPUTER READABLE MEDIUM FOR PROVIDING A MANAGED WIRELESS NETWORK USING SHORT-RANGE RADIO SIGNALS |                 |               |                             |  |
| <b>First Named Inventor/Applicant Name:</b> | Amit Haller  |                 |               |                             |  |
| <b>Filer:</b>                               | Peter George Korytnyk  |                 |               |                             |  |
| <b>Attorney Docket Number:</b>              | 0909-010   |                 |               |                             |  |
| Filed as Large Entity                       |  |                 |               |                             |  |
| <b>Filing Fees for ex parte reexam</b>      |  |                 |               |                             |  |
| <b>Description</b>                          | <b>Fee Code</b>  | <b>Quantity</b> | <b>Amount</b> | <b>Sub-Total in USD(\$)</b> |  |
| <b>Basic Filing:</b>                        |  |                 |               |                             |  |
| REQUEST FOR EX PARTE REEXAMINATION          | 1812   | 1               | 12000         | 12000                       |  |
| <b>Pages:</b>                               |  |                 |               |                             |  |
| <b>Claims:</b>                              |  |                 |               |                             |  |
| REEXAMINATION INDEPENDENT CLAIMS            | 1821   | 3               | 420           | 1260                        |  |
| REEXAMINATION CLAIMS IN EXCESS OF 20        | 1822   | 55              | 80            | 4400                        |  |
| <b>Miscellaneous-Filing:</b>                |  |                 |               |                             |  |
| <b>Petition:</b>                            |  |                 |               |                             |  |
| <b>Patent-Appeals-and-Interference:</b>     |  |                 |               |                             |  |

| Description                              | Fee Code | Quantity | Amount                   | Sub-Total in USD(\$) |
|--|----------|----------|--------------------------|----------------------|
| <b>Post-Allowance-and-Post-Issuance:</b> |          |          |                          |                      |
| <b>Extension-of-Time:</b>                |          |          |                          |                      |
| <b>Miscellaneous:</b>                    |          |          |                          |                      |
|  |          |          | <b>Total in USD (\$)</b> | <b>17660</b>         |

## Electronic Acknowledgement Receipt

|   |  |
|---|--|
| <b>EFS ID:</b>                              | 28736104   |
| <b>Application Number:</b>                  | 90013925   |
| <b>International Application Number:</b>    |  |
| <b>Confirmation Number:</b>                 | 1027   |
| <b>Title of Invention:</b>                  | SYSTEM, DEVICE AND COMPUTER READABLE MEDIUM FOR PROVIDING A MANAGED WIRELESS NETWORK USING SHORT-RANGE RADIO SIGNALS |
| <b>First Named Inventor/Applicant Name:</b> | Amit Haller  |
| <b>Customer Number:</b>                     | 41200  |
| <b>Filer:</b>                               | Peter George Korytnyk  |
| <b>Filer Authorized By:</b>                 |  |
| <b>Attorney Docket Number:</b>              | 0909-010   |
| <b>Receipt Date:</b>                        | 24-MAR-2017  |
| <b>Filing Date:</b>                         |  |
| <b>Time Stamp:</b>                          | 18:33:23   |
| <b>Application Type:</b>                    | Reexam (Patent Owner)  |

### Payment information:

|  |                       |
|--|-----------------------|
| Submitted with Payment                   | yes                   |
| Payment Type                             | CARD                  |
| Payment was successfully received in RAM | \$17660               |
| RAM confirmation Number                  | 032717INTEFSW18362300 |
| Deposit Account                          |                       |
| Authorized User                          |                       |

The Director of the USPTO is hereby authorized to charge indicated fees and credit any overpayment as follows:



| <b>File Listing:</b>   |                             |   |   |                         |                         |
|------------------------|-----------------------------|---|---|-------------------------|-------------------------|
| <b>Document Number</b> | <b>Document Description</b> | <b>File Name</b>                            | <b>File Size(Bytes)/<br/>Message Digest</b> | <b>Multi Part /.zip</b> | <b>Pages (if appl.)</b> |
| 1                      | Non Patent Literature       | Ex-1_01444-Final-Decision.pdf               | 844782                                      | no                      | 44                      |
|                        |                             |   | ac89c274a4002a17b396f0930ef69efe7b530629    |                         |                         |
| <b>Warnings:</b>       |                             |   |   |                         |                         |
| <b>Information:</b>    |                             |   |   |                         |                         |
| 2                      | Non Patent Literature       | Ex-2_Motorola-Article.pdf                   | 8024817                                     | no                      | 11                      |
|                        |                             |   | c8837ebe3936d43731c618ec8bfff0f613dfa609d   |                         |                         |
| <b>Warnings:</b>       |                             |   |   |                         |                         |
| <b>Information:</b>    |                             |   |   |                         |                         |
| 3                      | Non Patent Literature       | Ex-3_The-Evolution-of-Cell-Phone-Design.pdf | 8747968                                     | no                      | 115                     |
|                        |                             |   | 72270c9dd6bb4572067db4b7ef25915773adb674    |                         |                         |
| <b>Warnings:</b>       |                             |   |   |                         |                         |
| <b>Information:</b>    |                             |   |   |                         |                         |
| 4                      | Non Patent Literature       | Ex-4_Research-in-Motion.pdf                 | 2484636                                     | no                      | 6                       |
|                        |                             |   | 5eb5316f96a1f87c2a10bd1a991215603bb4fbc3    |                         |                         |
| <b>Warnings:</b>       |                             |   |   |                         |                         |
| <b>Information:</b>    |                             |   |   |                         |                         |
| 5                      | Non Patent Literature       | Ex-5_RIM-Article.pdf                        | 11659180                                    | no                      | 29                      |
|                        |                             |   | 8036230887dfce74e8624577c7b384f63f0c534     |                         |                         |
| <b>Warnings:</b>       |                             |   |   |                         |                         |
| <b>Information:</b>    |                             |   |   |                         |                         |
| 6                      | Non Patent Literature       | Ex-6_Whats-J2ME.pdf                         | 651205                                      | no                      | 5                       |
|                        |                             |   | 1a28df882ebb5401a435c0de7e0e6837a9d5500d    |                         |                         |
| <b>Warnings:</b>       |                             |   |   |                         |                         |
| <b>Information:</b>    |                             |   |   |                         |                         |

|                     |                       |  |   |    |    |
|---------------------|-----------------------|--|---|----|----|
| 7                   | Non Patent Literature | Ex-7-J2SE-2000.pdf                                     | 451612                                    | no | 4  |
|                     |                       |  | ece97b71733a2446f53fd20224e64eabb88d967   |    |    |
| <b>Warnings:</b>    |                       |  |   |    |    |
| <b>Information:</b> |                       |  |   |    |    |
| 8                   | Non Patent Literature | Ex-8_J2ME-step-by-step.pdf                             | 240371                                    | no | 41 |
|                     |                       |  | 20a730d645e70c040694332ca2bf6b0e59b4d721  |    |    |
| <b>Warnings:</b>    |                       |  |   |    |    |
| <b>Information:</b> |                       |  |   |    |    |
| 9                   | Non Patent Literature | Ex-9_PsiNaptic.pdf                                     | 365212                                    | no | 45 |
|                     |                       |  | bae4ade598397d409d0ad6ed199a18341cc536c8  |    |    |
| <b>Warnings:</b>    |                       |  |   |    |    |
| <b>Information:</b> |                       |  |   |    |    |
| 10                  | Non Patent Literature | Ex-10_IXI-PMG-System-Specifications.pdf                | 7309774                                   | no | 24 |
|                     |                       |  | 5a6b0702128dc17cea9fa5dba7c2cc4f0228d2ea  |    |    |
| <b>Warnings:</b>    |                       |  |   |    |    |
| <b>Information:</b> |                       |  |   |    |    |
| 11                  | Non Patent Literature | Ex-11_PMG-is-a-Cool-Idea.pdf                           | 403169                                    | no | 2  |
|                     |                       |  | a8034cccd816e5e99a52dc88da6e7162e277b2ba  |    |    |
| <b>Warnings:</b>    |                       |  |   |    |    |
| <b>Information:</b> |                       |  |   |    |    |
| 12                  | Non Patent Literature | Ex-12-Cautious-Optimism-at-the-3GSM-World-Congress.pdf | 8140640                                   | no | 31 |
|                     |                       |  | 9bad98208ce13f0d32ca64f8c5ee52c0412b22e4  |    |    |
| <b>Warnings:</b>    |                       |  |   |    |    |
| <b>Information:</b> |                       |  |   |    |    |
| 13                  | Non Patent Literature | Ex-13_Consumer-Gadgets.pdf                             | 820621                                    | no | 8  |
|                     |                       |  | a661039a92eaa7fde4efcd26e8221fd72c081b36b |    |    |
| <b>Warnings:</b>    |                       |  |   |    |    |
| <b>Information:</b> |                       |  |   |    |    |

|                     |                       |  |   |    |     |
|---------------------|-----------------------|--|---|----|-----|
| 14                  | Non Patent Literature | Ex-14_Brighthand.pdf   | 208873                                    | no | 3   |
|                     |                       |  | 9f3057d0ff0cd513e8a514ff22148d1727941419  |    |     |
| <b>Warnings:</b>    |                       |  |   |    |     |
| <b>Information:</b> |                       |  |   |    |     |
| 15                  | Non Patent Literature | Ex-15_The-Evolving-Mobile-User-Interface-Strategies-for-the-Wireless-Internet2.pdf | 12884616                                  | no | 109 |
|                     |                       |  | 34fd7f460469c184f2eaaad138a638d6d83a24980 |    |     |
| <b>Warnings:</b>    |                       |  |   |    |     |
| <b>Information:</b> |                       |  |   |    |     |
| 16                  | Non Patent Literature | Ex-16_Deutsche-Bank.pdf  | 1882928                                   | no | 13  |
|                     |                       |  | b42c23f5b0e87f958e9b3d07af67f208dc32cdd6  |    |     |
| <b>Warnings:</b>    |                       |  |   |    |     |
| <b>Information:</b> |                       |  |   |    |     |
| 17                  | Non Patent Literature | Ex-17_PMGs-Set-to-Explode-in-2004.pdf  | 2205366                                   | no | 23  |
|                     |                       |  | 79f0f948d646acd417adccc96a6f0070750af975  |    |     |
| <b>Warnings:</b>    |                       |  |   |    |     |
| <b>Information:</b> |                       |  |   |    |     |
| 18                  | Non Patent Literature | Ex-18_TNI-Securities-Equity-Research.pdf   | 3965712                                   | no | 11  |
|                     |                       |  | 3eabff6ef48cd64b2981d9d4cf00d43b80e0671a  |    |     |
| <b>Warnings:</b>    |                       |  |   |    |     |
| <b>Information:</b> |                       |  |   |    |     |
| 19                  | Non Patent Literature | Ex-19_Handbook-of-Wireless-Local-Area-Networks_p49.pdf                             | 591017                                    | no | 4   |
|                     |                       |  | 8c93771b4398691ff9e38bcfb64ee2d8748eb44c  |    |     |
| <b>Warnings:</b>    |                       |  |   |    |     |
| <b>Information:</b> |                       |  |   |    |     |
| 20                  | Non Patent Literature | Ex-20_Winning-Technology-Award.pdf   | 180555                                    | no | 3   |
|                     |                       |  | 0f558429cfdada8e631cff96c000d2ee10eff570a |    |     |
| <b>Warnings:</b>    |                       |  |   |    |     |
| <b>Information:</b> |                       |  |   |    |     |

|                     |   |  |  |    |     |
|---------------------|---|--|--|----|-----|
| 21                  | Copy of patent for which reexamination is requested | Exhibie-PAT-A-Haller-US7039033B2.pdf   | 9044618                                  | no | 22  |
|                     |   |  | 37979439a896ef57d1188be988fe9ebb61bb7440 |    |     |
| <b>Warnings:</b>    |   |  |  |    |     |
| <b>Information:</b> |   |  |  |    |     |
| 22                  | Other Reference-Patent/App/Search documents         | Exhibit-PA-A-Marchand-WO2001076154.pdf | 2920013                                  | no | 26  |
|                     |   |  | 5f5865cc96a05381cc986a6258df105c694b161e |    |     |
| <b>Warnings:</b>    |   |  |  |    |     |
| <b>Information:</b> |   |  |  |    |     |
| 23                  | Other Reference-Patent/App/Search documents         | Exhibit-PA-B-Nurmann-US6560642B1.pdf   | 1073056                                  | no | 9   |
|                     |   |  | 4939da4b892de32b6ce01eaf7eb1f32025de359  |    |     |
| <b>Warnings:</b>    |   |  |  |    |     |
| <b>Information:</b> |   |  |  |    |     |
| 24                  | Other Reference-Patent/App/Search documents         | Exhibit-PA-C-Vilander-US6771635B1.pdf  | 970153                                   | no | 7   |
|                     |   |  | fe8e8b40cc3d2e1943353ce64fa8888f8a344ddc |    |     |
| <b>Warnings:</b>    |   |  |  |    |     |
| <b>Information:</b> |   |  |  |    |     |
| 25                  | Other Reference-Patent/App/Search documents         | Exhibit-PA-D-Larsson-US6836474B1.pdf   | 943144                                   | no | 7   |
|                     |   |  | 0df041c92a02c4177b4130db520c9af241ead18  |    |     |
| <b>Warnings:</b>    |   |  |  |    |     |
| <b>Information:</b> |   |  |  |    |     |
| 26                  | Other Reference-Patent/App/Search documents         | Exhibit-PA-E-RFC-2543.pdf              | 392425                                   | no | 152 |
|                     |   |  | 3b934725ca5be92a83dbb1f525df22eccc0697d5 |    |     |
| <b>Warnings:</b>    |   |  |  |    |     |
| <b>Information:</b> |   |  |  |    |     |
| 27                  | Other Reference-Patent/App/Search documents         | Exhibit-PA-F-JINI-Spec-Part1.pdf       | 18666070                                 | no | 33  |
|                     |   |  | 9f3974c5e959141867201f279453fc49bc62df65 |    |     |
| <b>Warnings:</b>    |   |  |  |    |     |
| <b>Information:</b> |   |  |  |    |     |

|                     |   |                                  |  |    |    |
|---------------------|---|----------------------------------|--|----|----|
| 28                  | Other Reference-Patent/App/Search documents | Exhibit-PA-F-JINI-Spec-Part2.pdf | 18480774                                 | no | 29 |
|                     |   |                                  | 39ba53d2dd90a5e94614b5d76301ec6c43c64967 |    |    |
| <b>Warnings:</b>    |   |                                  |  |    |    |
| <b>Information:</b> |   |                                  |  |    |    |
| 29                  | Other Reference-Patent/App/Search documents | Exhibit-PA-F-JINI-Spec-Part3.pdf | 17689411                                 | no | 28 |
|                     |   |                                  | ddd6d6bb2c93c25cd436a4d42f9afd8aa04c25   |    |    |
| <b>Warnings:</b>    |   |                                  |  |    |    |
| <b>Information:</b> |   |                                  |  |    |    |
| 30                  | Other Reference-Patent/App/Search documents | Exhibit-PA-F-JINI-Spec-Part4.pdf | 17920325                                 | no | 31 |
|                     |   |                                  | 4527cbe5215d9f1d7682293b014780ce31b875dd |    |    |
| <b>Warnings:</b>    |   |                                  |  |    |    |
| <b>Information:</b> |   |                                  |  |    |    |
| 31                  | Other Reference-Patent/App/Search documents | Exhibit-PA-F-JINI-Spec-Part5.pdf | 17625524                                 | no | 30 |
|                     |   |                                  | 1a7aeed3fd84707832db82bd6f510e970643e27  |    |    |
| <b>Warnings:</b>    |   |                                  |  |    |    |
| <b>Information:</b> |   |                                  |  |    |    |
| 32                  | Other Reference-Patent/App/Search documents | Exhibit-PA-F-JINI-Spec-Part6.pdf | 17823128                                 | no | 28 |
|                     |   |                                  | 77c0f0c592e7654f5dbc507c1f481071a00f1035 |    |    |
| <b>Warnings:</b>    |   |                                  |  |    |    |
| <b>Information:</b> |   |                                  |  |    |    |
| 33                  | Other Reference-Patent/App/Search documents | Exhibit-PA-F-JINI-Spec-Part7.pdf | 17789024                                 | no | 26 |
|                     |   |                                  | 41f88ac414d0e4cc3dffbcfb5c0f9d11b8f3e882 |    |    |
| <b>Warnings:</b>    |   |                                  |  |    |    |
| <b>Information:</b> |   |                                  |  |    |    |
| 34                  | Other Reference-Patent/App/Search documents | Exhibit-PA-F-JINI-Spec-Part8.pdf | 16994360                                 | no | 25 |
|                     |   |                                  | dcf5754a99dd2d9a004535524a773f6933b364bc |    |    |
| <b>Warnings:</b>    |   |                                  |  |    |    |
| <b>Information:</b> |   |                                  |  |    |    |

|                     |  |  |   |    |    |
|---------------------|--|--|---|----|----|
| 35                  | Other Reference-Patent/App/Search documents        | Exhibit-PA-F-JINI-Spec-Part9.pdf       | 18971586                                  | no | 38 |
|                     |  |  | 74321167b619d8d2927b871aa91e54452f11adb   |    |    |
| <b>Warnings:</b>    |  |  |   |    |    |
| <b>Information:</b> |  |  |   |    |    |
| 36                  | Other Reference-Patent/App/Search documents        | Exhibit-PA-F-JINI-Spec-Part10.pdf      | 19383430                                  | no | 35 |
|                     |  |  | 91d4dc76e2f36ebf7c39fb9a17da55b15fbc0e062 |    |    |
| <b>Warnings:</b>    |  |  |   |    |    |
| <b>Information:</b> |  |  |   |    |    |
| 37                  | Other Reference-Patent/App/Search documents        | Exhibit-PA-F-JINI-Spec-Part11.pdf      | 19325429                                  | no | 31 |
|                     |  |  | 772dd34c50dc2f21a8ce43062dbe8e4548d997fa  |    |    |
| <b>Warnings:</b>    |  |  |   |    |    |
| <b>Information:</b> |  |  |   |    |    |
| 38                  | Other Reference-Patent/App/Search documents        | Exhibit-PA-F-JINI-Spec-Part12.pdf      | 18936952                                  | no | 49 |
|                     |  |  | 59ecd6f0ff860cf5b77472412f8150e06bde395f  |    |    |
| <b>Warnings:</b>    |  |  |   |    |    |
| <b>Information:</b> |  |  |   |    |    |
| 39                  | Other Reference-Patent/App/Search documents        | Exhibit-PA-F-JINI-Spec-Part13.pdf      | 12790213                                  | no | 20 |
|                     |  |  | 5b54d4c193cfd8bc2556114660f0183c93e311a41 |    |    |
| <b>Warnings:</b>    |  |  |   |    |    |
| <b>Information:</b> |  |  |   |    |    |
| 40                  | Information Disclosure Statement (IDS) Form (SB08) | SB08-0909-010-IDS.pdf                  | 1035235                                   | no | 4  |
|                     |  |  | bd9338fd818ad8e3a06842562199c1a0784d64ef  |    |    |
| <b>Warnings:</b>    |  |  |   |    |    |
| <b>Information:</b> |  |  |   |    |    |
| 41                  | Other Reference-Patent/App/Search documents        | Exhibit-OTH-A-Mandayam-Declaration.pdf | 1070961                                   | no | 51 |
|                     |  |  | 75b3723c62e879343197487d40fd1ebc764e2de2  |    |    |
| <b>Warnings:</b>    |  |  |   |    |    |
| <b>Information:</b> |  |  |   |    |    |

|                                     |   |   |  |           |    |
|-------------------------------------|---|---|--|-----------|----|
| 42                                  | Other Reference-Patent/App/Search documents | Exhibit-OTH-B-Mandayam-CV.pdf                     | 152098                                   | no        | 28 |
|                                     |   |   | 4b627555cce90b8c76d969d5d2ba89fbdd1f3064 |           |    |
| <b>Warnings:</b>                    |   |   |  |           |    |
| <b>Information:</b>                 |   |   |  |           |    |
| 43                                  | Other Reference-Patent/App/Search documents | Exhibit-OTH-C-Amended-Claims.pdf                  | 85349                                    | no        | 21 |
|                                     |   |   | d55df6f49c1ba3a692af8f7becc2917cf707c07f |           |    |
| <b>Warnings:</b>                    |   |   |  |           |    |
| <b>Information:</b>                 |   |   |  |           |    |
| 44                                  | Other Reference-Patent/App/Search documents | Exhibit-OTH-D-Support-for-Proposed-Amendments.pdf | 13831510                                 | no        | 54 |
|                                     |   |   | 53ff6b65b3c8e7b8aa762ac9f16fa410ea26b1be |           |    |
| <b>Warnings:</b>                    |   |   |  |           |    |
| <b>Information:</b>                 |   |   |  |           |    |
| 45                                  | Power of Attorney                           | POA-Pedersen-signed.pdf                           | 345342                                   | no        | 5  |
|                                     |   |   | 814df2d4bb0a7c7f06f362bd18efa50cb602d23e |           |    |
| <b>Warnings:</b>                    |   |   |  |           |    |
| <b>Information:</b>                 |   |   |  |           |    |
| 46                                  | Transmittal Letter                          | SB57-ReexamTransmittalForm.pdf                    | 344158                                   | no        | 3  |
|                                     |   |   | 19a7ff5a95b9125deca0ca60d13183d3bb503a3e |           |    |
| <b>Warnings:</b>                    |   |   |  |           |    |
| <b>Information:</b>                 |   |   |  |           |    |
| 47                                  | Receipt of Original Ex Parte Reexam Request | ReqforReexam.pdf                                  | 518296                                   | no        | 67 |
|                                     |   |   | 9ca0e0efc31c98847533cd261a894bde1cff588c |           |    |
| <b>Warnings:</b>                    |   |   |  |           |    |
| <b>Information:</b>                 |   |   |  |           |    |
| 48                                  | Fee Worksheet (SB06)                        | fee-info.pdf                                      | 35309                                    | no        | 2  |
|                                     |   |   | 5d107fe4666c32cc569db91591b3a4c04fe1475  |           |    |
| <b>Warnings:</b>                    |   |   |  |           |    |
| <b>Information:</b>                 |   |   |  |           |    |
| <b>Total Files Size (in bytes):</b> |   |   |  | 337220947 |    |

**This Acknowledgement Receipt evidences receipt on the noted date by the USPTO of the indicated documents, characterized by the applicant, and including page counts, where applicable. It serves as evidence of receipt similar to a Post Card, as described in MPEP 503.**

**New Applications Under 35 U.S.C. 111**

**If a new application is being filed and the application includes the necessary components for a filing date (see 37 CFR 1.53(b)-(d) and MPEP 506), a Filing Receipt (37 CFR 1.54) will be issued in due course and the date shown on this Acknowledgement Receipt will establish the filing date of the application.**

**National Stage of an International Application under 35 U.S.C. 371**

**If a timely submission to enter the national stage of an international application is compliant with the conditions of 35 U.S.C. 371 and other applicable requirements a Form PCT/DO/EO/903 indicating acceptance of the application as a national stage submission under 35 U.S.C. 371 will be issued in addition to the Filing Receipt, in due course.**

**New International Application Filed with the USPTO as a Receiving Office**

**If a new international application is being filed and the international application includes the necessary components for an international filing date (see PCT Article 11 and MPEP 1810), a Notification of the International Application Number and of the International Filing Date (Form PCT/RO/105) will be issued in due course, subject to prescriptions concerning national security, and the date shown on this Acknowledgement Receipt will establish the international filing date of the application.**



Exhibit PAT-A  
U.S. Patent No. 7,039,033  
Haller et al.



US007039033B2

(12) **United States Patent**  
**Haller et al.**

(10) **Patent No.:** **US 7,039,033 B2**  
(45) **Date of Patent:** **May 2, 2006**

(54) **SYSTEM, DEVICE AND COMPUTER READABLE MEDIUM FOR PROVIDING A MANAGED WIRELESS NETWORK USING SHORT-RANGE RADIO SIGNALS**

5,793,763 A 8/1998 Mayes et al.  
5,805,166 A 9/1998 Hall et al.  
5,838,252 A 11/1998 Kikinis

(Continued)

(75) **Inventors:** **Amif Haller**, Belmont, CA (US); **Peter Fornell**, Lake Oswego, OR (US); **Avraham Itzhak**, Ra'anana (IL); **Amir Glick**, Tel Aviv (IL); **Ziv Haparnas**, Tel Aviv (IL)

FOREIGN PATENT DOCUMENTS

JP 3153213 4/2001

(Continued)

OTHER PUBLICATIONS

Hardwick et al. Project P946-GI Smart Devices "When Things Start to Think", pp. 1-30, Jan. 2000.\*

(Continued)

*Primary Examiner*—Frank Duong

(74) *Attorney, Agent, or Firm*—Vierra Magen Marcus Harmon & DeNiro LLP

(\*) **Notice:** Subject to any disclaimer, the term of this patent is extended or adjusted under 35 U.S.C. 154(b) by 171 days.

(21) **Appl. No.:** **09/850,399**

(22) **Filed:** **May 7, 2001**

(65) **Prior Publication Data**

US 2002/0163895 A1 Nov. 7, 2002

(51) **Int. Cl.**  
**G01R 31/08** (2006.01)

(52) **U.S. Cl.** ..... **370/338; 370/401; 370/466; 370/469**

(58) **Field of Classification Search** ..... **370/259, 370/260, 320, 321, 328-339, 342, 347, 400-401, 370/395.5, 395.54, 465-649; 455/403, 422, 455/550, 556, 557; 709/203, 208**  
See application file for complete search history.

(56) **References Cited**

U.S. PATENT DOCUMENTS

5,442,680 A 8/1995 Schellinger et al.  
5,457,737 A 10/1995 Wen  
5,572,528 A 11/1996 Shuen  
5,742,237 A 4/1998 Bledsoe  
5,771,438 A 6/1998 Palermo et al.  
5,774,791 A 6/1998 Strohallen et al.

(57) **ABSTRACT**

A system, a wireless hand-held device, and software component for accessing information responsive to short-range radio signals is provided. The system includes a wireless gateway device coupled to a network, such as a cellular network. The wireless gateway device includes a network manager software component for accessing information from the network responsive to a first short-range radio signal. The network may be a corporate, private or public network, such as the Internet. A first wireless device is coupled to the wireless gateway device. The first wireless device provides the first short-range radio signal. In an embodiment of the present invention, the first wireless device is a cellular telephone, personal digital assistant or thin terminal having a Bluetooth™ processor and transmitter. In an embodiment of the present invention, the network manager software component includes a plug and play software component for loading and executing software for the first wireless device. In an embodiment of the present invention, a second wireless device accesses information on the first wireless device using the wireless gateway device.

56 Claims, 9 Drawing Sheets

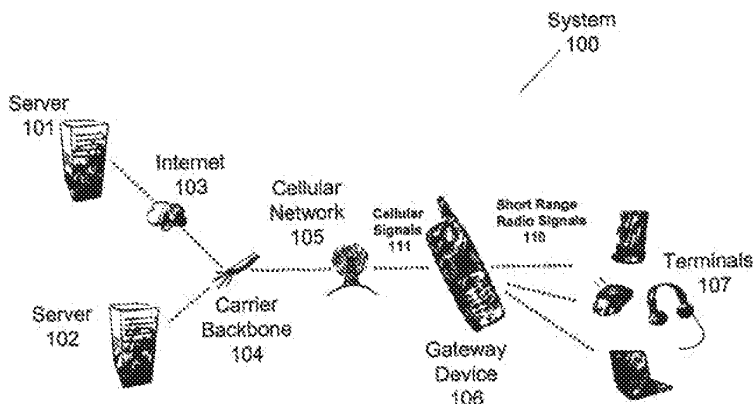

US 7,039,033 B2

Page 2

U.S. PATENT DOCUMENTS

5,896,369 A 4/1999 Warsta et al.  
 5,929,848 A 7/1999 Albukerk et al.  
 5,978,386 A 11/1999 Hamalainen et al.  
 5,987,011 A 11/1999 Toh  
 5,997,033 A 11/1999 Boer et al.  
 6,064,734 A 5/2000 Hasegawa et al.  
 6,067,291 A 5/2000 Kamerman et al.  
 6,069,896 A 5/2000 Borgstahl et al.  
 6,078,789 A 6/2000 Bodenmann et al.  
 6,085,098 A 7/2000 Moon et al.  
 6,130,602 A 10/2000 O'Toole et al.  
 6,151,628 A 11/2000 Xu et al.  
 6,192,257 B1 2/2001 Ray  
 6,198,948 B1 3/2001 Suoio et al.  
 6,218,958 B1 4/2001 Eichstaedt et al.  
 6,223,029 B1 4/2001 Steman et al.  
 6,243,581 B1 6/2001 Jawanda  
 6,265,788 B1 7/2001 Davidsen et al.  
 6,282,183 B1 8/2001 Harris et al.  
 6,298,443 B1 10/2001 Colligan et al.  
 6,326,926 B1 12/2001 Shoobridge et al.  
 6,333,973 B1 12/2001 Smith et al.  
 6,343,276 B1 1/2002 Barnett  
 6,405,027 B1 6/2002 Bell  
 6,430,408 B1 8/2002 Dorenbosch  
 6,434,537 B1 8/2002 Grimes  
 6,446,127 B1\* 9/2002 Schuster et al. .... 709/227  
 6,452,910 B1\* 9/2002 Vij et al. .... 370/310  
 6,459,882 B1 10/2002 Palermo et al.  
 6,463,078 B1 10/2002 Engstrom et al.  
 6,487,180 B1 11/2002 Borgstahl et al.  
 6,519,460 B1\* 2/2003 Haartsen ..... 455/452.1  
 6,532,366 B1 3/2003 Chung et al.  
 6,600,428 B1 7/2003 O'Toole et al.  
 6,600,734 B1 7/2003 Gemert  
 6,630,925 B1 10/2003 Östergård et al.  
 6,633,759 B1 10/2003 Kobayashi  
 6,636,489 B1 10/2003 Fingerhut  
 6,654,616 B1 11/2003 Pope et al.  
 6,665,549 B1 12/2003 Reed  
 6,690,929 B1 2/2004 Yeh  
 6,783,012 B1\* 7/2004 Lord et al. .... 370/338  
 6,763,247 B1 7/2004 Hallstrom et al.  
 6,871,063 B1 3/2005 Schiffer  
 2001/0047424 A1 11/2001 Alastalo et al.  
 2002/0019008 A1 1/2002 Beek et al.  
 2002/0010683 A1 1/2002 Aune  
 2002/0037700 A1 3/2002 Dooley et al.  
 2002/0055333 A1 5/2002 Davies et al.  
 2002/0058502 A1 5/2002 Stanforth  
 2002/0063472 A1 5/2002 Irvia  
 2002/0065099 A1 5/2002 Bjornadahl  
 2002/0065817 A1 5/2002 Ito et al.  
 2002/0068559 A1 6/2002 Sharma et al.  
 2002/0068600 A1 6/2002 Chihara et al.  
 2002/0069037 A1 6/2002 Hendrickson et al.  
 2002/0082954 A1 6/2002 Keinonen et al.  
 2002/0086718 A1 7/2002 Bigwood et al.  
 2002/0091633 A1 7/2002 Proctor  
 2002/0102974 A1 8/2002 Raith  
 2002/0118663 A1\* 8/2002 Dorenbosch et al. .... 370/338  
 2002/0124051 A1 9/2002 Liebenow  
 2002/0132610 A1 9/2002 Chaplin et al.  
 2002/0142762 A1 10/2002 Chmuytelli et al.  
 2002/0143932 A1 10/2002 Sugianto et al.  
 2002/0155830 A1 10/2002 Iyer  
 2002/0160764 A1 10/2002 Gorsuch  
 2003/0013438 A1 1/2003 Darby  
 2003/0017210 A1 1/2003 Janninck et al.  
 2003/0022690 A1 1/2003 Liu

2003/0027563 A1 2/2003 Herle et al.  
 2003/0032417 A1 2/2003 Minear et al.  
 2003/0050058 A1 3/2003 Walsh et al.  
 2003/0054765 A1 3/2003 Botteck  
 2003/0060188 A1 3/2003 Gidron  
 2003/0060189 A1 3/2003 Minear et al.  
 2003/0078036 A1 4/2003 Chang et al.  
 2003/0091917 A1 5/2003 Dawsonport et al.  
 2003/0114105 A1 6/2003 Haller et al.  
 2003/0115351 A1 6/2003 Giobbi  
 2003/0122856 A1 7/2003 Hubbard  
 2003/0143992 A1 7/2003 Humphrey et al.  
 2003/0153280 A1 8/2003 Kopp et al.  
 2003/0187807 A1 10/2003 Matsubara et al.  
 2003/0214940 A1 11/2003 Takken  
 2003/0224773 A1 12/2003 Deeds  
 2003/0232616 A1 12/2003 Gidron et al.  
 2004/0001467 A1 1/2004 Cromer et al.  
 2004/0048671 A1 3/2004 Rowe  
 2004/0066769 A1 4/2004 Ahmavaara et al.  
 2004/0192384 A1 9/2004 Anastasakos et al.  
 2004/0196812 A1 10/2004 Barber

FOREIGN PATENT DOCUMENTS

WO WO 99/48315 9/1999  
 WO WO 00/39967 7/2000  
 WO WO 01/048977 7/2001

OTHER PUBLICATIONS

Guthery et al, The WebSIM—Clever Smartcards Listen to Port 80, pp. 1-16, Dec. 1999.\*  
 Johansson et al, Short Range Radio Based Ad-hoc Networking: Performance and Properties, IEEE, pp. 1414-1420, 1999.\*  
 Haartsen, BLUETHOOH—The universal radio interface for ad hoc, wireless connectivity, Ericsson Review N. 3, pp. 110-117.\*  
 Lee et al, Integrating Bluetooth with Wireless and Ricocheting, IEEE, pp. 1310-1314, 2000.\*  
 Karagiannis, Mobility support for ubiquitous Internet access, ERICSSON Open report, pp. 1-70, Dec. 21, 2000.\*  
 Guthery et al., "The WebSIM—Clever Smartcards Listen to Port 80", version Dec. 15, 1999.  
 Project P946-GI, Smart Devices "When Things Start to Think", Jan. 2000, 2000 EURESCOM Participants in Project P946-GI.  
 Frodigh et al., "Wireless ad hoc networking—The art of networking without a network", Ericsson Review No. 4, 2000, pp. 248-263.  
 Faruque et al, "Design and Analysis of Ad Hoc Wireless Networks for Battlefield Applications", Part of the SPIE Conference on Digitization of the Battlespace IV, Orlando, Florida, Apr., 1999, pp. 118-122.  
 Garcia-Luna-Aceves et al., "Wireless Internet Gateways (Wings)", 1997 IEEE, pp. 1271-1276.  
 White Paper, Handheld Devices: Comparing the Major Platforms, www.dell.com/r&d, Dec. 2000.  
 Miyasu, Bluetooth Design Background and Its Technological Features, IEEE Trans, Fundamentals, vol. E83-A, No. 11, Nov. 2000.  
 Parakh, Operating Systems on Wireless Handheld Devices, A Strategic Market Analysis, Massachusetts Institute of Technology, Sep. 28, 2000.  
 Johansson, et al., Short Range Radio Based Ad-hoc Networking: Performance and Properties, IEEE, 1999.

\* cited by examiner

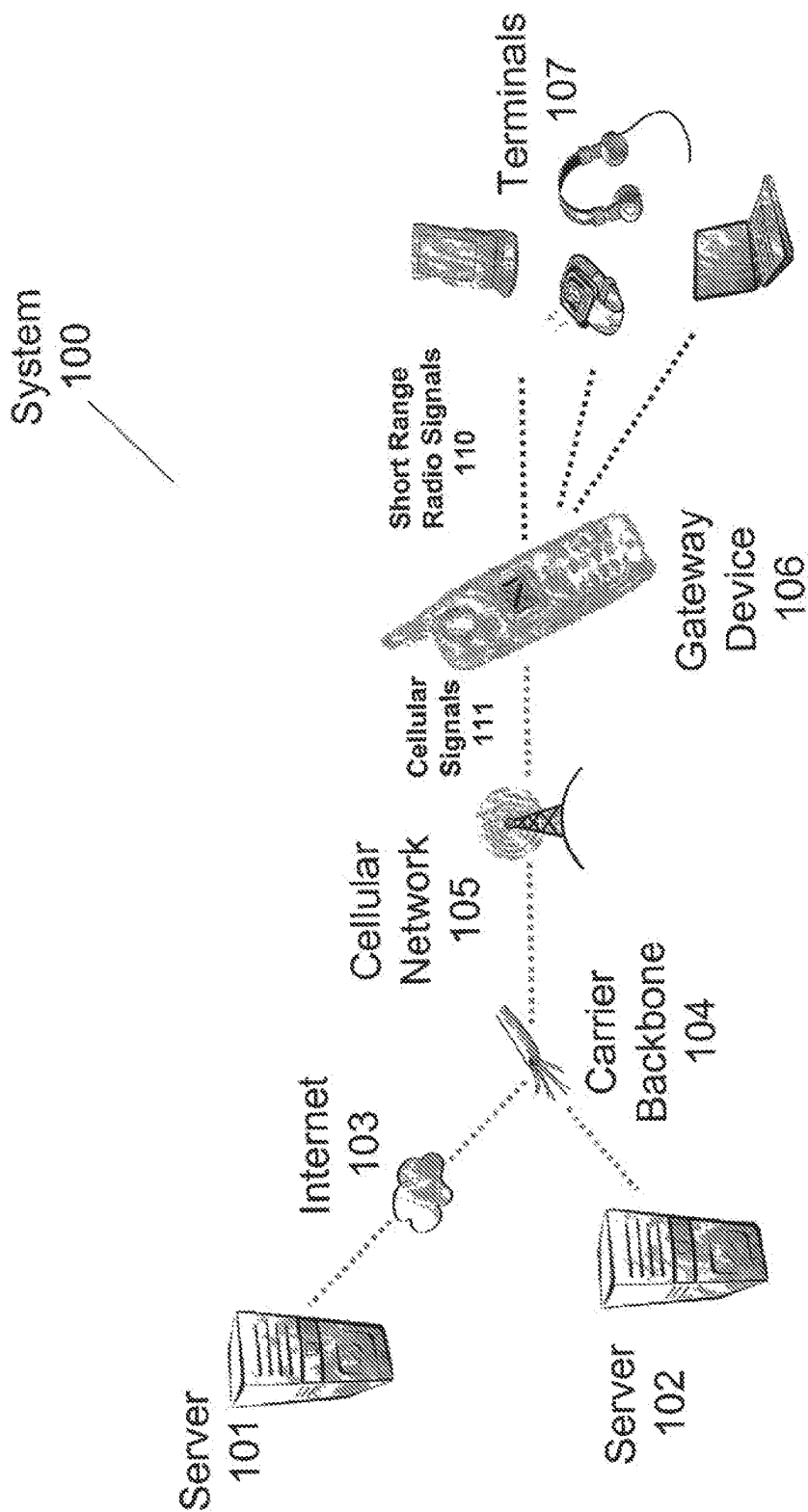

Fig. 1

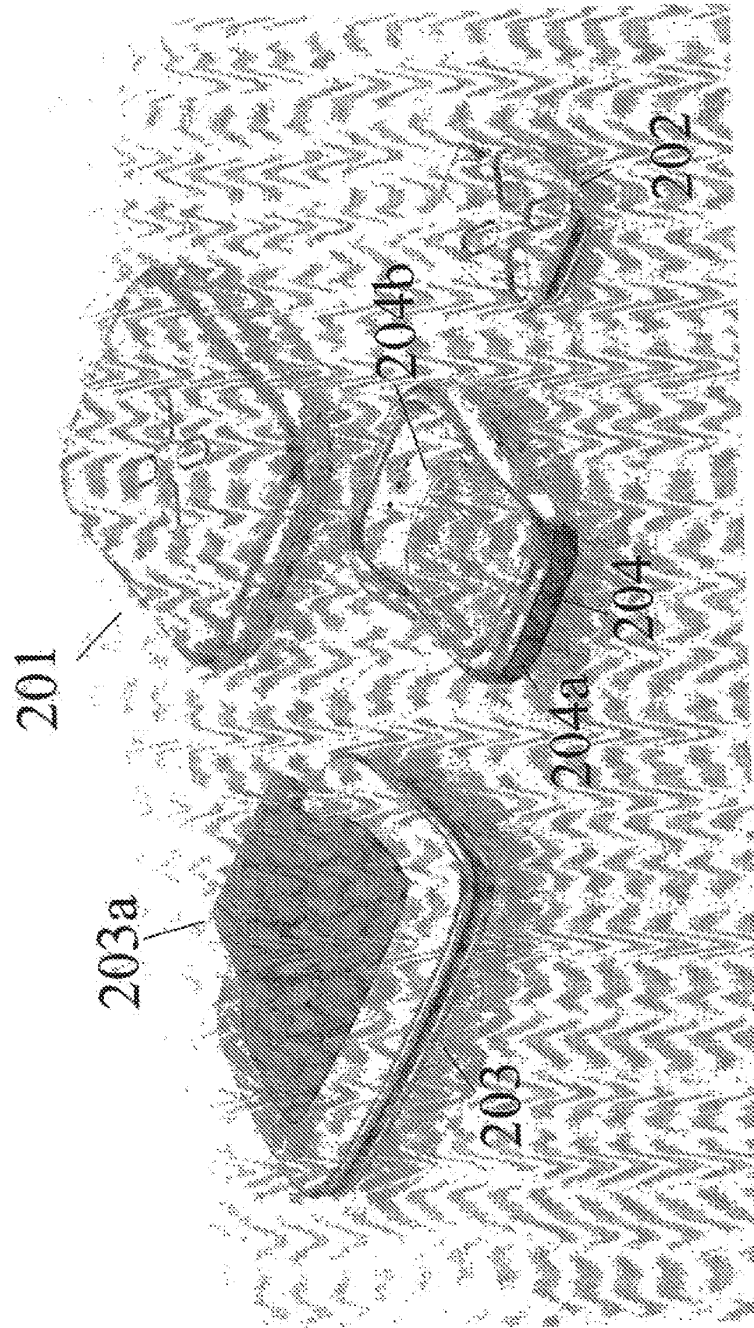

Fig. 2

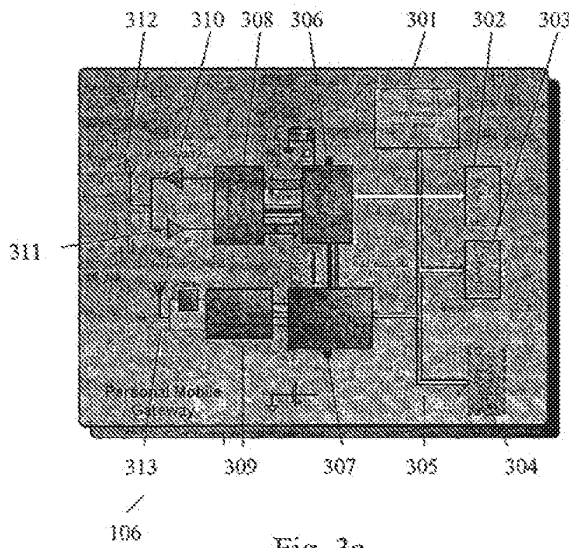

Fig. 3a

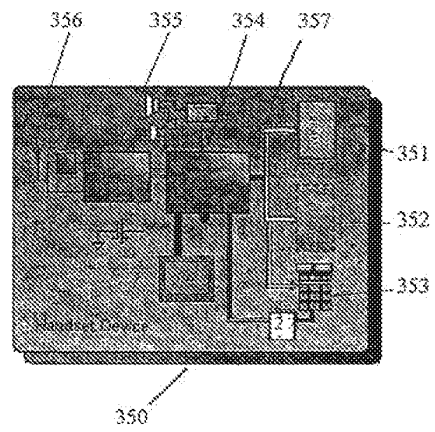

Fig. 3b

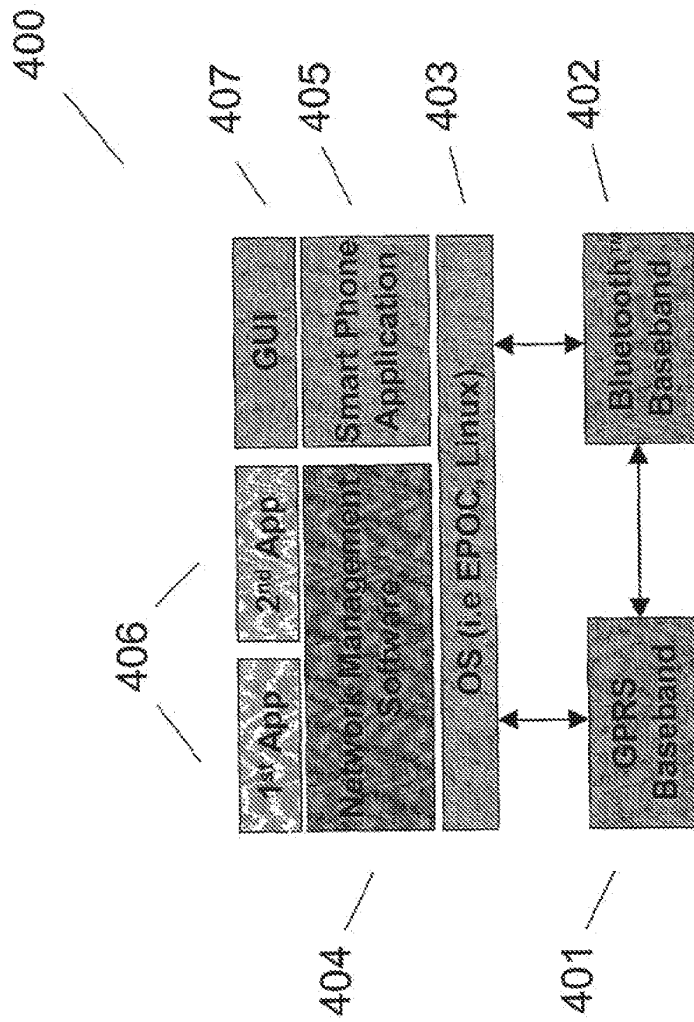

Fig. 4

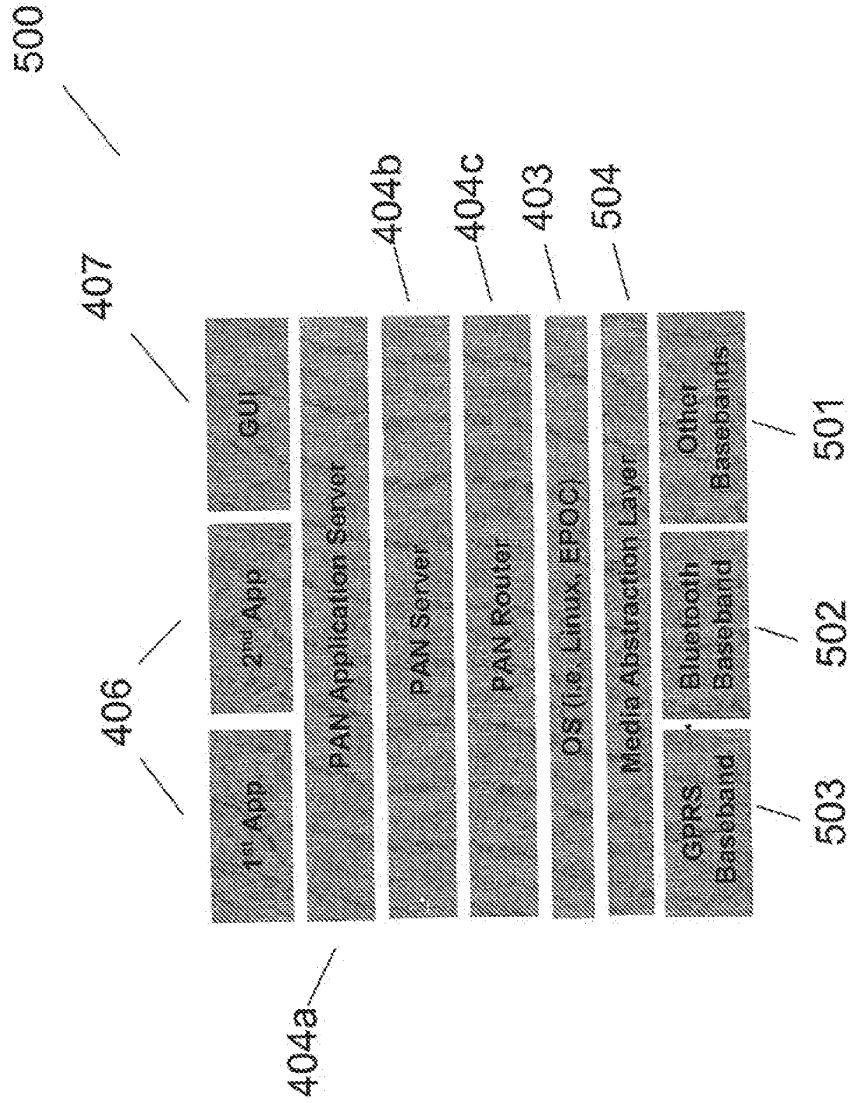

Fig. 5a



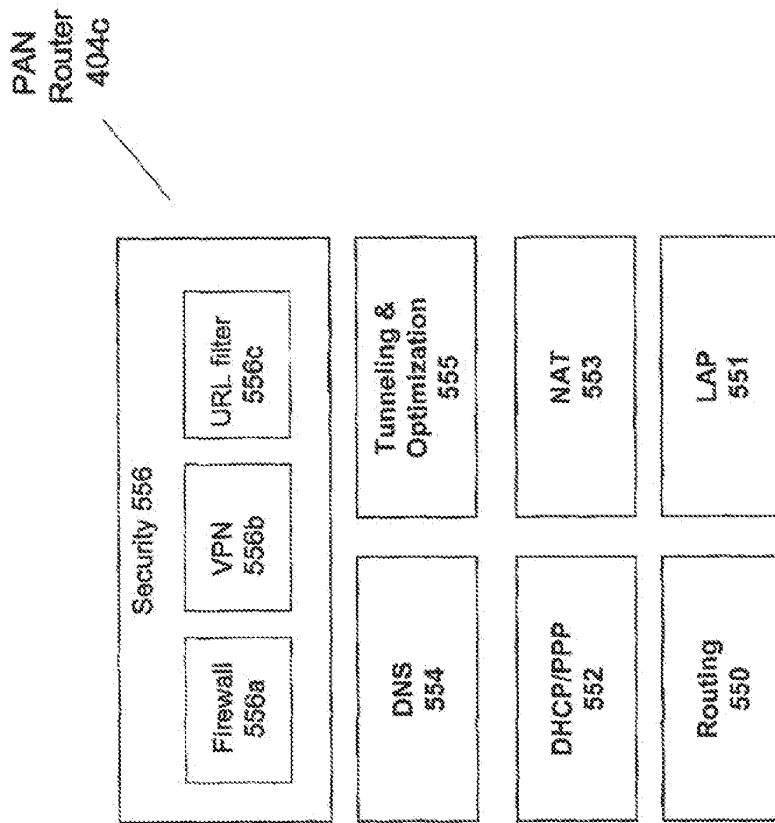

Fig. 5b

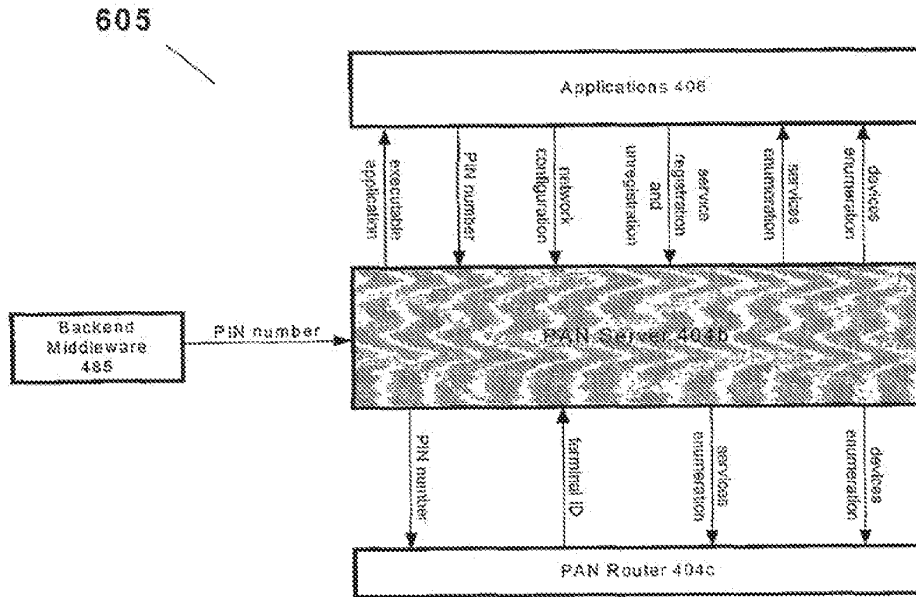

Fig. 6



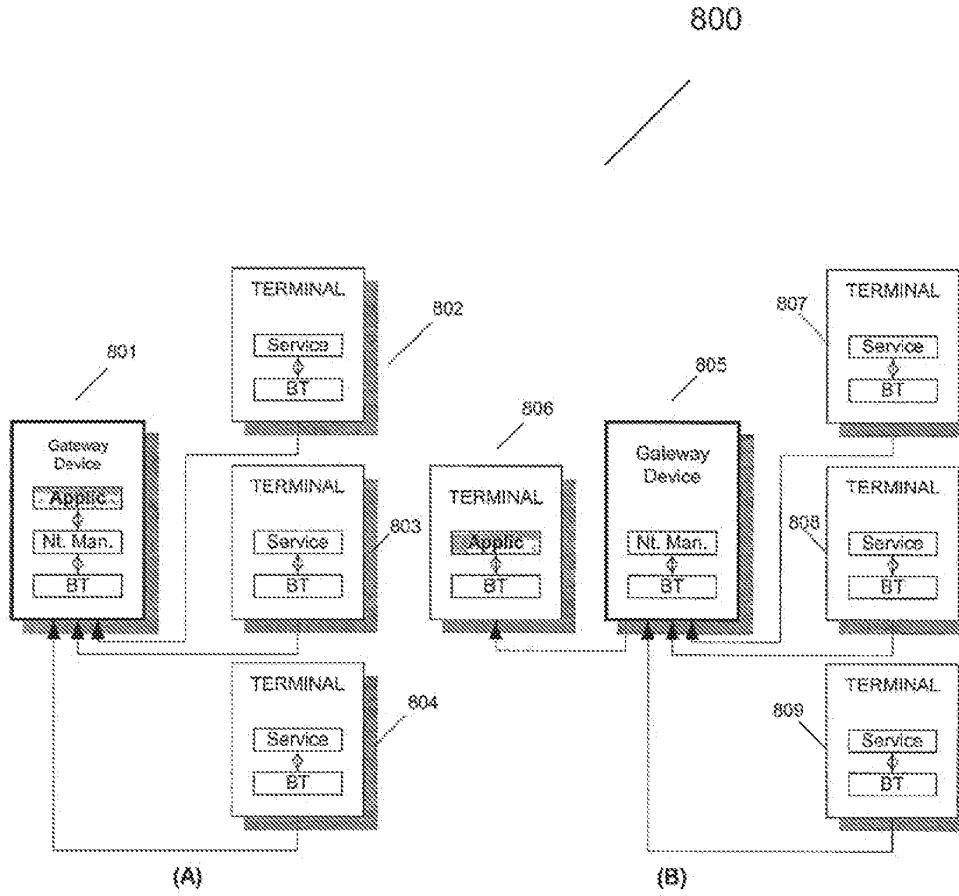

Fig. 8

**SYSTEM, DEVICE AND COMPUTER  
READABLE MEDIUM FOR PROVIDING A  
MANAGED WIRELESS NETWORK USING  
SHORT-RANGE RADIO SIGNALS**

**FIELD OF THE INVENTION**

This invention relates generally to wireless devices in a wireless network using short-range radio signals.

**BACKGROUND OF THE INVENTION**

A user has numerous wireless devices for accessing and processing information. For example, a user may have a cellular telephone for communicating with others, a personal digital assistant ("PDA") for storing contact information, a laptop computer for storing and processing files, a digital camera for obtaining images and a pager for being contacted. Each one of these devices also may access remote information on a private or public network, such as the Internet. However, this system suffers from several disadvantages.

First, typically only a single device originates and can access the Internet at a time.

Second, Internet protocol ("IP") addresses are held while connected to the Internet. This can be expensive and use scarce IP address resources.

Third, each device requires its own security management, such as a Virtual Private Network ("VPN") and firewall software component.

Fourth, there is no ability to share, add to or manage the services of the numerous wireless devices. In particular, there is no communication between wireless devices. If a user obtains a wireless device having an additional service, such as extra persistence storage, other wireless devices typically are not capable of using the extra persistence storage.

Bluetooth™ technology ([www.bluetooth.com](http://www.bluetooth.com)) provides wireless communications between devices. Yet, Bluetooth™ technology also suffers from many disadvantages. Bluetooth™ technology does not allow for a "plug and play" capability at a wireless device application level. In other words, a wireless device cannot merely be turned on and Bluetooth™ technology recognizes it and establishes a communication protocol. If a user desires a wireless device to communicate with a Bluetooth™ technology device, the added wireless device must have software drivers and applications loaded to operate. Otherwise, the Bluetooth™ technology device is not able to communicate with the newly added wireless device. This makes it difficult to add new functionality or types of wireless devices. Bluetooth™ technology does not provide an open environment for software programmers to provide application software components for wireless devices. Further, Bluetooth™ technology does not allow devices to share information and resources at an application level.

Therefore, it is desirable to provide a system of wireless devices which can effectively communicate with each other and access information on the Internet. The system of wireless devices should efficiently use IP resources and security management. The wireless devices should effectively share and manage services and allow for seamless plug and play capability. The system should allow for new functionality and types of wireless devices.

**SUMMARY OF THE INVENTION**

A system, coupled to a cellular network, provides access to the Internet according to an embodiment of the present invention. The system comprises a wireless gateway device, coupled to the cellular network, having a network manager software component for accessing information from the Internet responsive to a first short-range radio signal. A first wireless device is coupled to the wireless gateway device. The first wireless device provides the first short-range radio signal.

According to an embodiment of the present invention, the first wireless device is selected from a group consisting of a desktop computer, a laptop computer, a personal digital assistant, a headset, a printer, a pager, a watch, digital camera and an equivalent thereof.

According to an embodiment of the present invention, the wireless gateway device is a cellular telephone using a Global System for Mobile communications ("GSM") protocol.

According to an embodiment of the present invention, the wireless gateway device is a cellular telephone using a Code Division Multiple Access ("CDMA") protocol.

According to an embodiment of the present invention, the wireless gateway device is a cellular telephone using a Time Division Multiple Access ("TDMA") protocol.

According to an embodiment of the present invention, the first wireless device is a thin terminal.

According to an embodiment of the present invention, the first wireless device includes a Bluetooth™ processor having a 2.4 GHz transmitter.

According to an embodiment of the present invention, the wireless gateway device includes a Bluetooth™ processor having a 2.4 GHz transmitter.

According to an embodiment of the present invention, the network manager software component includes a plug and play software component for loading and executing software for the first wireless device.

According to an embodiment of the present invention, the network manager software component includes a PIN number management software component for obtaining and supplying PIN numbers.

According to an embodiment of the present invention, the network manager software component includes a service repository software component for obtaining and providing an availability of a service from the first wireless device.

According to an embodiment of the present invention, the first wireless device includes an application software component for providing a service. The network manager software component includes a management software component for accessing the service.

According to an embodiment of the present invention, the system further comprises a second wireless device coupled to the wireless gateway device. The second wireless device provides a short-range signal. The first wireless device communicates with the second wireless device through the wireless gateway device.

According to an embodiment of the present invention, the system further comprises a second wireless device coupled to the wireless gateway device. The wireless gateway device provides access to the Internet for the first and second wireless devices.

According to an embodiment of the present invention, the network manager software component operates with an operating system software component.

3

According to an embodiment of the present invention, the operating system component is a Linx, EPOC or a PocketPC operating system.

According to an embodiment of the present invention, the wireless gateway device includes 1) an application software component for providing a service, and 2) an application server software component coupled to the network management software component.

According to an embodiment of the present invention, the wireless gateway device further includes a firewall software component.

According to an embodiment of the present invention, the wireless gateway device includes a VPN software component.

According to an embodiment of the present invention, a hand-held device for providing a personal area network is provided. The hand-held device comprises a storage device coupled to a processor. The storage device stores a software component for controlling the processor. The processor operates with the component to provide a short-range radio Internet protocol communication between the first hand-held wireless device and a second hand-held wireless device.

According to an embodiment of the present invention, a Bluetooth™ transmitter is coupled to the processor.

According to an embodiment of the present invention, a GSM transmitter is coupled to the processor.

According to an embodiment of the present invention, a wireless hand-held device accesses a router in a personal network. The wireless hand-held device comprises a storage device coupled to a processor. The storage device stores a software component for controlling the processor. The processor operates with the component to provide a first short-range radio signal to the router for accessing the Internet and a second short-range radio signal to the router for accessing another wireless hand-held device.

According to an embodiment of the present invention, an article of manufacture, including a computer readable medium is provided. The article of manufacture comprises an application software component for providing a service. An application server software component provides the application software component. The article of manufacture also includes an Internet protocol network manager software component and an operating system software component. Also, a short-range radio software component for providing a short-range radio signal and a cellular software component for providing a communications signal to a cellular network is included with the article of manufacture.

Other aspects and advantages of the present invention can be seen upon review of the figures, the detailed description, and the claims that follow.

#### BRIEF DESCRIPTION OF THE FIGURES

FIG. 1 illustrates a system according to an embodiment of the present invention.

FIG. 2 illustrates thin terminals and a wireless gateway device according to an embodiment of the present invention.

FIGS. 3a-b are hardware block diagrams of a wireless gateway device and wireless hand held device according to an embodiment of the present invention.

FIGS. 4 and 5a-b are software block diagrams for a wireless gateway device according to an embodiment of the present invention.

FIG. 6 illustrates network management software interfaces according to an embodiment of the present invention.

FIG. 7 illustrates network management software components according to an embodiment of the present invention.

4

FIGS. 8a-b illustrate multiple wireless devices coupled to a wireless gateway device according to an embodiment of the present invention.

#### DETAILED DESCRIPTION

##### I. System Overview

The following description and claims relate to a system that accesses information from a wide area network ("WAN"), such as the Internet, and local wireless devices in response to short-range radio signals. The network may also be an IP based public or private network, such as a corporate secured network using VPN.

FIG. 1 illustrates system 100 according to an embodiment of the present invention. System 100 includes terminals 107 coupled to wireless gateway device 106. In an embodiment of the present invention, gateway device 106 and one or more terminals 107 communicate to form a personal area network ("PAN"). In an embodiment of the present invention, terminals 107 are coupled to gateway device 106 by short-range radio signals 110. In an embodiment of the present invention, terminals 107 are a desktop computer, a laptop computer, a personal digital assistant, a headset, a pager, a printer, a watch, thin terminal, digital camera or an equivalent thereof. In an embodiment of the present invention, terminals 107 include a Bluetooth™ 2.4 GHz transmitter/receiver. Likewise, gateway device 106 includes a Bluetooth™ 2.4 GHz transmitter/receiver. In an alternate embodiment of the present invention, a Bluetooth™ 5.7 GHz transmitter/receiver is used. Gateway device 106 and terminals 107 hardware are illustrated in FIGS. 3a-b.

In alternate embodiments of the present invention, other local wireless technologies such as 802.11 or HomeRF signals are used to communicate between gateway device 106 and terminals 107.

In an embodiment of the present invention, gateway device 106 is coupled to cellular network 105 by cellular signals 111 using a protocol, such as a Global and System for Mobile communications ("GSM") protocol. In alternate embodiments, a Code Division Multiple Access ("CDMA"), CDMA 2000 or Time Division Multiple Access ("TDMA"), or General Packet Radio Service ("GPRS") protocol is used.

In an alternate embodiment of the present invention, gateway device 106 is coupled to a landline network by an Ethernet, Digital Subscriber Line ("DSL"), or cable modem connection, singly or in combination.

In an embodiment of the present invention, gateway device 106 is a cellular telephone.

Cellular network 105 is coupled to a wireless carrier internal network or carrier backbone 104. In an embodiment of the present invention, server 102 is coupled to carrier backbone 104. In an alternate embodiment of the present invention, carrier backbone 104 is coupled to Internet 103. Server 101 is coupled to Internet 103. In an embodiment of the present invention, servers 101 and 102 provide information, such as web pages or application software components to terminals 107 by way of gateway device 106. In an embodiment of the present invention, terminals 107 share services and communicate by way of gateway device 106.

##### II. Gateway/Handheld Device Hardware

FIG. 2 illustrates terminals 107. In an embodiment of the present invention, there are two types of terminals: 1) Smart terminals and 2) Thin terminals. Smart terminals have a relatively powerful central processor, operating system and applications. Their main needs from a PAN are access to a WAN through TCP/IP and other network services such as

storage and execution. For example, a computer notebook and PDA are smart terminals. Thin terminals have a relatively low power central processor and operating system. They are mainly used as peripherals to an Application server in a PAN and their main task is user interaction, rendering output for a user and providing an Application server with a user's input. For example, a watch or a messaging terminal are thin terminals.

FIG. 2 illustrates thin terminals. Voice terminal 204 includes a display 204b and a retractable keypad 204a. Messaging Terminal 203 is illustrated in a closed position with a hinge 203a used to open and close terminal 203. Terminal 203 also includes a miniature QWERTY keyboard and display when opened. Gateway device 201 includes clip 202 for a belt.

In an embodiment, PMG device 201 is also illustrated in FIG. 2.

FIG. 3a illustrates a hardware block diagram of gateway device 106 in an embodiment of the present invention. Gateway device 106 includes both internal and removable memory. In particular, gateway device 106 includes internal FLASH (or Electrically Erasable Programmable Read-Only Memory ("EEPROM")) and static Random Access Memory ("SRAM") memory 302 and 303, respectively. Removable FLASH memory 304 is also used in an embodiment of the present invention. Memories 302, 303 and 304 are coupled to bus 305. In an embodiment of the present invention, bus 305 is an address and data bus. Application processor 301 is likewise coupled to bus 305. In an embodiment of the present invention, processor 301 is a 32 bit processor.

Bluetooth™ processor 307 is also coupled to bus 305. Bluetooth™ RF circuit 309 is coupled to Bluetooth™ processor 307 and antenna 313. Processor 307, RF circuit 309 and antenna 313 transmit and receive short-range radio signals to and from terminals 107 illustrated in FIG. 1, or device 350 illustrated in FIG. 3b.

Cellular, such as GSM, signals are transmitted and received using digital circuit 306, analog circuit 308, transmitter 310, receiver 311 and antenna 312. Digital circuit 306 is coupled to bus 305. In alternate embodiments, gateway device 106 includes a display, a speaker, a microphone, a keypad and a touchscreen, singly or in combination thereof.

FIG. 3b illustrates device 350 that is a hand-held device in an embodiment of the present invention. Device 350, in an embodiment of the present invention, is one of the terminals 107 illustrated in FIG. 1. Similar to gateway device 106, device 350 includes SRAM and FLASH memory 351 and 352, respectively. Memories 351 and 352 are coupled to bus 357. In an embodiment of the present invention, bus 357 is an address and data bus. Keypad 353 is also coupled to bus 357. Short-range radio signals are transmitted and received using Bluetooth™ processor 354 and Bluetooth™ RF circuit 355. Antenna 356 is coupled to Bluetooth™ RF circuit 355. In an embodiment of the present invention, antenna 356 transmits and receives short-range radio signals from gateway device 300. In alternate embodiments, device 350 includes a display, a speaker, a microphone, a keypad and a touchscreen, singly or in combination thereof.

### III. Gateway Software

FIG. 4 illustrates a software architecture 400 for gateway device 106 illustrated in FIG. 3a according to an embodiment of the present invention. Gateway software 400 is stored in FLASH 302. In an embodiment of the present invention, software components referenced in FIGS. 4-7 represent a software program, a software object, a software

function, a software subroutine, a software method, a software instance, a code fragment, singly or in combination. In an alternate embodiment, functions performed by software components illustrated in FIGS. 4-7 are carried out completely or partially by hardware.

In an embodiment of the present invention, gateway software 400, or components of gateway software 400, is stored in an article of manufacture, such as a computer readable medium. For example, gateway software 400 is stored in a magnetic hard disk, an optical disk, a floppy disk, CD-ROM (Compact Disk Read-Only Memory), RAM (Random Access Memory), ROM (Read-Only Memory), or other readable or writeable data storage technologies, singly or in combination. In yet another embodiment, gateway software 400, or components thereof, is downloaded from server 101 illustrated in FIG. 1.

Gateway software 400 includes telecommunication software or physical layer protocol stacks, in particular cellular communications software 401 and short-range radio communications software 402. In an embodiment, communication software 401 is a GPRS baseband software component used with processor 306 to transmit and receive cellular signals. In an embodiment, communication software 402 is a Bluetooth™ baseband software component used with processor 307 to transmit and receive short-range radio signals.

In an embodiment of the present invention, operating system 403 is used to communicate with telecommunications software 401 and 402. In an embodiment of the present invention, operating system 403 is a Linux operating system, EPOC operating system available from Symbian software of London, United Kingdom or a PocketPC or a Slinger operating system available from Microsoft of Redmond, Wash. Operating system 403 manages hardware and enables execution space for gateway device software components.

Network Management software 404 is used to provide a number of functions according to embodiments of the present invention: 1) routing, 2) device ping and play, 3) PIN number management, 4) network device management, and 5) service repository. In an embodiment of the present invention, network management software 404 is programmed in C++ software language.

Smart phone application software 405 communicates with operating system 403 and is used in a cellular telephone embodiment of the present invention.

1st and 2nd software application components 406 communicate with management software 404 and provide additional services to a user. For example, application components 406 may include: 1) a stock quote application for providing stock quotes, 2) a personal information manager application including calendars, to do lists, emails, or contacts, 3) a synchronization software application for synchronizing databases, 4) a telephony application for providing telephone services, or 5) a location application for providing a current location of a gateway device.

Furthermore, Graphics User Interface ("GUI") 407 is provided to allow a user-friendly interface.

FIG. 5a illustrates detailed gateway software architecture 500. In an embodiment of the present invention, network management software 404 illustrated in FIG. 4 includes three software components as illustrated in FIG. 5a: 1) PAN router 404c; 2) PAN server 404b; and 3) Application server 404a. GPRS baseband 503 and Bluetooth™ baseband 502 are software components used to generate communication signals to a cellular network 105 and terminals 107 as illustrated in FIG. 1. In an alternate embodiment, other baseband software components 501 are used to generate

communication signals. Media abstraction layer 504 allows operating system 403 to communicate with basebands 503, 502, and 501, respectively. Media abstraction layer 504 and other abstraction layers, described herein, translate a particular communication protocol, such as GPRS, into a standard command set used by a gateway device and/or terminal. The purpose of an abstraction layer is to isolate the physical stacks from the rest of the gateway device software components. This enables future usage of different physical stacks without changing any of the upper layer software and allows the gateway device software to work with any communication protocol.

PAN router 404c establishes a PAN network, implementing communication primitives, IP networking, IP services and similar tasks.

PAN server 404b is responsible for implementing PAN oriented services such as plug and play, terminal enumeration, application loading, storage space and other services. In an embodiment, PAN server 404b communicates directly with applications 406 using application drivers.

PAN application server 404a is responsible for implementing user and terminal oriented services and enables thin terminals. In an embodiment of the present invention, PAN application server 404a implements such applications as a GUI 407, a remote terminal driver application, a location application, a telephony application or an equivalent thereof.

FIG. 5a, like FIG. 4, illustrates 1st and 2nd software component applications 406 and GUI 407.

#### A. PAN Router

PAN router 404c enables a fully meshed IP based network. In an embodiment of the present invention, each terminal can leverage the existing IP protocol, exchange data with other terminals and gain access to a WAN through PAN router 404c.

FIG. 5b illustrates software components of PAN router 404c. In an embodiment of the present invention, routing component 550, Bluetooth™ LAN access Profile component 551, Dynamic Host Configuration Protocol/Point-to-Point Protocol ("DHCP/PPP") component 552 and Network Address Translator ("NAT") component 553 are used in PAN router 404c. In an alternate embodiment, Domain Naming Service ("DNS") component 554, Tunneling and Optimization component 555 and Security component 556, singly or in combination are used in PAN router 404c.

##### 1. Routing Component

Routing component 550 is implemented in Router 404c in order to realize a fully meshed IP network with access to a WAN. A routing component is responsible for initiating a fully meshed network based on a Master/Slave network.

Routing component 550 enables exchange of IP packets between two terminals, broadcasting of IP packets between all terminals on a PAN and routing of IP packets to and from a WAN.

##### 2. Bluetooth™ LAN Access Profile ("LAP") Component

A Bluetooth™ LAN Access Profile ("LAP") component 551 is used in order to enable terminals to seamlessly use IP base networking. LAP component 551 enables terminals to exchange IP packets between themselves and PAN router 404c. LAP component 551 is implemented over a PPP serial

Bluetooth™ connection. In an embodiment of the present invention, terminals, such as Smart terminals, include LAP chipsets.

##### 3. DHCP/PPP Component

DHCP and PPP components 552 are used in order to enable an IP network. PPP realizes an IP network layered over LAP component 551.

DHCP component manages a PAN's IP address space and IP services, enabling terminals to get IP networking properties, such as an IP address for a terminal, an address of a DNS and an address of a default gateway device.

##### 4. NAT Component

NAT component 553 translates a private IP address to and from a real IP address. Since mobile networks are typically capable of only providing a single IP address, the terminals will have to use private IP addresses supplied by NAT component 553.

##### 5. DNS Component

DNS component 554 translates services between human readable names and IP addresses. DNS component 554 enables a terminal to query another terminal's address based on the other terminal's name and to query for the IP address of a named service on a WAN.

##### 6. Tunneling and Optimization Component

Tunneling and Optimization component 555 allows terminals to use standard protocols. For example, accessing a WAN through a cellular GPRS/CDMA network using TCP/IP yields poor results because TCP/IP does not behave well over a bandwidth limited, high latency and high packet loss network, such as GPRS/CDMA.

Tunneling and Optimization component 555 is used to enable practical usage of IP in such networks. When using cellular, the tunnel will be between a mobile device having a PAN router and a landline operator's network. The tunneling and optimization network translates IP packets to more efficient transport methods for the specific access technology, and vice versa in a fully transparent fashion.

##### 7. Security Component

Accessing a WAN can typically be done in two ways: unsecured when accessing a public network, such as the Internet, or secured when accessing a private network, such as an Enterprise network, file system or Exchange server.

Security component 556 is a centralized managed way for controlling access to a secured private WAN. In order to avoid each one of the terminals from implementing its own security scheme and methods, a centralized security component 556 is used. In an embodiment of the present invention, security component 556 is a firewall 556a, VPN 556b or URL filter 556c, singly or in combination.

##### 8. Usage Scenario

In this scenario, a user is a traveling professional, who has a PDA and needs to synchronize the PDA against a corporate Exchange server while on the road. This synchronization needs to be done securely as the only way to enter the



corporate network is via a certified and an information technology ("IT") manager approved VPN.

The user has a gateway device enabled handset with an embedded PAN router 404c and VPN client, which the IT manager installed.

As the user turns on the PDA, which is a Bluetooth™ equipped PDA with a LAP component 551, the PDA connects to a gateway device handset via the LAP. The PDA receives a local PAN IP address.

The user loads the PDA synchronization software, which is configured to synchronize against the corporate Exchange server. When hitting the "Synchronize" button, the PDA opens a TCP connection to the IP address.

The IP packets travel across the Bluetooth™ air interface to the handset using a PPP protocol. At the handset, the packets go through a NAT component and a local IP address is translated to a real Internet IP address. The real IP address goes to the VPN, which identifies the destination as the corporate LAN. The VPN packages the packet over its Internet tunnel, encrypts and signs it. The packet is then sent through the cellular air interface to the operator and the Internet, reaching the corporate VPN and Exchange servers. The PDA is totally unaware of this process.

## B. PAN Server

PAN server 404b allows code to be downloaded to a PAN and executed in a central way. Similarly, PAN server 404b shares and stores data in a centralized manner.

### 1. PAN Server Interfaces

FIG. 6 illustrates software interfaces for PAN server 404b shown in FIG. 5a. PAN server 404b provides application program interfaces ("API") to applications 406. Applications 406 also queries PAN server 404b for specific services and/or terminal attributes in a PAN. Applications 406 provide at least three types of information to PAN server 404b. Applications 406 provide a Personal Identification Number ("PIN") number, network configuration information, service registration and unregistration information. PAN server 404a provides services and devices enumeration information to applications 406. In an embodiment of the present invention, a PIN number is an authorization code to enable a terminal to connect to a PAN.

PAN server 404b uses media abstraction layer 504 in order to communicate with terminals 107. PAN server 404b transfers services and devices enumerations to PAN router 404c; while, a terminal ID number is provided to PAN server 404b from PAN router 404c. A terminal ID is a unique code for identifying a particular terminal. Finally, a PIN number is transferred from PAN server 404b to PAN router 404c.

In an embodiment of the present invention, PAN server 404b loads an executable application software component to a selected terminal. Application server 404a retrieves the application software component locally from gateway device 106 memory or from either server 102 or 103 as illustrated in FIG. 1.

Backend middleware 485 provides a PIN number to router 404c. In an embodiment of the present invention, backend middleware 485 is stored on a server coupled to cellular network 105 shown in FIG. 1. In an embodiment of the present invention, backend middleware 485 is a software component for supplying PIN numbers and accessing application components for a particular terminal.

## 2. PAN Server Components

FIG. 7 illustrates software components of PAN server 404a according to an embodiment of the present invention: 1) plug and play software component 701, 2) PIN number management software component 702, 3) management software component 703, 4) service repository software component 704, and 5) application loader 705. In alternate embodiments, more or less components are used.

### a. Plug and Play Component

When a new terminal is introduced to a PAN, the software to support this terminal needs to be located, downloaded and executed. The Plug and Play component is responsible for identifying the introduction of the new terminal and deciding on the software needed to be downloaded.

An example of the Plug and Play usage is when a new thin terminal, like a messaging terminal, is introduced to a PAN. The terminal itself, being thin, has no embedded application code or data. The appropriate software package (messaging software in this case) needs to be found, downloaded and executed. The Plug and Play component will identify the messaging terminal and resolve the needed software to support it.

FIG. 7 illustrates the operation of Plug & Play component 701. In response to a terminal ID from PAN router 404c, Plug and Play component 701 will access the software package for a selected terminal from backend middleware 485 or locally from gateway device 106 memory. If the selected package is not locally available in gateway device 106 memory, a URL is provided from backend middleware 485 for accessing the package remotely. In an embodiment of the present invention, the selected package will install and run on different modules (typically but not necessarily a shell, service/terminal drivers and applications that can run on the terminal).

### b. Application Loader Component

Adding new capabilities to a PAN involves the loading of executable code to a PAN execution environment. Application loading can be a result of many events: plug and play component 701 can generate an application loading for supporting a new terminal on a PAN, a user can decide to actively load an application to a PAN or an operator on a cellular network can decide to load an application to a PAN. Application loader 705 is responsible for application software code transfer and execution.

### c. PIN Number Management Component

Whenever gateway device 106 and a terminal become aware of each other, a pairing process takes place between them. For example, gateway device 801 and terminal 802 are paired as illustrated in FIG. 8a. When this pairing takes place for a first time (or when the link key that they were sharing has been lost in one or both sides for any reason), a claimant side (for example, gateway device 801) must know a PIN number of terminal 802 in order to carry out a successful pairing. PAN server 404b will supply PIN number information to PAN router 404c for that purpose. A PIN number is used to generate an initialization key that is used as an encryption key for the exchange of initial parameters between a gateway device and terminals. In an embodiment of the present invention, PAN server 404b must be able to supply PIN number information according to different cri-

11

teria. For example, PAN server 404b supplies PIN numbers for only those terminals that are associated with a certain terminal class or ID number.

PAN server 404b will supply a PIN number upon an explicit request of another component, such as PAN router 404c. In an alternate embodiment, Application server 404b will supply PIN number information for terminals in order for them to establish a Bluetooth™ channel with other terminals without a gateway device 107 as a mediator.

In an embodiment of the present invention, PIN numbers are available from backend middleware 485. In alternate embodiments of the present invention, applications 406 provide a PIN number. For example, an application may allow a user to enter a PIN number or an application may cause backend middleware 485 to generate a PIN number. In an embodiment of the present invention, an application that supplies a PIN number states its origin.

There are two methods for obtaining PIN numbers. First, a push method occurs when the source of the PIN number transfers the PIN number when it becomes available. Second, a query method occurs when router 404c queries the source of the PIN number for a PIN number according to a certain criteria. A push method is preferred because it enables an immediate response to a request for a PIN number. However, if the PIN number is not available when a request arrives at the source of the PIN number, PAN server 404b attempts to obtain the PIN number using the query method. When the push method is used, the stimulus comes from the PIN number information source.

PIN number management software component 702 maintains a local database of PIN numbers with some attributes. An attribute may include a terminal class or terminal ID. PIN number management software component 702 adds, deletes and retrieves PIN numbers from the database. PIN number software component 702 also may retrieve all PIN numbers associated with a screen terminal class. In an embodiment, PIN number management software component 702 will have a persistent database. In an alternate embodiment, PIN number management software component 702 will not have a persistent database.

In alternate embodiments of the present invention, PIN number management 702 is a central storage location for PAN databases and/or caching. The storage component supports implementation of a file system that can be accessed by a terminal. Also, a storage component may have automatic backup to a backend server or transparent storage.

#### d. Network Management Component

Management software component 703 provides functions to configure a PAN.

First, management software component 703 provides a disconnect service function that forces specific applications to disconnect from a specific service.

Second, management software component 703 provides a disconnect terminal function that forces specific applications to disconnect from all services of a specific terminal.

Third, management software component 703 provides a disable service function that halts any usage of a specific terminal's service.

Fourth, management software component 703 provides a disable terminal function that halts any usage of all services of a specific terminal.

The disconnecting functions described above allow a high priority application to obtain a service from an application

12

using the service. The disabling functions allow for high priority applications to create personal area network restrictions.

Service repository software component 704 is used to cease offering services. PIN Number management 702 is used to delete a PIN number and abstraction layer I/O is used to halt service's data traffic.

#### e. Enumeration or Service Repository Component

Service repository software component 704 allows applications 406, which run on a gateway device 106 or terminals 107, to discover what services are offered by a PAN, and to determine the characteristics of the available services. The service could be offered by remote terminal, such as an application in terminal 806 illustrated in FIG. 8b. For example, terminal 806 could be a printer having a printing service. Also, the service could be offered by an application stored on gateway device 106, such as the application in gateway device 801 illustrated in FIG. 8a. For example, gateway device 801 is a cellular telephone having a telephony service provided by a cellular telephone application. Remote services are offered with the assistance of service logical drivers (SLDs) that are stored on gateway device 106. Whenever an application is interested in using a terminal service, the terminal interoperates with the corresponding gateway device SLD. For example, an application on terminal 809, shown in FIG. 8b, accesses a driver in gateway device 805 for a service provided by an application on terminal 806. Therefore, from an application's point of view, the SLD of the remote service acts the same way as a local application.

Service repository software component 704 offers a plurality of functions.

First, service repository software component 704 provides service registration of a service offered by application, or a hardware capability offered by terminal driver.

Second, service repository software component 704 provides service unregistration that cancels a registered service.

Third, service repository software component 704 provides registered services that suit a specific class.

Fourth, service repository software component 704 also provides searching of services. This function describes whether listed terminals support listed services. This function enables an application to quickly locate a specific service. A search of a general class of service, such as a search for a printers may be performed. Likewise, a search for specific attributes associated with that service, for example laser or color, is provided. Further, a search for specific instance of a service, for example a HP LaserJet model GTL is also provided.

Fifth, service repository software component 704 provides the capability of describing the participating terminals in a personal area network. The existence of these terminals is derived from a service registration function.

Sixth, service repository software component 704 provides a disabling function that ceases offering an unfriendly service.

Seventh, service repository software component 704 also provides an enabling function that cancels service disabling.

Eighth, service repository software component 704 provides a terminal disabling function that ceases offering all the services associated with an unfriendly terminal.

Ninth, service repository software component 704 provides a terminal enabling function that cancels terminal disabling.

13

In an embodiment, an application does not have to discover a service in order to connect with a terminal. If an application has previous knowledge of a terminal's service, the application needs to only search for the specific terminal.

In an embodiment of the present invention, service repository component 704 describes the terminals and the services that are available at a particular time, but service repository software component 704 does not describe the current status of the services. A service might be available in a PAN but not necessarily accessible since another application is exclusively using the service.

Since service repository software component 704 operates with local and remote applications, a uniform interface is used. In an embodiment of the present invention, remote applications use a Bluetooth™ Service Discovery Protocol ("SDP") to discover what services gateway device 106 offers. Similarly, local applications use SDP in an embodiment of the present invention.

### C. Application Server

Application Server component 404a illustrated in FIG. 5a allows for removing redundant capabilities from terminals and consolidating them in a centralized application server. This allows significant added value in minimizing the cost and complexity of the terminals in a PAN, as well as making their design intuitive and easy to use.

In an embodiment of the present invention, application server component 404a includes two components: 1) an execution environment and 2) services for being able to successfully execute software on a multi-terminal PAN, such as a file system.

Thin terminals, being optimized for low cost will not include an IP capability in most cases. Instead, they will use the native protocols offered by the PAN's physical layer. This does not conflict with the PAN router 404c since thin terminals are an extended remote I/O for applications running on a PAN application server 404a. All the logic, protocols and standard compatibility is implemented in the application server, in which standard protocols like IP are implemented and used.

### 1. Usage Scenario

In an embodiment of the present invention, a thin messaging terminal includes a color Liquid Crystal Display ("LCD"), QWERTY keypad, Bluetooth™ chipset and a small software stack for displaying graphical screens received over the Bluetooth™ air interface and transmit keypad actions back over the Bluetooth™ air interface.

When a terminal is turned on for the first time, a Plug and Play component 701 in the gateway device 106 identifies that this is a new terminal. Gateway device 106 communicates with Plug and Play component 701 in order to retrieve the needed software package to be executed on an application server 404a. In an embodiment of the present invention, a Plug and Play component 701 contains a URL for a chatting application package.

Application loader 705 gets the URL and loads the new package to PAN application server 404a in a gateway device 106 and executes the chatting software application. The chatting application software identifies the messaging device by enumerating a PAN for terminals and capabilities, and attaches itself to the right remote graphical driver and the remote keypad driver.

Now, all user interactions for the chatting application is displayed on the messaging terminal, and the keypad entries on the terminal are sent to the chatting application.

14

In this embodiment of the present invention, the terminal is used only for I/O and user interaction. The actual chatting logic is executed in application server 404a, which is located in gateway device 106.

## IV. Gateway Device/Terminal Operations

### A. Terminal Joins Personal Area Network

First, PAN router 404c requests a PIN number from PIN number management component 702. Second, if a PIN number is available, PIN number management 702 transfers the PIN number to PAN router 404c. Otherwise, PIN number management 702 attempts to obtain the PIN number from other sources, such as applications 406 or backend middleware 485, and transfers the PIN number to PAN router 404c. Third, PAN router 404c notifies plug and play 701 that a pairing has ended and delivers a terminal ID to plug and play 701. Fourth, plug and play 701 resolves the terminal package URL with backend middleware 485 if a package is not locally available; otherwise, the package is loaded and executed. Finally, if the package contains drivers, the driver's services are offered to service repository 704.

### B. Pin Number Received

Backend middleware 485 or an application acquires a PIN number. Second, the acquired PIN number is offered to PIN number management 702 by either backend middleware 485 or applications 406. In an alternate embodiment of the present invention, a PIN number is offered with additional characteristics of the associated terminal. PIN number information is then accepted and stored with the attributes in a database of PIN number management 702.

### C. Gateway Device Application Queries for a Specific Service

There are two methods for a gateway device 106 application to inquire for a specific service. The first terminal method includes the application asking service repository 704 to describe the terminals in the current personal area network and to describe whether any of these terminals provide the requested service. In an embodiment of the present invention, an application sorts the available terminals in order of preference. The application then queries abstraction layer I/O whether the most preferred terminal's service is available.

The second service method includes an application querying service repository 704 to provide the registered services that suit a requested service class. The application then searches the registered services to determine which capabilities are provided by the registered services. In an embodiment of the present invention, an application sorts the available services in order of preference. The application then queries abstract layer I/O whether the most preferred service is available.

### D. Terminal Application Queries for a Gateway Device Service

Media abstraction layer 504 obtains an SDP of a remote terminal application. Media abstraction layer 504 passes the SDP call to service repository 704. Service repository 704 answers media abstraction layer 504, using SDP, according to services that are registered. The abstraction layer 504 then sends the answers to an application on remote terminal.

15

In an alternate embodiment, service repository 704 pushes new services to a Bluetooth™ stack SDP database. The Bluetooth™ stack replies automatically and generates an SDP request.

#### E. High Priority Application Prevents Terminal Usage

In response to a network configuration signal from a high priority application in applications 406, management component 703 generates a delete PIN number signal to PIN number management component 702 which deletes the PIN number associated with the selected terminal. Management component 703 generates a disable signal to service repository component 704 to cease offering all the services associated with the selected terminal. Management component 703 generates a disable service signal to abstraction layer I/O in order to halt all the transport to and from the selected terminal's services.

Abstraction layer I/O sends halt notifications to the applications that are currently using the selected terminal's services. Abstraction layer I/O then stops any data transport to and from the selected terminal's services.

#### V. Conclusion

The foregoing description of the preferred embodiments of the present invention has been provided for the purposes of illustration and description. It is not intended to be exhaustive or to limit the invention to the precise forms disclosed. Obviously, many modifications and variations will be apparent to practitioners skilled in the art. The embodiments were chosen and described in order to best explain the principles of the invention and its practical applications, thereby enabling others skilled in the art to understand the invention for various embodiments and with the various modifications as are suited to the particular use contemplated. It is intended that the scope of the invention be defined by the following claims and their equivalents.

What is claimed is:

1. A system for providing access to the Internet, comprising:

a first wireless device, in a short distance wireless network, having a software component to access information from the Internet by communicating with a cellular network in response to a first short-range radio signal, wherein the first wireless device communicates with the cellular network and receives the first short-range radio signal; and,

a second wireless device, in the short distance wireless network, to provide the first short-range radio signal, wherein the software component includes a network address translator software component to translate between a first Internet Protocol ("IP") address provided to the first wireless device from the cellular network and a second address for the second wireless device provided by the first wireless device, wherein the software component includes a service repository software component to identify a service provided by the second wireless device.

2. The system of claim 1, wherein the second wireless device is selected from a group consisting of a desktop computer, a laptop computer, a personal digital assistant, a headset, a pager, a printer, a watch, and a digital camera.

3. The system of claim 1, wherein the first wireless device is a cellular telephone using a protocol selected from a group consisting of a Global System for Mobile Communications ("GSM") protocol, a Code Division Multiple Access

16

("CDMA") protocol, a cellular telephone using a CDMA 2000 protocol, and a Time Division Multiple Access ("TDMA") protocol.

4. The system of claim 1, wherein the service repository software component identifies whether the service is available at a particular time.

5. The system of claim 1, wherein the software component includes a domain naming service ("DNS") software component to translate between a human readable name and a second Internet Protocol ("IP") address.

6. The system of claim 1, wherein the software component includes a security software component to control access between the cellular network and the first wireless device.

7. The system of claim 1, wherein the second wireless device is a thin terminal.

8. The system of claim 1, wherein the second wireless device includes a Bluetooth™ processor and a 2.4 GHz transmitter.

9. The system of claim 1, wherein the first wireless device includes a Bluetooth™ processor and a 2.4 GHz transmitter.

10. The system of claim 1, wherein the second wireless device includes a Bluetooth™ processor and a 5.7 GHz transmitter.

11. The system of claim 1, wherein the first wireless device includes a Bluetooth™ processor and a 5.7 GHz transmitter.

12. The system of claim 1, wherein the software component includes a plug and play software component to load and execute software for the second wireless device.

13. The system of claim 1, wherein the software component includes a PIN number management software component to obtain and provide PIN numbers.

14. The system of claim 1, wherein the second wireless device includes an application software component that registers an availability of the service with the service repository software component.

15. The system of claim 1, further comprising:  
a third wireless device, in the short distance wireless network, having an application software component to obtain the service from the second wireless device.

16. The system of claim 15, wherein the first wireless device includes a service logical driver corresponding to the service, and wherein the application software component uses the service logical driver to obtain the service from the second wireless device.

17. The system of claim 1, wherein the software component operates with an operating system software component.

18. The system of claim 17, wherein the operating system software component is a Slinger operating system.

19. The system of claim 17, wherein the operating system software component is a Linux operating system.

20. The system of claim 17, wherein the operating system software component is a EPOC operating system.

21. The system of claim 17, wherein the operating system software component is a PocketPC operating system.

22. The system of claim 1, wherein the service repository software component identifies a class, attribute and instance of the service.

23. The system of claim 1, wherein the first wireless device further includes a virtual private network ("VPN") software component.

24. The system of claim 1, wherein the first wireless device further includes a firewall software component.

25. A system for providing access to information on a cellular network, comprising:

a first wireless device, in a short distance wireless network, to provide a first short-range radio signal; and,

17

a second wireless device, in the short distance wireless network and the cellular network, to selectively transfer information, including Internet Protocol ("IP") data packets, between the first wireless device and the cellular network in response to a security software component,

wherein the second wireless device includes a service repository software component that identifies a plurality of services, in the short distance wireless network, associated with a plurality of wireless devices, and wherein the service repository software component searches for a service, in the plurality of services, to be used by an application software component stored in the first wireless device.

26. The system of claim 25, wherein the first wireless device provides execution space for executable software from the second wireless device.

27. The system of claim 25, wherein the security software component is a firewall software component to control access to the cellular network.

28. The system of claim 25, wherein the security software component is a virtual private network ("VPN") to control access to the cellular network.

29. The system of claim 25, wherein the security software component is a uniform resource locator ("URL") filter to control access to the cellular network.

30. The system of claim 25, wherein the first short-range radio signal is selected from a group consisting of a HomeRF signal, an 802.11 signal and Bluetooth™.

31. The system of claim 25, wherein the information is provided in the form of data packets.

32. The system of claim 25, wherein the second wireless device is coupled to the cellular network by a landline network.

33. The system of claim 25, wherein the second wireless device is coupled to the cellular network by either an Ethernet connection, DSL connection or a cable modem.

34. A handheld device for providing a short distance wireless network, comprising:

a storage device;

a processor, coupled to the storage device; and,

the storage device to store a software component; and, the processor operative with the software component to: provide an Internet Protocol ("IP") data packet from the handheld device to a terminal using short-range radio signals,

control access between the short distance wireless network and a cellular network,

translate between a first IP address provided to the handheld device and a second IP address for the terminal provided by the handheld device in the short distance wireless network,

enumerate a list of services available from the handheld device and the terminal, wherein the handheld device and terminal register services available on the list, and search the list of services for a service to be used by an application software component stored on the terminal.

35. The device of claim 34, wherein the software component includes a management software component.

36. The device of claim 34, wherein the application software component uses a service logical driver stored in the storage device to obtain a service available on the handheld device.

37. The device of claim 34, further comprising: a Bluetooth™ transmitter, coupled to the processor, to generate the short-range radio signals.

18

38. The device of claim 34, further comprising: a GSM transmitter, coupled to the processor.

39. The device of claim 34, wherein the search includes searching the list of services by class, attribute or instance.

40. The device of claim 34, wherein the software component includes a plug and play software component to identify the terminal in the short distance wireless network and obtain the application software component for the terminal.

41. The device of claim 34, wherein the software component includes a PIN number management software component to provide a PIN number used in pairing the handheld device to the terminal in the short distance wireless network.

42. A first wireless handheld device, comprising:

a storage device;

a processor, coupled to the storage device; and,

the storage device to store a software component; and, the processor operative with the software component to:

access the Internet through a cellular network;

provide a first short-range radio signal to a second wireless handheld device and a second short-range radio signal to a third wireless handheld device,

control access between the Internet and the first, second and third wireless handheld devices.

translate between a first Internet Protocol ("IP") address provided to the first wireless handheld device from the cellular network and a second address for the second wireless handheld device provided by the first wireless handheld device, and a third address for the third wireless handheld device provided by the first wireless device,

enumerate a list of services available from the first, second and third wireless handheld devices, wherein the first, second and third wireless handheld devices register services available on the list, and

search the list of services for a class of service to be used by an application software component at a particular time, the application software component stored on the second wireless handheld device.

43. The first wireless handheld device of claim 42, wherein the first wireless handheld device includes a service logical driver corresponding to a service available from the third wireless device, and the application software component uses the service logical driver to obtain the service from the third wireless device.

44. The first wireless handheld device of claim 42, wherein the first wireless handheld device includes a 5.7 GHz transmitter coupled to the processor.

45. The first wireless handheld device of claim 42, wherein the second wireless handheld device is selected from a group consisting of a desktop computer, a laptop computer, a personal digital assistant, a headset, a pager, a watch, and a thin terminal a digital camera.

46. The first wireless handheld device of claim 42, wherein the second wireless handheld device is a thin terminal.

47. The first wireless handheld device of claim 42, wherein the first wireless handheld device includes a 2.4 GHz transmitter coupled to the processor.

48. An article of manufacture, including a computer readable medium, comprising:

a short-range radio software component to communicate with a device in a short distance wireless network by using a short-range radio signal;

a cellular software component to communicate with a cellular network by using a cellular signal;

a network software component to selectively transfer an Internet Protocol ("IP") data packet between the device and the cellular network;

a service repository software component to identify a plurality of available services from a plurality of devices in the short distance wireless network, the service repository software component having a uniform interface so that both a local application software component and a remote application software component identifies the plurality of available services; and a plurality of service logical drivers corresponding to the plurality of available services that are used to obtain the plurality of services, the plurality of service logical drivers are used in obtaining the plurality of services.

49. The article of manufacture of claim 48, wherein the cellular software component is a GSM component.

50. The article of manufacture of claim 48, wherein the short-range radio software component is a Bluetooth™ component.

51. The article of manufacture of claim 48, further comprising security software component to control access between the short distance wireless network and the cellular network.

52. The article of manufacture of claim 48, further comprising a network address translator software component to translate between a first Internet Protocol ("IP") address and a second IP address.

53. The article of manufacture of claim 48 further comprising a domain naming service ("DNS") software component to translate between a human readable name and an Internet Protocol ("IP") address.

54. The article of manufacture of claim 48, further comprising a plug and play software component to identify the terminal in the short distance wireless network and obtain an application software component for the terminal.

55. The article of manufacture of claim 48, wherein the article of manufacture is a memory storage device in a cellular telephone.

56. A handheld device for providing a short distance wireless network, comprising:

- a storage device;
- means for identifying an availability of a plurality of services to a plurality of application software components in the short distance wireless network;
- means for selectively providing the plurality of services to the plurality of application software components in the short distance wireless network; and
- means for selectively transferring an Internet Protocol ("IP") data packet between a cellular network and a selected application software component in the plurality of application software components in the short distance wireless network.

\* \* \* \* \*



UNITED STATES PATENT AND TRADEMARK OFFICE

UNITED STATES DEPARTMENT OF COMMERCE  
 United States Patent and Trademark Office  
 Address: COMMISSIONER FOR PATENTS  
 P.O. Box 1450  
 Alexandria, Virginia 22313-1450  
 www.uspto.gov



Bib Data Sheet

CONFIRMATION NO. 1027

|                                    |   |                     |                               |  |
|------------------------------------|---|---------------------|-------------------------------|--|
| <b>SERIAL NUMBER</b><br>90/013,925 | <b>FILING OR 371(c) DATE</b><br>03/24/2017<br><b>RULE</b> | <b>CLASS</b><br>370 | <b>GROUP ART UNIT</b><br>3992 | <b>ATTORNEY DOCKET NO.</b><br>0909-010 |
|------------------------------------|---|---------------------|-------------------------------|--|

AIA (First Inventor to File): YES

**INVENTORS**

7039033, Residence Not Provided;  
 FCO V CLO TRANSFEROR LLC, NEW YORK, NY;  
 PATENT OWNER, Residence Not Provided;

**APPLICANTS**

7039033, Residence Not Provided;  
 FCO V CLO TRANSFEROR LLC, NEW YORK, NY;  
 PATENT OWNER, Residence Not Provided;

**\*\* CONTINUING DATA \*\*\*\*\***

This application is a REX of 09/850,399 05/07/2001 PAT 7039033

**\*\* FOREIGN APPLICATIONS \*\*\*\*\***

|  |  |                         |                       |                           |                                |
|--|--|-------------------------|-----------------------|---------------------------|--------------------------------|
| Foreign Priority claimed<br>35 USC 119 (a-d) conditions met<br>Verified and Acknowledged | <input type="checkbox"/> yes <input type="checkbox"/> no<br><input type="checkbox"/> yes <input type="checkbox"/> no <input type="checkbox"/> Met after Allowance<br>Examiner's Signature _____ Initials _____ | <b>STATE OR COUNTRY</b> | <b>SHEETS DRAWING</b> | <b>TOTAL CLAIMS</b><br>56 | <b>INDEPENDENT CLAIMS</b><br>6 |
|--|--|-------------------------|-----------------------|---------------------------|--------------------------------|

**ADDRESS**  
41200

**TITLE**  
SYSTEM, DEVICE AND COMPUTER READABLE MEDIUM FOR PROVIDING A MANAGED WIRELESS NETWORK USING SHORT-RANGE RADIO SIGNALS

|                                     |   |   |
|-------------------------------------|---|---|
| <b>FILING FEE RECEIVED</b><br>12000 | FEES: Authority has been given in Paper<br>No. _____ to charge/credit DEPOSIT ACCOUNT<br>No. _____ for following: | <input type="checkbox"/> All Fees<br><input type="checkbox"/> 1.16 Fees ( Filing )<br><input type="checkbox"/> 1.17 Fees ( Processing Ext. of time )<br><input type="checkbox"/> 1.18 Fees ( Issue )<br><input type="checkbox"/> Other _____<br><input type="checkbox"/> Credit |
|-------------------------------------|---|---|