

DOCKET NO.: 0107131-00573US2

Filed on behalf of Intel Corporation

By: David L. Cavanaugh, Reg. No. 36,476  
John V. Hobgood, Reg. No. 61,540  
Benjamin S. Fernandez, Reg. No. 55,172  
Wilmer Cutler Pickering Hale and Dorr LLP  
1875 Pennsylvania Ave., NW  
Washington, DC 20006  
Tel: (202) 663-6000  
Email: David.Cavanaugh@wilmerhale.com  
John.Hobgood@wilmerhale.com  
Ben.Fernandez@wilmerhale.com

UNITED STATES PATENT AND TRADEMARK OFFICE

---

**BEFORE THE PATENT TRIAL AND APPEAL BOARD**

---

INTEL CORPORATION  
Petitioner

v.

QUALCOMM INCORPORATED  
Patent Owner

Case IPR2019-00048

**DECLARATION OF FRIEDHELM RODERMUND**  
**U.S. PATENT NO. 9,154,356**  
**CLAIMS 1, 9, 10, 17, and 18**

## Declaration of Friedhelm Rodermund

**I. INTRODUCTION**

1. My name is Friedhelm Rodermund. I have been retained by Intel Corporation (“Petitioner”) in connection with the petition for *inter partes* review of United States Patent No. 9,154,356.

2. I have prepared this declaration at the request of Petitioner to provide my expert conclusion regarding the public availability of 3GPP TR 36.912 v9.1.0 (2009-12), “3rd Generation Partnership Project; Technical Specification Group Radio Access Network; Feasibility Study for Further Advancements for E-UTRA (LTE-Advanced) (Release 9).”

3. This document was made publicly available by a standards development organization called the 3<sup>rd</sup> Generation Partnership Project (“3GPP”). Standards development organizations (“SDO”) are responsible for the development and formal adoption of telecommunications standards; for example, ETSI is responsible for the adoption of European telecommunications standards. SDOs rely on member companies and their employees to assess technical issues relating to such standards, and to draft and discuss technical proposals directed to such issues.

4. Based on my direct experience working at and with 3GPP for nearly 20 years, I conclude that this 3GPP document was publicly available no later than December 14, 2009. This declaration sets forth my conclusions regarding the public availability of this document in detail and provides the bases for those conclusions.

5. I am being compensated for my time spent working on this matter at my normal consulting rate for work of this type of €400 per hour, plus reimbursement for any additional reasonable expenses. My compensation is not in any way contingent on the

## Declaration of Friedhelm Rodermund

substance of my conclusions or outcome of the petition for *inter partes* review. I have no other interest in this matter.

**II. QUALIFICATIONS AND PROFESSIONAL EXPERIENCE**

6. I provide a detailed description of my experience and education in my CV attached hereto as Appendix A.

7. I attended the University of Technology Aachen in Aachen, Germany, where I performed graduate studies in Electrical Engineering with a focus on telecommunications technologies (Dipl.-Ing. TH). I also attended the University of Technology Trondheim in Trondheim, Norway, and completed my Diploma thesis, “Design of a dual processor computer for digital signal processing in power electronics,” in 1993.

8. Since obtaining my degree, I have worked continuously in the telecommunications field in various positions. In particular, I have more than 20 years of knowledge and experience working at and with standards development organizations including the European Telecommunication Standards Institute (“ETSI”), including nearly 20 years working at and with 3GPP.

9. From December 1993 to June 1998, I worked at Mannesmann Mobilfunk as a System Engineer and Project Manager in Quality Assurance and Technical Standards, with responsibilities as described in my CV. During that time, I also started working on cellular standards. I attended my first ETSI meeting in 1996.

10. From June 1998 to December 2004, I worked at ETSI as a project manager for various ETSI Special Mobile Group (“SMG”) and the 3GPP working groups.

## Declaration of Friedhelm Rodermund

- First, from 1998 to 1999, I served as a secretary of SMG4 “Data Services” and SMG8 “Base Stations Testing.”
- Then, from 1999 to 2004, I served as a project manager with the ETSI Mobile Competence Center (“MCC”). I supported the creation of 3GPP as the new international standards development organization for cellular telecommunications. ETSI is a constituent member of 3GPP, along with other regional SDOs. One of my roles was acting as Secretary for 3GPP’s Technical Specifications Group Terminals, Working Group “T2,” the group which played the leading role in the creation of standards for Multimedia such as the Multimedia Messaging Service (“MMS”).
- In 2002, I was assigned as the secretary of the highest level Technical Specifications Group “Terminals” and I served in this role until 2004.
- As part of my responsibilities at ETSI, I edited all technical specifications produced by my working groups and presented results to the parent body for approval. I attended all meetings (apart from some sub-working group meetings) and was also responsible for compiling meeting reports, for handling all the meeting documents, and managing the work plan. My role included guiding the groups and advising the chairs regarding 3GPP working methods and procedures, including document handling, and ensuring that delegates were aware of their company’s obligations under the 3GPP Intellectual Property Rights policy.

11. Further, I acted as 3GPP’s custodian of records by personally managing 3GPP’s public FTP folders, which I used to make various 3GPP documents publicly accessible, including versions of 3GPP specifications, technical reports, liaison statements,

## Declaration of Friedhelm Rodermund

change requests, contributions, agendas, meeting reports, and other 3GPP documents from my working groups. I am also knowledgeable about document management practices used in other working groups, and within 3GPP in general, to make documents publicly accessible through 3GPP's public FTP server.

12. After I left ETSI, I worked from January 2005 to October 2014 at Vodafone, first as a Project Manager for Mobile Broadcast Standards, and then as Vice Chairman OMA DM, and then as a Senior Standards Strategist, all with responsibilities as described on my CV. At Vodafone, I was deeply involved in standards work with ETSI and 3GPP and other standards setting organizations, including as a delegate to 3GPP SA1. As part of my responsibilities as a delegate to 3GPP SA1, I attended 3GPP meetings, and submitted documents to 3GPP. Further, during my time at Vodafone I used 3GPP resources (including 3GPP's FTP server) extensively and remained knowledgeable about 3GPP policies and procedures with regard to document management and public accessibility.

13. Since leaving Vodafone in 2014, I have performed consulting work regarding Internet of Things (IoT) and Machine to Machine (M2M) technology and standards, first at Friedhelm Rodermund Consulting and then as the Founder and Director of IOTECC GmbH. As part of my consulting work, I have extensively used 3GPP resources and have remained knowledgeable about 3GPP policies and procedures with regard to document management and public accessibility.

14. At the time of writing this declaration, I am active – including attending meetings - in the following standards committees: ETSI oneM2M, ETSI IPR Special Committee, Open Mobile Alliance, and 3GPP.

## Declaration of Friedhelm Rodermund

**III. OVERVIEW OF 3GPP AND THE STANDARD-SETTING PROCESS**

15. 3GPP was created in 1998 by a number of SDOs, including ETSI. When 3GPP was created, it focused on third-generation (“3G”) systems; since then, 3GPP has also worked on fourth-generation (“4G”) systems such as Long-Term Evolution (“LTE”) and LTE-Advanced, and is currently focusing on fifth-generation (“5G”) systems. 3GPP also continues to maintain standards relating to 2G, 3G and 4G systems.

16. The purpose of 3GPP is to produce technical proposals directed to standards-related issues through collaborative processes. In the context of 3GPP, such proposals are consolidated in “technical specifications” and “technical reports.” 3GPP implements procedures to facilitate the creation and consideration of technical specifications and technical reports that SDOs may publish as regional or national telecommunications standards. The ultimate goal of 3GPP, like other SDOs, is to encourage the adoption of standards that facilitate interoperability between otherwise disparate devices and networks. In the service of that goal, both interim and final 3GPP standards, as well as the technical reports, are generally available to the public without any compensation or membership requirement.

17. 3GPP includes, among others, seven “Organizational Partners” (i.e., SDOs such as ETSI and The Alliance for Telecommunications Industry Solutions, USA (“ATIS”)),<sup>1</sup> 19 “Market Representation Partners” (i.e., organizations that can “offer market

---

<sup>1</sup> See <http://www.3gpp.org/about-3gpp/partners> (identifying 3GPP Organizational Partners).

## Declaration of Friedhelm Rodermund

advice and bring a consensus view of market requirements”),<sup>2</sup> 607 “individual members” (i.e., companies that work to develop wireless telecommunications technologies, including Qualcomm, Apple, and Intel entities) from dozens of countries and numerous industry sectors, including members from the United States (other than the aforementioned Qualcomm and Apple entities), as well as other U.S. SDOs with U.S. members.<sup>3</sup> 3GPP materials are also generally freely and publicly available to outside observers (whether formal “Observers” in the sense of interim members, or informal observers in the sense of interested members of the general public).

18. Members of 3GPP participate in various “working groups,” which develop, evaluate, and recommend technological solutions to telecommunications standards issues. “Plenary” sessions consider whether to include working group proposals into standards specifications. In particular, 3GPP is divided into three “plenaries” known as Technical Specification Groups (“TSG”): (1) Core Network and Terminal (“TSG CT”); (2) Radio Access Network (“TSG RAN”); and (3) Service and System Aspects (“TSG SA”). Each TSG includes several working groups, as shown below:

---

<sup>2</sup> See <https://webapp.etsi.org/3gppmembership/Results.asp?SortMember=Name&DirMember=ASC&SortPartner=Name&DirPartner=ASC&Market=on&SortMarket=Name&DirMarket=ASC&SortObserver=Name&DirObserver=ASC&SortGuest=Name&DirGuest=ASC&Name=&search=Search> (identifying Market Representation Partners).

<sup>3</sup> See <http://www.3gpp.org/about-3gpp/membership> (describing participant types); see [https://webapp.etsi.org/3gppmembership/Results.asp?Member=ARIB&Member=ATIS&Member=CCSA&Member=ETSI&Member=TSDSI&Member=TTA&Member=TTC&Member=ALL\\_PARTNERS&SortMember=Name&DirMember=ASC&SortPartner=Name&DirPartner=ASC&SortMarket=Name&DirMarket=ASC&SortObserver=Name&DirObserver=ASC&SortGuest=Name&DirGuest=ASC&Name=&search=Search](https://webapp.etsi.org/3gppmembership/Results.asp?Member=ARIB&Member=ATIS&Member=CCSA&Member=ETSI&Member=TSDSI&Member=TTA&Member=TTC&Member=ALL_PARTNERS&SortMember=Name&DirMember=ASC&SortPartner=Name&DirPartner=ASC&SortMarket=Name&DirMarket=ASC&SortObserver=Name&DirObserver=ASC&SortGuest=Name&DirGuest=ASC&Name=&search=Search) (listing individual members).

## Declaration of Friedhelm Rodermund

<b>Project Co-ordination Group (PCG)</b>		
<b>TSG RAN</b> Radio Access Network	<b>TSG SA</b> Service & Systems Aspects	<b>TSG CT</b> Core Network & Terminals
<b>RAN WG1</b> Radio Layer 1 spec	<b>SA WG1</b> Services	<b>CT WG1</b> MM/CC/SM (lu)
<b>RAN WG2</b> Radio Layer 2 spec Radio Layer 3 RR spec	<b>SA WG2</b> Architecture	<b>CT WG3</b> Interworking with external networks
<b>RAN WG3</b> lub spec, lur spec, lu spec UTRAN O&M requirements	<b>SA WG3</b> Security	<b>CT WG4</b> MAP/GTP/BCH/SS
<b>RAN WG4</b> Radio Performance Protocol aspects	<b>SA WG4</b> Codec	<b>CT WG6</b> Smart Card Application Aspects
<b>RAN WG5</b> Mobile Terminal Conformance Testing	<b>SA WG5</b> Telecom Management	
<b>RAN WG6</b> Legacy RAN radio and protocol	<b>SA WG6</b> Mission-critical applications	

(Specifications Groups, <http://www.3gpp.org/specifications-groups>.) Individual working groups are often referred to using shorthand such as “RAN1” (i.e., RAN WG1) or “SA2” (i.e., SA WG2). In addition, individual working groups sometimes form ad hoc groups directed to specific issues.

19. Each TSG is responsible for the scope and structure of the specifications it defines as well as the identification and creation of working groups to contribute to a given specification. The working groups (and, when used, *ad hoc* groups) are then responsible for the creation of the details of the specifications. In particular, working group participants propose to include or change certain technology in the specification as a means of addressing



## Declaration of Friedhelm Rodermund

specific needs or problems.<sup>4</sup> A proposal to change a previously approved specification is known as a “change request” (“CR”).

20. Working group participants hold periodic in-person meetings at various locations, typically several times per year. Working group participants also discuss technical proposals via “email reflectors,” which are also sometimes referred to as “email exploder lists.” Reflectors are essentially email distribution lists that include the regular attendees of a given working group, and therefore provide insight into which working group participants contributed to a given discussion, especially between in-person working group meetings. Reflectors are typically publicly available and are therefore freely accessible not only to 3GPP members and participants, but also to outside observers.

#### **IV. PUBLIC AVAILABILITY OF 3GPP DOCUMENTS**

21. In addition to being one of the 3GPP founding partners, ETSI hosts the Mobile Competence Center (MCC), which provides administrative and technical support to the day-to-day work of 3GPP. Furthermore, ETSI manages 3GPP’s information technology services such as the 3GPP website, FTP server and email exploders.

22. In the ordinary course of its regularly conducted business activities, and pursuant to its standard business practices, 3GPP publishes 3GPP’s technical specifications, proposals, reports, and other documents related to the development of cellular telecommunications standards. Such documents are published for the purposes of discussion

---

<sup>4</sup> See 3GPP FAQs (“3GPP FAQs”), <http://www.3gpp.org/news-events/54-news-events/news-events-others/1615-3gpp-faqs> (“Any bona fide representative of any 3GPP Individual Member . . . can present a technical contribution . . .”)

## Declaration of Friedhelm Rodermund

and establishment of industry standards for cellular telecommunications. 3GPP has operated in this way since 1998.

23. In the ordinary course of 3GPP's regularly conducted business activities, and pursuant to its standard business practices, all draft technical specifications, proposals, reports, and other temporary documents to be discussed or considered in relation to 3GPP's telecommunications standards activities are assigned a temporary document number, circulated during the working group process, and otherwise made publicly available. Such documents are referred to as "Tdocs." Because there are often multiple ways of solving a given problem, multiple participants may make different proposals relating to the same or related technical issues. Because working group participants generally seek to achieve consensus on a given issue, discussion, debate, and revision of technical proposals may continue over many months. Final versions of the technical specifications are also publicly available. 3GPP has operated in this way from 1998 to the present.

24. In the ordinary course of 3GPP's regularly conducted business activities, and pursuant to its standard business practices, since at least as early as December 1998, 3GPP has published all its T-docs and all final versions of its technical specifications on its ftp server, <ftp://www.3gpp.org>. At least as early as December 1998, 3GPP's FTP server was publicly accessible to the public with no login, password, or membership requirement. 3GPP's FTP server has remained publicly accessible from 1998 to the present.

25. By 1999, at least 100 companies were members of 3GPP, ranging from Samsung to Sony to Nokia to Bosch and generally including those interested in the discussion, creation, and adoption of cellular telecommunications standards. 3GPP

## Declaration of Friedhelm Rodermund

participants also included members from the United States, for example AT&T, Alcatel, Bellsouth Cellular, GSM North America, IBM, Intel, Lucent Technologies, Motorola, Omnipoint Cooperation, Pacific Bell Wireless, and Qualcomm Incorporated. Each of these companies typically delegated multiple individuals to regularly participate in 3GPP meetings. Further, pursuant to 3GPP's standard business practices, 3GPP working groups have had a practice of sending emails notifying these individuals as soon as new or additional documents had been uploaded to 3GPP's FTP server. Thus, not only did the general public have access to the documents on the FTP server, but some of the most interested members of the public—those working to develop standards for cellular telecommunication—have been directly and personally informed of their availability by email.

26. By June 1999, 3GPP's FTP server was well known to persons in the cellular telecommunications industry as a source of public information regarding industry standards and technological advances.

27. It has been 3GPP's standard business practice to list on the face of each Tdoc the date, location, and meeting number of the meeting where the document is to be discussed (in addition to its temporary document number). This information is usually recorded on the first page of the document by one of the document's authors or editors at or near the time the document is created or presented to 3GPP.

28. In the ordinary course of 3GPP's regularly conducted business activities, and pursuant to its standard business practices, Tdocs are uploaded to 3GPP's FTP server and website before the meeting where they are to be discussed. The only exception is for

## Declaration of Friedhelm Rodermund

documents created during the course of a meeting, in which case the document is uploaded during the meeting, or, the week following the meeting (e.g., the meeting report of the meeting is ordinarily published for review during the week following the meeting). Before 2002, internet access during 3GPP meetings was not common, thus, documents produced during the meetings were ordinarily uploaded the week after the meetings by the working group's secretary. In the ordinary course of 3GPP's regularly conducted business activities, and pursuant to its standard business practices, versions of technical reports and standard specifications are also published on 3GPP's FTP server.

29. The timestamp on 3GPP's FTP server shows the date when the document was uploaded the last time. Thus, the timestamp shows the latest possible date the document became publicly available and accessible on 3GPP's FTP server. A document with a given timestamp might have been available earlier and the original timestamp might have been overwritten because the document was uploaded again. According to my experience, this is something that happened quite frequently. Thus, the FTP timestamp is reliable as the latest possible upload date, but one cannot always determine whether it represents the first upload of a document to the ftp server.

30. 3GPP's working practice to store its documents on its FTP server, as described above, has not changed over time. Since the first 3GPP meetings in 1998, all working groups and plenary meetings have been represented by dedicated meeting folders on the FTP server. These publicly-accessible meeting folders include the documents discussed at the meetings. Almost every week a new meeting folder with the respective documents is added. In addition to the plenary and working group meeting folders, and some other folders, there

## Declaration of Friedhelm Rodermund

is also the “Specs” folder, which holds all 3GPP specifications. Since the early days of 3GPP, a new folder has been added inside the “Specs” folder after each TSG plenary meeting to hold the latest versions of specifications approved at those TSG plenary meetings. This is still 3GPP’s working practice today.

31. A person seeking information regarding telecommunications standards would find that such information is readily available through 3GPP. This is so because 3GPP’s purpose is to facilitate the creation of specifications for telecommunications standards that are implemented and used by countless hardware and software developers and network operators throughout the world, and that are designed to maximize interoperability across borders and between devices.

32. Consistent with 3GPP’s open, collaborative approach, many types of 3GPP documents and communications are available on its public website (<http://www.3gpp.org>). Publicly available 3GPP TSG and working group materials include all versions of standards specifications as well as working group proposals, participant lists, reports of working group discussions and meetings, draft technical reports and technical specifications, CRs, and reflector communications. These materials are all clearly identified and dated, and organized by working group, and public availability is specifically encouraged. (*See, e.g., 3GPP FAQs (“TDoc numbers start to be allocated [to TDocs] some weeks before a 3GPP meeting, and the authors then create them and they or the group’s secretary **uploads them to the public file server as soon as possible.**”)* (emphasis added).)

## Declaration of Friedhelm Rodermund

**V. PUBLIC AVAILABILITY OF TR 36.912 V9.1.0**

33. I have been asked to specifically consider the following document: 3GPP TR 36.912 v9.1.0 (2009-12), “3rd Generation Partnership Project; Technical Specification Group Radio Access Network; Feasibility Study for Further Advancements for E-UTRA (LTE-Advanced) (Release 9)” (“TR 36.912 v9.1.0”).

34. 3GPP TR 36.912 v9.1.0 is a document of the type Technical Report (TR) versus a Technical Specification (TS). As a Technical Report, the 3GPP TR 36.912 v9.1.0 document provides technical input and explanatory material to be used for the work on the actual Technical Specifications. The resulting TSs describe the normative technical requirements for a 3GPP standard compliant implementation.

35. I recognize Exhibit 1104 of the '356 patent petition for *inter partes* review as a true and correct copy of TR 36.912 v9.1.0.

36. TR 36.912 v9.1.0 bears several indicators that it is a document developed by 3GPP members in the course of their standardization work:

- Title information such as “Feasibility study for Further Advancements for E-UTRA (LTE-Advanced)” and “TR 36.912” is consistent with 3GPP’s specification series index:

	of test points for radio transmission and reception conforming test cases
TR 36.912	Feasibility study for Further Advancements for E-UTRA (LTE-Advanced)
TR 36.913	Requirements for further advancements for Evolved Universal Terrestrial Dar

(<http://www.3gpp.org/DynaReport/36-series.htm>.)

- The cover page of TR 36.912 v9.1.0 bears the 3GPP logo.

## Declaration of Friedhelm Rodermund



([http://www.3gpp.org/.](http://www.3gpp.org/))

- The cover page of TR 36.912 v9.1.0 states that it “has been developed within the 3rd Generation Partnership Project (3GPP™).”

37. According to 3GPP’s public FTP server directory for the 36.912 series ([http://www.3gpp.org/ftp/Specs/archive/36\\_series/36.912/.](http://www.3gpp.org/ftp/Specs/archive/36_series/36.912/)), which is not password-protected and does not require user login of any sort, TR 36.912 v9.1.0 is dated December 14, 2009.

[\[To Parent Directory\]](#)

3/26/2009	1:44 PM	169663	<a href="#">36912-000.zip</a>
3/28/2009	3:54 AM	178322	<a href="#">36912-010.zip</a>
9/4/2009	6:27 AM	526596	<a href="#">36912-020.zip</a>
9/3/2009	11:11 AM	841998	<a href="#">36912-021.zip</a>
9/2/2009	8:28 AM	820296	<a href="#">36912-200.zip</a>
9/2/2009	8:35 AM	824663	<a href="#">36912-210.zip</a>
9/11/2009	2:08 PM	843201	<a href="#">36912-211.zip</a>
9/18/2009	10:12 AM	830365	<a href="#">36912-220.zip</a>
9/28/2009	9:27 AM	2629817	<a href="#">36912-900.zip</a>
12/14/2009	12:23 PM	2653229	<a href="#">36912-910.zip</a>
3/30/2010	11:29 AM	2671975	<a href="#">36912-920.zip</a>
6/4/2010	8:07 AM	2661070	<a href="#">36912-930.zip</a>
3/29/2011	11:02 AM	2661167	<a href="#">36912-a00.zip</a>
9/18/2012	4:54 PM	2661804	<a href="#">36912-b00.zip</a>
9/24/2014	4:22 PM	2637627	<a href="#">36912-c00.zip</a>
1/5/2016	8:22 AM	2535741	<a href="#">36912-d00.zip</a>
3/25/2017	10:34 PM	2532950	<a href="#">36912-e00.zip</a>

([http://www.3gpp.org/ftp/Specs/archive/36\\_series/36.912/.](http://www.3gpp.org/ftp/Specs/archive/36_series/36.912/))

38. I have clicked on the link shown above as “36912-910.zip”. I was not prompted for a password. The zip file I downloaded—which was also not password-protected—included several documents, including TR 36.912 v9.1.0. The file information

## Declaration of Friedhelm Rodermund

for TR 36.912 v9.1.0 indicates that the file was created on December 11, 2009 and confirms that this specific document within the zip file is not password-protected:

<input type="checkbox"/> Name	Type	Compressed size	Password ...	Size	Ratio	Date modified
<input checked="" type="checkbox"/> 36912-910.doc	Microsoft Word 97 - 2003 ...	816 KB	No	2,316 KB	65%	12/11/2009 10:11 AM
<input type="checkbox"/> RP-090744.zip	Compressed (zipped) Fol...	1,238 KB	No	1,238 KB	1%	9/18/2009 11:30 AM
<input type="checkbox"/> RP-090745.zip	Compressed (zipped) Fol...	208 KB	No	211 KB	2%	9/22/2009 12:45 PM
<input type="checkbox"/> RP-090746.zip	Compressed (zipped) Fol...	272 KB	No	277 KB	2%	9/18/2009 11:30 AM
<input type="checkbox"/> RP-090747.zip	Compressed (zipped) Fol...	58 KB	No	59 KB	2%	9/18/2009 11:30 AM

39. Consistent with my personal experience with FTP file access generally and FTP file access via 3gpp.org specifically, as well as my experience serving as a working group secretary and custodian of records at ETSI, the directory information shown above demonstrates that TR 36.912 v9.1.0 was uploaded at 12:23pm on December 14, 2009, at the latest. And because access to the directory is not restricted, this same directory information also demonstrates that TR 36.912 v9.1.0 was available not only to working group participants and other 3GPP members, but also to the public, without any request to or approval by 3GPP, as of December 14, 2009, at the latest.

40. Confirming that understanding, 3GPP's public portal webpage for the 36.912 technical report provides an additional link by which TR 36.912 v9.1.0 is publicly downloadable (again, without password protection of either the website, the link, or the file), and indicates that TR 36.912 v9.1.0 was addressed at meeting RAN#46:



## Declaration of Friedhelm Rodermund

3GPP Portal  
Specification #: 36.912

Meetings	Version	Upload date	Comment
SA#51	10.0.0	2011-03-30	Automatic upgrade from previo... ETSI TDoc CR
<b>Release 9 (Spec is UCC for this Release) Latest Remark:</b>			
Meetings	Version	Upload date	Comment
RAN#48	9.3.0	2010-06-14	ETSI TDoc CR
RAN#47	9.2.0	2010-03-30	ETSI TDoc CR
RAN#46	9.1.0	2009-12-16	ETSI TDoc CR
RAN#45	9.0.0	2009-09-28	RP-090743 ETSI TDoc CR
RAN#45	2.2.0	2009-09-25	RP-090737 ETSI TDoc CR
-	2.1.2		ETSI TDoc CR
-	2.1.1	2009-09-11	ETSI TDoc CR
-	2.1.0	2009-09-02	RT-090052 but version number ... ETSI TDoc CR
-	2.0.0	2009-09-02	R1-093736 = RT-090043 but his... ETSI TDoc CR
-	0.2.1	2009-09-02	R1-093716 ETSI TDoc CR
-	0.2.0	2009-09-04	R1-093685 ETSI TDoc CR
-	0.1.2		ETSI TDoc CR
-	0.1.0	2009-09-04	R1-091661 ETSI TDoc CR
-	0.0.0	2009-03-26	RP-092678 ETSI TDoc CR

(<https://portal.3gpp.org/desktopmodules/Specifications/SpecificationDetails.aspx?specificationId=2584>.)

41. TR 36.912 v9.1.0 also indicates in a summary of the “Change history” of the document, at page 58, that version 9.1.0 of TR 36.912 was addressed at the RAN#46 meeting dated December 1, 2009:



Change history							
Date	TSG #	TSG Doc.	CR	Rev	Subject/Comment	Old	New
2009/03	R1#56bis	R1-091661			Skeleton TR is endorsed	0.0.0	0.1.0
2009/08	R1#58	R1-093685			Capture the agreement in RAN1#57bis, RAN2#66 and #66bis	0.1.2	0.2.0
2009/08	R1#58	R1-093716			Capture the agreement in RAN1#58, RAN2#67 and RAN4#52	0.2.0	0.2.1
2009/08	R1#58	R1-093736			Version 0.2.1 was endorsed to v2.0.0	0.2.1	2.0.0
2009/08					Correction by RAN1. Some editorial corrections by ITU ad hoc	2.0.0	2.1.1
					Editorial corrections by editor	2.1.1	2.1.2
2009/09	RAN_45	RP-090737			Submit to RAN for approval		2.2.0
2009/09	RAN_45	RP-090743			Version 2.2.0 was approved to v9.0.0	2.2.0	9.0.0
01/12/09	RAN_46	RP-091173	0001	1	Editorial correction on TR36.912	9.0.0	9.1.0
01/12/09	RAN_46	RP-091173	0002	2	Updates on TR36.912	9.0.0	9.1.0
01/12/09	RAN_46	RP-091173	0003	3	RAN2 agreements on Carrier aggregations, PDCP and Contention based uplink	9.0.0	9.1.0

## Declaration of Friedhelm Rodermund

42. The 3GPP public portal webpage for the RAN#46 meeting indicates that the meeting was held from December 1-4 in Sanya, China, 2009, and included 176 participants:

### ETSI Calendar of Meetings

---

[Meetings Calendar](#) | 
 [Room Allocation](#)  | 
 [Meeting Management](#)  | 
 [Meetings Network](#)

Meeting Information - 3GPPRAN#46

<b>Meeting Identifier:</b>	26391		
<b>Meeting Contacts</b>	<input type="text" value=" &lt; None &gt;"/>		
<b>Meeting Reference</b>	<input calendar="" data-bbox="763 682 787 714" icon"="" type="text" value="3GPPRAN#46 &lt;img alt="/>		
<b>Meeting Type</b>	<input type="text" value="Ordinary"/>		
<b>Start Date</b>	<input type="text" value="01 Dec 2009 at 09:00 (Local time)"/>		
<b>End Date</b>	<input type="text" value="04 Dec 2009 at 17:00 (Local time)"/>		
<b>Registration will start at</b>	<input type="text" value="00:00"/>		
<b>Location</b>	<input type="text" value="Hilton Sanya Resort&lt;br/&gt;CN - Sanya"/>	<b>Zip</b>	<input type="text"/>
		<b>Country</b>	<input type="text" value="CN"/>

---

- [▶ List of 176 Participants](#)
- [▶ Administration](#) 





- [▶ No Document in ADN List](#)
- [▶ List of Documents via 3GPP Portal](#)
- [▶ Reserve a Tdoc via 3GPP Portal](#)
- [▶ Document Area \(FTP\)](#)  (restricted where applicable)

([https://portal.3gpp.org/webapp/meetingCalendar/MeetingDetails.asp?m\\_id=26391](https://portal.3gpp.org/webapp/meetingCalendar/MeetingDetails.asp?m_id=26391).) These participants included attendees from a range of companies and organizations across multiple countries, including companies from the United States such as: AT&T, Motorola, Qualcomm, Sprint, T-Mobile USA Inc., TruePosition Inc., and Verizon Wireless.

43. In addition, TR 36.912 v9.1.0 can be found in the ETSI “Work Programme.” The ETSI Work Programme provides an overview about ETSI’s standardization projects including information about the timing, resourcing and about the actual deliverables. The ETSI Work Programme webpages for TR 36.912 v9.1.0 state that TR 36.912 v9.1.0 was

## Declaration of Friedhelm Rodermund

created December 14, 2009, and that “publication” was “achieved” January 29, 2010. This date refers to the publication of TR 136 912 which is the number ETSI has assigned to 3GPP TR 36.912 during the adoption process, i.e., the transposition into an ETSI document:

2018-07-24 Work Programme <span style="float: right;">Version 2.3.3</span>						
<a href="#">Simple Search</a>   <a href="#">Advanced Search</a>   <a href="#">Pre-Defined Reports</a>   <a href="#">Help</a>						
Details of 'RTR/TSGR-0136912v910' Work Item						
	Work Item Reference	ETSI Doc. Number	STF	Technical Body in Charge	Download Standard	
	RTR/TSGR-0136912v910	TR 136 912		<a href="#">3GPP RAN 1</a>		
	Current Status (Click to View Full Schedule)	Latest Version	Cover Date	Standstill	Creation Date	
	<a href="#">Publication (2010-01-29)</a>	9.1.0	2010-01-29		2009-12-14	
	Rapporteur	Technical Officer		Harmonized Standard		
	<a href="#">Takehiro Nakamura</a> 	<a href="#">Patrick Merias</a> 		No		
Title	LTE; Feasibility study for Further Advancements for E-UTRA (LTE-Advanced) (3GPP TR 36.912 version 9.1.0 Release 9) Feasibility study for Further Advancements for E-UTRA (LTE-Advanced)					
Scope and Field of Application	RP-46					
Supporting Organizations	Not Available					
	Keywords	Projects	Clusters	Frequencies	Mandates	Directives
	LTE		Wireless Systems			
Official Journal						
Remarks						
 <span style="float: right;">Any comments or problems with this application? Please <a href="#">let us know...</a></span>						

([https://portal.etsi.org/webapp/workProgram/Report\\_WorkItem.asp?wki\\_id=33142.](https://portal.etsi.org/webapp/workProgram/Report_WorkItem.asp?wki_id=33142))

2018-07-24 Work Programme <span style="float: right;">Version 2.3.3</span>							
<a href="#">Simple Search</a>   <a href="#">Advanced Search</a>   <a href="#">Pre-Defined Reports</a>   <a href="#">Help</a>							
Details of 'RTR/TSGR-0136912v910' Work Item Schedule							
Code	Status	Milestone	Action	Action Nb	Target	Achieved	Version
0	Creation of WI by WG/TB	Creation of WI by WG/TB			2012-10-15	2009-12-04	
8	TB approval	TB approval				2009-12-04	9.1.0
8 A	Draft receipt by ETSI Secretariat	Draft receipt by ETSI Secretariat			2009-12-25	2009-12-16	
12	Publication	Publication	PU		2009-12-30	2010-01-29	9.1.0
 <span style="float: right;">Any comments or problems with this application? Please <a href="#">let us know...</a></span>							

## Declaration of Friedhelm Rodermund

([https://portal.etsi.org/webapp/workProgram/Report\\_Schedule.asp?WKI\\_ID=33142](https://portal.etsi.org/webapp/workProgram/Report_Schedule.asp?WKI_ID=33142).)

44. Based on my review of these 3GPP and ETSI materials and sources, and the fundamental interest of 3GPP and ETSI in public dissemination of potential and adopted standards as well as underlying technical proposals, I conclude that TR 36.912 v9.1.0 was freely and publicly available and catalogued on at least the 3GPP website (for example, via the specification page and FTP site discussed above) no later than December 14, 2009. Moreover, a person working on the development of technology for cellular communications, such as transceiver technology, would have looked to 3GPP materials such as TR 36.912 v9.1.0 for teachings in the field, would have known where to find and how to access these materials, and would have been able to do so without membership in 3GPP or ETSI, compensation to 3GPP or ETSI, or approval by 3GPP or ETSI.

45. Further confirming my conclusion, I note that the specification of United States Patent Application Publication No. US 2013/0034066 A1, which was filed February 9, 2011, cites TR 36.912 v9.1.0 and refers to its date as December 2009. (See Appendix B at ¶ 5.) Moreover, I note that the publicly available prosecution history of United States Patent Application Serial No. 12/753,257, filed on April 2, 2010, included an Information Disclosure Citation Form For Patent Application (FORM PTO-1449), bearing a Receipt date of April 2, 2010, that disclosed TR 36.912 V9.1.0 and also refers to its date as December 2009. (See Appendix C at 1).

## Declaration of Friedhelm Rodermund

**VI. SUPPLEMENTATION OF CONCLUSIONS**

46. I reserve the right to supplement my conclusions in the future to respond to any arguments that the Patent Owner raises and to take into account new information as it becomes available to me. I may supplement or amend my conclusions, and bases for them, in response to any opinions offered by the Patent Owner's experts. I may also supplement or amend my conclusions, and bases for them, in light of additional evidence, testimony, discovery, arguments on the part of the Patent Owner, or additional information I may become aware of after the date of this declaration. I may also prepare appendices, demonstrative appendices, summaries, tutorials, demonstrations, charts, drawings, tables, or animations to supplement or demonstrate my conclusions as appropriate.

**VII. SIGNATURE**

47. I declare that all statements made herein of my own knowledge are to the best of my knowledge true, and that all statements made on information and belief are believed to be true; and further that these statements were made with the knowledge that willful false statements and the like so made are punishable by fine or imprisonment, or both, under Section 1001 of Title 18 of the United States Code.

48. I declare under penalty of perjury that the foregoing is true and correct.

Friedhelm Rodermund

/Friedhelm Rodermund/

Dated: November 7, 2018

# Appendix A

# CURRICULUM VITAE

---

## I. PERSONAL DATA

Name: **Friedhelm RODERMUND**

Mailing address: Am Steiner Graben 18  
56077 Koblenz, Germany

Phone: +49 172 2606489

Email: friedhelm.rodermund@iotecc.com

---

## II. PROFESSIONAL EXPERIENCE

### Summary

Senior expert in telecommunications and Internet of Things (IoT). More than twenty years of experience within the mobile communications industry, and several years in IoT in various roles such as project management, technology innovation and evolution, standards development, technology strategy development, patent creation and patent litigations, and development/introduction of new services.

Widely recognized standards expert who was actively involved in leading roles in the development of key standards for mobile telephony and mobile data across standards development organizations such as 3GPP, ETSI, GSMA, IETF, OMA, and oneM2M. Currently developing and applying standards for the IoT.

Founder and director of IOTECC GmbH which provides consulting services around technologies enabling the Internet of Things, and provides consulting services related to patents for mobile telecommunications.

**01/2015 – present**     **IOTECC GmbH**     **Koblenz, Germany**

#### Founder and Director

- Internet of Things (IoT) and Machine to Machine (M2M) technology and standards consulting
  - Client: Vodafone Group Plc., UK
- Telecoms patent consulting
  - Consulting services around mobile communications patents in particular related to ETSI, 3GPP, and OMA standards
  - State-of-the-art/prior art research
  - Advising on Standards Development Organisations (SDO) working processes and IPR policy
  - Support of patent litigations (assertion and defence)
  - Experience as expert and fact witness
  - 3 depositions so far
  - Supported litigations (supported party in **bold**):
    - Intellectual Ventures v. **T-Mobile USA** (USA, 2015)
    - SSH** v. Sony (Germany, 2016)
    - Core Wireless v. **LGE** (USA, 2015-2016)
    - KPN v. **Samsung** (USA, 2016)

**11/2014 – 12/2014**     **Friedhelm Rodermund Consulting**     **Koblenz, Germany**

#### Internet of Things (IoT) Consultant

- M2M/IoT standards development and introduction of new M2M/IoT services

# CURRICULUM VITAE

---

**01/2011 – 10/2014**    **Vodafone Germany / Vodafone Group R&D**    **Düsseldorf, Germany**

Senior Standards Strategist

- Representing Vodafone in various standardisation bodies
- Driving the standardisation of the Internet of Things
- Work item lead, technical editor and key contributor of Open Mobile Alliance (OMA) “Lightweight M2M (LwM2M)” – the new standard for the Internet of Things
- Advising and supporting various M2M projects related to e.g. automotive, smart metering, health, industry
- Advising on the introduction of new M2M technologies and services
- Leading Proof of Concepts of emerging technologies
- Involved in innovation related activities
- Involved in creation and protection of Intellectual Property

**01/2009 – 12/2010**    **Vodafone Germany**    **Düsseldorf, Germany**

Vice Chairman Open Mobile Alliance (OMA) Device Management (DM)

- Responsible for Vodafone’s Device Management standardisation
- As OMA DM Vice Chairman, co-leading the group, chairing committee meetings and web conferences, steering the technical direction, management of the different work items
- Editor of several specifications, rapporteur of various work items
- Support of projects for the introduction of device management
- Delegate to 3GPP SA1 where I was responsible for the introduction of MTC (machine type communications) related service/network requirements

**01/2005 – 12/2008**    **Vodafone Germany**    **Düsseldorf, Germany**

Project Manager Mobile Broadcast Standards

- Responsible for Mobile Broadcast standardisation across different broadcast systems/standards bodies and across all Vodafone local operations
- Responsible for Mobile Broadcast standardisation strategy development and implementation
- Delegation Lead for the Open Mobile Alliance (OMA) BCAST working group
- Initiated and managed the BCAST device profile development in the BMCO Forum
- Leading the “Service Protection” (pay-TV) stream of the German DVB-H Consortium
- Filed several patents
- Supporting patent litigations and patent portfolio evaluation (various technical areas)

**04/2003 – 12/2003**    **GSM Association**    **London, United Kingdom**

Member of the MMS Task Force

- Verification of the MMS operator interworking framework
- Supporting the definition and specification of the MMS functional evolution
- Acting as a “link” between 3GPP and GSMA in the area of MMS

**06/1998 – 12/2004**    **European Telecommunications Standards Institute (ETSI)**    **Sophia Antipolis, France**

01/2002 – 12/2004: Secretary 3GPP Technical Specifications Group “Terminals” and Terminals Working Group 2 “Terminal Services and Capabilities”



## CURRICULUM VITAE

---

01/1999 – 12/2001: Secretary 3GPP Terminals Working Group 2 “Terminal Services and Capabilities” and GERAN 3 “Base Station Testing”

06/1998 – 03/1999: Secretary ETSI SMG4 “Data Services” and SMG8 “Base Station Testing”

- Supported the establishment of 3GPP (3<sup>rd</sup> Generation Partnership Project) as the leading standards organization for mobile telecommunications
- Project manager and secretary of TSG “Terminals” responsible for Terminal Conformance Testing, Terminal Services and Capabilities, Universal Subscriber Identity Module (USIM)
- Project manager and secretary of Terminals Working Group 2 “Terminal Services and Capabilities” that was responsible for Terminal Execution Environments, Messaging including Short Message Service (SMS), Cell Broadcast Service (CBS), Enhanced Messaging Service (EMS), Multimedia Messaging Service (MMS), Terminal Interfaces incl. AT-commands, Generic User Profile, Data Synchronization and others
- Establishment and management of the Work Plan and follow-up and report on the progress of the related work items
- Advising the chairmen and the standards groups on technical, procedural and political issues
- Editorship of various GSM and UMTS technical specifications
- Responsible for presenting the technical results of the working groups to the parent body
- Responsible for the communication with other standards bodies inside and outside 3GPP
- PR activities (articles, interviews)

**12/1993 – 06/1998 Mannesmann Mobilfunk GmbH**

**Düsseldorf, Germany**

System Engineer and Project Manager in Quality Assurance and Technical Standards

- Leadership and management of acceptance test projects in the area of GSM Base Station Controller (BSC) and GSM Base Station (BTS) hardware and software.
- Leading project teams of around 15 people
- Responsible for the clearance of releasing new software/hardware into the network
- Supported Request for Quotations, supplier evaluation and pre-selection, project manager of System Verification as a central part of the supplier selection process.
- Representation of Mannesmann Mobilfunk to the ETSI standardization group “Standardization Technical Committee SMG3 System Architecture”
- Conduction of product and hardware development quality audits
- Representative of Mannesmann Mobilfunk in A-interface testing activities
- Member of BSS product planning group which was defining operator requirements for future BSS releases
- Development of process improvements for type acceptance

# CURRICULUM VITAE

---

## III. EDUCATION

- 10/1984 – 10/1993**    **University of Technology Aachen**    **Aachen, Germany**  
Graduate of Electrical Engineering with a focus on telecommunications technologies (Dipl.-Ing. TH)
- 10/1992 – 04/1993**    **University of Technology Trondheim**    **Trondheim, Norway**  
Diploma Thesis "Design of a dual processor computer for digital signal processing in power electronics"

## IV. LANGUAGES

German, English, French

## V. RECENT PUBLICATIONS

- "Unlocking the internet of things and driving the need for interoperability", Global Telecoms Business, December 2013
- "The need for standardisation in the M2M services layer", Global Telecoms Business, February 2014
- White paper "Lightweight M2M: Enabling device management and applications for the internet of things", Open Mobile Alliance, March 2014
- "Objects are a new way to create M2M applications", Global Telecoms Business, April 2014
- "The need for standardisation in the M2M services layer", M2M Now, July 2015

# Appendix B



(19) **United States**

(12) **Patent Application Publication**  
**Kakishima et al.**

(10) **Pub. No.: US 2013/0034066 A1**

(43) **Pub. Date: Feb. 7, 2013**

(54) **RADIO BASE STATION APPARATUS,  
MOBILE TERMINAL DEVICE AND  
WIRELESS COMMUNICATION METHOD**

**Publication Classification**

(75) Inventors: **Yuichi Kakishima**, Tokyo (JP);  
**Hidekazu Taoka**, Tokyo (JP); **Teruo  
Kawamura**, Tokyo (JP); **Yoshihisa  
Kishiyama**, Tokyo (JP)

(51) **Int. Cl.**  
*H04B 1/707* (2011.01)  
*H04W 72/04* (2009.01)  
(52) **U.S. Cl.** .. **370/329; 375/146; 375/141; 375/E01.002**

(73) Assignee: **NTT DOCOMO, INC.**, Tokyo (JP)

(57) **ABSTRACT**

(21) Appl. No.: **13/578,871**

To provide a radio base station apparatus, mobile terminal device and wireless communication method for enabling the SRS to be used efficiently in an LTE-A system, a wireless communication method of the invention is characterized in that a radio base station apparatus performs OFDM modulation on a transmission signal including transmission information on sounding reference signals for each transmission antenna, and transmits the OFDM-modulated transmission signal, and that a mobile terminal device receives the signal including the transmission information, controls a transmission aspect of the sounding reference signals for each transmission antenna based on the transmission information, and transmits the sounding reference signals in the transmission aspect for each transmission antenna.

(22) PCT Filed: **Feb. 9, 2011**

(86) PCT No.: **PCT/JP2011/052693**

§ 371 (c)(1),  
(2), (4) Date: **Oct. 23, 2012**

(30) **Foreign Application Priority Data**

Feb. 15, 2010 (JP) ..... 2010-030626

CODEBOOK INDEX	PRECODING WEIGHT FOR RANK 1
#0	$\frac{1}{\sqrt{2}} \begin{bmatrix} 1 \\ 1 \end{bmatrix}$
#1	$\frac{1}{\sqrt{2}} \begin{bmatrix} 1 \\ -1 \end{bmatrix}$
#2	$\frac{1}{\sqrt{2}} \begin{bmatrix} 1 \\ j \end{bmatrix}$
#3	$\frac{1}{\sqrt{2}} \begin{bmatrix} 1 \\ -j \end{bmatrix}$
#4	$\frac{1}{\sqrt{2}} \begin{bmatrix} 1 \\ 0 \end{bmatrix}$
#5	$\frac{1}{\sqrt{2}} \begin{bmatrix} 0 \\ 1 \end{bmatrix}$

ATOV

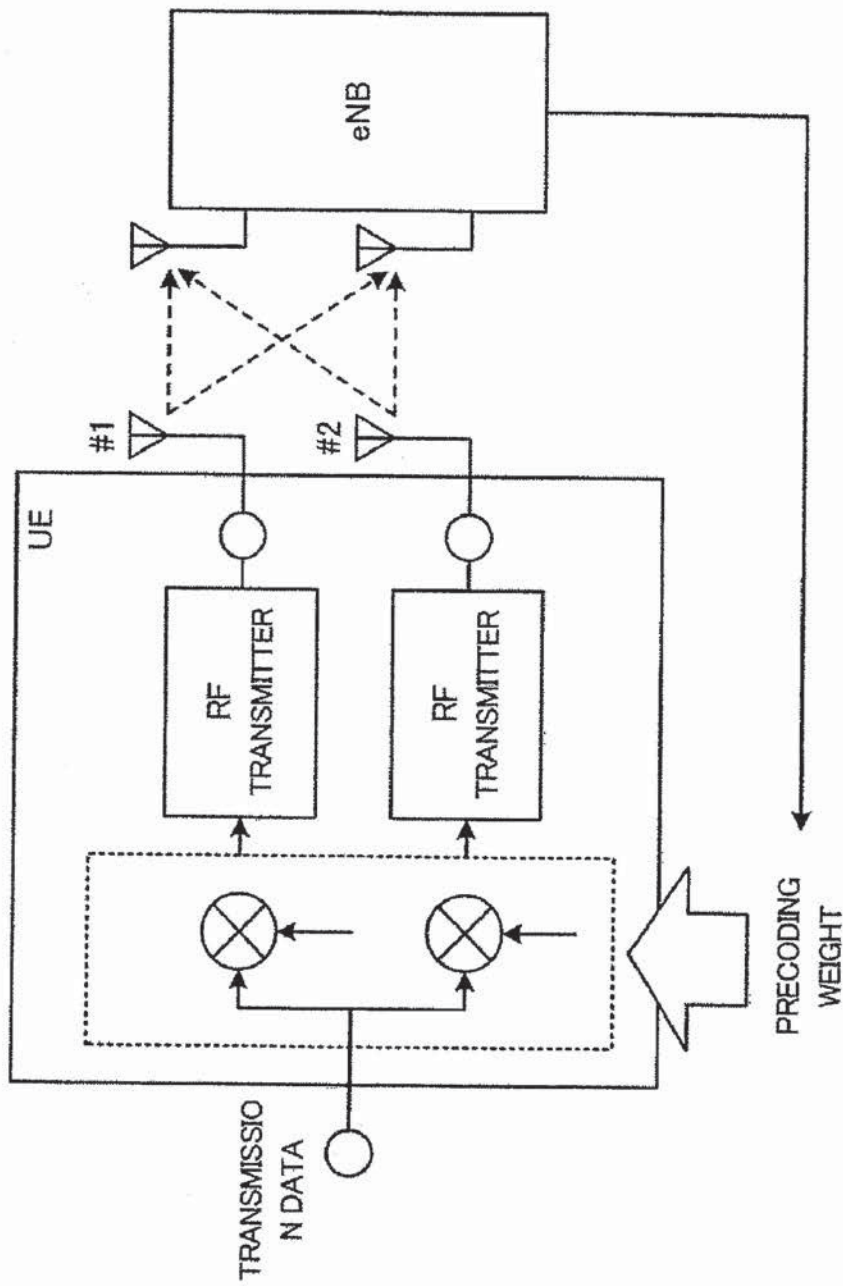

FIG. 1

CODEBOOK INDEX	PRECODING WEIGHT FOR RANK 1
#0	$\frac{1}{\sqrt{2}} \begin{bmatrix} 1 \\ 1 \end{bmatrix}$
#1	$\frac{1}{\sqrt{2}} \begin{bmatrix} 1 \\ -1 \end{bmatrix}$
#2	$\frac{1}{\sqrt{2}} \begin{bmatrix} 1 \\ j \end{bmatrix}$
#3	$\frac{1}{\sqrt{2}} \begin{bmatrix} 1 \\ -j \end{bmatrix}$
#4	$\frac{1}{\sqrt{2}} \begin{bmatrix} 1 \\ 0 \end{bmatrix}$ <span data-bbox="1161 1228 1274 1270" style="margin-left: 20px;">ATOV</span>
#5	$\frac{1}{\sqrt{2}} \begin{bmatrix} 0 \\ 1 \end{bmatrix}$

FIG. 2

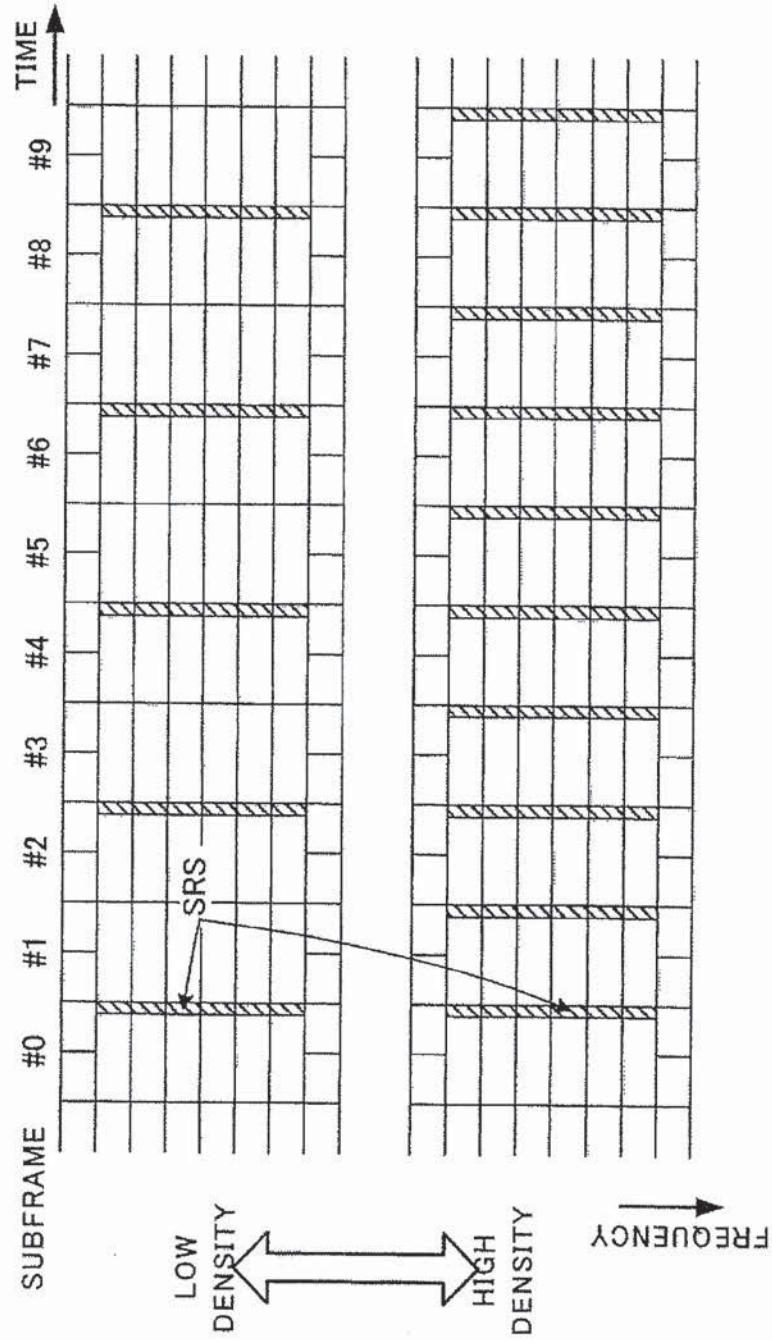

FIG. 3

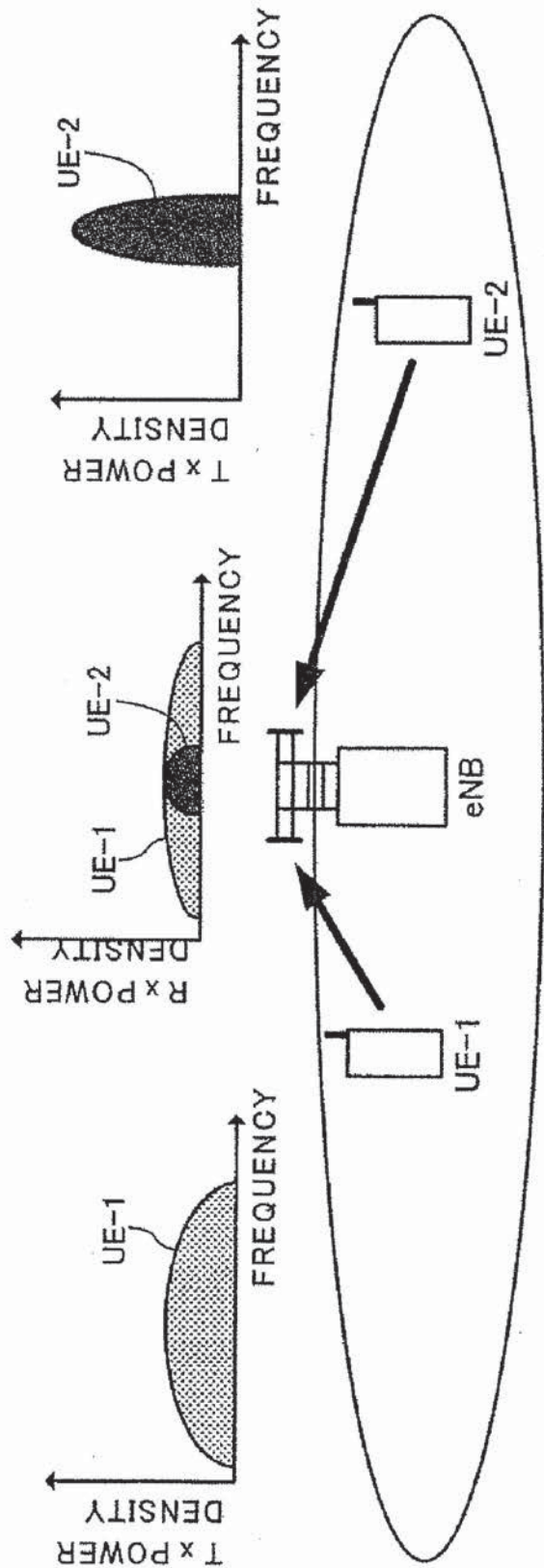

FIG. 4



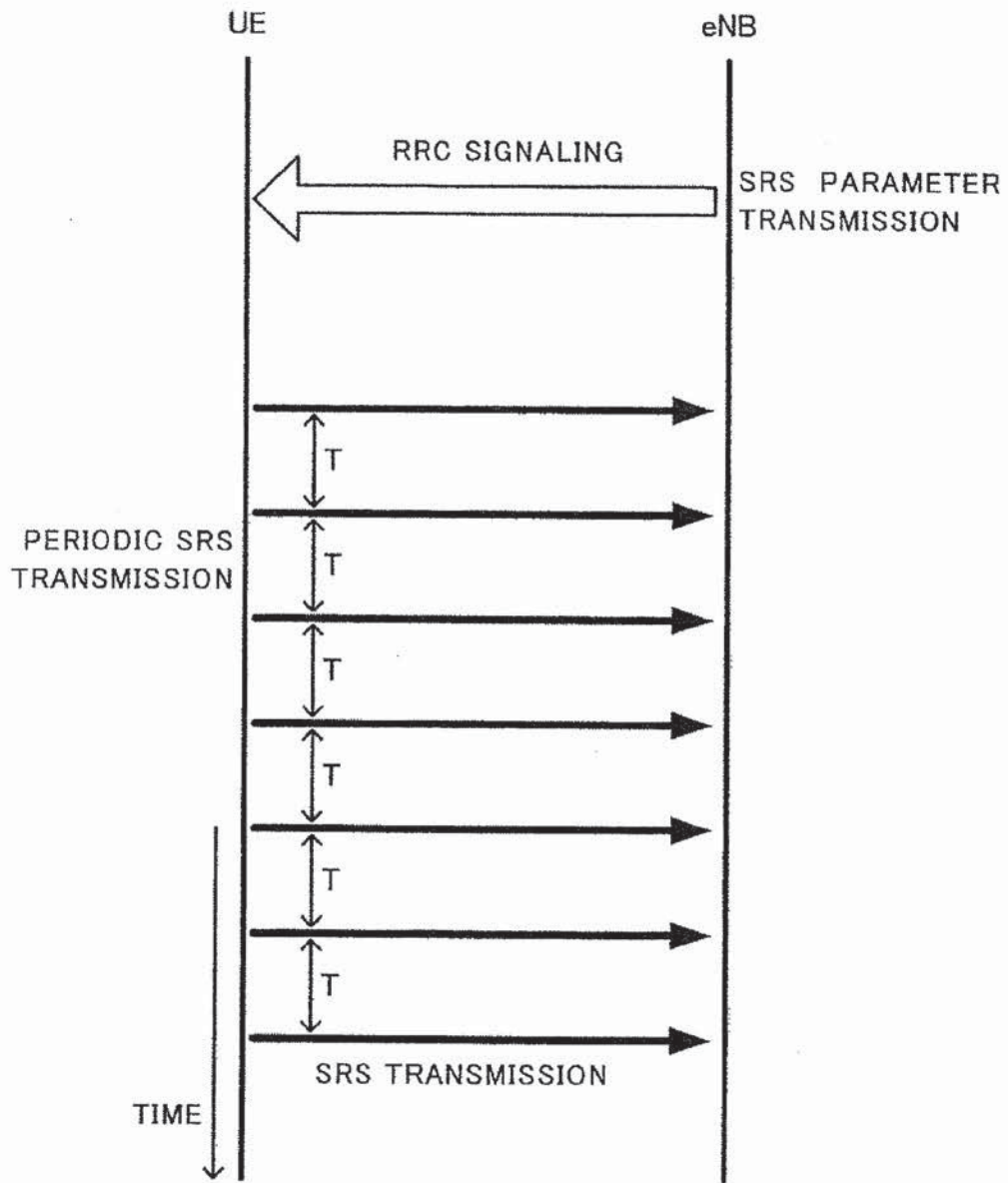

FIG. 5

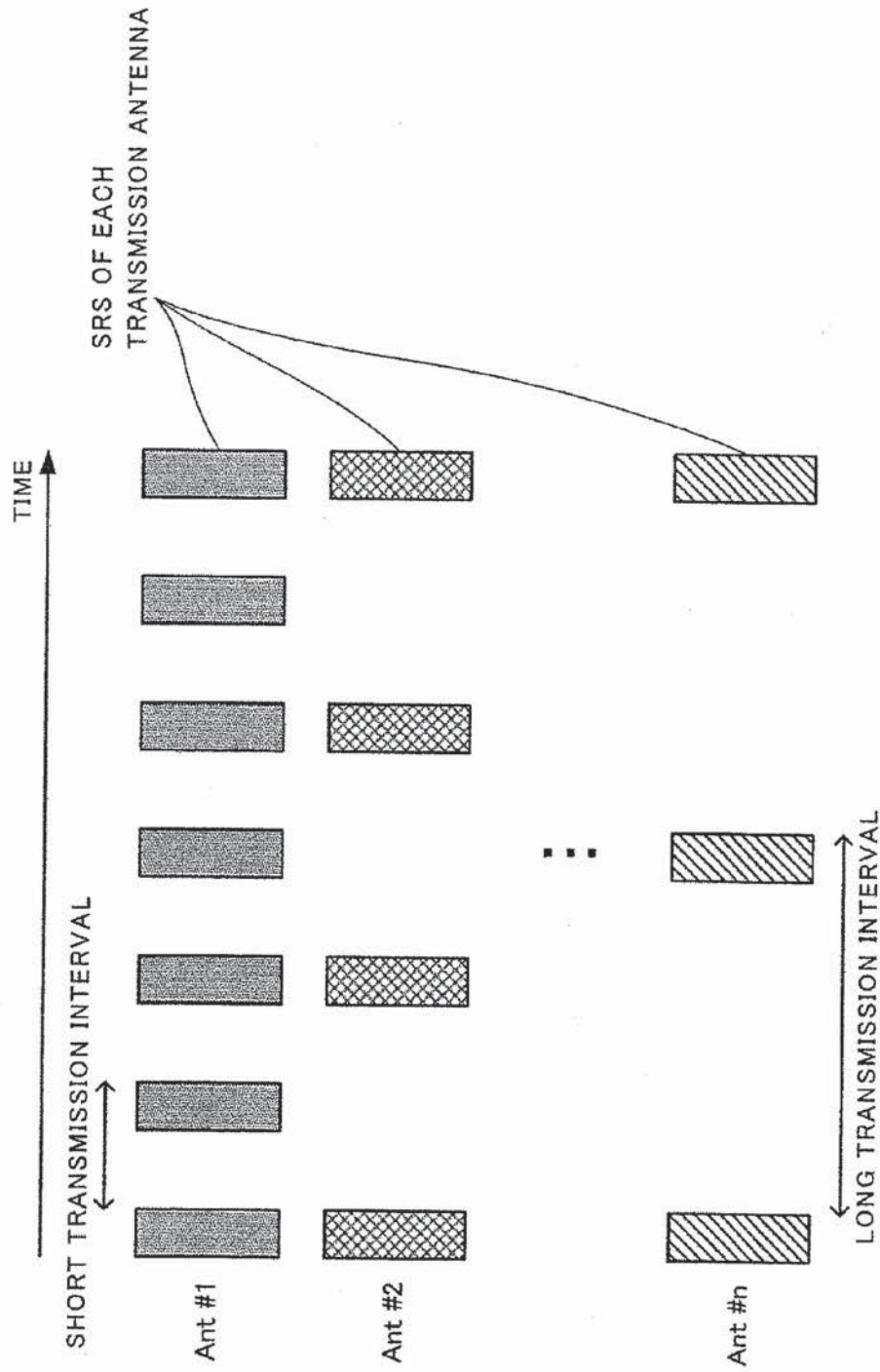

FIG. 6

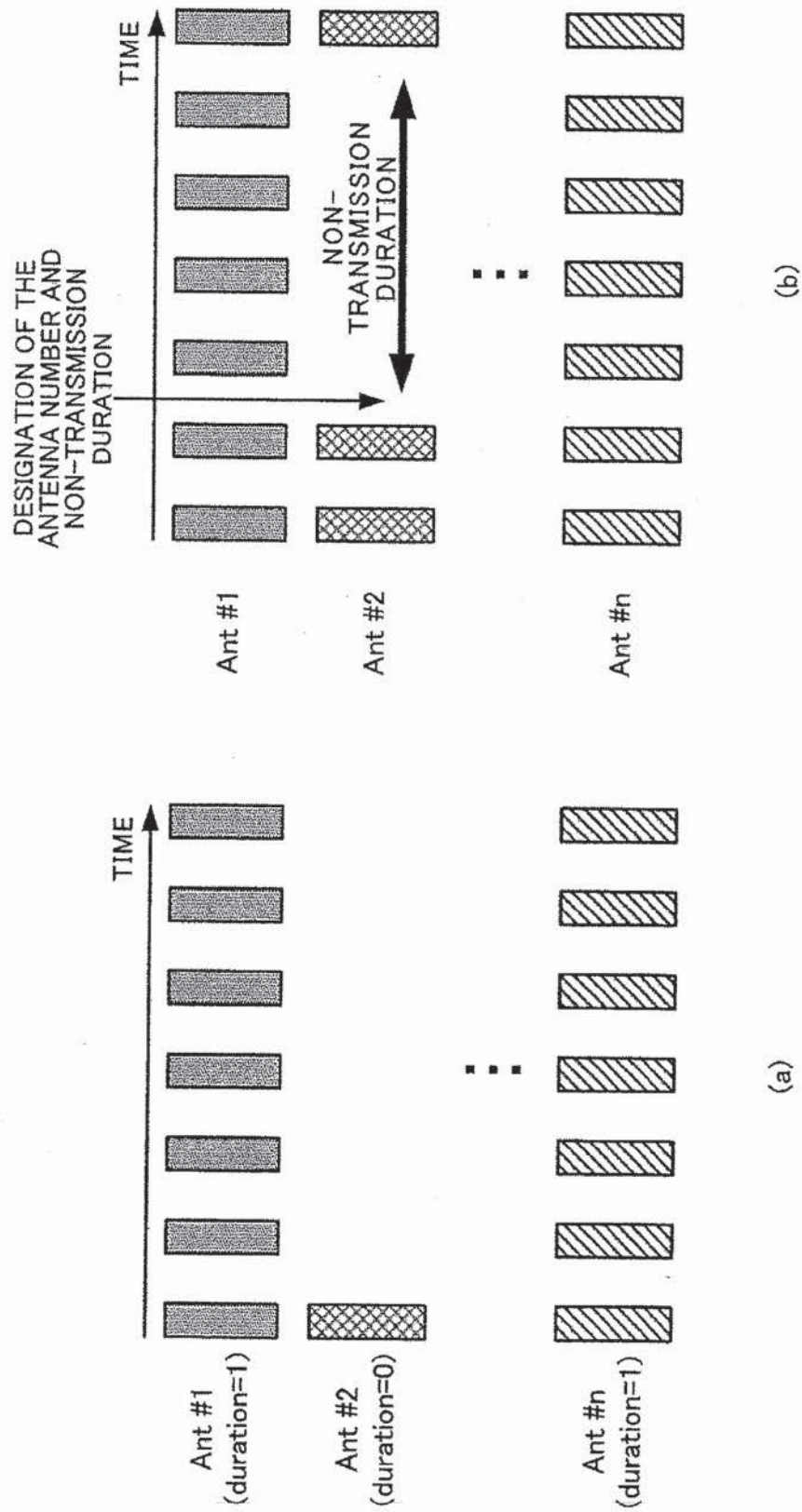

FIG. 7

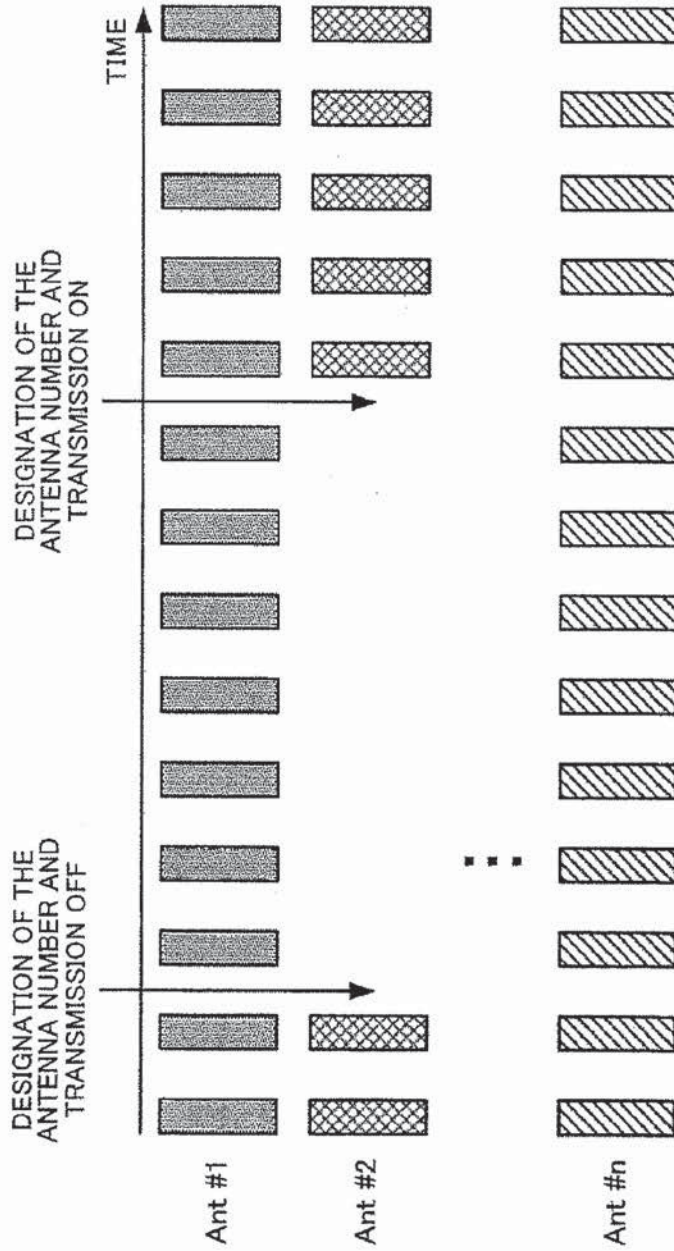

FIG. 8

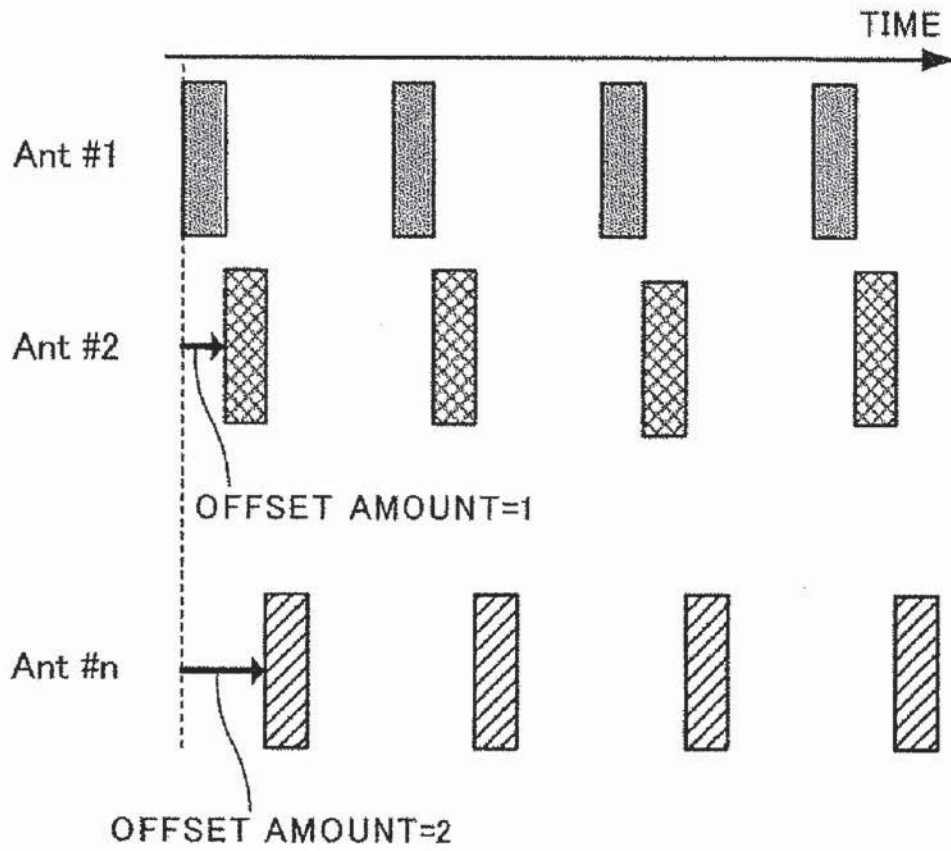

FIG. 9

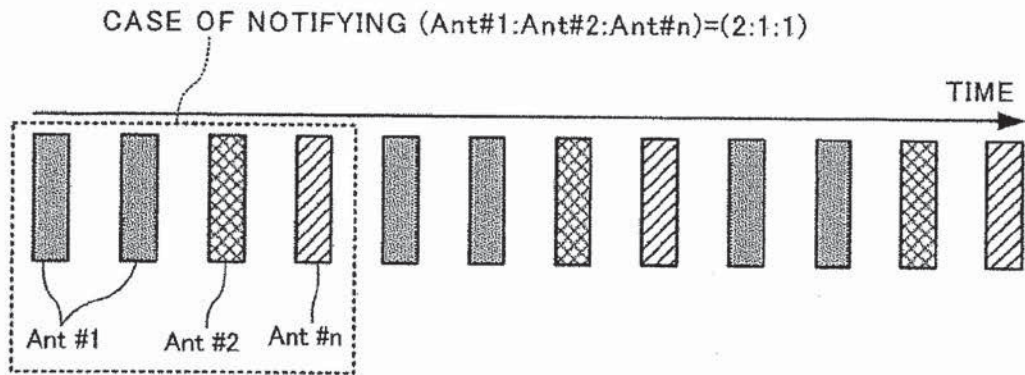

FIG. 10

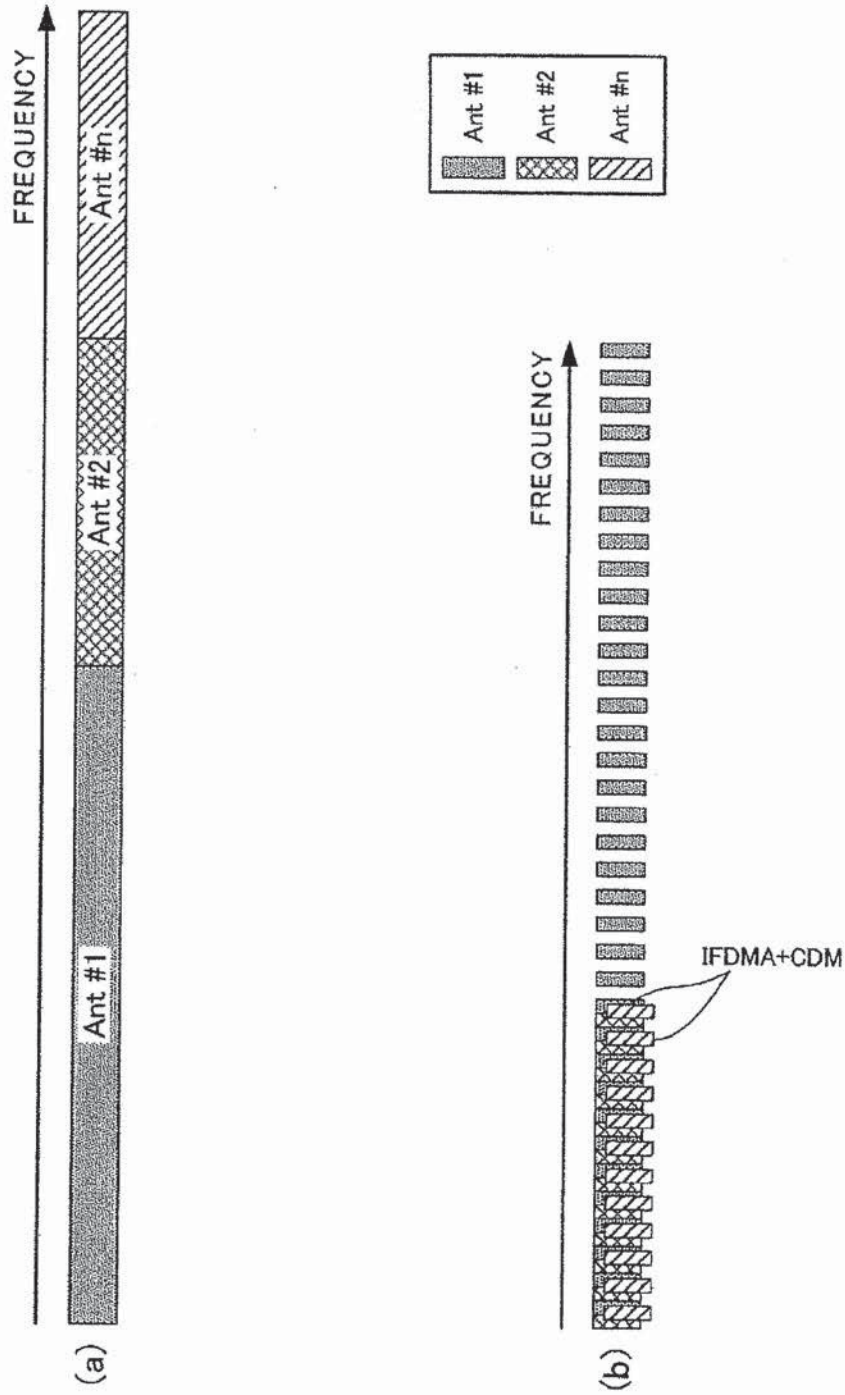

FIG. 11

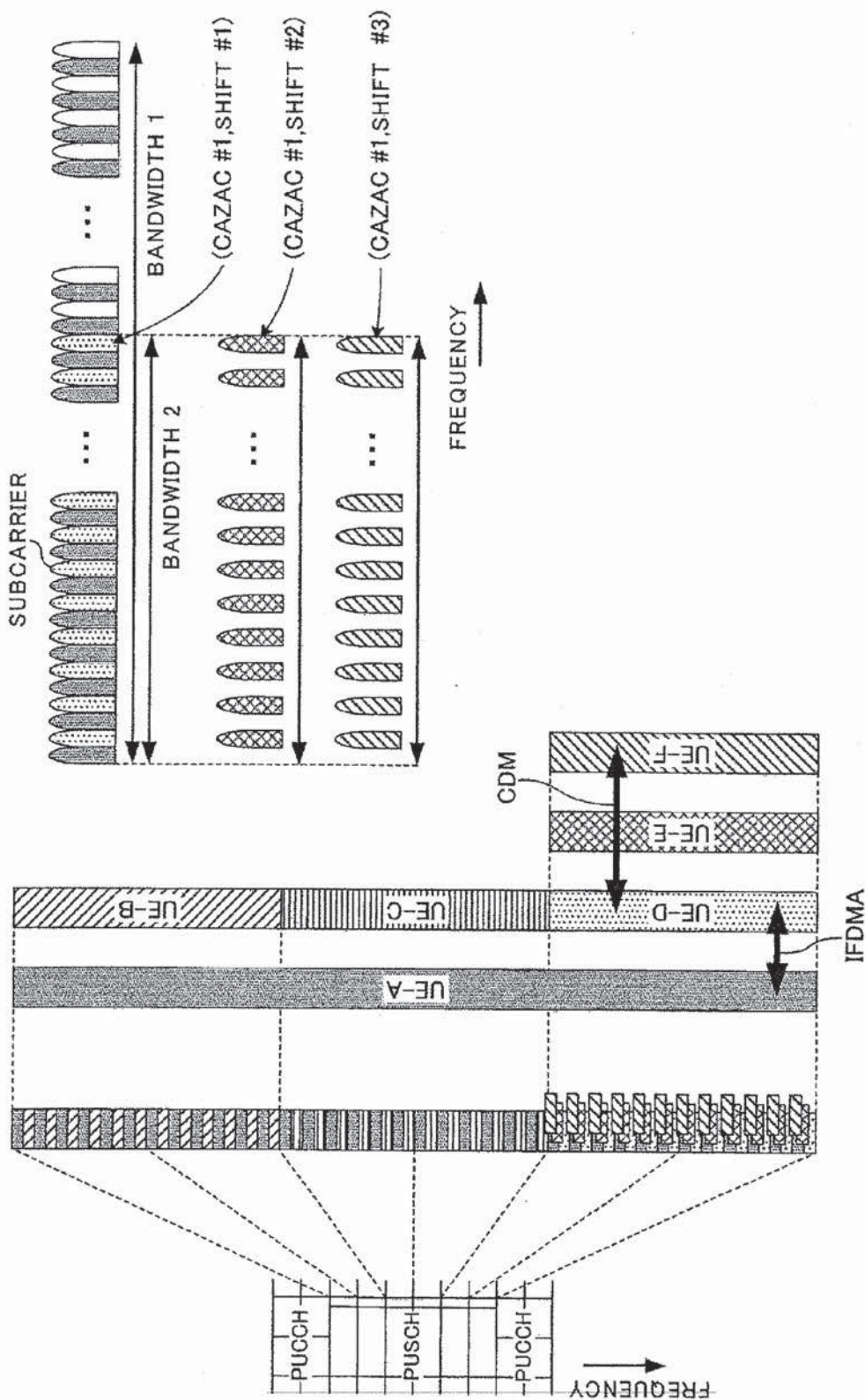

FIG. 12



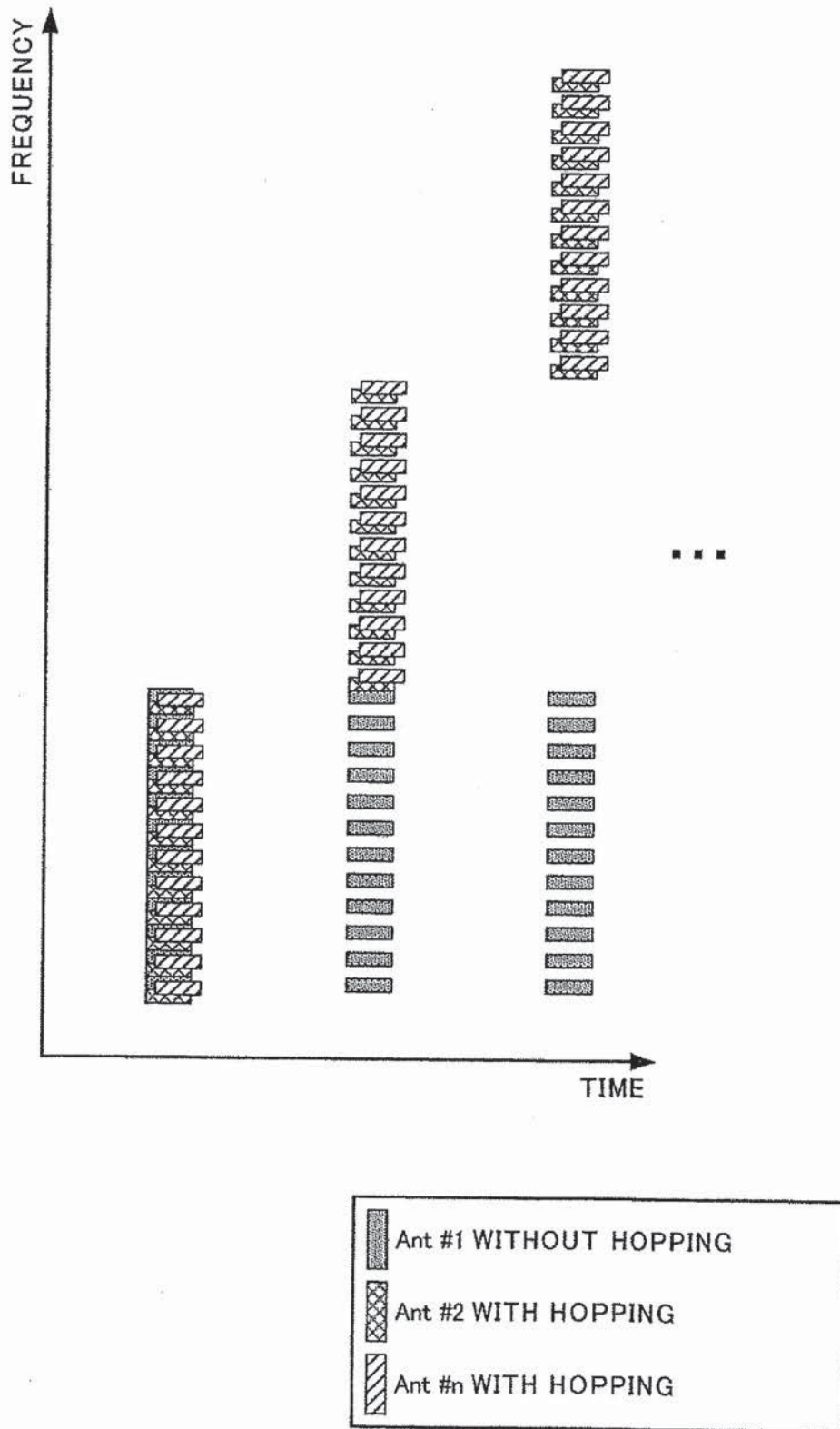

FIG. 13

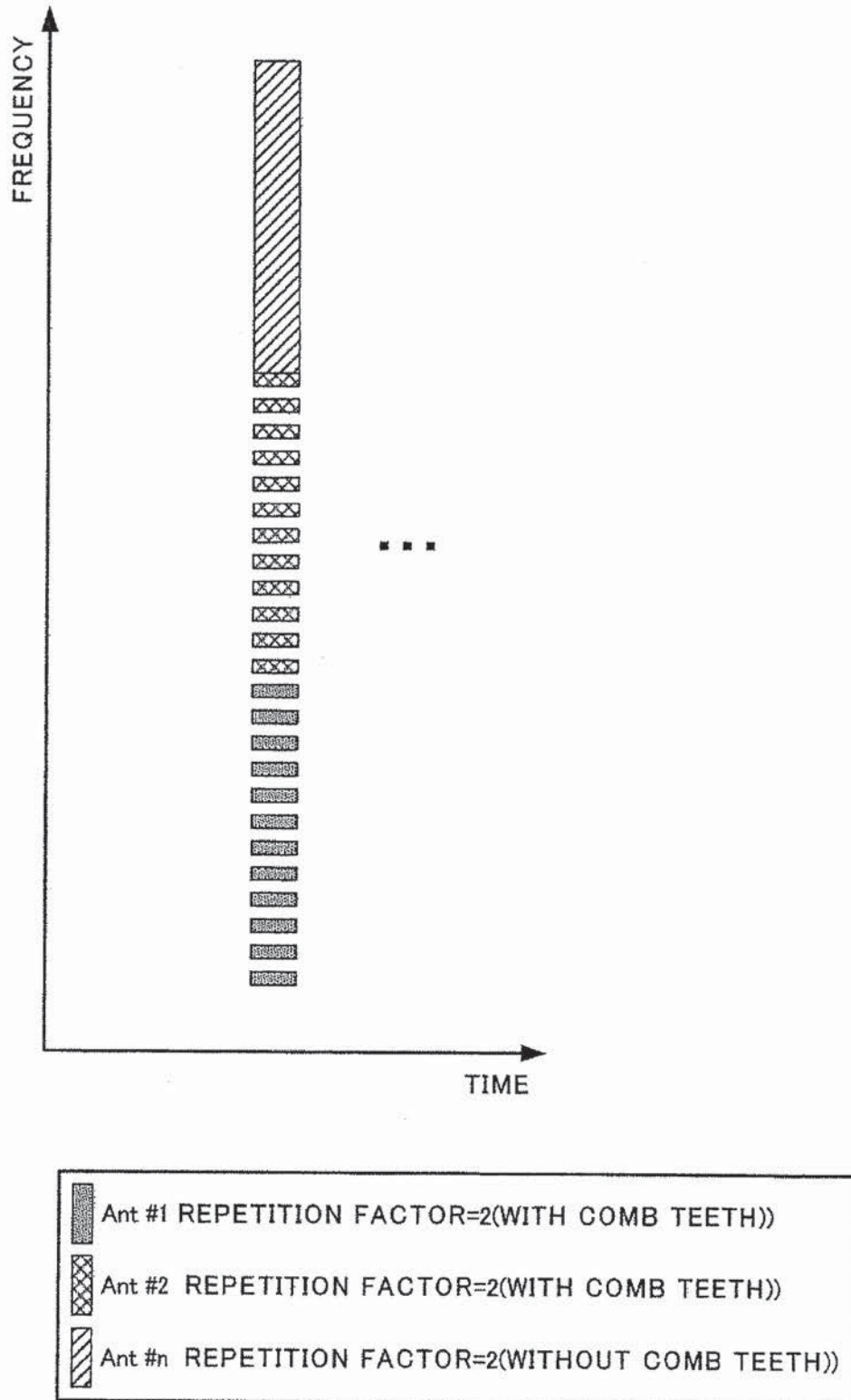

FIG. 14

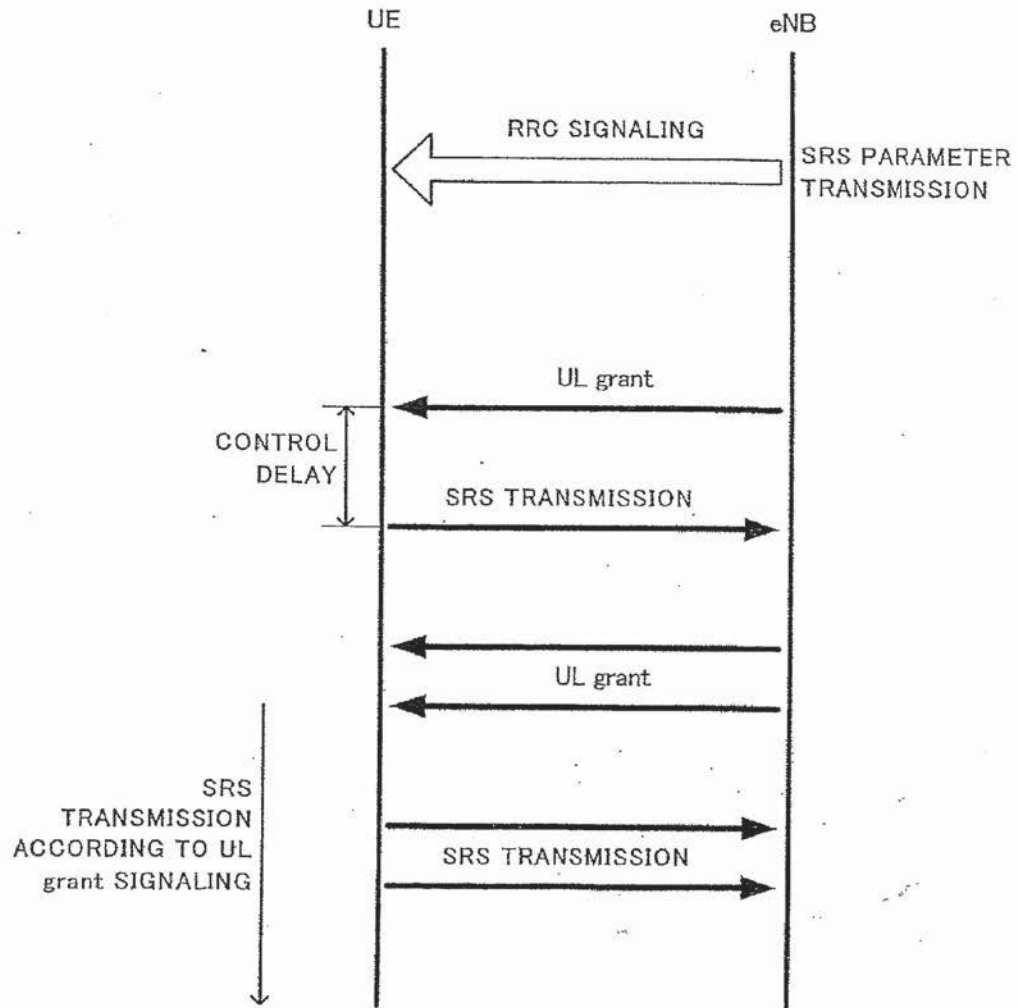

FIG. 15

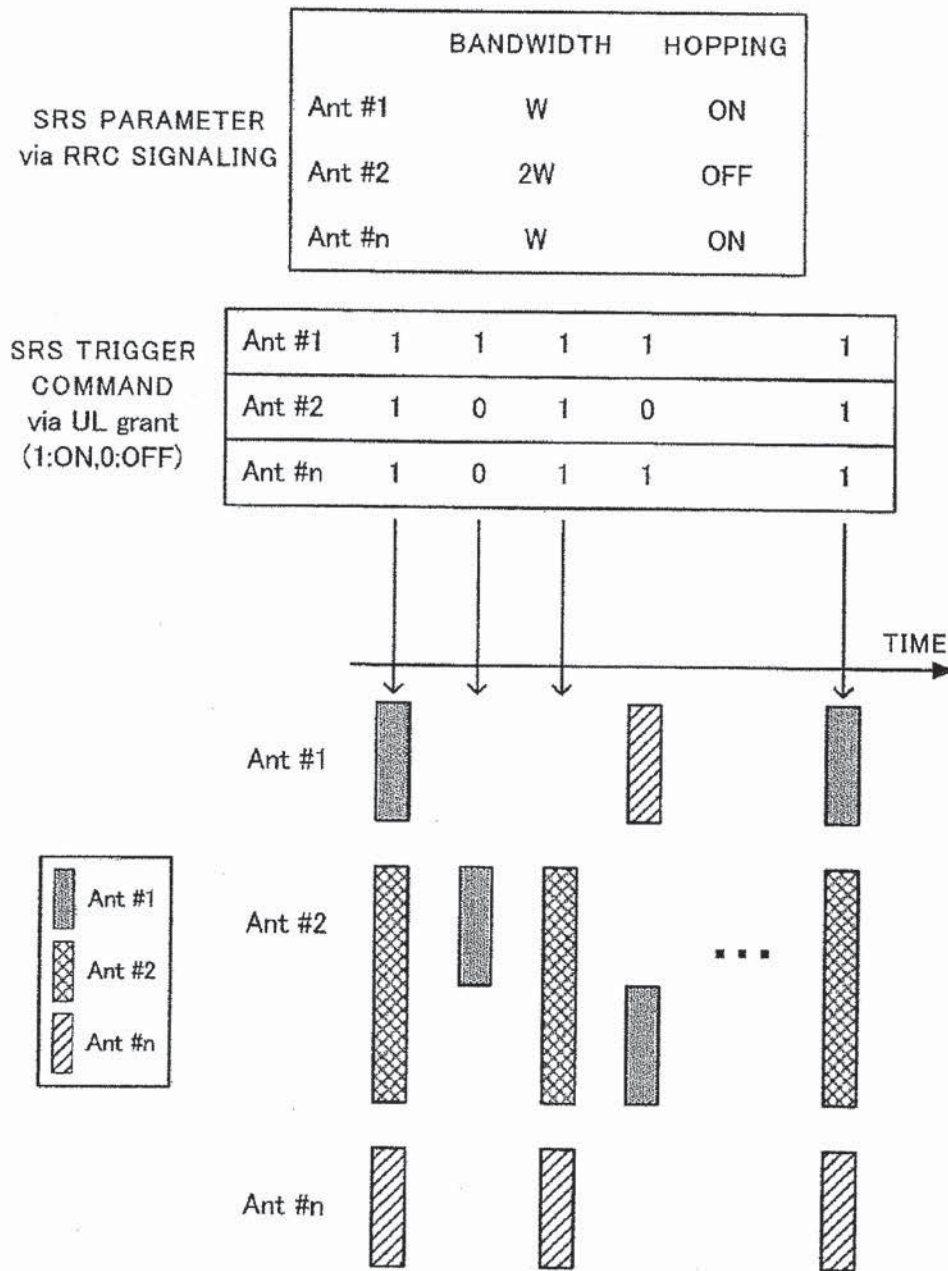

FIG. 16

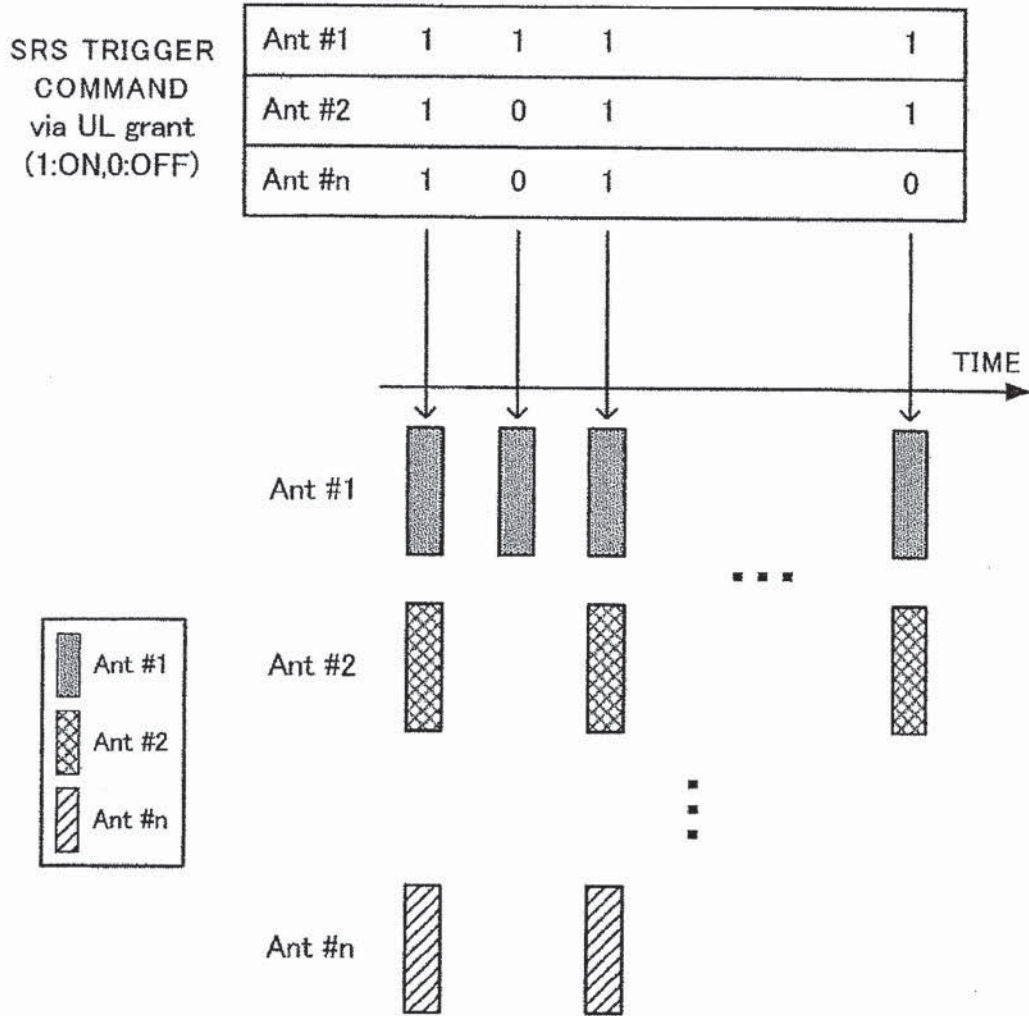

FIG. 17

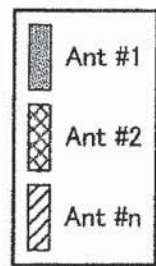
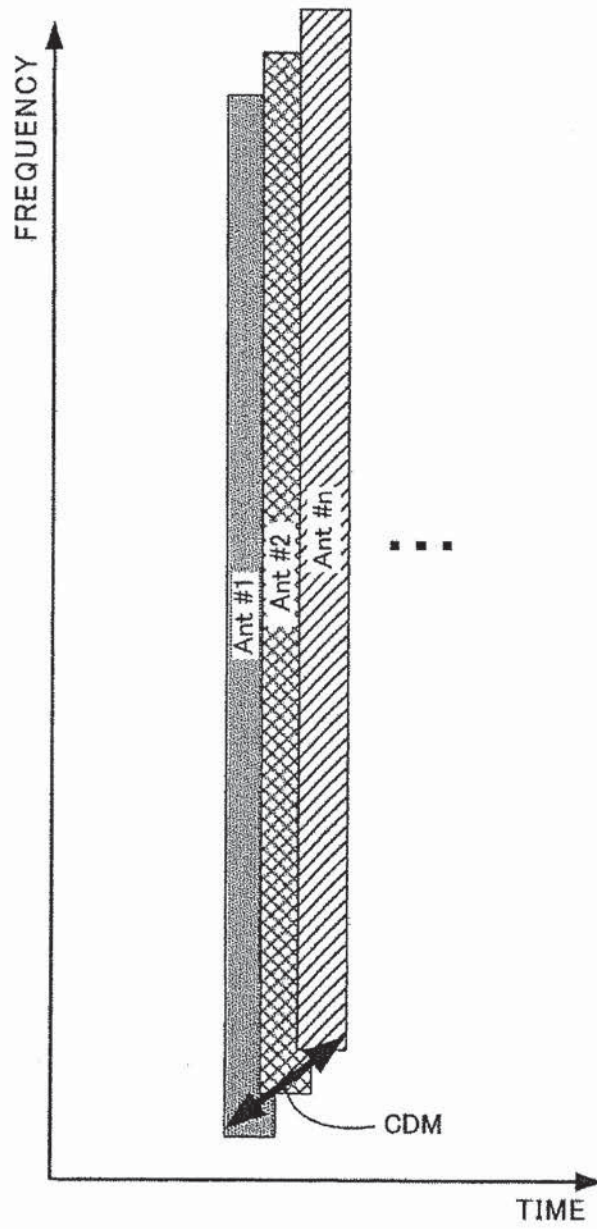

FIG. 18

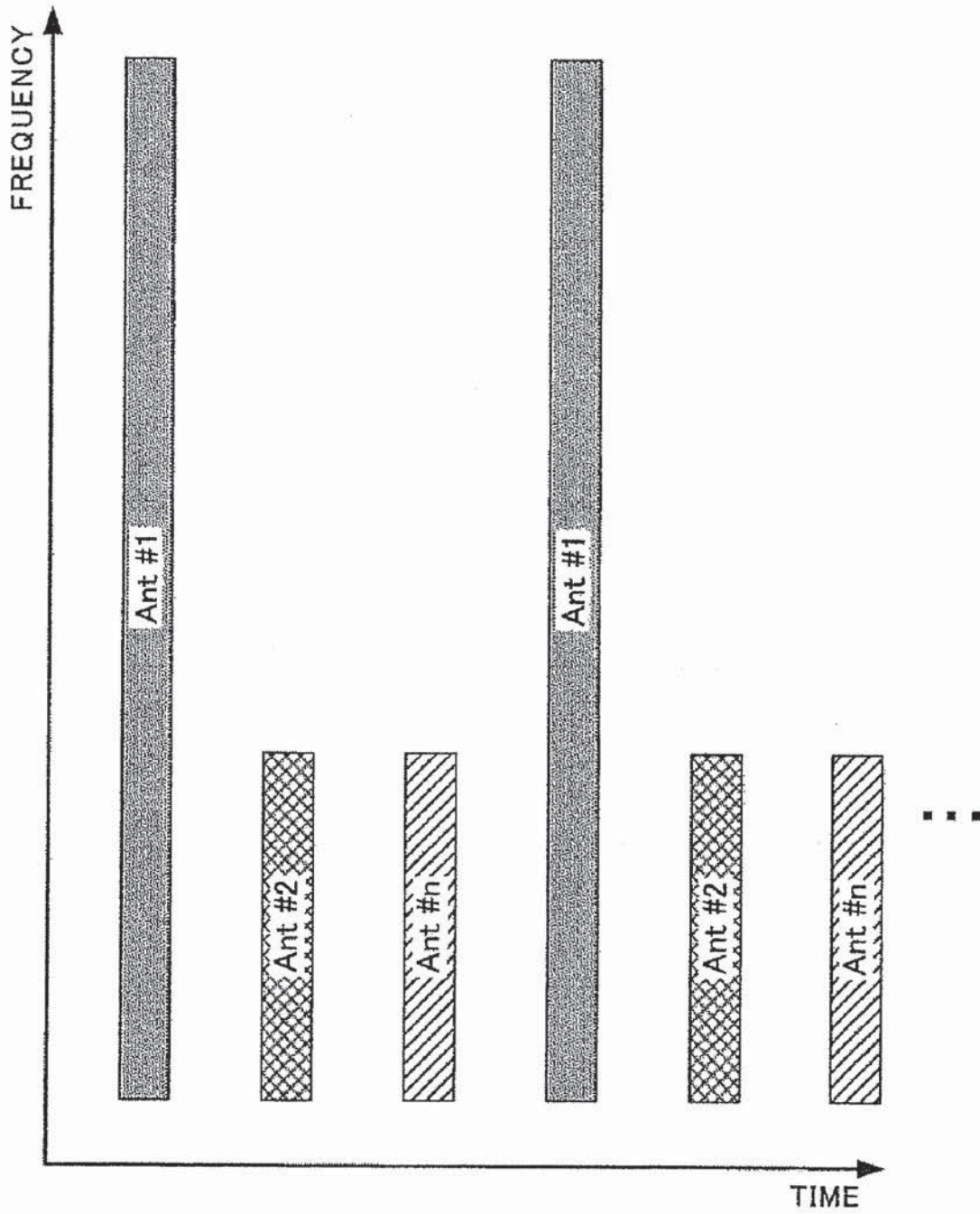

FIG. 19

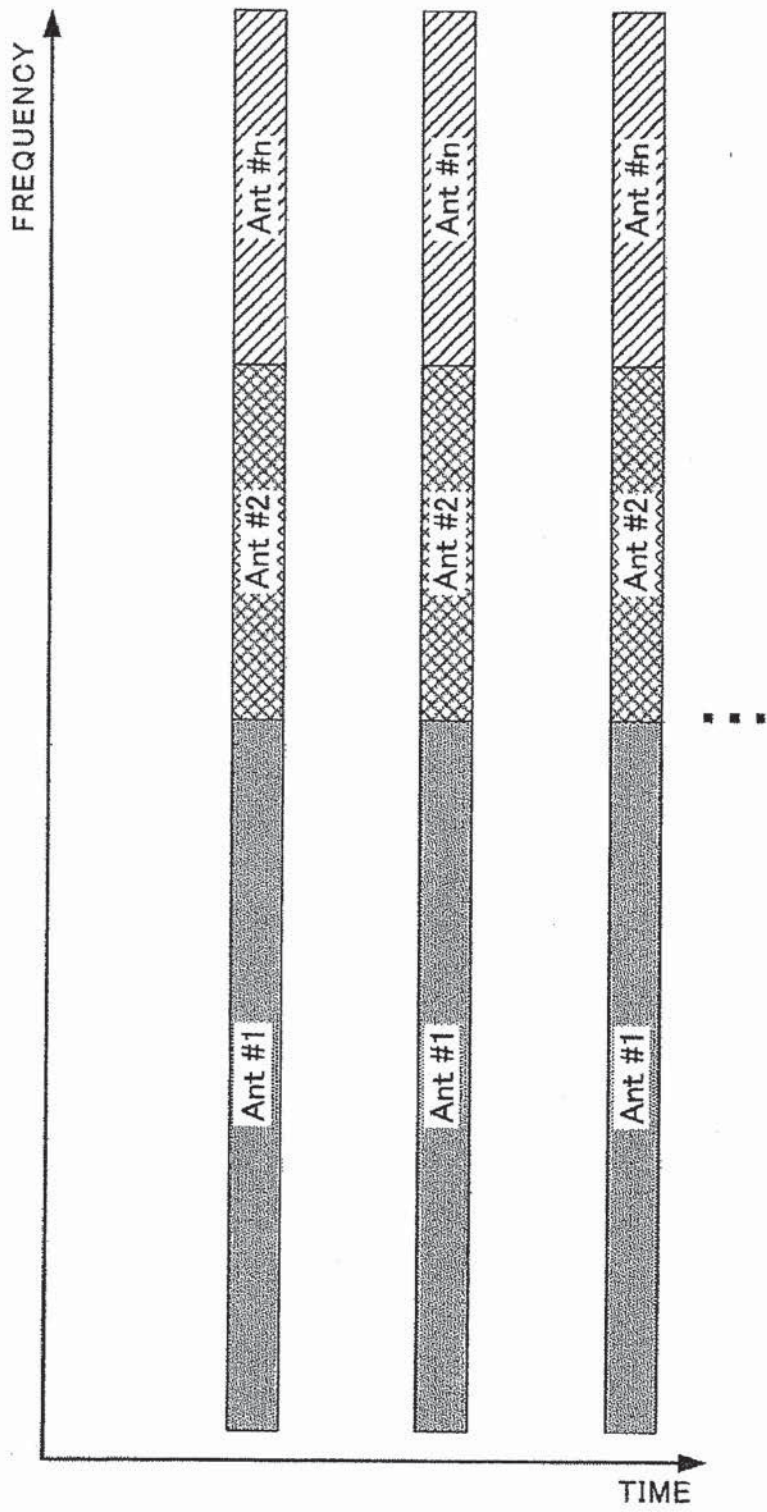

FIG. 20



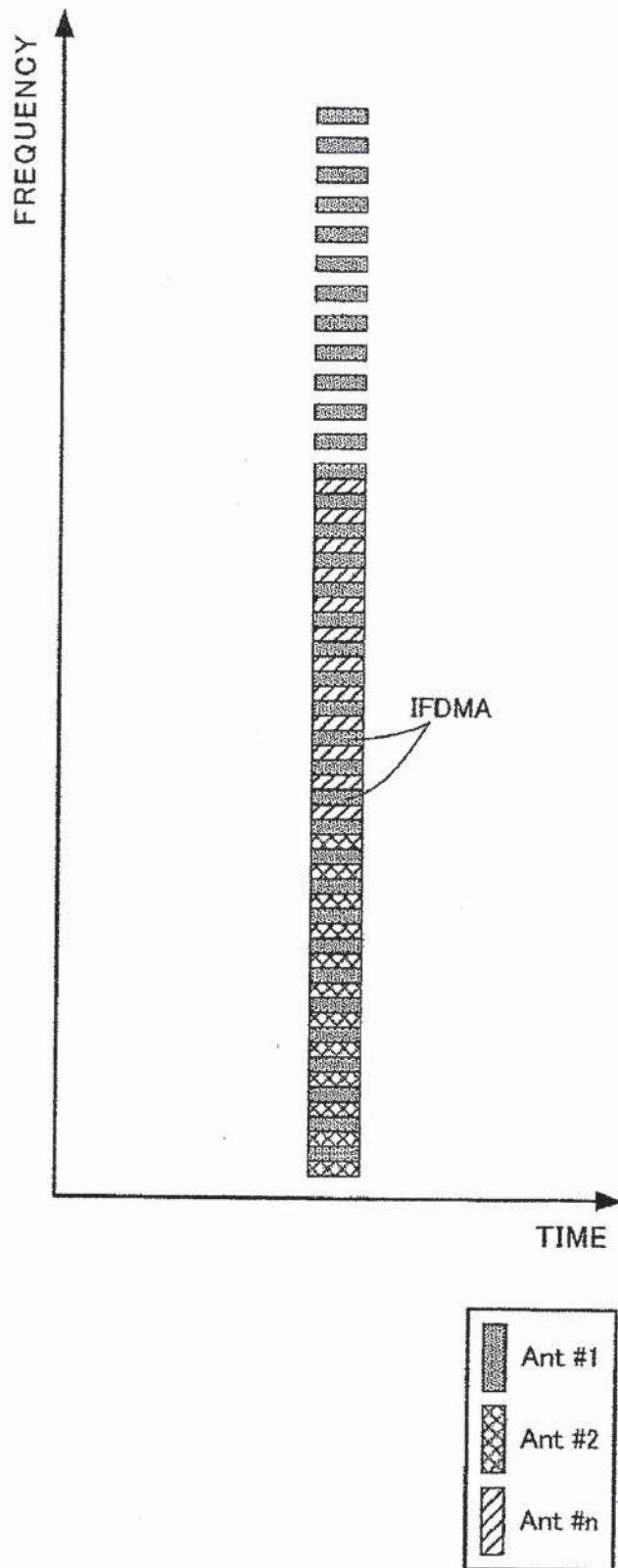

FIG. 21

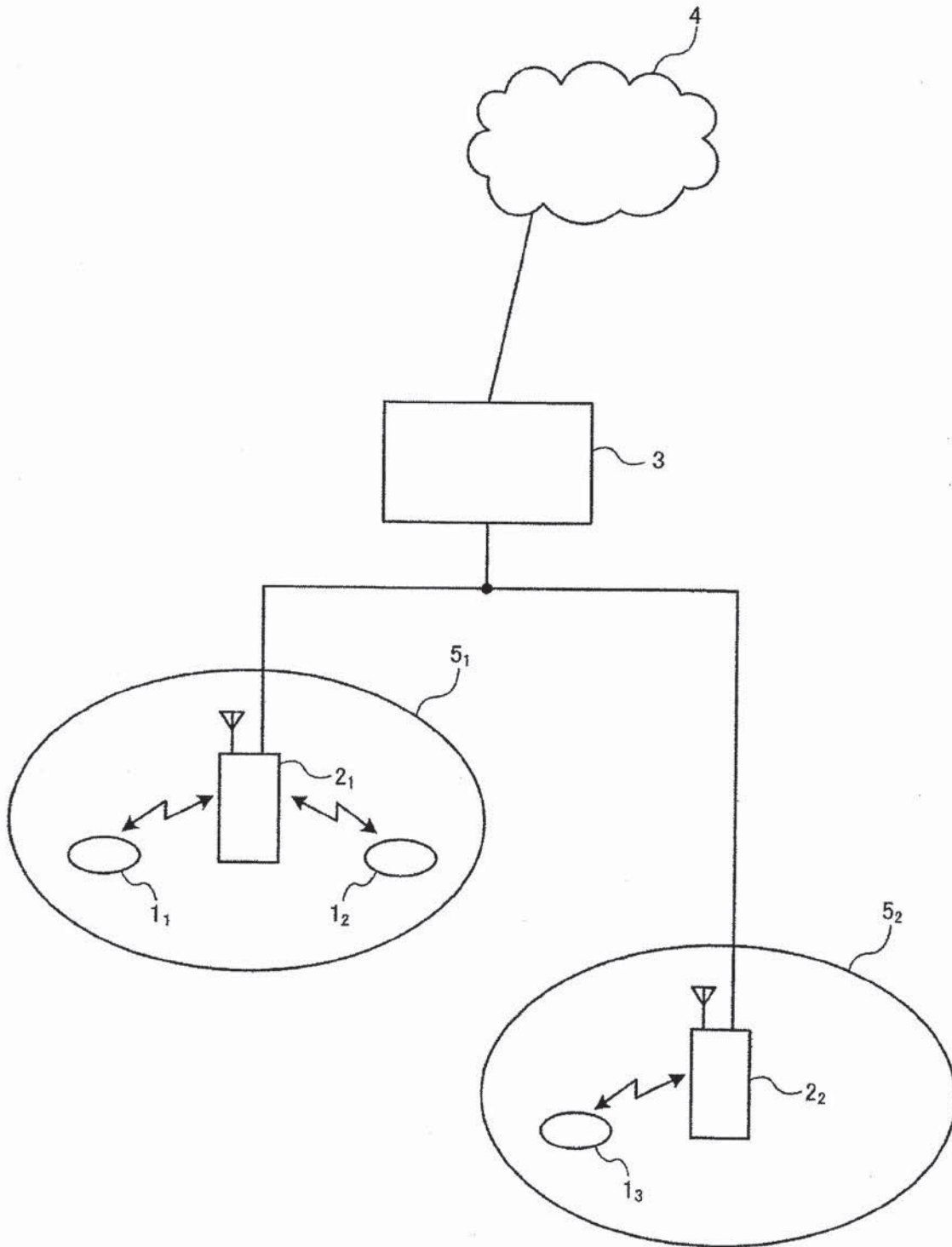

FIG. 22

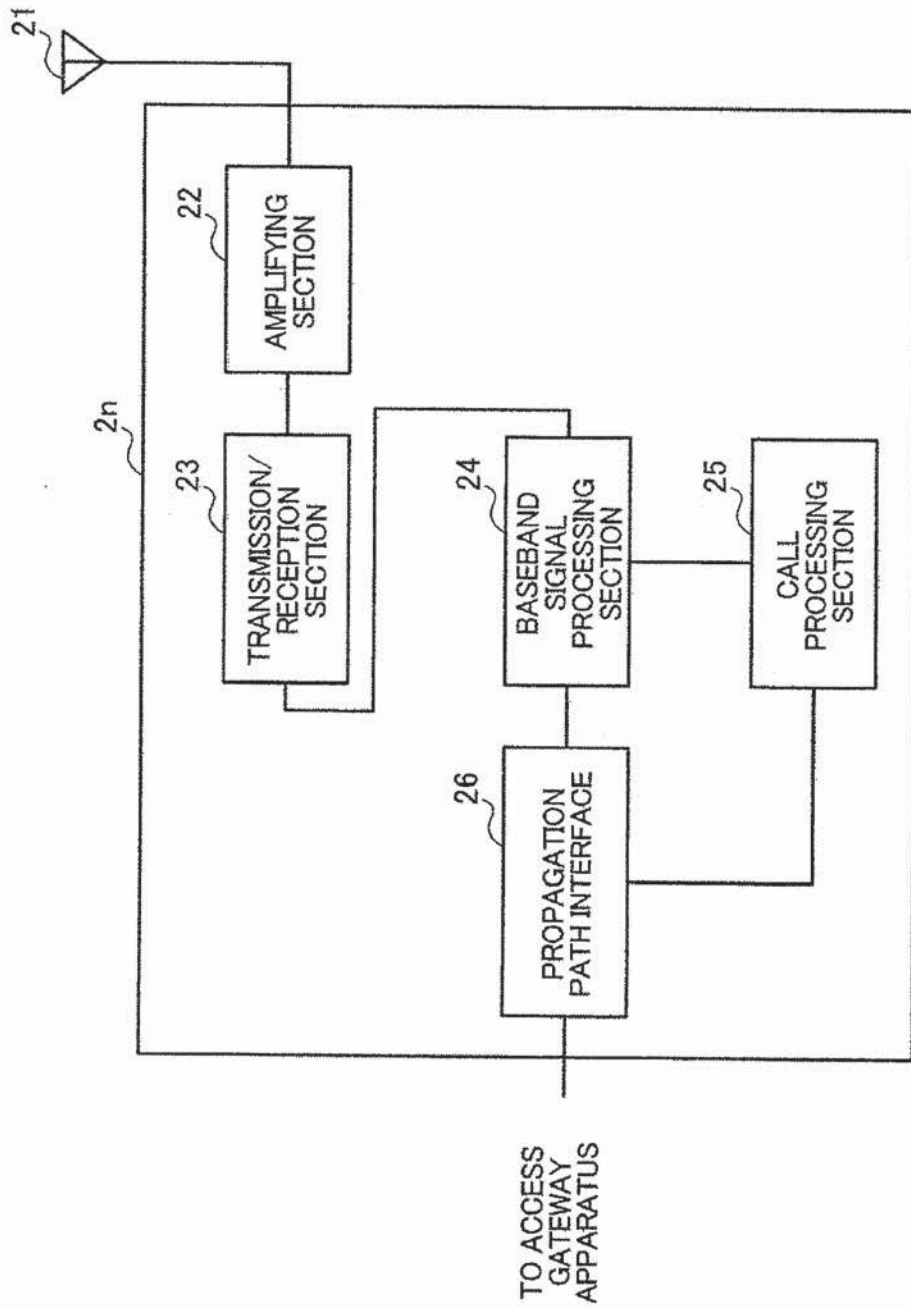

FIG. 23

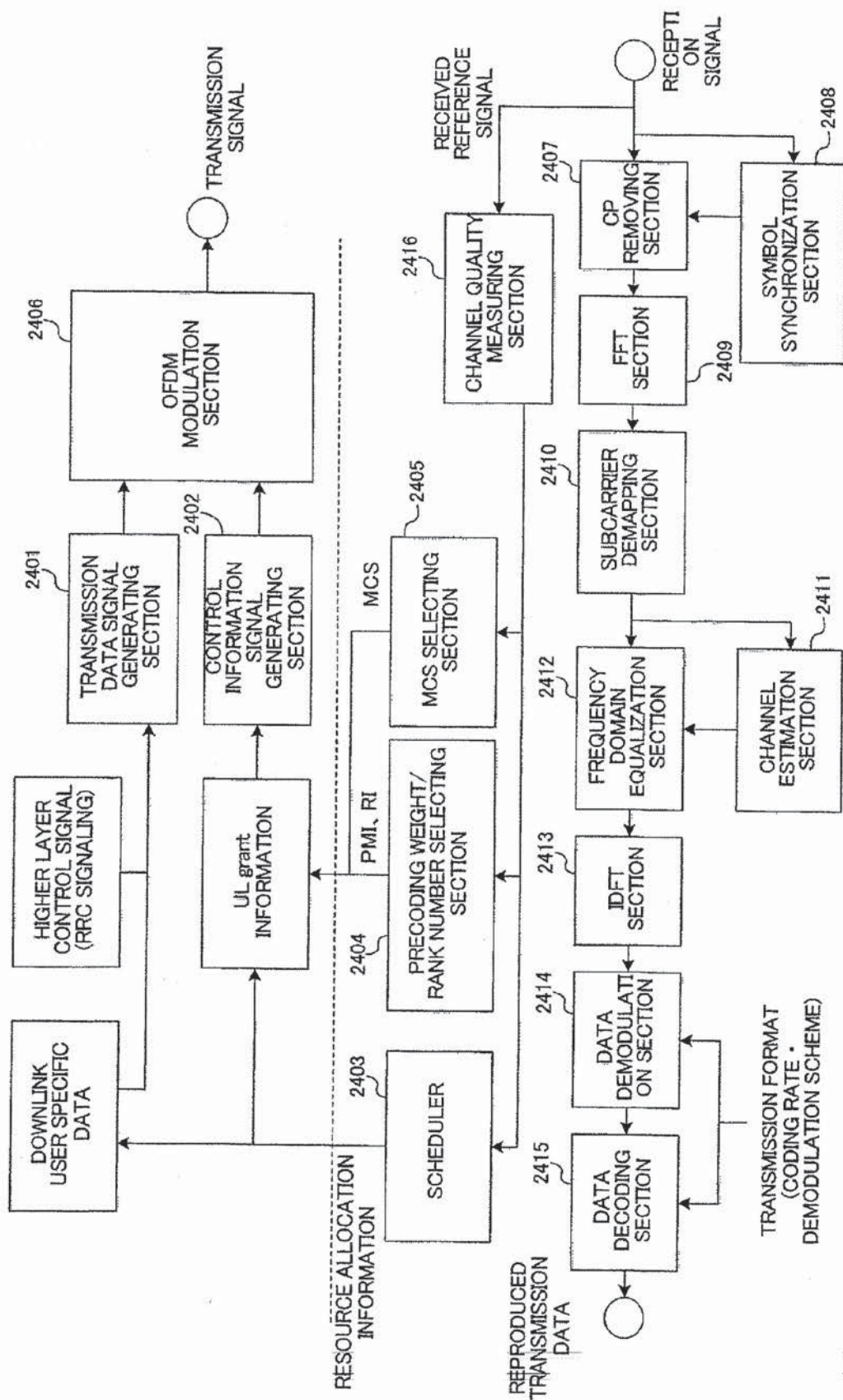

FIG. 24

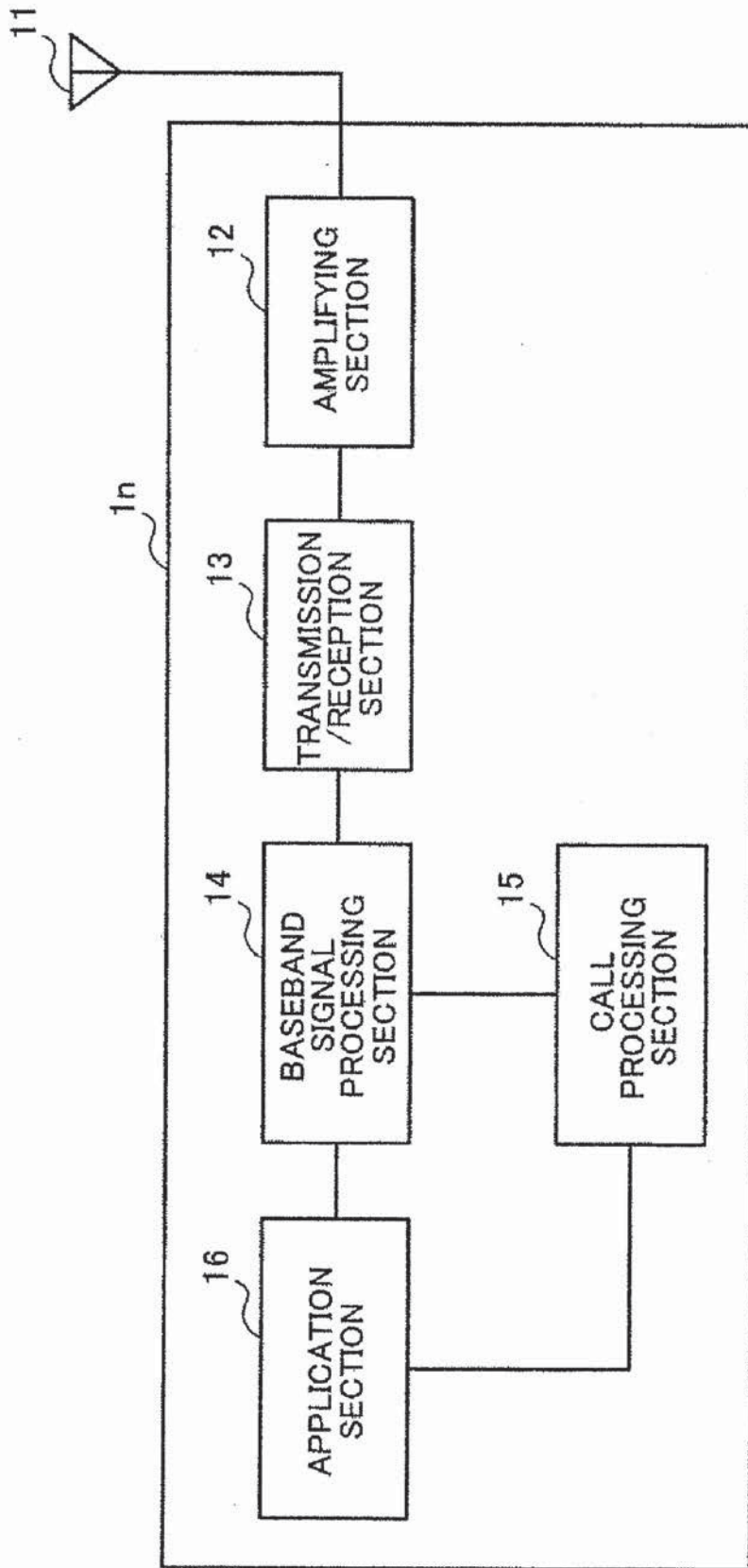

FIG. 25

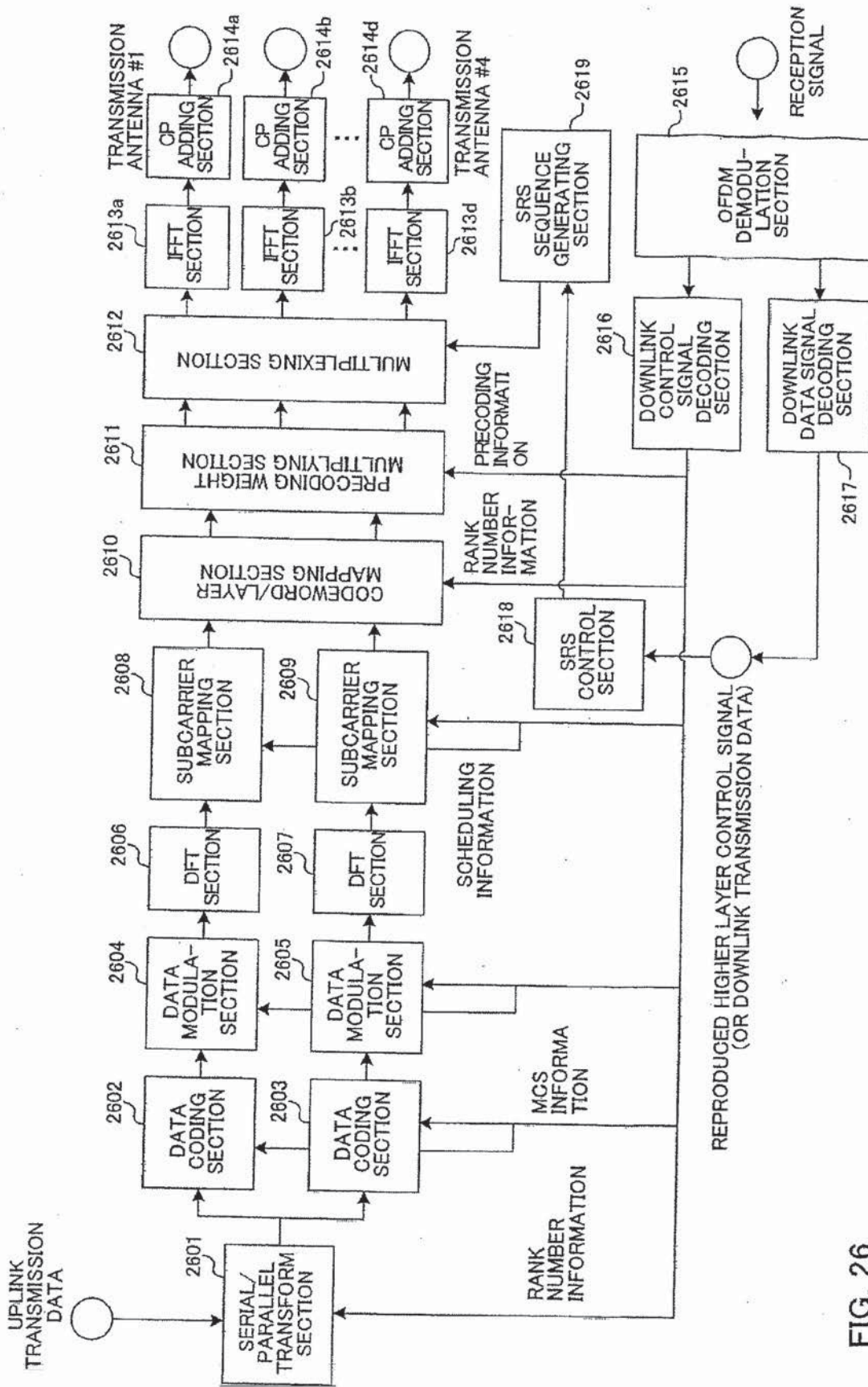

FIG. 26

## RADIO BASE STATION APPARATUS, MOBILE TERMINAL DEVICE AND WIRELESS COMMUNICATION METHOD

### TECHNICAL FIELD

[0001] The present invention relates to a radio base station apparatus, mobile terminal device and wireless communication method using SRSs (Sounding Reference Signals) efficiently in an LTE-A (Long Term Evolution-Advanced) system.

### BACKGROUND ART

[0002] In LTE (Long Term Evolution) systems specified in the 3GPP (3<sup>rd</sup> Generation Partnership Project), to actualize faster transmission, MIMO (Multiple Input Multiple Output) transmission is adopted in which a radio base station apparatus uses a plurality of transmission antennas. Further, in LTE-Advanced (LTE-A) systems with the purpose of increasing the band and speed more than the LTE system, MIMO multiplexing transmission of maximum 8 streams is performed in downlink, and MIMO multiplexing transmission of maximum 4 streams is performed in uplink.

[0003] In MIMO transmission in uplink, a transmission side (mobile terminal device: UE) transmits an SRS (Sounding Reference Signal) from each of transmission antennas (for example, #1, #2). A reception side (radio base station apparatus: eNB) measures each SRS, selects a phase/amplitude control amount based on a channel variance for each of transmission antennas (#1, #2), and transmits a PMI (Precoding Matrix Indicator) to the transmission side as feedback. The transmission side applies different phase/amplitude control (multiplication by a precoding weight) for each transmission antenna to the same signal to transmit (FIG. 1 shows an example of the case of two transmission antennas) (Non-patent Document 1).

[0004] Further, in MIMO transmission in uplink, in an environment in which Antenna Gain Imbalance (AGI) is large due to the effect of hand gripping or the like, precoding is performed using an ATOV (Antenna turn off vector) (halting transmission from a transmission antenna with a large propagation loss) as a PMI (see FIG. 2). By using thus ATOV, it is possible to provide the mobile terminal device with battery saving.

### PRIOR ART LITERATURE

#### Non-Patent Literature

[0005] [Non-patent Literature 1] 3GPP, TR36.912 (V9.1.0) "Feasibility study for Further Advancements for E-UTRA (LTE-Advanced)," December 2009.

### SUMMARY OF INVENTION

#### Technical Problem

[0006] In precoding in uplink MIMO transmission, it is necessary to perform channel estimation for each transmission antenna to select the PMI. In other words, the SRS is needed for each transmission antenna, and the number of resources for the SRS increases. Further, when the ATOV is used for power saving in an environment in which AGI is large due to hand gripping or the like, it becomes useless to transmit the SRS from a transmission antenna that does not transmit a PUSCH (Physical Uplink Shared Channel) signal.

[0007] The present invention was made in view of such a respect, and it is an object of the invention to provide a radio base station apparatus, mobile terminal device and wireless communication method for enabling the SRS to be used efficiently in an LTE-A system.

#### Solution to the Problem

[0008] A radio base station apparatus of the invention is characterized by having OFDM modulation section for performing OFDM modulation on a transmission signal including transmission information on sounding reference signals for each transmission antenna, and transmission section for transmitting the transmission signal subjected to OFDM modulation.

[0009] A mobile terminal device of the invention is characterized by having a plurality of transmission antennas, reception section for receiving a signal including transmission information on sounding reference signals for each of the transmission antennas, control section for controlling a transmission aspect of the sounding reference signals for each of the transmission antennas based on the transmission information, and transmission section for transmitting the sounding reference signals in the transmission aspect for each of the transmission antennas.

[0010] A wireless communication method of the invention is characterized by having the steps in a radio base station apparatus of performing OFDM modulation on a transmission signal including transmission information on sounding reference signals for each transmission antenna, and transmitting the transmission signal subjected to OFDM modulation, and the steps in a mobile terminal device of receiving the signal including the transmission information, controlling a transmission aspect of the sounding reference signals for each transmission antenna based on the transmission information, and transmitting the sounding reference signals in the transmission aspect for each transmission antenna.

#### Advantageous Effect of the Invention

[0011] According to the invention, a radio base station apparatus performs OFDM modulation on a transmission signal including transmission information on sounding reference signals for each transmission antenna, and transmits the transmission signal subjected to OFDM modulation, a mobile terminal device receives the signal including the transmission information, controls a transmission aspect of the sounding reference signals for each transmission antenna based on the transmission information, and transmits the sounding reference signals in the transmission aspect for each transmission antenna, and therefore, it is possible to efficiently use the SRS in the LTE-A system.

### BRIEF DESCRIPTION OF DRAWINGS

[0012] FIG. 1 is a diagram to explain MIMO transmission in uplink;

[0013] FIG. 2 is a diagram illustrating a precoding codebook used in MIMO transmission in uplink;

[0014] FIG. 3 is a diagram to explain an SRS arrangement;

[0015] FIG. 4 is a diagram to explain a transmission aspect of SRS;

[0016] FIG. 5 is a diagram illustrating a procedure of periodic SRS transmission;

[0017] FIG. 6 contains diagrams to explain transmission parameters of SRS;

[0018] FIGS. 7(a) and 7(b) are diagrams to explain transmission parameters of SRS;

[0019] FIG. 8 is another diagram to explain transmission parameters of SRS;

[0020] FIG. 9 is still another diagram to explain transmission parameters of SRS;

[0021] FIG. 10 is still another diagram to explain transmission parameters of SRS;

[0022] FIGS. 11(a) and 11(b) are diagrams to explain transmission parameters of SRS;

[0023] FIG. 12 is a diagram to explain IFDMA and CDM;

[0024] FIG. 13 is a diagram to explain transmission parameters of SRS;

[0025] FIG. 14 is another diagram to explain transmission parameters of SRS;

[0026] FIG. 15 is a diagram illustrating a procedure of aperiodic SRS transmission;

[0027] FIG. 16 is a diagram showing an example of aperiodic SRS transmission;

[0028] FIG. 17 is a diagram to explain transmission parameters of SRS;

[0029] FIG. 18 is a diagram to explain an SRS multiplexing aspect;

[0030] FIG. 19 is a diagram to explain another SRS multiplexing aspect;

[0031] FIG. 20 is a diagram to explain still another SRS multiplexing aspect;

[0032] FIG. 21 is a diagram to explain still another SRS multiplexing aspect;

[0033] FIG. 22 is a diagram illustrating a radio communication system for performing a wireless communication method of the invention;

[0034] FIG. 23 is a diagram illustrating a schematic configuration of a radio base station apparatus of the invention;

[0035] FIG. 24 is a block diagram to explain processing sections including a baseband processing section of the radio base station apparatus of the invention;

[0036] FIG. 25 is a diagram illustrating a schematic configuration of a mobile terminal device of the invention; and

[0037] FIG. 26 is a block diagram to explain processing sections including a baseband processing section of the mobile terminal device of the invention.

#### DESCRIPTION OF EMBODIMENTS

[0038] An Embodiment of the invention will specifically be described with reference to accompanying drawings.

[0039] In a wireless communication method of the invention, a radio base station apparatus performs OFDM modulation on a transmission signal including transmission information on sounding reference signals (SRSs) for each transmission antenna, and transmits the OFDM-modulated transmission signal, and a mobile terminal device receives the signal including the transmission information, controls a transmission aspect of the sounding reference signals for each transmission antenna based on the transmission information, and transmits the sounding reference signals in the transmission aspect for each transmission antenna.

[0040] The SRS is herein described. The uplink SRS is a reference signal used in measuring a channel variance in uplink, reception SINR (Signal to noise plus interference ratio) and the like. The SRS is transmitted over the whole band periodically independently of a PUSCH signal and a PUCCH (Physical Control Channel) signal. As shown in FIG. 3, the SRS is multiplexed into a last SC-FDMA (Single Car-

rier-Frequency Division Multiple Access) symbol in a subframe. Further, for overhead adjustments, it is possible to change the subframe to multiplex the SRS. In other words, as shown in FIG. 3, the SRS may be multiplexed into a last SC-FDMA symbol every two subframes (low density), or may be multiplexed into a last SC-FDMA symbol of each subframe (high density). In this case, a multiplexing subframe pattern is notified on a broadcast channel (for each cell) common to users.

[0041] As shown in FIG. 4, for a mobile terminal device (UE-1) near a radio base station apparatus (eNB), the SRS is transmitted in a wide band over the whole system band. Meanwhile, for a mobile terminal device (UE-2) at a cell edge, the SRS is transmitted in a narrow band to improve accuracy of reception SINR measurement in the radio base station apparatus. Thus, the SRS has a plurality of bandwidths, and is transmitted with the optimal bandwidth selected for each user. More specifically, the SRS is selected from 4 types of bandwidths. In addition, in the 3GPP, an SRS (Aperiodic SRS) to transmit non-periodically is also studied in addition to the SRS (Periodic SRS) to transmit periodically.

[0042] As described above, in the LTE-A system, MIMO multiplexing transmission of maximum 4 streams is performed in uplink. Therefore, in precoding in uplink MIMO transmission, it is necessary to perform channel estimation for each transmission antenna to select the PMI. In other words, the SRS is needed for each transmission antenna, and the number of resources for the SRS increases. Further, in using the ATOV for power saving in an environment with large AGI due to hand gripping and the like, it becomes useless to transmit the SRS from a transmission antenna that does not transmit a PUSCH signal. In this way, in the case of performing MIMO multiplexing transmission of maximum 4 streams in uplink in the LTE-A system, it is required to use the SRS efficiently.

[0043] Therefore, in the invention, a radio base station apparatus transmits transmission information of the SRS for each transmission antenna to a mobile terminal device, and the mobile terminal device controls a transmission aspect of the SRS based on the transmission information, and transmits the SRS for each transmission antenna. By this means, it is possible to use the SRS efficiently in the case of performing MIMO multiplexing transmission of maximum 4 streams in uplink in the LTE-A system.

[0044] Described herein are transmission information and transmission aspects of the SRS for each transmission antenna.

#### <Periodic SRS>

[0045] When the SRS is transmitted periodically, as the transmission information, there are a transmission interval of SRS, SRS transmission duration, information indicative of ON/OFF of SRS transmission, offset value of transmission timing of SRS, transmission ratio of SRS for each transmission antenna, transmission bandwidth of SRS, information indicative of ON/OFF of hopping of SRS transmission, repetition factor of SRS, spreading code sequence for SRS, etc. The transmission information is notified by user specific higher layer signaling (RRC(Radio Resource Control) signaling).

[0046] When the SRS is transmitted periodically, as shown in FIG. 5, a radio base station apparatus (eNB) transmits SRS parameters to a mobile terminal device (UE) by higher layer signaling (RRC signaling). The SRS parameters are the



above-mentioned bandwidth, hopping ON/OFF, frequency offset, cyclic shift sequence, repetition factor, transmission interval, transmission timing offset, etc.

[0047] When the mobile terminal device receives SRS parameters by RRC signaling, the mobile terminal device transmits the SRS periodically at particular time intervals (T). At this point, the mobile terminal device controls a transmission aspect of the SRS based on the SRS parameters, and transmits the SRS to the radio base station apparatus. In addition, in periodic SRS transmission, an uplink grant does not include information indicative of SRS transmission timing.

<SRS Transmission Interval: Periodicity>

[0048] In the invention, transmission intervals of SRS are set for each transmission antenna of the mobile terminal device. As shown in FIG. 6, a transmission antenna #1 (Ant #1) is set for a relatively short transmission interval, a transmission antenna #2 (Ant #2) is set for a next shorter transmission interval, and a transmission antenna #n (Ant #n) is set for a relatively long transmission interval. The transmission information in this case is information that associates the transmission antenna number with the transmission interval.

[0049] The transmission interval is determined based on antenna gain and propagation loss. For example, the transmission interval of SRS is set to be longer on a transmission antenna with low antenna gain, or transmission antenna with a large propagation loss. By this means, it is possible to reduce power consumption of the mobile terminal device. In addition, it is essential only that the transmission interval is set individually for each transmission antenna, and the transmission intervals of SRS may be different between all transmission antennas as shown in FIG. 6, or the transmission intervals may be the same among a plurality of transmission antennas.

<SRS Transmission Duration: Duration>

[0050] In the invention, the SRS transmission duration is set for each transmission antenna of the mobile terminal device. The SRS transmission duration is information indicative of transmitting the SRS temporarily, or successively, or providing the duration (non-transmission duration) in which the SRS is not transmitted. For example, as shown in FIG. 7(a), the transmission antenna #1 (Ant #1) and the transmission antenna #n (Ant #n) are set for successive transmission (Indefinite) (duration=1), and the transmission antenna #2 (Ant #2) is set for one shot transmission (Single) (duration=0). The transmission information in this case is information that associates the transmission antenna number with the duration. Further, for the non-transmission duration of SRS, for example, as shown in FIG. 7(b), the transmission antenna #2 (Ant #2) is provided with the non-transmission duration of SRS. The transmission information in this case is information that associates the transmission antenna number with designation (start position, period, etc.) of the non-transmission duration.

[0051] For example, it is possible to determine the transmission duration based on the average reception SINR or propagation loss of each transmission antenna. For example, for a transmission antenna with a large propagation loss, the transmission duration of SRS is set at one shot (single). By this means, it is possible to make a transmission amplifier of the antenna with a large propagation loss at OFF in SRS

non-transmission, and it is thereby possible to reduce power consumption of the mobile terminal device. Further, the non-transmission duration is determined based on the propagation loss. For example, for a transmission antenna with a large propagation loss, non-transmission duration of SRS is provided. By this means, it is possible to reduce power consumption. In addition, it is essential only that the transmission duration of the SRS is set individually for each transmission antenna, and which transmission antenna is assigned which transmission duration is not limited to FIG. 7, and is capable of being set as appropriate. Further, designation of the non-transmission duration may be notified to the mobile terminal device by PRC signaling common to antennas.

(Information Indicative of ON/OFF of SRS Transmission)

[0052] In the invention, ON/OFF of SRS transmission is set for each transmission antenna of the mobile terminal device. For example, as shown in FIG. 8, for the transmission antenna #1 (Ant #1) and the transmission antenna #n (Ant #n), SRS transmission is set at ON, and for the transmission antenna #2 (Ant #2), SRS transmission is set at OFF. The transmission information in this case is information that associates the transmission antenna number with designation of transmission OFF or information that associates the transmission antenna number with designation of transmission ON.

[0053] It is possible to determine ON/OFF of SRS transmission based on a propagation loss. For example, for a transmission antenna with a large propagation loss, the SRS is set for transmission OFF for a certain period. By this means, it is possible to control SRS transmission ON/OFF for arbitrary time, transmit the SRS in a good reception quality state, and transmit the SRS efficiently. In addition, it is essential only that ON/OFF of SRS transmission is set individually for each transmission antenna, and which transmission antenna is set for SRS transmission OFF for a certain period is not limited to FIG. 8, and is capable of being set as appropriate.

(Offset Value of SRS Transmission Timing: Subframe Offset)

[0054] In the invention, an offset value (offset of an SRS transmission subframe) of SRS transmission timing is set for each transmission antenna of the mobile terminal device. For example, as shown in FIG. 9, the transmission antenna #1 (Ant #1) is set for no offset, the transmission antenna #2 (Ant #2) is set for the offset amount=1, and the transmission antenna #n (Ant #n) is set for the offset amount=2. The transmission information in this case is information that associates the transmission antenna number with the offset amount.

[0055] It is possible to determine the offset value of SRS transmission timing based on a transmission aspect (multiplexing method) of SRS. For example, when the SRS is transmitted in TDM (Time Division Multiplexing), the time offset is set for each transmission antenna. By this means, it is possible to apply flexible multiplexing to the SRS. In addition, it is essential only that the offset value of SRS transmission timing is set individually for each transmission antenna, and which transmission antenna is set for which offset value is not limited to FIG. 9, and is capable of being set as appropriate.

(Transmission Ratio of SRS for Each Transmission Antenna)

[0056] In the invention, a transmission ratio of SRS is set for each transmission antenna of the mobile terminal device.

For example, when the transmission ratio of SRS between the transmission antenna #1 (Ant #1), the transmission antenna #2 (Ant #2) and the transmission antenna #n (Ant #n) is 2:1:1 (=Ant #1:Ant #2:Ant #n), as shown in FIG. 10, for a particular period, the rate is set so that the SRS transmitted from the Ant #1 is "2", the SRS transmitted from the Ant #2 is "1", and that the SRS transmitted from the Ant #n is "1". The transmission information in this case is information that associates the transmission antenna number with the rate of SRS. For example, it is possible to determine the transmission ratio of SRS based on the average reception SINR or propagation loss of each transmission antenna. For example, for a transmission antenna with a large propagation loss, the transmission rate of SRS is set to be small. By this means, it is possible to efficiently use resources of SRS. In addition, the transmission ratio of SRS for each transmission antenna is not limited to FIG. 10, and is capable of being modified as appropriate.

(Transmission Bandwidth of SRS: Bandwidth)

[0057] In the invention, the bandwidth of SRS is set for each transmission antenna of the mobile terminal device. For example, for the transmission antenna #1 (Ant #1), the transmission antenna #2 (Ant #2) and the transmission antenna #n (Ant #n), the bandwidth to transmit the SRS is set as shown in FIG. 11. This transmission bandwidth includes information (Frequency-domain position) of a frequency position of the SRS for each mobile terminal device when necessary. When the SRS is transmitted in Frequency Division Multiplexing (FDM), as shown in FIG. 11(a), the frequency band is assigned to each of the transmission antenna #1 (Ant #1), the transmission antenna #2 (Ant #2) and the transmission antenna #n (Ant #n). Meanwhile, in the case of transmitting in Interleaved Frequency Division Multiple Access (IFDMA) and Code Division Multiplexing (CDM), as shown in FIG. 11(b), the frequency bands are assigned to each of the transmission antenna #1 (Ant #1), the transmission antenna #2 (Ant #2) and the transmission antenna #n (Ant #n). The transmission information in this case is information that associates the transmission antenna number with the frequency bandwidth (frequency position). Particularly, in the case as shown in FIG. 11(b), as a method of sending the transmission information, the broadcast channel is used for designation-capable bandwidths (cell-specific SRS bandwidth set: SRS Bandwidth configuration), and higher layer signaling is used for the actual SRS transmission bandwidth. Accordingly, the transmission bandwidth is a bandwidth selected in the bandwidths broadcast on the broadcast channel.

[0058] IFDMA is described herein. IFDMA is a radio access scheme having features of both multicarrier and signal-carrier. In IFDMA, as in OFDMA of multicarrier, the entire band is divided into a plurality of narrow bands, sub-carriers arranged at equal intervals are multiplexed to respective users so that the users are alternately assigned in the shape of comb teeth, and orthogonal radio access is thereby achieved. Further, as in single-carrier, it is possible to generate a transmission signal only by signal processing in the time domain. In FIG. 12, a user A (UE-A) and user D (UE-D), user A (UE-A) and user C (UE-C), and user A (UE-A) and user B (UE-B) are respectively multiplexed in IFDMA.

[0059] Further, in FIG. 11(b), SRSs are multiplexed in CDM in addition to IFDMA. In FIG. 11(b), the SRS of the transmission antenna #1 (Ant #1), the SRS of the transmission antenna #2 (Ant #2), and the SRS of the transmission antenna #n (Ant #n) are multiplexed in IFDMA, and the SRS

of the transmission antenna #2 (Ant #2), and the SRS of the transmission antenna #n (Ant #n) are multiplexed in CDM. In multiplexing in CDM, as shown in FIG. 12, (CAZAC (Constant Amplitude Zero Correlation)) codes for orthogonalizing and multiplexing by orthogonal codes are used, and the cyclic shift amount is varied (shift #1 to shift #3). In FIG. 12, the user D (UE-D), user E (UE-E) and user F (UE-F) are multiplexed in CDM.

[0060] It is possible to determine the transmission bandwidth of SRS based on a propagation loss for each transmission antenna. For example, in the case as shown in FIG. 11(a), the transmission bandwidth of SRS is narrowed for a transmission antenna with a large propagation loss, while being broadened for a transmission antenna with a small propagation loss. By this means, it is possible to reduce transmission power (power consumption) in the mobile terminal device. In addition, it is essential only that the transmission bandwidth of SRS is set for each transmission antenna, and the bandwidths are not limited to FIG. 11, and are capable of being set as appropriate.

(Information Indicative of ON/OFF of Hopping of SRS Transmission: Frequency-Hopping Information)

[0061] In the invention, ON/OFF of hopping of SRS transmission is set for each transmission antenna of the mobile terminal device. For example, as shown in FIG. 13, the SRS of the transmission antenna #1 (Ant #1) is not provided with hopping, and the SRS of the transmission antenna #2 (Ant #2) and the SRS of the transmission antenna #n (Ant #n) are provided with hopping. The transmission information in this case is information that associates the transmission antenna number with the presence or absence of hopping. In addition, ON/OFF of hopping of SRS transmission for each transmission antenna is not limited to FIG. 13, and is capable of being set as appropriate.

(Repetition Factor of SRS: Transmission Comb)

[0062] In the invention, the repetition factor (the presence or absence of comb teeth state) of SRS is set for each transmission antenna of the mobile terminal device. For example, as shown in FIG. 14, the SRS of the transmission antenna #1 (Ant #1) and the SRS of the transmission antenna #2 (Ant #2) are set for the presence of comb teeth state, and the SRS of the transmission antenna #n (Ant #n) is set for the absence of comb teeth state. The transmission information in this case is information that associates the transmission antenna number with the repetition factor. For example, it is possible to determine the presence or absence of comb teeth state of SRS transmission based on the average reception SINR or propagation loss of each transmission antenna. For example, a transmission antenna with a large propagation loss is set for the presence of comb teeth state of SRS transmission. By this means, it is possible to efficiently use resources of SRS. In addition, the presence or absence of comb teeth state for each transmission antenna is not limited to FIG. 14, and is capable of being set as appropriate.

(Spreading Code Sequence for SRS: Cyclic Shift)

[0063] In the invention, the spreading code sequence for SRS is set for each transmission antenna of the mobile terminal device. The transmission information in this case is information that associates the transmission antenna number with the CAZAC code and cyclic shift amount. CDM multiplexing

is performed when transmission antennas are set for the same SRS transmission bandwidth. By this means, it is possible to perform channel quality measurement, PMI selection, etc. using SRSs transmitted at the same time from a plurality of transmission antennas. In addition, as the spreading code sequence, instead of the cyclic shift, block spreading may be used.

#### <Aperiodic SRS>

**[0064]** When the SRS is transmitted non-periodically, as the transmission information, there are transmission timing of SRS, transmission bandwidth of SRS, transmission frequency offset of SRS, repetition factor of SRS, spreading code sequence for SRS, etc. The transmission information is transmitted in an uplink grant.

**[0065]** When the SRS is transmitted non-periodically, as shown in FIG. 15, a radio base station apparatus (eNB) transmits principal transmission information (SRS parameters) to a mobile terminal device (UE) by higher layer signaling (RRC signaling). The SRS parameters are the above-mentioned bandwidth, hopping ON/OFF, frequency offset, cyclic shift sequence, repetition factor, etc.

**[0066]** Next, the radio base station apparatus (eNB) transmits an uplink grant including the other information (transmission timing common or specific to antennas, transmission information indicative of a frequency position and/or frequency bandwidth common or specific to antennas) to the mobile terminal device (UE). The mobile terminal device receives the principal transmission information by RRC signaling, further receives the uplink grant including the other transmission information, and then, transmits the SRS. In other words, SRS parameters are configured by RRC signaling, and then, notification of SRS transmission is disclosed by the uplink grant. Thus, in the case of aperiodic SRS transmission, the principal transmission information among the transmission information is high-layer signaled, and the other transmission information is transmitted by the uplink grant. Then, after the SRS parameters are configured by RRC signaling, the mobile terminal device transmits the SRS according to the uplink grant.

**[0067]** For example, as shown in FIG. 16, the radio base station apparatus (eNB) notifies the mobile terminal device (UE) of the bandwidth and the presence or absence of hopping as the principal transmission information (SRS parameters) by RRC signaling. Then, the radio base station apparatus (eNB) notifies the mobile terminal device (UE) of an SRS trigger command (transmission timing) as the other transmission information by the uplink grant. By this trigger command, the mobile terminal device transmits the SRS from each transmission antenna at timing as shown in FIG. 16. Thus, by beforehand configuring the SRS parameters except transmission timing by RRC signaling, it is possible to perform multiplexing and transmission of SRS with more flexibility and efficiency.

#### (Transmission Timing of SRS)

**[0068]** In the invention, transmission timing of SRS of transmission antennas in the mobile terminal device is set. In this case, the transmission timing of SRS includes transmission timing common to the transmission antennas, and transmission timing specific to the transmission antennas. For example, the transmission timing of SRS of the transmission antenna #1 (Ant #1), the transmission timing of SRS of the

transmission antenna #2 (Ant #2), and the transmission timing of SRS of the transmission antenna #n (Ant #n) are set as shown in FIG. 17. The trigger command corresponds to the transmission timing, and "1" is ON, while "0" is OFF. The transmission information in this case is the information (SRS trigger command) of transmission timing, or information that associates the transmission antenna number with the transmission timing (SRS trigger command). Thus, by controlling transmission timing of SRS, it is possible to control transmission ON/OFF of SRS for each transmission antenna on a subframe-by-subframe basis, and to reduce power consumption of the mobile terminal device more efficiently. Further, it is possible to use SRS resources more efficiently. By this means, it is possible to designate transmission of SRS only immediately before scheduling. In addition, transmission timing of SRS is not limited to FIG. 17, and is capable of being set as appropriate.

#### (Transmission Bandwidth of SRS: Bandwidth)

**[0069]** In the invention, the bandwidth of SRS of transmission antennas in the mobile terminal device is set. The transmission bandwidth of SRS includes the transmission bandwidth common to the transmission antennas, and transmission bandwidths specific to the transmission antennas. The transmission bandwidth of SRS is the same as in the case of periodic SRS, and the detailed description thereof is omitted.

#### (Transmission Frequency Offset of SRS: Frequency-Domain Position)

**[0070]** In the invention, the transmission frequency offset of SRS of transmission antennas in the mobile terminal device is set. The transmission frequency offset of SRS includes the transmission frequency offset common to the transmission antennas, and transmission frequency offsets specific to the transmission antennas. The transmission information in this case is the transmission frequency offset or information that associates the transmission antenna number with the transmission frequency offset.

#### (Repetition Factor of SRS: Transmission Comb)

**[0071]** In the invention, the repetition factor (the presence or absence of comb teeth state) of SRS of transmission antennas in the mobile terminal device is set. The repetition factor of SRS includes the repetition factor common to the transmission antennas, and repetition factors specific to the transmission antennas. The repetition factor of SRS is the same as in the case of periodic SRS, and the detailed description thereof is omitted.

#### (Spreading Code Sequence for SRS: Cyclic Shift)

**[0072]** In the invention, the spreading code sequence for SRS of transmission antennas in the mobile terminal device is set. The spreading code sequence for SRS includes the spreading code sequence for SRS common to the transmission antennas, and spreading code sequences for SRS specific to the transmission antennas. The spreading code sequence for SRS is the same as in the case of periodic SRS, and the detailed description thereof is omitted.

**[0073]** In addition, as parameters related to the SRS, there are a parameter (SRS subframe configuration) indicative of a subframe configuration to multiplex a cell-specific SRS, and a parameter (Simultaneous transmission of Ack/Nack and

SRS) indicating whether or not to permit transmission of ACK/NACK and SRS in the same subframe. These parameters are notified from the radio base station apparatus to the mobile terminal device on the broadcast channel.

#### <Multiplexing Method of SRS>

**[0074]** As a multiplexing method when the mobile terminal device transmits the SRS to the base station apparatus, there are a code division multiplexing method, time division multiplexing method, frequency division multiplexing method, interleaved frequency division multiplexing method, etc.

**[0075]** In transmitting the SRS in code division multiplexing, for example, as shown in FIG. 18, the SRS of the transmission antenna #1 (Ant #1), the SRS of the transmission antenna #2 (Ant #2), and the SRS of the transmission antenna #n (Ant #n) are assigned respective different spreading code sequences, for example, different cyclic shift amounts of the same CAZAC code. The cyclic shift amounts for the transmission antennas are notified by higher layer signaling or uplink grant on a common or individual to the transmission antennas basis as described above. It is preferable to use code division multiplexing when the same transmission bandwidth of SRS is set on the transmission antennas.

**[0076]** In transmitting the SRS in time division multiplexing, for example, as shown in FIG. 19, the SRS of the transmission antenna #1 (Ant #1), the SRS of the transmission antenna #2 (Ant #2), and the SRS of the transmission antenna #n (Ant #n) are transmitted at respective different timings. The transmission timing offsets for the transmission antennas are notified by higher layer signaling or uplink grant on a common or individual to the transmission antennas basis as described above.

**[0077]** In transmitting the SRS in frequency division multiplexing, for example, as shown in FIG. 20, the SRS of the transmission antenna #1 (Ant #1), the SRS of the transmission antenna #2 (Ant #2), and the SRS of the transmission antenna #n (Ant #n) are transmitted at respective different transmission bandwidths. The transmission bandwidths for the transmission antennas are notified by higher layer signaling or uplink grant on a common or individual to the transmission antennas basis as described above.

**[0078]** In transmitting the SRS in interleaved frequency division multiplexing, for example, as shown in FIG. 21, the SRS of the transmission antenna #1 (Ant #1), the SRS of the transmission antenna #2 (Ant #2), and the SRS of the transmission antenna #n (Ant #n) are transmitted corresponding to the presence or absence of comb teeth state. The presence or absence of comb teeth state on the transmission antennas is notified by higher layer signaling or uplink grant on a common or individual to the transmission antennas basis as described above.

**[0079]** FIG. 22 is a diagram illustrating a radio communication system having the mobile terminal devices and the radio base station apparatuses according to the Embodiment of the invention.

**[0080]** The radio communication system is a system to which, for example, E-UTRA (Evolved UTRA and UTRAN) is applied. The radio communication system is provided with radio base station apparatuses (eNB: eNode B) 2 ( $2_1, 2_2, \dots, 2_n$ , 1 is an integer where  $1 > 0$ ) and a plurality of mobile terminal devices (UE)  $1_n$  ( $1_1, 1_2, 1_3, \dots, 1_n$ , n is an integer where  $n > 0$ ) that communicate with the radio base station apparatuses 2. The radio base station apparatuses 2 are connected to an upper station, for example, an access gateway

apparatus 3, and the access gateway apparatus 3 is connected to a core network 4. The mobile terminal device  $1_n$  communicates with the radio base station apparatus 2 in a cell 5 ( $5_1, 5_2$ ) by E-UTRA. This Embodiment shows two cells, but the invention is similarly applicable to three cells or more. In addition, each of the mobile terminal devices ( $1_1, 1_2, 1_3, \dots, 1_n$ ) has the same configuration, function and state, and is described as a mobile terminal device  $1_n$  unless otherwise specified in the following description.

**[0081]** In the radio communication system, as a radio access scheme, OFDM (Orthogonal Frequency Division Multiplexing) is applied in downlink, while SC-FDMA (Single-Carrier Frequency Division Multiple Access) is applied in uplink. OFDM is a multicarrier transmission scheme for dividing a frequency band into a plurality of narrow frequency bands (subcarriers), and mapping data to each subcarrier to perform communication. SC-FDMA is a single-carrier transmission scheme for dividing a frequency band for each terminal so that a plurality of mobile terminal devices uses mutually different frequency bands, and thereby reducing interference among the mobile terminal devices.

Described Herein are Communication Channels in E-UTRA.

**[0082]** In downlink, used are the Physical Downlink Shared Channel (PDSCH) shared among the mobile terminal devices  $1_n$ , and the Physical Downlink Control Channel (PDCCH). The Physical Downlink Control Channel is also called the downlink L1/L2 control channel. User data i.e. normal data signals are transmitted on the Physical Downlink Shared Channel. Meanwhile, on the Physical Downlink Control Channel are transmitted downlink scheduling information (DL Scheduling Information), acknowledgement/negative acknowledgement information (ACK/NACK), uplink grant (UL Grant), TPC command (Transmission Power Control Command), etc. For example, the downlink scheduling information includes an ID of a user to perform communications using the Physical Downlink Shared Channel, information of a transport format of the user data, i.e. information on the data size, modulation scheme, and retransmission control (HARQ: Hybrid ARQ), downlink resource block assignment information, etc.

**[0083]** Meanwhile, for example, the uplink scheduling grant includes an ID of a user to perform communications using the Physical Uplink Shared Channel, information of a transport format of the user data, i.e. information on the data size and modulation scheme, uplink resource block assignment information, information on transmission power of the uplink shared channel, etc. Herein, the uplink resource block corresponds to frequency resources, and is also called the resource unit.

**[0084]** Further, the acknowledgement/negative acknowledgement information (ACK/NACK) is acknowledgement/negative acknowledgement information concerning the shared channel in uplink. The content of acknowledgement/negative acknowledgement information is expressed by Acknowledgement (ACK) indicating that the transmission signal is properly received or Negative Acknowledgement (NACK) indicating that the transmission signal is not properly received.

**[0085]** In uplink, used are the Physical Uplink Shared Channel (PUSCH) shared among the mobile terminal devices  $1_n$ , and the Physical Uplink Control Channel (PUSCH). User data i.e. normal data signals are transmitted on the Physical Uplink Shared Channel. Meanwhile, on the Physical Uplink

Control Channel is transmitted downlink channel quality information (CQI: Channel Quality Indicator) used in scheduling processing of the physical shared channel in downlink and adaptive modulation/demodulation and coding processing (AMC: Adaptive Modulation and Coding Scheme), and acknowledgement/negative acknowledgement information of the Physical Downlink Shared Channel.

[0086] On the Physical Uplink Control Channel, a scheduling request to request resource allocation of the uplink shared channel, release request in persistent scheduling and the like may be transmitted, in addition the CQI and acknowledgement/negative acknowledgement information. Herein, resource allocation of the uplink shared channel section that a radio base station apparatus notifies a mobile terminal device that the mobile terminal device is allowed to perform communications using an uplink shared channel in a subsequent subframe, using the Physical Downlink Control Channel in some subframe.

[0087] FIG. 23 is a block diagram illustrating a schematic configuration of the radio base station apparatus according to the Embodiment of the invention. The radio base station apparatus 2, as shown in FIG. 23 is mainly comprised of an antenna 21, amplifying section 22, transmission/reception section 23, baseband signal processing section 24, call processing section 25 and propagation path interface 26.

[0088] In the radio base station apparatus 2, with such a configuration, with respect to an uplink signal, a radio frequency signal received in the antenna 21 is amplified in the amplifying section 22 so that reception power is corrected to certain power under AGC. The amplified radio frequency signal is frequency-converted into a baseband signal in the transmission/reception section 23. The baseband signal is subjected to predetermined processing (error correction, decoding, etc.) in the baseband signal processing section 24, and then, is transferred to the access gateway apparatus, not shown, via the transmission path interface 25. The access gateway apparatus is connected to the core network, and manages each mobile terminal device. Further, concerning uplink, the reception SINR and interference level of the radio frequency signal received in the radio base station apparatus 2 are measured based on the uplink baseband signal.

[0089] The call processing section 25 transmits and receives call processing control signals to/from a radio control station that is an upper apparatus, and performs status management of the radio base station apparatus 2 and resource allocation.

[0090] With respect to a downlink signal, the upper apparatus inputs the signal to the baseband signal processing section 24 via the transmission path interface 26. The baseband signal processing section 24 performs retransmission control processing, scheduling, transmission format selection, channel coding and the like on the signal to transfer to the transmission/reception section 23. The transmission/reception section 23 frequency-converts the baseband signal output from the baseband signal processing section 24 into a radio frequency signal. The frequency-converted signal is then amplified in the amplifying section 22 and transmitted from the antenna 21.

[0091] FIG. 24 is a block diagram illustrating a configuration of processing sections including the baseband signal processing section in the radio base station apparatus as shown in FIG. 23. The radio base station apparatus as shown in FIG. 24 is provided with a transmission section and a reception section. The transmission section is provided with a

transmission data signal generating section 2401, control information signal generating section 2402, and OFDM modulation section 2406. The reception section is provided with a CP (Cyclic Prefix) removing section 2407, symbol synchronization section 2408, FFT section 2409, subcarrier demapping section 2410, channel estimation section 2411, frequency domain equalization section 2412, IDFT section 2413, data demodulation section 2414, and data decoding section 2415. Further, the radio base station apparatus is provided with a scheduler 2403, precoding weight/rank number selecting section 2404, and MCS selecting section 2405.

[0092] The transmission data signal generating section 2401 generates downlink user specific data and a higher layer control signal (RRC signaling) as a transmission data signal. The transmission data signal generating section 2401 outputs the transmission data signal to the OFDM modulation section 2406. The parameters of the periodic SRS are included in the signal, transmitted on the PDSCH, and are notified to the mobile terminal device. In the invention, the above-mentioned SRS parameters generated in the transmission data signal generating section 2401 are provided for each transmission antenna. The principal parameters of the aperiodic SRS are also included in the signal, transmitted on the PDSCH, and are notified to the mobile terminal device.

[0093] The control information signal generating section 2402 generates a control information signal including an uplink grant (UL grant information). The uplink grant includes resource allocation information, PMI, RI (Rank Indicator), and MCS. In the case of periodic SRS transmission, the uplink grant does not include the SRS parameters. Meanwhile, in the case of aperiodic SRS transmission, the uplink grant includes the SRS parameters for each transmission antenna. The control information signal generating section 2402 outputs the control information signal to the OFDM modulation section 2406. The OFDM modulation section 2406 performs predetermined OFDM modulation processing on the transmission data signal and control information signal to be a transmission signal.

[0094] The CP removing section 2407 removes a CP from the reception signal and extracts an effective signal portion. The CP removing section 2407 outputs the CP-removed reception signal to the FFT (Fast Fourier Transform) section 2409. The symbol synchronization section 2408 acquires symbol synchronization of the reception signal, and outputs information of symbol synchronization to the CP removing section 2407. Based on the information of symbol synchronization, the CP removing section 2407 removes the CP from the reception signal.

[0095] The FFT section 2409 performs FFT on the CP-removed reception signal to transform into the signal in the frequency domain. The FFT section 2409 outputs the FFT-processed signal to the subcarrier demapping section 2410. The subcarrier demapping section 2410 extracts a data signal from the FFT-processed signal that is the signal in the frequency domain using resource mapping information. The subcarrier demapping section 2410 outputs the signal subjected to subcarrier demapping to the channel estimation section 2411 and frequency domain equalization section 2412.

[0096] The channel estimation section 2411 performs channel estimation using the signal (reference signal) subjected to subcarrier demapping. The channel estimation section 2411 outputs the obtained channel estimation value to the frequency domain equalization section 2412. The frequency

domain equalization section 2412 compensates the data signal subjected to subcarrier demapping for the channel variance estimated in the channel estimation section 2411. The frequency domain equalization section 2412 outputs the equalized data signal to the IDFT (Inverse Discrete Fourier Transform) section 2413. The IDFT section 2413 transforms the signal in the frequency domain into the signal in the time domain. The IDFT section 2413 outputs the IDFT-processed signal to the data demodulation section 2414.

[0097] The data demodulation section 2414 performs data demodulation on the IDFT-processed signal with the data modulation scheme corresponding to the transmission format (coding rate/demodulation scheme). The data demodulation section 2414 outputs the data-demodulated signal to the data decoding section 2415. The data decoding section 2415 performs data decoding on the data-demodulated data signal to output as transmission data.

[0098] The channel quality measuring section 2416 measures quality information using the SRS transmitted from the mobile terminal device. The measured quality information is output to the scheduler 2403, precoding weight/rank number selecting section 2404 and MCS selecting section 2405.

[0099] The scheduler 2403 performs scheduling based on the quality information. The scheduler 2403 outputs resource allocation information to the transmission data signal generating section 2401 and control information signal generating section 2402. The precoding weight/rank number selecting section 2404 performs PMI selection and rank selection based on the quality information. The precoding weight/rank number selecting section 2404 outputs the PMI and RI to the control information signal generating section 2402. The MCS selecting section 2405 performs MCS selection based on the quality information. The MCS selecting section 2405 outputs the MCS to the control information signal generating section 2402.

[0100] FIG. 25 is a block diagram illustrating a schematic configuration of the mobile terminal device according to the Embodiment of the invention. The mobile terminal device 1<sub>n</sub>, as shown in FIG. 25 is mainly comprised of an antenna 11, amplifying section 12, transmission/reception section 13, baseband signal processing section 14, call processing section 15 and application section 16.

[0101] In the mobile terminal device 1<sub>n</sub>, with such a configuration, with respect to a downlink signal, a radio frequency signal received in the antenna 11 is amplified in the amplifying section 12 so that reception power is corrected to certain power under AGC (Auto Gain Control). The amplified radio frequency signal is frequency-converted into a baseband signal in the transmission/reception section 13. The baseband signal is subjected to predetermined processing (error correction, decoding, etc.) in the baseband signal processing section 14, and then, output to the call processing section 15 and application section 16. The call processing section 15 performs management of communications with the radio base station apparatus 2, and the application section 16 performs processing concerning higher layers than the physical layer and MAC layer. The mobile terminal device 1<sub>n</sub>, of the invention receives at least a downlink signal including a reference signal from each of a plurality of radio base station apparatuses involved in downlink CoMP.

[0102] With respect to an uplink signal, the application section 16 inputs the signal to the baseband signal processing section 14. The baseband signal processing section 14 performs retransmission control processing, scheduling, trans-

mission format selection, channel coding and the like on the signal to transfer to the transmission/reception section 13. The transmission/reception section 13 frequency-converts the baseband signal output from the baseband signal processing section 14 into a radio frequency signal. The frequency-converted signal is then amplified in the amplifying section 12 and transmitted from the antenna 11. The mobile terminal device 1<sub>n</sub>, of the invention transmits feedback information including a measurement result of channel quality to each of a plurality of radio base station apparatuses.

[0103] FIG. 26 is a block diagram illustrating a configuration of processing sections including the baseband signal processing section in the mobile terminal device as shown in FIG. 25. The mobile terminal device as shown in FIG. 26 is provided with a transmission section and a reception section. The transmission section is provided with a serial/parallel transform section 2601, data coding sections 2602, 2603, data modulation sections 2604, 2605, DFT sections 2606, 2607, subcarrier mapping sections 2608, 2609, codeword/layer mapping section 2610, precoding weight multiplying section 2611, multiplexing section 2612, IFFT sections 2613a to 2613d, and CP adding sections 2614a to 2614d. The reception section is provided with an OFDM demodulation section 2615, downlink control signal decoding section 2616, and downlink data signal decoding section 2617. Further, the mobile terminal device is provided with an SRS control section 2618 and SRS sequence generating section 2619. Described herein is the case where the rank number is "2" and the number of transmission antennas is "4".

[0104] The OFDM demodulation section 2615 performs predetermined OFDM demodulation processing on a reception signal. The OFDM demodulation section 2615 outputs the demodulated signal to the downlink control signal decoding section 2616 and the downlink data signal decoding section 2617. The downlink control signal decoding section 2616 decodes the demodulated downlink control signal (downlink L1/L2 control signal). Further, the downlink control signal decoding section 2616 outputs the demodulated downlink control signal to the serial/parallel transform section 2601, data coding sections 2602, 2603, data modulation sections 2604, 2605, subcarrier mapping sections 2608, 2609, SRS control section 2618, codeword/layer mapping section 2610, and precoding weight multiplying section 2611.

[0105] In other words, the RI (rank number information) is output to the serial/parallel transform section 2601 and codeword/layer mapping section 2610, the MCS information is output to the data coding sections 2602, 2603, and data modulation sections 2604, 2605, the scheduling information (resource allocation information) is output to the subcarrier mapping sections 2608, 2609, and the precoding information (PMI) is output to the precoding weight multiplying section 2611.

[0106] Since the transmission information (SRS parameters) for aperiodic SRS is included in an uplink grant, the SRS parameters (for example, transmission timing, etc.) are output to the SRS control section 2618. Meanwhile, in periodic SRS transmission, the transmission information (SRS parameters) is not output from the downlink control signal (downlink L1/L2 control signal).

[0107] The downlink data signal decoding section 2617 decodes the demodulated downlink data signal. Further, the downlink data signal decoding section 2617 outputs the demodulated downlink data signal to the SRS control section 2618. In periodic SRS transmission, the transmission infor-

mation (SRS parameters, for example, transmission interval) is extracted from the higher layer control signal or downlink transmission data and output to the SRS control section 2618. [0108] The SRS control section 2618 controls the SRS transmission aspect of each transmission antenna, using the SRS parameters that are the transmission information extracted from higher layer signaling (periodic SRS transmission, aperiodic SRS transmission) or uplink grant (aperiodic SRS transmission). Herein, the transmission aspect is assumed to include all transmission aspects as shown in FIGS. 6 to 14. Further, the SRS control section 2618 also controls the multiplexing method (FIGS. 17 to 21) of the SRS generated in the SRS sequence generating section 2619. Such control information according to the transmission aspect of the SRS is output to the multiplexing section 2612.

[0109] The serial/parallel transform section 2601 performs serial/parallel transform on uplink transmission data. The serial/parallel transform section 2601 outputs the signal subjected to serial/parallel transform to the data coding sections 2602, 2603. The data coding sections 2602, 2603 perform error correcting coding on the data signals, using the channel coding rate associated with the MCS information. The data coding sections 2602, 2603 output the data signals subjected to error correcting coding to the data modulation sections 2604, 2605.

[0110] The data modulation sections 2604, 2605 perform data modulation on the data-coded data signals with the data modulation scheme associated with the MCS information. The data modulation sections 2604, 2605 output the data-modulated data signals to the DFT (Discrete Fourier Transform) sections 2606, 2607. The DFT sections 2606, 2607 transform the data signals in the time domain into the signals in the frequency domain. The DFT sections 2606, 2607 output the DFT-processed data signals to the subcarrier mapping sections 2608, 2609.

[0111] The subcarrier mapping sections 2608, 2609 map the DFT-processed data signals to subcarriers based on the scheduling information. The subcarrier mapping sections 2608, 2609 output the subcarrier-mapped data signals to the codeword/layer mapping section 2610.

[0112] The codeword/layer mapping section 2610 maps a codeword to a layer based on the rank number information. The codeword/layer mapping section 2610 outputs the mapped signal to the precoding weight multiplying section 2611. The precoding weight multiplying section 2611 multiplies the signal mapped to the layer by a precoding weight, based on the precoding information. The precoding weight multiplying section 2611 outputs the precoded signal to the multiplexing section 2612.

[0113] The multiplexing section 2612 multiplexes the SRS into the precoded data signal. The multiplexing section 2612 outputs the signal with the SRS multiplexed to the IFFT (Inverse Fast Fourier Transform) sections 2613a to 2613d. The IFFT sections 2613a to 2613d perform IFFT on the multiplexed signals to transform into the signals in the time domain. The IFFT sections 2613a to 2613d output the IFFT-processed signals to the CP adding sections 2614a to 2614d. The CP adding sections 2614a to 2614d add CPs to the IFFT-processed signals.

[0114] In the above-mentioned radio communication system, when the SRS is transmitted periodically, the radio base station apparatus transmits the SRS parameters to the mobile terminal device by higher layer signaling (RRC signaling). The SRS parameters are the above-mentioned bandwidth,

hopping ON/OFF, frequency offset, cyclic shift sequence, repetition factor, transmission interval, transmission timing offset, etc. When the mobile terminal device receives the SRS parameters by RRC signaling, the mobile terminal device transmits the SRS periodically at particular time intervals (T). At this point, the mobile terminal device controls the transmission aspect of the SRS based on the SRS parameters, and transmits the SRS to the radio base station apparatus. In addition, in periodic SRS transmission, an uplink grant does not include information indicative of SRS transmission timing.

[0115] Meanwhile, when the SRS is transmitted non-periodically, the radio base station apparatus transmits the principal transmission information (SRS parameters) to the mobile terminal device by higher layer signaling (RRC signaling). The SRS parameters are the above-mentioned bandwidth, hopping ON/OFF, frequency offset, cyclic shift sequence, repetition factor, etc. Next, the radio base station apparatus transmits an uplink grant including the other information (transmission timing common or individual to antennas, transmission information indicative of frequency position and/or frequency bandwidth common or individual to antennas) to the mobile terminal device. The mobile terminal device receives the principal transmission information by RRC signaling, further receives the uplink grant including the other transmission information, and then, transmits the SRS.

[0116] Thus, according to the invention, the radio base station apparatus performs OFDM modulation on a transmission signal including transmission information on the SRS for each transmission antenna, and transmits the OFDM-modulated transmission signal, the mobile terminal device receives the signal including the transmission information, controls a transmission aspect of the SRS for each transmission antenna based on the transmission information, and transmits the SRS in the transmission aspect for each transmission antenna, and therefore, it is possible to efficiently use the SRS in the LTE-A system.

[0117] In a wireless communication method of the invention, it is possible to perform control as described below in periodic SRS transmission and aperiodic SRS transmission.

#### <Periodic SRS Transmission>

[0118] (1) Among a plurality of transmission antennas, when there is a transmission antenna of low gain, the radio base station apparatus side decreases the transmission interval of the transmission antenna or halts transmission temporarily or consecutively, and it is thereby possible to suppress resources of the SRS. At this point, by using the ATOV as the precoding weight, it is possible to suppress deterioration of characteristics of the data channel.

[0119] (2) Among a plurality of transmission antennas, when there is a transmission antenna of low gain, the radio base station apparatus side increases the SRS transmission intervals of transmission antennas except the transmission antenna, and it is thereby possible to enhance transmission characteristics of the data channel.

[0120] (3) In above-mentioned (1) and (2), the transmission interval is set corresponding to the variation amount (characteristics such as a variation period) of AGI, and it is thereby possible to efficiently use SRS resources.

[0121] (4) In an environment in which AGI is large, the SRS is transmitted in a narrow band from a transmission antenna of low gain (transmission antenna limited in maximum transmission power), while being transmitted in a broadband from

a transmission antenna of high gain, and it is thereby possible to efficiently transmit the SRS according to the AGI.

**[0122]** (5) In the case of a channel with large correlation between transmission antennas, since it is inefficient to transmit the SRS from a plurality of transmission antennas, it is possible to control the transmission antenna, transmission bandwidth and transmission interval to transmit the SRS adaptively.

**[0123]** (6) When the SRS is transmitted from a plurality of transmission antennas, the repetition factor is varied corresponding to antenna gain to control transmission power. Similarly, in a transmission antenna desired to increase channel estimation accuracy, in IFDMA, by setting the subcarrier spacing selected in the shape of comb teeth at a 2-subcarrier spacing (repetition factor=2), it is possible to enhance channel estimation accuracy.

#### <Aperiodic SRS Transmission>

**[0124]** (1) In an environment in which AGI is large, it is possible to confirm that characteristics of a transmission antenna, which have been poor, are improved.

**[0125]** (2) Among the parameters such as the frequency position, frequency bandwidth, ON/OFF of frequency hopping, transmission duration, transmission interval, offset of transmission subframe, the presence or absence of IFDMA, and spreading code sequence, some of the parameters are notified by an uplink grant, the other parameters are notified by RRC signaling, and it is thereby possible to reduce the control signal amount.

**[0126]** (3) In a system for dividing resources by scheduling, by assigning the SRS preferentially to a user of a high scheduling priority, it is possible to improve characteristics.

**[0127]** (4) Concerning SRS transmission, by using higher layer signaling for some of the parameters, it is possible to reduce control signals in aperiodic SRS transmission.

**[0128]** (5) SRS transmission is performed implicitly, for example, by using reception of a power control signal (TPC command or the like) from the radio base station apparatus as a trigger, and it is thereby possible to reduce control signals in aperiodic SRS transmission.

**[0129]** (6) By combining periodic SRS transmission and aperiodic SRS transmission, it is possible to obtain required sufficient channel information.

**[0130]** The present invention is not limited to the above-mentioned Embodiment, and is capable of being carried into practice with various modifications thereof. In the above-mentioned Embodiment, the rank number and the number of transmission antennas are examples, and the invention is not limited thereto. Further, without departing from the scope of the invention, the number of processing sections and processing procedures in the above-mentioned description are capable of being carried into practice with modifications thereof as appropriate. Furthermore, each element shown in the figures represents the function, and each functional block may be actualized by hardware or may be actualized by software. Moreover, the invention is capable of being carried into practice with modifications thereof as appropriate without departing from the scope of the invention.

#### INDUSTRIAL APPLICABILITY

**[0131]** The present invention is useful in the radio base station apparatus, mobile terminal device and wireless communication method in the LTE-A system.

**[0132]** The present application is based on Japanese Patent Application No. 2010-030626 filed on Feb. 15, 2010, entire content of which is expressly incorporated by reference herein.

**1.-29.** (canceled)

**30.** A mobile terminal device comprising:

- a plurality of transmission antennas;
- a reception section that receives a signal including transmission information including spreading code sequences of sounding reference signals for each of the transmission antennas; and
- a transmission section that transmits the sounding reference signals in code division multiplexing for each of the transmission antennas using the spreading code sequences.

**31.** The mobile terminal device according to claim 30, wherein the transmission section transmits the sounding reference signals in interleaved frequency division multiplexing for each of the transmission antennas using information associated the transmission antenna with the frequency position included in the transmission information.

**32.** The mobile terminal device according to claim 30, wherein the sounding reference signals are periodic sounding reference signals, and the transmission information is transmitted by higher layer signaling.

**33.** The mobile terminal device according to claim 30, wherein the sounding reference signals are aperiodic sounding reference signals, and the transmission information is transmitted by higher layer signaling and an uplink grant.

**34.** A radio base station apparatus comprising:

- an OFDM modulation section that performs OFDM modulation on a signal including transmission information including spreading code sequences of sounding reference signals for each transmission antenna; and
- a transmission section that transmits the transmission signal subjected to OFDM modulation.

**35.** The radio base station apparatus according to claim 34, wherein the transmission information includes information associated the transmission antenna with the frequency position.

**36.** The radio base station apparatus according to claim 34, wherein the sounding reference signals are periodic sounding reference signals, and the transmission information is transmitted by higher layer signaling.

**37.** The radio base station apparatus according to claim 34, wherein the sounding reference signals are aperiodic sounding reference signals, and the transmission information is transmitted by higher layer signaling and an uplink grant.

**38.** A wireless communication system comprising:

- a radio base station apparatus having an OFDM modulation section that performs OFDM modulation on a signal including transmission information including spreading code sequences of sounding reference signals for each transmission antenna; and a transmission section that transmits the transmission signal subjected to OFDM modulation to a mobile terminal device; and

a mobile terminal device having a plurality of transmission antennas; a reception section that receives a signal including transmission information from the radio base station apparatus; and a transmission section that transmits the sounding reference signals in code division multiplexing for each of the transmission antennas using the spreading code sequences.



39. The wireless communication system according to claim 38, wherein the transmission section of the mobile terminal device transmits the sounding reference signals in interleaved frequency division multiplexing for each of the transmission antennas using information associated the transmission antenna with the frequency position included in the transmission information.

40. A wireless communication method comprising:  
in a radio base station apparatus,  
performing OFDM modulation on a signal including transmission information including spreading code sequences of sounding reference signals for each transmission antenna;  
transmitting the transmission signal subjected to OFDM modulation to a mobile terminal device;

in the mobile terminal device,  
receiving the signal including the transmission information; and  
transmitting the sounding reference signals in code division multiplexing for each of the transmission antennas using the spreading code sequences.

41. The wireless communication method according to claim 40, wherein the mobile terminal device transmits the sounding reference signals in interleaved frequency division multiplexing for each of the transmission antennas using information associated the transmission antenna with the frequency position included in the transmission information.

\* \* \* \* \*

# Appendix C

Receipt date: 04/02/2010

Examiner: Amarnauth Persaud

12753257 - GAU: 2477

Page No.: 1 of: 1

<b>INFORMATION DISCLOSURE CITATION FORM FOR PATENT APPLICATION (FORM PTO-1449) (Substitute)</b>		Docket No.: 863.0185.U1(US)		Serial No.: to be assigned	
		Applicant(s): Benoist Sebire et al			
		Filing Date: Herewith		Group:	
<b>U.S. PATENT DOCUMENTS</b>					
Examiner Initials	Document Number (Number-Kind Code)	Publication Date (MM-DD-YYYY)	Name of Patentee or Applicant	Class	Sub-class
<b>FOREIGN PATENT DOCUMENTS</b>					
Examiner Initials	Document Number (Country Code-Number-Kind Code)	Publication Date (MM-DD-YYYY)	Name Of Patentee of Applicant	Translation? Yes/No/n/a	
<b>OTHER DOCUMENTS (Author (Capitalize), Title, Date, Pages, Etc., if known)</b>					
	"MAC Header Format For LTE-A", Samsung, 3GPP TSG-RAN WG2 #67, R2-094857, August 24-28, 2009, 3 pgs.				
	"Buffer Size Levels for BSR in E-UTRA Uplink" Ericsson, Nokia Corporation, Nokia Siemens Networks, Samsung, 3GPP TSG-RAN WG2 Meeting #62 bis, R2-083101, June 30-July 4, 2008, 3 pages				
	"3 <sup>rd</sup> General Partnership Project; Technical Specification Group Radio Access Network; Evolved Universal Terrestrial Radio Access (E-UTRA) Medium Access Control (MAC) protocol specification (Release 9)", 3GPP TS 36.321 V9.1.0, December 2009, 48 pgs.				
	"3 <sup>rd</sup> General Partnership Project; Technical Specification Group Radio Access Network; Feasibility Study For Further Advancements for E-UTRA (LTE-Advanced) (Release 9)", 3GPP TS 36.912 V9.1.0, December 2009, 58 pgs.				
Examiner's Signature: /Amarnauth Persaud/			Date Considered: 08/24/2012		
Initial if reference was considered, whether or not citation is in conformance with MPEP. Mark through citation if not considered. Include a copy of this citation form with your next correspondence to the Applicant(s).					

ALL REFERENCES CONSIDERED EXCEPT WHERE LINED THROUGH. /A.P./