

user action may prompt an automatic modification. As such, the court adopts the following construction: “a change by the system without a request or instruction to change from a user.”

**K. “location the user access”**

Claim 15 contains the term “location the user access”: “wherein the redirection server is configured to allow modification of at least a portion of the rule set as a function of some combination of time, data transmitted to or from the user, or *location the user access*.” This claim term is grammatically incorrect and may have a word missing. The specification explains that “a user may be periodically redirected to a location, based on the number of other factors, such as the number of locations accessed, the time spent at a location, the types of locations accessed, and other such factors.” (‘118 patent, 7:48-52). Linksmart argues that this term means “location or locations that the user accesses.” The defendants allege that “location the user access” is indefinite.

The defendants assert that “location the user access” is ambiguous because it is susceptible to more than one meaning. According to the defendants, this term may mean “location that the user accesses,” “location the user attempts to access,” “location from which the user accesses,” “location the user is allowed to access,” “number of locations the user accessed,” and “types of locations the user accessed.” During reexamination, Linksmart filed an amendment to claim 15 that read, “location the user *attempts to* access.” (Dkt. No. 414, Ex. 2, at 29). In addition, when accusing Cisco of infringement, Linksmart asserted that the term means “the location *from which* the user accesses the Accused Instrumentality.” (Dkt. No. 414, Ex. 2, at 53).

A district court cannot correct errors in a patent if the proposed correction is subject to reasonable debate. *Novo Indus.*, 350 F.3d at 1357. In *Novo Industries*, the disputed claim term was “stop means formed on a rotatable with said support finger.” *Id.* at 1352. The plaintiff argued that

this term contained an obvious typographical error and proposed two different corrections: “stop means on said support finger” and “stop means formed on a rotatable support finger.” *Id.* The Federal Circuit held that the error was not amenable to correction by the court, partly because the plaintiff itself suggested two different corrections, and thus the proposed correction was subject to reasonable debate. *Id.* at 1357. Likewise, in this case, “location the user access” has an obvious typographical or grammatical error, and the correction is subject to reasonable debate. Linksmart has suggested one correction to this court, offered a different correction to the PTO, and asserted yet another theory to Cisco.<sup>1</sup> Therefore, the term “location the user access” is insolubly ambiguous. As such, claim 15 is indefinite.

**L. “modifying at least a portion of the user’s rule set while the user’s rule set remains correlated to the temporarily assigned network address”**

The term “modifying at least a portion of the user’s rule set while the user’s rule set remains correlated to the temporarily assigned network address” is found in claim 25. The plaintiff argues that no construction of this term is necessary in light of other constructions. Alternatively, Linksmart proposes the following construction: “changing at least one of the elements or conditions about the user’s session during the session.” The defendants contend that “modifying at least a portion of the user’s rule set while the user’s rule set remains correlated to the temporarily assigned network address” means “changing at least one of the rules in the user’s rule set without ending the authorized session.”

The primary difference between the parties’ proposed constructions is whether termination

---

<sup>1</sup> Linksmart argues that its infringement contentions against Cisco are irrelevant for purposes of claim construction because they are litigation-related documents. But in *Novo Industries*, the Federal Circuit considered litigation-related positions in holding that the proposed correction was subject to reasonable debate. *See id.* (“Indeed, Novo itself suggested two different constructions to the district court . . .”).

of the user's session, which may be a form of a rule change, is covered by the patent term. According to the defendants, when the user's session is terminated, the system breaks the correlation between the user's rule set and the temporarily assigned network address. (*See* '118 patent, 3:21-26 (“When the user terminates the connection with the network, . . . the authentication accounting server . . . sends a message to the redirection server telling it to remove any remaining filtering and redirection information for the terminated user's temporary IP address.”); 4:67-5:4 (“When the redirection server [] receives information regarding a terminated session . . . , the redirection server [] removes any outstanding rule sets and information associated with the session.”)). But Linksmart argues that these quoted passages from the specification are preferred embodiments, and the claim should not be construed to exclude modifications that terminate the session.

The court is persuaded by Linksmart's argument. The system may first terminate the user's session, then break the correlation between the temporarily assigned network address and the user's rule set. The court therefore construes “modifying at least a portion of the user's rule set while the user's rule set remains correlated to the temporarily assigned network address” to mean “changing at least one of the elements or conditions in the ‘user's rule set’ during the session.”

#### **M. “database”**

Claim 1 contains the term “database”: “a *database* with entries correlating each of a plurality of user IDs with an individualized rule set.” The term “database” appears throughout the specification. The plaintiff asserts that no construction of “database” is necessary. If a construction is required, the plaintiff proposes “a structured set of data held in a computer.” In contrast, BWI contends that this term means a “relational database that stores data in a collection of records wherein each record has at least one field common to other records.”

BWI argues that “database” must be construed as a relational database. In support of its proposed construction, BWI quotes the following language from the specification: “The database 206 *is* a relational database which stores the system data.” (‘118 patent, 4:33-34) (emphasis added). BWI contends that this language does not state that the database *could be* or *may be* a relational database; instead, it says that the database *is* a relational database. But the quoted sentence is located within the “Detailed Description of the Invention”; this section begins with “[i]n the following embodiments of the invention.” (‘118 patent, 3:45). Figure 2 and the “database 206,” discussed in the Detailed Description, illustrate embodiments of the claimed invention. Although relational databases are a preferred embodiment, nothing in the claims or specification exclude other forms of data storage, such as a flat file. Therefore, the court construes “database” to mean “a structured set of data held in a computer.”

#### N. “entries”

Claim 1 contains the term “entries”: “a database with *entries* correlating each of a plurality of user IDs with an individualized rule set.” The specification states that “[t]he present invention allows for creating and implementing dynamically changing rules, to allow the redirection, blocking, or allowing, of specific data traffic for specific users, as a function of database *entries* and the user’s activity.” Linksmart states that no construction is necessary, or alternatively, proposes “records in a database.” BWI asserts the following construction: “records in a database, each record including a user ID and a unique rule set individualized for the user ID.”

According to BWI, the rule set must be unique and individualized for each user ID. But claim 7, which depends from claim 1, explains that the entries correlate a plurality of users’ IDs with a common individualized rule set. As such, the term “entries” does not require the entries to



correlate a unique rule set to each user ID.<sup>2</sup> BWI also asserts that each record must include a user ID and a rule set. BWI relies on a portion of the specification that illustrates a record containing a user ID and rule set. ('118 patent, 6:11-22). This portion of the specification describes an embodiment, however. The claim language states that the entries *correlate*, not *include*, the user IDs and rule sets. Nothing in the patent excludes a database with user IDs and rule sets stored in separate tables. Finally, the remainder of BWI's construction merely restates what is required in the claim language—the correlation of user IDs with rule sets. As such, the court construes “entries” to mean “records in a database.”

## **VI. Conclusion**

The court adopts the constructions set forth in this opinion for the disputed terms of the '118 patent. The parties are ordered that they may not refer, directly or indirectly, to each other's claim construction positions in the presence of the jury. Likewise, the parties are ordered to refrain from mentioning any portion of this opinion, other than the actual definitions adopted by the court, in the presence of the jury. Any reference to claim construction proceedings is limited to informing the jury of the definitions adopted by the court.

---

<sup>2</sup> At the May 25, 2010 claim construction hearing, counsel for BWI appeared to argue that the court should not consider claim 7 when construing “entries” because “claim 7 hasn't been asserted in this lawsuit.” A person of ordinary skill reading the '118 patent would discern, however, that claim 7 is intrinsic evidence regardless of whether Linksmart would later decline to assert that claim. *See also Phillips*, 415 F.3d at 1315 (“Other claims of the patent in question, both asserted and unasserted, can also be valuable sources of enlightenment as to the meaning of a claim term.”).

SIGNED this 30th day of June, 2010.

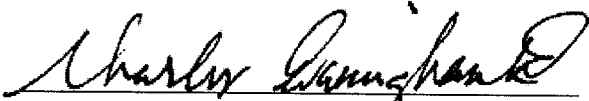
  
CHARLES EVERINGHAM IV  
UNITED STATES MAGISTRATE JUDGE

# EXHIBIT C



#18/Brief  
Appeal  
PATENT  
Sumner  
H-523

IN THE UNITED STATES PATENT AND TRADEMARK OFFICE

I hereby certify that this correspondence is being deposited with the U.S. Postal Service as first class mail in an envelope addressed to Commissioner of Patents and Trademarks, Washington, D.C. 20231 on November 22, 2002.

Marsha Cooper  
Name

Applicant : Koichiro Ikudome, et al.  
Application No. : 09/295,966  
Filed : April 21, 1999  
Title : USER SPECIFIC AUTOMATIC DATA REDIRECTION SYSTEM  
Grp./Div. : 3621  
Examiner : Pierre E. Elisca  
Docket No. : 34503/WWM/A522

RECEIVED  
DEC 05 2002  
GROUP 5300

APPELLANT'S BRIEF

Assistant Commissioner for Patents  
Washington, D.C. 20231

Post Office Box 7068  
Pasadena, CA 91109-7068  
November 22, 2002

Commissioner:

This is an appeal from the Final Rejection, dated October 12, 2001, of the claims in the above-referenced application.

1. REAL PARTY IN INTEREST

The real party in interest is the assignee of the subject application, Auric Web Systems.

2. RELATED APPEALS AND INTERFERENCES

There are no related appeals or interferences.

3. STATUS OF CLAIMS

Claims 1-29 are pending in the present application.

Claims 1-29 have been rejected in a final rejection, dated October 12, 2001 under 35 U.S.C. §102(b).

12/04/2002 CV0111 00000125 09295966

-1-

01 FC:2402

160.00 GP

**Application No. 09/295,966**

The claims on appeal are claims 1-29.

**4. STATUS OF AMENDMENTS**

Appellants submitted additional remarks in a response to the final rejection. This response did not amend any claims. The response was not deemed to overcome the rejections. See, Paper 14, dated October 22, 2002. There are no outstanding, unentered amendments.

**5. SUMMARY OF INVENTION**

The invention is an improved database system and method for redirecting and filtering Internet traffic. *Appellants' Specification* (hereinafter "Specification"), 1:10-11 (passages are indicated by page:line). One embodiment of the invention relates to a system and method including a database 206<sup>1</sup> with entries correlating each of a plurality of user IDs with an individualized rule set. A dial-up network server 102 receives user IDs from users' computers 100, and a redirection server 208 is connected to the dial-up network server 102 and a public network 110. An authentication accounting server 204 is connected to the database 206, the dial-up network server 102 and the redirection server 208. The dial-up network server 102 communicates a first user ID for one of the users' computers 100 and temporarily assigned network address for the first user ID to the authentication accounting server 204. The authentication accounting server 204 accesses the database 206 and communicates the individualized rule set that correlates with the first user ID and the temporarily assigned network address to the redirection server 208. *Specification*, 4:8-13. Data directed toward the public network 110 from one of the users' computers 100 are processed by the redirection server 208 according to the individualized rule set. *Specification*, 3:30-4:7.

One embodiment of the invention also redirects the data to and from the users' computers as a function of the individualized rule set. *Specification*, 3:26-28. In another embodiment, at least a portion of the rule set for a temporarily assigned network address is automatically modified or at least a portion of the rule set is modified while that rule set remains correlated to the temporarily assigned network address. *Specification*, 3:28-30.

---

<sup>1</sup>All numerals refer to FIG. 2.

**Application No. 09/295,966**

**6. ISSUES**

(1) Whether claims 1-29 are unpatentable under 35 U.S.C. § 102(b) over Horowitz, et al. (WO 96/05549).

**7. GROUPING OF CLAIMS**

For purposes of this appeal, the claims are grouped as follows and for the purposes of this appeal only, the claims within each group stand and fall together. The claims consist of four independent claims, claims 1, 8, 15, and 26. Claims 1 and 15 claim systems and claims 8 and 26 claim methods corresponding to those systems. For determining anticipation within the meaning of 35 U.S.C. § 102(b), the groups are:

Group I - 1-4, 7-11, 14

Group II - 5-6, 12-13

Group III- 15-29

**8. ARGUMENT**

**A. GROUP I**

Group I includes claims 1-4, 7-11 and 14. Independent claim 1 recites a system comprising a database with entries correlating each of a plurality of user IDs with an individualized rule set; a dial-up network server that receives user IDs from users' computers; a redirection server connected to the dial-up network server and a public network; and an authentication accounting server connected to the database, the dial-up network server and the redirection server, wherein the dial-up network server communicates a first user ID for one of the users' computers and a temporarily assigned network address for the first user ID to the authentication accounting server, wherein the authentication accounting server accesses the database and communicates the individualized rule set that correlates with the first user ID and the temporarily assigned network address to the redirection server, and wherein data directed toward the public network from the one of the users' computers are processed by the redirection server according to the individualized rule set.

Application No. 09/295,966

The Examiner has rejected independent claim 1 under 35 U.S.C. §102(b) as being anticipated by *Horowitz*. *Horowitz* is directed to a local network<sup>2</sup> remote access server. *Horowitz*, Abstract. Remote users, such as telecommuters, can dial directly into a remote access server<sup>3</sup> that checks the remote users' IDs and passwords against a database. *Horowitz*, 3:15-28. The database also includes pre-programed access filters indicating to which of the known devices connected to the local network (e.g., other computers, printers, etc.) the user can have access. *Horowitz*, 3:32-4:5. The remote access server can then allow or block the user from access to a particular device.

Similar packet filtering is discussed in the Appellants' background section. Specifically, "packet filtering is very limited because it is static. Once packet filtering rule sets are programed into a firewall or other packet filter device, the rule set can only be changed by manually reprogramming the device." *Specification*, 2:30-34. However, this disadvantage can be largely irrelevant on a local network because the devices and networks<sup>4</sup> on which the access filters are based are relatively static and known by the network administrator. *Horowitz* teaches that the database is "maintained by a network manager who has central control of and responsibility for the network 14 and the maintenance thereof." *Horowitz*, 8:31-9:2. Such control over a constantly changing *public* network, such as the Internet, is not feasible.

A single prior art reference will anticipate a claim only if it expressly or inherently describes each and every limitation in the claim. *Verdegaal Bros., Inc. v. Union Oil Co.*, 814 F.2d 628, 631 (Fed. Cir. 1987). *Horowitz* neither expressly nor inherently discloses every limitation of claim 1. Specifically, *Horowitz* does not disclose the claim element, "wherein data directed toward the public network from the one of the users' computers are processed by the redirection server according to the individualized rule set." The entirety of the Examiner's grounds for rejection with respect to this element is that the element is "disclosed by *Horowitz*, in the abstract, specifically wherein it is stated that the server also includes processing

---

<sup>2</sup>See, e.g., *Horowitz*, Abstract, 1:5-10 and 3:1-7.

<sup>3</sup>See *Horowitz*, 4:6-23.

<sup>4</sup>See *Horowitz*, 3:29-4:5.

**Application No. 09/295,966**

electronics which control the communication and network ports." See Final Office Action, p.

3. In an advisory action,<sup>5</sup> the Examiner essentially repeated this ground stating:

Applicant's representative argues that Horowitz does not [disclose] any about 'a system that control a user's access to a public network'...However, the Examiner respectfully disagrees because Horowitz in the Abstract, specifically wherein it is stated that processing [electronics] which control the communication...see office action mailed on 10/12/2001.

For a finding of anticipation, "the identical invention must be shown in as complete detail as is contained in the ...claim." *Richardson v. Suzuki Motor Co.*, 868 F.2d 1226, 1236 (Fed. Cir. 1989). However, nothing in the reference's passage from the Abstract cited by the Examiner discloses any data directed to a public network.

Although not explicitly stated, the Examiner appears to be making an assumption that "communication and network ports" inherently direct data to a public network. First, *Horowitz* fails to inherently anticipate the claimed element. "Inherent anticipation requires that the missing descriptive material is 'necessarily present,' not merely probably or possibly present, in the prior art." *Trintec Indus., Inc. v. Top-U.S.A. Corp.*, 295 F.3d 1292, 1295 (Fed. Cir. 2002). While it is true that it is possible to use "communication and network ports" to direct data to a public network, "communication and network ports" are often used in systems without directing data to a public network. For example, two stand alone computers directly connected over a telephone line with modems or two computers connected to each other in a simple LAN have "communication and network ports" controlled by processing electronics, but do not direct data toward a public network. Appellants therefore submit that the missing description of "directing data toward a public network" falls far short of being "necessarily present" in *Horowitz*, as is required by *Trintec Indus., Inc. v. Top-U.S.A. Corp.*

Second, the specific "communication and network ports" disclosed in *Horowitz* do not expressly teach or suggest anything about public networks or directing data to a public network. The "communication and network ports" in the *Horowitz* abstract cannot be read in

---

<sup>5</sup>See, Paper No. 14, sent November 8, 2002.



Application No. 09/295,966

a vacuum. They must be read in the context of the *Horowitz* disclosure. The entirety of *Horowitz* that discusses these ports is as follows:

Referring now to FIG. 4, in one embodiment, the remote access server 16 includes electronics 38, a plurality of serial communication ports 40<sub>1</sub>-40<sub>N</sub>, and a plurality of network ports 42<sub>1</sub>-42<sub>N</sub>. The server 16 also can include a plurality of internal modems 44<sub>1</sub>-44<sub>N</sub>. The serial ports 40 and the network ports 42 are controlled by the electronics 38.

The electronics 38 include, in some embodiments, a powerful 16 MHz 68EC020 microprocessor and memory such as up to 1 megabyte of battery backed-up static random access memory (SRAM) and possible 64 kilobytes in an erasable programmable read only memory (EPROM).

Each of the serial communication ports 40 is for coupling with a communication device (e.g., the modem 26 of FIG. 1), or for coupling directly with the telephone lines 22, to provide for communication with a remote computer (e.g., the remote computer 12 of FIGS 1 and 2) over the telephone lines 22. A connecting cable can be used to couple a serial port 40 with the communication device or with the telephone lines. Each of the serial ports 40 can simultaneously be coupled to a different one of the plurality of remote computers so as to provide simultaneous access to a local computer network for each of the remote computers, even if each of the remote computers employs a different protocol (e.g., IPX, TCP/IP, AppleTalk, NetBEUI, or 802.2/LLC)...

Each of the network ports 42 is for coupling with a local computer network (e.g., the network 14 of FIGS. 1 and 2), via a connecting cable, to provide for communication with the network...In some embodiments, the server 16 includes three network ports 42, one for 10BaseT Ethernet, one for Thin Ethernet, and one for Thick Ethernet. In some other embodiments, the server 16 includes a single network port 42 for Token Ring. In some other embodiments, the server 16 includes a single network port 42 for use with Apple LocalTalk.

*Horowitz*, 16:24-17:14, 17:24-18:1 (emphasis added). As indicated in the emphasized portion of this disclosure, the "communications ports" provide communication with remote computers used to remotely access the network that includes the communication ports, not a public network. Similarly, the "network ports" are coupled to a local computer network, not a public network. Nowhere in this discussion is there any teaching or suggestion of a public network or the "communication and network ports" being connected to one, and, in fact, the entire disclosure is expressly directed to only a *private* network.

**Application No. 09/295,966**

As discussed above, the differences between public and private networks are important. In private networks, such as in *Horowitz*, all of the resources and services are known. Private networks are "maintained by a network manager who has central control of and responsibility for the network 14 and the maintenance thereof." *Horowitz*, 8:31-9:2. All of the resources and services are known. Additionally, since these networks are "private," they are not accessible to the public. In a public network, the available resources and services are unknown and constantly changing. *Horowitz* states that an object of its access filter is to provide "security features" and "restrict access to the network on a per-user basis." Public networks are not secure and access is unrestricted. Because *Horowitz* fails to disclose the cited limitations either expressly or inherently, Appellants respectfully submit that claim 1 is not anticipated by *Horowitz*.

Independent claim 8 recites a method that corresponds to the system recited in claim 1. Appellants respectfully submit that claim 8 and its dependent claims 9-14 are therefore patentable over *Horowitz*. Appellants respectfully request that the rejections to claims 8-14 be withdrawn.

For all of the reasons stated above, Appellants respectfully submit that claim 1, its dependent claims 2-7, claim 8 and its dependent claims 9-14 are patentable over *Horowitz* and respectfully request that the rejection under §102 be withdrawn.

**B. GROUP II.**

Group II includes claims 5-6 and 12-13. Claims 5-6 and 12-13 recite systems and methods that redirect data to and from the users' computers via the redirection server as a function of the individualized rule set. The passages in *Horowitz* cited by the Examiner do not teach or suggest this limitation. Instead, these passages relate to only blocking or allowing access to the private network, or particular devices on the private network. *Horowitz*, Abstract, 9:20-29. The Appellants can find no teaching or suggestion anywhere in *Horowitz* of directing the data to or from the user to an alternate location based on the individualized rule set and the Examiner has not identified such teaching or suggestion.

**Application No. 09/295,966**

Appellants include an extensive discussion regarding redirection of data in their specification. *Specification*, 1:29-2:16. Redirection involves the server "directing" the user to another area of the network. If the user chooses on its own to try to access another, allowable area of the network, this is clearly not redirection by the server. *Horowitz*, therefore, does not disclose any server that redirects data, but rather only passively blocks or allows data. As this limitation is neither expressly or inherently present in *Horowitz*, Appellants respectfully request that the rejections to Group II be withdrawn. Additionally, Appellants submit that claims 5-6 and 12-13 are dependent on patentable independent claims 1 and 8, respectively, and should therefore be allowed. The difference between passive blocking and allowing data and the redirection in this group of claims also makes these claims patentably distinct from the claims in Group I, because the claims in Group I would cover passive blocking and allowing data.

**C. GROUP III.**

Group III includes claims 15-29. Independent claim 15 recites a system comprising a redirection server programed with a user's rule set correlated to a temporarily assigned network address; wherein the rule set contains at least one of a plurality of functions used to control passing between the user and a public network; and wherein the redirection server is configured to allow automated modification of at least a portion of the rule set correlated to the temporarily assigned network address.

The Examiner has rejected independent claim 15 under 35 U.S.C. §102(b) as being anticipated by *Horowitz*. As discussed in relation to Group I, above, *Horowitz* contains no express or inherent teaching or suggestion of a public network, or a rule set with functions used to control passing between the user and a public network. Appellants therefore respectfully submit that claim 15 and its dependent claims 16-25 are allowable and request that their rejections be withdrawn.

Additionally, *Horowitz* contains no teaching or suggestion of "automated modification of at least a portion of the rule set correlated to the temporarily assigned network address." Although Appellant brought the absence of this element to the Examiner's attention in every

**Application No. 09/295,966**

communication,<sup>6</sup> the Examiner has failed to cite any teaching or suggestion in *Horowitz* that meets this element or respond to Appellants' argument in any way. Appellant respectfully submits that the Examiner has failed to show that claims 15-25 are expressly or inherently anticipated by *Horowitz*, and therefore requests that the rejections to these claims be withdrawn. The automated modification element also distinguishes the claims of Group III from the claims of Group I as even if the claims of Group I were anticipated by *Horowitz*, there would be no anticipation of the Group III claims because *Horowitz* does not disclose or suggest the automated modification element.

Independent claim 26 recites a method that corresponds generally to the system recited in claim 15. Appellants respectfully submit that claim 26 and its dependent claims 27-29 are therefore patentable over *Horowitz*. Specifically, the Examiner has not cited any portion of *Horowitz* as disclosing "modifying at least a portion of the user's rule set while the user's rule set remains correlated to the temporarily assigned network address." Appellants respectfully request that the rejections to Group III be withdrawn.

**D. CONCLUSION.**

A single prior art reference will anticipate a claim only if it expressly or inherently describes each and every limitation in the claim. *Verdegaal Bros., Inc. v. Union Oil Co.*, 814 F.2d 628, 631 (Fed. Cir. 1987). Regarding Group I, the reference cited by the Examiner in support of his 35 U.S.C. §102(b) rejection fails to expressly or inherently teach or suggest "wherein data directed toward the public network from the one of the users' computers are processed by the redirection server according to the individualized rule set." *Horowitz*, in fact, contains no teaching or suggestion of a public network at all, and is expressly related to only a private network. Regarding Group II, the Examiner has failed to show any teaching or suggestion in *Horowitz* of "redirection of data to or from a user." Finally, regarding Group III, the Examiner has failed to show any teaching or suggestion in *Horowitz* of "modification of a

---

<sup>6</sup>See, Response to Office Action sent July 30, 2001 p. 7, Telephone conference of October 10, 2002, and Response to Office Action sent October 22, 2002 p. 3.

Application No. 09/295,966

rule set correlated to a temporarily assigned network address." In fact, the Examiner has offered no argument or reference related to this claim element. Accordingly, the Examiner has failed to make out a prima facie case of anticipation and the issuance of a notice of allowance is appropriate.

Respectfully submitted,

CHRISTIE, PARKER & HALE, LLP

By 

Wesley W. Monroe  
Reg. No. 39,778  
626/795-9900

Application No. 09/295,966

9. APPENDIX OF CLAIMS INVOLVED IN THE APPEAL

1. A system comprising:
  - a database with entries correlating each of a plurality of user IDs with an individualized rule set;
  - a dial-up network server that receives user IDs from users' computers;
  - a redirection server connected to the dial-up network server and a public network, and
  - an authentication accounting server connected to the database, the dial-up network server and the redirection server;
  - wherein the dial-up network server communicates a first user ID for one of the users' computers and a temporarily assigned network address for the first user ID to the authentication accounting server;
  - wherein the authentication accounting server accesses the database and communicates the individualized rule set that correlates with the first user ID and the temporarily assigned network address to the redirection server; and
  - wherein data directed toward the public network from the one of the users' computers are processed by the redirection server according to the individualized rule set.
2. The system of claim 1, wherein the redirection server further provides control over a plurality of data to and from the users' computers as a function of the individualized rule set.
3. The system of claim 1, wherein the redirection server further blocks the data to and from the users' computers as a function of the individualized rule set.
4. The system of claim 1, wherein the redirection server further allows the data to and from the users' computers as a function of the individualized rule set.

**Application No. 09/295,966**

5. The system of claim 1, wherein the redirection server further redirects the data to and from the users' computers as a function of the individualized rule set.

6. The system of claim 1, wherein the redirection server further redirects the data from the users' computers to multiple destinations as a function of the individualized rule set.

7. The system of claim 1, wherein the database entries for a plurality of the plurality of users' IDs are correlated with a common individualized rule set.

8. In a system comprising a database with entries correlating each of a plurality of user IDs with an individualized rule set; a dial-up network server that receives user IDs from users' computers; a redirection server connected to the dial-up network server and a public network, and an authentication accounting server connected to the database, the dial-up network server and the redirection server, the method comprising the steps of:

communicating a first user ID for one of the users' computers and a temporarily assigned network address for the first user ID from the dial-up network server to the authentication accounting server;

communicating the individualized rule set that correlates with the first user ID and the temporarily assigned network address to the redirection server from the authentication accounting server; and processing data directed toward the public network from the one of the users' computers according to the individualized rule set.

9. The method of claim 8, further including the step of controlling a plurality of data to and from the users' computers as a function of the individualized rule set.

10. The method of claim 8, further including the step of blocking the data to and from the users' computers as a function of the individualized rule set.

**Application No. 09/295,966**

11. The method of claim 8, further including the step of allowing the data to and from the users' computers as a function of the individualized rule set.

12. The method of claim 8, further including the step of redirecting the data to and from the users' computers as a function of the individualized rule set.

13. The method of claim 8, further including the step of redirecting the data from the users' computers to multiple destinations a function of the individualized rule set.

14. The method of claim 8, further including the step of creating database entries for a plurality of the plurality of users' IDs, the plurality of users' ID further being correlated with a common individualized rule set.

15. A system comprising:  
a redirection server programed with a user's rule set correlated to a temporarily assigned network address;  
wherein the rule set contains at least one of a plurality of functions used to control passing between the user and a public network; and  
wherein the redirection server is configured to allow automated modification of at least a portion of the rule set correlated to the temporarily assigned network address.

16. The system of claim 15, wherein the redirection server is configured to allow modification of at least a portion of the rule set as a function of time.

17. The system of claim 15, wherein the redirection server is configured to allow modification of at least a portion of the rule set as a function of the data transmitted to or from the user.



**Application No. 09/295,966**

18. The system of claim 15, wherein the redirection server is configured to allow modification of at least a portion of the rule set as a function of the location or locations the user access.

19. The system of claim 15, wherein the redirection server is configured to allow modification of at least a portion of the rule set as a function of some combination of time, data transmitted to or from the user, or location or locations the user access.

20. The system of claim 15, wherein the redirection server is configured to allow the removal or reinstatement of at least a portion of the rule set as a function of time.

21. The system of claim 15, wherein the redirection server is configured to allow the removal or reinstatement of at least a portion of the rule set as a function of the data transmitted to or from the user.

22. The system of claim 15, wherein the redirection server is configured to allow the removal or reinstatement of at least a portion of the rule set as a function of the location or locations the user access.

23. The system of claim 15, wherein the redirection server is configured to allow the removal or reinstatement of at least a portion of the rule set as a function of some combination of time, data transmitted to or from the user, or location or locations the user access.

24. The system of claim 15, wherein the redirection server has a user side that is connected to a computer using the temporarily assigned network address and a network side connected to a computer network and wherein the computer using the temporarily assigned network address is connected to the computer network through the redirection server.

**Application No. 09/295,966**

25. The system of claim 24 wherein instructions to the redirection server to modify the rule set are received by one or more of the user side of the redirection server and the network side of the redirection server.

26. In a system comprising a redirection server containing a user's rule set correlated to a temporarily assigned network address wherein the user's rule set contains at least one of a plurality of functions used to control data passing between the user and a public network; the method comprising the step of:

modifying at least a portion of the user's rule set while the user's rule set remains correlated to the temporarily assigned network address in the redirection server.

27. The method of claim 26, further including the step of modifying at least a portion of the user's rule set as a function of one or more of: time, data transmitted to or from the user, and location or locations the user access.

28. The method of claim 26, further including the step of removing or reinstating at least a portion of the user's rule set as a function of one or more of: time, the data transmitted to or from the user and the location or locations the user access.

29. The method of claim 26, wherein the redirection server has a user side that is connected to a computer using the temporarily assigned network address and a network side connected to a computer network and wherein the computer using the temporarily assigned network address is connected to the computer network through the redirection server and the method further includes the step of:

receiving instructions by the redirection server to modify at least a portion of the user's rule set through one or more of the user side of the redirection server and the network side of the redirection server.

WWM/rah

MO PAS474061 2\*-11/22/02 9:18 PM

# EXHIBIT D



UNITED STATES PATENT AND TRADEMARK OFFICE

① WWM  
② RAH

UNITED STATES DEPARTMENT OF COMMERCE  
United States Patent and Trademark Office  
Address: COMMISSIONER FOR PATENTS  
P.O. Box 1450  
Alexandria, Virginia 22313-1450  
www.uspto.gov

NOTICE OF ALLOWANCE AND FEE(S) DUE

23363 7590 03/16/2004  
CHRISTIE, PARKER & HALE, LLP  
350 WEST COLORADO BOULEVARD  
SUITE 500  
PASADENA, CA 91105

RECEIVED

MAR 20 2004

Christie, Parker & Hale, LLP

EXAMINER

ELISCA, PIERRE E

ART UNIT PAPER NUMBER

3621

DATE MAILED: 03/16/2004

APPLICATION NO.	FILING DATE	FIRST NAMED INVENTOR	ATTORNEY DOCKET NO.	CONFIRMATION NO.
09/295,966	04/21/1999	KOICHIRO IKUDOME	34503/WWM/A5	7800

TITLE OF INVENTION: USER SPECIFIC AUTOMATIC DATA REDIRECTION SYSTEM

APPLN. TYPE	SMALL ENTITY	ISSUE FEE	PUBLICATION FEE	TOTAL FEE(S) DUE	DATE DUE
nonprovisional	YES	\$665	\$0	\$665	06/16/2004

THE APPLICATION IDENTIFIED ABOVE HAS BEEN EXAMINED AND IS ALLOWED FOR ISSUANCE AS A PATENT. PROSECUTION ON THE MERITS IS CLOSED. THIS NOTICE OF ALLOWANCE IS NOT A GRANT OF PATENT RIGHTS. THIS APPLICATION IS SUBJECT TO WITHDRAWAL FROM ISSUE AT THE INITIATIVE OF THE OFFICE OR UPON PETITION BY THE APPLICANT. SEE 37 CFR 1.313 AND MPEP 1308.

THE ISSUE FEE AND PUBLICATION FEE (IF REQUIRED) MUST BE PAID WITHIN THREE MONTHS FROM THE MAILING DATE OF THIS NOTICE OR THIS APPLICATION SHALL BE REGARDED AS ABANDONED. THIS STATUTORY PERIOD CANNOT BE EXTENDED. SEE 35 U.S.C. 151. THE ISSUE FEE DUE INDICATED ABOVE REFLECTS A CREDIT FOR ANY PREVIOUSLY PAID ISSUE FEE APPLIED IN THIS APPLICATION. THE PTOL-85B (OR AN EQUIVALENT) MUST BE RETURNED WITHIN THIS PERIOD EVEN IF NO FEE IS DUE OR THE APPLICATION WILL BE REGARDED AS ABANDONED.

HOW TO REPLY TO THIS NOTICE:

I. Review the SMALL ENTITY status shown above.

If the SMALL ENTITY is shown as YES, verify your current SMALL ENTITY status:

A. If the status is the same, pay the TOTAL FEE(S) DUE shown above.

B. If the status is changed, pay the PUBLICATION FEE (if required) and twice the amount of the ISSUE FEE shown above and notify the United States Patent and Trademark Office of the change in status, or

If the SMALL ENTITY is shown as NO:

A. Pay TOTAL FEE(S) DUE shown above, or

B. If applicant claimed SMALL ENTITY status before, or is now claiming SMALL ENTITY status, check the box below and enclose the PUBLICATION FEE and 1/2 the ISSUE FEE shown above.

Applicant claims SMALL ENTITY status. See 37 CFR 1.27.

CASE # 34503 ACTION Issue Fee  
REMINDER \_\_\_\_\_ DUE DATE \_\_\_\_\_  
DEADLINE 6/16/04

II. PART B - FEE(S) TRANSMITTAL should be completed and returned to the United States Patent and Trademark Office (USPTO) with your ISSUE FEE and PUBLICATION FEE (if required). Even if the fee(s) have already been paid, Part B - Fee(s) Transmittal should be completed and returned. If you are charging the fee(s) to your deposit account, section "4b" of Part B - Fee(s) Transmittal should be completed and an extra copy of the form should be submitted.

III. All communications regarding this application must give the application number. Please direct all communications prior to issuance to Mail Stop ISSUE FEE unless advised to the contrary.

IMPORTANT REMINDER: Utility patents issuing on applications filed on or after Dec. 12, 1980 may require payment of maintenance fees. It is patentee's responsibility to ensure timely payment of maintenance fees when due.

**Notice of Allowability**

Application No.	Applicant(s)	
09/295,966	IKUDOME ET AL.	
Examiner	Art Unit	
Pierre E. Elisca	3621	

-- The MAILING DATE of this communication appears on the cover sheet with the correspondence address--

All claims being allowable, PROSECUTION ON THE MERITS IS (OR REMAINS) CLOSED in this application. If not included herewith (or previously mailed), a Notice of Allowance (PTOL-85) or other appropriate communication will be mailed in due course. **THIS NOTICE OF ALLOWABILITY IS NOT A GRANT OF PATENT RIGHTS.** This application is subject to withdrawal from issue at the initiative of the Office or upon petition by the applicant. See 37 CFR 1.313 and MPEP 1308.

- 1.  This communication is responsive to 6/30/2003.
- 2.  The allowed claim(s) is/are 1-18 and 20-28.
- 3.  The drawings filed on \_\_\_\_\_ are accepted by the Examiner.
- 4.  Acknowledgment is made of a claim for foreign priority under 35 U.S.C. § 119(a)-(d) or (f).
  - a)  All b)  Some\* c)  None of the:
    - 1.  Certified copies of the priority documents have been received.
    - 2.  Certified copies of the priority documents have been received in Application No. \_\_\_\_\_.
    - 3.  Copies of the certified copies of the priority documents have been received in this national stage application from the International Bureau (PCT Rule 17.2(a)).

\* Certified copies not received: \_\_\_\_\_.

Applicant has THREE MONTHS FROM THE "MAILING DATE" of this communication to file a reply complying with the requirements noted below. Failure to timely comply will result in ABANDONMENT of this application. **THIS THREE-MONTH PERIOD IS NOT EXTENDABLE.**

- 5.  A SUBSTITUTE OATH OR DECLARATION must be submitted. Note the attached EXAMINER'S AMENDMENT or NOTICE OF INFORMAL PATENT APPLICATION (PTO-152) which gives reason(s) why the oath or declaration is deficient.
  - 6.  CORRECTED DRAWINGS ( as "replacement sheets") must be submitted.
    - (a)  including changes required by the Notice of Draftsperson's Patent Drawing Review ( PTO-948) attached
      - 1)  hereto or 2)  to Paper No./Mail Date \_\_\_\_\_.
    - (b)  including changes required by the attached Examiner's Amendment / Comment or in the Office action of Paper No./Mail Date \_\_\_\_\_.
- Identifying indicia such as the application number (see 37 CFR 1.84(c)) should be written on the drawings in the front (not the back) of each sheet. Replacement sheet(s) should be labeled as such in the header according to 37 CFR 1.121(d).
- 7.  DEPOSIT OF and/or INFORMATION about the deposit of BIOLOGICAL MATERIAL must be submitted. Note the attached Examiner's comment regarding REQUIREMENT FOR THE DEPOSIT OF BIOLOGICAL MATERIAL.

**Attachment(s)**

- 1.  Notice of References Cited (PTO-892)
- 2.  Notice of Draftsperson's Patent Drawing Review (PTO-948)
- 3.  Information Disclosure Statements (PTO-1449 or PTO/SB/08), Paper No./Mail Date \_\_\_\_\_
- 4.  Examiner's Comment Regarding Requirement for Deposit of Biological Material
- 5.  Notice of Informal Patent Application (PTO-152)
- 6.  Interview Summary (PTO-413), Paper No./Mail Date \_\_\_\_\_
- 7.  Examiner's Amendment/Comment
- 8.  Examiner's Statement of Reasons for Allowance
- 9.  Other \_\_\_\_\_

*Pierre E. Elisca*  
**PRIMARY PATENT EXAMINER**

Art Unit: 3621

## REASONS FOR ALLOWANCE

1. This is an Examiner's Statement of Reasons for Allowance. The closest prior art (Grube et al. (U.S. pat. No. 6,157,829) discloses a central service agent that assigns a temporary alias ID and a permanent ID that is communicated, on a temporary basis, to a specific calling unit.

However, Grube singularly or in combination fails to anticipate or render obvious the recited feature:

As per claims 1 and 8 " wherein the authentication accounting server accesses the database and communicates the individualized rule set that correlates with the first user ID and the temporarily assigned network address to the redirection server, and wherein data directed toward the public network from the one of the users' computers are processed by the redirection server according to the individualized rule set".

As per claim 15 " wherein the redirection server is configured to allow automated modification of at least a portion of the rule set correlated to the temporarily assigned network address".

As per claim 26 " modifying at least a portion of the user's rule set while the user's rule set remains correlated to the temporarily assigned network address in the redirection server, and wherein the redirection server has a user side that is connected to a computer using the temporarily assigned network address and a network side connected to a computer network and wherein the computer using the temporarily assigned network address is connected to the computer network through the redirection server and the method further includes the step of receiving instructions by the

Art Unit: 3621

redirection server to modify at least a portion of the user's rule set through one or more of the user side of the redirection server and the network side of the redirection server".

#### Examiner's Amendment

2. Please cancel claims 19 and 29 without prejudice.

Please amend claims 15 and 26 as follow:

Claim 15, line 5, after " public network ; " delete " and ".

Claim 15, line 7, after "address" delete " ." and add -- ; --.

Claim 15, line 7, after "; " and add -- and wherein the redirection server is configured to allow modification of at least a portion of the rule set as a function of some combination of time, data transmitted to or from the user, or location the user access--.

Claim 26, line 6, after " redirection server " delete " ." and add -- ; and wherein the redirection server has a user side that is connected to a computer using the temporarily assigned network address and a network address and a network side connected to a computer network and wherein the computer using the temporarily assigned network address is connected to the computer network through the redirection server and the method further includes the step of receiving instructions by the redirection server to modify at least a portion of the user's rule set through one or more of the user side of the redirection server and the network side of the redirection server--.

**Conclusion**

3. Any inquiry concerning this communication or earlier communications from the examiner should be directed to Pierre E. Elisca whose telephone number is 703 305-3987. The examiner can normally be reached on 6:30 to 5:00.

If attempts to reach the examiner by telephone are unsuccessful, the examiner's supervisor, James Trammell can be reached on 703 305-9769. The fax phone number for the organization where this application or proceeding is assigned is 703-872-9306.

Information regarding the status of an application may be obtained from the Patent Application Information Retrieval (PAIR) system. Status information for published applications may be obtained from either Private PAIR or Public PAIR. Status information for unpublished applications is available through Private PAIR only. For more information about the PAIR system, see <http://pair-direct.uspto.gov>. Should you have questions on access to the Private PAIR system, contact the Electronic Business Center (EBC) at 866-217-9197 (toll-free).

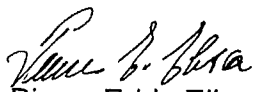
  
Pierre Eddy Elisca

Primary Patent Examiner

February 19, 2004





UNITED STATES PATENT AND TRADEMARK OFFICE

UNITED STATES DEPARTMENT OF COMMERCE
United States Patent and Trademark Office
Address: COMMISSIONER FOR PATENTS
P.O. Box 1450
Alexandria, Virginia 22313-1450
www.uspto.gov

Table with 5 columns: APPLICATION NO., FILING DATE, FIRST NAMED INVENTOR, ATTORNEY DOCKET NO., CONFIRMATION NO.
Row 1: 09/295,966, 04/21/1999, KOICHIRO IKUDOME, 34503/WWM/A5, 7800
Row 2: 23363, 7590, 03/16/2004, [EXAMINER], [ELISCA, PIERRE E]
Row 3: [ART UNIT], [PAPER NUMBER], [3621]

CHRISTIE, PARKER & HALE, LLP
350 WEST COLORADO BOULEVARD
SUITE 500
PASADENA, CA 91105

DATE MAILED: 03/16/2004

Determination of Patent Term Extension under 35 U.S.C. 154 (b)
(application filed after June 7, 1995 but prior to May 29, 2000)

The Patent Term Extension is 0 day(s). Any patent to issue from the above-identified application will include an indication of the 0 day extension on the front page.

If a Continued Prosecution Application (CPA) was filed in the above-identified application, the filing date that determines Patent Term Extension is the filing date of the most recent CPA.

Applicant will be able to obtain more detailed information by accessing the Patent Application Information Retrieval (PAIR) system (http://pair.uspto.gov).

Any questions regarding the Patent Term Extension or Adjustment determination should be directed to the Office of Patent Legal Administration at (703) 305-1383. Questions relating to issue and publication fee payments should be directed to the Customer Service Center of the Office of Patent Publication at (703) 305-8283.

**Notice of References Cited**

Application/Control No. 09/295,966	Applicant(s)/Patent Under Reexamination IKUDOME ET AL.	
Examiner Pierre E. Elisca	Art Unit 2785	Page 1 of 1

**U.S. PATENT DOCUMENTS**

*		Document Number Country Code-Number-Kind Code	Date MM-YYYY	Name	Classification
<input checked="" type="checkbox"/>	A	US-6,157,829	12-2000	Grube et al.	455/414.1
	B	US-			
	C	US-			
	D	US-			
	E	US-			
	F	US-			
	G	US-			
	H	US-			
	I	US-			
	J	US-			
	K	US-			
	L	US-			
	M	US-			

**FOREIGN PATENT DOCUMENTS**

*		Document Number Country Code-Number-Kind Code	Date MM-YYYY	Country	Name	Classification
	N					
	O					
	P					
	Q					
	R					
	S					
	T					

**NON-PATENT DOCUMENTS**

*		Include as applicable: Author, Title Date, Publisher, Edition or Volume, Pertinent Pages)
	U	
	V	
	W	
	X	

A copy of this reference is not being furnished with this Office action. (See MPEP § 707.05(a).) Dates in MM-YYYY format are publication dates. Classifications may be US or foreign.

## Electronic Patent Application Fee Transmittal

<b>Application Number:</b>	90009301
<b>Filing Date:</b>	17-Dec-2008
<b>Title of Invention:</b>	USER SPECIFIC AUTOMATIC DATA REDIRECTION SYSTEM
<b>First Named Inventor/Applicant Name:</b>	6,779,118 B1
<b>Filer:</b>	Abraham Hershkovitz/Brian Berman
<b>Attorney Docket Number:</b>	R1341006

Filed as Small Entity

### ex parte reexam Filing Fees

Description	Fee Code	Quantity	Amount	Sub-Total in USD(\$)
<b>Basic Filing:</b>				
<b>Pages:</b>				
<b>Claims:</b>				
<b>Miscellaneous-Filing:</b>				
<b>Petition:</b>				
<b>Patent-Appeals-and-Interference:</b>				
Filing a brief in support of an appeal	2402	1	270	270

### Post-Allowance-and-Post-Issuance:

**Extension-of-Time:**

Description	Fee Code	Quantity	Amount	Sub-Total in USD(\$)
<b>Miscellaneous:</b>				
<b>Total in USD (\$)</b>				<b>270</b>

## Electronic Acknowledgement Receipt

<b>EFS ID:</b>	9357099
<b>Application Number:</b>	90009301
<b>International Application Number:</b>	
<b>Confirmation Number:</b>	6609
<b>Title of Invention:</b>	USER SPECIFIC AUTOMATIC DATA REDIRECTION SYSTEM
<b>First Named Inventor/Applicant Name:</b>	6,779,118 B1
<b>Customer Number:</b>	40401
<b>Filer:</b>	Abraham Hershkovitz
<b>Filer Authorized By:</b>	
<b>Attorney Docket Number:</b>	R1341006
<b>Receipt Date:</b>	01-FEB-2011
<b>Filing Date:</b>	17-DEC-2008
<b>Time Stamp:</b>	18:59:20
<b>Application Type:</b>	Reexam (Third Party)

### Payment information:

Submitted with Payment	yes
Payment Type	Credit Card
Payment was successfully received in RAM	\$270
RAM confirmation Number	7094
Deposit Account	
Authorized User	

### File Listing:

Document Number	Document Description	File Name	File Size(Bytes)/ Message Digest	Multi Part	Pages (if-app)

1	Transmittal Letter	R1341006_A13_transmittal.pdf	51828 6470e1686986f9d9a2f92ea2c77f090505a9e7b4	no	1
<b>Warnings:</b>					
<b>Information:</b>					
2	Appeal Brief-Owner	R1341006_A13_appeal_brief.pdf	1437657 6bba9885c3a7baa0a0c600f3c299e162544ae750	no	45
<b>Warnings:</b>					
<b>Information:</b>					
3	Reexam Miscellaneous Incoming Letter	R1341006_A13_exhibit_A.pdf	27848 beb41fd398f487a5f1a95077b687a448fa95c23	no	2
<b>Warnings:</b>					
<b>Information:</b>					
4	Reexam Miscellaneous Incoming Letter	R1341006_A13_exhibit_B.pdf	1051757 f96dc3cb974742ec77d39cc153d60667e09594e8	no	24
<b>Warnings:</b>					
<b>Information:</b>					
5	Reexam Miscellaneous Incoming Letter	R1341006_A13_exhibit_C.pdf	1026230 203331d586b08ccd2f4cab7739c8f79a10233c25	no	16
<b>Warnings:</b>					
<b>Information:</b>					
6	Reexam Miscellaneous Incoming Letter	R1341006_A13_exhibit_D.pdf	331571 56bb56b85716b62ccc650e1dd1fada9b475e988ca	no	8
<b>Warnings:</b>					
<b>Information:</b>					
7	Fee Worksheet (PTO-875)	fee-info.pdf	30256 8a45e959bfc50ceb26e5053f1b988508af91fb90	no	2
<b>Warnings:</b>					
<b>Information:</b>					
<b>Total Files Size (in bytes):</b>			3957147		

**This Acknowledgement Receipt evidences receipt on the noted date by the USPTO of the indicated documents, characterized by the applicant, and including page counts, where applicable. It serves as evidence of receipt similar to a Post Card, as described in MPEP 503.**

**New Applications Under 35 U.S.C. 111**

**If a new application is being filed and the application includes the necessary components for a filing date (see 37 CFR 1.53(b)-(d) and MPEP 506), a Filing Receipt (37 CFR 1.54) will be issued in due course and the date shown on this Acknowledgement Receipt will establish the filing date of the application.**

**National Stage of an International Application under 35 U.S.C. 371**

**If a timely submission to enter the national stage of an international application is compliant with the conditions of 35 U.S.C. 371 and other applicable requirements a Form PCT/DO/EO/903 indicating acceptance of the application as a national stage submission under 35 U.S.C. 371 will be issued in addition to the Filing Receipt, in due course.**

**New International Application Filed with the USPTO as a Receiving Office**

**If a new international application is being filed and the international application includes the necessary components for an international filing date (see PCT Article 11 and MPEP 1810), a Notification of the International Application Number and of the International Filing Date (Form PCT/RO/105) will be issued in due course, subject to prescriptions concerning national security, and the date shown on this Acknowledgement Receipt will establish the international filing date of the application.**

IN THE UNITED STATES PATENT AND TRADEMARK OFFICE

Inventor: Koichiro Ikudome, et al.

Art Unit: 3992

Reexamination Proceeding: 90/009,301  
(based on U.S. Patent No. 6,779,118)

Confirmation No.: 6609

Reexamination Filed: December 17, 2008

Examiner: Sam Rimell

For: USER SPECIFIC AUTOMATIC DATA REDIRECTION SYSTEM

**NOTICE OF APPEAL**

Attn: Mail Stop "Board of Patent Appeals and Interferences"  
Commissioner for Patents  
United States Patent & Trademark Office  
P.O. Box 1450  
Alexandria, Virginia 23313-1450

Sir:

Patent Owner hereby appeals to the Board of Patent Appeals and Interferences from the final Office Action mailed August 2, 2010, and the Advisory Action dated November 15, 2010 in which the Examiner finally rejected patented claims 1-27 and new claims 28-47.

The Appeal fee is being submitted concurrently through EFS. However, the Patent and Trademark Office is hereby authorized to charge any fees in connection herewith or any fees necessary to preserve the pendency of this Reexamination Proceeding, or credit any overpayment, to H&A Deposit Account No. 50-2929, referencing Attorney Docket No. R1341006.



A copy of this Notice of Appeal is being served on the third party requester pursuant to 37 CFR 1.248 and 37 CFR 1.550(f).

Respectfully submitted,  
LINKSMART WIRELESS TECHNOLOGY, LLC



---

Abraham Hershkovitz  
Reg. No. 45,294

Ed Garcia-Otero  
Reg. No. 56,609

December 1, 2010  
HERSHKOVITZ & ASSOCIATES, LLC  
2845 Duke Street  
Alexandria, VA 22314  
TEL: (703) 370-4800  
FAX: (703) 370-4809  
E-MAIL: [patent@hershkovitz.net](mailto:patent@hershkovitz.net)

AH/EG

**CERTIFICATE OF SERVICE**

It is hereby certified that the attached Notice of Appeal is being served by first class mail on the third party requester at the third party requestor's address:

JERRY TURNER SEWELL  
P.O. BOX 10999  
NEWPORT BEACH, CA 92658-5015

  
Abraham Hershkovitz

December 1, 2010  
Date

Under the Paperwork Reduction Act of 1995, no persons are required to respond to a collection of information unless it displays a valid OMB control number.

<b>NOTICE OF APPEAL FROM THE EXAMINER TO                  THE BOARD OF PATENT APPEALS AND INTERFERENCES</b>	Docket Number (Optional) <b>R1341006</b>
---	---

I hereby certify that this correspondence is being facsimile transmitted to the USPTO or deposited with the United States Postal Service with sufficient postage as first class mail in an envelope addressed to "Commissioner for Patents, P.O. Box 1450, Alexandria, VA 22313-1450" [37 CFR 1.8(a)] on _____  Signature _____  Typed or printed name _____	In re Application of <b>IKUDOME et al.</b>  <table border="1" style="width:100%; border-collapse: collapse;"> <tr> <td style="width:50%;">Application Number <b>90/009,301</b></td> <td style="width:50%;">Filed <b>12/17/2008</b></td> </tr> </table> For <b>USER SPECIFIC AUTOMATIC DATA REDIRECTION SYSTEM</b>  <table border="1" style="width:100%; border-collapse: collapse;"> <tr> <td style="width:50%;">Art Unit <b>3992</b></td> <td style="width:50%;">Examiner <b>Sam RIMELL</b></td> </tr> </table>	Application Number <b>90/009,301</b>	Filed <b>12/17/2008</b>	Art Unit <b>3992</b>	Examiner <b>Sam RIMELL</b>
Application Number <b>90/009,301</b>	Filed <b>12/17/2008</b>				
Art Unit <b>3992</b>	Examiner <b>Sam RIMELL</b>				

Applicant hereby **appeals** to the Board of Patent Appeals and Interferences from the last decision of the examiner.

The fee for this Notice of Appeal is (37 CFR 41.20(b)(1)) \$ 540.00

- Applicant claims small entity status. See 37 CFR 1.27. Therefore, the fee shown above is reduced by half, and the resulting fee is: \$ 270.00
- A check in the amount of the fee is enclosed.
- Payment by credit card. *Via EFS.*
- The Director has already been authorized to charge fees in this application to a Deposit Account.
- The Director is hereby authorized to charge any fees which may be required, or credit any overpayment to Deposit Account No. 50-2929
- A petition for an extension of time under 37 CFR 1.136(a) (PTO/SB/22) is enclosed.

**WARNING: Information on this form may become public. Credit card information should not be included on this form. Provide credit card information and authorization on PTO-2038.**

I am the

- applicant/inventor.
- assignee of record of the entire interest.  
See 37 CFR 3.71. Statement under 37 CFR 3.73(b) is enclosed.  
(Form PTO/SB/96)
- attorney or agent of record. 45,294  
Registration number \_\_\_\_\_
- attorney or agent acting under 37 CFR 1.34.  
Registration number if acting under 37 CFR 1.34. \_\_\_\_\_

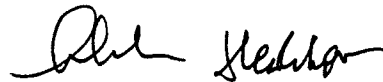

Signature

**ABRAHAM HERSHKOVITZ**

Typed or printed name

703-370-4800

Telephone number

DECEMBER 1, 2010

Date

NOTE: Signatures of all the inventors or assignees of record of the entire interest or their representative(s) are required. Submit multiple forms if more than one signature is required, see below\*.

\*Total of \_\_\_\_\_ forms are submitted.

This collection of information is required by 37 CFR 41.31. The information is required to obtain or retain a benefit by the public which is to file (and by the USPTO to process) an application. Confidentiality is governed by 35 U.S.C. 122 and 37 CFR 1.11, 1.14 and 41.6. This collection is estimated to take 12 minutes to complete, including gathering, preparing, and submitting the completed application form to the USPTO. Time will vary depending upon the individual case. Any comments on the amount of time you require to complete this form and/or suggestions for reducing this burden, should be sent to the Chief Information Officer, U.S. Patent and Trademark Office, U.S. Department of Commerce, P.O. Box 1450, Alexandria, VA 22313-1450. DO NOT SEND FEES OR COMPLETED FORMS TO THIS ADDRESS. **SEND TO: Commissioner for Patents, P.O. Box 1450, Alexandria, VA 22313-1450.**

*If you need assistance in completing the form, call 1-800-PTO-9199 and select option 2.*

## Electronic Patent Application Fee Transmittal

<b>Application Number:</b>	90009301
<b>Filing Date:</b>	17-Dec-2008
<b>Title of Invention:</b>	USER SPECIFIC AUTOMATIC DATA REDIRECTION SYSTEM
<b>First Named Inventor/Applicant Name:</b>	6,779,118 B1
<b>Filer:</b>	Abraham Hershkovitz/Daniel James
<b>Attorney Docket Number:</b>	R1341006

Filed as Small Entity

### ex parte reexam Filing Fees

Description	Fee Code	Quantity	Amount	Sub-Total in USD(\$)
<b>Basic Filing:</b>				
<b>Pages:</b>				
<b>Claims:</b>				
<b>Miscellaneous-Filing:</b>				
<b>Petition:</b>				
<b>Patent-Appeals-and-Interference:</b>				
Notice of appeal	2401	1	270	270

### Post-Allowance-and-Post-Issuance:

### Extension-of-Time:

Description	Fee Code	Quantity	Amount	Sub-Total in USD(\$)
<b>Miscellaneous:</b>				
<b>Total in USD (\$)</b>				<b>270</b>

## Electronic Acknowledgement Receipt

<b>EFS ID:</b>	8946702
<b>Application Number:</b>	90009301
<b>International Application Number:</b>	
<b>Confirmation Number:</b>	6609
<b>Title of Invention:</b>	USER SPECIFIC AUTOMATIC DATA REDIRECTION SYSTEM
<b>First Named Inventor/Applicant Name:</b>	6,779,118 B1
<b>Customer Number:</b>	40401
<b>Filer:</b>	Abraham Hershkovitz/Dinh Nguyen
<b>Filer Authorized By:</b>	Abraham Hershkovitz
<b>Attorney Docket Number:</b>	R1341006
<b>Receipt Date:</b>	01-DEC-2010
<b>Filing Date:</b>	17-DEC-2008
<b>Time Stamp:</b>	17:25:01
<b>Application Type:</b>	Reexam (Patent Owner)

### Payment information:

Submitted with Payment	yes
Payment Type	Credit Card
Payment was successfully received in RAM	\$270
RAM confirmation Number	4615
Deposit Account	
Authorized User	

### File Listing:

Document Number	Document Description	File Name	File Size(Bytes)/ Message Digest	Multi Part	Pages (if-app)

1		R1341006_Submission.pdf	167966 68d15b2930016bbdf4ec83bd324cb3c1a4140efa	yes	5
<b>Multipart Description/PDF files in .zip description</b>					
		<b>Document Description</b>	<b>Start</b>	<b>End</b>	
		Transmittal Letter	1	1	
		Notice of Appeal Filed	2	3	
		Reexam Certificate of Service	4	4	
		Notice of Appeal Filed	5	5	
<b>Warnings:</b>					
<b>Information:</b>					
2	Fee Worksheet (PTO-875)	fee-info.pdf	30091 7df2482cd1562a08255096bda1ec00ecf907306d	no	2
<b>Warnings:</b>					
<b>Information:</b>					
<b>Total Files Size (in bytes):</b>			198057		
<p><b>This Acknowledgement Receipt evidences receipt on the noted date by the USPTO of the indicated documents, characterized by the applicant, and including page counts, where applicable. It serves as evidence of receipt similar to a Post Card, as described in MPEP 503.</b></p> <p><b><u>New Applications Under 35 U.S.C. 111</u></b>  <b>If a new application is being filed and the application includes the necessary components for a filing date (see 37 CFR 1.53(b)-(d) and MPEP 506), a Filing Receipt (37 CFR 1.54) will be issued in due course and the date shown on this Acknowledgement Receipt will establish the filing date of the application.</b></p> <p><b><u>National Stage of an International Application under 35 U.S.C. 371</u></b>  <b>If a timely submission to enter the national stage of an international application is compliant with the conditions of 35 U.S.C. 371 and other applicable requirements a Form PCT/DO/EO/903 indicating acceptance of the application as a national stage submission under 35 U.S.C. 371 will be issued in addition to the Filing Receipt, in due course.</b></p> <p><b><u>New International Application Filed with the USPTO as a Receiving Office</u></b>  <b>If a new international application is being filed and the international application includes the necessary components for an international filing date (see PCT Article 11 and MPEP 1810), a Notification of the International Application Number and of the International Filing Date (Form PCT/RO/105) will be issued in due course, subject to prescriptions concerning national security, and the date shown on this Acknowledgement Receipt will establish the international filing date of the application.</b></p>					

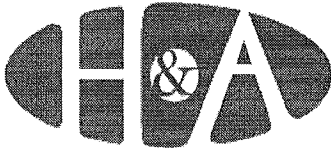

# HERSHKOVITZ & ASSOCIATES, LLC

PATENT AGENCY

2845 DUKE STREET, ALEXANDRIA, VA 22314

TEL. 703-370-4800 ~ FACSIMILE 703-370-4809

patent@hershkovitz.net ~ www.hershkovitz.net

Inventor: IKUDOME, Koichiro *et al.*  
Reexamination Proceeding: 90/009,301  
(based on U.S. Patent No. 6,779,118)  
Reexamination Filed: December 17, 2008

Docket No.: R1341006  
Confirmation No.: 6609  
Art Unit: 3992  
Examiner: RIMELL, Samuel

For: USER SPECIFIC AUTOMATIC DATA REDIRECTION SYSTEM

Mail Stop: Ex Parte Reexam  
Central Reexamination Unit  
COMMISSIONER FOR PATENTS  
P.O. Box 1450  
Alexandria, Virginia 22313-1450

Dear Commissioner:

Transmitted herewith: **NOTICE OF APPEAL** and **FORM PTO/SB/31** in the above proceeding.

The fee has been calculated as shown below:

Claims After Amendment	No. of Claims Previously Paid	Present Extra	Small Entity		Large Entity	
			Rate	Fee	Rate	Fee
Total Claims:			x 26=	\$	X 52=	\$
Indep. Claims:			x 110=	\$	X 220=	\$
<b>Notice of Appeal Fee</b>				\$270.00		\$
Total:				<b>\$270.00</b>		<b>\$</b>

Payment made via EFS.

The U.S. Patent and Trademark Office is hereby authorized to charge payment of the following fees associated with this communication or credit any overpayment to Deposit Account No. **50-2929**:

Any additional filing fees required under 37 C.F.R. 1.16.

Any patent application processing fees under 37 C.F.R. 1.17, including any required extension of time fees in any concurrent or future reply requiring a petition for extension of time for its timely submission (37 CFR 1.136)(a)(3).

December 1, 2010  
Date

Abraham Hershkovitz  
Reg. No. 45,294

R1341006.A12 AH/ dj



IN THE UNITED STATES PATENT AND TRADEMARK OFFICE

Inventor: Koichiro Ikudome, et al.

Art Unit: 3992

Reexamination Proceeding: 90/009,301  
(based on U.S. Patent No. 6,779,118)

Confirmation No.: 6609

Reexamination Filed: December 17, 2008

Examiner: Sam Rimell

For: USER SPECIFIC AUTOMATIC DATA REDIRECTION SYSTEM

**AFTER FINAL RESPONSE UNDER 37 CFR 1.116  
AND PROPOSED AMENDMENT UNDER 37 CFR 1.530**

Attn: Mail Stop "Ex Parte Reexamination"  
August 20, 2010  
Central Reexamination Unit  
Commissioner for Patents  
United States Patent & Trademark Office  
P.O. Box 1450  
Alexandria, Virginia 23313-1450

Dear Commissioner:

This after final Response is in reply to the final Office Action mailed August 2, 2010, and the Personal Interview held on September 21, 2010 in the above-identified *ex-parte* reexamination proceeding. The due date for filing a Response is October 2, 2010. Accordingly, this Response is timely filed.

Statement of Interview and an Information Disclosure Statement (IDS) are being submitted concurrently. Please amend the present claims and add new claims as proposed below and consider the detailed traversal below, wherein:

The Status of claims is listed on page 2 of this paper.

Amendments to the Claims begin on page 3 of this paper.

Remarks/Arguments begin on page 7 of this paper.

Evidence of Service of this Response on the 3<sup>rd</sup> party requester is found after the last page of this paper.

Enter upon filing of Notice of Appeal, Appeal Brief, and requisite fees ESK for SR 15 NOV 2012



UNITED STATES PATENT AND TRADEMARK OFFICE

UNITED STATES DEPARTMENT OF COMMERCE  
United States Patent and Trademark Office  
Address: COMMISSIONER FOR PATENTS  
P.O. Box 1450  
Alexandria, Virginia 22313-1450  
www.uspto.gov

APPLICATION NO.	FILING DATE	FIRST NAMED INVENTOR	ATTORNEY DOCKET NO.	CONFIRMATION NO.
90/009,301	12/17/2008	6,779,118 B1	R1341006	6609
40401	7590	11/15/2010	EXAMINER	
Hershkovitz & Associates, LLC 2845 Duke Street Alexandria, VA 22314			ART UNIT	PAPER NUMBER

DATE MAILED: 11/15/2010

Please find below and/or attached an Office communication concerning this application or proceeding.



UNITED STATES PATENT AND TRADEMARK OFFICE

---

Commissioner for Patents  
United States Patents and Trademark Office  
P.O. Box 1450  
Alexandria, VA 22313-1450  
www.uspto.gov

THIRD PARTY REQUESTER'S CORRESPONDENCE ADDRESS  
JERRY TURNER SEWELL  
P.O. BOX 10999  
NEWPORT BEACH, CA 92658-5015

Date:

MAILED

NOV 15 2010

CENTRAL REEXAMINATION UNIT

**EX PARTE REEXAMINATION COMMUNICATION TRANSMITTAL FORM**

REEXAMINATION CONTROL NO. : 90009301  
PATENT NO. : 6779118  
ART UNIT : 3992

Enclosed is a copy of the latest communication from the United States Patent and Trademark Office in the above identified ex parte reexamination proceeding (37 CFR 1.550(f)).

Where this copy is supplied after the reply by requester, 37 CFR 1.535, or the time for filing a reply has passed, no submission on behalf of the ex parte reexamination requester will be acknowledged or considered (37 CFR 1.550(g)).

---

**Ex Parte Reexamination  
Advisory Action  
Before the Filing of an Appeal Brief**

Control No.

90/009,301

Patent Under Reexamination

6,779,118

Examiner

Sam Rimell

Art Unit

3992

*--The MAILING DATE of this communication appears on the cover sheet with the correspondence address--*

THE PROPOSED RESPONSE FILED 02 October 2010 FAILS TO OVERCOME ALL OF THE REJECTIONS IN THE FINAL REJECTION MAILED 02 August 2010.

1.  Unless a timely appeal is filed, or other appropriate action by the patent owner is taken to overcome all of the outstanding rejection(s), this prosecution of the present *ex parte* reexamination proceeding WILL BE TERMINATED and a Notice of Intent to Issue *Ex Parte* Reexamination Certificate will be mailed in due course. Any finally rejected claims, or claims objected to, will be CANCELLED.

THE PERIOD FOR RESPONSE IS EXTENDED TO RUN 4 MONTHS FROM THE MAILING DATE OF THE FINAL REJECTION. Extensions of time are governed by 37 CFR 1.550(c).

**NOTICE OF APPEAL**

2.  An Appeal Brief is due two months from the date of the Notice of Appeal filed on \_\_\_\_\_ to avoid dismissal of the appeal. See 37 CFR 41.37(a). Extensions of time are governed by 37 CFR 1.550(c). See 37 CFR 41.37(e).

**AMENDMENTS**

3.  The proposed amendment(s) filed after a final action, but prior to the date of filing a brief, will not be entered because:
- (a)  They raise new issues that would require further consideration and/or search (see NOTE below);
  - (b)  They raise the issue of new matter (see NOTE below);
  - (c)  They are not deemed to place the proceeding in better form for appeal by materially reducing or simplifying the issues for appeal; and/or
  - (d)  They present additional claims without canceling a corresponding number of finally rejected claims.

NOTE: \_\_\_\_\_ (See 37 CFR 1.116 and 41.33(a)).

4.  Patent owner's proposed response filed 02 October 2010 has overcome the following rejection(s): Rejections under 35 USC 112, second paragraph

5.  The proposed new or amended claim(s) \_\_\_\_\_ would be allowable if submitted in a separate, timely filed amendment canceling the non-allowable claim(s).

6.  For purposes of appeal, the proposed amendment(s) a)  will not be entered, or b)  will be entered and an explanation of how the new or amended claim(s) would be rejected is provided below or appended.

The status of the claim(s) is (or will be) as follows:

Claim(s) patentable and/or confirmed: \_\_\_\_\_

Claim(s) objected to: \_\_\_\_\_

Claim(s) rejected: 1-47

Claim(s) not subject to reexamination: \_\_\_\_\_

**AFFIDAVIT OR OTHER EVIDENCE**

7.  The affidavit or other evidence filed after a final action, but before or on the date of filing a Notice of Appeal will not be entered because patent owner failed to provide a showing of good and sufficient reasons why the affidavit or other evidence is necessary and was not earlier presented. See 37 CFR 1.116(e).
8.  The affidavit or other evidence filed after the date of filing a Notice of Appeal, but prior to the date of filing a brief, will not be entered because the affidavit or other evidence fails to overcome all rejections under appeal and/or appellant failed to provide a showing of good and sufficient reasons why the affidavit or other evidence is necessary and was not earlier presented. See 37 CFR 41.33(d)(1).
9.  The affidavit or other evidence is entered. An explanation of the status of the claims after entry is below or attached.

**REQUEST FOR RECONSIDERATION/OTHER**

10.  The request for reconsideration has been considered but does NOT place the application in condition for allowance because: See "Attachment to Advisory Action".
11.  Note the attached Information Disclosure Statement(s), PTO/SB/08, Paper No(s) \_\_\_\_\_.
12.  Other: \_\_\_\_\_

/Sam Rimell/

Primary Examiner, Art Unit 3992

cc: Requester (if third party requester)

**Attachment to Advisory Action**

Preliminary Observation: Patent owner at page 13 of the remarks provides a copy of a drawing from US Patent 6,088,451 to He et al which is alleged to represent FIG 10. It is noted that the figure provided in the remarks represents FIG 2, not FIG. 10. The examiner's final rejection references FIG 10.

(1) Patent owner at pages 9-12 presents a discussion regarding a flow chart that was previously considered and addressed during the interview of September 21, 2010. The examiner's position regarding this flow chart was addressed in the interview summary as follows:

“Examiners replied that each of the independent claims are addressed to a physical system, and that the claims do not define a seven step ordered sequence as suggested by the flow chart. Examiners indicated that such arguments would not be persuasive in addressing the statutory rejection”.

For example, claim 1 is addressed to a physical system defined by four physical structures (a database, a dial-up network server, a redirection server, and an authentication accounting server). The claims then sets forth two “wherein clauses” that define functionalities associated with the physical structures, not a sequential set of steps. As a result, the recited "flow chart" has no bearing the claim language as it currently appears, since the claims does not define a set of seven sequential method steps.

(2) Patent owner at page 14, last paragraph states:

*“After sending the credential ticket back to the user, the credential server (204) (the examiner improperly equated the credential server with a redirection server) is not involved in the communications between a user (102) and a network element (104)”.*

Art Unit: 3992

This assertion is not correct. In the reference to He et al, the user 102 cannot communicate with the network elements unless processing of an authorization list occurs at the credential server 204. Thus it is incorrect to state that the credential server is "not involved" in user communications with network elements 104. It is involved in this communication in that such communication would not be possible without the processing action of the credential server 204.

(3) Patent owner at page 16, last paragraph states:

*"Rather, the examiner was asserting that a redirection server did not necessarily have to be capable of performing redirection".*

No such assertion has been made by the examiners. The position of the examiners is that the term "redirection server" encompasses the block/pass function disclosed in He et al. This is due to the fact that: (a) the claims do not define the nature of redirection, and (b) the reexamination patent explicitly defines the block/pass function as a redirection function (see US Patent 6,779,118 at, for example, col. 3, lines 12-21). Also see the remarks on this same issue in the final office action at page 27, third paragraph through page 28, fourth paragraph.

(4) Patent owner at page 17, last four paragraphs indicate that the meaning of the term "redirection server" is dependent upon the meaning of this term as it was applied in a *Markman* hearing. This assertion is not correct. The USPTO is not bound to the claim constructions developed during a *Markman* hearing (*In re Trans Texas Holdings Corp.*, 498 F.3d 1290, 83 USPQ2d 1835 (Fed. Cir. 2007) and *In re Translogic Technology, Inc.*, 504 F.3d 1249, 84 USPQ2d 1929 (Fed. Cir. 2007).

(5) Patent owner at page 19, fourth paragraph states:

*“Patent owner submits that the “redirection server connected to the dial up network server and a public network” feature of claim 1 is not disclosed by the combination of He’ 451 and Zenchelsky”.*

This assertion is not correct. He et al at FG 10 illustrates redirection server 204, dial up server 1002 and public network 106 as being clearly interconnected.

(6) Patent owner at page 19, last paragraph states:

*“Element 106 of He et al is a local network, not a public network”.*

This assertion is incorrect. The network 106 in He et al is the Internet (col. 30, lines 47-57). There is no basis for asserting that the network 106 He et al is limited to a LAN.

(7) Patent owner at page 22, sixth paragraph states:

*“In contrast to claim 1, the credential server of He’ 451 merely receives a message from user 102 and then sends a credential ticket back to the user. Neither the message from the user, nor the credential ticket to the user, disclose data directed toward the public network”.*

He et al does disclose communications between the user the public network 106, with such communications permitted by the granting of limited access privileges to that public network. While it is true that He et al does disclose the transmission and receipt of tickets between the user and the credential server, it further discloses the user's communication with the public network based upon the credentials obtained from these tickets.

(8) While patent owner’s remaining arguments address all the remaining claims of record, these arguments address primarily address the same issues as addressed in sections (1)-(7) above.

FORM PTO/SB/08A/B (10-01) Substitute for PTO-1449A/B  <b>INFORMATION DISCLOSURE</b>  <b>STATEMENT BY APPLICANT</b>  (use as many sheets as necessary)	<b>Attorney Docket Number</b>	62986/A522 (R1341006)
	<b>Application Number</b>	90/009,301
	<b>Filing Date</b>	December 17, 2008
	<b>Applicant(s)</b>	Ikudome, Koichiro et al.
	<b>Group Art Unit</b>	3992
	<b>Examiner Name</b>	Rimell, Samuel G.

U.S. PATENT DOCUMENTS				
EXAMINER INITIALS	Cite No. <sup>1</sup>	DOCUMENT NUMBER Number - Kind Code <sup>2</sup> (if known)	PUBLICATION DATE MM-DD-YYYY	NAME OF PATENTEE

FOREIGN PATENT DOCUMENTS					
EXAMINER INITIALS	Cite No. <sup>1</sup>	Foreign Patent Document Country Code <sup>2</sup> - Number <sup>3</sup> - Kind Code <sup>4</sup> (if known)	Publication Date MM-DD-YYYY	Name of Patentee or Applicant of Cited Document	T <sup>5</sup> (✓)

PRINTED PUBLICATIONS		
EXAMINER INITIALS	Cite No. <sup>1</sup>	Include name of the author (in CAPITAL LETTERS), title of the article, title of the item (book, magazine, journal, serial, symposium, catalog, etc.), date, page(s), volume-issue number(s), publisher, city and/or country where published
<i>d</i>	C39	Armistead, Jason, Internet post: "Re: redirect," dated March 2, 1998, as archived at <www.squid-cache.org>, document states that archive was generated on December 9, 2003, 2 pages.
<i>d</i>	C40	Comer, Douglas, Internetworking with TCP/IP, 3rd ed., vol. 1, cover, title page, p. 46 (3 pages) 1995.
<i>A</i>	C41	Dominik, Internet post: "redirect," dated November 30, 1997, as archived at <www.squid-cache.org>, document states that archive was generated on December 9, 2003, 1 page.
<i>A</i>	C42	"MAX 6000 Series Administration Guide," Ascend Communications, Inc., 428 pages, (copyright notice 1998).
<i>A</i>	C43	"MAX 6000 Series Hardware Installation Guide," Ascend Communications, Inc., 159 pages, (copyright notice 1998).
<i>A</i>	C44	"MAX 6000 Series Network Configuration Guide," Ascend Communications, Inc., 523 pages, (copyright notice 1998).
<i>A</i>	C45	"MAX 800 Series Administration Guide," Ascend Communications, Inc., 286 pages, (copyright notice 1998).
<i>A</i>	C46	"MAX 800 Series Hardware Installation Guide," Ascend Communications, Inc., 51 pages, (copyright notice 1998).
<i>A</i>	C47	"MAX 800 Series Network Configuration Guide," Ascend Communications, Inc., 280 pages, (copyright notice 1998).

EXAMINER SIGNATURE	<i>Samuel G. Rimell</i>	DATE CONSIDERED	11/9/10
EXAMINER: Initial if reference considered, whether or not citation is in conformance with MPEP 609; Draw line through citation if not in conformance and not considered. Include copy of this form with next communication to applicant. <sup>1</sup> Applicant's unique citation designation number (optional). <sup>2</sup> See Kinds Codes of USPTO Patent Documents at www.pto.gov or MPEP 901.4. <sup>3</sup> Enter Office that issued the document, by the two-letter code (WIPO standard ST.3). <sup>4</sup> For Japanese patent documents, the indication of the year of the reign of the Emperor must precede the serial number of the patent document. <sup>5</sup> Kind of document by the appropriate symbols as indicated on the document under WIPO Standard ST.16 if possible. <sup>6</sup> Applicant is to place a check mark here if English Language Translation is attached.			

Patent and Trademark Office; U.S. DEPARTMENT OF COMMERCE



FORM PTO/SB/08A/B (10-01) Substitute for PTO-1449A/B  <b>INFORMATION DISCLOSURE</b>  <b>STATEMENT BY APPLICANT</b>  (use as many sheets as necessary)	<b>Attorney Docket Number</b>	62986/A522 (R1341006)
	<b>Application Number</b>	90/009,301
	<b>Filing Date</b>	December 17, 2008
	<b>Applicant(s)</b>	Ikudome, Koichiro et al.
	<b>Group Art Unit</b>	3992
	<b>Examiner Name</b>	Rimell, Samuel G.

PRINTED PUBLICATIONS		
EXAMINER INITIALS	Cite No. <sup>1</sup>	Include name of the author (in CAPITAL LETTERS), title of the article, title of the item (book, magazine, journal, serial, symposium, catalog, etc.), date, page(s), volume-issue number(s), publisher, city and/or country where published.
<i>d</i>	C48	"MAX Glossary," Ascend Communications, Inc., 226pages, (copyright notice 1998).
<i>d</i>	C49	"MAX RADIUS Configuration Guide," Ascend Communications, Inc., 556 pages, (copyright notice 1998).
<i>d</i>	C50	"MAX Reference Guide," Ascend Communications, Inc., 307 pages, (copyright notice 1998).
<i>d</i>	C51	"MAX Security Supplement," Ascend Communications, Inc., 176 pages, (copyright notice 1998).
<i>d</i>	C52	"NavisConnect User's Guide," Ascend Communications, Inc., 46 pages, (copyright notice 1998).
<i>d</i>	C53	Nordstrom, Henrik, Internet post: "Re: redirect," dated March 2, 1998, as archived at <www.squid-cache.org>, document states that archive was generated on December 9, 2003, 1 page.
	C54	<del>PC Work, article with picture of ODN Web Card, 1 page, December 1998, Japan (in Japanese).</del>

OTHER INFORMATION 37 CFR 1.98(a)(2)(iv)		
EXAMINER INITIALS	Cite No. <sup>1</sup>	Title of the item, date (if any), page(s), other information.
<i>xy</i>	D7	<del>Best Western's Supplemental Claim Construction Brief, Linksmart Wireless Technology, LLC v. T-Mobile USA, Inc., et al., U.S. District Court of Eastern District of Texas, Marshall Division, Case No. 2:08-cv-00264-DF-CE, filed April 16, 2010, pp. 1-16 (including Exhibits 1-2)</del>
<i>xy</i>	D8	<del>Claim Construction Brief of Defendants, Linksmart Wireless Technology, LLC v. T-Mobile USA, Inc., et al., U.S. District Court of Eastern District of Texas, Marshall Division, Case No. 2:08-cv-00264-DF-CE, filed April 16, 2010, pp. 1-39</del>
<i>xy</i>	D9	<del>Declaration of Kevin Jeffay, PH.D, Linksmart Wireless Technology, LLC v. T-Mobile USA, Inc., et al., U.S. District Court of Eastern District of Texas, Marshall Division, Case No. 2:08-cv-00264-DF-CE, filed April 16, 2010, pp. 1-21 (including Exhibit A)</del>
<i>xy</i>	D10	<del>Invalidity Contentions of AT&amp;T et al., Linksmart Wireless Technology, LLC v. T-Mobile USA, Inc., et al., Case Nos. (consolidated) 2:08-cv-00264-DF-CE, 2:08-cv-00304-DF-CE, 2:08-cv-00385-DF-CD, 2:09-cv-00026-DE-CE, U.S. District Court, Eastern District of Texas, Marshall Division, 754 pages (including appendixes A-C), October 8, 2009</del>

*xy* DOES NOT COMPLY WITH 37 CFR 1.98 (A)(3)(ii) *xy* NOT A PATENT OR PRINTED PUBLICATION (35 USC 301)

EXAMINER SIGNATURE	<i>[Signature]</i>	DATE CONSIDERED	11/9/10
EXAMINER: Initial if reference considered, whether or not citation is in conformance with MPEP 609; Draw line through citation if not in conformance and not considered. Include copy of this form with next communication to applicant. <sup>1</sup> Applicant's unique citation designation number (optional). <sup>2</sup> See Kinds Codes of USPTO Patent Documents at www.pto.gov or MPEP 901.4. <sup>3</sup> Enter Office that issued the document, by the two-letter code (WIPO standard ST.3). <sup>4</sup> For Japanese patent documents, the indication of the year of the reign of the Emperor must precede the serial number of the patent document. <sup>5</sup> Kind of document by the appropriate symbols as indicated on the document under WIPO Standard ST.16 if possible. <sup>6</sup> Applicant is to place a check mark here if English Language Translation is attached.			

Patent and Trademark Office; U.S. DEPARTMENT OF COMMERCE

<b>FORM PTO/SB/08A/B (10-01)</b> Substitute for PTO-1449A/B  <b>INFORMATION DISCLOSURE</b>  <b>STATEMENT BY APPLICANT</b>  (use as many sheets as necessary)	<b>Attorney Docket Number</b>	62986/A522 (R1341006)
	<b>Application Number</b>	90/009,301
	<b>Filing Date</b>	December 17, 2008
	<b>Applicant(s)</b>	Ikudome, Koichiro et al.
	<b>Group Art Unit</b>	3992
	<b>Examiner Name</b>	Rimell, Samuel G.

OTHER INFORMATION 37 CFR 1.98(a)(2)(iv)		
EXAMINER INITIALS	Cite No. <sup>1</sup>	Title of the item, date (if any), page(s), other information.
	D11	Invalidity Contentions of T-Mobile USA, Inc. et al., Linksmart Wireless Technology, LLC v. T-Mobile USA, Inc., et al., Case Nos. (consolidated) <del>2:08-cv-00264-DF-CE</del> , 2:08-cv-00304-DFCE, 2:08-cv-00385-DF-CD, 2:09-cv-00026-DF-CE, U.S. District Court, Eastern District of Texas, Marshall Division, 325 pages (including appendix A), October 8, 2009

ASL PAS927589.1-\* -11/11/10 5:06 PM

*NOT A PATENT OR PRINTED PUBLICATION (35 USC 301)*

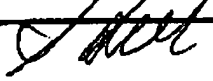
EXAMINER SIGNATURE		DATE CONSIDERED	11/9/10
<small>EXAMINER: Initial if reference considered, whether or not citation is in conformance with MPEP 609; Draw line through citation if not in conformance and not considered. Include copy of this form with next communication to applicant. <sup>1</sup>Applicant's unique citation designation number (optional). <sup>2</sup>See Kinds Codes of USPTO Patent Documents at www.pto.gov or MPEP 901.4. <sup>3</sup>Enter Office that issued the document, by the two-letter code (WIPO standard ST.3). <sup>4</sup>For Japanese patent documents, the indication of the year of the reign of the Emperor must precede the serial number of the patent document. <sup>5</sup>Kind of document by the appropriate symbols as indicated on the document under WIPO Standard ST.16 if possible. <sup>6</sup>Applicant is to place a check mark here if English Language Translation is attached.</small>			

Patent and Trademark Office, U.S. DEPARTMENT OF COMMERCE

FORM PTO/SB/08A/B (10-01) Substitute for PTO-1449A/B  <b>INFORMATION DISCLOSURE</b>  <b>STATEMENT BY APPLICANT</b>  (use as many sheets as necessary)	<b>Attorney Docket Number</b>	62986/A522
	<b>Application Number</b>	90/009301
	<b>Filing Date</b>	December 17, 2008
	<b>Applicant(s)</b>	6,779,118 B1
	<b>Group Art Unit</b>	3992
	<b>Examiner Name</b>	Rimell, Samuel G.

U.S. PATENT DOCUMENTS				
EXAMINER INITIALS	Cite No. <sup>1</sup>	DOCUMENT NUMBER Number - Kind Code <sup>2</sup> (if Known)	PUBLICATION DATE MM-DD-YYYY	NAME OF PATENTEE

FOREIGN PATENT DOCUMENTS					
EXAMINER INITIALS	Cite No. <sup>1</sup>	Foreign Patent Document Country Code <sup>1</sup> - Number <sup>1</sup> - Kind Code <sup>2</sup> (if Known)	Publication Date MM-DD-YYYY	Name of Patentee or Applicant of Cited Document	T* (v)

PRINTED PUBLICATIONS		
EXAMINER INITIALS	Cite No. <sup>1</sup>	Include name of the author (in CAPITAL LETTERS), title of the article, title of the item (book, magazine, journal, serial, symposium, catalog, etc.), date, page(s), volume-issue number(s), publisher, city and/or country where published.
sl	C28	"ChoiceNet Administrator's Guide," Livingston Enterprises, 88 pages, January 1997.
sl	C29	"Livingston ChoiceNet - How It Works," <www.livingston.com/Marketing/Products/choicenet_HIW.shtml>, retrieved from <web.archive.org>, purportedly archived on April 30, 1997, 1 page.
sl	C30	MALKIN, <i>Comprehensive Networking Glossary and Acronym Guide</i> , 1995, title page, preface, pp. 46-47, 114-115, 154-155 (4 pages).
sl	C31	"MAX T1/PRI RADIUS Supplement," Ascend Communications, Inc., 82 pages, 1996.
sl	C32	NEWTON, <i>Newton's Telecom Dictionary</i> , Telecom Books and Flatiron Publishing, 10th ed., January 1998, cover, title page, p. 194 (3 pages).
*	C33	"ODN Web Card," <http://www.asahi.com/ad/clients/touuhan/entry.html>, 1 page, March-April 1998, Japan (in Japanese).
sl	C34	"Proxy Server Version 2.0: Reviewer's Guide," Microsoft, 88 pages, 1997.
sl	C35	"sampleNET Products," <samplenet.com>, retrieved from <web.archive.org>, purportedly archived on April 4, 1997, 2 pages.
sl	C36	Sclater, Neil, Markus, John, <i>McGraw-Hill Electronics Dictionary</i> , 6th ed., 1997, cover, title pages (2), pp. 110, 119 (5 pages).
*	C37	<del>Trendy, article on second page with picture of Japan Telecom ODN Web Card, 2 pages, May 1998, Japan (in Japanese).</del>

EXAMINER SIGNATURE	<i>Sl</i>	DATE CONSIDERED	11/2/08
--------------------	-----------	-----------------	---------

EXAMINER: Initial if reference considered, whether or not citation is in conformance with MPEP 609; Draw line through citation if not in conformance and not considered. Include copy of this form with next communication to applicant. <sup>1</sup>Applicant's unique citation designation number (optional). <sup>2</sup>See Kinds Codes of USPTO Patent Documents at www.pto.gov or MPEP 901.4. <sup>3</sup>Enter Office that issued the document, by the two-letter code (WIPO standard ST.3). <sup>4</sup>For Japanese patent documents, the indication of the year of the reign of the Emperor must precede the serial number of the patent document. <sup>5</sup>Kind of document by the appropriate symbols as indicated on the document under WIPO Standard ST.16 if possible. <sup>6</sup>Applicant is to place a check mark here if English Language Translation is attached.

Patent and Trademark Office; U.S. DEPARTMENT OF COMMERCE

WWM/asl

\* DOES NOT COMPLY WITH  
37 CFR 1.98 (A) (3) (4)

Sheet 1 of 2

Panasonic-1009  
Page 555 of 1492

FORM PTO/SB/08A/B (10-01) Substitute for PTO-1449A/B  <b>INFORMATION DISCLOSURE</b>  <b>STATEMENT BY APPLICANT</b>  (use as many sheets as necessary)	Attorney Docket Number	62986/A522
	Application Number	90/009301
	Filing Date	December 17, 2008
	Applicant(s)	6,779,118 B1
	Group Art Unit	3992
	Examiner Name	Rimell, Samuel G.

PRINTED PUBLICATIONS		
EXAMINER INITIALS	Cite No. <sup>1</sup>	Include name of the author (in CAPITAL LETTERS), title of the article, title of the item (book, magazine, journal, serial, symposium, catalog, etc.), date, page(s), volume-issue number(s), publisher, city and/or country where published.
	C38	<del>Yomiuri On Line, article on second page regarding "ODN Web Card," 2 pages, February 20, 1998, Japan (in Japanese).</del>

OTHER INFORMATION 37 CFR 1.98(a)(2)(iv)		
EXAMINER INITIALS	Cite No. <sup>1</sup>	Title of the item, date (if any), page(s), other information.
	D4	<del>Linksmart Opening Claim Construction Brief, Linksmart Wireless Technology, LLC v. T-Mobile USA, Inc., et al., Case Nos. (consolidated) 2:08-cv-00264-DF-CE, 2:08-cv-00304-DFCE, 2:08-cv-00385-DF-CD, 2:09-cv-00026-DF-CE, U.S. District Court, Eastern District of Texas, Marshall Division, 31 pages, March 19, 2010</del>
	D5	<del>First Supplemental Invalidity Contentions of Cisco Systems, Inc. et al., Linksmart Wireless Technology, LLC v. T-Mobile USA, Inc., et al., Case Nos. (consolidated) 2:08-cv-00264-DF-CE, 2:08-cv-00304-DF-CE, 2:08-cv-00385-DF-CD, 2:09-cv-00026-DF-CE, U.S. District Court, Eastern District of Texas, Marshall Division, 91 pages, May 17, 2010.</del>
	D6	<del>Second Supplemental Invalidity Contentions of Cisco Systems, Inc. et al., Linksmart Wireless Technology, LLC v. T-Mobile USA, Inc., et al., Case Nos. (consolidated) 2:08-cv-00264-DF-CE, 2:08-cv-00304-DF-CE, 2:08-cv-00385-DF-CD, 2:09-cv-00026-DF-CE, U.S. District Court, Eastern District of Texas, Marshall Division, 11 pages, August 19, 2010</del>

ASL PAS923974.1--10/15/10 3:08 PM

*\* DOES NOT COMPLY WITH 37 CFR 1.98(A)(3)(i)*  
*\* NOT A PATENT OR PRINTED PUBLICATION (35 USC 301)*

EXAMINER SIGNATURE	<i>S. Rimell</i>	DATE CONSIDERED	11/9/10
EXAMINER: Initial if reference considered, whether or not citation is in conformance with MPEP 609; Draw line through citation if not in conformance and not considered. Include copy of this form with next communication to applicant. <sup>1</sup> Applicant's unique citation designation number (optional). <sup>2</sup> See Kinds Codes of USPTO Patent Documents at www.pto.gov or MPEP 901.4. <sup>3</sup> Enter Office that issued the document, by the two-letter code (WIPO standard ST.3). <sup>4</sup> For Japanese patent documents, the indication of the year of the reign of the Emperor must precede the serial number of the patent document. <sup>5</sup> Kind of document by the appropriate symbols as indicated on the document under WIPO Standard ST.16 if possible. <sup>6</sup> Applicant is to place a check mark here if English Language Translation is attached.			

Patent and Trademark Office; U.S. DEPARTMENT OF COMMERCE

WWM/asl

Sheet 2 of 2

FORM PTO/SB/08A/B (10-01) Substitute for PTO-1449A/B  <b>INFORMATION DISCLOSURE</b>  <b>STATEMENT BY APPLICANT</b>  (use as many sheets as necessary)	<b>Attorney Docket Number</b>	62986/A522
	<b>Application Number</b>	90/009301
	<b>Filing Date</b>	December 17, 2008
	<b>Applicant(s)</b>	6,779,118 B1
	<b>Group Art Unit</b>	3992
	<b>Examiner Name</b>	Rimell, Samuel G.

U.S. PATENT DOCUMENTS				
EXAMINER INITIALS	Cite No. <sup>1</sup>	DOCUMENT NUMBER Number - Kind Code <sup>3</sup> (If Known)	PUBLICATION DATE MM-DD-YYYY	NAME OF PATENTEE
<i>el</i>	A1	5,987,523	11-16-1999	Hind et al.

FOREIGN PATENT DOCUMENTS					
EXAMINER INITIALS	Cite No. <sup>1</sup>	Foreign Patent Document Country Code <sup>2</sup> - Number <sup>1</sup> - Kind Code <sup>3</sup> (If Known)	Publication Date MM-DD-YYYY	Name of Patentee or Applicant of Cited Document	T <sup>4</sup> (✓)

PRINTED PUBLICATIONS		
EXAMINER INITIALS	Cite No. <sup>1</sup>	Include name of the author (in CAPITAL LETTERS), title of the article, title of the item (book, magazine, journal, serial, symposium, catalog, etc.), date, page(s), volume-issue number(s), publisher, city and/or country where published.
<i>el</i>	C27	ELMASRI et al., <i>Fundamentals of Database Systems</i> , ed.2, Addison-Wesley, 1994.

OTHER INFORMATION 37 CFR 1.98(a)(2)(iv)		
EXAMINER INITIALS	Cite No. <sup>1</sup>	Title of the item, date (if any), page(s), other information.

ASL PAS923139.1-\* -10/6/10 4:51 PM

EXAMINER SIGNATURE	<i>[Signature]</i>	DATE CONSIDERED	11/9/10
<small>EXAMINER: Initial if reference considered, whether or not citation is in conformance with MPEP 609; Draw line through citation if not in conformance and not considered. Include copy of this form with next communication to applicant. <sup>1</sup>Applicant's unique citation designation number (optional). <sup>2</sup>See Kinds Codes of USPTO Patent Documents at www.pto.gov or MPEP 901.4. <sup>3</sup>Enter Office that issued the document, by the two-letter code (WIPO standard ST.3). <sup>4</sup>For Japanese patent documents, the indication of the year of the reign of the Emperor must precede the serial number of the patent document. <sup>5</sup>Kind of document by the appropriate symbols as indicated on the document under WIPO Standard ST.16 if possible. <sup>6</sup>Applicant is to place a check mark here if English Language Translation is attached.</small>			

Patent and Trademark Office; U.S. DEPARTMENT OF COMMERCE

WWM/asl

FORM PTO/SB/08A/B (10-01) Substitute for PTO-1449A/B  <b>INFORMATION DISCLOSURE</b>  <b>STATEMENT BY APPLICANT</b>  (use as many sheets as necessary)	<b>Attorney Docket Number</b>	62986/A522
	<b>Application Number</b>	90/009301
	<b>Filing Date</b>	December 17, 2008
	<b>Applicant(s)</b>	6,779,118 B1
	<b>Group Art Unit</b>	3992
	<b>Examiner Name</b>	Rimell, Samuel G.

U.S. PATENT DOCUMENTS				
EXAMINER INITIALS	Cite No. <sup>1</sup>	DOCUMENT NUMBER Number - Kind Code <sup>2</sup> (If Known)	PUBLICATION DATE MM-DD-YYYY	NAME OF PATENTEE

FOREIGN PATENT DOCUMENTS					
EXAMINER INITIALS	Cite No. <sup>1</sup>	Foreign Patent Document Country Code <sup>3</sup> - Number <sup>4</sup> - Kind Code <sup>5</sup> (If Known)	Publication Date MM-DD-YYYY	Name of Patentee or Applicant of Cited Document	T <sup>6</sup> (✓)

PRINTED PUBLICATIONS		
EXAMINER INITIALS	Cite No. <sup>1</sup>	Include name of the author (in CAPITAL LETTERS), title of the article, title of the item (book, magazine, journal, serial, symposium, catalog, etc.), date, page(s), volume-issue number(s), publisher, city and/or country where published.
AL	C1	ARAR, Yardena, Prepaid Internet Access Cards: Instant ISP, <i>pcworld.com</i> , 1 page, July 14, 1997.
d	C2	Auric Web Systems, News, web page at < <a href="http://www.auricweb.com/news.html">http://www.auricweb.com/news.html</a> >, 3 pages, accessed July 12, 1999, including press releases: Prepaid Card Has Made An Exciting Debut, December 10, 1998, ISP's Now Can Provide "Commercial Breaks" on the Web With Out user Side Software, December 7, 1998, Beyond Banner Ads, Beyond "Push", June 16, 1998, New Internet Advertisement Tool Make a Successful Debut, May 18, 1998, Auric Web Systems announces Micro Gateway, September 1, 1997, Auric Web Systems announces ISP Enhancer, December 15, 1997, and Auric Web Systems announces EC Gateway, January 15, 1997.
d	C3	Auric Web Systems unveils software to reduce the operating costs of Internet service providers, press release, Auric Web Systems, Inc., Business Wire, 2 pages, March 25, 1997.
d	C4	Auric Web Unveils Tool To Navigate Customer Directly To A Specific Website, press release, Auric Web Systems, Inc., 1 page, November 24, 1997.
d	C5	Baker, Mary G. et al., Supporting Mobility in MosquitoNet, <i>Proceedings of the 1996 USENIX Technical Conference</i> , San Diego, CA, 13 pages, January 1996.

EXAMINER SIGNATURE	<i>[Signature]</i>	DATE CONSIDERED	08/9/10
EXAMINER: Initial if reference considered, whether or not citation is in conformance with MPEP 609; Draw line through citation if not in conformance and not considered. Include copy of this form with next communication to applicant. <sup>1</sup> Applicant's unique citation designation number (optional). <sup>2</sup> See Kinds Codes of USPTO Patent Documents at <a href="http://www.pto.gov">www.pto.gov</a> or MPEP 901.4. <sup>3</sup> Enter Office that issued the document, by the two-letter code (WIPO standard ST.3). <sup>4</sup> For Japanese patent documents, the indication of the year of the reign of the Emperor must precede the serial number of the patent document. <sup>5</sup> Kind of document by the appropriate symbols as indicated on the document under WIPO Standard ST.16 if possible. <sup>6</sup> Applicant is to place a check mark here if English Language Translation is attached.			

Patent and Trademark Office; U.S. DEPARTMENT OF COMMERCE

FORM PTO/SB/08A/B (10-01) Substitute for PTO-1449A/B  <b>INFORMATION DISCLOSURE</b>  <b>STATEMENT BY APPLICANT</b>  (use as many sheets as necessary)	<b>Attorney Docket Number</b>	62986/A522
	<b>Application Number</b>	90/009301
	<b>Filing Date</b>	December 17, 2008
	<b>Applicant(s)</b>	6,779,118 B1
	<b>Group Art Unit</b>	3992
	<b>Examiner Name</b>	Rimell, Samuel G.

PRINTED PUBLICATIONS		
EXAMINER INITIALS	Cite No. <sup>1</sup>	Include name of the author (in CAPITAL LETTERS), title of the article, title of the item (book, magazine, journal, serial, symposium, catalog, etc.), date, page(s), volume-issue number(s), publisher, city and/or country where published.
d	C6	Buying Made Easy: Auric Web Bypasses Credit Cards, <i>Internet Week</i> , 1 page, February 17, 1997.
d	C7	Cisco 2500 Access Server Series, Data Sheet, Cisco Systems, 5 pages, September 1997.
d	C8	Cisco 2509-2512 Series Access Servers, Product Announcement, I.D. Number: 027ALL, Cisco Systems, 8 pages, undated (1995 copyright notice).
d	C9	Cisco 6510 Service Selection Gateway, End of Sale Announcement, End-of-Life Notice No. 1135, Cisco Systems, 4 pages, April 2005.
d	C10	Cisco 6510 Service Selection Gateway Version 1.0(2), Release Notes, Doc. No. 78-5181-03, Cisco Systems, 6 pages, undated (1998 copyright notice).
d	C11	Cisco Announces DSL Service Creation and Control Platforms: Enables Service Providers to Create Differentiated Internet Services on a Per-User Basis, press release, Cisco Systems, 2 pages, May 26, 1998.
d	C12	CiscoSecure ACS 2.1(4) for Windows NT, Release Notes, Doc. No. 78-5462-01 Rev. A0, Cisco Systems, 6 pages, June 15, 1998.
d	C13	Droms, R., <i>Dynamic Host Configuration Protocol</i> , Network Working Group, Request for Comments 2131, 43 pages, March 1997.
d	C14	Grice, Corey, Comcast launches broadband portal, <i>news.cnet.com</i> , 3 pages, January 4, 1999.
d	C15	Interactive Media Works and Netcom Incorporate NetCruiser Software and Internet Access with sampleNET, press release, Interactive Media Works, LLC, 1 page, Feb. 5, 1996.
d	C16	Interactive Media Works Brings Web Browsing to Pre-Paid Phone Cards with the sampleNET Card, press release, Interactive Media Works, LLC, 2 pages, Feb. 13, 1996.
d	C17	Kostick, Chris, System Administration: IP Masquerading Code Follow-up, <i>Linux Journal</i> , (accessed at <a href="http://delivery.acm.org/10.1145/330000/327059/">http://delivery.acm.org/10.1145/330000/327059/</a> ), 14 pages, November 1997.
d	C18	Lopez, Bryan S., <i>An Investigation and Assessment of Linux IPChains and Its Vulnerability with Respect to Network Security</i> , Thesis, Naval Postgraduate School, Monterey, CA, 136 pages, June 2000.
d	C19	Mockapetris, P., <i>Domain Names - Implementation and Specification</i> , Network Working Group, Request for Comments 1035; 52 pages, November 1987.

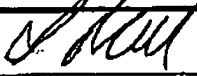
EXAMINER SIGNATURE		DATE CONSIDERED	11/9/10
<small>EXAMINER: Initial if reference considered, whether or not citation is in conformance with MPEP 609; Draw line through citation if not in conformance and not considered. Include copy of this form with next communication to applicant. <sup>1</sup>Applicant's unique citation designation number (optional). <sup>2</sup>See Kinds Codes of USPTO Patent Documents at <a href="http://www.pto.gov">www.pto.gov</a> or MPEP 901.4. <sup>3</sup>Enter Office that issued the document, by the two-letter code (WIPO standard ST.3). <sup>4</sup>For Japanese patent documents, the indication of the year of the reign of the Emperor must precede the serial number of the patent document. <sup>5</sup>Kind of document by the appropriate symbols as indicated on the document under WIPO Standard ST.16 if possible. <sup>6</sup>Applicant is to place a check mark here if English Language Translation is attached.</small>			

Patent and Trademark Office; U.S. DEPARTMENT OF COMMERCE

FORM PTO/SB/08A/B (10-01) Substitute for PTO-1449A/B  <b>INFORMATION DISCLOSURE</b>  <b>STATEMENT BY APPLICANT</b>  (use as many sheets as necessary)	<b>Attorney Docket Number</b>	62986/A522
	<b>Application Number</b>	90/009301
	<b>Filing Date</b>	December 17, 2008
	<b>Applicant(s)</b>	6,779,118 B1
	<b>Group Art Unit</b>	3992
	<b>Examiner Name</b>	Rimell, Samuel G.

PRINTED PUBLICATIONS		
EXAMINER INITIALS	Cite No. <sup>1</sup>	Include name of the author (in CAPITAL LETTERS), title of the article, title of the item (book, magazine, journal, serial, symposium, catalog, etc.), date, page(s), volume-issue number(s), publisher, city and/or country where published.
sl	C20	Phone Cards and the Internet: A profitable Link, <i>Intele-Card News</i> , 2 pages, March 1996.
sl	C21	Pop Go The Ads With Auric Systems Software, <i>The Los Angeles Times</i> , 1 page, January 4, 1999.
sl	C22	Prepaid Internet Access Cards, <i>CardTrack Online</i> , <www.ramresearch.com/cardtrak/news/cf7_14f_97.html>, 1 page, July 14, 1997.
sl	C23	Prepaid Web-Surfing Cards Now Available For Easy Internet Access From PCs And Video Game Boxes, press release, Seer Technologies Inc., Business Wire; 2 pages, October 8, 1996.
sl	C24	Riedman, Pat, Alcone's NetPerks to offer rewards to frequent surfers, <i>Advertising Age</i> , 1 page, Jan. 6, 1997.
sl	C25	Russell, Rusty, <i>Linux IPCHAINS-HOWTO</i> , v1.0.8, 55 pages <u>dated July 4, 2000</u> , <del>publication date unknown.</del>
sl	C26	Squid: Optimising Web Delivery, <i>squid-cache.org</i> , 1 page, August 25, 2009.

OTHER INFORMATION 37 CFR 1.98(a)(2)(iv)		
EXAMINER INITIALS	Cite No. <sup>1</sup>	Title of the item, date (if any), page(s), other information.
FF	D1	Amended Invalidation Contentions of AT&T et al., <del>Linksmart Wireless Technology, LLC v. T-Mobile USA, Inc., et al., Case Nos. (consolidated) 2:08-cv-00264-DF-CE, 2:08-cv-00304-DF-CE, 2:08-cv-00385-DF-CD, 2:09-cv-00026-DF-CE, U.S. District Court, Eastern District of Texas, Marshall Division, 100 pages, August 19, 2010</del>
FF	D2	First Supplemental Invalidation Contentions of AT&T et al., <del>Linksmart Wireless Technology, LLC v. T-Mobile USA, Inc., et al., Case Nos. (consolidated) 2:08-cv-00264-DF-CE, 2:08-cv-00304-DF-CE, 2:08-cv-00385-DF-CD, 2:09-cv-00026-DF-CE, U.S. District Court, Eastern District of Texas, Marshall Division, 82 pages, March 25, 2010</del>

EXAMINER SIGNATURE	<i>[Signature]</i>	DATE CONSIDERED	11/9/10
EXAMINER: Initial if reference considered, whether or not citation is in conformance with MPEP 609; Draw line through citation if not in conformance and not considered. Include copy of this form with next communication to applicant. <sup>1</sup> Applicant's unique citation designation number (optional). <sup>2</sup> See Kinds Codes of USPTO Patent Documents at www.pto.gov or MPEP 901.4. <sup>3</sup> Enter Office that issued the document, by the two-letter code (WIPO standard ST.3). <sup>4</sup> For Japanese patent documents, the indication of the year of the reign of the Emperor must precede the serial number of the patent document. <sup>5</sup> Kind of document by the appropriate symbols as indicated on the document under WIPO Standard ST.16 if possible. <sup>6</sup> Applicant is to place a check mark here if English Language Translation is attached.			

Patent and Trademark Office; U.S. DEPARTMENT OF COMMERCE

WWM/asi

FF NOT A PATENT OR PRINTED PUBLICATION  
(35 USC 301)

Sheet 3 of 4



FORM PTO/SB/08A/B (10-01) Substitute for PTO-1449A/B  <b>INFORMATION DISCLOSURE          STATEMENT BY APPLICANT</b>  (use as many sheets as necessary)	<b>Attorney Docket Number</b>	62986/A522
	<b>Application Number</b>	90/009301
	<b>Filing Date</b>	December 17, 2008
	<b>Applicant(s)</b>	6,779,118 B1
	<b>Group Art Unit</b>	3992
	<b>Examiner Name</b>	Rimell, Samuel G.

OTHER INFORMATION 37 CFR 1.98(a)(2)(iv)		
EXAMINER INITIALS	Cite No. <sup>1</sup>	Title of the item, date (if any), page(s), other information.
	D3	Memorandum and Order [regarding claim construction issues], <del>Linksmart Wireless Technology, LLC v. T-Mobile USA, Inc., et al., Case Nos. 2:08-cv-264-DF-CE, U.S. District Court, Eastern District of Texas, Marshall Division, 23 pages, June 30, 2010</del>

ASL PAS923128.1-\* -10/4/10 8:50 PM

*NOT A PATENT OR PRINTED PUBLICATION (35 USC 304)*

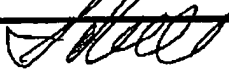
EXAMINER SIGNATURE		DATE CONSIDERED	11/9/10
<small>EXAMINER: Initial if reference considered, whether or not citation is in conformance with MPEP 609; Draw line through citation if not in conformance and not considered. Include copy of this form with next communication to applicant. <sup>1</sup>Applicant's unique citation designation number (optional). <sup>2</sup>See Kinds Codes of USPTO Patent Documents at www.pto.gov or MPEP 901.4. <sup>3</sup>Enter Office that issued the document, by the two-letter code (WIPO standard ST.3). <sup>4</sup>For Japanese patent documents, the indication of the year of the reign of the Emperor must precede the serial number of the patent document. <sup>5</sup>Kind of document by the appropriate symbols as indicated on the document under WIPO Standard ST.16 if possible. <sup>6</sup>Applicant is to place a check mark here if English Language Translation is attached.</small>			

Patent and Trademark Office; U.S. DEPARTMENT OF COMMERCE

WWM/asl

Sheet 4 of 4

FORM PTO/SB/08A/B (10-01) Substitute for PTO-1449A/B  <b>INFORMATION DISCLOSURE</b>  <b>STATEMENT BY APPLICANT</b>  (use as many sheets as necessary)	<b>Attorney Docket Number</b>	62986/A522 (R1341006)
	<b>Application Number</b>	90/009,301
	<b>Filing Date</b>	December 17, 2008
	<b>Applicant(s)</b>	Ikudome, Koichiro et al.
	<b>Group Art Unit</b>	3992
	<b>Examiner Name</b>	Rimell, Samuel G.

**U.S. PATENT DOCUMENTS**

EXAMINER INITIALS	Cite No. <sup>1</sup>	DOCUMENT NUMBER Number - Kind Code <sup>2</sup> (If Known)	PUBLICATION DATE MM-DD-YYYY	NAME OF PATENTEE

**FOREIGN PATENT DOCUMENTS**

EXAMINER INITIALS	Cite No. <sup>1</sup>	Foreign Patent Document Country Code <sup>3</sup> - Number <sup>4</sup> - Kind Code <sup>5</sup> (If Known)	Publication Date MM-DD-YYYY	Name of Patentee or Applicant of Cited Document	T <sup>6</sup> ( <input checked="" type="checkbox"/> )

**PRINTED PUBLICATIONS**

EXAMINER INITIALS	Cite No. <sup>1</sup>	Include name of the author (in CAPITAL LETTERS), title of the article, title of the item (book, magazine, journal, serial, symposium, catalog, etc.), date, page(s), volume-issue number(s), publisher, city and/or country where published.
	C39	Armistead, Jason, Internet post: "Re: redirect," dated March 2, 1998, as archived at <www.squid-cache.org>, document states that archive was generated on December 9, 2003, 2 pages.
	C40	Comer, Douglas, Internetworking with TCP/IP, 3rd ed., vol. 1, cover, title page, p. 46 (3 pages) 1995.
	C41	Dominik, Internet post: "redirect," dated November 30, 1997, as archived at <www.squid-cache.org>, document states that archive was generated on December 9, 2003, 1 page.
	C42	"MAX 6000 Series Administration Guide," Ascend Communications, Inc., 428 pages, (copyright notice 1998).
	C43	"MAX 6000 Series Hardware Installation Guide," Ascend Communications, Inc., 159 pages, (copyright notice 1998).
	C44	"MAX 6000 Series Network Configuration Guide," Ascend Communications, Inc., 523 pages, (copyright notice 1998).
	C45	"MAX 800 Series Administration Guide," Ascend Communications, Inc., 286 pages, (copyright notice 1998).
	C46	"MAX 800 Series Hardware Installation Guide," Ascend Communications, Inc., 51 pages, (copyright notice 1998).
	C47	"MAX 800 Series Network Configuration Guide," Ascend Communications, Inc., 280 pages, (copyright notice 1998).

EXAMINER SIGNATURE		DATE CONSIDERED	
EXAMINER: Initial if reference considered, whether or not citation is in conformance with MPEP 609; Draw line through citation if not in conformance and not considered. Include copy of this form with next communication to applicant. <sup>1</sup> Applicant's unique citation designation number (optional). <sup>2</sup> See Kinds Codes of USPTO Patent Documents at www.pto.gov or MPEP 901.4. <sup>3</sup> Enter Office that issued the document, by the two-letter code (WIPO standard ST.3). <sup>4</sup> For Japanese patent documents, the indication of the year of the reign of the Emperor must precede the serial number of the patent document. <sup>5</sup> Kind of document by the appropriate symbols as indicated on the document under WIPO Standard ST.16 if possible. <sup>6</sup> Applicant is to place a check mark here if English Language Translation is attached.			

Patent and Trademark Office; U.S. DEPARTMENT OF COMMERCE

FORM PTO/SB/08A/B (10-01) Substitute for PTO-1449A/B  <b>INFORMATION DISCLOSURE</b>  <b>STATEMENT BY APPLICANT</b>  (use as many sheets as necessary)	<b>Attorney Docket Number</b>	62986/A522 (R1341006)
	<b>Application Number</b>	90/009,301
	<b>Filing Date</b>	December 17, 2008
	<b>Applicant(s)</b>	Ikudome, Koichiro et al.
	<b>Group Art Unit</b>	3992
	<b>Examiner Name</b>	Rimell, Samuel G.

PRINTED PUBLICATIONS		
EXAMINER INITIALS	Cite No. <sup>1</sup>	Include name of the author (in CAPITAL LETTERS), title of the article, title of the item (book, magazine, journal, serial, symposium, catalog, etc.), date, page(s), volume-issue number(s), publisher, city and/or country where published.
	C48	"MAX Glossary," Ascend Communications, Inc., 226pages, (copyright notice 1998).
	C49	"MAX RADIUS Configuration Guide," Ascend Communications, Inc., 556 pages, (copyright notice 1998).
	C50	"MAX Reference Guide," Ascend Communications, Inc., 307 pages, (copyright notice 1998).
	C51	"MAX Security Supplement," Ascend Communications, Inc., 176 pages, (copyright notice 1998).
	C52	"NavisConnect User's Guide," Ascend Communications, Inc., 46 pages, (copyright notice 1998).
	C53	Nordstrom, Henrik, Internet post: "Re: redirect," dated March 2, 1998, as archived at <www.squid-cache.org>, document states that archive was generated on December 9, 2003, 1 page.
	C54	PC Work, article with picture of ODN Web Card, 1 page, December 1998, Japan (in Japanese).

OTHER INFORMATION 37 CFR 1.98(a)(2)(iv)		
EXAMINER INITIALS	Cite No. <sup>1</sup>	Title of the item, date (if any), page(s), other information.
	D7	Best Western's Supplemental Claim Construction Brief, Linksmart Wireless Technology, LLC v. T-Mobile USA, Inc., et al., U.S. District Court of Eastern District of Texas, Marshall Division, Case No. 2:08-cv-00264-DF-CE, filed April 16, 2010, pp. 1-16 (including Exhibits 1-2)
	D8	Claim Construction Brief of Defendants, Linksmart Wireless Technology, LLC v. T-Mobile USA, Inc., et al., U.S. District Court of Eastern District of Texas, Marshall Division, Case No. 2:08-cv-00264-DF-CE, filed April 16, 2010, pp. 1-39
	D9	Declaration of Kevin Jeffay, PH.D, Linksmart Wireless Technology, LLC v. T-Mobile USA, Inc., et al., U.S. District Court of Eastern District of Texas, Marshall Division, Case No. 2:08-cv-00264-DF-CE, filed April 16, 2010, pp. 1-21 (including Exhibit A)
	D10	Invalidity Contentions of AT&T et al., Linksmart Wireless Technology, LLC v. T-Mobile USA, Inc., et al., Case Nos. (consolidated) 2:08-cv-00264-DF-CE, 2:08-cv-00304-DF-CE, 2:08-cv-00385-DF-CD, 2:09-cv-00026-DF-CE, U.S. District Court, Eastern District of Texas, Marshall Division, 754 pages (including appendixes A-C), October 8, 2009

EXAMINER SIGNATURE	DATE CONSIDERED
EXAMINER: Initial if reference considered, whether or not citation is in conformance with MPEP 609; Draw line through citation if not in conformance and not considered. Include copy of this form with next communication to applicant. <sup>1</sup> Applicant's unique citation designation number (optional). <sup>2</sup> See Kinds Codes of USPTO Patent Documents at www.pto.gov or MPEP 901.4. <sup>3</sup> Enter Office that issued the document, by the two-letter code (WIPO standard ST.3). <sup>4</sup> For Japanese patent documents, the indication of the year of the reign of the Emperor must precede the serial number of the patent document. <sup>5</sup> Kind of document by the appropriate symbols as indicated on the document under WIPO Standard ST.16 if possible. <sup>6</sup> Applicant is to place a check mark here if English Language Translation is attached.	

Patent and Trademark Office; U.S. DEPARTMENT OF COMMERCE

FORM PTO/SB/08A/B (10-01) Substitute for PTO-1449A/B  <b>INFORMATION DISCLOSURE</b>  <b>STATEMENT BY APPLICANT</b>  (use as many sheets as necessary)	<b>Attorney Docket Number</b>	62986/A522 (R1341006)
	<b>Application Number</b>	90/009,301
	<b>Filing Date</b>	December 17, 2008
	<b>Applicant(s)</b>	Ikudome, Koichiro et al.
	<b>Group Art Unit</b>	3992
	<b>Examiner Name</b>	Rimell, Samuel G.

OTHER INFORMATION 37 CFR 1.98(a)(2)(iv)		
EXAMINER INITIALS	Cite No. <sup>1</sup>	Title of the item, date (if any), page(s), other information.
	D11	Invalidity Contentions of T-Mobile USA, Inc. et al., Linksmart Wireless Technology, LLC v. T-Mobile USA, Inc., et al., Case Nos. (consolidated) 2:08-cv-00264-DF-CE, 2:08-cv-00304-DFCE, 2:08-cv-00385-DF-CD, 2:09-cv-00026-DF-CE, U.S. District Court, Eastern District of Texas, Marshall Division, 325 pages (including appendix A), October 8, 2009

ASL PAS927589.1-\*-11/1/10 5:06 PM

EXAMINER SIGNATURE	DATE CONSIDERED
EXAMINER: Initial if reference considered, whether or not citation is in conformance with MPEP 609; Draw line through citation if not in conformance and not considered. Include copy of this form with next communication to applicant. <sup>1</sup> Applicant's unique citation designation number (optional). <sup>2</sup> See Kinds Codes of USPTO Patent Documents at www.pto.gov or MPEP 901.4. <sup>3</sup> Enter Office that issued the document, by the two-letter code (WIPO standard ST.3). <sup>4</sup> For Japanese patent documents, the indication of the year of the reign of the Emperor must precede the serial number of the patent document. <sup>5</sup> Kind of document by the appropriate symbols as indicated on the document under WIPO Standard ST.16 if possible. <sup>6</sup> Applicant is to place a check mark here if English Language Translation is attached.	

Patent and Trademark Office; U.S. DEPARTMENT OF COMMERCE

Control No. 90/009,301  
Docket No. 62986/A522 (R1341006)  
Date of deposit: November 2, 2010

**CERTIFICATE OF SERVICE**

I certify that on November 2, 2010, the foregoing documents: (1) **INFORMATION DISCLOSURE STATEMENT UNDER 37 CFR §1.555** (2) **FORM PTO/SB/08A/B** (3) **Twenty-one Non-Patent Literature (NPL) documents** were electronically filed with:

Mail Stop Ex Parte Reexam  
ATTN: Central Reexamination Unit  
Commissioner for Patents  
P.O. Box 1450  
Alexandria, VA 22313-1450

It is further certified that on November 2, 2010, the foregoing documents: (1) **INFORMATION DISCLOSURE STATEMENT UNDER 37 CFR §1.555** (2) **FORM PTO/SB/08A/B** (3) **Twenty-one Non-Patent Literature (NPL) documents** are being served as indicated, to the party listed below:

Jerry Turner Sewell  
P.O. Box 10999  
Newport Beach, CA 92658-5015

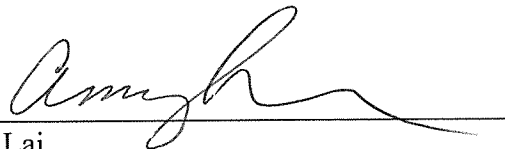
By   
Amy Lai  
Assistant to Wesley W. Monroe  
CHRISTIE, PARKER & HALE, LLP  
P.O. Box 7068  
Pasadena, CA 91109-7068

ASL PAS927770.1-\* -11/2/10 6:01 PM

## Electronic Acknowledgement Receipt

<b>EFS ID:</b>	8747326
<b>Application Number:</b>	90009301
<b>International Application Number:</b>	
<b>Confirmation Number:</b>	6609
<b>Title of Invention:</b>	USER SPECIFIC AUTOMATIC DATA REDIRECTION SYSTEM
<b>First Named Inventor/Applicant Name:</b>	6,779,118 B1
<b>Customer Number:</b>	40401
<b>Filer:</b>	Wesley W. Monroe/Amy Lai
<b>Filer Authorized By:</b>	Wesley W. Monroe
<b>Attorney Docket Number:</b>	R1341006
<b>Receipt Date:</b>	02-NOV-2010
<b>Filing Date:</b>	17-DEC-2008
<b>Time Stamp:</b>	21:32:29
<b>Application Type:</b>	Reexam (Patent Owner)

### Payment information:

Submitted with Payment	no
------------------------	----

### File Listing:

Document Number	Document Description	File Name	File Size(Bytes)/ Message Digest	Multi Part /.zip	Pages (if appl.)
1	Transmittal Letter	62986idsletter.pdf	61160 <small>0d0405643bc85984e27f4bc733cee642dd95fc4d</small>	no	4

### Warnings:

### Information:

2	Information Disclosure Statement (IDS) Filed (SB/08)	62986ptoformsb08ab.pdf	106783 29c79d8870b86a32829cbe310a631649cc6 adf3f	no	3
<b>Warnings:</b>					
<b>Information:</b>					
This is not an USPTO supplied IDS fillable form					
3	Miscellaneous Incoming Letter	62986certofservice.pdf	14381 8a92da6e88d665eaac34ffa8f2ff23b25cb2d e01	no	1
<b>Warnings:</b>					
<b>Information:</b>					
4	NPL Documents	62986npl_Armistead.pdf	116597 4ef7d94764d4d6ea5cc80e7c4e38cd072c4e e29a	no	2
<b>Warnings:</b>					
<b>Information:</b>					
5	NPL Documents	62986npl_ATT.pdf	1841108 fd263bee6b6139b2e6604738ba172357137 2ccab	no	754
<b>Warnings:</b>					
<b>Information:</b>					
6	NPL Documents	62986npl_BestWestern.pdf	125744 ed97b0e839d44fc74fb199a5142ce133b36 446ee	no	10
<b>Warnings:</b>					
<b>Information:</b>					
7	NPL Documents	62986npl_COMER.pdf	1131098 471456e38708b3e3f8b194bfd191c4fc4004 ec84	no	3
<b>Warnings:</b>					
<b>Information:</b>					
8	NPL Documents	62986npl_DecJeffay.pdf	1032289 6d6f70558d155e71a418438cd14a7af7c434 426d	no	21
<b>Warnings:</b>					
<b>Information:</b>					
9	NPL Documents	62986npl_DfndtsClaimConstru ctionBrief.pdf	21586222 85d6673a7104a2e7cb758911af55d7171ee 9972f	no	39
<b>Warnings:</b>					
<b>Information:</b>					
10	NPL Documents	62986npl_Dominik.pdf	58484 ce11948528cd55ffa1ddc5bc4c0015ca64b4 27da	no	1

<b>Warnings:</b>					
<b>Information:</b>					
11	NPL Documents	62986npl_MAX800SeriesAG.pdf	1664190 651425787d1604c98c6904d9c850ea823edc5689	no	286
<b>Warnings:</b>					
<b>Information:</b>					
12	NPL Documents	62986npl_MAX800SeriesHardware.pdf	783187 ca26a6052b1f2c6caf173d55533110078115f59e	no	51
<b>Warnings:</b>					
<b>Information:</b>					
13	NPL Documents	62986npl_MAX800SeriesNetwork.pdf	2387126 00ef36d9be891f87813d993f7f58586fbc4de2b6	no	280
<b>Warnings:</b>					
<b>Information:</b>					
14	NPL Documents	62986npl_MAX6000SeriesAG.pdf	2388769 0ddf3c81dffcb71f3801308a9ad63e45a87ce100	no	428
<b>Warnings:</b>					
<b>Information:</b>					
15	NPL Documents	62986npl_MAX6000SeriesHardware.pdf	3408706 411e4510a563bae1271677217dbe78111feb519f	no	159
<b>Warnings:</b>					
<b>Information:</b>					
16	NPL Documents	62986npl_MAX6000SeriesNetwork.pdf	4370502 9b7453d4f3ed96748c435389e17b269a28d90124	no	523
<b>Warnings:</b>					
<b>Information:</b>					
17	NPL Documents	62986npl_MAXGlossary.pdf	2226227 31cb40d34b5a104fb4278e3a6ffd727646ba867f	no	226
<b>Warnings:</b>					
<b>Information:</b>					
18	NPL Documents	62986npl_MAXRADIUS.pdf	4140340 b23d16e1fc96d7e1486c2e6f9494404be939f224	no	556
<b>Warnings:</b>					
<b>Information:</b>					
19	NPL Documents	62986npl_MAXReferenceGuide.pdf	1498697 55e7dc41e4c297e39a31a496cf17226076a1a79c	no	307



<b>Warnings:</b>					
<b>Information:</b>					
20	NPL Documents	62986npl_MAXSecurity.pdf	1246014 6ce978171cbabda21a0ce644ae831b3e537e5bc	no	176
<b>Warnings:</b>					
<b>Information:</b>					
21	NPL Documents	62986npl_NavisConnect.pdf	1368455 e8034aa1132375533b91438e5413c0600803cb84	no	46
<b>Warnings:</b>					
<b>Information:</b>					
22	NPL Documents	62986npl_Nordstrom.pdf	79107 a3f30bd8f9246e57c7ae071b34d3eebc72dae11f	no	1
<b>Warnings:</b>					
<b>Information:</b>					
23	NPL Documents	62986npl_PCWork.pdf	179333 e6128a368ef82f9967535345946d10d7a75d195e	no	1
<b>Warnings:</b>					
<b>Information:</b>					
24	NPL Documents	62986npl_TMobile.pdf	692735 6aecb4e6b41f34bce7927e74f6af33a180e0ad12	no	325
<b>Warnings:</b>					
<b>Information:</b>					
<b>Total Files Size (in bytes):</b>			52507254		

**This Acknowledgement Receipt evidences receipt on the noted date by the USPTO of the indicated documents, characterized by the applicant, and including page counts, where applicable. It serves as evidence of receipt similar to a Post Card, as described in MPEP 503.**

**New Applications Under 35 U.S.C. 111**

**If a new application is being filed and the application includes the necessary components for a filing date (see 37 CFR 1.53(b)-(d) and MPEP 506), a Filing Receipt (37 CFR 1.54) will be issued in due course and the date shown on this Acknowledgement Receipt will establish the filing date of the application.**

**National Stage of an International Application under 35 U.S.C. 371**

**If a timely submission to enter the national stage of an international application is compliant with the conditions of 35 U.S.C. 371 and other applicable requirements a Form PCT/DO/EO/903 indicating acceptance of the application as a national stage submission under 35 U.S.C. 371 will be issued in addition to the Filing Receipt, in due course.**

**New International Application Filed with the USPTO as a Receiving Office**

**If a new international application is being filed and the international application includes the necessary components for an international filing date (see PCT Article 11 and MPEP 1810), a Notification of the International Application Number and of the International Filing Date (Form PCT/RO/105) will be issued in due course, subject to prescriptions concerning national security, and the date shown on this Acknowledgement Receipt will establish the international filing date of the application.**

**IN THE UNITED STATES PATENT AND TRADEMARK OFFICE**

*I hereby certify that this correspondence is being electronically filed with the United States Patent and Trademark Office on November 2, 2010 at or before 11:59 p.m. Pacific Time under the Rules of 37 CFR § 1.8.*

Amy Lai

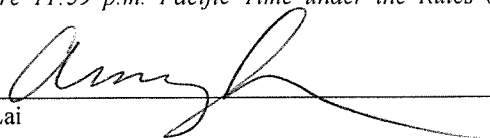

Applicant : Ikudome, Koichiro et al. Confirmation No. 6609  
 Application No. : 90/009,301  
 Filed : December 17, 2008  
 Title : USER SPECIFIC AUTOMATIC DATA REDIRECTION SYSTEM  
 Grp./Div. : 3992  
 Examiner : Rimell, Samuel G.  
 Docket No. : 62986/A522 (R1341006)

**INFORMATION DISCLOSURE STATEMENT  
 UNDER 37 CFR § 1.555**

Mail Stop Ex Parte Reexam  
 Central Reexamination Unit  
 Commissioner for Patents  
 P.O. Box 1450  
 Alexandria, VA 22313-1450

Post Office Box 7068  
 Pasadena, CA 91109-7068  
 November 2, 2010

Commissioner:

In compliance with the duty of disclosure under 37 CFR §§ 1.555 and in accordance with the provisions in the Manual of Patent Examining Procedure §§ 2280, enclosed is FORM PTO/SB/08A/B listing references that are known to Patent Owner.

Printed publications C39, C41, and C53 were listed together as reference 102 on Substitute Form PTO-1449 submitted by Patent Owner's representative on November 16, 2009. However, they were not considered by the Examiner when previously submitted because the Substitute Form PTO-1449 did not list a publication date. The three references are now listed separately, with their apparent dates of publication.

Two other references listed on Substitute Form PTO-1449 submitted by Patent Owner's representative on November 16, 2009, Chapman and Zwicky, *Building Internet Firewalls* (orig.

**Application No. 90/009,301**

ref #67) and Comer, *Internetworking with TCP/IP*, 3<sup>rd</sup> ed. (orig. ref. #71) were indicated on the corresponding Information Disclosure Statement as having copies of them being provided to the Office with the Information Disclosure Statement. This statement was in error as copies of these references were not submitted to the Office. While these two references were listed in invalidity contentions served by defendants in the litigation, *Linksmart Wireless Technology, LLC v. T-Mobile USA, Inc., et al.*, U.S. District Court, Eastern District of Texas, Marshall Division, 2:08-cv-00264-DF-CE, 2:08-cv-00304-DF-CE, 2:08-cv-00385-DF-CD, 2:09-cv-00026-DF-CE, copies of the references were not produced by defendants because they are both bound books and the defendants stated that they could not make copies of the references to produce to the plaintiff because of copyright restrictions. Accordingly, Patent Owner does not have copies of these references and did not submit copies to the Office. However, more recently, a page from one of these references, Comer, was produced by defendants and this excerpt is cited on the attached FORM PTO/SB/08A/B as printed publication C40 and a copy of this excerpt is submitted presently.

The Information Disclosure Statement filed on November 16, 2009 stated that the references in the corresponding Substitute Form PTO-1449 “have been either cited in currently pending continuation Application No. 11/645,924, filed December 26, 2006, of the present patent under reexamination, and/or referenced in invalidity contentions served by defendants in” the *Linksmart* litigation mentioned above. The Information Disclosure Statement then lists 19 non-patent literature documents that are “[a]lso listed on Substitute Form PTO-1449.” It has occurred to Patent Owner that this language, “also listed,” could be misinterpreted to mean that the nineteen specifically listed non-patent literature documents were neither cited in the currently pending continuation application nor referenced in the invalidity contentions. This is not the case and is not what was intended by Patent Owner. Rather, with the exception of reference #104 (Wessels, “Squid Proxy Server Configuration File”), each of these specifically listed non-patent literature documents were cited in the currently pending continuation application but were not referenced in the invalidity contentions as of November 16, 2009. Reference #104 (Wessels, “Squid Proxy Server Configuration File”), was cited in the currently pending continuation application and was also referenced in the invalidity contentions as of November 16, 2009.

## Application No. 90/009,301

Since November 16, 2009, reference #91 (Mockpetris, RFC 1034) has also been cited in additional invalidity contentions submitted by defendants.

Printed publications C42-C52 listed were referenced in invalidity contentions served by defendants in the litigation, *Linksmart Wireless Technology, LLC v. T-Mobile USA, Inc., et al.*, U.S. District Court, Eastern District of Texas, Marshall Division, 2:08-cv-00264-DF-CE, 2:08-cv-00304-DF-CE, 2:08-cv-00385-DF-CD, 2:09-cv-00026-DF-CE.

Printed publication C54 is in Japanese. Written English-language translations of these publications or portions of these publications are not within the possession, custody, or control of, or is readily available to Patent Owner or its representatives. Patent Owner's present understanding of the relevance of reference C54 is that it is a short article regarding a product of Japan Telecom, ODN Web Card that is also described in the first press release appearing in reference C2, submitted to the Office as part of the IDS filed by Patent Owner's representative on October 4, 2010 (Auric Web Systems, News, web page at <<http://www.auricweb.com/news.html>> , 3 pages, accessed July 12, 1999, including press release: Prepaid Card Has Made An Exciting Debut, December 10, 1998). A similar product, using the name WEBGate card is described in reference C4, submitted to the Office as part of the IDS filed by Patent Owner's representative on October 4, 2010 (Auric Web Unveils Tool To Navigate Customer Directly To A Specific Website, press release, Auric Web Systems, Inc., 1 page, November 24, 1997).

Listed under the heading "Other Information" on enclosed FORM PTO/SB/08A/B and submitted pursuant to MPEP §2207, "Entry of Court Decision in Patent File," are court papers listed as item D7-D11 from the litigation, *Linksmart Wireless Technology, LLC v. T-Mobile USA, Inc., et al.*, U.S. District Court, Eastern District of Texas, Marshall Division, 2:08-cv-00264-DF-CE, 2:08-cv-00304-DF-CE, 2:08-cv-00385-DF-CD, 2:09-cv-00026-DF-CE. While not printed publications, under MPEP §2207, "The Office will also accept for entry into the patent file other court papers, or papers filed in the court, from litigations or other proceedings involving the patent." The patent presently under reexamination is the subject of this litigation and this litigation is referenced in the Reexam Litigation Search report, dated July 21, 2009, for

**Application No. 90/009,301**

the present reexamination. Accordingly, these documents should not be crossed out on FORM PTO/SB/08A/B. More specifically, items D7 and D8 are Claim Construction Briefs submitted by defendants and D9 is a Declaration of an expert witness in support of defendants' Claim Construction Briefs. Items D7-C9 are submitted to the extent that the Examiner may find them important in determining the broadest reasonable interpretation of various claim terms. Items D10 and D11 are Invalidity Contentions of defendants from the above reference litigation and are submitted to the extent that the Examiner may find them important in learning how defendants suggest that certain references might be applied to the claims of the issued patent.

Enclosed are copies of each reference listed under "Printed Publications" and "Other Information."

It is respectfully requested that the listed references be considered in this reexamination and identified on the list of references cited on the certificate issuing for this reexamination. Patent Owner also requests that an initialed copy of FORM PTO/SB/08A/B be entered in the reexamination file and returned to applicant with the next communication from the Patent Office.

The Commissioner is hereby authorized to charge any fees which may be required by this paper to Deposit Account No. 03-1728. Please show our docket number with any Deposit Account transaction.

Respectfully submitted,  
CHRISTIE, PARKER & HALE, LLP

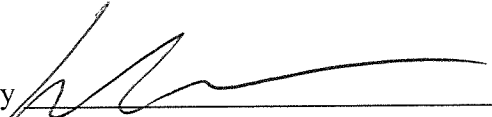
By   
Wesley W. Monroe  
Reg. No. 39,778  
626/795-9900

WWM/asl  
Enclosures: PTO/SB/08A/B, w/references

ASL PAS927528.1-\* -11/1/10 5:05 PM

FORM PTO/SB/08A/B (10-01) Substitute for PTO-1449A/B  <b>INFORMATION DISCLOSURE</b>  <b>STATEMENT BY APPLICANT</b>  (use as many sheets as necessary)	<b>Attorney Docket Number</b>	62986/A522
	<b>Application Number</b>	90/009301
	<b>Filing Date</b>	December 17, 2008
	<b>Applicant(s)</b>	6,779,118 B1
	<b>Group Art Unit</b>	3992
	<b>Examiner Name</b>	Rimell, Samuel G.

U.S. PATENT DOCUMENTS				
EXAMINER INITIALS	Cite No. <sup>1</sup>	DOCUMENT NUMBER Number - Kind Code <sup>2</sup> (If Known)	PUBLICATION DATE MM-DD-YYYY	NAME OF PATENTEE

FOREIGN PATENT DOCUMENTS					
EXAMINER INITIALS	Cite No. <sup>1</sup>	Foreign Patent Document Country Code <sup>3</sup> - Number <sup>4</sup> - Kind Code <sup>5</sup> (If Known)	Publication Date MM-DD-YYYY	Name of Patentee or Applicant of Cited Document	T <sup>6</sup> (✓)

PRINTED PUBLICATIONS		
EXAMINER INITIALS	Cite No. <sup>1</sup>	Include name of the author (in CAPITAL LETTERS), title of the article, title of the item (book, magazine, journal, serial, symposium, catalog, etc.), date, page(s), volume-issue number(s), publisher, city and/or country where published.
	C28	"ChoiceNet Administrator's Guide," Livingston Enterprises, 88 pages, January 1997.
	C29	"Livingston ChoiceNet – How It Works," <www.livingston.com/Marketing/Products/choicenet_HIW.shtml>, retrieved from <web.archive.org>, purportedly archived on April 30, 1997, 1 page.
	C30	MALKIN, <i>Comprehensive Networking Glossary and Acronym Guide</i> , 1995, title page, preface, pp. 46-47, 114-115, 154-155 (4 pages).
	C31	"MAX T1/PRI RADIUS Supplement," Ascend Communications, Inc., 82 pages, 1996.
	C32	NEWTON, <i>Newton's Telecom Dictionary</i> , Telecom Books and Flatiron Publishing, 10th ed., January 1998, cover, title page, p. 194 (3 pages).
	C33	"ODN Web Card," <http://www.asahi.com/ad/clients/tsuuhhan/entry.html>, 1 page, March-April 1998, Japan (in Japanese).
	C34	"Proxy Server Version 2.0: Reviewer's Guide," Microsoft, 88 pages, 1997.
	C35	"sampleNET Products," <samplenet.com>, retrieved from <web.archive.org>, purportedly archived on April 4, 1997, 2 pages.
	C36	Sclater, Neil, Markus, John, <i>McGraw-Hill Electronics Dictionary, 6th ed.</i> , 1997, cover, title pages (2), pp. 110, 119 (5 pages).
	C37	<i>Trendy</i> , article on second page with picture of Japan Telecom ODN Web Card, 2 pages, May 1998, Japan (in Japanese).

EXAMINER SIGNATURE	DATE CONSIDERED
EXAMINER: Initial if reference considered, whether or not citation is in conformance with MPEP 609; Draw line through citation if not in conformance and not considered. Include copy of this form with next communication to applicant. <sup>1</sup> Applicant's unique citation designation number (optional). <sup>2</sup> See Kinds Codes of USPTO Patent Documents at www.pto.gov or MPEP 901.4. <sup>3</sup> Enter Office that issued the document, by the two-letter code (WIPO standard ST.3). <sup>4</sup> For Japanese patent documents, the indication of the year of the reign of the Emperor must precede the serial number of the patent document. <sup>5</sup> Kind of document by the appropriate symbols as indicated on the document under WIPO Standard ST.16 if possible. <sup>6</sup> Applicant is to place a check mark here if English Language Translation is attached.	

Patent and Trademark Office; U.S. DEPARTMENT OF COMMERCE

FORM PTO/SB/08A/B (10-01) Substitute for PTO-1449A/B  <b>INFORMATION DISCLOSURE</b>  <b>STATEMENT BY APPLICANT</b>  (use as many sheets as necessary)	<b>Attorney Docket Number</b>	62986/A522
	<b>Application Number</b>	90/009301
	<b>Filing Date</b>	December 17, 2008
	<b>Applicant(s)</b>	6,779,118 B1
	<b>Group Art Unit</b>	3992
	<b>Examiner Name</b>	Rimell, Samuel G.

**PRINTED PUBLICATIONS**

EXAMINER INITIALS	Cite No. <sup>1</sup>	Include name of the author (in CAPITAL LETTERS), title of the article, title of the item (book, magazine, journal, serial, symposium, catalog, etc.), date, page(s), volume-issue number(s), publisher, city and/or country where published.
	C38	Yomiuri On-Line, article on second page regarding "ODN Web Card," 2 pages, February 20, 1998, Japan (in Japanese).

**OTHER INFORMATION 37 CFR 1.98(a)(2)(iv)**

EXAMINER INITIALS	Cite No. <sup>1</sup>	Title of the item, date (if any), page(s), other information.
	D4	Linksmart Opening Claim Construction Brief, Linksmart Wireless Technology, LLC v. T-Mobile USA, Inc., et al., Case Nos. (consolidated) 2:08-cv-00264-DF-CE, 2:08-cv-00304-DFCE, 2:08-cv-00385-DF-CD, 2:09-cv-00026-DF-CE, U.S. District Court, Eastern District of Texas, Marshall Division, 31 pages, March 19, 2010
	D5	First Supplemental Invalidity Contentions of Cisco Systems, Inc. et al., <i>Linksmart Wireless Technology, LLC v. T-Mobile USA, Inc., et al.</i> , Case Nos. (consolidated) 2:08-cv-00264-DF-CE, 2:08-cv-00304-DF-CE, 2:08-cv-00385-DF-CD, 2:09-cv-00026-DF-CE, U.S. District Court, Eastern District of Texas, Marshall Division, 91 pages, May 17, 2010.
	D6	Second Supplemental Invalidity Contentions of Cisco Systems, Inc. et al., <i>Linksmart Wireless Technology, LLC v. T-Mobile USA, Inc., et al.</i> , Case Nos. (consolidated) 2:08-cv-00264-DF-CE, 2:08-cv-00304-DF-CE, 2:08-cv-00385-DF-CD, 2:09-cv-00026-DF-CE, U.S. District Court, Eastern District of Texas, Marshall Division, 11 pages, August 19, 2010

ASL PAS923974.1-\*--10/15/10 3:08 PM

EXAMINER SIGNATURE	DATE CONSIDERED
EXAMINER: Initial if reference considered, whether or not citation is in conformance with MPEP 609; Draw line through citation if not in conformance and not considered. Include copy of this form with next communication to applicant. <sup>1</sup> Applicant's unique citation designation number (optional). <sup>2</sup> See Kinds Codes of USPTO Patent Documents at www.pto.gov or MPEP 901.4. <sup>3</sup> Enter Office that issued the document, by the two-letter code (WIPO standard ST.3). <sup>4</sup> For Japanese patent documents, the indication of the year of the reign of the Emperor must precede the serial number of the patent document. <sup>5</sup> Kind of document by the appropriate symbols as indicated on the document under WIPO Standard ST.16 if possible. <sup>6</sup> Applicant is to place a check mark here if English Language Translation is attached.	

Patent and Trademark Office; U.S. DEPARTMENT OF COMMERCE

Control No. 90/009,301  
Docket No. 62986/A522  
Date of deposit: October 15, 2010

**CERTIFICATE OF SERVICE**

I certify that on October 15, 2010, the foregoing documents: (1) **INFORMATION DISCLOSURE STATEMENT UNDER 37 CFR §1.555** (2) **FORM PTO/SB/08A/B** (3) **Fourteen Non-Patent Literature (NPL) documents** were electronically filed with:

Mail Stop Ex Parte Reexam  
ATTN: Central Reexamination Unit  
Commissioner for Patents  
P.O. Box 1450  
Alexandria, VA 22313-1450

It is further certified that on October 15, 2010, the foregoing documents: (1) **INFORMATION DISCLOSURE STATEMENT UNDER 37 CFR §1.555** (2) **FORM PTO/SB/08A/B** (3) **Fourteen Non-Patent Literature (NPL) documents** are being served as indicated, to the party listed below:

Jerry Turner Sewell  
P.O. Box 10999  
Newport Beach, CA 92658-5015

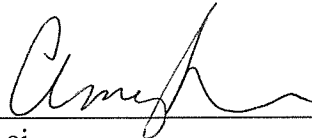
By  \_\_\_\_\_  
Amy Lai  
Assistant to Wesley W. Monroe  
CHRISTIE, PARKER & HALE, LLP  
P.O. Box 7068  
Pasadena, CA 91109-7068

ASL PAS925270.1-\* -10/15/10 3:41 PM



## Electronic Acknowledgement Receipt

<b>EFS ID:</b>	8640123
<b>Application Number:</b>	90009301
<b>International Application Number:</b>	
<b>Confirmation Number:</b>	6609
<b>Title of Invention:</b>	USER SPECIFIC AUTOMATIC DATA REDIRECTION SYSTEM
<b>First Named Inventor/Applicant Name:</b>	6,779,118 B1
<b>Customer Number:</b>	40401
<b>Filer:</b>	Wesley W. Monroe/Amy Lai
<b>Filer Authorized By:</b>	Wesley W. Monroe
<b>Attorney Docket Number:</b>	R1341006
<b>Receipt Date:</b>	15-OCT-2010
<b>Filing Date:</b>	17-DEC-2008
<b>Time Stamp:</b>	21:22:51
<b>Application Type:</b>	Reexam (Patent Owner)

### Payment information:

Submitted with Payment	no
------------------------	----

### File Listing:

Document Number	Document Description	File Name	File Size(Bytes)/ Message Digest	Multi Part /.zip	Pages (if appl.)
1	Transmittal Letter	62986idstransmittal.pdf	47577 <small>87ef5d34f13340c534b1413a1762c8bead1ed33f</small>	no	3

### Warnings:

### Information:

2	Information Disclosure Statement (IDS) Filed (SB/08)	62986idsptoformsb08ab.pdf	78404 a91f05d8d383e5658172602c4eee8a4d93a c81b9	no	2
<b>Warnings:</b>					
<b>Information:</b>					
This is not an USPTO supplied IDS fillable form					
3	NPL Documents	62986npl_ChoiceNet.pdf	2514013 4c68bd47cf6294a2777d61f969da0181630 0166a	no	88
<b>Warnings:</b>					
<b>Information:</b>					
4	NPL Documents	62986npl_CiscoFirstAmended InvalidityContentions.pdf	1532064 a57a4de6b7b163538b07c19d2be40a6f9f6 74b1e	no	91
<b>Warnings:</b>					
<b>Information:</b>					
5	NPL Documents	62986npl_CiscoSecondAmend edInvalidity.pdf	218945 dce6c44828e7d9996169f2c895e438ab899 30c08	no	11
<b>Warnings:</b>					
<b>Information:</b>					
6	NPL Documents	62986npl_LinksmartOpeningCl aimConstructionBrief.pdf	305334 d661666a18765098b7da3a3faca01085c41 ddb48	no	31
<b>Warnings:</b>					
<b>Information:</b>					
7	NPL Documents	62986npl_LivingstonChoiceNet .pdf	195732 3601d1a315f86f7dcabb7a1a3e4857d84ab 804d2	no	1
<b>Warnings:</b>					
<b>Information:</b>					
8	NPL Documents	62986npl_Malkin.pdf	548711 d5c08e4b502343fe41ee4bd55368de806ce ed82a	no	4
<b>Warnings:</b>					
<b>Information:</b>					
9	NPL Documents	62986npl_MAX.pdf	3663569 4e2e4a86deebd76099e3a7e56c9e2b4a8a5 07a2e	no	82
<b>Warnings:</b>					
<b>Information:</b>					
10	NPL Documents	62986npl_Newton2.pdf	81341 8f7f522ddeef5c19c0ca741cdcf2a7e7481 ec8	no	3

<b>Warnings:</b>					
<b>Information:</b>					
11	NPL Documents	62986npl_ODNWebCard.pdf	64113 a345ee834cfdc3eda2c8eedb9e3edea3303b31	no	1
<b>Warnings:</b>					
<b>Information:</b>					
12	NPL Documents	62986npl_ProxyServer2.pdf	4617378 63b4aa599964882cec0cef3cb4ab5158305db928	no	88
<b>Warnings:</b>					
<b>Information:</b>					
13	NPL Documents	62986npl_SampleNet.pdf	178770 b41197b3211f800c6a3522c33e6e408fc29a824a	no	2
<b>Warnings:</b>					
<b>Information:</b>					
14	NPL Documents	62986npl_Scalter.pdf	1658172 8e7a4d3733977ae13a9e976b61e14469e6e2e227	no	5
<b>Warnings:</b>					
<b>Information:</b>					
15	NPL Documents	62986npl_Trendy.pdf	738110 37f64f5a1377d1bc1c109d18584ea00d60009493	no	2
<b>Warnings:</b>					
<b>Information:</b>					
16	NPL Documents	62986npl_Yomiuri.pdf	384627 7ce4da7ad6020bb94d7f6291be982a2471760353	no	2
<b>Warnings:</b>					
<b>Information:</b>					
17	Miscellaneous Incoming Letter	62986certificateofservice.pdf	14016 bd77864ade70ec01145b4a4dbb750020b157a768	no	1
<b>Warnings:</b>					
<b>Information:</b>					
<b>Total Files Size (in bytes):</b>			16840876		

**This Acknowledgement Receipt evidences receipt on the noted date by the USPTO of the indicated documents, characterized by the applicant, and including page counts, where applicable. It serves as evidence of receipt similar to a Post Card, as described in MPEP 503.**

**New Applications Under 35 U.S.C. 111**

**If a new application is being filed and the application includes the necessary components for a filing date (see 37 CFR 1.53(b)-(d) and MPEP 506), a Filing Receipt (37 CFR 1.54) will be issued in due course and the date shown on this Acknowledgement Receipt will establish the filing date of the application.**

**National Stage of an International Application under 35 U.S.C. 371**

**If a timely submission to enter the national stage of an international application is compliant with the conditions of 35 U.S.C. 371 and other applicable requirements a Form PCT/DO/EO/903 indicating acceptance of the application as a national stage submission under 35 U.S.C. 371 will be issued in addition to the Filing Receipt, in due course.**

**New International Application Filed with the USPTO as a Receiving Office**

**If a new international application is being filed and the international application includes the necessary components for an international filing date (see PCT Article 11 and MPEP 1810), a Notification of the International Application Number and of the International Filing Date (Form PCT/RO/105) will be issued in due course, subject to prescriptions concerning national security, and the date shown on this Acknowledgement Receipt will establish the international filing date of the application.**

**IN THE UNITED STATES PATENT AND TRADEMARK OFFICE**

*I hereby certify that this correspondence is being electronically filed with the United States Patent and Trademark Office on October 15, 2010 at or before 11:59 p.m. Pacific Time under the Rules of 37 CFR § 1.8.*

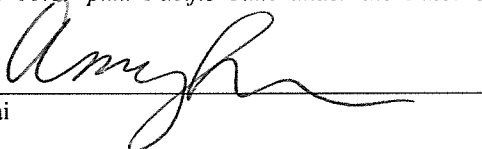
  
\_\_\_\_\_  
Amy Lai

Applicant	: <b>Ikudome, Koichiro et al.</b>	Confirmation No. 6609
Control No.	: 90/009,301	
Filed	: December 17, 2008	
Title	: USER SPECIFIC AUTOMATIC DATA REDIRECTION SYSTEM	
Grp./Div.	: 3992	
Examiner	: Rimell, Samuel G.	
Docket No.	: 62986/A522	

**INFORMATION DISCLOSURE STATEMENT  
UNDER 37 CFR § 1.555**

Mail Stop Ex Parte Reexam  
Central Reexamination Unit  
Commissioner for Patents  
P.O. Box 1450  
Alexandria, VA 22313-1450

Post Office Box 7068  
Pasadena, CA 91109-7068  
October 15, 2010

Commissioner:

In compliance with the duty of disclosure under 37 CFR §§ 1.555 and in accordance with the provisions in the Manual of Patent Examining Procedure §§ 2280, enclosed is FORM PTO/SB/08A/B listing references that are known to Patent Owner. Printed publication C30 was listed as reference C15 on Substitute Form 1449 submitted by Patent Owner's representative on May 13, 2010, but as indicated in the Information Disclosure Statement filed therewith, a copy of the reference was not submitted as it was then available to Patent Owner's representative. Similarly, Other Information item D4, discussed in more detail below, was listed as part of item C13 on the Substitute Form 1449 submitted by Patent Owner's representative on May 13, 2010, but was not submitted to the Office at that time (the portions of the documents listed C13 that are not part of item D4 now submitted consist of documents from file histories of the present patent

**Application No. 90/009,301**

and related applications and references that have been or are being submitted to the Office as separate items. Copies of these documents are now available and are submitted presently.

Printed publications C28-C29, C31, C33-C35, and C37-C38 listed were referenced in invalidity contentions served by defendants in the litigation, *Linksmart Wireless Technology, LLC v. T-Mobile USA, Inc., et al.*, U.S. District Court, Eastern District of Texas, Marshall Division, 2:08-cv-00264-DF-CE, 2:08-cv-00304-DF-CE, 2:08-cv-00385-DF-CD, 2:09-cv-00026-DF-CE. Printed publications C32 and C36 were referenced in Patent Owner's Opening Claim Construction Brief (D4) in the litigation, *Linksmart Wireless Technology, LLC v. T-Mobile USA, Inc., et al.*, U.S. District Court, Eastern District of Texas, Marshall Division, 2:08-cv-00264-DF-CE, 2:08-cv-00304-DF-CE, 2:08-cv-00385-DF-CD, 2:09-cv-00026-DF-CE.

Printed publications C33, C37, and C38 are in Japanese. Written English-language translations of these publications or portions of these publications are not within the possession, custody, or control of, or is readily available to Patent Owner or its representatives. Patent Owner's present understanding of the relevance of references C33, C37, and C38 is that all three are short articles regarding a product of Japan Telecom, ODN Web Card that is also described in the first press release appearing in reference C2, submitted to the Office as part of the IDS filed by Patent Owner's representative on October 4, 2010 (Auric Web Systems, News, web page at <<http://www.auricweb.com/news.html>> , 3 pages, accessed July 12, 1999, including press release: Prepaid Card Has Made An Exciting Debut, December 10, 1998). A similar product, using the name WEBGate card is described in reference C4, submitted to the Office as part of the IDS filed by Patent Owner's representative on October 4, 2010 (Auric Web Unveils Tool To Navigate Customer Directly To A Specific Website, press release, Auric Web Systems, Inc., 1 page, November 24, 1997).

Listed under the heading "Other Information" on enclosed FORM PTO/SB/08A/B and submitted pursuant to MPEP §2207, "Entry of Court Decision in Patent File," are court papers listed as item D4-D6 from the litigation, *Linksmart Wireless Technology, LLC v. T-Mobile USA, Inc., et al.*, U.S. District Court, Eastern District of Texas, Marshall Division, 2:08-cv-00264-DF-CE, 2:08-cv-00304-DF-CE, 2:08-cv-00385-DF-CD, 2:09-cv-00026-DF-CE. While not printed

**Application No. 90/009,301**

publications, under MPEP §2207, “The Office will also accept for entry into the patent file other court papers, or papers filed in the court, from litigations or other proceedings involving the patent.” The patent presently under reexamination is the subject of this litigation and this litigation is referenced in the Reexam Litigation Search report, dated July 21, 2009, for the present reexamination. Accordingly, these documents should not be crossed out on FORM PTO/SB/08A/B. More specifically, item D4 is the patent owners Opening Claim Construction Brief, which is submitted to address any possibility that statements in this brief are inconsistent with positions taken by Patent Owner in this reexamination and items D5 and D6 are two recently filed First and Second Supplemental Invalidity Contentions of defendants from the above reference litigation.

Enclosed are copies of each reference listed under "Printed Publications" and “Other Information.”

It is respectfully requested that the listed references be considered in this reexamination and identified on the list of references cited on the certificate issuing for this reexamination. Patent Owner also requests that an initialed copy of FORM PTO/SB/08A/B be entered in the reexamination file and returned to applicant with the next communication from the Patent Office.

The Commissioner is hereby authorized to charge any fees which may be required by this paper to Deposit Account No. 03-1728. Please show our docket number with any Deposit Account transaction.

Respectfully submitted,  
CHRISTIE PARKER & HALE, LLP

By

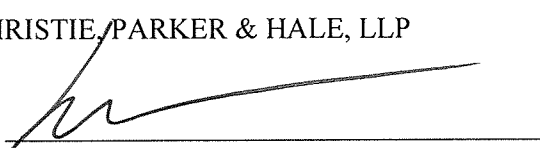
  
Wesley W. Monroe  
Reg. No. 39,778  
626/795-9900

WWM/asl  
Enclosures: PTO/SB/08A/B, w/references

ASL PAS925265.1-\*-10/15/10 5:57 PM

FORM PTO/SB/08A/B (10-01) Substitute for PTO-1449A/B  <b>INFORMATION DISCLOSURE</b>  <b>STATEMENT BY APPLICANT</b>  (use as many sheets as necessary)	<b>Attorney Docket Number</b>	62986/A522
	<b>Application Number</b>	90/009301
	<b>Filing Date</b>	December 17, 2008
	<b>Applicant(s)</b>	6,779,118 B1
	<b>Group Art Unit</b>	3992
	<b>Examiner Name</b>	Rimell, Samuel G.

U.S. PATENT DOCUMENTS				
EXAMINER INITIALS	Cite No. <sup>1</sup>	DOCUMENT NUMBER Number - Kind Code <sup>2</sup> (If Known)	PUBLICATION DATE MM-DD-YYYY	NAME OF PATENTEE
	A1	5,987,523	11-16-1999	Hind et al.

FOREIGN PATENT DOCUMENTS					
EXAMINER INITIALS	Cite No. <sup>1</sup>	Foreign Patent Document Country Code <sup>3</sup> - Number <sup>4</sup> - Kind Code <sup>5</sup> (If Known)	Publication Date MM-DD-YYYY	Name of Patentee or Applicant of Cited Document	T <sup>6</sup> (✓)

PRINTED PUBLICATIONS		
EXAMINER INITIALS	Cite No. <sup>1</sup>	Include name of the author (in CAPITAL LETTERS), title of the article, title of the item (book, magazine, journal, serial, symposium, catalog, etc.), date, page(s), volume-issue number(s), publisher, city and/or country where published.
	C27	ELMASRI et al., <i>Fundamentals of Database Systems</i> , ed.2, Addison-Wesley, 1994.

OTHER INFORMATION 37 CFR 1.98(a)(2)(iv)		
EXAMINER INITIALS	Cite No. <sup>1</sup>	Title of the item, date (if any), page(s), other information.

ASL PAS923139.1-\*-10/6/10 4:51 PM

EXAMINER SIGNATURE	DATE CONSIDERED
EXAMINER: Initial if reference considered, whether or not citation is in conformance with MPEP 609; Draw line through citation if not in conformance and not considered. Include copy of this form with next communication to applicant. <sup>1</sup> Applicant's unique citation designation number (optional). <sup>2</sup> See Kinds Codes of USPTO Patent Documents at www.pto.gov or MPEP 901.4. <sup>3</sup> Enter Office that issued the document, by the two-letter code (WIPO standard ST.3). <sup>4</sup> For Japanese patent documents, the indication of the year of the reign of the Emperor must precede the serial number of the patent document. <sup>5</sup> Kind of document by the appropriate symbols as indicated on the document under WIPO Standard ST.16 if possible. <sup>6</sup> Applicant is to place a check mark here if English Language Translation is attached.	

Patent and Trademark Office; U.S. DEPARTMENT OF COMMERCE



Control No. 90/009,301  
Docket No. 62986/A522  
Date of deposit: October 6, 2010

**CERTIFICATE OF SERVICE**

I certify that on October 6, 2010, the foregoing documents: (1) **INFORMATION DISCLOSURE STATEMENT UNDER 37 CFR §1.555 (2) FORM PTO/SB/08A/B (3) One Non-Patent Literature (NPL) document** are being electronically filed with:

Mail Stop Ex Parte Reexam  
ATTN: Central Reexamination Unit  
Commissioner for Patents  
P.O. Box 1450  
Alexandria, VA 22313-1450

It is further certified that on October 6, 2010, the foregoing documents: (1) **INFORMATION DISCLOSURE STATEMENT UNDER 37 CFR §1.555 (2) FORM PTO/SB/08A/B (3) One Non-Patent Literature (NPL) document** are being served as indicated, to the party listed below:

Jerry Turner Sewell  
P.O. Box 10999  
Newport Beach, CA 92658-5015

By   
Amy Lai  
Assistant to Wesley W. Monroe  
CHRISTIE, PARKER & HALE, LLP  
P.O. Box 7068  
Pasadena, CA 91109-7068

ASL PAS923569.1-\*-10/6/10 5:02 PM

## Electronic Acknowledgement Receipt

<b>EFS ID:</b>	8575866
<b>Application Number:</b>	90009301
<b>International Application Number:</b>	
<b>Confirmation Number:</b>	6609
<b>Title of Invention:</b>	USER SPECIFIC AUTOMATIC DATA REDIRECTION SYSTEM
<b>First Named Inventor/Applicant Name:</b>	6,779,118 B1
<b>Customer Number:</b>	40401
<b>Filer:</b>	Wesley W. Monroe/Amy Lai
<b>Filer Authorized By:</b>	Wesley W. Monroe
<b>Attorney Docket Number:</b>	R1341006
<b>Receipt Date:</b>	06-OCT-2010
<b>Filing Date:</b>	17-DEC-2008
<b>Time Stamp:</b>	20:41:31
<b>Application Type:</b>	Reexam (Patent Owner)

### Payment information:

Submitted with Payment	no
------------------------	----

### File Listing:

Document Number	Document Description	File Name	File Size(Bytes)/ Message Digest	Multi Part /.zip	Pages (if appl.)
1	Transmittal Letter	62986idstransmittalletter.pdf	26057 <small>2184f828c1bcdaf719784e7dd545a7bbab9b2772</small>	no	2

### Warnings:

### Information:

2	Information Disclosure Statement (IDS) Filed (SB/08)	62986ptoformsb08ab.pdf	32229 <small>9d4543b3840fbf37bd3ca9fd507089081fb8e7</small>	no	1
<b>Warnings:</b>					
<b>Information:</b>					
This is not an USPTO supplied IDS fillable form					
3	NPL Documents	62986npl_elmasri.pdf	303178 <small>07bac8e4973aacd9db7d7317309401063238a225</small>	no	2
<b>Warnings:</b>					
<b>Information:</b>					
4	Miscellaneous Incoming Letter	62986certofservice.pdf	13556 <small>81b089317a29507cb36a82c6391246f2858b6cc3</small>	no	1
<b>Warnings:</b>					
<b>Information:</b>					
<b>Total Files Size (in bytes):</b>			375020		
<p><b>This Acknowledgement Receipt evidences receipt on the noted date by the USPTO of the indicated documents, characterized by the applicant, and including page counts, where applicable. It serves as evidence of receipt similar to a Post Card, as described in MPEP 503.</b></p> <p><b><u>New Applications Under 35 U.S.C. 111</u></b> If a new application is being filed and the application includes the necessary components for a filing date (see 37 CFR 1.53(b)-(d) and MPEP 506), a Filing Receipt (37 CFR 1.54) will be issued in due course and the date shown on this Acknowledgement Receipt will establish the filing date of the application.</p> <p><b><u>National Stage of an International Application under 35 U.S.C. 371</u></b> If a timely submission to enter the national stage of an international application is compliant with the conditions of 35 U.S.C. 371 and other applicable requirements a Form PCT/DO/EO/903 indicating acceptance of the application as a national stage submission under 35 U.S.C. 371 will be issued in addition to the Filing Receipt, in due course.</p> <p><b><u>New International Application Filed with the USPTO as a Receiving Office</u></b> If a new international application is being filed and the international application includes the necessary components for an international filing date (see PCT Article 11 and MPEP 1810), a Notification of the International Application Number and of the International Filing Date (Form PCT/RO/105) will be issued in due course, subject to prescriptions concerning national security, and the date shown on this Acknowledgement Receipt will establish the international filing date of the application.</p>					

**IN THE UNITED STATES PATENT AND TRADEMARK OFFICE**

*I hereby certify that this correspondence is being electronically filed with the United States Patent and Trademark Office on October 6, 2010 at or before 11:59 p.m. Pacific Time under the Rules of 37 CFR § 1.8.*

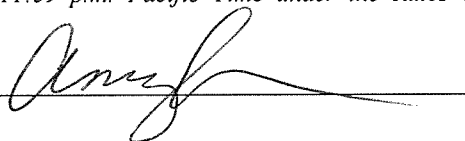
  
\_\_\_\_\_  
Amy Lai

Applicant : **Ikudome, Koichiro et al.** Confirmation No. 6609  
Control No. : 90/009,301  
Filed : December 17, 2008  
Title : USER SPECIFIC AUTOMATIC DATA REDIRECTION SYSTEM  
  
Grp./Div. : 3992  
Examiner : Rimell, Samuel G.  
  
Docket No. : 62986/A522

**INFORMATION DISCLOSURE STATEMENT B  
UNDER 37 CFR § 1.555**

Mail Stop Ex Parte Reexam  
Central Reexamination Unit  
Commissioner for Patents  
P.O. Box 1450  
Alexandria, VA 22313-1450

Post Office Box 7068  
Pasadena, CA 91109-7068  
October 6, 2010

Commissioner:

In compliance with the duty of disclosure under 37 CFR §§ 1.555 and in accordance with the provisions in the Manual of Patent Examining Procedure §§ 2280, enclosed is FORM PTO/SB/08A/B listing references that are known to applicant. Reference A1 was used in a rejection in currently pending continuation Application No. 11/645, 924, filed December 26, 2006, of the present patent under reexamination. Reference C27 is being cited again because

**Application No. 90/009,301**

Examiner could not locate a copy of the reference and crossed out the reference as being not considered on the Information Disclosure Statement By Applicant filed May 13, 2010.

Enclosed is a copy of the reference listed under "Printed Publications."

It is respectfully requested that the listed references be considered in this reexamination and identified on the list of references cited on the certificate issuing for this reexamination. Applicant also requests that an initialed copy of FORM PTO/SB/08A/B be entered in the reexamination file and returned to applicant with the next communication from the Patent Office.

The Commissioner is hereby authorized to charge any fees which may be required by this paper to Deposit Account No. 03-1728. Please show our docket number with any Deposit Account transaction.

Respectfully submitted,  
CHRISTIE, PARKER & HALE, LLP

By   
\_\_\_\_\_  
Wesley W. Monroe  
Reg. No. 39,778  
626/795-9900

WWM/asl  
Enclosures: PTO/SB/08A/B, w/references

ASL PAS923564.1-\*-10/6/10 4:57 PM

## Electronic Acknowledgement Receipt

<b>EFS ID:</b>	8558950
<b>Application Number:</b>	90009301
<b>International Application Number:</b>	
<b>Confirmation Number:</b>	6609
<b>Title of Invention:</b>	USER SPECIFIC AUTOMATIC DATA REDIRECTION SYSTEM
<b>First Named Inventor/Applicant Name:</b>	6,779,118 B1
<b>Customer Number:</b>	40401
<b>Filer:</b>	Wesley W. Monroe/Amy Lai
<b>Filer Authorized By:</b>	Wesley W. Monroe
<b>Attorney Docket Number:</b>	R1341006
<b>Receipt Date:</b>	05-OCT-2010
<b>Filing Date:</b>	17-DEC-2008
<b>Time Stamp:</b>	00:17:59
<b>Application Type:</b>	Reexam (Patent Owner)

### Payment information:

Submitted with Payment	no
------------------------	----

### File Listing:

Document Number	Document Description	File Name	File Size(Bytes)/ Message Digest	Multi Part /.zip	Pages (if appl.)
1	NPL Documents	ArarD07.pdf	254529 <small>1760062cbb3ede62e31feae004e9d8393d7e3dd3</small>	no	1

### Warnings:

### Information:

2	NPL Documents	AuricWebSystemsNewsD27.pdf	866089 6ef8ef39f6902eb16f35da3e38e0d7aa9474c65e	no	3
<b>Warnings:</b>					
<b>Information:</b>					
3	NPL Documents	AuricWebSystemsunveilsToolD28.pdf	212457 a6870eb397531cd05387dd850f9c7330e97dc002	no	1
<b>Warnings:</b>					
<b>Information:</b>					
4	NPL Documents	BuyingMadeEasyD05.pdf	354430 52933df43a9a654784827e41f24ed53de723a991	no	1
<b>Warnings:</b>					
<b>Information:</b>					
5	NPL Documents	KostickSystemAdministrationIPMasqurading.pdf	131435 507dfd50a4fbb19b1861c38ec40735220118cb41	no	14
<b>Warnings:</b>					
<b>Information:</b>					
6	NPL Documents	LopezIPChains.pdf	18716902 b799f04a8c01d248fad84ee016691abba04a23b	no	136
<b>Warnings:</b>					
<b>Information:</b>					
7	NPL Documents	PrepaidInternetAccessCardsD06.pdf	225950 274cc02fee034eb8b09e8d1a7de31aa3670d1fa0	no	1
<b>Warnings:</b>					
<b>Information:</b>					
8	NPL Documents	AmendedInvContATT.pdf	278272 24111b0d8136e185f8c2204921d57a7387f95c08	no	100
<b>Warnings:</b>					
<b>Information:</b>					
9	NPL Documents	FirstSupplInvContATT.pdf	219718 a6e74eda218af05335beee34fba97fa5038eb2fb	no	82
<b>Warnings:</b>					
<b>Information:</b>					
10	NPL Documents	MemorandandOrderClaimConstruction.pdf	108066 9e3c978312821bc53ab1f387a463f95105425ace	no	23
<b>Warnings:</b>					
<b>Information:</b>					

This Acknowledgement Receipt evidences receipt on the noted date by the USPTO of the indicated documents, characterized by the applicant, and including page counts, where applicable. It serves as evidence of receipt similar to a Post Card, as described in MPEP 503.

**New Applications Under 35 U.S.C. 111**

If a new application is being filed and the application includes the necessary components for a filing date (see 37 CFR 1.53(b)-(d) and MPEP 506), a Filing Receipt (37 CFR 1.54) will be issued in due course and the date shown on this Acknowledgement Receipt will establish the filing date of the application.

**National Stage of an International Application under 35 U.S.C. 371**

If a timely submission to enter the national stage of an international application is compliant with the conditions of 35 U.S.C. 371 and other applicable requirements a Form PCT/DO/EO/903 indicating acceptance of the application as a national stage submission under 35 U.S.C. 371 will be issued in addition to the Filing Receipt, in due course.

**New International Application Filed with the USPTO as a Receiving Office**

If a new international application is being filed and the international application includes the necessary components for an international filing date (see PCT Article 11 and MPEP 1810), a Notification of the International Application Number and of the International Filing Date (Form PCT/RO/105) will be issued in due course, subject to prescriptions concerning national security, and the date shown on this Acknowledgement Receipt will establish the international filing date of the application.



Control No. 90/009,301  
Docket No. 62986/A522  
Date of deposit: October 5, 2010

**CERTIFICATE OF SERVICE**

I certify that on October 4, 2010, the foregoing documents: (1) **INFORMATION DISCLOSURE STATEMENT UNDER 37 CFR §1.555** (2) **FORM PTO/SB/08A/B** (3) **Twenty-nine Non-Patent Literature (NPL) documents** were electronically filed with:

Mail Stop Ex Parte Reexam  
ATTN: Central Reexamination Unit  
Commissioner for Patents  
P.O. Box 1450  
Alexandria, VA 22313-1450

It is further certified that on October 5, 2010, the foregoing documents: (1) **INFORMATION DISCLOSURE STATEMENT UNDER 37 CFR §1.555** (2) **FORM PTO/SB/08A/B** (3) **Twenty-nine Non-Patent Literature (NPL) documents** are being served as indicated, to the party listed below:

Jerry Turner Sewell  
P.O. Box 10999  
Newport Beach, CA 92658-5015

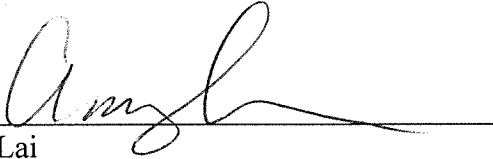
By   
Amy Lai  
Assistant to Wesley W. Monroe  
CHRISTIE, PARKER & HALE, LLP  
P.O. Box 7068  
Pasadena, CA 91109-7068

ASL PAS923216.1-\*-10/5/10 12:12 PM

## Electronic Acknowledgement Receipt

<b>EFS ID:</b>	8563803
<b>Application Number:</b>	90009301
<b>International Application Number:</b>	
<b>Confirmation Number:</b>	6609
<b>Title of Invention:</b>	USER SPECIFIC AUTOMATIC DATA REDIRECTION SYSTEM
<b>First Named Inventor/Applicant Name:</b>	6,779,118 B1
<b>Customer Number:</b>	40401
<b>Filer:</b>	Gabriel Fitch/Amy Lai
<b>Filer Authorized By:</b>	Gabriel Fitch
<b>Attorney Docket Number:</b>	R1341006
<b>Receipt Date:</b>	05-OCT-2010
<b>Filing Date:</b>	17-DEC-2008
<b>Time Stamp:</b>	16:21:29
<b>Application Type:</b>	Reexam (Patent Owner)

### Payment information:

Submitted with Payment	no
------------------------	----

### File Listing:

Document Number	Document Description	File Name	File Size(Bytes)/ Message Digest	Multi Part /.zip	Pages (if appl.)
1	Miscellaneous Incoming Letter	62986certificateofservice.pdf	14090 <small>a5d2866b646f86c07f1d22ce6a38455456172067</small>	no	1

### Warnings:

### Information:

This Acknowledgement Receipt evidences receipt on the noted date by the USPTO of the indicated documents, characterized by the applicant, and including page counts, where applicable. It serves as evidence of receipt similar to a Post Card, as described in MPEP 503.

**New Applications Under 35 U.S.C. 111**

If a new application is being filed and the application includes the necessary components for a filing date (see 37 CFR 1.53(b)-(d) and MPEP 506), a Filing Receipt (37 CFR 1.54) will be issued in due course and the date shown on this Acknowledgement Receipt will establish the filing date of the application.

**National Stage of an International Application under 35 U.S.C. 371**

If a timely submission to enter the national stage of an international application is compliant with the conditions of 35 U.S.C. 371 and other applicable requirements a Form PCT/DO/EO/903 indicating acceptance of the application as a national stage submission under 35 U.S.C. 371 will be issued in addition to the Filing Receipt, in due course.

**New International Application Filed with the USPTO as a Receiving Office**

If a new international application is being filed and the international application includes the necessary components for an international filing date (see PCT Article 11 and MPEP 1810), a Notification of the International Application Number and of the International Filing Date (Form PCT/RO/105) will be issued in due course, subject to prescriptions concerning national security, and the date shown on this Acknowledgement Receipt will establish the international filing date of the application.



UNITED STATES PATENT AND TRADEMARK OFFICE

UNITED STATES DEPARTMENT OF COMMERCE  
United States Patent and Trademark Office  
Address: COMMISSIONER FOR PATENTS  
P.O. Box 1450  
Alexandria, Virginia 22313-1450  
www.uspto.gov

APPLICATION NO.	FILING DATE	FIRST NAMED INVENTOR	ATTORNEY DOCKET NO.	CONFIRMATION NO.
90/009,301	12/17/2008	6,779,118 B1	R1341006	6609

40401          7590          10/05/2010  
Hershkovitz & Associates, LLC  
2845 Duke Street  
Alexandria, VA 22314

EXAMINER

ART UNIT          PAPER NUMBER

DATE MAILED: 10/05/2010

Please find below and/or attached an Office communication concerning this application or proceeding.



**DO NOT USE IN PALM PRINTER**

(THIRD PARTY REQUESTER'S CORRESPONDENCE ADDRESS)

Jerry Turner Sewell  
P.O. Box 10999  
Newport Beach, CA 92658-5015

**MAILED**  
**OCT 05 2010**  
CENTRAL REEXAMINATION UNIT

## **EX PARTE REEXAMINATION COMMUNICATION TRANSMITTAL FORM**

REEXAMINATION CONTROL NO. 90/009,301.

PATENT NO. 6,779,118 B1 ET.

ART UNIT 3992.

Enclosed is a copy of the latest communication from the United States Patent and Trademark Office in the above identified *ex parte* reexamination proceeding (37 CFR 1.550(f)).

Where this copy is supplied after the reply by requester, 37 CFR 1.535, or the time for filing a reply has passed, no submission on behalf of the *ex parte* reexamination requester will be acknowledged or considered (37 CFR 1.550(g)).

<b>Ex Parte Reexamination Interview Summary</b>	<b>Control No.</b>	<b>Patent Under Reexamination</b>	
	90/009,301	6,779,118 B1 ET	
	<b>Examiner</b>	<b>Art Unit</b>	
	Sam Rimell	3992	

All participants (USPTO personnel, patent owner, patent owner's representative):

- (1) Sam Rimell-Will Wood-Jessica Harrison (3) Ed Garcia-Otero  
(2) Abraham Hershkovitz (4) Koichiro Ikudome

Date of Interview: 21 September 2010

Type: a)  Telephonic b)  Video Conference  
c)  Personal (copy given to: 1)  patent owner 2)  patent owner's representative)

Exhibit shown or demonstration conducted: d)  Yes e)  No.  
If Yes, brief description: \_\_\_\_\_

Agreement with respect to the claims f)  was reached. g)  was not reached. h)  N/A.  
Any other agreement(s) are set forth below under "Description of the general nature of what was agreed to..."

Claim(s) discussed: 1 and 5.

Identification of prior art discussed: He et al (US Patent 6,088,451).

Description of the general nature of what was agreed to if an agreement was reached, or any other comments:  
See Continuation Sheet.

(A fuller description, if necessary, and a copy of the amendments which the examiner agreed would render the claims patentable, if available, must be attached. Also, where no copy of the amendments that would render the claims patentable is available, a summary thereof must be attached.)

**A FORMAL WRITTEN RESPONSE TO THE LAST OFFICE ACTION MUST INCLUDE PATENT OWNER'S STATEMENT OF THE SUBSTANCE OF THE INTERVIEW. (See MPEP § 2281). IF A RESPONSE TO THE LAST OFFICE ACTION HAS ALREADY BEEN FILED, THEN PATENT OWNER IS GIVEN ONE MONTH FROM THIS INTERVIEW DATE TO PROVIDE THE MANDATORY STATEMENT OF THE SUBSTANCE OF THE INTERVIEW (37 CFR 1.560(b)). THE REQUIREMENT FOR PATENT OWNER'S STATEMENT CAN NOT BE WAIVED. EXTENSIONS OF TIME ARE GOVERNED BY 37 CFR 1.550(c).**

/Sam Rimell/ Primary Examiner, Art Unit 3992		
---	--	--

cc: Requester (if third party requester)

Continuation of Description of the general nature of what was agreed to if an agreement was reached, or any other comments: (1) Discussed rejection under 35 USC 112 and examiner suggested language to overcome this issue (2) Examiners heard verbal testimony from Koichiro Ikudome regarding development history of redirection technologies. Examiners asked for additional details regarding "dynamic redirection" and how dynamic redirection was performed within the invention. Examiners suggested placing such testimony and information in writing. (3) Reviewed flow chart (attached to this summary) indicating sequential steps of action associated with FIG 2. Patent owner asserted in particular that steps C, D2, F and G were not defined. Examiners replied that each of the independent claims are addressed to a physical system and that the claims do not define a seven step ordered sequence as suggested by the flow chart. Examiners indicated that such arguments would not be persuasive in addressing the statutory rejection.

G Data Directed Toward Public Network From One Of The Users' Computers Are Processed By The Redirection Server According To The Individualized Rule Set

B Dial Up Server Receives User IDs From Users' Computers

C Redirection Server Connected To The Dial-Up Network Server And A Public Network

FIG. 2

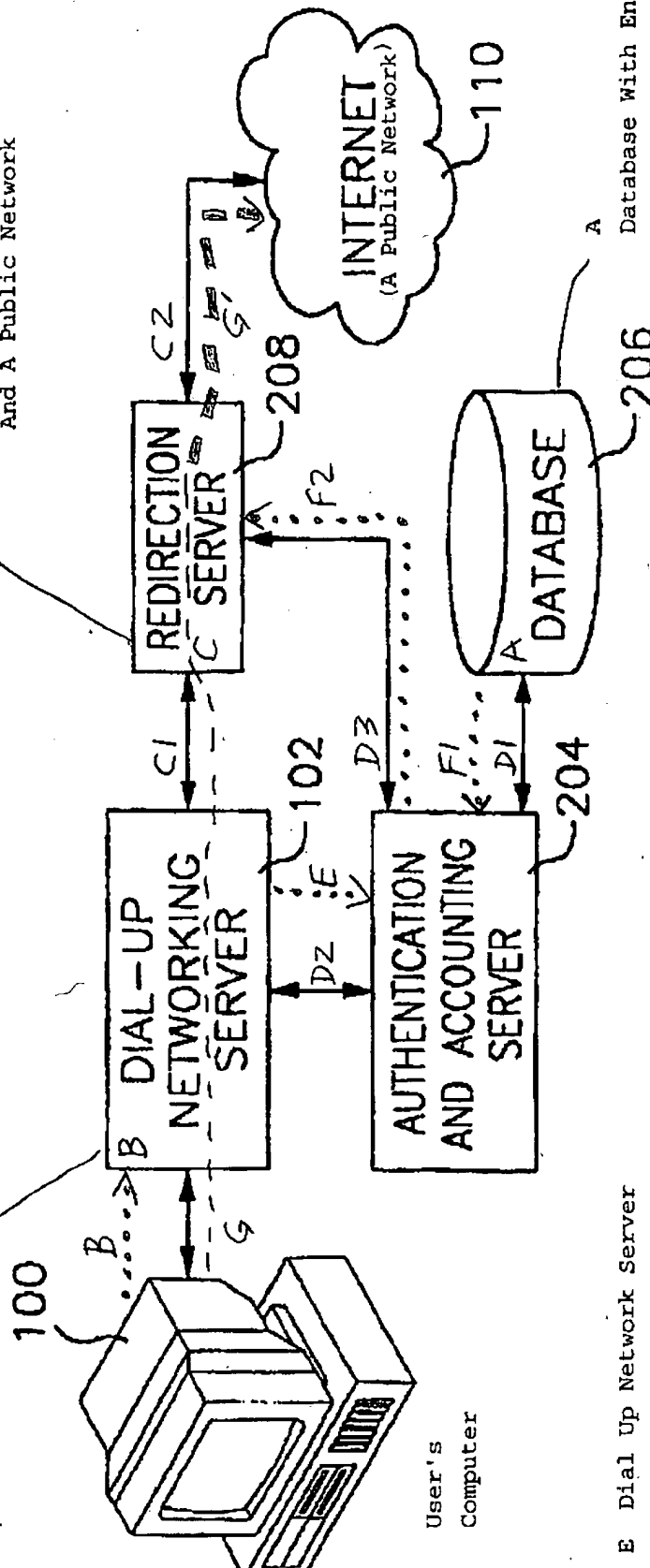

A Database With Entries Correlating Each Of A Plurality Of User IDs With An Individualized Rule Set

E Dial Up Network Server Communicates A First User ID ... And A Temp Address ... To The Authentication Server wherein The Authentication Server F1 Accesses The Database F2 And Communicates The Individualized Rule Set To The Redirection Server



FORM PTO/SB/08A/B (10-01) Substitute for PTO-1449A/B  <b>INFORMATION DISCLOSURE</b>  <b>STATEMENT BY APPLICANT</b>  (use as many sheets as necessary)	<b>Attorney Docket Number</b>	62986/A522
	<b>Application Number</b>	90/009301
	<b>Filing Date</b>	December 17, 2008
	<b>Applicant(s)</b>	6,779,118 B1
	<b>Group Art Unit</b>	3992
	<b>Examiner Name</b>	Rimell, Samuel G.

U.S. PATENT DOCUMENTS				
EXAMINER INITIALS	Cite No. <sup>1</sup>	DOCUMENT NUMBER Number - Kind Code <sup>2</sup> (If Known)	PUBLICATION DATE MM-DD-YYYY	NAME OF PATENTEE

FOREIGN PATENT DOCUMENTS					
EXAMINER INITIALS	Cite No. <sup>1</sup>	Foreign Patent Document Country Code <sup>3</sup> - Number <sup>4</sup> - Kind Code <sup>5</sup> (If Known)	Publication Date MM-DD-YYYY	Name of Patentee or Applicant of Cited Document	T <sup>6</sup> (✓)

PRINTED PUBLICATIONS		
EXAMINER INITIALS	Cite No. <sup>1</sup>	Include name of the author (in CAPITAL LETTERS), title of the article, title of the item (book, magazine, journal, serial, symposium, catalog, etc.), date, page(s), volume-issue number(s), publisher, city and/or country where published.
	C1	ARAR, Yardena, Prepaid Internet Access Cards: Instant ISP, <i>pcworld.com</i> , 1 page, July 14, 1997.
	C2	Auric Web Systems, News, web page at < <a href="http://www.auricweb.com/news.html">http://www.auricweb.com/news.html</a> > , 3 pages, accessed July 12, 1999, including press releases: Prepaid Card Has Made An Exciting Debut, December 10, 1998, ISP's Now Can Provide "Commercial Breaks" on the Web With Out user Side Software, December 7, 1998, Beyond Banner Ads, Beyond "Push", June 16, 1998, New Internet Advertisement Tool Make a Successful Debut, May 18, 1998, Auric Web Systems announces Micro Gateway, September 1, 1997, Auric Web Systems announces ISP Enhancer, December 15, 1997, and Auric Web Systems announces EC Gateway, January 15, 1997.
	C3	Auric Web Systems unveils software to reduce the operating costs of Internet service providers, press release, Auric Web Systems, Inc., Business Wire, 2 pages, March 25, 1997.
	C4	Auric Web Unveils Tool To Navigate Customer Directly To A Specific Website, press release, Auric Web Systems, Inc., 1 page, November 24, 1997.
	C5	Baker, Mary G. et al., Supporting Mobility in MosquitoNet, <i>Proceedings of the 1996 USENIX Technical Conference</i> , San Diego, CA, 13 pages, January 1996.

EXAMINER SIGNATURE	DATE CONSIDERED
EXAMINER: Initial if reference considered, whether or not citation is in conformance with MPEP 609; Draw line through citation if not in conformance and not considered. Include copy of this form with next communication to applicant. <sup>1</sup> Applicant's unique citation designation number (optional). <sup>2</sup> See Kinds Codes of USPTO Patent Documents at <a href="http://www.pto.gov">www.pto.gov</a> or MPEP 901.4. <sup>3</sup> Enter Office that issued the document, by the two-letter code (WIPO standard ST.3). <sup>4</sup> For Japanese patent documents, the indication of the year of the reign of the Emperor must precede the serial number of the patent document. <sup>5</sup> Kind of document by the appropriate symbols as indicated on the document under WIPO Standard ST.16 if possible. <sup>6</sup> Applicant is to place a check mark here if English Language Translation is attached.	

Patent and Trademark Office; U.S. DEPARTMENT OF COMMERCE

FORM PTO/SB/08A/B (10-01) Substitute for PTO-1449A/B  <b>INFORMATION DISCLOSURE</b>  <b>STATEMENT BY APPLICANT</b>  (use as many sheets as necessary)	<b>Attorney Docket Number</b>	62986/A522
	<b>Application Number</b>	90/009301
	<b>Filing Date</b>	December 17, 2008
	<b>Applicant(s)</b>	6,779,118 B1
	<b>Group Art Unit</b>	3992
	<b>Examiner Name</b>	Rimell, Samuel G.

**PRINTED PUBLICATIONS**

EXAMINER INITIALS	Cite No. <sup>1</sup>	Include name of the author (in CAPITAL LETTERS), title of the article, title of the item (book, magazine, journal, serial, symposium, catalog, etc.), date, page(s), volume-issue number(s), publisher, city and/or country where published.
	C6	Buying Made Easy: Auric Web Bypasses Credit Cards, <i>Internet Week</i> , 1 page, February 17, 1997.
	C7	Cisco 2500 Access Server Series, Data Sheet, Cisco Systems, 5 pages, September 1997.
	C8	Cisco 2509-2512 Series Access Servers, Product Announcement, I.D. Number: 027ALL, Cisco Systems, 8 pages, undated (1995 copyright notice).
	C9	Cisco 6510 Service Selection Gateway, End of Sale Announcement, End-of-Life Notice No. 1135, Cisco Systems, 4 pages, April 2005.
	C10	Cisco 6510 Service Selection Gateway Version 1.0(2), Release Notes, Doc. No. 78-5181-03, Cisco Systems, 6 pages, undated (1998 copyright notice).
	C11	Cisco Announces DSL Service Creation and Control Platforms: Enables Service Providers to Create Differentiated Internet Services on a Per-User Basis, press release, Cisco Systems, 2 pages, May 26, 1998.
	C12	CiscoSecure ACS 2.1(4) for Windows NT, Release Notes, Doc. No. 78-5462-01 Rev. A0, Cisco Systems, 6 pages, June 15, 1998.
	C13	Droms, R., <i>Dynamic Host Configuration Protocol</i> , Network Working Group, Request for Comments 2131, 43 pages, March 1997.
	C14	Grice, Corey, Comcast launches broadband portal, <i>news.cnet.com</i> , 3 pages, January 4, 1999.
	C15	Interactive Media Works and Netcom Incorporate NetCruiser Software and Internet Access with sampleNET, press release, Interactive Media Works, LLC, 1 page, Feb. 5, 1996.
	C16	Interactive Media Works Brings Web Browsing to Pre-Paid Phone Cards with the sampleNET Card, press release, Interactive Media Works, LLC, 2 pages, Feb. 13, 1996.
	C17	Kostick, Chris, System Administration: IP Masquerading Code Follow-up, <i>Linux Journal</i> , (accessed at <a href="http://delivery.acm.org/10.1145/330000/327059/">http://delivery.acm.org/10.1145/330000/327059/</a> ), 14 pages, November 1997.
	C18	Lopez, Bryan S., <i>An Investigation and Assessment of Linux IPChains and Its Vulnerability with Respect to Network Security</i> , Thesis, Naval Postgraduate School, Monterey, CA, 136 pages, June 2000.
	C19	Mockapetris, P., <i>Domain Names - Implementation and Specification</i> , Network Working Group, Request for Comments 1035; 52 pages, November 1987.

EXAMINER SIGNATURE	DATE CONSIDERED
EXAMINER: Initial if reference considered, whether or not citation is in conformance with MPEP 609; Draw line through citation if not in conformance and not considered. Include copy of this form with next communication to applicant. <sup>1</sup> Applicant's unique citation designation number (optional). <sup>2</sup> See Kinds Codes of USPTO Patent Documents at <a href="http://www.pto.gov">www.pto.gov</a> or MPEP 901.4. <sup>3</sup> Enter Office that issued the document, by the two-letter code (WIPO standard ST.3). <sup>4</sup> For Japanese patent documents, the indication of the year of the reign of the Emperor must precede the serial number of the patent document. <sup>5</sup> Kind of document by the appropriate symbols as indicated on the document under WIPO Standard ST.16 if possible. <sup>6</sup> Applicant is to place a check mark here if English Language Translation is attached.	

Patent and Trademark Office; U.S. DEPARTMENT OF COMMERCE

FORM PTO/SB/08A/B (10-01) Substitute for PTO-1449A/B  <b>INFORMATION DISCLOSURE</b>  <b>STATEMENT BY APPLICANT</b>  (use as many sheets as necessary)	<b>Attorney Docket Number</b>	62986/A522
	<b>Application Number</b>	90/009301
	<b>Filing Date</b>	December 17, 2008
	<b>Applicant(s)</b>	6,779,118 B1
	<b>Group Art Unit</b>	3992
	<b>Examiner Name</b>	Rimell, Samuel G.

PRINTED PUBLICATIONS		
EXAMINER INITIALS	Cite No. <sup>1</sup>	Include name of the author (in CAPITAL LETTERS), title of the article, title of the item (book, magazine, journal, serial, symposium, catalog, etc.), date, page(s), volume-issue number(s), publisher, city and/or country where published.
	C20	Phone Cards and the Internet: A profitable Link, <i>Intele-Card News</i> , 2 pages, March 1996.
	C21	Pop Go The Ads With Auric Systems Software, <i>The Los Angeles Times</i> , 1 page, January 4, 1999.
	C22	Prepaid Internet Access Cards, <i>CardTrack Online</i> , < <a href="http://www.ramresearch.com/cardtrak/news/cf7_14f_97.html">www.ramresearch.com/cardtrak/news/cf7_14f_97.html</a> >, 1 page, July 14, 1997.
	C23	Prepaid Web-Surfing Cards Now Available For Easy Internet Access From PCs And Video Game Boxes, press release, Seer Technologies Inc., Business Wire; 2 pages, October 8, 1996.
	C24	Riedman, Pat, Alcone's NetPerks to offer rewards to frequent surfers, <i>Advertising Age</i> , 1 page, Jan. 6, 1997.
	C25	Russell, Rusty, <i>Linux IPCHAINS-HOWTO</i> , v1.0.8, 55 pages, dated July 4, 2000, publication date unknown.
	C26	Squid: Optimising Web Delivery, <i>squid-cache.org</i> , 1 page, August 25, 2009.

OTHER INFORMATION 37 CFR 1.98(a)(2)(iv)		
EXAMINER INITIALS	Cite No. <sup>1</sup>	Title of the item, date (if any), page(s), other information.
	D1	Amended Invalidity Contentions of AT&T et al., Linksmart Wireless Technology, LLC v. T-Mobile USA, Inc., et al., Case Nos. (consolidated) 2:08-cv-00264-DF-CE, 2:08-cv-00304-DF-CE, 2:08-cv-00385-DF-CD, 2:09-cv-00026-DF-CE, U.S. District Court, Eastern District of Texas, Marshall Division, 100 pages, August 19, 2010
	D2	First Supplemental Invalidity Contentions of AT&T et al., Linksmart Wireless Technology, LLC v. T-Mobile USA, Inc., et al., Case Nos. (consolidated) 2:08-cv-00264-DF-CE, 2:08-cv-00304-DF-CE, 2:08-cv-00385-DF-CD, 2:09-cv-00026-DF-CE, U.S. District Court, Eastern District of Texas, Marshall Division, 82 pages, March 25, 2010

EXAMINER SIGNATURE	DATE CONSIDERED
EXAMINER: Initial if reference considered, whether or not citation is in conformance with MPEP 609; Draw line through citation if not in conformance and not considered. Include copy of this form with next communication to applicant. <sup>1</sup> Applicant's unique citation designation number (optional). <sup>2</sup> See Kinds Codes of USPTO Patent Documents at <a href="http://www.pto.gov">www.pto.gov</a> or MPEP 901.4. <sup>3</sup> Enter Office that issued the document, by the two-letter code (WIPO standard ST.3). <sup>4</sup> For Japanese patent documents, the indication of the year of the reign of the Emperor must precede the serial number of the patent document. <sup>5</sup> Kind of document by the appropriate symbols as indicated on the document under WIPO Standard ST.16 if possible. <sup>6</sup> Applicant is to place a check mark here if English Language Translation is attached.	

Patent and Trademark Office; U.S. DEPARTMENT OF COMMERCE

FORM PTO/SB/08A/B (10-01) Substitute for PTO-1449A/B  <b>INFORMATION DISCLOSURE</b>  <b>STATEMENT BY APPLICANT</b>  (use as many sheets as necessary)	<b>Attorney Docket Number</b>	62986/A522
	<b>Application Number</b>	90/009301
	<b>Filing Date</b>	December 17, 2008
	<b>Applicant(s)</b>	6,779,118 B1
	<b>Group Art Unit</b>	3992
	<b>Examiner Name</b>	Rimell, Samuel G.

OTHER INFORMATION 37 CFR 1.98(a)(2)(iv)		
EXAMINER INITIALS	Cite No. <sup>1</sup>	Title of the item, date (if any), page(s), other information.
	D3	Memorandum and Order [regarding claim construction issues], Linksmart Wireless Technology, LLC v. T-Mobile USA, Inc., et al., Case Nos. 2:08-cv-264-DF-CE, U.S. District Court, Eastern District of Texas, Marshall Division, 23 pages, June 30, 2010

ASL PAS923128.1-\*-10/4/10 8:50 PM

EXAMINER SIGNATURE	DATE CONSIDERED
EXAMINER: Initial if reference considered, whether or not citation is in conformance with MPEP 609; Draw line through citation if not in conformance and not considered. Include copy of this form with next communication to applicant. <sup>1</sup> Applicant's unique citation designation number (optional). <sup>2</sup> See Kinds Codes of USPTO Patent Documents at www.pto.gov or MPEP 901.4. <sup>3</sup> Enter Office that issued the document, by the two-letter code (WIPO standard ST.3). <sup>4</sup> For Japanese patent documents, the indication of the year of the reign of the Emperor must precede the serial number of the patent document. <sup>5</sup> Kind of document by the appropriate symbols as indicated on the document under WIPO Standard ST.16 if possible. <sup>6</sup> Applicant is to place a check mark here if English Language Translation is attached.	

Patent and Trademark Office; U.S. DEPARTMENT OF COMMERCE

## Electronic Acknowledgement Receipt

<b>EFS ID:</b>	8558936
<b>Application Number:</b>	90009301
<b>International Application Number:</b>	
<b>Confirmation Number:</b>	6609
<b>Title of Invention:</b>	USER SPECIFIC AUTOMATIC DATA REDIRECTION SYSTEM
<b>First Named Inventor/Applicant Name:</b>	6,779,118 B1
<b>Customer Number:</b>	40401
<b>Filer:</b>	Wesley W. Monroe/Amy Lai
<b>Filer Authorized By:</b>	Wesley W. Monroe
<b>Attorney Docket Number:</b>	R1341006
<b>Receipt Date:</b>	04-OCT-2010
<b>Filing Date:</b>	17-DEC-2008
<b>Time Stamp:</b>	23:59:40
<b>Application Type:</b>	Reexam (Patent Owner)

### Payment information:

Submitted with Payment	no
------------------------	----

### File Listing:

Document Number	Document Description	File Name	File Size(Bytes)/ Message Digest	Multi Part /.zip	Pages (if appl.)
1	NPL Documents	AuricWebSystemsunveilssoftw areD23.pdf	72836 <small>9c5b4cd19e94aa6fe7843818f58f3b9ad9ccf5b9</small>	no	2

### Warnings:

### Information:

2	NPL Documents	Baker_SupportingMobilityinMo squitoNet.pdf	1893444	no	13
			937bdb23e9f48cb6a21840be6d6589c9f50 81e03		
<b>Warnings:</b>					
<b>Information:</b>					
3	NPL Documents	Cisco2500AccessServerSeriesD ataSheet.pdf	351586	no	5
			9be821087a2e2cf9981ed9d1d199706811b 51fd9		
<b>Warnings:</b>					
<b>Information:</b>					
4	NPL Documents	Cisco2509_2512SeriesAccessSe rversProductAnnouncement. pdf	631555	no	8
			6108e19a2887ed36a3f306030ade8663a7a 60149		
<b>Warnings:</b>					
<b>Information:</b>					
5	NPL Documents	Cisco6510EndofSaleAnnounce ment.pdf	187695	no	4
			360be121b405f69c12fbff8338683f14e97a 618		
<b>Warnings:</b>					
<b>Information:</b>					
6	NPL Documents	Cisco6510ServiceSelectionGate wayReleaseNotes.pdf	478832	no	6
			67d5f79da04bbbed2b5c354e5d153d5dbba 6f2a22		
<b>Warnings:</b>					
<b>Information:</b>					
7	NPL Documents	CiscoAnnouncesDSLServiceCre ationandControlPlatforms.pdf	160662	no	2
			f937627aff821db82e8f71a7d058990d18f8 6584		
<b>Warnings:</b>					
<b>Information:</b>					
8	NPL Documents	CiscoSecureACS.pdf	382027	no	6
			27f88860b414bace25fc13027419756d83d dee2e		
<b>Warnings:</b>					
<b>Information:</b>					
9	NPL Documents	DromsRFC2131.pdf	121310	no	43
			d264d333224478bd3341c9a6669a6c4C5 debe2		
<b>Warnings:</b>					
<b>Information:</b>					
10	NPL Documents	Grice.pdf	223066	no	3
			b7c899fc5b9b5d73aaf29fc0c3c3935e7b5 a9a9		
<b>Warnings:</b>					
<b>Information:</b>					

11	NPL Documents	InteractiveMediaNetcruiser.pdf	104410 ed55793c54035e305ba190f100fc50339ed1422a	no	1
<b>Warnings:</b>					
<b>Information:</b>					
12	NPL Documents	InteractiveMediaPrepaid.pdf	247564 65154ae68ae11b571952466d87b20c65b1a17f1e	no	3
<b>Warnings:</b>					
<b>Information:</b>					
13	NPL Documents	MockapetrisRFC1035.pdf	134998 984f8b7c266d33d08a7eff42f9fb367f1dcda	no	52
<b>Warnings:</b>					
<b>Information:</b>					
14	NPL Documents	PhoneCardsandtheInternet_2pages.pdf	4455657 998568688464b8c6fb0e7c8f88c390407406e618	no	2
<b>Warnings:</b>					
<b>Information:</b>					
15	NPL Documents	PopGotheAds.pdf	148686 6d3bdffd509cf0b17c614a5ad96d297ccbdf77a61	no	1
<b>Warnings:</b>					
<b>Information:</b>					
16	NPL Documents	PrepaidWebSurfingCards.pdf	156167 c9783c6ad769a5fe61d5669329d52ca6bfd07278	no	2
<b>Warnings:</b>					
<b>Information:</b>					
17	NPL Documents	Riedman.pdf	213055 a9809c3f130b83ac7c49417a02386cc394e86acd	no	1
<b>Warnings:</b>					
<b>Information:</b>					
18	NPL Documents	Russell.pdf	162572 3ee7a8f27e74ffd349269c04ed0c0b5216767003	no	55
<b>Warnings:</b>					
<b>Information:</b>					
19	NPL Documents	squidcache.pdf	118801 dd37834dccc39fa4f3386ca28f19ab705b844314	no	1
<b>Warnings:</b>					
<b>Information:</b>					

20	Transmittal Letter	idsletter.pdf	38967	no	3
			76e08aa1a88b4fadf2decfba2ed04a710436f92		

**Warnings:**

**Information:**

21	Information Disclosure Statement (IDS) Filed (SB/08)	idsptoformsb08ab.pdf	140318	no	4
			fabacff5f06e5eca8d2a989b784cf47358c60a9c		

**Warnings:**

**Information:**

This is not an USPTO supplied IDS fillable form

<b>Total Files Size (in bytes):</b>	10424208
-------------------------------------	----------

**This Acknowledgement Receipt evidences receipt on the noted date by the USPTO of the indicated documents, characterized by the applicant, and including page counts, where applicable. It serves as evidence of receipt similar to a Post Card, as described in MPEP 503.**

**New Applications Under 35 U.S.C. 111**

**If a new application is being filed and the application includes the necessary components for a filing date (see 37 CFR 1.53(b)-(d) and MPEP 506), a Filing Receipt (37 CFR 1.54) will be issued in due course and the date shown on this Acknowledgement Receipt will establish the filing date of the application.**

**National Stage of an International Application under 35 U.S.C. 371**

**If a timely submission to enter the national stage of an international application is compliant with the conditions of 35 U.S.C. 371 and other applicable requirements a Form PCT/DO/EO/903 indicating acceptance of the application as a national stage submission under 35 U.S.C. 371 will be issued in addition to the Filing Receipt, in due course.**

**New International Application Filed with the USPTO as a Receiving Office**

**If a new international application is being filed and the international application includes the necessary components for an international filing date (see PCT Article 11 and MPEP 1810), a Notification of the International Application Number and of the International Filing Date (Form PCT/RO/105) will be issued in due course, subject to prescriptions concerning national security, and the date shown on this Acknowledgement Receipt will establish the international filing date of the application.**



PATENT

**IN THE UNITED STATES PATENT AND TRADEMARK OFFICE**

*I hereby certify that this correspondence is being electronically filed with the United States Patent and Trademark Office on October 4, 2010 at or before 11:59 p.m. Pacific Time under the Rules of 37 CFR § 1.8.*

Amy Lai

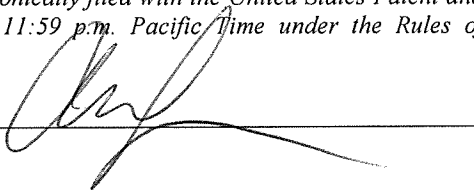

Applicant : **Ikudome, Koichiro et al.** Confirmation No. 6609  
Control No. : 90/009,301  
Filed : December 17, 2008  
Title : USER SPECIFIC AUTOMATIC DATA REDIRECTION SYSTEM  
  
Grp./Div. : 3992  
Examiner : Rimell, Samuel G.  
  
Docket No. : 62986/A522

**INFORMATION DISCLOSURE STATEMENT B  
UNDER 37 CFR § 1.555**

Mail Stop Ex Parte Reexam  
Central Reexamination Unit  
Commissioner for Patents  
P.O. Box 1450  
Alexandria, VA 22313-1450

Post Office Box 7068  
Pasadena, CA 91109-7068  
October 4, 2010

Commissioner:

In compliance with the duty of disclosure under 37 CFR §§ 1.555 and in accordance with the provisions in the Manual of Patent Examining Procedure §§ 2280, enclosed is FORM PTO/SB/08A/B listing references that are known to applicant. Printed publications C1-C9, C11-C13, C15-C16, and C19-C25 listed were referenced in invalidity contentions served by defendants in the litigation, *Linksmart Wireless Technology, LLC v. T-Mobile USA, Inc., et al.*, U.S. District Court, Eastern District of Texas, Marshall Division, 2:08-cv-00264-DF-CE, 2:08-

**Application No. 90/009,301**

cv-00304-DF-CE, 2:08-cv-00385-DF-CD, 2:09-cv-00026-DF-CE. Printed publications C10, C14, C17, C18, and C26 were produced by defendants in the litigation, *Linksmart Wireless Technology, LLC v. T-Mobile USA, Inc., et al.*, U.S. District Court, Eastern District of Texas, Marshall Division, 2:08-cv-00264-DF-CE, 2:08-cv-00304-DF-CE, 2:08-cv-00385-DF-CD, 2:09-cv-00026-DF-CE.

Pursuant to MPEP §2207, "Entry of Court Decision in Patent File," listed as item D3 under "Other Information" on enclosed FORM PTO/SB/08A/B, is a "Memorandum and Order" issued by the Court regarding claim construction in the litigation, *Linksmart Wireless Technology, LLC v. T-Mobile USA, Inc., et al.*, U.S. District Court, Eastern District of Texas, Marshall Division, 2:08-cv-00264-DF-CE, 2:08-cv-00304-DF-CE, 2:08-cv-00385-DF-CD, 2:09-cv-00026-DF-CE. While not a printed publication, under MPEP §2207, "it is considered desirable" that this Order be submitted to the Office and that "the Office will accept at *any time* from *any party* for placement in the patent file" such a submission (emphasis in original). Accordingly, this reference should not be crossed out on FORM PTO/SB/08A/B. Also listed, as items D1 and D2 are two recently filed Amended and Supplemental Invalidity Contentions of defendants from the above reference litigation. The patent presently under reexamination is the subject of this litigation and this litigation is referenced in the Reexam Litigation Search report, dated July 21, 2009, for the present reexamination.

Enclosed are copies of each reference listed under "Printed Publications" and "Other Information."

It is respectfully requested that the listed reference be considered in this reexamination and identified on the list of references cited on the certificate issuing for this reexamination. Applicant also requests that an initialed copy of FORM PTO/SB/08A/B be entered in the reexamination file and returned to applicant with the next communication from the Patent Office.

**Application No. 90/009,301**

The Commissioner is hereby authorized to charge any fees which may be required by this paper to Deposit Account No. 03-1728. Please show our docket number with any Deposit Account transaction.

Respectfully submitted,

CHRISTIE, PARKER & HALE, LLP

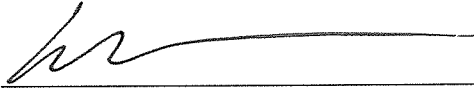
By 

Wesley W. Monroe

Reg. No. 39,778

626/795-9900

WWM/asl

Enclosures: PTO/SB/08A/B, w/references

ASL PAS923129.1-\*-10/4/10 8:50 PM

**IN THE UNITED STATES PATENT AND TRADEMARK OFFICE**

Inventor: Koichiro Ikudome, et al.

Art Unit: 3992

Reexamination Proceeding: 90/009,301  
(based on U.S. Patent No. 6,779,118)

Confirmation No.: 6609

Reexamination Filed: December 17, 2008

Examiner: Sam Rimell

For: USER SPECIFIC AUTOMATIC DATA REDIRECTION SYSTEM

**AFTER FINAL RESPONSE UNDER 37 CFR 1.116  
AND PROPOSED AMENDMENT UNDER 37 CFR 1.530**

Attn: Mail Stop "Ex Parte Reexamination"  
August 20, 2010  
Central Reexamination Unit  
Commissioner for Patents  
United States Patent & Trademark Office  
P.O. Box 1450  
Alexandria, Virginia 23313-1450

Dear Commissioner:

This after final Response is in reply to the final Office Action mailed August 2, 2010, and the Personal Interview held on September 21, 2010 in the above-identified *ex-parte* reexamination proceeding. The due date for filing a Response is October 2, 2010. Accordingly, this Response is timely filed.

Statement of Interview and an Information Disclosure Statement (IDS) are being submitted concurrently. Please amend the present claims and add new claims as proposed below and consider the detailed traversal below, wherein:

The Status of claims is listed on page 2 of this paper.

Amendments to the Claims begin on page 3 of this paper.

Remarks/Arguments begin on page 7 of this paper.

Evidence of Service of this Response on the 3<sup>rd</sup> party requester is found after the last page of this paper.

### STATUS OF CLAIMS

Claims 1-47 are subject to reexamination, and are rejected.

The amendments to claims 15, 18, 21, 26, and 27 were previously submitted in the supplemental Response filed on May 24, 2010, and were not entered by the Office. These amendments are repeated herein. For the convenience of the Examiner, Appendix A illustrates the amendments to claims 15, 18, 21, 26, and 27 relative to the Response filed on November 14, 2009. Additionally, new claims 28-31 and 33-36 have been amended to recite “the individualized rule set,” and new claims 38-47 have been amended to recite “the modified rule set” to overcome the antecedent basis rejection under 35 USC 112, second paragraph. During the Personal Interview held on September 21, 2010, the Examiner stated that these minor amendments probably would be entered if submitted in an after-final Response.

Patent Owner respectfully submits that all of the above amendments should be entered under 37 CFR 1.116 for correction of informalities and/or for simplification of issues for appeal.

AMENDMENTS TO THE CLAIMS

*Claims 1-47 are pending.*

*Please amend claims 15, 18, 21, 26, and 27 as previously requested in the Response filed on November 14, 2009. Per 37 CFR 1.530(i) and MPEP 2250, these amendments are made relative to the patent as of the date of filing the request for examination.*

*For the convenience of the Examiner, Appendix A illustrates the amendments to claims 15, 18, 21, 26, and 27 relative to the Response filed on November 14, 2009.*

*Additionally, new claims 28-31 and 33-36 have been amended to recite "the individualized rule set," and claims 38-47 have been amended to recite "the modified rule set" to overcome the antecedent basis rejection under 35 USC 112, second paragraph.*

*This Amendment does not raise new issues requiring further consideration relative to the previous Amendment. In fact, this Amendment places the proceeding in better condition for issuance of a Notice of Intent to Issue Reexamination Certificate. In the alternative, this Amendment reduces the issues for appeal. Accordingly, entry of this Amendment is appropriate and is urged.*

15. (Twice Amended) A system comprising:

a redirection server [programed] programmed with a user's rule set correlated to a temporarily assigned network address; wherein the rule set contains at least one of a plurality of functions used to control data passing between the user and a public network;

wherein the redirection server is configured to allow automated modification of at least a portion of the rule set correlated to the temporarily assigned network address; and

wherein the redirection server is configured to allow automated modification of at least a portion of the rule set as a function of some combination of time, data transmitted to or from the user, or location the user accesses. [access.]

18. (Twice Amended) The system of claim 15, wherein the redirection server is configured to allow modification of at least a portion of the rule set as a function of the location or locations the user accesses. [access.]

21. (Twice Amended) The system of claim 15, wherein the redirection server is configured to

allow the removal or reinstatement of at least a portion of the rule set as a function of the location or locations the user accesses. [access.]

26. (Twice Amended) The method of claim 25, further including the step of modifying at least a portion of the user's rule set as a function of one or more of: time, data transmitted to or from the user, and location or locations the user accesses. [access.]

27. (Twice Amended) The method of claim 25, further including the step of removing or reinstating at least a portion of the user's rule set as a function of one or more of: time, the data transmitted to or from the user and [the] a location or locations the user accesses. [access.]

28. (New) The system of claim 1, wherein the individualized rule set includes at least one rule as a function of a type of IP (Internet Protocol) service.

29. (New) The system of claim 1, wherein the individualized rule set includes an initial temporary rule set and a standard rule set, and wherein the redirection server is configured to utilize the temporary rule set for an initial period of time and to thereafter utilize the standard rule set.

30. (New) The system of claim 1, wherein the individualized rule set includes at least one rule allowing access based on a request type and a destination address.

31. (New) The system of claim 1, wherein the individualized rule set includes at least one rule redirecting the data to a new destination address based on a request type and an attempted destination address.

32. (New) The system of claim 1, wherein the redirection server is configured to redirect data from the users' computers by replacing a first destination address in an IP (Internet protocol) packet header by a second destination address as a function of the individualized rule set.

33. (New) The method of claim 8, wherein the individualized rule set includes at least one

rule as a function of a type of IP (Internet Protocol) service.

34. (New) The method of claim 8, wherein the individualized rule set includes an initial temporary rule set and a standard rule set, and wherein the redirection server is configured to utilize the temporary rule set for an initial period of time and to thereafter utilize the standard rule set.

35. (New) The method of claim 8, wherein the individualized rule set includes at least one rule allowing access based on a request type and a destination address.

36. (New) The method of claim 8, wherein the individualized rule set includes at least one rule redirecting the data to a new destination address based on a request type and an attempted destination address.

37. (New) The method of claim 8, wherein the redirection server is configured to redirect data from the users' computers by replacing a first destination address in an IP (Internet protocol) packet header by a second destination address as a function of the individualized rule set.

38. (New) The system of claim 15, wherein the modified rule set includes at least one rule as a function of a type of IP (Internet Protocol) service.

39. (New) The system of claim 15, wherein the modified rule set includes an initial temporary rule set and a standard rule set, and wherein the redirection server is configured to utilize the temporary rule set for an initial period of time and to thereafter utilize the standard rule set.

40. (New) The system of claim 15, wherein the modified rule set includes at least one rule allowing access based on a request type and a destination address.

41. (New) The system of claim 15, wherein the modified rule set includes at least one rule



redirecting the data to a new destination address based on a request type and an attempted destination address.

42. (New) The system of claim 15, wherein the redirection server is configured to redirect data from the users' computers by replacing a first destination address in an IP (Internet protocol) packet header by a second destination address as a function of the modified rule set.

43. (New) The method of claim 25, wherein the modified rule set includes at least one rule as a function of a type of IP (Internet Protocol) service.

44. (New) The method of claim 25, wherein the modified rule set includes an initial temporary rule set and a standard rule set, and wherein the redirection server is configured to utilize the temporary rule set for an initial period of time and to thereafter utilize the standard rule set.

45. (New) The method of claim 25, wherein the modified rule set includes at least one rule allowing access based on a request type and a destination address.

46. (New) The method of claim 25, wherein the modified rule set includes at least one rule redirecting the data to a new destination address based on a request type and an attempted destination address.

47. (New) The method of claim 25, wherein the redirection server is configured to redirect data from the users' computers by replacing a first destination address in an IP (Internet protocol) packet header by a second destination address as a function of the individualized rule set.

## **REMARKS**

### **I. Introduction and Discussion of Preliminary Issues**

#### **A. Introduction**

This after final Response is in reply to the final Office Action mailed on August 2, 2010 in the above-identified *ex-parte* reexamination proceeding.

Claims 1-47 are subject to reexamination, and are rejected. Claims 28-47 are proposed new claims which were presented in the Response filed on November 14, 2009.

The amendments to claims 15, 18, 21, 26, and 27 were previously submitted in the supplemental Response filed on May 24, 2010, and were not entered by the Office. These amendments are repeated herein.

Further, new claims 28-31 and 33-36 have been amended to recite “the individualized rule set,” and new claims 38-47 have been amended to recite “the modified rule set” to overcome the antecedent basis rejection under 35 USC 112, second paragraph. No new matter is added, nor is the scope of the claims enlarged.

A copy of this Supplemental Response is being served on the third party requester pursuant to 37 CFR 1.248 and 37 CFR 1.550(f).

#### **B. All Amendments should be entered under 37 CFR 1.116**

Patent Owner respectfully submits that these amendments should be entered under 37 CFR 1.116 as placing the proceeding in better condition of a Notice of Intent to Issue Reexamination Certificate, or for simplification of issues for appeal. During the Personal Interview held on September 21, 2010, the Examiner stated that these amendments probably would be entered if submitted in an after-final Response.

Patent Owner provides Appendix A illustrating the amendments to claims 15, 18, 21, 26, and 27 relative to the Response filed on November 14, 2009. This Appendix should reduce the burden on the Examiner in determining what the differences are between the two amendments.

Additionally, amendments to new claims 28-31, 33-36, and 38-47 are provided herein merely to overcome a 35 USC 112, second paragraph indefiniteness rejection by resolving antecedent basis issues.

Thus, Patent Owner respectfully submits that all of the above amendments be permitted, and should be entered under 37 CFR 1.116(b).

**C. Amendments regarding “the user access” (should read “the user accesses”)**

As patented, claims 15, 18, 21, 26, and 27 each recited, “the user access.” In order to clarify this ungrammatical term, the Response filed on November 14, 2009 amended these claims to recite “the user attempts to access.” Upon further review, Patent Owner submits that it is even more clear to amend these claims to recite “**the user accesses.**”

To keep the record clear, Patent Owner respectfully directs the Examiner’s attention to a court order (Case 2:08-cv-00264-DF-CE, Document 492, issued on 06/30/10, MEMORANDUM OPINION AND ORDER) which is being provided separately in an Information Disclosure Statement (IDS). A copy was received by the Firm of the undersigned on September 22, 2010. The court order, at pages 18-19, discusses the term “location the user access” from original patented claim 15, and states that claim 15 is indefinite. The Examiner is invited to review the memorandum in its entirety.

Patent Owner submits that original patented claims 15, 18, 21, 26, and 27 are merely ungrammatical, and these claims have been clarified by amendment to recite “**the user accesses.**”

This amendment is supported by, at a minimum, the specification at column 7, lines 48 to 52:

In an alternate embodiment a user may be periodically redirected to a location, based on the number of other factors, such as the number of locations accessed, the time spent at a location, the types of locations accessed, and other such factors.

**D. Interview Summary mailing date is not correct**

Patent Owner respectfully submits that the Interview Summary contains a typographical error regarding the mailing date. Specifically, a Personal Interview was held on November 12, 2009. The Interview Summary cover page (form PTO-90C) asserts a mailing date of November 9, 2009, which precedes the date of the interview. Patent Owner respectfully submits this is a clear typographical error, and that the mailing date is November 12, 2009, or later.

## **II. SIGNAL FLOW CHART (illustrating signal flows of claim 1)-GENERAL**

A signal flow chart is attached as Exhibit A. Exhibit A is a “blown up” copy of FIG. 2 of the specification, with annotations illustrating the signal paths of claim 1. Two small updates have been made with respect to the version presented at the recent Personal Interview: the letter “D” has been inserted into element 204 (AUTHENTICATION AND ACCOUNTING SERVER) for identification, and the reexamination number and the docket number have been inserted to identify the document.

During the Personal Interview, one Examiner correctly pointed out that claim 1 does not expressly require that signal path G flow through Dial-up Network Server B. The flow of signal path G through Dial-up Network Server B is exemplary, and signal path G may bypass Network Server B.

Patent Owner’s representatives wish to make one additional comment regarding this figure, which might not have been clearly stated during the Personal Interview. Path G is complex, and not all possibilities from claim 1 are expressly illustrated. Specifically, claim 1 recites, in part, “processed by the redirection server according to the individualized rule set.” In the signal flow chart, Path G is represented by a dashed line from Computer 100 to Redirection Server C, and then a series of rectangles (or a thick dashed line) labeled “G” from Redirection Server C to Public Network 110 to indicate the processing by Redirection Server C has been performed upon the signal.

The processing is “according to the individualized rule set,” according to claim 1. The processing may be, for example, redirecting. In this case, the processed signal would be a redirected signal, as illustrated by G’ from Redirection Server C to Public Network 110 in signal flow chart Exhibit A.

The specification, at 4:59-66, provides the clearest description of the redirection functionality of the redirection server, and recites, in part, “[t]he redirection server 208 receives the IP address and rule set, and is programmed to implement the rule set for the IP address, as well as . . . performing the physical redirection of data packets based on the rule sets.”

In other words, **the redirection server of claim 1 must be capable of redirecting.**

In contrast, the applied art does not disclose redirection. A more detailed discussion of this issue will be provided below.

### **III. SIGNAL FLOW CHART (illustrating signal flows of claim 1)-DETAILED**

The following clearly maps the language of claim 1 to the features of the signal flow chart (Exhibit A). Claim 1 recites, in full (with line breaks and labels A-G added for convenience):

1. A system comprising:

A) a database with entries correlating each of a plurality of user IDs with an individualized rule set;

B) a dial-up network server that receives user IDs from users' computers;

C) a redirection server connected to the dial-up network server and a public network, and

D) an authentication accounting server connected to the database, the dial-up network server and the redirection server;

E) wherein the dial-up network server communicates a first user ID for one of the users' computers and a temporarily assigned network address for the first user ID to the authentication accounting server;

F) wherein the authentication accounting server accesses the database and communicates the individualized rule set that correlates with the first user ID and the temporarily assigned network address to the redirection server; and

G) wherein data directed toward the public network from the one of the users' computers are processed by the redirection server according to the individualized rule set.

Patent Owner submits that a person of ordinary skill in the art would interpret claim 1 in view of the specification by mapping the signal flows of claim 1 directly onto FIG. 2. Now each feature will be individually mapped in detail to the signal flow chart.

#### **A) a database with entries correlating each of a plurality of user IDs with an individualized rule set;**

Database A (206) illustrates the above database. Signal flows D1 and F1 are discussed below with respect to Authentication and Accounting Server D (hereinafter "Authentication Server D" for the sake of brevity) and feature F below.

**B) a dial-up network server that receives user IDs from users' computers;**

Dial-Up Network Server B (102) receives user IDs from users' computers via signal path B (the dotted line from Users' Computers (100) to Dial-Up Server B). Note that arrow heads indicate a direction of flow in the signal paths.

Signal paths C1, D2, E, and G are discussed below.

**C) a redirection server connected to the dial-up network server and a public network, and**

Redirection Server C (208) is:

connected to the Dial-Up Server B via path C1, and  
connected to Public Network (110) via path C2.

**D) an authentication accounting server connected to the database, the dial-up network server and the redirection server;**

Authentication Server D is:

connected to Database A via path D1,  
connected to Dial-Up Networking Server B via path D2, and  
connected to Redirection Server C via path D3.

**E) wherein the dial-up network server communicates a first user ID for one of the users' computers and a temporarily assigned network address for the first user ID to the authentication accounting server;**

Dial-Up Network Server B communicates a first user ID for one of the users' computers (100) and a temporarily assigned network address for the first user ID to the Authentication Server D via signal flow E.

**F) wherein the authentication accounting server accesses the database and communicates the individualized rule set that correlates with the first user ID and the temporarily assigned network address to the redirection server; and**

The Authentication Server D accesses the Database A via signal path F1, and communicates the individualized rule set that correlates with the first user ID and the temporarily assigned network address to the Redirection Server C via signal path F2.

**G) wherein data directed toward the public network from the one of the users' computers are processed by the redirection server according to the individualized rule set.**

Data is directed toward the Public Network 110 from one of the users' computers 100 via signal path G (and perhaps G'). This data is "processed" by the Redirection Server C according to the individualized rule set. Processing was discussed above in detail, and this discussion is repeated immediately below for the sake of completeness and detail.

The signal path G may flow through the Dial-up Network Server B (as shown), or may flow around the Dial-up Network Server B.

Path G is complex, and not all possibilities from claim 1 are expressly illustrated. Specifically, claim 1 recites, in part, "processed by the redirection server according to the individualized rule set." In the signal flow chart, Path G is represented by a dashed line from Computer 100 to Redirection Server C, and then a series of rectangles (or a thick dashed line) labeled "G" from Redirection Server C to Public Network 110 to indicate the processing by Redirection Server C has been performed upon the signal.

The processing is "according to the individualized rule set," according to claim 1. The processing may, for example, redirect the data in signal path G.

The specification, at 4:59-66, provides the clearest description of the redirection functionality of the redirection server, and recites, in part, "[t]he redirection server 208 receives the IP address and rule set, and is programmed to implement the rule set for the IP address, as well as . . . performing the physical redirection of data packets based on the rule sets."

In other words, **the redirection server of claim 1 must be capable of redirecting.**

#### IV. Detailed Discussion of He '451 (primary applied reference)

U.S. Patent No. 6,088,451 (hereinafter "He '451") provides a security system/method for network element access in an enterprise network. Security is enforced using Credential/Privileges control for each individual user, and a user may be granted or denied access to specific elements within an enterprise. FIG. 10 of He '451 is provide immediately below for convenience.

FIG. 10 OF He '451

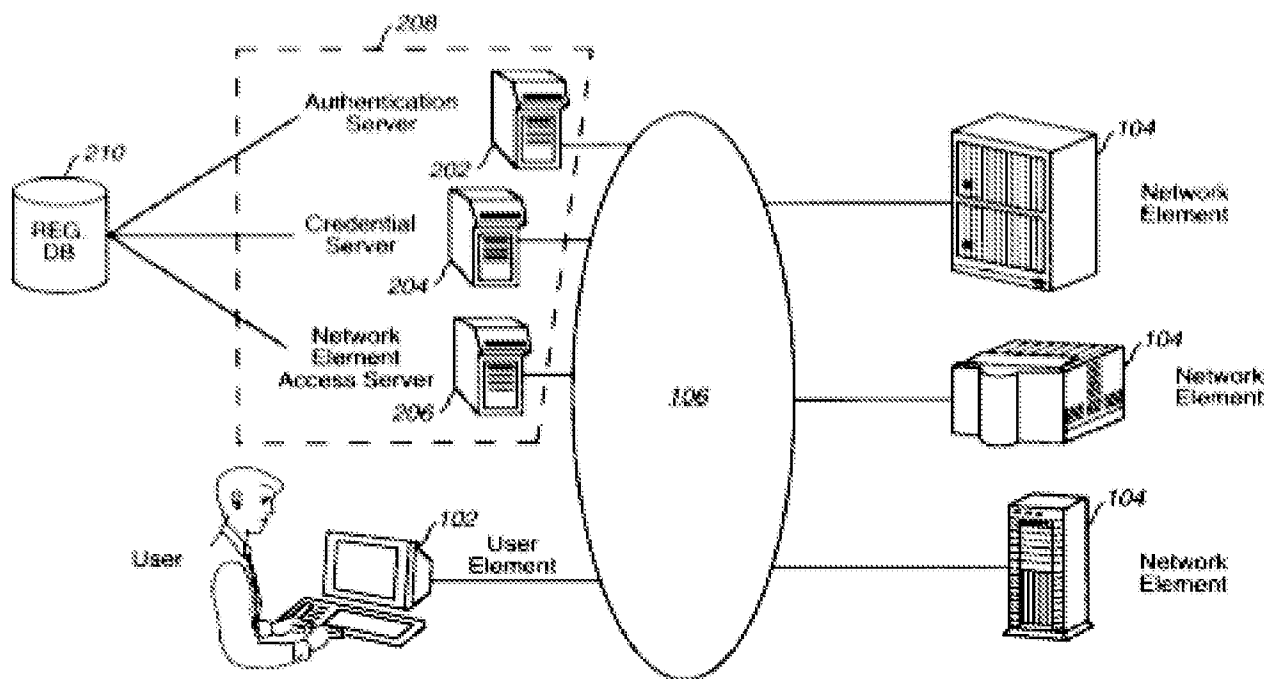

Element 106 of FIG. 10 of He '451 is a local network, and is not a public network as required by paragraph c) of claim 1. For example, He '451, at 4:31-32, states, "the interconnection network 106." Further, He '451, at 4:49, states, "local access control." Additionally, see "Enterprise Network" at 4:53.

In He '451, the user has to send a message to the credential server (18:57-58). Then the credential server sends a credential ticket back to the user (19:5-8).

He '451 requires a user to go through the following steps in order to gain access credential to a network element. The following figure was created by the Patent Owner to illustrate the steps of He '451, based on the specification of He '451.



## STEPS OF He '451

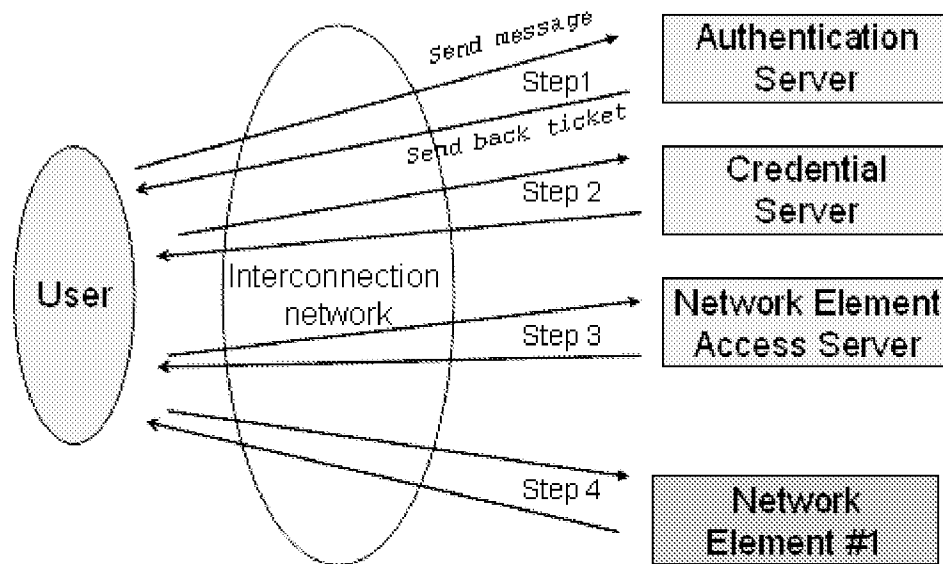

## Step 1:

User (102) sends a message to authentication server (202) to get a general ticket (17:55 through 18:2).

## Step 2:

User (102) sends message to the credential server (204) to get a credential ticket (18:57 through 19:8).

## Step 3:

User (102) sends a message to the network element access server to get a ticket to access to specific network element (104) (20:28-55).

## Step 4:

Then User (102) accesses to the specific network element (104) with the ticket obtained at step 3 (21:32-37). It is the specific network element that makes the decision as to act on user's request or stop based on the ticket supplied by the user (HE, fig 8).

These steps of He '451 illustrate a conventional client-server arrangement. **After sending a credential ticket back to the user, the credential server (204) (the Examiner improperly equated this credential server with a redirection server) is not involved in the communications between a user (102) and a network element (104).** Therefore, there is no

way for credential server (204) to *process data* directed toward the public network from one of the user's computers, as required by paragraph g) claim 1. Other features of claim 1 are also not disclosed by He '451, as discussed in detail below.

## **V. Summary of Rejections**

Claims 28-31, 33-36, and 38-47 are rejected under 35 USC 112, second paragraph, as being indefinite regarding antecedent basis. Patent Owner has amended these claims to overcome this rejection, as discussed above.

Claims 1-31, 33-36, 38-41, and 43-46 are rejected under 35 U.S.C. § 103(a) as being unpatentable over U.S. Patent No. 6,088,451 (hereinafter "He '451") in view of U.S. Patent No. 6,233,686 (hereinafter "Zenchelsky"). Patent Owner respectfully disagrees, as explained in detail below.

Claims 32, 37, 42, and 47 are rejected under 35 U.S.C. § 103(a) as being unpatentable over He '451, in view of Zenchelsky, and further in view of alleged admitted prior art ("Background of the Invention" at column 1, lines 53-57 of the Present Patent, hereinafter "AAPA"). Patent Owner respectfully disagrees, as explained in detail below.

Claims 1, 8, 15, and 25 are the sole independent claims of the Present Patent. The rejections are discussed below in detail.

## **VI. Rejections under 35 USC 112, second paragraph**

Claims 28-31, 33-36, and 38-47 are rejected under 35 USC 112, second paragraph, as being indefinite regarding antecedent basis. Patent Owner has amended these claims to overcome this rejection, as discussed above.

## **VII. Rejection under 35 USC 103(a) of claims 1-31, 33-36, 38-41, and 43-46**

Claims 1-31, 33-36, 38-41, and 43-46 are rejected under 35 U.S.C. § 103(a) as being unpatentable over U.S. Patent No. 6,088,451 (hereinafter "He '451") in view of U.S. Patent No. 6,233,686 (hereinafter "Zenchelsky"). Patent Owner respectfully disagrees, as explained below.

Claims 1, 8, 14, and 25 are independent.

**A. Independent Claim 1**

Independent claim 1 recites, in full (with line breaks and labels A-G added for convenience):

1. A system comprising:

A) a database with entries correlating each of a plurality of user IDs with an individualized rule set;

B) a dial-up network server that receives user IDs from users' computers;

C) a redirection server connected to the dial-up network server and a public network, and

D) an authentication accounting server connected to the database, the dial-up network server and the redirection server;

E) wherein the dial-up network server communicates a first user ID for one of the users' computers and a temporarily assigned network address for the first user ID to the authentication accounting server;

F) wherein the authentication accounting server accesses the database and communicates the individualized rule set that correlates with the first user ID and the temporarily assigned network address to the redirection server; and

G) wherein data directed toward the public network from the one of the users' computers are processed by the redirection server according to the individualized rule set.

Patent Owner will distinguish multiple features of claim 1 over the combination of He '451 and Zenchelsky, one feature at a time. While the most distinguishing features are discussed below, other distinguishing features also exist.

1a. Define "redirection server" – Personal Interview

Patent Owner respectfully submits that the "**redirection server**" feature of claim 1 is not disclosed by the combination of He '451 and Zenchelsky.

During the recent Personal Interview, it became clear that the Examiner was not asserting that the prior art disclosed a redirection function. Rather, the **Examiner was asserting that a redirection server did not necessarily have to be capable of performing redirection**, but merely had to be capable of performing any one of three functions: allow/pass, block, or

modify/redirect. This interpretation was not clear from any of the Office Actions. Patent Owner respectfully disagrees.

Patent Owner's representatives submit that the redirection server of claim 1 must be capable of performing redirection.

The specification, at 4:59-65, provides the clearest description of the redirection functionality of the redirection server, and recites, in part, “[t]he redirection server 208 receives the IP address and rule set, and is programmed to implement the rule set for the IP address, as well as . . . performing the physical redirection of data packets based on the rule sets.”

In other words, **the redirection server of claim 1 must be capable of redirecting based on the rule set.**

1b. Define “redirection server” – Court Interpretation

The Court Order (Case 2:08-cv-00264-DF-CE, Document 492, issued on 06/30/10, MEMORANDUM OPINION AND ORDER, a copy of which was received by the Firm of the undersigned on September 22, 2010) appears to be consistent with Patent Owner's interpretation of the redirection server of claim 1. A review of the Court's interpretation may prove beneficial.

As a starting point, the Order, at page 11, considers the term “control data passing” and quotes the specification as follows, “The present invention allows for creating and implementing dynamically changing rules to allow the *redirection, blocking, or allowing of specific data traffic for specific users*, as a function of database entries and the user's activity.” (Present Patent, 2:61-65, emphasis added by Court).

The Order, at page 11, asserts that other text in the specification confirms this functionality, and quotes the specification exactly as follows, “The redirection server . . . is programmed to implement . . . checking data packets and blocking or allowing the packets . . . [and] performing the physical redirection of packets . . . .” (Present Patent, 4:59-65, the bracketed term “[and]” inserted by the Court). **It is important to note that the Court intentionally inserted the bracketed term “[and]” to clarify that the redirection server is programmed to perform redirection.**

Further, page 14 of the Order constructs the term “redirection server” as “a server

logically located between the user's computer and the network that controls the user's access to the network." The **Court's analysis arriving at this definition appears to take it for granted that the redirection server is capable of performing redirection** (this appears to be so obvious that it go without saying).

Thus, the Order appears to recognize that the redirection function is a mandatory (and the expressly named or nominal) function of the redirection server.

1c. Define "redirection server" – nominal function

Patent Owner further respectfully submits that names have meaning. As such, a server that is named a redirection server must have, by the plain meaning of words, a redirection function. Redirection is, literally, the nominal meaning of a redirection server. This argument is consistent with the Court's interpretation.

1d. Example of "redirection"

The Present Patent, at 6:21, and at column 6:46-49, provides an illustrative and non-limiting example of redirecting a message from a first destination address (or attempted destination address, or target address) of "\*.xyz.com" to a second destination address (or redirected destination address) of "www.us.com."

1e. Distinguish "redirection" over applied art

The final Office Action, at page 5, asserts that the redirection server of claim 1 is disclosed by credential server 204 of FIG 10 of He '451. However, He '451, at column 12, line 65 to column 13, line 42, merely states:

2.2.2. Credential Server

The credential server 204 is responsible for controlling network user credentials or privileges, which is essential for effective network access control. In addition, the credential server 204 provides the means for the central administration and management of user credentials for effective and efficient administration, the same as the authentication server 202.

The authentication server 202 only authenticates the user identity to network elements. However, the ultimate access decision may also depend on some user account information other than merely the user identity. Thus, it is necessary to implement this extra level of control on the essential user account information, called user credentials, for effective access control to network resources and information. This control is based

on the suspicion that authenticated users may not be honest about their personal credentials in order to gain access to network resources and information that otherwise would not be allowed to them. User credential/privilege control is an integral part of the user sign-on process that leads to the final access decisions to **grant or to deny user access requests** for network resources and information. (emphasis added)

The credential server of He '451 merely discloses a server configured to “grant or deny user access requests,” and does not disclose the mandatory “redirection” functionality of the “redirection server” of claim 1. See the above detailed discussion of He '451 for additional details.

Thus, He '451 does not teach or suggest the redirection functionality of the “redirection server” feature of claim 1.

2. Distinguish “redirection server connected to the dial-up network server and a public network”

Patent Owner respectfully submits that the “**redirection server connected to the dial-up network server and a public network**” feature of claim 1 is not disclosed by the combination of He '451 and Zenchelsky.

As an illustrative and non-limiting example of this feature of claim 1, FIG. 2 of the Present Patent illustrates dial up network server 102 connected to redirection server 208 which, in turn, is connected to internet 110.

Arguendo, even if the credential server 204 in FIG. 10 of He '451 disclosed a redirection server (which Patent Owner does not admit), this credential server of He '451 is not “connected to the dial up network server and a public network,” as required by claim 1.

Specifically, the final Office Action, at page 5, asserts that the above recited feature of claim 1 is disclosed by FIG. 10 of He '451, asserting that credential server 204 interconnects to dial up server 1002 via the public network 106.

However, FIG. 10 of He '451 does not teach or suggest “a public network,” as required by claim 1. Element 106 of He '451 is a local network, and is not a public network. He '451, at column 4, line 31-32, states, “the interconnection network 106.” Further, He '451, at column 4, line 49, states, “local access control.” See the above detailed discussion of He '451 for additional details.

Thus, He '451 does not teach or suggest the "redirection server connected to the dial-up network server and a **public network**" feature of claim 1.

3. Distinguish "the authentication accounting server accesses the database and communicates the individualized rule set that correlates with the first user ID and the temporarily assigned network address to the redirection server."

Independent claim 1 recites, in part, "wherein **the authentication accounting server** accesses the database and **communicates the individualized rule set** that correlates with the first user ID and the temporarily assigned network address **to the redirection server.**"

As an illustrative and non-limiting example of claim 1, the Present Patent states that the "Auto-Navi component of the authentication accounting server 204 queries the database for the rule set to apply to each new session, and forwards the rule set and the currently assigned IP address to the redirection server 208." (4:55-59) Also see the above detailed discussion of the exemplary signal flow chart (Exhibit A) for claim 1. **Specifically, in Exhibit A, the Authentication Server D communicates the individualized rule set to the redirection server C through signal path F2.**

The final Office Action, at page 6, asserts that the above feature of claim 1 is disclosed by He '451 at 17:61-66, 17:67 through 18:1, and 19:2-7.

However, He '451, at 17:61 to 18:1, merely states:

(2) Upon receiving the user request message, the authentication server 202 uses the user identifier in the message to look up the user registration database 210 and retrieves a record corresponding to that user (user record). A response message is prepared by the authentication server 202 and **sent back to the user**. The response message contains a general ticket for the user to communicate with the credential server 204 for authentication. (emphasis added)

However, the above portion of He '451 authentication server merely sends the response message **back to the user, not to credential server**. In other words, He'451 does not teach signal path F2.

Additionally, He '451, at column 16, lines 52-67, states that a "record" may include the list of "user credentials" reflecting "the most recent changes to the privilege set for the user." He '451, at column 19, lines 2-8, merely states:

Based on the user identification, the credential server 204 will retrieve the

list of user credentials from the registration database 210 and enclose the list in a credential ticket. The credential ticket is sent back in a response message and will be used for the user to communicate with the network element access server 206.

However the credential ticket is not an individualized rule set. Thus, He '451 does not teach or suggest that the authentication accounting server “accesses the database and **communicates the individualized rule set** that correlates with the first user ID and the temporarily assigned network address **to the redirection server,**” as required by claim 1.

Additionally, **the final Office Action, at the top paragraph of page 27, asserts “claim 1 does not explicitly indicate which structure (the server or the database) is passing the rule set** to the redirection server, nor is there an indication in claim 1 that the rule set is passed directly from authentication server to redirection server. Claim 1 appears to allow the rule set to reach the redirection server from either the authentication server or from the database.”

Patent Owner respectfully submits that the above interpretation of the final Office Action is contrary to the clear language of claim 1. Claim 1 states, “**the authentication accounting server** accesses the database **and communicates the individualized rule set** that correlates with the first user ID and the temporarily assigned network address **to the redirection server.**” More concisely and more clearly, claim 1 states, “the authentication accounting server accesses the database and communicates . . . to the redirection server.”

Clearly the authentication accounting server of claim 1 is accessing the database, and then the authentication accounting server is also **communicating to** the redirection server. The term “accesses the database and communicates” clearly and unambiguously modifies the term “the authentication server.” In other words, claim 1 requires that the authentication accounting server communicates the individualized rule set to the redirection server. See the signal flow chart (Exhibit A) for additional details.

In order to reach the interpretation of the final Office Action (at the top paragraph of page 27), claim 1 would have to be substantially amended as follows: “the authentication accounting server accesses the database and either the authentication server or the database communicates... to the redirection server.”

**Patent Owner respectfully submits that the final Office Action interpretation (at page 27) would require amendment of the claim language by insertion of seven words as shown above, and therefore is not a reasonable interpretation of the clear claim language.**



Thus, He '451 does not teach or suggest the above recited feature of claim 1.

4a. Distinguish “data directed toward the public network from the one of the users' computers are processed by the redirection server according to the individualized rule set”

Independent claim 1 recites, in part, “**data directed toward the public network** from the one of the users' computers are **processed by the redirection server according to the individualized rule set.**”

As discussed above, this feature of claim 1 is represented, in one example, by signal flow G of Exhibit A.

He '451 does not disclose the programmed redirection function of the “processed by the redirection server” feature of claim 1.

Additionally, claim 1 expressly requires that “**data directed toward the public network . . . are processed by the redirection server.**”

In contrast to claim 1, the credential server of He '451 merely receives a message from User (102), and then sends a credential ticket back to the user. Neither the message from the user, nor the credential ticket to the user, disclose data directed toward the public network. He'451 does not teach any server that processes data directed toward the public network from the one of the user's computers.

In fact, He '451 does not even teach or suggest “a public network,” as required by claim 1. Element 106 of He '451 is a local network, and is not a public network. He '451, at column 4, line 31-32, states, “the interconnection network 106.” Further, He '451, at column 4, line 49, states, “local access control.” See the above detailed discussion of He '451 for additional details.

In summary, Patent Owner respectfully submits that He '451 does not teach or suggest any of the above discussed features of claim 1. Further, the other applied art does not remedy the deficiencies of He '451.

Thus, the rejection of claim 1 should be withdrawn. Further, Patent Owner submits that dependent claims 2-7 and 28-32 depend from claim 1, and are patentable for the same reasons as claim 1, as well as on their own merits.

Therefore, Patent Owner submits that the rejections of claims 1-7 and 28-32 should be

withdrawn.

**B. Dependent Claim 5 (depends from claim 1)**

Dependent claim 5 recites, in part, “the redirection server further **redirects the data** to and from the users’ computers as a function of the individualized rule set.”

As an illustrative and non-limiting example of claim 5, the present patent states: “[t]he redirection server programs the rule set and the IP address so as to filter and redirect the user’s packets according to the rule set” (6:37-39); “dynamically changing rules, to allow the redirection, blocking, or allowing” (2:62-63); and “pass . . . block . . . or modify the request according to the redirection information” (3:8-20).

Further, the Present Patent provides a specific illustrative and non-limiting example of **redirecting a message from a first destination address (or attempted destination address) of “\*.xyz.com” to a second destination address (or redirected destination address) of “www.us.com”** (at column 6 line 21, and at column 6 lines 46-49).

As discussed above with respect to claim 1, Patent Owner respectfully submits that the redirection server of claim 1 is programmed to perform redirection, and He ‘451 does not disclose the capability of performing redirection.

Even if the claim 1 feature “redirection server” is disclosed by a server merely having a functionality of blocking (which Patent Owner does not admit), dependent claim 5 expressly requires that “the redirection server further **redirects the data.**” **Thus, claim 5 expressly requires that the redirection server have the redirecting functionality.**

The final Office Action, at page 7, asserts that He ‘451 discloses the above feature at column 19, lines 2-11. However, He ‘451, at column 19, lines 2-11, merely states:

Based on the user identifier, the credential server 204 will retrieve the list of user credentials from the registration database 210 and enclose the list in a credential ticket. The credential ticket is **sent back in a response message and will be used for the user** to communicate with the network element access server 206. (emphasis added)

Additionally, He ‘451, at column 9, lines 38-41, merely discloses “an access control list for each network resource or information . . . shall contain the list of user identifiers who are allowed to access it and the kind of access rights that are allowed to each user.” In other words, He ‘451 merely determines the kind of access rights that are allowed to each user who is allowed

access. He '451 **does not teach how to redirect data directed toward public network from one of a user's computer**. In fact, He '451 does not disclose any type of redirection at all.

Patent Owner respectfully submits that the other applied art (Zenchelsky and AAPA) does not remedy the deficiencies of He '451.

Therefore, Patent Owner submits that the rejection of dependent claim 5 should be withdrawn for the same reasons as base claim 1, as well as on its own merits.

**C. Dependent Claim 6 (depends from claim 1)**

Dependent claim 6 recites, in part, “the redirection server further **redirects the data from the users' computers to multiple destinations** as a function of the individualized rule set.” Illustrative examples of redirecting data are discussed above with respect to claim 5.

The final Office Action, at pages 7 and 28, asserts that He '451 discloses the above feature at FIG. 10, wherein the plural network elements 104 allegedly represent multiple potential destinations for interaction based on particular user credentials.

First, as discussed above with respect to claim 5, He '451 merely determines the kind of access rights that are allowed to each user who is allowed access. He '451 **does not redirect the data in any way**.

Second, claim 6 expressly redirects the data to “multiple destinations as a function of the individualized rule set.” For example, the individualized rule set may redirect a message to a first redirected address and then to a second redirected address, resulting in multiple destinations as a function of the individualized rule set. In other words a single individualized rule set results in redirections to multiple destinations.

Thus, He '451 does not teach or suggest that “the redirection server further **redirects** the data directed toward the public network from the users' computers to **multiple destinations** as a function of the individualized rule set,” as required by dependent claim 6.

Patent Owner respectfully submits that the other applied art (Zenchelsky and AAPA) does not remedy the deficiencies of He '451.

Therefore, Patent Owner submits that the rejection of dependent claim 6 should be withdrawn for the same reasons as base claim 1, as well as on its own merits.

**D. New Dependent Claim 28 (depends from claim 1)**

New dependent claim 28 recites, in part, “wherein the individualized rule set includes at least one rule as a function of a type of IP (Internet Protocol) service.”

The Office Action, at page 17, asserts that a rule “does not change the structure of a physical system, and also does not change the functionality of the system unless the rule is executed” and therefore this rule is given no patentable weight, citing *In re Ngai* 367 F.3d 1336 USPQ 2d 1862 (Fed. Cir. 2004). Patent Owner respectfully disagrees.

Dependent claim 28 depends from claim 1, which recites, in part, “**authentication accounting server . . . communicates the individualized rule set**” and “**processed by the redirection server according to the individualized rule set.**”

Thus, Patent Owner respectfully submits that the authentication accounting server must be configured to be capable of communicating the individualized rule set including “at least one rule as a function of a type of IP (Internet Protocol) service,” and this first configuration feature changes the structure and/or changes the functionality of the authentication accounting server.

Additionally, Patent Owner respectfully submits that the redirection server must be configured to process the data “according to the individualized rule set,” and therefore this second configuration feature changes the structure and/or the functionality of the redirection server.

Therefore, Patent Owner submits that the rejection of dependent claim 28 should be withdrawn for the same reasons as base claim 1, as well as on its own merits.

**E. New Dependent Claim 29 (depends from claim 1)**

New dependent claim 29 recites, in part, “the individualized rule set includes an initial temporary rule set and a standard rule set, and wherein the redirection server is configured to utilize the temporary rule set for an initial period of time and to thereafter utilize the standard rule set.”

The final Office Action, at page 18, asserts that the “user credential” of He ‘451 corresponds to a rule, and that switching from a first rule of a first user to a second rule of a second user discloses the above recited feature of claim 29. Patent Owner respectfully disagrees.

Claim 29 requires that “the individualized rule set includes an initial temporary rule set and a standard rule set.” There is no such individualized rule set (including an initial temporary

rule set and a standard rule set) disclosed by He '451. Note that both the initial temporary rule set and the standard rule set belong to (are included by) the individualized rule set. Thus, the two different rule sets from He '451 each belong to different users (the first user and the second user), and do not belong to an individualized rule set. In other words, an individualized rule set is not a first rule set for a first user and a second rule set for a second user.

Therefore, Patent Owner submits that the rejection of dependent claim 29 should be withdrawn for the same reasons as base claim 1, as well as on its own merits.

**F. New Dependent Claim 30 (depends from claim 1)**

New dependent claim 30 recites, in part, “the individualized rule set includes at least one rule allowing access based on a request type and a destination address.”

The final Office Action, at page 18, asserts that a rule “does not change the structure of a physical system, and also does not change the functionality of the system unless the rule is executed” and therefore this rule is given no patentable weight, citing *In re Ngai* 367 F.3d 1336 USPQ 2d 1862 (Fed. Cir. 2004). Patent Owner respectfully disagrees.

Dependent claim 30 depends from claim 1, which recites, in part, “**authentication accounting server . . . communicates the individualized rule set**” and “**processed by the redirection server according to the individualized rule set.**”

Thus, Patent Owner respectfully submits that the authentication accounting server must be first configured to be capable of communicating the individualized rule set including “at least one rule as a function of a type of IP (Internet Protocol) service,” and this first configuration feature patentably changes the structure and/or changes the functionality of the authentication accounting server.

Additionally, Patent Owner respectfully submits that the redirection server must be second configured to process the data “according to the individualized rule set,” and therefore this second configuration feature patentably changes the structure and/or the functionality of the redirection server.

Therefore, Patent Owner submits that the rejection of dependent claim 30 should be withdrawn for the same reasons as base claim 1, as well as on its own merits.

**G. New Dependent Claim 31 (depends from claim 1)**

New dependent claim 31 recites, in part, “wherein the individualized rule set includes at least one rule redirecting the data to a new destination address based on a request type and an attempted destination address.”

The final Office Action, at page 18, asserts that a rule “does not change the structure of a physical system, and also does not change the functionality of the system unless the rule is executed” and therefore this rule is given no patentable weight, citing *In re Ngai* 367 F.3d 1336 USPQ 2d 1862 (Fed. Cir. 2004). Patent Owner respectfully disagrees.

Dependent claim 31 depends from claim 1, which recites, in part, “**authentication accounting server . . . communicates the individualized rule set**” and “**processed by the redirection server according to the individualized rule set.**”

Thus, Patent Owner respectfully submits that the authentication accounting server must be first configured to be capable of communicating the individualized rule set including “at least one rule as a function of a type of IP (Internet Protocol) service,” and this first configuration feature patentably changes the structure and/or changes the functionality of the authentication accounting server.

Additionally, Patent Owner respectfully submits that the redirection server must be second configured to process the data “according to the individualized rule set,” and therefore this second configuration feature patentably changes the structure and/or the functionality of the redirection server.

Therefore, Patent Owner submits that the rejection of dependent claim 31 should be withdrawn for the same reasons as base claim 1, as well as on its own merits.

#### **H. Independent Claim 8**

Independent claim 8 recites, in full:

In a system comprising a database with entries correlating each of a plurality of user IDs with an individualized rule set; a dial-up network server that receives user IDs from users' computers; a redirection server connected to the dial-up network server and a public network, and an authentication accounting server connected to the database, the dial-up network server and the redirection server, the method comprising the steps of:

- communicating a first user ID for one of the users' computers and a temporarily assigned network address for the first user ID from the dial-up network server to the authentication accounting server;
- communicating the individualized rule set that correlates with the

first user ID and the temporarily assigned network address to the redirection server from the authentication accounting server;  
and processing data directed toward the public network from the one of the users' computers according to the individualized rule set.

Independent claim 8 recites features similar to independent claim 1, and is patentable over the applied art for reasons similar to those of independent claim 1 with respect to the similar features, as well as on its own merits.

For example, independent claim 8 recites, “**communicating the individualized rule set that correlates with the first user ID and the temporarily assigned network address to the redirection server from the authentication accounting server.**”

The Office Action, at page 8, asserts that the above recited feature is disclosed by He ‘451 at 17:61-66, and 17:67 to 18:1. As discussed above with respect to claim 1, He ‘451 does not disclose a redirection server.

Additionally, the credential server (204) of FIG. 10 of He ‘451 merely receives a request message from the User (102), and send a credential ticket back to the User (102). This is described in detail at 18:57 to 19:8 of He ‘451.

Patent Owner respectfully submits that the other applied art does not remedy the deficiencies of He ‘451. Thus, Patent Owner submits that the rejection of independent claim 8 should be withdrawn.

Further, dependent claims 9-14 and 33-39 are patentable for, at a minimum, the same reasons as base claim 8, as well as on their own merits.

**I. Dependent claims 9-14 (depending from claim 8)**

Dependent claims 9-14 recite features similar to those of claims 2-7, and are patentable over the applied art for, at a minimum, reasons similar to claims 2-7, as well as the same reasons as base claim 8, and as well as on their own merits.

**J. New dependent claims 33-36 (depending from claim 8)**

New dependent claims 33-36 recite features similar to those of new dependent claims 28-31, and are patentable over the applied art for, at a minimum, reasons similar to claims 28-31, as well as the same reasons as base claim 8, and as well as on their own merits.

**K. Independent claim 15**

Independent claim 15 recites features similar to those of independent claim 1, and is patentable over the cited art for reasons similar to those of independent claim 1 with respect to the similar features, as well as on its own merits

Amended independent claim 15 recites, in part, “a redirection server programmed with a user’s rule set correlated to a temporarily assigned network address” and “the redirection server is configured to allow **automated modification of at least a portion of the rule set . . . as a function of some combination of time, data transmitted to or from the user, or a location that the user accesses.**” The specification at 4:59-66, “The redirection server . . . dynamically changing the rule sets based on condition” provides clear description.

As an illustrative and non-limiting example of claim 15, see the Present patent at 7:48 to 8:11 regarding automatically deleting a redirection rule after a questionnaire has been successfully completed.

The final Office Action, at pages 10 and 11, asserts that the above feature of claim 15 is disclosed by He ‘451 at 17:13, and 17:19-21. However, He ‘451 merely discloses a system security administrator (a person) and a database tool for the person, but does not teach or suggest an “**automated modification** of at least a portion of the rule set,” as required by claim 15. Requiring a person is inconsistent with the automation feature of claim 15.

Additionally, the database tool of He ‘451 appears intended to modify information in database 210 of FIG. 10. In contrast, claim 15 requires that the automatic modification occur on the rule set programmed in the redirection server (not in the database).

Specifically, in He ‘451, the authentication server (202) generates a general ticket, and the credential server (204) generates a credential ticket. The “maximum lifetime” of each authentication is He ‘451 is merely a bit of stored administrative information, and appears to refer to the lifetime of the credential ticket. See He ‘451, at 17:6-13. The “maximum lifetime” remains unchanged until the system administrator uses the database tool to manually change the value of the maximum lifetime of each authentication, as stored administrative information. This administrative information appears to be general purpose information, which is applied to the system. **In any case, the “maximum lifetime” of He ‘451 is not automatically modified.** Further, He’451 does not disclose modifying rule sets while the user’s rule set remains correlated to the temporarily assigned network address.



Thus, Patent Owner submits that He '451 does not teach or suggest “**automated modification of at least a portion of the rule set . . . as a function of some combination of time, data transmitted to or from the user, or a location that the user accesses,**” as required by claim 15.

Patent Owner respectfully submits that the other applied art does not remedy the deficiencies of He '451.

Further, Patent Owner submits that dependent claims 16-24 and 38-42 depend from claim 15, and are patentable for the same reasons as claim 15, as well as on their own merits.

Therefore, Patent Owner submits that the rejections of claims 15-24, and 38-42 should be withdrawn.

**L. Dependent claims 16-24 (depending from claim 15)**

Dependent claims 16-24 are patentable over the applied art for the same reasons as base claim 15, and as well as on their own merits.

**M. Dependent claim 16 (depending from claim 15)**

Dependent claim 16 recites, in part, “the redirection server is configured to allow **modification of at least a portion of the rule set as a function of time.**” As discussed above with respect to claim 15, He '451 does not teach or suggest automatic modification, and certainly does not teach automatic modification as a function of time. Patent Owner respectfully submits that the other applied art does not remedy the deficiencies of He '451.

Thus, Patent Owner submits that the rejection of dependent claim 16 should be withdrawn.

**N. Dependent claim 17 (depending from claim 15)**

Dependent claim 17 recites, in part, “the redirection server is configured to allow **modification of at least a portion of the rule set as a function of the data transmitted to or from the user.**”

The final Office Action, at page 12, asserts that this feature is optionally recited in claim 15, and can be interpreted as an optional recitation in a claim dependent on claim 15. Patent Owner respectfully disagrees.

Even if this feature is optional in claim 15 (“some combination of . . .”), this feature in dependent claim 17 must be given patentable weight. Claim 17 feature requires “modification . . . as a function of the data transmitted **to or from the user.**” In other words, the term “to or from the user” is mandatory, although which specific option (to the user, or from the user) is optional.

The final Office Action, at page 17, also states that this feature is disclosed by He ‘451 at 17:19-21, wherein data input by a system administrator can modify the rule set. Patent Owner respectfully submits that the data input by a system administrator via a database tool set to modify the database does not disclose “modification of at least a portion of the rule set as a **function of the data transmitted to or from the user.**”

The data transmitted to or from the user in dependent claim 17 finds antecedent basis in the “data passing between the user and a public network” as recited by amended base claim 15.

In contrast to claim 17, He ‘451 merely discloses data input by a system administrator via a database tool set to modify the database (data input directed towards a local database). Patent Owner respectfully submits that the other applied art does not remedy the deficiencies of He ‘451.

Thus, Patent Owner submits that the rejection of dependent claim 17 should be withdrawn.

**O. Dependent claim 18 (depending from claim 15)**

Dependent claim 18, recites, in part, “the redirection server is configured to allow modification of at least a portion of the rule set as a **function of the location or locations the user accesses.**”

The final Office Action, at pages 12 and 13, asserts that the above recited feature of claim 18 is disclosed by He ‘451 at 17:19-21, wherein data being supplied by the system administrator modifies a rule set by deletion, and the location of the administrator is the location at which modification is permitted. Patent Owner respectfully disagrees.

The claim 18 term “location or location the user accesses” refers to target locations in the sense of target URLs (uniform resource locators), or target addresses of target websites in the public network. In contrast to claim 18, He ‘451 the location of the administrator appears to be the location from which the user begins his communications.

Therefore, He '451 does not teach or suggest the above recited feature of claim 18. Patent Owner respectfully submits that the other applied art does not remedy the deficiencies of He '451.

Thus, Patent Owner submits that the rejection of dependent claim 18 should be withdrawn.

**P. Dependent claim 19 (depending from claim 15)**

Dependent claim 19, recites, in part, “the redirection server is configured to **allow** the removal or reinstatement of at least a portion of the rule set **as a function of time.**”

The final Office Action, at page 13, asserts that the above recited feature of claim 19 is disclosed by the administrator of He '451 creating or deleting any portion of the user account, which inherently occurs over some given period of time. Patent Owner respectfully disagrees.

Dependent claim 19 requires “allowing . . . as a function of time.” In contrast to claim 19, the He '451 administrator appears to create or delete at any time, without respect to the time, and independent of the time. Thus, He '451 does not disclose the function of **allowing** any removal or reinstatement of at least a portion of the rule set **as a function of time.** Patent Owner respectfully submits that the other applied art does not remedy the deficiencies of He '451.

Thus, Patent Owner submits that the rejection of dependent claim 19 should be withdrawn.

**Q. Dependent claims 20-22 (depending from claim 15)**

Patent Owner respectfully submits that dependent claims 20-22 are patentable over the applied art for reasons similar to those of dependent claims 16-19 as discussed above, as well as on their own merits.

Patent Owner respectfully submits that the other applied art does not remedy the deficiencies of He '451. Thus, Patent Owner submits that the rejection of dependent claims 20-22 should be withdrawn.

**R. New dependent claims 38-41 (depending from claim 15)**

New dependent claims 38-41 recite features similar to those of new dependent claims 28-

31, and are patentable over the applied art for, at a minimum, reasons similar to claims 28-31, as well as the same reasons as base claim 15, and as well as on their own merits.

**S. Independent claim 25**

Independent claim 25 recites features similar to those of independent claim 1, and is patentable over the applied art for reasons similar to those of independent claim 1 with respect to the similar features, as well as on its own merits.

Independent claim 25 recites, in full:

In a system comprising a redirection server containing a user's rule set correlated to a temporarily assigned network address wherein the user's rule set contains at least one of a plurality of functions used to control data passing between the user and a public network; the method comprising the step of:

modifying at least a portion of the user's rule set while the user's rule set remains correlated to the temporarily assigned network address in the redirection server; and

wherein the redirection server has a user side that is connected to a computer using the temporarily assigned network address and a network address and a network side connected to a computer network and

wherein the computer using the temporarily assigned network address is connected to the computer network through the redirection server and the method further includes the step of receiving instructions by the redirection server to modify at least a portion of the user's rule set through one or more of the user side of the redirection server and the network side of the redirection server.

For example, the claim 25 feature of “**modifying at least a portion of the user's rule set while the user's rule set remains correlated to the temporarily assigned network address in the redirection server**” is not disclosed by the applied art. Note that any modifications by the administrator in He '451 using the database tool are performed upon the database, and not upon the user's rule set in the redirection server. Further, He'451 does not disclose modifying rule sets while the user's rule set remains correlated to the temporarily assigned network address.

Patent Owner respectfully submits that the other applied art does not remedy the deficiencies of He '451.

Further, Patent Owner respectfully submits that dependent claims 26, 27, and 43-47 are patentable for, at a minimum, the same reasons as base claim 25, as well as on their own merits.

Thus, Patent Owner submits that the rejection of claims 25-27 and 43-47 should be withdrawn.

**T. Dependent claim 26 (depending from claim 25)**

Dependent claim 26, recites, in part, “modifying at least a portion of the user's rule set **as a function of** one or more of: time, data transmitted to or from the user, and location or locations the user accesses.”

As discussed above with respect to dependent claims 16-21, the applied art does not disclose any “as a function of” modification of the user’s rule set.

Thus, Patent Owner submits that the rejection of dependent claim 26 should be withdrawn.

**U. Dependent claim 27 (depending from claim 25)**

Dependent claim 27, recites, in part, “removing or reinstating at least a portion of the user's rule set **as a function of** one or more of: time, the data transmitted to or from the user and the location or locations the user access.”

As discussed above with respect to dependent claims 16-21, the applied art does not disclose any “as a function of” modification of the user’s rule set.

Thus, Patent Owner submits that the rejection of dependent claim 27 should be withdrawn.

**V. New dependent claims 43-46 (depending from claim 25)**

New dependent claims 43-46 recite features similar to those of new dependent claims 28-31, and are patentable over the applied art for, at a minimum, reasons similar to claims 28-31, as well as the same reasons as base claim 25, and as well as on their own merits.

**VIII. Rejections under 35 USC 103(a) of claims 32, 37, 42, and 47**

Claims 32, 37, 42, and 47 are rejected under 35 U.S.C. § 103(a) as being unpatentable over He ‘451, in view of Zenchelsky, and further in view of alleged admitted prior art (“Background of the Invention” at column 1, lines 53-57 of the Present Patent, hereinafter “AAPA”). Patent Owner respectfully disagrees.

Claims 32, 37, 42, and 47 depend respectively from independent claims 1, 8, 15, and 25, and each of claims 32, 37, 42, and 47 recites, in part, “**the redirection server is configured to**

**redirect data from the users' computers by replacing a first destination address in an IP (Internet protocol) packet header by a second destination address as a function of the individualized rule set."**

The Office Action, at page 23, asserts that the above recited feature is disclosed by Applicant's Admitted Prior Art (AAPR), as discussed in 1:46-47 of the Present Patent.

Patent Owner respectfully submits that Column 1 of the BACKGROUND OF THE INVENTION section of the Present Patent does discuss the concept of redirection, but Patent Owner does not admit that redirection in the particular combination claimed is known prior art.

Additionally, nowhere in the BACKGROUND OF THE INVENTION is there any disclosure of replacing a first destination address by a second destination address **"as a function of the individualized rule set,"** as required by dependent claims 32, 37, 42, and 47.

Patent Owner respectfully submits that the other applied art does not remedy the deficiencies of AAPR. Thus, Patent Owner submits that the rejection of dependent claims 32, 37, 42, and 47 should be withdrawn.

## **IX. Conclusion**

For at least the above reasons, it is respectfully submitted that claims 1-47 are patentably distinguished over the applied prior art. Thus, reconsideration and confirmation of the patentability of claims 1-27, allowance of new claims 28-47, and an early Notice of Intent to Issue a Reexamination Certificate are respectfully solicited.

It is believed that all of the pending issues have been addressed. However, the absence of a reply to a specific rejection, issue or comment does not signify agreement with or concession of that rejection, issue or comment. In addition, because the arguments made above may not be exhaustive, there may be reasons for patentability of any or all pending claims (or other claims) that have not been expressed. Finally, nothing in this reply should be construed as an intent to concede any issue with regard to any claim, except as specifically stated in this reply, and the amendment of any claim does not necessarily signify concession of unpatentability of the claim prior to its amendment.

Patent Owner has submitted herewith the fees for the newly added claims. It is believed that no other fees are required. However, should any additional fee or fees be necessary for consideration of the papers filed herein, please charge any such fee or fees and refund any excess payments to Deposit Account No. 50-2929, referencing docket no. R1341006.

Should the Examiner have any questions or comments regarding this matter, the undersigned may be contacted at the below-listed telephone number.

Respectfully submitted,  
Koichiro Ikudome et al.

/Abe Hershkovitz/  
Abraham Hershkovitz  
Reg. No. 45,294

Ed Garcia-Otero  
Reg. No. 56,609

Appendix A: Claim amendments of claims 15, 18, 21, 26, and 27  
(relative to the Response filed November 14, 2009)

Exhibit A: Updated Signal Flow Chart

October 4, 2010

HERSHKOVITZ & ASSOCIATES, LLC  
2845 Duke Street  
Alexandria, VA 22314  
TEL: (703) 370-4800  
FAX: (703) 370-4809  
E-MAIL: patent@hershkovitz.net

R1341006.A06; AH/EG

APPENDIX A: CLAIM AMENDMENTS OF CLAIMS 15, 18, 21, 26, and 27  
RELATIVE TO THE RESPONSE FILED NOVEMBER 14, 2009

*For the sake of clarity and for the convenience of the Examiner, this appendix tracks the changes of claims 15, 18, 21, 26, and 27 relative to the Response filed November 14, 2009.*

15. (Twice Amended) A system comprising:

a redirection server programmed with a user's rule set correlated to a temporarily assigned network address; wherein the rule set contains at least one of a plurality of functions used to control data passing between the user and a public network;

wherein the redirection server is configured to allow automated modification of at least a portion of the rule set correlated to the temporarily assigned network address; and

wherein the redirection server is configured to allow automated modification of at least a portion of the rule set as a function of some combination of time, data transmitted to or from the user, or location the user accesses. [attempts to access.]

18. (Twice Amended) The system of claim 15, wherein the redirection server is configured to allow modification of at least a portion of the rule set as a function of the location or locations the user accesses. [attempts to access.]

21. (Twice Amended) The system of claim 15, wherein the redirection server is configured to allow the removal or reinstatement of at least a portion of the rule set as a function of the



location or locations the user accesses. [attempts to access.]

26. (Twice Amended) The method of claim 25, further including the step of modifying at least a portion of the user's rule set as a function of one or more of: time, data transmitted to or from the user, and location or locations the user accesses. [attempts to access.]

27. (Twice Amended) The method of claim 25, further including the step of removing or reinstating at least a portion of the user's rule set as a function of one or more of: time, the data transmitted to or from the user and a location or locations the user accesses. [attempts to access.]

**CERTIFICATE OF SERVICE**

It is hereby certified that the attached after final **Response Under 37 CFR 1.116 and Proposed Amendment under 37 CFR 1.530 (including Appendix A and Exhibit A)** is being served by first class mail on the third party requester at the third party requestor's address:

JERRY TURNER SEWELL  
P.O. BOX 10999  
NEWPORT BEACH, CA 92658-5015

/Abe Hershkovitz/  
**Abe Hershkovitz**

October 4, 2010  
**Date**

## Electronic Acknowledgement Receipt

<b>EFS ID:</b>	8548471
<b>Application Number:</b>	90009301
<b>International Application Number:</b>	
<b>Confirmation Number:</b>	6609
<b>Title of Invention:</b>	USER SPECIFIC AUTOMATIC DATA REDIRECTION SYSTEM
<b>First Named Inventor/Applicant Name:</b>	6,779,118 B1
<b>Customer Number:</b>	40401
<b>Filer:</b>	Abraham Hershkovitz
<b>Filer Authorized By:</b>	
<b>Attorney Docket Number:</b>	R1341006
<b>Receipt Date:</b>	02-OCT-2010
<b>Filing Date:</b>	17-DEC-2008
<b>Time Stamp:</b>	22:45:03
<b>Application Type:</b>	Reexam (Patent Owner)

### Payment information:

Submitted with Payment	no
------------------------	----

### File Listing:

Document Number	Document Description	File Name	File Size(Bytes)/ Message Digest	Multi Part /.zip	Pages (if appl.)
1	Transmittal Letter	Xmittal.pdf	475807 <small>560b3211be8661f5ebf98dc82e45d774e5cd1</small>	no	1

### Warnings:

### Information:

2	Applicant summary of interview with examiner	Statement.pdf	475638 9779b7034de70a7090002d67aeb8d586b4264548	no	7
<b>Warnings:</b>					
<b>Information:</b>					
3	Miscellaneous Incoming Letter	Exhibit_A.pdf	553079 542ad3b2f7ae409aae435aac849465d16b876ea4	no	1
<b>Warnings:</b>					
<b>Information:</b>					
4	Reexam Response to Final Rejection	R1341006_AF_Response.pdf	620508 07393562123c3ce0cbaf7553939eff378a87b5b3	no	39
<b>Warnings:</b>					
<b>Information:</b>					
<b>Total Files Size (in bytes):</b>				2125032	

**This Acknowledgement Receipt evidences receipt on the noted date by the USPTO of the indicated documents, characterized by the applicant, and including page counts, where applicable. It serves as evidence of receipt similar to a Post Card, as described in MPEP 503.**

**New Applications Under 35 U.S.C. 111**

**If a new application is being filed and the application includes the necessary components for a filing date (see 37 CFR 1.53(b)-(d) and MPEP 506), a Filing Receipt (37 CFR 1.54) will be issued in due course and the date shown on this Acknowledgement Receipt will establish the filing date of the application.**

**National Stage of an International Application under 35 U.S.C. 371**

**If a timely submission to enter the national stage of an international application is compliant with the conditions of 35 U.S.C. 371 and other applicable requirements a Form PCT/DO/EO/903 indicating acceptance of the application as a national stage submission under 35 U.S.C. 371 will be issued in addition to the Filing Receipt, in due course.**

**New International Application Filed with the USPTO as a Receiving Office**

**If a new international application is being filed and the international application includes the necessary components for an international filing date (see PCT Article 11 and MPEP 1810), a Notification of the International Application Number and of the International Filing Date (Form PCT/RO/105) will be issued in due course, subject to prescriptions concerning national security, and the date shown on this Acknowledgement Receipt will establish the international filing date of the application.**



# HERSHKOVITZ & ASSOCIATES, LLC

PATENT AGENCY

2845 DUKE STREET, ALEXANDRIA, VA 22314

TEL. 703-370-4800 ~ FACSIMILE 703-370-4809

patent@hershkovitz.net ~ www.hershkovitz.net

Inventor: IKUDOME, Koichiro *et al.*  
Reexamination Proceeding: 90/009,301  
(based on U.S. Patent No. 6,779,118)  
Reexamination Filed: December 17, 2008

Docket No.: R1341006  
Confirmation No.: 6609  
Art Unit: 3992  
Examiner: RIMELL, Samuel

For: USER SPECIFIC AUTOMATIC DATA REDIRECTION SYSTEM

Mail Stop: Ex Parte Reexam  
Central Reexamination Unit  
COMMISSIONER FOR PATENTS  
P.O. Box 1450  
Alexandria, Virginia 22313-1450

Dear Commissioner:

Transmitted herewith: **AFTER FINAL RESPONSE UNDER 37 CFR 1.116 AND PROPOSED AMENDMENT UNDER 37 CFR 1.530 and STATEMENT OF INTERVIEW UNDER 37 CFR 1.560(b)** in the above proceeding.

The fee has been calculated as shown below:

Claims After Amendment	No. of Claims Previously Paid	Present Extra	Small Entity		Large Entity	
			Rate	Fee	Rate	Fee
Total Claims: 47	47	0	x 26=	\$	X 52=	\$
Indep. Claims: 4	4	0	x 110=	\$	X 220=	\$
						\$
Total:				\$		\$

Payment made via EFS.

The U.S. Patent and Trademark Office is hereby authorized to charge payment of the following fees associated with this communication or credit any overpayment to Deposit Account No. **50-2929**:

Any additional filing fees required under 37 C.F.R. 1.16.

Any patent application processing fees under 37 C.F.R. 1.17, including any required extension of time fees in any concurrent or future reply requiring a petition for extension of time for its timely submission (37 CFR 1.136)(a)(3).

October 1, 2010  
Date

/Abe Hershkovitz/  
Abraham Hershkovitz  
Reg. No. 45,294

R1341006.A11; AH/ dj

IN THE UNITED STATES PATENT AND TRADEMARK OFFICE

Inventor: Koichiro Ikudome, et al.

Art Unit: 3992

Reexamination Proceeding: 90/009,301  
(based on U.S. Patent No. 6,779,118)

Confirmation No.: 6609

Reexamination Filed: December 17, 2008

Examiner: Sam Rimell

For: USER SPECIFIC AUTOMATIC DATA REDIRECTION SYSTEM

**STATEMENT OF INTERVIEW UNDER 37 CFR 1.560(b)**

Attn: Mail Stop "Ex Parte Reexamination"  
Central Reexamination Unit  
Commissioner for Patents  
United States Patent & Trademark Office  
P.O. Box 1450  
Alexandria, Virginia 23313-1450

Sir:

This Statement of Interview is in response to a Personal Interview held on September 21, 2010. This Substance of Interview is filed within one month of the date of the interview, and therefore is timely filed. A copy of the Examiner's Interview Summary has not yet been received.

Evidence of Service of this Statement of Interview on the 3<sup>rd</sup> party requester is found after the last page of this paper.

## **REMARKS**

### **I. Introduction**

Patent Owner appreciates the courtesies extended by the Examiners (Sam Rimell, Jessica Harrison, and Will Wood) to the representatives of the Patent Owner (Abraham Hershkovitz and Ed Garcia-Otero) and to co-inventor Ko Ikudome during the Personal Interview held on September 22, 2010. Examiner Will Wood participated by telephone.

### **II. Inventor Ko Ikudome**

Co-inventor Ko Ikudome presented a brief discussion of his technical and educational background, and described the history of how he invented the claimed invention.

### **III. Discussion of Rejections**

Patent Owner outlined the rejections made in the Final Office Action.

Claims 28-31, 33-36, and 38-47 were rejected under 35 USC 112, second paragraph, as being indefinite regarding antecedent basis.

Claims 1-31, 33-36, 38-41, and 43-46 were rejected under 35 U.S.C. § 103(a) as being unpatentable over U.S. Patent No. 6,088,451 (hereinafter "He '451") in view of U.S. Patent No. 6,233,686 (hereinafter "Zenchelsky").

Claims 32, 37, 42, and 47 were rejected under 35 U.S.C. § 103(a) as being unpatentable over He '451, in view of Zenchelsky, and further in view of alleged admitted prior art ("Background of the Invention" at column 1, lines 53-57 of the Present Patent, hereinafter "AAPA").

Claims 1, 8, 15, and 25 are the sole independent claims of the Present Patent. Patent Owner's representatives explained why independent claims 1, 15, 18, and 25, dependent claim 5, and new dependent claim 29 are patentably distinct over the cited prior art.

Patent Owner's representatives indicated that they would check whether all relevant litigation documents had been reported in a previous Information Disclosure Statement (IDS), and that Patent Owner's representatives would promptly report any relevant documents it was aware of in a new Information Disclosure Statement (IDS), if necessary.

#### **IV. Typographical corrections**

Patent Owner's representatives proposed minor typographical and grammatical corrections. For example, claim 15 would recite "location the user accesses" after correction. The Examiners indicated that these minor corrections appeared acceptable, and would be entered if presented in an after-final Response.

The Examiners also indicated that the pending rejections under 35 USC 112, second paragraph appeared minor, and probably could easily be corrected in the next Response.

#### **III. Exhibit A: Modified FIG 2 aka SIGNAL FLOW CHART**

Patent Owner's representatives presented a "blown up" copy of FIG. 2 of the specification, with annotations illustrating the signal paths of preferred embodiment of claim 1. This signal flow chart is attached as Exhibit A. Two small updates have been made with respect to the version presented at the interview: the letter "D" has been inserted into element 204 (AUTHENTICATION AND ACCOUNTING SERVER) for identification, and the reexamination number and the docket number have been inserted to identify the document.

These signal paths were discussed in detail. One Examiner correctly pointed out that claim 1 does not expressly require that signal path G flow through Dial-up Network Server B. Patent Owner agrees that claim 1 does not require signal path G to flow through Dial-up Network Server B.

Patent Owner's representatives wish to make one additional comment regarding this figure, which might not have been clearly stated during the interview (due to a lack of time). Path G is complex, and not all possibilities from claim 1 are expressly illustrated.

#### **IV. Independent Claim 1**

Patent Owner's representatives presented multiple arguments. First, during the interview it became clear the Examiner was not asserting that the prior art disclosed a redirection function. Rather, the **Examiner was asserting that a redirection server did not necessarily have to be capable of performing redirection**, but merely had to be capable of performing one of three functions: allow/pass, block, or modify/redirect. This interpretation was not clear from any of the Office Actions.

It was noted that that the terms "allow" and "pass" are used interchangeably throughout



the specification, and the terms “modify” and “redirect” are used interchangeably throughout the specification in the context of capabilities of the redirection server. See specification at 2:61-65; 3:15-20, and 4:59-67.

**Patent Owner’s representatives argued that the redirection server of claim 1 must be capable of redirecting.**

In view of the Examiner’s improperly broad interpretation (not requiring the redirection functionality) of the term “redirection server,” Patent Owner’s representatives presented a detailed analysis of the signal flows to support arguments regarding signal flows. Some of these signal flows were previously distinguished over the applied art in the most recent response. Other signal flows were presented in the Personal Interview, for the sake of completeness.

Specifically, signal flows F1 and F2 regarding the Authentication and Accounting Server D were distinguished over the applied art in Supplement Response filed May 24, 2010. These arguments were repeated at the Personal Interview, with the assistance of the Signal Flow Chart. For the sake of clarity and completeness, signal flow G was also discussed in detail, and distinguished over the cited art.

#### **V. Dependent Claim 5**

Patent Owner’s representatives discussed claim 5, which recites “the redirection server further **redirects data** to and from the users’ computers as a function of the individualized rule set.”

In dependent claim 5, the redirection server expressly and explicitly redirects data. It was argued that even if the redirection server of claim 1 is interpreted as not necessarily having the capability of redirecting data (which Patent Owner does not admit), **claim 5 expressly requires that the redirection server redirects data**. The applied art does not redirect data.

Patent Owner’s representatives explained that the credential server of He ‘451 might, at best, be associated with an allow function and a block function through issuance of a ticket. In contrast to the credential server of He ‘451, claim 5 expressly “redirects data” as a function of the individualized rule set. Allowing and/or blocking do not disclose redirection. See the Present Patent at 6:37-48 for a detailed example of redirection.

Thus, it was argued that dependent claim 5 is patentably distinguished over the applied art, for, at a minimum, the same reasons as base claim 1, as well as on its own merits for

expressly redirecting data.

**VI. Independent claims 8, 15, and 25 (remaining patented independent claims)**

Patent Owner's representatives stated that independent claims 8, 15, and 25 each contain some features similar to independent claim 1, and therefore are distinguished over the applied art for, at a minimum, the same reasons as independent claim 1 regarding similar features, as well as on their own merits.

**VII. New dependent claim 29**

The issue of dynamically changing rules was brought up. As well as independent claim 15 and 25, new dependent claim 29 recites, in part, "the individual rule set includes an initial temporary rule set and a standard rule set, and wherein **the redirection server is configured to utilize the temporary rule set for an initial period of time and to thereafter utilize the standard rule set.**"

Thus, claim 29 dynamically changes (switches) from the temporary rule set to the standard rule set after an initial period of time passes. It was emphasized that the applied art does not disclose this feature of claim 29.

An Examiner stated that the term "dynamically" did not appear in the specification. To keep the record clear, this term does appear in the specification, for example at column 4, line 67, which states, "dynamically changing the rule sets based on conditions."

**CONCLUSION**

Patent Owner appreciates the courtesies shown by the Examiners to the Patent Owner's representatives. At least one Examiner appeared to be persuaded by some of the arguments made during the personal interview, although no commitments were made regarding a finding of patentability.

Should the Examiner have any questions or comments regarding this matter, the undersigned may be contacted at the below-listed telephone number.

Respectfully submitted,  
LINKSMART WIRELESS TECHNOLOGY, LLC

/Abe HersHKovitz/  
Abraham HersHKovitz  
Reg. No. 45,294

Ed Garcia-Otero  
Reg. No. 56,609

Attachment: Exhibit A: Signal Flow Chart from Personal Interview

October 1, 2010  
HERSHKOVITZ & ASSOCIATES, LLC  
2845 Duke Street  
Alexandria, VA 22314  
TEL: (703) 370-4800  
FAX: (703) 370-4809  
E-MAIL: [patent@hershkovitz.net](mailto:patent@hershkovitz.net)

AH/EG

**CERTIFICATE OF SERVICE**

It is hereby certified that the attached Statement of Interview held on September 21, 2010 under 37 CFR 1.560(b) is being served by first class mail on the third party requester at the third party requestor's address:

JERRY TURNER SEWELL  
P.O. BOX 10999  
NEWPORT BEACH, CA 92658-5015

/Abe Hershkovitz/  
Abraham Hershkovitz

October 4, 2010  
Date

# INFORMATION DISCLOSURE STATEMENT BY PATENT OWNER

*(Use as many sheets as necessary)*

Sheet	1	of	2	Attorney Docket Number	<b>R1341006</b>
-------	---	----	---	------------------------	-----------------

Complete if Known

Reexamination Number	<b>90/009,301</b>
Filing Date	<b>December 17, 2008</b>
First Named Inventor	<b>Koichiro IKUDOME</b>
Art Unit	<b>3992</b>
Examiner Name	<b>Sam RIMELL</b>

## U.S. PATENT DOCUMENTS

Examiner Initials*	Cite No. <sup>1</sup>	Document Number Number-Kind Code <sup>2</sup> (if known)	Publication Date MM-DD-YYYY	Name of Patentee or Applicant of Cited Document	Pages, Columns, Lines, Where Relevant Passages or Relevant Figures Appear
	<b>A4</b>	<b>US-5,987,523</b>	<b>11-16-1999</b>	<b>HIND ET AL.</b>	

## FOREIGN PATENT DOCUMENTS

Examiner Initials*	Cite No. <sup>1</sup>	Foreign Patent Document Country Code <sup>3</sup> -Number <sup>4</sup> - Kind Code <sup>5</sup> (if known)	Publication Date MM-DD-YYYY	Name of Patentee or Applicant of Cited Document	Pages, Columns, Lines, Where Relevant Passages or Relevant Figures Appear	T <sup>6</sup>

## NON PATENT LITERATURE DOCUMENTS

Examiner Initials*	Cite No. <sup>1</sup>	Include name of the author (in CAPITAL LETTERS), title of the article (when appropriate), title of the item (book, magazine, journal, serial, symposium, catalog, etc.), date, page(s), volume-issue number(s), publisher, city and/or country where published.	T <sup>2</sup>

Examiner Signature		Date Considered	
--------------------	--	-----------------	--

\*EXAMINER: Initial if reference considered, whether or not citation is in conformance with MPEP 609. Draw line through citation if not in conformance and not considered. Include copy of this form with next communication to applicant. 1 Applicant's unique citation designation number (optional). 2 See Kinds Codes of USPTO Patent Documents at [www.uspto.gov](http://www.uspto.gov) or MPEP 901.04. 3 Enter Office that issued the document, by the two-letter code (WIPO Standard ST.3). 4 For Japanese patent documents, the indication of the year of the reign of the Emperor must precede the serial number of the patent document. 5 Kind of document by the appropriate symbols as indicated on the document under WIPO Standard ST.16 if possible. 6 Applicant is to place a check mark here if English language Translation is attached. This collection of information is required by 37 CFR 1.97 and 1.98. The information is required to obtain or retain a benefit by the public which is to file (and by the USPTO to process) an application. Confidentiality is governed by 35 U.S.C. 122 and 37 CFR 1.14. **SEND TO: Commissioner for Patents, P.O. Box 1450, Alexandria, VA 22313-1450.**

## Electronic Acknowledgement Receipt

<b>EFS ID:</b>	8476630
<b>Application Number:</b>	90009301
<b>International Application Number:</b>	
<b>Confirmation Number:</b>	6609
<b>Title of Invention:</b>	USER SPECIFIC AUTOMATIC DATA REDIRECTION SYSTEM
<b>First Named Inventor/Applicant Name:</b>	6,779,118 B1
<b>Customer Number:</b>	40401
<b>Filer:</b>	Abraham Hershkovitz/Dinh Nguyen
<b>Filer Authorized By:</b>	Abraham Hershkovitz
<b>Attorney Docket Number:</b>	R1341006
<b>Receipt Date:</b>	22-SEP-2010
<b>Filing Date:</b>	17-DEC-2008
<b>Time Stamp:</b>	18:22:04
<b>Application Type:</b>	Reexam (Patent Owner)

### Payment information:

Submitted with Payment	no
------------------------	----

### File Listing:

Document Number	Document Description	File Name	File Size(Bytes)/ Message Digest	Multi Part /.zip	Pages (if appl.)
1		R1341006_Submission.pdf	161011 <small>0114ba6fa2d087f905f99339538ba64419e1d43b</small>	yes	5

<b>Multipart Description/PDF files in .zip description</b>			
<b>Document Description</b>		<b>Start</b>	<b>End</b>
Transmittal Letter		1	1
Miscellaneous Incoming Letter		2	3
Reexam Certificate of Service		4	4
Information Disclosure Statement (IDS) Filed (SB/08)		5	5

**Warnings:**

**Information:**

<b>Total Files Size (in bytes):</b>	161011
-------------------------------------	--------

**This Acknowledgement Receipt evidences receipt on the noted date by the USPTO of the indicated documents, characterized by the applicant, and including page counts, where applicable. It serves as evidence of receipt similar to a Post Card, as described in MPEP 503.**

**New Applications Under 35 U.S.C. 111**

**If a new application is being filed and the application includes the necessary components for a filing date (see 37 CFR 1.53(b)-(d) and MPEP 506), a Filing Receipt (37 CFR 1.54) will be issued in due course and the date shown on this Acknowledgement Receipt will establish the filing date of the application.**

**National Stage of an International Application under 35 U.S.C. 371**

**If a timely submission to enter the national stage of an international application is compliant with the conditions of 35 U.S.C. 371 and other applicable requirements a Form PCT/DO/EO/903 indicating acceptance of the application as a national stage submission under 35 U.S.C. 371 will be issued in addition to the Filing Receipt, in due course.**

**New International Application Filed with the USPTO as a Receiving Office**

**If a new international application is being filed and the international application includes the necessary components for an international filing date (see PCT Article 11 and MPEP 1810), a Notification of the International Application Number and of the International Filing Date (Form PCT/RO/105) will be issued in due course, subject to prescriptions concerning national security, and the date shown on this Acknowledgement Receipt will establish the international filing date of the application.**

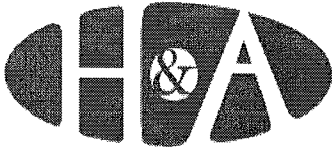

# HERSHKOVITZ & ASSOCIATES, LLC

PATENT AGENCY

2845 DUKE STREET, ALEXANDRIA, VA 22314

TEL. 703-370-4800 ~ FACSIMILE 703-370-4809

patent@hershkovitz.net ~ www.hershkovitz.net

Inventor: IKUDOME, Koichiro *et al.*  
Reexamination Proceeding: 90/009,301  
(based on U.S. Patent No. 6,779,118)  
Reexamination Filed: December 17, 2008

Docket No.: R1341006  
Confirmation No.: 6609  
Art Unit: 3992  
Examiner: RIMELL, Samuel

For: USER SPECIFIC AUTOMATIC DATA REDIRECTION SYSTEM

Mail Stop: Ex Parte Reexam  
Central Reexamination Unit  
COMMISSIONER FOR PATENTS  
P.O. Box 1450  
Alexandria, Virginia 22313-1450

Dear Commissioner:

Transmitted herewith are a **Supplemental Information Disclosure Statement**, a **Substitute Form PTO-1449** and a **Certificate of Service** in the above proceeding.

The fee has been calculated as shown below:

Claims After Amendment	No. of Claims Previously Paid	Present Extra	Small Entity		Large Entity	
			Rate	Fee	Rate	Fee
Total Claims:			x 26=	\$	X 52=	\$
Indep. Claims:			x 110=	\$	X 220=	\$
						\$
Total:				\$		\$

     Please charge the above fees to a credit card as authorized.

The U.S. Patent and Trademark Office is hereby authorized to charge payment of the following fees associated with this communication or credit any overpayment to Deposit Account No. **50-2929**:

Any additional filing fees required under 37 C.F.R. 1.16.

Any patent application processing fees under 37 C.F.R. 1.17, including any required extension of time fees in any concurrent or future reply requiring a petition for extension of time for its timely submission (37 CFR 1.136)(a)(3).

September 21, 2010  
Date

Abraham Hershkovitz  
Reg. No. 45,294

Dinh X. Nguyen  
Reg. No. 54,923

R1341006.A07; AH/DN/dj



**IN THE UNITED STATES PATENT AND TRADEMARK OFFICE**

Inventor: Koichiro Ikudome *et al.*

Art Unit: 3992

Reexamination Proceeding: 90/009,301

Confirmation No.: 6609

(based on U.S. Patent No. 6,779,118)

Reexamination Filed: December 17, 2008

Examiner: Sam RIMELL

For: USER SPECIFIC AUTOMATIC DATA REDIRECTION SYSTEM

**SUPPLEMENTAL INFORMATION DISCLOSURE STATEMENT**

Commissioner for Patents

Mail Stop Reexamination

PO Box 1450

Alexandria, Virginia 23313-1450

Dear Commissioner:

Pursuant to 37 C.F.R. 1.555, the Patent Owner hereby directs the Examiner's attention to the reference listed in the accompanying Substitute Form PTO-1449.

Further to the Information Disclosure Statement filed on May 13, 2010, Patent Owner directs the Examiner's attention to the following reference, which was brought to the attention of the undersigned on September 20, 2010, as having been cited in a related-pending application:

1. US-5,987,523.

A copy of the document is not being provided as it is a U.S. Patent, readily available to the Examiner. Accordingly, the Examiner is requested to consider this document by initialing in the appropriate space on the attached Substitute Form PTO-1449.

R1341006.A07

While a fee is not believed to be required, should this submission require a fee, the Commissioner is authorized to charge any fees to Deposit Account No. 50-2929, referencing Docket No. R1341006.

Should the Examiner have any questions or comments regarding this matter, the undersigned may be contacted at the below-listed telephone number.

Respectfully submitted,  
LINKSMART WIRELESS TECHNOLOGY, LLC

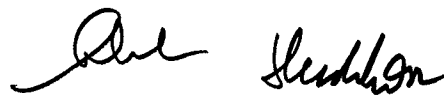

Abraham Hershkovitz  
Reg. No. 45,294

Dinh Nguyen  
Reg. No. 54,923

Date: September 21, 2010  
HERSHKOVITZ & ASSOCIATES, LLC  
2845 Duke Street  
Alexandria, VA 22314  
TEL: (703) 370-4800  
FAX: (703) 370-4809  
E-MAIL: [patent@hershkovitz.net](mailto:patent@hershkovitz.net)

R1341006.A07; AH/DN/dj

**CERTIFICATE OF SERVICE**

It is hereby certified that the attached Supplemental Information Disclosure Statement, Substitute Form PTO-1449 and reference are being served by first class mail on the third party requester at the third party requestor's address:

Jerry Turner Sewell  
P.O. Box 10999  
Newport Beach, CA 92658-5015

  
Abraham Hershkovitz

September 22, 2010  
Date

IN THE UNITED STATES PATENT AND TRADEMARK OFFICE

Inventor: Koichiro Ikudome, et al.

Art Unit: 3992

Reexamination Proceeding: 90/009,301  
(based on U.S. Patent No. 6,779,118)

Confirmation No.: 6609

Reexamination Filed: December 17, 2008

Examiner: Sam Rimell

For: USER SPECIFIC AUTOMATIC DATA REDIRECTION SYSTEM

**PERSONAL INTERVIEW REQUEST UNDER MPEP 2281**

Sir:

In response to the final Office Action mailed on August 2, 2010 in the above-identified *ex-parte* reexamination proceeding, Patent Owner requests a personal interview.

The tentative participants are: Abraham Hershkovitz (Patent Owner representative); Ed Garcia-Otero (Patent Owner representative); and Koichiro Ikudome (co-Inventor).

Patent Owner proposes the dates of September 7, 2010, or September 16, 2010, or September 21, 2010. Patent Owner proposes the times of 1:00 pm, or 2:00 pm, or 3:00 pm. Patent Owner is very flexible, and willing to consider other dates and times in the interests of performing an interview before October 2, 2010 (which is the due date for responding to the pending Office Action).

Patent Owner proposes discussing the following issues: entering minor amendments previously refused entry; entering additional minor amendments regarding antecedent basis; and technical clarification by co-inventor.

**1. ENTERING MINOR AMENDMENTS PREVIOUSLY REFUSED ENTRY**

Amendments to claims 15, 18, 21, 26, and 27 were previously submitted in the

supplemental Response filed on May 24, 2010, and were not entered by the final Office Action mailed on August 2, 2010 (the pending Office Action).

Patent Owner respectfully wishes to discuss whether these amendments should be entered under 37 CFR 1.111(2)(E) for correction of informalities, and/or 37 CFR 1.111(2)(F) for simplification of issues for appeal.

## **2. ENTERING ADDITIONAL MINOR AMENDMENTS**

Patent Owner proposes amending new claims 28-31 and 33-36 to recite “the individualized rule set,” and new claims 38-47 to recite “the modified rule set” in order to overcome the final Office Action antecedent basis rejection under 35 USC 112, second paragraph.

Patent Owner respectfully wishes to discuss whether these amendments should be entered under 37 CFR 1.111(2)(E) for correction of informalities, and/or 37 CFR 1.111(2)(F) for simplification of issues for appeal.

## **3. TECHNICAL CLARIFICATION BY CO-INVENTOR**

In view of the final Office Action, it appears that a personal interview including the co-Inventor should clarify some of the technical issues regarding distinguishing the claimed invention over the applied art.

Patent Owner respectfully asserts that all of the features of independent claim 1 are not disclosed by the combination of He ‘451 (US 6,088,451) and Zenchelsky (US 6,233,686). For example, claim 1 recites “data directed toward the public network from one of the users’ computers are processed by the redirection server according to the individualized rule set.”

In contrast to claim 1, the credential server 204 in FIG. 10 of He '451 is part of a client-server system that is substantially and patentably distinct from the redirection server of claim 1. Further, Zenchelsky does not remedy the deficiencies of He '451.

Patent Owner respectfully submits **that the technical differences between the claimed invention and the applied art are very advanced, and that that a personal interview including the co-Inventor will, at a minimum, clarify the issues for appeal, and may overcome some or all of the pending rejections.**

#### 4. CONCLUSION

Patent Owner appreciates the courtesies of Primary Examiner Sam Rimell, and is willing to consider any dates and times that are convenient for Primary Examiner Sam Rimell in the interests of performing an interview before October 2, 2010 (which is the due date for responding to the pending Office Action).

Should the Examiner have any questions or comments regarding this matter, the undersigned may be contacted at the below-listed telephone number.

Respectfully submitted,  
LINKSMART WIRELESS TECHNOLOGY, LLC



Abraham Hershkovitz  
Reg. No. 45,294

Ed Garcia-Otero  
Reg. No. 56,609

September 1, 2010  
HERSHKOVITZ & ASSOCIATES, LLC  
2845 Duke Street  
Alexandria, VA 22314

TEL: (703) 370-4800  
FAX: (703) 370-4809  
E-MAIL: [patent@hershkovitz.net](mailto:patent@hershkovitz.net)

AH/EG

**CERTIFICATE OF SERVICE**

It is hereby certified that the attached Personal Interview Request is being served by first class mail on the third party requester at the third party requestor's address:

JERRY TURNER SEWELL  
P.O. BOX 10999  
NEWPORT BEACH, CA 92658-5015



Abraham Hershkovitz

September 1, 2010

**Date**



## Electronic Acknowledgement Receipt

<b>EFS ID:</b>	8335129
<b>Application Number:</b>	90009301
<b>International Application Number:</b>	
<b>Confirmation Number:</b>	6609
<b>Title of Invention:</b>	USER SPECIFIC AUTOMATIC DATA REDIRECTION SYSTEM
<b>First Named Inventor/Applicant Name:</b>	6,779,118 B1
<b>Customer Number:</b>	40401
<b>Filer:</b>	Abraham Hershkovitz
<b>Filer Authorized By:</b>	
<b>Attorney Docket Number:</b>	62986/A522/WWM
<b>Receipt Date:</b>	01-SEP-2010
<b>Filing Date:</b>	17-DEC-2008
<b>Time Stamp:</b>	15:19:30
<b>Application Type:</b>	Reexam (Patent Owner)

### Payment information:

Submitted with Payment	no
------------------------	----

### File Listing:

Document Number	Document Description	File Name	File Size(Bytes)/ Message Digest	Multi Part /.zip	Pages (if appl.)
1	Transmittal Letter	R1341006Trans.pdf	40026 <small>c8b213c9d6a5bad85acbc8f53ff3af4e97d966b</small>	no	1

### Warnings:

### Information:

2	Miscellaneous Incoming Letter	R1341006Letter.pdf	114095	no	4
			4c858fe922c631c8740165348db04da1b341ae81		

**Warnings:**

**Information:**

3	Reexam Certificate of Service	R1341006Certf.pdf	12339	no	1
			2321dcbd3f65763907df5c3d5ad6de2a51414f48		

**Warnings:**

**Information:**

<b>Total Files Size (in bytes):</b>			166460		
-------------------------------------	--	--	--------	--	--

**This Acknowledgement Receipt evidences receipt on the noted date by the USPTO of the indicated documents, characterized by the applicant, and including page counts, where applicable. It serves as evidence of receipt similar to a Post Card, as described in MPEP 503.**

**New Applications Under 35 U.S.C. 111**

**If a new application is being filed and the application includes the necessary components for a filing date (see 37 CFR 1.53(b)-(d) and MPEP 506), a Filing Receipt (37 CFR 1.54) will be issued in due course and the date shown on this Acknowledgement Receipt will establish the filing date of the application.**

**National Stage of an International Application under 35 U.S.C. 371**

**If a timely submission to enter the national stage of an international application is compliant with the conditions of 35 U.S.C. 371 and other applicable requirements a Form PCT/DO/EO/903 indicating acceptance of the application as a national stage submission under 35 U.S.C. 371 will be issued in addition to the Filing Receipt, in due course.**

**New International Application Filed with the USPTO as a Receiving Office**

**If a new international application is being filed and the international application includes the necessary components for an international filing date (see PCT Article 11 and MPEP 1810), a Notification of the International Application Number and of the International Filing Date (Form PCT/RO/105) will be issued in due course, subject to prescriptions concerning national security, and the date shown on this Acknowledgement Receipt will establish the international filing date of the application.**

**HERSHKOVITZ & ASSOCIATES, LLC**  
**2845 DUKE STREET**  
**ALEXANDRIA, VA 22314**  
**703-370-4800**

Inventor: IKUDOME, Koichiro *et al.*  
 Reexamination Proceeding: 90/009,301  
 (based on U.S. Patent No. 6,779,118)  
 Reexamination Filed: December 17, 2008

Docket No.: R1341006  
 Confirmation No.: 6609  
 Art Unit: 3992  
 Examiner: RIMELL, Samuel

For: USER SPECIFIC AUTOMATIC DATA REDIRECTION SYSTEM

Mail Stop: Ex Parte Reexam  
 Central Reexamination Unit  
 COMMISSIONER FOR PATENTS  
 P.O. Box 1450  
 Alexandria, Virginia 22313-1450

Dear Commissioner:

Transmitted herewith are a **Personal Interview Request Under MPEP 2281** and a **Certificate of Service** in the above proceeding.

The fee has been calculated as shown below:

Claims After Amendment	No. of Claims Previously Paid	Present Extra	Small Entity		Large Entity	
			Rate	Fee	Rate	Fee
Total Claims:			x 26=	\$	X 52=	\$
Indep. Claims:			x 110=	\$	X 220=	\$
						\$
Total:				\$		\$

Please charge the above fees to a credit card as authorized.

The U.S. Patent and Trademark Office is hereby authorized to charge payment of the following fees associated with this communication or credit any overpayment to Deposit Account No. **50-2929**:

Any additional filing fees required under 37 C.F.R. 1.16.

Any patent application processing fees under 37 C.F.R. 1.17, including any required extension of time fees in any concurrent or future reply requiring a petition for extension of time for its timely submission (37 CFR 1.136)(a)(3).

September 1, 2010  
 Date



Abraham Hershkovitz  
 Reg. No. 45,294

Ed Garcia-Otero  
 Reg. No. 56,609

R1341006.A06; AH/EG/ea

08/10/2010 11:56

RECEIVED  
CENTRAL FAX CENTER

AUG 10 2010

FAX RECEIVED

=== COVER PAGE ===

AUG 10 2010

CENTRAL REEXAMINATION UNIT

FROM: HERSHKOVITZ & ASSOC.

FAX: 7033704809

TEL: 7033704800

COMMENT:

PAGE 17 \* RCVD AT 8/10/2010 11:24:50 AM [Eastern Daylight Time] \* SVR:USPTO-EFAX-6/10 \* DNIS:2738300 \* CSID:7033704809 \* DURATION (mm-ss):02-06

RECEIVED

CENTRAL FAX CENTER

AUG 10 2010

FAX RECEIVED

AUG 10 2010



HERSHKOVITZ & ASSOCIATES, LLC

2845 DUKE STREET  
ALEXANDRIA, VA 22314  
Tel: 703-370-4800  
Fax: 703-370-4809  
patent@hershkovitz.net

CENTRAL REEXAMINATION UNIT Fax

To: US PTO	From: Abe Hershkovitz
Fax: 571-273-8300	Date: November 4, 2009
Phone:	Pages: 6

Re: Ex Parte Reexamination Proceeding No.: 90/009,301; Docket No: R1341006

Urgent   
 For Review   
 Please Comment   
 Please Reply   
 Please Recycle

\*\*\*\*\***CONFIDENTIALITY NOTE**\*\*\*\*\*

The documents accompanying this facsimile transmission contain information from the patent firm of Hershkovitz & Associates which is confidential and/or privileged. The information is intended to be for the use of the individual or entity named on this transmission sheet. If you are not the intended recipient, be aware that any disclosure, copying, distribution or use of the contents of this facsimile information is prohibited. If you have received this facsimile in error, please notify us by telephone at (703) 370-4800 immediately so that we can arrange for the retrieval of the original documents at no cost to you.

\*\*\*\*\*

Dear Commissioner:

**PLEASE SEE ATTACHED**

HERSHKOVITZ & ASSOCIATES, LLC

R1341006.F01; AH/dj

RECEIVED  
CENTRAL FAX CENTER

AUG 10 2010

FAX RECEIVED

AUG 10 2010

CENTRAL REEXAMINATION UNIT



HERSHKOVITZ & ASSOCIATES, LLC  
2845 DUKE STREET  
ALEXANDRIA, VA 22314  
703-370-4800

In re application of : Ikudome KOICHIRO Docket No.: R1341006  
Proceeding No. : 90/009,301 Group Art Unit: 3992  
Filed : December 17, 2008 Examiner: Samuel G. RIMELL  
For : USER SPECIFIC AUTOMATIC DATA REDIRECTION SYSTEM

COMMISSIONER FOR PATENTS  
P.O. Box 1450  
Alexandria, Virginia 22313-1450

Dear Commissioner:

Transmitted herewith is a **Revocation of Power of Attorney and Patent Assignment Abstract of Title** in the above-captioned application.

The fee has been calculated as shown below:

Claims After Amendment	No. of Claims Previously Paid	Present Extra	Small Entity		Large Entity	
			Rate	Fee	Rate	Fee
Total Claims:			x 26=	\$	x 52=	\$
Indep. Claims:			x 110=	\$	x 220=	\$
Issue Fee			755=	\$	1,510=	\$
Publication Fee			300	\$	300	\$
Advance Copy				\$		\$
Total:				\$	Total:	0

Please charge my Deposit Account No. 50-2929 in the amount of \$ \_.

A Check in the amount of \$ \_ to cover the necessary fee is included.

Please charge the above fees to a credit card as authorized by EFS-Web.

The U.S. Patent and Trademark Office is hereby authorized to charge payment of the following fees associated with this communication or credit any overpayment to Deposit Account No. 50-2929:

Any additional issue fees required under 37 C.F.R. 1.18.

Any patent application processing fees under 37 C.F.R. 1.17, including any required extension of time fees in any concurrent or future reply requiring a petition for extension of time for its timely submission (37 CFR 1.136)(a)(3).

November 4, 2009  
Date

R1341006.A01: AH/dj

Abraham Hershkovitz  
Reg. No. 45,294

FAX RECEIVED

AUG 10 2010

Substitute Form PTO/SB/81 (01-09)

AUG 10 2010

CENTRAL REEXAMINATION UNIT

**POWER OF ATTORNEY  
OR  
REVOCATION OF POWER OF ATTORNEY  
WITH A NEW POWER OF ATTORNEY  
AND  
CHANGE OF CORRESPONDENCE ADDRESS**

*I hereby revoke all previous powers of attorney given in the patent(s) and/or application(s) identified herein.*

A Power of Attorney is submitted herewith.

**OR**

I hereby appoint the practitioners associated with the Customer Number: 000040401 for the patent(s)/application(s) identified herein.

Practitioner Under Customer No.: Abraham Hershkovitz, Reg. No. 45,294

Please change the correspondence address for the patent(s)/application(s) identified below to:

**CORRESPONDENCE ADDRESS**

Customer Number: 000040401 OR  Correspondence address below

Name		<b>HERSHKOVITZ &amp; ASSOCIATES, LLC</b>			
Address					
City		State		Zip Code	
Country	Email	Telephone	Facsimile		
	<b>patent@hershkovitz.net</b>	<b>703-370-4800</b>			

*I am the:*

Applicant/Inventor

Assignee of record of the entire interest in the patent(s)/application(s) identified herein. See 37 CFR §3.71.

Statement under 37 CFR 3.73(b):

The documentary evidence of a chain of title from the original owner to the Assignee, as recorded in the Assignment records of the Office, is attached hereto, for the patent(s)/application(s) identified herein:

Application Number	Filing Date	Patent Number	Issue Date
<b>90/009,301</b>	<b>12/17/2008</b>		
		<b>6,779,118</b>	<b>08/17/2004</b>

**FAX RECEIVED**  
AUG 10 2010

Substitute Form PTO/SB/81 (01-09) - Page 2

CENTRAL REEXAMINATION UNIT

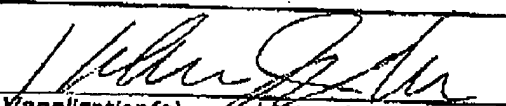
<b>SIGNATURE OF APPLICANT(S) OR ASSIGNEE OF RECORD</b> <i>The individual(s) whose signature(s) is/are supplied below is/are the Applicant(s)/Inventor(s), or is authorized to act on behalf of Assignee, in the patent(s)/application(s) identified herein.</i>			
<i>Printed Name of Signatory (if acting for Assignee)</i>	<b>Koichiro Ikudome</b> on behalf of <b>LINKSMART WIRELESS TECHNOLOGY, LLC.</b>		
<i>Title (if acting for Assignee)</i>			
<i>Signature</i>		<i>Date</i>	10/30/09

Any additional patent(s)/application(s), or additional signature(s) of Applicant(s)/Inventor(s), are submitted on the attached page(s).

Total Additional Pages Attached: \_\_\_\_\_



RECEIVED  
CENTRAL FAX CENTER

AUG 10 2010

FAX RECEIVED

AUG 10 2010

CENTRAL REEXAMINATION UNIT



HERSHKOVITZ & ASSOCIATES, LLC  
2845 DUKE STREET  
ALEXANDRIA, VA 22314  
703-370-4800

In re application of : Ikudome KOICHIRO Docket No.: R1341006  
Proceeding No. : 90/009,301 Group Art Unit: 3992  
Filed : December 17, 2008 Examiner: Samuel G. RIMELL  
For : USER SPECIFIC AUTOMATIC DATA REDIRECTION SYSTEM

COMMISSIONER FOR PATENTS  
P.O. Box 1450  
Alexandria, Virginia 22313-1450

Dear Commissioner:

Transmitted herewith is a **Revocation of Power of Attorney and Patent Assignment Abstract of Title** in the above-captioned application.

The fee has been calculated as shown below:

Claims After Amendment	No. of Claims Previously Paid	Present Extra	Small Entity		Large Entity	
			Rate	Fee	Rate	Fee
Total Claims:			x 26=	\$	x 52=	\$
Indep. Claims:			x 110=	\$	x 220=	\$
Issue Fee			755=	\$	1,510=	\$
Publication Fee			300	\$	300	\$
Advance Copy				\$		\$
			Total:	\$	Total:	0

     Please charge my Deposit Account No. 50-2929 in the amount of \$     .

     A Check in the amount of \$      to cover the necessary fee is included.

Please charge the above fees to a credit card as authorized by EFS-Web.

The U.S. Patent and Trademark Office is hereby authorized to charge payment of the following fees associated with this communication or credit any overpayment to Deposit Account No. 50-2929:

- Any additional issue fees required under 37 C.F.R. 1.18.
- Any patent application processing fees under 37 C.F.R. 1.17, including any required extension of time fees in any concurrent or future reply requiring a petition for extension of time for its timely submission (37 CFR 1.136)(a)(3).

November 4, 2009  
Date

R1341006.A01: AH/dj

Abraham Hershkovitz  
Reg. No. 45,294



United States Patent and Trademark Office

Home | Site Index | Search | Guides | Contacts | eBusiness | eBiz alerts | News | Help



Assignments on the Web > Patent Query

Patent Assignment Abstract of Title

**NOTE: Results display only for issued patents and published applications. For pending or abandoned applications please consult USPTO staff.**

Total Assignments: 2

Patent #: 6779118

Issue Dt: 08/17/2004

Application #: 09295966

Filing Dt: 04/21/1999

Inventors: KOICHIRO IKUDOME, MOON TAI YEUNG

Title: USER SPECIFIC AUTOMATIC DATA REDIRECTION SYSTEM

Assignment: 1

Reel/Frame: 010062/0040

Recorded: 06/29/1999

Pages: 3

Conveyance: ASSIGNMENT OF ASSIGNORS INTEREST (SEE DOCUMENT FOR DETAILS).

Assignors: IKUDOME, KOICHIRO

Exec Dt: 06/15/1999

YEUNG, MOON TAI

Exec Dt: 06/15/1999

Assignee: AURIC WEB SYSTEMS

3452 EAST FOOTHILL BOULEVARD, SUITE 300

PASADENA, CALIFORNIA 91107

Correspondent: CHRISTIE, PARKER & HALE, LLP

WESLEY W. MONROE

P.O. BOX 7068

PASADENA, CA 91109-7068

Assignment: 2

Reel/Frame: 021185/0416

Recorded: 07/02/2008

Pages: 12

Conveyance: ASSIGNMENT OF ASSIGNORS INTEREST (SEE DOCUMENT FOR DETAILS).

Assignor: AJRIQ SYSTEMS, INC.

Exec Dt: 06/25/2008

Assignee: LINKSMART WIRELESS TECHNOLOGY, LLC

3452 E. FOOTHILL BLVD.

SUITE 320

PASADENA, CALIFORNIA 91107

Correspondent: CLARK D. GROSS

12424 WILSHIRE BOULEVARD, STE. 1200

LOS ANGELES, CA 90025

PAGE 6/7 \* RCVD AT 8/10/2010 11:24:50 AM [Eastern Daylight Time] \* SVR:USPTO-EF-XRF-6/10 \* DNS:2738300 \* CSID:7033704809 \* DURATION (mm-ss):02-06

08/10/2010 11:56

7033704809

HERSHKOVITZ & ASSOC.

PAGE 05/06

If you have any comments or questions concerning the data displayed, contact PRD / Assignments at 571-272-3333.  
Web interface last modified: October 18, 2008 v.2.0.2

Search Results as of: 10/28/2009 04:32 PM

| HOME | INDEX | SEARCH | eBUSINESS | CONTACT US | PRIVACY STATEMENT

PAGE 77 \* RCVD AT 8/10/2010 11:24:50 AM [Eastern Daylight Time] \* SVR:USPTO-EF-XRF-6/10 \* DNS:2738300 \* CSID:7033704809 \* DURATION (mm-ss):02:06

08/10/2010 11:56 7033704809

HERSHKOVITZ & ASSOC.

PAGE 06/06



UNITED STATES PATENT AND TRADEMARK OFFICE

UNITED STATES DEPARTMENT OF COMMERCE  
United States Patent and Trademark Office  
Address: COMMISSIONER FOR PATENTS  
P.O. Box 1450  
Alexandria, Virginia 22313-1450  
www.uspto.gov

APPLICATION NO.	FILING DATE	FIRST NAMED INVENTOR	ATTORNEY DOCKET NO.	CONFIRMATION NO.
90/009,301	12/17/2008	6,779,118 B1	62986/A522/WWM	6609

23363            7590            08/02/2010  
CHRISTIE, PARKER & HALE, LLP  
PO BOX 7068  
PASADENA, CA 91109-7068

EXAMINER

ART UNIT            PAPER NUMBER

DATE MAILED: 08/02/2010

Please find below and/or attached an Office communication concerning this application or proceeding.



**DO NOT USE IN PALM PRINTER**

(THIRD PARTY REQUESTER'S CORRESPONDENCE ADDRESS)

Jerry Turner Sewell  
P.O. Box 10999  
Newport Beach, CA 92658-5015

**MAILED**

**AUG 02 2010**

**CENTRAL REEXAMINATION UNIT**

## **EX PARTE REEXAMINATION COMMUNICATION TRANSMITTAL FORM**

REEXAMINATION CONTROL NO. 90/009,301.

PATENT NO. 6,779,118 B1 ET.

ART UNIT 3992.

Enclosed is a copy of the latest communication from the United States Patent and Trademark Office in the above identified *ex parte* reexamination proceeding (37 CFR 1.550(f)).

Where this copy is supplied after the reply by requester, 37 CFR 1.535, or the time for filing a reply has passed, no submission on behalf of the *ex parte* reexamination requester will be acknowledged or considered (37 CFR 1.550(g)).

<b>Office Action in Ex Parte Reexamination</b>	Control No. 90/009,301	Patent Under Reexamination 6,779,118 B1 ET	
	Examiner Sam Rimell	Art Unit 3992	

-- The MAILING DATE of this communication appears on the cover sheet with the correspondence address --

- a  Responsive to the communication(s) filed on 14 November 2009.      b  This action is made FINAL.  
c  A statement under 37 CFR 1.530 has not been received from the patent owner.

A shortened statutory period for response to this action is set to expire 2 month(s) from the mailing date of this letter. Failure to respond within the period for response will result in termination of the proceeding and issuance of an *ex parte* reexamination certificate in accordance with this action. 37 CFR 1.550(d). **EXTENSIONS OF TIME ARE GOVERNED BY 37 CFR 1.550(c)**. If the period for response specified above is less than thirty (30) days, a response within the statutory minimum of thirty (30) days will be considered timely.

**Part I THE FOLLOWING ATTACHMENT(S) ARE PART OF THIS ACTION:**

1.  Notice of References Cited by Examiner, PTO-892.      3.  Interview Summary, PTO-474.  
2.  Information Disclosure Statement, PTO/SB/08.      4.  \_\_\_\_\_.

**Part II SUMMARY OF ACTION**

- 1a.  Claims 1-47 are subject to reexamination.  
1b.  Claims \_\_\_\_\_ are not subject to reexamination.  
2.  Claims \_\_\_\_\_ have been canceled in the present reexamination proceeding.  
3.  Claims \_\_\_\_\_ are patentable and/or confirmed.  
4.  Claims 1-47 are rejected.  
5.  Claims \_\_\_\_\_ are objected to.  
6.  The drawings, filed on \_\_\_\_\_ are acceptable.  
7.  The proposed drawing correction, filed on \_\_\_\_\_ has been (7a)  approved (7b)  disapproved.  
8.  Acknowledgment is made of the priority claim under 35 U.S.C. § 119(a)-(d) or (f).  
a)  All b)  Some\* c)  None of the certified copies have  
1  been received.  
2  not been received.  
3  been filed in Application No. \_\_\_\_\_.  
4  been filed in reexamination Control No. \_\_\_\_\_.  
5  been received by the International Bureau in PCT application No. \_\_\_\_\_.  
\* See the attached detailed Office action for a list of the certified copies not received.  
9.  Since the proceeding appears to be in condition for issuance of an *ex parte* reexamination certificate except for formal matters, prosecution as to the merits is closed in accordance with the practice under *Ex parte* Quayle, 1935 C.D. 11, 453 O.G. 213.  
10.  Other: \_\_\_\_\_

cc: Requester (if third party requester)

**EX PARTE REEXAMINATION FINAL OFFICE ACTION**

This is a reexamination of U.S. Patent 6,779,118. Claims 1-27 are pending were previously pending. Claims 15, 18, 21, 26 and 27 have been amended. Claims 28-47 have been added. Accordingly, claims 1-47 are pending and subject to reexamination.

**Amendment by Patent Owner**

Patent owner submitted a response with amendments and remarks on November 14, 2009, and a supplemental response with amendments and remarks on May 24, 2010. Since the supplemental response of May 24, 2010 does not comply with the requirements of 37 CFR 1.111(B)(2), this response has not been approved for entry. The response of November 14, 2009 has been entered and is the response which is treated in this action.

**Information Submissions**

Patent owner submitted information disclosure statements on November 16, 2009 and May 13, 2010. Copies of the Forms PTO/SB08 are attached to this action. Note MPEP 2256, which states:

*“Where patents, publications, and other such items of information are submitted by a party (patent owner or requester) in compliance with the requirements of the rules, the requisite degree of consideration to be given to such information will be normally limited by the degree to which the party filing the information citation has explained the content and relevance of the information. The initials of the examiner placed adjacent to the citations on the form PTO /SB /08A and 08B or its equivalent, without an indication to the contrary in the record, do not signify*

Art Unit: 3992

*that the information has been considered by the examiner any further than to the extent noted above.”*

For those prior art references for which the examiner has placed initials next to the citation, the consideration is made in accordance with the above policy. For those references which are not initialed by the examiner, the form SB08 is annotated with an explanation as to why the particular reference is not initialed.

### **Rejections under 35 USC 112**

The following is a quotation of the second paragraph of 35 U.S.C. 112:

The specification shall conclude with one or more claims particularly pointing out and distinctly claiming the subject matter which the applicant regards as his invention.

Newly added claims 28-31, 33-36 and 38-47 are rejected under 35 U.S.C. 112, second paragraph, as being indefinite for failing to particularly point out and distinctly claim the subject matter which applicant regards as the invention.

Claims 28-31: The phrase “the individual rule set” lacks antecedent basis with respect to claim 1, from which they depend.

Claims 33-36: The phrase “the individual rule set” lacks antecedent basis with respect to claim 8, from which they depend.

Claims 38-41: The phrase “the individual rule set” lacks antecedent basis with respect to claim 15, from which they depend.

Claim 42: The phrase “the individualized rule set” lacks antecedent basis with respect to claim 15, from which it depends.

Claims 43-46: The phrase “the individual rule set” lacks antecedent basis with respect to claim 25 from which they depend.



Art Unit: 3992

Claim 47: The phrase “the individualized rule set” lacks antecedent basis with respect to claim 25 from which it depends.

**Rejections under 35 USC 103**

The following is a quotation of 35 U.S.C. 103(a) which forms the basis for all obviousness rejections set forth in this Office action:

(a) A patent may not be obtained though the invention is not identically disclosed or described as set forth in section 102 of this title, if the differences between the subject matter sought to be patented and the prior art are such that the subject matter as a whole would have been obvious at the time the invention was made to a person having ordinary skill in the art to which said subject matter pertains. Patentability shall not be negated by the manner in which the invention was made.

Claims 1-31, 33-36, 38-41 and 43-46 are rejected under 35 U.S.C. 103(a) as being unpatentable over He et al (U.S. Patent 6,088,451) in view of Zenchelsky et al (U.S. Patent 6,233,686).

The reference to He et al was filed June 28, 1996, making the reference available as prior art under 35 USC 102(e). Note MPEP 2244 which states:

*“The examiner can find “a substantial new question of patentability” based upon the prior art patents or printed publications relied on in the request, a combination of the prior art relied on in the request and other prior art found elsewhere, or based entirely on different patents or printed publications.”*

The reference to He et al raises substantial new questions of patentability due to its teachings of dial up servers, authentications servers and databases with user ID entries associated with rules, as provided in the detailed analysis below. The reference to He et al was not cited during the prosecution history of U.S. Patent 6,779,118 and is available for application in this action.

The reference to Zenchelsky et al was previously identified in the order of February 27, 2009 as being available as prior art and of raising substantial new questions of patentability.

**Claim 1: A system (He et al; FIG 10) comprising:**

**a database (He et al; FIG 10, database 210) with entries correlating each of a plurality of user IDs with an individualized rule set (He et al; col. 16, lines 54-57 teach “user ID”, col. 16, lines 61-67 teach “user credentials” corresponding to a rule set)**

**a dial-up network server (He et al; FIG 10, dial up server 1002) that receives user IDs from users' computers (He et al; col. 17, lines 57-58, “The request message contains the user identifier”)**

**a redirection server (He et al; credential server 204) connected to the dial-up network server and a public network (He et al; FIG 10, server 204 interconnects to dial up server 1002 via the public network 106), and**

**an authentication accounting server (He et al; authentication server 202) connected to the database, the dial-up network server and the redirection server (He et al; FIG 10, server 202 interconnects to dial up server 1002 via the public network 106 and redirection server 204 via public network 106);**

**wherein the dial-up network server communicates a first user ID for one of the users' computers (He et al; col. 31, lines 1-9) and**

**a temporarily assigned network address for the first user ID to the authentication accounting server (Zenchelsky et al; col. 1, lines 30-35 establish well known nature of assigning temporary IP address to user at session login; col. 1, lines 60-64 establish well known nature of having source and destination address encoded into communication packets as**

Art Unit: 3992

necessary to facilitate communication between source and destination. It would have been obvious to one of ordinary skill in the art to modify He et al; so to provide temporary IP address to a user node and additionally encode communications packets with source and destination address as necessarily to facilitate communication through a switched packet network as taught by Zenchelsky et al);

**wherein the authentication accounting server accesses the database and communicates the individualized rule set that correlates with the first user ID and the temporarily assigned network address (He et al; col. 17, lines 61-66) to the redirection server (credentials passed from database 210 to credential server 204; He et al; col. 17, lines 67 through col. 18, line 1 and col. 19, lines 2-7); and wherein data directed toward the public network from the one of the users' computers (He et al; col. 18, lines 24-30) are processed by the redirection server according to the individualized rule set (He et al; col. 19, lines 2-8, the user credentials are individualized rule set).**

**Claim 2: The system of claim 1, wherein the redirection server (He et al; credential server 204) further provides control over a plurality of data to and from the users' computers as a function of the individualized rule set (He et al; col. 19, lines 2-11, credential server 204 retrieves user credentials which correspond to an individualized rule set that controls access. Also see He et al at col. 16, lines 61-67 for detail of user credentials).**

**Claim 3: The system of claim 1, wherein the redirection server (He et al; credential server 204) further blocks the data to and from the users' computers as a function of the individualized rule set (He et al; credential server 204 retrieves user credentials which correspond to an individualized rule set that controls access to network elements 104.**

Art Unit: 3992

Conversely, network elements 104 which cannot be accessed in accordance with the user credentials are inherently blocked from access. Also see He et al at col. 19, lines 24-31 which describe the scenario where the user access ticket is actively voided, corresponding to a blocking action).

**Claim 4: The system of claim 1, wherein the redirection server further allows the data to and from the users' computers as a function of the individualized rule set (He et al; col. 19, lines 2-11, credential server 204 retrieves user credentials which correspond to an individualized rule set that controls access to network elements 104. Data exchange occurs between accessed network elements 104).**

**Claim 5: The system of claim 1, wherein the redirection server further redirects the data to and from the users' computers as a function of the individualized rule set (He et al; col. 19, lines 2-11, credential server 204 retrieves user credentials which correspond to an individualized rule set that controls access to network elements 104. Data access to network elements 104 corresponds to data moving to and from users' computers).**

**Claim 6: The system of claim 1, wherein the redirection server further redirects the data from the users' computers to multiple destinations as a function of the individualized rule set (He et al; FIG 10, plural network elements 104 represent multiple potential destinations for interaction based on particular user credentials).**

**Claim 7: The system of claim 1, wherein the database entries for a plurality of the plurality of users' IDs are correlated with a common individualized rule set (He et al; col. 16, line 54 through line 68. Each database entry (record) includes a user ID accompanied by user credentials. The user credentials are the individualized rules for a particular user).**

Art Unit: 3992

**Claim 8:** In a system (He et al; FIG 10) comprising a database (He et al; FIG 10, database 210) with entries correlating each of a plurality of user IDs with an individualized rule set (He et al; col. 16, lines 54-57 teach “user ID”, col. 16, lines 61-67 teach “user credentials” corresponding to a rule set); a dial up network server (He et al; FIG 10, dial up server 1002) that receives user IDs from users' computers (He et al; col. 17, lines 57-58, “The request message contains the user identifier”); a redirection server (He et al; credential server 204) connected to the dial-up network server and a public network (He et al; FIG 10, server 204 interconnects to dial up server 1002 via the public network 106), and an authentication accounting server (He et al; authentication server 202) connected to the database, the dial-up network server and the redirection server (He et al; FIG 10, server 202 interconnects to dial up server 1002 via the public network 106 and redirection server 204 via public network 106); the method comprising the steps of:

communicating a first user ID for one of the users' computers (He et al; col. 31, lines 1-9) and a temporarily assigned network address for the first user ID from the dial-up network server to the authentication accounting server (Zenchelsky et al; col. 1, lines 30-35 establish well known nature of assigning temporary IP address to user at session login; col. 1, lines 60-64 establish well known nature of having source and destination address encoded into communication packets as necessary to facilitate communication between source and destination. It would have been obvious to one of ordinary skill in the art to modify He et al; so to provide temporary IP address to a user node and additionally encode communications packets with source and destination address as necessarily to facilitate communication through a switched packet network as taught by Zenchelsky et al);

Art Unit: 3992

communicating the individualized rule set that correlates with the first user ID and the temporarily assigned network address (He et al; col. 17, lines 61-66) to the redirection server from the authentication accounting server (He et al; col. 17, line 67 through col. 18, line 1. The authentication accounting creates a ticket which gets passed by the user to the credential server 204 allowing access to the user credentials that define rules); and

processing data directed toward the public network from the one of the users' computers according to the individualized rule set (He et al; col. 19, lines 2-8, the user credentials are individualized rule set).

Claim 9: The method of claim 8, further including the step of controlling a plurality of data to and from the users' computers as a function of the individualized rule set (He et al; col. 19, lines 2-11, credential server 204 retrieves user credentials which correspond to an individualized rule set that controls access. Also see He et al at col 16, lines 61-67 for detail of user credentials).

Claim 10: The method of claim 8, further including the step of blocking the data to and from the users' computers as a function of the individualized rule set (He et al; credential server 204 retrieves user credentials which correspond to an individualized rule set that controls access to network elements 104. Conversely, network elements 104 which cannot be accessed in accordance with the user credentials are inherently blocked from access. Also see He et al at col. 19, lines 24-31 which describe the scenario where the user access ticket is actively voided, corresponding to a blocking action).

Claim 11: The method of claim 8, further including the step of allowing the data to and from the users' computers as a function of the individualized rule set. (He et al; col.

Art Unit: 3992

19, lines 2-11, credential server 204 retrieves user credentials which correspond to an individualized rule set that controls access to network elements 104. Data exchange occurs between accessed network elements 104).

**Claim 12: The method of claim 8, further including the step of redirecting the data to and from the users' computers as a function of the individualized rule set (He et al; col. 19, lines 2-11, credential server 204 retrieves user credentials which correspond to an individualized rule set that controls access to network elements 104. Data access to network elements 104 corresponds to data moving to and from users' computers).**

**Claim 13: The method of claim 8, further including the step of redirecting the data from the users' computers to multiple destinations a function of the individualized rule set (He et al; FIG 10, plural network elements 104 represent multiple potential destinations for interaction based on particular user credentials).**

**Claim 14: The method of claim 8, further including the step of creating database entries for a plurality of the plurality of users' IDs, the plurality of users' ID further being correlated with a common individualized rule set (He et al; col. 16, line 54 through line 68. Each database entry (record) includes a user ID accompanied by user credentials. The user credentials are the individualized rules for a particular user).**

**Claim 15: A system (He et al; FIG 10) comprising: a redirection server (He et al; FIG 10, credential server 204) programmed with a user's rule set (He et al; col. 19, line 3, credential server retrieves user credentials, which correspond to a rule set. When the credential server 204 retrieves the user credentials, it is programmed with that particular rule set. Alternatively, providing access by the credential server to the database containing the rule set**

Art Unit: 3992

can constitute being programmed with the rule set) **correlated to a temporarily assigned network address** (Zenchelsky et al; col. 1, lines 30-35 establish well known nature of assigning temporary IP address to user at session login; col. 1, lines 60-64 establish well known nature of having source and destination address encoded into communication packets as necessary to facilitate communication between source and destination. It would have been obvious to one of ordinary skill in the art to modify He et al; so to provide temporary IP address to a user node and additionally encode data communication packets with source and destination address as necessarily to facilitate communication through a switched packet network as taught by Zenchelsky et al);

**wherein the rule set contains at least one of a plurality of functions used to control data passing between the user and a public network** (He et al; col. 16, lines 61-67, credentials define plural functions. Also, note the additional functions at col. 17, lines 6-27 attributed to the overall server system 208);

**wherein the redirection server is configured to allow automated modification of at least a portion of the rule set correlated to the temporarily assigned network address** (He et al; col. 17, lines 19-21, database tool associated with server system 208 can create or delete user accounts) **and wherein the redirection server is configured to allow automated modification of at least a portion of the rule set** (He et al; col 17, lines 19-21, any of the user account information can be modified) **as a function of some combination of time, data transmitted to or from the user, or location the user attempts to access** (He et al; col 17, line 13 attributes a "lifetime" to the authentication. Since any portion of the user account can be modified, the length of the "lifetime" can be modified as well. Alternatively, since the



Art Unit: 3992

modification can be made at any time, the modification can occur “as a function of time”. The “data transmitted” and “location” are optional recitations, and thus do not carry patentable weight in the current claim (MPEP 2106, Section C). It is also noted that the phrase “some combination” does not necessarily require two or more of the elements to be present. For example, a subcombination could be a combination that invokes only one of the elements recited).

**Claim 16: The system of claim 15, wherein the redirection server is configured to allow modification of at least a portion of the rule set as a function of time (He et al; col 17, line 13 attributes a “lifetime” to the authentication. Since any portion of the user account can be modified, the length of the “lifetime” can be modified).**

**Claim 17: The system of claim 15, wherein the redirection server is configured to allow modification of at least a portion of the rule set as a function of the data transmitted to or from the user (This feature is optionally recited in claim 15, and can be interpreted as an optional recitation in a claim dependent on claim 15. Such optional recitations do not carry patentable weight (MPEP 2106, Section C). Nonetheless, He et al at col 17, lines 19-21 define data input being supplied by a system administrator which can modify the rule set, for example, by deleting it. The system administrator is one of the system users).**

**Claim 18: The system of claim 15, wherein the redirection server is configured to allow modification of at least a portion of the rule set as a function of the location or locations the user attempts to access (This feature is optionally recited in claim 15, and can be interpreted as an optional recitation in a claim dependent on claim 15. Such optional recitations do not carry patentable weight (MPEP 2106, Section C). Nonetheless, He et al at col 17, lines**

Art Unit: 3992

19-21 define data input being supplied by a system administrator which can modify the rule set, for example, by deleting it. The location of the administrator is the location at which modification is permitted).

**Claim 19: The system of claim 15, wherein the redirection server is configured to allow the removal or reinstatement of at least a portion of the rule set as a function of time** (He et al; col 17, lines 19-21, the administrator is allowed to create or delete (i.e. remove or reinstate) any portion of the user account. Any actions of administrator inherently occur over some given period time).

**Claim 20: The system of claim 15, wherein the redirection server is configured to allow the removal or reinstatement of at least a portion of the rule set as a function of the data transmitted to or from the user.** (This feature is optionally recited in claim 15, and can be interpreted as an optional recitation in a claim dependent on claim 15. Such optional recitations do not carry patentable weight (MPEP 2106, Section C). Nonetheless, He et al at col 17, lines 19-21 define data input being supplied by a system administrator which can create or delete (i.e. remove or reinstate) any portion of the user account. The system administrator is one of the system users).

**Claim 21: The system of claim 15, wherein the redirection server is configured to allow the removal or reinstatement of at least a portion of the rule set as a function of the location or locations the user attempts to access** (This feature is optionally recited in claim 15, and can be interpreted as an optional recitation in a claim dependent on claim 15. Such optional recitations do not carry patentable weight (MPEP 2106, Section C). Nonetheless, He et al at col 17, lines 19-21 define data input being supplied by a system administrator which can

Art Unit: 3992

create or delete (i.e. remove or reinstate) any portion of the user account. The location of the administrator is the location at which modification is permitted).

**Claim 22: The system of claim 15, wherein the redirection server is configured to allow the removal or reinstatement of at least a portion of the rule set as a function of some combination of time, data transmitted to or from the user, or location or locations the user access. (He et al; col 17, lines 19-21, the administrator is allowed to create or delete (i.e. remove or reinstate) any portion of the user account. Any actions of administrator inherently occur over some given period time. He et al at col 17, lines 19-21 define data input being supplied by a system administrator which can create or delete (i.e. remove or reinstate) any portion of the user account. He et al at col 17, lines 19-21 define data input being supplied by a system administrator which can create or delete (i.e. remove or reinstate) any portion of the user account. The location of the administrator is the location at which modification is permitted).**

**Claim 23: The system of claim 15, wherein the redirection server (He et al; credential server 204) has a user side (He et al; FIG 10, any one of or both of the dial up server 1002 and dial up access network 1004) that is connected to a computer (He et al; FIG 10, user element 102) using the temporarily assigned network address (Zenchelsky et al; col. 1, lines 29-35) and a network side (He et al; FIG 10, any one of or both of the interconnection network 106 and network elements 104) connected to a computer network (He et al; interconnection network 106) and wherein the computer (He et al; FIG 10, user element 102) using the temporarily assigned network address (Zenchelsky et al; col. 1, lines 29-35) is connected to**

Art Unit: 3992

the computer network through the redirection server (He et al; FIG 10, computer 102 is connected to the interconnection network 106 via the credential server 204).

**Claim 24: The system of claim 23 wherein instructions to the redirection server to modify the rule set are received by one or more of the user side of the redirection server and the network side of the redirection server (He et al; col 17, lines 19-21 refer to a network administrator modifying any portion of a user account. He et al at FIG 10 illustrates that users presenting input to the network (a network administrator is also a user). Accordingly, instructions transmitted from a network administrator originate at terminal 102 and proceed through the user side elements 1002, 1004 as well as the network side element 106).**

**Claim 25: In a system (He et al; FIG 10) comprising a redirection server (He et al; FIG 10, credential server 204) containing a user's rule set (He et al; col. 19, line 3, credential server retrieves user credentials, which correspond to a rule set. When the credential server 204 retrieves the user credentials, it contains that particular rule set. Alternatively, providing access by the credential server to the database containing the rule set can constitute the server containing the rule set as a result of direct access) correlated to a temporarily assigned network address (Zenchelsky et al; col. 1, lines 30-35 establish well known nature of assigning temporary IP address to user at session login; col. 1, lines 60-64 establish well known nature of having source and destination address encoded into communication packets as necessary to facilitate communication between source and destination. It would have been obvious to one of ordinary skill in the art to modify He et al; so to provide temporary IP address to a user node and additionally encode data communication packets with source and destination address as necessarily to facilitate communication through a switched packet network as taught by**

Art Unit: 3992

Zenchelsky et al); wherein the user's rule set contains at least one of a plurality of functions used to control data passing between the user and a public network (He et al; col. 16, lines 61-67, credentials define plural functions. Also, note the additional functions at col. 17, lines 6-27 attributed to the overall server system 208); **the method comprising the step of:**

**modifying at least a portion of the user's rule set while the user's rule set remains correlated to the temporarily assigned network address in the redirection server (He et al; col. 17, lines 19-21); and wherein the redirection server has a user side (He et al; FIG 10, any one of or both of the dial up server 1002 and dial up access network 1004) that is connected to a computer (He et al; FIG 10, user element 102) using the temporarily assigned network address (Zenchelsky et al; col. 1, lines 29-35) and a network address and a network side (He et al; FIG 10, any one of or both of the interconnection network 106 and network elements 104) connected to a computer network (He et al; interconnection network 106. *Note that a computer address is not a physical object, and thus is not physically connected to anything*) and wherein the computer using the temporarily assigned network address is connected to the computer network through the redirection server (He et al; FIG 10, computer 102 is connected to the interconnection network 106 via the credential server 204) and the method further includes the step of receiving instructions by the redirection server to modify at least a portion of the user's rule set through one or more of the user side of the redirection server and the network side of the redirection server (He et al; col 17, lines 19-21 refer to a network administrator modifying any portion of a user account. He et al at FIG 10 illustrates that users presenting input to the network (a network administrator is also a user). Accordingly, instructions transmitted from a network administrator originate at**

Art Unit: 3992

terminal 102 and proceed through the user side elements 1002, 1004 as well as the network side element 106).

**Claim 26: The method of claim 25, further including the step of modifying at least a portion of the user's rule set (He et al; col 17, lines 19-21, the administrator is allowed to create or delete any portion of the user account) as a function of one or more of: time (any actions of administrator inherently occur over some given period time), data transmitted to or from the user (He et al at col 17, lines 19-21 define data input being supplied by a system administrator which can create or delete any portion of the user account), and location or locations the user attempts to access (the location of the administrator is the location at which modification is permitted).**

**Claim 27: The method of claim 25, further including the step of removing or reinstating at least a portion of the user's rule set (He et al; col 17, lines 19-21, the administrator is allowed to create or delete (i.e. remove or reinstate) any portion of the user account) as a function of one or more of: time (any actions of administrator inherently occur over some given period time), the data transmitted to or from the user (He et al at col 17, lines 19-21 define data input being supplied by a system administrator which can create or delete (i.e. remove or reinstate) any portion of the user account), and a location or locations the user attempts to access (the location of the administrator is the location at which modification is permitted).**

**Claim 28: The system of claim 1, wherein the individual rule set includes at least one rule as a function of a type of IP (Internet Protocol) service (A "rule" does not change the structure of a physical system, and also does not change the functionality of the system**

Art Unit: 3992

unless the rule is executed. Since this rule imparts neither structure nor new functionality (it is not executed or invoked) it imparts no additional patentable weight (*In re Ngai* 367 F.3d 1336, USPQ2d 1862 (Fed. Cir. 2004)).

**Claim 29: The system of claim 1, wherein the individual rule set includes an initial temporary rule set and a standard rule set, and wherein the redirection server is configured to utilize the temporary rule set for an initial period of time and to thereafter utilize the standard rule set (Each “user credential” of He et al corresponds to a rule. Since multiple user credentials exist in the system of He et al, invoking a first user’s credentials and subsequently invoking a second user’s credentials corresponds to utilizing a temporary rule set and then utilizing a standard rule set).**

**Claim 30: The system of claim 1, wherein the individual rule set includes at least one rule allowing access based on a request type and a destination address (A “rule” does not change the structure of a physical system, and also does not change the functionality of the system unless the rule is executed. Since this rule imparts neither structure nor new functionality (it is not executed or invoked) it imparts no additional patentable weight (*In re Ngai* 367 F.3d 1336, USPQ2d 1862 (Fed. Cir. 2004)).**

**Claim 31: The system of claim 1, wherein the individual rule set includes at least one rule redirecting the data to a new destination address based on a request type and an attempted destination address (A “rule” does not change the structure of a physical system, and also does not change the functionality of the system unless the rule is executed. Since this rule imparts neither structure nor new functionality (it is not executed or invoked) it imparts no additional patentable weight (*In re Ngai* 367 F.3d 1336, USPQ2d 1862 (Fed. Cir. 2004)).**

**Claim 33: The method of claim 8, wherein the individual rule set includes at least one rule as a function of a type of IP (Internet Protocol) service (A “rule” does not change the structure of a physical system, and additionally does not affect method steps performed unless the rule is invoked. Since this rule imparts neither structure nor any additional method steps (it is not executed or invoked) it imparts no additional patentable weight (*In re Ngai* 367 F.3d 1336, USPQ2d 1862 (Fed. Cir. 2004)).**

**Claim 34: The method of claim 8, wherein the individual rule set includes an initial temporary rule set and a standard rule set, and wherein the redirection server is configured to utilize the temporary rule set for an initial period of time and to thereafter utilize the standard rule set (Each “user credential” of He et al corresponds to a rule. Since multiple user credentials exist in the system of He et al, invoking a first user’s credentials and subsequently invoking a second user’s credentials corresponds to utilizing a temporary rule set and then utilizing a standard rule set).**

**Claim 35: The method of claim 8, wherein the individual rule set includes at least one rule allowing access based on a request type and a destination address (A “rule” does not change the structure of a physical system, and additionally does not affect method steps performed unless the rule is invoked. Since this rule imparts neither structure nor any additional method steps (it is not executed or invoked) it imparts no additional patentable weight (*In re Ngai* 367 F.3d 1336, USPQ2d 1862 (Fed. Cir. 2004)).**

**Claim 36: The method of claim 8, wherein the individual rule set includes at least one rule redirecting the data to a new destination address based on a request type and an attempted destination address (A “rule” does not change the structure of a physical system,**



Art Unit: 3992

and additionally does not affect method steps performed unless the rule is invoked. Since this rule imparts neither structure nor any additional method steps (it is not executed or invoked) it imparts no additional patentable weight (*In re Ngai* 367 F.3d 1336, USPQ2d 1862 (Fed. Cir. 2004)).

**Claim 38: The system of claim 15, wherein the individual rule set includes at least one rule as a function of a type of IP (Internet Protocol) service (A “rule” does not change the structure of a physical system, and also does not change the functionality of the system unless the rule is executed. Since this rule imparts neither structure nor new functionality (it is not executed or invoked) it imparts no additional patentable weight (*In re Ngai* 367 F.3d 1336, USPQ2d 1862 (Fed. Cir. 2004)).**

**Claim 39: The system of claim 15, wherein the individual rule set includes an initial temporary rule set and a standard rule set, and wherein the redirection server is configured to utilize the temporary rule set for an initial period of time and to thereafter utilize the standard rule set (Each “user credential” of He et al corresponds to a rule. Since multiple user credentials exist in the system of He et al, invoking a first user’s credentials and subsequently invoking a second user’s credentials corresponds to utilizing a temporary rule set and then utilizing a standard rule set).**

**Claim 40: The system of claim 15, wherein the individual rule set includes at least one rule allowing access based on a request type and a destination address (A “rule” does not change the structure of a physical system, and also does not change the functionality of the system unless the rule is executed. Since this rule imparts neither structure nor new**

Art Unit: 3992

functionality (it is not executed or invoked) it imparts no additional patentable weight (*In re Ngai* 367 F.3d 1336, USPQ2d 1862 (Fed. Cir. 2004)).

**Claim 41: The system of claim 15, wherein the individual rule set includes at least one rule redirecting the data to a new destination address based on a request type and an attempted destination address (A “rule” does not change the structure of a physical system, and also does not change the functionality of the system unless the rule is executed. Since this rule imparts neither structure nor new functionality (it is not executed or invoked) it imparts no additional patentable weight (*In re Ngai* 367 F.3d 1336, USPQ2d 1862 (Fed. Cir. 2004)).**

**Claim 43: The method of claim 25, wherein the individual rule set includes at least one rule as a function of a type of IP (Internet Protocol) service. (A “rule” does not change the structure of a physical system, and additionally does not affect method steps performed unless the rule is invoked. Since this rule imparts neither structure nor any additional method steps (it is not executed or invoked) it imparts no additional patentable weight (*In re Ngai* 367 F.3d 1336, USPQ2d 1862 (Fed. Cir. 2004)).**

**Claim 44: The method of claim 25, wherein the individual rule set includes an initial temporary rule set and a standard rule set, and wherein the redirection server is configured to utilize the temporary rule set for an initial period of time and to thereafter utilize the standard rule set (Each “user credential” of He et al corresponds to a rule. Since multiple user credentials exist in the system of He et al, invoking a first user’s credentials and subsequently invoking a second user’s credentials corresponds to utilizing a temporary rule set and then utilizing a standard rule set).**

Art Unit: 3992

**Claim 45: The method of claim 25, wherein the individual rule set includes at least one rule allowing access based on a request type and a destination address. (A “rule” does not change the structure of a physical system, and additionally does not affect method steps performed unless the rule is invoked. Since this rule imparts neither structure nor any additional method steps (it is not executed or invoked) it imparts no additional patentable weight (*In re Ngai* 367 F.3d 1336, USPQ2d 1862 (Fed. Cir. 2004)).**

**Claim 46: The method of claim 25, wherein the individual rule set includes at least one rule redirecting the data to a new destination address based on a request type and an attempted destination address. (A “rule” does not change the structure of a physical system, and additionally does not affect method steps performed unless the rule is invoked. Since this rule imparts neither structure nor any additional method steps (it is not executed or invoked) it imparts no additional patentable weight (*In re Ngai* 367 F.3d 1336, USPQ2d 1862 (Fed. Cir. 2004)).**

The following is a quotation of 35 U.S.C. 103(a) which forms the basis for all obviousness rejections set forth in this Office action:

(a) A patent may not be obtained though the invention is not identically disclosed or described as set forth in section 102 of this title, if the differences between the subject matter sought to be patented and the prior art are such that the subject matter as a whole would have been obvious at the time the invention was made to a person having ordinary skill in the art to which said subject matter pertains. Patentability shall not be negated by the manner in which the invention was made.

Claims 32, 37, 42 and 47 are rejected under 35 U.S.C. 103(a) as being unpatentable over He et al (U.S. Patent 6,088,451) in view of Zenchelsky et al (U.S. Patent 6,233,686) and further in view of admitted prior art (US patent 6,779,118, “Background of the Invention” at col. 1, lines 53-57).

Art Unit: 3992

See MPEP 2258 (F)(1): "However, an admission by patent owner of record in the file or in a court record may be utilized in combination with a patent or printed publication".

Also see 37 CFR 1.104(c)(3): "In rejecting claims the examiner may rely upon admissions by the applicant, or the patent owner in a reexamination proceeding, as to any matter affecting patentability and, insofar as rejections in applications are concerned, may also rely upon facts within his or her knowledge pursuant to paragraph (d)(2) of this section."

**Claim 32: The system of claim 1, wherein the redirection server is configured to redirect data from the users' computers by replacing a first destination address in an IP (Internet protocol) packet header by a second destination address as a function of the individualized rule set (admitted prior art at col. 1, lines 46-47 refers to a browser being redirected to a different web page than the page that was originally requested. Redirection inherently requires replacing a first destination address with a new destination address in order to initiate the redirection to a new site. It would have been obvious to modify He et al (U.S. Patent 6,088,451) in view of Zenchelsky et al (U.S. Patent 6,233,686) to include a mechanism for destination address redirection as taught by the admitted prior art so as to permit, for example, directing users to migrated websites or directing users away from closed websites).**

**Claim 37: The method of claim 8, wherein the redirection server is configured to redirect data from the users' computers by replacing a first destination address in an IP (Internet protocol) packet header by a second destination address as a function of the individualized rule set (admitted prior art at col. 1, lines 46-47 refers to a browser being redirected to a different web page than the page that was originally requested. Redirection inherently requires replacing a first destination address with a new destination address in order to**

Art Unit: 3992

initiate the redirection to a new site. It would have been obvious to modify He et al (U.S. Patent 6,088,451) in view of Zenchelsky et al (U.S. Patent 6,233,686) to include a mechanism for destination address redirection as taught by the admitted prior art so as to permit, for example, directing users to migrated websites or directing users away from closed websites).

**Claim 42: The system of claim 15, wherein the redirection server is configured to redirect data from the users' computers by replacing a first destination address in an IP (Internet protocol) packet header by a second destination address as a function of the individualized rule set (admitted prior art at col. 1, lines 46-47 refers to a browser being redirected to a different web page than the page that was originally requested. Redirection inherently requires replacing a first destination address with a new destination address in order to initiate the redirection to a new site. It would have been obvious to modify He et al (U.S. Patent 6,088,451) in view of Zenchelsky et al (U.S. Patent 6,233,686) to include a mechanism for destination address redirection as taught by the admitted prior art so as to permit, for example, directing users to migrated websites or directing users away from closed websites).**

**Claim 47: The method of claim 25, wherein the redirection server is configured to redirect data from the users' computers by replacing a first destination address in an IP (Internet protocol) packet header by a second destination address as a function of the individualized rule (admitted prior art at col. 1, lines 46-47 refers to a browser being redirected to a different web page than the page that was originally requested. Redirection inherently requires replacing a first destination address with a new destination address in order to initiate the redirection to a new site. It would have been obvious to modify He et al (U.S. Patent 6,088,451) in view of Zenchelsky et al (U.S. Patent 6,233,686) to include a mechanism for**

Art Unit: 3992

destination address redirection as taught by the admitted prior art so as to permit, for example, directing users to migrated websites or directing users away from closed websites).

**Response to Remarks of November 14, 2009**

(1) Patent owner at page 9, third paragraph states:

*“Thus, patent owner interprets the Office Action as determining that all of proposed rejections from the Request for Reexamination are improper, and determining that patented claims 1-27 are patentable over all the proposed rejections from the request for reexamination”.*

These assertions are not correct for several different reasons:

(a) 37 CFR 1.2 states:

“All business with the Patent and Trademark Office should be transacted in writing. The personal attendance of applicants or their attorneys or agents at the Patent and Trademark Office is unnecessary. The action of the Patent and Trademark Office will be based exclusively on the written record in the Office. No attention will be paid to any alleged oral promise, stipulation, or understanding in relation to which there is disagreement or doubt” (emphasis added)”.

The position of the USPTO is that which is set forth in the written record. Accordingly, if no specific statement is made in the written record that certain proposed issues are improper, than no presumption should be made that such issues have been specifically ruled as improper.

(b) 37 CFR 1.104 (c)(2) states:

“In rejecting the claims for want of novelty or for obviousness, the examiner must cite the best references at his or her command”.

Both the non-final office action of September 19, 2009 and the present office action are based on the requirements for citing and applying the best references or combination of references which are available. Examiner maintains that those prior art references which are currently relied upon in this action represent the "the best references at his or her command" and that both the previous action and the present action have been drafted in compliance with this requirement.

(c) The requirement for ruling upon every proposed rejection in the first office action after the order for reexamination only exists in *Inter Partes* reexamination, not in *Ex Parte* reexamination (See MPEP 2660, Section III for *Inter Partes* actions as compared to MPEP 2262 for *Ex Parte* actions). Office Actions in *Ex Parte* reexamination are drafted in accordance with the requirements of 37 CFR 1.104 and additionally considering the requirements for "special dispatch" as set forth in 35 USC 305.

(2) Patent owner at page 11, last two paragraphs state:

*"He '451, at column 16, lines 52-67, states that a "record" may include the list of "user credentials" reflecting "the most recent changes to the privilege set for the user." However, He '451 merely sends the response message back to the user.*

*Thus, He '451 does not teach or suggest that the authentication accounting server "accesses the database and communicates the individualized rule set that correlates with the first user ID and the temporarily assigned network address to the redirection server," as required by claim 1."*

Patent owner is asserting that in claim 1, the authentication accounting server directly passes the individualized rule set to the redirection server. However, claim 1 does not explicitly indicate which structure (the server or the database) is passing the rule set to the redirection server, nor is there an indication in claim 1 that the rule set is passed directly from authentication server to redirection server. Claim 1 appears to allow the rule set to reach the redirection server from either the authentication server or from the database.

In He et al, the authentication server 202 accesses the database 210 to prepare a "general ticket" (He et al at col 17, line 67). The ticket is then passed to the user who presents the ticket to the credential server (corresponding to the claimed redirection server) to access the credentials (He et al at col 19, lines 2-7). Accordingly, both claimed features of having the authentication server access a database and the redirection server receive the credentials from a database are met by He et al.

(3) Patent owner at page 13, third paragraph states:

*"As discussed in the He '451 specification at column 26, line 33 to column 27, line 12, FIG. 5 illustrates an exemplary state diagram of an operational flow. There is no disclosure of redirecting data from a user. Rather, FIG. 5 appears to merely block data from a user when the "No Match" state is reached, and also when the "Terminate" state is reached. Further, FIG. 5 also appears to merely allow data (without redirection) when the "Authorization OK" state is reached."*

Patent owner here is asserting that the function of "redirection" does not correspond to the action of blocking or allowing access to data. However, this assertion contradicts the



Art Unit: 3992

language of claims 3-4, where the redirection server has only one assigned function, that being blocking access to data or alternatively allowing access to data. US Patent 6,779,118 itself admits (at col. 4, lines 63-64) that a function of the redirection server is that of “blocking or allowing packets as a function of the rule sets”. Accordingly, the above quoted argument contradicts the recited functions attributed to the redirection server. The “redirection function” as described in each of the claims corresponds to the functions performed by He et al's credential server 204.

(4) Patent owner at page 14, second paragraph states:

*“He '451 does not teach or suggest “the redirection server further redirects data from the user’s computers to multiple destinations.”*

In He et al at FIG 10, plural network elements 104 represent multiple potential destinations of interaction based on user credentials. The “redirection” may correspond to the action of selectively allowing access or blocking data packets, as admitted in claims 3-4 and at US Patent 6,779,118 at col. 4, lines 63-64.

(5) Patent owner presents arguments at pages 15-17 pertaining to claims 8, 12 and 13 which essentially repeat the same arguments discussed in sections 1-4 above. Examiner’s position with respect to these arguments are those set forth in the previous sections (1)-(4) above.

(6) Patent owner at page 18, third paragraph states:

Art Unit: 3992

*“First He ‘451 merely discloses a security system administrator (a person) and does not teach or suggest an automated modification of at least a portion of a rule set”, as required by claim 1.”*

Claim 1 contains no such language, although it is understood that patent owner is referring to claim 15, which does recite this language. As stated in both the previous office action and the present office action, the automated modification is performed by a “data base tool” described by He et al at col. 17, lines 19-21. The database tool is not a human operator, and the text of He et al at col. 17, lines 19-21 clearly distinguishes the database tool from the human security administrator.

(7) Patent owner at page 18, fourth paragraph states:

*“Second, He ‘451 merely discloses a “maximum lifetime of each authentication”, But does not teach or suggest “modification” of at least a portion of a rule set as a function of “time, data transmitted to or from the user, or a location that the user attempts to access”, as required by claim 1.”*

Again, claim 1 contains no such language, although it is understood that patent owner is referring to claim 15, which does recite this language. This argument is not correct. He et al at col 17, line 13 attributes a “lifetime” to the authentication. Since any portion of the user account can be modified, the length of the “lifetime” can be modified as well. Alternatively, since the modification can be made it any time, the modification can occur “as a function of time”. The “data transmitted” and “location” are optional recitations, and thus do not carry patentable weight in the current claim (MPEP 2106, Section C: *“Language that suggests or makes*

Art Unit: 3992

*optional but does not require steps to be performed or does not limit a claim to a particular structure does not limit the scope of a claim or claim limitation”).*

It is also noted that the phrase “some combination” does not necessarily require two or more of the elements to be present. For example, a subcombination could be a combination that invokes only one of the elements recited.

(8) Patent owner at pages 19-20 presents arguments which pertain to claims 16 and 18. These arguments are only generic assertions of patentability, and do not address the specific rationales for rejection raised for these claims.

(9) Patent owner at page 20, third to last paragraph states:

*“Thus, He ‘451 does not teach or suggest “modifying at least a portion of the user’s rule set while the user’s rule set remains correlated to the temporarily assigned network address in the redirection server”.*

This assertion is not correct. The modification of the rule set is taught by He et al at col. 17, lines 19-21. The implementation of the temporary address is taught by Zenchelsky et al. Col. 1, lines 30-35 of Zenchelsky establish well known nature of assigning temporary IP address to user at session login; col. 1, lines 60-64 establish well known nature of having source and destination address encoded into communication packets as necessary to facilitate communication between source and destination. It would have been obvious to one of ordinary skill in the art to modify He et al; so to provide temporary IP address to a user node and additionally encode data communication packets with source and destination address as

Art Unit: 3992

necessarily to facilitate communication through a switched packet network as taught by Zenchelsky et al.

(10) Patent owner's remaining remarks at pages 21-22 are generic assertions of patentability in relation to newly added claims 28-47. The specific rationales for rejection under 35 USC 112, second paragraph and 35 USC 103 are detailed in the above action.

**Final Office Action**

**THIS ACTION IS MADE FINAL.**

A shortened statutory period for response to this action is set to expire TWO from the mailing date of this action.

**Extensions of time under 37 CFR 1.136(a) do not apply in reexamination proceedings.** The provisions of 37 CFR 1.136 apply only to "an applicant" and not to parties in a reexamination proceeding. Further, in 35 U.S.C. 305 and in 37 CFR 1.550(a), it is required that reexamination proceedings "will be conducted with special dispatch within the Office."

**Extensions of time in reexamination proceedings are provided for in 37 CFR 1.550(c).** A request for extension of time must be filed on or before the day on which a response to this action is due, and it must be accompanied by the petition fee set forth in 37 CFR 1.17(g). The mere filing of a request will not effect any extension of time. An extension of time will be granted only for sufficient cause, and for a reasonable time specified.

The filing of a timely first response to this final rejection will be construed as including a request to extend the shortened statutory period for an additional month, which will be granted even if previous extensions have been granted. In no event however, will the statutory period for

Art Unit: 3992

response expire later than SIX MONTHS from the mailing date of the final action. See MPEP § 2265.

**Note Regarding After Final Practice**

Patent owner is reminded of the limitations on after final practice, set forth in MPEP 2272 as follows:

“It is intended that prosecution before the examiner in a reexamination proceeding will be concluded with the final action. Once a final rejection that is not premature has been entered in a reexamination proceeding, the patent owner no longer has any right to unrestricted further prosecution. Consideration of amendments submitted after final rejection and prior to, or with, the appeal will be governed by the strict standards of 37 CFR 1.116. Further, consideration of amendments submitted after appeal will be governed by the strict standards of 37 CFR 41.33. Both the examiner and the patent owner should recognize that substantial patent rights will be at issue with no opportunity for the patent owner to refile under 37 CFR 1.53(b), or 1.53(d), and with no opportunity to file a request for continued examination under 37 CFR 1.114. Accordingly, both the examiner and the patent owner should identify and develop all issues prior to the final Office action, including the presentation of evidence under 37 CFR 1.131 and 1.132.”

**Litigation Activity Reminder**

The patent owner is reminded of the continuing responsibility under 37 CFR 1.565(a) to apprise the Office of any litigation activity, or other prior or concurrent proceeding, involving Patent No. 6,779,118 throughout the course of this reexamination proceeding. The third party requester is also reminded of the ability to similarly apprise the Office of any such activity or

Art Unit: 3992

proceeding throughout the course of this reexamination proceeding. See MPEP §§ 2207, 2282 and 2286.

**Correspondence**

All correspondence relating to this *ex parte* reexamination proceeding should be directed:

By Mail to: Mail Stop *Ex Parte* Reexam  
Central Reexamination Unit  
Commissioner for Patents  
United States Patent & Trademark Office  
P.O. Box 1450  
Alexandria, VA 22313-1450

By FAX to: (571) 273-9900  
Central Reexamination Unit

By hand: Customer Service Window  
Randolph Building  
401 Dulany Street  
Alexandria, VA 22314

Registered users of EFS-Web may alternatively submit such correspondence via the electronic filing system EFS-Web, at <https://sportal.uspto.gov/authenticate/authenticateuserlocalepf.html>. EFS-Web offers the benefit of quick submission to the particular area of the Office that needs to act on the correspondence. Also, EFS-Web submissions are “soft scanned” (i.e., electronically uploaded) directly into the official file for the reexamination proceeding, which offers parties the opportunity to review the content of their submissions after the “soft scanning” process is complete.

Any inquiry concerning this communication should be directed to **the Central Reexamination Unit** at telephone number **(571) 272-7705**.

/Sam Rimell/

---

Primary Patent Examiner  
Central Reexamination Unit 3992  
(571) 272-4084

Conferees:

/William H. Wood/  
Examiner, Art Unit 3992



**JESSICA HARRISON**  
**SUPERVISORY PATENT EXAMINER**

FORM PTO/SB/08A/B (10-01) Substitute for PTO-1449A/B  <b>INFORMATION DISCLOSURE</b>  <b>STATEMENT BY APPLICANT</b>  (use as many sheets as necessary)	<b>Attorney Docket Number</b>	R1341006
	<b>Application Number</b>	90/009,301
	<b>Filing Date</b>	December 17, 2008
	<b>Applicant(s)</b>	Ikudome, Koichiro et al.
	<b>Group Art Unit</b>	3992
	<b>Examiner Name</b>	RIMELL, Samuel G.

U.S. PATENT DOCUMENTS				
EXAMINER INITIALS	Cite No. <sup>1</sup>	DOCUMENT NUMBER Number - Kind Code <sup>2</sup> (if Known)	PUBLICATION DATE MM-DD-YYYY	NAME OF PATENTEE
<i>d</i>	1.	5,678,041	10/14/1997	Baker et al.
<i>d</i>	2.	5,708,780	01-13-1998	Lcvergood et al.
<i>d</i>	3.	5,749,075	05-05-1998	Toader et al.
<i>d</i>	4.	5,774,869	6/30/1998	Toader
<i>d</i>	5.	5,781,550	07-14-1998	Templin et al.
<i>d</i>	6.	5,794,210	08-11-1998	Goldhaber et al.
<i>d</i>	7.	5,802,320	09-01-1998	Baehr et al.
<i>d</i>	8.	5,805,803	9/8/1998	Birrell et al.
<i>d</i>	9.	5,806,043	9/8/1998	Toader
<i>d</i>	10.	5,812,776	09-22-1998	Gifford
<i>d</i>	11.	5,835,727	11/10/1998	Wong et al.
<i>d</i>	12.	5,848,233	12/8/1998	Radia et al.
<i>d</i>	13.	5,850,517	12/15/1998	Verkler et al.
<i>d</i>	14.	5,855,008	12-29-1998	Goldhaber et al.
<i>d</i>	15.	5,864,683	1/26/1999	Boebert et al.
<i>d</i>	16.	5,881,234	3/9/1999	Schwob
<i>d</i>	17.	5,889,958	3/30/1999	Willens
<i>d</i>	18.	5,915,093	6/22/1999	Berlin et al.
<i>d</i>	19.	5,918,018	6/29/1999	Gooderum et al.
<i>d</i>	20.	5,948,061	09-07-1999	Merriman et al.
<i>d</i>	21.	5,950,195	9/7/1999	Stockwell et al.
<i>d</i>	22.	5,956,697	09-21-1999	Usui
<i>d</i>	23.	5,960,409	09-28-1999	Wexler
<i>d</i>	24.	5,963,915	10-05-1999	Kirsch

EXAMINER SIGNATURE	<i>[Signature]</i>	DATE CONSIDERED	<i>7/15/10</i>
<small>EXAMINER: Initial if reference considered, whether or not citation is in conformance with MPEP 609; Draw line through citation if not in conformance and not considered. Include copy of this form with next communication to applicant. <sup>1</sup>Applicant's unique citation designation number (optional). <sup>2</sup>See Kinds Codes of USPTO Patent Documents at www.pto.gov or MPEP 901.4. <sup>3</sup>Enter Office that issued the document, by the two-letter code (WIPO standard ST.3). <sup>4</sup>For Japanese patent documents, the indication of the year of the reign of the Emperor must precede the serial number of the patent document. <sup>5</sup>Kind of document by the appropriate symbols as indicated on the document under WIPO Standard ST.16 if possible. <sup>6</sup>Applicant is to place a check mark here if English Language Translation is attached.</small>			

Patent and Trademark Office; U.S. DEPARTMENT OF COMMERCE



FORM PTO/SB/08A/B (10-01)  
Substitute for PTO-1449A/B

**INFORMATION DISCLOSURE  
STATEMENT BY APPLICANT**

(use as many sheets as necessary)

<b>Attorney Docket Number</b>	R1341006
<b>Application Number</b>	90/009,301
<b>Filing Date</b>	December 17, 2008
<b>Applicant(s)</b>	Ikudome, Koichiro et al.
<b>Group Art Unit</b>	3992
<b>Examiner Name</b>	RIMELL, Samuel G.

**U.S. PATENT DOCUMENTS**

EXAMINER INITIALS	Cite No. <sup>1</sup>	DOCUMENT NUMBER Number - Kind Code <sup>2</sup> (if Known)	PUBLICATION DATE MM-DD-YYYY	NAME OF PATENTEE
<i>[Handwritten Initials]</i>	25.	5,987,430	11/16/1999	Van Horne et al.
<i>[Handwritten Initials]</i>	26.	6,014,698	01-11-2000	Griffiths
<i>[Handwritten Initials]</i>	27.	6,052,725	04-18-2000	McCann et al.
<i>[Handwritten Initials]</i>	28.	6,070,243	5/30/2000	See et al.
<i>[Handwritten Initials]</i>	29.	6,098,172	08-01-2000	Coss et al.
<i>[Handwritten Initials]</i>	30.	6,112,239	8/29/2000	Kenner et al.
<i>[Handwritten Initials]</i>	31.	6,119,160	9/12/2000	Zhang et al.
<i>[Handwritten Initials]</i>	32.	6,119,162	09-12-2000	Li et al.
<i>[Handwritten Initials]</i>	33.	6,154,775	11/28/2000	Coss et al.
<i>[Handwritten Initials]</i>	34.	6,158,008	12/5/2000	Maria et al.
<i>[Handwritten Initials]</i>	35.	6,182,139	01-30-2001	Brendel
<i>[Handwritten Initials]</i>	36.	6,219,790	4/17/2001	Lloyd et al.
<i>[Handwritten Initials]</i>	37.	6,223,209	04-24-2001	Watson
<i>[Handwritten Initials]</i>	38.	6,226,677	05-01-2001	Slemmer
<i>[Handwritten Initials]</i>	39.	6,233,618	5/15/2001	Shannon
<i>[Handwritten Initials]</i>	40.	6,247,054	6/12/2001	Malkin
<i>[Handwritten Initials]</i>	41.	6,311,275	10/30/2001	Jin et al.
<i>[Handwritten Initials]</i>	42.	6,321,336	11/20/2001	Applegate et al.
<i>[Handwritten Initials]</i>	43.	6,377,990	4/23/2002	Slemmer et al.
<i>[Handwritten Initials]</i>	44.	6,438,125	8/20/2002	Brothers
<i>[Handwritten Initials]</i>	45.	6,460,084	10/1/2002	Van Horne et al.
<i>[Handwritten Initials]</i>	46.	6,636,894	10-21-2003	Short et al.
<i>[Handwritten Initials]</i>	47.	6,687,732	2/3/2004	Bector et al.
<i>[Handwritten Initials]</i>	48.	6,721,306	4/13/2004	Farris et al.

EXAMINER SIGNATURE	<i>[Handwritten Signature]</i>	DATE CONSIDERED	<i>7/15/10</i>
--------------------	--------------------------------	-----------------	----------------

EXAMINER: Initial if reference considered, whether or not citation is in conformance with MPEP 609; Draw line through citation if not in conformance and not considered. Include copy of this form with next communication to applicant. <sup>1</sup>Applicant's unique citation designation number (optional). <sup>2</sup>See Kinds Codes of USPTO Patent Documents at www.pto.gov or MPEP 901.4. <sup>3</sup>Enter Office that issued the document, by the two-letter code (WIPO standard ST.3). <sup>4</sup>For Japanese patent documents, the indication of the year of the reign of the Emperor must precede the serial number of the patent document. <sup>5</sup>Kind of document by the appropriate symbols as indicated on the document under WIPO Standard ST.16 if possible. <sup>6</sup>Applicant is to place a check mark here if English Language Translation is attached.

Patent and Trademark Office; U.S. DEPARTMENT OF COMMERCE

P1341006 A02: DM/...

FORM PTO/SB/08A/B (10-01) Substitute for PTO-1449A/B  <b>INFORMATION DISCLOSURE</b>  <b>STATEMENT BY APPLICANT</b>  (use as many sheets as necessary)	<b>Attorney Docket Number</b>	R1341006
	<b>Application Number</b>	90/009,301
	<b>Filing Date</b>	December 17, 2008
	<b>Applicant(s)</b>	Ikudome, Koichiro et al.
	<b>Group Art Unit</b>	3992
	<b>Examiner Name</b>	RIMELL, Samuel G.

FOREIGN PATENT DOCUMENTS					
EXAMINER INITIALS	Cite No. <sup>1</sup>	Foreign Patent Document Country Code <sup>2</sup> - Number <sup>3</sup> - Kind Code <sup>3</sup> (If Known)	Publication Date MM-DD-YYYY	Name of Patentee or Applicant of Cited Document	T <sup>4</sup> (✓)
<i>SL</i>	49.	GB 2316841	03-04-1998	Kubota et al.	
<i>SL</i>	50.	WO 96/05549	02-22-1996	Horowitz et al.	
<i>SL</i>	51.	WO 96/39668	12-12-1996	Toader	
<i>SL</i>	52.	WO 97/11429	03-27-1997	Graber et al.	

OTHER DOCUMENTS		
EXAMINER INITIALS	Cite No. <sup>1</sup>	Include name of the author (in CAPITAL LETTERS), title of the article, title of the item (book, magazine, journal, serial, symposium, catalog, etc.), date, page(s), volume-issue number(s), publisher, city and/or country where published.
<i>SL</i>	53.	"Phone Cards and the Internet: A profitable Link," 1 page; Intele-Card News, March 1996
<i>SL</i>	54.	"New Internet Card Offers Free Access," 3 pages; The Yomiuri Shimbun/Daily Yomiuri, September 29, 1998
<i>SL</i>	55.	AAS, GISLE, MACEACHERN, DOUG; Apache.pm; 18 pages; available at <http://www.apache.org/docs>.
<i>SL</i>	56.	<del>Amended Complaint, Demand for Jury Trial, <i>IP3 Networks, Inc. vs. Nomadix, Inc.</i>; Case No. 04 CV 1485 DMS (POR), 48 pages (including Exhibits 1-3), September 20, 2004; United States District Court, Southern District of California.</del>
<i>SL</i>	57.	<del>Answer and Counterclaims of Nomadix Inc. to the Amended Complaint, <i>IP3 Networks, Inc. vs. Nomadix, Inc.</i>, Case No. 04 CV 1485 DMS (POR), 46 pages; Filed October 21, 2004; United States District Court, Southern District of California.</del>
<i>SL</i>	58.	Avolio and Ranum, "A Network Perimeter with Secure External Access," 11 pages; Trusted Information Systems, Jan. 25, 1994
<i>SL</i>	59.	Baker et al. "Local Control Over Filtered WWW Access," 12 pages; <a href="http://www.w3.org/Conferences/WWW4/Papers/117">http://www.w3.org/Conferences/WWW4/Papers/117</a> Fourth International World Wide Web Conference Dec. 1995
<i>SL</i>	60.	BEERMAN; CORD, <i>Re: Support for cern like Pass/Fair proxy limits?</i> ; 2 pages; available at < <a href="http://www.squid-cache.org/mail-archives/squid-users/199611/0385.html">http://www.squid-cache.org/mail-archives/squid-users/199611/0385.html</a> > (visited 0002-01-2005)

EXAMINER SIGNATURE	<i>[Signature]</i>	DATE CONSIDERED	7/15/10
EXAMINER: Initial if reference considered, whether or not citation is in conformance with MPEP 609; Draw line through citation if not in conformance and not considered. Include copy of this form with next communication to applicant. <sup>1</sup> Applicant's unique citation designation number (optional). <sup>2</sup> See Kinds Codes of USPTO Patent Documents at <a href="http://www.pto.gov">www.pto.gov</a> or MPEP 901.4. <sup>3</sup> Enter Office that issued the document, by the two-letter code (WIPO standard ST.3). <sup>4</sup> For Japanese patent documents, the indication of the year of the reign of the Emperor must precede the serial number of the patent document. <sup>5</sup> Kind of document by the appropriate symbols as indicated on the document under WIPO Standard ST.16 if possible. <sup>6</sup> Applicant is to place a check mark here if English Language Translation is attached.			

Patent and Trademark Office; U.S. DEPARTMENT OF COMMERCE

*NOT A PATENT OR PRINTED PUBLICATION  
(35 USC 301)*

FORM PTO/SB/08A/B (10-01) Substitute for PTO-1449A/B  <b>INFORMATION DISCLOSURE          STATEMENT BY APPLICANT</b>  (use as many sheets as necessary)	Attorney Docket Number	R1341006
	Application Number	90/009,301
	Filing Date	December 17, 2008
	Applicant(s)	Ikudome, Koichiro et al.
	Group Art Unit	3992
	Examiner Name	RIMELL, Samuel G.

OTHER DOCUMENTS		
EXAMINER INITIALS	Cite No. <sup>1</sup>	Include name of the author (in CAPITAL LETTERS), title of the article, title of the item (book, magazine, journal, serial, symposium, catalog, etc.), date, page(s), volume-issue number(s), publisher, city and/or country where published.
d	61.	BERNERS-LEE, T. et al., Network Working Group, Request for Comments: 1945, "Hypertext Transfer Protocol - HTTP/1.0," May 1996, 60 pp.
d	62.	Blankers, "Network solutions for Internet access servers," 12 pages; Ericsson Review, Internet Access Servers 1998
d	63.	Boutell, "CGI Programming in C & Perl," 7 pages; 1996
d	64.	BRADEN, B., POSTEL, J.; <i>Requirements for Internet Gateways</i> ; June 1987; 50 pages; Network Working Group, Request for Comments 1009.
d	65.	"Campus World," Presentation by Phil Moore, 1998; 15 pages
d	66.	CARL-MITCHELL, SMOOT, QUARTERMAN, JOHN S.; <i>Using ARP to Implement Transparent Subnet Gateways</i> ; October 1987; 8 pages; Network Working Group, Request for Comments 1027.
d	67.	Chapman and Zwicky, <i>Building Internet Firewalls</i> O'Reilly & Associates, 1995
d	68.	CHATEL, M.; <i>Classical Versus Transparent IP Proxies</i> ; March 1996; 32 pages; Network Working Group, Request for Comments 1919.
+	69.	<del>Complaint, Demand for Jury Trial; <i>IP3 Networks, Inc. vs. Nomadic, Inc.</i>; Case No. 04 CV 1485 DMS (POR); 48 pages; Filed July 23, 2004; United States District Court, Southern District of California.</del>
d	70.	D. Carrel, L. Grant, "TACACS+ Protocol Version 1.75," 40 pages; Internet Draft (TACACS+)/RFC1492; Cisco Systems; Oct. 1996
l	71.	Douglas Comer, <i>Internetworking with TCP/IP</i> , 3rd ed. 1995
d	72.	DROMS, R.; <i>Dynamic Host Configuration Protocol</i> ; October 1993; 35 pages; Network Working Group, Request for Comments 1531.
d	73.	Duane Wessels, "Squid and ICP: Past, Present and Future," 15 pages; Aug. 16, 1997
d	74.	EGEVANG, K., FRANCIS, P.; <i>The IP Network Address Translator (NAT)</i> ; May 1994; 9 pages; Network Working Group, Request for Comments 1631.
d	75.	FELTON, E.W., et al., "Web Spoofing: An Internet Con Game," <i>Technical Report 540-96 (revised Feb. 1997)</i> , Department of Computer Science, Princeton University, 1996, 1997, 9 pp.
d	76.	FIEDLER, D., et al., "DR. WEBSITE: Using META Tags for Identification and Control of Pages," <a href="http://www.webdeveloper.com/drweb/19971103-drweb.html">http://www.webdeveloper.com/drweb/19971103-drweb.html</a> , 11/3/1997, 4 pp.

EXAMINER SIGNATURE		DATE CONSIDERED	7/15/10
EXAMINER: Initial if reference considered, whether or not citation is in conformance with MPEP 609; Draw line through citation if not in conformance and not considered. Include copy of this form with next communication to applicant. <sup>1</sup> Applicant's unique citation designation number (optional). <sup>2</sup> See Kinds Codes of USPTO Patent Documents at <a href="http://www.pto.gov">www.pto.gov</a> or MPEP 901.4. <sup>3</sup> Enter Office that issued the document, by the two-letter code (WIPO standard ST.3). <sup>4</sup> For Japanese patent documents, the indication of the year of the reign of the Emperor must precede the serial number of the patent document. <sup>5</sup> Kind of document by the appropriate symbols as indicated on the document under WIPO Standard ST.16 if possible. <sup>6</sup> Applicant is to place a check mark here if English Language Translation is attached.			

Patent and Trademark Office; U.S. DEPARTMENT OF COMMERCE

NOT A PATENT OR PRINTED PUBLICATION  
(35 USC 301)

FORM PTO/SB/08A/B (10-01) Substitute for PTO-1449A/B  <b>INFORMATION DISCLOSURE</b>  <b>STATEMENT BY APPLICANT</b>  (use as many sheets as necessary)	<b>Attorney Docket Number</b>	R1341006
	<b>Application Number</b>	90/009,301
	<b>Filing Date</b>	December 17, 2008
	<b>Applicant(s)</b>	Ikudome, Koichiro et al.
	<b>Group Art Unit</b>	3992
	<b>Examiner Name</b>	RIMELL, Samuel G.

OTHER DOCUMENTS		
EXAMINER INITIALS	Cite No. <sup>1</sup>	Include name of the author (in CAPITAL LETTERS), title of the article, title of the item (book, magazine, journal, serial, symposium, catalog, etc.), date, page(s), volume-issue number(s), publisher, city and/or country where published.
dl	77.	George, Mike, "Hardware Hustle Hits the Classroom," 3 pages; The Independent, May 20, 1996
d	78.	Guido Appenzeller, Mema Roussopoulos and Mary Baker, "User-Friendly Access Control for Public Network Ports," 8 pages; IEEE Transactions, March 1999
d	79.	HORNIG, CHARLES; <i>A Standard for the Transmission of IP Datagrams over Ethernet Networks</i> ; April 1984; 3 pages; Network Working Group, Request for Comments 894.
d	80.	Housel and Lindquist, "WebExpress: A System for Optimizing Web Browsing in a Wireless Environment," 10 pages; Proceedings of the Second Annual International Conference on Mobile Computing and Networking, Nov. 1996
d	81.	Iain Langdon, "Education for Changing Times -- An Online Learning Framework," 3 pages; WebNet 96, Oct. 15-19, 1996
d	82.	INFORMATION SCIENCES INSTITUTE; <i>Internet Protocol, DARPA Internet Program, Protocol Specification</i> ; September 1981; 49 pages; available at < <a href="http://www.faqs.org/rfcs/rfc791.html">http://www.faqs.org/rfcs/rfc791.html</a> > (visited 0002-01-2005).
*	<del>83.</del>	<del>Invalidity Contentions of AT&amp;T et al., Case No. <i>Linksmart Wireless Technology, LLC v. T-Mobile USA, Inc., et al.</i>, Case Nos. (consolidated) 2:08-cv-00264-DF-CE, 2:08-cv-00304-DF-CE, 2:08-cv-00385-DF-CD, 2:09-cv-00026-DF-CE, U.S. District Court, Eastern District of Texas, Marshall Division, 754 pages (including appendixes A-C), October 8, 2009</del>
*	<del>84.</del>	<del>Invalidity Contentions of T-Mobile USA, Inc. et al., Case No. <i>Linksmart Wireless Technology, LLC v. T-Mobile USA, Inc., et al.</i>, Case Nos. (consolidated) 2:08-cv-00264-DF-CE, 2:08-cv-00304-DF-CE, 2:08-cv-00385-DF-CD, 2:09-cv-00026-DF-CE, U.S. District Court, Eastern District of Texas, Marshall Division, 325 pages (including appendix A), October 8, 2009</del>
d	85.	Kostick, "Building a Linux firewall," 9 pages; Linux Journal, April 1996 (accessed at <a href="http://delivery.acm.org/10.1145/330000/3255560">http://delivery.acm.org/10.1145/330000/3255560</a> )
d	86.	Loon et al., "Alleviating the Latency and Bandwidth Problems in WWW Browsing," 13 pages; Proceedings of the USENIX Symposium on Internet Technologies and Systems, Monterey, California, December 1997
A	87.	LUOTONEN, ARI, ALTIS, KEVIN; <i>World-Wide Web Proxies</i> ; April 1994; 8 pages.
d	88.	MACEACHERN, DOUG; <i>Apache/Perl Integration Project</i> ; README; 2 pages; available at < <a href="http://apache.perl.org">http://apache.perl.org</a> >, < <a href="http://outside.organic.com/mail-archives/modperl">http://outside.organic.com/mail-archives/modperl</a> >, and < <a href="http://www.ping.de/~fdc/mod_perl">http://www.ping.de/~fdc/mod_perl</a> >.

EXAMINER SIGNATURE		DATE CONSIDERED	7/15/10
--------------------	---	-----------------	---------

EXAMINER: Initial if reference considered, whether or not citation is in conformance with MPEP 609; Draw line through citation if not in conformance and not considered. Include copy of this form with next communication to applicant. <sup>1</sup>Applicant's unique citation designation number (optional). <sup>2</sup>See Kinds Codes of USPTO Patent Documents at [www.pto.gov](http://www.pto.gov) or MPEP 901.4. <sup>3</sup>Enter Office that issued the document, by the two-letter code (WIPO standard ST.3). <sup>4</sup>For Japanese patent documents, the indication of the year of the reign of the Emperor must precede the serial number of the patent document. <sup>5</sup>Kind of document by the appropriate symbols as indicated on the document under WIPO Standard ST.16 if possible. <sup>6</sup>Applicant is to place a check mark here if English Language Translation is attached.

\* USE A PATENT OR PRINTED PUBLICATION  
 (35 USC 301)  
 Panasonic-1009  
 Page 724 of 1492

FORM PTO/SB/08A/B (10-01) Substitute for PTO-1449A/B  <b>INFORMATION DISCLOSURE</b>  <b>STATEMENT BY APPLICANT</b>  (use as many sheets as necessary)	Attorney Docket Number	R1341006
	Application Number	90/009,301
	Filing Date	December 17, 2008
	Applicant(s)	Ikudome, Koichiro et al.
	Group Art Unit	3992
	Examiner Name	RIMELL, Samuel G.

OTHER DOCUMENTS		
EXAMINER INITIALS	Cite No. <sup>1</sup>	Include name of the author (in CAPITAL LETTERS), title of the article, title of the item (book, magazine, journal, serial, symposium, catalog, etc.), date, page(s), volume-issue number(s), publisher, city and/or country where published.
d	89.	"Major Telecom Company launches Education Internet Service for Schools," 3 pages; Learning in a Global Information Society, Sep. 20, 1995
L	90.	Make users go thru login, Available at <a href="http://www.microsoft.public.inetsrvr.iis.activeserverpages.html">http://www.microsoft.public.inetsrvr.iis.activeserverpages.html</a> (visited October 5, 2005 but including items dated January 19, 1998), 2 pp.
d	91.	MOCKAPETRIS, P.; <i>Domain Names - Concepts and Facilities</i> ; November 1987; 49 pages; Network Working Group, Request for Comments 1034.
d	92.	<i>Mod_perl.c</i> ; Copyright; 1995-1997 The Apache Group; 20 pages.
d	93.	Phil C. Leveridge, "CampusWorld and BT's On-Line Education Services," 6 pages; BT Technology Journal, Vol. 15, No. 2, April 1997
x	<del>94.</del>	<del>Plaintiff/Counter-Defendant IPE Networks, Inc.'s Reply to Defendant Nomadix, Inc.'s Counterclaim, IP3 Networks, Inc. vs. Nomadix, Inc., Case No. 04 CV 1485 DMS (POR), 8 pages, November 15, 2004, United States District Court, Southern District of California</del>
d	95.	PLUMMER, DAVID C.; <i>An Ethernet Address Resolution Protocol or Converting Network Protocol Addresses to 48-bit Ethernet Address for Transmission on Ethernet Hardware</i> ; November 1982; 8 pages; Network Working Group, Request for Comments 826.
d	96.	Poger et al., "Secure Public Internet Access Handler (SPINACH)," Proceedings of the USENIX Symposium on Internet Technologies and Systems, Monterey, California Dec. 1997; 12 pages
d	97.	POSTEL, J.; <i>Multi-Lan Address Resolution</i> ; October 1984; 14 pages; Network Working Group, Request for Comments 925.
d	98.	RIGNEY, C., <i>Radius Accounting</i> , Network Working Group, Request for Comments: 2139, April 1997, 25 pp.
d	99.	S.D. Hubbard et al., "Firewalling the Nct," 13 pages; BT Technology Journal, Vol. 15, No. 2, April 1997
d	100.	STEWART, JOHN N.; <i>Working with Proxy Servers</i> ; March 1997; Pages 19-22; <u>WebServer Magazine</u> .
L	101.	Stuart Elliot, "The Media Business: Advertising - Addenda; Interactive Media Begins Samplcnet," 1 page; The New York Times, Jul. 17, 1995
+	102.	Various Authors, <a href="http://www.squid-cache.org">www.squid-cache.org</a> , 4 pp.

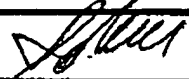
EXAMINER SIGNATURE		DATE CONSIDERED	7/15/10
EXAMINER: Initial if reference considered, whether or not citation is in conformance with MPEP 609; Draw line through citation if not in conformance and not considered. Include copy of this form with next communication to applicant. <sup>1</sup> Applicant's unique citation designation number (optional). <sup>2</sup> See Kinds Codes of USPTO Patent Documents at <a href="http://www.pto.gov">www.pto.gov</a> or MPEP 901.4. <sup>3</sup> Enter Office that issued the document, by the two-letter code (WIPO standard ST.3). <sup>4</sup> For Japanese patent documents, the indication of the year of the reign of the Emperor must precede the serial number of the patent document. <sup>5</sup> Kind of document by the appropriate symbols as indicated on the document under WIPO Standard ST.16 if possible. <sup>6</sup> Applicant is to place a check mark here if English Language Translation is attached.			

Patent and Trademark Office; U.S. DEPARTMENT OF COMMERCE

*\* NOT A PATENT OR PRINTED PUBLICATION (35 USC 301)*  
*\* DOES NOT COMPLY WITH 37 CFR 1.98(B)(5)*

<b>FORM PTO/SB/08A/B (10-01)</b> Substitute for PTO-1449A/B  <b>INFORMATION DISCLOSURE</b>  <b>STATEMENT BY APPLICANT</b>  (use as many sheets as necessary)	<b>Attorney Docket Number</b>	R1341006
	<b>Application Number</b>	90/009,301
	<b>Filing Date</b>	December 17, 2008
	<b>Applicant(s)</b>	Ikudome, Koichiro et al.
	<b>Group Art Unit</b>	3992
	<b>Examiner Name</b>	RIMELL, Samuel G.

OTHER DOCUMENTS		
EXAMINER INITIALS	Cite No. <sup>1</sup>	Include name of the author (in CAPITAL LETTERS), title of the article, title of the item (book, magazine, journal, serial, symposium, catalog, etc.), date, page(s), volume-issue number(s), publisher, city and/or country where published.
el	103.	Welsh, "Implementing Loadable Kernel Modules for Linux," Dr. Dobb's Software Tools for the Professional Programmer, May 1995 (accessed at <a href="http://www.ddj.com">http://www.ddj.com</a> ); 9 pages
dl	104.	WESSELS, D.; <i>Squid Proxy Server Configuration File 1.932.2</i> , TAG deny_info"; March 1997; 19 pages; available at < <a href="http://www.squid-cache.org/mail-archievc/squid-users/199703/att-0250/squid.conf">http://www.squid-cache.org/mail-archievc/squid-users/199703/att-0250/squid.conf</a> >; (visited 02-01-2005).

EXAMINER SIGNATURE		DATE CONSIDERED	7/15/10
<small>EXAMINER: Initial if reference considered, whether or not citation is in conformance with MPEP 609; Draw line through citation if not in conformance and not considered. Include copy of this form with next communication to applicant. <sup>1</sup>Applicant's unique citation designation number (optional). <sup>2</sup>See Kinds Codes of USPTO Patent Documents at <a href="http://www.pto.gov">www.pto.gov</a> or MPEP 901.4. <sup>3</sup>Enter Office that issued the document, by the two-letter code (WIPO standard ST.3). <sup>4</sup>For Japanese patent documents, the indication of the year of the reign of the Emperor must precede the serial number of the patent document. <sup>5</sup>Kind of document by the appropriate symbols as indicated on the document under WIPO Standard ST.16 if possible. <sup>6</sup>Applicant is to place a check mark here if English Language Translation is attached.</small>			

Patent and Trademark Office; U.S. DEPARTMENT OF COMMERCE

P1341006 1007 01/08/08

# INFORMATION DISCLOSURE STATEMENT BY PATENT OWNER

Complete if Known

Reexamination Number	90/009,301
Filing Date	December 17, 2008
First Named Inventor	Koichiro IKUDOME
Art Unit	3992
Examiner Name	Sam RIMELL
Attorney Docket Number	R1341006

(Use as many sheets as necessary)

Sheet 1 of 2

## U.S. PATENT DOCUMENTS

Examiner Initials*	Cite No. <sup>1</sup>	Document Number Number-Kind Code <sup>2</sup> (if known)	Publication Date MM-DD-YYYY	Name of Patentee or Applicant of Cited Document	Pages, Columns, Lines, Where Relevant Passages or Relevant Figures Appear
A	A1	US-5,845,267	12-01-1998	Ronen	
A	A2	US-6,272,115	08-07-2001	Elliott III	
A	A3	US-6,779,118	08-17-2004	Ikudome <i>et al.</i>	

## FOREIGN PATENT DOCUMENTS

Examiner Initials*	Cite No. <sup>1</sup>	Foreign Patent Document Country Code <sup>3</sup> -Number <sup>4</sup> -Kind Code <sup>5</sup> (if known)	Publication Date MM-DD-YYYY	Name of Patentee or Applicant of Cited Document	Pages, Columns, Lines, Where Relevant Passages or Relevant Figures Appear	T <sup>6</sup>

## NON PATENT LITERATURE DOCUMENTS

Examiner Initials*	Cite No. <sup>1</sup>	Include name of the author (in CAPITAL LETTERS), title of the article (when appropriate), title of the item (book, magazine, journal, serial, symposium, catalog, etc.), date, page(s), volume-issue number(s), publisher, city and/or country where published.	T <sup>2</sup>
*	C1	<del>Best Western's Supplemental Claim Construction Brief of LINKSMART WIRELESS TECHNOLOGIES, LLC v. T-MOBILE USA, INC., et al., U.S. District Court of Eastern District of Texas, Marshall Division, Case No. 2:08-cv-00264-DF-CE, filed April 16, 2010, pp. 1-16 (including Exhibits 1-2)</del>	
	C2	Cisco Internetworking Technologies Handbook, Chapter 15, entitled Dial-up Technology, Cisco, pp. 1-12	
*	C3	<del>Claim Construction Brief of Defendants of LINKSMART WIRELESS TECHNOLOGIES, LLC v. T-MOBILE USA, INC., et al., U.S. District Court of Eastern District of Texas, Marshall Division, Case No. 2:08-cv-00264-DF-CE, filed April 16, 2010, pp. 1-39</del>	
	C4	CONNOLY <i>et al.</i> , Database Systems: A Practical Approach to Design, Implementation, and Management, ed.3, Addison-Wesley, 2002 (PAGE 72 ONLY)	
*	C5	<del>Declaration of Kevin Jeffay, PH.D in LINKSMART WIRELESS TECHNOLOGIES, LLC v. T-MOBILE USA, INC., et al., U.S. District Court of Eastern District of Texas, Marshall Division, Case No. 2:08-cv-00264-DF-CE, filed April 16, 2010, pp. 1-53 (including Exhibits A-C)</del>	
*	C6	<del>Declaration of Noah A. Levine in Support of Claim Construction Brief of Defendants, in LINKSMART WIRELESS TECHNOLOGIES, LLC v. T-MOBILE USA, INC., et al., U.S. District Court of Eastern District of Texas, Marshall Division, Case No. 2:08-cv-00264-DF-CE, filed April 16, 2010, pp. 1-131 (including exhibits 1-9)</del>	
*	C7	<del>Defendants' Patent Local Rule 4.2 Preliminary Constructions and Extrinsic Evidence of LINKSMART TECHNOLOGY, LLC v. T-MOBILE USA, INC., et al., U.S. District Court of Eastern District of Texas, Marshall</del>	

\* NOT A PATENT OR PRINTED PUBLICATION

d	C8	Dial-up Networking and Mobile Computing: The Basics, <u>Microsoft TechNet</u> , available at <a href="http://technet.microsoft.com/en-us/library/cc751107(printer).aspx">http://technet.microsoft.com/en-us/library/cc751107(printer).aspx</a> on January 21, 2010, pp. 1-26	
xf	<del>C9</del>	<del>ELMASRI et al., Fundamentals of Database Systems, ed.2, Addison-Wesley, 1994</del>	
d	C10	How to Determine the Version of Windows 95/98/Me in Use May 12, 2007, <u>Microsoft</u> , available at <a href="http://support.microsoft.com/kb/158238">http://support.microsoft.com/kb/158238</a> on January 21, 2010 (4 pages)	
xf	<del>C11</del>	<del>Ikudome et al., User Specific Automatic Web Redirection System: Technical Innovation Report, Auric Web Systems, Date: unknown, 19 pages (including Appendix)</del>	
d	C12	LEVENE et al., A Guided Tour of Relational Databases and Beyond, <u>Springer</u> , 1999, pp 1-12	
x	<del>C13</del>	<del>Linksmart Markman Brief, Weiss Declaration and Exhibits</del>	
tc	<del>C14</del>	<del>Linksmart Wireless Technology, LLC Disclosure of Asserted Claims and Infringement Contentions Against Defendants</del>	
d	C15	MALKIN, Comprehensive Networking Glossary and Acronym Guide 47, 1995	
d	C16	BAHN (ed.), Microsoft Computer Dictionary, <u>Microsoft Press</u> , 4 <sup>th</sup> ed. 1999, p. 136	
d	C17	Microsoft Windows NT Server Resource Kit, Version 4.0, Supplement One, <u>Microsoft Press</u> , 1997, pp. 88-89	
d	C18	Microsoft Windows NT Workstation Resource Kit: Comprehensive Resource Guide and Utilities for Windows NT Workstation Version 4.0, <u>Microsoft Press</u> , 1996, pp. 1023-1025	
d	C19	NEWTON, Newton's Telecom Dictionary, <u>Telecom Books and Flatiron Publishing</u> , 10 <sup>th</sup> ed., January 1998, p. 206	
d	C20	SIMPSON ET AL (eds.), Oxford English Dictionary, <u>Clarendon Press</u> , 2d. ed. 1998, v.3, pp. 514-515	
d	C21	SIMPSON ET AL (eds.), Oxford English Dictionary, <u>Clarendon Press</u> , 2d. ed. 1998, v.7, p. 881	
d	C22	PERSON et al., Using Windows 95, <u>Platinum Edition</u> , <u>Que Corporation</u> , 1996, pp. 205 (7 pages)	
d	C23	INTERNATIONAL TELECOMMUNICATION UNION, Telecommunication Standard ITU-T Standard: Data Communication Over The Telephone Network, v.8, <u>ITU</u> , September 1994, PP. 1-10	
d	C24	Windows History: Windows Desktop Timeline, June 30, 2003, available at <a href="http://www.microsoft.com/windows/WinHistoryProGraphic.msp">http://www.microsoft.com/windows/WinHistoryProGraphic.msp</a> on January 21, 2010, <u>Microsoft</u> , pp. 1-2	
Examiner Signature		<i>[Signature]</i>	Date Considered
			7/15/10

\*EXAMINER: Initial if reference considered, whether or not citation is in conformance with MPEP 809. Draw line through citation if not in conformance and not considered. Include copy of this form with next communication to applicant. 1 Applicant's unique citation designation number (optional). 2 See Kinds Codes of USPTO Patent Documents at [www.uspto.gov](http://www.uspto.gov) or MPEP 901.04. 3 Enter Office that issued the document, by the two-letter code (WIPO Standard ST 3). 4 For Japanese patent documents, the indication of the year of the reign of the Emperor must precede the serial number of the patent document. 5 Kind of document by the appropriate symbols as indicated on the document under WIPO Standard ST.16 if possible. 6 Applicant is to place a check mark here if English language Translation is attached. This collection of information is required by 37 CFR 1.97 and 1.98. The information is required to obtain or retain a benefit by the public which is to file (and by the USPTO to process) an application. Confidentiality is governed by 35 U.S.C. 122 and 37 CFR 1.14. SEND TO: Commissioner for Patents, P.O. Box 1450, Alexandria, VA 22313-1450.

✗ NOT A PATENT OR PRINTED PUBLICATION (35 USC 90c)

✗✗ NO COPY

✗✗ DOES NOT COMPLY WITH 37 CFR 1.98 (b) (3) (i) 927



<b>Reexamination</b> 	Application/Control No. 90009301	Applicant(s)/Patent Under Reexamination 6,779,118 B1 ET AL.
	Certificate Date	Certificate Number

**Requester Correspondence Address:**       Patent Owner       Third Party

Jerry Turner Sewell  
P.O. Box 10999  
Newport Beach, CA 92658-5015

LITIGATION REVIEW <input checked="" type="checkbox"/>	/SR/ (examiner initials)	07/20/2010 (date)
Case Name	Director Initials	
Linksmart Wireless Technology v SBC Internet Services Inc,	<i>Sharron for SA</i> ↓	
Linksmark Wireless Technology, LLC v Cisco Systems Inc et al		
Linksmart Wireless Technology Inc v T-Mobile USA Inc et al		
Linksmart Wireless Technology Inc v Six Continents Hotels, In		

COPENDING OFFICE PROCEEDINGS	
TYPE OF PROCEEDING	NUMBER
1. None	

--	--

# Litigation Search Report CRU 3999

Reexam Control No. 90/009,301

**TO: Sam Rimell**  
**Location: CRU**  
**Art Unit: 3992**  
**Date: 07/14/10**

**From: Patricia Volpe**  
**Location: CRU 3999**  
**MDW 7C69**  
**Phone: (571) 272-6825**

**Patricia.volpe@uspto.gov**

## Search Notes

Litigation Search for U.S. Patent Number: **6,779,118**

Status (**OPEN**) 2:09cv26 *Linksmart Wireless Technology Llc v. Six Continents Hotels Inc et A*

Status (**OPEN**) 2:08cv385 *Linksmart Wireless Technology Llc v. Sbc Internet Services, Inc*

Status (**OPEN**) 2:08cv304 *Linksmart Wireless Technology Llc v Cisco Systems, Inc et A*

Status (**OPEN**) 2:08cv264 *Linksmart Wireless Technology Llc v T-Mobile USA, Inc et al*

- 1) I performed a KeyCite Search in Westlaw, which retrieves all history on the patent including any litigation.
- 2) I performed a search on the patent in Lexis CourtLink for any open dockets or closed cases.
- 3) I performed a search in Lexis in the Federal Courts and Administrative Materials databases for any cases found.
- 4) I performed a search in Lexis in the IP Journal and Periodicals database for any articles on the patent.
- 5) I performed a search in Lexis in the news databases for any articles about the patent or any articles about litigation on this patent.

**KEYCITE**

**H US PAT 6779118 USER SPECIFIC AUTOMATIC DATA REDIRECTION SYSTEM, Assignee: Aurig Systems, Inc. (Aug 17, 2004)**

**History****Direct History**

=> **1 USER SPECIFIC AUTOMATIC DATA REDIRECTION SYSTEM, US PAT 6779118, 2004 WL 1841593 (U.S. PTO Utility Aug 17, 2004) (NO. 09/295966)**

*Construed by*

**H 2 Linksmart Wireless Technology, LLC v. T-Mobile USA, Inc., 2010 WL 2640402, 2010 Markman 2640402 (E.D.Tex. Jun 30, 2010) (NO. 2:08-CV-264-DF-CE) (Markman Order Version)**

**Court Documents****Trial Court Documents (U.S.A.)****E.D.Tex. Trial Pleadings**

- 3 LINKSMART WIRELESS TECHNOLOGY, LLC, Plaintiff, v. 1. T-MOBILE USA, INC.; 2. Wayport, Inc.; 3. AT&T, Inc.; 4. AT&T Mobility, LLC; 5. Lodgenet Interactive Corp.; 6. Ibahn General Holdings Corp.; 7. Ethostream, LLC; 8. Hot Point Wireless, Inc.; 9. Netnearu Corp.; 10. Pronto Networks, Inc.; 11. Aptilo N, 2008 WL 3538408 (Trial Pleading) (E.D.Tex. Jul. 1, 2008) **Complaint and Demand for Jury Trial (NO. 08CV00264)**
- 4 LINKSMART WIRELESS TECHNOLOGY, LLC, Plaintiff, v. T-MOBILE USA, INC., et al., Defendants., 2008 WL 4355636 (Trial Pleading) (E.D.Tex. Aug. 21, 2008) **Linksmart Wireless Technology, LLC'S Reply to Ethostream, LLC'S Counterclaim (NO. 208CV00264)**
- 5 LINKSMART WIRELESS TECHNOLOGY, LLC, Plaintiff, v. T-MOBILE USA, INC., et al., Defendants., 2008 WL 4355637 (Trial Pleading) (E.D.Tex. Aug. 29, 2008) **Answer and Counterclaim (NO. 208CV00264)**
- 6 LINKSMART WIRELESS TECHNOLOGY, LLC, Plaintiff, v. (1) T-MOBILE USA, INC., (2) Wayport, Inc., (3) AT&T, Inc., (4) AT&T Mobility, LLC, (5) Lodgenet Interactive Corp., (6) ibahn General Holdings Corp., (7) Ethostream, LLC, (8) Hot Point Wireless, Inc., (9) Netnearu Corp., (10) Pronto Networks, Inc. (11, 2008 WL 5369919 (Trial Pleading) (E.D.Tex. Sep. 12, 2008) **Defendant ibahn General Holdings Corp.'s Answer and Counterclaims to Linksmart Wireless Technology, LLC's Complaint (NO. 208-CV-00264-TJW-CE)**
- 7 LINKSMART WIRELESS TECHNOLOGY, LLC, Plaintiff, v. T-MOBILE USA, INC.; Wayport, Inc.; At&t, Inc.; AT&T Mobility, LLC; Lodgenet Interactive Corporation; Ibahn General Holdings Corp.; Ethostream, LLC; Hot Point Wireless, Inc.; Netnearu Corp.; Pronto Networks, Inc.; Aptilo Networks, Inc.; Freefi Network, 2008 WL 5369920 (Trial Pleading) (E.D.Tex. Sep.

- 12, 2008) **Defendant Aptilo Networks, Inc.'s Answer, Affirmative Defenses and Counterclaims to Plaintiff's Complaint for Patent Infringement** (NO. 208-CV-264TJW-CE)
- 8 **LINKSMART WIRELESS TECHNOLOGY, LLC, Plaintiff, v. 1. T-MOBILE USA, INC.; 2. Wayport, Inc.; 3. AT&T, Inc.; Jury 4. AT&T Mobility, LLC; 5. Lodgenet Interactive Corp.; 6. Ibahn General Holdings Corp.; 7. Ethostream, LLC; 8. Hot Point Wireless, Inc.; 9. Netnearu Corp.; 10. Pronto Networks, Inc.; 11. Apt, 2008 WL 5369909 (Trial Pleading) (E.D.Tex. Sep. 15, 2008) Defendant Marriott International, Inc.'s Answer and Counterclaims to Linksmart Wireless Technology, LLC's Complaint** (NO. 208-CV-00264-TJW-CE)
- 9 **LINKSMART WIRELESS TECHNOLOGY, LLC, Plaintiff, v. T-MOBILE USA, INC., et al., Defendants., 2008 WL 5369910 (Trial Pleading) (E.D.Tex. Sep. 15, 2008) Wayport, Inc.'s Answer, Defenses, and Counterclaims to Complaint** (NO. 208-CV-00264-TJW-CE)
- 10 **LINKSMART WIRELESS TECHNOLOGY, LLC, Plaintiff, v. T-MOBILE USA, INC. et al., Defendants., 2008 WL 5369911 (Trial Pleading) (E.D.Tex. Sep. 15, 2008) Defendant Barnes & Noble Booksellers, Inc. Answer to Plaintiff's Complaint** (NO. 208-CV-00264-TJW-CE)
- 11 **LINKSMART WIRELESS TECHNOLOGY, LLC, Plaintiff, v. T-MOBILE USA, INC., et al., Defendants., 2008 WL 5369912 (Trial Pleading) (E.D.Tex. Sep. 15, 2008) McDonald's Corp.'s Answer, Defenses, and Counterclaims to Complaint** (NO. 208-CV-00264-TJW-CE)
- 12 **LINKSMART WIRELESS TECHNOLOGY, LLC, Plaintiff, v. T-MOBILE USA, INC., et al., Defendants., 2008 WL 5369913 (Trial Pleading) (E.D.Tex. Sep. 15, 2008) Meraki, Inc.'s Answer, Defenses, and Counterclaims to Complaint** (NO. 208-CV-00264-TJW-CE)
- 13 **LINKSMART WIRELESS TECHNOLOGY, LLC, Plaintiff, v. T-MOBILE USA, INC., et al., Defendants., 2008 WL 5369914 (Trial Pleading) (E.D.Tex. Sep. 15, 2008) Best Western International, Inc.'s Answer to Plaintiff's Complaint and Counterclaims** (NO. 208-CV-00264-TJW-CE)
- 14 **LINKSMART WIRELESS TECHNOLOGY, LLC, Plaintiff, v. T-MOBILE USA, INC.; et al., Defendants., 2008 WL 5369921 (Trial Pleading) (E.D.Tex. Sep. 15, 2008) T-Mobile USA, Inc.'s Answer and Counterclaims** (NO. 208-CV-00264-TJW-CE)
- 15 **LINKSMART WIRELESS TECHNOLOGY, LLC, Plaintiff, v. T-MOBILE USA, Inc. et al., Defendants., 2008 WL 5369922 (Trial Pleading) (E.D.Tex. Sep. 15, 2008) Defendant Mail Boxes Etc., Inc.'s Answer to Plaintiff's Complaint** (NO. 208-CV-00264-TJW)
- 16 **LINKSMART WIRELESS TECHNOLOGY, LLC, Plaintiff, v. T-MOBILE USA, INC.; Wayport, Inc.; AT&T, Inc.; AT&T Mobility, LLC; Lodgenet Interactive Corporation; Ibahn General Holdings Corp.; Ethostream, LLC; Hot Point Wireless, Inc.; Netnearu Corp.; Pronto Networks, Inc.; Aptilo Networks, Inc.; Freefi Network, 2008 WL 5369915 (Trial Pleading) (E.D.Tex. Sep. 19, 2008) Ramada Worldwide, Inc.'s Answer to Complaint and Counterclaims** (NO. 208-CV-00264-TJW-CE)
- 17 **LINKSMART WIRELESS TECHNOLOGY, LLC, Plaintiff, v. T-MOBILE USA, INC., et al., Defendants., 2008 WL 5369916 (Trial Pleading) (E.D.Tex. Sep. 19, 2008) Pronto Networks, Inc.'s Answer, Defenses, and Counterclaims to the Complaint** (NO. 208-CV-00264-TJW-CE)
- 18 **LINKSMART WIRELESS TECHNOLOGY, LLC, Plaintiff, v. 1. T-MOBILE USA, INC.; 2. Wayport, Inc.; 3. AT&T, Inc.; 4. AT&T Mobility, LLC; 5. Lodgenet Interactive Corp.; 6. Ibahn General Holdings Corp.; 7. Ethostream, LLC; 8. Hot Point Wireless, Inc.; 9. Netnearu Corp.; 10. Pronto Networks, Inc.; 11. Aptilo N, 2008 WL 5369917 (Trial Pleading) (E.D.Tex. Sep. 22,**

- 2008) **Defendant Freefi Networks. Inc.'s Answer and Counterclaims to Original Complaint** (NO. 208CV00264TJW)
- 19 LINKSMART WIRELESS TECHNOLOGY, LLC, Plaintiff, v. T-MOBILE USA, INC., et al., Defendants. BEST WESTERN INTERNATIONAL, INC., Third-Party Plaintiff, v. BESTCOMM NETWORKS, INC. and Nomadix, Inc., Third-Party Defendants., 2009 WL 5819738 (Trial Pleading) (E.D.Tex. Nov. 13, 2009) **Third Party Complaint of Best Western International, Inc.** (NO. 208CV00264)
- 20 LINKSMART WIRELESS TECHNOLOGY, LLC, Plaintiff, v. T-MOBILE USA, INC., et al., Defendant., 2009 WL 5819739 (Trial Pleading) (E.D.Tex. Nov. 20, 2009) **Ramada Worldwide, Inc.'s Amended Answer to Complaint and Counterclaims** (NO. 208CV00264)
- 21 LINKSMART WIRELESS TECHNOLOGY, LLC, Plaintiff, v. T-MOBILE USA, INC., et al., Defendant., 2009 WL 5819740 (Trial Pleading) (E.D.Tex. Nov. 20, 2009) **Ethostream, LLC's Amended Answer and Counterclaim** (NO. 208CV00264)

**E.D.Tex. Trial Motions, Memoranda And Affidavits**

- 22 LINKSMART WIRELESS TECHNOLOGY, LLC, Plaintiff, v. T-MOBILE USA, Inc. et al., Defendants., 2008 WL 5369918 (Trial Motion, Memorandum and Affidavit) (E.D.Tex. Sep. 22, 2008) **Defendant At&T Mobility LLC's Motion to Dismiss** (NO. 208-CV-00264-TJW-CE)
- 23 LINKSMART WIRELESS TECHNOLOGY, LLC, Plaintiff, v. T-MOBILE USA, INC.; et al., Defendants; Linksmart Wireless Technology, LLC, Plaintiff, v. Cisco Systems, Inc.; Et Al., Defendants; Linksmart Wireless Technology, LLC, Plaintiff, v. SBC Internet Services, Inc. d/b/a AT&T Internet Services, Defendants;, 2009 WL 721149 (Trial Motion, Memorandum and Affidavit) (E.D.Tex. Jan. 23, 2009) **Joint Motion to Consolidate** (NO. 208-CV-002640TJW-CE, 208-CV-00304-DF-CE, 208-CV-00385-TJW, 209-CV-00026-TJW-CE)
- 24 LINKSMART WIRELESS TECHNOLOGY, LLC, Plaintiff, v. T-MOBILE USA, INC.; et al., Defendants; Linksmart Wireless Technology, LLC, Plaintiff, v. Cisco Systems, Inc.; et al., Defendants; Linksmart Wireless Technology, LLC, Plaintiff, v. SBC Internet Services, Inc. d/b/a At&t Internet Services, Defendants;, 2009 WL 721433 (Trial Motion, Memorandum and Affidavit) (E.D.Tex. Jan. 23, 2009) **Joint Motion to Consolidate** (NO. 208-CV-00264-TJW-CE, 208-CV-00304-DF-CE, 208-CV-00385-TJW, 209-CV-00026-TJW-CE)
- 25 LINKSMART WIRELESS TECHNOLOGY, LLC, Plaintiff, v. T-MOBILE USA, INC., et al., Defendants., 2009 WL 714069 (Trial Motion, Memorandum and Affidavit) (E.D.Tex. Feb. 27, 2009) **Plaintiff Linksmart Wireless Technology, LLC's Motion for Default Judgment Against Hot Point Wireless, Inc. and Second Rule LLC** (NO. 208-CV-00264-DF-CE)
- 26 LINKSMART WIRELESS TECHNOLOGY, LLC, Plaintiff, v. T-MOBILE USA, INC., et al., Defendants. Best Western International, Inc., Third-Party Plaintiff, v. Bestcomm Networks, Inc. and Nomadix, Inc., Third-Party Defendants., 2010 WL 974673 (Trial Motion, Memorandum and Affidavit) (E.D.Tex. Feb. 25, 2010) **Third-Party Defendant Nomadix, Inc.'s Motion to Strike or Dismiss Third-Party Complaint of Best Western International, Inc.** (NO. 208-CV-00264-DF-CE, 208-CV-00304-DF-CE, 208-CV-00385-DF-CE, 209-CV-00026-DF-CE)
- 27 LINKSMART WIRELESS TECHNOLOGY, LLC, Plaintiff, v. T-MOBILE USA, INC., et al., Defendants., 2010 WL 2155255 (Trial Motion, Memorandum and Affidavit) (E.D.Tex. Mar. 19, 2010) **Plaintiff Linksmart Wireless Technology, LLC's Opening Claim Construction Brief**

- (NO. 208CV00264)
- 28 LINKSMART WIRELESS TECHNOLOGY, LLC, Plaintiff, v. T-MOBILE USA, INC., et al., Defendants. BEST WESTERN INTERNATIONAL, INC., Third-Party Plaintiff, v. BESTCOMM NETWORKS, INC. and Nomadix, Inc., Third-Party Defendants., 2010 WL 2155256 (Trial Motion, Memorandum and Affidavit) (E.D.Tex. Mar. 31, 2010) **Best Western International's Opposition to Nomadix's Motion to Strike or Dismiss Third Party Complaint** (NO. 208CV00264)
- 29 LINKSMART WIRELESS TECHNOLOGY, LLC, Plaintiff, v. T-MOBILE USA, INC., et al., Defendants. BEST WESTERN INTERNATIONAL, INC., Third-Party Plaintiff, v. BESTCOMM NETWORKS, NOMADIX, INC., Third-Party Defendants. BESTCOMM NETWORKS, INC., Third-Party Defendant, v. NOMADIX, INC., Third-Party Defendant., 2010 WL 2155257 (Trial Motion, Memorandum and Affidavit) (E.D.Tex. Apr. 16, 2010) **Nomadix, Inc.'s Motion to Dismiss Bestcomm Networks, Inc.'s Crossclaims** (NO. 208CV00264)
- 30 LINKSMART WIRELESS TECHNOLOGY, LLC, Plaintiff, v. T-MOBILE USA, INC., et al., Defendants., 2010 WL 2155258 (Trial Motion, Memorandum and Affidavit) (E.D.Tex. Apr. 16, 2010) **Claim Construction Brief of Defendants** (NO. 208CV00264)
- 31 LINKSMART WIRELESS TECHNOLOGY, LLC, Plaintiff, v. T-MOBILE USA, INC., et al., Defendants., 2010 WL 2155259 (Trial Motion, Memorandum and Affidavit) (E.D.Tex. Apr. 19, 2010) **Best Western's Supplemental Claim Construction Brief** (NO. 208CV00264)
- 32 LINKSMART WIRELESS TECHNOLOGY, LLC, Plaintiff, v. T-MOBILE USA, INC., et al., Defendants., 2010 WL 2155260 (Trial Motion, Memorandum and Affidavit) (E.D.Tex. Apr. 29, 2010) **Defendants' Motion to Exclude the Expert Declaration of Dr. Tal Lavian in Support of Plaintiff's Claim Construction Reply Brief** (NO. 208CV00264)
- 33 LINKSMART WIRELESS TECHNOLOGY, LLC, Plaintiff, v. T-MOBILE USA, INC., et al., Defendants., 2010 WL 2155261 (Trial Motion, Memorandum and Affidavit) (E.D.Tex. Apr. 30, 2010) **Plaintiff Linksmart Wireless Technology, LLC's Reply Claim Construction Brief** (NO. 208CV00264)

#### E.D.Tex. Trial Filings

- 34 LINKSMART WIRELESS TECHNOLOGY, LLC, Plaintiff, v. T-MOBILE USA, INC., et al., Defendants; Linksmart Wireless Technology, LLC, Plaintiff, v. Cisco Systems, Inc., et al., Defendants; Linksmart Wireless Technology, LLC, Plaintiff, v. SBC Internet Services, Inc. D/B/A AT&T Internet Services, Defendants;, 2009 WL 3147057 (Trial Filing) (E.D.Tex. Jun. 1, 2009) **Joint Case Management Report** (NO. 208-CV-00264-DF-CE, 208-CV-00304-DF-CE, 208-CV-00385-DF-CE, 209-CV-00026-DF-CE)
- 35 LINKSMART WIRELESS TECHNOLOGY, LLC, Plaintiff, v. T-MOBILE USA, INC., et al., Defendants; Linksmart Wireless Technology, LLC, Plaintiff, v. Cisco Systems, Inc., et al., Defendants; Linksmart Wireless Technology, LLC, Plaintiff, v. SBC Internet Services, Inc. D/B/A AT&T Internet Services, Defendants;, 2009 WL 3147069 (Trial Filing) (E.D.Tex. Jun. 1, 2009) **Joint Case Management Report** (NO. 208-CV-00264-DF-CE, 208-CV-00304-DF-CE, 208-CV-00385-DF-CE, 209-CV-00026-DF-CE)
- 36 LINKSMART WIRELESS TECHNOLOGY, LLC, Plaintiff, v. T-MOBILE USA, INC., et al., Defendants; Linksmart Wireless Technology, LLC, Plaintiff, v. Cisco Systems, Inc., et al., De-

- defendants; Linksmart Wireless Technology, LLC, Plaintiff, v. SBC Internet Services, Inc. D/B/A AT&T Internet Services, Defendants;, 2009 WL 3147139 (Trial Filing) (E.D.Tex. Jun. 1, 2009) **Joint Case Management Report** (NO. 208-CV-00264-DF-CE, 208-CV-00304-DF-CE, 208-CV-00385-DF-CE, 209-CV-00026-DF-CE)
- 37 LINKSMART WIRELESS TECHNOLOGY, LLC, v. T-MOBILE USA, INC. et al., 2010 WL 1733529 (Trial Filing) (E.D.Tex. Feb. 19, 2010) **Claim Construction Chart** (NO. 208CV00264)

**E.D.Tex. Verdicts, Agreements and Settlements**

- 38 LINKSMART WIRELESS TECHNOLOGY, LLC, Plaintiff, v. T-MOBILE USA, INC.; Wayport, Inc.; AT&T, Inc.; AT&T Mobility, LLC; Lodgenet Interactive Corp.; Ibahn General Holdings Corp.; Ethostream, LLC; Hot Point Wireless, Inc.; Netnearu Corp.; Pronto Networks, Inc.; Freefi Networks, Inc.; Meraki, Inc. Second, 2008 WL 5533263 (Verdict, Agreement and Settlement) (E.D.Tex. Dec. 9, 2008) **Jury** (NO. 208CV00264)
- 39 LINKSMART WIRELESS TECHNOLOGY, LLC, Plaintiff, v. T-MOBILE USA, INC., et al., Defendants; Linksmart Wireless Technology, LLC, Plaintiff, v. Cisco Systems, Inc., et al., Defendants; Linksmart Wireless Technology, LLC, Plaintiff, v. SBC Internet Services, Inc. d/b/a AT&T Internet Services, Defendants;, 2009 WL 3147112 (Verdict, Agreement and Settlement) (E.D.Tex. Jun. 1, 2009) **Joint Case Management Report** (NO. 208-CV-00264-DF-CE, 208-CV-00304-DF-CE, 208-CV-00385-DF-CE, 209-CV-00026-DF-CE)

**Dockets (U.S.A.)**

**E.D.Tex.**

- 40 LINKSMART WIRELESS TECHNOLOGY, LLC v. T-MOBILE USA, INC. ET AL, NO. 2:08cv00264 (Docket) (E.D.Tex. Jul. 1, 2008)

**Patent Family**

- 41 AUTOMATIC DATA REDIRECTION SYSTEM FOR INTERNET COMMUNICATION, Derwent World Patents Legal 2000-072306

**Assignments**

- 42 Action: ASSIGNMENT OF ASSIGNORS INTEREST (SEE DOCUMENT FOR DETAILS). Number of Pages: 012, (DATE RECORDED: Jul 02, 2008)
- 43 ACTION: ASSIGNMENT OF ASSIGNORS INTEREST (SEE DOCUMENT FOR DETAILS). NUMBER OF PAGES: 003, (DATE RECORDED: Jun 29, 1999)

**Patent Status Files**

- .. Patent Suit(See LitAlert Entries),
- .. Patent Suit(See LitAlert Entries),
- .. Request for Re-Examination, (OG DATE: Dec 02, 2008)
- .. Patent Suit(See LitAlert Entries),

#### **Docket Summaries**

- 48 LINKSMART WIRELESS TECHNOLOGY LLC v. SIX CONTINENTS HOTELS INC ET AL, (E.D.TEX. Jan 21, 2009) (NO. 2:09CV00026), (28 USC 1338 PATENT INFRINGEMENT)
- 49 LINKSMART WIRELESS TECHNOLOGY, LLC v. SBC INTERNET SERVICES, INC., (E.D.TEX. Oct 09, 2008) (NO. 2:08CV00385), (15 USC 1126 PATENT INFRINGEMENT)
- 50 LINKSMART WIRELESS TECHNOLOGY, LLC v. CISCO SYSTEMS, INC. ET AL, (E.D.TEX. Aug 04, 2008) (NO. 2:08CV00304), (35 USC 271 PATENT INFRINGEMENT)
- 51 LINKSMART WIRELESS TECHNOLOGY, LLC v. T-MOBILE USA, INC. ET AL, (E.D.TEX. Jul 01, 2008) (NO. 2:08CV00264), (15 USC 1126 PATENT INFRINGEMENT)

#### **Litigation Alert**

- .. Derwent LitAlert P2009-07-58 (Jan 21, 2009) Action Taken: Complaint
- .. Derwent LitAlert P2009-06-09 (Aug 04, 2008) Action Taken: Complaint
- 54 Derwent LitAlert P2008-47-12 (Jul 01, 2008) Action Taken: Complaint

#### **Prior Art (Coverage Begins 1976)**

- C** 55 METHOD OF PROVIDING TEMPORARY ACCESS OF A CALLING UNIT TO AN ANONYMOUS UNIT, US PAT 6157829 Assignee: Motorola, Inc., (U.S. PTO Utility 2000)
- C** 56 SECURITY SYSTEM FOR INTERNET PROVIDER TRANSACTION, US PAT 5845070 Assignee: Auric Web Systems, Inc., (U.S. PTO Utility 1998)
- C** 57 SYSTEM AND METHOD FOR DATABASE ACCESS CONTROL, US PAT 5696898 Assignee: Lucent Technologies Inc., (U.S. PTO Utility 1997)
- C** 58 SYSTEM AND METHOD FOR PROVIDING PEER LEVEL ACCESS CONTROL ON A NETWORK, US PAT 6233686 Assignee: AT & T Corp., (U.S. PTO Utility 2001)



---

**US District Court Civil Docket**

**U.S. District - Texas Eastern  
(Marshall)**

**2:09cv26**

**Linksmart Wireless Technology Llc v. Six Continents Hotels Inc et A**

This case was retrieved from the court on Wednesday, May 26, 2010

---

<b>Date Filed: 01/21/2009</b>	<b>Class Code:</b>
<b>Assigned To: Judge David Folsom</b>	<b>Closed: No</b>
<b>Referred To: Magistrate Judge Charles Everingham</b>	<b>Statute: 28:1338</b>
<b>Nature of suit: Patent (830)</b>	<b>Jury Demand: Defendant</b>
<b>Cause: Patent Infringement</b>	<b>Demand Amount: \$0</b>
<b>Lead Docket: 2:08-cv-00264-DF-CE</b>	<b>NOS Description: Patent</b>
<b>Other Docket: 2:08-cv-00264-DF-CE</b>	
<b>2:08-cv-00304-DF-CE</b>	
<b>2:08-cv-00385-D</b>	
<b>Jurisdiction: Federal Question</b>	

**Litigants**

Linksmart Wireless Technology Llc  
Plaintiff

**Attorneys**

Marc A Fenster  
[COR LD NTC]  
Russ August & Kabat  
12424 Wilshire Boulevard  
12TH Floor  
Los Angeles , CA 90025  
USA  
310/ 826-7474  
Fax: 310/ 826-6991  
Email: Mfenster@raklaw.com

Andrew W Spangler  
[COR LD NTC]  
Spangler Law PC  
208 N Green St  
Suite 300  
Longview , TX 75601  
USA  
903-753-9300  
Fax: 903-553-0403  
Email: SPANGLER@SPANGLERLAWPC.COM

Andrew D Weiss  
[COR LD NTC]  
Russ August & Kabat  
12424 Wilshire Boulevard  
12TH Floor  
Los Angeles , CA 90025  
USA  
310/ 826-7474  
Fax: 310/ 826-6991  
Email: AWEISS@RAKLAW.COM

Six Continents Hotels Inc

John M Guaragna

Defendant

[COR LD NTC]  
Dla Piper US LLP -Austin  
401 Congress Ave  
Suite 2500  
Austin , TX 78701-3799  
USA  
512/ 457-7000  
Fax: 512/ 457-7001  
Email: JOHN.GUARAGNA@DLAPIPER.COM

Intercontinental Hotels Group Resources Inc  
Defendant

John M Guaragna  
[COR LD NTC]  
Dla Piper US LLP -Austin  
401 Congress Ave  
Suite 2500  
Austin , TX 78701-3799  
USA  
512/ 457-7000  
Fax: 512/ 457-7001  
Email: JOHN.GUARAGNA@DLAPIPER.COM

Six Continents Hotels Inc  
Counter Claimant

John M Guaragna  
[COR LD NTC]  
Dla Piper US LLP -Austin  
401 Congress Ave  
Suite 2500  
Austin , TX 78701-3799  
USA  
512/ 457-7000  
Fax: 512/ 457-7001  
Email: JOHN.GUARAGNA@DLAPIPER.COM

Intercontinental Hotels Group Resources Inc  
Counter Claimant

John M Guaragna  
[COR LD NTC]  
Dla Piper US LLP -Austin  
401 Congress Ave  
Suite 2500  
Austin , TX 78701-3799  
USA  
512/ 457-7000  
Fax: 512/ 457-7001  
Email: JOHN.GUARAGNA@DLAPIPER.COM

Linksmart Wireless Technology Llc  
Counter Defendant

Marc A Fenster  
[COR LD NTC]  
Russ August & Kabat  
12424 Wilshire Boulevard  
12TH Floor  
Los Angeles , CA 90025  
USA  
310/ 826-7474  
Fax: 310/ 826-6991  
Email: Mfenster@raklaw.com

Andrew W Spangler  
[COR LD NTC]  
Spangler Law PC  
208 N Green St  
Suite 300  
Longview , TX 75601  
USA  
903-753-9300  
Fax: 903-553-0403

Email: SPANGLER@SPANGLERLAWPC.COM

Andrew D Weiss  
[COR LD NTC]  
Russ August & Kabat  
12424 Wilshire Boulevard  
12TH Floor  
Los Angeles , CA 90025  
USA  
310/ 826-7474  
Fax: 310/ 826-6991  
Email: AWEISS@RAKLAW.COM

Date	#	Proceeding Text
01/21/2009	1	COMPLAINT against Six Continents Hotels Inc, Intercontinental Hotels Group Resources Inc ( Filing fee \$ 350 receipt number 0540000000001843024.), filed by Linksmart Wireless Technology LLC. (Attachments: # 1 Exhibit A, # 2 Civil Cover Sheet)(Fenster, Marc) (Entered: 01/21/2009)
01/21/2009	2	Notice of Filing of Patent/Trademark Form (AO 120). AO 120 mailed to the Director of the U.S. Patent and Trademark Office. (Fenster, Marc) (Entered: 01/21/2009)
01/21/2009	3	CORPORATE DISCLOSURE STATEMENT filed by Linksmart Wireless Technology LLC (Fenster, Marc) (Entered: 01/21/2009)
01/21/2009	4	NOTICE by Linksmart Wireless Technology LLC of Related Cases (Fenster, Marc) (Entered: 01/21/2009)
01/21/2009	5	E-GOV SEALED SUMMONS Issued as to Six Continents Hotels Inc, Intercontinental Hotels Group Resources Inc. (Attachments: # 1 summons InterContinental Hotels)(ehs, ) (Entered: 01/21/2009)
01/21/2009	6	ORDER REFERRING CASE for Pretrial proceedings to Magistrate Judge Charles Everingham. Signed by Judge T. John Ward on 1/21/09. (ehs, ) (Entered: 01/21/2009)
01/21/2009	7	Magistrate Consent Form Mailed to Linksmart Wireless Technology LLC (ehs, ) (Entered: 01/21/2009)
01/22/2009	8	NOTICE of Attorney Appearance by Andrew D Weiss on behalf of Linksmart Wireless Technology LLC (Weiss, Andrew) (Entered: 01/22/2009)
01/22/2009	9	NOTICE of Attorney Appearance by Andrew Wesley Spangler on behalf of Linksmart Wireless Technology LLC (Spangler, Andrew) (Entered: 01/22/2009)
01/23/2009	10	Joint MOTION to Consolidate Cases by Linksmart Wireless Technology LLC. (Attachments: # 1 Text of Proposed Order)(Weiss, Andrew) (Entered: 01/23/2009)
02/03/2009	11	ORDER REASSIGNING CASE. Case reassigned to Judge David Folsom for all further proceedings. Judge T. John Ward no longer assigned to case. Signed by Judge T. John Ward on 2/2/09. (ch, ) (Entered: 02/03/2009)
02/06/2009	12	E-GOV SEALED SUMMONS Returned Executed by Linksmart Wireless Technology LLC. Intercontinental Hotels Group Resources Inc served on 1/21/2009 to John Guaragna DLA Piper by CM RRR, answer due 2/10/2009. (ehs, ) (Entered: 02/06/2009)
02/06/2009	13	E-GOV SEALED SUMMONS Returned Executed by Linksmart Wireless Technology LLC. Six Continents Hotels Inc served on 1/21/2009 to John Guaragna, DLA Piper by CM RRR, answer due 2/10/2009. (ehs, ) (Entered: 02/06/2009)
02/10/2009	14	ANSWER to 1 Complaint,, COUNTERCLAIM against Linksmart Wireless Technology LLC by Six Continents Hotels Inc, Intercontinental Hotels Group Resources Inc.(Guaragna, John) (Entered: 02/10/2009)
02/10/2009	15	CORPORATE DISCLOSURE STATEMENT filed by Six Continents Hotels Inc, Intercontinental Hotels Group Resources Inc identifying Corporate Parent InterContinental Hotels Group PLC for Intercontinental Hotels Group Resources Inc, Six Continents Hotels Inc. (Guaragna, John) (Entered: 02/10/2009)
02/27/2009	16	ANSWER to 14 Answer to Complaint, Counterclaim by Linksmart Wireless Technology LLC. (Weiss, Andrew) (Entered: 02/27/2009)
04/22/2009	17	NOTICE of Change of Address by John M Guaragna (Guaragna, John) (Entered: 04/22/2009)

05/01/2009 18 ORDER granting 10 Motion to Consolidate Cases. ORDERED that the above- captioned actions are consolidated for all purposes pursuant to Federal Rule of Civil Procedure 42(a) and Local Rule CV-42(b) and (c).. Signed by Magistrate Judge Charles Everingham on 5/1/09. (ch, ) (Entered: 05/01/2009)

05/01/2009 -- NOTICE OF FILING DOCUMENTS IN CONSOLIDATED CASES re 18 Order on Motion to Consolidate Cases. ALL FUTURE FILINGS TO BE FILED IN LEAD CASE 2:08cv264 ONLY (ehs, ) (Entered: 09/03/2009)

05/04/2009 19 NOTICE of Hearing: Scheduling Conference set for 6/3/2009 10:00 AM in Mag Ctrm (Marshall) before Magistrate Judge Charles Everingham. (jml, ) (Entered: 05/04/2009)

05/06/2009 20 Notice of Scheduling Conference, Proposed Deadlines for Docket Control Order and Discovery Order. Scheduling Conference set for 6/3/2009 10:00 AM before Magistrate Judge Charles Everingham. The parties are directed to meet and confer in accordance with Fed. R. Civ. P. 26(f) no later than 5/27/09. Signed by Magistrate Judge Charles Everingham on 5/5/09. (ch, ) (Entered: 05/06/2009)

06/01/2009 21 REPORT of Rule 26(f) Planning Meeting. (Attachments: # 1 Exhibit A - Proposed Docket Control Order)(Weiss, Andrew) (Additional attachment(s) added on 6/1/2009: # 2 Revised Scheduling Order) (sm, ). (Entered: 06/01/2009)

06/03/2009 22 Minute Entry for proceedings held before Magistrate Judge Charles Everingham: Scheduling Conference held on 6/3/2009. (Court Reporter Susan Simmons, CSR.) (jml) (Entered: 06/04/2009)

---

Copyright © 2010 LexisNexis CourtLink, Inc. All rights reserved.  
\*\*\* THIS DATA IS FOR INFORMATIONAL PURPOSES ONLY \*\*\*

---

**US District Court Civil Docket**

**U.S. District - Texas Eastern  
(Marshall)**

**2:08cv385**

**Linksmart Wireless Technology, Llc v. Sbc Internet Services, Inc**

This case was retrieved from the court on Wednesday, May 26, 2010

---

<b>Date Filed: 10/09/2008</b>	<b>Class Code:</b>
<b>Assigned To: Judge David Folsom</b>	<b>Closed: No</b>
<b>Referred To: Magistrate Judge Charles Everingham</b>	<b>Statute: 15:1126</b>
<b>Nature of suit: Patent (830)</b>	<b>Jury Demand: Both</b>
<b>Cause: Patent Infringement</b>	<b>Demand Amount: \$0</b>
<b>Lead Docket: 2:08-cv-00264-DF-CE</b>	<b>NOS Description: Patent</b>
<b>Other Docket: 2:08-cv-00264-DF-CE</b>	
<b>2:08-cv-00304-DF-CE</b>	
<b>2:09-cv-00026-D</b>	
<b>Jurisdiction: Federal Question</b>	

**Litigants**

Linksmart Wireless Technology, Llc  
Plaintiff

**Attorneys**

Marc A Fenster  
[COR LD NTC]  
Russ August & Kabat  
12424 Wilshire Boulevard  
12TH Floor  
Los Angeles , CA 90025  
USA  
310/ 826-7474  
Fax: 310/ 826-6991  
Email: Mfenster@raklaw.com

Andrew W Spangler  
[COR LD NTC]  
Spangler Law PC  
208 N Green St  
Suite 300  
Longview , TX 75601  
USA  
903-753-9300  
Fax: 903-553-0403  
Email: SPANGLER@SPANGLERLAWPC.COM

Andrew D Weiss  
[COR LD NTC]  
Russ August & Kabat  
12424 Wilshire Boulevard  
12TH Floor  
Los Angeles , CA 90025  
USA  
310/ 826-7474  
Fax: 310/ 826-6991  
Email: AWEISS@RAKLAW.COM

Sbc Internet Services, Inc Doing Business as At&T

Richard Alan Sayles

Internet Services  
Defendant

[COR LD NTC]  
Sayles Werbner  
1201 Elm Street  
4400 Renaissance Tower  
Dallas , TX 75270  
USA  
214/ 939-8700  
Fax: 12149398787  
Email: Dsayles@swtriallaw.com

David T Pritikin  
[COR LD NTC]  
Sidley Austin -Chicago Bank One Plaza  
One South Dearborn Ave  
Chicago , IL 60603  
USA  
312/ 853-7359  
Fax: 312/ 853-7036  
Email: DPRITIKIN@SIDLEY.COM

EVE L Henson  
[COR LD NTC]  
Sayles | Werbner  
1201 Elm Street  
4400 Renaissance Tower  
Dallas , TX 75270  
USA  
214/ 939-8700  
Fax: 12149398787  
Email: Ehenson@swtriallaw.com

Hugh A Abrams  
[COR LD NTC]  
Sidley Austin -Chicago Bank One Plaza  
One South Dearborn Ave  
Chicago , IL 60603  
USA  
312/ 853-7017  
Fax: 13128537036  
<i>pro Hac Vice</ I>  
Email: HABRAMS@SIDLEY.COM

Mark Daniel Strachan  
[COR LD NTC]  
Sayles Webner  
4400 Renaissance  
1201 Elm Street  
Dallas , TX 75270  
USA  
214-939-8707  
Fax: 214-939-8787  
Email: Mstrachan@swtriallaw.com

Rachel D Sher  
[COR LD NTC]  
Sidley Austin -Chicago  
One South Dearborn St  
Chicago , IL 60603  
USA  
312/ 853-7000  
Fax: 312/ 853-7036  
Email: RSHER@SIDLEY.COM

Richard T McCaulley , Jr  
[COR LD NTC]  
Sidley Austin -Chicago Bank One Plaza  
One South Dearborn Ave

Chicago , IL 60603  
USA  
312/ 853-7000  
Fax: 312/ 853-7036  
Email: RMCCAULLEY@SIDLEY.COM

Sbc Internet Services, Inc  
Counter Claimant

Richard Alan Sayles  
[COR LD NTC]  
Sayles Werbner  
1201 Elm Street  
4400 Renaissance Tower  
Dallas , TX 75270  
USA  
214/ 939-8700  
Fax: 12149398787  
Email: Dsayles@swtriallaw.com

David T Pritikin  
[COR LD NTC]  
Sidley Austin -Chicago Bank One Plaza  
One South Dearborn Ave  
Chicago , IL 60603  
USA  
312/ 853-7359  
Fax: 312/ 853-7036  
Email: DPRITIKIN@SIDLEY.COM

Rachel D Sher  
[COR LD NTC]  
Sidley Austin -Chicago  
One South Dearborn St  
Chicago , IL 60603  
USA  
312/ 853-7000  
Fax: 312/ 853-7036  
Email: RSHER@SIDLEY.COM

Richard T McCaulley , Jr  
[COR LD NTC]  
Sidley Austin -Chicago Bank One Plaza  
One South Dearborn Ave  
Chicago , IL 60603  
USA  
312/ 853-7000  
Fax: 312/ 853-7036  
Email: RMCCAULLEY@SIDLEY.COM

Linksmart Wireless Technology, Llc  
Counter Defendant

Marc A Fenster  
[COR LD NTC]  
Russ August & Kabat  
12424 Wilshire Boulevard  
12TH Floor  
Los Angeles , CA 90025  
USA  
310/ 826-7474  
Fax: 310/ 826-6991  
Email: Mfenster@raklaw.com

Andrew D Weiss  
[COR LD NTC]  
Russ August & Kabat  
12424 Wilshire Boulevard  
12TH Floor  
Los Angeles , CA 90025  
USA

310/ 826-7474  
Fax: 310/ 826-6991  
Email: AWEISS@RAKLAW.COM

Date	#	Proceeding Text
10/10/2008	1	COMPLAINT AND DEMAND FOR JURY TRIAL against SBC Internet Services, Inc. (Filing fee \$ 350 receipt number 0540000000001724676), filed by Linksmart Wireless Technology, LLC. (Attachments: # 1 Civil Cover Sheet)(ch, ) (Entered: 10/10/2008)
10/10/2008	--	Case Assigned to Judge T. John Ward. (ch, ) (Entered: 10/10/2008)
10/10/2008	2	Magistrate Consent Form Mailed to Linksmart Wireless Technology, LLC (ch, ) (Entered: 10/10/2008)
10/10/2008	3	E-GOV SEALED SUMMONS Issued as to SBC Internet Services, Inc.. (ch, ) (Entered: 10/10/2008)
10/10/2008	4	CORPORATE DISCLOSURE STATEMENT filed by Linksmart Wireless Technology, LLC (Fenster, Marc) (Entered: 10/10/2008)
10/10/2008	5	NOTICE by Linksmart Wireless Technology, LLC of Related Cases (Fenster, Marc) (Entered: 10/10/2008)
10/10/2008	6	Notice of Filing of Patent/Trademark Form (AO 120). AO 120 mailed to the Director of the U.S. Patent and Trademark Office. (Fenster, Marc) (Entered: 10/10/2008)
10/23/2008	7	E-GOV SEALED SUMMONS Returned Executed by Linksmart Wireless Technology, LLC. SBC Internet Services, Inc. served on 10/14/2008, answer due 11/3/2008. (ehs, ) (Entered: 10/23/2008)
11/03/2008	8	ANSWER to 1 Complaint, COUNTERCLAIM against Linksmart Wireless Technology, LLC by SBC Internet Services, Inc..(Sayles, Richard) (Entered: 11/03/2008)
11/03/2008	9	CORPORATE DISCLOSURE STATEMENT filed by SBC Internet Services, Inc. identifying Corporate Parent AT&T Inc., Other Affiliate AT&T Mobility LLC, Other Affiliate AT&T Mobility Corporation, Other Affiliate SBC Long Distance, LLC, Other Affiliate SBC Alloy Holdings, Inc., Other Affiliate BLS Cingular Holdings, LLC, Other Affiliate BellSouth Mobile Data, Inc. for SBC Internet Services, Inc.. (Sayles, Richard) (Entered: 11/03/2008)
11/03/2008	10	NOTICE of Attorney Appearance by Eve L Henson on behalf of SBC Internet Services, Inc. (Henson, Eve) (Entered: 11/03/2008)
11/17/2008	11	APPLICATION to Appear Pro Hac Vice by Attorney Rachel D Sher for SBC Internet Services, Inc. (APPROVED) (FEE PAID) 2-1-4232. (ch, ) (Entered: 11/19/2008)
11/17/2008	12	APPLICATION to Appear Pro Hac Vice by Attorney David T Pritikin for SBC Internet Services, Inc. (APPROVED)(FEE PAID) 2-1-4232. (ch, ) (Entered: 11/19/2008)
11/17/2008	13	APPLICATION to Appear Pro Hac Vice by Attorney Richard T McCaulley, Jr for SBC Internet Services, Inc. (APPROVED)(FEE PAID) 2-1-4232. (ch, ) (Entered: 11/19/2008)
01/14/2009	14	NOTICE of Attorney Appearance by Andrew Wesley Spangler on behalf of Linksmart Wireless Technology, LLC (Spangler, Andrew) (Entered: 01/14/2009)
01/14/2009	15	NOTICE of Attorney Appearance by Andrew D Weiss on behalf of Linksmart Wireless Technology, LLC (Weiss, Andrew) (Entered: 01/14/2009)
01/20/2009	16	Unopposed MOTION for Extension of Time to File Response/Reply to SBC's Counterclaims by Linksmart Wireless Technology, LLC. (Attachments: # 1 Text of Proposed Order)(Weiss, Andrew) (Entered: 01/20/2009)
01/21/2009	17	ORDER granting 16 Motion for Extension of Time to File Response/Reply Responses due by 1/23/2009. Signed by Judge T. John Ward on 1/21/09. (ch, ) (Entered: 01/21/2009)
01/21/2009	18	ANSWER to 8 Answer to Complaint, Counterclaim by Linksmart Wireless Technology, LLC. (Weiss, Andrew) (Entered: 01/21/2009)
01/23/2009	19	Joint MOTION to Consolidate Casés by SBC Internet Services, Inc.. (Attachments: # 1 Text of Proposed Order)(Sayles, Richard) (Entered: 01/23/2009)
02/03/2009	20	ORDER REASSIGNING CASE. Case reassigned to Judge David Folsom for all further proceedings. Judge T. John Ward no longer assigned to case. Signed by Judge T. John Ward on 2/2/09. (ch, ) (Entered: 02/03/2009)
02/10/2009	21	ORDER REFERRING CASE to Magistrate Judge Charles Everingham for case management.



Signed by Judge David Folsom on 2/10/009. (mrm, ), (Entered: 02/10/2009)

05/01/2009 22 ORDER granting 19 Motion to Consolidate Cases. ORDERED that the above- captioned actions are consolidated for all purposes pursuant to Federal Rule of Civil Procedure 42(a) and Local Rule CV-42(b) and (c).. Signed by Magistrate Judge Charles Everingham on 5/1/09. (ch, ) (Entered: 05/01/2009)

05/01/2009 -- NOTICE OF FILING DOCUMENTS IN CONSOLIDATED CASES re 22 Order on Motion to Consolidate Cases. ALL FUTURE FILINGS TO BE FILED IN LEAD CASE 2:08cv264 ONLY (ehs, ) (Entered: 09/03/2009)

05/04/2009 23 NOTICE of Hearing: Scheduling Conference set for 6/3/2009 10:00 AM in Mag Ctrm (Marshall) before Magistrate Judge Charles Everingham. (jml) (Entered: 05/04/2009)

05/06/2009 24 Notice of Scheduling Conference, Proposed Deadlines Scheduling Conference set for 6/3/2009 10:00 AM before Magistrate Judge Charles Everingham. The parties are directed to meet and confer in accordance with Fed. R. Civ. P. 26(f) no later than 5/27/09. Signed by Magistrate Judge Charles Everingham on 5/5/09. (ch, ) (Entered: 05/06/2009)

05/06/2009 25 NOTICE of Attorney Appearance by Mark Daniel Strachan on behalf of SBC Internet Services, Inc. (Strachan, Mark) (Entered: 05/06/2009)

06/01/2009 26 REPORT of Rule 26(f) Planning Meeting. (Attachments: # 1 Exhibit A - Proposed Docket Control Order)(Weiss, Andrew) (Additional attachment(s) added on 6/1/2009: # 2 Revised Docket Control Order) (sm, ). (Entered: 06/01/2009)

06/03/2009 27 Minute Entry for proceedings held before Magistrate Judge Charles Everingham: Scheduling Conference held on 6/3/2009. (Court Reporter Susan Simmons, CSR.) (jml) (Entered: 06/04/2009)

08/14/2009 28 APPLICATION to Appear Pro Hac Vice by Attorney Hugh A Abrams for SBC Internet Services, Inc. (APPROVED FEE PAID) 2-1-4865. (ch, ) (Entered: 08/14/2009)

---

Copyright © 2010 LexisNexis CourtLink, Inc. All rights reserved.  
\*\*\* THIS DATA IS FOR INFORMATIONAL PURPOSES ONLY \*\*\*

---

## US District Court Civil Docket

U.S. District - Texas Eastern  
(Marshall)

2:08cv304

### Linksmart Wireless Technology, Llc v. Cisco Systems, Inc et A

This case was retrieved from the court on Wednesday, May 26, 2010

---

<b>Date Filed:</b> 08/04/2008	<b>Class Code:</b>
<b>Assigned To:</b> Judge David Folsom	<b>Closed:</b> No
<b>Referred To:</b> Magistrate Judge Charles Everingham	<b>Statute:</b> 35:271
<b>Nature of suit:</b> Patent (830)	<b>Jury Demand:</b> Plaintiff
<b>Cause:</b> Patent Infringement	<b>Demand Amount:</b> \$0
<b>Lead Docket:</b> 2:08-cv-00264-DF-CE	<b>NOS Description:</b> Patent
<b>Other Docket:</b> 2:08-cv-00264-DF-CE 2:08-cv-00385-D 2:09-cv-00026-DF-CE	
<b>Jurisdiction:</b> Federal Question	

#### Litigants

Linksmart Wireless Technology, Llc  
Plaintiff

#### Attorneys

Marc A Fenster  
[COR LD NTC]  
Russ August & Kabat  
12424 Wilshire Boulevard  
12TH Floor  
Los Angeles , CA 90025  
USA  
310/ 826-7474  
Fax: 310/ 826-6991  
Email: Mfenster@raklaw.com

Andrew W Spangler  
[COR LD NTC]  
Spangler Law PC  
208 N Green St  
Suite 300  
Longview , TX 75601  
USA  
903-753-9300  
Fax: 903-553-0403  
Email: SPANGLER@SPANGLERLAWPC.COM

Andrew D Weiss  
[COR LD NTC]  
Russ August & Kabat  
12424 Wilshire Boulevard  
12TH Floor  
Los Angeles , CA 90025  
USA  
310/ 826-7474  
Fax: 310/ 826-6991  
Email: AWEISS@RAKLAW.COM

Cisco Systems, Inc

David J Beck

Defendant

[COR LD NTC]  
Beck Redden & Secrest  
1221 McKinney St, Suite 4500  
One Houston Center  
Houston, TX 77010-2020  
USA  
713/ 951-3700  
Fax: 17139513720  
Email: Dbeck@brsfirm.com

David B Bassett  
[COR LD NTC]  
Wilmer Cutler Pickering Hale & Dorr -New York  
399 Park Avenue  
New York, NY 10022  
USA  
212/ 230-8800  
Fax: 212/ 230-8888  
Email: DAVID.BASSETT@WILMERHALE.COM

James P Barabas  
[COR LD NTC]  
Wilmer Cutler Pickering Hale & Dorr -New York  
399 Park Avenue  
New York, NY 10022  
USA  
212/ 230-8800  
Fax: 212/ 230-8888  
Email: JAMES.BARABAS@WILMERHALE.COM

Joyce Chen  
[COR LD NTC]  
Wilmer Cutler Pickering Hale & Dorr -New York  
399 Park Avenue  
New York, NY 10022  
USA  
212/ 230-8809  
Fax: 212/ 230-8888  
<i>pro Hac Vice</ I>  
Email: JOYCE.CHEN@WILMERHALE.COM

Michael Ernest Richardson  
[COR LD NTC]  
Beck Redden & Secrest -Houston  
1221 McKinney  
Suite 4500  
Houston, TX 77010-2010  
USA  
713/ 951-6284  
Fax: 17139513720  
Email: Mrichardson@brsfirm.com

Noah A Levine  
[COR LD NTC]  
Wilmer Cutler Pickering Hale & Dorr -New York  
399 Park Avenue  
New York, NY 10022  
USA  
212/ 230-8800  
Fax: 212/ 230-8888  
<i>pro Hac Vice</ I>  
Email: NOAH.LEVINE@WILMERHALE.COM

Peter M Diciara  
[COR LD NTC]  
Wilmer Cutler Pickering Hale & Dorr -Boston  
60 State Street

Boston , MA 02109  
USA  
617/ 526-6466  
Fax: 617/ 526-5000  
<i>pro Hac Vice</ I>  
Email: PETER.DICHIARA@WILMERHALE.COM

Robert David Daniel  
[COR LD NTC]  
Beck Redden & Secrest LLP  
One Houston Center  
1221 McKinney St, Suite 4500  
Houston , TX 77010-2020  
USA  
713/ 951-3700  
Fax: 17139513720  
Email: Bddaniel@brsfirm.com

William F Lee  
[COR LD NTC]  
Wilmer Cutler Pickering Hale & Dorr -Boston  
60 State Street  
Boston , MA 02109  
USA  
617-526-6556  
Fax: 617-526-5000  
Email: William.lee@wilmerhale.com

Juniper Networks, Inc  
Defendant  
[Term: 09/03/2008]

Aruba Networks, Inc  
Defendant  
[Term: 09/03/2008]

Cisco Systems, Inc  
Counter Claimant

David J Beck  
[COR LD NTC]  
Beck Redden & Secrest  
1221 McKinney St, Suite 4500  
One Houston Center  
Houston , TX 77010-2020  
USA  
713/ 951-3700  
Fax: 17139513720  
Email: Dbeck@brsfirm.com

James P Barabas  
[COR LD NTC]  
Wilmer Cutler Pickering Hale & Dorr -New York  
399 Park Avenue  
New York , NY 10022  
USA  
212/ 230-8800  
Fax: 212/ 230-8888  
Email: JAMES.BARABAS@WILMERHALE.COM

Michael Ernest Richardson  
[COR LD NTC]  
Beck Redden & Secrest -Houston  
1221 McKinney  
Suite 4500  
Houston , TX 77010-2010  
USA  
713/ 951-6284  
Fax: 17139513720

Email: Mrichardson@brsfirm.com

Noah A Levine  
[COR LD NTC]  
Wilmer Cutler Pickering Hale & Dorr -New York  
399 Park Avenue  
New York , NY 10022  
USA  
212/ 230-8800  
Fax: 212/ 230-8888  
<i>pro Hac Vice</ I>  
Email: NOAH.LEVINE@WILMERHALE.COM

William F Lee  
[COR LD NTC]  
Wilmer Cutler Pickering Hale & Dorr -Boston  
60 State Street  
Boston , MA 02109  
USA  
617-526-6556  
Fax: 617-526-5000  
Email: William.lee@wilmerhale.com

Linksmart Wireless Technology, Llc  
Counter Defendant

Marc A Fenster  
[COR LD NTC]  
Russ August & Kabat  
12424 Wilshire Boulevard  
12TH Floor  
Los Angeles , CA 90025  
USA  
310/ 826-7474  
Fax: 310/ 826-6991  
Email: Mfenster@raklaw.com

Andrew D Weiss  
[COR LD NTC]  
Russ August & Kabat  
12424 Wilshire Boulevard  
12TH Floor  
Los Angeles , CA 90025  
USA  
310/ 826-7474  
Fax: 310/ 826-6991  
Email: AWEISS@RAKLAW.COM

Cisco Systems, Inc  
Counter Defendant

David J Beck  
[COR LD NTC]  
Beck Redden & Secrest  
1221 McKinney St, Suite 4500  
One Houston Center  
Houston , TX 77010-2020  
USA  
713/ 951-3700  
Fax: 17139513720  
Email: Dbeck@brsfirm.com

Michael Ernest Richardson  
[COR LD NTC]  
Beck Redden & Secrest -Houston  
1221 McKinney  
Suite 4500  
Houston , TX 77010-2010  
USA  
713/ 951-6284  
Fax: 17139513720

Date	#	Proceeding Text
08/04/2008	1	COMPLAINT and Demand for Jury Trial against Cisco Systems, Inc., Juniper Networks, Inc., Aruba Networks, Inc. ( Filing fee \$ 350 receipt number 0540000000001643001.), filed by Linksmart Wireless Technology, LLC. (Attachments: # 1 Exhibit A to Complaint, # 2 Civil Cover Sheet)(Fenster, Marc) (Entered: 08/04/2008)
08/04/2008	2	Notice of Filing of Patent/Trademark Form (AO 120). AO 120 mailed to the Director of the U.S. Patent and Trademark Office. (Fenster, Marc) (Entered: 08/04/2008)
08/04/2008	3	CORPORATE DISCLOSURE STATEMENT filed by Linksmart Wireless Technology, LLC (Fenster, Marc) (Entered: 08/04/2008)
08/04/2008	4	NOTICE by Linksmart Wireless Technology, LLC of Related Case (Fenster, Marc) (Entered: 08/04/2008)
08/04/2008	--	Case Assigned to Judge David Folsom. (ch, ) (Entered: 08/05/2008)
08/05/2008	5	STANDING ORDER REFERRING CASE - to Magistrate Judge Charles Everingham. Signed by Judge David Folsom on 8/5/08. (ch, ) (Entered: 08/05/2008)
08/05/2008	6	Magistrate Consent Form Mailed to Linksmart Wireless Technology, LLC (ch, ) (Entered: 08/05/2008)
08/05/2008	--	E-GOV SEALED SUMMONS Issued as to Cisco Systems, Inc., Juniper Networks, Inc., Aruba Networks, Inc.. (ch, ) (Entered: 08/05/2008)
08/07/2008	--	E-GOV SEALED SUMMONS REISSUED as to Cisco Systems, Inc., Juniper Networks, Inc., Aruba Networks, Inc., attorney didn't receive the ones issued on 8/5/08. (ch, ) (Entered: 08/07/2008)
09/02/2008	7	NOTICE by Linksmart Wireless Technology, LLC of Dismissal Without Prejudice as to Defs Juniper Networks, Inc. and Aruba Networks, Inc. ONLY (Fenster, Marc) (Additional attachment (s) added on 9/3/2008: # 1 Text of Proposed Order) (sm, ). (Entered: 09/02/2008)
09/03/2008	8	ORDER GRANTING PLAINTIFFS REQUEST FOR DISMISSAL WITHOUT PREJUDICE; re 7 Notice (Other) filed by Linksmart Wireless Technology, LLC, Motions terminated:, Aruba Networks, Inc. and Juniper Networks, Inc. terminated.. Signed by Judge David Folsom on 9/3/08. (mrm, ) (Entered: 09/03/2008)
10/30/2008	9	E-GOV SEALED SUMMONS Returned Executed by Linksmart Wireless Technology, LLC. Cisco Systems, Inc. served on 10/22/2008, answer due 11/12/2008. (ch, ) (Entered: 10/30/2008)
11/06/2008	10	Cisco Systems, Inc.'s Answer and Counterclaims ANSWER to 1 Complaint,, COUNTERCLAIM against Linksmart Wireless Technology, LLC, Cisco Systems, Inc. by Cisco Systems, Inc..(Beck, David) (Entered: 11/06/2008)
11/06/2008	11	CORPORATE DISCLOSURE STATEMENT filed by Cisco Systems, Inc. (Beck, David) (Entered: 11/06/2008)
11/17/2008	12	APPLICATION to Appear Pro Hac Vice by Attorney William F Lee for Cisco Systems, Inc. (APPROVED)(FEE PAID) 2-1-4231. (ch, ) (Entered: 11/19/2008)
11/17/2008	13	APPLICATION to Appear Pro Hac Vice by Attorney James P Barabas for Cisco Systems, Inc. (APPROVED)(FEE PAID) 2-1-4244. (ch, ) (Entered: 11/19/2008)
11/17/2008	14	APPLICATION to Appear Pro Hac Vice by Attorney Noah A Levine for Cisco Systems, Inc. (APPROVED)(FEE PAID) 2-1-4244. (ch, ) (Entered: 11/20/2008)
11/26/2008	16	APPLICATION to Appear Pro Hac Vice by Attorney David B Bassett for Cisco Systems, Inc. (APPROVED)(FEE PAID) 2-1-4277. (ch, ) (Entered: 12/02/2008)
12/01/2008	15	Linksmart's ANSWER to 10 Answer to Complaint, Counterclaim of Cisco Systems, Inc. by Linksmart Wireless Technology, LLC.(Fenster, Marc) (Entered: 12/01/2008)
01/13/2009	17	NOTICE of Attorney Appearance by Andrew Wesley Spangler on behalf of Linksmart Wireless Technology, LLC (Spangler, Andrew) (Entered: 01/13/2009)
01/14/2009	18	NOTICE of Attorney Appearance by Andrew D Weiss on behalf of Linksmart Wireless Technology, LLC (Weiss, Andrew) (Entered: 01/14/2009)
01/21/2009	19	NOTICE of Hearing: Scheduling Conference set for 2/17/2009 02:30 PM in Mag Ctrm (Marshall) before Magistrate Judge Charles Everingham. (jml, ) (Entered: 01/21/2009)
01/23/2009	20	Joint MOTION to Consolidate Cases by Cisco Systems, Inc.. (Attachments: # 1 Text of Proposed

Order)(Beck, David) (Entered: 01/23/2009)

01/26/2009 21 Notice of Scheduling Conference, Proposed Deadlines for Docket Control Order and Discovery Order. Scheduling Conference set for 2/17/2009 02:30 PM before Magistrate Judge Charles Everingham.. Signed by Magistrate Judge Charles Everingham on 1/26/09. (ch, ) (Entered: 01/26/2009)

01/29/2009 22 NOTICE of Attorney Appearance by Michael Ernest Richardson on behalf of Cisco Systems, Inc. (Richardson, Michael) (Entered: 01/29/2009)

02/10/2009 23 NOTICE of Hearing: Scheduling Conference set for 2/17/2009, 02:30 PM, in Mag Ctrm (Marshall) before Magistrate Judge Charles Everingham is CANCELLED.(delat) (Entered: 02/10/2009)

02/13/2009 24 APPLICATION to Appear Pro Hac Vice by Attorney Peter M Dichiara for Cisco Systems, Inc. (APPROVED FEE PAID) 2-1-4494. (ch, ) (Entered: 02/13/2009)

05/01/2009 25 ORDER granting 20 Motion to Consolidate Cases. ORDERED that the above- captioned actions are consolidated for all purposes pursuant to Federal Rule of Civil Procedure 42(a) and Local Rule CV-42(b) and (c).. Signed by Magistrate Judge Charles Everingham on 5/1/09. (ch, ) (Entered: 05/01/2009)

05/01/2009 -- NOTICE OF FILING DOCUMENTS IN CONSOLIDATED CASES re 25 Order GRANTING Motion to Consolidate Cases. ALL FUTURE FILING ARE TO BE FILED IN THE LEAD CASE ONLY 2:08cv264 (ehs, ) (Entered: 09/02/2009)

05/04/2009 26 NOTICE of Hearing: Scheduling Conference set for 6/3/2009 10:00 AM in Mag Ctrm (Marshall) before Magistrate Judge Charles Everingham. (jml) (Entered: 05/04/2009)

05/06/2009 27 Notice of Scheduling Conference, Proposed Deadlines for Docket Control Order, and Discovery Order. Scheduling Conference set for 6/3/2009 10:00 AM before Magistrate Judge Charles Everingham. The parties are directed to meet and confer in accordance with the Fed. R. Civ. P. 26(f) no later than 5/27/09. Signed by Magistrate Judge Charles Everingham on 5/5/09. (ch, ) (Entered: 05/06/2009)

06/01/2009 28 REPORT of Rule 26(f) Planning Meeting. (Attachments: # 1 Exhibit A - Proposed Docket Control Order)(Weiss, Andrew) (Additional attachment(s) added on 6/1/2009: # 2 Revised Scheduling Order) (sm, ). (Entered: 06/01/2009)

06/03/2009 29 Minute Entry for proceedings held before Magistrate Judge Charles Everingham: Scheduling Conference held on 6/3/2009. (Court Reporter Susan Simmons, CSR.) (jml) (Entered: 06/04/2009)

07/10/2009 30 APPLICATION to Appear Pro Hac Vice by Attorney Joyce Chen for Cisco Systems, Inc. (APPROVED FEE PAID) 2-1-4798. (ch, ) (Entered: 07/10/2009)

08/19/2009 31 NOTICE of Attorney Appearance by Robert David Daniel on behalf of Cisco Systems, Inc. (Daniel, Robert) (Entered: 08/19/2009)

---

**US District Court Civil Docket**

**U.S. District - Texas Eastern  
(Marshall)**

**2:08cv264**

**Linksmart Wireless Technology, Llc v. T-Mobile USA, Inc. et al**

This case was retrieved from the court on Wednesday, July 07, 2010

---

<b>Date Filed: 07/01/2008</b>	<b>Class Code: DISCMAG, JURY, LEAD, MEDIATION, PATENT/TRADEMARK</b>
<b>Assigned To: Judge David Folsom</b>	<b>Closed: No</b>
<b>Referred To: Magistrate Judge Charles Everingham</b>	<b>Statute: 15:1126</b>
<b>Nature of suit: Patent (830)</b>	<b>Jury Demand: Both</b>
<b>Cause: Patent Infringement</b>	<b>Demand Amount: \$\$0</b>
<b>Lead Docket: None</b>	<b>NOS Patent</b>
<b>Other Docket: Member case: 2:08-cv-00304-DF-CE</b>	<b>Description: Patent</b>
<b>Member case: 2:08-cv-00385-DF-CE</b>	
<b>Member case: 2:09-cv-00026-DF-CE</b>	
<b>Related case: 2:09-cv-00026-DF-CE</b>	
<b>Related case: 2:08-cv-00385-DF-CE</b>	
<b>Related case: 2:08-cv-00304-DF-CE</b>	
<b>Jurisdiction: Federal Question</b>	

**Litigants**

James W Knowles: Mediator  
Mediator

Linksmart Wireless Technology, Llc  
Plaintiff

**Attorneys**

James W Knowles  
Knowles Mediations  
909 East South East Loop 323  
Ste 410  
Tyler , TX 75701  
USA  
Phone: (903)534-3800  
Fax: (903)534-3806  
Attorney to be Noticed  
Email: jimk@knowlesmed.com

Adam S Hoffman  
Russ August & Kabat  
12424 Wilshire Boulevard  
12th Floor  
Los Angeles , CA 90025  
USA  
Phone: (310)826-7474  
Fax: (310)826-6991  
Attorney to be Noticed  
Email: ahoffman@raklaw.com

Alexander Chester Giza



Russ August & Kabat  
12424 Wilshire Boulevard  
12th Floor  
Los Angeles , CA 90025  
USA  
Phone: (310)826-7474  
Fax: (310)826-6991  
Attorney to be Noticed  
Email: agiza@raklaw.com

Andrew W. Spangler  
Spangler Law PC  
208 N. Green St.  
Suite 300  
Longview , TX 75601  
USA  
Phone: (903)753-9300  
Fax: (903)553-0403  
Attorney to be Noticed  
Email: spangler@spanglerlawpc.com

Andrew D Weiss  
Russ August & Kabat  
12424 Wilshire Boulevard  
12th Floor  
Los Angeles , CA 90025  
USA  
Phone: (310)826-7474  
Fax: (310)826-6991  
Attorney to be Noticed  
Email: aweiss@raklaw.com

Eric Charles Flagel  
Russ August & Kabat  
12424 Wilshire Boulevard  
12th Floor  
Los Angeles , CA 90025  
USA  
Phone: (310)826-7474  
Fax: (310)826-6991  
Attorney to be Noticed  
Email: eflagel@raklaw.com

Irene Y Lee  
Russ August & Kabat  
12424 Wilshire Boulevard  
12th Floor  
Los Angeles , CA 90025  
USA  
Phone: (310)826-7474  
Fax: (310)826-6991  
Attorney to be Noticed  
Email: ilee@raklaw.com

Larry C Russ  
Russ August & Kabat  
12424 Wilshire Boulevard  
12th Floor  
Los Angeles , CA 90025  
USA  
Phone: (310)826-7474  
Fax: (310)826-6991  
Pro Hac Vice  
Attorney to be Noticed  
Email: lruss@raklaw.com

Marc A Fenster

Russ August & Kabat  
12424 Wilshire Boulevard  
12th Floor  
Los Angeles , CA 90025  
USA  
Phone: (310)826-7474  
Fax: (310)826-6991  
Attorney to be Noticed  
Email: mfenster@raklaw.com

Stanley H Thompson , Jr  
Russ August & Kabat  
12424 Wilshire Boulevard  
12th Floor  
Los Angeles , CA 90025  
USA  
Phone: (310)826-7474  
Fax: (310)826-6991  
Attorney to be Noticed  
Email: sthompson@raklaw.com

Stephen M Lobbin  
Russ August & Kabat  
12424 Wilshire Boulevard  
12th Floor  
Los Angeles , CA 90025  
USA  
Phone: (310)826-7474  
Fax: (310)826-6991  
Pro Hac Vice  
Attorney to be Noticed  
Email: slobbin@raklaw.com

Todd Y Brandt  
[Term: 06/04/2010]  
Spangler Law PC  
208 N. Green Street  
Ste 300  
Longview , TX 75601  
USA  
Phone: (903)753-9300  
Fax: (903)553-0403

Email: brandt@spanglerlawpc.com

Linksmart Wireless Technology, Llc  
Consol Plaintiff

Andrew W. Spangler  
Spangler Law PC  
208 N. Green St.  
Suite 300  
Longview , TX 75601  
USA  
Phone: (903)753-9300  
Fax: (903)553-0403  
Attorney to be Noticed  
Email: spangler@spanglerlawpc.com

Andrew D Weiss  
Russ August & Kabat  
12424 Wilshire Boulevard  
12th Floor  
Los Angeles , CA 90025  
USA  
Phone: (310)826-7474  
Fax: (310)826-6991  
Attorney to be Noticed  
Email: aweiss@raklaw.com

T-Mobile USA, Inc.  
Defendant

Marc A Fenster  
Russ August & Kabat  
12424 Wilshire Boulevard  
12th Floor  
Los Angeles , CA 90025  
USA  
Phone: (310)826-7474  
Fax: (310)826-6991  
Attorney to be Noticed  
Email: mfenster@raklaw.com

David J Beck  
Lead Attorney  
Beck Redden & Secrest  
1221 McKinney St, Suite 4500  
One Houston Center  
Houston , TX 77010-2020  
USA  
Phone: (713)951-3700  
Fax: 17139513720  
Attorney to be Noticed  
Email: dbeck@brsfirm.com

Alexandra B McTague  
Wilmer Cutler Pickering Hale & Dorr - New York  
399 Park Avenue  
New York , NY 10022  
USA  
Phone: (212)230-8800  
Fax: (212)230-8888  
Pro Hac Vice  
Attorney to be Noticed  
Email: alexandra.mctague@wilmerhale.com

David B Bassett  
Wilmer Cutler Pickering Hale & Dorr - New York  
399 Park Avenue  
New York , NY 10022  
USA  
Phone: (212)230-8800  
Fax: (212)230-8888  
Attorney to be Noticed  
Email: David.Bassett@wilmerhale.com

James P Barabas  
Wilmer Cutler Pickering Hale & Dorr - New York  
399 Park Avenue  
New York , NY 10022  
USA  
Phone: (212)230-8800  
Fax: (212)230-8888  
Attorney to be Noticed  
Email: james.barabas@wilmerhale.com

Jonathan Andron  
Wilmer Cutler Pickering Hale & Dorr - Boston  
60 State Street  
Boston , MA 02109  
USA  
Phone: (617)526-6749  
Fax: (617)526-5000  
Pro Hac Vice  
Attorney to be Noticed  
Email: jonathan.andron@wilmerhale.com

Joyce Chen  
Wilmer Cutler Pickering Hale & Dorr - New York  
399 Park Avenue  
New York , NY 10022  
USA  
Phone: (212)230-8809  
Fax: (212)230-8888  
Pro Hac Vice  
Attorney to be Noticed  
Email: joyce.chen@wilmerhale.com

Kirk R Ruthenberg  
Sonnenschein Nath & Rosenthal LLP - DC  
1301 K Street, NW  
Suite 600E  
Washington , DC 20005  
USA  
Phone: (202)408-6410  
Fax: (202)408-6399  
Attorney to be Noticed  
Email: kruthenberg@sonnenschein.com

Michael Ernest Richardson  
Beck Redden & Secrest - Houston  
1221 McKinney  
Suite 4500  
Houston , TX 77010-2010  
USA  
Phone: (713)951-6284  
Fax: 17139513720  
Attorney to be Noticed  
Email: mrichardson@brsfirm.com

Noah A Levine  
Wilmer Cutler Pickering Hale & Dorr - New York  
399 Park Avenue  
New York , NY 10022  
USA  
Phone: (212)230-8800  
Fax: (212)230-8888  
Pro Hac Vice  
Attorney to be Noticed  
Email: Noah.Levine@wilmerhale.com

Peter M Dichiara  
Wilmer Cutler Pickering Hale & Dorr - Boston  
60 State Street  
Boston , MA 02109  
USA  
Phone: (617)526-6466  
Fax: (617)526-5000  
Pro Hac Vice  
Attorney to be Noticed  
Email: peter.dichiara@wilmerhale.com

Robert David Daniel  
Beck Redden & Secrest LLP  
One Houston Center  
1221 McKinney St, Suite 4500  
Houston , TX 77010-2020  
USA  
Phone: (713)951-3700  
Fax: 17139513720  
Attorney to be Noticed  
Email: bddaniel@brsfirm.com

William F Lee

Wayport, Inc.  
Defendant

Wilmer Cutler Pickering Hale & Dorr - Boston  
60 State Street  
Boston , MA 02109  
USA  
Phone: (617)526-6556  
Fax: (617)526-5000  
Attorney to be Noticed  
Email: william.lee@wilmerhale.com

Brian C Bianco  
Lead Attorney  
Sidley Austin - Chicago  
Bank One Plaza  
One South Dearborn Ave  
Chicago , IL 60603  
USA  
Phone: (312)853-7000  
Fax: (312)853-7036  
Attorney to be Noticed  
Email: bcbianco@sidley.com

Marvin Craig Tyler  
Lead Attorney  
[Term: 01/28/2009]  
Wilson Sonsini Goodrich & Rosati PC  
900 South Capital of Texas Highway  
Las Cimas IV, Fifth Floor  
Austin , TX 78746-5546  
USA  
Phone: (512)338-5410  
Fax: 15123385499

Email: ctyler@wsgr.com

Richard Alan Sayles  
Lead Attorney  
Sayles Werbner  
1201 Elm Street  
4400 Renaissance Tower  
Dallas , TX 75270  
USA  
Phone: (214)939-8700  
Fax: 12149398787  
Attorney to be Noticed  
Email: dsayles@swtriallaw.com

David T Pritikin  
Sidley Austin - Chicago  
Bank One Plaza  
One South Dearborn Ave  
Chicago , IL 60603  
USA  
Phone: (312)853-7359  
Fax: (312)853-7036  
Attorney to be Noticed  
Email: dpritikin@sidley.com

Elizabeth L Maxeiner  
Sidley Austin - Chicago  
One South Dearborn St  
Chicago , IL 60603  
USA  
Phone: (312)853-2225  
Fax: (312)853-7036  
Pro Hac Vice  
Attorney to be Noticed

Email: [emaxeiner@sidley.com](mailto:emaxeiner@sidley.com)

Eve L Henson  
Sayles | Werbner  
1201 Elm Street  
4400 Renaissance Tower  
Dallas , TX 75270  
USA  
Phone: (214)939-8700  
Fax: 12149398787  
Attorney to be Noticed  
Email: [ehenson@swtriallaw.com](mailto:ehenson@swtriallaw.com)

Hugh A Abrams  
Sidley Austin - Chicago  
Bank One Plaza  
One South Dearborn Ave  
Chicago , IL 60603  
USA  
Phone: (312)853-7017  
Fax: 13128537036  
Pro Hac Vice  
Attorney to be Noticed  
Email: [habrams@sidley.com](mailto:habrams@sidley.com)

Jose Carlos Villarreal  
[Term: 01/28/2009]  
Wilson Sonsini Goodrich & Rosati  
8911 Capital of Texas Highway  
Westech 360, Ste 3350  
Austin , TX 78759-7247  
USA  
Phone: (512)338-5400  
Fax: 15123385499

Email: [jvillarreal@wsgr.com](mailto:jvillarreal@wsgr.com)

Lisa A Schneider  
Sidley Austin - Chicago  
Bank One Plaza  
One South Dearborn Ave  
Chicago , IL 60603  
USA  
Phone: (312)853-7567  
Fax: (312)253-7036  
Pro Hac Vice  
Attorney to be Noticed  
Email: [lschneider@sidley.com](mailto:lschneider@sidley.com)

Mark Daniel Strachan  
Sayles Webner  
4400 Renaissance  
1201 Elm Street  
Dallas , TX 75270  
USA  
Phone: (214)939-8707  
Fax: (214)939-8787  
Attorney to be Noticed  
Email: [mstrachan@swtriallaw.com](mailto:mstrachan@swtriallaw.com)

Michael Ernest Richardson  
Beck Redden & Secrest - Houston  
1221 McKinney  
Suite 4500  
Houston , TX 77010-2010  
USA  
Phone: (713)951-6284

Fax: 17139513720  
Attorney to be Noticed  
Email: mrichardson@brsfirm.com

Noah A Levine  
Wilmer Cutler Pickering Hale & Dorr - New York  
399 Park Avenue  
New York , NY 10022  
USA  
Phone: (212)230-8800  
Fax: (212)230-8888  
Attorney to be Noticed  
Email: Noah.Levine@wilmerhale.com

Rachel D Sher  
Sidley Austin - Chicago  
One South Dearborn St  
Chicago , IL 60603  
USA  
Phone: (312)853-7000  
Fax: (312)853-7036  
Attorney to be Noticed  
Email: rsher@sidley.com

Richard A Cederoth  
Sidley Austin - Chicago  
One South Dearborn St  
Chicago , IL 60603  
USA  
Phone: (312)853-7000  
Fax: (312)853-7036  
Pro Hac Vice  
Attorney to be Noticed  
Email: rcederoth@sidley.com

Richard T McCaulley , Jr  
[Term: 08/10/2009]  
Sidley Austin - Chicago  
Bank One Plaza  
One South Dearborn Ave  
Chicago , IL 60603  
USA  
Phone: (312)853-7000  
Fax: (312)853-7036

Email: rmccaulley@sidley.com

Richard Alan Sayles  
Lead Attorney  
[Term: 09/24/2008]  
Sayles Werbner  
1201 Elm Street  
4400 Renaissance Tower  
Dallas , TX 75270  
USA  
Phone: (214)939-8700  
Fax: 12149398787

Email: dsayles@swtriallaw.com

Michael E Jones  
[Term: 09/24/2008]  
Potter Minton PC  
110 N College  
Suite 500  
PO Box 359

At&T, Inc.  
Defendant  
[Term: 09/24/2008]

Tyler , TX 75710-0359  
USA  
Phone: (930)597-8311  
Fax: (903)593-0846

Email: mikejones@potterminton.com

At&T Mobility, Llc  
Defendant  
[Term: 10/08/2008]

Richard Alan Sayles  
Lead Attorney  
[Term: 10/08/2008]  
Sayles Werbner  
1201 Elm Street  
4400 Renaissance Tower  
Dallas , TX 75270  
USA  
Phone: (214)939-8700  
Fax: 12149398787

Email: dsayles@swtriallaw.com

Eve L Henson  
[Term: 10/08/2008]  
Sayles  
Werbner  
1201 Elm Street 4400 Renaissance Tower , Dallas TX  
75270  
Phone: ehenson@swtriallaw.com  
Fax: (214)939-8700

Email: USA

Michael E Jones  
[Term: 10/08/2008]  
Potter Minton PC  
110 N College  
Suite 500  
PO Box 359  
Tyler , TX 75710-0359  
USA  
Phone: (930)597-8311  
Fax: (903)593-0846

Email: mikejones@potterminton.com

Lodgenet Interactive Corporation  
Defendant

Harold L Socks  
Lead Attorney  
[Term: 09/24/2009]  
Ray Valdez McChristian & Jeans - San Antonio  
North Frost Center  
1250 NE Loop 410  
Suite 700  
San Antonio , TX 78209  
USA  
Phone: (210)341-3554  
Fax: (210)341-3557

Email: bsocks@rvmjfirm.com

Cynthia Lopez Beverage  
Morrison & Foerster LLP - Washington  
2000 Pennsylvania Avenue NW  
Suite 6000  
Washington , DC 20006  
USA  
Phone: (202)887-6950



Fax: (202)785-7635  
Attorney to be Noticed  
Email: cbeverage@mofocom

Jennifer Parker Ainsworth  
Wilson Robertson & Cornelius PC  
909 ESE Loop 323  
Suite 400  
P.O. Box 7339  
Tyler, TX 75711-7339  
USA  
Phone: (903)509-5000  
Fax: (903)509-5092  
Attorney to be Noticed  
Email: jainsworth@wilsonlawfirm.com

Mark E Ungerman  
Morrison & Foerster LLP - Washington  
2000 Pennsylvania Avenue NW  
Suite 6000  
Washington, DC 20006  
USA  
Phone: (202)887-1535  
Fax: 12028870763  
Attorney to be Noticed  
Email: mungerman@mofocom

Michael Ernest Richardson  
Beck Redden & Secrest - Houston  
1221 McKinney  
Suite 4500  
Houston, TX 77010-2010  
USA  
Phone: (713)951-6284  
Fax: 17139513720  
Attorney to be Noticed  
Email: mrichardson@brsfirm.com

Noah A Levine  
Wilmer Cutler Pickering Hale & Dorr - New York  
399 Park Avenue  
New York, NY 10022  
USA  
Phone: (212)230-8800  
Fax: (212)230-8888  
Attorney to be Noticed  
Email: Noah.Levine@wilmerhale.com

Robert David Daniel  
Beck Redden & Secrest LLP  
One Houston Center  
1221 McKinney St, Suite 4500  
Houston, TX 77010-2020  
USA  
Phone: (713)951-3700  
Fax: 17139513720  
Attorney to be Noticed  
Email: bddaniel@brsfirm.com

Ibahn General Holdings Corp.  
Defendant

Michael E Jones  
Lead Attorney  
Potter Minton PC  
110 N College  
Suite 500  
PO Box 359  
Tyler, TX 75710-0359

USA  
Phone: (930)597-8311  
Fax: (903)593-0846  
Attorney to be Noticed  
Email: mikejones@potterminton.com

Allen Franklin Gardner  
Potter Minton PC  
110 N College  
Suite 500  
PO Box 359  
Tyler , TX 75710-0359  
USA  
Phone: (903)597-8311  
Attorney to be Noticed  
Email: allengardner@potterminton.com

David J Burman  
Perkins Coie LLP - Seattle  
1201 Third Avenue  
Ste 4800  
Seattle , WA 98101-3099  
USA  
Phone: (206)359-8426  
Fax: (206)359-9426  
Pro Hac Vice  
Attorney to be Noticed  
Email: dburman@perkinscoie.com

Kameron Parvin  
Perkins Coie LLP - Seattle  
1201 Third Avenue  
Ste 4800  
Seattle , WA 98101-3099  
USA  
Phone: (206)359-6111  
Fax: (206)359-7111  
Pro Hac Vice  
Attorney to be Noticed  
Email: kparvin@perkinscoie.com

Michael D Broaddus  
Perkins Coie LLP - Seattle  
1201 Third Avenue  
Ste 4800  
Seattle , WA 98101-3099  
USA  
Phone: (206)359-8694  
Fax: (206)359-9694  
Pro Hac Vice  
Attorney to be Noticed  
Email: MBroaddus@perkinscoie.com

Michael Ernest Richardson  
Beck Redden & Secrest - Houston  
1221 McKinney  
Suite 4500  
Houston , TX 77010-2010  
USA  
Phone: (713)951-6284  
Fax: 17139513720  
Attorney to be Noticed  
Email: mrichardson@brsfirm.com

Noah A Levine  
Wilmer Cutler Pickering Hale & Dorr - New York  
399 Park Avenue

New York , NY 10022  
USA  
Phone: (212)230-8800  
Fax: (212)230-8888  
Attorney to be Noticed  
Email: Noah.Levine@wilmerhale.com

Ethostream, Llc  
Defendant

Dean Danyl Hunt  
Lead Attorney  
Baker & Hostetler  
1000 Louisiana  
Suite 2000  
Houston , TX 77002-5009  
USA  
Phone: (713)646-1346  
Attorney to be Noticed  
Email: dhunt@bakerlaw.com

Christina J Moser  
Baker & Hostetler - Cleveland  
1900 East Ninth Street  
3200 National City Center  
Cleveland , OH 44114  
USA  
Phone: (216)861-7818  
Fax: (216)696-0740  
Pro Hac Vice  
Attorney to be Noticed  
Email: cmoser@bakerlaw.com

Michael Ernest Richardson  
Beck Redden & Secrest - Houston  
1221 McKinney  
Suite 4500  
Houston , TX 77010-2010  
USA  
Phone: (713)951-6284  
Fax: 17139513720  
Attorney to be Noticed  
Email: mrichardson@brsfirm.com

Noah A Levine  
Wilmer Cutler Pickering Hale & Dorr - New York  
399 Park Avenue  
New York , NY 10022  
USA  
Phone: (212)230-8800  
Fax: (212)230-8888  
Attorney to be Noticed  
Email: Noah.Levine@wilmerhale.com

Hot Point Wireless, Inc.  
Defendant

Netnearu Corp.  
Defendant  
[Term: 02/23/2009]

Pronto Networks, Inc.  
Defendant  
[Term: 06/09/2010]

Jose Carlos Villarreal  
Lead Attorney  
Wilson Sonsini Goodrich & Rosati  
8911 Capital of Texas Highway  
Westech 360, Ste 3350  
Austin , TX 78759-7247  
USA

Phone: (512)338-5400  
Fax: 15123385499

Email: [jvillarreal@wsgr.com](mailto:jvillarreal@wsgr.com)

Aden Martin Allen  
Wilson Sonsini Goodrich & Rosati  
8911 Capital of Texas Highway  
Westech 360, Ste 3350  
Austin, TX 78759-7247  
USA  
Phone: (512)338-5437  
Fax: (512)338-5499

Email: [aallen@wsgr.com](mailto:aallen@wsgr.com)

Michael Ernest Richardson  
Beck Redden & Secrest - Houston  
1221 McKinney  
Suite 4500  
Houston, TX 77010-2010  
USA  
Phone: (713)951-6284  
Fax: 17139513720

Email: [mrichardson@brsfirm.com](mailto:mrichardson@brsfirm.com)

Noah A Levine  
Wilmer Cutler Pickering Hale & Dorr - New York  
399 Park Avenue  
New York, NY 10022  
USA  
Phone: (212)230-8800  
Fax: (212)230-8888

Email: [Noah.Levine@wilmerhale.com](mailto:Noah.Levine@wilmerhale.com)

Aptilo Networks, Inc.  
Defendant

Clyde Moody Siebman  
Siebman Reynolds Burg & Phillips LLP  
300 N Travis St  
Sherman, TX 75090-0070  
USA  
Phone: (903)870-0070  
Fax: 19038700066  
Attorney to be Noticed  
Email: [siebman@siebman.com](mailto:siebman@siebman.com)

Lawrence Augustine Phillips  
Siebman Reynolds Burg & Phillips LLP  
300 N Travis St  
Sherman, TX 75090-9969  
USA  
Phone: (903)870-0070  
Fax: (903)870-0066  
Attorney to be Noticed  
Email: [larryphillips@siebman.com](mailto:larryphillips@siebman.com)

Michael T Herbst  
[Term: 12/03/2009]  
Thorelli & Associates  
70 W Madison St  
#5750  
Chicago, IL 60602  
USA  
Phone: (312)357-0300  
Fax: 13123570328

Email: michael@thorelli.com

Michael Ernest Richardson  
Beck Redden & Secrest - Houston  
1221 McKinney  
Suite 4500  
Houston , TX 77010-2010  
USA  
Phone: (713)951-6284  
Fax: 17139513720  
Attorney to be Noticed  
Email: mrichardson@brsfirm.com

Noah A Levine  
Wilmer Cutler Pickering Hale & Dorr - New York  
399 Park Avenue  
New York , NY 10022  
USA  
Phone: (212)230-8800  
Fax: (212)230-8888  
Attorney to be Noticed  
Email: Noah.Levine@wilmerhale.com

Steven L Wiser  
Thorelli & Associates  
70 W Madison St  
#5750  
Chicago , IL 60602  
USA  
Phone: (312)357-0300  
Fax: 13123570328  
Attorney to be Noticed  
Email: steve@thorelli.com

Theodore J Koerth  
Thorelli & Associates  
70 W Madison St  
#5750  
Chicago , IL 60602  
USA  
Phone: (312)357-0300  
Fax: (312)357-0328  
Pro Hac Vice  
Attorney to be Noticed  
Email: ted@thorelli.com

Roy William Hardin  
Lead Attorney  
[Term: 06/08/2009]  
Locke Lord Bissell & Liddell, LLP  
2200 Ross Ave  
Suite 2200  
Dallas , TX 75201-6776  
USA  
Phone: (214)740-8000  
Fax: (214)756-8556  
Email: rhardin@lockelord.com

John W MacPete  
[Term: 06/08/2009]  
Locke Lord Bissell & Liddell LLP - Dallas  
2200 Ross Ave  
Suite 2200  
Dallas , TX 75201-6776

Freefi Networks, Inc.  
Defendant  
[Term: 09/09/2009]

USA  
Phone: (214)347-4700  
Fax: (214)347-4799

Email: jmacpete@lockelord.com

Michael Scott Fuller  
[Term: 06/08/2009]  
Locke Lord Bissell & Liddell LLP - Dallas  
2200 Ross Ave  
Suite 2200  
Dallas , TX 75201-6776  
USA  
Phone: (214)740-8601  
Fax: (214)756-8601

Email: sfuller@lockelord.com

Meraki, Inc.  
Defendant  
[Term: 11/05/2009]

Marvin Craig Tyler  
Lead Attorney  
Wilson Sonsini Goodrich & Rosati PC  
900 South Capital of Texas Highway  
Las Cimas IV, Fifth Floor  
Austin , TX 78746-5546  
USA  
Phone: (512)338-5410  
Fax: 15123385499

Email: ctyler@wsgr.com

Aden Martin Allen  
Wilson Sonsini Goodrich & Rosati  
8911 Capital of Texas Highway  
Westech 360, Ste 3350  
Austin , TX 78759-7247  
USA  
Phone: (512)338-5437  
Fax: (512)338-5499

Email: aallen@wsgr.com

Jose Carlos Villarreal  
Wilson Sonsini Goodrich & Rosati  
8911 Capital of Texas Highway  
Westech 360, Ste 3350  
Austin , TX 78759-7247  
USA  
Phone: (512)338-5400  
Fax: 15123385499

Email: jvillarreal@wsgr.com

Robin Lynn Brewer  
Wilson Sonsini Goodrich & Rosati - Palo Alto  
650 Page Mill Rd  
Palo Alto , CA 94304-1050  
USA  
Phone: (650)493-9300  
Fax: (650)493-6811  
Pro Hac Vice  
Attorney to be Noticed  
Email: rbrewer@wsgr.com

Second Rule Llc  
Defendant

Mail Boxes Etc., Inc.  
Defendant

Brian C Bianco  
Lead Attorney  
Sidley Austin - Chicago  
Bank One Plaza  
One South Dearborn Ave  
Chicago , IL 60603  
USA  
Phone: (312)853-7000  
Fax: (312)853-7036  
Attorney to be Noticed  
Email: bcbianco@sidley.com

Michael Charles Smith  
Lead Attorney  
[Term: 02/11/2009]  
Siebman Reynolds Burg Phillips & Smith, LLP-Marshall  
713 South Washington  
Marshall , TX 75670  
USA  
Phone: (903)938-8900  
Fax: 19727674620

Email: michaelsmith@siebman.com

Richard Alan Sayles  
Lead Attorney  
Sayles Werbner  
1201 Elm Street  
4400 Renaissance Tower  
Dallas , TX 75270  
USA  
Phone: (214)939-8700  
Fax: 12149398787  
Attorney to be Noticed  
Email: dsayles@swtriallaw.com

David T Pritikin  
Sidley Austin - Chicago  
Bank One Plaza  
One South Dearborn Ave  
Chicago , IL 60603  
USA  
Phone: (312)853-7359  
Fax: (312)853-7036  
Attorney to be Noticed  
Email: dpritikin@sidley.com

Elizabeth L Maxeiner  
Sidley Austin - Chicago  
One South Dearborn St  
Chicago , IL 60603  
USA  
Phone: (312)853-2225  
Fax: (312)853-7036  
Pro Hac Vice  
Attorney to be Noticed  
Email: emaxeiner@sidley.com

Eve L Henson  
Sayles  
Werbner  
1201 Elm Street 4400 Renaissance Tower , Dallas TX  
75270  
Phone: ehenson@swtriallaw.com  
Fax: (214)939-8700  
Attorney to be Noticed  
Email: USA

Holmes J Hawkins , III  
King & Spalding - Atlanta  
1180 Peachtree Street, NE  
Atlanta , GA 30309-3521  
USA  
Phone: (404)572-4600  
Fax: (404)572-5134  
Attorney to be Noticed  
Email: hhawkins@kslaw.com

Hugh A Abrams  
Sidley Austin - Chicago  
Bank One Plaza  
One South Dearborn Ave  
Chicago , IL 60603  
USA  
Phone: (312)853-7017  
Fax: 13128537036  
Pro Hac Vice  
Attorney to be Noticed  
Email: habrams@sidley.com

Lisa A Schneider  
Sidley Austin - Chicago  
Bank One Plaza  
One South Dearborn Ave  
Chicago , IL 60603  
USA  
Phone: (312)853-7567  
Fax: (312)253-7036  
Pro Hac Vice  
Attorney to be Noticed  
Email: lschneider@sidley.com

Mark Daniel Strachan  
Sayles Webner  
4400 Renaissance  
1201 Elm Street  
Dallas , TX 75270  
USA  
Phone: (214)939-8707  
Fax: (214)939-8787  
Attorney to be Noticed  
Email: mstrachan@swtriallaw.com

Michael Ernest Richardson  
Beck Redden & Secrest - Houston  
1221 McKinney  
Suite 4500  
Houston , TX 77010-2010  
USA  
Phone: (713)951-6284  
Fax: 17139513720  
Attorney to be Noticed  
Email: mrichardson@brsfirm.com

Noah A Levine  
Wilmer Cutler Pickering Hale & Dorr - New York  
399 Park Avenue  
New York , NY 10022  
USA  
Phone: (212)230-8800  
Fax: (212)230-8888  
Attorney to be Noticed  
Email: Noah.Levine@wilmerhale.com



Rachel D Sher  
Sidley Austin - Chicago  
One South Dearborn St  
Chicago , IL 60603  
USA  
Phone: (312)853-7000  
Fax: (312)853-7036  
Attorney to be Noticed  
Email: rsher@sidley.com

Richard A Cederoth  
Sidley Austin - Chicago  
One South Dearborn St  
Chicago , IL 60603  
USA  
Phone: (312)853-7000  
Fax: (312)853-7036  
Pro Hac Vice  
Attorney to be Noticed  
Email: rcederoth@sidley.com

Steven T Snyder  
King & Spalding LLP - Charlotte  
227 West Trade Street  
Suite 600  
Charlotte , NC 28202  
USA  
Phone: (704)503-2630  
Fax: (704)503-2622  
Attorney to be Noticed  
Email: ssnyder@kslaw.com

Mcdonalds Corp.  
Defendant

Marvin Craig Tyler  
Lead Attorney  
[Term: 04/24/2009]  
Wilson Sonsini Goodrich & Rosati PC  
900 South Capital of Texas Highway  
Las Cimas IV, Fifth Floor  
Austin , TX 78746-5546  
USA  
Phone: (512)338-5410  
Fax: 15123385499  
Email: ctyler@wsgr.com

Richard Alan Sayles  
Lead Attorney  
Sayles Werbner  
1201 Elm Street  
4400 Renaissance Tower  
Dallas , TX 75270  
USA  
Phone: (214)939-8700  
Fax: 12149398787  
Attorney to be Noticed  
Email: dsayles@swtriallaw.com

Brian C Bianco  
Sidley Austin - Chicago  
Bank One Plaza  
One South Dearborn Ave  
Chicago , IL 60603  
USA  
Phone: (312)853-7000  
Fax: (312)853-7036  
Attorney to be Noticed

Email: [bcbianco@sidley.com](mailto:bcbianco@sidley.com)

David T Pritikin  
Sidley Austin - Chicago  
Bank One Plaza  
One South Dearborn Ave  
Chicago , IL 60603  
USA  
Phone: (312)853-7359  
Fax: (312)853-7036  
Attorney to be Noticed  
Email: [dpritikin@sidley.com](mailto:dpritikin@sidley.com)

Elizabeth L Maxeiner  
Sidley Austin - Chicago  
One South Dearborn St  
Chicago , IL 60603  
USA  
Phone: (312)853-2225  
Fax: (312)853-7036  
Pro Hac Vice  
Attorney to be Noticed  
Email: [emaxeiner@sidley.com](mailto:emaxeiner@sidley.com)

Eve L Henson  
Sayles  
Werbner  
1201 Elm Street 4400 Renaissance Tower , Dallas TX  
75270  
Phone: [ehenson@swtriallaw.com](mailto:ehenson@swtriallaw.com)  
Fax: (214)939-8700  
Attorney to be Noticed  
Email: USA

Hugh A Abrams  
Sidley Austin - Chicago  
Bank One Plaza  
One South Dearborn Ave  
Chicago , IL 60603  
USA  
Phone: (312)853-7017  
Fax: 13128537036  
Pro Hac Vice  
Attorney to be Noticed  
Email: [habrams@sidley.com](mailto:habrams@sidley.com)

Jose Carlos Villarreal  
[Term: 04/24/2009]  
Wilson Sonsini Goodrich & Rosati  
8911 Capital of Texas Highway  
Westech 360, Ste 3350  
Austin , TX 78759-7247  
USA  
Phone: (512)338-5400  
Fax: 15123385499

Email: [jvillarreal@wsgr.com](mailto:jvillarreal@wsgr.com)

Lisa A Schneider  
Sidley Austin - Chicago  
Bank One Plaza  
One South Dearborn Ave  
Chicago , IL 60603  
USA  
Phone: (312)853-7567  
Fax: (312)253-7036  
Pro Hac Vice

Attorney to be Noticed  
Email: lschneider@sidley.com

Mark Daniel Strachan  
Sayles Webner  
4400 Renaissance  
1201 Elm Street  
Dallas , TX 75270  
USA  
Phone: (214)939-8707  
Fax: (214)939-8787  
Attorney to be Noticed  
Email: mstrachan@swtriallaw.com

Michael Ernest Richardson  
Beck Redden & Secret - Houston  
1221 McKinney  
Suite 4500  
Houston , TX 77010-2010  
USA  
Phone: (713)951-6284  
Fax: 17139513720  
Attorney to be Noticed  
Email: mrichardson@brsfirm.com

Noah A Levine  
Wilmer Cutler Pickering Hale & Dorr - New York  
399 Park Avenue  
New York , NY 10022  
USA  
Phone: (212)230-8800  
Fax: (212)230-8888  
Attorney to be Noticed  
Email: Noah.Levine@wilmerhale.com

Rachel D Sher  
Sidley Austin - Chicago  
One South Dearborn St  
Chicago , IL 60603  
USA  
Phone: (312)853-7000  
Fax: (312)853-7036  
Attorney to be Noticed  
Email: rsher@sidley.com

Richard A Cederroth  
Sidley Austin - Chicago  
One South Dearborn St  
Chicago , IL 60603  
USA  
Phone: (312)853-7000  
Fax: (312)853-7036  
Pro Hac Vice  
Attorney to be Noticed  
Email: rcederth@sidley.com

Richard T McCaulley , Jr  
[Term: 08/10/2009]  
Sidley Austin - Chicago  
Bank One Plaza  
One South Dearborn Ave  
Chicago , IL 60603  
USA  
Phone: (312)853-7000  
Fax: (312)853-7036

Email: rmccaulley@sidley.com

Barnes & Noble Booksellers, Inc.  
Defendant

Brian C Bianco  
Lead Attorney  
Sidley Austin - Chicago  
Bank One Plaza  
One South Dearborn Ave  
Chicago , IL 60603  
USA  
Phone: (312)853-7000  
Fax: (312)853-7036  
Attorney to be Noticed  
Email: bcbianco@sidley.com

Richard Alan Sayles  
Lead Attorney  
Sayles Werbner  
1201 Elm Street  
4400 Renaissance Tower  
Dallas , TX 75270  
USA  
Phone: (214)939-8700  
Fax: 12149398787  
Attorney to be Noticed  
Email: dsayles@swtriallaw.com

David T Pritikin  
Sidley Austin - Chicago  
Bank One Plaza  
One South Dearborn Ave  
Chicago , IL 60603  
USA  
Phone: (312)853-7359  
Fax: (312)853-7036  
Attorney to be Noticed  
Email: dpritikin@sidley.com

Elizabeth L Maxeiner  
Sidley Austin - Chicago  
One South Dearborn St  
Chicago , IL 60603  
USA  
Phone: (312)853-2225  
Fax: (312)853-7036  
Pro Hac Vice  
Attorney to be Noticed  
Email: emaxeiner@sidley.com

Eve L Henson  
Sayles  
Werbner  
1201 Elm Street 4400 Renaissance Tower , Dallas TX  
75270  
Phone: ehenson@swtriallaw.com  
Fax: (214)939-8700  
Attorney to be Noticed  
Email: USA

Hugh A Abrams  
Sidley Austin - Chicago  
Bank One Plaza  
One South Dearborn Ave  
Chicago , IL 60603  
USA  
Phone: (312)853-7017  
Fax: 13128537036  
Pro Hac Vice

Attorney to be Noticed  
Email: habrams@sidley.com

Lisa A Schneider  
Sidley Austin - Chicago  
Bank One Plaza  
One South Dearborn Ave  
Chicago , IL 60603  
USA  
Phone: (312)853-7567  
Fax: (312)253-7036  
Pro Hac Vice  
Attorney to be Noticed  
Email: lschneider@sidley.com

Mark Daniel Strachan  
Sayles Webner  
4400 Renaissance  
1201 Elm Street  
Dallas , TX 75270  
USA  
Phone: (214)939-8707  
Fax: (214)939-8787  
Attorney to be Noticed  
Email: mstrachan@swtriallaw.com

Michael Ernest Richardson  
Beck Redden & Secrest - Houston  
1221 McKinney  
Suite 4500  
Houston , TX 77010-2010  
USA  
Phone: (713)951-6284  
Fax: 17139513720  
Attorney to be Noticed  
Email: mrichardson@brsfirm.com

Noah A Levine  
Wilmer Cutler Pickering Hale & Dorr - New York  
399 Park Avenue  
New York , NY 10022  
USA  
Phone: (212)230-8800  
Fax: (212)230-8888  
Attorney to be Noticed  
Email: Noah.Levine@wilmerhale.com

Rachel D Sher  
Sidley Austin - Chicago  
One South Dearborn St  
Chicago , IL 60603  
USA  
Phone: (312)853-7000  
Fax: (312)853-7036  
Attorney to be Noticed  
Email: rsher@sidley.com

Richard A Cederoth  
Sidley Austin - Chicago  
One South Dearborn St  
Chicago , IL 60603  
USA  
Phone: (312)853-7000  
Fax: (312)853-7036  
Pro Hac Vice  
Attorney to be Noticed  
Email: rcederoth@sidley.com

Ramada Worldwide, Inc.  
Defendant

Christina J Moser  
Baker & Hostetler - Cleveland  
1900 East Ninth Street  
3200 National City Center  
Cleveland , OH 44114  
USA  
Phone: (216)861-7818  
Fax: (216)696-0740  
Pro Hac Vice  
Attorney to be Noticed  
Email: cmoser@bakerlaw.com

David M Stein  
McDermott Will & Emery  
18191 Von Karman Avenue  
Suite 500  
Irvine , CA 92612-7108  
USA  
Phone: (949)851-0633  
Fax: (949)851-9348  
Attorney to be Noticed  
Email: dstein@mwe.com

Dean Danyl Hunt  
Baker & Hostetler  
1000 Louisiana  
Suite 2000  
Houston , TX 77002-5009  
USA  
Phone: (713)646-1346  
Attorney to be Noticed  
Email: dhunt@bakerlaw.com

Fay E Morisseau  
McDermott Will & Emery - Houston  
1000 Louisiana, Suite 3900  
Houston , TX 77002  
USA  
Phone: (713)653-1700  
Fax: (713)653-7592  
Attorney to be Noticed  
Email: fmorisseau@mwe.com

J Thad Heartfield  
The Heartfield Law Firm  
2195 Dowlen Rd  
Beaumont , TX 77706  
USA  
Phone: (409)866-3318  
Fax: 14098665789  
Attorney to be Noticed  
Email: thad@jth-law.com

Jennifer L Yokoyama  
Cooley, Godward, Cronish LLP  
5 Palo Alto Square  
3000 ElCamino  
Palo Alto , CA 94306-2155  
USA  
Phone: (650)213-0332  
Fax: (650)213-8158  
Attorney to be Noticed  
Email: jyokoyama@whitecase.com

Michael Ernest Richardson

Beck Redden & Secrest - Houston  
1221 McKinney  
Suite 4500  
Houston , TX 77010-2010  
USA  
Phone: (713)951-6284  
Fax: 17139513720  
Attorney to be Noticed  
Email: mrichardson@brsfirm.com

Noah A Levine  
Wilmer Cutler Pickering Hale & Dorr - New York  
399 Park Avenue  
New York , NY 10022  
USA  
Phone: (212)230-8800  
Fax: (212)230-8888  
Attorney to be Noticed  
Email: Noah.Levine@wilmerhale.com

Marriott International, Inc.  
Defendant

John M Guaragna  
Lead Attorney  
DLA Piper US LLP - Austin  
401 Congress Ave  
Suite 2500  
Austin , TX 78701-3799  
USA  
Phone: (512)457-7000  
Fax: (512)457-7001  
Attorney to be Noticed  
Email: John.Guaragna@dlapiper.com

Erin Penning  
DLA Piper US LLP - San Diego  
401 B Street  
Suite 1700  
San Diego , CA 92101  
USA  
Phone: (619)699-2862  
Fax: (619)699-2700  
Attorney to be Noticed  
Email: erin.penning@dlapiper.com

John D Kinton  
DLA Piper US LLP - San Diego  
401 B Street  
Suite 1700  
San Diego , CA 92101  
USA  
Phone: (619)699-2700  
Fax: (619)699-2701  
Pro Hac Vice  
Attorney to be Noticed  
Email: john.kinton@dlapiper.com

Michael Ernest Richardson  
Beck Redden & Secrest - Houston  
1221 McKinney  
Suite 4500  
Houston , TX 77010-2010  
USA  
Phone: (713)951-6284  
Fax: 17139513720  
Attorney to be Noticed  
Email: mrichardson@brsfirm.com

Noah A Levine  
Wilmer Cutler Pickering Hale & Dorr - New York  
399 Park Avenue  
New York , NY 10022  
USA  
Phone: (212)230-8800  
Fax: (212)230-8888  
Attorney to be Noticed  
Email: Noah.Levine@wilmerhale.com

Intercontinental Hotels Group Plc  
Defendant  
[Term: 12/12/2008]

Erin Penning  
[Term: 12/12/2008]  
DLA Piper US LLP - San Diego  
401 B Street  
Suite 1700  
San Diego , CA 92101  
USA  
Phone: (619)699-2862  
Fax: (619)699-2700

Email: erin.penning@dlapiper.com

John M Guaragna  
[Term: 12/12/2008]  
DLA Piper US LLP - Austin  
401 Congress Ave  
Suite 2500  
Austin , TX 78701-3799  
USA  
Phone: (512)457-7000  
Fax: (512)457-7001

Email: John.Guaragna@dlapiper.com

John D Kinton  
[Term: 12/12/2008]  
DLA Piper US LLP - San Diego  
401 B Street  
Suite 1700  
San Diego , CA 92101  
USA  
Phone: (619)699-2700  
Fax: (619)699-2701  
Pro Hac Vice

Email: john.kinton@dlapiper.com

Michael Ernest Richardson  
Beck Redden & Secrest - Houston  
1221 McKinney  
Suite 4500  
Houston , TX 77010-2010  
USA  
Phone: (713)951-6284  
Fax: 17139513720  
Attorney to be Noticed  
Email: mrichardson@brsfirm.com

Noah A Levine  
Wilmer Cutler Pickering Hale & Dorr - New York  
399 Park Avenue  
New York , NY 10022  
USA  
Phone: (212)230-8800  
Fax: (212)230-8888  
Attorney to be Noticed



Email: Noah.Levine@wilmerhale.com

Choice Hotels International Inc.  
Defendant

Gregory R Lyons  
Wiley Rein LLP  
1776 K Street NW  
Washington , DC 20006  
USA  
Phone: (202)719-7356  
Fax: (202)719-7049  
Attorney to be Noticed  
Email: glyons@wileyrein.com

Kevin P Anderson  
Wiley Rein LLP  
1776 K Street NW  
Washington , DC 20006  
USA  
Phone: (202)719-7000  
Fax: (202)719-7049  
Attorney to be Noticed  
Email: kanderson@wileyrein.com

Michael Ernest Richardson  
Beck Redden & Secret - Houston  
1221 McKinney  
Suite 4500  
Houston , TX 77010-2010  
USA  
Phone: (713)951-6284  
Fax: 17139513720  
Attorney to be Noticed  
Email: mrichardson@brsfirm.com

Michael Charles Smith  
Siebman Reynolds Burg Phillips & Smith, LLP-Marshall  
713 South Washington  
Marshall , TX 75670  
USA  
Phone: (903)938-8900  
Fax: 19727674620  
Attorney to be Noticed  
Email: michaelsmith@siebman.com

Noah A Levine  
Wilmer Cutler Pickering Hale & Dorr - New York  
399 Park Avenue  
New York , NY 10022  
USA  
Phone: (212)230-8800  
Fax: (212)230-8888  
Attorney to be Noticed  
Email: Noah.Levine@wilmerhale.com

Best Western International, Inc.  
Defendant

Christopher Michael Joe  
Lead Attorney  
Buether Joe & Carpenter, LLC  
1700 Pacific Avenue  
Suite 2390  
Dallas , TX 75201  
USA  
Phone: (214)466-1272  
Fax: (214)635-1828  
Attorney to be Noticed  
Email: Chris.Joe@bjciplaw.com

Andrea L Marconi  
[Term: 07/02/2010]  
Squire Sanders & Dempsey - Phoenix  
Two Renaissance Square  
40 North Central Avenue, Suite 2700  
Phoenix , AZ 85004-4498  
USA  
Phone: (602)916-5424  
Fax: (602)916-5624

Email: amarconi@fclaw.com

Brian Andrew Carpenter  
Buether Joe & Carpenter, LLC  
1700 Pacific Avenue  
Suite 2390  
Dallas , TX 75201  
USA  
Phone: (214)466-1273  
Fax: (214)635-1829  
Attorney to be Noticed  
Email: brian.carpenter@BJCIPlaw.com

David E Rogers  
Squire Sanders & Dempsey - Phoenix  
Two Renaissance Square  
40 North Central Avenue, Suite 2700  
Phoenix , AZ 85004-4498  
USA  
Phone: (602)528-4122  
Fax: (602)253-8129  
Attorney to be Noticed  
Email: drogers@ssd.com

Donald A Wall  
Squire Sanders & Dempsey - Phoenix  
Two Renaissance Square  
40 North Central Avenue, Suite 2700  
Phoenix , AZ 85004-4498  
USA  
Phone: (602)528-4000  
Fax: (602)253-8129  
Pro Hac Vice  
Attorney to be Noticed  
Email: dwall@ssd.com

Michael Ernest Richardson  
Beck Redden & Secrest - Houston  
1221 McKinney  
Suite 4500  
Houston , TX 77010-2010  
USA  
Phone: (713)951-6284  
Fax: 17139513720  
Attorney to be Noticed  
Email: mrichardson@brsfirm.com

Noah A Levine  
Wilmer Cutler Pickering Hale & Dorr - New York  
399 Park Avenue  
New York , NY 10022  
USA  
Phone: (212)230-8800  
Fax: (212)230-8888  
Attorney to be Noticed  
Email: Noah.Levine@wilmerhale.com

Cisco Systems, Inc.  
Consol Defendant

David J Beck  
Lead Attorney  
Beck Redden & Secrest  
1221 McKinney St, Suite 4500  
One Houston Center  
Houston , TX 77010-2020  
USA  
Phone: (713)951-3700  
Fax: 17139513720  
Attorney to be Noticed  
Email: dbeck@brsfirm.com

Alexandra B McTague  
Wilmer Cutler Pickering Hale & Dorr - New York  
399 Park Avenue  
New York , NY 10022  
USA  
Phone: (212)230-8800  
Fax: (212)230-8888  
Pro Hac Vice  
Attorney to be Noticed  
Email: alexandra.mctague@wilmerhale.com

David B Bassett  
Wilmer Cutler Pickering Hale & Dorr - New York  
399 Park Avenue  
New York , NY 10022  
USA  
Phone: (212)230-8800  
Fax: (212)230-8888  
Attorney to be Noticed  
Email: David.Bassett@wilmerhale.com

James P Barabas  
Wilmer Cutler Pickering Hale & Dorr - New York  
399 Park Avenue  
New York , NY 10022  
USA  
Phone: (212)230-8800  
Fax: (212)230-8888  
Attorney to be Noticed  
Email: james.barabas@wilmerhale.com

Joyce Chen  
Wilmer Cutler Pickering Hale & Dorr - New York  
399 Park Avenue  
New York , NY 10022  
USA  
Phone: (212)230-8809  
Fax: (212)230-8888  
Pro Hac Vice  
Attorney to be Noticed  
Email: joyce.chen@wilmerhale.com

Michael Ernest Richardson  
Beck Redden & Secrest - Houston  
1221 McKinney  
Suite 4500  
Houston , TX 77010-2010  
USA  
Phone: (713)951-6284  
Fax: 17139513720  
Attorney to be Noticed  
Email: mrichardson@brsfirm.com

Noah A Levine  
Wilmer Cutler Pickering Hale & Dorr - New York

399 Park Avenue  
New York , NY 10022  
USA  
Phone: (212)230-8800  
Fax: (212)230-8888  
Pro Hac Vice  
Attorney to be Noticed  
Email: Noah.Levine@wilmerhale.com

Peter M Dichiara  
Wilmer Cutler Pickering Hale & Dorr - Boston  
60 State Street  
Boston , MA 02109  
USA  
Phone: (617)526-6466  
Fax: (617)526-5000  
Pro Hac Vice  
Attorney to be Noticed  
Email: peter.dichiara@wilmerhale.com

Robert David Daniel  
Beck Redden & Secrest LLP  
One Houston Center  
1221 McKinney St, Suite 4500  
Houston , TX 77010-2020  
USA  
Phone: (713)951-3700  
Fax: 17139513720  
Attorney to be Noticed  
Email: bddaniel@brsfirm.com

William F Lee  
Wilmer Cutler Pickering Hale & Dorr - Boston  
60 State Street  
Boston , MA 02109  
USA  
Phone: (617)526-6556  
Fax: (617)526-5000  
Attorney to be Noticed  
Email: william.lee@wilmerhale.com

Sbc Internet Services, Inc.: Doing Business as At&T  
Internet Services  
Consol Defendant

Richard Alan Sayles  
Lead Attorney  
Sayles Werbner  
1201 Elm Street  
4400 Renaissance Tower  
Dallas , TX 75270  
USA  
Phone: (214)939-8700  
Fax: 12149398787  
Attorney to be Noticed  
Email: dsayles@swtriallaw.com

David T Pritikin  
Sidley Austin - Chicago  
Bank One Plaza  
One South Dearborn Ave  
Chicago , IL 60603  
USA  
Phone: (312)853-7359  
Fax: (312)853-7036  
Attorney to be Noticed  
Email: dpritikin@sidley.com

Elizabeth L Maxeiner  
Sidley Austin - Chicago

One South Dearborn St  
Chicago , IL 60603  
USA  
Phone: (312)853-2225  
Fax: (312)853-7036  
Pro Hac Vice  
Attorney to be Noticed  
Email: emaxeiner@sidley.com

Eve L Henson  
Sayles  
Werbner  
1201 Elm Street 4400 Renaissance Tower , Dallas TX  
75270  
Phone: ehenson@swtriallaw.com  
Fax: (214)939-8700  
Attorney to be Noticed  
Email: USA

Hugh A Abrams  
Sidley Austin - Chicago  
Bank One Plaza  
One South Dearborn Ave  
Chicago , IL 60603  
USA  
Phone: (312)853-7017  
Fax: 13128537036  
Pro Hac Vice  
Attorney to be Noticed  
Email: habrams@sidley.com

Lisa A Schneider  
Sidley Austin - Chicago  
Bank One Plaza  
One South Dearborn Ave  
Chicago , IL 60603  
USA  
Phone: (312)853-7567  
Fax: (312)253-7036  
Pro Hac Vice  
Attorney to be Noticed  
Email: lschneider@sidley.com

Michael Ernest Richardson  
Beck Redden & Secrest - Houston  
1221 McKinney  
Suite 4500  
Houston , TX 77010-2010  
USA  
Phone: (713)951-6284  
Fax: 17139513720  
Attorney to be Noticed  
Email: mrichardson@brsfirm.com

Noah A Levine  
Wilmer Cutler Pickering Hale & Dorr - New York  
399 Park Avenue  
New York , NY 10022  
USA  
Phone: (212)230-8800  
Fax: (212)230-8888  
Attorney to be Noticed  
Email: Noah.Levine@wilmerhale.com

Rachel D Sher  
Sidley Austin - Chicago  
One South Dearborn St

Chicago , IL 60603  
USA  
Phone: (312)853-7000  
Fax: (312)853-7036  
Attorney to be Noticed  
Email: rsher@sidley.com

Richard A Cederoth  
Sidley Austin - Chicago  
One South Dearborn St  
Chicago , IL 60603  
USA  
Phone: (312)853-7000  
Fax: (312)853-7036  
Pro Hac Vice  
Attorney to be Noticed  
Email: rcederoth@sidley.com

Richard T McCaulley , Jr  
[Term: 08/10/2009]  
Sidley Austin - Chicago  
Bank One Plaza  
One South Dearborn Ave  
Chicago , IL 60603  
USA  
Phone: (312)853-7000  
Fax: (312)853-7036  
Email: rmccaulley@sidley.com

Six Continents Hotels Inc  
Consol Defendant

John M Guaragna  
Lead Attorney  
DLA Piper US LLP - Austin  
401 Congress Ave  
Suite 2500  
Austin , TX 78701-3799  
USA  
Phone: (512)457-7000  
Fax: (512)457-7001  
Attorney to be Noticed  
Email: John.Guaragna@dlapiper.com

Erin P Gibson  
DLA Piper US LLP - San Diego  
401 B Street  
Suite 1700  
San Diego , CA 92101  
USA  
Phone: (619)699-2700  
Fax: (619)699-2701  
Pro Hac Vice  
Attorney to be Noticed  
Email: erin.gibson@dlapiper.com

John D Kinton  
DLA Piper US LLP - San Diego  
401 B Street  
Suite 1700  
San Diego , CA 92101  
USA  
Phone: (619)699-2700  
Fax: (619)699-2701  
Pro Hac Vice  
Attorney to be Noticed  
Email: john.kinton@dlapiper.com

Michael Ernest Richardson  
Beck Redden & Secrest - Houston  
1221 McKinney  
Suite 4500  
Houston , TX 77010-2010  
USA  
Phone: (713)951-6284  
Fax: 17139513720  
Attorney to be Noticed  
Email: mrichardson@brsfirm.com

Noah A Levine  
Wilmer Cutler Pickering Hale & Dorr - New York  
399 Park Avenue  
New York , NY 10022  
USA  
Phone: (212)230-8800  
Fax: (212)230-8888  
Attorney to be Noticed  
Email: Noah.Levine@wilmerhale.com

Intercontinental Hotels Group Resources Inc  
Consol Defendant

John M Guaragna  
Lead Attorney  
DLA Piper US LLP - Austin  
401 Congress Ave  
Suite 2500  
Austin , TX 78701-3799  
USA  
Phone: (512)457-7000  
Fax: (512)457-7001  
Attorney to be Noticed  
Email: John.Guaragna@dlapiper.com

Erin P Gibson  
DLA Piper US LLP - San Diego  
401 B Street  
Suite 1700  
San Diego , CA 92101  
USA  
Phone: (619)699-2700  
Fax: (619)699-2701  
Pro Hac Vice  
Attorney to be Noticed  
Email: erin.gibson@dlapiper.com

John D Kinton  
DLA Piper US LLP - San Diego  
401 B Street  
Suite 1700  
San Diego , CA 92101  
USA  
Phone: (619)699-2700  
Fax: (619)699-2701  
Pro Hac Vice  
Attorney to be Noticed  
Email: john.kinton@dlapiper.com

Michael Ernest Richardson  
Beck Redden & Secrest - Houston  
1221 McKinney  
Suite 4500  
Houston , TX 77010-2010  
USA  
Phone: (713)951-6284  
Fax: 17139513720  
Attorney to be Noticed

Email: mrichardson@brsfirm.com

Noah A Levine  
Wilmer Cutler Pickering Hale & Dorr - New York  
399 Park Avenue  
New York , NY 10022  
USA  
Phone: (212)230-8800  
Fax: (212)230-8888  
Attorney to be Noticed  
Email: Noah.Levine@wilmerhale.com

Cisco Systems, Inc.  
Consol Counter Claimant

David J Beck  
Lead Attorney  
Beck Redden & Secrest  
1221 McKinney St, Suite 4500  
One Houston Center  
Houston , TX 77010-2020  
USA  
Phone: (713)951-3700  
Fax: 17139513720  
Attorney to be Noticed  
Email: dbeck@brsfirm.com

James P Barabas  
Wilmer Cutler Pickering Hale & Dorr - New York  
399 Park Avenue  
New York , NY 10022  
USA  
Phone: (212)230-8800  
Fax: (212)230-8888  
Attorney to be Noticed  
Email: james.barabas@wilmerhale.com

Joyce Chen  
Wilmer Cutler Pickering Hale & Dorr - New York  
399 Park Avenue  
New York , NY 10022  
USA  
Phone: (212)230-8809  
Fax: (212)230-8888  
Pro Hac Vice  
Attorney to be Noticed  
Email: joyce.chen@wilmerhale.com

Michael Ernest Richardson  
Beck Redden & Secrest - Houston  
1221 McKinney  
Suite 4500  
Houston , TX 77010-2010  
USA  
Phone: (713)951-6284  
Fax: 17139513720  
Attorney to be Noticed  
Email: mrichardson@brsfirm.com

Noah A Levine  
Wilmer Cutler Pickering Hale & Dorr - New York  
399 Park Avenue  
New York , NY 10022  
USA  
Phone: (212)230-8800  
Fax: (212)230-8888  
Pro Hac Vice  
Attorney to be Noticed  
Email: Noah.Levine@wilmerhale.com



Sbc Internet Services, Inc.  
Consol Counter Claimant

William F Lee  
Wilmer Cutler Pickering Hale & Dorr - Boston  
60 State Street  
Boston , MA 02109  
USA  
Phone: (617)526-6556  
Fax: (617)526-5000  
Attorney to be Noticed  
Email: william.lee@wilmerhale.com

Richard Alan Sayles  
Lead Attorney  
Sayles Werbner  
1201 Elm Street  
4400 Renaissance Tower  
Dallas , TX 75270  
USA  
Phone: (214)939-8700  
Fax: 12149398787  
Attorney to be Noticed  
Email: dsayles@swtriallaw.com

David T Pritikin  
Sidley Austin - Chicago  
Bank One Plaza  
One South Dearborn Ave  
Chicago , IL 60603  
USA  
Phone: (312)853-7359  
Fax: (312)853-7036  
Attorney to be Noticed  
Email: dpritikin@sidley.com

Hugh A Abrams  
Sidley Austin - Chicago  
Bank One Plaza  
One South Dearborn Ave  
Chicago , IL 60603  
USA  
Phone: (312)853-7017  
Fax: 13128537036  
Pro Hac Vice  
Attorney to be Noticed  
Email: habrams@sidley.com

Michael Ernest Richardson  
Beck Redden & Secrest - Houston  
1221 McKinney  
Suite 4500  
Houston , TX 77010-2010  
USA  
Phone: (713)951-6284  
Fax: 17139513720  
Attorney to be Noticed  
Email: mrichardson@brsfirm.com

Rachel D Sher  
Sidley Austin - Chicago  
One South Dearborn St  
Chicago , IL 60603  
USA  
Phone: (312)853-7000  
Fax: (312)853-7036  
Attorney to be Noticed  
Email: rsher@sidley.com

Richard A Cederoth  
Sidley Austin - Chicago  
One South Dearborn St  
Chicago , IL 60603  
USA  
Phone: (312)853-7000  
Fax: (312)853-7036  
Pro Hac Vice  
Attorney to be Noticed  
Email: rcederoth@sidley.com

Richard T McCaulley , Jr  
[Term: 08/10/2009]  
Sidley Austin - Chicago  
Bank One Plaza  
One South Dearborn Ave  
Chicago , IL 60603  
USA  
Phone: (312)853-7000  
Fax: (312)853-7036

Email: rmccaulley@sidley.com

Six Continents Hotels Inc  
Consol Counter Claimant

John M Guaragna  
Lead Attorney  
DLA Piper US LLP - Austin  
401 Congress Ave  
Suite 2500  
Austin , TX 78701-3799  
USA  
Phone: (512)457-7000  
Fax: (512)457-7001  
Attorney to be Noticed  
Email: John.Guaragna@dlapiper.com

Erin P Gibson  
DLA Piper US LLP - San Diego  
401 B Street  
Suite 1700  
San Diego , CA 92101  
USA  
Phone: (619)699-2700  
Fax: (619)699-2701  
Pro Hac Vice  
Attorney to be Noticed  
Email: erin.gibson@dlapiper.com

John D Kinton  
DLA Piper US LLP - San Diego  
401 B Street  
Suite 1700  
San Diego , CA 92101  
USA  
Phone: (619)699-2700  
Fax: (619)699-2701  
Pro Hac Vice  
Attorney to be Noticed  
Email: john.kinton@dlapiper.com

Michael Ernest Richardson  
Beck Redden & Secrest - Houston  
1221 McKinney  
Suite 4500  
Houston , TX 77010-2010  
USA

Phone: (713)951-6284  
Fax: 17139513720  
Attorney to be Noticed  
Email: mrichardson@brsfirm.com

Intercontinental Hotels Group Resources Inc  
Consol Counter Claimant

John M Guaragna  
Lead Attorney  
DLA Piper US LLP - Austin  
401 Congress Ave  
Suite 2500  
Austin , TX 78701-3799  
USA  
Phone: (512)457-7000  
Fax: (512)457-7001  
Attorney to be Noticed  
Email: John.Guaragna@dlapiper.com

Erin P Gibson  
DLA Piper US LLP - San Diego  
401 B Street  
Suite 1700  
San Diego , CA 92101  
USA  
Phone: (619)699-2700  
Fax: (619)699-2701  
Pro Hac Vice  
Attorney to be Noticed  
Email: erin.gibson@dlapiper.com

John D Kinton  
DLA Piper US LLP - San Diego  
401 B Street  
Suite 1700  
San Diego , CA 92101  
USA  
Phone: (619)699-2700  
Fax: (619)699-2701  
Pro Hac Vice  
Attorney to be Noticed  
Email: john.kinton@dlapiper.com

Michael Ernest Richardson  
Beck Redden & Secrest - Houston  
1221 McKinney  
Suite 4500  
Houston , TX 77010-2010  
USA  
Phone: (713)951-6284  
Fax: 17139513720  
Attorney to be Noticed  
Email: mrichardson@brsfirm.com

Linksmart Wireless Technology, Llc  
Consol Counter Defendant

Andrew D Weiss  
Russ August & Kabat  
12424 Wilshire Boulevard  
12th Floor  
Los Angeles , CA 90025  
USA  
Phone: (310)826-7474  
Fax: (310)826-6991  
Attorney to be Noticed  
Email: aweiss@raklaw.com

Marc A Fenster  
Russ August & Kabat

12424 Wilshire Boulevard  
12th Floor  
Los Angeles , CA 90025  
USA  
Phone: (310)826-7474  
Fax: (310)826-6991  
Attorney to be Noticed  
Email: mfenster@raklaw.com

Cisco Systems, Inc.  
Consol Counter Defendant

David J Beck  
Lead Attorney  
Beck Redden & Secrest  
1221 McKinney St, Suite 4500  
One Houston Center  
Houston , TX 77010-2020  
USA  
Phone: (713)951-3700  
Fax: 17139513720  
Attorney to be Noticed  
Email: dbeck@brsfirm.com

Joyce Chen  
Wilmer Cutler Pickering Hale & Dorr - New York  
399 Park Avenue  
New York , NY 10022  
USA  
Phone: (212)230-8809  
Fax: (212)230-8888  
Pro Hac Vice  
Attorney to be Noticed  
Email: joyce.chen@wilmerhale.com

Michael Ernest Richardson  
Beck Redden & Secrest - Houston  
1221 McKinney  
Suite 4500  
Houston , TX 77010-2010  
USA  
Phone: (713)951-6284  
Fax: 17139513720  
Attorney to be Noticed  
Email: mrichardson@brsfirm.com

Bestcomm Networks, Inc.  
Thirdparty Defendant

Morris C Carrington  
Lead Attorney  
Mehaffy & Weber - Beaumont  
P.O. Box 16  
Beaumont , TX 77704-0016  
USA  
Phone: (409)835-5011  
Fax: 14098355177  
Attorney to be Noticed  
Email: mccarrington@mehaffyweber.com

David J Leonard  
Leonard & Felker  
P O Box 19101  
Tucson , AZ 85731  
USA  
Phone: (520)622-7737  
Fax: (623)321-8085  
Pro Hac Vice  
Attorney to be Noticed  
Email: dovidle@aol.com

Nomadix, Inc.  
Thirdparty Defendant

Douglas G Muehlhauser  
Knobbe Martens Olson & Bear LLP - Irvine,CA  
2040 Main St  
Fourteenth Floor  
Irvine , CA 92614  
USA  
Phone: (949)760-0404  
Fax: (949)760-9502  
Pro Hac Vice  
Attorney to be Noticed  
Email: Doug.Muehlhauser@kmob.com

Elizabeth L DeRieux  
Capshaw DeRieux, LLP  
1127 Judson Road  
Ste 220  
Longview , TX 75601-5157  
USA  
Phone: (903)233-4816  
Fax: (903)236-8787  
Attorney to be Noticed  
Email: ederieux@capshawlaw.com

Sidney Calvin Capshaw , III  
Capshaw DeRieux, LLP  
1127 Judson Road  
Ste 220  
Longview , TX 75601-5157  
USA  
Phone: (903)233-4826  
Fax: (903)236-8787  
Attorney to be Noticed  
Email: ccapshaw@capshawlaw.com

Ethostream, Llc  
Counter Claimant

Dean Danyl Hunt  
Lead Attorney  
Baker & Hostetler  
1000 Louisiana  
Suite 2000  
Houston , TX 77002-5009  
USA  
Phone: (713)646-1346  
Attorney to be Noticed  
Email: dhunt@bakerlaw.com

Christina J Moser  
Baker & Hostetler - Cleveland  
1900 East Ninth Street  
3200 National City Center  
Cleveland , OH 44114  
USA  
Phone: (216)861-7818  
Fax: (216)696-0740  
Pro Hac Vice  
Attorney to be Noticed  
Email: cmoser@bakerlaw.com

Michael Ernest Richardson  
Beck Redden & Secrest - Houston  
1221 McKinney  
Suite 4500  
Houston , TX 77010-2010  
USA  
Phone: (713)951-6284  
Fax: 17139513720  
Attorney to be Noticed

Email: mrichardson@brsfirm.com

Linksmart Wireless Technology, Llc  
Counter Defendant

Andrew D Weiss  
Russ August & Kabat  
12424 Wilshire Boulevard  
12th Floor  
Los Angeles , CA 90025  
USA  
Phone: (310)826-7474  
Fax: (310)826-6991  
Attorney to be Noticed  
Email: aweiss@raklaw.com

Larry C Russ  
Russ August & Kabat  
12424 Wilshire Boulevard  
12th Floor  
Los Angeles , CA 90025  
USA  
Phone: (310)826-7474  
Fax: (310)826-6991  
Attorney to be Noticed  
Email: lruss@raklaw.com

Marc A Fenster  
Russ August & Kabat  
12424 Wilshire Boulevard  
12th Floor  
Los Angeles , CA 90025  
USA  
Phone: (310)826-7474  
Fax: (310)826-6991  
Attorney to be Noticed  
Email: mfenster@raklaw.com

Stanley H. Thompson , Jr  
Russ August & Kabat  
12424 Wilshire Boulevard  
12th Floor  
Los Angeles , CA 90025  
USA  
Phone: (310)826-7474  
Fax: (310)826-6991  
Attorney to be Noticed  
Email: sthompson@raklaw.com

Stephen M Lobbin  
Russ August & Kabat  
12424 Wilshire Boulevard  
12th Floor  
Los Angeles , CA 90025  
USA  
Phone: (310)826-7474  
Fax: (310)826-6991  
Attorney to be Noticed  
Email: slobbin@raklaw.com

Lodgenet Interactive Corporation  
Counter Claimant

Harold L Socks  
Lead Attorney  
[Term: 09/24/2009]  
Ray Valdez McChristian & Jeans - San Antonio  
North Frost Center  
1250 NE Loop 410  
Suite 700  
San Antonio , TX 78209

USA  
Phone: (210)341-3554  
Fax: (210)341-3557

Email: bsocks@rvmjfirm.com

Cynthia Lopez Beverage  
Morrison & Foerster LLP - Washington  
2000 Pennsylvania Avenue NW  
Suite 6000  
Washington , DC 20006  
USA  
Phone: (202)887-6950  
Fax: (202)785-7635  
Attorney to be Noticed  
Email: cbeverage@mofo.com

Michael Ernest Richardson  
Beck Redden & Secret - Houston  
1221 McKinney  
Suite 4500  
Houston , TX 77010-2010  
USA  
Phone: (713)951-6284  
Fax: 17139513720  
Attorney to be Noticed  
Email: mrichardson@brsfirm.com

Linksmart Wireless Technology, Llc  
Counter Defendant

Andrew D Weiss  
Russ August & Kabat  
12424 Wilshire Boulevard  
12th Floor  
Los Angeles , CA 90025  
USA  
Phone: (310)826-7474  
Fax: (310)826-6991  
Attorney to be Noticed  
Email: aweiss@raklaw.com

Larry C Russ  
Russ August & Kabat  
12424 Wilshire Boulevard  
12th Floor  
Los Angeles , CA 90025  
USA  
Phone: (310)826-7474  
Fax: (310)826-6991  
Attorney to be Noticed  
Email: lruss@raklaw.com

Marc A Fenster  
Russ August & Kabat  
12424 Wilshire Boulevard  
12th Floor  
Los Angeles , CA 90025  
USA  
Phone: (310)826-7474  
Fax: (310)826-6991  
Attorney to be Noticed  
Email: mfenster@raklaw.com

Stanley H Thompson , Jr  
Russ August & Kabat  
12424 Wilshire Boulevard  
12th Floor  
Los Angeles , CA 90025

USA  
Phone: (310)826-7474  
Fax: (310)826-6991  
Attorney to be Noticed  
Email: sthompson@raklaw.com

Stephen M Lobbin  
Russ August & Kabat  
12424 Wilshire Boulevard  
12th Floor  
Los Angeles , CA 90025  
USA  
Phone: (310)826-7474  
Fax: (310)826-6991  
Attorney to be Noticed  
Email: slobbin@raklaw.com

Ibahn General Holdings Corp.  
Counter Claimant

Michael E Jones  
Lead Attorney  
Potter Minton PC  
110 N College  
Suite 500  
PO Box 359  
Tyler , TX 75710-0359  
USA  
Phone: (930)597-8311  
Fax: (903)593-0846  
Attorney to be Noticed  
Email: mikejones@potterminton.com

David J Burman  
Perkins Coie LLP - Seattle  
1201 Third Avenue  
Ste 4800  
Seattle , WA 98101-3099  
USA  
Phone: (206)359-8426  
Fax: (206)359-9426  
Pro Hac Vice  
Attorney to be Noticed  
Email: dburman@perkinscoie.com

Kameron Parvin  
Perkins Coie LLP - Seattle  
1201 Third Avenue  
Ste 4800  
Seattle , WA 98101-3099  
USA  
Phone: (206)359-6111  
Fax: (206)359-7111  
Pro Hac Vice  
Attorney to be Noticed  
Email: kparvin@perkinscoie.com

Michael D Broaddus  
Perkins Coie LLP - Seattle  
1201 Third Avenue  
Ste 4800  
Seattle , WA 98101-3099  
USA  
Phone: (206)359-8694  
Fax: (206)359-9694  
Pro Hac Vice  
Attorney to be Noticed  
Email: MBroaddus@perkinscoie.com



Linksmart Wireless Technology, Llc  
Counter Defendant

Michael Ernest Richardson  
Beck Redden & Secrest - Houston  
1221 McKinney  
Suite 4500  
Houston , TX 77010-2010  
USA  
Phone: (713)951-6284  
Fax: 17139513720  
Attorney to be Noticed  
Email: mrichardson@brsfirm.com

Andrew D Weiss  
Russ August & Kabat  
12424 Wilshire Boulevard  
12th Floor  
Los Angeles , CA 90025  
USA  
Phone: (310)826-7474  
Fax: (310)826-6991  
Attorney to be Noticed  
Email: aweiss@raklaw.com

Larry C Russ  
Russ August & Kabat  
12424 Wilshire Boulevard  
12th Floor  
Los Angeles , CA 90025  
USA  
Phone: (310)826-7474  
Fax: (310)826-6991  
Attorney to be Noticed  
Email: lruss@raklaw.com

Marc A Fenster  
Russ August & Kabat  
12424 Wilshire Boulevard  
12th Floor  
Los Angeles , CA 90025  
USA  
Phone: (310)826-7474  
Fax: (310)826-6991  
Attorney to be Noticed  
Email: mfenster@raklaw.com

Stanley H Thompson , Jr  
Russ August & Kabat  
12424 Wilshire Boulevard  
12th Floor  
Los Angeles , CA 90025  
USA  
Phone: (310)826-7474  
Fax: (310)826-6991  
Attorney to be Noticed  
Email: sthompson@raklaw.com

Stephen M Lobbin  
Russ August & Kabat  
12424 Wilshire Boulevard  
12th Floor  
Los Angeles , CA 90025  
USA  
Phone: (310)826-7474  
Fax: (310)826-6991  
Attorney to be Noticed  
Email: slobbin@raklaw.com

Aptilo Networks, Inc.  
Counter Claimant

Clyde Moody Siebman  
Siebman Reynolds Burg & Phillips LLP  
300 N Travis St  
Sherman , TX 75090-0070  
USA  
Phone: (903)870-0070  
Fax: 19038700066  
Attorney to be Noticed  
Email: siebman@siebman.com

Lawrence Augustine Phillips  
Siebman Reynolds Burg & Phillips LLP  
300 N Travis St  
Sherman , TX 75090-9969  
USA  
Phone: (903)870-0070  
Fax: (903)870-0066  
Attorney to be Noticed  
Email: larryphillips@siebman.com

Michael T Herbst  
[Term: 12/03/2009]  
Thorelli & Associates  
70 W Madison St  
#5750  
Chicago , IL 60602  
USA  
Phone: (312)357-0300  
Fax: 13123570328

Email: michael@thorelli.com

Michael Ernest Richardson  
Beck Redden & Secrest - Houston  
1221 McKinney  
Suite 4500  
Houston , TX 77010-2010  
USA  
Phone: (713)951-6284  
Fax: 17139513720  
Attorney to be Noticed  
Email: mrichardson@brsfirm.com

Steven L Wiser  
Thorelli & Associates  
70 W Madison St  
#5750  
Chicago , IL 60602  
USA  
Phone: (312)357-0300  
Fax: 13123570328  
Attorney to be Noticed  
Email: steve@thorelli.com

Linksmart Wireless Technology, LLC  
Counter Defendant

Andrew D Weiss  
Russ August & Kabat  
12424 Wilshire Boulevard  
12th Floor  
Los Angeles , CA 90025  
USA  
Phone: (310)826-7474  
Fax: (310)826-6991  
Attorney to be Noticed  
Email: aweiss@raklaw.com

Larry C Russ

Russ August & Kabat  
12424 Wilshire Boulevard  
12th Floor  
Los Angeles , CA 90025  
USA  
Phone: (310)826-7474  
Fax: (310)826-6991  
Attorney to be Noticed  
Email: lruss@raklaw.com

Marc A Fenster  
Russ August & Kabat  
12424 Wilshire Boulevard  
12th Floor  
Los Angeles , CA 90025  
USA  
Phone: (310)826-7474  
Fax: (310)826-6991  
Attorney to be Noticed  
Email: mfenster@raklaw.com

Stanley H Thompson , Jr  
Russ August & Kabat  
12424 Wilshire Boulevard  
12th Floor  
Los Angeles , CA 90025  
USA  
Phone: (310)826-7474  
Fax: (310)826-6991  
Attorney to be Noticed  
Email: sthompson@raklaw.com

Stephen M Lobbin  
Russ August & Kabat  
12424 Wilshire Boulevard  
12th Floor  
Los Angeles , CA 90025  
USA  
Phone: (310)826-7474  
Fax: (310)826-6991  
Attorney to be Noticed  
Email: slobbin@raklaw.com

T-Mobile USA, Inc.  
Counter Claimant

David J Beck  
Lead Attorney  
Beck Redden & Secrest  
1221 McKinney St, Suite 4500  
One Houston Center  
Houston , TX 77010-2020  
USA  
Phone: (713)951-3700  
Fax: 17139513720  
Attorney to be Noticed  
Email: dbeck@brsfirm.com

David B Bassett  
Wilmer Cutler Pickering Hale & Dorr - New York  
399 Park Avenue  
New York , NY 10022  
USA  
Phone: (212)230-8800  
Fax: (212)230-8888  
Attorney to be Noticed  
Email: David.Bassett@wilmerhale.com

James P Barabas

Wilmer Cutler Pickering Hale & Dorr - New York  
399 Park Avenue  
New York , NY 10022  
USA  
Phone: (212)230-8800  
Fax: (212)230-8888  
Attorney to be Noticed  
Email: james.barabas@wilmerhale.com

Joyce Chen  
Wilmer Cutler Pickering Hale & Dorr - New York  
399 Park Avenue  
New York , NY 10022  
USA  
Phone: (212)230-8809  
Fax: (212)230-8888  
Pro Hac Vice  
Attorney to be Noticed  
Email: joyce.chen@wilmerhale.com

Kirk R Ruthenberg  
Sonnenschein Nath & Rosenthal LLP - DC  
1301 K Street, NW  
Suite 600E  
Washington , DC 20005  
USA  
Phone: (202)408-6410  
Fax: (202)408-6399  
Pro Hac Vice  
Attorney to be Noticed  
Email: kruthenberg@sonnenschein.com

Michael Ernest Richardson  
Beck Redden & Secrest - Houston  
1221 McKinney  
Suite 4500  
Houston , TX 77010-2010  
USA  
Phone: (713)951-6284  
Fax: 17139513720  
Attorney to be Noticed  
Email: mrichardson@brsfirm.com

Noah A Levine  
Wilmer Cutler Pickering Hale & Dorr - New York  
399 Park Avenue  
New York , NY 10022  
USA  
Phone: (212)230-8800  
Fax: (212)230-8888  
Pro Hac Vice  
Attorney to be Noticed  
Email: Noah.Levine@wilmerhale.com

Peter M Dichiara  
Wilmer Cutler Pickering Hale & Dorr - Boston  
60 State Street  
Boston , MA 02109  
USA  
Phone: (617)526-6466  
Fax: (617)526-5000  
Pro Hac Vice  
Attorney to be Noticed  
Email: peter.dichiara@wilmerhale.com

Counter Defendant

Russ August & Kabat  
12424 Wilshire Boulevard  
12th Floor  
Los Angeles , CA 90025  
USA  
Phone: (310)826-7474  
Fax: (310)826-6991  
Attorney to be Noticed  
Email: aweiss@raklaw.com

Larry C Russ  
Russ August & Kabat  
12424 Wilshire Boulevard  
12th Floor  
Los Angeles , CA 90025  
USA  
Phone: (310)826-7474  
Fax: (310)826-6991  
Attorney to be Noticed  
Email: lruss@raklaw.com

Marc A Fenster  
Russ August & Kabat  
12424 Wilshire Boulevard  
12th Floor  
Los Angeles , CA 90025  
USA  
Phone: (310)826-7474  
Fax: (310)826-6991  
Attorney to be Noticed  
Email: mfenster@raklaw.com

Stanley H Thompson , Jr  
Russ August & Kabat  
12424 Wilshire Boulevard  
12th Floor  
Los Angeles , CA 90025  
USA  
Phone: (310)826-7474  
Fax: (310)826-6991  
Attorney to be Noticed  
Email: sthompson@raklaw.com

Stephen M Lobbin  
Russ August & Kabat  
12424 Wilshire Boulevard  
12th Floor  
Los Angeles , CA 90025  
USA  
Phone: (310)826-7474  
Fax: (310)826-6991  
Attorney to be Noticed  
Email: slobbin@raklaw.com

Mail Boxes Etc., Inc.  
Counter Claimant

Brian C Bianco  
Lead Attorney  
Sidley Austin - Chicago  
Bank One Plaza  
One South Dearborn Ave  
Chicago , IL 60603  
USA  
Phone: (312)853-7000  
Fax: (312)853-7036  
Attorney to be Noticed  
Email: bcbianco@sidley.com

Michael Charles Smith  
Lead Attorney  
[Term: 02/11/2009]  
Siebman Reynolds Burg Phillips & Smith, LLP-Marshall  
713 South Washington  
Marshall , TX 75670  
USA  
Phone: (903)938-8900  
Fax: 19727674620

Email: [michaelsmith@siebman.com](mailto:michaelsmith@siebman.com)

Richard Alan Sayles  
Lead Attorney  
Sayles Werbner  
1201 Elm Street  
4400 Renaissance Tower  
Dallas , TX 75270  
USA  
Phone: (214)939-8700  
Fax: 12149398787  
Attorney to be Noticed  
Email: [dsayles@swtriallaw.com](mailto:dsayles@swtriallaw.com)

Holmes J Hawkins , III  
King & Spalding - Atlanta  
1180 Peachtree Street, NE  
Atlanta , GA 30309-3521  
USA  
Phone: (404)572-4600  
Fax: (404)572-5134  
Attorney to be Noticed  
Email: [hhawkins@kslaw.com](mailto:hhawkins@kslaw.com)

Hugh A Abrams  
Sidley Austin - Chicago  
Bank One Plaza  
One South Dearborn Ave  
Chicago , IL 60603  
USA  
Phone: (312)853-7017  
Fax: 13128537036  
Pro Hac Vice  
Attorney to be Noticed  
Email: [habrams@sidley.com](mailto:habrams@sidley.com)

Michael Ernest Richardson  
Beck Redden & Secrest - Houston  
1221 McKinney  
Suite 4500  
Houston , TX 77010-2010  
USA  
Phone: (713)951-6284  
Fax: 17139513720  
Attorney to be Noticed  
Email: [mrichardson@brsfirm.com](mailto:mrichardson@brsfirm.com)

Steven T Snyder  
King & Spalding LLP - Charlotte  
227 West Trade Street  
Suite 600  
Charlotte , NC 28202  
USA  
Phone: (704)503-2630  
Fax: (704)503-2622  
Attorney to be Noticed  
Email: [ssnyder@kslaw.com](mailto:ssnyder@kslaw.com)

Linksmart Wireless Technology, Llc  
Counter Defendant

Andrew D Weiss  
Russ August & Kabat  
12424 Wilshire Boulevard  
12th Floor  
Los Angeles , CA 90025  
USA  
Phone: (310)826-7474  
Fax: (310)826-6991  
Attorney to be Noticed  
Email: aweiss@raklaw.com

Larry C Russ  
Russ August & Kabat  
12424 Wilshire Boulevard  
12th Floor  
Los Angeles , CA 90025  
USA  
Phone: (310)826-7474  
Fax: (310)826-6991  
Attorney to be Noticed  
Email: lruss@raklaw.com

Marc A Fenster  
Russ August & Kabat  
12424 Wilshire Boulevard  
12th Floor  
Los Angeles , CA 90025  
USA  
Phone: (310)826-7474  
Fax: (310)826-6991  
Attorney to be Noticed  
Email: mfenster@raklaw.com

Stanley H Thompson , Jr  
Russ August & Kabat  
12424 Wilshire Boulevard  
12th Floor  
Los Angeles , CA 90025  
USA  
Phone: (310)826-7474  
Fax: (310)826-6991  
Attorney to be Noticed  
Email: sthompson@raklaw.com

Stephen M Lobbin  
Russ August & Kabat  
12424 Wilshire Boulevard  
12th Floor  
Los Angeles , CA 90025  
USA  
Phone: (310)826-7474  
Fax: (310)826-6991  
Attorney to be Noticed  
Email: slobbin@raklaw.com

Marriott International, Inc.  
Counter Claimant

John M Guaragna  
Lead Attorney  
DLA Piper US LLP - Austin  
401 Congress Ave  
Suite 2500  
Austin , TX 78701-3799  
USA  
Phone: (512)457-7000  
Fax: (512)457-7001

Attorney to be Noticed  
Email: John.Guaragna@dlapiper.com

Michael Ernest Richardson  
Beck Redden & Secrest - Houston  
1221 McKinney  
Suite 4500  
Houston , TX 77010-2010  
USA  
Phone: (713)951-6284  
Fax: 17139513720  
Attorney to be Noticed  
Email: mrichardson@brsfirm.com

Linksmart Wireless Technology, Llc  
Counter Defendant

Andrew D Weiss  
Russ August & Kabat  
12424 Wilshire Boulevard  
12th Floor  
Los Angeles , CA 90025  
USA  
Phone: (310)826-7474  
Fax: (310)826-6991  
Attorney to be Noticed  
Email: aweiss@raklaw.com

Larry C Russ  
Russ August & Kabat  
12424 Wilshire Boulevard  
12th Floor  
Los Angeles , CA 90025  
USA  
Phone: (310)826-7474  
Fax: (310)826-6991  
Attorney to be Noticed  
Email: lruss@raklaw.com

Marc A Fenster  
Russ August & Kabat  
12424 Wilshire Boulevard  
12th Floor  
Los Angeles , CA 90025  
USA  
Phone: (310)826-7474  
Fax: (310)826-6991  
Attorney to be Noticed  
Email: mfenster@raklaw.com

Stanley H Thompson , Jr  
Russ August & Kabat  
12424 Wilshire Boulevard  
12th Floor  
Los Angeles , CA 90025  
USA  
Phone: (310)826-7474  
Fax: (310)826-6991  
Attorney to be Noticed  
Email: sthompson@raklaw.com.

Stephen M Lobbin  
Russ August & Kabat  
12424 Wilshire Boulevard  
12th Floor  
Los Angeles , CA 90025  
USA  
Phone: (310)826-7474  
Fax: (310)826-6991



Wayport, Inc.  
Counter Claimant

Attorney to be Noticed  
Email: slobbin@raklaw.com

Brian C Bianco  
Lead Attorney  
Sidley Austin - Chicago  
Bank One Plaza  
One South Dearborn Ave  
Chicago , IL 60603  
USA  
Phone: (312)853-7000  
Fax: (312)853-7036  
Attorney to be Noticed  
Email: bcbianco@sidley.com

Marvin Craig Tyler  
Lead Attorney  
[Term: 01/28/2009]  
Wilson Sonsini Goodrich & Rosati PC  
900 South Capital of Texas Highway  
Las Cimas IV, Fifth Floor  
Austin , TX 78746-5546  
USA  
Phone: (512)338-5410  
Fax: 15123385499  
Email: ctyler@wsgr.com

Hugh A Abrams  
Sidley Austin - Chicago  
Bank One Plaza  
One South Dearborn Ave  
Chicago , IL 60603  
USA  
Phone: (312)853-7017  
Fax: 13128537036  
Pro Hac Vice  
Attorney to be Noticed  
Email: habrams@sidley.com

Jose Carlos Villarreal  
[Term: 01/28/2009]  
Wilson Sonsini Goodrich & Rosati  
8911 Capital of Texas Highway  
Westech 360, Ste 3350  
Austin , TX 78759-7247  
USA  
Phone: (512)338-5400  
Fax: 15123385499  
Email: jvillarreal@wsgr.com

Michael Ernest Richardson  
Beck Redden & Secrest - Houston  
1221 McKinney  
Suite 4500  
Houston , TX 77010-2010  
USA  
Phone: (713)951-6284  
Fax: 17139513720  
Attorney to be Noticed  
Email: mrichardson@brsfirm.com

Linksmart Wireless Technology, LLC  
Counter Defendant

Andrew D Weiss  
Russ August & Kabat

12424 Wilshire Boulevard  
12th Floor  
Los Angeles , CA 90025  
USA  
Phone: (310)826-7474  
Fax: (310)826-6991  
Attorney to be Noticed  
Email: aweiss@raklaw.com

Larry C Russ  
Russ August & Kabat  
12424 Wilshire Boulevard  
12th Floor  
Los Angeles , CA 90025  
USA  
Phone: (310)826-7474  
Fax: (310)826-6991  
Attorney to be Noticed  
Email: lruss@raklaw.com

Marc A Fenster  
Russ August & Kabat  
12424 Wilshire Boulevard  
12th Floor  
Los Angeles , CA 90025  
USA  
Phone: (310)826-7474  
Fax: (310)826-6991  
Attorney to be Noticed  
Email: mfenster@raklaw.com

Stanley H Thompson , Jr  
Russ August & Kabat  
12424 Wilshire Boulevard  
12th Floor  
Los Angeles , CA 90025  
USA  
Phone: (310)826-7474  
Fax: (310)826-6991  
Attorney to be Noticed  
Email: sthompson@raklaw.com

Stephen M Lobbin  
Russ August & Kabat  
12424 Wilshire Boulevard  
12th Floor  
Los Angeles , CA 90025  
USA  
Phone: (310)826-7474  
Fax: (310)826-6991  
Attorney to be Noticed  
Email: slobbin@raklaw.com

Barnes & Noble Booksellers, Inc.  
Counter Claimant

Brian C Bianco  
Lead Attorney  
Sidley Austin - Chicago  
Bank One Plaza  
One South Dearborn Ave  
Chicago , IL 60603  
USA  
Phone: (312)853-7000  
Fax: (312)853-7036  
Attorney to be Noticed  
Email: bcbianco@sidley.com

Richard Alan Sayles

Lead Attorney  
Sayles Werbner  
1201 Elm Street  
4400 Renaissance Tower  
Dallas , TX 75270  
USA  
Phone: (214)939-8700  
Fax: 12149398787  
Attorney to be Noticed  
Email: dsayles@swtriallaw.com

Hugh A Abrams  
Sidley Austin - Chicago  
Bank One Plaza  
One South Dearborn Ave  
Chicago , IL 60603  
USA  
Phone: (312)853-7017  
Fax: 13128537036  
Pro Hac Vice  
Attorney to be Noticed  
Email: habrams@sidley.com

Michael Ernest Richardson  
Beck Redden & Secret - Houston  
1221 McKinney  
Suite 4500  
Houston , TX 77010-2010  
USA  
Phone: (713)951-6284  
Fax: 17139513720  
Attorney to be Noticed  
Email: mrichardson@brsfirm.com

Linksmart Wireless Technology, Llc  
Counter Defendant

Andrew D Weiss  
Russ August & Kabat  
12424 Wilshire Boulevard  
12th Floor  
Los Angeles , CA 90025  
USA  
Phone: (310)826-7474  
Fax: (310)826-6991  
Attorney to be Noticed  
Email: aweiss@raklaw.com

Larry C Russ  
Russ August & Kabat  
12424 Wilshire Boulevard  
12th Floor  
Los Angeles , CA 90025  
USA  
Phone: (310)826-7474  
Fax: (310)826-6991  
Attorney to be Noticed  
Email: lruss@raklaw.com

Marc A Fenster  
Russ August & Kabat  
12424 Wilshire Boulevard  
12th Floor  
Los Angeles , CA 90025  
USA  
Phone: (310)826-7474  
Fax: (310)826-6991  
Attorney to be Noticed  
Email: mfenster@raklaw.com

Stanley H Thompson , Jr  
Russ August & Kabat  
12424 Wilshire Boulevard  
12th Floor  
Los Angeles , CA 90025  
USA  
Phone: (310)826-7474  
Fax: (310)826-6991  
Attorney to be Noticed  
Email: sthompson@raklaw.com

Stephen M Lobbin  
Russ August & Kabat  
12424 Wilshire Boulevard  
12th Floor  
Los Angeles , CA 90025  
USA  
Phone: (310)826-7474  
Fax: (310)826-6991  
Attorney to be Noticed  
Email: slobbin@raklaw.com

Mcdonalds Corp.  
Counter Claimant

Marvin Craig Tyler  
Lead Attorney  
[Term: 04/24/2009]  
Wilson Sonsini Goodrich & Rosati PC  
900 South Capital of Texas Highway  
Las Cimas IV, Fifth Floor  
Austin , TX 78746-5546  
USA  
Phone: (512)338-5410  
Fax: 15123385499  
Email: ctyler@wsgr.com

Hugh A Abrams  
Sidley Austin - Chicago  
Bank One Plaza  
One South Dearborn Ave  
Chicago , IL 60603  
USA  
Phone: (312)853-7017  
Fax: 13128537036  
Pro Hac Vice  
Attorney to be Noticed  
Email: habrams@sidley.com

Jose Carlos Villarreal  
[Term: 04/24/2009]  
Wilson Sonsini Goodrich & Rosati  
8911 Capital of Texas Highway  
Westech 360, Ste 3350  
Austin , TX 78759-7247  
USA  
Phone: (512)338-5400  
Fax: 15123385499  
Email: jvillarreal@wsgr.com

Jose Carlos Villarreal  
[Term: 04/24/2009]  
Wilson Sonsini Goodrich & Rosati  
8911 Capital of Texas Highway  
Westech 360, Ste 3350  
Austin , TX 78759-7247

USA  
Phone: (512)338-5400  
Fax: 15123385499  
Attorney to be Noticed  
Email: jvillarreal@wsgr.com

Michael Ernest Richardson  
Beck Redden & Secrest - Houston  
1221 McKinney  
Suite 4500  
Houston , TX 77010-2010  
USA  
Phone: (713)951-6284  
Fax: 17139513720  
Attorney to be Noticed  
Email: mrichardson@brsfirm.com

Linksmart Wireless Technology, Llc  
Counter Defendant

Andrew D Weiss  
Russ August & Kabat  
12424 Wilshire Boulevard  
12th Floor  
Los Angeles , CA 90025  
USA  
Phone: (310)826-7474  
Fax: (310)826-6991  
Attorney to be Noticed  
Email: aweiss@raklaw.com

Larry C Russ  
Russ August & Kabat  
12424 Wilshire Boulevard  
12th Floor  
Los Angeles , CA 90025  
USA  
Phone: (310)826-7474  
Fax: (310)826-6991  
Attorney to be Noticed  
Email: lruss@raklaw.com

Marc A Fenster  
Russ August & Kabat  
12424 Wilshire Boulevard  
12th Floor  
Los Angeles , CA 90025  
USA  
Phone: (310)826-7474  
Fax: (310)826-6991  
Attorney to be Noticed  
Email: mfenster@raklaw.com

Stanley H Thompson , Jr  
Russ August & Kabat  
12424 Wilshire Boulevard  
12th Floor  
Los Angeles , CA 90025  
USA  
Phone: (310)826-7474  
Fax: (310)826-6991  
Attorney to be Noticed  
Email: sthompson@raklaw.com

Stephen M Lobbin  
Russ August & Kabat  
12424 Wilshire Boulevard  
12th Floor  
Los Angeles , CA 90025

Meraki, Inc.  
Counter Claimant  
[Term: 11/05/2009]

Linksmart Wireless Technology, LLC  
Counter Defendant

USA  
Phone: (310)826-7474  
Fax: (310)826-6991  
Attorney to be Noticed  
Email: slobbin@raklaw.com

Marvin Craig Tyler  
Lead Attorney  
Wilson Sonsini Goodrich & Rosati PC  
900 South Capital of Texas Highway  
Las Cimas IV, Fifth Floor  
Austin, TX 78746-5546  
USA  
Phone: (512)338-5410  
Fax: 15123385499

Email: ctyler@wsgr.com

Aden Martin Allen  
Wilson Sonsini Goodrich & Rosati  
8911 Capital of Texas Highway  
Westech 360, Ste 3350  
Austin, TX 78759-7247  
USA  
Phone: (512)338-5437  
Fax: (512)338-5499

Email: aallen@wsgr.com

Jose Carlos Villarreal  
Wilson Sonsini Goodrich & Rosati  
8911 Capital of Texas Highway  
Westech 360, Ste 3350  
Austin, TX 78759-7247  
USA  
Phone: (512)338-5400  
Fax: 15123385499

Email: jvillarreal@wsgr.com

Andrew D Weiss  
Russ August & Kabat  
12424 Wilshire Boulevard  
12th Floor  
Los Angeles, CA 90025  
USA  
Phone: (310)826-7474  
Fax: (310)826-6991  
Attorney to be Noticed  
Email: aweiss@raklaw.com

Larry C Russ  
Russ August & Kabat  
12424 Wilshire Boulevard  
12th Floor  
Los Angeles, CA 90025  
USA  
Phone: (310)826-7474  
Fax: (310)826-6991  
Attorney to be Noticed  
Email: lruss@raklaw.com

Marc A Fenster  
Russ August & Kabat  
12424 Wilshire Boulevard

12th Floor  
Los Angeles , CA 90025  
USA  
Phone: (310)826-7474  
Fax: (310)826-6991  
Attorney to be Noticed  
Email: mfenster@raklaw.com

Stanley H Thompson , Jr  
Russ August & Kabat  
12424 Wilshire Boulevard  
12th Floor  
Los Angeles , CA 90025  
USA  
Phone: (310)826-7474  
Fax: (310)826-6991  
Attorney to be Noticed  
Email: sthompson@raklaw.com

Stephen M Lobbin  
Russ August & Kabat  
12424 Wilshire Boulevard  
12th Floor  
Los Angeles , CA 90025  
USA  
Phone: (310)826-7474  
Fax: (310)826-6991  
Attorney to be Noticed  
Email: slobbin@raklaw.com

Best Western International, Inc.  
Counter Claimant

Christopher Michael Joe  
Lead Attorney  
Buether Joe & Carpenter, LLC  
1700 Pacific Avenue  
Suite 2390  
Dallas , TX 75201  
USA  
Phone: (214)466-1272  
Fax: (214)635-1828  
Attorney to be Noticed  
Email: Chris.Joe@bjciplaw.com

David E Rogers  
Squire Sanders & Dempsey - Phoenix  
Two Renaissance Square  
40 North Central Avenue, Suite 2700  
Phoenix , AZ 85004-4498  
USA  
Phone: (602)528-4122  
Fax: (602)253-8129  
Attorney to be Noticed  
Email: drogers@ssd.com

Michael Ernest Richardson  
Beck Redden & Secrest - Houston  
1221 McKinney  
Suite 4500  
Houston , TX 77010-2010  
USA  
Phone: (713)951-6284  
Fax: 17139513720  
Attorney to be Noticed  
Email: mrichardson@brsfirm.com

Linksmart Wireless Technology, LLC

Andrew D Weiss

Counter Defendant

Russ August & Kabat  
12424 Wilshire Boulevard  
12th Floor  
Los Angeles , CA 90025  
USA  
Phone: (310)826-7474  
Fax: (310)826-6991  
Attorney to be Noticed  
Email: aweiss@raklaw.com

Larry C Russ  
Russ August & Kabat  
12424 Wilshire Boulevard  
12th Floor  
Los Angeles , CA 90025  
USA  
Phone: (310)826-7474  
Fax: (310)826-6991  
Attorney to be Noticed  
Email: lruss@raklaw.com

Marc A Fenster  
Russ August & Kabat  
12424 Wilshire Boulevard  
12th Floor  
Los Angeles , CA 90025  
USA  
Phone: (310)826-7474  
Fax: (310)826-6991  
Attorney to be Noticed  
Email: mfenster@raklaw.com

Stanley H Thompson , Jr  
Russ August & Kabat  
12424 Wilshire Boulevard  
12th Floor  
Los Angeles , CA 90025  
USA  
Phone: (310)826-7474  
Fax: (310)826-6991  
Attorney to be Noticed  
Email: sthompson@raklaw.com

Stephen M Lobbin  
Russ August & Kabat  
12424 Wilshire Boulevard  
12th Floor  
Los Angeles , CA 90025  
USA  
Phone: (310)826-7474  
Fax: (310)826-6991  
Attorney to be Noticed  
Email: slobbin@raklaw.com

Ramada Worldwide, Inc.  
Counter Claimant

Christina J Moser  
Baker & Hostetler - Cleveland  
1900 East Ninth Street  
3200 National City Center  
Cleveland , OH 44114  
USA  
Phone: (216)861-7818  
Fax: (216)696-0740  
Pro Hac Vice  
Attorney to be Noticed  
Email: cmoser@bakerlaw.com



David M Stein  
McDermott Will & Emery  
18191 Von Karman Avenue  
Suite 500  
Irvine , CA 92612-7108  
USA  
Phone: (949)851-0633  
Fax: (949)851-9348  
Attorney to be Noticed  
Email: dstein@mwe.com

Dean Danyl Hunt  
Baker & Hostetler  
1000 Louisiana  
Suite 2000  
Houston , TX 77002-5009  
USA  
Phone: (713)646-1346  
Attorney to be Noticed  
Email: dhunt@bakerlaw.com

Fay E Morisseau  
McDermott Will & Emery - Houston  
1000 Louisiana, Suite 3900  
Houston , TX 77002  
USA  
Phone: (713)653-1700  
Fax: (713)653-7592  
Attorney to be Noticed  
Email: fmorisseau@mwe.com

J Thad Heartfield  
The Heartfield Law Firm  
2195 Dowlen Rd  
Beaumont , TX 77706  
USA  
Phone: (409)866-3318  
Fax: 14098665789  
Attorney to be Noticed  
Email: thad@jth-law.com

Jennifer L Yokoyama  
Cooley, Godward, Cronish LLP  
5 Palo Alto Square  
3000 ElCamino  
Palo Alto , CA 94306-2155  
USA  
Phone: (650)213-0332  
Fax: (650)213-8158  
Attorney to be Noticed  
Email: jyokoyama@whitecase.com

Michael Ernest Richardson  
Beck Redden & Secrest - Houston  
1221 McKinney  
Suite 4500  
Houston , TX 77010-2010  
USA  
Phone: (713)951-6284  
Fax: 17139513720  
Attorney to be Noticed  
Email: mrichardson@brsfirm.com

Linksmart Wireless Technology, LLC  
Counter Defendant

Andrew D Weiss  
Russ August & Kabat  
12424 Wilshire Boulevard

12th Floor  
Los Angeles , CA 90025  
USA  
Phone: (310)826-7474  
Fax: (310)826-6991  
Attorney to be Noticed  
Email: aweiss@raklaw.com

Larry C Russ  
Russ August & Kabat  
12424 Wilshire Boulevard  
12th Floor  
Los Angeles , CA 90025  
USA  
Phone: (310)826-7474  
Fax: (310)826-6991  
Attorney to be Noticed  
Email: lruss@raklaw.com

Marc A Fenster  
Russ August & Kabat  
12424 Wilshire Boulevard  
12th Floor  
Los Angeles , CA 90025  
USA  
Phone: (310)826-7474  
Fax: (310)826-6991  
Attorney to be Noticed  
Email: mfenster@raklaw.com

Stanley H Thompson , Jr  
Russ August & Kabat  
12424 Wilshire Boulevard  
12th Floor  
Los Angeles , CA 90025  
USA  
Phone: (310)826-7474  
Fax: (310)826-6991  
Attorney to be Noticed  
Email: sthompson@raklaw.com

Stephen M Lobbin  
Russ August & Kabat  
12424 Wilshire Boulevard  
12th Floor  
Los Angeles , CA 90025  
USA  
Phone: (310)826-7474  
Fax: (310)826-6991  
Attorney to be Noticed  
Email: slobbin@raklaw.com

Pronto Networks, Inc.  
Counter Claimant  
[Term: 06/09/2010]

Jose Carlos Villarreal  
Lead Attorney  
Wilson Sonsini Goodrich & Rosati  
8911 Capital of Texas Highway  
Westech 360, Ste 3350  
Austin , TX 78759-7247  
USA  
Phone: (512)338-5400  
Fax: 15123385499

Email: jvillarreal@wsgr.com

Aden Martin Allen  
Wilson Sonsini Goodrich & Rosati

8911 Capital of Texas Highway  
Westech 360, Ste 3350  
Austin , TX 78759-7247  
USA  
Phone: (512)338-5437  
Fax: (512)338-5499

Email: aallen@wsgr.com

Michael Ernest Richardson  
Beck Redden & Secrest - Houston  
1221 McKinney  
Suite 4500  
Houston , TX 77010-2010  
USA  
Phone: (713)951-6284  
Fax: 17139513720

Email: mrichardson@brsfirm.com

Linksmart Wireless Technology, LLC  
Counter Defendant

Andrew D Weiss  
Russ August & Kabat  
12424 Wilshire Boulevard  
12th Floor  
Los Angeles , CA 90025  
USA  
Phone: (310)826-7474  
Fax: (310)826-6991  
Attorney to be Noticed  
Email: aweiss@raklaw.com

Larry C Russ  
Russ August & Kabat  
12424 Wilshire Boulevard  
12th Floor  
Los Angeles , CA 90025  
USA  
Phone: (310)826-7474  
Fax: (310)826-6991  
Attorney to be Noticed  
Email: lruss@raklaw.com

Marc A Fenster  
Russ August & Kabat  
12424 Wilshire Boulevard  
12th Floor  
Los Angeles , CA 90025  
USA  
Phone: (310)826-7474  
Fax: (310)826-6991  
Attorney to be Noticed  
Email: mfenster@raklaw.com

Stanley H Thompson , Jr  
Russ August & Kabat  
12424 Wilshire Boulevard  
12th Floor  
Los Angeles , CA 90025  
USA  
Phone: (310)826-7474  
Fax: (310)826-6991  
Attorney to be Noticed  
Email: sthompson@raklaw.com

Stephen M Lobbin  
Russ August & Kabat

12424 Wilshire Boulevard  
12th Floor  
Los Angeles , CA 90025  
USA  
Phone: (310)826-7474  
Fax: (310)826-6991  
Attorney to be Noticed  
Email: slobbin@raklaw.com

Freefi Networks, Inc.  
Counter Claimant  
[Term: 09/09/2009]

Roy William Hardin  
Lead Attorney  
[Term: 06/08/2009]  
Locke Lord Bissell & Liddell, LLP  
2200 Ross Ave  
Suite 2200  
Dallas , TX 75201-6776  
USA  
Phone: (214)740-8000  
Fax: (214)756-8556

Email: rhardin@lockelord.com

John W MacPete  
[Term: 06/08/2009]  
Locke Lord Bissell & Liddell LLP - Dallas  
2200 Ross Ave  
Suite 2200  
Dallas , TX 75201-6776  
USA  
Phone: (214)347-4700  
Fax: (214)347-4799

Email: jmacpete@lockelord.com

Michael Scott Fuller  
[Term: 06/08/2009]  
Locke Lord Bissell & Liddell LLP - Dallas  
2200 Ross Ave  
Suite 2200  
Dallas , TX 75201-6776  
USA  
Phone: (214)740-8601  
Fax: (214)756-8601

Email: sfuller@lockelord.com

Linksmart Wireless Technology, Llc  
Counter Defendant

Andrew D Weiss  
Russ August & Kabat  
12424 Wilshire Boulevard  
12th Floor  
Los Angeles , CA 90025  
USA  
Phone: (310)826-7474  
Fax: (310)826-6991  
Attorney to be Noticed  
Email: aweiss@raklaw.com

Best Western International, Inc.  
Thirdparty Plaintiff

Christopher Michael Joe  
Lead Attorney  
Buether Joe & Carpenter, LLC  
1700 Pacific Avenue  
Suite 2390  
Dallas , TX 75201  
USA

Phone: (214)466-1272  
Fax: (214)635-1828  
Attorney to be Noticed  
Email: Chris.Joe@bjciplaw.com

Brian Andrew Carpenter  
Buether Joe & Carpenter, LLC  
1700 Pacific Avenue  
Suite 2390  
Dallas , TX 75201  
USA  
Phone: (214)466-1273  
Fax: (214)635-1829  
Attorney to be Noticed  
Email: brian.carpenter@BJCIPlaw.com

David E Rogers  
Squire Sanders & Dempsey - Phoenix  
Two Renaissance Square  
40 North Central Avenue, Suite 2700  
Phoenix , AZ 85004-4498  
USA  
Phone: (602)528-4122  
Fax: (602)253-8129  
Attorney to be Noticed  
Email: drogers@ssd.com

Michael Ernest Richardson  
Beck Redden & Secrest - Houston  
1221 McKinney  
Suite 4500  
Houston , TX 77010-2010  
USA  
Phone: (713)951-6284  
Fax: 17139513720  
Attorney to be Noticed  
Email: mrichardson@brsfirm.com

Ramada Worldwide, Inc.  
Counter Claimant

Michael Ernest Richardson  
Beck Redden & Secrest - Houston  
1221 McKinney  
Suite 4500  
Houston , TX 77010-2010  
USA  
Phone: (713)951-6284  
Fax: 17139513720  
Attorney to be Noticed  
Email: mrichardson@brsfirm.com

Linksmart Wireless Technology, Llc  
Counter Defendant

Marc A Fenster  
Lead Attorney  
Russ August & Kabat  
12424 Wilshire Boulevard  
12th Floor  
Los Angeles , CA 90025  
USA  
Phone: (310)826-7474  
Fax: (310)826-6991  
Attorney to be Noticed  
Email: mfenster@raklaw.com

Andrew W. Spangler  
Spangler Law PC  
208 N. Green St.  
Suite 300

Longview , TX 75601  
USA  
Phone: (903)753-9300  
Fax: (903)553-0403  
Attorney to be Noticed  
Email: spangler@spanglerlawpc.com

Andrew D Weiss  
Russ August & Kabat  
12424 Wilshire Boulevard  
12th Floor  
Los Angeles , CA 90025  
USA  
Phone: (310)826-7474  
Fax: (310)826-6991  
Attorney to be Noticed  
Email: aweiss@raklaw.com

Larry C Russ  
Russ August & Kabat  
12424 Wilshire Boulevard  
12th Floor  
Los Angeles , CA 90025  
USA  
Phone: (310)826-7474  
Fax: (310)826-6991  
Attorney to be Noticed  
Email: lruss@raklaw.com

Stanley H Thompson , Jr  
Russ August & Kabat  
12424 Wilshire Boulevard  
12th Floor  
Los Angeles , CA 90025  
USA  
Phone: (310)826-7474  
Fax: (310)826-6991  
Attorney to be Noticed  
Email: sthompson@raklaw.com

Stephen M Lobbin  
Russ August & Kabat  
12424 Wilshire Boulevard  
12th Floor  
Los Angeles , CA 90025  
USA  
Phone: (310)826-7474  
Fax: (310)826-6991  
Attorney to be Noticed  
Email: slobbin@raklaw.com

Ethostream, Llc  
Counter Claimant

Michael Ernest Richardson  
Beck Redden & Secrest - Houston  
1221 McKinney  
Suite 4500  
Houston , TX 77010-2010  
USA  
Phone: (713)951-6284  
Fax: 17139513720  
Attorney to be Noticed  
Email: mrichardson@brsfirm.com

Linksmart Wireless Technology, Llc  
Counter Defendant

Andrew W. Spangler  
Lead Attorney  
Spangler Law PC

208 N. Green St.  
Suite 300  
Longview , TX 75601  
USA  
Phone: (903)753-9300  
Fax: (903)553-0403  
Attorney to be Noticed  
Email: spangler@spanglerlawpc.com

Andrew D Weiss  
Russ August & Kabat  
12424 Wilshire Boulevard  
12th Floor  
Los Angeles , CA 90025  
USA  
Phone: (310)826-7474  
Fax: (310)826-6991  
Attorney to be Noticed  
Email: aweiss@raklaw.com

Larry C Russ  
Russ August & Kabat  
12424 Wilshire Boulevard  
12th Floor  
Los Angeles , CA 90025  
USA  
Phone: (310)826-7474  
Fax: (310)826-6991  
Attorney to be Noticed  
Email: lruss@raklaw.com

Marc A Fenster  
Russ August & Kabat  
12424 Wilshire Boulevard  
12th Floor  
Los Angeles , CA 90025  
USA  
Phone: (310)826-7474  
Fax: (310)826-6991  
Attorney to be Noticed  
Email: mfenster@raklaw.com

Stanley H Thompson , Jr  
Russ August & Kabat  
12424 Wilshire Boulevard  
12th Floor  
Los Angeles , CA 90025  
USA  
Phone: (310)826-7474  
Fax: (310)826-6991  
Attorney to be Noticed  
Email: sthompson@raklaw.com

Stephen M Lobbin  
Russ August & Kabat  
12424 Wilshire Boulevard  
12th Floor  
Los Angeles , CA 90025  
USA  
Phone: (310)826-7474  
Fax: (310)826-6991  
Attorney to be Noticed  
Email: slobbin@raklaw.com

Bestcomm Networks, Inc.  
Cross Claimant

Morris C Carrington  
Lead Attorney

Mehaffy & Weber - Beaumont  
P.O. Box 16  
Beaumont , TX 77704-0016  
USA  
Phone: (409)835-5011  
Fax: 14098355177  
Attorney to be Noticed  
Email: mccarrington@mehaffyweber.com

David J Leonard  
Leonard & Felker  
P O Box 19101  
Tucson , AZ 85731  
USA  
Phone: (520)622-7737  
Fax: (623)321-8085  
Attorney to be Noticed  
Email: dovidle@aol.com

Nomadix, Inc.  
Cross Defendant

Douglas G Muehlhauser  
Knobbe Martens Olson & Bear LLP - Irvine,CA  
2040 Main St  
Fourteenth Floor  
Irvine , CA 92614  
USA  
Phone: (949)760-0404  
Fax: (949)760-9502  
Pro Hac Vice  
Attorney to be Noticed  
Email: Doug.Muehlhauser@kmob.com

Elizabeth L DeRieux  
Capshaw DeRieux, LLP  
1127 Judson Road  
Ste 220  
Longview , TX 75601-5157  
USA  
Phone: (903)233-4816  
Fax: (903)236-8787  
Attorney to be Noticed  
Email: ederieux@capshawlaw.com

Sidney Calvin Capshaw , III  
Capshaw DeRieux, LLP  
1127 Judson Road  
Ste 220  
Longview , TX 75601-5157  
USA  
Phone: (903)233-4826  
Fax: (903)236-8787  
Attorney to be Noticed  
Email: ccapshaw@capshawlaw.com

Sbc Internet Services, Inc.  
Counter Claimant

Richard Alan Sayles  
Lead Attorney  
Sayles Werbner  
1201 Elm Street  
4400 Renaissance Tower  
Dallas , TX 75270  
USA  
Phone: (214)939-8700  
Fax: 12149398787  
Attorney to be Noticed  
Email: dsayles@swtriallaw.com



David T Pritikin  
Sidley Austin - Chicago  
Bank One Plaza  
One South Dearborn Ave  
Chicago , IL 60603  
USA  
Phone: (312)853-7359  
Fax: (312)853-7036  
Attorney to be Noticed  
Email: dpritikin@sidley.com

Elizabeth L Maxeiner  
Sidley Austin - Chicago  
One South Dearborn St  
Chicago , IL 60603  
USA  
Phone: (312)853-2225  
Fax: (312)853-7036  
Attorney to be Noticed  
Email: emaxeiner@sidley.com

Eve L Henson  
Sayles  
Werbner  
1201 Elm Street 4400 Renaissance Tower , Dallas TX  
75270  
Phone: ehenson@swtriallaw.com  
Fax: (214)939-8700  
Attorney to be Noticed  
Email: USA

Hugh A Abrams  
Sidley Austin - Chicago  
Bank One Plaza  
One South Dearborn Ave  
Chicago , IL 60603  
USA  
Phone: (312)853-7017  
Fax: 13128537036  
Attorney to be Noticed  
Email: habrams@sidley.com

Lisa A Schneider  
Sidley Austin - Chicago  
Bank One Plaza  
One South Dearborn Ave  
Chicago , IL 60603  
USA  
Phone: (312)853-7567  
Fax: (312)253-7036  
Attorney to be Noticed  
Email: lschneider@sidley.com

Michael Ernest Richardson  
Beck Redden & Secrest - Houston  
1221 McKinney  
Suite 4500  
Houston , TX 77010-2010  
USA  
Phone: (713)951-6284  
Fax: 17139513720  
Attorney to be Noticed  
Email: mrichardson@brsfirm.com

Rachel D Sher  
Sidley Austin - Chicago  
One South Dearborn St

Chicago , IL 60603  
USA  
Phone: (312)853-7000  
Fax: (312)853-7036  
Attorney to be Noticed  
Email: rsher@sidley.com

Richard A Cederroth  
Sidley Austin - Chicago  
One South Dearborn St  
Chicago , IL 60603  
USA  
Phone: (312)853-7000  
Fax: (312)853-7036  
Pro Hac Vice  
Attorney to be Noticed  
Email: rcederOTH@sidley.com

Richard T McCaulley , Jr  
[Term: 08/10/2009]  
Sidley Austin - Chicago  
Bank One Plaza  
One South Dearborn Ave  
Chicago , IL 60603  
USA  
Phone: (312)853-7000  
Fax: (312)853-7036  
Email: rmccaulley@sidley.com

Linksmart Wireless Technology, Llc  
Counter Defendant

Alexander Chester Giza  
Russ August & Kabat  
12424 Wilshire Boulevard  
12th Floor  
Los Angeles , CA 90025  
USA  
Phone: (310)826-7474  
Fax: (310)826-6991  
Attorney to be Noticed  
Email: agiza@raklaw.com

Andrew W. Spangler  
Spangler Law PC  
208 N. Green St.  
Suite 300  
Longview , TX 75601  
USA  
Phone: (903)753-9300  
Fax: (903)553-0403  
Attorney to be Noticed  
Email: spangler@spanglerlawpc.com

Andrew D Weiss  
Russ August & Kabat  
12424 Wilshire Boulevard  
12th Floor  
Los Angeles , CA 90025  
USA  
Phone: (310)826-7474  
Fax: (310)826-6991  
Attorney to be Noticed  
Email: aweiss@raklaw.com

Larry C Russ  
Russ August & Kabat  
12424 Wilshire Boulevard

12th Floor  
Los Angeles , CA 90025  
USA  
Phone: (310)826-7474  
Fax: (310)826-6991  
Attorney to be Noticed  
Email: lruss@raklaw.com

Marc A Fenster  
Russ August & Kabat  
12424 Wilshire Boulevard  
12th Floor  
Los Angeles , CA 90025  
USA  
Phone: (310)826-7474  
Fax: (310)826-6991  
Attorney to be Noticed  
Email: mfenster@raklaw.com

Stanley H Thompson , Jr  
Russ August & Kabat  
12424 Wilshire Boulevard  
12th Floor  
Los Angeles , CA 90025  
USA  
Phone: (310)826-7474  
Fax: (310)826-6991  
Attorney to be Noticed  
Email: sthompson@raklaw.com

Stephen M Lobbin  
Russ August & Kabat  
12424 Wilshire Boulevard  
12th Floor  
Los Angeles , CA 90025  
USA  
Phone: (310)826-7474  
Fax: (310)826-6991  
Attorney to be Noticed  
Email: slobbin@raklaw.com

Wayport, Inc.  
Counter Claimant

Brian C Bianco  
Lead Attorney  
Sidley Austin - Chicago  
Bank One Plaza  
One South Dearborn Ave  
Chicago , IL 60603  
USA  
Phone: (312)853-7000  
Fax: (312)853-7036  
Attorney to be Noticed  
Email: bcbianco@sidley.com

Marvin Craig Tyler  
Lead Attorney  
[Term: 01/28/2009]  
Wilson Sonsini Goodrich & Rosati PC  
900 South Capital of Texas Highway  
Las Cimas IV, Fifth Floor  
Austin , TX 78746-5546  
USA  
Phone: (512)338-5410  
Fax: 15123385499  
Email: ctyler@wsgr.com

Richard Alan Sayles  
Lead Attorney  
Sayles Werbner  
1201 Elm Street  
4400 Renaissance Tower  
Dallas , TX 75270  
USA  
Phone: (214)939-8700  
Fax: 12149398787  
Attorney to be Noticed  
Email: dsayles@swtriallaw.com

David T Pritikin  
Sidley Austin - Chicago  
Bank One Plaza  
One South Dearborn Ave  
Chicago , IL 60603  
USA  
Phone: (312)853-7359  
Fax: (312)853-7036  
Attorney to be Noticed  
Email: dpritikin@sidley.com

Elizabeth L Maxeiner  
Sidley Austin - Chicago  
One South Dearborn St  
Chicago , IL 60603  
USA  
Phone: (312)853-2225  
Fax: (312)853-7036  
Attorney to be Noticed  
Email: emaxeiner@sidley.com

Eve L Henson  
Sayles  
Werbner  
1201 Elm Street 4400 Renaissance Tower , Dallas TX  
75270  
Phone: ehenson@swtriallaw.com  
Fax: (214)939-8700  
Attorney to be Noticed  
Email: USA

Hugh A Abrams  
Sidley Austin - Chicago  
Bank One Plaza  
One South Dearborn Ave  
Chicago , IL 60603  
USA  
Phone: (312)853-7017  
Fax: 13128537036  
Attorney to be Noticed  
Email: habrams@sidley.com

Jose Carlos Villarreal  
[Term: 01/28/2009]  
Wilson Sonsini Goodrich & Rosati  
8911 Capital of Texas Highway  
Westech 360, Ste 3350  
Austin , TX 78759-7247  
USA  
Phone: (512)338-5400  
Fax: 15123385499

Email: jvillarreal@wsgr.com

Lisa A Schneider

Sidley Austin - Chicago  
Bank One Plaza  
One South Dearborn Ave  
Chicago , IL 60603  
USA  
Phone: (312)853-7567  
Fax: (312)253-7036  
Attorney to be Noticed  
Email: lschneider@sidley.com

Mark Daniel Strachan  
Sayles Webner  
4400 Renaissance  
1201 Elm Street  
Dallas , TX 75270  
USA  
Phone: (214)939-8707  
Fax: (214)939-8787  
Attorney to be Noticed  
Email: mstrachan@swtriallaw.com

Michael Ernest Richardson  
Beck Redden & Secrest - Houston  
1221 McKinney  
Suite 4500  
Houston , TX 77010-2010  
USA  
Phone: (713)951-6284  
Fax: 17139513720  
Attorney to be Noticed  
Email: mrichardson@brsfirm.com

Rachel D Sher  
Sidley Austin - Chicago  
One South Dearborn St  
Chicago , IL 60603  
USA  
Phone: (312)853-7000  
Fax: (312)853-7036  
Attorney to be Noticed  
Email: rsher@sidley.com

Richard T McCaulley , Jr  
[Term: 08/10/2009]  
Sidley Austin - Chicago  
Bank One Plaza  
One South Dearborn Ave  
Chicago , IL 60603  
USA  
Phone: (312)853-7000  
Fax: (312)853-7036  
Email: rmccaulley@sidley.com

Linksmart Wireless Technology, Llc  
Counter Defendant

Andrew D Weiss  
Russ August & Kabat  
12424 Wilshire Boulevard  
12th Floor  
Los Angeles , CA 90025  
USA  
Phone: (310)826-7474  
Fax: (310)826-6991  
Attorney to be Noticed  
Email: aweiss@raklaw.com

Larry C Russ

Russ August & Kabat  
12424 Wilshire Boulevard  
12th Floor  
Los Angeles , CA 90025  
USA  
Phone: (310)826-7474  
Fax: (310)826-6991  
Attorney to be Noticed  
Email: lruss@raklaw.com

Marc A Fenster  
Russ August & Kabat  
12424 Wilshire Boulevard  
12th Floor  
Los Angeles , CA 90025  
USA  
Phone: (310)826-7474  
Fax: (310)826-6991  
Attorney to be Noticed  
Email: mfenster@raklaw.com

Stanley H Thompson , Jr  
Russ August & Kabat  
12424 Wilshire Boulevard  
12th Floor  
Los Angeles , CA 90025  
USA  
Phone: (310)826-7474  
Fax: (310)826-6991  
Attorney to be Noticed  
Email: sthompson@raklaw.com

Stephen M Lobbin  
Russ August & Kabat  
12424 Wilshire Boulevard  
12th Floor  
Los Angeles , CA 90025  
USA  
Phone: (310)826-7474  
Fax: (310)826-6991  
Attorney to be Noticed  
Email: slobbin@raklaw.com

Mcdonalds Corp.  
Counter Claimant

Marvin Craig Tyler  
Lead Attorney  
[Term: 04/24/2009]  
Wilson Sonsini Goodrich & Rosati PC  
900 South Capital of Texas Highway  
Las Cimas IV, Fifth Floor  
Austin , TX 78746-5546  
USA  
Phone: (512)338-5410  
Fax: 15123385499

Email: ctyler@wsgr.com

Richard Alan Sayles  
Lead Attorney  
Sayles Werbner  
1201 Elm Street  
4400 Renaissance Tower  
Dallas , TX 75270  
USA  
Phone: (214)939-8700  
Fax: 12149398787  
Attorney to be Noticed

Email: dsayles@swtriallaw.com

Brian C Bianco  
Sidley Austin - Chicago  
Bank One Plaza  
One South Dearborn Ave  
Chicago , IL 60603  
USA  
Phone: (312)853-7000  
Fax: (312)853-7036  
Attorney to be Noticed  
Email: bcbianco@sidley.com

David T Pritikin  
Sidley Austin - Chicago  
Bank One Plaza  
One South Dearborn Ave  
Chicago , IL 60603  
USA  
Phone: (312)853-7359  
Fax: (312)853-7036  
Attorney to be Noticed  
Email: dpritikin@sidley.com

Elizabeth L Maxeiner  
Sidley Austin - Chicago  
One South Dearborn St  
Chicago , IL 60603  
USA  
Phone: (312)853-2225  
Fax: (312)853-7036  
Attorney to be Noticed  
Email: emaxeiner@sidley.com

Eve L Henson  
Sayles  
Werbner  
1201 Elm Street 4400 Renaissance Tower , Dallas TX  
75270  
Phone: ehenson@swtriallaw.com  
Fax: (214)939-8700  
Attorney to be Noticed  
Email: USA

Hugh A Abrams  
Sidley Austin - Chicago  
Bank One Plaza  
One South Dearborn Ave  
Chicago , IL 60603  
USA  
Phone: (312)853-7017  
Fax: 13128537036  
Attorney to be Noticed  
Email: habrams@sidley.com

Jose Carlos Villarreal  
[Term: 04/24/2009]  
Wilson Sonsini Goodrich & Rosati  
8911 Capital of Texas Highway  
Westech 360, Ste 3350  
Austin , TX 78759-7247  
USA  
Phone: (512)338-5400  
Fax: 15123385499

Email: jvillarreal@wsgr.com

Lisa A Schneider  
Sidley Austin - Chicago  
Bank One Plaza  
One South Dearborn Ave  
Chicago , IL 60603  
USA  
Phone: (312)853-7567  
Fax: (312)253-7036  
Attorney to be Noticed  
Email: lschneider@sidley.com

Mark Daniel Strachan  
Sayles Webner  
4400 Renaissance  
1201 Elm Street  
Dallas , TX 75270  
USA  
Phone: (214)939-8707  
Fax: (214)939-8787  
Attorney to be Noticed  
Email: mstrachan@swtriallaw.com

Michael Ernest Richardson  
Beck Redden & Secrest - Houston  
1221 McKinney  
Suite 4500  
Houston , TX 77010-2010  
USA  
Phone: (713)951-6284  
Fax: 17139513720  
Attorney to be Noticed  
Email: mrichardson@brsfirm.com

Rachel D Sher  
Sidley Austin - Chicago  
One South Dearborn St  
Chicago , IL 60603  
USA  
Phone: (312)853-7000  
Fax: (312)853-7036  
Attorney to be Noticed  
Email: rsher@sidley.com

Richard T McCaulley , Jr  
[Term: 08/10/2009]  
Sidley Austin - Chicago  
Bank One Plaza  
One South Dearborn Ave  
Chicago , IL 60603  
USA  
Phone: (312)853-7000  
Fax: (312)853-7036

Email: rmccaulley@sidley.com

Linksmart Wireless Technology, LLC  
Counter Defendant

Alexander Chester Giza  
Russ August & Kabat  
12424 Wilshire Boulevard  
12th Floor  
Los Angeles , CA 90025  
USA  
Phone: (310)826-7474  
Fax: (310)826-6991  
Attorney to be Noticed  
Email: agiza@raklaw.com



Andrew W. Spangler  
Spangler Law PC  
208 N. Green St.  
Suite 300  
Longview , TX 75601  
USA  
Phone: (903)753-9300  
Fax: (903)553-0403  
Attorney to be Noticed  
Email: spangler@spanglerlawpc.com

Andrew D Weiss  
Russ August & Kabat  
12424 Wilshire Boulevard  
12th Floor  
Los Angeles , CA 90025  
USA  
Phone: (310)826-7474  
Fax: (310)826-6991  
Attorney to be Noticed  
Email: aweiss@raklaw.com

Larry C Russ  
Russ August & Kabat  
12424 Wilshire Boulevard  
12th Floor  
Los Angeles , CA 90025  
USA  
Phone: (310)826-7474  
Fax: (310)826-6991  
Attorney to be Noticed  
Email: lruss@raklaw.com

Marc A Fenster  
Russ August & Kabat  
12424 Wilshire Boulevard  
12th Floor  
Los Angeles , CA 90025  
USA  
Phone: (310)826-7474  
Fax: (310)826-6991  
Attorney to be Noticed  
Email: mfenster@raklaw.com

Stanley H Thompson , Jr  
Russ August & Kabat  
12424 Wilshire Boulevard  
12th Floor  
Los Angeles , CA 90025  
USA  
Phone: (310)826-7474  
Fax: (310)826-6991  
Attorney to be Noticed  
Email: sthompson@raklaw.com

Stephen M Lobbin  
Russ August & Kabat  
12424 Wilshire Boulevard  
12th Floor  
Los Angeles , CA 90025  
USA  
Phone: (310)826-7474  
Fax: (310)826-6991  
Attorney to be Noticed  
Email: slobbin@raklaw.com

Barnes & Noble Booksellers, Inc.  
Counter Claimant

Brian C Bianco  
Lead Attorney  
Sidley Austin - Chicago  
Bank One Plaza  
One South Dearborn Ave  
Chicago , IL 60603  
USA  
Phone: (312)853-7000  
Fax: (312)853-7036  
Attorney to be Noticed  
Email: bcbianco@sidley.com

Richard Alan Sayles  
Lead Attorney  
Sayles Werbner  
1201 Elm Street  
4400 Renaissance Tower  
Dallas , TX 75270  
USA  
Phone: (214)939-8700  
Fax: 12149398787  
Attorney to be Noticed  
Email: dsayles@swtriallaw.com

David T Pritikin  
Sidley Austin - Chicago  
Bank One Plaza  
One South Dearborn Ave  
Chicago , IL 60603  
USA  
Phone: (312)853-7359  
Fax: (312)853-7036  
Attorney to be Noticed  
Email: dpritikin@sidley.com

Elizabeth L Maxeiner  
Sidley Austin - Chicago  
One South Dearborn St  
Chicago , IL 60603  
USA  
Phone: (312)853-2225  
Fax: (312)853-7036  
Attorney to be Noticed  
Email: emaxeiner@sidley.com

Eve L Henson  
Sayles  
Werbner  
1201 Elm Street 4400 Renaissance Tower , Dallas TX  
75270  
Phone: ehenson@swtriallaw.com  
Fax: (214)939-8700  
Attorney to be Noticed  
Email: USA

Hugh A Abrams  
Sidley Austin - Chicago  
Bank One Plaza  
One South Dearborn Ave  
Chicago , IL 60603  
USA  
Phone: (312)853-7017  
Fax: 13128537036  
Attorney to be Noticed  
Email: habrams@sidley.com

Lisa A Schneider

Sidley Austin - Chicago  
Bank One Plaza  
One South Dearborn Ave  
Chicago , IL 60603  
USA  
Phone: (312)853-7567  
Fax: (312)253-7036  
Attorney to be Noticed  
Email: lschneider@sidley.com

Mark Daniel Strachan  
Sayles Webner  
4400 Renaissance  
1201 Elm Street  
Dallas , TX 75270  
USA  
Phone: (214)939-8707  
Fax: (214)939-8787  
Attorney to be Noticed  
Email: mstrachan@swtriallaw.com

Michael Ernest Richardson  
Beck Redden & Secrest - Houston  
1221 McKinney  
Suite 4500  
Houston , TX 77010-2010  
USA  
Phone: (713)951-6284  
Fax: 17139513720  
Attorney to be Noticed  
Email: mrichardson@brsfirm.com

Rachel D Sher  
Sidley Austin - Chicago  
One South Dearborn St  
Chicago , IL 60603  
USA  
Phone: (312)853-7000  
Fax: (312)853-7036  
Attorney to be Noticed  
Email: rsher@sidley.com

Linksmart Wireless Technology, Llc  
Counter Defendant

Alexander Chester Giza  
Russ August & Kabat  
12424 Wilshire Boulevard  
12th Floor  
Los Angeles , CA 90025  
USA  
Phone: (310)826-7474  
Fax: (310)826-6991  
Attorney to be Noticed  
Email: agiza@raklaw.com

Andrew W. Spangler  
Spangler Law PC  
208 N. Green St.  
Suite 300  
Longview , TX 75601  
USA  
Phone: (903)753-9300  
Fax: (903)553-0403  
Attorney to be Noticed  
Email: spangler@spanglerlawpc.com

Andrew D Weiss  
Russ August & Kabat

12424 Wilshire Boulevard  
12th Floor  
Los Angeles , CA 90025  
USA  
Phone: (310)826-7474  
Fax: (310)826-6991  
Attorney to be Noticed  
Email: aweiss@raklaw.com

Larry C Russ  
Russ August & Kabat  
12424 Wilshire Boulevard  
12th Floor  
Los Angeles , CA 90025  
USA  
Phone: (310)826-7474  
Fax: (310)826-6991  
Attorney to be Noticed  
Email: lruss@raklaw.com

Marc A Fenster  
Russ August & Kabat  
12424 Wilshire Boulevard  
12th Floor  
Los Angeles , CA 90025  
USA  
Phone: (310)826-7474  
Fax: (310)826-6991  
Attorney to be Noticed  
Email: mfenster@raklaw.com

Stanley H Thompson , Jr  
Russ August & Kabat  
12424 Wilshire Boulevard  
12th Floor  
Los Angeles , CA 90025  
USA  
Phone: (310)826-7474  
Fax: (310)826-6991  
Attorney to be Noticed  
Email: sthompson@raklaw.com

Stephen M Lobbin  
Russ August & Kabat  
12424 Wilshire Boulevard  
12th Floor  
Los Angeles , CA 90025  
USA  
Phone: (310)826-7474  
Fax: (310)826-6991  
Attorney to be Noticed  
Email: slobbin@raklaw.com

Brian C Bianco  
Lead Attorney  
Sidley Austin - Chicago  
Bank One Plaza  
One South Dearborn Ave  
Chicago , IL 60603  
USA  
Phone: (312)853-7000  
Fax: (312)853-7036  
Attorney to be Noticed  
Email: bcbianco@sidley.com

Michael Charles Smith

Mail Boxes Etc., Inc.  
Counter Claimant

Lead Attorney  
[Term: 02/11/2009]  
Siebman Reynolds Burg Phillips & Smith, LLP-Marshall  
713 South Washington  
Marshall , TX 75670  
USA  
Phone: (903)938-8900  
Fax: 19727674620

Email: michaelsmith@siebman.com

Richard Alan Sayles  
Lead Attorney  
Sayles Werbner  
1201 Elm Street  
4400 Renaissance Tower  
Dallas , TX 75270  
USA  
Phone: (214)939-8700  
Fax: 12149398787  
Attorney to be Noticed  
Email: dsayles@swtriallaw.com

David T Pritikin  
Sidley Austin - Chicago  
Bank One Plaza  
One South Dearborn Ave  
Chicago , IL 60603  
USA  
Phone: (312)853-7359  
Fax: (312)853-7036  
Attorney to be Noticed  
Email: dpritikin@sidley.com

Elizabeth L Maxeiner  
Sidley Austin - Chicago  
One South Dearborn St  
Chicago , IL 60603  
USA  
Phone: (312)853-2225  
Fax: (312)853-7036  
Attorney to be Noticed  
Email: emaxeiner@sidley.com

Eve L Henson  
Sayles  
Werbner  
1201 Elm Street 4400 Renaissance Tower , Dallas TX  
75270  
Phone: ehenson@swtriallaw.com  
Fax: (214)939-8700  
Attorney to be Noticed  
Email: USA

Holmes J Hawkins , III  
King & Spalding - Atlanta  
1180 Peachtree Street, NE  
Atlanta , GA 30309-3521  
USA  
Phone: (404)572-4600  
Fax: (404)572-5134  
Attorney to be Noticed  
Email: hhawkins@kslaw.com

Hugh A Abrams  
Sidley Austin - Chicago  
Bank One Plaza

One South Dearborn Ave  
Chicago , IL 60603  
USA  
Phone: (312)853-7017  
Fax: 13128537036  
Attorney to be Noticed  
Email: habrams@sidley.com

Lisa A Schneider  
Sidley Austin - Chicago  
Bank One Plaza  
One South Dearborn Ave  
Chicago , IL 60603  
USA  
Phone: (312)853-7567  
Fax: (312)253-7036  
Attorney to be Noticed  
Email: lschneider@sidley.com

Mark Daniel Strachan  
Sayles Webner  
4400 Renaissance  
1201 Elm Street  
Dallas , TX 75270  
USA  
Phone: (214)939-8707  
Fax: (214)939-8787  
Attorney to be Noticed  
Email: mstrachan@swtriallaw.com

Michael Ernest Richardson  
Beck Redden & Secrest - Houston  
1221 McKinney  
Suite 4500  
Houston , TX 77010-2010  
USA  
Phone: (713)951-6284  
Fax: 17139513720  
Attorney to be Noticed  
Email: mrichardson@brsfirm.com

Rachel D Sher  
Sidley Austin - Chicago  
One South Dearborn St  
Chicago , IL 60603  
USA  
Phone: (312)853-7000  
Fax: (312)853-7036  
Attorney to be Noticed  
Email: rsher@sidley.com

Steven T Snyder  
King & Spalding LLP - Charlotte  
227 West Trade Street  
Suite 600  
Charlotte , NC 28202  
USA  
Phone: (704)503-2630  
Fax: (704)503-2622  
Attorney to be Noticed  
Email: ssnyder@kslaw.com

Linksmart Wireless Technology, LLC  
Counter Defendant

Alexander Chester Giza  
Russ August & Kabat  
12424 Wilshire Boulevard  
12th Floor

Los Angeles , CA 90025  
USA  
Phone: (310)826-7474  
Fax: (310)826-6991  
Attorney to be Noticed  
Email: agiza@raklaw.com

Andrew W. Spangler  
Spangler Law PC  
208 N. Green St.  
Suite 300  
Longview , TX 75601  
USA  
Phone: (903)753-9300  
Fax: (903)553-0403  
Attorney to be Noticed  
Email: spangler@spanglerlawpc.com

Andrew D Weiss  
Russ August & Kabat  
12424 Wilshire Boulevard  
12th Floor  
Los Angeles , CA 90025  
USA  
Phone: (310)826-7474  
Fax: (310)826-6991  
Attorney to be Noticed  
Email: aweiss@raklaw.com

Larry C Russ  
Russ August & Kabat  
12424 Wilshire Boulevard  
12th Floor  
Los Angeles , CA 90025  
USA  
Phone: (310)826-7474  
Fax: (310)826-6991  
Attorney to be Noticed  
Email: lruss@raklaw.com

Marc A Fenster  
Russ August & Kabat  
12424 Wilshire Boulevard  
12th Floor  
Los Angeles , CA 90025  
USA  
Phone: (310)826-7474  
Fax: (310)826-6991  
Attorney to be Noticed  
Email: mfenster@raklaw.com

Stanley H Thompson , Jr  
Russ August & Kabat  
12424 Wilshire Boulevard  
12th Floor  
Los Angeles , CA 90025  
USA  
Phone: (310)826-7474  
Fax: (310)826-6991  
Attorney to be Noticed  
Email: sthompson@raklaw.com

Stephen M Lobbin  
Russ August & Kabat  
12424 Wilshire Boulevard  
12th Floor  
Los Angeles , CA 90025

Best Western International, Inc.  
Counter Claimant

USA  
Phone: (310)826-7474  
Fax: (310)826-6991  
Attorney to be Noticed  
Email: slobbin@raklaw.com

Christopher Michael Joe  
Lead Attorney  
Buether Joe & Carpenter, LLC  
1700 Pacific Avenue  
Suite 2390  
Dallas , TX 75201  
USA  
Phone: (214)466-1272  
Fax: (214)635-1828  
Attorney to be Noticed  
Email: Chris.Joe@bjciplaw.com

Andrea L Marconi  
[Term: 07/02/2010]  
Squire Sanders & Dempsey - Phoenix  
Two Renaissance Square  
40 North Central Avenue, Suite 2700  
Phoenix , AZ 85004-4498  
USA  
Phone: (602)916-5424  
Fax: (602)916-5624

Email: amarconi@fclaw.com

Brian Andrew Carpenter  
Buether Joe & Carpenter, LLC  
1700 Pacific Avenue  
Suite 2390  
Dallas , TX 75201  
USA  
Phone: (214)466-1273  
Fax: (214)635-1829  
Attorney to be Noticed  
Email: brian.carpenter@BJCIPlaw.com

David E Rogers  
Squire Sanders & Dempsey - Phoenix  
Two Renaissance Square  
40 North Central Avenue, Suite 2700  
Phoenix , AZ 85004-4498  
USA  
Phone: (602)528-4122  
Fax: (602)253-8129  
Attorney to be Noticed  
Email: drogers@ssd.com

Donald A Wall  
Squire Sanders & Dempsey - Phoenix  
Two Renaissance Square  
40 North Central Avenue, Suite 2700  
Phoenix , AZ 85004-4498  
USA  
Phone: (602)528-4000  
Fax: (602)253-8129  
Attorney to be Noticed  
Email: dwall@ssd.com

Michael Ernest Richardson  
Beck Redden & Secrest - Houston  
1221 McKinney



Suite 4500  
Houston , TX 77010-2010  
USA  
Phone: (713)951-6284  
Fax: 17139513720  
Attorney to be Noticed  
Email: mrichardson@brsfirm.com

Noah A Levine  
Wilmer Cutler Pickering Hale & Dorr - New York  
399 Park Avenue  
New York , NY 10022  
USA  
Phone: (212)230-8800  
Fax: (212)230-8888  
Attorney to be Noticed  
Email: Noah.Levine@wilmerhale.com

Linksmart Wireless Technology, Llc  
Counter Defendant

Adam S Hoffman  
Russ August & Kabat  
12424 Wilshire Boulevard  
12th Floor  
Los Angeles , CA 90025  
USA  
Phone: (310)826-7474  
Fax: (310)826-6991  
Attorney to be Noticed  
Email: ahoffman@raklaw.com

Alexander Chester Giza  
Russ August & Kabat  
12424 Wilshire Boulevard  
12th Floor  
Los Angeles , CA 90025  
USA  
Phone: (310)826-7474  
Fax: (310)826-6991  
Attorney to be Noticed  
Email: agiza@raklaw.com

Andrew W. Spangler  
Spangler Law PC  
208 N. Green St.  
Suite 300  
Longview , TX 75601  
USA  
Phone: (903)753-9300  
Fax: (903)553-0403  
Attorney to be Noticed  
Email: spangler@spanglerlawpc.com

Andrew D Weiss  
Russ August & Kabat  
12424 Wilshire Boulevard  
12th Floor  
Los Angeles , CA 90025  
USA  
Phone: (310)826-7474  
Fax: (310)826-6991  
Attorney to be Noticed  
Email: aweiss@raklaw.com

Larry C Russ  
Russ August & Kabat  
12424 Wilshire Boulevard  
12th Floor

Los Angeles , CA 90025  
USA  
Phone: (310)826-7474  
Fax: (310)826-6991  
Attorney to be Noticed  
Email: lruss@raklaw.com

Marc A Fenster  
Russ August & Kabat  
12424 Wilshire Boulevard  
12th Floor  
Los Angeles , CA 90025  
USA  
Phone: (310)826-7474  
Fax: (310)826-6991  
Attorney to be Noticed  
Email: mfenster@raklaw.com

Stanley H Thompson , Jr  
Russ August & Kabat  
12424 Wilshire Boulevard  
12th Floor  
Los Angeles , CA 90025  
USA  
Phone: (310)826-7474  
Fax: (310)826-6991  
Attorney to be Noticed  
Email: sthompson@raklaw.com

Stephen M Lobbin  
Russ August & Kabat  
12424 Wilshire Boulevard  
12th Floor  
Los Angeles , CA 90025  
USA  
Phone: (310)826-7474  
Fax: (310)826-6991  
Attorney to be Noticed  
Email: slobbin@raklaw.com

Todd Y Brandt  
[Term: 06/04/2010]  
Spangler Law PC  
208 N. Green Street  
Ste 300  
Longview , TX 75601  
USA  
Phone: (903)753-9300  
Fax: (903)553-0403

Email: brandt@spanglerlawpc.com

Date	#	Proceeding Text
07/01/2008	1	COMPLAINT against all defendants ( Filing fee \$ 350 receipt number 0540000000001601022.), filed by Linksmart Wireless Technology, LLC.(Fenster, Marc) (Additional attachment(s) added on 7/2/2008: # 1 Civil Cover Sheet) (mpv, ). (Entered: 07/01/2008)
07/01/2008	2	***FILED IN ERROR; PLEASE IGNORE*** NOTICE of Disclosure by Linksmart Wireless Technology, LLC (Fenster, Marc) Modified on 7/2/2008 (mpv, ). (Entered: 07/01/2008)
07/01/2008	3	Notice of Filing of Patent/Trademark Form (AO 120). AO 120 mailed to the Director of the U.S. Patent and Trademark Office. (Fenster, Marc) (Entered: 07/01/2008)
07/01/2008	4	***FILED IN ERROR; PLEASE IGNORE*** Additional Attachments to Main Document: 1 Complaint.. (Fenster, Marc) Modified on 7/2/2008 (mpv, ). (Entered: 07/01/2008)
07/02/2008	--	E-GOV SEALED SUMMONS Issued as to NetNearU Corp., Pronto Networks, Inc., Aptilo Networks,

Inc., FreeFi Networks, Inc., Meraki, Inc., Second Rule LLC, Mail Boxes Etc., Inc., McDonalds Corp., Barnes & Noble Booksellers, Inc., Ramada Worldwide, Inc., Marriott International, Inc., InterContinental Hotels Group PLC, Choice Hotels International Inc., Best Western International, Inc., T-Mobile USA, Inc., Wayport, Inc., AT&T, Inc., AT&T Mobility, LLC, LodgeNet Interactive Corporation, iBAHN General Holdings Corp., EthoStream, LLC, Hot Point Wireless, Inc.. (ch, ) (Entered: 07/02/2008)

- 07/02/2008 -- \*\*\*FILED IN ERROR. Document # 4, Additional attachments to main document. PLEASE IGNORE. Civil Cover Sheet now attached as an attachment to #1 Complaint by clerk\*\*\* (mpv, ) (Entered: 07/02/2008)
- 07/02/2008 -- NOTICE of Deficiency regarding #2 the NOTICE of Disclosure submitted Docketed incorrectly, attorney to refile as Corporate Disclosure Statement. Correction should be made by one business day (mpv, ) (Entered: 07/02/2008)
- 07/02/2008 -- Case Assigned to Judge T. John Ward. (ch, ) (Entered: 07/02/2008)
- 07/02/2008 5 ORDER REFERRING CASE to Magistrate Judge Charles Everingham. Signed by Judge T. John Ward on 7/2/08. (ch, ) (Entered: 07/02/2008)
- 07/02/2008 6 Magistrate Consent Form Mailed to Linksmart Wireless Technology, LLC (ch, ) (Entered: 07/02/2008)
- 07/02/2008 7 CORPORATE DISCLOSURE STATEMENT filed by Linksmart Wireless Technology, LLC (Fenster, Marc) (Entered: 07/02/2008)
- 07/09/2008 8 APPLICATION to Appear Pro Hac Vice by Attorney Larry C Russ for Linksmart Wireless Technology, LLC. (FEE PAID) 2-1-3936 (ehs, ) (Entered: 07/09/2008)
- 07/09/2008 9 APPLICATION to Appear Pro Hac Vice by Attorney Stanley H Thompson, Jr for Linksmart Wireless Technology, LLC. (FEE PAID) 2-1-3936 (ehs, ) (Entered: 07/09/2008)
- 07/09/2008 10 APPLICATION to Appear Pro Hac Vice by Attorney Stephen M Lobbin for Linksmart Wireless Technology, LLC. (FEE PAID) 2-1-3936 (ehs, ) (Entered: 07/09/2008)
- 07/18/2008 11 E-GOV SEALED SUMMONS Returned Executed by Linksmart Wireless Technology, LLC. Ramada Worldwide, Inc. served on 7/10/2008, answer due 7/30/2008. (ehs, ) (Entered: 07/18/2008)
- 07/18/2008 12 E-GOV SEALED SUMMONS Returned Executed by Linksmart Wireless Technology, LLC. AT&T Mobility, LLC served on 7/10/2008, answer due 7/30/2008. (ehs, ) (Entered: 07/18/2008)
- 07/18/2008 13 E-GOV SEALED SUMMONS Returned Executed by Linksmart Wireless Technology, LLC. Barnes & Noble Booksellers, Inc. served on 7/11/2008, answer due 7/31/2008. (ehs, ) (Entered: 07/18/2008)
- 07/18/2008 14 E-GOV SEALED SUMMONS Returned Executed by Linksmart Wireless Technology, LLC. Best Western International, Inc. served on 7/10/2008, answer due 7/30/2008. (ehs, ) (Entered: 07/18/2008)
- 07/18/2008 15 E-GOV SEALED SUMMONS Returned Executed by Linksmart Wireless Technology, LLC. Choice Hotels International Inc. served on 7/14/2008, answer due 8/4/2008. (ehs, ) (Entered: 07/18/2008)
- 07/18/2008 16 E-GOV SEALED SUMMONS Returned Executed by Linksmart Wireless Technology, LLC. EthoStream, LLC served on 7/14/2008, answer due 8/4/2008. (ehs, ) (Entered: 07/18/2008)
- 07/18/2008 17 E-GOV SEALED SUMMONS Returned Executed by Linksmart Wireless Technology, LLC. iBAHN General Holdings Corp. served on 7/10/2008, answer due 7/30/2008. (ehs, ) (Entered: 07/18/2008)
- 07/18/2008 18 NOTICE of Attorney Appearance by David M Stein on behalf of Ramada Worldwide, Inc. (Stein, David) (Entered: 07/18/2008)
- 07/18/2008 19 NOTICE of Attorney Appearance by Fay E Morisseau on behalf of Ramada Worldwide, Inc. (Morisseau, Fay) (Entered: 07/18/2008)
- 07/18/2008 20 E-GOV SEALED SUMMONS Returned Executed by Linksmart Wireless Technology, LLC. InterContinental Hotels Group PLC served on 7/11/2008, answer due 7/31/2008. (ehs, ) (Entered: 07/18/2008)
- 07/18/2008 21 E-GOV SEALED SUMMONS Returned Executed by Linksmart Wireless Technology, LLC. LodgeNet Interactive Corporation served on 7/11/2008, answer due 7/31/2008. (ehs, ) (Entered: 07/18/2008)
- 07/18/2008 22 E-GOV SEALED SUMMONS Returned Executed by Linksmart Wireless Technology, LLC. McDonalds Corp. served on 7/11/2008, answer due 7/31/2008. (ehs, ) (Entered: 07/18/2008)
- 07/18/2008 23 E-GOV SEALED SUMMONS Returned Executed by Linksmart Wireless Technology, LLC. Mail

Boxes Etc., Inc. served on 7/10/2008, answer due 7/30/2008. (ehs, ) (Entered: 07/18/2008)

07/18/2008 24 E-GOV SEALED SUMMONS Returned Executed by Linksmart Wireless Technology, LLC. Marriott International, Inc. served on 7/11/2008, answer due 7/31/2008. (ehs, ) (Entered: 07/18/2008)

07/18/2008 25 E-GOV SEALED SUMMONS Returned Executed by Linksmart Wireless Technology, LLC. Second Rule LLC served on 7/10/2008, answer due 7/30/2008. (ehs, ) (Entered: 07/18/2008)

07/18/2008 26 E-GOV SEALED SUMMONS Returned Executed by Linksmart Wireless Technology, LLC. T-Mobile USA, Inc. served on 7/10/2008, answer due 7/30/2008. (ehs, ) (Entered: 07/18/2008)

07/18/2008 27 E-GOV SEALED SUMMONS Returned Executed by Linksmart Wireless Technology, LLC. Wayport, Inc. served on 7/10/2008, answer due 7/30/2008. (ehs, ) (Entered: 07/18/2008)

07/22/2008 28 NOTICE of Attorney Appearance by J Thad Heartfield on behalf of Ramada Worldwide, Inc. (Heartfield, J) (Entered: 07/22/2008)

07/24/2008 29 Defendant's Unopposed First Application for Extension of Time to Answer Complaint re Ramada Worldwide, Inc..( Heartfield, J) (Entered: 07/24/2008)

07/24/2008 30 E-GOV SEALED SUMMONS Returned Executed by Linksmart Wireless Technology, LLC. Pronto Networks, Inc. served on 7/11/2008, answer due 7/31/2008. (ch, ) (Entered: 07/24/2008)

07/24/2008 31 E-GOV SEALED SUMMONS Returned Executed by Linksmart Wireless Technology, LLC. Aptilo Networks, Inc. served on 7/15/2008, answer due 8/4/2008. (ch, ) (Entered: 07/24/2008)

07/24/2008 32 E-GOV SEALED SUMMONS Returned Executed by Linksmart Wireless Technology, LLC. AT&T, Inc. served on 7/14/2008, answer due 8/4/2008. (ch, ) (Entered: 07/24/2008)

07/24/2008 33 E-GOV SEALED SUMMONS Returned Executed by Linksmart Wireless Technology, LLC. Meraki, Inc. served on 7/16/2008, answer due 8/5/2008. (ch, ) (Entered: 07/24/2008)

07/24/2008 34 E-GOV SEALED SUMMONS Returned Executed by Linksmart Wireless Technology, LLC. NetNearU Corp. served on 7/14/2008, answer due 8/4/2008. (ch, ) (Entered: 07/24/2008)

07/24/2008 -- Defendant's Unopposed First Application for Extension of Time to Answer Complaint is GRANTED pursuant to Local Rule CV-12 for Ramada Worldwide, Inc. to 8/29/2008. 30 Days Granted for Deadline Extension.( ljjw, ) (Entered: 07/24/2008)

07/24/2008 35 Defendant T-MOBILE USA, INC.'s Unopposed First Application for Extension of Time to Answer Complaint (Fenster, Marc, counsel for Plaintiff Linksmart Wireless Technology, LLC) (Entered: 07/24/2008)

07/24/2008 36 Defendant LodgeNet Interactive Corp.'s Unopposed First Application for Extension of Time to Answer Complaint(Fenster, Marc) (Entered: 07/24/2008)

07/24/2008 37 Defendant NetNearU Corp.'s Unopposed First Application for Extension of Time to Answer Complaint (Fenster, Marc) (Entered: 07/24/2008)

07/24/2008 38 Defendant Best Western International, Inc.'s Unopposed First Application for Extension of Time to Answer Complaint (Fenster, Marc) (Entered: 07/24/2008)

07/24/2008 39 Defendant InterContinental Hotels Groups PLC's Unopposed First Application for Extension of Time to Answer Complaint (Fenster, Marc) (Entered: 07/24/2008)

07/25/2008 40 Defendant's Unopposed First Application for Extension of Time to Answer Complaint re iBAHN General Holdings Corp..( Jones, Michael) (Entered: 07/25/2008)

07/25/2008 -- Defendant's Unopposed First Application for Extension of Time to Answer Complaint is GRANTED pursuant to Local Rule CV-12 for NetNearU Corp. to 8/29/2008; InterContinental Hotels Group PLC to 8/29/2008; Best Western International, Inc. to 8/29/2008; T-Mobile USA, Inc. to 8/29/2008; LodgeNet Interactive Corporation to 8/29/2008. 30 Days Granted for Deadline Extension.( ch, ) (Entered: 07/25/2008)

07/25/2008 -- Defendant's Unopposed First Application for Extension of Time to Answer Complaint is GRANTED pursuant to Local Rule CV-12 for iBAHN General Holdings Corp. to 8/29/2008. 30 Days Granted for Deadline Extension.( ch, ) (Entered: 07/25/2008)

07/25/2008 41 NOTICE of Attorney Appearance by Richard Alan Sayles on behalf of AT&T, Inc., AT&T Mobility, LLC (Sayles, Richard) (Entered: 07/25/2008)

07/25/2008 42 Defendant's Unopposed First Application for Extension of Time to Answer Complaint re AT&T, Inc., AT&T Mobility, LLC.( Sayles, Richard) (Entered: 07/25/2008)

07/25/2008 43 Defendant Barnes & Noble Booksellers, Inc.'s Unopposed First Application for Extension of Time to Answer Complaint (Fenster, Marc) (Entered: 07/25/2008)

07/28/2008 -- Defendant's Unopposed First Application for Extension of Time to Answer Complaint is GRANTED pursuant to Local Rule CV-12 for AT&T, Inc. to 8/29/2008; AT&T Mobility, LLC to 8/29/2008. 30

Days Granted for Deadline Extension.( ch, ) (Entered: 07/28/2008)

07/28/2008 -- Defendant's Unopposed First Application for Extension of Time to Answer Complaint is GRANTED pursuant to Local Rule CV-12 for Barnes & Noble Booksellers, Inc. to 8/29/2008. 30 Days Granted for Deadline Extension.( ch, ) (Entered: 07/28/2008)

07/28/2008 44 APPLICATION to Appear Pro Hac Vice by Attorney Jennifer L Yokoyama for Ramada Worldwide, Inc. (APPROVED)(FEE PAID)2-1-3983. (ch, ) (Entered: 07/28/2008)

07/29/2008 45 Defendant's Unopposed First Application for Extension of Time to Answer Complaint re Wayport, Inc..( Tyler, Marvin) (Entered: 07/29/2008)

07/29/2008 46 Defendant's Unopposed First Application for Extension of Time to Answer Complaint re Meraki, Inc..( Tyler, Marvin) (Entered: 07/29/2008)

07/30/2008 -- Defendant's Unopposed First Application for Extension of Time to Answer Complaint is GRANTED pursuant to Local Rule CV-12 for Wayport, Inc. to 8/29/2008. 30 Days Granted for Deadline Extension.( ch, ) (Entered: 07/30/2008)

07/30/2008 -- Defendant's Unopposed First Application for Extension of Time to Answer Complaint is GRANTED pursuant to Local Rule CV-12 for Meraki, Inc. to 9/4/2008. 30 Days Granted for Deadline Extension.( ch, ) (Entered: 07/30/2008)

07/30/2008 47 Defendant's Unopposed First Application for Extension of Time to Answer Complaint re McDonalds Corp..( Tyler, Marvin) (Entered: 07/30/2008)

07/30/2008 -- Defendant's Unopposed First Application for Extension of Time to Answer Complaint is GRANTED pursuant to Local Rule CV-12 for McDonalds Corp. to 8/29/2008. 29 Days Granted for Deadline Extension.( ch, ) (Entered: 07/30/2008)

07/30/2008 48 Defendant's Unopposed First Application for Extension of Time to Answer Complaint re Marriott International, Inc..( Guaragna, John) (Entered: 07/30/2008)

07/30/2008 -- Defendant's Unopposed First Application for Extension of Time to Answer Complaint is GRANTED pursuant to Local Rule CV-12 for Marriott International, Inc. to 8/29/2008. 30 Days Granted for Deadline Extension.( ch, ) (Entered: 07/30/2008)

07/30/2008 49 Defendant's Unopposed First Application for Extension of Time to Answer Complaint re Mail Boxes Etc., Inc.(Smith, Michael) (Entered: 07/30/2008)

07/30/2008 -- Defendant's Unopposed First Application for Extension of Time to Answer Complaint is GRANTED pursuant to Local Rule CV-12 for Mail Boxes Etc., Inc. to 8/29/2008. 30 Days Granted for Deadline Extension.( ch, ) (Entered: 07/30/2008)

07/31/2008 50 Defendant's Unopposed First Application for Extension of Time to Answer Complaint re Pronto Networks, Inc..( Lobbin, Stephen) (Entered: 07/31/2008)

07/31/2008 -- Defendant's Unopposed First Application for Extension of Time to Answer Complaint is GRANTED pursuant to Local Rule CV-12 for Pronto Networks, Inc. to 8/29/2008. 29 Days Granted for Deadline Extension.( ch, ) (Entered: 07/31/2008)

08/01/2008 51 E-GOV SEALED SUMMONS Returned Executed by Linksmart Wireless Technology, LLC. Hot Point Wireless, Inc. served on 7/17/2008, answer due 8/6/2008. (ehs, ) (Entered: 08/01/2008)

08/01/2008 52 ANSWER to 1 Complaint, COUNTERCLAIM against Linksmart Wireless Technology, LLC by EthoStream, LLC.(Hunt, Dean) (Entered: 08/01/2008)

08/01/2008 53 Defendant's Unopposed First Application for Extension of Time to Answer Complaint re Choice Hotels International Inc..( Lobbin, Stephen) (Entered: 08/01/2008)

08/01/2008 -- Defendant's Unopposed First Application for Extension of Time to Answer Complaint is GRANTED pursuant to Local Rule CV-12 for Choice Hotels International Inc. to 9/2/2008. 30 Days Granted for Deadline Extension.( ch, ) (Entered: 08/01/2008)

08/01/2008 54 NOTICE of Attorney Appearance by Clyde Moody Siebman on behalf of Aptilo Networks, Inc. (Siebman, Clyde) (Entered: 08/01/2008)

08/01/2008 55 NOTICE of Attorney Appearance by Lawrence Augustine Phillips on behalf of Aptilo Networks, Inc. (Phillips, Lawrence) (Entered: 08/01/2008)

08/01/2008 56 Defendant's Unopposed First Application for Extension of Time to Answer Complaint re Aptilo Networks, Inc..( Phillips, Lawrence) (Entered: 08/01/2008)

08/04/2008 -- Defendant's Unopposed First Application for Extension of Time to Answer Complaint is GRANTED pursuant to Local Rule CV-12 for Aptilo Networks, Inc. to 9/3/2008. 30 Days Granted for Deadline Extension.( sm, ) (Entered: 08/04/2008)

08/04/2008 57 APPLICATION to Appear Pro Hac Vice by Attorney Michael T Herbst for Aptilo Networks, Inc.

(APPROVED)(FEE PAID) 4-2-2335. (ch, ) (Additional attachment(s) added on 8/5/2008: # 1 Confidential Information) (ch, ). (Entered: 08/05/2008)

08/04/2008 58 APPLICATION to Appear Pro Hac Vice by Attorney Steven L Wiser for Aptilo Networks, Inc. (APPROVED)(FEE PAID) 4-2-2335. (ch, ) (Entered: 08/05/2008)

08/06/2008 59 Defendant's Unopposed First Application for Extension of Time to Answer Complaint re FreeFi Networks, Inc..( Lobbin, Stephen) (Entered: 08/06/2008)

08/06/2008 -- Defendant's Unopposed First Application for Extension of Time to Answer Complaint is granted pursuant to Local Rule CV-12 for FreeFi Networks, Inc. to 8/29/2008. 29 Days Granted for Deadline Extension.( mpv, ) (Entered: 08/06/2008)

08/06/2008 60 E-GOV SEALED SUMMONS Returned Executed by Linksmart Wireless Technology, LLC. FreeFi Networks, Inc. served on 8/1/2008, answer due 8/29/2008. (ehs, ) (Entered: 08/06/2008)

08/06/2008 62 APPLICATION to Appear Pro Hac Vice by Attorney Steven T Snyder for Mail Boxes Etc., Inc. (APPROVED)(FEE PAID) 2-1-4001. (ch, ) (Entered: 08/07/2008)

08/07/2008 61 APPLICATION to Appear Pro Hac Vice by Attorney Holmes J Hawkins, III for Mail Boxes Etc., Inc. (APPROVED)(FEE PAID) 2-1-4001. (ch, ) (Entered: 08/07/2008)

08/15/2008 63 NOTICE of Attorney Appearance by Michael Edwin Jones on behalf of AT&T, Inc., AT&T Mobility, LLC (Jones, Michael) (Entered: 08/15/2008)

08/21/2008 64 Defendant's Unopposed Second Application for Extension of Time to Answer Complaint re T-Mobile USA, Inc..( Heartfield, J) (Entered: 08/21/2008)

08/21/2008 65 Defendant's Unopposed Second Application for Extension of Time to Answer Complaint re Wayport, Inc..( Heartfield, J) (Entered: 08/21/2008)

08/21/2008 66 Defendant's Unopposed Second Application for Extension of Time to Answer Complaint re AT&T, Inc..( Heartfield, J) (Entered: 08/21/2008)

08/21/2008 67 Defendant's Unopposed Second Application for Extension of Time to Answer Complaint re AT&T Mobility, LLC.( Heartfield, J) (Entered: 08/21/2008)

08/21/2008 68 Defendant's Unopposed Second Application for Extension of Time to Answer Complaint re LodgeNet Interactive Corporation.( Heartfield, J) (Entered: 08/21/2008)

08/21/2008 69 Defendant's Unopposed Second Application for Extension of Time to Answer Complaint re iBAHN General Holdings Corp..( Heartfield, J) (Entered: 08/21/2008)

08/21/2008 70 Defendant's Unopposed Second Application for Extension of Time to Answer Complaint re NetNearU Corp..( Heartfield, J) (Entered: 08/21/2008)

08/21/2008 71 Defendant's Unopposed Second Application for Extension of Time to Answer Complaint re Pronto Networks, Inc..( Heartfield, J) (Entered: 08/21/2008)

08/21/2008 72 Defendant's Unopposed Second Application for Extension of Time to Answer Complaint re Aptilo Networks, Inc..( Heartfield, J) (Entered: 08/21/2008)

08/21/2008 73 Defendant's Unopposed First Application for Extension of Time to Answer Complaint re FreeFi Networks, Inc..( Heartfield, J) (Entered: 08/21/2008)

08/21/2008 74 Defendant's Unopposed Second Application for Extension of Time to Answer Complaint re Meraki, Inc..( Heartfield, J) (Entered: 08/21/2008)

08/21/2008 75 Defendant's Unopposed Second Application for Extension of Time to Answer Complaint re Mail Boxes Etc., Inc..( Heartfield, J) (Entered: 08/21/2008)

08/21/2008 76 Defendant's Unopposed Second Application for Extension of Time to Answer Complaint re McDonalds Corp..( Heartfield, J) (Entered: 08/21/2008)

08/21/2008 77 Defendant's Unopposed Second Application for Extension of Time to Answer Complaint re Barnes & Noble Booksellers, Inc..( Heartfield, J) (Entered: 08/21/2008)

08/21/2008 78 Defendant's Unopposed Second Application for Extension of Time to Answer Complaint re Ramada Worldwide, Inc..( Heartfield, J) (Entered: 08/21/2008)

08/21/2008 79 Defendant's Unopposed Second Application for Extension of Time to Answer Complaint re Marriott International, Inc..( Heartfield, J) (Entered: 08/21/2008)

08/21/2008 80 Defendant's Unopposed Second Application for Extension of Time to Answer Complaint re InterContinental Hotels Group PLC.( Heartfield, J) (Entered: 08/21/2008)

08/21/2008 81 Defendant's Unopposed Second Application for Extension of Time to Answer Complaint re Choice Hotels International Inc..( Heartfield, J) (Entered: 08/21/2008)

08/21/2008 82 Defendant's Unopposed Second Application for Extension of Time to Answer Complaint re Best

Western International, Inc..( Heartfield, J) (Entered: 08/21/2008)

08/21/2008 83 Linksmart REPLY to EthoStream's COUNTERCLAIM ANSWER to 52 Answer to Complaint, Counterclaim, filed by Ethostream (Fenster, Marc) Modified on 8/22/2008 (sm, ). (Entered: 08/21/2008)

08/22/2008 -- Defendant's Unopposed Second Application for Extension of Time to Answer Complaint is GRANTED pursuant to Local Rule CV-12 for NetNearU Corp. to 9/15/2008; Pronto Networks, Inc. to 9/15/2008; Aptilo Networks, Inc. to 9/15/2008; FreeFi Networks, Inc. to 9/15/2008; T-Mobile USA, Inc. to 9/15/2008; Wayport, Inc. to 9/15/2008; AT&T, Inc. to 9/15/2008; AT&T Mobility, LLC to 9/15/2008; LodgeNet Interactive Corporation to 9/15/2008; iBAHN General Holdings Corp. to 9/15/2008. 15 Days Granted for Deadline Extension.( sm, ) (Entered: 08/22/2008)

08/22/2008 -- Defendant's Unopposed Second Application for Extension of Time to Answer Complaint is GRANTED pursuant to Local Rule CV-12 for Meraki, Inc. to 9/15/2008; Mail Boxes Etc., Inc. to 9/15/2008; McDonalds Corp. to 9/15/2008; Barnes & Noble Booksellers, Inc. to 9/15/2008; Ramada Worldwide, Inc. to 9/15/2008; Marriott International, Inc. to 9/15/2008; InterContinental Hotels Group PLC to 9/15/2008; Choice Hotels International Inc. to 9/15/2008; Best Western International, Inc. to 9/15/2008. 15 Days Granted for Deadline Extension.( sm, ) (Entered: 08/22/2008)

08/29/2008 84 ANSWER to 1 Complaint and, COUNTERCLAIM against Linksmart Wireless Technology, LLC by LodgeNet Interactive Corporation.(Socks, Harold) (Entered: 08/29/2008)

09/02/2008 85 ANSWER to 1 Complaint by Choice Hotels International Inc..(Smith, Michael) (Entered: 09/02/2008)

09/11/2008 86 Defendant's Unopposed Third Application for Extension of Time to Answer Complaint re AT&T, Inc..( Sayles, Richard) (Entered: 09/11/2008)

09/11/2008 87 Defendant's Unopposed Third Application for Extension of Time to Answer Complaint re AT&T Mobility, LLC.( Sayles, Richard) (Entered: 09/11/2008)

09/12/2008 -- Defendant's Unopposed Third Application for Extension of Time to Answer Complaint is GRANTED pursuant to Local Rule CV-12 for AT&T, Inc. to 9/22/2008; AT&T Mobility, LLC to 9/22/2008. 7 Days Granted for Deadline Extension.( sm, ) (Entered: 09/12/2008)

09/12/2008 88 ANSWER to 1 Complaint and, COUNTERCLAIM against Linksmart Wireless Technology, LLC by iBAHN General Holdings Corp..(Jones, Michael) (Entered: 09/12/2008)

09/12/2008 89 CORPORATE DISCLOSURE STATEMENT filed by iBAHN General Holdings Corp. identifying Corporate Parent None for iBAHN General Holdings Corp.. (Jones, Michael) (Entered: 09/12/2008)

09/12/2008 90 Defendant Aptilo Networks, Inc.'s ANSWER to 1 Complaint, COUNTERCLAIM against Linksmart Wireless Technology, LLC by Aptilo Networks, Inc..(Siebman, Clyde) (Entered: 09/12/2008)

09/15/2008 91 ANSWER to 1 Complaint : T-Mobile USA, Inc.'s Answer and, COUNTERCLAIM against Linksmart Wireless Technology, LLC by T-Mobile USA, Inc..(Richardson, Michael) (Entered: 09/15/2008)

09/15/2008 92 NOTICE of Attorney Appearance by Roy William Hardin on behalf of FreeFi Networks, Inc. (Hardin, Roy) (Entered: 09/15/2008)

09/15/2008 93 NOTICE of Attorney Appearance by John W MacPete on behalf of FreeFi Networks, Inc. (MacPete, John) (Entered: 09/15/2008)

09/15/2008 94 NOTICE of Attorney Appearance by Michael Scott Fuller on behalf of FreeFi Networks, Inc. (Fuller, Michael) (Entered: 09/15/2008)

09/15/2008 95 Defendant FreeFi Networks, Inc.'s Second Unopposed Application for Extension of Time to Answer Complaint.( Fuller, Michael) (Entered: 09/15/2008)

09/15/2008 96 Defendant's Unopposed Third Application for Extension of Time to Answer Complaint re Ramada Worldwide, Inc.( Stein, David) (Entered: 09/15/2008)

09/15/2008 97 ANSWER to 1 Complaint, COUNTERCLAIM against Linksmart Wireless Technology, LLC by Mail Boxes Etc., Inc..(Sayles, Richard) (Entered: 09/15/2008)

09/15/2008 98 NOTICE of Attorney Appearance by Cynthia Lopez Beverage on behalf of LodgeNet Interactive Corporation (Beverage, Cynthia) (Entered: 09/15/2008)

09/15/2008 99 CORPORATE DISCLOSURE STATEMENT filed by Mail Boxes Etc., Inc. identifying Corporate Parent United Parcel Service of America, Inc. for Mail Boxes Etc., Inc.. (Sayles, Richard) (Entered: 09/15/2008)

09/15/2008 100 NOTICE of Attorney Appearance by Eve L Henson on behalf of Mail Boxes Etc., Inc. (Henson,

Eve) (Entered: 09/15/2008)

09/15/2008 101 ANSWER to 1 Complaint, COUNTERCLAIM against Linksmart Wireless Technology, LLC by Marriott International, Inc..(Guaragna, John) (Entered: 09/15/2008)

09/15/2008 -- Defendant's Unopposed Second Application for Extension of Time to Answer Complaint is GRANTED pursuant to Local Rule CV-12 for FreeFi Networks, Inc. to 9/22/2008. 7 Days Granted for Deadline Extension.( sm, ) (Entered: 09/15/2008)

09/15/2008 102 CORPORATE DISCLOSURE STATEMENT filed by Marriott International, Inc. (Guaragna, John) (Entered: 09/15/2008)

09/15/2008 -- Defendant's Unopposed Third Application for Extension of Time to Answer Complaint is GRANTED pursuant to Local Rule CV-12 for Ramada Worldwide, Inc. to 9/19/2008. 4 Days Granted for Deadline Extension.( sm, ) (Entered: 09/15/2008)

09/15/2008 103 ANSWER to 1 Complaint by InterContinental Hotels Group PLC.(Guaragna, John) (Entered: 09/15/2008)

09/15/2008 104 Wayport, Inc.'s ANSWER to 1 Complaint, COUNTERCLAIM against Linksmart Wireless Technology, LLC by Wayport, Inc..(Villarreal, Jose) (Entered: 09/15/2008)

09/15/2008 105 CORPORATE DISCLOSURE STATEMENT filed by InterContinental Hotels Group PLC (Guaragna, John) (Entered: 09/15/2008)

09/15/2008 106 ANSWER to 1 Complaint, COUNTERCLAIM against Linksmart Wireless Technology, LLC by Barnes & Noble Booksellers, Inc..(Sayles, Richard) (Entered: 09/15/2008)

09/15/2008 107 CORPORATE DISCLOSURE STATEMENT filed by Barnes & Noble Booksellers, Inc. identifying Corporate Parent Barnes & Noble, Inc. for Barnes & Noble Booksellers, Inc.. (Sayles, Richard) (Entered: 09/15/2008)

09/15/2008 108 McDonald's Corp.'s ANSWER to 1 Complaint, COUNTERCLAIM against Linksmart Wireless Technology, LLC by McDonalds Corp..(Villarreal, Jose) (Entered: 09/15/2008)

09/15/2008 109 NOTICE of Attorney Appearance by Eve L Henson on behalf of Barnes & Noble Booksellers, Inc. (Henson, Eve) (Entered: 09/15/2008)

09/15/2008 110 Meraki, Inc.'s ANSWER to 1 Complaint, COUNTERCLAIM against Linksmart Wireless Technology, LLC by Meraki, Inc..(Villarreal, Jose) (Entered: 09/15/2008)

09/15/2008 111 Best Western International, Inc.'s Answer to Plaintiff's Complaint and Counterclaims - ANSWER to 1 Complaint, COUNTERCLAIM against Linksmart Wireless Technology, LLC by Best Western International, Inc..(Joe, Christopher) (Entered: 09/15/2008)

09/15/2008 112 CORPORATE DISCLOSURE STATEMENT filed by Best Western International, Inc. (Joe, Christopher) (Entered: 09/15/2008)

09/15/2008 113 CORPORATE DISCLOSURE STATEMENT filed by McDonalds Corp. (Villarreal, Jose) (Entered: 09/15/2008)

09/15/2008 114 Defendant's Unopposed Third Application for Extension of Time to Answer Complaint re Pronto Networks, Inc..( Villarreal, Jose) (Entered: 09/15/2008)

09/16/2008 -- Defendant's Unopposed Third Application for Extension of Time to Answer Complaint is GRANTED pursuant to Local Rule CV-12 for Pronto Networks, Inc. to 9/19/2008. 4 Days Granted for Deadline Extension.( sm, ) (Entered: 09/16/2008)

09/16/2008 115 CORPORATE DISCLOSURE STATEMENT filed by Aptilo Networks, Inc. identifying Corporate Parent Aptilo Networks AB for Aptilo Networks, Inc.. (Siebman, Clyde) (Entered: 09/16/2008)

09/16/2008 116 CORPORATE DISCLOSURE STATEMENT filed by Meraki, Inc. (Tyler, Marvin) (Entered: 09/16/2008)

09/17/2008 117 CORPORATE DISCLOSURE STATEMENT (Deutsche Telecom AG is parent corporation) filed by T-Mobile USA, Inc. (Beck, David) Modified on 9/19/2008 (sm, ). (Entered: 09/17/2008)

09/17/2008 118 CORPORATE DISCLOSURE STATEMENT filed by Wayport, Inc. (Villarreal, Jose) (Entered: 09/17/2008)

09/17/2008 134 APPLICATION to Appear Pro Hac Vice by Attorney Mark E Ungerma for LodgeNet Interactive Corporation. (APPROVED)(FEE PAID) 2-1-4088 (ch, ) (Entered: 09/24/2008)

09/18/2008 119 Linksmart's REPLY to LodgeNet's COUNTERCLAIM ANSWER to 84 Answer to Complaint, Counterclaim of LodgeNet Interactive Corp. by Linksmart Wireless Technology, LLC.(Fenster, Marc) (Entered: 09/18/2008)

09/18/2008 127 APPLICATION to Appear Pro Hac Vice by Attorney Michael D Broaddus for iBAHN General Holdings Corp., David J Burman for iBAHN General Holdings Corp., Kameron Parvin for iBAHN



General Holdings Corp. RECEIPT 6-1-15221. (Attachments: # 1 PHV David Burman, # 2 PHV Kameron Parvin)(rml, ) (Entered: 09/22/2008)

09/19/2008 120 Ramada Worldwide, Inc.'s ANSWER to 1 Complaint filed by Linksmart Wireless Technology, LLC, COUNTERCLAIM against Linksmart Wireless Technology, LLC by Ramada Worldwide, Inc..(Hunt, Dean) (Entered: 09/19/2008)

09/19/2008 121 CORPORATE DISCLOSURE STATEMENT filed by Ramada Worldwide, Inc. (Hunt, Dean) (Entered: 09/19/2008)

09/19/2008 122 Pronto Networks, Inc.'s ANSWER to 1 Complaint, COUNTERCLAIM against Linksmart Wireless Technology, LLC by Pronto Networks, Inc..(Villarreal, Jose) (Entered: 09/19/2008)

09/22/2008 123 ANSWER to 1 Complaint, COUNTERCLAIM against all plaintiffs by FreeFi Networks, Inc..(Fuller, Michael) (Entered: 09/22/2008)

09/22/2008 124 MOTION to Dismiss by AT&T Mobility, LLC. (Attachments: # 1 Text of Proposed Order)(Sayles, Richard) Modified on 9/25/2008 (rml, ). (Entered: 09/22/2008)

09/22/2008 125 CORPORATE DISCLOSURE STATEMENT filed by AT&T Mobility, LLC identifying Corporate Parent AT&T Inc. for AT&T Mobility, LLC. (Sayles, Richard) (Entered: 09/22/2008)

09/22/2008 126 NOTICE of Attorney Appearance by Eve L Henson on behalf of AT&T Mobility, LLC (Henson, Eve) (Entered: 09/22/2008)

09/22/2008 128 NOTICE of Voluntary Dismissal by Linksmart Wireless Technology, LLC (Attachments: # 1 Text of Proposed Order)(Fenster, Marc) (Entered: 09/22/2008)

09/23/2008 129 CORPORATE DISCLOSURE STATEMENT filed by AT&T Mobility, LLC identifying Other Affiliate AT&T Mobility Corporation, Other Affiliate SBC Long Distance, LLC, Other Affiliate SBC Alloy Holdings, Inc., Other Affiliate BLS Cingular Holdings, LLC, Other Affiliate BellSouth Mobile Data, Inc. for AT&T Mobility, LLC. (Sayles, Richard) (Entered: 09/23/2008)

09/23/2008 130 CORPORATE DISCLOSURE STATEMENT filed by Pronto Networks, Inc. (Tyler, Marvin) (Entered: 09/23/2008)

09/23/2008 132 APPLICATION to Appear Pro Hac Vice by Attorney John D Kinton for Marriott International, Inc. and InterContinental Hotels Group PLC. (APPROVED)(FEE PAID) 2-1-4098 (ch, ) (Entered: 09/24/2008)

09/23/2008 133 APPLICATION to Appear Pro Hac Vice by Attorney Erin Penning for Marriott International, Inc. and InterContinental Hotels Group PLC. (APPROVED)(FEE PAID) 2-1-4098 (ch, ) (Entered: 09/24/2008)

09/24/2008 131 ORDER granting 128 Dismissal of Claims against AT&T, Mobility Inc. are hereby DISMISSED WITHOUT PREJUDICE. Signed by Judge T. John Ward on 9/24/08. (ch, ) Modified on 9/25/2008 (rml, ). (Entered: 09/24/2008)

09/24/2008 135 APPLICATION to Appear Pro Hac Vice by Attorney David T Pritikin for Mail Boxes Etc., Inc. and Barnes & Noble Booksellers, Inc. (APPROVED)(FEE PAID) 2-1-4107. (ch, ) (Entered: 09/24/2008)

09/24/2008 136 APPLICATION to Appear Pro Hac Vice by Attorney Rachel D Sher for Mail Boxes Etc., Inc. and Barnes & Noble Booksellers, Inc. (APPROVED)(FEE PAID) 2-1-4107. (ch, ) (Entered: 09/24/2008)

09/25/2008 -- \*\*\*Document # 131, Order Dismissing AT&T Inc. was linked to Doc 124 MOTION to Dismiss by AT&T Mobility, LLC. rather than doc 128, dismissal of AT&T Inc; AT&T Inc has now been dismissed; AT&T Mobility LLC remains pending..\*\*\* (rml, ) (Entered: 09/25/2008)

10/02/2008 137 Linksmart's REPLY to iBahn's Counterclaim ANSWER to 88 Answer to Complaint, Counterclaim by Linksmart Wireless Technology, LLC.(Fenster, Marc) (Entered: 10/02/2008)

10/02/2008 138 Linksmart's REPLY to Aptilo's Counterclaim ANSWER to 90 Answer to Complaint, Counterclaim by Linksmart Wireless Technology, LLC.(Fenster, Marc) (Entered: 10/02/2008)

10/03/2008 139 CORPORATE DISCLOSURE STATEMENT filed by LodgeNet Interactive Corporation (Beverage, Cynthia) (Entered: 10/03/2008)

10/06/2008 140 Linksmart REPLY to T-Mobile Counterclaim ANSWER to 91 Answer to Complaint, Counterclaim by Linksmart Wireless Technology, LLC.(Fenster, Marc) (Entered: 10/06/2008)

10/06/2008 141 Linksmart REPLY to Wayport Counterclaim ANSWER to 104 Answer to Complaint, Counterclaim by Linksmart Wireless Technology, LLC.(Fenster, Marc) (Entered: 10/06/2008)

10/06/2008 142 Linksmart REPLY to Meraki Counterclaim ANSWER to 110 Answer to Complaint, Counterclaim by Linksmart Wireless Technology, LLC.(Fenster, Marc) (Entered: 10/06/2008)

10/06/2008 143 Linksmart REPLY to Mail Boxes Etc Counterclaim ANSWER to 97 Answer to Complaint, Counterclaim by Linksmart Wireless Technology, LLC.(Fenster, Marc) (Entered: 10/06/2008)

10/06/2008 144 Linksmart REPLY to McDonalds Counterclaim ANSWER to 108 Answer to Complaint, Counterclaim by Linksmart Wireless Technology, LLC.(Fenster, Marc) (Entered: 10/06/2008)

10/06/2008 145 Linksmart REPLY to BarnesNoble Counterclaim ANSWER to 106 Answer to Complaint, Counterclaim by Linksmart Wireless Technology, LLC.(Fenster, Marc) (Entered: 10/06/2008)

10/06/2008 146 Linksmart REPLY to Best Westrn Counterclaim ANSWER to 111 Answer to Complaint, Counterclaim by Linksmart Wireless Technology, LLC.(Fenster, Marc) (Entered: 10/06/2008)

10/06/2008 147 Linksmart REPLY to Marriott International Counterclaim ANSWER to 101 Answer to Complaint, Counterclaim by Linksmart Wireless Technology, LLC.(Fenster, Marc) (Entered: 10/06/2008)

10/07/2008 148 Joint MOTION to Dismiss AT&T Mobility, LLC Without Prejudice by Linksmart Wireless Technology, LLC. (Attachments: # 1 Text of Proposed Order re Joint Motion for Voluntary Dismissal of AT&T Mobility, LLC Without Prejudice)(Fenster, Marc) (Entered: 10/07/2008)

10/08/2008 149 ORDER granting 148 Motion to Dismiss. AT&T Mobility LLC is DISMISSED WITHOUT PREJUDICE. And the Motion to Dismiss filed on 9/22/08 124 is taken off calendar. Signed by Judge T. John Ward on 10/8/08. (ch, ) Modified on 10/8/2008 to correct text to read dismissed without prejudice (ehs, ). (Entered: 10/08/2008)

10/09/2008 150 Linksmart's REPLY to Ramada's Counterclaim ANSWER to 120 Answer to Complaint, Counterclaim by Linksmart Wireless Technology, LLC.(Fenster, Marc) (Entered: 10/09/2008)

10/09/2008 151 Linksmart's REPLY to Pronto's Counterclaim ANSWER to 122 Answer to Complaint, Counterclaim by Linksmart Wireless Technology, LLC.(Fenster, Marc) (Entered: 10/09/2008)

10/14/2008 152 Linksmart's REPLY to Freefi Networks' Counterclaim ANSWER to 123 Answer to Complaint, Counterclaim by Linksmart Wireless Technology, LLC.(Fenster, Marc) (Entered: 10/14/2008)

10/16/2008 153 E-GOV SEALED SUMMONS Returned Executed by Linksmart Wireless Technology, LLC. Second Rule LLC served on 10/8/2008, answer due 10/28/2008. (ehs, ) (Entered: 10/16/2008)

10/30/2008 154 APPLICATION to Appear Pro Hac Vice by Attorney Noah A Levine for T-Mobile USA, Inc. (APPROVED)(FEE PAID) 2-1-4198. (ch, ) (Entered: 10/30/2008)

10/30/2008 155 APPLICATION to Appear Pro Hac Vice by Attorney David B Bassett for T-Mobile USA, Inc. (APPROVED)(FEE PAID) 2-1-4197. (ch, ) (Entered: 10/30/2008)

10/30/2008 156 APPLICATION to Appear Pro Hac Vice by Attorney James P Barabas for T-Mobile USA, Inc. (APPROVED)(FEE PAID) 2-1-4196. (ch, ) (Entered: 10/30/2008)

11/03/2008 157 APPLICATION to Appear Pro Hac Vice by Attorney William F Lee for T-Mobile USA, Inc. APPROVED (Rec# 2-1-4208 (poa, ) (Entered: 11/05/2008)

11/17/2008 158 APPLICATION to Appear Pro Hac Vice by Attorney Christina J Moser for EthoStream, LLC, Ramada Worldwide, Inc. and EthoStream, LLC. (APPROVED FEE PAID 2-1-4227) (ehs, ) (Entered: 11/17/2008)

11/21/2008 159 APPLICATION to Appear Pro Hac Vice by Attorney Kirk R Ruthenberg for T-Mobile USA, Inc. (APPROVED)(FEE PAID) 2-1-4252. (ch, ) (Entered: 11/21/2008)

11/21/2008 160 APPLICATION to Appear Pro Hac Vice by Attorney Kirk R Ruthenberg for T-Mobile USA, Inc.. (APPROVED FEE PAID 2-1-4252) (ehs, ) (Entered: 11/21/2008)

12/09/2008 161 STIPULATION of Dismissal of Intercontinental Hotels Group PLC by Linksmart Wireless Technology, LLC, InterContinental Hotels Group PLC. (Attachments: # 1 Text of Proposed Order)(Guaragna, John) (Entered: 12/09/2008)

12/12/2008 162 ORDER - granting 161 Stipulation of Dismissal. Intercontinental Hotels Group PLC is dismissed without prejudice. Signed by Judge T. John Ward on 12/12/08. (ch, ) (Entered: 12/12/2008)

12/22/2008 163 NOTICE of Attorney Appearance by Andrew Wesley Spangler on behalf of Linksmart Wireless Technology, LLC (Spangler, Andrew) (Entered: 12/22/2008)

01/14/2009 164 NOTICE of Attorney Appearance by Andrew D Weiss on behalf of Linksmart Wireless Technology, LLC (Weiss, Andrew) (Entered: 01/14/2009)

01/23/2009 165 Joint MOTION to Consolidate Cases by T-Mobile USA, Inc.. (Attachments: # 1 Text of Proposed Order)(Beck, David) (Entered: 01/23/2009)

01/23/2009 166 NOTICE of Attorney Appearance by Rachel D Sher on behalf of Wayport, Inc. (Sher, Rachel) (Entered: 01/23/2009)

01/26/2009 167 NOTICE of Attorney Appearance by Richard T McCaulley, Jr on behalf of Wayport, Inc. (McCaulley, Richard) (Entered: 01/26/2009)

01/27/2009 168 NOTICE of Attorney Appearance by David T Pritikin on behalf of Wayport, Inc. (Pritikin, David) (Entered: 01/27/2009)

01/27/2009 169 Unopposed MOTION to Withdraw as Attorney by Wayport, Inc.. (Attachments: # 1 Text of Proposed Order Proposed Order)(Tyler, Marvin) (Entered: 01/27/2009)

01/28/2009 170 ORDER granting 169 Motion to Withdraw as Attorney. Attorney Marvin Craig Tyler and Jose Carlos Villarreal terminated as counsel for deft Wayport Inc. Signed by Magistrate Judge Charles Everingham on 1/28/09. (ehs, ) (Entered: 01/28/2009)

01/29/2009 171 NOTICE of Attorney Appearance by Michael Ernest Richardson on behalf of T-Mobile USA, Inc. (Richardson, Michael) (Entered: 01/29/2009)

01/29/2009 172 NOTICE of Attorney Appearance by Richard Alan Sayles on behalf of Wayport, Inc. (Sayles, Richard) (Entered: 01/29/2009)

01/29/2009 173 NOTICE of Attorney Appearance by Eve L Henson on behalf of Wayport, Inc. (Henson, Eve) (Entered: 01/29/2009)

01/30/2009 175 APPLICATION to Appear Pro Hac Vice by Attorney Brian C Bianco for Mail Boxes Etc., Inc., Barnes & Noble Booksellers, Inc., Mail Boxes Etc., Inc., Wayport, Inc. and Barnes & Noble Booksellers, Inc.. (APPROVED FEE PAID) 2-1-4459 (ch, ) (Entered: 02/05/2009)

02/03/2009 174 ORDER REASSIGNING CASE. Case reassigned to Judge David Folsom for all further proceedings. Judge T. John Ward no longer assigned to case. Signed by Judge T. John Ward on 2/2/09. (ch, ) (Entered: 02/03/2009)

02/09/2009 176 Unopposed MOTION to Withdraw as Attorney by Mail Boxes Etc., Inc.. (Attachments: # 1 Text of Proposed Order)(Smith, Michael) (Entered: 02/09/2009)

02/11/2009 177 ORDER granting 176 Motion to Withdraw as Attorney. Attorney Michael Charles Smith terminated as counsel for Mail Boxes, Etc. Signed by Magistrate Judge Charles Everingham on 2/11/09. (ch, ) (Entered: 02/11/2009)

02/13/2009 178 APPLICATION to Appear Pro Hac Vice by Attorney Peter M Dichiara for T-Mobile USA, Inc. (APPROVED FEE PAID) 2-1-4493. (ch, ) (Entered: 02/13/2009)

02/18/2009 179 Request by Linksmart Wireless Technology, LLC for Clerk's Entry of Default against Second Rule LLC, Hot Point Wireless, Inc.. (Weiss, Andrew) (Additional attachment(s) added on 2/19/2009: # 1 Clerks Entry of Default) (sm, ). (Entered: 02/18/2009)

02/18/2009 180 Additional Attachments to Main Document: 179 Request for Entry of Default by Clerk.. (Attachments: # 1 Exhibit A)(Weiss, Andrew) (Entered: 02/18/2009)

02/19/2009 181 NOTICE of Voluntary Dismissal by Linksmart Wireless Technology, LLC (Weiss, Andrew) (Additional attachment(s) added on 2/19/2009: # 1 Text of Proposed Order) (sm, ). (Entered: 02/19/2009)

02/23/2009 182 \*\*\*FILED IN ERROR. CASE IS NO LONGER JUDGE WARD'S PER ORDER #174 REASSIGNING CASE TO JUDGE FOLSOM\*\*\* Order - granting 181 Notice of Voluntary Dismissal. All claims asserted between Linksmart and NetNearU Corp are hereby DISMISSED WITHOUT PREJUDICE. All attorney's fees and costs are to be borne by the party that incurred them. Signed by Judge T. John Ward on 2/23/09. (ch, ) Modified on 2/24/2009 (ch, ). (Entered: 02/23/2009)

02/23/2009 183 Clerk's ENTRY OF DEFAULT as to Hot Point Wireless, Inc. (ehs, ) (Entered: 02/23/2009)

02/24/2009 184 ORDER OF DISMISSAL WITHOUT PREJUDICE re 181 Notice of Voluntary Dismissal filed by Linksmart Wireless Technology, LLC, ORDERED, ADJUDGED and DECREED that all claims asserted in this suit between Linksmart and Netnearu are hereby dismissed without prejudice.. Signed by Judge David Folsom on 2/23/09. (mrm, ) (Entered: 02/24/2009)

02/27/2009 185 MOTION for Default Judgment as to Hot Point Wireless, Inc. and Second Rule, LLC by Linksmart Wireless Technology, LLC. (Attachments: # 1 Text of Proposed Order)(Weiss, Andrew) (Entered: 02/27/2009)

04/10/2009 186 NOTICE of Attorney Appearance by David T Pritikin on behalf of McDonalds Corp. (Pritikin, David) (Entered: 04/10/2009)

04/10/2009 187 NOTICE of Attorney Appearance by Richard T McCaulley, Jr on behalf of McDonalds Corp. (McCaulley, Richard) (Entered: 04/10/2009)

04/10/2009 188 NOTICE of Attorney Appearance by Rachel D Sher on behalf of McDonalds Corp. (Sher, Rachel) (Entered: 04/10/2009)

04/10/2009 189 NOTICE of Attorney Appearance by Brian C Bianco on behalf of McDonalds Corp. (Bianco, Brian) (Entered: 04/10/2009)

04/22/2009 190 NOTICE of Change of Address by John M Guaragna (Guaragna, John) (Entered: 04/22/2009)

04/23/2009 191 Unopposed MOTION to Withdraw as Attorney by McDonalds Corp.. (Attachments: # 1 Text of Proposed Order Proposed Order)(Tyler, Marvin) (Entered: 04/23/2009)

04/24/2009 192 ORDER granting 191 Motion to Withdraw as Attorney. Attorney Marvin Craig Tyler and Jose Carlos Villarreal terminated as counsel for McDonald's Corp. Signed by Magistrate Judge Charles Everingham on 4/24/09. (ehs, ) (Entered: 04/24/2009)

05/01/2009 193 ORDER granting 165 Motion to Consolidate Cases. ORDERED that the above- captioned actions are consolidated for all purposes pursuant to Federal Rule of Civil Procedure 42(a) and Local Rule CV-42(b) and (c).. Signed by Magistrate Judge Charles Everingham on 5/1/09. (ch, ) (Entered: 05/01/2009)

05/04/2009 194 NOTICE of Hearing: Scheduling Conference set for 6/3/2009 10:00 AM in Mag Ctrm (Marshall) before Magistrate Judge Charles Everingham. (jml, ) (Entered: 05/04/2009)

05/06/2009 195 Notice of Scheduling Conference, Proposed Deadlines for Docket Control Order, and Discovery Order. Scheduling Conference set for 6/3/2009 10:00 AM before Magistrate Judge Charles Everingham. The parties are directed to meet and confer in accordance with Fed. R. Civ. P. 26(f) no later than May 27, 2009. Signed by Magistrate Judge Charles Everingham on 5/5/09. (ch, ) (Entered: 05/06/2009)

05/06/2009 196 NOTICE of Attorney Appearance by Richard Alan Sayles on behalf of McDonalds Corp. (Sayles, Richard) (Entered: 05/06/2009)

05/06/2009 197 NOTICE of Attorney Appearance by Eve L Henson on behalf of McDonalds Corp. (Henson, Eve) (Entered: 05/06/2009)

05/06/2009 198 NOTICE of Attorney Appearance by Mark Daniel Strachan on behalf of McDonalds Corp. (Strachan, Mark) (Entered: 05/06/2009)

05/06/2009 199 NOTICE of Attorney Appearance by Mark Daniel Strachan on behalf of Mail Boxes Etc., Inc. (Strachan, Mark) (Entered: 05/06/2009)

05/06/2009 200 NOTICE of Attorney Appearance by Mark Daniel Strachan on behalf of Barnes & Noble Booksellers, Inc. (Strachan, Mark) (Entered: 05/06/2009)

05/06/2009 201 NOTICE of Attorney Appearance by Mark Daniel Strachan on behalf of Wayport, Inc. (Strachan, Mark) (Entered: 05/06/2009)

05/29/2009 202 NOTICE of Attorney Appearance by Jennifer Parker Ainsworth on behalf of LodgeNet Interactive Corporation (Ainsworth, Jennifer) (Entered: 05/29/2009)

05/29/2009 203 Unopposed MOTION to Withdraw as Attorney by Locke Lord Bissell & Liddell LLP by FreeFi Networks, Inc.. (Attachments: # 1 Exhibit Proposed Order)(Fuller, Michael) (Entered: 05/29/2009)

06/01/2009 204 REPORT of Rule 26(f) Planning Meeting. (Attachments: # 1 Exhibit A - Proposed Docket Control Order)(Weiss, Andrew) (Additional attachment(s) added on 6/1/2009: # 2 Revised Scheduling Order) (sm, ). (Entered: 06/01/2009)

06/03/2009 205 Minute Entry for proceedings held before Magistrate Judge Charles Everingham: Scheduling Conference held on 6/3/2009. (Court Reporter Susan Simmons, CSR.) (jml, ) (Entered: 06/04/2009)

06/05/2009 206 APPLICATION to Appear Pro Hac Vice by Attorney Gregory Lyons for Choice Hotels International Inc. (APPROVED FEE PAID) 2-1-4733. (ch, ) (Entered: 06/05/2009)

06/05/2009 207 APPLICATION to Appear Pro Hac Vice by Attorney Kevin P Anderson for Choice Hotels International Inc. (APPROVED FEE PAID) 2-1-4733. (ch, ) (Entered: 06/05/2009)

06/08/2009 208 ORDER granting 203 Motion to Withdraw as Attorney. Attorney John W MacPete; Michael Scott Fuller and Roy William Hardin terminated as counsel for FreeFi. Accordingly, the court, sua sponte, provides FreeFi thirty days in which to retain counsel in the above matter. Should FreeFi not retain counsel by that date, the plaintiff is ordered to notify the court. Signed by Magistrate Judge Charles Everingham on 6/8/09. (ch, ) (Entered: 06/08/2009)

06/17/2009 209 MOTION for Extension of Time to File Joint Motion to Extend Deadline for Submission of Proposed Protective Order by T-Mobile USA, Inc., Cisco Systems, Inc.. (Attachments: # 1 Text of Proposed Order)(Richardson, Michael) (Entered: 06/17/2009)

06/24/2009 210 ORDER granting 209 Motion for Extension of Time for Submission of Proposed Protective Order. Deadline extended to 6/24/09. Signed by Magistrate Judge Charles Everingham on 6/24/09. (ehs, ) (Entered: 06/24/2009)

06/24/2009 211 Joint MOTION for Extension of Time to File Joint Motion to Extend Deadline for Submission of

Proposed Protective Order by T-Mobile USA, Inc., Cisco Systems, Inc.. (Attachments: # 1 Text of Proposed Order)(Richardson, Michael) (Entered: 06/24/2009)

06/26/2009 212 JOINT GENERAL DISCOVERY ORDER. Signed by Magistrate Judge Charles Everingham on 6/26/09. (ehs, ) (Entered: 06/26/2009)

06/26/2009 213 DOCKET CONTROL ORDER - Joinder of Parties due by 11/13/2009., Markman Hearing set for 5/25/2010 09:00 AM before Magistrate Judge Charles Everingham., Motions due by 11/19/2010., Pretrial Order due by 2/18/2011., Scheduling Conference set for 6/3/2009 10:00 AM before Judge David Folsom. Signed by Magistrate Judge Charles Everingham on 6/26/09. (ehs, ) (Entered: 06/26/2009)

06/26/2009 214 ORDER granting 211 Motion for Extension of Time to File. Deadline for submission of a proposed protective order is extended until July 1,2009. Signed by Magistrate Judge Charles Everingham on 6/26/09. (ehs, ) (Entered: 06/26/2009)

07/01/2009 215 Joint MOTION for Extension of Time to File and to Extend Deadline for Submission of the Name of an Agreed Mediator by T-Mobile USA, Inc.. (Attachments: # 1 Text of Proposed Order Order Granting Joint Motion to Extend Deadline for Submission of the Name of an Agreed Mediator) (Richardson, Michael) Modified on 7/1/2009 (sm, ). (Entered: 07/01/2009)

07/01/2009 216 \*\*\*FILED IN ERROR. ORDERS ARE NOT FILED SEPARATELY. PLEASE IGNORE.\*\*\* Submission of Proposed Agreed Protective order by Linksmart Wireless Technology, LLC. (Weiss, Andrew) Modified on 7/2/2009 (ch, ). (Entered: 07/01/2009)

07/02/2009 217 ORDER granting 215 Motion for Extension of Time to File. Deadline for submission of the name of an agreed mediator is extended until July 27,2009. Signed by Magistrate Judge Charles Everingham on 7/2/09. (ch, ) (Entered: 07/02/2009)

07/02/2009 -- NOTICE of Deficiency regarding the 216 submitted by Linksmart Wireless Technology, LLC. Order not filed as separate document. Correction should be made by one business day (ch, ) (Entered: 07/02/2009)

07/02/2009 218 NOTICE of Disclosure by Linksmart Wireless Technology, LLC of Compliance re PR 3-1 and 3-2 Disclosures (Weiss, Andrew) (Entered: 07/02/2009)

07/02/2009 219 \*\*\*DEFICIENT DOCUMENT. USED WRONG EVENT. PLEASE IGNORE. Submission of Proposed Agreed Protective order by Linksmart Wireless Technology, LLC. (Attachments: # 1 Text of Proposed Order)(Weiss, Andrew) Modified on 7/6/2009 (ch, ). (Entered: 07/02/2009)

07/06/2009 -- NOTICE of Deficiency regarding the 219 submitted by Linksmart Wireless Technology, LLC. Joint Motion filed under wrong event.. Correction should be made by one business day (ch, ) (Entered: 07/06/2009)

07/06/2009 220 \*\*\*REPLACES # 219 \*\*\* Agreed MOTION for Protective Order for Entry of Protective Order by Linksmart Wireless Technology, LLC. (Attachments: # 1 Text of Proposed Order [Proposed] Agreed Protective Order)(Weiss, Andrew) Modified on 7/6/2009 (ch, ). (Entered: 07/06/2009)

07/08/2009 221 Unopposed MOTION for Extension of Time to File - Extending Time Allowed for Freefi to Retain Counsel by Linksmart Wireless Technology, LLC. (Attachments: # 1 Text of Proposed Order) (Weiss, Andrew) (Entered: 07/08/2009)

07/13/2009 222 AGREED PROTECTIVE ORDER 220 Motion for Protective Order. Signed by Magistrate Judge Charles Everingham on July 13, 2009. (jml) (Entered: 07/13/2009)

07/13/2009 223 ORDER granting 221 Motion for Extension of Time to File. Signed by Magistrate Judge Charles Everingham on July 13, 2009. (jml) (Entered: 07/13/2009)

07/21/2009 224 APPLICATION to Appear Pro Hac Vice by Attorney Joyce Chen for T-Mobile USA, Inc. and Cisco Systems, Inc.. (APPROVED, FEE PAID 2-1-4827) (ehs, ) (Entered: 07/21/2009)

07/27/2009 225 Joint MOTION Appointment of Mediator by Linksmart Wireless Technology, LLC. (Attachments: # 1 Text of Proposed Order)(Weiss, Andrew) (Entered: 07/27/2009)

07/27/2009 226 NOTICE of Attorney Appearance by Aden Martin Allen on behalf of Pronto Networks, Inc., Meraki, Inc. (Allen, Aden) (Entered: 07/27/2009)

07/28/2009 227 ORDER REFERRING CASE to Mediator. James W Knowles added as Mediator. Signed by Magistrate Judge Charles Everingham on July 28, 2009. (jml) (Entered: 07/28/2009)

08/06/2009 228 Unopposed MOTION to Withdraw as Attorney by McDonalds Corp., Wayport, Inc., SBC Internet Services, Inc.. (Attachments: # 1 Text of Proposed Order)(Henson, Eve) (Entered: 08/06/2009)

08/06/2009 229 Unopposed MOTION for Extension of Time to File Allowed for Freefi to Retain Counsel by Linksmart Wireless Technology, LLC. (Attachments: # 1 Text of Proposed Order)(Weiss, Andrew) (Entered: 08/06/2009)

08/07/2009 230 ORDER granting 229 Motion for Extension of Time Allowed for Freefi to Retain Counsel. Signed by Magistrate Judge Charles Everingham on August 7, 2009. (jml) (Entered: 08/07/2009)

08/07/2009 231 \*\*\*DEFICIENT DOCUMENT. NOT IN PDF SEARCHABLE FORMAT. PLEASE IGNORE.\*\*\* Unopposed MOTION to Withdraw as Attorney by LodgeNet Interactive Corporation. (Socks, Harold) Modified on 8/7/2009 (ch, ). (Entered: 08/07/2009)

08/07/2009 -- NOTICE of Deficiency regarding the 231 submitted by LodgeNet Interactive Corporation. NOT IN PDF SEARCHABLE FORMAT. Correction should be made by 8/7/09 (ch, ) (Entered: 08/07/2009)

08/07/2009 232 \*\*\*REPLACES # 231 \*\*\* Unopposed MOTION to Withdraw as Attorney by LodgeNet Interactive Corporation. (Attachments: # 1 Text of Proposed Order Order Granting Unopposed Motion for Withdrawal)(Socks, Harold) Modified on 8/11/2009 (ch, ). (Entered: 08/07/2009)

08/10/2009 233 ORDER granting 228 Motion to Withdraw as Attorney. Attorney Richard T McCaulley, Jr terminated as counsel for Dft's SBC Internet Services, Inc., McDonalds Corp., and Wayport, Inc. Signed by Magistrate Judge Charles Everingham on 8/7/09. (ch, ) (Entered: 08/10/2009)

08/14/2009 234 APPLICATION to Appear Pro Hac Vice by Attorney Lisa A Schneider for Mail Boxes Etc., Inc., McDonalds Corp., Barnes & Noble Booksellers, Inc., Wayport, Inc. and SBC Internet Services, Inc. (APPROVED FEE PAID) 2-1-4865. (ch, ) (Entered: 08/14/2009)

08/18/2009 235 APPLICATION to Appear Pro Hac Vice by Attorney Robin Lynn Brewer for Meraki, Inc. (APPROVED FEE PAID) 2-1-4871. (ch, ) (Entered: 08/19/2009)

08/19/2009 236 NOTICE of Attorney Appearance by Robert David Daniel on behalf of T-Mobile USA, Inc. (Daniel, Robert) (Entered: 08/19/2009)

08/28/2009 237 NOTICE of Disclosure by Pronto Networks, Inc. (Allen, Aden) (Entered: 08/28/2009)

08/28/2009 238 NOTICE of Disclosure by Choice Hotels International Inc. of Rule 26 Initial Disclosures (Smith, Michael) (Entered: 08/28/2009)

08/28/2009 239 Unopposed MOTION for Extension of Time to Complete Discovery , to Serve Initial Disclosures by Mail Boxes Etc., Inc., McDonalds Corp., Barnes & Noble Booksellers, Inc., Wayport, Inc., SBC Internet Services, Inc.. (Attachments: # 1 Text of Proposed Order)(Sayles, Richard) (Entered: 08/28/2009)

08/28/2009 240 NOTICE of Disclosure by EthoStream, LLC (Hunt, Dean) (Entered: 08/28/2009)

08/28/2009 241 NOTICE of Disclosure by Ramada Worldwide, Inc. (Hunt, Dean) (Entered: 08/28/2009)

08/28/2009 242 NOTICE of Disclosure by LodgeNet Interactive Corporation (Beverage, Cynthia) (Entered: 08/28/2009)

08/28/2009 243 NOTICE of Disclosure by IBAHN General Holdings Corp. regarding Initial Disclosures (Jones, Michael) (Entered: 08/28/2009)

08/28/2009 244 NOTICE of Disclosure by Meraki, Inc. (Brewer, Robin) (Entered: 08/28/2009)

08/28/2009 245 NOTICE by Marriott International, Inc. of Compliance re Initial Disclosures (Guaragna, John) (Entered: 08/28/2009)

08/28/2009 246 NOTICE by Six Continents Hotels Inc, Intercontinental Hotels Group Resources Inc of Compliance re Initial Disclosures (Guaragna, John) (Entered: 08/28/2009)

08/28/2009 247 NOTICE of Disclosure by Linksmart Wireless Technology, LLC of Rule 26 Initial Disclosure (Weiss, Andrew) (Entered: 08/28/2009)

08/28/2009 248 Consent MOTION for Extension of Time to File Initial Disclosures by Aptilo Networks, Inc.. (Attachments: # 1 Text of Proposed Order)(Siebman, Clyde) (Entered: 08/28/2009)

08/31/2009 249 NOTICE of Disclosure by T-Mobile USA, Inc., Cisco Systems, Inc. (Notice of Filing Rule 26 Initial Disclosures) (Daniel, Robert) (Entered: 08/31/2009)

08/31/2009 250 ORDER granting 239 Motion for Extension of Time to Complete Discovery. Defendants serve their Initial Disclosures on or before September 11, 2009.. Signed by Magistrate Judge Charles Everingham on 8/31/09. (ehs, ) (Entered: 08/31/2009)

08/31/2009 251 ORDER granting 248 Motion for Extension of Time to File Defendants Initial Disclosures on or before September 11, 2009.. Signed by Magistrate Judge Charles Everingham on 8/31/09. (ehs, ) (Entered: 08/31/2009)

09/01/2009 252 NOTICE of Disclosure by Best Western International, Inc. Notice of Compliance With Rule 26 by Best Western International, Inc. (Joe, Christopher) (Entered: 09/01/2009)

09/04/2009 253 MOTION to Dismiss Defendant Freefi Networks, Inc. by Linksmart Wireless Technology, LLC. (Attachments: # 1 Text of Proposed Order)(Weiss, Andrew) (Entered: 09/04/2009)

09/09/2009 254 ORDER granting 253 Motion to Dismiss Dft Freefi Networks, Inc.. Signed by Judge David Folsom on 9/9/2009. (sm, ) (Entered: 09/09/2009)

09/09/2009 255 REPORT AND RECOMMENDATIONS recommending 185 MOTION for Default Judgment as to Hot Point Wireless, Inc. and Second Rule, LLC filed by Linksmart Wireless Technology, LLC be granted. Signed by Magistrate Judge Charles Everingham on 9/9/09. (ehs, ) (Entered: 09/09/2009)

09/09/2009 256 ORDER granting 185 Motion for Default Judgment. Because the sum of damages is not certain, Linksmart is entitled to take discovery from Hot Point Wireless, Inc. (Hot Point) and Second Rule LLC (Second Rule) to determine the appropriate amount of compensatory damages as a result of their infringement of the 118 patent. The Court will determine a schedule to allow Linksmart to conduct such discovery. The Court will then hold a hearing to determine the exact amount of damages, pre- and post-judgment interest, attorneys fees and costs, and expenses to which Linksmart is entitled as a result of Hot Points and Second Rules infringement of the 118 patent. Signed by Magistrate Judge Charles Everingham on 9/9/09. (ehs, ) (Entered: 09/09/2009)

09/11/2009 257 NOTICE by Wayport, Inc., SBC Internet Services, Inc. of Filing Rule 26 Initial Disclosures (Bianco, Brian) (Entered: 09/11/2009)

09/11/2009 258 NOTICE by Barnes & Noble Booksellers, Inc. of Filing Rule 26 Initial Disclosures (Bianco, Brian) (Entered: 09/11/2009)

09/11/2009 259 NOTICE by Mail Boxes Etc., Inc. of Filing Rule 26 Initial Disclosures (Bianco, Brian) (Entered: 09/11/2009)

09/11/2009 260 NOTICE by McDonalds Corp. of Filing Rule 26 Initial Disclosures (Bianco, Brian) (Entered: 09/11/2009)

09/14/2009 261 NOTICE of Disclosure by Aptilo Networks, Inc. (Initial Disclosures) (Siebman, Clyde) (Entered: 09/14/2009)

09/18/2009 262 Unopposed MOTION for Extension of Time to Serve Invalidation Contentions and Accompanying Document Production by Marriott International, Inc., Six Continents Hotels Inc, Intercontinental Hotels Group Resources Inc. (Attachments: # 1 Text of Proposed Order)(Guaragna, John) (Entered: 09/18/2009)

09/21/2009 263 Unopposed MOTION for Extension of Time to Serve Invalidation Contentions and Accompanying Document Production by Choice Hotels International Inc.. (Attachments: # 1 Text of Proposed Order)(Smith, Michael) (Entered: 09/21/2009)

09/22/2009 264 ORDER granting 262 Motion Unopposed Motion for Extension of Time to Serve Invalidation Contentions and Accompanying Document Production. Deadline is extended to 10/8/09. Signed by Magistrate Judge Charles Everingham on 9/22/09. (ch, ) (Entered: 09/22/2009)

09/22/2009 265 Unopposed MOTION for Extension of Time to File Best Western International, Inc.'s Unopposed Motion for Extension of Time to Serve Invalidation Contentions and Accompanying Document Production by Best Western International, Inc.. (Attachments: # 1 Text of Proposed Order)(Joe, Christopher) (Entered: 09/22/2009)

09/22/2009 266 Unopposed MOTION Extension of Time to Serve Invalidation Contentions and Accompanying Document Production by Pronto Networks, Inc.. (Attachments: # 1 Text of Proposed Order) (Allen, Aden) (Entered: 09/22/2009)

09/22/2009 267 \*\*\*FILED IN ERROR. NOT IN PDF SEARCHABLE FORMAT AND NO ORDER ATTACHED. PLEASE IGNORE.\*\*\* MOTION for Extension of Time to Complete Discovery Unopposed Motion for Extension of Time to Serve Invalidation Contentions by iBAHN General Holdings Corp.. (Broadus, Michael) Modified on 9/23/2009 (ch, ). (Entered: 09/22/2009)

09/22/2009 268 Unopposed MOTION for Extension of Time to File Invalidation Contentions and Accompanying Document Production by Ramada Worldwide, Inc.. (Attachments: # 1 Text of Proposed Order) (Hunt, Dean) (Additional attachment(s) added on 9/23/2009: # 2 REVISED ORDER) (ch, ). (Entered: 09/22/2009)

09/22/2009 269 Unopposed MOTION for Extension of Time to File Invalidation Contentions and Accompanying Document Production by EthoStream, LLC. (Attachments: # 1 Text of Proposed Order)(Hunt, Dean) (Additional attachment(s) added on 9/23/2009: # 2 REVISED ORDER) (ch, ). (Entered: 09/22/2009)

09/22/2009 270 Unopposed MOTION Motion for Extension of Time to Serve Invalidation Contentions and Accompanying Document Production by Meraki, Inc.. (Attachments: # 1 Text of Proposed Order)(Brewer, Robin) (Entered: 09/22/2009)

09/23/2009 -- \*\*\*FILED IN ERROR. NOT IN PDF SEARCHABLE FORMAT AND NO ORDER ATTACHED Document # 267, Motion for Extension of Time. PLEASE IGNORE.\*\*\* (ch, ) (Entered: 09/23/2009)

09/23/2009 271 Unopposed MOTION For Extension of Time to Serve Invalidity Contentions and Accompanying Document Production by Aptilo Networks, Inc.. (Attachments: # 1 Text of Proposed Order) (Siebman, Clyde) (Entered: 09/23/2009)

09/23/2009 272 Unopposed MOTION for Extension of Time to File /Serve Invalidity Contentions and Accompanying Document Production by T-Mobile USA, Inc., LodgeNet Interactive Corporation, Cisco Systems, Inc.. (Attachments: # 1 Text of Proposed Order)(Daniel, Robert) (Entered: 09/23/2009)

09/23/2009 273 Unopposed MOTION for Extension of Time to Complete Discovery to Serve Invalidity Contentions and Accompanying Document Production by Mail Boxes Etc., Inc., McDonalds Corp., Barnes & Noble Booksellers, Inc., Wayport, Inc., SBC Internet Services, Inc.. (Attachments: # 1 Text of Proposed Order)(Sayles, Richard) (Entered: 09/23/2009)

09/23/2009 274 \*\*\*REPLACES # 267 \*\*\* Unopposed MOTION for Extension of Time to Complete Discovery with regarding to Invalidity Contentions by iBAHN General Holdings Corp.. (Attachments: # 1 Text of Proposed Order)(Jones, Michael) Modified on 9/24/2009 (ch, ). (Entered: 09/23/2009)

09/24/2009 275 ORDER granting 266 Unopposed Motion for Extension of Time to Serve Invalidity Contentions and Accompanying Document Production. Deadline is extended to 10/15/09. Signed by Magistrate Judge Charles Everingham on 9/24/09. (ch, ) (Entered: 09/24/2009)

09/24/2009 276 ORDER granting 265 Motion for Extension of Time to Serve Invalidity Contentions and Accompanying Document Production. Best Western International Inc deadline is extended to 10/8/09. Signed by Magistrate Judge Charles Everingham on 9/24/09. (ch, ) (Entered: 09/24/2009)

09/24/2009 277 ORDER granting 263 Unopposed Motion for extension of time to Serve Invalidity Contentions and Accompanying Document Production. Choice Hotels International Inc. deadline is extended to 10/8/09. Signed by Magistrate Judge Charles Everingham on 9/24/09. (ch, ) (Entered: 09/24/2009)

09/24/2009 278 ORDER granting 232 Motion to Withdraw as Attorney. Attorney Harold L Socks terminated as counsel for LodgeNet Interactive Corp.. Signed by Magistrate Judge Charles Everingham on 9/24/09. (ch, ) (Entered: 09/24/2009)

09/24/2009 279 ORDER granting 274 Motion for Extension of Time to Complete Discovery. Deadline is 10/8/09. Signed by Magistrate Judge Charles Everingham on 9/24/09. (ch, ) (Entered: 09/24/2009)

09/24/2009 280 ORDER granting 273 Motion for Extension of Time to Complete Discovery. Deadline is extended to 10/8/09. Signed by Magistrate Judge Charles Everingham on 9/24/09. (ch, ) (Entered: 09/24/2009)

09/24/2009 281 ORDER granting 272 Motion for Extension of Time to Serve Invalidity Contentions. Deadline is extended to 10/8/09. Signed by Magistrate Judge Charles Everingham on 9/24/09. (ch, ) (Entered: 09/24/2009)

09/24/2009 282 ORDER granting 271 Unopposed Motion for Extension of Time to Serve Invalidity Contentions and Accompanying Document Production. Deadline is extended to 10/8/09. Signed by Magistrate Judge Charles Everingham on 9/24/09. (ch, ) (Entered: 09/24/2009)

09/24/2009 283 ORDER granting 270 Motion Unopposed Motion for Extension of Time to Serve Invalidity Contentions and Accompanying Document Production. Deadline extended to 10/8/09. Signed by Magistrate Judge Charles Everingham on 9/24/09. (ch, ) (Entered: 09/24/2009)

09/24/2009 284 ORDER granting 269 Motion for Extension of Time to Serve Invalidity Contentions and Accompanying Document Production. Deadline is extended to 10/8/09. Signed by Magistrate Judge Charles Everingham on 9/24/09. (ch, ) (Entered: 09/24/2009)

09/24/2009 285 ORDER granting 268 Motion for Extension of Time to Serve Invalidity Contentions and Accompanying Document Production. Deadline is extended to 10/8/09. Signed by Magistrate Judge Charles Everingham on 9/24/09. (ch, ) (Entered: 09/24/2009)

10/06/2009 286 Unopposed MOTION for Extension of Time to Complete Discovery to Serve Invalidity Contentions and Accompanying Document Production by Meraki, Inc.. (Attachments: # 1 Text of Proposed Order)(Brewer, Robin) (Entered: 10/06/2009)

10/08/2009 287 ORDER granting 286 Motion for Extension of Time to Complete Discovery. Meraki, Inc. will have through 10/22/09, to serve its invalidity contentions and accompanying document production in accordance with Patent Rules 3-3 and 3-4. Signed by Magistrate Judge Charles Everingham on 10/8/09. (ch, ) (Entered: 10/08/2009)

10/08/2009 288 NOTICE of Disclosure by Mail Boxes Etc., Inc., McDonalds Corp., Barnes & Noble Booksellers, Inc., Wayport, Inc., SBC Internet Services, Inc. of Invalidity Contentions (Sayles, Richard) (Entered: 10/08/2009)



10/08/2009 289 NOTICE by Six Continents Hotels Inc, Intercontinental Hotels Group Resources Inc of Compliance (Invalidity Contentions and Accompanying Document Production) (Guaragna, John) (Entered: 10/08/2009)

10/08/2009 290 NOTICE by Marriott International, Inc. of Compliance (Invalidity Contentions and Accompanying Document Production) (Guaragna, John) (Entered: 10/08/2009)

10/08/2009 291 NOTICE by EthoStream, LLC of Disclosure of Invalidity Contentions (Hunt, Dean) (Entered: 10/08/2009)

10/08/2009 292 NOTICE by Ramada Worldwide, Inc. of Disclosure of Invalidity Contentions (Hunt, Dean) (Entered: 10/08/2009)

10/09/2009 293 NOTICE by T-Mobile USA, Inc., Cisco Systems, Inc. (of Service of Patent Rules 3-3 and 3-4 Disclosures) (Daniel, Robert) (Entered: 10/09/2009)

10/09/2009 294 NOTICE of Disclosure by iBAHN General Holdings Corp. regarding PR 3-3 and 3-4 (Jones, Michael) (Entered: 10/09/2009)

10/09/2009 295 NOTICE of Disclosure by LodgeNet Interactive Corporation under Patent Rules 3-3 and 3-4 (Ungerman, Mark) (Entered: 10/09/2009)

10/12/2009 296 NOTICE of Disclosure by Pronto Networks, Inc. (Allen, Aden) (Entered: 10/12/2009)

10/12/2009 297 Unopposed MOTION for Extension of Time to Complete Discovery to Serve Accompanying Document Production Pursuant to P.R. 3-4 by Pronto Networks, Inc.. (Attachments: # 1 Text of Proposed Order)(Allen, Aden) (Entered: 10/12/2009)

10/12/2009 298 NOTICE of Disclosure by Best Western International, Inc. Defendant Best Western International, Inc.'s Notice of Compliance Regarding P.R. 3-3 and 3-4 Disclosures (Carpenter, Brian) (Entered: 10/12/2009)

10/12/2009 299 NOTICE by Aptilo Networks, Inc. NOTICE OF COMPLIANCE REGARDING P.R. 3-3 AND 3-4 DISCLOSURES (Siebman, Clyde) (Entered: 10/12/2009)

10/13/2009 300 NOTICE of Disclosure by Choice Hotels International Inc. Pursuant to PR 3-3 and 3-4 (Smith, Michael) (Entered: 10/13/2009)

10/13/2009 301 APPLICATION to Appear Pro Hac Vice by Attorney Elizabeth L Maxeiner for Mail Boxes Etc., Inc., McDonalds Corp., Barnes & Noble Booksellers, Inc., Wayport, Inc. and SBC Internet Services, Inc. (APPROVED FEE PAID) 2-1-4961. (ch, ) (Entered: 10/14/2009)

10/14/2009 302 ORDER granting 297 Motion for Extension of Time to Complete Discovery. Pronto Networks, Inc. will have through October 21, 2009 to serve its accompanying document production to the invalidity contentions in accordance with Patent Rule 3-4. Signed by Magistrate Judge Charles Everingham on 10/14/09. (ehs, ) (Entered: 10/14/2009)

10/20/2009 303 Unopposed MOTION for Extension of Time to Complete Discovery to Serve Accompanying Document Production Pursuant to P.R. 3-4 by Pronto Networks, Inc.. (Attachments: # 1 Text of Proposed Order)(Allen, Aden) (Entered: 10/20/2009)

10/21/2009 304 Unopposed MOTION for Extension of Time to Complete Discovery to Serve Invalidity Contentions and Accompanying Document Production by Meraki, Inc.. (Attachments: # 1 Text of Proposed Order)(Brewer, Robin) (Entered: 10/21/2009)

10/21/2009 305 AMENDED CORPORATE DISCLOSURE STATEMENT filed by T-Mobile USA, Inc. (Richardson, Michael) Modified on 10/21/2009 (sm, ). (Entered: 10/21/2009)

10/21/2009 306 ORDER granting 303 Motion for Extension of Time to Complete Discovery. Deadline extended to 10/30/09. Signed by Magistrate Judge Charles Everingham on 10/21/09. (ehs, ) (Entered: 10/21/2009)

10/23/2009 307 ORDER granting 304 Motion for Extension of Time to Complete Discovery. Meraki, Inc. deadline is 11/5/09 to serve its invalidity contentions and accompanying document production in accordance with Patent Rules 3-3 and 3-4. Signed by Magistrate Judge Charles Everingham on 10/23/09. (ch, ) (Entered: 10/23/2009)

10/30/2009 308 Unopposed MOTION for Extension of Time to Complete Discovery to Serve Accompanying Document Production Pursuant to P.R. 3-4 by Pronto Networks, Inc.. (Attachments: # 1 Text of Proposed Order)(Allen, Aden) (Entered: 10/30/2009)

11/03/2009 309 NOTICE of Disclosure by Mail Boxes Etc., Inc., McDonalds Corp., Barnes & Noble Booksellers, Inc., Wayport, Inc., SBC Internet Services, Inc. (Sayles, Richard) (Entered: 11/03/2009)

11/04/2009 310 ORDER granting 308 Motion for Extension of Time to Complete Discovery. Pronto Networks, Inc. will have through November 20, 2009 to serve its accompanying document production to the invalidity contentions in accordance with Patent Rule 3-4. Signed by Magistrate Judge Charles

Everingham on 11/4/09. (ehs, ) (Entered: 11/04/2009)

11/04/2009 311 Joint MOTION to Dismiss Meraki, Inc. with Prejudice by Linksmart Wireless Technology, LLC. (Attachments: # 1 Text of Proposed Order)(Weiss, Andrew) (Entered: 11/04/2009)

11/05/2009 312 ORDER granting 311 Motion to Dismiss Defendant Meraki of all claims and counterclaims between plaintiff and Meraki. Signed by Judge David Folsom on 11/5/2009. (sm, ) (Entered: 11/05/2009)

11/13/2009 313 THIRD PARTY COMPLAINT against BestComm Networks, Inc., Nomadix, Inc., filed by Best Western International, Inc.. (Attachments: # 1 Civil Cover Sheet)(Joe, Christopher) (Entered: 11/13/2009)

11/16/2009 314 E-GOV SEALED SUMMONS Issued as to BestComm Networks, Inc., (Attachments: # 1 Nomadix Inc.)(ch, ) (Entered: 11/16/2009)

11/17/2009 315 E-GOV SEALED SUMMONS REISSUED as to BestComm Networks, Inc., (Attachments: # 1 Nomadix Inc)(ch, ) (Entered: 11/17/2009)

11/19/2009 316 Unopposed MOTION for Extension of Time to Complete Discovery to Serve Accompanying Document Production Pursuant to P.R. 3-4 by Pronto Networks, Inc.. (Attachments: # 1 Text of Proposed Order)(Allen, Aden) (Entered: 11/19/2009)

11/20/2009 317 AMENDED ANSWER to 1 Complaint and, COUNTERCLAIM against Linksmart Wireless Technology, LLC by Ramada Worldwide, Inc.. (Hunt, Dean) (Entered: 11/20/2009)

11/20/2009 318 AMENDED ANSWER to 1 Complaint and, COUNTERCLAIM against Linksmart Wireless Technology, LLC by EthoStream, LLC. (Hunt, Dean) (Entered: 11/20/2009)

11/24/2009 319 ORDER granting 316 Motion for Extension of Time to Complete Discovery. Pronto Networks, Inc. will have through December 11, 2009 to serve its accompanying document production to the invalidity contentions in accordance with Patent Rule 3-4. Signed by Magistrate Judge Charles Everingham on 11/24/09. (ehs, ) (Entered: 11/24/2009)

11/24/2009 320 NOTICE of Attorney Appearance by Brian Andrew Carpenter on behalf of Best Western International, Inc. (Carpenter, Brian) (Entered: 11/24/2009)

11/25/2009 321 NOTICE of Disclosure by Linksmart Wireless Technology, LLC re Local Rule 4.1 (Weiss, Andrew) (Entered: 11/25/2009)

11/30/2009 322 NOTICE of Disclosure by T-Mobile USA, Inc., Cisco Systems, Inc. (Daniel, Robert) (Entered: 11/30/2009)

11/30/2009 323 NOTICE by Six Continents Hotels Inc, Intercontinental Hotels Group Resources Inc of Compliance with Local Patent Rule 4-1 (Guaragna, John) (Entered: 11/30/2009)

11/30/2009 324 NOTICE by Marriott International, Inc. of Compliance with Local Patent Rule 4-1 (Guaragna, John) (Entered: 11/30/2009)

11/30/2009 325 NOTICE of Disclosure by Mail Boxes Etc., Inc., McDonalds Corp., Barnes & Noble Booksellers, Inc., Wayport, Inc., SBC Internet Services, Inc. re: Compliance with Patent Rule 4-1 (Sayles, Richard) (Entered: 11/30/2009)

11/30/2009 326 NOTICE by Pronto Networks, Inc. of Compliance with Local Patent Rule 4-1 (Allen, Aden) (Entered: 11/30/2009)

11/30/2009 327 NOTICE of Disclosure by Choice Hotels International Inc. Pursuant to PR 4-1 (Smith, Michael) (Entered: 11/30/2009)

12/01/2009 328 NOTICE of Disclosure by iBAHN General Holdings Corp. regarding PR 4-1 Compliance (Jones, Michael) (Entered: 12/01/2009)

12/01/2009 329 E-GOV SEALED SUMMONS Returned Executed by Best Western International, Inc.. Nomadix, Inc. served on 11/18/2009, answer due 12/9/2009. (ehs, ) (Entered: 12/01/2009)

12/01/2009 330 E-GOV SEALED SUMMONS Returned Executed by Best Western International, Inc.. BestComm Networks, Inc. served on 11/18/2009, answer due 12/9/2009. (ehs, ) (Entered: 12/01/2009)

12/01/2009 331 NOTICE by Ramada Worldwide, Inc. of Compliance Regarding Local Patent Rule 4-1 (Hunt, Dean) (Entered: 12/01/2009)

12/01/2009 332 NOTICE of Disclosure by EthoStream, LLC of Invalidity Contentions (Hunt, Dean) (Entered: 12/01/2009)

12/01/2009 333 Unopposed MOTION to Withdraw as Attorney (Withdrawal of Attorney Michael Herbst) by Aptilo Networks, Inc.. (Attachments: # 1 Text of Proposed Order)(Phillips, Lawrence) (Entered: 12/01/2009)

12/01/2009 334 NOTICE by Best Western International, Inc. of Compliance Regarding Local Patent Rule 4-1

(Carpenter, Brian) (Entered: 12/01/2009)

12/01/2009 335 NOTICE of Disclosure by Aptilo Networks, Inc. (Phillips, Lawrence) (Entered: 12/01/2009)

12/01/2009 336 NOTICE by LodgeNet Interactive Corporation of Compliance with Local Patent Rule 4-1 (Ungerma, Mark) (Entered: 12/01/2009)

12/03/2009 337 ORDER granting 333 Motion to Withdraw as Attorney. Attorney Michael T Herbst terminated as counsel for Dft Aptilo Networks, Inc. Signed by Magistrate Judge Charles Everingham on 12/3/09. (ch, ) (Entered: 12/03/2009)

12/04/2009 338 APPLICATION to Appear Pro Hac Vice by Attorney Theodore J Koerth for Aptilo Networks, Inc. (APPROVED FEE PAID) 2-1-5066. (ch, ) (Entered: 12/04/2009)

12/10/2009 339 ANSWER to 317 Amended Answer to Complaint, Counterclaim of Ramada Worldwide, Inc. by Linksmart Wireless Technology, LLC.(Weiss, Andrew) (Entered: 12/10/2009)

12/10/2009 340 ANSWER to 318 Amended Answer to Complaint, Counterclaim of Ethnostream, LLC by Linksmart Wireless Technology, LLC.(Weiss, Andrew) (Entered: 12/10/2009)

12/10/2009 341 Unopposed MOTION for Extension of Time to Complete Discovery to Serve Accompanying Document Production Pursuant to P.R. 3-4 by Pronto Networks, Inc.. (Attachments: # 1 Text of Proposed Order)(Allen, Aden) (Entered: 12/10/2009)

12/11/2009 342 ORDER granting 341 Motion for Extension of Time to Complete Discovery Pronto Networks, Inc. will have through 12/31/09 to serve its accompanying document production to the invalidity contentions in accordance with Patent Rule 3-4. Signed by Magistrate Judge Charles Everingham on 12/11/09. (ch, ) (Entered: 12/11/2009)

12/11/2009 343 NOTICE of Attorney Appearance by Elizabeth L DeRieux on behalf of Nomadix, Inc. (DeRieux, Elizabeth) (Entered: 12/11/2009)

12/11/2009 344 Defendant's Unopposed First Application for Extension of Time to Answer Complaint re Nomadix, Inc..( DeRieux, Elizabeth) (Entered: 12/11/2009)

12/11/2009 -- Defendant's Unopposed First Application for Extension of Time to Answer Complaint is GRANTED pursuant to Local Rule CV-12 for Nomadix, Inc. to 1/25/2010. 45 Days Granted for Deadline Extension.( ch, ) (Entered: 12/11/2009)

12/11/2009 345 NOTICE by Linksmart Wireless Technology, LLC of Ten Asserted Claims (Weiss, Andrew) (Entered: 12/11/2009)

12/17/2009 346 Defendant's Unopposed first Application for Extension of Time to Answer Complaint re BestComm Networks, Inc..( Carrington, Morris) (Entered: 12/17/2009)

12/17/2009 -- Defendant's Unopposed First Application for Extension of Time to Answer TP Complaint is GRANTED pursuant to Local Rule CV-12 for BestComm Networks, Inc. to 1/22/2010. 45 Days Granted for Deadline Extension.( sm, ) (Entered: 12/17/2009)

12/18/2009 347 NOTICE of Attorney Appearance by Sidney Calvin Capshaw, III on behalf of Nomadix, Inc. (Capshaw, Sidney) (Entered: 12/18/2009)

12/18/2009 348 Unopposed MOTION to Continue Extend Docket Control Order by Linksmart Wireless Technology, LLC. (Attachments: # 1 Text of Proposed Order)(Weiss, Andrew) (Entered: 12/18/2009)

12/21/2009 349 NOTICE of Attorney Appearance by Alexander Chester Giza on behalf of Linksmart Wireless Technology, LLC (Giza, Alexander) (Entered: 12/21/2009)

12/22/2009 350 ORDER granting 348 Motion To Extend Docket Control Order. The deadline for early mediation at Parties' request is changed to February 26, 2010. Signed by Magistrate Judge Charles Everingham on 12/22/09. (ehs, ) (Entered: 12/22/2009)

12/31/2009 351 Unopposed MOTION for Extension of Time to Complete Discovery to Serve Accompanying Document Production Pursuant to P.R. 3-4 by Pronto Networks, Inc.. (Attachments: # 1 Text of Proposed Order)(Allen, Aden) (Entered: 12/31/2009)

01/05/2010 352 ORDER granting 351 Motion for Extension of Time to Complete Discovery. Pronto Networks, Inc. will have through January 15, 2010 to serve its accompanying document production to the invalidity contentions in accordance with Patent Rule 3-4. Signed by Magistrate Judge Charles Everingham on 1/5/10. (ehs, ) (Entered: 01/05/2010)

01/08/2010 353 APPLICATION to Appear Pro Hac Vice by Attorney David J Leonard for BestComm Networks, Inc. (APPROVED FEE PAID) 2-1-5124. (ch, ) (Entered: 01/08/2010)

01/13/2010 354 APPLICATION to Appear Pro Hac Vice by Attorney Alexandra B McTague for T-Mobile USA, Inc. and Cisco Systems, Inc. (APPROVED FEE PAID) 2-1-5131. (ch, ) (Entered: 01/13/2010)

01/13/2010 355 APPLICATION to Appear Pro Hac Vice by Attorney Jonathan Andron for T-Mobile USA, Inc.. (APPROVED, FEE PAID 2-1-5131) (ehs, ) (Additional attachment(s) added on 1/27/2010: # 1 Confidential Information) (ch, ). (Entered: 01/13/2010)

01/15/2010 356 Unopposed MOTION for Extension of Time to Complete Discovery to Serve Accompanying Document Production Pursuant to P.R. 3-4 by Pronto Networks, Inc.. (Attachments: # 1 Text of Proposed Order)(Allen, Aden) (Entered: 01/15/2010)

01/21/2010 357 ORDER granting 356 Motion for Extension of Time to Complete Discovery. Defendant Pronto Networks, Inc.s Seventh Unopposed Motion for Extension of Time to Serve Accompanying Document Production Pursuant to P.R. 3-4 is GRANTED. Pronto Networks, Inc. will have through January 29, 2010 to serve its accompanying document production to the invalidity contentions in accordance with Patent Rule 3-4. Signed by Magistrate Judge Charles Everingham on 1/21/10. (ehs, ) (Entered: 01/21/2010)

01/22/2010 358 NOTICE by EthoStream, LLC of Joinder and Notice of Compliance Regarding Local Patent Rule 4-2 (Hunt, Dean) (Entered: 01/22/2010)

01/22/2010 359 NOTICE by Ramada Worldwide, Inc. of Joinder and Notice of Compliance With Local Patent Rule 4-2 (Hunt, Dean) (Entered: 01/22/2010)

01/22/2010 360 \*\*\*FILED IN ERROR, PLEASE IGNORE.\*\*\* NOTICE by Ramada Worldwide, Inc., EthoStream, LLC of Appearance (Hunt, Dean) Modified on 1/25/2010 (sm, ). (Entered: 01/22/2010)

01/22/2010 361 NOTICE by Pronto Networks, Inc. of Compliance with Local Patent Rule 4-2 (Allen, Aden) (Entered: 01/22/2010)

01/22/2010 362 NOTICE by T-Mobile USA, Inc., Cisco Systems, Inc. (of Service of Patent Rule 4-2 Disclosure) (Daniel, Robert) (Entered: 01/22/2010)

01/22/2010 363 NOTICE of Disclosure by Linksmart Wireless Technology, LLC of Preliminary Claim Constructions and Extrinsic Evidence Under P.R. 4-2 (Weiss, Andrew) (Entered: 01/22/2010)

01/25/2010 364 NOTICE of Disclosure by Mail Boxes Etc., Inc., McDonalds Corp., Barnes & Noble Booksellers, Inc., Wayport, Inc., SBC Internet Services, Inc. re: P.R. 4-2 (Sayles, Richard) (Entered: 01/25/2010)

01/25/2010 365 NOTICE of Disclosure by Best Western International, Inc. Notice of Compliance Regarding P.R. 4-2 Disclosures (Joe, Christopher) (Entered: 01/25/2010)

01/25/2010 366 NOTICE of Disclosure by iBAHN General Holdings Corp. regarding Compliance of PR 4-2 Disclosures (Jones, Michael) (Entered: 01/25/2010)

01/25/2010 367 NOTICE by Marriott International, Inc., Six Continents Hotels Inc, Intercontinental Hotels Group Resources Inc of Compliance with Local Patent Rule 4-2 (Guaragna, John) (Entered: 01/25/2010)

01/25/2010 -- \*\*\*FILED IN ERROR, WRONG EVENT USED AND ATTY WANTING TO APPEAR MUST LOGIN AND FILE. Document # 360, Notice. PLEASE IGNORE.\*\*\* (sm, ) (Entered: 01/25/2010)

01/25/2010 368 NOTICE of Disclosure by Choice Hotels International Inc. Regarding PR 4-2 Disclosures (Smith, Michael) (Entered: 01/25/2010)

01/25/2010 369 NOTICE by LodgeNet Interactive Corporation of Compliance Regarding P.R. 4-2 (Ungerman, Mark) (Entered: 01/25/2010)

01/25/2010 370 Unopposed MOTION for Extension of Time to File Answer re 313 Third Party Complaint by Nomadix, Inc.. (Attachments: # 1 Text of Proposed Order)(Capshaw, Sidney) (Entered: 01/25/2010)

01/25/2010 371 Unopposed MOTION for Extension of Time to File Answer re 313 Third Party Complaint of Best Western International Inc. by BestComm Networks, Inc.. (Attachments: # 1 Text of Proposed Order Proposed Order)(Carrington, Morris) (Entered: 01/25/2010)

01/26/2010 372 ORDER granting 371 Motion for Extension of Time to Answer. BestComm Networks, Inc. deadline is extended to 2/27/2010. Signed by Magistrate Judge Charles Everingham on 1/26/2010. (ch, ) (Entered: 01/26/2010)

01/26/2010 -- Answer Due Deadline Updated for BestComm Networks, Inc. to 2/27/2010. (ch, ) (Entered: 01/26/2010)

01/26/2010 373 ORDER granting 370 Motion for Extension of Time to Answer. Nomadix Inc deadline is extended to 2/25/2010. Signed by Magistrate Judge Charles Everingham on 1/26/2010. (ch, ) (Entered: 01/26/2010)

01/26/2010 -- Answer Due Deadline Updated for Nomadix, Inc. to 2/25/2010. (ch, ) (Entered: 01/26/2010)

01/28/2010 374 Unopposed MOTION for Extension of Time to Complete Discovery Eighth Unopposed Motion for

Extension of Time to Serve Accompanying Document Production Pursuant to P.R. 3-4 by Pronto Networks, Inc.. (Attachments: # 1 Text of Proposed Order)(Allen, Aden) (Entered: 01/28/2010)

01/29/2010 375 ORDER granting 374 Motion for Extension of Time to Complete Discovery. Defendant Pronto Networks, Inc.s Eighth Unopposed Motion for Extension of Time to Serve Accompanying Document Production Pursuant to P.R. 3-4 is GRANTED. Pronto Networks, Inc. will have through February 19, 2010 to serve its accompanying document production to the invalidity contentions in accordance with Patent Rule 3-4. Signed by Magistrate Judge Charles Everingham on 1/29/10. (ehs, ) (Entered: 01/29/2010)

01/29/2010 376 ORDER that the parties, including BestComm and Nomadix, are ordered to meet and confer on an amended docket control order that allows the third party defendants to meet their obligations. The parties shall jointly file the amended docket control order within 7 days after BestComm and Nomadix answer the third-party complaint. Signed by Magistrate Judge Charles Everingham on 1/29/10. (ehs, ) (Entered: 01/29/2010)

02/17/2010 377 BestComm Networks, Inc.'s ANSWER to 313 Third Party Complaint of Best Western International, Inc., CROSSCLAIM against Nomadix, Inc. by BestComm Networks, Inc.. (Carrington, Morris) (Entered: 02/17/2010)

02/18/2010 378 Unopposed MOTION for Extension of Time to Complete Discovery to Serve Accompanying Document Production Pursuant to P.R. 3-4 by Pronto Networks, Inc.. (Attachments: # 1 Text of Proposed Order)(Allen, Aden) (Entered: 02/18/2010)

02/18/2010 379 NOTICE of Change of Address by Christopher Michael Joe (Joe, Christopher) (Entered: 02/18/2010)

02/19/2010 380 JOINT CLAIM CONSTRUCTION AND PREHEARING STATEMENT filed by Linksmart Wireless Technology, LLC. (Attachments: # 1 Exhibit A)(Weiss, Andrew) (Entered: 02/19/2010)

02/22/2010 381 ORDER granting 378 Motion for Extension of Time to Complete Discovery. ORDERED that Defendant Pronto Networks, Inc.s Ninth Unopposed Motion for Extension of Time to Serve Accompanying Document Production Pursuant to P.R. 3-4 is GRANTED. Pronto Networks, Inc. will have through 3/5/2010 to serve its accompanying document production to the invalidity contentions in accordance with Patent Rule 3-4. Signed by Magistrate Judge Charles Everingham on 2/22/2010. (ch, ) (Entered: 02/22/2010)

02/25/2010 382 MOTION to Strike 313 Third Party Complaint or Dismiss by Nomadix, Inc.. (Attachments: # 1 Affidavit Muehlhauser Declaration, # 2 Exhibit 1, # 3 Exhibit 2, # 4 Text of Proposed Order) (Capshaw, Sidney) (Entered: 02/25/2010)

03/04/2010 383 Unopposed MOTION for Extension of Time to Complete Discovery to Serve Accompanying Document Production Pursuant to P.R. 3-4 by Pronto Networks, Inc.. (Attachments: # 1 Text of Proposed Order)(Allen, Aden) (Entered: 03/04/2010)

03/04/2010 384 Unopposed MOTION for Extension of Time to File Response/Reply as to 382 MOTION to Strike 313 Third Party Complaint or Dismiss Best Western International, Inc.'s Unopposed Motion for Extension of Time to Respond to Third-Party Defendant Nomadix, Inc.'s Motion to Strike or Dismiss by Best Western International, Inc.. (Attachments: # 1 Text of Proposed Order)(Joe, Christopher) (Entered: 03/04/2010)

03/04/2010 385 APPLICATION to Appear Pro Hac Vice by Attorney Donald A Wall for Best Western International, Inc. (APPROVED FEE PAID) 2-1-5235. (ch, ) (Entered: 03/05/2010)

03/04/2010 386 APPLICATION to Appear Pro Hac Vice by Attorney David E Rogers for Best Western International, Inc. (APPROVED FEE PAID) 2-1-5235. (ch, ) (Entered: 03/05/2010)

03/04/2010 387 APPLICATION to Appear Pro Hac Vice by Attorney Andrea L Marconi for Best Western International, Inc. (APPROVED FEE PAID) 2-1-5235. (ch, ) (Entered: 03/05/2010)

03/05/2010 388 ORDER granting 383 Motion for Extension of Time to Complete Discovery. Pronto Networks, Inc. will have through 3/19/2010, to serve its accompanying document production to the invalidity contentions in accordance with Patent Rule 3-4. Signed by Magistrate Judge Charles Everingham on 3/5/2010. (ch, ) (Entered: 03/05/2010)

03/05/2010 389 ORDER granting 384 Motion for Extension of Time to File Response/Reply re 382 MOTION to Strike 313 Third Party Complaint or Dismiss Responses due by 3/24/2010. Signed by Magistrate Judge Charles Everingham on 3/5/2010. (ch, ) (Entered: 03/05/2010)

03/12/2010 390 Unopposed MOTION for Extension of Time to File Response/Reply as to 377 Answer to Third Party Complaint, Crossclaim by Nomadix, Inc.. (Attachments: # 1 Text of Proposed Order) (Capshaw, Sidney) (Entered: 03/12/2010)

03/15/2010 391 NOTICE of Attorney Appearance by Christopher Michael Joe on behalf of Best Western International, Inc. (Joe, Christopher) (Entered: 03/15/2010)

03/16/2010 392 ORDER granting 390 Motion for Extension of Time to File Response/Reply. Nomadix Inc deadline to respond to the Cross-Claim of BestComm Networks Inc Responses due by 4/2/2010. Signed by Magistrate Judge Charles Everingham on 3/16/2010. (ch, ) (Entered: 03/16/2010)

03/18/2010 393 NOTICE of Attorney Appearance by Allen Franklin Gardner on behalf of iBAHN General Holdings Corp. (Gardner, Allen) (Entered: 03/18/2010)

03/19/2010 394 Unopposed MOTION for Extension of Time to Complete Discovery to Serve Accompanying Document Production Pursuant to P.R. 3-4 by Pronto Networks, Inc.. (Attachments: # 1 Text of Proposed Order)(Allen, Aden) (Entered: 03/19/2010)

03/19/2010 395 CLAIM CONSTRUCTION BRIEF (Supplemental Claim Construction and Prehearing Statement) filed by Best Western International, Inc.. (Attachments: # 1 Exhibit A to Best Western's Supplemental Claim Construction and Prehearing Statement)(Rogers, David) Modified on 3/22/2010 (sm, ). (Entered: 03/19/2010)

03/19/2010 396 CLAIM CONSTRUCTION BRIEF filed by Linksmart Wireless Technology, LLC. (Attachments: # 1 Affidavit Declaration of Andrew Weiss, # 2 Exhibit Exhibit A, # 3 Exhibit Exhibit B, # 4 Exhibit Exhibit C, # 5 Exhibit Exhibit D, # 6 Exhibit Exhibit E, # 7 Exhibit Exhibit F, # 8 Exhibit Exhibit G, # 9 Exhibit Exhibit H, # 10 Exhibit Exhibit I, # 11 Exhibit Exhibit J, # 12 Exhibit Exhibit K, # 13 Exhibit Exhibit L, # 14 Exhibit Exhibit M)(Weiss, Andrew) (Entered: 03/19/2010)

03/22/2010 -- NOTICE FROM CLERK re 395 Claim Construction Brief. Clerk has modified to show that it is a supplemental claim construction and prehearing statement. (sm, ) (Entered: 03/22/2010)

03/22/2010 397 ORDER granting 394 Motion for Extension of Time to Complete Discovery. Defendant Pronto Networks, Inc.'s Eleventh Unopposed Motion for Extension of Time to Serve Accompanying Document Production Pursuant to P.R. 3-4 is GRANTED. Pronto Networks, Inc. will have through April 2, 2010 to serve its accompanying document production to the invalidity contentions in accordance with Patent Rule 3-4. Signed by Magistrate Judge Charles Everingham on 3/22/10. (ehs, ) (Entered: 03/22/2010)

03/23/2010 398 Second MOTION for Extension of Time to File Response/Reply as to 382 MOTION to Strike 313 Third Party Complaint or Dismiss Best Western's Unopposed Second Motion For Extension of Time to Respond to Third-Party Defendant Nomadix, Inc.'s Motion to Strike or Dismiss by Best Western International, Inc.. (Attachments: # 1 Text of Proposed Order)(Joe, Christopher) (Entered: 03/23/2010)

03/24/2010 399 ORDER granting 398 Motion for Extension of Time to File Response/Reply re 382 MOTION to Strike 313 Third Party Complaint or Dismiss Responses due by 3/31/2010. Signed by Magistrate Judge Charles Everingham on 3/24/2010. (ch, ) (Entered: 03/24/2010)

03/30/2010 400 Unopposed SEALED PATENT MOTION for Leave to Amend Invalidity Contentions by Barnes & Noble Booksellers, Inc., Mail Boxes Etc., Inc., McDonalds Corp., SBC Internet Services, Inc., Wayport, Inc.. (Attachments: # 1 Exhibit A, # 2 Text of Proposed Order)(Sayles, Richard) (Entered: 03/30/2010)

03/31/2010 401 ORDER granting 400 AT&T/Wayports Unopposed Sealed Patent Motion for Leave to Amend Invalidity Contentions. Signed by Magistrate Judge Charles Everingham on 3/31/2010. (ch, ) (Entered: 03/31/2010)

03/31/2010 402 RESPONSE in Opposition re 382 MOTION to Strike 313 Third Party Complaint or Dismiss filed by Best Western International, Inc.. (Attachments: # 1 Affidavit Declaration of Sara V. Ransom in Support of Third Party Plaintiff Best Western International, Inc.'s Opposition to Motion to Strike or Dismiss Third-Party Complaint, # 2 Exhibit A, February 26, 2004 Direct Sales Contract, # 3 Exhibit B, March 15, 2002 Reseller Agreement, # 4 Exhibit C, July 20, 2004 Nomadix press release, # 5 Exhibit D, Purchase Order, # 6 Text of Proposed Order [Proposed] Order on Third-Party Defendant Nomadix, Inc.'s Motion to Strike or Dismiss Third-Party Complaint of Best Western International, Inc.)(Rogers, David) (Entered: 03/31/2010)

04/02/2010 403 Unopposed MOTION for Extension of Time to Complete Discovery to Serve Accompanying Document Production Pursuant to P.R. 3-4 by Pronto Networks, Inc.. (Attachments: # 1 Text of Proposed Order)(Allen, Aden) (Entered: 04/02/2010)

04/02/2010 404 Unopposed MOTION for Extension of Time to File Response/Reply as to 377 Answer to Third Party Complaint, Crossclaim by Nomadix, Inc.. (Attachments: # 1 Text of Proposed Order) (Capshaw, Sidney) (Entered: 04/02/2010)

04/05/2010 405 ORDER granting 403 Motion for Extension of Time to Complete Discovery. Pronto Networks, Inc. will have through 4/16/2010 to serve its accompanying document production to the invalidity contentions in accordance with Patent Rule 3-4. Signed by Magistrate Judge Charles Everingham on 4/5/2010. (ch, ) (Entered: 04/05/2010)

04/05/2010 406 ORDER granting 404 Motion for Extension of Time to File Response/Reply Nomadix, Inc. be given to and including 4/16/2010 to respond to the Cross-Claim of BestComm Networks, Inc.

Responses due by 4/16/2010. Signed by Magistrate Judge Charles Everingham on 4/5/2010.  
(ch, ) (Entered: 04/05/2010)

04/07/2010 407 APPLICATION to Appear Pro Hac Vice by Attorney Douglas G Muehlhauser for Nomadix, Inc., Douglas G Muehlhauser for Nomadix, Inc. (RECEIPT 2-1-5289). (rml, ) (Entered: 04/07/2010)

04/12/2010 408 Unopposed MOTION for Extension of Time to File Response/Reply as to 382 MOTION to Strike 313 Third Party Complaint or Dismiss by Nomadix, Inc.. (Attachments: # 1 Text of Proposed Order)(Capshaw, Sidney) (Entered: 04/12/2010)

04/13/2010 409 ORDER granting 408 Motion for Extension of Time to File Response/Reply re 382 MOTION to Strike 313 Third Party Complaint or Dismiss Responses due by 4/26/2010. Signed by Magistrate Judge Charles Everingham on 4/13/2010. (ch, ) (Entered: 04/13/2010)

04/13/2010 410 NOTICE of Designation of Attorney in Charge to Andrew Wesley Spangler on behalf of Linksmart Wireless Technology, LLC (Spangler, Andrew) (Entered: 04/13/2010)

04/15/2010 411 Unopposed MOTION for Extension of Time to Complete Discovery to Serve Accompanying Document Production Pursuant to P.R. 3-4 by Pronto Networks, Inc.. (Attachments: # 1 Text of Proposed Order)(Allen, Aden) (Entered: 04/15/2010)

04/16/2010 412 ORDER granting 411 Motion for Extension of Time to Complete Discovery. Pronto Networks, Inc. will have through April 30, 2010 to serve its accompanying document production to the invalidity contentions in accordance with Patent Rule 3-4. Signed by Magistrate Judge Charles Everingham on 4/16/10. (ehs, ) (Entered: 04/16/2010)

04/16/2010 413 MOTION to Dismiss BestComm Networks, Inc.'s Crossclaims by Nomadix, Inc.. (Attachments: # 1 Affidavit Muehlhauser Declaration, # 2 Exhibit 1, # 3 Exhibit 2, # 4 Exhibit 3, # 5 Text of Proposed Order)(Capshaw, Sidney) (Entered: 04/16/2010)

04/16/2010 414 CLAIM CONSTRUCTION BRIEF filed by Cisco Systems, Inc., T-Mobile USA, Inc., SBC Internet Svcs, Wayport, Inc, LodgeNet Interactive Corp, EthoStream LLC, Pronto Networks, Aptilo Networks, Mail Boxes Etc, McDonalds Corp, Barnes and Nobles Booksellers, Ramada WORldwide, Mariott Intl, Choice Hotels Intl, Best Western Intl, Six Continents Hotels, Intercontinental Hotels Group (Attachments: # 1 Affidavit Declaration of Noah Levine in Support of Claim Construction Brief of Defendants with exhibits 1 to 5, # 2 Exhibit Exhibits 6 to 9 of Declaration of Noah Levine in Support of Claim Construction Brief of Defendants, # 3 Affidavit Declaration of Kevin Jaffay, Ph.D. with exhibits a through c)(Daniel, Robert) Modified on 4/19/2010 (sm, ). (Entered: 04/16/2010)

04/16/2010 415 \*\*\*FILED IN ERROR, PLEASE IGNORE.\*\*\* RESPONSE in Support re 411 Unopposed MOTION for Extension of Time to Complete Discovery to Serve Accompanying Document Production Pursuant to P.R. 3-4 filed by Best Western International, Inc.. (Attachments: # 1 Exhibit 1, # 2 Exhibit 2)(Rogers, David) Modified on 4/19/2010 (sm, ). (Entered: 04/16/2010)

04/16/2010 416 \*\*\*FILED IN ERROR, PLEASE IGNORE.\*\*\* NOTICE by Best Western International, Inc. Claim Construction Brief (Attachments: # 1 Exhibit 1, # 2 Exhibit 2)(Rogers, David) Modified on 4/19/2010 (sm, ). (Entered: 04/16/2010)

04/16/2010 417 \*\*\*DEFICIENT DOCUMENT, PELASE IGNORE.\*\*\* MOTION for Leave to File motion for partial summary judgment of invalidity for indefiniteness by Cisco Systems, Inc., T-Mobile USA, Inc.. (Levine, Noah) Modified on 4/19/2010 (sm, ). (Entered: 04/16/2010)

04/19/2010 -- \*\*\*FILED IN ERROR, WRONG EVENT USED, ATTY MUST REFILE USING CORRECT EVENT. Document # 415 and #416, Response in Support and Notice. PLEASE IGNORE.\*\*\* (sm, ) (Entered: 04/19/2010)

04/19/2010 -- NOTICE of DEFICIENCY regarding the #417 Motion for leave submitted by Cisco Systems, Inc., T-Mobile USA, Inc.. Not in proper pleading format which includes certificate of conference etc.. Correction should be made by 1 business day and refiled in proper motion format or as a notice, attaching the letter. (sm, ) (Entered: 04/19/2010)

04/19/2010 418 SUPPLEMENTAL CLAIM CONSTRUCTION BRIEF filed by Best Western International, Inc.. (Attachments: # 1 Exhibit 1, # 2 Exhibit 2)(Rogers, David) (Entered: 04/19/2010)

04/19/2010 419 NOTICE by Aptilo Networks, Inc., Barnes & Noble Booksellers, Inc., Best Western International, Inc., Choice Hotels International Inc., Cisco Systems, Inc., EthoStream, LLC, Intercontinental Hotels Group Resources Inc, LodgeNet Interactive Corporation, Mail Boxes Etc., Inc., Marriott International, Inc., McDonalds Corp., Pronto Networks, Inc., Ramada Worldwide, Inc., SBC Internet Services, Inc., Six Continents Hotels Inc, T-Mobile USA, Inc., Wayport, Inc. of Letter Requesting Leave to File Summary Judgment Motion (Attachments: # 1 Exhibit A)(Daniel, Robert) (Entered: 04/19/2010)

04/19/2010 420 Additional Attachments to Main Document (Certificate of Service): 414 Claim Construction

Brief,.. (Daniel, Robert) Modified on 4/19/2010 (sm, ). (Entered: 04/19/2010)

04/19/2010 -- NOTICE FROM CLERK re 414 Claim Construction Brief. Clerk modified entry to all all the defendant filers that were previously not entered when filed. (sm, ) (Entered: 04/19/2010)

04/22/2010 421 Unopposed MOTION for Leave to File Amended First Answers and Counterclaims by Barnes & Noble Booksellers, Inc., Mail Boxes Etc., Inc., McDonalds Corp., SBC Internet Services, Inc., Wayport, Inc.. (Attachments: # 1 Text of Proposed Order)(Sayles, Richard) (Entered: 04/22/2010)

04/22/2010 422 First Amended ANSWER to 1 Complaint, COUNTERCLAIM against Linksmart Wireless Technology, LLC by SBC Internet Services, Inc..(Sayles, Richard) (Entered: 04/22/2010)

04/22/2010 423 First Amended ANSWER to 1 Complaint, COUNTERCLAIM against Linksmart Wireless Technology, LLC by Wayport, Inc..(Sayles, Richard) (Entered: 04/22/2010)

04/22/2010 424 First Amended ANSWER to 1 Complaint, COUNTERCLAIM against Linksmart Wireless Technology, LLC by McDonalds Corp..(Sayles, Richard) (Entered: 04/22/2010)

04/22/2010 425 First Amended ANSWER to 1 Complaint, COUNTERCLAIM against Linksmart Wireless Technology, LLC by Barnes & Noble Booksellers, Inc..(Sayles, Richard) (Entered: 04/22/2010)

04/22/2010 426 First Amended ANSWER to 1 Complaint, COUNTERCLAIM against Linksmart Wireless Technology, LLC by Mail Boxes Etc., Inc..(Sayles, Richard) (Entered: 04/22/2010)

04/22/2010 427 NOTICE of Attorney Appearance by Adam S Hoffman on behalf of Linksmart Wireless Technology, LLC (Hoffman, Adam) (Entered: 04/22/2010)

04/23/2010 428 ORDER granting 421 Motion for Leave to Amend Their Respective First Answers And Counterclaims. Signed by Magistrate Judge Charles Everingham on 4/23/10. (ehs, ) (Entered: 04/23/2010)

04/23/2010 429 MOTION for Extension of Time to File Response/Reply as to 402 Response in Opposition to Motion,, 382 MOTION to Strike 313 Third Party Complaint or Dismiss by Nomadix, Inc.. (Attachments: # 1 Text of Proposed Order)(Muehlhauser, Douglas) (Entered: 04/23/2010)

04/27/2010 430 ORDER granting 429 Motion for Extension of Time to File Response/Reply. Nomadix shall have to 5/10/2010 to reply to the Opposition of Best Western International Inc Responses due by 5/10/2010. Signed by Magistrate Judge Charles Everingham on 4/27/2010. (ch, ) (Entered: 04/27/2010)

04/29/2010 431 ORDER - granting 419 Dfts notice to request permission to file for partial summary judgment of invalidity. Signed by Magistrate Judge Charles Everingham on 4/29/2010. (ch, ) (Entered: 04/29/2010)

04/29/2010 432 MOTION to Strike 396 Claim Construction Brief, Defendants' Motion to Exclude the Expert Declaration of Dr. Tal Lavian in Support of Plaintiff's Claim Construction Reply Brief by Aptilo Networks, Inc., Barnes & Noble Booksellers, Inc., Best Western International, Inc., Choice Hotels International Inc., Cisco Systems, Inc., EthoStream, LLC, LodgeNet Interactive Corporation, Mail Boxes Etc., Inc., McDonalds Corp., Ramada Worldwide, Inc., SBC Internet Services, Inc., T-Mobile USA, Inc.. (Attachments: # 1 Affidavit Declaration of Alexandra McTague, # 2 Exhibit A, # 3 Exhibit B, # 4 Exhibit C, # 5 Exhibit D, # 6 Text of Proposed Order)(Richardson, Michael) (Entered: 04/29/2010)

04/29/2010 433 Unopposed MOTION for Leave to File Excess Pages by Linksmart Wireless Technology, LLC. (Attachments: # 1 Text of Proposed Order)(Spangler, Andrew) (Entered: 04/29/2010)

04/30/2010 434 Unopposed MOTION for Extension of Time to Complete Discovery to Serve Accompanying Document Production Pursuant to P.R. 3-4 by Pronto Networks, Inc.. (Attachments: # 1 Text of Proposed Order)(Allen, Aden) (Entered: 04/30/2010)

04/30/2010 435 Unopposed MOTION for Extension of Time to File Response/Reply as to 413 MOTION to Dismiss BestComm Networks, Inc.'s Crossclaims by BestComm Networks, Inc.. (Attachments: # 1 Text of Proposed Order)(Carrington, Morris) (Entered: 04/30/2010)

04/30/2010 436 REPLY to 418 Claim Construction Brief, 414 Claim Construction Brief,, filed by Linksmart Wireless Technology, LLC. (Attachments: # 1 Affidavit of Andrew D. Weiss, # 2 Exhibit A to Weiss Decl., # 3 Affidavit of Tal Lavian, PH.D.)(Weiss, Andrew) (Entered: 04/30/2010)

05/03/2010 439 ORDER granting 435 Unopposed Motion for Extension of Time to File Response to Nomandix Inc Mo to Dismiss BestComm Networks Crossclaims and BestComm is hereby given an extension of time up to and including Monday, May 24, 2010 to respond to Nomadix Inc's Motion to Dismisss BestComm Networks Crossclaims. Signed by Magistrate Judge Charles Everingham on 5/3/10. (poa, ) (Entered: 05/04/2010)

05/04/2010 437 ORDER granting 433 Unopposed Motion for Leave to File Excess Pages. Order that the Plaintiff is



granted leave to exceed the page limits for its Reply Brief required by P.R.4-5(c) by 5 pages. Signed by Magistrate Judge Charles Everingham on 5/3/10. (poa, ) (Entered: 05/04/2010)

- 05/04/2010 438 ORDER granting 434 Fourteenth Unopposed Motion for Extension of Time to Serve Accompanying Document Production Pursuant to PR 3-4. Pronto Networks Inc will have through May 14, 2010 to serve its accompanying document production to the invalidity contentions in accordance with Patent Rule 3-4. Signed by Magistrate Judge Charles Everingham on 5/3/10. (poa, ) (Entered: 05/04/2010)
- 05/05/2010 440 NOTICE of Attorney Appearance by Todd Y Brandt on behalf of Linksmart Wireless Technology, LLC (Brandt, Todd) (Entered: 05/05/2010)
- 05/07/2010 441 Unopposed MOTION for Extension of Time to File Response/Reply to the Opposition of Best Western International, Inc. to Nomadix, Inc.'s Motion to Dismiss by Nomadix, Inc.. (Attachments: # 1 Text of Proposed Order)(Muehlhauser, Douglas) (Entered: 05/07/2010)
- 05/07/2010 442 Unopposed MOTION for Leave to File Claim Construction Sur-Reply by Aptilo Networks, Inc., Barnes & Noble Booksellers, Inc., Best Western International, Inc., Choice Hotels International Inc., Cisco Systems, Inc., EthoStream, LLC, InterContinental Hotels Group PLC, Intercontinental Hotels Group Resources Inc, LodgeNet Interactive Corporation, Mail Boxes Etc., Inc., Marriott International, Inc., McDonalds Corp., Pronto Networks, Inc., Ramada Worldwide, Inc., SBC Internet Services, Inc., Six Continents Hotels Inc, T-Mobile USA, Inc., Wayport, Inc., iBAHN General Holdings Corp.. (Attachments: # 1 Text of Proposed Order granting defendants' unopposed motion for leave to file sur-reply, # 2 Exhibit Defendants' claim construction sur-reply, # 3 Affidavit of Noah Levine in support of defendants' claim construction sur-reply) (Levine, Noah) (Entered: 05/07/2010)
- 05/07/2010 443 Unopposed MOTION for Leave to File Claim Construction Surreply Brief by Aptilo Networks, Inc., iBAHN General Holdings Corp.. (Attachments: # 1 Text of Proposed Order)(Gardner, Allen) (Entered: 05/07/2010)
- 05/07/2010 444 CLAIM CONSTRUCTION SUR-REPLY BRIEF filed by Aptilo Networks, Inc., iBAHN General Holdings Corp.. (Gardner, Allen) (Entered: 05/07/2010)
- 05/07/2010 445 Unopposed MOTION for Leave to File Best Western's International, Inc.'s Unopposed Motion For Leave to Amend Its Answer and Counterclaims by Best Western International, Inc.. (Attachments: # 1 Text of Proposed Order)(Joe, Christopher) (Entered: 05/07/2010)
- 05/07/2010 446 First Amended ANSWER to 1 Complaint Best Western International, Inc.'s First Amended Answer, Defenses and Counterclaims, COUNTERCLAIM against Linksmart Wireless Technology, LLC by Best Western International, Inc..(Joe, Christopher) (Entered: 05/07/2010)
- 05/07/2010 447 Unopposed MOTION for Leave to File Claim Construction Sur-Reply by Best Western International, Inc.. (Attachments: # 1 Text of Proposed Order, # 2 Claim Construction Brief, # 3 Exhibit Exhibit 3, # 4 Exhibit Exhibit 4)(Rogers, David) (Entered: 05/07/2010)
- 05/10/2010 448 Linksmart Wireless Technology, LLC's Reply ANSWER to 423 Answer to Complaint, Counterclaim Wayport's Amended Counterclaim by Linksmart Wireless Technology, LLC.(Weiss, Andrew) (Entered: 05/10/2010)
- 05/10/2010 449 Linksmart Wireless Technology LLC's Reply ANSWER to 422 Answer to Complaint, Counterclaim SBC Internet Services dba ATT Internet Services Amended Counterclaim by Linksmart Wireless Technology, LLC.(Weiss, Andrew) (Entered: 05/10/2010)
- 05/10/2010 450 Linksmart Wireless Technology LLC's Reply ANSWER to 424 Answer to Complaint, Counterclaim McDonald's Amended Counterclaims by Linksmart Wireless Technology, LLC.(Weiss, Andrew) (Entered: 05/10/2010)
- 05/10/2010 451 Linksmart Wireless Technology LLC's Reply ANSWER to 426 Answer to Complaint, Counterclaim Mail Boxes Etc. Amended Counterclaims by Linksmart Wireless Technology, LLC.(Weiss, Andrew) (Entered: 05/10/2010)
- 05/10/2010 452 Linksmart Wireless Technology LLC's Reply ANSWER to 446 Answer to Complaint, Counterclaim,, Best Western International, Inc's Amended Counterclaims by Linksmart Wireless Technology, LLC.(Weiss, Andrew) (Entered: 05/10/2010)
- 05/10/2010 453 Linksmart Wireless Technology LLC's Reply ANSWER to 425 Answer to Complaint, Counterclaim Barnes & Noble Booksellers Inc.'s Amended Counterclaims by Linksmart Wireless Technology, LLC.(Weiss, Andrew) (Entered: 05/10/2010)
- 05/11/2010 454 ORDER granting 441 Motion for Extension of Time to File Response/Reply to the Opposition of Best Western International Inc Responses due by 6/1/2010. Signed by Magistrate Judge Charles Everingham on 5/11/2010. (ch, ) (Entered: 05/11/2010)
- 05/11/2010 455 ORDER granting 442 Motion for Leave to File Claim Construction SurReply. Signed by Magistrate Judge Charles Everingham on 5/11/2010. (ch, ) (Entered: 05/11/2010)

05/11/2010 456 ORDER granting 443 Motion for Leave to File a Claim Construction Sur-reply Brief. Defendant iBAHN General Holdings Corp., joined by Aptilo Networks, Inc., may file its Claim Construction Sur-reply Brief. Signed by Magistrate Judge Charles Everingham on 5/11/10. (ehs, ) (Entered: 05/11/2010)

05/11/2010 457 ORDER granting 445 Motion for Leave to File Amend Answer and Counteclaims. Signed by Magistrate Judge Charles Everingham on 5/11/2010. (ch, ) (Entered: 05/11/2010)

05/11/2010 458 ORDER granting 447 Motion for Leave to File Claim Construction Sur-Rèply. Signed by Magistrate Judge Charles Everingham on 5/11/10. (ehs, ) (Entered: 05/11/2010)

05/11/2010 459 RESPONSE to 436 Reply to Claim Construction Brief, Claim Construction Sur-Reply Brief of Defendants by Aptilo Networks, Inc., Barnes & Noble Booksellers, Inc., Best Western International, Inc., Choice Hotels International Inc., Cisco Systems, Inc., EthoStream, LLC, InterContinental Hotels Group PLC, LodgeNet Interactive Corporation, Mail Boxes Etc., Inc., Marriott International, Inc., McDonalds Corp., Pronto Networks, Inc., Ramada Worldwide, Inc., SBC Internet Services, Inc., Six Continents Hotels Inc, T-Mobile USA, Inc., Wayport, Inc.. (Attachments: # 1 Affidavit Declaration of Noah A. Levine, # 2 Exhibit 1)(Richardson, Michael) (Entered: 05/11/2010)

05/12/2010 460 Unopposed MOTION for Leave to File Amended Answer by Choice Hotels International Inc.. (Attachments: # 1 Text of Proposed Order)(Smith, Michael) (Entered: 05/12/2010)

05/12/2010 461 First Amended ANSWER to 1 Complaint by Choice Hotels International Inc..(Smith, Michael) (Entered: 05/12/2010)

05/13/2010 462 NOTICE of Disclosure by SBC Internet Services, Inc., Wayport, Inc. of Second Supplemental Rule 26(a) Disclosures (Sayles, Richard) (Entered: 05/13/2010)

05/14/2010 463 ORDER granting 460 Motion for Leave to File amended it answer. Signed by Magistrate Judge Charles Everingham on 5/14/10. (ehs, ) (Entered: 05/14/2010)

05/14/2010 464 Unopposed MOTION for Extension of Time to Complete Discovery to Serve Accompanying Document Production Pursuant to P.R. 3-4 by Pronto Networks, Inc.. (Attachments: # 1 Text of Proposed Order)(Allen, Aden) (Entered: 05/14/2010)

05/14/2010 465 CLAIM CONSTRUCTION CHART filed by Linksmart Wireless Technology, LLC. (Attachments: # 1 Exhibit Exhibit A)(Weiss, Andrew) (Entered: 05/14/2010)

05/14/2010 466 NOTICE by Linksmart Wireless Technology, LLC Notice of Submission of Tutorial (Attachments: # 1 Exhibit Ex. A - Tutorial)(Giza, Alexander) (Entered: 05/14/2010)

05/14/2010 469 APPLICATION to Appear Pro Hac Vice by Attorney Erin P Gibson,John D Kinton for Intercontinental Hotels Group Resources Inc,Erin P Gibson,John D Kinton for Intercontinental Hotels Group Resources Inc,Erin P Gibson,John D Kinton for Six Continents Hotels Inc,Erin P Gibson,John D Kinton for Six Continents Hotels Inc. (Attachments: # 1 PHV Kinton RECEIPT 2-1-5362)(rml, ) (Entered: 05/17/2010)

05/17/2010 467 Unopposed SEALED PATENT MOTION for Leave to File First Supplemental Invalidity Contentions by Aptilo Networks, Inc., Barnes & Noble Booksellers, Inc., Best Western International, Inc., Choice Hotels International Inc., Cisco Systems, Inc., EthoStream, LLC, Intercontinental Hotels Group Resources Inc, LodgeNet Interactive Corporation, Mail Boxes Etc., Inc., Marriott International, Inc., McDonalds Corp., Pronto Networks, Inc., Ramada Worldwide, Inc., SBC Internet Services, Inc., Six Continents Hotels Inc, T-Mobile USA, Inc., Wayport, Inc.. (Attachments: # 1 Exhibit A, # 2 Text of Proposed Order)(Richardson, Michael) (Entered: 05/17/2010)

05/17/2010 468 MOTION for Summary Judgment of Invalidity for Indefiniteness Under 35 U.S.C. Section 112, 2 by Aptilo Networks, Inc., Barnes & Noble Booksellers, Inc., Best Western International, Inc., Choice Hotels International Inc., Cisco Systems, Inc., EthoStream, LLC, InterContinental Hotels Group PLC, LodgeNet Interactive Corporation, Marriott International, Inc., McDonalds Corp., Pronto Networks, Inc., Ramada Worldwide, Inc., SBC Internet Services, Inc., Six Continents Hotels Inc, T-Mobile USA, Inc., Wayport, Inc.. (Attachments: # 1 Affidavit (Part 1 of 2) Declaration of Noah A. Levine, # 2 Affidavit (Part 2 of 2) Delcaration of Noah A. Levine, # 3 Text of Proposed Order)(Richardson, Michael) (Entered: 05/17/2010)

05/17/2010 470 RESPONSE in Opposition re 432 MOTION to Strike 396 Claim Construction Brief, Defendants' Motion to Exclude the Expert Declaration of Dr. Tal Lavian in Support of Plaintiff's Claim Construction Reply Brief MOTION to Strike 396 Claim Construction Brief, Defendants' Motion to Exclude the Expert Declaration of Dr. Tal Lavian in Support of Plaintiff's Claim Construction Reply Brief MOTION to Strike 396 Claim Construction Brief, Defendants' Motion to Exclude the Expert Declaration of Dr. Tal Lavian in Support of Plaintiff's Claim Construction Reply Brief filed by Linksmart Wireless Technology, LLC. (Weiss, Andrew) (Entered: 05/17/2010)

05/18/2010 471 ORDER granting 464 Motion for Extension of Time to Complete Discovery. ORDERED that

Defendant Pronto Networks, Inc.s Fifteenth Unopposed Motion for Extension of Time to Serve Accompanying Document Production Pursuant to P.R. 3-4 is GRANTED. Pronto Networks, Inc. will have through 5/28/2010 to serve its accompanying document production to the invalidity contentions in accordance with Patent Rule 3-4. Signed by Magistrate Judge Charles Everingham on 5/18/2010. (ch, ) (Entered: 05/18/2010)

- 05/18/2010 472 ORDER granting 467 Sealed Patent Motion for leave to file First Supplemental Invalidity Contentions. Signed by Magistrate Judge Charles Everingham on 5/18/2010. (ch, ) (Entered: 05/18/2010)
- 05/20/2010 473 APPLICATION to Appear Pro Hac Vice by Attorney Richard A Cederoth for Barnes & Noble Booksellers, Inc.,Richard A Cederoth for Mail Boxes Etc., Inc.,Richard A Cederoth for McDonalds Corp.,Richard A Cederoth for SBC Internet Services, Inc.,Richard A Cederoth for SBC Internet Services, Inc.,Richard A Cederoth for SBC Internet Services, Inc.,Richard A Cederoth for Wayport, Inc. (APPROVED FEE PAID) 2-1-5371. (ch, ) (Entered: 05/20/2010)
- 05/21/2010 474 Unopposed MOTION for Extension of Time to File Response/Reply as to 413 MOTION to Dismiss BestComm Networks, Inc.'s Crossclaims by BestComm Networks, Inc.. (Attachments: # 1 Text of Proposed Order)(Carrington, Morris) (Entered: 05/21/2010)
- 05/23/2010 475 RESPONSE in Opposition re 468 MOTION for Summary Judgment of Invalidity for Indefiniteness Under 35 U.S.C. Section 112, 2 filed by Linksmart Wireless Technology, LLC. (Attachments: # 1 Affidavit of Tal Lavian, Ph.D.)(Weiss, Andrew) (Entered: 05/23/2010)
- 05/25/2010 476 ORDER granting 474 Motion for Extension of Time to File Response to Nomadix, Inc.s Motion to Dismiss BestComm Networks, Inc.s Crossclaims. Responses due by 6/14/2010. Signed by Magistrate Judge Charles Everingham on 5/25/10. (ehs, ) (Entered: 05/25/2010)
- 05/25/2010 477 Minute Entry for proceedings held before Magistrate Judge Charles Everingham: Markman Hearing held on 5/25/2010. (Court Reporter Shelly Holmes, CSR.) (Attachments: # 1 Attorney sign-in sheet) (jml) (Entered: 05/25/2010)
- 05/28/2010 478 Unopposed MOTION for Extension of Time to Complete Discovery to Serve Accompanying document Production Pursuant to P.R. 3-4 by Pronto Networks, Inc.. (Attachments: # 1 Text of Proposed Order)(Allen, Aden) (Entered: 05/28/2010)
- 06/01/2010 479 ORDER granting 478 Motion for Extension of Time to to Serve Accompanying Document Production Pursuant to P.R. 3-4. Defendant Pronto Networks, Inc.s Sixteenth Unopposed Motion for Extension of Time to Serve Accompanying Document Production Pursuant to P.R. 3-4 is GRANTED. Pronto Networks, Inc. will have through June 11, 2010 to serve its accompanying document production to the invalidity contentions in accordance with Patent Rule 3-4.. Signed by Magistrate Judge Charles Everingham on 6/1/10. (ehs, ) (Entered: 06/01/2010)
- 06/01/2010 480 Unopposed MOTION for Extension of Time to File Response/Reply to 402 Opposition of Best Western International, Inc. to Nomadix, Inc.'s Motion to Dismiss by Nomadix, Inc.. (Attachments: # 1 Text of Proposed Order)(Muehlhauser, Douglas) (Entered: 06/01/2010)
- 06/02/2010 481 ORDER granting 480 Motion for Extension of Time to File Response/Reply - reply to the Opposition of Best Western International Inc Responses due by 6/22/2010. Signed by Magistrate Judge Charles Everingham on 6/2/2010. (ch, ) (Entered: 06/02/2010)
- 06/02/2010 482 REPLY TO RESPONSE in Support re 468 MOTION for Summary Judgment of Invalidity for Indefiniteness Under 35 U.S.C. Section 112, 2 Defendants' Reply in Support of Their Motion for Partial Summary Judgment of Invalidity for Indefiniteness Under 35 U.S.C. 112.2 filed by Aptilo Networks, Inc., Barnes & Noble Booksellers, Inc., Best Western International, Inc., Choice Hotels International Inc., Cisco Systems, Inc., EthoStream, LLC, Intercontinental Hotels Group Resources Inc, LodgeNet Interactive Corporation, Mail Boxes Etc., Inc., Marriott International, Inc., McDonalds Corp., Ramada Worldwide, Inc., SBC Internet Services, Inc., Six Continents Hotels Inc, T-Mobile USA, Inc., Wayport, Inc., iBAHN General Holdings Corp.. (Richardson, Michael) Modified on 6/2/2010 (sm, ). (Entered: 06/02/2010)
- 06/02/2010 -- NOTICE FROM CLERK re 482 Response in Support of Motion. Entry was modified by clerk to show that it is a reply to response. (sm, ) (Entered: 06/02/2010)
- 06/03/2010 483 Unopposed MOTION to Withdraw as Attorney by Linksmart Wireless Technology, LLC. (Attachments: # 1 Text of Proposed Order)(Brandt, Todd) (Entered: 06/03/2010)
- 06/04/2010 484 ORDER granting 483 Motion to Withdraw as Attorney. Attorney Todd Y Brandt terminated Linksmart Wireless Technology LLC. Signed by Magistrate Judge Charles Everingham on 6/4/2010. (ch, ) (Entered: 06/04/2010)
- 06/07/2010 485 Joint MOTION to Dismiss Pronto Networks, Inc. with Prejudice by Linksmart Wireless Technology, LLC. (Attachments: # 1 Text of Proposed Order Proposed Order)(Weiss, Andrew) (Entered: 06/07/2010)

06/09/2010 486 ORDER, granting 485 Joint MOTION to Dismiss Pronto Networks, Inc. with Prejudice filed by Linksmart Wireless Technology, LLC., Pronto Networks, Inc. terminated.. Signed by Judge David Folsom on 6/9/10. (mrm, ) (Entered: 06/09/2010)

06/11/2010 487 Unopposed MOTION for Extension of Time to File Response/Reply as to 413 MOTION to Dismiss BestComm Networks, Inc.'s Crossclaims by BestComm Networks, Inc.. (Attachments: # 1 Text of Proposed Order)(Carrington, Morris) (Entered: 06/11/2010)

06/15/2010 488 ORDER granting 487 Motion for Extension of Time to File Response/Reply re 413 MOTION to Dismiss BestComm Networks, Inc.'s Crossclaims Responses due by 7/6/2010. Signed by Magistrate Judge Charles Everingham on 6/15/2010. (ch, ) (Entered: 06/15/2010)

06/18/2010 489 APPLICATION to Appear Pro Hac Vice by Attorney Eric Charles Fligel for Linksmart Wireless Technology, LLC. (APPROVED, FEE PAID 2-1-5415) (ehs, ) (Entered: 06/18/2010)

06/22/2010 490 Unopposed MOTION for Extension of Time to File Response/Reply to 402 Opposition of Best Western International, Inc. to Nomadix, Inc.'s Motion to Strike or Dismiss Third-Party Complaint by Nomadix, Inc.. (Attachments: # 1 Text of Proposed Order)(Muehlhauser, Douglas) (Entered: 06/22/2010)

06/23/2010 491 ORDER granting 490 Motion for Extension of Time to File Response/Reply re: to Best Western International Inc Opposition to Nomadix's Motion to Strike or Dismiss Third-Party complaint Responses due by 7/6/2010. Signed by Magistrate Judge Charles Everingham on 6/23/2010. (ch, ) (Entered: 06/23/2010)

06/30/2010 492 MEMORANDUM OPINION AND ORDER - the court issues the following order concerning the claim construction issues. Signed by Magistrate Judge Charles Everingham on 6/30/2010. (ch, ) (Entered: 06/30/2010)

06/30/2010 493 NOTICE of Attorney Appearance by Irene Y Lee on behalf of Linksmart Wireless Technology, LLC (Lee, Irene) (Entered: 06/30/2010)

07/01/2010 494 Unopposed MOTION for Extension of Time to File Response/Reply as to 413 MOTION to Dismiss BestComm Networks, Inc.'s Crossclaims by BestComm Networks, Inc.. (Attachments: # 1 Text of Proposed Order)(Carrington, Morris) (Entered: 07/01/2010)

07/01/2010 495 REPORT AND RECOMMENDATIONS re 468 MOTION for Summary Judgment of Invalidity for Indefiniteness Under 35 U.S.C. Section 112, recommending granting in part deft's motion. Signed by Magistrate Judge Charles Everingham on 7/1/10. (ehs, ) (Entered: 07/01/2010)

07/01/2010 496 Unopposed MOTION to Withdraw as Attorney by Best Western International, Inc.. (Attachments: # 1 Text of Proposed Order)(Rogers, David) (Entered: 07/01/2010)

07/02/2010 497 ORDER granting 494 Motion for Extension of Time to File Response to Nomadix, Inc.s Motion to Dismiss BestComm Networks, Inc.s Crossclaims. Responses due by 8/20/2010. Signed by Magistrate Judge Charles Everingham on 7/2/10. (ehs, ) (Entered: 07/02/2010)

07/02/2010 498 ORDER granting 496 Motion to Withdraw as Attorney. Attorney Andrea L Marconi terminated. Signed by Magistrate Judge Charles Everingham on 7/2/10. (ehs, ) (Entered: 07/02/2010)

07/06/2010 499 NOTICE OF FILING OF OFFICIAL TRANSCRIPT of CLAIM CONSTRUCTION HEARING held on 5/25/10 before Judge Chad Everingham. Court Reporter/Transcriber: Shelly Holmes, CSR, Telephone number: (903) 663-5082. (116 Pages) NOTICE RE REDACTION OF TRANSCRIPTS: The parties have seven (7) business days to file with the Court a Notice of Intent to Request Redaction of this transcript. If no such Notice is filed, the transcript will be made remotely electronically available to the public without redaction after 90 calendar days. The policy is located on our website at www.txed.uscourts.gov Transcript may be viewed at the court public terminal or purchased through the Court Reporter/Transcriber before the deadline for Release of Transcript Restriction. After that date it may be obtained through PACER. Redaction Request due 7/30/2010. Redacted Transcript Deadline set for 8/9/2010. Release of Transcript Restriction set for 10/7/2010. (tja, ) (Entered: 07/06/2010)

07/06/2010 500 MOTION for Extension of Time to File Response/Reply to 402 Opposition of Best Western International, Inc. to 382 Nomadix, Inc.'s Motion to Strike or Dismiss Third-Party Complaint by Nomadix, Inc.. (Attachments: # 1 Text of Proposed Order)(Muehlhauser, Douglas) (Entered: 07/06/2010)

295966 (09) 6779118 August 17, 2004

UNITED STATES PATENT AND TRADEMARK OFFICE GRANTED PATENT

**6779118**

[Get Drawing Sheet 1 of 1](#)  
[Access PDF of Official Patent \\*](#)  
[Order Patent File History / Wrapper from REEDFAX@](#)  
[Link to Claims Section](#)

August 17, 2004

User specific automatic data redirection system

**REEXAM-LITIGATE:** October 10, 2008 - Reexamination requested October 10, 2008 by Jerry Turner Sewell, Newport Beach, CA, Reexamination No. 90/009,301 (O.G. December 2, 2008) Ex. Gp.: 3992

NOTICE OF LITIGATION

Linksmart Wireless Technology, LLC v. T-Mobile USA, Inc et al, Filed July 1, 2008, D.C. E.D. Texas, Doc. No. 2:08cv264

NOTICE OF LITIGATION

Linksmart Wireless Technology, LLC v. SBC Internet Services, Inc, Filed October 9, 2008, D.C. E.D. Texas, Doc. No. 2:08cv385

NOTICE OF LITIGATION

Linksmart Wireless Technology LLC v. Six Continents Hotels Inc et al, Filed January 21, 2009, D.C. E.D. Texas, Doc. No. 2:09cv26

**APPL-NO:** 295966 (09)

**FILED-DATE:** April 21, 1999

**GRANTED-DATE:** August 17, 2004

**ASSIGNEE-PRE-ISSUE:** June 29, 1999 - ASSIGNMENT OF ASSIGNORS INTEREST (SEE DOCUMENT FOR DETAILS)., AURIC WEB SYSTEMS 3452 EAST FOOTHILL BOULEVARD, SUITE 300PASADENA, CALIFORNIA, 91107, Reel and Frame Number: 010062/0040

**ASSIGNEE-AT-ISSUE:** Auriq Systems, Inc., Pasadena, California, United States (US), United States company or corporation (02)

**PRIM-EXMR:** Elisca, Pierre

**CORE TERMS:** user, server, redirection, network, authentication, packet, accounting, www, database, dial-up, filter, com, session, send, web, password, filtering, redirect, traffic, assigned, http, computer, protocol, proxy, site, redirected, destination, connect, remote, firewall

Legal > /.../> Patent Cases from Federal Courts and Administrative Materials ⓘ

Search

Select Search Type and Enter Search Terms

Terms & Connectors	6779118 or 6,779,118
Natural Language	
Easy Search™	

[Suggest terms for my search](#)

[Check spelling](#)

Restrict by Document Segment

Select a document segment, enter search terms for the segment, then click Add.

Select a Segment  Add ↑

Note: Segment availability differs between sources. Segments may not be applied consistently across sources.

Restrict by Date

No Date Restrictions  From  To  Date formats...

Search Connectors

and	and	w/p	in same paragraph
or	or	w/seg	in same segment
w/N	within N words	w/s	in same sentence
pre/N	precedes by N words	and not	and not

> [More Connectors & Commands...](#)

How Do I...?

- > [Combine sources?](#)
- > [Restrict by date?](#)
- > [Restrict by document segment?](#)
- > [Use wildcards as placeholders for one or more characters?](#)

[View Tutorials](#)



2010 U.S. Dist. LEXIS 65424, \*

Linksmart Wireless Tech., LLC v. T-Mobile USA, Inc.

CASE NO. 2:08-CV-264-DF-CE

UNITED STATES DISTRICT COURT FOR THE EASTERN DISTRICT OF TEXAS, MARSHALL  
DIVISION

2010 U.S. Dist. LEXIS 65424

June 30, 2010, Decided

June 30, 2010, Filed

**CORE TERMS:** user, server, network, redirection, specification, assigned, session, database, individualized, invention ...

## OPINION

... [\*16] BWI"), iBAHN General Holdings, Corp., Ethostream, LLC, Ramada Worldwide, Inc., Pronto Networks, Inc., and Aptilo Networks, Inc. infringe various claims of United States Patent No. **6,779,118** ("the '118 patent"). This memorandum addresses the parties' various claim construction disputes. The memorandum will first briefly address the technology at issue in the case ...

Source: [Legal > / ... / > Patent Cases from Federal Courts and Administrative Materials](#) 

Terms: **6779118** or **6,779,118** ([Edit Search](#) | [Suggest Terms for My Search](#))

View: KWIC

Date/Time: Wednesday, July 14, 2010 - 2:45 PM EDT



[About LexisNexis](#) | [Terms & Conditions](#) | [Contact Us](#)

Copyright © 2010 LexisNexis, a division of Reed Elsevier Inc. All rights reserved.

Legal > Area of Law - By Topic > Patent Law > Search News > Patent, Trademark & Copyright  
Periodicals, Combined

Search

Select Search Type and Enter Search Terms

Terms & Connectors	6779118 or 6,779,118
Natural Language	
Easy Search™	

[Suggest terms for my search](#)

[Check spelling](#)

Restrict by Document Segment

Select a document segment, enter search terms for the segment, then click Add.

Select a Segment  Add

Note: Segment availability differs between sources. Segments may not be applied consistently across sources.

Restrict by Date

No Date Restrictions   From  To  [Date formats...](#)

Search Connectors

<a href="#">and</a>	and	<a href="#">w/p</a>	in same paragraph
<a href="#">or</a>	or	<a href="#">w/seg</a>	in same segment
<a href="#">w/N</a>	within N words	<a href="#">w/s</a>	in same sentence
<a href="#">pre/N</a>	precedes by N words	<a href="#">and not</a>	and not

> [More Connectors & Commands...](#)

How Do I...?

- > [Combine sources?](#)
- > [Restrict by date?](#)
- > [Restrict by document segment?](#)
- > [Use wildcards as placeholders for one or more characters?](#)

[View Tutorials](#)





## No Documents Found

No documents were found for your search terms

"6779118 or 6,779,118"

---

Click "Save this search as an Alert" to schedule your search to run in the future.

- OR -

Click "Edit Search" to return to the search form and modify your search.

### Suggestions:

- Check for spelling errors .
  - Remove some search terms.
  - Use more common search terms, such as those listed in "Suggested Words and Concepts"
  - Use a less restrictive date range.
- 

Save this Search as an Alert

Edit Search



[About LexisNexis](#) | [Terms & Conditions](#) | [Contact Us](#)

Copyright © 2010 LexisNexis, a division of Reed Elsevier Inc. All rights reserved.

*NxStage Medical Reports First Quarter 2007 Results; Company Signs Six Strategic Agreements in Q1 to Drive Growth and Increase Gross Margins PR Newswire US May 8, 2007 Tuesday 11:00 AM GMT*

Copyright 2007 PR Newswire Association LLC.  
All Rights Reserved.  
PR Newswire US

May 8, 2007 Tuesday 11:00 AM GMT

**LENGTH:** 2229 words

**HEADLINE:** NxStage Medical Reports First Quarter 2007 Results; Company Signs Six Strategic Agreements in Q1 to Drive Growth and Increase Gross Margins

**DATELINE:** LAWRENCE, Mass. May 8

**BODY:**

...  
...  
...  
...  
...

Other assets	6,779,118	546,178
--------------	-----------	---------

Source: [Legal > / ... / > News, All \(English, Full Text\)](#) 

Terms: **6779118** or **6,779,118** ([Edit Search](#) | [Suggest Terms for My Search](#))

View: KWIC

Date/Time: Wednesday, July 14, 2010 - 2:46 PM EDT



[About LexisNexis](#) | [Terms & Conditions](#) | [Contact Us](#)  
Copyright © 2010 LexisNexis, a division of Reed Elsevier Inc. All rights reserved.

**HERSHKOVITZ & ASSOCIATES, LLC**  
**2845 DUKE STREET**  
**ALEXANDRIA, VA 22314**  
**703-370-4800**

Inventor: IKUDOME, Koichiro *et al.*  
 Reexamination Proceeding: 90/009,301  
 (based on U.S. Patent No. 6,779,118)  
 Reexamination Filed: December 17, 2008

Docket No.: R1341006  
 Confirmation No.: 6609  
 Art Unit: 3992  
 Examiner: RIMELL, Samuel

For: USER SPECIFIC AUTOMATIC DATA REDIRECTION SYSTEM

Mail Stop: Ex Parte Reexam  
 Central Reexamination Unit  
 COMMISSIONER FOR PATENTS  
 P.O. Box 1450  
 Alexandria, Virginia 22313-1450

Dear Commissioner:

Transmitted herewith are a **Supplemental Response under 37 CFR 1.111 and Proposed Amendment under 37 CFR 1.530, and a Certificate of Service** in the above proceeding.

The fee has been calculated as shown below:

Claims After Amendment	No. of Claims Previously Paid	Present Extra	Small Entity		Large Entity	
			Rate	Fee	Rate	Fee
Total Claims: <b>47</b>	<b>47</b>	<b>0</b>	x 26=	\$ 0	X 52=	\$
Indep. Claims: <b>4</b>	<b>4</b>	<b>0</b>	x 110=	\$ 0	X 220=	\$
						\$
Total:				\$ 0		\$

Please charge the above fees to a credit card as authorized.

The U.S. Patent and Trademark Office is hereby authorized to charge payment of the following fees associated with this communication or credit any overpayment to Deposit Account No. **50-2929**:

Any additional filing fees required under 37 C.F.R. 1.16.

Any patent application processing fees under 37 C.F.R. 1.17, including any required extension of time fees in any concurrent or future reply requiring a petition for extension of time for its timely submission (37 CFR 1.136(a)(3)).

May 24, 2010  
 Date

  
 Abraham Hershkovitz  
 Reg. No. 45,294  
 Ed Garcia-Otero  
 Reg. No. 56,609

R1341006.A05; AH/EG/cgvr

**IN THE UNITED STATES PATENT AND TRADEMARK OFFICE**

Inventor: Koichiro Ikudome, et al.

Art Unit: 3992

Reexamination Proceeding: 90/009,301  
(based on U.S. Patent No. 6,779,118)

Confirmation No.: 6609

Reexamination Filed: December 17, 2008

Examiner: Sam Rimell

For: USER SPECIFIC AUTOMATIC DATA REDIRECTION SYSTEM

**SUPPLEMENTAL RESPONSE UNDER 37 CFR 1.111  
AND PROPOSED AMENDMENT UNDER 37 CFR 1.530**

Attn: Mail Stop "Ex Parte Reexamination"  
Central Reexamination Unit  
Commissioner for Patents  
United States Patent & Trademark Office  
P.O. Box 1450  
Alexandria, Virginia 23313-1450

May 24, 2010

Dear Commissioner:

This Supplemental Response supplements the response filed on November 14, 2009 in reply to the Patent Office communication mailed on September 15, 2009 in the above-identified *ex-parte* reexamination proceeding. Please amend the present claims and add new claims as proposed below and consider the detailed traversal below, wherein:

The Status of claims is listed on page 2 of this paper.

Amendments to the Claims begin on page 3 of this paper.

Remarks/Arguments begin on page 8 of this paper.

Notice of Concurrent Litigation appears on page 8 of this paper.

Evidence of Service of this Response on the 3<sup>rd</sup> party requester is found after the last page of this paper.

STATUS OF CLAIMS

Claims 1-27 are subject to reexamination, and are rejected. Claims 1-14, 16, 17, 19, 20, and 22-25 are not amended. Claims 15, 18, 21, 26, and 27 are proposed to be amended. Claims 28-47 are proposed new claims. Specifically, claims 15, 18, 21, 26, and 27 are amended relative to the Response filed on November 14, 2009. Appendix A illustrates the amendments to the claims relative to the Response filed on November 14, 2009.

AMENDMENTS TO THE CLAIMS

*Please amend claims 15, 18, 21, 26, and 27, and add proposed new claims 28-47 as follows. Per 37 CFR 1.530(i) and MPEP 2250, the amendments are made relative to the patent as of the date of filing the request for examination.*

*Appendix A illustrates the amendments to the claims relative to the Response filed on November 14, 2009. Specifically, claims 15, 18, 21, 26, and 27 are amended relative to the Response filed on November 14, 2009.*

15. (Twice Amended) A system comprising:

a redirection server [programed] programmed with a user's rule set correlated to a temporarily assigned network address; wherein the rule set contains at least one of a plurality of functions used to control data passing between the user and a public network;

wherein the redirection server is configured to allow automated modification of at least a portion of the rule set correlated to the temporarily assigned network address; and

wherein the redirection server is configured to allow automated modification of at least a portion of the rule set as a function of some combination of time, data transmitted to or from the user, or location the user accesses. [access.]

18. (Twice Amended) The system of claim 15, wherein the redirection server is configured to allow modification of at least a portion of the rule set as a function of the location or locations the user accesses. [access.]

21. (Twice Amended) The system of claim 15, wherein the redirection server is configured to

allow the removal or reinstatement of at least a portion of the rule set as a function of the location or locations the user accesses. [access.]

26. (Twice Amended) The method of claim 25, further including the step of modifying at least a portion of the user's rule set as a function of one or more of: time, data transmitted to or from the user, and location or locations the user accesses. [access.]

27. (Twice Amended) The method of claim 25, further including the step of removing or reinstating at least a portion of the user's rule set as a function of one or more of: time, the data transmitted to or from the user and [the] a location or locations the user accesses. [access.]

28. (New) The system of claim 1, wherein the individual rule set includes at least one rule as a function of a type of IP (Internet Protocol) service.

29. (New) The system of claim 1, wherein the individual rule set includes an initial temporary rule set and a standard rule set, and wherein the redirection server is configured to utilize the temporary rule set for an initial period of time and to thereafter utilize the standard rule set.

30. (New) The system of claim 1, wherein the individual rule set includes at least one rule allowing access based on a request type and a destination address.

31. (New) The system of claim 1, wherein the individual rule set includes at least one rule redirecting the data to a new destination address based on a request type and an attempted

destination address.

32. (New) The system of claim 1, wherein the redirection server is configured to redirect data from the users' computers by replacing a first destination address in an IP (Internet protocol) packet header by a second destination address as a function of the individualized rule set.

33. (New) The method of claim 8, wherein the individual rule set includes at least one rule as a function of a type of IP (Internet Protocol) service.

34. (New) The method of claim 8, wherein the individual rule set includes an initial temporary rule set and a standard rule set, and wherein the redirection server is configured to utilize the temporary rule set for an initial period of time and to thereafter utilize the standard rule set.

35. (New) The method of claim 8, wherein the individual rule set includes at least one rule allowing access based on a request type and a destination address.

36. (New) The method of claim 8, wherein the individual rule set includes at least one rule redirecting the data to a new destination address based on a request type and an attempted destination address.

37. (New) The method of claim 8, wherein the redirection server is configured to redirect data from the users' computers by replacing a first destination address in an IP (Internet protocol) packet header by a second destination address as a function of the individualized rule set.



38. (New) The system of claim 15, wherein the individual rule set includes at least one rule as a function of a type of IP (Internet Protocol) service.

39. (New) The system of claim 15, wherein the individual rule set includes an initial temporary rule set and a standard rule set, and wherein the redirection server is configured to utilize the temporary rule set for an initial period of time and to thereafter utilize the standard rule set.

40. (New) The system of claim 15, wherein the individual rule set includes at least one rule allowing access based on a request type and a destination address.

41. (New) The system of claim 15, wherein the individual rule set includes at least one rule redirecting the data to a new destination address based on a request type and an attempted destination address.

42. (New) The system of claim 15, wherein the redirection server is configured to redirect data from the users' computers by replacing a first destination address in an IP (Internet protocol) packet header by a second destination address as a function of the individualized rule set.

43. (New) The method of claim 25, wherein the individual rule set includes at least one rule as a function of a type of IP (Internet Protocol) service.

44. (New) The method of claim 25, wherein the individual rule set includes an initial temporary

rule set and a standard rule set, and wherein the redirection server is configured to utilize the temporary rule set for an initial period of time and to thereafter utilize the standard rule set.

45. (New) The method of claim 25, wherein the individual rule set includes at least one rule allowing access based on a request type and a destination address.

46. (New) The method of claim 25, wherein the individual rule set includes at least one rule redirecting the data to a new destination address based on a request type and an attempted destination address.

47. (New) The method of claim 25, wherein the redirection server is configured to redirect data from the users' computers by replacing a first destination address in an IP (Internet protocol) packet header by a second destination address as a function of the individualized rule set.

**REMARKS/ARGUMENTS****I. Introduction and Discussion of Preliminary Issues****A. Introduction**

This Supplemental Response supplements the response filed on November 14, 2009 in reply to the Patent Office communication mailed on September 15, 2009 in the above-identified *ex-parte* reexamination proceeding.

Claims 1-27 are subject to reexamination, and are rejected. Claims 1-14, 16, 17, 19, 20, and 22-25 are not amended. Claims 15, 18, 21, 26, and 27 are proposed to be amended. Claims 28-47 are proposed new claims. No new matter is added, nor is the scope of the claims enlarged.

A copy of this Supplemental Response is being served on the third party requester pursuant to 37 CFR 1.248 and 37 CFR 1.550(f).

**B. Changes relative to Response filed on November 14, 2009**

Claims 15, 18, 21, 26, and 27 are amended relative to the Response filed on November 14, 2009. No other changes have been made relative to the Response filed November 14, 2009. Appendix A illustrates the amendments to the claims relative to the Response filed on November 14, 2009.

As patented, claims 15, 18, 21, 26, and 27 each recited, “the user access.” In order to clarify this ungrammatical term, the Response filed on November 14, 2009 amended these claims to recite “the user attempts to access.” Upon further review, Patent Owner submits that it is more clear to amend these claims to recite “the user accesses.”

This amendment is supported by, at a minimum, the specification at column 7, lines 48 to column 8, line 11:

In an alternate embodiment a user may be periodically redirected to a location, based on the number of other factors, such as the number of locations accessed, the time spent at a location, the types of locations accessed, and other such factors.

A user's account can also be disabled after the user has exceeded a length of time. The authentication accounting server 204 keeps track of user's time online. Prepaid use subscriptions can thus be easily managed by the authentication accounting Server 204.

In yet another embodiment, signals from the Internet 110 side of redirection server 208 can be used to **modify rule sets** being used by the redirection server. Preferably, encryption and/or authentication are used to verify that the server or other computer on the Internet 110 side of redirection server 208 is authorized to modify the rule set or rule sets that are being attempted to be modified. An example of this embodiment is where it is desired that a user be redirected to a particular web site until the fill out a questionnaire or satisfy some other requirement on such a web site. **In this example, the redirection server redirects a user to a particular web site that includes a questionnaire. After this web site receives acceptable data in all required fields, the web site then sends an authorization to the redirection server that deletes the redirection to the questionnaire web site from the rule set for the user who successfully completed the questionnaire.** Of course, the type of modification an outside server can make to a rule set on the redirection server is not limited to deleting a redirection rule, but can include any other type of modification to the rule set that is supported by the redirection server as discussed above.

In the above example, the user attempts to access a first web site (first location), is redirected by the rule set to a second web site (second location) that includes a questionnaire (**the user accesses** the second web site). Upon filling in all the required fields of the questionnaire, the redirection server automatically (upon receiving an authorization from the second web site that the questionnaire has been successfully completed) deletes the redirection from the rule set for the user (automated modification of at least a portion of the rule set).

Additional examples are discussed below with respect to the rejection of claim 15 over applied art.

No other changes are presented relative to the Response filed on November 14, 2009.

**C. Notice of Concurrent Litigation**

Patent Owner notes that the Present Patent is involved in the following Civil Actions:

*Linksmart Wireless Technology, LLC v. T-Mobile USA, Inc.*, No. 2:08-cv-00264-TJW-CE  
in the United States District Court for the Eastern District of Texas;

*Linksmart Wireless Technology, LLC v. Cisco Systems, Inc.*, No. 2:08-cv-00304-DF-CE  
in the United States District Court for the Eastern District of Texas; and

*Linksmart Wireless Technology, LLC v. SBC Internet Services, Inc.*, No. 2:08-cv-00385-  
TJW in the United States District Court for the Eastern District of Texas.

**D. Proposed Rejections from Request for Reexamination are Not Used**

Patent Owner notes that the pending Office Action did not use any of the rejections which were proposed by the Request for Reexamination. The Office Action introduced new rejections which were not proposed by the Request for Reexamination.

Specifically, the pending Office Action rejected claims 1-27 under 35 U.S.C. § 103(a) as being unpatentable over U.S. Patent No. 6,088,451 (hereinafter "He '451") in view of U.S. Patent No. 6,233,686 (hereinafter "Zenchelsky"). As stated on page 2 of the Office Action, He '451 is newly-cited art. Patent Owner notes that Zenchelsky was previously cited in the Request for Reexamination.

Thus, Patent Owner interprets the Office Action as determining that all of proposed rejections from the Request for Reexamination are improper, and as determining that patented claims 1-27 are patentable over all of the proposed rejections from the Request for

Reexamination.

## **II. Amendments - New Claims**

By this Amendment, claims 15, 18, 21, 26, and 27 are amended to correct minor typographical and grammatical errors, and new claims 28-47 are proposed to be added.

The newly added claims find support throughout the patent specification and claims, as originally filed. Specific examples of support for each of the new claims are mentioned below, although the totality of support for each claim is not necessarily limited to any such specific support.

New dependent claims 28, 33, 38, and 43 are supported by, at a minimum, the Present Patent at column 2, lines 8-14. New dependent claims 29, 34, 39, and 44 are supported by, at a minimum, the Present Patent at column 5, lines 31-44. New dependent claims 30, 35, 40, and 45 are supported by, at a minimum, the Present Patent at column 6, lines 43 and 44. New dependent claim 31, 36, 41, and 46 are supported by, at a minimum, the Present Patent at column 6, lines 47-49. New dependent claims 32, 37, 42, and 47 are supported by, at a minimum, the Present Patent at column 6, lines 47-49.

## **III. Summary of Rejections**

Claims 1-27 are rejected under 35 U.S.C. § 103(a) as being unpatentable over U.S. Patent No. 6,088,451 (hereinafter "He '451") in view of U.S. Patent No. 6,233,686 (hereinafter "Zenchelsky"). Patent Owner respectfully disagrees.

Claims 1, 8, 15, and 25 are the sole independent claims of the Present Patent. The rejections are discussed below, and are organized according to the independent claims.

#### IV. Rejection of Claims 1-7

##### A. Independent Claim 1

Independent claim 1 recites, in part, “wherein **the authentication accounting server** accesses the database and **communicates the individualized rule set** that correlates with the first user ID and the temporarily assigned network address **to the redirection server.**”

As an illustrative and non-limiting example of claim 1, the Present Patent states (at lines 55-59 of column 4) that the “Auto-Navi component of the authentication accounting server 204 queries the database for the rule set to apply to each new session, and forwards the rule set and the currently assigned IP address to the redirection server 208.”

The Office Action, at page 4, asserts that the above feature of claim 1 is disclosed by He ‘451 at column 17, line 61 to column 18, line 1. However, He ‘451, at column 17, line 61 to column 18, line 1, merely states:

(2) Upon receiving the user request message, the authentication server 202 uses the user identifier in the in the message to look up the user registration database 210 and retrieves a record corresponding to that user (user record). A response message is prepared by the authentication server 202 and **sent back to the user**. The response message contains a general ticket for the user to communicate with the credential server 204 for authentication. (emphasis added)

He ‘451, at column 16, lines 52-67, states that a “record” may include the list of “user credentials” reflecting “the most recent changes to the privilege set for the user.” However, He ‘451 merely sends the response message **back to the user**.

Thus, He ‘451 does not teach or suggest that the authentication accounting server “accesses the database and **communicates the individualized rule set** that correlates with the first user ID and the temporarily assigned network address **to the redirection server,**” as required by claim 1.

Further, Patent Owner submits that dependent claims 2-7 depend from claim 1, and are patentable for the same reasons as claim 1, as well as on their own merits.

Therefore, Patent Owner submits that the rejections of claims 1-7 should be withdrawn.

**B. Dependent Claim 5 (depends from claim 1)**

Dependent claim 5 recites, in part, “the redirection server further **redirects the data** to and from the users’ computers as a function of the individualized rule set.”

As an illustrative and non-limiting example of claim 5, the present patent states: “[t]he redirection server programs the rule set and the IP address so as to filter and redirect the user’s packets according to the rule set” (at column 6, lines 37-39); “dynamically changing rules, to allow the redirection, blocking, or allowing” (at column 2, lines 62-63); and “pass . . . block . . . or modify the request according to the redirection information” (at column 3, lines 18-20).

Further, the Present Patent provides a specific illustrative and non-limiting example of **redirecting a message from a first destination address (or attempted destination address) of “\*.xyz.com” to a second destination address (or redirected destination address) of “www.us.com”** (at column 6 line 21, and at column 6 lines 46-49).

The Office Action, at page 5, asserts that He ‘451 discloses the above feature at column 19, lines 2-11. However, He ‘451, at column 19, lines 2-11, merely states:

Based on the user identifier, the credential server 204 will retrieve the list of user credentials from the registration database 210 and enclose the list in a credential ticket. The credential ticket is **sent back in a response message and will be used for the user** to communicate with the network element access server 206. (emphasis added)

Additionally, He ‘451, at column 9, lines 38-41, merely discloses “an access control list for each network resource or information . . . shall contain the list of user identifiers who are



allowed to access it and the kind of access rights that are allowed to each user.” In other words, He ‘451 **merely blocks or allows access**, and merely determines the kind of access rights that are allowed to each user who is allowed access. He ‘451 **does not redirect data**.

Further, FIG. 5 of He ‘451 merely discloses a state diagram. Specifically, element 504 is the “Login” state, which can transition to three other states:

- a) element 506: the “Authorization OK” state;
- b) element 508: the “No Match” state; and
- c) element 510: the “Terminate” state.

As discussed in the He ‘451 specification at column 26, line 33 to column 27, line 12, FIG. 5 illustrates an exemplary state diagram of an operational flow. There is no disclosure of redirecting data from a user. Rather, FIG. 5 appears to merely block data from a user when the “No Match” state is reached, and also when the “Terminate” state is reached. Further, FIG. 5 also appears to merely allow data (without redirection) when the “Authorization OK” state is reached.

Thus, He ‘451 does not teach or suggest that the redirection server “**redirects the data**” as required by dependent claim 5.

Therefore, Patent Owner submits that the rejection of dependent claim 5 should be withdrawn.

### C. **Dependent Claim 6 (depends from claim 1)**

Dependent claim 6 recites, in part, “the redirection server further **redirects the data from the users’ computers to multiple destinations** as a function of the individualized rule set.” Illustrative examples of redirecting data are discussed above with respect to claim 5.

The Office Action, at page 6, asserts that He '451 discloses the above feature at FIG. 10, wherein the plural network elements 104 allegedly represent multiple potential destinations for interaction based on particular user credentials. However, as discussed above with respect to claim 5, He '451 merely blocks or allows access, and merely determines the kind of access rights that are allowed to each user who is allowed access. He '451 **does not redirect data**.

Thus, He '451 does not teach or suggest that “the redirection server further **redirects the data from the users’ computers to multiple destinations** as a function of the individualized rule set,” as required by dependent claim 6.

Therefore, Patent Owner submits that the rejection of dependent claim 6 should be withdrawn.

## V. Rejection of claims 8-14

### A. Independent Claim 8

Independent claim 8 recites, in part, “**communicating the individualized rule set** that correlates with the first user ID and the temporarily assigned network address **to the redirection sever** from the authentication accounting server.”

As an illustrative and non-limiting example of claim 8, the Present Patent states (at lines 55-59 of column 4) that the “Auto-Navi component of the authentication accounting server 204 queries the database for the rule set to apply to each new session, and forwards the rule set and the currently assigned IP address to the redirection server 208.”

The Office Action, at page 7, asserts that the above feature of claim 8 is disclosed by He '451 at column 17, line 61 to column 18, line 1. However, He '451, at column 17, line 61 to column 18, line 1, merely states:

(2) Upon receiving the user request and retrieves a record corresponding to that user (user record). A response message is prepared by the authentication server 202 and message, the authentication server 202 uses the user identifier in the in the message to look up the user registration database 210 **sent back to the user**. The response message contains a general ticket for the user to communicate with the credential server 204 for authentication. (emphasis added)

He '451, at column 16, lines 52-67, states that a "record" may include the list of "user credentials" reflecting "the most recent changes to the privilege set for the user." However, He '451 merely prepares a response message and sends the response message **back to the user**.

Thus, He '451 does not teach or suggest that the authentication accounting server "accesses the database and **communicates the individualized rule set** that correlates with the first user ID and the temporarily assigned network address **to the redirection server**," as required by claim 8.

Further, Patent Owner submits that dependent claims 9-14 depend from claim 8, and are patentable for the same reasons as claim 8, as well as on their own merits.

Therefore, Patent Owner submits that these rejections of claims 8-14 should be withdrawn.

**B. Dependent Claim 12 (depends from claim 8)**

Dependent claim 12 recites, in part, "**redirecting the data to and from the users' computers as a function of the individualized rule set.**"

As an illustrative and non-limiting embodiment of claim 12, the Present Patent states: "[t]he redirection server programs the rule set and the IP address so as to filter and redirect the user's packets according to the rule set" (at column 6, lines 37-39); "dynamically changing rules, to allow the redirection, blocking, or allowing" (at column 2, lines 62-63); and "pass . . .

block . . . or modify the request according to the redirection information” (at column 3, lines 18-20 20). Further, Present Patent provides a specific illustrative example of **redirecting a message from a destination address of “\*.xyz.com” to a redirected destination address of “www.us.com”** (at column 6 line 21, and at column 6 lines 46-48).

The Office Action, at page 8, asserts that He ‘451 discloses the above feature at column 19, lines 2-11. However, He ‘451, at column 19, lines 2-11, merely states:

Based on the user identifier, the credential server 204 will retrieve the list of user credentials from the registration database 210 and enclose the list in a credential ticket. The credential ticket is **sent back in a response message and will be used for the user** to communicate with the network element access server 206. (emphasis added)

Additionally, He ‘451, at column 9, lines 38-41, merely discloses “an access control list for each network resource or information . . . shall contain the list of user identifiers who are allowed to access it and the kind of access rights that are allowed to each user.” In other words, He ‘451 **merely blocks or allows access**, and merely determines the kind of access rights that are allowed to each user who is allowed access. He ‘451 does not redirect data.

Thus, He ‘451 does not teach or suggest “**redirecting the data**” as required by dependent claim 12.

Therefore, Patent Owner submits that the rejection of dependent claim 12 should be withdrawn.

**C. Dependent claim 13 (depends from claim 8)**

Dependent claim 13 recites, in part, “the redirection server further **redirects the data from the users’ computers to multiple destinations** as a function of the individualized rule set.” Illustrative examples of redirecting data are discussed above with respect to claim 12.

The Office Action, at pages 8 and 9, asserts that He '451 discloses the above feature at FIG. 10, wherein the plural network elements 104 allegedly represent multiple potential destinations for interaction based on particular user credentials. However, as discussed above with respect to claim 12, He '451 **merely blocks or allows access**, and merely determines the kind of access rights that are allowed to each user who is allowed access. He '451 does not redirect data as discussed above with respect to claim 12.

Thus, He '451 does not teach or suggest that the redirection server “**redirects the data from the users’ computers to multiple destinations**” as required by dependent claim 13.

Therefore, Patent Owner submits that the rejection of dependent claim 13 should be withdrawn.

## VI. Rejection of claims 15-24

### A. Independent Claim 15

Amended independent claim 15 recites, in part, “the redirection server is configured to allow **automated modification of at least a portion of the rule set . . . as a function of some combination of time, data transmitted to or from the user, or a location that the user accesses.**”

As a first illustrative and non-limiting example of claim 15, the Present Patent (at column 7, at lines 9-10) states that **a redirection rule (“\*=>www.widgetsell.com”) will expire after being invoked a single time (“expire” and “1x”).** The expired rule may be automatically removed from the rule set after being invoked a single time. In this example, the rule set is automatically modified (by removal) as a function of a combination of time and the location that the user accesses a single time.

Similarly, as a second illustrative and non-limiting example of claim 15, a redirection rule that will expire after two uses (“expire” and “2x”) may be decremented (automatically modified) after the first invocation to expire after one more use (“expire” and “1x”), and then may be removed (automatically modified again) after the modified rule (“1x”) is invoked.

Additionally, as a third illustrative and non-limiting example of claim 15, see the specification at column 7, line 48 to column 8, line 11, regarding deleting a redirection rule after a questionnaire has been successfully completed.

The Office Action, at page 10, asserts that the above feature of claim 15 is disclosed by He ‘451 at column 17, line 13, and column 17, lines 19-21. However, He ‘451, at column 17, lines 6-13, merely states, “[o]ther **administrative information** to enhance the effectiveness of the network security mechanisms. The administrative information includes, but not limited to . . . **the maximum lifetime of each authentication.**” Further, He ‘451, at column 17, lines 19-21, merely provides a database tool for “the **security system administrator** [a human] to **create, delete, disable and modify a user account.**” However, the user records of He ‘451 appear to remain unchanged, even after the maximum lifetime of the authentication expires.

First, He ‘451 merely discloses a system security administrator (a person), and does not teach or suggest an “**automated** modification of at least a portion of the rule set,” as required by claim 1.

Second, He ‘451 merely discloses a “maximum lifetime of each authentication,” but does not teach or suggest “**modification**” at least a portion of the rule set **as a function of** “time, data transmitted to or from the user, or a location that the user accesses,” as required by claim 1.

Third, even if He ‘451 discloses modifying at least a portion of the rule set as a function of time (which the Patent Owner does not admit), then He ‘451 still does not teach or suggest

“automated **modification** of at least a portion of the rule set . . . as a function of some **combination of time, data transmitted to or from the user, or a location that the user accesses.**”

Thus, Patent Owner submits that He ‘451 does not teach or suggest “**automated modification of at least a portion of the rule set . . . as a function of some combination of time, data transmitted to or from the user, or a location that the user accesses,**” as required by claim 15.

Further, Patent Owner submits that dependent claims 16-24 depend from claim 15, and are patentable for the same reasons as claim 15, as well as on their own merits.

Therefore, Patent Owner submits that the rejections of claims 15-24 should be withdrawn.

**B. Dependent claim 16 (depends from claim 15)**

Dependent claim 16 recites, in part, “the redirection server is configured to allow **modification of at least a portion of the rule set as a function of time.**” As discussed above with respect to claim 15, He ‘451 does not teach or suggest this feature.

Thus, Patent Owner submits that the rejection of dependent claim 16 should be withdrawn.

**C. Dependent claim 18 (depends from claim 15)**

Amended dependent claim 18 recites, in part, “the redirection server is configured to allow **modification** of at least a portion of the rule set **as a function of the location the user accesses.**”

The Office Action, at page 11, asserts that the above feature of claim 18 is disclosed by

He '451 at column 17, lines 19-21. However, He '451, at column 17, lines 19-21, merely provides a database tool for the security system administrator (a human) to “**create, delete, disable and modify a user account.**”

Thus, He '451 does not teach or suggest modifying the rule set “**as a function of the location the user accesses,**” as required by dependent claim 18.

Therefore, Patent Owner submits that the rejection of dependent claim 18 should be withdrawn.

## **VII. Rejection of claims 25-27**

### **A. Independent Claim 25**

Independent claim 25 recites, in part, “**modifying** at least a portion of the user’s rule set **while the user’s rule set remains correlated to the temporarily assigned network address** in the redirection server.”

The Office Action, at page 14, asserts that the above feature of claim 25 is disclosed by He '451 at column 17, lines 19-21. However, He '451, at column 17, lines 19-21, merely states, “[i]t is desirable that a database be provided for the system security administrator to create, delete, disable and modify a user account.” In other words, He '451 merely modifies, but does not teach or suggest when this modification occurs.

Thus, He '451 does not teach or suggest “**modifying** at least a portion of the user’s rule set **while the user’s rule set remains correlated to the temporarily assigned network address** in the redirection server,” as required by independent claim 25.

Dependent claim 26 and 27 depend from independent claim 25, and are patentable for at least the same reasons as independent claim 25, as well as on their own merits.



Therefore, Patent Owner submits that the rejection of claims 25-27 should be withdrawn.

### **VIII. New Claims (dependent claims 28-47)**

Each of the proposed new claims (28-47) is of the same scope (with changes in wording as permitted under the statutes and the regulations), or of a narrower scope than at least one of the claims of the Present Patent. Since all of the original claims of the Present Patent are patentable for the reasons discussed above, the proposed new claims are patentable for at least the same reasons as their respective base claims, as well as on their own merits. Specific additional reasons for patentability of each of the proposed new claims 28-47 are provided below.

Proposed new dependent claims 28, 33, 38, and 43 depend respectively from independent claims 1, 8, 15, and 25. Each of new dependent claims 28, 33, 38, and 43 recites, in part, “**the individual rule set includes at least one rule as a function of a type of IP (Internet Protocol) service.**” Patent Owner submits that this claimed feature is not disclosed by He ‘451 or by Zenchelsky, and thus these new dependent claims are patentable over the cited prior art.

Proposed new dependent claim 29, 34, 39, and 44 depend respectively from independent claims 1, 8, 15, and 25. Each of new dependent claims 29, 34, 39, and 44 recites, in part, “**wherein the individual rule set includes an initial temporary rule set and a standard rule set, and wherein the redirection server is configured to utilize the temporary rule set for an initial period of time and to thereafter utilize the standard rule set.**” Patent Owner submits that this claimed feature is not disclosed by He ‘451 or by Zenchelsky, and thus these new dependent claims are patentable over the cited prior art.

Proposed new dependent claims 30, 35, 40, and 45 depend respectively from independent

claims 1, 8, 15, and 25. Each of new dependent claims 30, 35, 40, and 45 recites, in part, “**the individual rule set includes at least one rule allowing access based on a request type and a destination address.**” Patent Owner submits that this claimed feature is not disclosed by He ‘451 or by Zenchelsky, and thus these new dependent claims are patentable over the cited prior art.

Proposed new dependent claims 31, 36, 41, and 46 depend respectively from independent claims 1, 8, 15, and 25. Each of new dependent claims 31, 36, 41, and 46 recites, in part, “**the individual rule set includes at least one rule redirecting data to a new destination address based on a request type and an attempted destination address.**” Patent Owner submits that this claimed feature is not disclosed by He ‘451 or by Zenchelsky, and thus these new dependent claims are patentable over the cited prior art.

Proposed new dependent claims 32, 27, 42, and 47 depend respectively from independent claims 1, 8, 15, and 25. Each of new dependent claims 32, 27, 42, and 47 recites, in part, “**the redirection server is configured to redirect data from the users’ computers by replacing a first destination address in an IP (Internet protocol) packet header by a second destination address as a function of the individualized rule set.**” Patent Owner submits that this claimed feature is not disclosed by He ‘451 or by Zenchelsky, and thus these new dependent claims are patentable over the cited prior art.

Thus, Patent Owner respectfully submits that proposed new claims 28-47 should be allowed.

**IX. Conclusion**

For at least the above reasons, it is respectfully submitted that patented claims 1-27 are patentably distinguished over the applied prior art. Thus, reconsideration and confirmation of the patentability of claims 1-27, allowance of new claims 28-47 and an early Notice of Intent to Issue a Reexamination Certificate are respectfully solicited.

It is believed that all of the pending issues have been addressed. However, the absence of a reply to a specific rejection, issue or comment does not signify agreement with or concession of that rejection, issue or comment. In addition, because the arguments made above may not be exhaustive, there may be reasons for patentability of any or all pending claims (or other claims) that have not been expressed. Finally, nothing in this reply should be construed as an intent to concede any issue with regard to any claim, except as specifically stated in this reply, and the amendment of any claim does not necessarily signify concession of unpatentability of the claim prior to its amendment.

Patent Owner has submitted herewith the fees for the newly added claims. It is believed that no other fees are required. However, should any additional fee or fees be necessary for consideration of the papers filed herein, please charge any such fee or fees and refund any excess payments to Deposit Account No. 50-2929, referencing docket no. R1341006.

Should the Examiner have any questions or comments regarding this matter, the undersigned may be contacted at the below-listed telephone number.

Respectfully submitted,  
Koichiro Ikudome et al.

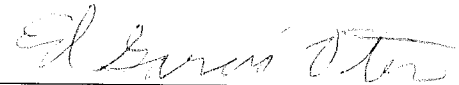

Abraham Hershkovitz  
Reg. No. 45,294

Ed Garcia-Otero  
Reg. No. 56,609

Appendix A: Claim amendments relative to the Response filed November 14, 2009

HERSHKOVITZ & ASSOCIATES, LLC  
2845 Duke Street  
Alexandria, VA 22314  
TEL: (703) 370-4800  
FAX: (703) 370-4809  
E-MAIL: patent@hershkovitz.net

R1341006.A06; GR/EG

APPENDIX A: CLAIM AMENDMENTS RELATIVE TO THE RESPONSE FILED  
NOVEMBER 14, 2009

*For the sake of clarity and for the convenience of the Examiner, this appendix tracks the changes relative to the Response filed November 14, 2009. Only claims 15, 18, 21, 26, and 27 are changed relative to the Response filed November 14, 2009.*

15. (Twice Amended) A system comprising:

a redirection server programmed with a user's rule set correlated to a temporarily assigned network address; wherein the rule set contains at least one of a plurality of functions used to control data passing between the user and a public network;

wherein the redirection server is configured to allow automated modification of at least a portion of the rule set correlated to the temporarily assigned network address; and

wherein the redirection server is configured to allow automated modification of at least a portion of the rule set as a function of some combination of time, data transmitted to or from the user, or location the user accesses. [attempts to access.]

18. (Twice Amended) The system of claim 15, wherein the redirection server is configured to allow modification of at least a portion of the rule set as a function of the location or locations the user accesses. [attempts to access.]

21. (Twice Amended) The system of claim 15, wherein the redirection server is configured to

allow the removal or reinstatement of at least a portion of the rule set as a function of the location or locations the user accesses. [attempts to access.]

26. (Twice Amended) The method of claim 25, further including the step of modifying at least a portion of the user's rule set as a function of one or more of: time, data transmitted to or from the user, and location or locations the user accesses. [attempts to access.]

27. (Twice Amended) The method of claim 25, further including the step of removing or reinstating at least a portion of the user's rule set as a function of one or more of: time, the data transmitted to or from the user and a location or locations the user accesses. [attempts to access.]

**CERTIFICATE OF SERVICE**

It is hereby certified that the attached **Supplemental Response Under 37 CFR 1.111 and Proposed Amendment under 37 CFR 1.530** is being served by first class mail on the third party requester at the third party requestor's address:

JERRY TURNER SEWELL  
P.O. BOX 10999  
NEWPORT BEACH, CA 92658-5015

  
Ed Garcia-Otero

May 24, 2009  
Date

## Electronic Acknowledgement Receipt

<b>EFS ID:</b>	7675873
<b>Application Number:</b>	90009301
<b>International Application Number:</b>	
<b>Confirmation Number:</b>	6609
<b>Title of Invention:</b>	USER SPECIFIC AUTOMATIC DATA REDIRECTION SYSTEM
<b>First Named Inventor/Applicant Name:</b>	6,779,118 B1
<b>Customer Number:</b>	23363
<b>Filer:</b>	Abraham Hershkovitz/Ed Garcia-Otero
<b>Filer Authorized By:</b>	Abraham Hershkovitz
<b>Attorney Docket Number:</b>	62986/A522/WWM
<b>Receipt Date:</b>	24-MAY-2010
<b>Filing Date:</b>	17-DEC-2008
<b>Time Stamp:</b>	17:36:34
<b>Application Type:</b>	Reexam (Third Party)

### Payment information:

Submitted with Payment	no
------------------------	----

### File Listing:

Document Number	Document Description	File Name	File Size(Bytes)/ Message Digest	Multi Part /.zip	Pages (if appl.)
1		R1341006-A05_Supp111.pdf	1005998 <small>4ed7ecb9b69ed517ab81681998f5e25c355b3e49</small>	yes	29



<b>Multipart Description/PDF files in .zip description</b>			
<b>Document Description</b>		<b>Start</b>	<b>End</b>
Trans Letter filing of a response in a reexam		1	1
Response after non-final action-owner timely		2	28
Reexam Certificate of Service		29	29

**Warnings:**

**Information:**

<b>Total Files Size (in bytes):</b>	1005998
-------------------------------------	---------

**This Acknowledgement Receipt evidences receipt on the noted date by the USPTO of the indicated documents, characterized by the applicant, and including page counts, where applicable. It serves as evidence of receipt similar to a Post Card, as described in MPEP 503.**

**New Applications Under 35 U.S.C. 111**

**If a new application is being filed and the application includes the necessary components for a filing date (see 37 CFR 1.53(b)-(d) and MPEP 506), a Filing Receipt (37 CFR 1.54) will be issued in due course and the date shown on this Acknowledgement Receipt will establish the filing date of the application.**

**National Stage of an International Application under 35 U.S.C. 371**

**If a timely submission to enter the national stage of an international application is compliant with the conditions of 35 U.S.C. 371 and other applicable requirements a Form PCT/DO/EO/903 indicating acceptance of the application as a national stage submission under 35 U.S.C. 371 will be issued in addition to the Filing Receipt, in due course.**

**New International Application Filed with the USPTO as a Receiving Office**

**If a new international application is being filed and the international application includes the necessary components for an international filing date (see PCT Article 11 and MPEP 1810), a Notification of the International Application Number and of the International Filing Date (Form PCT/RO/105) will be issued in due course, subject to prescriptions concerning national security, and the date shown on this Acknowledgement Receipt will establish the international filing date of the application.**

# INFORMATION DISCLOSURE STATEMENT BY PATENT OWNER

(Use as many sheets as necessary)

Sheet

1

of

2

## Complete if Known

Reexamination Number	90/009,301
Filing Date	December 17, 2008
First Named Inventor	Koichiro IKUDOME
Art Unit	3992
Examiner Name	Sam RIMELL
Attorney Docket Number	R1341006

## U.S. PATENT DOCUMENTS

Examiner Initials*	Cite No. <sup>1</sup>	Document Number Number-Kind Code <sup>2</sup> (if known)	Publication Date MM-DD-YYYY	Name of Patentee or Applicant of Cited Document	Pages, Columns, Lines, Where Relevant Passages or Relevant Figures Appear
	A1	US-5,845,267	12-01-1998	Ronen	
	A2	US-6,272,115	08-07-2001	Elliott III	
	A3	US-6,779,118	08-17-2004	Ikudome <i>et al.</i>	

## FOREIGN PATENT DOCUMENTS

Examiner Initials*	Cite No. <sup>1</sup>	Foreign Patent Document Country Code <sup>3</sup> -Number <sup>4</sup> - Kind Code <sup>5</sup> (if known)	Publication Date MM-DD-YYYY	Name of Patentee or Applicant of Cited Document	Pages, Columns, Lines, Where Relevant Passages or Relevant Figures Appear	T <sup>6</sup>

## NON PATENT LITERATURE DOCUMENTS

Examiner Initials*	Cite No. <sup>1</sup>	Include name of the author (in CAPITAL LETTERS), title of the article (when appropriate), title of the item (book, magazine, journal, serial, symposium, catalog, etc.), date, page(s), volume-issue number(s), publisher, city and/or country where published.	T <sup>2</sup>
	C1	<b>Best Western's Supplemental Claim Construction Brief of LINKSMART WIRELESS TECHNOLOGIES, LLC v. T-MOBILE USA, INC., et al., U.S. District Court of Eastern District of Texas, Marshall Division, Case No. 2:08-cv-00264-DF-CE, filed April 16, 2010, pp. 1-16 (including Exhibits 1-2)</b>	
	C2	<b>Cisco Internetworking Technologies Handbook, Chapter 15, entitled Dial-up Technology, Cisco, pp. 1-12</b>	
	C3	<b>Claim Construction Brief of Defendants of LINKSMART WIRELESS TECHNOLOGIES, LLC v. T-MOBILE USA, INC., et al., U.S. District Court of Eastern District of Texas, Marshall Division, Case No. 2:08-cv-00264-DF-CE, filed April 16, 2010, pp. 1-39</b>	
	C4	<b>CONNOLY et al., Database Systems: A Practical Approach to Design, Implementation, and Management, ed.3, Addison-Wesley, 2002</b>	
	C5	<b>Declaration of Kevin Jeffay, PH.D in LINKSMART WIRELESS TECHNOLOGIES, LLC v. T-MOBILE USA, INC., et al., U.S. District Court of Eastern District of Texas, Marshall Division, Case No. 2:08-cv-00264-DF-CE, filed April 16, 2010, pp. 1-53 (including Exhibits A-C)</b>	
	C6	<b>Declaration of Noah A. Levine in Support of Claim Construction Brief of Defendants, in LINKSMART WIRELESS TECHNOLOGIES, LLC v. T-MOBILE USA, INC., et al., U.S. District Court of Eastern District of Texas, Marshall Division, Case No. 2:08-cv-00264-DF-CE, filed April 16, 2010, pp. 1-131 (including exhibits 1-9)</b>	
	C7	<b>Defendants' Patent Local Rule 4-2 Preliminary Constructions and Extrinsic Evidence of LINKSMART TECHNOLOGY, LLC v. T-MOBILE USA, INC. et al., U.S. District Court of Eastern District of Texas, Marshall Division, Case No. 2:08-cv-00264-DF-CE, filed April 16, 2010, pp. 1-6</b>	

C8	Dial-up Networking and Mobile Computing: The Basics, <u>Microsoft TechNet</u> , available at <a href="http://technet.microsoft.com/en-us/library/cc751107(printer).aspx">http://technet.microsoft.com/en-us/library/cc751107(printer).aspx</a> on January 21, 2010, pp. 1-26	
C9	ELMASRI <i>et al.</i> , Fundamentals of Database Systems, ed.2, <u>Addison-Wesley</u> , 1994	
C10	How to Determine the Version of Windows 95/98/Me in Use May 12, 2007, <u>Microsoft</u> , available at <a href="http://support.microsoft.com/kb/158238">http://support.microsoft.com/kb/158238</a> on January 21, 2010 (4 pages)	
C11	Ikudome <i>et al.</i> , User Specific Automatic Web Redirection System: Technical Innovation Report, <u>Auric Web Systems</u> , Date: unknown, 19 pages (including Appendix)	
C12	LEVENE <i>et al.</i> , A Guided Tour of Relational Databases and Beyond, <u>Springer</u> , 1999, pp 1-12	
C13	Linksmart Markman Brief, Weiss Declaration and Exhibits	
C14	Linksmart Wireless Technology, LLC Disclosure of Asserted Claims and Infringement Contentions Against Defendants	
C15	MALKIN, Comprehensive Networking Glossary and Acronym Guide 47, 1995	
C16	BAHN (ed.), Microsoft Computer Dictionary, <u>Microsoft Press</u> , 4 <sup>th</sup> ed. 1999, p. 136	
C17	Microsoft Windows NT Server Resource Kit, Version 4.0, Supplement One, <u>Microsoft Press</u> , 1997, pp. 88-89	
C18	Microsoft Windows NT Workstation Resource Kit: Comprehensive Resource Guide and Utilities for Windows NT Workstation Version 4.0, <u>Microsoft Press</u> , 1996, pp. 1023-1025	
C19	NEWTON, Newton's Telecom Dictionary, <u>Telecom Books and Flatiron Publishing</u> , 10 <sup>th</sup> ed., January 1998, p. 206	
C20	SIMPSON ET AL (eds.), Oxford English Dictionary, <u>Clarendon Press</u> , 2d. ed. 1998, v.3, pp. 514-515	
C21	SIMPSON ET AL (eds.), Oxford English Dictionary, <u>Clarendon Press</u> , 2d. ed. 1998, v.7, p. 881	
C22	PERSON <i>et al.</i> , Using Windows 95, <i>Platinum Edition</i> , <u>Que Corporation</u> , 1996, pp. 205 (7 pages)	
C23	INTERNATIONAL TELECOMMUNICATION UNION, Telecommunication Standard ITU-T Standard: Data Communication Over The Telephone Network, v.8, <u>ITU</u> , September 1994, PP. 1-10	
C24	Windows History: Windows Desktop Timeline, June 30, 2003, available at <a href="http://www.microsoft.com/windows/WinHistoryProGraphic.msp">http://www.microsoft.com/windows/WinHistoryProGraphic.msp</a> on January 21, 2010, <u>Microsoft</u> , pp. 1-2	
Examiner Signature		Date Considered

\*EXAMINER: Initial if reference considered, whether or not citation is in conformance with MPEP 609. Draw line through citation if not in conformance and not considered. Include copy of this form with next communication to applicant. 1 Applicant's unique citation designation number (optional). 2 See Kinds Codes of USPTO Patent Documents at [www.uspto.gov](http://www.uspto.gov) or MPEP 901.04. 3 Enter Office that issued the document, by the two-letter code (WIPO Standard ST.3). 4 For Japanese patent documents, the indication of the year of the reign of the Emperor must precede the serial number of the patent document. 5 Kind of document by the appropriate symbols as indicated on the document under WIPO Standard ST.16 if possible. 6 Applicant is to place a check mark here if English language Translation is attached. This collection of information is required by 37 CFR 1.97 and 1.98. The information is required to obtain or retain a benefit by the public which is to file (and by the USPTO to process) an application. Confidentiality is governed by 35 U.S.C. 122 and 37 CFR 1.14. SEND TO: Commissioner for Patents, P.O. Box 1450, Alexandria, VA 22313-1450.

## Electronic Acknowledgement Receipt

<b>EFS ID:</b>	7605141
<b>Application Number:</b>	90009301
<b>International Application Number:</b>	
<b>Confirmation Number:</b>	6609
<b>Title of Invention:</b>	USER SPECIFIC AUTOMATIC DATA REDIRECTION SYSTEM
<b>First Named Inventor/Applicant Name:</b>	6,779,118 B1
<b>Customer Number:</b>	23363
<b>Filer:</b>	Abraham Hershkovitz
<b>Filer Authorized By:</b>	
<b>Attorney Docket Number:</b>	62986/A522/WWM
<b>Receipt Date:</b>	13-MAY-2010
<b>Filing Date:</b>	17-DEC-2008
<b>Time Stamp:</b>	14:21:44
<b>Application Type:</b>	Reexam (Third Party)

### Payment information:

Submitted with Payment	no
------------------------	----

### File Listing:

Document Number	Document Description	File Name	File Size(Bytes)/ Message Digest	Multi Part /.zip	Pages (if appl.)
1		R1341006-A04_SIDS.pdf	349265 <small>9ca99f6f5c5b35552340217d1e272a7b8d6ef3d6</small>	yes	8

Multipart Description/PDF files in .zip description			
Document Description	Start	End	
Transmittal Letter	1	1	
Transmittal Letter	2	5	
Reexam Certificate of Service	6	6	
Information Disclosure Statement (IDS) Filed (SB/08)	7	8	

**Warnings:**

**Information:**

2	NPL Documents	4_16_10_BW-Suppl-CC-Brf-415.pdf	125744 ed97b0e839d44fc74fb199a5142ce133b36446ee	no	10
---	---------------	---------------------------------	--	----	----

**Warnings:**

**Information:**

3	NPL Documents	4_16_10_Exh1-415-1.pdf	1102040 324734c528a8f60dd25e71ff2dfe5e3a1ed41e64	no	3
---	---------------	------------------------	---	----	---

**Warnings:**

**Information:**

4	NPL Documents	4_16_10_Exh2-415-2.pdf	1649196 186a262eca99232a22bfc5118f399e93711ae6a	no	3
---	---------------	------------------------	--	----	---

**Warnings:**

The page size in the PDF is too large. The pages should be 8.5 x 11 or A4. If this PDF is submitted, the pages will be resized upon entry into the Image File Wrapper and may affect subsequent processing

**Information:**

5	NPL Documents	CISCO_Chapter15-DialUpTechnologyNEW.pdf	17305943 69da8d0b6988fb2774b2d01bfd0d8beae0c90408	no	12
---	---------------	---	--	----	----

**Warnings:**

**Information:**

6	NPL Documents	4_16_10_DfndtsCCBrief-414-NEW_Part1.pdf	21761166 231579ac1016f60a28e7caf521bb520ca5a822cf	no	14
---	---------------	---	--	----	----

**Warnings:**

**Information:**

7	NPL Documents	4_16_10_DfndtsCCBrief-414-NEW_Part2.pdf	24697327 21e777cad8066f98a1f9921bbdf870d66290935e	no	14
---	---------------	---	--	----	----

**Warnings:**

**Information:**

8	NPL Documents	4_16_10_DfndtsCCBrief-414-NEW_Part3.pdf	12148303 da122dca86018ad386417f82743c02abca20c54	no	11
<b>Warnings:</b>					
<b>Information:</b>					
9	NPL Documents	CISCO-ET-AL_DefendantsRule4-2-NEW.pdf	988269 e4c6875553c69cb7844e94fca22595aca0cb623b	no	6
<b>Warnings:</b>					
<b>Information:</b>					
10	NPL Documents	MicrosoftTechNet_DialUpNetworkingNEW.pdf	16365324 4c57ad48ed7502fb24aba3ddb5d99448972113e2	no	26
<b>Warnings:</b>					
<b>Information:</b>					
11	NPL Documents	HowToDetermineVersionOfWindows95-98-Me-NEW.pdf	2465833 4454add3c047483da6a7049b3887dd5ad6bbe10	no	4
<b>Warnings:</b>					
<b>Information:</b>					
12	NPL Documents	LEVENE-ET-AL_GuidedTourNEW.pdf	19399146 7383c494c86c35a7ddb916da6a19f33f28e03a23	no	23
<b>Warnings:</b>					
<b>Information:</b>					
13	NPL Documents	MicrosoftCompDictionaryNEW.pdf	910550 3f17c14804eb1fd500daf5886c2f659cd67336c1	no	3
<b>Warnings:</b>					
<b>Information:</b>					
14	NPL Documents	Microsoft_ServerKitNEW.pdf	1316703 ed9513db31fdc12238e18c45c434bd1ff234e276	no	4
<b>Warnings:</b>					
<b>Information:</b>					
15	NPL Documents	Microsoft_WorkstationKitNEW.pdf	1608433 1df90f2b11a55ba3ff8807dbd4a5893f607818d3	no	5
<b>Warnings:</b>					
<b>Information:</b>					
16	NPL Documents	NewtonsTelecomDictionaryNEW.pdf	1197016 44cea97cae8b449566797b3108c1535479e0d446	no	3
<b>Warnings:</b>					
<b>Information:</b>					

17	NPL Documents	OXFORD-DIC_Vol3-NEW.pdf	1214402 5bc3b72a2958e6b179a7814a955673558f2f697	no	4
<b>Warnings:</b>					
<b>Information:</b>					
18	NPL Documents	OXFORD-DIC_Vol7-NEW.pdf	873216 3fa905db5da1c94bf5249ac78a920a6b5b40381	no	3
<b>Warnings:</b>					
<b>Information:</b>					
19	NPL Documents	PERSON-ET-AL_UsingWIN95-NEW.pdf	19323666 d2d2dbb59762cd92a2c899fa002b5aa982e0f292	no	7
<b>Warnings:</b>					
<b>Information:</b>					
20	NPL Documents	ITU-T-NEW.pdf	13226659 b8418dde50a80bb3db8ce6c3dd1e8a9da5e5e41c	no	14
<b>Warnings:</b>					
<b>Information:</b>					
21	NPL Documents	WINHistory_TimelineNEW.pdf	1451605 a45c5ada526a6e1bf7fe7a711dea729dd4f8819a	no	2
<b>Warnings:</b>					
<b>Information:</b>					
<b>Total Files Size (in bytes):</b>			159479806		

**This Acknowledgement Receipt evidences receipt on the noted date by the USPTO of the indicated documents, characterized by the applicant, and including page counts, where applicable. It serves as evidence of receipt similar to a Post Card, as described in MPEP 503.**

**New Applications Under 35 U.S.C. 111**

**If a new application is being filed and the application includes the necessary components for a filing date (see 37 CFR 1.53(b)-(d) and MPEP 506), a Filing Receipt (37 CFR 1.54) will be issued in due course and the date shown on this Acknowledgement Receipt will establish the filing date of the application.**

**National Stage of an International Application under 35 U.S.C. 371**

**If a timely submission to enter the national stage of an international application is compliant with the conditions of 35 U.S.C. 371 and other applicable requirements a Form PCT/DO/EO/903 indicating acceptance of the application as a national stage submission under 35 U.S.C. 371 will be issued in addition to the Filing Receipt, in due course.**

**New International Application Filed with the USPTO as a Receiving Office**

**If a new international application is being filed and the international application includes the necessary components for an international filing date (see PCT Article 11 and MPEP 1810), a Notification of the International Application Number and of the International Filing Date (Form PCT/RO/105) will be issued in due course, subject to prescriptions concerning national security, and the date shown on this Acknowledgement Receipt will establish the international filing date of the application.**

**HERSHKOVITZ & ASSOCIATES, LLC**  
**2845 DUKE STREET**  
**ALEXANDRIA, VA 22314**  
**703-370-4800**

Inventor: IKUDOME, Koichiro *et al.*  
 Reexamination Proceeding: 90/009,301  
 (based on U.S. Patent No. 6,779,118)  
 Reexamination Filed: December 17, 2008

Docket No.: R1341006  
 Confirmation No.: 6609  
 Art Unit: 3992  
 Examiner: RIMELL, Samuel

For: USER SPECIFIC AUTOMATIC DATA REDIRECTION SYSTEM

Mail Stop: Ex Parte Reexam  
 Central Reexamination Unit  
 COMMISSIONER FOR PATENTS  
 P.O. Box 1450  
 Alexandria, Virginia 22313-1450

Dear Commissioner:

Transmitted herewith are a **Supplemental Information Disclosure Statement, a Substitute Form PTO-1449, References and a Certificate of Service** in the above proceeding.

The fee has been calculated as shown below:

Claims After Amendment	No. of Claims Previously Paid	Present Extra	<i>Small Entity</i>		<i>Large Entity</i>	
			Rate	Fee	Rate	Fee
Total Claims:			x 26=	\$	X 52=	\$
Indep. Claims:			x 110=	\$	X 220=	\$
						\$
Total:				\$		\$

Please charge the above fees to a credit card as authorized.

The U.S. Patent and Trademark Office is hereby authorized to charge payment of the following fees associated with this communication or credit any overpayment to Deposit Account No. **50-2929**:

Any additional filing fees required under 37 C.F.R. 1.16.

Any patent application processing fees under 37 C.F.R. 1.17, including any required extension of time fees in any concurrent or future reply requiring a petition for extension of time for its timely submission (37 CFR 1.136)(a)(3).

May 13, 2010  
 Date



Abraham HersHKovitz  
 Reg. No. 45,294

Dinh X. Nguyen  
 Reg. No. 54,923

R1341006.A04; AH/DN/cgvr



**IN THE UNITED STATES PATENT AND TRADEMARK OFFICE**Inventor: Koichiro Ikudome *et al.*

Art Unit: 3992

Reexamination Proceeding: 90/009,301

Confirmation No.: 6609

(based on U.S. Patent No. 6,779,118)

Reexamination Filed: December 17, 2008

Examiner: Sam RIMELL

For: USER SPECIFIC AUTOMATIC DATA REDIRECTION SYSTEM

**SUPPLEMENTAL INFORMATION DISCLOSURE STATEMENT**

Commissioner for Patents  
Mail Stop Reexamination  
PO Box 1450  
Alexandria, Virginia 23313-1450

Dear Commissioner:

Pursuant to 37 C.F.R. 1.555, the Patent Owner hereby directs the Examiner's attention to the references listed in the below-identified litigation documents and in the accompanying Substitute Form PTO-1449.

Further to the Information Disclosure Statement filed on November 17, 2009, Patent Owner directs the Examiner's attention to the following litigation documents and references cited therein:

1. US-5,845,267;  
US-5,987,430 (not listed on Form PTO-1449 as this document was already cited on Form PTO-1449 filed on November 17, 2009);  
US-6,088,451 (not listed on Form PTO-1449 as this document was already cited by the Examiner on September 15, 2009);
2. US-6,272,115;
3. US-6,779,118;
4. Best Western's Supplemental Claim Construction Brief of LINKSMART WIRELESS TECHNOLOGIES, LLC v. T-MOBILE USA, INC., *et al.*, U.S. District Court of Eastern District of Texas, Marshall Division, Case No. 2:08-cv-00264-DF-CE, filed April 16,

- 2010, pp. 1-16 (including Exhibits 1-2);
5. Cisco Internetworking Technologies Handbook, Chapter 15, entitled Dial-up Technology, Cisco, pp. 1-12;
  6. Claim Construction Brief of Defendants of LINKSMART WIRELESS TECHNOLOGIES, LLC v. T-MOBILE USA, INC., *et al.*, U.S. District Court of Eastern District of Texas, Marshall Division, Case No. 2:08-cv-00264-DF-CE, filed April 16, 2010, pp. 1-39;  
COMER, Internetworking with TCP/IP, 3rd ed. 1995 (not listed on Form PTO-1449 as this document was already cited on Form PTO-1449 filed on November 17, 3009);
  7. CONNOLLY *et al.*, Database Systems: A Practical Approach to Design, Implementation, and Management, ed.3, Addison-Wesley, 2002;
  8. Declaration of Kevin Jeffay, PH.D *in* LINKSMART WIRELESS TECHNOLOGIES, LLC v. T-MOBILE USA, INC., *et al.*, U.S. District Court of Eastern District of Texas, Marshall Division, Case No. 2:08-cv-00264-DF-CE, filed April 16, 2010, pp. 1-53 (including Exhibits A-C);
  9. Declaration of Noah A. Levine in Support of Claim Construction Brief of Defendants, *in* LINKSMART WIRELESS TECHNOLOGIES, LLC v. T-MOBILE USA, INC., *et al.*, U.S. District Court of Eastern District of Texas, Marshall Division, Case No. 2:08-cv-00264-DF-CE, filed April 16, 2010, pp. 1-131 (including exhibits 1-9);
  10. Defendants' Patent Local Rule 4-2 Preliminary Constructions and Extrinsic Evidence of LINKSMART TECHNOLOGY, LLC v. T-MOBILE USA, INC. *et al.*, U.S. District Court of Eastern District of Texas, Marshall Division, Case No. 2:08-cv-00264-DF-CE, filed April 16, 2010, pp. 1-6;
  11. Dial-up Networking and Mobile Computing: The Basics, Microsoft TechNet, available at [http://technet.microsoft.com/en-us/library/cc751107\(printer\).aspx](http://technet.microsoft.com/en-us/library/cc751107(printer).aspx) on January 21, 2010, pp. 1-26;
  12. ELMASRI *et al.*, Fundamentals of Database Systems, ed.2, Addison-Wesley, 1994;
  13. How to Determine the Version of Windows 95/98/Me in Use May 12, 2007, Microsoft, available at <http://support.microsoft.com/kb/158238> on January 21, 2010 (4 pages);
  14. Ikudome *et al.*, User Specific Automatic Web Redirection System: Technical Innovation Report, Auric Web Systems, Date: unknown, 19 pages (including Appendix);

15. LEVENE *et al.*, *A Guided Tour of Relational Databases and Beyond*, Springer, 1999, pp 1-12;
16. Linksmart Markman Brief, Weiss Declaration and Exhibits;
17. Linksmart Wireless Technology, LLC Disclosure of Asserted Claims and Infringement Contentions Against Defendants;
18. MALKIN, *Comprehensive Networking Glossary and Acronym Guide* 47, 1995;
19. BAHN (ed.), *Microsoft Computer Dictionary*, Microsoft Press, 4<sup>th</sup> ed. 1999, p. 136;
20. *Microsoft Windows NT Server Resource Kit, Version 4.0, Supplement One*, Microsoft Press, 1997, pp. 88-89;
21. *Microsoft Windows NT Workstation Resource Kit: Comprehensive Resource Guide and Utilities for Windows NT Workstation Version 4.0*, Microsoft Press, 1996, pp. 1023-1025;
22. NEWTON, *Newton's Telecom Dictionary*, Telecom Books and Flatiron Publishing, 10<sup>th</sup> ed., January 1998, p. 206;
23. SIMPSON ET AL (eds.), *Oxford English Dictionary*, Clarendon Press, 2d. ed. 1998, v.3, pp. 514-515;
24. SIMPSON ET AL (eds.), *Oxford English Dictionary*, Clarendon Press, 2d. ed. 1998, v.7, p. 881;
25. PERSON *et al.*, *Using Windows 95, Platinum Edition*, Que Corporation, 1996, pp. 205 (7 pages);
26. INTERNATIONAL TELECOMMUNICATION UNION, *Telecommunication Standard ITU-T Standard: Data Communication Over The Telephone Network*, v.8, ITU, September 1994, PP. 1-10; and
27. *Windows History: Windows Desktop Timeline*, June 30, 2003, available at <http://www.microsoft.com/windows/WinHistoryProGraphic.msp> on January 21, 2010, Microsoft, pp. 1-2.

Copies of the above-listed documents (5), (6-12), (13-16) and (20-28) are enclosed herewith, as is a duly completed Substitute Form PTO-1449, listing above-mentioned documents (1) through (28). Copies of the above-listed documents (12), and (17-19) will be provided to the Examiner once they become available to Patent Owner's representative. Copies of the above-

listed U.S. Patents are not submitted herewith because they are readily available to the Examiner, in accordance with M.P.E.P. Section 609.

The Examiner is accordingly requested to consider all of the documents cited on this Information Disclosure Statement and on the Substitute Form PTO-1449, and to make them of record in this proceeding by initialing in the appropriate spaces on the form.

While a fee is not believed to be required, should this submission require a fee, the Commissioner is authorized to charge any fees to Deposit Account No. 50-2929, referencing Docket No. R1341006.

Should the Examiner have any questions or comments regarding this matter, the undersigned may be contacted at the below-listed telephone number.

Respectfully submitted,  
LINKSMART WIRELESS TECHNOLOGY, LLC



Abraham HersHKovitz  
Reg. No. 45,294

Dinh Nguyen  
Reg. No. 54,923

Date: May 13, 2010  
HERSHKOVITZ & ASSOCIATES, LLC  
2845 Duke Street  
Alexandria, VA 22314  
TEL: (703) 370-4800  
FAX: (703) 370-4809  
E-MAIL: [patent@hershkovitz.net](mailto:patent@hershkovitz.net)

R1341006.A04; AH/DN/cgvr

**CERTIFICATE OF SERVICE**

It is hereby certified that the attached Supplemental Information Disclosure Statement, Substitute Form PTO-1449 and references are being served by first class mail on the third party requester at the third party requestor's address:

Jerry Turner Sewell  
P.O. Box 10999  
Newport Beach, CA 92658-5015

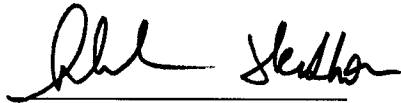

**Abraham Hershkovitz**

**May 13, 2010**

**Date**

## Electronic Acknowledgement Receipt

<b>EFS ID:</b>	7607980
<b>Application Number:</b>	90009301
<b>International Application Number:</b>	
<b>Confirmation Number:</b>	6609
<b>Title of Invention:</b>	USER SPECIFIC AUTOMATIC DATA REDIRECTION SYSTEM
<b>First Named Inventor/Applicant Name:</b>	6,779,118 B1
<b>Customer Number:</b>	23363
<b>Filer:</b>	Abraham Hershkovitz/Carolina Rios
<b>Filer Authorized By:</b>	Abraham Hershkovitz
<b>Attorney Docket Number:</b>	62986/A522/WWM
<b>Receipt Date:</b>	13-MAY-2010
<b>Filing Date:</b>	17-DEC-2008
<b>Time Stamp:</b>	16:10:34
<b>Application Type:</b>	Reexam (Third Party)

### Payment information:

Submitted with Payment	no
------------------------	----

### File Listing:

Document Number	Document Description	File Name	File Size(Bytes)/ Message Digest	Multi Part /.zip	Pages (if appl.)
1	NPL Documents	4_16_10_Exh6-9-414-2.pdf	3139317 <small>e9897965e89adbcd181d892d700233b834a3432</small>	no	65

### Warnings:

### Information:

2	NPL Documents	4_16_10_DecJeffay414-3- withExhA-C.pdf	3789846	no	53
			5986892e1ad6c768e4cc2c23f98cd06ddf36b4f		

**Warnings:**

**Information:**

3	NPL Documents	4_16_10_DecNLevine414-1-2. pdf	3541133	no	66
			197e833ac421b8f58a7369c6ab7412725bff58f1		

**Warnings:**

**Information:**

<b>Total Files Size (in bytes):</b>			10470296		
-------------------------------------	--	--	----------	--	--

**This Acknowledgement Receipt evidences receipt on the noted date by the USPTO of the indicated documents, characterized by the applicant, and including page counts, where applicable. It serves as evidence of receipt similar to a Post Card, as described in MPEP 503.**

**New Applications Under 35 U.S.C. 111**

**If a new application is being filed and the application includes the necessary components for a filing date (see 37 CFR 1.53(b)-(d) and MPEP 506), a Filing Receipt (37 CFR 1.54) will be issued in due course and the date shown on this Acknowledgement Receipt will establish the filing date of the application.**

**National Stage of an International Application under 35 U.S.C. 371**

**If a timely submission to enter the national stage of an international application is compliant with the conditions of 35 U.S.C. 371 and other applicable requirements a Form PCT/DO/EO/903 indicating acceptance of the application as a national stage submission under 35 U.S.C. 371 will be issued in addition to the Filing Receipt, in due course.**

**New International Application Filed with the USPTO as a Receiving Office**

**If a new international application is being filed and the international application includes the necessary components for an international filing date (see PCT Article 11 and MPEP 1810), a Notification of the International Application Number and of the International Filing Date (Form PCT/RO/105) will be issued in due course, subject to prescriptions concerning national security, and the date shown on this Acknowledgement Receipt will establish the international filing date of the application.**



**HERSHKOVITZ & ASSOCIATES, LLC**  
**2845 DUKE STREET**  
**ALEXANDRIA, VA 22314**  
**703-370-4800**

Inventor: IKUDOME, Koichiro *et al.*  
 Reexamination Proceeding: 90/009,301  
 (based on U.S. Patent No. 6,779,118)  
 Reexamination Filed: December 17, 2008

Docket No.: R1341006  
 Confirmation No.: 6609  
 Art Unit: 3992  
 Examiner: RIMELL, Samuel

For: USER SPECIFIC AUTOMATIC DATA REDIRECTION SYSTEM

Mail Stop: Ex Parte Reexam  
 Central Reexamination Unit  
 COMMISSIONER FOR PATENTS  
 P.O. Box 1450  
 Alexandria, Virginia 22313-1450

Dear Commissioner:

Transmitted herewith is a **STATEMENT OF INTERVIEW UNDER 37 CFR 1.560(b)** in the above application.

The fee has been calculated as shown below:

Claims After Amendment	No. of Claims Previously Paid	Present Extra	<i>Small Entity</i>		<i>Large Entity</i>	
			Rate	Fee	Rate	Fee
Total Claims:			x 26=	\$	X 52=	\$
Indep. Claims:			x 110=	\$	X 220=	\$
						\$
Total:				\$		\$

Please charge the above fees to a credit card as authorized.

The U.S. Patent and Trademark Office is hereby authorized to charge payment of the following fees associated with this communication or credit any overpayment to Deposit Account No. **50-2929**:

Any additional filing fees required under 37 C.F.R. 1.16.

Any patent application processing fees under 37 C.F.R. 1.17, including any required extension of time fees in any concurrent or future reply requiring a petition for extension of time for its timely submission (37 CFR 1.136)(a)(3).

December 10, 2009  
 Date

Abraham Hershkovitz  
 Reg. No. 45,294

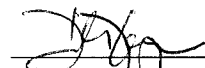
  
 \_\_\_\_\_  
 Dinh X. Nguyen  
 Reg. No. 54,923

R1341006.A03; AH/DN/dj



IN THE UNITED STATES PATENT AND TRADEMARK OFFICE

Inventor: Koichiro Ikudome, et al.

Art Unit: 3992

Reexamination Proceeding: 90/009,301  
(based on U.S. Patent No. 6,779,118)

Confirmation No.: 6609

Reexamination Filed: December 17, 2008

Examiner: Sam Rimell

For: USER SPECIFIC AUTOMATIC DATA REDIRECTION SYSTEM

**STATEMENT OF INTERVIEW UNDER 37 CFR 1.560(b)**

Attn: Mail Stop "Ex Parte Reexamination"  
Central Reexamination Unit  
Commissioner for Patents  
United States Patent & Trademark Office  
P.O. Box 1450  
Alexandria, Virginia 23313-1450

Sir:

This Statement of Interview is in response to a Personal Interview held on November 12, 2009. This Substance of Interview is filed within one month of the date of the interview, and therefore is timely filed.

Evidence of Service of this Statement of Interview on the 3<sup>rd</sup> party requester is found after the last page of this paper.

**REMARKS**

**I. Introduction**

Patent Owner appreciates the courtesies extended by the Examiners (Sam Rimell, Jessica Harrison, and Eric Kiss) to the representatives of the Patent Owner (Abraham Hershkovitz, Gene Rzucidlo, and Ed Garcia-Otero) during the Personal Interview held on November 12, 2009.

Claims 1-27 are patented claims. Claims 1-27 are subject to reexamination. Claims 1-27 are rejected under 35 U.S.C. § 103(a) as being unpatentable over U.S. Patent No. 6,088,451 (hereinafter “He ‘451”) in view of U.S. Patent No. 6,233,686 (hereinafter “Zenchelsky” or “Zen”). Patent Owner respectfully disagrees.

Patent Owner explained why independent claims 1, 15, 18, and 25, and dependent claim 5 are patentably distinct over the cited prior art.

Further, Patent Owner proposed minor typographical and grammatical corrections to claim 15, and similar corrections to other claims. The Examiners indicated that these minor corrections were acceptable.

The possibility of adding a dependent claim regarding redirecting by the specific mechanism of replacing a first destination address in an IP (Internet protocol) packet header with a second destination address was discussed.

## II. Summary of Rejections

Claims 1-27 are rejected under 35 U.S.C. § 103(a) as being unpatentable over U.S. Patent No. 6,088,451 (hereinafter “He ‘451”) in view of U.S. Patent No. 6,233,686 (hereinafter “Zenchelsky”). Patent Owner respectfully disagrees.

Claims 1, 8, 15, and 25 are the sole independent claims of the Present Patent. The rejections are discussed below, and are organized according to the independent claims.

## III. Rejection of Claims 1-7

### A. Independent Claim 1

Independent claim 1 recites, in part, “wherein **the authentication accounting server** accesses the database and **communicates the individualized rule set** that correlates with the first user ID and the temporarily assigned network address **to the redirection server.**”

As an illustrative and non-limiting example of claim 1, the Present Patent states (at lines 55-59 of column 4) that the “Auto-Navi component of the authentication accounting server 204 queries the database for the rule set to apply to each new session, and forwards the rule set and the currently assigned IP address to the redirection server 208.”

The Office Action, at page 4, asserts that the above feature of claim 1 is disclosed by He ‘451 at column 17, line 61 to column 18, line 1. However, He ‘451, at column 17, line 61 to column 18, line 1, merely states:

(2) Upon receiving the user request message, the authentication server 202 uses the user identifier in the in the message to look up the user registration database 210 and retrieves a record corresponding to that user (user record). A response message is prepared by the authentication server 202 and **sent back to the user**. The response message contains a general ticket for the user to communicate with the credential server 204 for authentication. (emphasis added)

He '451, at column 16, lines 52-67, states that a "record" may include the list of "user credentials" reflecting "the most recent changes to the privilege set for the user." However, He '451 merely sends the response message **back to the user**.

Thus, He '451 does not teach or suggest that the authentication accounting server "accesses the database and **communicates the individualized rule set** that correlates with the first user ID and the temporarily assigned network address **to the redirection server,**" as required by claim 1.

Further, Patent Owner submits that dependent claims 2-7 depend from claim 1, and are patentable for the same reasons as claim 1, as well as on their own merits.

Therefore, Patent Owner submits that the rejections of claims 1-7 should be withdrawn.

B. Dependent Claim 5 (depends from claim 1)

Dependent claim 5 recites, in part, "the redirection server further **redirects the data** to and from the users' computers as a function of the individualized rule set."

As an illustrative and non-limiting example of claim 5, the present patent states: "[t]he redirection server programs the rule set and the IP address so as to filter and redirect the user's packets according to the rule set" (at column 6, lines 37-39); "dynamically changing rules, to allow the redirection, blocking, or allowing" (at column 2, lines 62-63); and "pass . . . block . . . or modify the request according to the redirection information" (at column 3, lines 18-20).

Further, the Present Patent provides a specific illustrative and non-limiting example of **redirecting a message from a first destination address (or attempted destination address) of "\*.xyz.com" to a second destination address (or redirected destination address) of "www.us.com"** (at column 6 line 21, and at column 6 lines 46-49).

The Office Action, at page 5, asserts that He '451 discloses the above feature at column 19, lines 2-11. However, He '451, at column 19, lines 2-11, merely states:

Based on the user identifier, the credential server 204 will retrieve the list of user credentials from the registration database 210 and enclose the list in a credential ticket. The credential ticket is **sent back in a response message and will be used for the user** to communicate with the network element access server 206. (emphasis added)

Additionally, He '451, at column 9, lines 38-41, merely discloses “an access control list for each network resource or information . . . shall contain the list of user identifiers who are allowed to access it and the kind of access rights that are allowed to each user.” In other words, He '451 **merely blocks or allows access**, and merely determines the kind of access rights that are allowed to each user who is allowed access. He '451 **does not redirect data**.

Further, FIG. 5 of He '451 merely discloses a state diagram. Specifically, element 504 is the “Login” state, which can transition to three other states:

- a) element 506: the “Authorization OK” state;
- b) element 508: the “No Match” state; and
- c) element 510: the “Terminate” state.

As discussed in the He '451 specification at column 26, line 33 to column 27, line 12, FIG. 5 illustrates an exemplary state diagram of an operational flow. There is no disclosure of redirecting data from a user. Rather, FIG. 5 appears to merely block data from a user when the “No Match” state is reached, and also when the “Terminate” state is reached. Further, FIG. 5 also appears to merely allow data (without redirection) when the “Authorization OK” state is reached.

Thus, He '451 does not teach or suggest that the redirection server “**redirects the data**” as required by dependent claim 5.

Therefore, Patent Owner submits that the rejection of dependent claim 5 should be withdrawn.

#### **IV. Rejection of claims 8-14**

##### **A. Independent Claim 8**

Independent claim 8 recites, in part, “**communicating the individualized rule set** that correlates with the first user ID and the temporarily assigned network address **to the redirection sever** from the authentication accounting server.”

As an illustrative and non-limiting example of claim 8, the Present Patent states (at lines 55-59 of column 4) that the “Auto-Navi component of the authentication accounting server 204 queries the database for the rule set to apply to each new session, and forwards the rule set and the currently assigned IP address to the redirection server 208.”

The Office Action, at page 7, asserts that the above feature of claim 8 is disclosed by He ‘451 at column 17, line 61 to column 18, line 1. However, He ‘451, at column 17, line 61 to column 18, line 1, merely states:

(2) Upon receiving the user request and retrieves a record corresponding to that user (user record). A response message is prepared by the authentication server 202 and message, the authentication server 202 uses the user identifier in the in the message to look up the user registration database 210 **sent back to the user**. The response message contains a general ticket for the user to communicate with the credential server 204 for authentication. (emphasis added)

He ‘451, at column 16, lines 52-67, states that a “record” may include the list of “user credentials” reflecting “the most recent changes to the privilege set for the user.” However, He ‘451 merely prepares a response message and sends the response message **back to the user**.

Thus, He ‘451 does not teach or suggest that the authentication accounting server

“accesses the database and **communicates the individualized rule set** that correlates with the first user ID and the temporarily assigned network address **to the redirection server,**” as required by claim 8.

Further, Patent Owner submits that dependent claims 9-14 depend from claim 8, and are patentable for the same reasons as claim 8, as well as on their own merits.

Therefore, Patent Owner submits that these rejections of claims 8-14 should be withdrawn.

**V. Rejection of claims 15-24**

**A. Independent Claim 15**

Amended independent claim 15 recites, in part, “the redirection server is configured to allow **automated modification of at least a portion of the rule set . . . as a function of some combination of time, data transmitted to or from the user, or a location that the user attempts to access.**”

As an illustrative and non-limiting example of claim 15, the Present Patent (at column 7, at lines 9-10) states that **a redirection rule (“\*=>www.widgetsell.com”) will expire after being invoked a single time (“expire” and “1x”).** The expired rule may be automatically removed from the rule set after being invoked a single time. In this example, the rule set is automatically modified (by removal) as a function of a combination of time and the location that the user attempts to access.

Similarly, as another illustrative and non-limiting example of claim 15, a redirection rule that will expire after two uses (“expire” and “2x”) may be decremented (automatically modified) after the first invocation to expire after one more use (“expire” and “1x”), and then may be

removed (automatically modified again) after the modified rule (“1x”) is invoked.

The Office Action, at page 10, asserts that the above feature of claim 15 is disclosed by He ‘451 at column 17, line 13, and column 17, lines 19-21. However, He ‘451, at column 17, lines 6-13, merely states, “[o]ther **administrative information** to enhance the effectiveness of the network security mechanisms. The administrative information includes, but not limited to . . . **the maximum lifetime of each authentication.**” Further, He ‘451, at column 17, lines 19-21, merely provides a database tool for “the **security system administrator** [a human] to **create, delete, disable and modify a user account.**” However, the user records of He ‘451 appear to remain unchanged, even after the maximum lifetime of the authentication expires.

First, He ‘451 merely discloses a system security administrator (a person), and does not teach or suggest an “**automated** modification of at least a portion of the rule set,” as required by claim 1.

Second, He ‘451 merely discloses a “maximum lifetime of each authentication,” but does not teach or suggest “**modification**” at least a portion of the rule set **as a function of** “time, data transmitted to or from the user, or a location that the user attempts to access,” as required by claim 1.

Third, even if He ‘451 discloses modifying at least a portion of the rule set as a function of time (which the Patent Owner does not admit), then He ‘451 still does not teach or suggest “automated **modification** of at least a portion of the rule set . . . as a function of some **combination of** time, data transmitted to or from the user, or a location that the user attempts to access.”

Thus, Patent Owner submits that He ‘451 does not teach or suggest “**automated modification of at least a portion of the rule set . . . as a function of some combination of**



**time, data transmitted to or from the user, or a location that the user attempts to access,”**  
as required by claim 15.

Further, Patent Owner submits that dependent claims 16-24 depend from claim 15, and are patentable for the same reasons as claim 15, as well as on their own merits.

Therefore, Patent Owner submits that the rejections of claims 15-24 should be withdrawn.

## **VII. Rejection of claims 25-27**

### **A. Independent Claim 25**

Independent claim 25 recites, in part, “**modifying** at least a portion of the user’s rule set **while the user’s rule set remains correlated to the temporarily assigned network address** in the redirection server.”

The Office Action, at page 14, asserts that the above feature of claim 25 is disclosed by He ‘451 at column 17, lines 19-21. However, He ‘451, at column 17, lines 19-21, merely states, “[i]t is desirable that a database be provided for the system security administrator to create, delete, disable and modify a user account.” In other words, He ‘451 merely modifies, but does not teach or suggest when this modification occurs.

Thus, He ‘451 does not teach or suggest “**modifying** at least a portion of the user’s rule set **while the user’s rule set remains correlated to the temporarily assigned network address** in the redirection server,” as required by independent claim 25.

Dependent claim 26 and 27 depend from independent claim 25, and are patentable for at least the same reasons as independent claim 25, as well as on their own merits.

Therefore, Patent Owner submits that the rejection of claims 25-27 should be withdrawn

**CONCLUSION**

The Examiners appeared to be persuaded by the arguments made during the personal interview, although no commitments were made regarding a finding of patentability.

It is believed that no fees are required. However, should any additional fee or fees be necessary for consideration of the papers filed herein, please charge any such fee or fees and refund any excess payments to Deposit Account No. 50-2929, referencing docket no. R1341006.

Should the Examiner have any questions or comments regarding this matter, the undersigned may be contacted at the below-listed telephone number.

Respectfully submitted,  
LINKSMART WIRELESS TECHNOLOGY, LLC

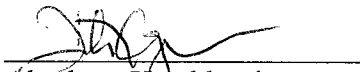
  
Abraham Hershkovitz  
Reg. No. 45,294

Dinh X. Nguyen  
Reg. No. 54,923

Ed Garcia-Otero  
Reg. No. 56,609

December 10, 2009  
HERSHKOVITZ & ASSOCIATES, LLC  
2845 Duke Street  
Alexandria, VA 22314  
TEL: (703) 370-4800  
FAX: (703) 370-4809  
E-MAIL: [patent@hershkovitz.net](mailto:patent@hershkovitz.net)

AH/DN/EG/dj

**CERTIFICATE OF SERVICE**

It is hereby certified that the attached Statement of Interview under 37 CFR 1.560(b) is being served by first class mail on the third party requester at the third party requestor's address:

JERRY TURNER SEWELL  
P.O. BOX 10999  
NEWPORT BEACH, CA 92658-5015

  
\_\_\_\_\_  
**Abraham Hershkovitz**  
**Dinh Nguyen**

**December 10, 2009**  
**Date**

## Electronic Acknowledgement Receipt

<b>EFS ID:</b>	6614692
<b>Application Number:</b>	90009301
<b>International Application Number:</b>	
<b>Confirmation Number:</b>	6609
<b>Title of Invention:</b>	USER SPECIFIC AUTOMATIC DATA REDIRECTION SYSTEM
<b>First Named Inventor/Applicant Name:</b>	6,779,118 B1
<b>Customer Number:</b>	23363
<b>Filer:</b>	Abraham Hershkovitz/Dinh Nguyen
<b>Filer Authorized By:</b>	Abraham Hershkovitz
<b>Attorney Docket Number:</b>	62986/A522/WWM
<b>Receipt Date:</b>	10-DEC-2009
<b>Filing Date:</b>	17-DEC-2008
<b>Time Stamp:</b>	18:15:19
<b>Application Type:</b>	Reexam (Patent Owner)

### Payment information:

Submitted with Payment	no
------------------------	----

### File Listing:

Document Number	Document Description	File Name	File Size(Bytes)/ Message Digest	Multi Part /.zip	Pages (if appl.)
1	Transmittal Letter	R1341006_Transmittal.pdf	44237 <small>48de3bc53f98ae7794ce47b1c1d542b752b4012b</small>	no	1

### Warnings:

### Information:

2	Reexam Miscellaneous Incoming Letter	R1341006_Statement_of_Inter view.pdf	366534  76427bbc167b1a1f21c88d84e42dd1f3f407 1eab	no	11
---	--------------------------------------	---	--	----	----

**Warnings:**

**Information:**

<b>Total Files Size (in bytes):</b>	410771
-------------------------------------	--------

**This Acknowledgement Receipt evidences receipt on the noted date by the USPTO of the indicated documents, characterized by the applicant, and including page counts, where applicable. It serves as evidence of receipt similar to a Post Card, as described in MPEP 503.**

**New Applications Under 35 U.S.C. 111**

**If a new application is being filed and the application includes the necessary components for a filing date (see 37 CFR 1.53(b)-(d) and MPEP 506), a Filing Receipt (37 CFR 1.54) will be issued in due course and the date shown on this Acknowledgement Receipt will establish the filing date of the application.**

**National Stage of an International Application under 35 U.S.C. 371**

**If a timely submission to enter the national stage of an international application is compliant with the conditions of 35 U.S.C. 371 and other applicable requirements a Form PCT/DO/EO/903 indicating acceptance of the application as a national stage submission under 35 U.S.C. 371 will be issued in addition to the Filing Receipt, in due course.**

**New International Application Filed with the USPTO as a Receiving Office**

**If a new international application is being filed and the international application includes the necessary components for an international filing date (see PCT Article 11 and MPEP 1810), a Notification of the International Application Number and of the International Filing Date (Form PCT/RO/105) will be issued in due course, subject to prescriptions concerning national security, and the date shown on this Acknowledgement Receipt will establish the international filing date of the application.**

## Electronic Acknowledgement Receipt

<b>EFS ID:</b>	6466526
<b>Application Number:</b>	90009301
<b>International Application Number:</b>	
<b>Confirmation Number:</b>	6609
<b>Title of Invention:</b>	USER SPECIFIC AUTOMATIC DATA REDIRECTION SYSTEM
<b>First Named Inventor/Applicant Name:</b>	6,779,118 B1
<b>Customer Number:</b>	23363
<b>Filer:</b>	Abraham Hershkovitz/Dinh Nguyen
<b>Filer Authorized By:</b>	Abraham Hershkovitz
<b>Attorney Docket Number:</b>	62986/A522/WWM
<b>Receipt Date:</b>	17-NOV-2009
<b>Filing Date:</b>	17-DEC-2008
<b>Time Stamp:</b>	16:01:28
<b>Application Type:</b>	Reexam (Third Party)

### Payment information:

Submitted with Payment	no
------------------------	----

### File Listing:

Document Number	Document Description	File Name	File Size(Bytes)/ Message Digest	Multi Part /.zip	Pages (if appl.)
1	NPL Documents	Aas_Apache-pm.pdf	552807 <small>f2248b62616c58deab2681d33be28f5cb57fdd1</small>	no	18

### Warnings:

### Information:

2	NPL Documents	AmendedCompaint.pdf	2544255	no	48
			67808659b8f5d276a34cd1ca71d78a0ad3e982eb		
<b>Warnings:</b>					
<b>Information:</b>					
3	NPL Documents	Answer.pdf	2396873	no	46
			f80606197c5ea4e7e3a228946a232a884e713816		
<b>Warnings:</b>					
<b>Information:</b>					
4	NPL Documents	Beermann_ReSupport-for-cern-like-Pass-Fail-proxy-limits.pdf	73601	no	2
			dfb7e3d3b8a0d0b875c79108624f7f25aa4d0a52		
<b>Warnings:</b>					
<b>Information:</b>					
5	NPL Documents	Berners-Lee_RFC1945.pdf	4040605	no	60
			b6b6ec3c29da076aa0f728ecb6ca91cf0167a811		
<b>Warnings:</b>					
<b>Information:</b>					
6	NPL Documents	Braden_RFC1009.pdf	2096925	no	50
			e6c2e0fee090976ede8a7c0af1d2936a6ee6a076		
<b>Warnings:</b>					
<b>Information:</b>					
7	NPL Documents	Carl-Mitchell_RFC1027.pdf	374516	no	8
			df860a6de455c2ec82ffb74876c745b98aad2b81		
<b>Warnings:</b>					
<b>Information:</b>					
8	NPL Documents	Chatel_RFC1919.pdf	1297405	no	32
			aa4e079ce8e128df6a29d6c444c76565bc2108		
<b>Warnings:</b>					
<b>Information:</b>					
9	NPL Documents	Complaint.pdf	2760984	no	49
			27381496363cb8efeed488ee5e41c84aef7d5b		
<b>Warnings:</b>					
<b>Information:</b>					
10	NPL Documents	Droms_RFC1531.pdf	1504179	no	35
			2ff98b426824efbf5c965261c78b7dbc264362a1		
<b>Warnings:</b>					
<b>Information:</b>					

11	NPL Documents	Egevang_RFC1631.pdf	381169 c7f48052139ab6cfd73d2778d59d46753432cfd6	no	9
<b>Warnings:</b>					
<b>Information:</b>					
12	NPL Documents	Felton_WebSpoofing.pdf	744336 46e33fb2c7611a235ef134208c5a330238158dee	no	9
<b>Warnings:</b>					
<b>Information:</b>					
13	NPL Documents	Fielder_DrWebsite.pdf	342410 815c2f7bcd889e22a33db1b814dd99c9f161b55	no	4
<b>Warnings:</b>					
<b>Information:</b>					
14	NPL Documents	Hornig_RFC894.pdf	101424 4bc304efa1994137a4f73497fab6c865a5687f1d	no	3
<b>Warnings:</b>					
<b>Information:</b>					
15	NPL Documents	ISI_RFC791_InternetProtocol.pdf	1294150 bc12e82ff5ca12c78e60dfe90978755ba35aed52	no	49
<b>Warnings:</b>					
<b>Information:</b>					
16	NPL Documents	Luotonen_World-WideWebProxies.pdf	432561 63eae9dd59036b554c62de29e7910a7654fd8204	no	8
<b>Warnings:</b>					
<b>Information:</b>					
17	NPL Documents	Maceachern_Apache-PerlIntegrationProjectReadme.pdf	71511 7c592c6c44e50aac3499991931fa351cc3a41436	no	2
<b>Warnings:</b>					
<b>Information:</b>					
18	NPL Documents	MakeUsersGoThruLogin.pdf	83909 e8a5e56f6677b7e03237f48eb85252bcf53572dc	no	2
<b>Warnings:</b>					
<b>Information:</b>					
19	NPL Documents	Mockapetris_RFC1034.pdf	2043642 3b1ec7c4629f5366eee5043de8f7f0d47deacf72	no	49
<b>Warnings:</b>					
<b>Information:</b>					



20	NPL Documents	Mod_perlC.pdf	529219 f48c0775b01ce2dd47b997fe2f693c652bb1768e9	no	20
----	---------------	---------------	---	----	----

**Warnings:**

**Information:**

<b>Total Files Size (in bytes):</b>	23666481
-------------------------------------	----------

**This Acknowledgement Receipt evidences receipt on the noted date by the USPTO of the indicated documents, characterized by the applicant, and including page counts, where applicable. It serves as evidence of receipt similar to a Post Card, as described in MPEP 503.**

**New Applications Under 35 U.S.C. 111**

**If a new application is being filed and the application includes the necessary components for a filing date (see 37 CFR 1.53(b)-(d) and MPEP 506), a Filing Receipt (37 CFR 1.54) will be issued in due course and the date shown on this Acknowledgement Receipt will establish the filing date of the application.**

**National Stage of an International Application under 35 U.S.C. 371**

**If a timely submission to enter the national stage of an international application is compliant with the conditions of 35 U.S.C. 371 and other applicable requirements a Form PCT/DO/EO/903 indicating acceptance of the application as a national stage submission under 35 U.S.C. 371 will be issued in addition to the Filing Receipt, in due course.**

**New International Application Filed with the USPTO as a Receiving Office**

**If a new international application is being filed and the international application includes the necessary components for an international filing date (see PCT Article 11 and MPEP 1810), a Notification of the International Application Number and of the International Filing Date (Form PCT/RO/105) will be issued in due course, subject to prescriptions concerning national security, and the date shown on this Acknowledgement Receipt will establish the international filing date of the application.**

## Electronic Acknowledgement Receipt

<b>EFS ID:</b>	6466724
<b>Application Number:</b>	90009301
<b>International Application Number:</b>	
<b>Confirmation Number:</b>	6609
<b>Title of Invention:</b>	USER SPECIFIC AUTOMATIC DATA REDIRECTION SYSTEM
<b>First Named Inventor/Applicant Name:</b>	6,779,118 B1
<b>Customer Number:</b>	23363
<b>Filer:</b>	Abraham Hershkovitz/Dinh Nguyen
<b>Filer Authorized By:</b>	Abraham Hershkovitz
<b>Attorney Docket Number:</b>	62986/A522/WWM
<b>Receipt Date:</b>	17-NOV-2009
<b>Filing Date:</b>	17-DEC-2008
<b>Time Stamp:</b>	16:27:26
<b>Application Type:</b>	Reexam (Third Party)

### Payment information:

Submitted with Payment	no
------------------------	----

### File Listing:

Document Number	Document Description	File Name	File Size(Bytes)/ Message Digest	Multi Part /.zip	Pages (if appl.)
1	NPL Documents	PlaintiffsReplyToCounterclaim.pdf	254910 <small>34543adf1be2714688d4f54868dc7c5b7c366981</small>	no	8

### Warnings:

### Information:

2	NPL Documents	Plummer_RFC826.pdf	415471	no	8
			1fb9f046a3dfb8181389f8e1b3a392e84660834a		
<b>Warnings:</b>					
<b>Information:</b>					
3	NPL Documents	Postel_RFC925.pdf	508531	no	14
			9d8ef69e697092f7e02debb5f64019f548954ba5		
<b>Warnings:</b>					
<b>Information:</b>					
4	NPL Documents	Rigney_RFC2139_RadiusAccounting.pdf	1490521	no	25
			07109bc8fab71864403c5149cbe10c89a71032ac		
<b>Warnings:</b>					
<b>Information:</b>					
5	NPL Documents	Stewart_WorkingWithProxyServers.pdf	590820	no	4
			1cfafe728a3d6f091a4b2e679fbc8d854e21c4db31		
<b>Warnings:</b>					
<b>Information:</b>					
6	NPL Documents	Wessels_SquidProxyServerConfigurationFile.pdf	745444	no	19
			d3c9f901e34fbb855f6f5888eb66ffccdbca2f4ec		
<b>Warnings:</b>					
<b>Information:</b>					
7	NPL Documents	Appenzeller_UserFriendlyAccessControlForPublicNetworkPort.pdf	1404390	no	8
			285256ff260c2cebee482a2033f2121508a8a238		
<b>Warnings:</b>					
<b>Information:</b>					
8	NPL Documents	Avolio_ANetworkPerimeterWithSecureExternalAccess.pdf	1417942	no	11
			62935939b6e2c58dab6884ac3049d2c47113a842		
<b>Warnings:</b>					
<b>Information:</b>					
9	NPL Documents	Baker_LocalControlOverFilteredWWWAccess.pdf	1186629	no	12
			4fc453499803c88ac073169f803058cd77ab3d74		
<b>Warnings:</b>					
<b>Information:</b>					
10	NPL Documents	Blankers_NetworkSolutionsForInternetAccessServices.pdf	1032993	no	12
			9861748f7d61222f8d43c9dd6c869a261033003		
<b>Warnings:</b>					
<b>Information:</b>					

11	NPL Documents	Boutell_CGI-ProgrammingIn-CandPerl.pdf	849369 6d0d1cc300e724cac8e45158b0863d70896538d8	no	7
<b>Warnings:</b>					
<b>Information:</b>					
12	NPL Documents	Carrel_TheTACACsplusProtocolVersion175.pdf	2179159 cf07f96288de8030bfb864ca0ab0e924da002b7f	no	40
<b>Warnings:</b>					
<b>Information:</b>					
13	NPL Documents	Elliot_TheMediaBusinessAdvertisingAddenda.pdf	105636 3aa901c9993a63f041e5d3587ec69e374d529611	no	1
<b>Warnings:</b>					
<b>Information:</b>					
14	NPL Documents	George_HardwareHustleHitsTheClassroom.pdf	242683 733abd858a49359346d646f10f977e10f78c82c5	no	3
<b>Warnings:</b>					
<b>Information:</b>					
15	NPL Documents	Housel_AsystemForOptimizingWebBrowsingInAWirelessEnvironment.pdf	1439653 527d497cb52efdc006214942f6a6d3e92aab51aa	no	10
<b>Warnings:</b>					
<b>Information:</b>					
16	NPL Documents	Hubbard_FirewallingTheNet.pdf	1642652 ac67e5dad74058d744a6202dcd0a3ee9dff948b6	no	13
<b>Warnings:</b>					
<b>Information:</b>					
17	NPL Documents	Kostick_BuildingALinuxFirewall.pdf	863224 ca655ff283e76f0df146f616bd2e5f26d77b1619	no	9
<b>Warnings:</b>					
<b>Information:</b>					
18	NPL Documents	Langdon_EducationForChangingTimes.pdf	316031 1b0eb6451bbfc36250b3113592facbd42adfbdb0b	no	3
<b>Warnings:</b>					
<b>Information:</b>					
19	NPL Documents	Leveridge_CampusWorldAndBtsOnlineEducationServices.pdf	618603 c7eadb2d50baa7dc031794205c1768ec1da4a504	no	6
<b>Warnings:</b>					
<b>Information:</b>					

20	NPL Documents	Loon_AlleviatingTheLatencyAndBandwidthProblemsInWWWBrowsering.pdf	1531175 7a7500f436b89cf5f64b08c42b22e8169cfc65e0	no	13
<b>Warnings:</b>					
<b>Information:</b>					
21	NPL Documents	MajorTelecomCompanyLaunchesEducationInternetServiceForSchool.pdf	281583 2ed440445d9713d1324ddb87091aa98c0642b3ee	no	3
<b>Warnings:</b>					
<b>Information:</b>					
22	NPL Documents	Moore_CampusWorld.pdf	835356 d8cd96f81d5e54273797957f7f54146c235581d9	no	15
<b>Warnings:</b>					
<b>Information:</b>					
23	NPL Documents	NewInternetCardToOfferFreeAccess.pdf	83898 550dfe6ad1c3dad68ec81ee6a7d5a330c9e0970b	no	3
<b>Warnings:</b>					
<b>Information:</b>					
24	NPL Documents	PhoneCardsAndTheInternet.pdf	2899909 37d4c6732dcff23e3c80aa8bda23821896bb19a3	no	1
<b>Warnings:</b>					
<b>Information:</b>					
25	NPL Documents	Poger_SecurePublicInternetAccessHandler.pdf	1464989 35a262160643d80c7d6f1e0a949bc1ea30813c26	no	12
<b>Warnings:</b>					
<b>Information:</b>					
26	NPL Documents	VariousAuthors_PostsReRedirectOnwww-squid-cache-org.pdf	230889 0752e5422b4a66ee8ad6385ffb6193a9002f24a	no	4
<b>Warnings:</b>					
<b>Information:</b>					
27	NPL Documents	Welsh_ImplementingLoadableKernelModulesForLinux.pdf	952585 2d5b171063c4185176c3316316ba7fa2a8fcdddb	no	9
<b>Warnings:</b>					
<b>Information:</b>					
28	NPL Documents	Wessels_SquidAndICPPastPresentandFuture.pdf	1476612 d9d9f04b5767bc8ebdc87f38c821b49d240b6a6d	no	15
<b>Warnings:</b>					
<b>Information:</b>					

This Acknowledgement Receipt evidences receipt on the noted date by the USPTO of the indicated documents, characterized by the applicant, and including page counts, where applicable. It serves as evidence of receipt similar to a Post Card, as described in MPEP 503.

**New Applications Under 35 U.S.C. 111**

If a new application is being filed and the application includes the necessary components for a filing date (see 37 CFR 1.53(b)-(d) and MPEP 506), a Filing Receipt (37 CFR 1.54) will be issued in due course and the date shown on this Acknowledgement Receipt will establish the filing date of the application.

**National Stage of an International Application under 35 U.S.C. 371**

If a timely submission to enter the national stage of an international application is compliant with the conditions of 35 U.S.C. 371 and other applicable requirements a Form PCT/DO/EO/903 indicating acceptance of the application as a national stage submission under 35 U.S.C. 371 will be issued in addition to the Filing Receipt, in due course.

**New International Application Filed with the USPTO as a Receiving Office**

If a new international application is being filed and the international application includes the necessary components for an international filing date (see PCT Article 11 and MPEP 1810), a Notification of the International Application Number and of the International Filing Date (Form PCT/RO/105) will be issued in due course, subject to prescriptions concerning national security, and the date shown on this Acknowledgement Receipt will establish the international filing date of the application.

## Electronic Acknowledgement Receipt

<b>EFS ID:</b>	6467460
<b>Application Number:</b>	90009301
<b>International Application Number:</b>	
<b>Confirmation Number:</b>	6609
<b>Title of Invention:</b>	USER SPECIFIC AUTOMATIC DATA REDIRECTION SYSTEM
<b>First Named Inventor/Applicant Name:</b>	6,779,118 B1
<b>Customer Number:</b>	23363
<b>Filer:</b>	Abraham Hershkovitz/Dinh Nguyen
<b>Filer Authorized By:</b>	Abraham Hershkovitz
<b>Attorney Docket Number:</b>	62986/A522/WWM
<b>Receipt Date:</b>	17-NOV-2009
<b>Filing Date:</b>	17-DEC-2008
<b>Time Stamp:</b>	16:31:28
<b>Application Type:</b>	Reexam (Third Party)

### Payment information:

Submitted with Payment	no
------------------------	----

### File Listing:

Document Number	Document Description	File Name	File Size(Bytes)/ Message Digest	Multi Part /.zip	Pages (if appl.)
1	NPL Documents	ATandTetallInvalidityContentionsNEW_Part1.pdf	24754402 <small>05f14e679edff6c65a6eab26f86e7d6317d6a7191</small>	no	190

### Warnings:

### Information:

2	NPL Documents	ATandTetalInvalidityContentionsNEW_Part2.pdf	21627492 97fdd75802a0bbd2770f2d15ed5a32f0104988bf	no	190
<b>Warnings:</b>					
<b>Information:</b>					
3	NPL Documents	ATandTetalInvalidityContentionsNEW_Part3.pdf	19545574 8406d439fd2f34fbc75bc917ac1ece23e1f086e4	no	190
<b>Warnings:</b>					
<b>Information:</b>					
4	NPL Documents	ATandTetalInvalidityContentionsNEW_Part4.pdf	19402344 83af4462f281540ae47d68797047b184b7845413	no	184
<b>Warnings:</b>					
<b>Information:</b>					
5	NPL Documents	TMOBILE-InvalidityContentionsNEW_Part1.pdf	13011028 8b67aa3e3976f2e18b17770eae3e1fa1cecc5fd9	no	115
<b>Warnings:</b>					
<b>Information:</b>					
6	NPL Documents	TMOBILE-InvalidityContentionsNEW_Part2.pdf	3866497 14ebd5eefa31b8ec00a3ba0730ba16f2fabbbfd4e	no	41
<b>Warnings:</b>					
<b>Information:</b>					
7	NPL Documents	TMOBILE-InvalidityContentionsNEW_Part3.pdf	6962168 0a311b419b518628615101a1941700178607acf	no	95
<b>Warnings:</b>					
<b>Information:</b>					
<b>Total Files Size (in bytes):</b>			109169505		



**This Acknowledgement Receipt evidences receipt on the noted date by the USPTO of the indicated documents, characterized by the applicant, and including page counts, where applicable. It serves as evidence of receipt similar to a Post Card, as described in MPEP 503.**

**New Applications Under 35 U.S.C. 111**

**If a new application is being filed and the application includes the necessary components for a filing date (see 37 CFR 1.53(b)-(d) and MPEP 506), a Filing Receipt (37 CFR 1.54) will be issued in due course and the date shown on this Acknowledgement Receipt will establish the filing date of the application.**

**National Stage of an International Application under 35 U.S.C. 371**

**If a timely submission to enter the national stage of an international application is compliant with the conditions of 35 U.S.C. 371 and other applicable requirements a Form PCT/DO/EO/903 indicating acceptance of the application as a national stage submission under 35 U.S.C. 371 will be issued in addition to the Filing Receipt, in due course.**

**New International Application Filed with the USPTO as a Receiving Office**

**If a new international application is being filed and the international application includes the necessary components for an international filing date (see PCT Article 11 and MPEP 1810), a Notification of the International Application Number and of the International Filing Date (Form PCT/RO/105) will be issued in due course, subject to prescriptions concerning national security, and the date shown on this Acknowledgement Receipt will establish the international filing date of the application.**

**INFORMATION DISCLOSURE  
STATEMENT BY APPLICANT**

(use as many sheets as necessary)

**Attorney Docket Number**

R1341006

**Application Number**

90/009,301

**Filing Date**

December 17, 2008

**Applicant(s)**

Ikudome, Koichiro et al.

**Group Art Unit**

3992

**Examiner Name**

RIMELL, Samuel G.

**U.S. PATENT DOCUMENTS**

EXAMINER INITIALS	Cite No. <sup>1</sup>	DOCUMENT NUMBER Number - Kind Code <sup>2</sup> (If Known)	PUBLICATION DATE MM-DD-YYYY	NAME OF PATENTEE
	1.	5,678,041	10/14/1997	Baker et al.
	2.	5,708,780	01-13-1998	Levergood et al.
	3.	5,749,075	05-05-1998	Toader et al.
	4.	5,774,869	6/30/1998	Toader
	5.	5,781,550	07-14-1998	Templin et al.
	6.	5,794,210	08-11-1998	Goldhaber et al.
	7.	5,802,320	09-01-1998	Bachr et al.
	8.	5,805,803	9/8/1998	Birrell et al.
	9.	5,806,043	9/8/1998	Toader
	10.	5,812,776	09-22-1998	Gifford
	11.	5,835,727	11/10/1998	Wong et al.
	12.	5,848,233	12/8/1998	Radia et al.
	13.	5,850,517	12/15/1998	Verkler et al.
	14.	5,855,008	12-29-1998	Goldhaber et al.
	15.	5,864,683	1/26/1999	Boebert et al.
	16.	5,881,234	3/9/1999	Schwob
	17.	5,889,958	3/30/1999	Willens
	18.	5,915,093	6/22/1999	Berlin et al.
	19.	5,918,018	6/29/1999	Gooderum et al.
	20.	5,948,061	09-07-1999	Merriman et al.
	21.	5,950,195	9/7/1999	Stockwell et al.
	22.	5,956,697	09-21-1999	Usui
	23.	5,960,409	09-28-1999	Wexler
	24.	5,963,915	10-05-1999	Kirsch

EXAMINER SIGNATURE

DATE CONSIDERED

EXAMINER: Initial if reference considered, whether or not citation is in conformance with MPEP 609; Draw line through citation if not in conformance and not considered. Include copy of this form with next communication to applicant. <sup>1</sup>Applicant's unique citation designation number (optional). <sup>2</sup>See Kinds Codes of USPTO Patent Documents at [www.pto.gov](http://www.pto.gov) or MPEP 901.4. <sup>3</sup>Enter Office that issued the document, by the two-letter code (WIPO standard ST.3). <sup>4</sup>For Japanese patent documents, the indication of the year of the reign of the Emperor must precede the serial number of the patent document. <sup>5</sup>Kind of document by the appropriate symbols as indicated on the document under WIPO Standard ST.16 if possible. <sup>6</sup>Applicant is to place a check mark here if English Language Translation is attached.

**INFORMATION DISCLOSURE  
STATEMENT BY APPLICANT**

(use as many sheets as necessary)

<b>Attorney Docket Number</b>	R1341006
<b>Application Number</b>	90/009,301
<b>Filing Date</b>	December 17, 2008
<b>Applicant(s)</b>	Ikudome, Koichiro et al.
<b>Group Art Unit</b>	3992
<b>Examiner Name</b>	RIMELL, Samuel G.

**U.S. PATENT DOCUMENTS**

EXAMINER INITIALS	Cite No. <sup>1</sup>	DOCUMENT NUMBER Number - Kind Code <sup>2</sup> (If Known)	PUBLICATION DATE MM-DD-YYYY	NAME OF PATENTEE
	25.	5,987,430	11/16/1999	Van Horne et al.
	26.	6,014,698	01-11-2000	Griffiths
	27.	6,052,725	04-18-2000	McCann et al.
	28.	6,070,243	5/30/2000	See et al.
	29.	6,098,172	08-01-2000	Coss et al.
	30.	6,112,239	8/29/2000	Kenner et al.
	31.	6,119,160	9/12/2000	Zhang et al.
	32.	6,119,162	09-12-2000	Li et al.
	33.	6,154,775	11/28/2000	Coss et al.
	34.	6,158,008	12/5/2000	Maria et al.
	35.	6,182,139	01-30-2001	Brendel
	36.	6,219,790	4/17/2001	Lloyd et al.
	37.	6,223,209	04-24-2001	Watson
	38.	6,226,677	05-01-2001	Slemmer
	39.	6,233,618	5/15/2001	Shannon
	40.	6,247,054	6/12/2001	Malkin
	41.	6,311,275	10/30/2001	Jin et al.
	42.	6,321,336	11/20/2001	Applegate et al.
	43.	6,377,990	4/23/2002	Slemmer et al.
	44.	6,438,125	8/20/2002	Brothers
	45.	6,460,084	10/1/2002	Van Horne et al.
	46.	6,636,894	10-21-2003	Short et al.
	47.	6,687,732	2/3/2004	Bector et al.
	48.	6,721,306	4/13/2004	Farris et al.

EXAMINER SIGNATURE	DATE CONSIDERED
<p>EXAMINER: Initial if reference considered, whether or not citation is in conformance with MPEP 609; Draw line through citation if not in conformance and not considered. Include copy of this form with next communication to applicant. <sup>1</sup>Applicant's unique citation designation number (optional). <sup>2</sup>See Kinds Codes of USPTO Patent Documents at <a href="http://www.pto.gov">www.pto.gov</a> or MPEP 901.4. <sup>3</sup>Enter Office that issued the document, by the two-letter code (WIPO standard ST.3). <sup>4</sup>For Japanese patent documents, the indication of the year of the reign of the Emperor must precede the serial number of the patent document. <sup>5</sup>Kind of document by the appropriate symbols as indicated on the document under WIPO Standard ST.16 if possible. <sup>6</sup>Applicant is to place a check mark here if English Language Translation is attached.</p>	

FORM PTO/SB/08A/B (10-01) Substitute for PTO-1449A/B  <b>INFORMATION DISCLOSURE</b>  <b>STATEMENT BY APPLICANT</b>  (use as many sheets as necessary)	<b>Attorney Docket Number</b>	R1341006
	<b>Application Number</b>	90/009,301
	<b>Filing Date</b>	December 17, 2008
	<b>Applicant(s)</b>	Ikudome, Koichiro et al.
	<b>Group Art Unit</b>	3992
	<b>Examiner Name</b>	RIMELL, Samuel G.

FOREIGN PATENT DOCUMENTS					
EXAMINER INITIALS	Cite No. <sup>1</sup>	Foreign Patent Document Country Code <sup>3</sup> - Number <sup>4</sup> - Kind Code <sup>5</sup> (If Known)	Publication Date MM-DD-YYYY	Name of Patentee or Applicant of Cited Document	T <sup>6</sup> ( <input checked="" type="checkbox"/> )
	49.	GB 2316841	03-04-1998	Kubota et al.	
	50.	WO 96/05549	02-22-1996	Horowitz et al.	
	51.	WO 96/39668	12-12-1996	Toader	
	52.	WO 97/11429	03-27-1997	Graber et al.	

OTHER DOCUMENTS		
EXAMINER INITIALS	Cite No. <sup>1</sup>	Include name of the author (in CAPITAL LETTERS), title of the article, title of the item (book, magazine, journal, serial, symposium, catalog, etc.), date, page(s), volume-issue number(s), publisher, city and/or country where published.
	53.	"Phone Cards and the Internet: A profitable Link," 1 page; Intele-Card News, March 1996
	54.	"New Internet Card Offers Free Access," 3 pages; The Yomiuri Shimbun/Daily Yomiuri, September 29, 1998
	55.	AAS, GISLE, MACEACHERN, DOUG; Apache.pm; 18 pages; available at < <a href="http://www.apache.org/docs">http://www.apache.org/docs</a> >.
	56.	Amended Complaint, Demand for Jury Trial; <i>IP3 Networks, Inc. vs. Nomadix, Inc.</i> ; Case No. 04 CV 1485 DMS (POR), 48 pages (including Exhibits 1-3); September 20, 2004; United States District Court, Southern District of California.
	57.	Answer and Counterclaims of Nomadix Inc. to the Amended Complaint; <i>IP3 Networks, Inc. vs. Nomadix, Inc.</i> ; Case No. 04 CV 1485 DMS (POR); 46 pages; Filed October 21, 2004; United States District Court, Southern District of California.
	58.	Avolio and Ranum, "A Network Perimeter with Secure External Access," 11 pages; Trusted Information Systems, Jan. 25, 1994
	59.	Baker et al. "Local Control Over Filtered WWW Access," 12 pages; <a href="http://www.w3.org/Conferences/WWW4/Papers/117">http://www.w3.org/Conferences/WWW4/Papers/117</a> Fourth International World Wide Web Conference Dec. 1995
	60.	BEERMAN; CORD, <i>Re: Support for cern like Pass/Fair proxy limits?</i> ; 2 pages; available at < <a href="http://www.squid-cache.org/mail-archieve/squid-users/199611/0385.html">http://www.squid-cache.org/mail-archieve/squid-users/199611/0385.html</a> > (visited 0002-01-2005)

EXAMINER SIGNATURE	DATE CONSIDERED
EXAMINER: Initial if reference considered, whether or not citation is in conformance with MPEP 609; Draw line through citation if not in conformance and not considered. Include copy of this form with next communication to applicant. <sup>1</sup> Applicant's unique citation designation number (optional). <sup>2</sup> See Kinds Codes of USPTO Patent Documents at <a href="http://www.pto.gov">www.pto.gov</a> or MPEP 901.4. <sup>3</sup> Enter Office that issued the document, by the two-letter code (WIPO standard ST.3). <sup>4</sup> For Japanese patent documents, the indication of the year of the reign of the Emperor must precede the serial number of the patent document. <sup>5</sup> Kind of document by the appropriate symbols as indicated on the document under WIPO Standard ST.16 if possible. <sup>6</sup> Applicant is to place a check mark here if English Language Translation is attached.	

Patent and Trademark Office; U.S. DEPARTMENT OF COMMERCE

FORM PTO/SB/08A/B (10-01) Substitute for PTO-1449A/B  <b>INFORMATION DISCLOSURE</b>  <b>STATEMENT BY APPLICANT</b>  (use as many sheets as necessary)	<b>Attorney Docket Number</b>	R1341006
	<b>Application Number</b>	90/009,301
	<b>Filing Date</b>	December 17, 2008
	<b>Applicant(s)</b>	Ikudome, Koichiro et al.
	<b>Group Art Unit</b>	3992
	<b>Examiner Name</b>	RIMELL, Samuel G.

OTHER DOCUMENTS		
EXAMINER INITIALS	Cite No. <sup>1</sup>	Include name of the author (in CAPITAL LETTERS), title of the article, title of the item (book, magazine, journal, serial, symposium, catalog, etc.), date, page(s), volume-issue number(s), publisher, city and/or country where published.
	61.	BERNERS-LEE, T. et al., Network Working Group, Request for Comments: 1945, "Hypertext Transfer Protocol - HTTP/1.0, " May 1996, 60 pp.
	62.	Blankers, "Network solutions for Internet access servers," 12 pages; Ericsson Review, Internet Access Servers 1998
	63.	Boutell, "CGI Programming in C & Perl," 7 pages; 1996
	64.	BRADEN, B., POSTEL, J.; <i>Requirements for Internet Gateways</i> ; June 1987; 50 pages; Network Working Group, Request for Comments 1009.
	65.	"Campus World," Presentation by Phil Moore, 1998; 15 pages
	66.	CARL-MITCHELL, SMOOT, QUARTERMAN, JOHN S.; <i>Using ARP to Implement Transparent Subnet Gateways</i> ; October 1987; 8 pages; Network Working Group, Request for Comments 1027.
	67.	Chapman and Zwicky, <i>Building Internet Firewalls</i> O'Reilly & Associates, 1995
	68.	CHATEL, M.; <i>Classical Versus Transparent IP Proxies</i> ; March 1996; 32 pages; Network Working Group, Request for Comments 1919.
	69.	Complaint, Demand for Jury Trial; <i>IP3 Networks, Inc. vs. Nomadix, Inc.</i> ; Case No. 04 CV 1485 DMS (POR); 48 pages; Filed July 23, 2004; United States District Court, Southern District of California.
	70.	D. Carrel, L. Grant, "TACACS+ Protocol Version 1.75," 40 pages; Internet Draft (TACACS+)/RFC1492; Cisco Systems; Oct. 1996
	71.	Douglas Comer, <i>Internetworking with TCP/IP</i> , 3rd ed. 1995
	72.	DROMS, R.; <i>Dynamic Host Configuration Protocol</i> ; October 1993; 35 pages; Network Working Group, Request for Comments 1531.
	73.	Duane Wessels, "Squid and ICP: Past, Present and Future," 15 pages; Aug. 16, 1997
	74.	EGEVANG, K., FRANCIS, P.; <i>The IP Network Address Translator (NAT)</i> ; May 1994; 9 pages; Network Working Group, Request for Comments 1631.
	75.	FELTON, E.W., et al., "Web Spoofing: An Internet Con Game," <i>Technical Report 540-96 (revised Feb. 1997)</i> , Department of Computer Science, Princeton University, 1996, 1997, 9 pp.
	76.	FIEDLER, D., et al., "DR. WEBSITE: Using META Tags for Identification and Control of Pages," <a href="http://www.webdeveloper.com/drweb/19971103-drweb.html">http://www.webdeveloper.com/drweb/19971103-drweb.html</a> , 11/3/1997, 4 pp.

EXAMINER SIGNATURE	DATE CONSIDERED
EXAMINER: Initial if reference considered, whether or not citation is in conformance with MPEP 609; Draw line through citation if not in conformance and not considered. Include copy of this form with next communication to applicant. <sup>1</sup> Applicant's unique citation designation number (optional). <sup>2</sup> See Kinds Codes of USPTO Patent Documents at <a href="http://www.pto.gov">www.pto.gov</a> or MPEP 901.4. <sup>3</sup> Enter Office that issued the document, by the two-letter code (WIPO standard ST.3). <sup>4</sup> For Japanese patent documents, the indication of the year of the reign of the Emperor must precede the serial number of the patent document. <sup>5</sup> Kind of document by the appropriate symbols as indicated on the document under WIPO Standard ST.16 if possible. <sup>6</sup> Applicant is to place a check mark here if English Language Translation is attached.	

Patent and Trademark Office; U.S. DEPARTMENT OF COMMERCE

FORM PTO/SB/08A/B (10-01) Substitute for PTO-1449A/B  <b>INFORMATION DISCLOSURE</b>  <b>STATEMENT BY APPLICANT</b>  (use as many sheets as necessary)	<b>Attorney Docket Number</b>	R1341006
	<b>Application Number</b>	90/009,301
	<b>Filing Date</b>	December 17, 2008
	<b>Applicant(s)</b>	Ikudome, Koichiro et al.
	<b>Group Art Unit</b>	3992
	<b>Examiner Name</b>	RIMELL, Samuel G.

OTHER DOCUMENTS		
EXAMINER INITIALS	Cite No. <sup>1</sup>	Include name of the author (in CAPITAL LETTERS), title of the article, title of the item (book, magazine, journal, serial, symposium, catalog, etc.), date, page(s), volume-issue number(s), publisher, city and/or country where published.
	77.	George, Mike, "Hardware Hustle Hits the Classroom," 3 pages; The Independent, May 20, 1996
	78.	Guido Appenzeller, Mema Roussopoulos and Mary Baker, "User-Friendly Access Control for Public Network Ports," 8 pages; IEEE Transactions, March 1999
	79.	HORNIG, CHARLES; <i>A Standard for the Transmission of IP Datagrams over Ethernet Networks</i> ; April 1984; 3 pages; Network Working Group, Request for Comments 894.
	80.	Housel and Lindquist, "WebExpress: A System for Optimizing Web Browsing in a Wireless Environment," 10 pages; Proceedings of the Second Annual International Conference on Mobile Computing and Networking, Nov. 1996
	81.	Iain Langdon, "Education for Changing Times -- An Online Learning Framework," 3 pages; WebNet 96, Oct. 15-19, 1996
	82.	INFORMATION SCIENCES INSTITUTE; <i>Internet Protocol, DARPA Internet Program, Protocol Specification</i> ; September 1981; 49 pages; available at < <a href="http://www.faqs.org/rfcs/rfc791.html">http://www.faqs.org/rfcs/rfc791.html</a> > (visited 0002-01-2005).
	83.	Invalidity Contentions of AT&T et al., Case No. <i>Linksmart Wireless Technology, LLC v. T-Mobile USA, Inc., et al.</i> , Case Nos. (consolidated) 2:08-cv-00264-DF-CE, 2:08-cv-00304-DF-CE, 2:08-cv-00385-DF-CD, 2:09-cv-00026-DF-CE, U.S. District Court, Eastern District of Texas, Marshall Division, 754 pages (including appendixes A-C), October 8, 2009
	84.	Invalidity Contentions of T-Mobile USA, Inc. et al., Case No. <i>Linksmart Wireless Technology, LLC v. T-Mobile USA, Inc., et al.</i> , Case Nos. (consolidated) 2:08-cv-00264-DF-CE, 2:08-cv-00304-DF-CE, 2:08-cv-00385-DF-CD, 2:09-cv-00026-DF-CE, U.S. District Court, Eastern District of Texas, Marshall Division, 325 pages (including appendix A), October 8, 2009
	85.	Kostick, "Building a Linux firewall," 9 pages; Linux Journal, April 1996 (accessed at <a href="http://delivery.acm.org/10.1145/330000/3255560">http://delivery.acm.org/10.1145/330000/3255560</a> )
	86.	Loon et al., "Alleviating the Latency and Bandwidth Problems in WWW Browsing," 13 pages; Proceedings of the USENIX Symposium on Internet Technologies and Systems, Monterey, California, December 1997
	87.	LUOTONEN, ARI, ALTIS, KEVIN; <i>World-Wide Web Proxies</i> ; April 1994; 8 pages.
	88.	MACEACHERN, DOUG; <i>Apache/Perl Integration Project</i> ; README; 2 pages; available at < <a href="http://apache.perl.org">http://apache.perl.org</a> > , < <a href="http://outside.organic.com/mail-archives/modperl">http://outside.organic.com/mail-archives/modperl</a> > , and < <a href="http://www.ping.de/~fdc/mod_perl">http://www.ping.de/~fdc/mod_perl</a> >.

EXAMINER SIGNATURE	DATE CONSIDERED
EXAMINER: Initial if reference considered, whether or not citation is in conformance with MPEP 609; Draw line through citation if not in conformance and not considered. Include copy of this form with next communication to applicant. <sup>1</sup> Applicant's unique citation designation number (optional). <sup>2</sup> See Kinds Codes of USPTO Patent Documents at <a href="http://www.pto.gov">www.pto.gov</a> or MPEP 901.4. <sup>3</sup> Enter Office that issued the document, by the two-letter code (WIPO standard ST.3). <sup>4</sup> For Japanese patent documents, the indication of the year of the reign of the Emperor must precede the serial number of the patent document. <sup>5</sup> Kind of document by the appropriate symbols as indicated on the document under WIPO Standard ST.16 if possible. <sup>6</sup> Applicant is to place a check mark here if English Language Translation is attached.	

Patent and Trademark Office; U.S. DEPARTMENT OF COMMERCE

FORM PTO/SB/08A/B (10-01) Substitute for PTO-1449A/B  <b>INFORMATION DISCLOSURE</b>  <b>STATEMENT BY APPLICANT</b>  (use as many sheets as necessary)	<b>Attorney Docket Number</b>	R1341006
	<b>Application Number</b>	90/009,301
	<b>Filing Date</b>	December 17, 2008
	<b>Applicant(s)</b>	Ikudome, Koichiro et al.
	<b>Group Art Unit</b>	3992
	<b>Examiner Name</b>	RIMELL, Samuel G.

OTHER DOCUMENTS		
EXAMINER INITIALS	Cite No. <sup>1</sup>	Include name of the author (in CAPITAL LETTERS), title of the article, title of the item (book, magazine, journal, serial, symposium, catalog, etc.), date, page(s), volume-issue number(s), publisher, city and/or country where published.
	89.	"Major Telecom Company launches Education Internet Service for Schools," 3 pages; Learning in a Global Information Society, Sep. 20, 1995
	90.	<i>Make users go thru login</i> , Available at <a href="http://www.microsoft.public.inetserver.iis.activeserverpages.html">http://www.microsoft.public.inetserver.iis.activeserverpages.html</a> (visited October 5, 2005 but including items dated January 19, 1998), 2 pp.
	91.	MOCKAPETRIS, P.; <i>Domain Names - Concepts and Facilities</i> ; November 1987; 49 pages; Network Working Group, Request for Comments 1034.
	92.	<i>Mod_perl.c</i> ; Copyright; 1995-1997 The Apache Group; 20 pages.
	93.	Phil C. Leveridge, "CampusWorld and BT's On-Line Education Services," 6 pages; BT Technology Journal, Vol. 15, No. 2, April 1997
	94.	Plaintiff/Counter-Defendant IPE Networks Inc.'s Reply to Defendant Nomadix, Inc.'s Counterclaim; <i>IP3 Networks, Inc. vs. Nomadix, Inc.</i> ; Case No. 04 CV 1485 DMS (POR); 8 pages; November 15, 2004; United States District Court, Southern District of California.
	95.	PLUMMER, DAVID C.; <i>An Ethernet Address Resolution Protocol or Converting Network Protocol Addresses to 48.bit Ethernet Address for Transmission on Ethernet Hardware</i> ; November 1982; 8 pages; Network Working Group, Request for Comments 826.
	96.	Poger et al., "Secure Public Internet Access Handler (SPINACH)," Proceedings of the USENIX Symposium on Internet Technologies and Systems, Monterey, California Dec. 1997; 12 pages
	97.	POSTEL, J.; <i>Multi-Lan Address Resolution</i> ; October 1984; 14 pages; Network Working Group, Request for Comments 925.
	98.	RIGNEY, C., <i>Radius Accounting</i> , Network Working Group, Request for Comments: 2139, April 1997, 25 pp.
	99.	S.D. Hubbard et al., "Firewalling the Net," 13 pages; BT Technology Journal, Vol. 15, No. 2, April 1997
	100.	STEWART, JOHN N.; <i>Working with Proxy Servers</i> ; March 1997; Pages 19-22; <u>WebServer Magazine</u> .
	101.	Stuart Elliot, "The Media Business: Advertising – Addenda; Interactive Media Begins Samplenet," 1 page; The New York Times, Jul. 17, 1995
	102.	Various Authors, <a href="http://www.squid-cache.org">www.squid-cache.org</a> , 4 pp.

EXAMINER SIGNATURE	DATE CONSIDERED
EXAMINER: Initial if reference considered, whether or not citation is in conformance with MPEP 609; Draw line through citation if not in conformance and not considered. Include copy of this form with next communication to applicant. <sup>1</sup> Applicant's unique citation designation number (optional). <sup>2</sup> See Kinds Codes of USPTO Patent Documents at <a href="http://www.pto.gov">www.pto.gov</a> or MPEP 901.4. <sup>3</sup> Enter Office that issued the document, by the two-letter code (WIPO standard ST.3). <sup>4</sup> For Japanese patent documents, the indication of the year of the reign of the Emperor must precede the serial number of the patent document. <sup>5</sup> Kind of document by the appropriate symbols as indicated on the document under WIPO Standard ST.16 if possible. <sup>6</sup> Applicant is to place a check mark here if English Language Translation is attached.	

Patent and Trademark Office; U.S. DEPARTMENT OF COMMERCE

FORM PTO/SB/08A/B (10-01) Substitute for PTO-1449A/B  <b>INFORMATION DISCLOSURE</b>  <b>STATEMENT BY APPLICANT</b>  (use as many sheets as necessary)	<b>Attorney Docket Number</b>	R1341006
	<b>Application Number</b>	90/009,301
	<b>Filing Date</b>	December 17, 2008
	<b>Applicant(s)</b>	Ikudome, Koichiro et al.
	<b>Group Art Unit</b>	3992
	<b>Examiner Name</b>	RIMELL, Samuel G.

OTHER DOCUMENTS		
EXAMINER INITIALS	Cite No. <sup>1</sup>	Include name of the author (in CAPITAL LETTERS), title of the article, title of the item (book, magazine, journal, serial, symposium, catalog, etc.), date, page(s), volume-issue number(s), publisher, city and/or country where published.
	<b>103.</b>	Welsh, "Implementing Loadable Kernal Modules for Linux," Dr. Dobb's Software Tools for the Professional Programmer, May 1995 (accessed at <a href="http://www.ddj.com">http://www.ddj.com</a> ); 9 pages
	<b>104.</b>	WESSELS, D.; <i>Squid Proxy Server Configuration File 1.932.2</i> , TAG deny_info"; March 1997; 19 pages; available at < <a href="http://www.squid-cache.org/mail-archieve/squid-users/199703/att-0250/squid.conf">http://www.squid-cache.org/mail-archieve/squid-users/199703/att-0250/squid.conf</a> >; (visited 02-01-2005).

EXAMINER SIGNATURE		DATE CONSIDERED	
EXAMINER: Initial if reference considered, whether or not citation is in conformance with MPEP 609; Draw line through citation if not in conformance and not considered. Include copy of this form with next communication to applicant. <sup>1</sup> Applicant's unique citation designation number (optional). <sup>2</sup> See Kinds Codes of USPTO Patent Documents at <a href="http://www.pto.gov">www.pto.gov</a> or MPEP 901.4. <sup>3</sup> Enter Office that issued the document, by the two-letter code (WIPO standard ST.3). <sup>4</sup> For Japanese patent documents, the indication of the year of the reign of the Emperor must precede the serial number of the patent document. <sup>5</sup> Kind of document by the appropriate symbols as indicated on the document under WIPO Standard ST.16 if possible. <sup>6</sup> Applicant is to place a check mark here if English Language Translation is attached.			

Patent and Trademark Office; U.S. DEPARTMENT OF COMMERCE



(12) **UK Patent Application** (19) **GB** (11) **2 316 841** (13) **A**

(43) Date of A Publication **04.03.1998**

(21) Application No **9718374.3**

(22) Date of Filing **29.08.1997**

(30) Priority Data

(31) **08227969** (32) **29.08.1996** (33) **JP**

(71) Applicant(s)

**Kokusai Denshin Denwa Co Ltd**

**(Incorporated in Japan)**

**3-2 Nishishinjuku 2-chome, Shinjuku-ku, Tokyo 163, Japan**

(72) Inventor(s)

**Ayumu Kubota  
Kazuki Katagishi  
Tohru Asami**

(74) Agent and/or Address for Service

**Bout Wade Tennant  
27 Furnival Street, LONDON, EC4A 1PQ,  
United Kingdom**

(51) INT CL<sup>6</sup>

**H04L 9/32**

(52) UK CL (Edition P)

**H4P PPEB  
H4L LDSC**

(56) Documents Cited

**INSPEC Abstract No.B9502-6210L-059,  
C9502-5620W-012 & Tenth Comp. Sec.  
Conference,1994,IEEE,pp212-18**

(58) Field of Search

**UK CL (Edition O) H4P PPEB  
INT CL<sup>6</sup> H04L 9/32 12/22 29/06  
Online:- WPI, INSPEC, JAPIO**

(54) **Method for controlling a firewall**

(57) When a mobile terminal 21 connected to an Internet service provider (ISP) 30 intends to access an inner network 20 within a firewall 22 via the Internet 10, the ISP sends terminal user information to the inner network. An agent host 32 investigates the Internet protocol (IP) address and the account of the terminal and determines whether the mobile terminal is a terminal moved from the inner network based on this information. If this is the case, a host 23 managing the firewall sets a filter in the firewall allowing telecommunication between the mobile terminal and the inner network. The communication between the terminal and inner network may be by means of a two-way IP tunnel 40.

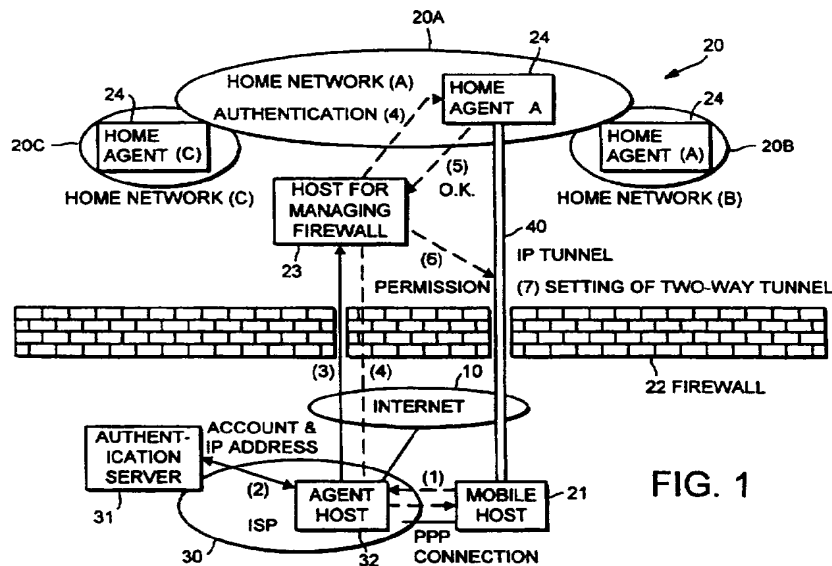

FIG. 1

At least one drawing originally filed was informal and the print reproduced here is taken from a later filed formal copy.

This print takes account of replacement documents submitted after the date of filing to enable the application to comply with the formal requirements of the Patents Rules 1995

GB 2 316 841 A

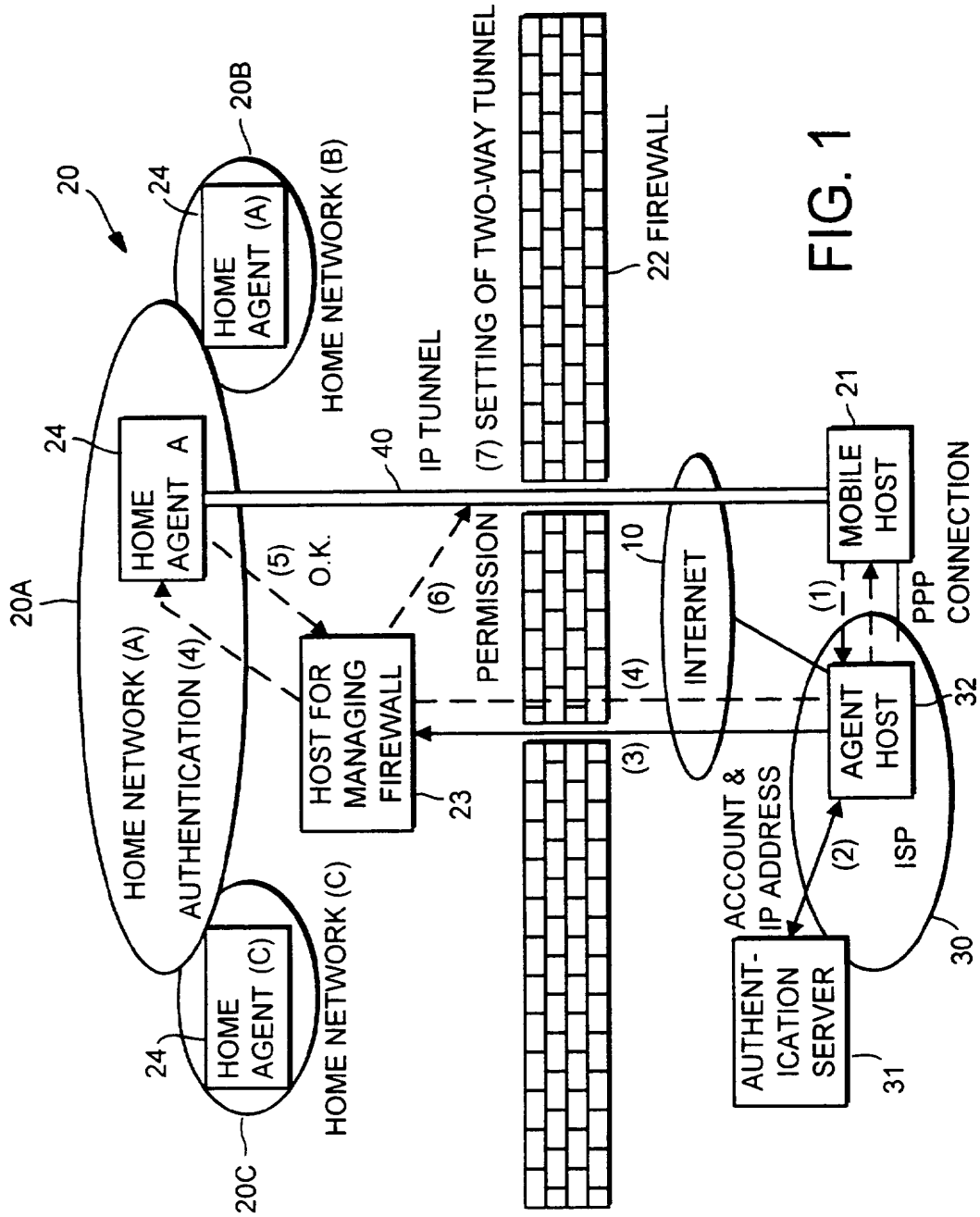
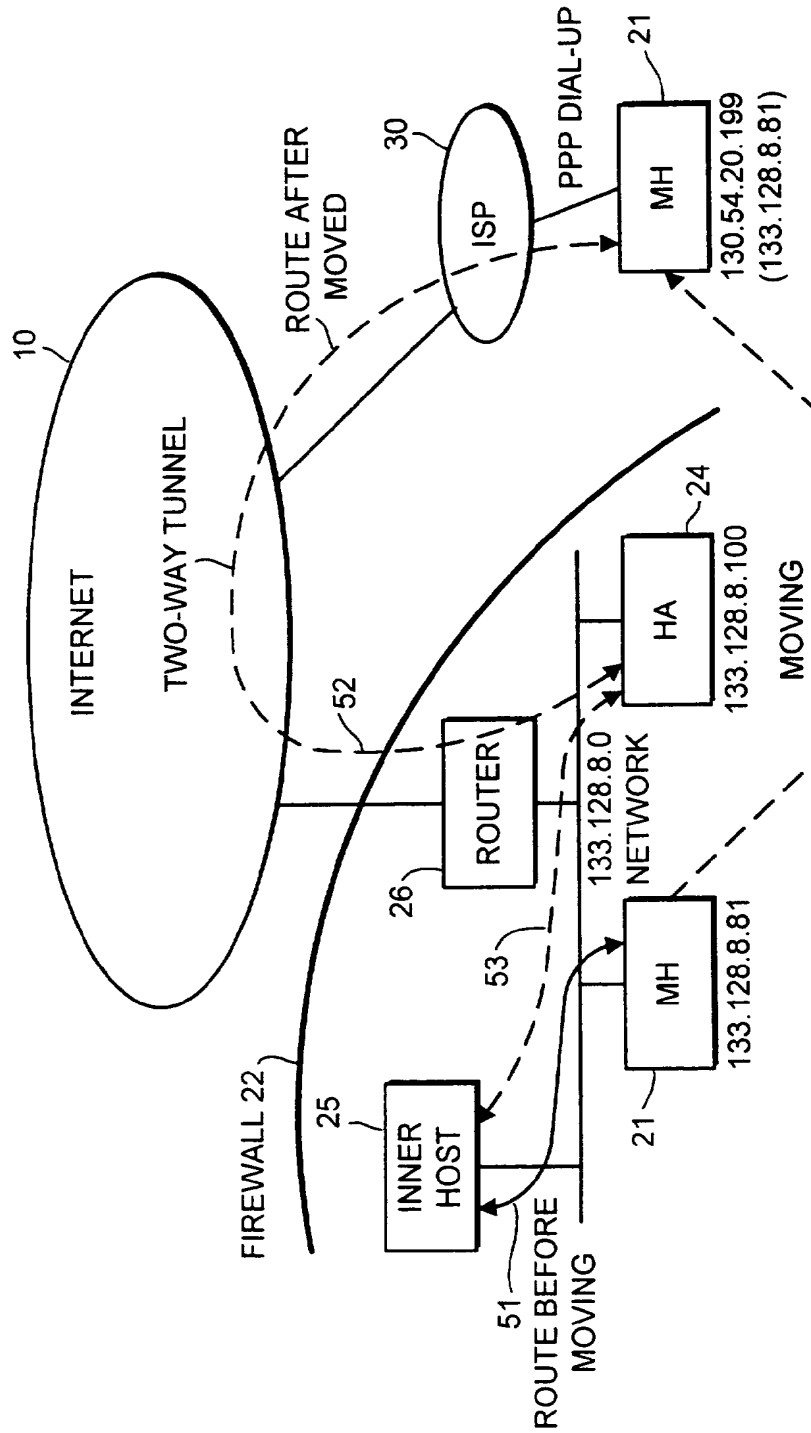

FIG. 1



**FIG. 2**

MOBILE-IP (ADAPTIVE TO FIREWALL)

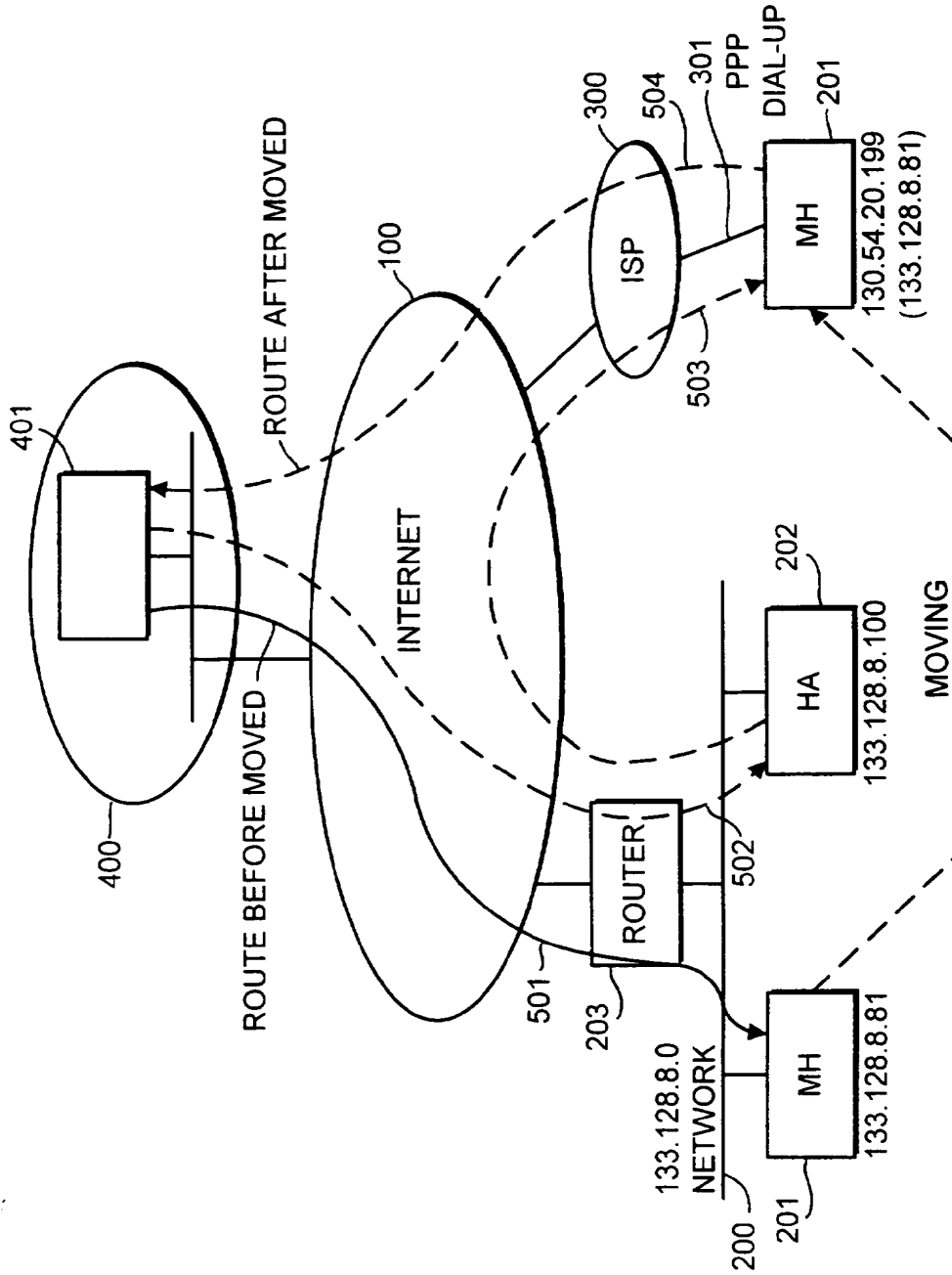

FIG. 3

PRIOR ART MOBILE-IP (NOT ADAPTIVE TO FIREWALL)

Specification

TITLE OF THE INVENTION

Method for dynamically controlling a firewall

FIELD OF THE INVENTION

This invention relates to a method for dynamically controlling a firewall.

BACKGROUND OF THE INVENTION

In a case of connecting a private network with the Internet, it is necessary to prevent a dishonest access from the Internet. However, if perfectly shut down a telecommunication between an internal network and an external network, it is impossible for a user of the internal network to access to his home network via the Internet.

Therefore, it is necessary to construct a firewall which selectively permits a telecommunication from an outside via the Internet.

In a prior art of a firewall, out of all data packets between the internal network and the external network, a previously permitted packet is only passed, but, another packet is shut down by using a filter.

Generally, such a filter is set by designating an IP (Internet Protokol) address of a terminal sending a packet, an IP address of a terminal receiving the packet, a kind of used protokol and a port number etc. For example, in a case of a telecommunication from an specific external IP address to any internal host (terminal) by using TCP (Transmission Control Protokol), a telecommunication using a specific port number (for example, 110) is permitted.

Wherein, the port number is an identifier for indicating a process of an upper layer in TCP or UDP (User Datagram Protokol).

However, it is difficult to obtain a pertinent filtering when a

user accesses to his home network, by a dial-up or ppp connection via an ISP (Internet Service Provider) at outside of the home network, by using a mobile computer such as a note-type personal computer (a note-type PC), because upper 4 digits indicates a network with which the mobile PC is connected and lower 4 digits indicates an identifier of the mobile PC in the network, while the IP address used in the Internet telecommunication is indicated by 4 bytes number.

Namely, in a case of dial-up connection by a mobile host (MH) moved from its home network, the IP address assigned to the mobile host is different every connection, then it is impossible to take a telecommunication using an IP address assigned in its home network.

Therefore, it is difficult to set a filter in the firewall by designating an IP (Internet Protokol) address of the terminal sending a data packet and an IP address of the terminal receiving the data packet, because an IP address of a moved terminal is not constant in the dial-up connection.

Furthermore, it is not always possible for the user to use inner resources (a disk, data base and WWW etc.) of the home network to which he usually accesses, even if the filter of the firewall is pertinently set and it is possible only for an authorized mobile host and its user to permit an access from outside to the home network, because an access to the inner resources is individually limited and the access is permitted or is not permitted based on an IP address of a client terminal.

Next, referring to Fig.3, a mobile-IP address is explained, the mobile-IP is under work for standardization.

The mobile IP is a technique which enables to use a same IP address to the mobile terminal which moves anywhere, whenever the mobile terminal connects the Internet.

However, now, the mobile-IP is not adaptive to a network having the firewall.

In Fig.3, 100 denotes the Internet, 200 denotes a home network of a mobile terminal 201, 202 denotes a home agent (HA) on the home network 200, 203 denotes a router, 300 denotes an ISP, 400 denotes another network and 401 denotes a terminal on the network 400.

In Fig.3, an IP address of the home network 200 to which the mobile terminal 201 is usually connected is [133.128.8.0], an IP address of the mobile terminal 201 on the home network 200 is [133.128.8.81], an IP address of the home agent 202 is [133.128.8.100], and, an IP address of the mobile terminal 201 is [130.54.20.199] which is assigned by the ISP when the terminal 201 connects to the ISP by dial-up connection.

Generally, when a packet is sent from the terminal 401 on the network 400 to the terminal 201, as a rout 501 shown in Fig.3, the packet is transferred to the home network 200 to which the terminal 201 is usually connected. Therefore, when the terminal has been moved to another network, for example the ISP 300, it is necessary to transfer the packet to the network 300.

For transferring the packet, in the mobile-IP, an agent host is respectively provided to the network from which the mobile terminal is moved and the network to which the mobile terminal is moved. The agent in the network from which the mobile terminal is moved is called as a home agent and the agent in the network to which the mobile terminal is moved is called as a foreign agent. It is possible that the mobile terminal has a function of the foreign agent. In Fig.3, the mobile terminal 201 has a function of the foreign agent.

When the terminal 201 moved from its home network 200 connects to the ISP 300 by dial-up connection 301, a temporary IP address [130.54.2

0.199] is assigned to the terminal 201 by the ISP.

The IP address [130.54.20.199] of the mobile terminal 201 and its IP address [133.128.8.81] in the home network 200 are informed to the home agent 202 in the home network 200 via the ISP and the Internet100.

Then, the home agent 202 records that the terminal 201 having the IP [133.128.8.81] is moving and its temporary IP address is [130.54.20.199] in its data base, based on the received information.

When a packet is sent from the terminal 401 in the network 400 to the terminal 201 by using the usual IP address [133.128.8.81], as shown by route 502, the home agent 202 receives the packet instead of the mobile terminal 201. Then, as shown by the route 503, the home agent 202 transfers the packet from the terminal 401 to the mobile terminal 201 via the Internet 100 and the ISP 300 to the mobile terminal 201, by embedding the packet from the terminal 401 into a packet forwarded to the temporary IP address [130.54.20.199]. The mobile terminal 201 obtains the original packet of the terminal 401 from the received packet, if necessary, as shown by the route 504, any packet to the terminal 401 via the ISP and the Internet.

As mentioned-above, in the mobile-IP, it is possible to a packet from the terminal 401 to the mobile terminal 201 by using the usual IP address [133.128.8.81].

However, the telecommunication using the temporary IP address [130.54.20.199] is necessary between the mobile terminal 201 and the home agent 202.

Namely, in the mobile-IP, since any process is not applied to the packet send from the mobile terminal 201, an usual routing is necessary.

Therefore, it is impossible for the mobile terminal 201 to another terminal inside the home network 200 except for the home agent 202 under the above-mentioned firewall, because only the telecommunication



between the mobile terminal 201 and the home agent 202 is allowed. This means that the mobile terminal 201 is limited to access to the resource of its home network 200.

An object of the present invention is to provide a method for dynamically controlling a firewall which enables to set a filter pertinent to the mobile terminal being connected with the ISP (Internet Service Provider) by the dial-up connection and its user.

An object of embodiments of the present invention is to provide a method for dynamically controlling a firewall which enables to pertinently permit that said mobile terminal and its user access to the resource of the home network from outside.

The present invention enables to set a pertinent filter by obtaining a user information from an Internet service provider. Embodiments of the present invention resolve an limitation of an access to a resource of a home network by combining the filter setting with a mobile-IP.

According to the present invention there is provided a method for enabling a pertinent filter comprising the steps of:

a step for sending a user information of a terminal being connected to an internet service provider by dial-up connection to an inner network inside a firewall from said internet service provider when said terminal accesses to said inner network via the Internet.

a step that said inner network determines whether said terminal is a mobile terminal moved from said inner network, based on said user information;

a step for setting a filter of said firewall to permit a telecommunication between said terminal when said terminal is said mobile terminal moved from said inner network.

In a method embodying the present invention, for resolving an limitation of an access, further an

IP tunnel is used after setting of said filter for a telecommunication between said terminal and inner network.

In another embodiment for resolving an limitation of an access, said user information is transferred between an agent host provided in said internet service provider and a host for managing said firewall which sets said filter of said firewall provided in said inner network, and said telecommunication using said IP tunnel is done between said terminal and a home agent provided in said inner network.

#### BRIEF DESCRIPTION OF THE DRAWINGS

Fig. 1 shows a configuration of a system to which a method embodying the present invention is applied.

Fig. 2 shows a mobile-IP which is adaptive to a firewall.

Fig. 3 shows an prior art mobile-IP which is not adaptive to a firewall.

#### DETAILED DESCRIPTION OF PREFERRED EMBODIMENTS

An embodiment of the present invention will be explained referring to the drawings.

In Fig. 1, 10 denotes the Internet, 20 denotes an inner network having plural home networks 20A, 20B and 20C, 21 denotes a mobile terminal which is usually connected to the inner network 20, 22 denotes a firewall, 23 denotes a host for managing the firewall, 24 denotes a home agent provided in each of home networks 20A, 20B and 20C,

30 denotes an ISP (Internet Service Provider), 31 denotes a server for authentication in the ISP, 32 denotes an agent host in the ISP.

The mobile terminal 21 has a function of a foreign agent for mobile-IP. The mobile terminal 21 is intended to connect the inner network 20 via the Internet, by dial-up connection to the ISP at any location after moving from the home network.

In this embodiment, a mechanism for controlling the firewall based

on a user information obtained from the ISP and a mobile-IP mechanism adaptive to the firewall are provided.

The mechanism for controlling the firewall 22 based on the user information obtained from ISP 30 will be explained referring to Fig.1.

A user account (ID) and a pass word are input to the ISP 30, when a user of the mobile terminal 21 intends to connect to the ISP 30 by the dial-up connection. In the ISP 30, the authentication server 31 determines whether the user input data are proper or not. Only when the user input data are proper, an IP address is assigned to the mobile terminal 21, then the mobile terminal 21 is connected to the Internet 100. For this purpose, the ISP 30 can always grasp which user is connecting to the ISP 30 based on the user information and which IP address is assigned to the mobile terminal 21.

When the inner network 20 can know the user and an IP address used by the user, by obtaining the user information from the ISP 30, it is possible to properly set the filter. Then, it is possible to permit a telecommunication from a user who is previously allowed to access to the inner network 20 and to exclude an access from a user who has not authority for the access.

In Fig.1, a mechanism for adding and/or deleting a filter is provided, by providing the host 23 for managing the firewall within the inner network 20. Further, the agent host 32 is provided within the ISP so that only the telecommunication between the agent host 32 and the host 23 for managing the firewall can be allowed. Since the hosts 23 and 32 can use a fixed IP address for this telecommunication, there is no problem on setting the filter for the firewall.

Concretely, the filter is set by the following steps (1)~(7).

The step (n) corresponds to an symbol (n) in Fig,1.

(1) When the mobile terminal 21 intends to access to the inner network

20 from outside of it, the mobile terminal 21 requests an establishment of the connection between the mobile terminal 21 and the inner network 20 via the the agent host 32 in the ISP.

(2) The agent host 32 investigates an IP address and an account at dial-up connection of the mobile terminal 21.

(3) The agent host 32 relays a message from the mobile terminal 21 to the host 23 for managing the firewall, only when the mobile terminal 21 is connected by using a specific account which is allowed to access inside the firewall 22.

(4) An authentication is done by end-to-end method between the mobile terminal 21 and the home agent 24 via the host 23 for managing the firewall, because, in mobile-IP, an authentication must be done between the mobile terminal and the home agent.

(5) If the authentication is successful, the home agent sends a message of the success to the host 23 for managing the firewall.

(6) Then, the host 23 for managing the firewall changes the setting of the firewall 22 so as to permit the telecommunication between the mobile terminal 21 and the home agent 24.

(7) At the time when the host 23 for managing the firewall enables the telecommunication between the mobile terminal 21 and the home agent 24 by changing the setting of the firewall 22, the host 23 informs it to the home agent 24 and the host 23 informs it to the mobile terminal 21 via the agent host 32. After receiving the message, the home agent 24 sets an IP tunnel to the mobile terminal 21 and the mobile terminal 21 sets an IP tunnel to the home agent 24, then a two-way IP tunnel 40 is set.

By using the two-way IP tunnel 40, the mobile terminal 21 telecommunicates with each terminal of the inner network 20. Wherein, the mobile terminal 21 periodically sends a message for maintaining the

connection to the host 23 for managing the firewall. When the message for maintaining the connection from a certain mobile terminal stops, the host 23 for managing the firewall automatically deletes the filter setting to the mobile terminal.

As mentioned above, it is possible to set the firewall 22 only within a necessary term and only for the telecommunication of which start point and end point are distinctly restricted.

A specification of the mobile-IP which is under work for standardization is not adaptive to the network 20 having the firewall 22.

Then, the mobile-IP is improved to adapt to the firewall 22 as follows, and the improved mobile-IP is combined with the above-mentioned filter setting.

An combination of the mobile-IP and the dynamic firewall control will be explained referring to Fig.2.

As a route 52 shown in Fig.2, a packet from the mobile terminal 21 to the terminal 25 inside the firewall 22 is embedded in a packet to the home agent 24, then sent out. The home agent 24 obtains an original packet out of the received packet. The home agent 24 sends the obtained packet to the inner terminal 25, as a route 53 shown in Fig.2, by sends again the obtained packet to the Internet. In Fig.2, 26 denotes a router. When the mobile terminal exist in the inner network 20, the mobile terminal 21 telecommunicates with the inner terminal 25 via a route 51.

As mentioned-above, even if an authority is individually allowed in the inner network 20, it is possible to permit the access based on the IP address of the mobile terminal 21 which is usually connected with the network 20 by using the two-way tunnel between the mobile terminal 21 and the home agent 24. Therefore, it is possible to

communicate between the mobile terminal 21 and the inner terminal 25.

According to the present invention, it is possible to set the firewall so as to permit the communication from the specific user in connection with the ISP by dail-up connection.

Further, according to embodiments of the present invention, because of an improvement and an combination of the mobile-IP, it is possible to access to the resources of the inner network from outside as same as connected with the inner network.

WHAT IS CLAIMED IS:

1. A method for dynamically controlling a firewall comprising steps of:

a step for sending a user information of a terminal being connected to an internet service provider by dial-up connection to an inner network inside a firewall from said internet service provider when said terminal accesses to said inner network via the Internet;

a step that said inner network determines whether said terminal is a mobile terminal moved from said inner network, based on said user information;

a step for setting a filter of said firewall to permit a telecommunication between said terminal when said terminal is said mobile terminal moved from said inner network.

2. The method claimed in claim 1 wherein, an IP tunnel is used after setting of said filter for a telecommunication between said terminal and said inner network.

3. The method claimed in claim 2 wherein, said user information is transferred between an agent host provided in said internet service provider and a host for managing said firewall which sets said filter of said firewall provided in said inner network, and said telecommunication using said IP tunnel is done between said terminal and a home agent provided in said inner network.

4. A method for dynamically controlling a firewall substantially as hereinbefore described with reference to the accompanying drawings.



12

**Application No:** GB 9718374.3  
**Claims searched:** 1-4

**Examiner:** Matthew Nelson  
**Date of search:** 20 November 1997

**Patents Act 1977  
Search Report under Section 17**

**Databases searched:**

UK Patent Office collections, including GB, EP, WO & US patent specifications, in:  
UK Cl (Ed.O): H4P (PPEB)  
Int Cl (Ed.6): H04L 9/32, 12/22, 29/06  
Other: Online:- WPI, JAPIO, INSPEC

**Documents considered to be relevant:**

Category	Identity of document and relevant passage	Relevant to claims
X	INSPEC Abstract No. B9502-6210L-059, C9502-5620W-012 & "Tenth Annual Computer Security Applications Conference", published 1994, IEEE, pp212-18, Goldberg "The MITRE security perimeter" (see abstract).	

X	Document indicating lack of novelty or inventive step	A	Document indicating technological background and/or state of the art.
Y	Document indicating lack of inventive step if combined with one or more other documents of same category.	P	Document published on or after the declared priority date but before the filing date of this invention.
&	Member of the same patent family	E	Patent document published on or after, but with priority date earlier than, the filing date of this application.



PCT

WORLD INTELLECTUAL PROPERTY  
International Bureau

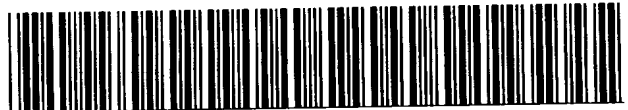

INTERNATIONAL APPLICATION PUBLISHED UNDER T

WO 9605549A1

<p>(51) International Patent Classification <sup>6</sup> : <b>G06F 1/00</b></p>	<p><b>A1</b></p>	<p>(11) International Publication Number: <b>WO 96/05549</b>   (43) International Publication Date: 22 February 1996 (22.02.96)</p>
<p>(21) International Application Number: PCT/US95/08900  (22) International Filing Date: 14 July 1995 (14.07.95)   (30) Priority Data:  08/287,790                      9 August 1994 (09.08.94)                      US   (71) Applicant: SHIVA CORPORATION [US/US]; Northwest Park, 63 Third Avenue, Burlington, MA 01803 (US).   (72) Inventors: HOROWITZ, Michael, Alan; 578 Centre Street, Newton, MA 02158 (US). RODWIN, Andrew, S.; 126 Box Mill Road, Boxborough, MA 01719 (US). WENOCUR, Jonathan, H.; 140 Kilsyth Road, No 4, Brighton, MA 02146 (US).   (74) Agent: TOSTI, Robert, J.; Testa, Hurwitz &amp; Thibeault, High Street Tower, 125 High Street, Boston, MA 02110-2711 (US).</p>	<p>(81) Designated States: AM, AU, BB, BG, BR, BY, CA, CN, CZ, EE, FI, GE, HU, IS, JP, KG, KP, KR, KZ, LK, LR, LT, LV, MD, MG, MN, MX, NO, NZ, PL, RO, RU, SG, SI, SK, TJ, TM, TT, UA, UZ, VN, European patent (AT, BE, CH, DE, DK, ES, FR, GB, GR, IE, IT, LU, MC, NL, PT, SE), OAPI patent (BF, BJ, CF, CG, CI, CM, GA, GN, ML, MR, NE, SN, TD, TG), ARIPO patent (KE, MW, SD, SZ, UG).</p> <p><b>Published</b>  <i>With international search report.  Before the expiration of the time limit for amending the claims and to be republished in the event of the receipt of amendments.</i></p>	

(54) Title: APPARATUS AND METHOD FOR RESTRICTING ACCESS TO A LOCAL COMPUTER NETWORK

(57) Abstract

A remote access server limits access to a local computer network. The server includes at least one communication port for allowing communication with a remote computer and at least one network port for coupling to a local computer network to allow communication with the local computer network. The server also includes processing electronics which control the communication and network ports. The processing electronics also receive a user identification string from the communication port. The string having been entered by a remote user at a remote computer, and it identifies the remote user. The server uses the string to access a database and determine at least one access filter associated with the string. The access filter is used to prevent the remote computer from communicating with at least one predetermined resource on the local computer network. The database includes a user identification string for each remote user and at least one access filter for each user identification string. The server allows the remote computer to access the local computer network and to communicate on the local computer network, but the remote computer is prevented from communicating with the predetermined resource because of the access filter associated with the remote user.

**FOR THE PURPOSES OF INFORMATION ONLY**

Codes used to identify States party to the PCT on the front pages of pamphlets publishing international applications under the PCT.

AT	Austria	GB	United Kingdom	MR	Mauritania
AU	Australia	GE	Georgia	MW	Malawi
BB	Barbados	GN	Guinea	NE	Niger
BE	Belgium	GR	Greece	NL	Netherlands
BF	Burkina Faso	HU	Hungary	NO	Norway
BG	Bulgaria	IE	Ireland	NZ	New Zealand
BJ	Benin	IT	Italy	PL	Poland
BR	Brazil	JP	Japan	PT	Portugal
BY	Belarus	KE	Kenya	RO	Romania
CA	Canada	KG	Kyrgyzstan	RU	Russian Federation
CF	Central African Republic	KP	Democratic People's Republic of Korea	SD	Sudan
CG	Congo	KR	Republic of Korea	SE	Sweden
CH	Switzerland	KZ	Kazakhstan	SI	Slovenia
CI	Côte d'Ivoire	LI	Liechtenstein	SK	Slovakia
CM	Cameroon	LK	Sri Lanka	SN	Senegal
CN	China	LU	Luxembourg	TD	Chad
CS	Czechoslovakia	LV	Latvia	TG	Togo
CZ	Czech Republic	MC	Monaco	TJ	Tajikistan
DE	Germany	MD	Republic of Moldova	TT	Trinidad and Tobago
DK	Denmark	MG	Madagascar	UA	Ukraine
ES	Spain	ML	Mali	US	United States of America
FI	Finland	MN	Mongolia	UZ	Uzbekistan
FR	France			VN	Viet Nam
GA	Gabon				

APPARATUS AND METHOD  
FOR RESTRICTING ACCESS TO A LOCAL COMPUTER NETWORK

5                   Field of the Invention

This invention relates to an apparatus and method for restricting a remote user's access to a local computer network, and more particularly to a remote access server which restricts the access.

10

Background of the Invention

The client-server computer networking model allows organizations of all sizes to utilize group productivity products such as e-mail. Many business  
15 organizations have grown to rely heavily on network services. Employees who travel typically need to access the same network services and resources provided to them at work. Field offices also frequently need to access the headquarter's network services. The term  
20 "telecommuter" has been used to describe an employee who stays at home and conducts business by accessing the network services provided at the traditional worksite. These types of users are sometimes referred to as "remote" because they typically are located in a  
25 physically remote place from the networks and because they do not connect to the networks locally or directly. Remote users typically connect to the networks via telephone lines. The terms "remote access" and "remote networking" are used to identify  
30 the situation in which a remote user accesses a computer network over analog or digital telephone lines.

A remote user generally can utilize any type of

- 2 -

computer to access the network. The computer can be, for example, a personal computer, a workstation, or a portable computer such as a laptop computer or a notebook computer. Also, the computer can be, for  
5 example, an IBM PC or compatible, an Apple Macintosh, or a Unix-based computer. The user typically connects a modem or similar communication device to a serial  
10 port of the computer. The modem connected to the user's remote computer communicates over the telephone lines with another modem which is coupled to a server. The other modem and the server are located at the network which the remote computer is attempting to  
15 access. The server is coupled directly to the network. It is the server which provides the remote computer with controlled access to the network and the services  
20 and resources thereon. The server is referred to as a "remote access server," and it typically includes a serial port for connecting to the other modem, a port for connecting to the network, and electronics which  
include at least a microprocessor and memory.

It is desirable for the remote access server to have a variety of features. For example, the remote access server should make accessing the network  
25 transparent to the remote user. The remote access server also should be easy for a network manager to install and maintain.

- 3 -

Summary of the Invention

It is an object of the invention to provide a remote access server which allows one or more remote computers to access simultaneously a local computer network, even if each of the remote computers employs a different protocol (e.g., IPX, TCP/IP, AppleTalk, NetBEUI, or 802.2/LLC).

It is another object of the invention to provide a remote access server which provides user authentication and security features. One aspect of these features is that the server can restrict access to the network on a per-user basis. The remote access server controls a remote user's access to the various network services and resources by locating and utilizing one or more access filters for that remote user. The server ensures that each remote user has a particular set of access filters assigned to him or her every time that remote user makes a remote access connection to the network via the server, even though that remote user may utilize a different remote computer every time a remote access connection is made. The server uses a user identification string, which is entered into the remote computer by the remote user, to retrieve from a server-internal or server-external database the access filters associated with that remote user. The database typically is centrally maintained by a network manager with authority to add and delete remote users and access filters.

The remote access server uses the access filters to control the remote users' access to the network and the services, resources, and devices available thereon. The server typically limits a remote user's network access to one or more network "zones" and/or one or more network devices. Zones are pre-defined groups of

- 4 -

devices on the network, and devices can include  
computers coupled directly to the local network,  
various servers (e.g., e-mail, database, etc.) and  
various other network nodes such as printers and  
5 plotters.

Because it has the power to control a remote user's  
access to the resources of the network, the remote  
access server can ensure that only certain remote users  
are allowed access to certain resources of the network,  
10 such as only those resources listed in the database.  
If the server locates an access filter for a remote  
user which indicates that the remote user should not  
have access to a particular zone or device, that remote  
user will not be allowed to communicate with that zone  
15 or device regardless of the remote computer used in the  
attempt to gain access. The remote user will, however,  
be able to communicate with other non-restricted parts  
of the network. The network restrictions are done by  
the remote access server on a per-user basis. The  
20 remote access server will identify and use access  
filters for each remote user which attempts to gain  
access to the network via the server.

Per-user assignment of access filters is very  
different from other network restriction techniques  
25 such as per-port schemes and per-server schemes. With  
per-port filter assignment, each port of the server has  
one or more filters associated therewith and those  
filters are assigned to whichever remote computer  
happens to communicate through that port. With per-  
30 server filter assignment, the server has one or more  
filters associated therewith and those filters are  
assigned to whichever remote computers dial into that  
server. Both the per-port and per-server schemes,  
unlike per-user, do not provide a correspondence

- 5 -

between a remote user and a set of access filters. These two other schemes do not, unlike per-user, tie network access restriction to remote user identity. It therefore is not possible with either per-port or per-  
5 server to control network access precisely, as it is with per-user which is based on the identity of the remote user.

Other objects, aspects, features, and advantages of the invention will become apparent from the following  
10 description and from the claims.

- 6 -

Brief Description of the Drawings

In the drawings, like reference characters generally refer to the same parts throughout the different views. Also, the drawings are not  
5 necessarily to scale, emphasis instead generally being placed upon illustrating the principles of the invention.

FIG. 1 is a diagram of a remote access system in which a remote access server according to the invention  
10 provides a remote user at a remote computer with access to a local computer network.

FIG. 2 is a diagram of a remote access system shown in more detail than the system shown in FIG. 1.

FIG. 3 is a flowchart of the steps a remote access  
15 server performs in order to provide a remote user at a remote computer with access to a local computer network according to the invention.

FIG. 4 is a block diagram showing major components of a remote access server according to the invention.



- 7 -

Description

Referring to FIG. 1, in a remote access system 10, a remote computer 12 is allowed access to a local computer network 14 by a remote access server 16. As  
5 will be described in more detail later with reference to FIG. 4, the remote access server 16 is itself a powerful programmable computer. In the disclosed embodiment, the remote access server 16 is a LanRover which is available from Shiva Corporation of  
10 Burlington, MA. A remote user 18 at the remote computer 12 initiates an attempt to gain access to the network 14 (and the network services and resources available thereon) via the remote access server 16 by entering a user identification (ID) string 20 into the  
15 remote computer 12. The user ID string is a pre-determined code which uniquely identifies the remote user, and it typically is assigned to the remote user by a network manager who has central control of and responsibility for the network 14 and the maintenance  
20 thereof.

The user ID string 20 entered by the remote user 18 is sent by the remote computer 12 to the remote access server 16 over telephone lines 22. The term telephone lines 22 is used herein to mean any digital and/or  
25 analog communication link or links used to transmit voice and/or data including wireless and cellular data links such as Cellular Digital Packet Data (CDPD). In the disclosed embodiment, a modem 24 is connected to the remote computer 12, and another modem 26 is  
30 connected to the remote access server 16. The modems 24, 26 allow the remote computer 12 and the remote access server 16 to communicate over the telephone lines 22. Note that the modem 26 connected to the remote access server 16 could be part of the

- 8 -

server 16 (e.g., included within the server housing), as indicated by the dotted-line box 28 enclosing the server 16 and the modem 26 connected thereto. Also note that the modems 24, 26 could be Integrated Services Digital Network (ISDN) terminal adapters if the telephone lines 22 are the ISDN, or the modems 24, 26 could be any of a variety of other switched-access devices.

The remote access server 16 receives the user ID string 20 which was entered by the remote user 18 and sent by the remote computer 12. An optional user authentication procedure may occur at this time where a remote user proves his or her identity by entering a password, by reference to an authentication server database, or by any other method. Once the remote user is authenticated, that remote user is granted access to the network. Further authorization may occur in order for an authenticated user to become an authorized user and be granted access to specific network services. In any event, the server 16 uses the user ID string 20 to index into a database 30 and retrieve one or more access filters associated with the user ID string 20. The server 16 uses these access filters to control the remote user's access to the network 14 and the network services and resources available thereon. The database 30 can be resident in the remote access server 16, or it can be maintained on a node (e.g., a database server) on the network 14. The database 30 includes a unique user ID string for each remote user and at least one access filter for each user ID string. The database 30 typically is maintained by a network manager who has central control of and responsibility for the network 14 and the maintenance thereof. The network manager generally controls (e.g., has the

- 9 -

authority and ability to define, add, and delete) remote user names and access filters.

After the remote access server 16 identifies the access filters for this remote user based on the user  
5 ID string 20, the server 16 uses the filters to limit the remote user's network access. Every time the remote computer 12 attempts to communicate on the network 14 via the remote access server 16, the server 16 uses the access filters for that remote user  
10 to prevent the remote user from communicating with whatever network resources the filters indicate are off-limits to that remote user.

An access filter can be data packets or words which identify particular network resources such as zones or  
15 devices. A zone is a pre-defined group of devices on the network 14. A network device can include computers coupled directly to the local network 14, various servers (e.g., e-mail, database, etc.) coupled directly to the local network 14, and various other nodes on the  
20 network 14 such as printers and plotters. Whatever the network resource or resources identified in the access filter, the filter is used by the server 16 to prevent the remote user's remote computer 12 from communicating with the resource(s). Because the database 30 contains  
25 a particular set of access filters for certain remote users, the server 16 is able to match one or more filters to each access attempt by those remote users and to limit the network access of those remote users if the filters so dictate.

30 Filters are protocol dependent and generally employ a look-up service that functions in the following manner. Various network services advertise their presence on the network. Requests for access to network services are processed by the remote access

- 10 -

server. The remote access server refers to another network server that contains an access list. If the user is identified as authorized by the access list, access is granted, otherwise services are simply not  
5 identified as being available to the requesting user.

In general, the remote access server 16 will not restrict network access unless the user ID string 20 entered by the remote user 18 at the remote computer 12 corresponds to one or more access filters in the  
10 database 30. That is, if the remote access server 16 searches the database 30 but fails to find any access filters associated with the user ID string 20 which the remote user 18 entered at the remote computer 12 (because, for example, the user ID string 20 is in the  
15 database 30 but there is no associated access filters listed in the database 30), the remote access server 16 will not limit the network access for that remote user, and thus that remote user will be able to communicate freely on the network 14. In this situation, the  
20 remote access server 16 will pass all data packets from the remote computer 12 or the remote user 18 on to the network 14.

The remote access server 16 ensures that each remote user 18 whose network access should be  
25 restricted as indicated by the access filters in the database 30 is in fact so restricted every time that remote user 18 makes a remote access connection to the network 14 via the server 16, even though that remote user 18 may utilize a different remote computer 12  
30 every time a remote access connection is made. By linking network access to the identity of the individual remote users, the remote access server 16 can effectively restrict remote users' network access to only those network resources authorized by a central

- 11 -

controller (i.e., the network manager who maintains the database 30).

The remote access system 10 shown generally in FIG. 1 is shown in more detail in FIG. 2. Referring to FIG. 2, the remote computer 12 is a portable laptop computer. In general, the remote computer 12 can be any type of portable computer (e.g., a laptop or a notebook), workstation, or personal computer (e.g., an IBM PC or compatible, an Apple Macintosh, or a Unix-based computer). The remote computer 12 generally must be able to function as a stand-alone computer system when not connected to a network, and as a full network node when it is dialed-in to the network 14 through the remote access server 16. For a remote Macintosh system, it generally is preferred that the computer have a 25 MHz 68030 processor. For a remote PC system, it generally is preferred that the computer have at least a 25 MHz 486 processor.

The remote access system 10 described herein is not to be confused with a remote control system. In a remote control system, a remote user dials-in to the local network with his or her remote computer and takes control of a local computer on the network. Once the remote user's remote computer is connected to the local network in a remote control system, the remote user actually uses the local computer, not the remote computer. That is, only user-interface data (e.g., screen images and keyboard/mouse input) are transferred to the remote computer from the local computer; the remote computer acts as a dumb terminal in a remote control system.

A remote control system is very different from the remote access system 10. In the remote access system 10, the remote computer 12 must perform

- 12 -

adequately by itself, with enough processing power, memory, and disk storage space to run (on the remote computer 12 itself) the remote user's chosen applications without relying upon the on-network communication speed which typically is much higher than the speed of the telephone line link 22. Some telephone lines 22 allow speeds of up to 28.8 kilobits per second whereas the local computer network 14 can operate in ranges from 1 to 100 megabits per second depending on the type of network. The local computer network 14 can be, for example, Ethernet or Token Ring.

The remote computer 12 typically will have a serial port 32 which is managed by a serial controller such as a 16550A serial controller chip which can receive or transmit up to sixteen characters without intervention from the central processing unit (CPU) of the remote computer 12. The modem 24 connected to the serial port 32 can be, for example, a 2400 bits per second or faster Hayes or Hayes compatible modem. A rate of 9600 bits per second or above is recommended for the modem 24. The modem 24 also can be, for example, a V.32bis modem (14.4 kilobits per second) or an ISDN terminal adapter. The other modem 26 (which is not shown in FIG. 2 because it is internal to the remote access server 16) is selected to operate properly given the telephone lines 22 employed and the modem 24 connected to the serial port 32.

The network services and resources available on the network 14 which the remote user 18 might access via the remote access server 16 can include, for example, a Notes Server 46, an E-Mail Server 48, and a Database Server 50. The Database Server 50 can be used to maintain the database 30 of user names and access filters which was described previously with reference

- 13 -

to FIG. 1.

The remote computer 12 can be loaded with network application software 34 and remote access client software 36. The remote access client software 36 can  
5 allow, for example, a Macintosh computer to use AppleTalk Remote Access (ARA), a Unix-based computer to use a Point-to-Point Protocol (PPP) implementation, and a PC-based computer to use any standard (if any) or vendor-supplied remote access clients. Briefly, a  
10 remote access client includes a "dialer" which establishes and terminates the remote access connection and a "driver" which interfaces with the network protocol stacks and the serial port 32 to send and receive network data. The remote access client can  
15 operate with a variety of protocols including IPX, TCP/IP, NetBEUI, LLC/802.2, and AppleTalk. Novell's IPX is the native protocol for NetWare. TCP/IP is widely used in Unix-based systems and client-server databases, and TCP/IP also is becoming standard for  
20 many other applications. NetBEUI is used for LAN Manager and Microsoft's Windows for Workgroups. LLC/802.2 is for IBM LAN Server and host connectivity. The combination of AppleTalk and TCP/IP covers almost all Macintosh applications.

25 The performance of the remote access server 16 is primarily determined by the ability to move data through its serial ports (shown in FIG. 4 but not in FIG. 2) without much attention from its CPU (also shown in FIG. 4 but not in FIG. 2). The performance of the  
30 server 16 also is determined by its CPU's ability to perform the routing, filtering, IP address tracking, etc. that the CPU must do without adding undue delays as it forwards data packets. The server 16 thus has generally been optimized for serial port throughput and

- 14 -

general CPU power. Because the server 16 must be highly reliable and efficient, it includes solid-state, non-volatile storage for the controlling software. The software is upgradeable via downloading from the  
5 network 14 to the server 16. The network manager can perform any upgrades.

The software in the remote access server 16 causes the server 16 to perform the various functions described herein, although it should be noted that it  
10 is possible to use dedicated electronic hardware to perform all server functionality described herein. The steps which the server performs in order to control a remote user's access to a local computer network according to the invention are shown in FIG. 3.

15 Referring to FIG. 3, it is first necessary to set-up the connections by coupling a communication port of the remote access server to the telephone lines (step 52) and coupling a network port of the remote access server to the local computer network (step 54).  
20 The server is now ready to receive a dial-in from a remote computer over the telephone lines and to communicate on the local network. After the remote access server is set-up, the remote user can cause the remote computer to dial-in and connect to the server  
25 over the telephone lines. The remote user then enters into the remote computer a user ID string which the remote computer sends to the server over the telephone lines. The user ID string uniquely identifies that remote user. The remote access server receives the  
30 user ID string from the communication port (step 56). Note that after step 56, an optional user authentication procedure may occur where a remote user proves his or her identity by entering a password, by reference to an authentication server database, or by



any other method. Once the remote user is authenticated, that remote user is granted access to the network. Further authorization may occur in order for an authenticated user to become an authorized user and be granted access to specific network services. In any event, the remote access server then uses the received user ID string to perform a look-up in the database of user ID strings and access filters (step 58). The remote access server retrieves from the database one or more access filters associated with the user ID string, if any (step 60). The remote access server then allows the remote computer to access the local computer network and to communicate on the network, but the server uses the access filter(s) to prevent the remote computer from communicating with the network resource(s) identified by the access filter(s) associated with this remote user (step 62).

Table 1 below shows the database. A variety of other configurations can be employed for the database. Also, the database can include different and/or additional parameters.

25	USER ID 1	PASSWORD 1	FILTER(S) 1
	USER ID 2	PASSWORD 2	FILTER(S) 2
	USER ID 3	PASSWORD 3	FILTER(S) 3
30	·	·	·
	·	·	·
	·	·	·
35	USER ID N	PASSWORD N	FILTER(S) N

TABLE 1 - Remote User Information Database

Table 2 below shows an access filter for use in the

remote access system according to the invention. Other configurations of the access filter can be employed. Also, the access filter can include different and/or additional fields. As stated previously, access filters are protocol dependent. As shown in Table 2, a Name Binding Protocol (NBP) Filter includes a Show/Hide (S/H) field, and NBP name field, and a NBP type field.

10

	S/H		NBP Name		NBP Type	
--	-----	--	----------	--	----------	--

TABLE 2 - NBP Filter

15 As shown in Table 3, a Zone Filter includes an S/H field and a Zone field.

20

	S/H		Zone	
--	-----	--	------	--

TABLE 2 - Zone Filter

Referring now to FIG. 4, in one embodiment, the remote access server 16 includes electronics 38, a plurality of serial communication ports 40<sub>1</sub>-40<sub>N</sub>, and a plurality of network ports 42<sub>1</sub>-42<sub>N</sub>. The server 16 also can include a plurality of internal modems 44<sub>1</sub>-44<sub>N</sub>. The serial ports 40 and the network ports 42 are controlled by the electronics 38.

The electronics 38 include, in some embodiments, a powerful 16 MHz 68EC020 microprocessor and memory such as up to 1 megabyte of battery backed-up static random access memory (SRAM) and possibly 64 kilobytes in an erasable programmable read only memory (EPROM).

Each of the serial communication ports 40 is for

- 17 -

coupling with a communication device (e.g., the modem 26 of FIG. 1), or for coupling directly with the telephone lines 22, to provide for communication with a remote computer (e.g., the remote computer 12 of FIGS. 1 and 2) over the telephone lines 22. A connecting cable can be used to couple a serial port 40 with the communication device or with the telephone lines. Each of the serial ports 40 can simultaneously be coupled to a different one of the plurality of remote computers so as to provide simultaneous access to a local computer network for each of the remote computers, even if each of the remote computers employs a different protocol (e.g., IPX, TCP/IP, AppleTalk, NetBEUI, or 802.2/LLC). In some embodiments, the server 16 includes either four or eight serial ports 40, and each port 40 is a DB-25 asynchronous serial port which supports speeds of up to 57.6 kilobits per second (kbps). In some other embodiments, the server 16 includes four 57.6 kbps ports 40 with an internal V.32bis modem 44 associated with each, and four high-speed (115.2 kbps) serial ports 40 with no internal modem associated therewith. In some other embodiments, the server 16 includes a single port 40 for use with ARA.

Each of the network ports 42 is for coupling with a local computer network (e.g., the network 14 of FIGS. 1 and 2), via a connecting cable, to provide for communication with the network. Typically, the server 16 is connected to only one network during normal operation. In some embodiments, the server 16 includes three network ports 42, one for 10BaseT Ethernet, one for Thin Ethernet, and one for Thick Ethernet. In some other embodiments, the server 16 includes a single network port 42 for Token Ring. In some other embodiments, the server 16 includes a single

- 18 -

network port 42 for use with Apple LocalTalk.

The remote access server 16 shown functionally in FIG. 4 can be contained in a housing similar to that shown in FIG. 2. The housing is less than or equal to  
5 about 1.7 by 17 by 10 inches. The housing can be made rack-mountable.

Other modifications and implementations will occur to those of ordinary skill in the art without departing from the spirit and the scope of the invention as  
10 claimed. Accordingly, the invention is to be defined not by the preceding illustrative description but instead by the following claims.

What is claimed is:

- 19 -

Claims

1           1. A method for limiting access to a local  
2 computer network, comprising:  
3           receiving a user identification string from a  
4 communication port, the string having been entered by a  
5 remote user at a remote computer which is coupled to  
6 the communication port, the string identifying the  
7 remote user;  
8           using the user identification string to access a  
9 database and determine at least one access filter  
10 associated with the user identification string, the  
11 access filter for preventing the remote computer from  
12 communicating with at least one predetermined resource  
13 on a local computer network, the database including a  
14 user identification string for each remote user and at  
15 least one access filter for each user identification  
16 string;  
17           allowing the remote computer to access the local  
18 computer network and to communicate on the local  
19 computer network; and  
20           using the access filter to prevent the remote  
21 computer from communicating with the predetermined  
22 resource on the local computer network.

1           2. The method of claim 1 further comprising  
2 maintaining the database.

1           3. The method of claim 1 further comprising  
2 coupling a communication device to the communication  
3 port for communicating with the remote computer.

1           4. The method of claim 3 wherein the communication  
2 port is a serial port.

- 20 -

1           5. The method of claim 4 wherein the communication  
2 device is a modem.

1           6. A method for limiting access to a local  
2 computer network, comprising:  
3           providing a communication port to provide for  
4 communication with a remote computer;  
5           coupling a network port to a local computer network  
6 to provide for communication with the local computer  
7 network;  
8           receiving a user identification string from the  
9 communication port, the string having been entered by a  
10 remote user at a remote computer which is coupled to  
11 the communication port, the string identifying the  
12 remote user;  
13           using the user identification string to access a  
14 database and determine at least one access filter  
15 associated with the user identification string, the  
16 access filter for preventing the remote computer from  
17 communicating with at least one predetermined resource  
18 on a local computer network, the database including a  
19 user identification string for each remote user and at  
20 least one access filter for each user identification  
21 string;  
22           allowing the remote computer to access the local  
23 computer network and to communicate on the local  
24 computer network; and  
25           using the access filter to prevent the remote  
26 computer from communicating with the predetermined  
27 resource on the local computer network.

1           7. The method of claim 6 further comprising  
2 coupling a plurality of communication ports such that a

- 21 -

3 plurality of remote computers are provided simultaneous  
4 limited access to the local computer network.

1 8. The method of claim 6 further comprising  
2 maintaining the database.

1 9. The method of claim 6 further comprising  
2 coupling a communication device to the communication  
3 port for communicating with the remote computer.

1 10. The method of claim 9 wherein the  
2 communication port is a serial port.

1 11. The method of claim 10 wherein the  
2 communication device is a modem.

1 12. A server for limiting access to a local  
2 computer network, comprising:  
3 at least one communication port to provide for  
4 communication with a remote computer;  
5 at least one network port for coupling to a local  
6 computer network to provide for communication with the  
7 local computer network; and  
8 processing electronics for:  
9 controlling the communication port and the  
10 network port,  
11 receiving from the communication port a user  
12 identification string which was entered by a remote  
13 user at a remote computer and which identifies the  
14 remote user,  
15 using the user identification string to access  
16 a database and determine at least one access filter  
17 associated with the user identification string, the  
18 access filter for preventing the remote computer from

- 22 -

19 communicating with at least one predetermined resource  
20 on the local computer network, the database including a  
21 user identification string for each remote user and at  
22 least one access filter for each user identification  
23 string,

24 allowing the remote computer to access the  
25 local computer network and to communicate on the local  
26 computer network, and

27 using the access filter to prevent the remote  
28 computer from communicating with the predetermined  
29 resource on the local computer network.

1 13. The server of claim 12 further comprising a  
2 plurality of communication ports such that a plurality  
3 of remote computers are provided simultaneous access to  
4 the local computer network through the server.

1 14. The server of claim 12 wherein the processing  
2 electronics includes a microprocessor and memory.

1 15. The server of claim 12 wherein the database is  
2 maintained internally by the server.

1 16. The server of claim 12 wherein the database is  
2 maintained on the local computer network and-external  
3 from the server.

1 17. The server of claim 12 further comprising a  
2 communication device coupled to the communication port  
3 for communicating with the remote computer.

1 18. The server of claim 17 wherein the  
2 communication port is a serial port.



- 23 -

1       19. The server of claim 18 wherein the  
2 communication device is a modem.

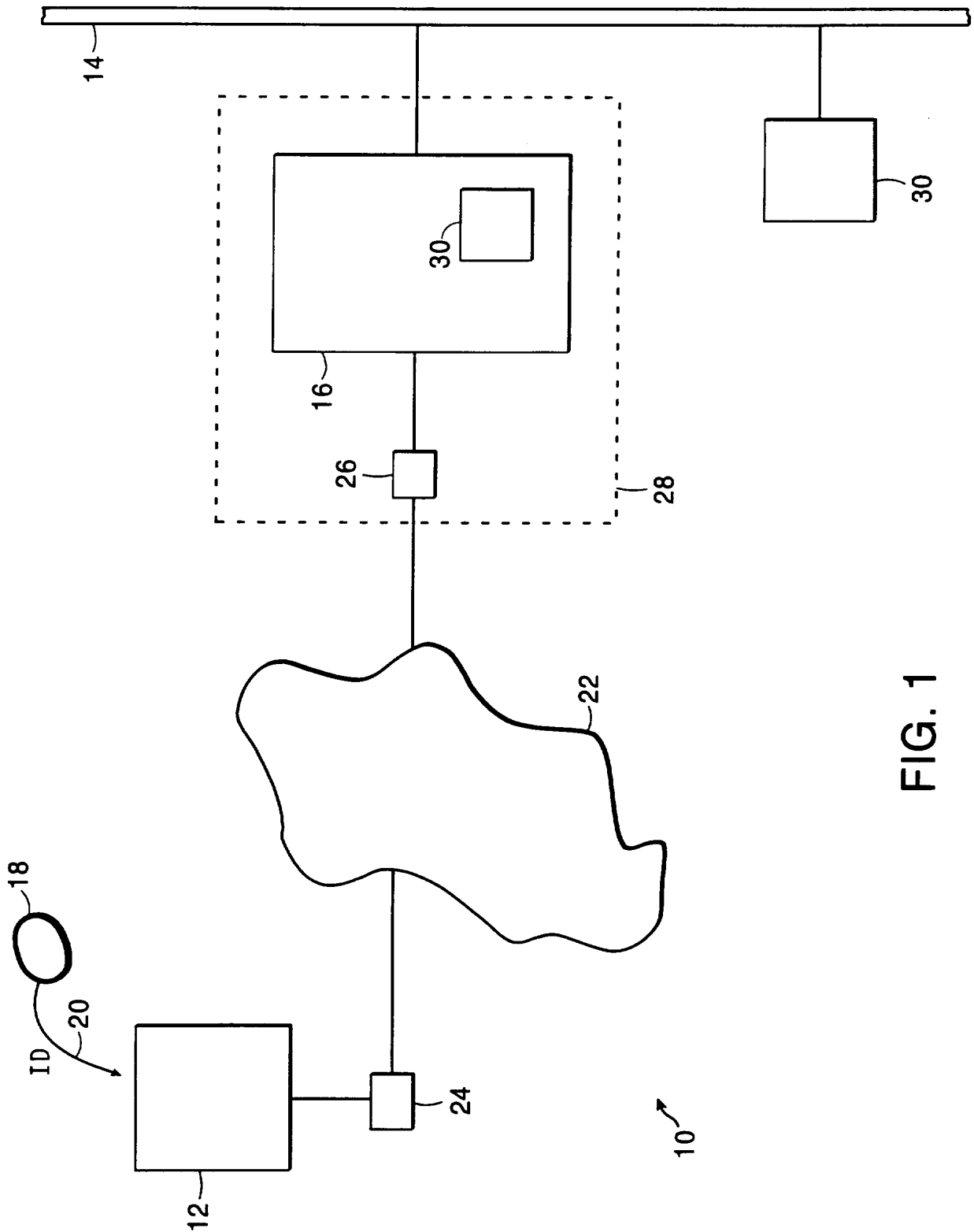

FIG. 1

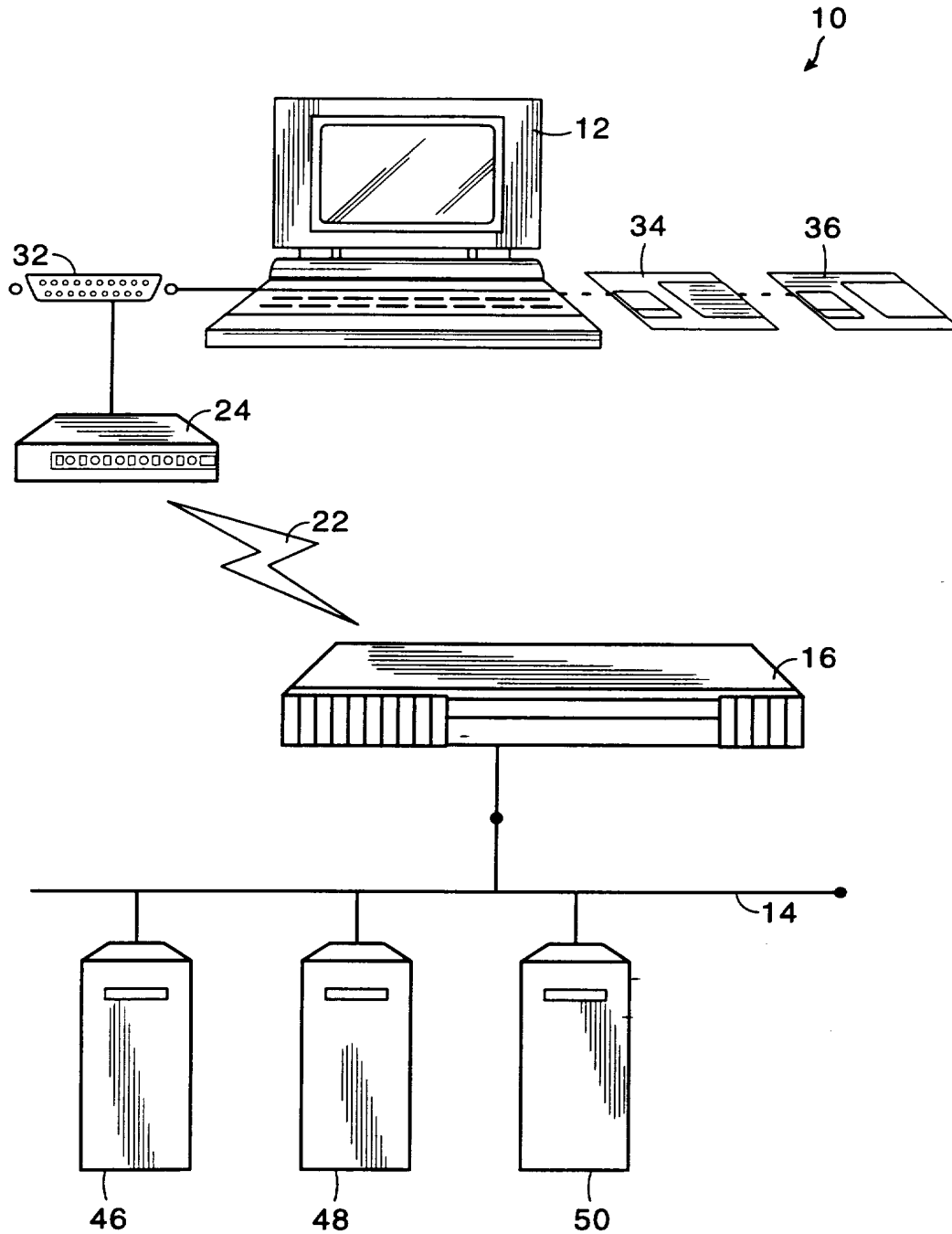

FIG. 2

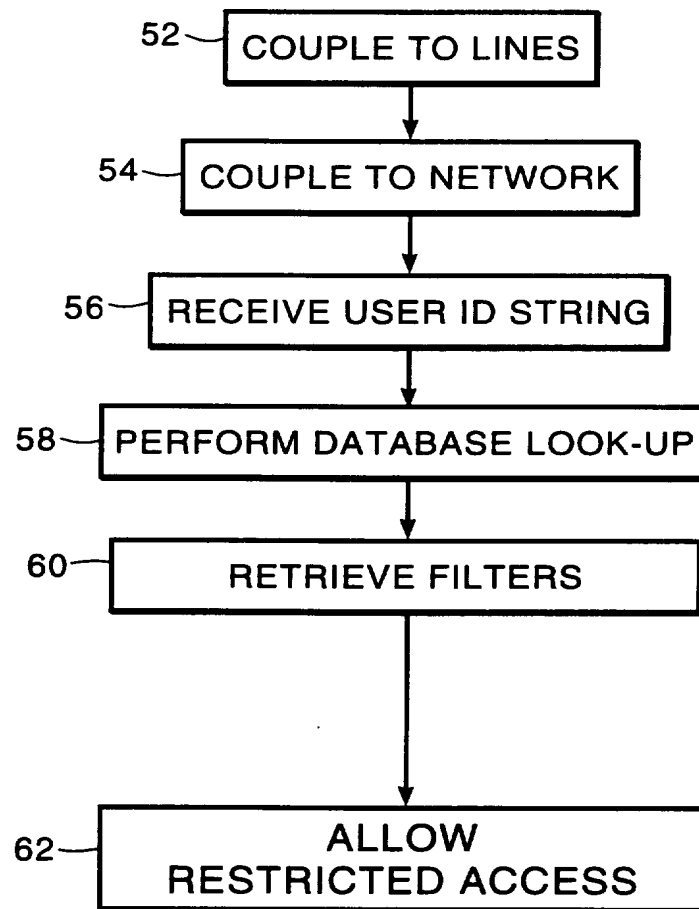

FIG. 3

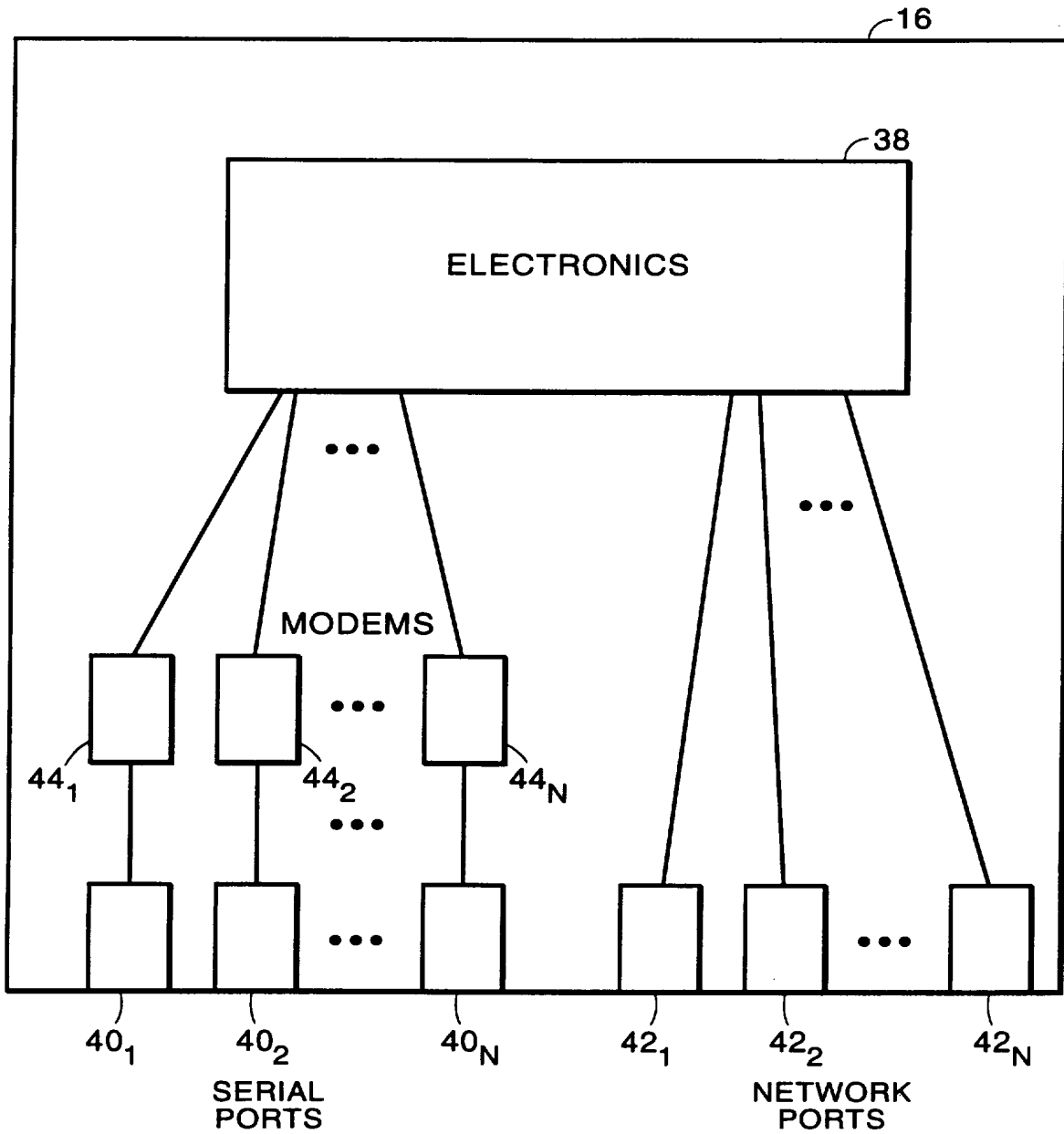

FIG. 4

# INTERNATIONAL SEARCH REPORT

Int. .onal Application No  
PCT/US 95/08900

**A. CLASSIFICATION OF SUBJECT MATTER**  
IPC 6 G06F1/00

According to International Patent Classification (IPC) or to both national classification and IPC

**B. FIELDS SEARCHED**

Minimum documentation searched (classification system followed by classification symbols)  
IPC 6 G06F

Documentation searched other than minimum documentation to the extent that such documents are included in the fields searched

Electronic data base consulted during the international search (name of data base and, where practical, search terms used)

**C. DOCUMENTS CONSIDERED TO BE RELEVANT**

Category *	Citation of document, with indication, where appropriate, of the relevant passages	Relevant to claim No.
Y	EP,A,0 513 484 (BULL HN INFO. SYSTEMS) 19 November 1992 see abstract; figures 1-3 see column 3, line 51 - column 4, line 15 see column 5, line 3 - line 50 ---	1-12, 14, 15, 17-19
Y	INTERNATIONAL CONF. ON ENERGY, COMPUTER, COMMUNICATION AND CONTROL SYSTEMS, 30 August 1991, NEW DELHI, INDIA; pages 103 - 107 S.K.BOSE ET AL 'Remote DOS Disk Server on a UNIX Machine' see abstract; figure 4 see page 105, left column, line 7 - line 46 see page 106, left column, line 62 - page 107, left column, line 12 --- -/--	1-12, 14, 15, 17-19

Further documents are listed in the continuation of box C.

Patent family members are listed in annex.

\* Special categories of cited documents :

- \*A\* document defining the general state of the art which is not considered to be of particular relevance
- \*E\* earlier document but published on or after the international filing date
- \*L\* document which may throw doubts on priority claim(s) or which is cited to establish the publication date of another citation or other special reason (as specified)
- \*O\* document referring to an oral disclosure, use, exhibition or other means
- \*P\* document published prior to the international filing date but later than the priority date claimed

- \*T\* later document published after the international filing date or priority date and not in conflict with the application but cited to understand the principle or theory underlying the invention
- \*X\* document of particular relevance; the claimed invention cannot be considered novel or cannot be considered to involve an inventive step when the document is taken alone
- \*Y\* document of particular relevance; the claimed invention cannot be considered to involve an inventive step when the document is combined with one or more other such documents, such combination being obvious to a person skilled in the art.
- \*&\* document member of the same patent family

Date of the actual completion of the international search

17 November 1995

Date of mailing of the international search report

**27.12.95**

Name and mailing address of the ISA

European Patent Office, P.B. 5818 Patentlaan 2  
NL - 2280 HV Rijswijk  
Tel. (+ 31-70) 340-2040, Tx. 31 651 epo nl,  
Fax: (+ 31-70) 340-3016

Authorized officer

Powell, D



# INTERNATIONAL SEARCH REPORT

Information on patent family members

International Application No

PCT/US 95/08900

Patent document cited in search report	Publication date	Patent family member(s)	Publication date
EP-A-0513484	19-11-92	AU-B- 1135392	24-09-92
US-A-4310720	12-01-82	CA-A- 1102453	02-06-81
		DE-A- 2912696	11-10-79
		FR-A, B 2421426	26-10-79
		GB-A, B 2019060	24-10-79
		GB-A, B 2076615	02-12-81
		JP-A- 54136205	23-10-79





INTERNATIONAL APPLICATION PUBLISHED UNDER THE PATENT COOPERATION TREATY (PCT)

<p>(51) International Patent Classification <sup>6</sup> : <b>G06F 13/00, 19/00</b></p>	<p><b>A1</b></p>	<p>(11) International Publication Number: <b>WO 96/39668</b> (43) International Publication Date: 12 December 1996 (12.12.96)</p>
<p>(21) International Application Number: PCT/US96/08307 (22) International Filing Date: 3 June 1996 (03.06.96) (30) Priority Data: 08/471,337 6 June 1995 (06.06.95) US 08/554,271 6 November 1995 (06.11.95) US 08/579,881 28 December 1995 (28.12.95) US (71) Applicant (for all designated States except US): INTERACTIVE MEDIA WORKS, L.L.C. [US/US]; Suite 200, 10500 Barkley, Overland Park, KS 66212 (US). (72) Inventor; and (75) Inventor/Applicant (for US only): TOADER, Adrian [US/US]; 11814 Hardy, Overland Park, KS 66210 (US). (74) Agent: ERICKSON, Kent, R.; Litman, McMahon &amp; Brown, L.L.C., Suite 1600, 1200 Main Street, Kansas City, MO 64105 (US).</p>		<p>(81) Designated States: AM, AT, AU, BB, BG, BR, BY, CA, CH, CN, CZ, DE, DK, EE, ES, FI, GB, GE, HU, IS, JP, KE, KG, KP, KR, KZ, LK, LR, LT, LU, LV, MD, MG, MK, MN, MW, MX, NO, NZ, PL, PT, RO, RU, SD, SE, SG, SI, SK, TJ, TM, TT, UA, UG, US, UZ, VN, ARIPO patent (KE, LS, MW, SD, SZ, UG), European patent (AT, BE, CH, DE, DK, ES, FI, FR, GB, GR, IE, IT, LU, MC, NL, PT, SE), OAPI patent (BF, BJ, CF, CG, CI, CM, GA, GN, ML, MR, NE, SN, TD, TG).</p> <p><b>Published</b> <i>With international search report. Before the expiration of the time limit for amending the claims and to be republished in the event of the receipt of amendments.</i></p>
<p>(54) Title: PROMOTIONAL AND PRODUCT ON-LINE HELP METHODS VIA INTERNET</p>		
<p>(57) Abstract</p> <p>Three methods for promoting a sponsor's products each include the provision of a consumer or potential consumer with Internet access time and software for allowing such Internet access. In a first method (1), free software is distributed for use. In a second method (31), telephone calling cards are distributed which allow a recipient to call and request the software. In a third method (61), the software is distributed with a consumer product to allow the purchaser to access on-line help via the Internet. In each method, an Internet Entry Server (IES) provides the access and performs a registration process (5). The IES then initially gives the user a mandatory "guided tour" (13) of the sponsor's Internet Home Page and domain prior to releasing them to the Internet at large, or, in the third method, to an Internet accessed on-line help service. With each method, the consumer is given a variety of options (91, 101, 111) for extending the access time.</p>		

**FOR THE PURPOSES OF INFORMATION ONLY**

Codes used to identify States party to the PCT on the front pages of pamphlets publishing international applications under the PCT.

AM	Armenia	GB	United Kingdom	MW	Malawi
AT	Austria	GE	Georgia	MX	Mexico
AU	Australia	GN	Guinea	NE	Niger
BB	Barbados	GR	Greece	NL	Netherlands
BE	Belgium	HU	Hungary	NO	Norway
BF	Burkina Faso	IE	Ireland	NZ	New Zealand
BG	Bulgaria	IT	Italy	PL	Poland
BJ	Benin	JP	Japan	PT	Portugal
BR	Brazil	KE	Kenya	RO	Romania
BY	Belarus	KG	Kyrgystan	RU	Russian Federation
CA	Canada	KP	Democratic People's Republic of Korea	SD	Sudan
CF	Central African Republic	KR	Republic of Korea	SE	Sweden
CG	Congo	KZ	Kazakhstan	SG	Singapore
CH	Switzerland	LI	Liechtenstein	SI	Slovenia
CI	Côte d'Ivoire	LK	Sri Lanka	SK	Slovakia
CM	Cameroon	LR	Liberia	SN	Senegal
CN	China	LT	Lithuania	SZ	Swaziland
CS	Czechoslovakia	LU	Luxembourg	TD	Chad
CZ	Czech Republic	LV	Larvia	TG	Togo
DE	Germany	MC	Monaco	TJ	Tajikistan
DK	Denmark	MD	Republic of Moldova	TT	Trinidad and Tobago
EE	Estonia	MG	Madagascar	UA	Ukraine
ES	Spain	ML	Mali	UG	Uganda
FI	Finland	MN	Mongolia	US	United States of America
FR	France	MR	Mauritania	UZ	Uzbekistan
GA	Gabon			VN	Viet Nam

## PROMOTIONAL AND PRODUCT ON-LINE HELP METHODS VIA INTERNET

BACKGROUND OF THE INVENTION5 I. Field of The Invention

The present invention relates to a method for providing sponsor promotion or on-line product help services to consumers while simultaneously providing consumers with Internet access. More particularly, a first  
10 inventive promotion method includes the distribution of Internet access software which allows a consumer to access the Internet via an Internet Entry Server (IES), but which access directs the consumer first to the sponsor's home page for a mandatory tour. A second promotion method  
15 includes the distribution of specialized calling cards. A toll free telephone number is distributed along with the calling cards which number can be called to connect to an Enhanced Entry Server to order free or low cost software for accessing the Internet. For sponsor promotions, the  
20 Internet access software is designed such that, as the user initially accesses the Internet, the sponsor's "home page" and domain is automatically accessed as well. The specialized calling card can be used for Internet access time, for long distance calling time, or for any  
25 combination of Internet time and calling time. Finally, in an on-line help method, a purchaser of a consumer product, such as software, for example, is provided with a predetermined amount of prepaid Internet Access time to an Internet Entry Server which automatically hot-links the  
30 customer to the sponsor/vendor's domain and "Home Page".

The customer can then access the sponsor/vendor's Home page to get on-line help, either in real time or time delayed via Electronic mail, for questions regarding the product.

5 **II. Description of The Related Art**

In marketing of consumer products, particularly in the United States, it has long been common for manufacturers to use promotions in the form of discount coupons, sweepstakes, or other giveaways and contests. One object  
10 of such promotions is to develop a customer profile database which can yield valuable marketing information. Another object is to develop consumer mailing lists to identify customers who would be prime targets for promotional materials.

15 Traditionally, mail-in rebates have been one method of choice for developing such survey information and mailing lists. Such rebates are traditionally distributed by attaching refund offers directly to the product, or to display them alongside the product on a retail shelf, which  
20 refunds can be mailed into the manufacturer, along with a proof of purchase, to get a refund or rebate on the product. Some retail merchants provide a central bulletin board where all of the rebate forms are placed, requiring interested consumers to look through all of the forms to  
25 locate the one or ones in which they are interested. In addition to this time consuming search for relevant refund offers, there are several additional disadvantages of this rebate approach. Members of "discount or rebate clubs" will often take an entire booklet of refund forms from a

display for trade or sale within the club, thus totally disrupting the manufacturer's promotional scheme. The rebate forms must be printed and distributed by the manufacturers to participating retailers, which represents a significant ongoing cost. Often manufacturers can supply only the largest retailers with refund forms, which diminishes the effectiveness of promotions and information gathering by virtually eliminating small merchants from the marketing effort. Consumers often do not know of the existence of the refund until he or she actually examines the product or the display in the store. Furthermore, since rebates are typically for nominal amounts, such as \$.25 or \$.50, for example, the postage costs to mail in these forms for a rebate are often prohibitive if the consumer is asked to bear them or, if the manufacturer uses prepaid postage, the postage will dramatically increase the promotional costs. The requirement to send in a proof of purchase, typically a store receipt, causes additional inconvenience. Finally, where it is important to collect consumer profile or mailing list information in a set time frame, the rebate coupons are returned to a manufacturer over a period of weeks, if not months. Once received, the information on the forms must be coded in by personnel at the manufacturer's collection facility, representing an added expense.

Recent advances in personal computer technology and the ever increasing percentage of the population with access to a personal computer have made the Internet a viable alternative marketing tool. Many on-line computer

services, such as Prodigy and America On-Line, provide, for a fee as a part of their on-line service, software for connecting to and accessing the Internet. There are literally thousands of companies and organizations which  
5 maintain Internet/World Wide Web sites or "domains" which are accessible by users of the Internet. A problem with using such Web Sites and associated "Home Pages" as a marketing tool, is the huge number of options available to a user. In other words, without some incentive or  
10 direction for a user to access a particular company's home page, there is little likelihood that a particular user will access that home page, or even be aware of its existence.

Recent competition in the long distance carrier market  
15 has led to a proliferation of new products and marketing techniques for selling long distance time. One recent innovation is the sale of prepaid telephone calling cards which entitle the bearer to a certain amount of long distance time, typically within the continental United  
20 States.

In marketing of many consumer products, including software products, it is customary to provide the customer with a limited amount of free access to on-line help regarding the product. Typically this help is provided via  
25 a toll free "800" telephone number or it can be accessed via a customer paid telephone number, i.e. the help is free but the customer pays for the telephone time. It is very expensive for a software developer and vendor to maintain adequate staffing of persons skilled enough technically to

provide reliable software support, particularly to provide real time support during peak inquiry times. Furthermore, toll free telephone accounts can be very expensive, particularly since access to them is typically open ended.

5 It is apparent that a new marketing strategy and method is needed to take advantage of the Internet to provide a more desirable and convenient method of featuring a company's (sponsor's) products or services while providing a reliable source of consumer profile and mailing  
10 list information. Such a method should limit, or even eliminate, the requirement for printing and distributing rebate coupons and should allow sponsors an opportunity to feature, in real time, specific products or services. Such a method should allow the sponsor to target likely  
15 recipients for the Internet access at minimal cost. Such a method should provide the potential for continued marketing access to the customers for additional promotions at minimal or no additional cost to the sponsor. Alternatively, an enhanced retail market for telephone  
20 calling cards is needed to maximize card sales. Finally, a reliable method for allowing purchasers of consumer products to access on-line help via the Internet could present significant savings for product manufacturers.

25

#### Summary of the Invention

A first of the inventive methods involves promoting a sponsor's products or services by providing a consumer or potential consumer with sponsor-paid access to the Internet

for a limited time. The method includes the step of distributing, by mail, or in specially marked packages of the sponsor's products, a floppy disc with Internet access software thereon. Associated with the floppy disc is a  
5 unique personal identification number (PIN) along with instructions on installing and using the Internet access software on a personal computer (PC). The Internet access software accesses and "handshakes" with an "Internet Entry Server", which verifies the PIN number, provides the access  
10 and times the user's access time. The Internet Entry Server is programmed to recognize the PIN number as entitling the user to a limited prepaid or "free" Internet access time. Typically such a time period could be 30 minutes, for example, which is paid for by the sponsor. In  
15 return, the Internet Entry Server performs a registration process which includes a number of personal questions and custom data gathering in the form of queries provided by the sponsor for response by the user. The pertinent answers are then immediately provided to the sponsor. The  
20 Internet Entry Server also initially gives the user a mandatory "guided tour" of the sponsor's Home Page and domain where the user is exposed to any current product promotion by the sponsor and can download promotional coupons, product information, etc. After this mandatory  
25 guided tour is completed, the user is allowed to access any other information on the Internet. The Internet Entry Server also tracks the locations visited by the user during the allotted time period, which information is also