

FIG. 6

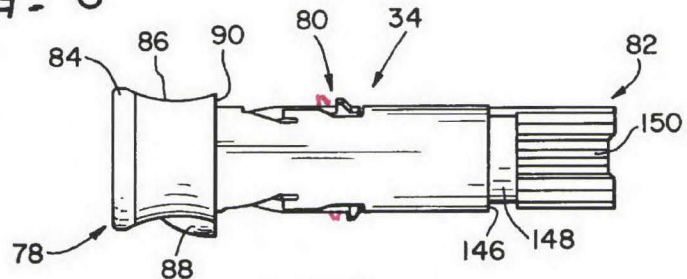

FIG. 7

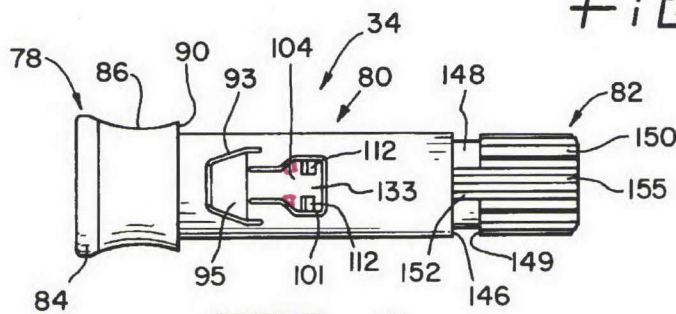

FIG. 8

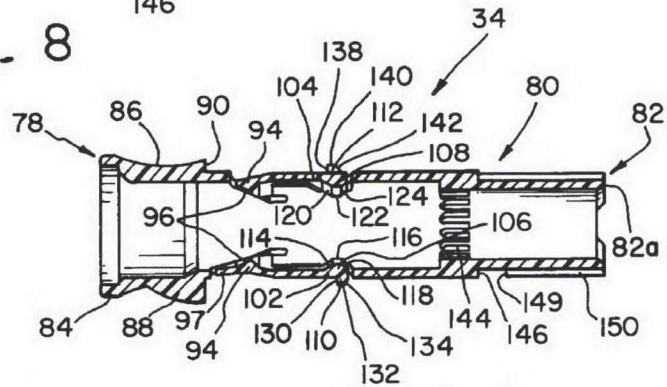

FIG. 9

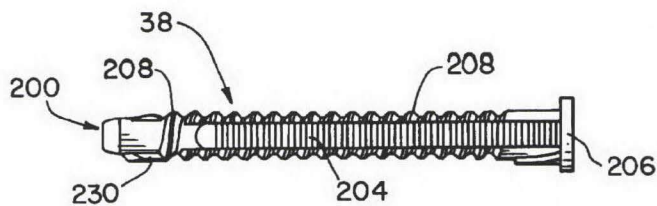
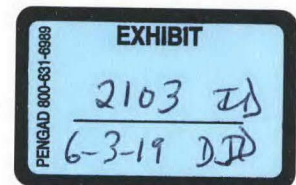

FIG. 12



Mylan Exhibit - 1013
Mylan v. Sanofi

Sanofi Exhibit 2103.001

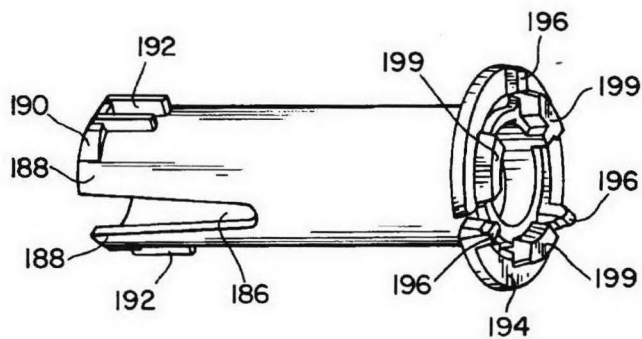

FIG. 10

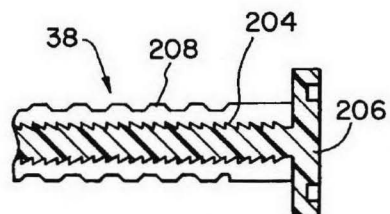

FIG. 13

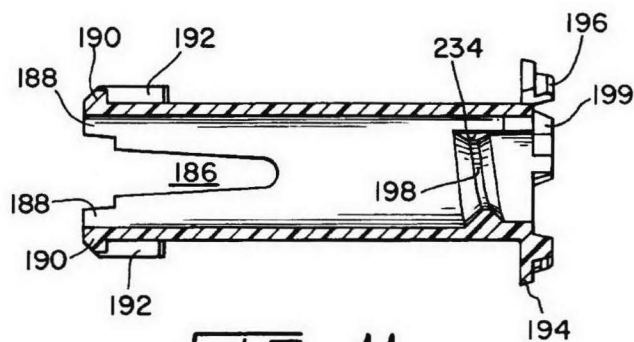

FIG. 11

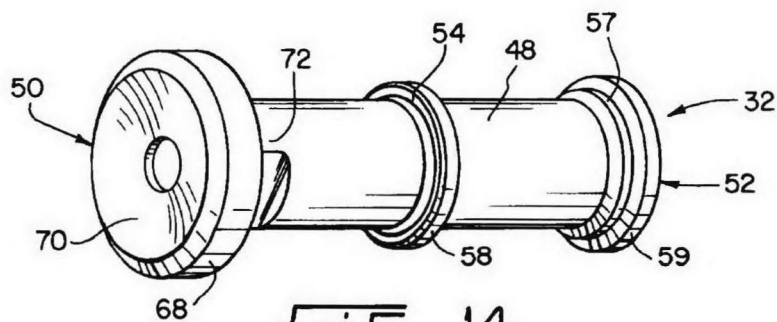

FIG. 14

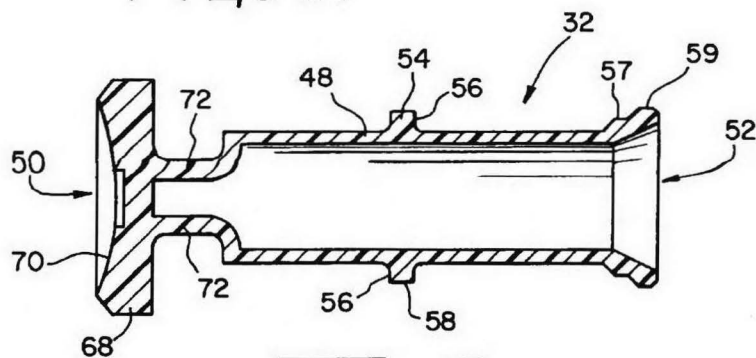

FIG. 15

Mylan Exhibit - 1013
Mylan v. Sanofi

Sanofi Exhibit 2103.002