



US007180502B2

(12) **United States Patent**  
**Marvit et al.**

(10) **Patent No.:** **US 7,180,502 B2**  
(45) **Date of Patent:** **Feb. 20, 2007**

(54) **HANDHELD DEVICE WITH PREFERRED MOTION SELECTION**

6,245,014 B1 6/2001 Brainard, II ..... 600/300  
6,288,704 B1 9/2001 Flack et al. .... 345/158

(75) Inventors: **David L. Marvit**, San Francisco, CA (US); **B. Thomas Adler**, Menlo Park, CA (US); **Albert H. M. Reinhardt**, San Francisco, CA (US); **Bruce A. Wilcox**, San Luis Obispo, CA (US)

(Continued)

FOREIGN PATENT DOCUMENTS

GB 2378878 2/2003

(73) Assignee: **Fujitsu Limited**, Kawasaki (JP)

(Continued)

(\* ) Notice: Subject to any disclaimer, the term of this patent is extended or adjusted under 35 U.S.C. 154(b) by 511 days.

OTHER PUBLICATIONS

(21) Appl. No.: **10/807,570**

Westeyn et al., "Georgia Tech Gesture Toolkit: Supporting Experiments in Gesture Recognition", ICMI '03, Vancouver, British Columbia, Canada, 8 pages, Nov. 5, 2003.

(22) Filed: **Mar. 23, 2004**

(Continued)

(65) **Prior Publication Data**

US 2005/0212758 A1 Sep. 29, 2005

Primary Examiner—Regina Llang  
(74) Attorney, Agent, or Firm—Baker Botts L.L.P.

(51) **Int. Cl.**

**G09G 5/00** (2006.01)

(57) **ABSTRACT**

(52) **U.S. Cl.** ..... **345/156; 345/158**

(58) **Field of Classification Search** ..... **345/156–158; 715/856–864; 348/734**  
See application file for complete search history.

A motion controlled handheld device includes a display having a viewable surface and operable to generate an image and a motion detection module operable to detect motion of the device within three dimensions and to identify components of the motion in relation to the viewable surface. The components comprise a first component parallel to the viewable surface, a second component parallel to the viewable surface and perpendicular to the first component, and a third component perpendicular to the viewable surface. The device includes a motion processing module operable to compare the components, to isolate a preferred one of the components based on the comparison, and to adjust a magnitude of the preferred component by an augmentation factor. The device also includes a motion response module operable to modify the image based on the augmented preferred component.

(56) **References Cited**

U.S. PATENT DOCUMENTS

4,812,831 A	3/1989	Laier	340/711
5,112,785 A	5/1992	Brun et al.	502/108
5,142,655 A	8/1992	Drumm	379/52
5,506,605 A	4/1996	Paley	345/163
5,543,588 A	8/1996	Bisset et al.	178/18
5,602,566 A	2/1997	Motosyuku et al.	345/123
5,734,371 A	3/1998	Kaplan	345/158
6,008,810 A	12/1999	Bertram et al.	345/347
6,057,554 A	5/2000	Plesko	250/566
6,088,023 A	7/2000	Louis et al.	345/173
6,121,960 A	9/2000	Carroll et al.	345/173
6,184,847 B1	2/2001	Fatch et al.	345/8
6,201,554 B1	3/2001	Lands	346/169

**21 Claims, 11 Drawing Sheets**

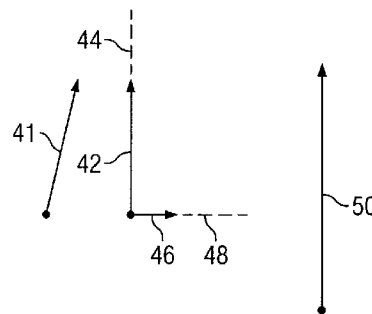
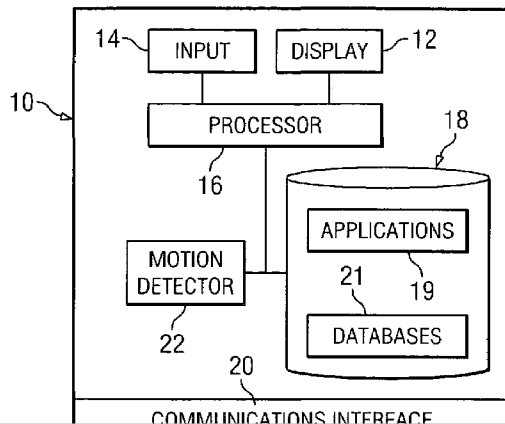

## U.S. PATENT DOCUMENTS

6,466,198	B1	10/2002	Feinstein	.....	345/158
2002/0190947	A1	12/2002	Feinstein	.....	345/158
2004/0027330	A1	2/2004	Bradski	.....	345/158

## FOREIGN PATENT DOCUMENTS

WO	WO 01/86920	11/2001
WO	WO 03/001340	1/2003

## OTHER PUBLICATIONS

Yee, Ka-Ping, "Peephole Displays: Pen Interaction on Spatially Aware Handheld Computers", CHI 2003, Ft. Lauderdale, Florida, 8 pages, Apr. 5, 2003.

Patent Application entitled, "Distinguishing Tilt and Translation Motion Components in Handheld Devices", 68 pages specification, claims and abstract, 11 pages of drawings, inventors Marvit et al, Mar. 23, 2004.

Patent Application entitled, "Motion Sensor Engagement for a Handheld Device", 68 pages specification, claims and abstract, 11 pages of drawings, inventors Marvit et al, Mar. 23, 2004.

Patent Application entitled, "Selective Engagement of Motion Detection", 66 pages specification, claims and abstract, 11 pages of drawings, inventors Marvit et al, Mar. 23, 2004.

Patent Application entitled, "Gesture Based Navigation of a Handheld User Interface", 69 pages specification, claims and abstract, 11 pages of drawings, inventors Marvit et al, Mar. 23, 2004.

Patent Application entitled, "Translation Controlled Cursor", 66 pages specification, claims and abstract, 11 pages of drawings, inventors Reinhardt et al, Mar. 23, 2004.

Patent Application entitled, "Selective Engagement of Motion Input Modes", 66 pages specification, claims and abstract, 11 pages of drawings, inventors Marvit et al, Mar. 23, 2004.

Patent Application entitled, "Feedback Based User Interface for Motion Controlled Handheld Devices", 66 pages specification, claims and abstract, 11 pages of drawings, inventor Marvit et al, Mar. 23, 2004.

Patent Application entitled, "Spatial Signatures", 64 pages specification, claims and abstract, 11 pages of drawings, inventors Marvit et al, Mar. 23, 2004.

Patent Application entitled, "Motion Controlled Remote Controller", 65 pages specification, claims and abstract, 11 pages of drawings, inventors Marvit et al, Mar. 23, 2004.

Patent Application entitled, "Gesture Identification of Controlled Devices", 65 pages specification, claims and abstract, 11 pages of drawings, inventors Marvit et al, Mar. 23, 2004.

Patent Application entitled, "Environmental Modeling for Motion Controlled Handheld Devices", 65 pages specification, claims and abstract, 11 pages of drawings, inventors Marvit et al, Mar. 23, 2004.

Patent Application entitled, "Gesture Based User Interface Supporting Preexisting Symbols", 65 pages specification, claims and abstract, 11 pages of drawings, inventors Marvit et al, Mar. 23, 2004.

Patent Application entitled, "Context Dependent Gesture Response", 66 pages specification, claims and abstract, 11 pages of drawings, inventors Marvit et al, Mar. 23, 2004.

Patent Application entitled, "Customizable Gesture Mappings for Motion Controlled Handheld Devices", 67 pages specification, claims and abstract, 11 pages of drawings, inventors Marvit et al, Mar. 23, 2004.

Patent Application entitled, "User Definable Gestures for Motion Controlled Handheld Devices", 66 pages specification, claims and abstract, 11 pages of drawings, inventors Marvit et al, Mar. 23, 2004.

Patent Application entitled, "Non-Uniform Gesture Precision", 66 pages specification, claims and abstract, 11 pages of drawings, inventors Marvit et al, Mar. 23, 2004.

Patent Application entitled, "Dynamic Adaptation of Gestures for Motion Controlled Handheld Devices", 65 pages specification, claims and abstract, 11 pages of drawings, inventors Marvit et al, Mar. 23, 2004.

PCT Notification of Transmittal of the International Search Report and the Written Opinion of the International Searching Authority, or the Declaration, mailed Nov. 3, 2005, re PCT/US2005/007409 filed Mar 7, 2005, 13 pages.

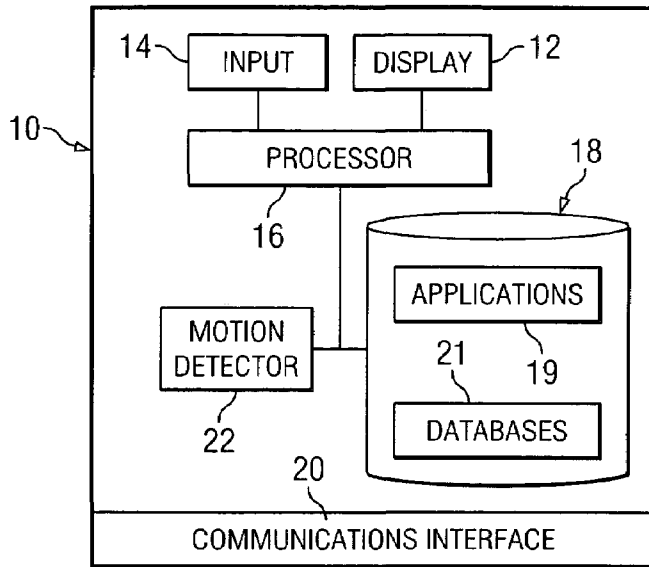

FIG. 1

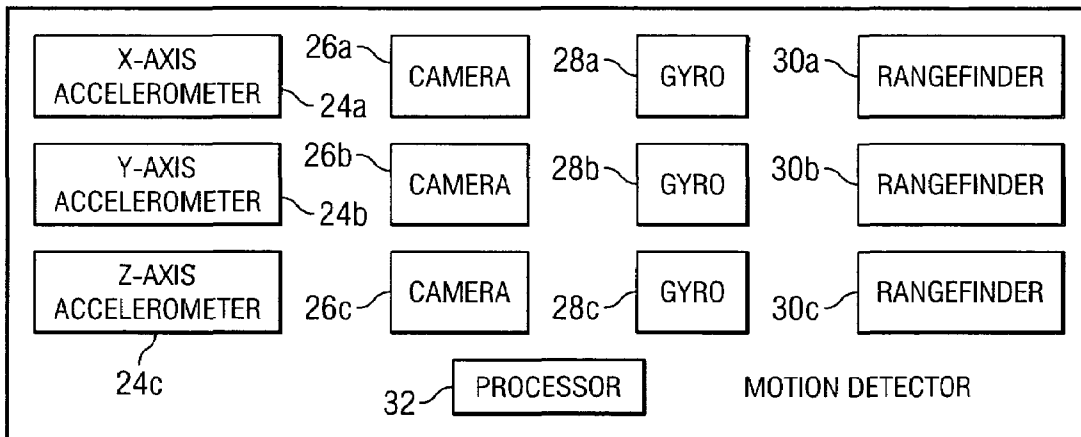

FIG. 2

22

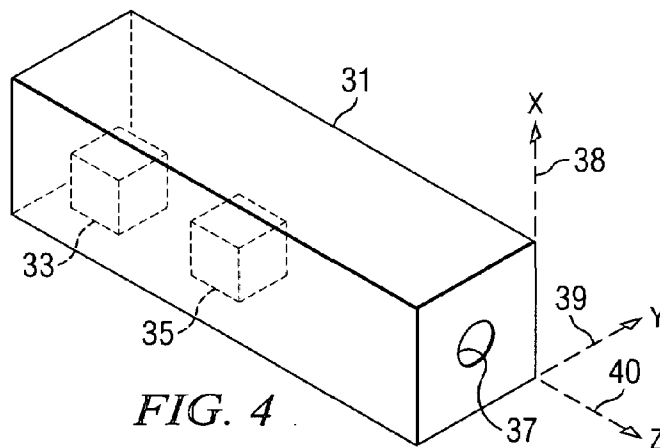

FIG. 4

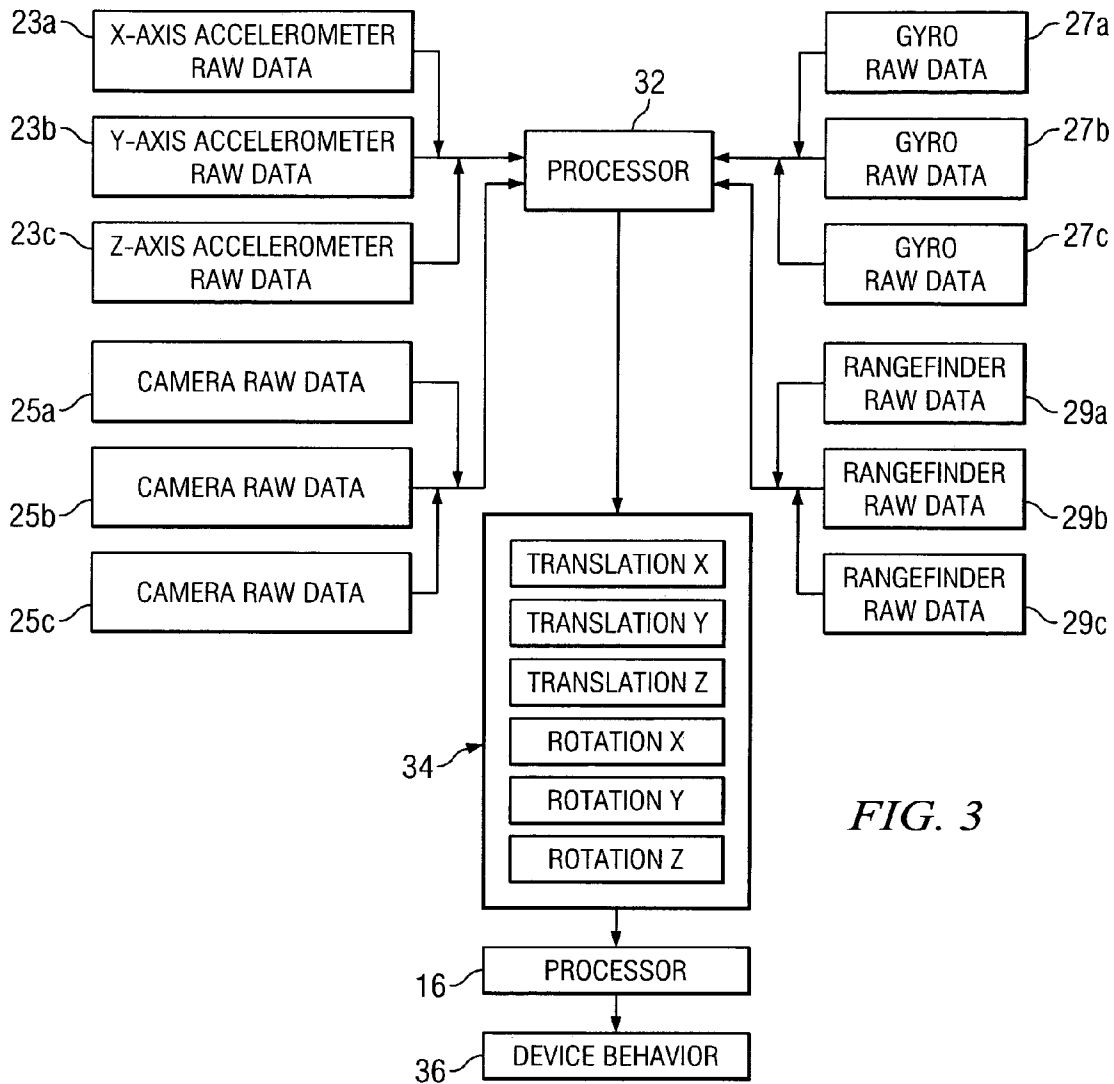

FIG. 3

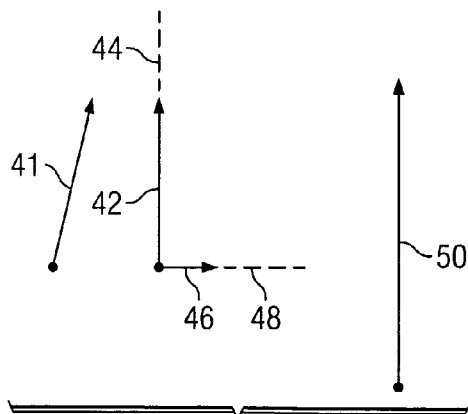
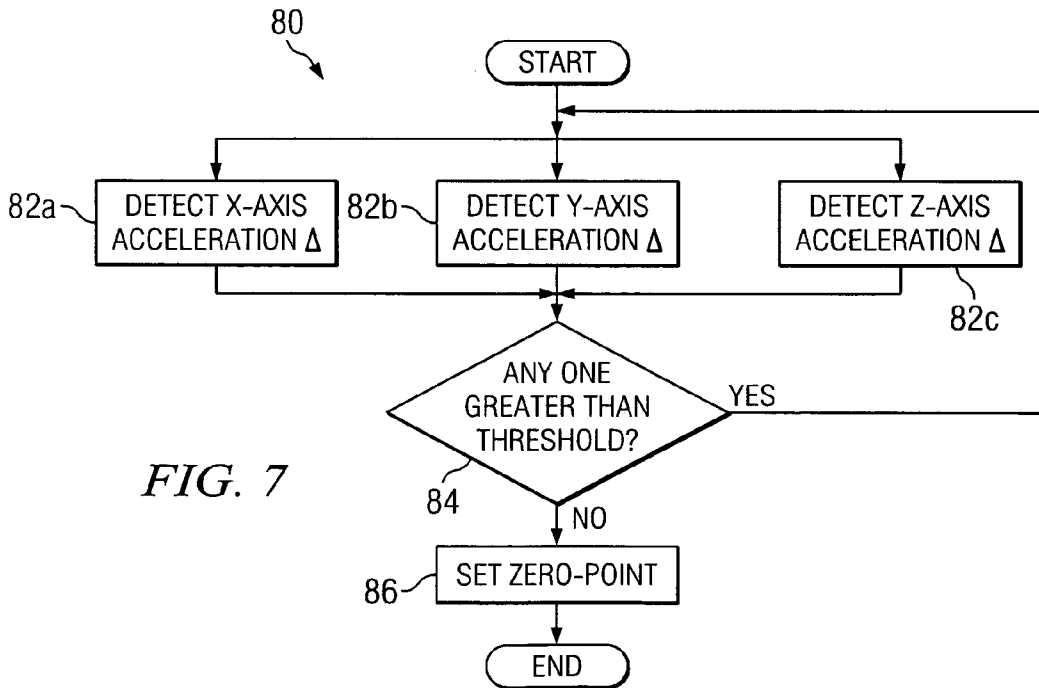
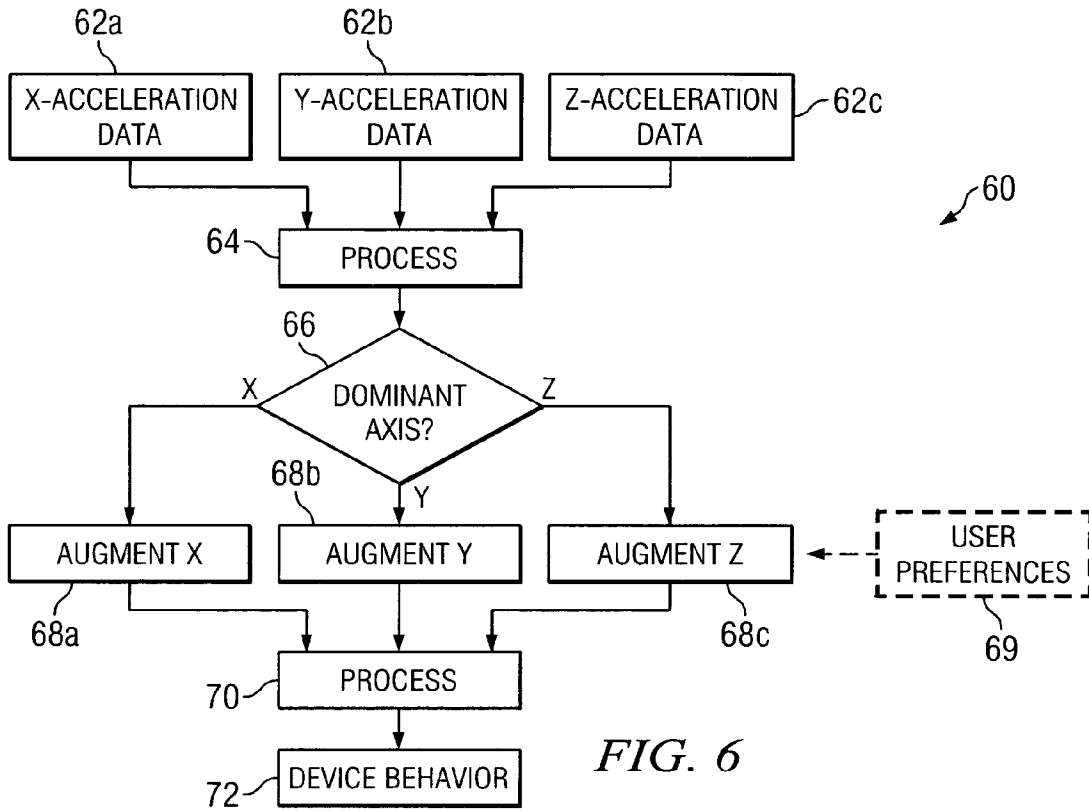

FIG. 5



# Explore Litigation Insights

Docket Alarm provides insights to develop a more informed litigation strategy and the peace of mind of knowing you're on top of things.

## Real-Time Litigation Alerts



Keep your litigation team up-to-date with **real-time alerts** and advanced team management tools built for the enterprise, all while greatly reducing PACER spend.

Our comprehensive service means we can handle Federal, State, and Administrative courts across the country.

## Advanced Docket Research



With over 230 million records, Docket Alarm's cloud-native docket research platform finds what other services can't. Coverage includes Federal, State, plus PTAB, TTAB, ITC and NLRB decisions, all in one place.

Identify arguments that have been successful in the past with full text, pinpoint searching. Link to case law cited within any court document via Fastcase.

## Analytics At Your Fingertips



Learn what happened the last time a particular judge, opposing counsel or company faced cases similar to yours.

Advanced out-of-the-box PTAB and TTAB analytics are always at your fingertips.

## API

Docket Alarm offers a powerful API (application programming interface) to developers that want to integrate case filings into their apps.

## LAW FIRMS

Build custom dashboards for your attorneys and clients with live data direct from the court.

Automate many repetitive legal tasks like conflict checks, document management, and marketing.

## FINANCIAL INSTITUTIONS

Litigation and bankruptcy checks for companies and debtors.

## E-DISCOVERY AND LEGAL VENDORS

Sync your system to PACER to automate legal marketing.