

UTILITY PATENT APPLICATION TRANSMITTAL <small>(Only for new nonprovisional applications under 37 CFR 1.53(b))</small>	Attorney Docket No.	SRC015 CON
	First Inventor	Jon M. Huppenthal et al.
	Title	MULTI-ADAPTIVE PROCESSING SYSTEMS AND TECHNIQUES FOR ENHANCING PARALLELISM AND PERFORMANCE OF COMPUTATIONAL FUNCTIONS
		EFS-Web

APPLICATION ELEMENTS	Commissioner for Patents P.O. Box 1450 Alexandria, VA 22313-1450
-----------------------------	--

1. <input type="checkbox"/> Fee Transmittal Form <small>(submit an original and a duplicate for fee processing)</small> 2. <input type="checkbox"/> Applicant claims small entity status. See 37 CFR 1.27 3. <input checked="" type="checkbox"/> Specification [total pages <u>38</u>] <small>(preferred Arrangement set forth below)</small> - Descriptive title of the Invention - Cross References to Related Applications - Statement Regarding Fed sponsored R&D - Reference to sequence listing, a table, or a computer program listing appendix - Background of the Invention - Brief Summary of the Invention - Brief Description of the Drawings - Detailed Description - Claim(s) - Abstract of the Disclosure 4. <input checked="" type="checkbox"/> Drawing(s) [total sheets <u>20</u>] 5. <input checked="" type="checkbox"/> Oath or Declaration [total pages <u>3</u>] a. <input type="checkbox"/> Newly executed (original or copy) b. <input checked="" type="checkbox"/> Copy from prior appl. (37 C.F.R. § 1.63(d)) <small>(for continuation/divisional with Box 18 completed)</small> i. <input type="checkbox"/> DELETION OF INVENTOR(S) <small>Signed statement attached deleting inventor(s) named in prior application, see 37 C.F.R. §§ 1.63(d)(2) and 1.33(b).</small>	6. <input checked="" type="checkbox"/> Application Data Sheet. (See 37 CFR 1.76) 7. <input type="checkbox"/> CD-ROM or CD-R in duplicate, large table or Computer Program (Appendix) 8. Nucleotide and/or Amino Acid Sequence Submission <small>(if applicable, all necessary)</small> a. <input type="checkbox"/> Computer Readable Form b. <input type="checkbox"/> Specification Sequence Listing on: i. <input type="checkbox"/> CD-ROM or CD-R (2 copies); or ii. <input type="checkbox"/> paper c. <input type="checkbox"/> Statements verifying identity of above copies
--	--

ACCOMPANYING APPLICATION PARTS	
9. <input type="checkbox"/> Assignment Papers (coversheet/document(s))	
10. <input type="checkbox"/> 37 CFR. 3.73(b) Statement <small>(when there is an assignee)</small>	<input checked="" type="checkbox"/> Power of Attorney
11. <input type="checkbox"/> English Translation Document	
12. <input type="checkbox"/> IDS & Form PTO/SB/08A	<input type="checkbox"/> Copies of IDS Citations
13. <input type="checkbox"/> Preliminary Amendment	
14. <input type="checkbox"/> Return Receipt Postcard (MPEP 503)	
15. <input type="checkbox"/> Certified Copy of Priority Document(s)	
16. <input type="checkbox"/> Nonpublication Request Under 35 USC 122(b)(2)(B)(i). Applicant must attach form PTO/SB/35	
17. <input type="checkbox"/> Other: Certificate of Mailing by Express Mail	

18. If a **CONTINUING APPLICATION**, check appropriate box, and supply the requisite information below and in a preliminary amendment, or in an Application Data Sheet under 37 CFR 1.76:

Continuation Divisional Continuation-in-part (CIP) of prior application No.: 10/285,318

Prior application information: Examiner: Coleman, Eric Group/Art Unit: 2183

FOR CONTINUATION OR DIVISIONAL APPS only: The entire disclosure of the prior application, from which an oath or declaration is supplied under Box 5b, is considered a part of the disclosure of the accompanying continuation or divisional application and is hereby incorporated by reference. The incorporation can only be relied upon when a portion has been inadvertently omitted from the submitted application parts.

19. CORRESPONDENCE ADDRESS

Customer Number **25235** or Correspondence address below

Name		Address	
City	State	ZIP	
Country	Telephone	Fax	

Name (Print/Type)	Michael C. Martensen	Registration No.	46901
(Signature)		Date	<u>April 9, 2007</u>

MULTI-ADAPTIVE PROCESSING SYSTEMS AND TECHNIQUES FOR
ENHANCING PARALLELISM AND PERFORMANCE OF COMPUTATIONAL
FUNCTIONS

CROSS REFERENCE TO RELATED PATENT APPLICATIONS

The present application is a Continuation of U.S. Patent Application Serial No. 10/285,318 filed October 31, 2002 which is related to the subject matter of United States Patent Application Ser. No. 09/755,744 filed January 5, 2001 for: "Multiprocessor Computer Architecture Incorporating a Plurality of Memory Algorithm Processors in the Memory Subsystem" and is further related to the subject matter of United States Patent No. 6,434,687 for: "System and Method for Accelerating Web Site Access and Processing Utilizing a Computer System Incorporating Reconfigurable Processors Operating Under a Single Operating System Image", all of which are assigned to SRC Computers, Inc., Colorado Springs, Colorado and the disclosures of which are herein specifically incorporated in their entirety by this reference.

COPYRIGHT NOTICE/PERMISSION

A portion of the disclosure of this patent document may contain material which is subject to copyright protection. The copyright owner has no objection to the facsimile reproduction by anyone of the patent document or the patent disclosure as it appears in the United States Patent and Trademark Office patent file or records, but otherwise, reserves all copyright rights

whatsoever. The following notice applies to the software and data and described below, inclusive of the drawing figures where applicable: Copyright © 2000, SRC Computers, Inc.

BACKGROUND OF THE INVENTION

The present invention relates, in general, to the field of computing systems and techniques. More particularly, the present invention relates to multi-adaptive processing systems and techniques for enhancing parallelism and performance of computational functions.

Currently, most large software applications achieve high performance operation through the use of parallel processing. This technique allows multiple processors to work simultaneously on the same problem to achieve a solution in a fraction of the time required for a single processor to accomplish the same result. The processors in use may be performing many copies of the same operation, or may be performing totally different operations, but in either case all processors are working simultaneously.

The use of such parallel processing has led to the proliferation of both multi-processor boards and large scale clustered systems. However, as more and more performance is required, so is more parallelism, resulting in ever larger systems. Clusters exist today that have tens of thousands of processors and can occupy football fields of space. Systems of such a large physical size present many obvious downsides, including, among other factors, facility requirements, power, heat generation and reliability.

SUMMARY OF THE INVENTION

However, if a processor technology could be employed that offers orders of magnitude more parallelism per processor, these systems could be reduced in size by a comparable factor. Such a processor or processing element is possible through the use of a reconfigurable processor. Reconfigurable processors instantiate only the functional units needed to solve a particular application, and as a result, have available space to instantiate as many functional units as may be required to solve the problem up to the total capacity of the integrated circuit chips they employ.

At present, reconfigurable processors, such as multi-adaptive processor elements (MAPTM, a trademark of SRC Computers, Inc.) can achieve two to three orders of magnitude more parallelism and performance than state-of-the-art microprocessors. Through the advantageous application of adaptive processing techniques as disclosed herein, this type of reconfigurable processing parallelism may be employed in a variety of applications resulting in significantly higher performance than that which can now be achieved while using significantly smaller and less expensive computer systems.

However, in addition to these benefits, there is an additional much less obvious one that can have even greater impact on certain applications and has only become available with the advent of multi-million gate reconfigurable chips. Performance gains are also realized by reconfigurable processors due to the much tighter coupling of the parallel functional units within

each chip than can be accomplished in a microprocessor based computing system.

In a multi-processor, microprocessor-based system, each processor is allocated but a relatively small portion of the total problem called a cell. However, to solve the total problem, results of one processor are often required by many adjacent cells because their cells interact at the boundary and upwards of six or more cells, all having to interact to compute results, would not be uncommon. Consequently, intermediate results must be passed around the system in order to complete the computation of the total problem. This, of necessity, involves numerous other chips and busses that run at much slower speeds than the microprocessor thus resulting in system performance often many orders of magnitude lower than the raw computation time.

On the other hand, in the use of an adaptive processor-based system, since ten to one thousand times more computations can be performed within a single chip, any boundary data that is shared between these functional units need never leave a single integrated circuit chip. Therefore, data moving around the system, and its impact on reducing overall system performance, can also be reduced by two or three orders of magnitude. This will allow both significant improvements in performance in certain applications as well as enabling certain applications to be performed in a practical timeframe that could not previously be accomplished.

Particularly disclosed herein is a method for data processing in a reconfigurable computing system comprising a plurality of functional units. The method

comprises: defining a calculation for the reconfigurable computing system; instantiating at least two of the functional units to perform the calculation; utilizing a first of the functional units to operate upon a subsequent data dimension of the calculation and substantially concurrently utilizing a second of the functional units to operate upon a previous data dimension of the calculation.

Further disclosed herein is a method for data processing in a reconfigurable computing system comprising a plurality of functional units. The method comprises: defining a first systolic wall comprising rows of cells forming a subset of the plurality of functional units; computing a value at each of the cells in at least a first row of the first systolic wall; communicating the values between cells in the first row of the cells to produce updated values; communicating the updated values to a second row of the first systolic wall; and substantially concurrently providing the updated values to a first row of a second systolic wall of rows of cells in the subset of the plurality of functional units.

Also disclosed herein is a method for data processing in a reconfigurable processing system which includes setting up a systolic processing form employing a speculative processing strategy.

BRIEF DESCRIPTION OF THE DRAWINGS

The aforementioned and other features and objects of the present invention and the manner of attaining them will become more apparent and the invention itself will be best understood by reference to the following

description of a preferred embodiment taken in conjunction with the accompanying drawings, wherein:

Fig. 1 is a simplified functional block diagram of typical clustered inter-processor communications path in a conventional multi-processor computing system;

Fig. 2 is a functional block diagram of an adaptive processor communications path illustrating the many functional units ("FU") interconnected by reconfigurable routing resources within the adaptive processor chip;

Fig. 3A is a graph of the actual performance improvement versus the number of processors utilized and illustrating the deviation from perfect scalability of a particular application utilizing a conventional multi-processor computing system such as that illustrated in Fig. 1;

Fig. 3B is a corresponding graph of the actual performance improvement versus the number of processors utilized and illustrating the performance improvement over a conventional multi-processor computing system utilizing an adaptive processor-based computing system such as that illustrated in Fig. 2;

Fig. 4A is a simplified logic flowchart illustrating a conventional sequential processing operation in which nested Loops A and B are alternately active on different phases of the process;

Fig. 4B is a comparative, simplified logic flowchart illustrating multi-dimensional processing in accordance with the technique of the present invention wherein multiple dimensions of data are processed by both Loops A and B such that the computing system logic is operative on every clock cycle;

Fig. 5A is illustrative of a general process for performing a representative multi-dimensional pipeline operation in the form of a seismic migration imaging function utilizing the parallelism available in the utilization of the adaptive processing techniques of the present invention;

Fig. 5B is a follow-on illustration of the computation phases employed in implementing the exemplary seismic migration imaging function of the preceding figure;

Fig. 6A is a simplified logic flowchart for a particular seismic migration imaging application illustrative of the parallelism provided in the use of an adaptive processor-based computing system;

Fig 6B illustrates the computational process which may be employed by a microprocessor in the execution of the seismic imaging application of the preceding figure;

Fig. 6C illustrates the first step in the computational process which may be employed by an adaptive processor in the execution of the seismic imaging application of Fig. 6A in which a first shot (S1) is started;

Fig. 6D illustrates the second step in the same computational process for the execution of the seismic imaging application of Fig. 6A in which a second shot (S2) is started;

Fig. 6E illustrates the third step in the same computational process for the execution of the seismic imaging application of Fig. 6A in which the operation on the first and second shots is continued through compute;

Fig. 6F illustrates the fourth step in the same computational process showing the subsequent operation on shots S1 and S2;

Fig. 6G illustrates the fifth step in the same computational process followed by the continued downward propagation of shots S1 and S2 over all of the depth slices;

Fig. 7A illustrates a process for performing a representative systolic wavefront operation in the form of a reservoir simulation function also utilizing the parallelism available in the utilization of the adaptive processing techniques of the present invention;

Fig. 7B illustrates the general computation of fluid flow properties in the reservoir simulation of the preceding figure which are communicated to neighboring cells;

Fig. 7C illustrates the creation of a systolic wall of computation at Time Set 1 which has been started for a vertical wall of cells and in which communication of values between adjacent rows in the vertical wall can occur without storing values to memory;

Fig. 7D is a follow on illustration of the creation of a systolic wall of computation at Time Set 1 and Time Set 2 showing how a second vertical wall of cells is started after the computation for cells in the corresponding row of the first wall has been completed;

Fig. 8A illustrates yet another process for performing a representative systolic wavefront operation in the form of the systolic processing of bioinformatics also utilizing the parallelism available in the

utilization of the adaptive processing techniques of the present invention;

Fig. 8B illustrates a systolic wavefront processing operation which further incorporates a speculative processing strategy based upon an evaluation of the rate of change of XB;

Fig. 8C is a further illustration of the systolic wavefront processing operation of the preceding figure incorporating speculative processing;

Fig. 9A illustrates still another process for performing a representative systolic wavefront operation in the form of structure codes calculating polynomials at grid intersections, again utilizing the parallelism available in the utilization of the adaptive processing techniques of the present invention;

Fig. 9B illustrates the computation start for a vertical wall of grid points at Time Set 1 for a polynomial evaluation performed on grid intersections wherein calculations between rows are done in a stochastic fashion using values from a previous row; and

Fig. 9C is a further illustration of the polynomial evaluation performed on grid intersections of the preceding figure wherein a second wall is started after the cells in the corresponding row of the first wall have been completed.

DESCRIPTION OF A REPRESENTATIVE EMBODIMENT

This application incorporates by reference the entire disclosure of Caliga, D. et al. "Delivering Acceleration: The Potential for Increased HPC Application Performance Using Reconfigurable Logic", SC2001, November 2001, ACM 1-58113-293-X/01/0011.

With reference now to Fig. 1, a simplified functional block diagram of typical clustered inter-processor communications path in a conventional multi-processor computing system 100 is shown. The computer system comprises a number of memory and input/output ("I/O" controller integrated circuits ("ICs") 102₀ through 102_N, (e.g. "North Bridge") 102 such as the P4X333/P4X400 devices available from VIA Technologies, Inc.; the M1647 device available from Acer Labs, Inc. and the 824430X device available from Intel Corporation. The North Bridge IC 102 is coupled by means of a Front Side Bus ("FSB") to one or more microprocessors 104₀₀ through 104₀₃ and 104_{N0} through 104_{N3} such as one of the Pentium® series of processors also available from Intel Corporation.

The North Bridge ICs 102₀ through 102_N are coupled to respective blocks of memory 106₀ through 106_N as well as to a corresponding I/O bridge element 108₀ through 108_N. A network interface card ("NIC") 110₀ through 110_N couples the I/O bus of the respective I/O bridge 108₀ through 108_N to a cluster bus coupled to a common clustering hub (or Ethernet Switch) 112.

Since typically a maximum of four microprocessors 104, each with two or four functional units, can reside on a single Front Side Bus, any communication to more than four must pass over the Front Side Bus, inter-bridge bus, input/output ("I/O") bus, cluster interconnect (e.g. an Ethernet clustering hub 112) and then back again to the receiving processor 104. The I/O bus is typically an order of magnitude lower in bandwidth than the Front Side Bus, which means that any

processing involving more than the four processors 104 will be significantly throttled by the loose coupling caused by the interconnect. All of this is eliminated with a reconfigurable processor having hundreds or thousands of functional units per processor.

With reference additionally now to Fig. 2, a functional block diagram of an adaptive processor 200 communications path for implementing the technique of the present invention is shown. The adaptive processor 200 includes an adaptive processor chip 202 incorporates a large number of functional units ("FU") 204 interconnected by reconfigurable routing resources. The adaptive processor chip 202 is coupled to a memory element 206 as well as an interconnect 208 and a number of additional adaptive processor chips 210.

As shown, each adaptive processor chip 202 can contain thousands of functional units 204 dedicated to the particular problem at hand. Interconnect between these functional units is created by reconfigurable routing resources inside each chip 202. As a result, the functional units 204 can share or exchange data at much higher data rates and lower latencies than a standard microprocessor 104 (Fig. 1). In addition, the adaptive processor chips 202 can connect directly to the inter-processor interconnect 208 and do not require the data to be passed through multiple chips in a chipset in order to communicate. This is because the adaptive processor can implement whatever kind of interface is needed to accomplish this connection.

With reference additionally now to Fig. 3A, a graph of the actual performance improvement versus the number

of processors utilized in a conventional multi-processor computing system 100 (Fig. 1) is shown. In this figure, the deviation from perfect scalability of a particular application is illustrated for such a system.

With reference additionally now to Fig. 3B, a corresponding graph of the actual performance improvement versus the number of processors utilized in an adaptive processor-based computing system 200 (Fig. 2) is shown. In this figure, the performance improvement provided with an adaptive processor-based computing system 200 over that of a conventional multi-processor computing system 100 is illustrated.

With reference additionally now to Fig. 4A, a simplified logic flowchart is provided illustrating a conventional sequential processing operation 400 in which nested Loops A (first loop 402) and B (second loop 404) are alternately active on different phases of the process.

As shown, the standard implementation of applications that have a set of nested loops 402,404 is to complete the processing of the first loop 402 before proceeding to the second loop 404. The problem inherent in this approach, particularly when utilized in conjunction with field programmable gate arrays ("FPGAs") is that all of the logic that has been instantiated is not being completely utilized.

With reference additionally now to Fig. 4B, a comparative, simplified logic flowchart is shown illustrating a multi-dimensional process 410 in accordance with the technique of the present invention. The multi-dimensional process 410 is effectuated such

that multiple dimensions of data are processed by both Loops A (first loop 412) and B (second loop 414) such that the computing system logic is operative on every clock cycle.

In contrast to the sequential processing operation 400 (Fig. 4A) the solution to the problem of most effectively utilizing available resources is to have an application evaluate a problem in a data flow sense. That is, it will "pass" a subsequent dimension of a given problem through the first loop 412 of logic concurrently with the previous dimension of data being processed through the second loop 414. In practice, a "dimension" of data can be: multiple vectors of a problem, multiple planes of a problem, multiple time steps in a problem and so forth.

With reference additionally now to Fig. 5A, a general process for performing a representative multi-dimensional pipeline operation is shown in the form of a seismic migration imaging function 500. The process 500 can be adapted to utilize the parallelism available in the utilization of the adaptive processing techniques of the present invention in the form of a multi-adaptive processor (MAPTM, a trademark of SRC Computers, Inc., assignee of the present invention) STEP3d routine 502. The MAP STEP3d routine 502 is operation to utilize velocity data 504, source data 506 and receiver data 508 to produce a resultant image 510 as will be more fully described hereinafter.

With reference additionally now to Fig. 5B, the MAP STEP3d routine 502 of the preceding figure is shown in

the various computational phases of: MAPTRI_x 520, MAPTRI_y 522, MAPTRI_d+ 524 and MAPTRI_d- 526.

With reference additionally now to Fig. 6A, a simplified logic flowchart for a particular seismic migration imaging application 600 is shown. The seismic migration imaging application 600 is illustrative of the parallelism provided in the use of an adaptive processor-based computing system 200 such as that shown in Fig. 2. The representative application 600 demonstrates a nested loop parallelism in the tri-diagonal solver and the same logic can be implemented for the multiple tri-diagonal solvers in the x, y, d+ and d- directions. The computational phases of: MAPTRI_x 520, MAPTRI_y 522, MAPTRI_d+ 524 and MAPTRI_d- 526 are again illustrated.

With reference additionally now to Fig. 6B, a computational process 610 is shown which may be employed by a microprocessor ("mP") in the execution of the seismic imaging application 600 of the preceding figure. The process 610 includes the step 612 of reading the source field [S(Z₀)] and receiver field [R(Z₀)] as well as the velocity field [V(Z₀)] at step 614. At step 616 values are computed for S(Z_{nz}), R(Z_{nz}) which step is followed by the phases MAPTRI_x 520 and MAPTRI_y 522. At step 618, the image of Z_{1/2} is computed. This is followed by the phases MAPTRI_d+ 524 and MAPTRI_d- 526 to produce the resultant image Z at step 620. The process 610 loops over the depth slices as indicated by reference number 622 and loops over the shots as indicated by reference number 624.

With reference additionally now to Fig. 6C, the first step in a computational process 650 in accordance with the technique of the present invention is shown in which a first shot (S1) is started. The process 650 may be employed by an adaptive processor (e.g. a MAPTM adaptive processor) as disclosed herein in the execution of the seismic imaging application 600 of Fig. 6A. As indicated by the shaded block, the phase MAPTRI_x 520 is active.

With reference additionally now to Fig. 6D, the second step in the computational process 650 is shown at a point at which a second shot (S2) is started. Again, as indicated by the shaded blocks, the phase MAPTRI_x 520 is active for S2, the phase MAPTRI_y 522 is active for S1 and image $Z_{1/2}$ has been produced at step 618. As shown, adaptive processors in accordance with the disclosure of the present invention support computation pipelining in multiple dimensions and the parallelism in Z and shots is shown at step 612.

With reference additionally now to Fig. 6E, the third step in the computational process 650 is shown in which the operation on the first and second shots is continued through compute. As indicated by the shaded blocks, the phase MAPTRI_d+ 524 is active for S1, the phase MAPTRI_y 522 is active for S2 and image $Z_{1/2}$ has been produced at step 618.

With reference additionally now to Fig. 6F, the fourth step in the computational process 650 is shown illustrating the subsequent operation on shots S1 and S2. The phase MAPTRI_d+ 524 is active for S2, the phase

MAPTRI_d- 526 is active for S1 and image Z has been produced at step 620.

With reference additionally now to Fig. 6G, the fifth step in the computational process 650 is shown as followed by the continued downward propagation of shots S1 and S2 over all of the depth slices. The phase MAPTRI_x 520 is active for S1, the phase MAPTRI_d- 526 is active for S2 and image Z has been produced at step 620.

With reference additionally now to Fig. 7A, a process 700 for performing a representative systolic wavefront operation in the form of a reservoir simulation function is shown which utilizes the parallelism available in the adaptive processing techniques of the present invention. The process 700 includes a "k" loop 702, "j" loop 704 and "i" loop 706 as shown.

With reference additionally now to Fig. 7B, the general computation of fluid flow properties in the reservoir simulation process 700 of the preceding figure are illustrated as values are communicated between a group of neighboring cells 710. The group of neighboring cells 710 comprises, in the simplified illustration shown, first, second and third walls of cells 712, 714 and 716 respectively. Each of the walls of cells includes a corresponding number of first, second, third and fourth rows 718, 720, 722 and 724 respectively.

As shown, the computation of fluid flow properties are communicated to neighboring cells 710 and, importantly, this computation can be scheduled to

eliminate the need for data storage. In accordance with the technique of the present invention, a set of cells can reside in an adaptive processor and the pipeline of computation can extend across multiple adaptive processors. Communication overhead between multiple adaptive processors may be advantageously minimized through the use of MAPTM adaptive processor chain ports as disclosed in U.S. Patent No. 6,339,819 issued on January 15, 2002 for: "Multiprocessor With Each Processor Element Accessing Operands in Loaded Input Buffer and Forwarding Results to FIFO Output Buffer", assigned to SRC Computers, Inc., assignee of the present invention, the disclosure of which is herein specifically incorporated by this reference.

With reference additionally now to Fig. 7C, the creation of a systolic wall 712 of computation at Time Set 1 is shown. The systolic wall 712 has been started for a vertical wall of cells and communication of values between adjacent rows 718 through 724 in the vertical wall can occur without storing values to memory.

With reference additionally now to Fig. 7D, a follow on illustration of the creation of a systolic wall 712 of computation at Time Set 1 and a second systolic wall 714 at Time Set 2 is shown. In operation, a second vertical wall of cells is started after the computation for cells in the corresponding row of the first wall has been completed. Thus, for example, at time t_0 , the first row 718 of systolic wall 712 is completed and the results passed to the first row 718 of the second systolic wall 714. At time t_1 , the second row 720 of the first systolic wall 712 and the first row

718 of the second systolic wall 714 are computed. Thereafter, at time t_2 , the third row 722 of the first systolic wall 712 and the second row 720 of the second systolic wall 714 are computed. The process continues in this manner for all rows and all walls.

With reference additionally now to Fig. 8A, yet another process 800 for performing a representative systolic wavefront operation is shown. The process 800 is in the form of the systolic processing of bioinformatics and also utilizes the parallelism available in the adaptive processing techniques of the present invention. As shown, systolic processing in the process 800 can pass previously computed data down within a column (e.g. one of columns 802, 804 and 806) as to subsequent columns as well (e.g. from column 802 to 804; from column 804 to 806 etc.) The computational advantage provided is the processing of the second column 804 can begin after only a few clock cycles following the start of the processing of the first column 802 to compute the first "match" state.

With reference additionally now to Fig. 8B, a systolic wavefront processing operation 810 is shown. The processing operation 810, comprising "i" loop 812 and "k" loop 814 now further incorporates a speculative processing strategy based upon an evaluation of the rate of change of XB.

A straightforward systolic processing operation could be used for performing the operation 810 but for the problem inherent in the computation of XB as its value $XB[i]$ 816 can not be known until the completion of the entire "k" loop 814. After evaluating the rate of

change of XB, it was determined that a speculative processing strategy could be used for the problem. A normal systolic form is set up and the value of XB is held constant for the set of columns computed in the systolic set. At the bottom of each column, the value of XB[i] 816 is then computed.

With reference additionally now to Fig. 8C, a further illustration of the systolic wavefront processing operation 810 incorporating speculative processing of the preceding figure is shown. The speculative processing includes "j" columns 818₀ through 818_j as shown. Each of the columns 818 assumes that XB[i+j] has a constant value. A test is conducted at the bottom of each of the columns 818 to determine with the XB value changes as indicated at steps 820₁ through 820_j. If the value of XB changes at the i+n column, the process is then restarted at that column 818. Since the rate of change of XB is relatively slow, the "cost" of the compute operation can be greatly reduced.

With reference additionally now to Fig. 9A, another process 900 for performing a representative systolic wavefront operation is shown in the form of structure codes calculating polynomials at grid intersections 902. The process 900 advantageously utilizes the parallelism available in the adaptive processing techniques of the present invention.

With reference additionally now to Figs. 9B and 9C, the computation start for a vertical wall 910 of grid points at Time Set 1 is shown for a polynomial evaluation performed on grid intersections 902 (Fig. 9A) wherein calculations between rows 912, 914, 916 and 918

are done in a stochastic fashion using values from a previous row. As shown, a polynomial evaluation is performed on the grid intersections 902 such that a second wall 910₁ is started after the cells in the corresponding row of the first wall 910₀ have been completed.

As can be determined from the foregoing, the multi-adaptive processing systems and techniques for enhancing parallelism and performance of computational functions disclosed herein can be employed in a myriad of applications including multi-dimensional pipeline computations for seismic applications, search algorithms, information security, chemical and biological applications, filtering and the like as well as for systolic wavefront computations for fluid flow and structures analysis, bioinformatics etc. Some applications may also employ both the multi-dimensional pipeline and systolic wavefront methodologies.

Following are representative applications of the techniques for adaptive processor based computation disclosed herein:

Imaging

Seismic: These applications, typically used in the oil and gas exploration industries, process echo data to produce detailed analysis of subsurface features. The applications use data collected at numerous points and consisting of many repeated parameters. Due to this, these programs are ideal candidates to take advantage of parallel computing. In addition, because the results of the computation on one data point are used in the computation of the next, these programs will

particularly benefit from the tight parallelism that can be found in the use of adaptive or reconfigurable processors.

Synthetic Aperture Radar ("SAR"): These applications are typically used in geographical imaging. The applications use data collected in swaths. Processing consists of repeated operations on data that has been sectioned in cells. These programs are also ideal candidates to take advantage of parallel computing and in particular to benefit from the tight parallelism that can be found in adaptive or reconfigurable processors.

JPEG Image compression: These applications partition an image into numerous blocks. These blocks then have a set of operations performed on them. The operations can be parallelized across numerous blocks. The combination of the set of operations and the parallelism will particularly benefit from the tight parallelism that can be found in adaptive or reconfigurable processors.

MPEG Image compression: These applications partition a frame into numerous blocks. These blocks then have a set of operations performed on them. The operations can be parallelized across numerous blocks. In addition, there are numerous operations that are performed on adjacent frames. The combination of the set of operations and the parallelism will particularly benefit from the tight parallelism that can be found in adaptive or reconfigurable processors.

Fluid flow

Reservoir Simulation: These applications, also typically used in the oil and gas production industries, process fluid flow data in the oil and gas subsurface reservoirs to produce extraction models. The application will define a three dimensional ("3d") set of cells that contain the oil and gas reservoir. These programs are ideal candidates to take advantage of parallel or adaptive computing because there are repeated operations on each cell. In addition, information computed for each cell is then passed to neighboring cells. These programs will particularly benefit from the tight parallelism that can be found in adaptive or reconfigurable processors.

Weather prediction: Such an application will partition the forecast area into logical grid cells. The computational algorithms will then perform calculations that have polynomials that have nodes associated with the grid cells. These programs are ideal candidates to take advantage of adaptive or parallel computing because there are repeated operations on each cell associated with the set of times computed in the forecast.

Automotive: These applications investigate the aerodynamics of automobile or other aerodynamic structures. The application generally divides the space surrounding the automobile structure into logical cells that are associated with nodes in computational polynomials. These programs are ideal candidates to take advantage of adaptive or parallel computing because there are repeated operations on each cell associated

with the set of wind velocities computed in the forecast. These programs will benefit from the tight parallelism that can be found in adaptive or reconfigurable processors.

Aerospace: These applications investigate the aerodynamics of aerospace/airplane structures. The application divides the space surrounding the aerospace/airplane structure into logical cells that are associated with nodes in computational polynomials. These programs are ideal candidates to take advantage of parallel computing because there are repeated operations on each cell associated with the set of wind velocities computed in the forecast. These programs will benefit from the tight parallelism that can be found in adaptive or reconfigurable processors.

Plastic Injection Molding: These applications investigate the molding parameters of injecting liquid plastic into molds. The application divides the space inside the mold into logical cells that are also associated with nodes in computational polynomials. These programs are ideal candidates to take advantage of parallel computing because there are repeated operations on each cell associated with the set of injection parameters. These programs will benefit from the tight parallelism that can be found in adaptive or reconfigurable processors.

Structures

Crash Analysis: These applications are typically used in the automotive or aviation industry. The application will partition the entire automobile into components. These components are then subdivided into

cells. The application will analyze the effect of a collision on the structure of the automobile. These programs are ideal candidates for parallel computing because there are repeated operations on each cell and they receive computed information from their neighboring cells. These programs will benefit from the tight parallelism that can be found in adaptive or reconfigurable processors.

Structural Analysis: These applications investigate the properties of structural integrity. The application divides the structure into logical cells that are associated with nodes in computational polynomials. These programs are ideal candidates to take advantage of parallel computing because there are repeated operations on each cell associated with load and stress. These programs will benefit from the tight parallelism that can be found in adaptive or reconfigurable processors.

Search algorithms

Image searches: These applications are typically used in the security industry for fingerprint matching, facial recognition and the like. The application seeks matches in either a collection of subsets of the total image or the total image itself. The process compares pixels of the model to pixels of a record from an image database. These programs are ideal candidates for parallel computing because of the correlation of comparison results that exist for each pixel in the subsets or entire image. These programs will benefit from the tight parallelism that can be found in adaptive or reconfigurable processors.

Data mining: These applications are typically used in commercial market spaces. The application seeks matches in a set of search information (e.g. character strings) in each record in a database. The application then produces a match correlation for all data records. A match correlation is produced from the comparison results for each set of search information with all characters in a database record. These programs are ideal candidates for parallel computing because of the repeated comparison operations that exist all character comparisons of the set of search information with each character in the database record. These programs will benefit from the tight parallelism that can be found in adaptive or reconfigurable processors.

Finance

Financial modeling: The application creates numerous strategies for each decision step in the modeling process. The results of a computational step are feed into another set of strategies for subsequent modeling steps. These programs are ideal candidates to take advantage of parallel computing because there are repeated operations on each strategy within a modeling step. These programs will benefit from the tight parallelism that can be found in adaptive or reconfigurable processors.

Information Security

Encryption/Decryption: The application applies an algorithm that converts the original data into an encrypted, or "protected", form. The process is applied to each set of N bits in the original data. Decryption reverses the process to deliver the original data.

These programs are ideal candidates for parallel computing because there are repeated operations on each N bits of data. These programs will benefit from the tight parallelism that can be found in adaptive or reconfigurable processors.

Chemistry/Biology

Genetic pattern matching: These applications are typically used in the bioinformatics industry. The application looks for matches of a particular genetic sequence (or model) to a database of genetic records. The application compares each character in the model to the characters in genetic record. These programs are ideal candidates for parallel computing because of the repeated comparison operations that exist for all character comparisons of the model with each character in the genetic record. These programs will benefit from the tight parallelism that can be found in adaptive or reconfigurable processors.

Protein Folding: These applications are typically used by pharmaceutical companies. The application investigates the dynamics of the deformation of the protein structure. The application uses a set of equations which are recomputed at various "time" intervals to model the protein folding. These programs are ideal candidates for parallel computing because of the repeated computations on a large set of time intervals in the modeling sequence. These programs will benefit from the tight parallelism that can be found in adaptive or reconfigurable processors

Organic structure interaction: These applications are typically used by chemical and drug companies. The

application investigates the dynamics of organic structures as they are interacting. The application uses a set of equations which are recomputed at various "time" intervals to model how the organic structure interact. These programs are ideal candidates for parallel computing because of the repeated computations on a large set of time intervals in the modeling sequence. These programs will benefit from the tight parallelism that can be found in adaptive or reconfigurable processors

Signals

Filtering: Applications often utilize filtering techniques to "clean-up" a recorded data sequence. This technique is utilized in a wide variety of industries. The application generally applies a set of filter coefficients to each data point in the recorded sequence. These programs are ideal candidates for parallel computing because of the repeated computations to all data points in the sequence and all sequences. These programs will benefit from the tight parallelism that can be found in adaptive or reconfigurable processors.

While there have been described above the principles of the present invention in conjunction with specific, exemplary applications for the use of adaptive processor-based systems in the implementation of multi-dimensional pipeline and systolic wavefront computations, it is to be clearly understood that the foregoing descriptions are made only by way of example and not as a limitation to the scope of the invention. Particularly, it is recognized that the teachings of the

foregoing disclosure will suggest other modifications to those persons skilled in the relevant art. Such modifications may involve other features which are already known per se and which may be used instead of or in addition to features already described herein. Although claims have been formulated in this application to particular combinations of features, it should be understood that the scope of the disclosure herein also includes any novel feature or any novel combination of features disclosed either explicitly or implicitly or any generalization or modification thereof which would be apparent to persons skilled in the relevant art, whether or not such relates to the same invention as presently claimed in any claim and whether or not it mitigates any or all of the same technical problems as confronted by the present invention. The applicants hereby reserve the right to formulate new claims to such features and/or combinations of such features during the prosecution of the present application or of any further application derived therefrom.

What is claimed is:

CLAIMS:

1. A method for data processing in a reconfigurable computing system, the reconfigurable computing system comprising at least one reconfigurable processor, the reconfigurable processor comprising a plurality of functional units, said method comprising:

transforming an algorithm into a data driven calculation that is implemented by said reconfigurable computing system at the at least one reconfigurable processor;

forming at least two of said functional units at the at least one reconfigurable processor to perform said calculation wherein only functional units needed to solve the calculation are formed and wherein each formed functional unit at the at least one reconfigurable processor interconnects with each other formed functional unit at the at least one reconfigurable processor based on reconfigurable routing resources within the at least one reconfigurable processor as established at formation, and wherein lines of code of said calculation are formed as clusters of functional units within the at least one reconfigurable processor;

utilizing a first of said formed functional units to operate upon a subsequent data dimension of said calculation forming a first computational loop; and

substantially concurrently utilizing a second of said formed functional units to operate upon a previous data dimension of said calculation generating a second computational loop wherein said implementation of said calculation enables said first computational loop and said second computational loop execute concurrently and

pass computed data seamlessly between said computational loops.

2. The method of claim 1 wherein said subsequent and previous data dimensions of said calculation comprise multiple vectors in said calculation.

3. The method of claim 1 wherein said subsequent and previous data dimensions of said calculation comprise multiple planes in said calculation.

4. The method of claim 1 wherein said subsequent and previous data dimensions of said calculation comprise multiple time steps in said calculation.

5. The method of claim 1 wherein said subsequent and previous data dimensions of said calculation comprise multiple grid points in said calculation.

6. The method of claim 1 wherein said calculation comprises a seismic imaging calculation.

7. The method of claim 1 wherein said calculation comprises a synthetic aperture radar imaging calculation.

8. The method of claim 1 wherein said calculation comprises a JPEG image compression calculation.

9. The method of claim 1 wherein said calculation comprises an MPEG image compression calculation.

10. The method of claim 1 wherein said calculation comprises a fluid flow calculation for a reservoir simulation.

11. The method of claim 1 wherein said calculation comprises a fluid flow calculation for weather prediction.

12. The method of claim 1 wherein said calculation comprises a fluid flow calculation for automotive applications.

13. The method of claim 1 wherein said calculation comprises a fluid flow calculation for aerospace applications.

14. The method of claim 1 wherein said calculation comprises a fluid flow calculation for an injection molding application.

15. The method of claim 1 wherein instantiating includes establishing a stream communication connection between functional units.

16. The method of claim 1 wherein said calculation is comprises a structures calculation for structural analysis.

17. The method of claim 1 wherein said calculation comprises a search algorithm for an image search.

18. The method of claim 1 wherein said calculation comprises a search algorithm for data mining.

19. The method of claim 1 wherein said calculation comprises a financial modeling application.

20. The method of claim 1 wherein said calculation comprises an encryption algorithm.

21. The method of claim 1 wherein said calculation comprises a genetic pattern matching function.

22. The method of claim 1 wherein said calculation comprises a protein folding function.

23. The method of claim 1 wherein said calculation comprises an organic structure interaction function.

24. The method of claim 1 wherein said calculation comprises a signal filtering application.

25. A method for data processing in a reconfigurable computing system, the reconfigurable computing system comprising at least one reconfigurable processor comprising a plurality of functional units, said method comprising:

transforming an algorithm into a data driven calculation that is implemented by said reconfigurable computing system at the at least one reconfigurable processor wherein linked lines of code of said calculation are fashioned as walls of functional units within the at least one reconfigurable processor;

defining a first wall comprising rows of cells forming a subset of said plurality of functional units;

computing at the at least one reconfigurable processor a value at each of said cells in at least a first row of said first wall substantially concurrently;

communicating said values between cells in said first row of said cells to produce updated values, wherein communicating said values is based on reconfigurable routing resources within the at least one reconfigurable processor;

communicating said updated values substantially concurrently to a second row of said first wall, wherein communicating said updated values is based on reconfigurable routing resources within the at least one reconfigurable processor; and

communicating said updated values substantially concurrently to a first row of a second wall of rows of cells in said subset of said plurality of functional units, wherein communicating said updated values is based on reconfigurable routing resources within the at least one reconfigurable processor and wherein said first wall of rows of cells and said second wall of rows of cells execute substantially concurrently and pass computed data seamlessly between said walls.

26. The method of claim 25 wherein said values correspond to vectors in a computation.

27. The method of claim 25 wherein said values correspond to planes in a computation.

28. The method of claim 25 wherein said values correspond to time steps in a computation.

29. The method of claim 25 wherein said values correspond to grid points in a computation.

30. The method of claim 25 wherein said step of communicating said updated values to a second row of said first systolic wall is carried out without storing said updated values in an extrinsic memory.

31. The method of claim 25 wherein said values correspond to a seismic imaging calculation.

32. The method of claim 25 wherein said values correspond to a synthetic aperture radar imaging calculation.

33. The method of claim 25 wherein said values correspond to a JPEG image compression calculation.

34. The method of claim 25 wherein said values correspond to an MPEG image compression calculation.

35. The method of claim 25 wherein said values correspond to a fluid flow calculation for a reservoir simulation.

36. The method of claim 25 wherein said values correspond to a fluid flow calculation for weather prediction.

37. The method of claim 25 wherein said values correspond to a fluid flow calculation for automotive applications.

38. The method of claim 25 wherein said values correspond to a fluid flow calculation for aerospace applications.

39. The method of claim 25 wherein said values correspond to a fluid flow calculation for an injection molding application.

40. The method of claim 25 wherein defining includes establishing a stream communication connection between functional units and wherein only functional units needed to solve the calculations are instantiated.

41. The method of claim 25 wherein said values correspond to a structures calculation for structural analysis.

42. The method of claim 25 wherein said values correspond to a search algorithm for an image search.

43. The method of claim 25 wherein said values correspond to a search algorithm for data mining.

44. The method of claim 25 wherein said values correspond to a financial modeling application.

45. The method of claim 25 wherein said values correspond to an encryption algorithm.

46. The method of claim 25 wherein said values correspond to a genetic pattern matching function.

47. The method of claim 25 wherein said values correspond to a protein folding function.

48. The method of claim 25 wherein said values correspond to an organic structure interaction function.

49. The method of claim 25 wherein said values correspond to a signal filtering application.

50. The method of claim 25 wherein said reconfigurable computing system comprises at least one microprocessor.

51. A method for data processing in a reconfigurable computing system, the reconfigurable computer system comprising at least one reconfigurable processor

comprising a plurality of functional units, said method comprising:

transforming an algorithm into a calculation implemented by said reconfigurable computing system at the at least one reconfigurable processor and driven by data propagation wherein lines of code of said calculation are linked based on said data propagation and fashioned as subsets of said plurality of functional units within the at least one reconfigurable processor forming columns of said calculation;

performing said calculation at the at least one reconfigurable processor by said subsets of said plurality of functional units to produce computed data;

exchanging said computed data between a first column of said calculation and a next column in said calculation, wherein said exchanging is based on reconfigurable routing resources within the at least one reconfigurable processor and wherein execution of said subsets of said plurality of function units occurs concurrently and said computed data is seamlessly passed between said first column of said calculation and said second column of said calculation;

evaluating a rate of change in at least one variable for each of said columns in said calculation;

continuing said calculation when said variable does not change for a particular column of said calculation; and

restarting said calculation at said column of said calculation where said variable does change.

52. The method of claim 51 wherein how many functional units comprise the subset and functional type of each

functional unit in said subset is based on the calculation.

ABSTRACT OF THE DISCLOSURE

Multi-adaptive processing systems and techniques for enhancing parallelism and performance of computational functions are disclosed which can be employed in a myriad of applications including multi-dimensional pipeline computations for seismic applications, search algorithms, information security, chemical and biological applications, filtering and the like as well as for systolic wavefront computations for fluid flow and structures analysis, bioinformatics etc. Some applications may also employ both the multi-dimensional pipeline and systolic wavefront methodologies disclosed.

DECLARATION FOR UTILITY OR DESIGN PATENT APPLICATION (37 CFR 1.63)	Attorney Docket No.	SRC015
	First Named Inventor	Jon M. Huppenthal et al.
	<i>COMPLETE IF KNOWN</i>	
	Application Number	10/285,318
<input type="checkbox"/> Declaration Submitted with Initial Filing OR <input checked="" type="checkbox"/> Declaration Submitted after Initial Filing--surcharge 37 CFR 1.16(e) required	Filing Date	October 31, 2002
	Group Art Unit	2121
	Examiner Name	Not yet assigned

As a below named inventor, I hereby declare that:

My residence, mailing address, and citizenship are as stated below next to my name.

I believe I am the original, first and sole inventor (if only one name is listed below) or an original, first and joint inventor (if plural names are listed below) of the subject matter which is claimed and for which a patent is sought on the invention entitled:

MULTI-ADAPTIVE PROCESSING SYSTEMS AND TECHNIQUES FOR ENHANCING PARALLELISM AND PERFORMANCE OF COMPUTATIONAL FUNCTIONS

the specification of which

is attached hereto

OR

was filed on (MM/DD/YYYY) 10/31/2002 as U.S. Application No. or PCT International Application No. 10/285,318

and was amended on (MM/DD/YYYY) (if applicable)

I hereby state that I have reviewed and understand the contents of the above identified specification, including the claims, as amended by any amendment specifically referred to above.

I acknowledge the duty to disclose information which is material to patentability as defined in 37 CFR 1.56, including for continuation-in-part applications, material information which became available between the filing date of the prior application and the national or PCT international filing date of the continuation-in-part application.

I hereby claim foreign priority benefits under 35 U.S.C § 119(a)-(d) or (f), or 365(b) of any foreign application(s) for patent or inventor's certificate, or § 365(a) of any PCT international application which designated at least one country other than the United States of America, listed below and have also identified below, by checking the box, any foreign application for patent or inventor's certificate, or of any PCT international application having a filing date before that of the application on which priority is claimed.

Prior Foreign Appl. No.(s)	Country	Foreign Filing Date (MM/DD/YYYY)	Priority Not Claimed	Certified Copy Attached?	
				Yes	No
			<input type="checkbox"/>	<input type="checkbox"/>	<input type="checkbox"/>
			<input type="checkbox"/>	<input type="checkbox"/>	<input type="checkbox"/>

Additional foreign application nos. are listed on a supplemental priority data sheet PTO/SB/02B attached hereto:

I hereby claim the benefit under 35 U.S.C. § 119(e) of any United States provisional application(s) listed below.

Application Number(s)	Filing Date (MM/DD/YYYY)

DECLARATION – Utility or Design Patent Application

I hereby claim the benefit under 35 U.S.C. 120 of any U.S. application(s) or 365(c) of any PCT international application designating the United States of America, listed below and, insofar as the subject matter of each of the claims of this application is not disclosed in the prior United States or PCT international application in the manner provided by the first paragraph of 35 U.S.C. 112, I acknowledge the duty to disclose information which is material to patentability as defined in 37 CFR 1.56 which became available between the filing date of the prior application and the national or PCT international filing date of this application

U.S. Parent Application or PCT Parent No.	Parent Filing Date (MM/DD/YY)	Parent Patent No. (if applicable)

Additional U.S. or PCT international application nos. listed on PTO/SB/02B attached hereto.

As a named inventor, I hereby appoint the following registered practitioner(s) to prosecute this application and to transact all business in the Patent Trademark Office connected therewith:

Customer Number **25235** Place bar code label here 00 

OR

Registered practitioner(s) name/registration number listed below

Name	Registration Number	Name	Registration Number

Additional registered practitioner(s) named on supplemental sheet PTO/SB/02C attached hereto.

Direct all correspondence to: Customer Number **25235** OR Correspondence address below
 or Bar Code Label 

Name					
Address					
City		State		ZIP	
Country	Telephone			Fax	

I hereby declare that all statements made herein of my own knowledge are true and that all statements made on information and belief are believed to be true; and further that these statements were made with the knowledge that willful false statements and the like so made are punishable by fine or imprisonment, or both, under 18 U.S.C. 1001 and such willful false statements may jeopardize the validity of the application or any patent issued thereon.

Name of Sole or First Inventor: A petition has been filed for this unsigned inventor.

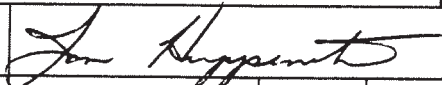
Given Name (first and middle [if any])	Family Name or Surname		
Jon M.	Huppenthal		
Inventor's Signature	Date		
	1/6/03		
Residence City	State	Country	Citizenship
Colorado Springs	Colorado	USA	USA
Mailing Address	10015 Burgess Road		
City	State	ZIP	Country
Colorado Springs	Colorado	80908	USA

Additional inventors are named on _1_ supplemental additional inventor(s) sheet(s) PTO/SB/02A attached

DECLARATION

ADDITIONAL INVENTOR(S)
Supplemental Sheet
Page 1 of 1

Name of Additional Joint Inventor, if any:		<input type="checkbox"/> A petition has been filed for this unsigned inventor					
Given Name (first and middle [if any])		Family Name or Surname					
David E.		Caliga					
Inventor's Signature	<i>D. E. Caliga</i>					Date	1/6/2003
Residence: City	Colorado Springs	State	CO	Country	USA	Citizenship	USA
Mailing Address	8445 Lauralwood Lane						
City	Colorado Springs	State	CO	ZIP	80919	Country	USA
Name of Additional Joint Inventor, if any:		<input type="checkbox"/> A petition has been filed for this unsigned inventor					
Given Name (first and middle [if any])		Family Name or Surname					
Inventor's Signature						Date	
Residence: City		State		Country		Citizenship	
Mailing Address							
City		State		ZIP		Country	
Name of Additional Joint Inventor, if any:		<input type="checkbox"/> A petition has been filed for this unsigned inventor					
Given Name (first and middle [if any])		Family Name or Surname					
Inventor's Signature						Date	
Residence: City		State		Country		Citizenship	
Mailing Address							
City		State		ZIP		Country	

IN THE UNITED STATES PATENT AND TRADEMARK OFFICE

Serial No. ----- Application of: Jon M. Huppenthal and David E. Caliga Filed: Herewith Attorney Docket No. SRC015 CON For: MULTI-ADAPTIVE PROCESSING SYSTEMS AND TECHNIQUES FOR ENHANCING PARALLELISM AND PERFORMANCE OF COMPUTATIONAL FUNCTIONS	Art Unit: Confirmation No.: Examiner: Customer No.: 25235
---	---

INFORMATION DISCLOSURE STATEMENT
UNDER 37 C.F.R. § 1.97

Commissioner for Patents
P.O. Box 1450
Alexandria, VA 22313-1450

Sir:

Pursuant to 37 C.F.R. § 1.97, the Examiner may wish to consider the references listed on the attached Form PTO/SB/08A. In submitting these references, no representation is made or implied that the references are or are not material to the examination of this application. Pursuant to 37 C.F.R. 1.98(d), copies of the references are not enclosed, as each reference was either provided or cited in U.S. Patent Application Serial No. 10/285,318, which is related to U.S. Patent Application Serial No. 09/755,744, which is related to U.S. Patent Application Serial No. 09/888,276, now U.S. Patent No. 6,434,687, from which priority under 35 U.S.C. 120 was claimed.

This Information Disclosure Statement is filed before mailing of a first Office Action in the above case. Accordingly, no fee is believed due. However, any fee associated herewith may be charged to Deposit Account No. 50-1123.

Respectfully submitted,

9 April 2009
Date

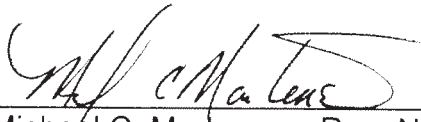
Michael C. Martensen, Reg. No. 46901
HOGAN & HARTSON LLP
One Tabor Center
1200 17th Street, Suite 1500
Denver, Colorado 80202
(719) 448-5910 Tel
(303) 899-7333 Fax

Under the Paperwork Reduction Act of 1995, no persons are required to respond to a collection of information unless it displays a valid OMB control number.

Substitute for form 1449A/PTO INFORMATION DISCLOSURE STATEMENT BY APPLICANT <i>(Use as many sheets as necessary)</i>				Application Number	
				Filing Date	Herewith
				First Named Inventor	Jon M. Huppenthal et al.
				Art Unit	
				Examiner Name	
Sheet	1	of	8	Attorney Docket No.	SRC015 CON

U.S. PATENT DOCUMENTS					
Examiner Initials	Cite No. ¹	Document No. No. -- Kind Code ²	Publication Date MM-DD-YYYY	Name of Patentee or Applicant of Cited Doc	Pages, Columns, Lines, Where Relevant Passages or Relevant Figures Appear
		US-6,215,898	04/10/2001	Woodfill et al.	Fig. 3 and col. 9, line 32-col. 16, line 45, and col. 57, line 6-col.67, line 23.
		US-5,020,059	05/28/1991	Gorin et al.	Figs. 5, 9 and col. 7, line 28-col. 9, line 53.
		US-5,471,627	11/28/1995	Means et al.	Fig. 3 and col. 4, line 40- col. 12, line 42.
		US-4,727,503	02/23/1988	McWhirter	Column 3, line 49-col. 4, line 64.
		US-5,477,221	12/19/1995	Chang et al.	Fig. 5 and col. 6, line 48-col. 9, line 9.
		US-			
		US-			
		US-			
		US-			
		US-			
		US-			

FOREIGN PATENT DOCUMENTS							
Examiner Initials	Cite No. ¹	Foreign Patent Document		Publication Date MM-DD-YYYY	Name of Patentee or Applicant of Cited Doc	Pages, Columns, Lines Where Relevant Passages or Relevant Figures Appear	T ⁶
		Country Code ³	Number ⁴ Kind Code ⁵				

EXAMINER SIGNATURE		DATE CONSIDERED	
<p>EXAMINER: Initial if reference considered, whether or not citation is in conformance with MPEP 609. Draw line through citation if not in conformance and not considered. Include copy of this form with next communication to applicant. ¹ Applicant's unique citation designation number (optional). ² See Kinds Codes of USPTO Patent Documents at www.uspto.gov or MPEP 901.04. ³ Enter Office that issued the document, by the two-letter code (WIPO Standard ST.3). ⁴ For Japanese patent documents, the indication of the year of the reign of the Emperor must precede the serial number of the patent document. ⁵ Kind of document by the appropriate symbols as indicated on the document under WIPO Standard ST. 16 if possible. ⁶ Applicant is to place a check mark here if English language Translation is attached.</p> <p>This collection of information is required by 37 CFR 1.97 and 1.98. The information is required to obtain or retain a benefit by the public which is to file (and by the USPTO to process) and application. Confidentiality is governed by 35 U.S.C. 122 and 37 CFR 1.14. This collection is estimated to take 2 hours to complete, including gathering, preparing, and submitting the completed application form to the USPTO. Time will vary depending upon the individual case. Any comments on the amount of time you require to complete this form and/or suggestions for reducing this burden, should be sent to the Chief Information Officer, U.S. Patent and Trademark Office, U.S. Department of Commerce, P.O. Box 1450, Alexandria, VA 22313-1450. DO NOT SEND FEES OR COMPLETED FORMS TO THIS ADDRESS. SEND TO: Commissioner for Patents, P.O. Box 1450, Alexandria, VA 22313-1450.</p>			

Under the Paperwork Reduction Act of 1995, no persons are required to respond to a collection of information unless it displays a valid OMB control number.

Substitute for form 1449A/PTO INFORMATION DISCLOSURE STATEMENT BY APPLICANT (Use as many sheets as necessary)				Application Number	
				Filing Date	Herewith
				First Named Inventor	Jon M. Huppenthal et al.
				Art Unit	
				Examiner Name	
Sheet	2	of	8	Attorney Docket No.	SRC015 CON

U.S. PATENT DOCUMENTS					
Examiner Initials	Cite No. ¹	Document No. No. – Kind Code ²	Publication Date MM-DD-YYYY	Name of Patentee or Applicant of Cited Doc	Pages, Columns, Lines, Where Relevant Passages or Relevant Figures Appear
		US-6,385,757	05/07/2002	Gupta et al.	
		US-4,872,133	10/03/1989	Leeland	
		US-5,274,832	12/28/1993	Khan	
		US-5,072,371	12/10/1991	Benner et al.	
		US-5,072,371	12-1991	Benner et al.	
		US-4,962,381	10-1990	Helbig, Sr., Walter A.	
		US-5,784,108	07-1998	Skaletzky et al.	
		US-6,061,706	05-2000	Gai et al.	
		US-5,956,518	09-1999	DeHon et al.	
		US-5,640,586	06-1997	Pechanek et al.	
		US5,915,123	06-1999	Miirsky et al.	
		US-6,289,440-	09-2001	Casselman, Steven	

FOREIGN PATENT DOCUMENTS								
Examiner Initials	Cite No. ¹	Foreign Patent Document			Publication Date MM-DD-YYYY	Name of Patentee or Applicant of Cited Doc	Pages, Columns, Lines Where Relevant Passages or Relevant Figures Appear	T ⁶
		Country Code ³	Number ⁴	Kind Code ⁵				

EXAMINER SIGNATURE	DATE CONSIDERED
---------------------------	------------------------

EXAMINER: Initial if reference considered, whether or not citation is in conformance with MPEP 609. Draw line through citation if not in conformance and not considered. Include copy of this form with next communication to applicant. ¹ Applicant's unique citation designation number (optional). ² See Kinds Codes of USPTO Patent Documents at www.uspto.gov or MPEP 901.04. ³ Enter Office that issued the document, by the two-letter code (WIPO Standard ST.3). ⁴ For Japanese patent documents, the indication of the year of the reign of the Emperor must precede the serial number of the patent document. ⁵ Kind of document by the appropriate symbols as indicated on the document under WIPO Standard ST. 16 if possible. ⁶ Applicant is to place a check mark here if English language Translation is attached.

This collection of information is required by 37 CFR 1.97 and 1.98. The information is required to obtain or retain a benefit by the public which is to file (and by the USPTO to process) and application. Confidentiality is governed by 35 U.S.C. 122 and 37 CFR 1.14. This collection is estimated to take 2 hours to complete, including gathering, preparing, and submitting the completed application form to the USPTO. Time will vary depending upon the individual case. Any comments on the amount of time you require to complete this form and/or suggestions for reducing this burden, should be sent to the Chief Information Officer, U.S. Patent and Trademark Office, U.S. Department of Commerce, P.O. Box 1450, Alexandria, VA 22313-1450. DO NOT SEND FEES OR COMPLETED FORMS TO THIS ADDRESS. SEND TO: Commissioner for Patents, P.O. Box 1450, Alexandria, VA 22313-1450.

Under the Paperwork Reduction Act of 1995, no persons are required to respond to a collection of information unless it displays a valid OMB control number.

Substitute for form 1449A/PTO INFORMATION DISCLOSURE STATEMENT BY APPLICANT (Use as many sheets as necessary)	Application Number		
	Filing Date		Herewith
	First Named Inventor		Jon M. Huppenthal et al.
	Art Unit		
	Examiner Name		
Sheet	3	of	8
Attorney Docket No.		SRC015 CON	

NON PATENT LITERATURE DOCUMENTS			
Examiner Initials*	Cite No. ¹	Include name of the author (in CAPITAL LETTERS), title of the article (when appropriate), title of the item (book, magazine, journal, serial, symposium, catalog, etc.), date, page(s), volume-issue number(s) publisher, city and/or country where published	T ²
		MIYAMORI, TAKASHI, "REMARC: Reconfigurable Multimedia Array Coprocessor", IEICE Transactions on Information and Systems, Information & Systems Society, Tokyo, JP, vol. E82-D, no. 2, February 1999 (1999-02), pgs. 389-397, XP000821922.	
		GROSS THOMAS, et al., "Compilation for a High-performance Systolic Array", Sigplan Notices USA, vol. 21, no. 7, July 1986, (1986-07), pgs. 27-38, XP002418625.	
		RAUCHWERGER, LAWRENCE, et al., "The LRPD Test: Speculative Run-Time Parallelization of Loops with Privatization and Reduction Parallelization", IEEE Transactions on Parallel and Distributed Systems, IEEE Service Center, Los Alamitos, CA, vol. 10, no. 2, February 1999 (1999-02), pgs. 160-180, XP000908318.	
		ARNOLD JEFFREY M. et al., "The Splash 2 Processor and Applications", Computer Design: VLSI in Computers and Processors, 1993, ICCD '93 Proceedings, 1993 IEEE International Conference on Cambridge, MA, 3-6 Oct. 1993, Los Alamitos, CA, IEEE Comput. Soc., 3 October 1993 (1993-10-03), pgs. 482-485, XP010134571.	
		HWANG, KAI, "Computer Architecture and Parallel Processing", Data Flow Computers and VLSI Computations, 1985, McGraw Hill, Chapter 10, pgs. 732-807, XP-002418655	
		HARTENSTEIN, REINER W., et al. "A Synthesis System for Bus-based Wavefront Array Architectures", Proceedings, International Conference on Application-Specific Systems, Architectures and Processors, 1996, pgs 274-283, XP002132819.	
		ALEXANDER, THOMAS, et al. "A Reconfigurable Approach To A Systolic Sorting Architecture", ISCAS 89, 8 May 1989, (1989-05-08), pgs. 1178-1182, XP010084477.	
		WU, YOUFENG, et al. "Better Exploration of Region-Level Value Locality with Integrated Computation Reuse and Value Prediction", Proceedings of the 28th International Symposium on Computer Architecture, ISCA 2001, Goteborg, Sweden, June 30-July 4, 2001, International Symposium on Computer Architecture, (ISCA), Los Alamitos, CA, IEEE Comp. Soc, US, 30 June 2001 (2001-06-30), pgs. 93-103, XP010552866.	

EXAMINER SIGNATURE	DATE CONSIDERED
EXAMINER: Initial if reference considered, whether or not citation is in conformance with MPEP 609. Draw line through citation if not in conformance and not considered. Include copy of this form with next communication to applicant.	
¹ Applicant's unique citation designation number (optional). ² Applicant is to place a check mark here if English language Translation is attached. This collection of information is required by 37 CFR 1.97 and 1.98. The information is required to obtain or retain a benefit by the public which is to file (and by the USPTO to process) and application. Confidentiality is governed by 35 U.S.C. 122 and 37 CFR 1.14. This collection is estimated to take 2 hours to complete, including gathering, preparing, and submitting the completed application form to the USPTO. Time will vary depending upon the individual case. Any comments on the amount of time you require to complete this form and/or suggestions for reducing this burden, should be sent to the Chief information Officer, U.S. Patent and Trademark Office, U.S. Department of Commerce, P.O. Box 1450, Alexandria, VA 22313-1450. DO NOT SEND FEES OR COMPLETED FORMS TO THIS ADDRESS. SEND TO: Commissioner for Patents, P.O. Box 1450, Alexandria, VA 22313-1450.	

Substitute for form 1449A/PTO INFORMATION DISCLOSURE STATEMENT BY APPLICANT <i>(Use as many sheets as necessary)</i>				Application Number	
				Filing Date	Herewith
				First Named Inventor	Jon M. Huppenthal et al.
				Art Unit	
				Examiner Name	
Sheet	4	of	8	Attorney Docket No.	SRC015 CON

NON PATENT LITERATURE DOCUMENTS			
Examiner Initials*	Cite No. ¹	Include name of the author (in CAPITAL LETTERS), title of the article (when appropriate), title of the item (book, magazine, journal, serial, symposium, catalog, etc.), date, page(s), volume-issue number(s) publisher, city and/or country where published	T ²
		BABB, JONATHAN, et al., "Parallelizing applications into silicon", © 1999 IEEE.	
		DESHPANDE, DEEPALI, et al., "Hybrid data/configuration caching for striped FPGAs" © 1999 IEEE.	
		PURNA, KARTHIKEYA, et al., "Temporal partitioning and scheduling data flow graphs for reconfigurable computers", © 1999 IEEE, Publ. No. 0018-9340/99, Pages 579-590.	
		GIBBS, W. WAYT, "Blitzing bits", © 1999 Scientific American Presents, Pages 57-61.	
		GONZALEZ, RICARDO, "Configurable and extensible processors change system design", August 15-17, 1999, Hot Chips 11 Tutorials, Pages 135-146.	
		GRAHAM, PAUL, et al., "FPGA-based sonar processing", © 1998 ACM 0-89791-978-5/98, Pages 201-208.	
		HASEBE, A., et al., "Architecture of SIPS, a real time image processing system," © 1988 IEEE, Publ. No. CH2603-9/88/0000/0621, Pages 621-630.	
		HAMMOND, LANCE, et al., "The Stanford Hydra CMP", August 15-17, 1999 Hot Chips 11 Tutorials, Pages 23-31.	
		JEAN, JACK, et al., "Dynamic reconfiguration to support concurrent applications", © 1999 IEEE, Publ. No. 0018-9340/99, Pages 591-602.	
		KASTRUP, BERNARDO, et al., "Concise: a compiler-driven CPLD-based instruction set accelerator", © 1999 IEEE.	
		MOTOMURA, MASATO, et al., "An embedded DRAM-FPGA chip with instantaneous logic reconfiguration", © 1998 IEEE, Publ. No. 0-8186-8900-5/98, Pages 264-266.	
		MCCONNELL, RAY, "Massively parallel computing on the FUZION chip", August 15-17, 1999, Hot Chips 11 Tutorials, Pages 83-84.	
		MCSHANE, ERIK, et al., "Functionally integrated systems on a chip: technologies, architectures, CAD tools, and applications", © 1998 IEEE, Publ. No. 8-8186-8424-0/98, Pages 67-75.	
		RUPP, CHARLEY, et al., "The NAPA adaptive processing architecture", © 1998 the Authors, Pages 1-10.	
		SAITO, OSAMU, et al., "A 1M synapse self learning digital neural network chip", © 1998 IEEE, Publ. No. 0-7803-4344/1/98, Pages 94-95.	
		SCHOTT, BRIAN, et al., "Architectures for system-level applications of adaptive computing", © 1999 IEEE.	
		MENCER, OSKAR, et al., "PAM-Blox: High Performance FPGA Design for Adaptive Computing", © 1998 IEEE, Conference Paper, INSPEC Abstract Nos. B9811-1265B-044, C9811-5210-009.	
		MIYAMORI, TAKASHI, et al., "A quantitative analysis of reconfigurable coprocessors for multimedia applications", © 1998 IEEE, Conference Paper, INSPEC Abstract Nos. B9811-1265F-011, C 9811-5310-010.	
EXAMINER SIGNATURE		DATE CONSIDERED	
<small>EXAMINER: Initial if reference considered, whether or not citation is in conformance with MPEP 609. Draw line through citation if not in conformance and not considered. Include copy of this form with next communication to applicant.</small>			
<small>¹ Applicant's unique citation designation number (optional). ² Applicant is to place a check mark here if English language Translation is attached. This collection of information is required by 37 CFR 1.97 and 1.98. The information is required to obtain or retain a benefit by the public which is to file (and by the USPTO to process) and application. Confidentiality is governed by 35 U.S.C. 122 and 37 CFR 1.14. This collection is estimated to take 2 hours to complete, including gathering, preparing, and submitting the completed application form to the USPTO. Time will vary depending upon the individual case. Any comments on the amount of time you require to complete this form and/or suggestions for reducing this burden, should be sent to the Chief Information Officer, U.S. Patent and Trademark Office, U.S. Department of Commerce, P.O. Box 1450, Alexandria, VA 22313-1450. DO NOT SEND FEES OR COMPLETED FORMS TO THIS ADDRESS. SEND TO: Commissioner for Patents, P.O. Box 1450, Alexandria, VA 22313-1450.</small>			

PTO/SB/08A (10/01) (Substitute for form 1449A/PTO)		ATTY. DOCKET NO. SRC015 CON Client/Matter No. 80404.0018.001		APPLICATION NO.		
INFORMATION DISCLOSURE STATEMENT BY APPLICANT		FIRST NAMED INVENTOR Jon M. Huppenthal et al.				
(Use several sheets if necessary) Sheet <u> 5 </u> of <u> 8 </u>		FILING DATE Herewith		ART UNIT		
U.S. PATENT DOCUMENTS						
Examiner Initials	Cite No.	Document No. No. – Kind Code	Publication Date MM-DD-YYYY	Name of Patentee or Applicant of Cited Doc	Pages, Columns, Lines, Where Relevant Passages or Relevant Figures Appear	
		US-5,230,057	07/20/93	Shido, et al.		
		US-5,892,962	04/06/99	Cloutier		
		US-5,903,771	05/11/1999	Sgro et al.	Figs 1 & 6, col. 3, lines 30-67, col 4, lines 1-51, col 7, lines 1-27.	
		US-6,192,439	02/20/2001	Grunewald et al.	Fig 3, col 3, lines 53-67, col 4, lines 1-64.	
		US-6,076,152	06/13/2000	Huppenthal et al.		
		US-6,052,773	04/18/2000	DeHon et al.		
		US-6,226,776	05/01/2001	Panchul et al.		
		US-6,023,755	02/08/2000	Casselman		
		US-5,737,766	04/07/1998	Tan		
		US-5,570,040	10/29/1996	Lytle et al.		
FOREIGN PATENT DOCUMENTS						
Examiner Initials	Cite No.	Foreign Patent Doc cntry code – No. – Kind Code	Publication Date MM-DD-YYYY	Name of Patentee or Applicant of Cited Doc	Pages, Columns, Lines Where Relevant Passages or Relevant Figures Appear	TRANSL ATION
						YES
OTHER PRIOR ART – NON PATENT LITERATURE DOCUMENTS						
Examiner Initials	Cite No.	Include name of the author (in CAPITAL LETTERS), title of the article (when appropriate), title of the item (book, magazine, journal, serial, symposium, catalog, etc.), date, page(s), volume-issue number(s) publisher, city and/or country where published				
		AGARWAL, A., et al., "The Raw Compiler Project", pages 1-12, http://cag-www.lcs.mit.edu/raw , Proceedings of the Second SUIF Compiler Workshop, Augs. 21-23, 1997.				
		ALBAHARNA, OSAMA, et al., "On the viability of FPGA-based integrated coprocessors", © 1996 IEEE, Publ. No. 0-8186-7548-9/96, Pages 206-215.				
		AMERSON, RICK, et al., "Teramac---Configurable Custom Computing", © 1995 IEEE, Publ. No. 0-8186-7086-X/95, Pages 32-38.				

		BARTHEL, DOMINIQUE August 25-26, 1997, "PVP a Parallel Video coProcessor", Hot Chips IX, Pages 203-210.
		BERTIN, PATRICE, et al., "Programmable active memories: a performance assessment", © 1993 Massachusetts Institute of Technology, Pages 88-102.
		BITTNER, RAY, et al., "Computing kernels implemented with a wormhole RTR CCM", © 1997 IEEE, Publ. No. 0-8186-8159-4/97, Pages 98-105.
		BUELL, D., et al. "Splash 2: FPGAs in a Custom Computing Machine – Chapter 1 -- Custom Computing Machines: An Introduction", Pages 1-11, http://www.computer.org/espress/catalog/bp07413/spls-ch1.html (originally believed published in J. of Supercomputing, Vol. IX, 1995, PP. 219-230).
		CASSELMAN, STEVEN, "Virtual Computing and The Virtual Computer", © 1993 IEEE, Publ. No. 0-8186-3890-7/93, Pages 43-48.
		CHAN, PAK, et al., "Architectural tradeoffs in field-programmable-device-based computing systems", © 1993 IEEE, Publ. No. 0-8186-3890-7/93, Pages 152-161.
		CLARK, DAVID, et al., "Supporting FPGA microprocessors through retargetable software tools", © 1996 IEEE, Publ. No. 0-8186-7548-9/96, Pages 195-103.
		CUCCARO, STEVEN, et al., "The CM-2X: a hybrid CM-2/Xilinx prototype", © 1993 IEEE, Publ. No. 0-8186-3890-7/93, Pages 121-130.
		CULBERTSON, W. BRUCE, et al., "Exploring architectures for volume visualization on the Teramac custom computer", © 1996 IEEE, Publ. No. 0-8186-7548-9/96, Pages 80-88.
		CULBERTSON, W. BRUCE, et al., "Defect tolerance on the Teramac custom computer", © 1997 IEEE, Publ. No. 0-8186-8159-4/97, Pages 116-123.
		DEHON, ANDRE, "DPGA-Coupled microprocessors: commodity IC for the early 21 st century", © 1994 IEEE, Publ. No. 0-8186-5490-2/94, Pages 31-39.
		DEHON, A., et al., "MATRIX A Reconfigurable Computing Device with Configurable Instruction Distribution", Hot Chips IX, August 25-26, 1997, Stanford, California, MIT Artificial Intelligence Laboratory.
		DHAUSSY, PHILIPPE, et al., "Global control synthesis for an MIMD/FPGA machine", © 1994 IEEE, Publ. No. 0-8186-5490-2/94, Pages 72-81.
		ELLIOTT, DUNCAN, et al., "Computational Ram: a memory-SIMD hybrid and its application to DSP", © 1992 IEEE, Publ. No. 0-7803-0246-X/92, Pages 30.6.1-30.6.4.
		FORTES, JOSE, et al., "Systolic arrays, a survey of seven projects", © 1987 IEEE, Publ. No. 0018-9162/87/0700-0091, Pages 91-103.
		GOKHALE, M., et al., "Processing in Memory: The Terasys Massively Parallel PIM Array" © April 1995, IEEE, Pages 23-31.
		GUNTHER, BERNARD, et al., "Assessing Document Relevance with Run-Time Reconfigurable Machines", © 1996 IEEE, Publ. No. 0-8186-7548-9/96, Pages 10-17.
		HAGIWARA, HIROSHI, et al., "A dynamically microprogrammable computer with low-level parallelism", © 1980 IEEE, Publ. No. 0018-9340/80/07000-0577, Pages 577-594.
		HARTENSTEIN, R. W., et al. "A General Approach in System Design Integrating Reconfigurable Accelerators," http://xputers.informatik.uni-kl.de/papers/paper026-1.html , IEEE 1996 Conference, Austin, TX, Oct. 9-11, 1996.
		HARTENSTEIN, REINER, et al., "A reconfigurable data-driven ALU for Xputers", © 1994 IEEE, Publ. No. 0-8186-5490-2/94, Pages 139-146.
		HAUSER, JOHN, et al.: "GARP: a MIPS processor with a reconfigurable co-processor", © 1997 IEEE, Publ. No. 0-8186-8159-4/97, Pages 12-21.
		HAYES, JOHN, et al., "A microprocessor-based hypercube, supercomputer", © 1986 IEEE, Publ. No. 0272-1732/86/1000-0006, Pages 6-17.
		HERPEL, H. -J., et al., "A Reconfigurable Computer for Embedded Control Applications", © 1993 IEEE, Publ. No. 0-8186-3890-7/93, Pages 111-120.
		HOGL, H., et al., "Enable++: A second generation FPGA processor", © 1995 IEEE, Publ. No. 0-8186-7086-X/95, Pages 45-53.
		KING, WILLIAM, et al., "Using MORRPH in an industrial machine vision system". © 1996 IEEE, Publ. No. 08186-7548-9/96, Pages 18-26.

		MANOHAR, SWAMINATHAN, et al., "A pragmatic approach to systolic design", © 1988 IEEE, Publ. No. CH2603-9/88/0000/0463, Pages 463-472.
		MAUDUIT, NICOLAS, et al., "Lneuro 1.0: a piece of hardware LEGO for building neural network systems," © 1992 IEEE, Publ. No. 1045-9227/92, Pages 414-422.
		MIRSKY, ETHAN A., "Coarse-Grain Reconfigurable Computing", Massachusetts Institute of Technology, June 1996.
		MIRSKY, ETHAN, et al., "MATRIX: A Reconfigurable Computing Architecture with Configurable Instruction Distribution and Deployable Resources", © 1996 IEEE, Publ. No. 0-8186-7548-9/96, Pages 157-166.
		MORLEY, ROBERT E., Jr., et al., "A Massively Parallel Systolic Array Processor System", © 1988 IEEE, Publ. No. CH2603-9/88/0000/0217, Pages 217-225.
		PATTERSON, DAVID, et al., "A case for Intelligent DRAM: IRAM", Hot Chips VIII, August 19-20, 1996, Pages 75-94.
		PETERSON, JANES, et al., "Scheduling and partitioning ANSI-C programs onto multi-FPGA CCM architectures", © 1996 IEEE, Publ. No. 0-8186-7548-9/96, Pages 178-187.
		SCHMIT, HERMAN, "Incremental reconfiguration for pipelined applications," © 1997 IEEE, Publ. No. 0-8186-8159-4/97, Pages 47-55.
		SITKOFF, NATHAN, et al., "Implementing a Genetic Algorithm on a Parallel Custom Computing Machine", Publ. No. 0-8186-7086-X/95, Pages 180-187.
		STONE, HAROLD, "A logic-in-memory computer", © 1970 IEEE, IEEE Transactions on Computers, Pages 73-78, January 1990.
		TANGEN, UWE, et al., "A parallel hardware evolvable computer POLYP extended abstract", © 1997 IEEE, Publ. No. 0-8186-8159/4/97, Pages 238-239.
		THORNBURG, MIKE, et al., "Transformable Computers", © 1994 IEEE, Publ. No. 0-8186-5602-6/94, Pages 674-679.
		TOMITA, SHINJI, et al., "A computer low-level parallelism QA-2", © 1986 IEEE, Publ. No. 0-0384-7495/86/0000/0280, Pages 280-289.
		TRIMBERGER, STEVE, et al., "A time-multiplexed FPGA", © 1997 IEEE, Publ. No. 0-8186-8159-4/97, Pages 22-28.
		UEDA, HIROTADA, et al., "A multiprocessor system utilizing enhanced DSP's for Image processing", © 1988 IEEE, Publ. No. CH2603-9/88/0000/0611, Pages 611-620.
		VILLASENOR, JOHN, et al., "Configurable computing", © 1997 Scientific American, June 1997.
		WANG, QUIANG, et al., "Automated field-programmable compute accelerator design using partial evaluation", © 1997 IEEE, Publ. No. 0-8186-8159-4/97, Pages 145-154.
		W.H. Manglone-Smith and B.L. Hutchings. Configurable computing: The Road Ahead. In Proceedings of the Reconfigurable Architectures Workshop (RAW'97), pages 81-96, 1997.
		WIRTHLIN, MICHAEL, et al., "The Nano processor: a low resource reconfigurable processor", © 1994 IEEE, Publ. No. 0-8186-5490-2/94, Pages 23-30.
		WIRTHLIN, MICHAEL, et al., "A dynamic instruction set computer", © 1995 IEEE, Publ. No. 0-8186-7086-X/95, Pages 99-107.
		WITTIG, RALPH, et al., "One Chip: An FPGA processor with reconfigurable logic", © 1996 IEEE, Publ. No. 0-8186-7548-9/96, Pages 126-135.
		YAMAUCHI, TSUKASA, et al., "SOP: A reconfigurable massively parallel system and its control-data flow based compiling method", © 1996 IEEE, Publ. No. 0-8186-7548-9/96, Pages 148-156.
		"Information Brief", PCI Bus Technology, © IBM Personal Computer Company, 1997, Pages 1-3.
		YUN, HYUN-KYU AND SILVERMAN, H. F.; "A distributed memory MIMD multi-computer with reconfigurable custom computing capabilities", Brown University, 10-13 Dec. 1997, pp. 7-13.
		HOOVER, CHRIS AND HART, DAVID; "San Diego Supercomputer Center, Timelogic and Sun Validate Ultra-Fast Hidden Markov Model Analysis-One DeCypher-accelerated Sun Fire 6800 beats 2,600 CPUs running Linux-", San Diego Supercomputer Center, http://www.sdsc.edu/Press/02/050802_markovmodel.html , May 8, 2002, pp. 1-3.

		CALIGA, DAVID AND BARKER, DAVID PETER, "Delivering Acceleration: The Potential for Increased HPC Application Performance Using Reconfigurable Logic", SRC Computers, Inc., November 2001, pp. 20.
		HAMMES, J.P., RINKER, R. E., MCCLURE, D. M., BÖHM, A. P. W., NAJJAR, W. A., "The SA-C Compiler Dataflow Description", Colorado State University, June 21, 2001, pp. 1-25.
		CALLAHAN, TIMOTHY J. AND WAWRZYNEK, JOHN, "Adapting Software Pipelining for Reconfigurable Computing", University of California at Berkeley, November 17-19, 2000, pp. 8.
		RATHA, NALINI K., JAIN, ANIL K. AND ROVER, DIANE T., "An FPGA-based Point Pattern Matching Processor with Application to Fingerprint Matching", Michigan State University, Department of Computer Science, pp. 8.
		DEHON, ANDRÉ, "Comparing Computing Machines", University of California at Berkeley, Proceedings of SPIE Vol. 3526, November 2-3, 1998, pp. 11.
		YEMURI, RANGA R. AND HARR, RANDOLPH E., "Configurable Computing: Technology and Applications", University of Cincinnati and Synopsys Inc., IEEE, April 2000, pp. 39-40.
		DEHON, ANDRÉ, "The Density Advantage of Configurable Computing", California Institute of Technology, IEEE, April 2000. pp. 41-49.
		HAYNES, SIMON D., STONE, JOHN, CHEUNG, PETER Y.K. AND LUK, WAYNE, "Video Image Processing with the Sonic Architecture", Sony Broadcast & Professional Europe, Imperial College, University of London, IEEE, April 2000, pp. 50-57.
		PLATZNER, MARCO, "Reconfigurable Accelerators for Combinatorial Problems", Swiss Federal Institute of Technology (ETH) Zurich, IEEE, April 2000, pp. 58-60.
		CALLAHAN, TIMOTHY J., HAUSER, JOHN R. AND WAWRZYNEK, JOHN, "The Garp Architecture and C Compiler", University of California, Berkeley, IEEE, April 2000. pp. 62-69.
		GOLDSTEIN, SETH COPEN, SCHMIT, HERMAN, BUDIU, MIHAI, CADAMBI, SRIHARI, MOE, MATT AND TAYLOR, R. REED, "PipeRench: A Reconfigurable Architecture and Compiler", Carnegie Mellon University, IEEE, April 2000, pp. 70-76.
		MUCHNICK, STEVEN S., "Advanced Compiler Design and Implementation", Morgan Kaufmann Publishers, pp. 217.
		HAMMES, JEFFREY P., Dissertation "Compiling SA-C To Reconfigurable Computing Systems", Colorado State University, Department of Computer Science, Summer 2000, pp. 179.
		Automatic Target Recognition, Colorado State University & USAF, http://www.cs.colostate.edu/cameron/applications.html , pp. 1-3.
		CHODOWIEC, PAWEL, KHUON, PO, GAJ, KRIS, Fast Implementations of Secret-Key Block Ciphers Using Mixed Inner- and Outer-Round Pipelining, George Mason University, February 11-13, 2001, pp.9.
EXAMINER		DATE CONSIDERED
EXAMINER: Initial if citation considered, whether or not citation is in conformance with MPEP 609; Draw line through citation if not in conformance and not considered. Include copy of this form with next communication to applicant.		

Under the Paperwork Reduction Act of 1995, no persons are required to respond to a collection of information unless it contains a valid OMB control number.

Application Data Sheet 37 CFR 1.76		Attorney Docket Number	SRC015 CON
		Application Number	
Title of Invention	MULTI-ADAPTIVE PROCESSING SYSTEMS AND TECHNIQUES FOR ENHANCING PARALLELISM AND PERFORMANCE OF COMPUTATIONAL FUNCTIONS		
The application data sheet is part of the provisional or nonprovisional application for which it is being submitted. The following form contains the bibliographic data arranged in a format specified by the United States Patent and Trademark Office as outlined in 37 CFR 1.76. This document may be completed electronically and submitted to the Office in electronic format using the Electronic Filing System (EFS) or the document may be printed and included in a paper filed application.			

Secrecy Order 37 CFR 5.2

Portions or all of the application associated with this Application Data Sheet may fall under a Secrecy Order pursuant to 37 CFR 5.2 (Paper filers only. Applications that fall under Secrecy Order may not be filed electronically.)

Applicant Information:

Applicant 1						<input type="button" value="Remove"/>	
Applicant Authority		<input checked="" type="radio"/> Inventor		<input type="radio"/> Legal Representative under 35 U.S.C. 117		<input type="radio"/> Party of Interest under 35 U.S.C. 118	
Prefix	Given Name	Middle Name	Family Name		Suffix		
	Jon	M.	Huppenthal				
Residence Information (Select One) <input checked="" type="radio"/> US Residency <input type="radio"/> Non US Residency <input type="radio"/> Active US Military Service							
City	Colorado Springs	State/Province	CO	Country of Residenceⁱ	US		
Citizenship under 37 CFR 1.41(b)ⁱ		US					
Mailing Address of Applicant:							
Address 1		10015 Burgess Road					
Address 2							
City	Colorado Springs	State/Province	CO				
Postal Code	80908	Countryⁱ					
Applicant 2						<input type="button" value="Remove"/>	
Applicant Authority		<input checked="" type="radio"/> Inventor		<input type="radio"/> Legal Representative under 35 U.S.C. 117		<input type="radio"/> Party of Interest under 35 U.S.C. 118	
Prefix	Given Name	Middle Name	Family Name		Suffix		
	David	E.	Caliga				
Residence Information (Select One) <input checked="" type="radio"/> US Residency <input type="radio"/> Non US Residency <input type="radio"/> Active US Military Service							
City	Colorado Springs	State/Province	CO	Country of Residenceⁱ	US		
Citizenship under 37 CFR 1.41(b)ⁱ		US					
Mailing Address of Applicant:							
Address 1		8445 Loralwood Lane					
Address 2							
City	Colorado Springs	State/Province	CO				
Postal Code	80919	Countryⁱ	US				
All Inventors Must Be Listed - Additional Inventor Information blocks may be generated within this form by selecting the Add button.						<input type="button" value="Add"/>	

Correspondence Information:

Enter either Customer Number or complete the Correspondence Information section below.
For further information see 37 CFR 1.33(a).

An Address is being provided for the correspondence Information of this application.

Application Data Sheet 37 CFR 1.76		Attorney Docket Number	SRC015 CON	
		Application Number		
Title of Invention	MULTI-ADAPTIVE PROCESSING SYSTEMS AND TECHNIQUES FOR ENHANCING PARALLELISM AND PERFORMANCE OF COMPUTATIONAL FUNCTIONS			
Customer Number	25235			
Email Address			<input type="button" value="Add Email"/>	<input type="button" value="Remove Email"/>

Application Information:

Title of the Invention	MULTI-ADAPTIVE PROCESSING SYSTEMS AND TECHNIQUES FOR ENHANCING PARALLELISM AND PERFORMANCE OF COMPUTATIONAL FUNCTIONS			
Attorney Docket Number	SRC015 CON	Small Entity Status Claimed	<input type="checkbox"/>	
Application Type	Nonprovisional			
Subject Matter	Utility			
Suggested Class (if any)		Sub Class (if any)		
Suggested Technology Center (if any)				
Total Number of Drawing Sheets (if any)	20	Suggested Figure for Publication (if any)		
Publication Information:				
<input type="checkbox"/> Request Early Publication (Fee required at time of Request 37 CFR 1.219)				
<input type="checkbox"/> Request Not to Publish. I hereby request that the attached application not be published under 35 U.S.C. 122(b) and certify that the invention disclosed in the attached application has not been and will not be the subject of an application filed in another country, or under a multilateral agreement, that requires publication at eighteen months after filing.				

Representative Information:

Representative information should be provided for all practitioners having a power of attorney in the application. Providing this information in the Application Data Sheet does not constitute a power of attorney in the application (see 37 CFR 1.32). Enter either Customer Number or complete the Representative Name section below. If both sections are completed the Customer Number will be used for the Representative Information during processing.			
Please Select One:	<input checked="" type="radio"/> Customer Number	<input type="radio"/> US Patent Practitioner	<input type="radio"/> US Representative (37 CFR 11.9)
Customer Number	25235		

Domestic Priority Information:

This section allows for the applicant to claim benefit under 35 U.S.C. 119(e), 120, 121, or 365(c). Providing this information in the application data sheet constitutes the specific reference required by 35 U.S.C. 119(e) or 120, and 37 CFR 1.78(a)(2) or CFR 1.78(a)(4), and need not otherwise be made part of the specification.			
Prior Application Status	Pending	<input type="button" value="Remove"/>	
Application Number	Continuity Type	Prior Application Number	Filing Date (YYYY-MM-DD)
	Continuation of	10285318	2002-10-31
Additional Domestic Priority Data may be generated within this form by selecting the Add button.			<input type="button" value="Add"/>

Foreign Priority Information:

Under the Paperwork Reduction Act of 1995, no persons are required to respond to a collection of information unless it contains a valid OMB control number.

Application Data Sheet 37 CFR 1.76	Attorney Docket Number	SRC015 CON
	Application Number	
Title of Invention	MULTI-ADAPTIVE PROCESSING SYSTEMS AND TECHNIQUES FOR ENHANCING PARALLELISM AND PERFORMANCE OF COMPUTATIONAL FUNCTIONS	

This section allows for the applicant to claim benefit of foreign priority and to identify any prior foreign application for which priority is not claimed. Providing this information in the application data sheet constitutes the claim for priority as required by 35 U.S.C. 119(b) and 37 CFR 1.55(a).

<input type="button" value="Remove"/>			
Application Number	Country ⁱ	Parent Filing Date (YYYY-MM-DD)	Priority Claimed
			<input type="radio"/> Yes <input checked="" type="radio"/> No
Additional Foreign Priority Data may be generated within this form by selecting the Add button.			<input type="button" value="Add"/>

Assignee Information:

Providing this information in the application data sheet does not substitute for compliance with any requirement of part 3 of Title 37 of the CFR to have an assignment recorded in the Office.

Assignee 1				<input type="button" value="Remove"/>
If the Assignee is an Organization check here. <input checked="" type="checkbox"/>				
Organization Name	SRC Computers, Inc.			
Mailing Address Information:				
Address 1	4240 N. Nevada Ave.			
Address 2				
City	Colorado Springs	State/Province	CO	
Country ⁱ	US	Postal Code	80907	
Phone Number		Fax Number		
Email Address				
Additional Assignee Data may be generated within this form by selecting the Add button.				<input type="button" value="Add"/>

Signature:

A signature of the applicant or representative is required in accordance with 37 CFR 1.33 and 10.18. Please see 37 CFR 1.4(d) for the form of the signature.

Signature	/michael martensen/		Date (YYYY-MM-DD)	2007-04-09	
First Name	Michael	Last Name	Martensen	Registration Number	46901

This collection of information is required by 37 CFR 1.76. The information is required to obtain or retain a benefit by the public which is to file (and by the USPTO to process) an application. Confidentiality is governed by 35 U.S.C. 122 and 37 CFR 1.14. This collection is estimated to take 23 minutes to complete, including gathering, preparing, and submitting the completed application data sheet form to the USPTO. Time will vary depending upon the individual case. Any comments on the amount of time you require to complete this form and/or suggestions for reducing this burden, should be sent to the Chief Information Officer, U.S. Patent and Trademark Office, U.S. Department of Commerce, P.O. Box 1450, Alexandria, VA 22313-1450. DO NOT SEND FEES OR COMPLETED FORMS TO THIS ADDRESS. **SEND TO: Commissioner for Patents, P.O. Box 1450, Alexandria, VA 22313-1450.**

Privacy Act Statement

The Privacy Act of 1974 (P.L. 93-579) requires that you be given certain information in connection with your submission of the attached form related to a patent application or patent. Accordingly, pursuant to the requirements of the Act, please be advised that: (1) the general authority for the collection of this information is 35 U.S.C. 2(b)(2); (2) furnishing of the information solicited is voluntary; and (3) the principal purpose for which the information is used by the U.S. Patent and Trademark Office is to process and/or examine your submission related to a patent application or patent. If you do not furnish the requested information, the U.S. Patent and Trademark Office may not be able to process and/or examine your submission, which may result in termination of proceedings or abandonment of the application or expiration of the patent.

The information provided by you in this form will be subject to the following routine uses:

1. The information on this form will be treated confidentially to the extent allowed under the Freedom of Information Act (5 U.S.C. 552) and the Privacy Act (5 U.S.C. 552a). Records from this system of records may be disclosed to the Department of Justice to determine whether the Freedom of Information Act requires disclosure of these records.
2. A record from this system of records may be disclosed, as a routine use, in the course of presenting evidence to a court, magistrate, or administrative tribunal, including disclosures to opposing counsel in the course of settlement negotiations.
3. A record in this system of records may be disclosed, as a routine use, to a Member of Congress submitting a request involving an individual, to whom the record pertains, when the individual has requested assistance from the Member with respect to the subject matter of the record.
4. A record in this system of records may be disclosed, as a routine use, to a contractor of the Agency having need for the information in order to perform a contract. Recipients of information shall be required to comply with the requirements of the Privacy Act of 1974, as amended, pursuant to 5 U.S.C. 552a(m).
5. A record related to an International Application filed under the Patent Cooperation Treaty in this system of records may be disclosed, as a routine use, to the International Bureau of the World Intellectual Property Organization, pursuant to the Patent Cooperation Treaty.
6. A record in this system of records may be disclosed, as a routine use, to another federal agency for purposes of National Security review (35 U.S.C. 181) and for review pursuant to the Atomic Energy Act (42 U.S.C. 218(c)).
7. A record from this system of records may be disclosed, as a routine use, to the Administrator, General Services, or his/her designee, during an inspection of records conducted by GSA as part of that agency's responsibility to recommend improvements in records management practices and programs, under authority of 44 U.S.C. 2904 and 2906. Such disclosure shall be made in accordance with the GSA regulations governing inspection of records for this purpose, and any other relevant (i.e., GSA or Commerce) directive. Such disclosure shall not be used to make determinations about individuals.
8. A record from this system of records may be disclosed, as a routine use, to the public after either publication of the application pursuant to 35 U.S.C. 122(b) or issuance of a patent pursuant to 35 U.S.C. 151. Further, a record may be disclosed, subject to the limitations of 37 CFR 1.14, as a routine use, to the public if the record was filed in an application which became abandoned or in which the proceedings were terminated and which application is referenced by either a published application, an application open to public inspections or an issued patent.
9. A record from this system of records may be disclosed, as a routine use, to a Federal, State, or local law enforcement agency, if the USPTO becomes aware of a violation or potential violation of law or regulation.

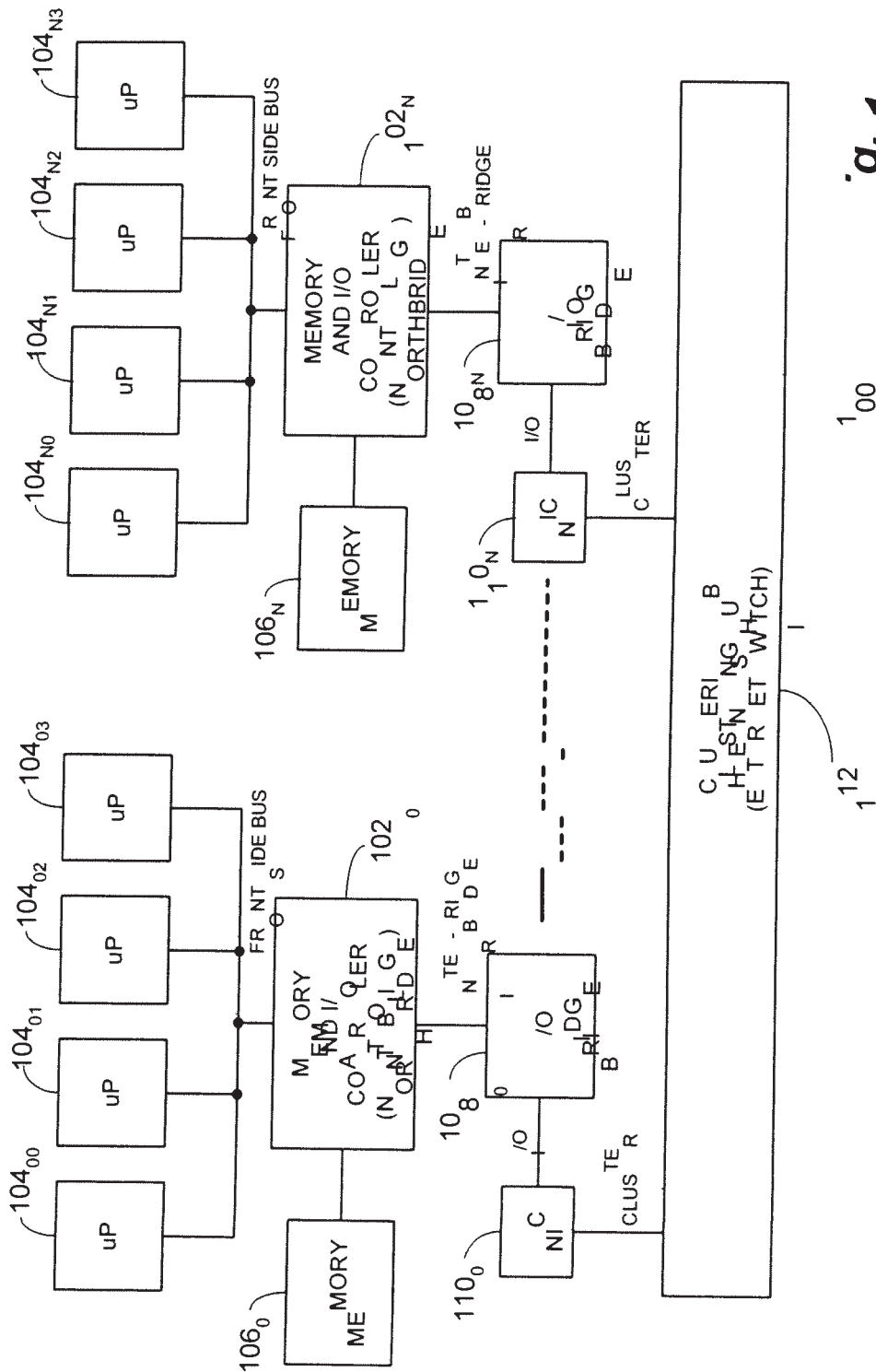
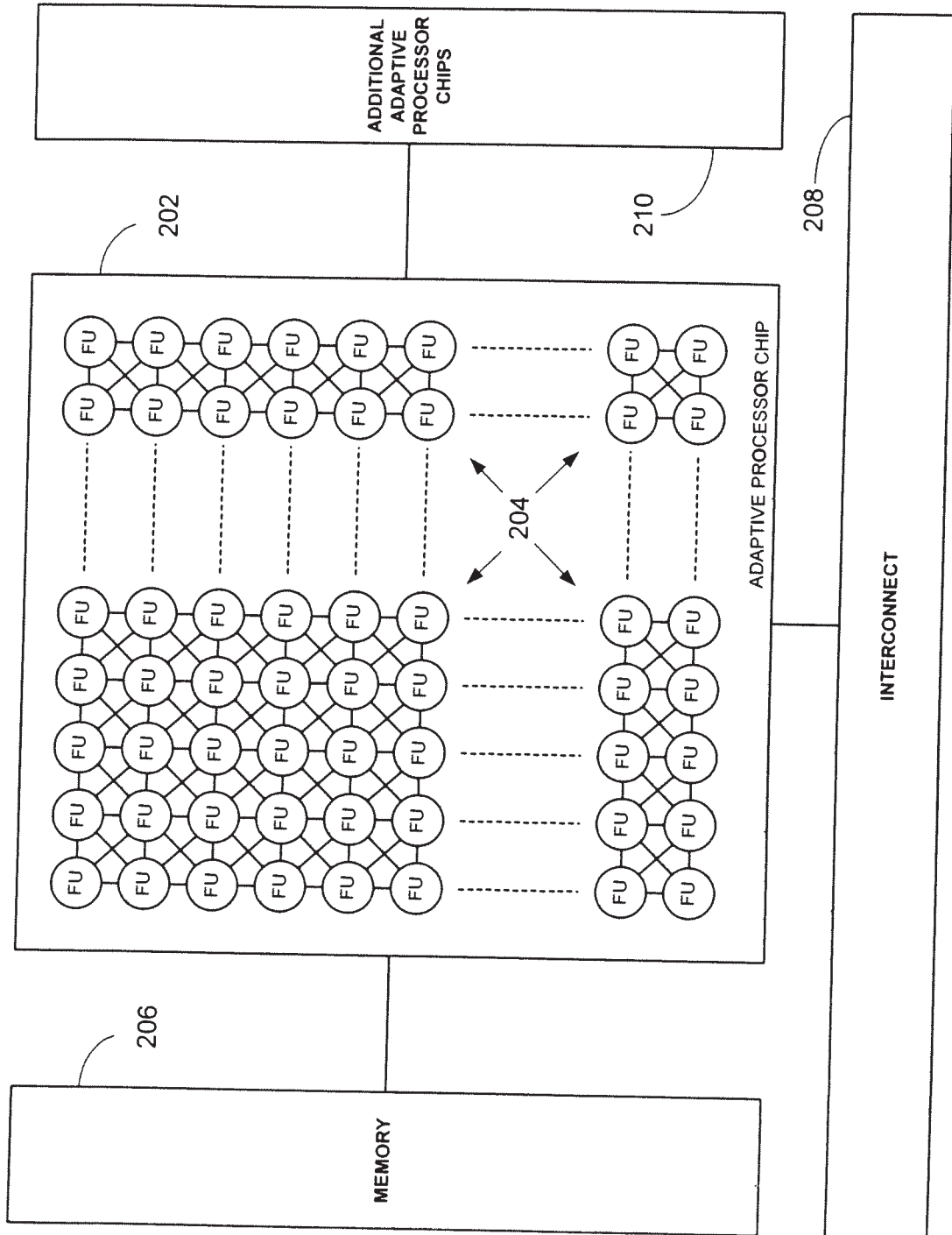

Fig. 1
 Prior Art

100

112



200 **Fig. 2**

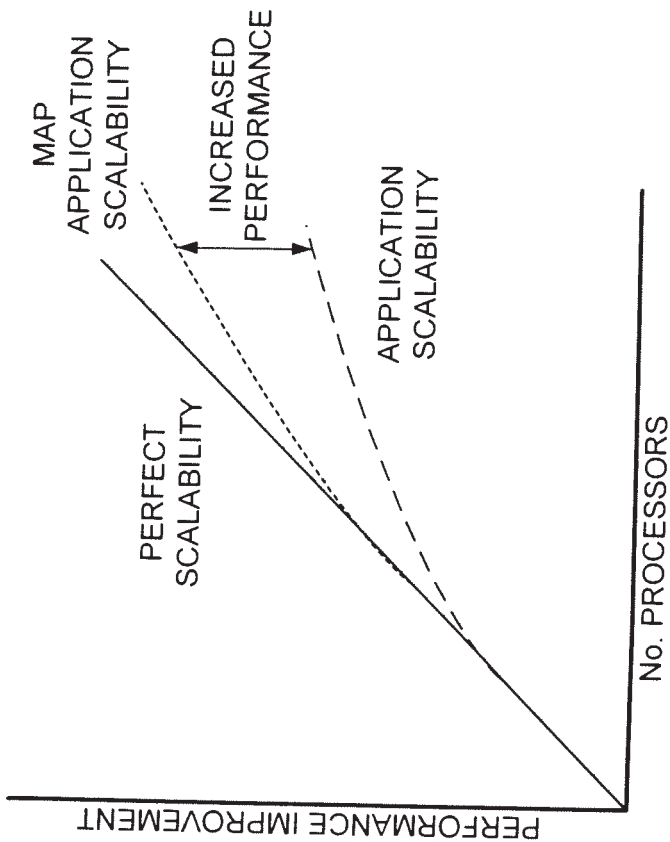

Fig. 3B

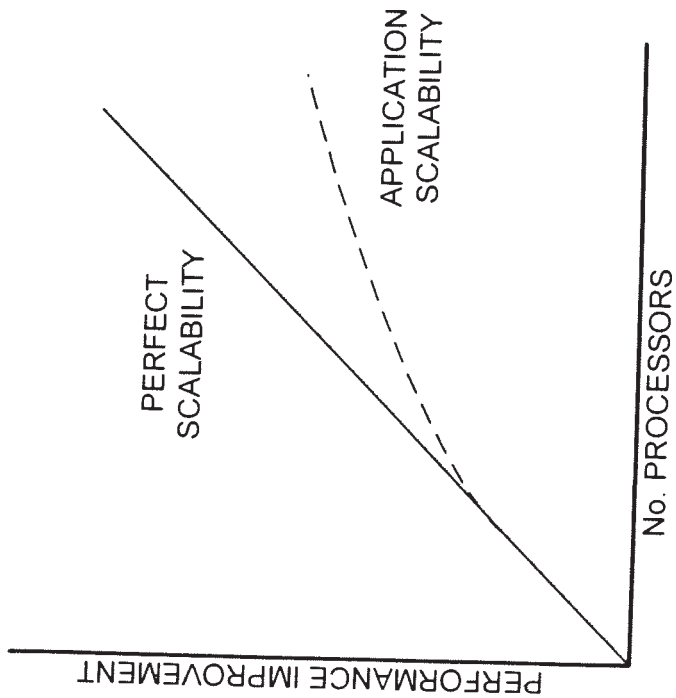

Fig. 3A
PRIOR ART

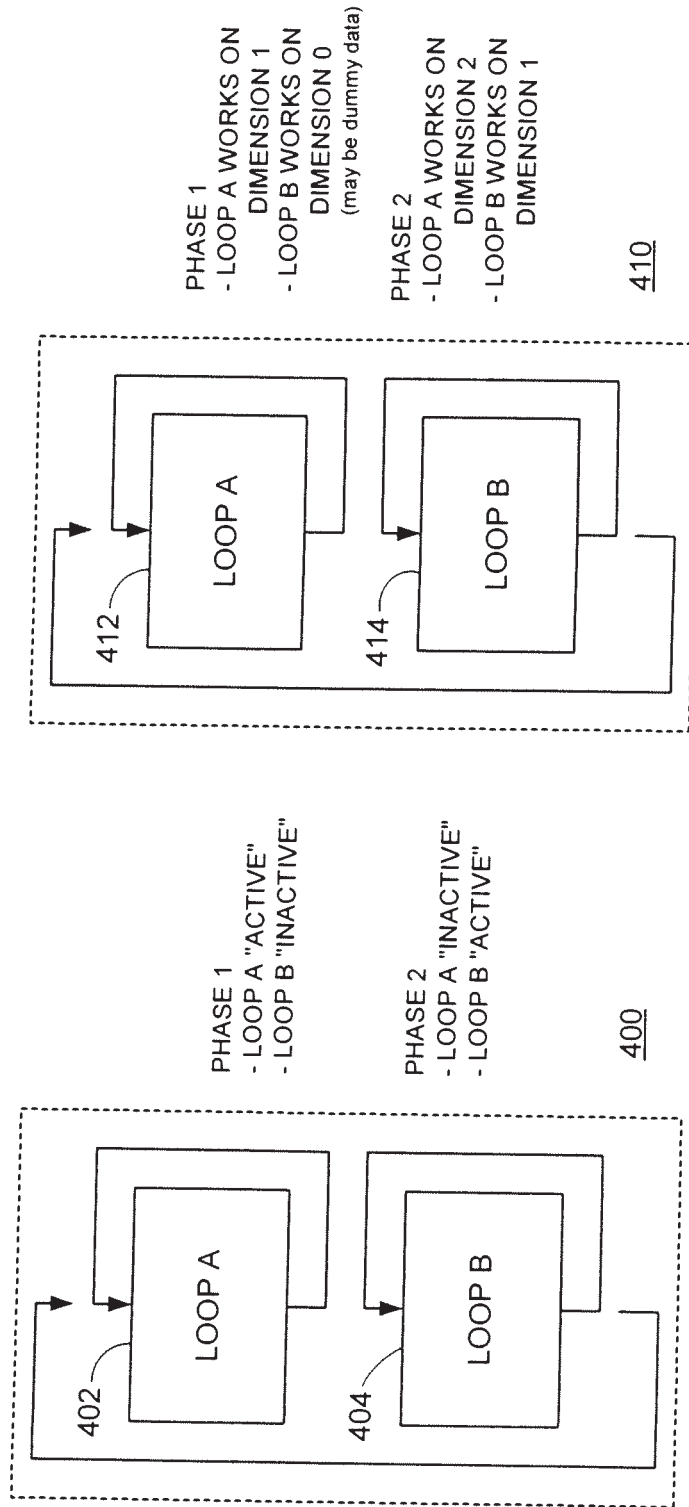

Fig. 4A
 Prior Art

Fig. 4B

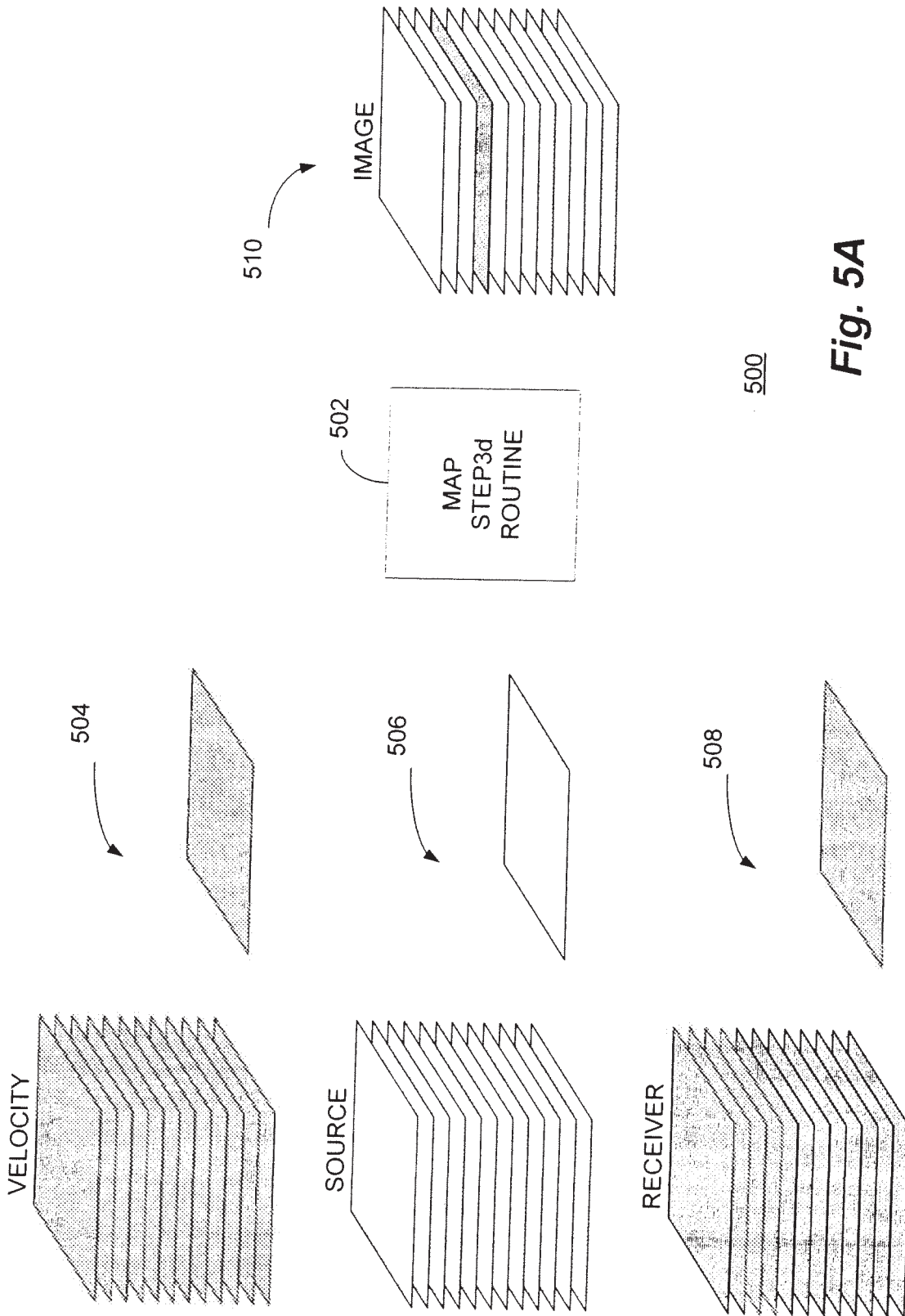

Fig. 5A

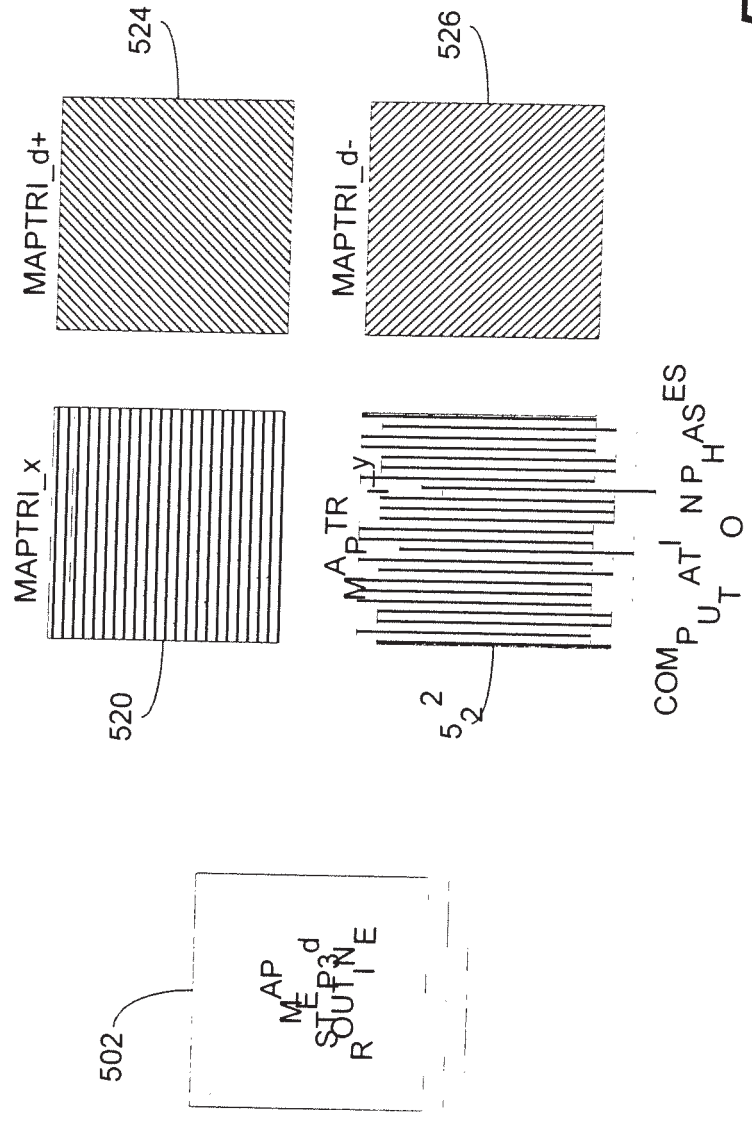

Fig. 5B

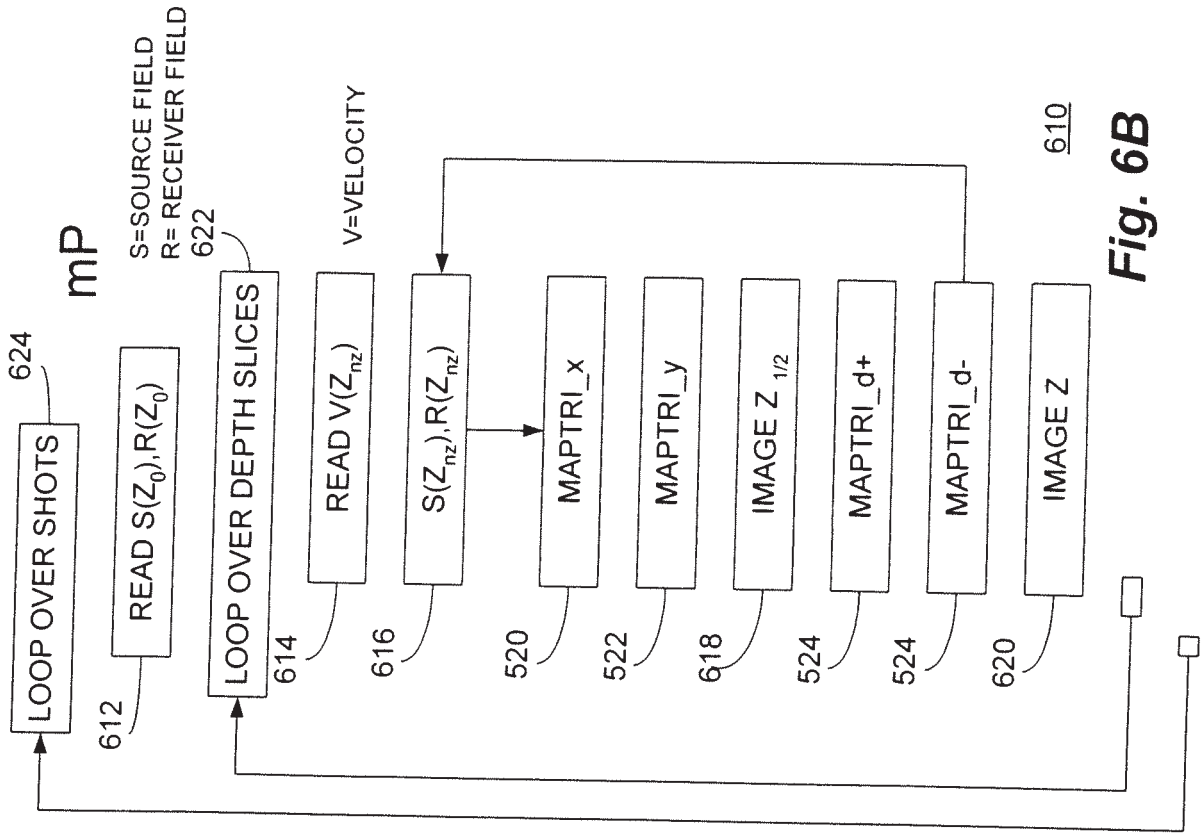

Fig. 6B

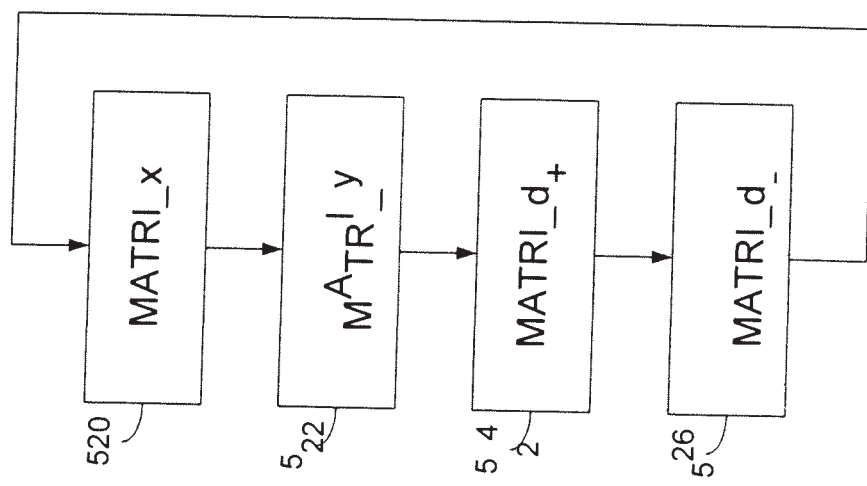

Fig. 6A

600

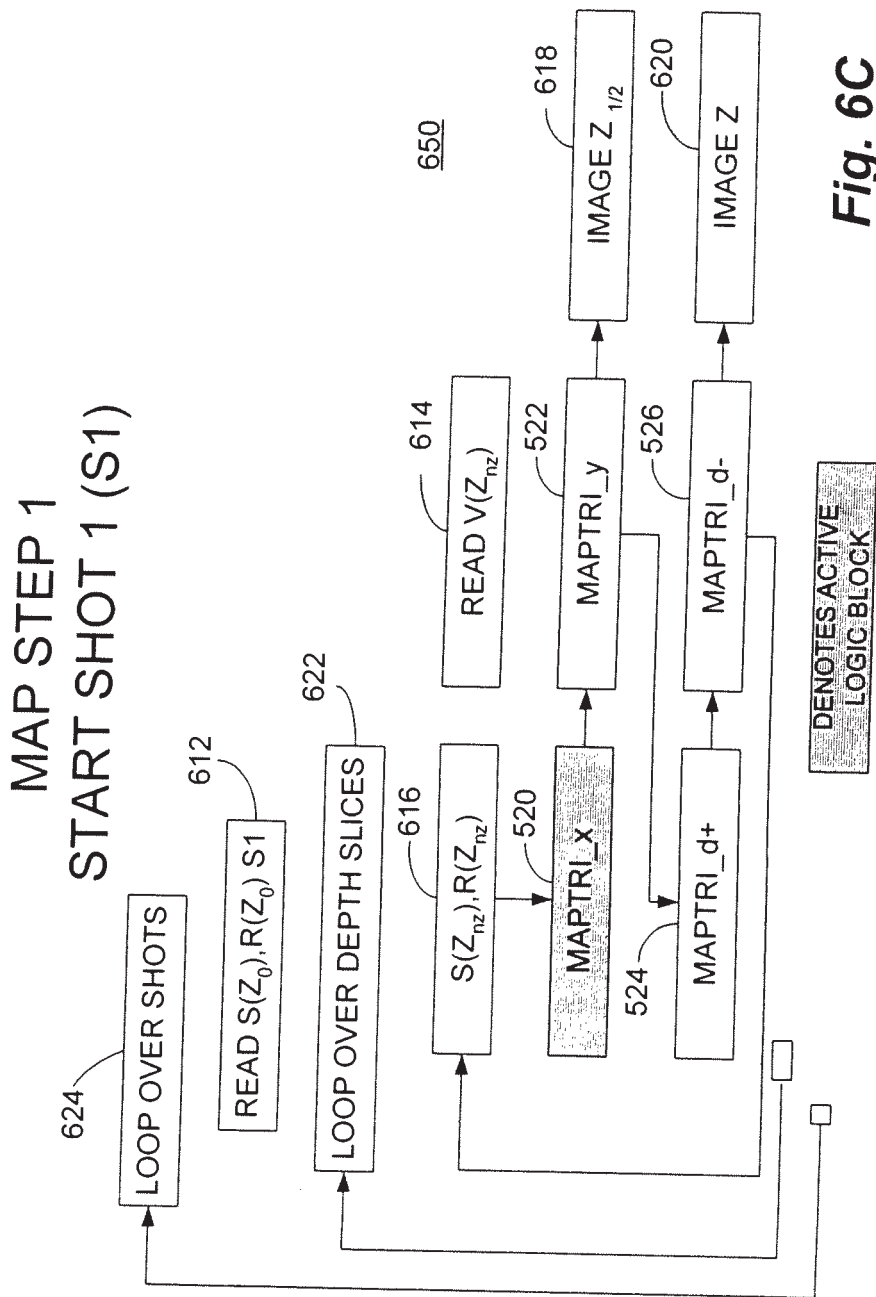

Fig. 6C

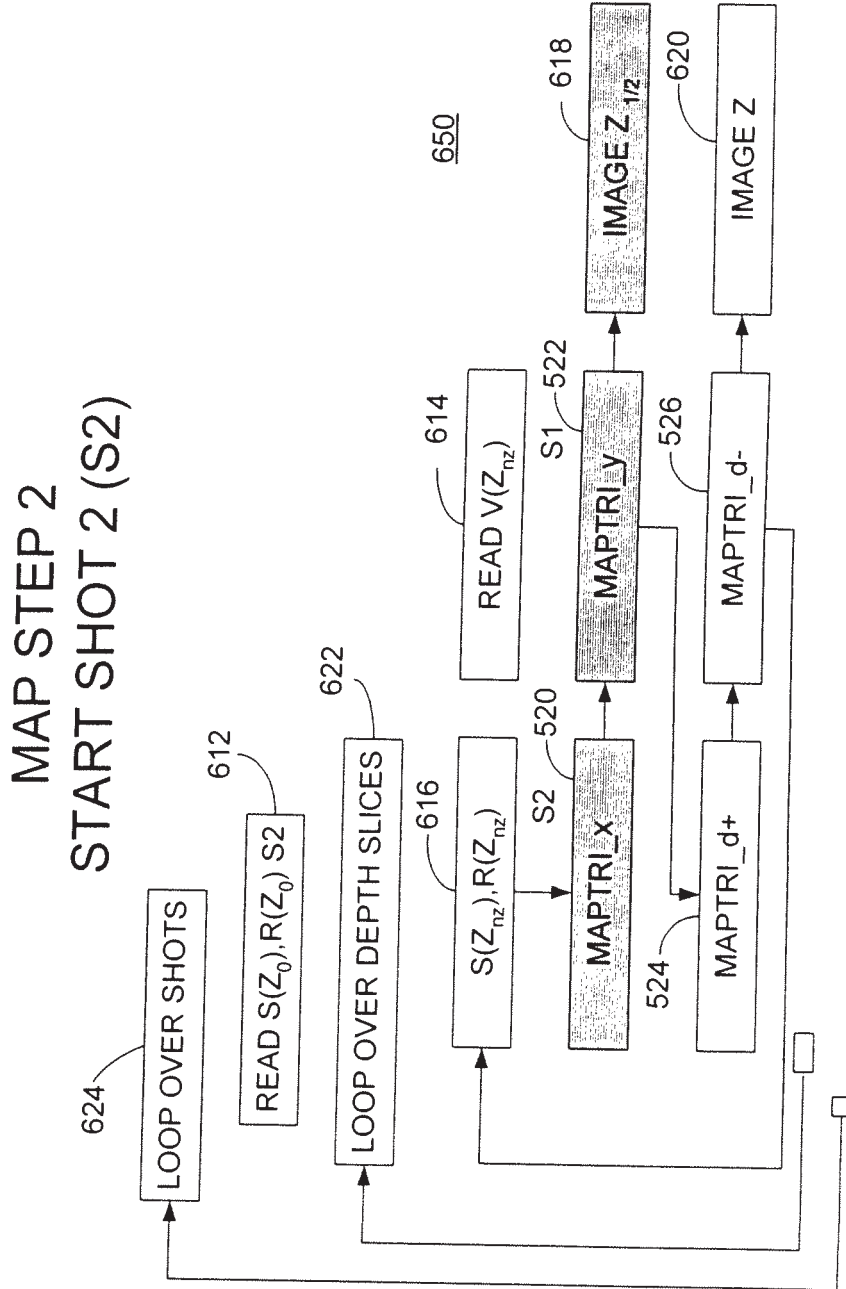

Fig. 6D

CONTINUE S1 AND S2 THROUGH COMPUTE
 624

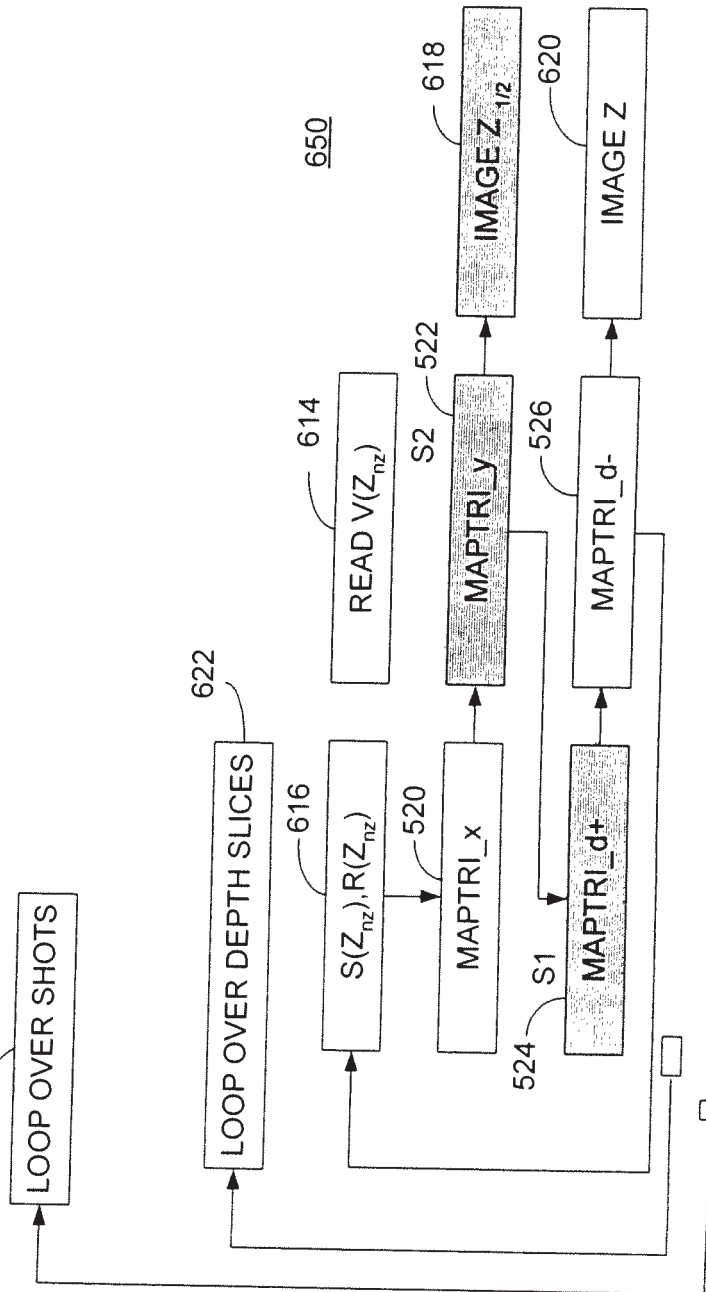

Fig. 6E

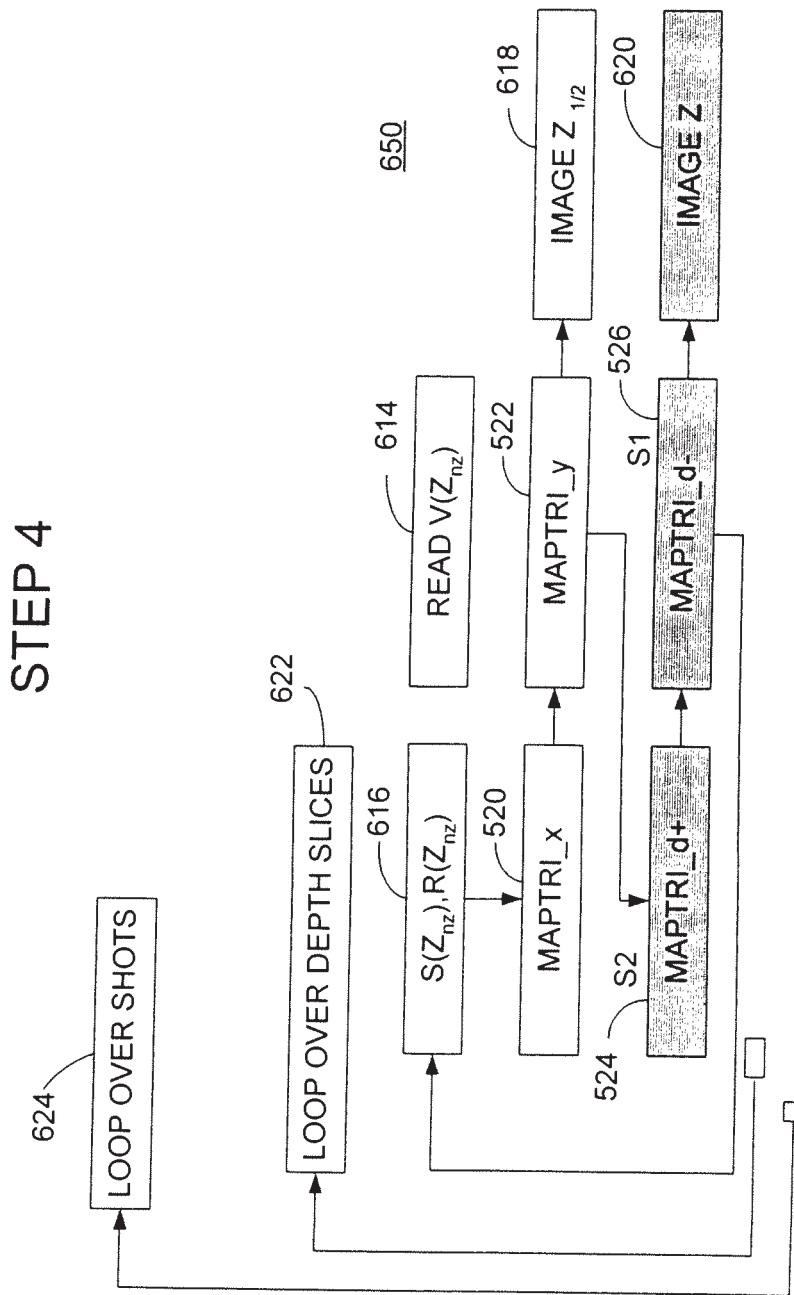

Fig. 6F

STEP 5

CONTINUE THE DOWNWARD PROPOGATION OF
 S1 AND S2 OVER ALL OF THE DEPTH SLICES

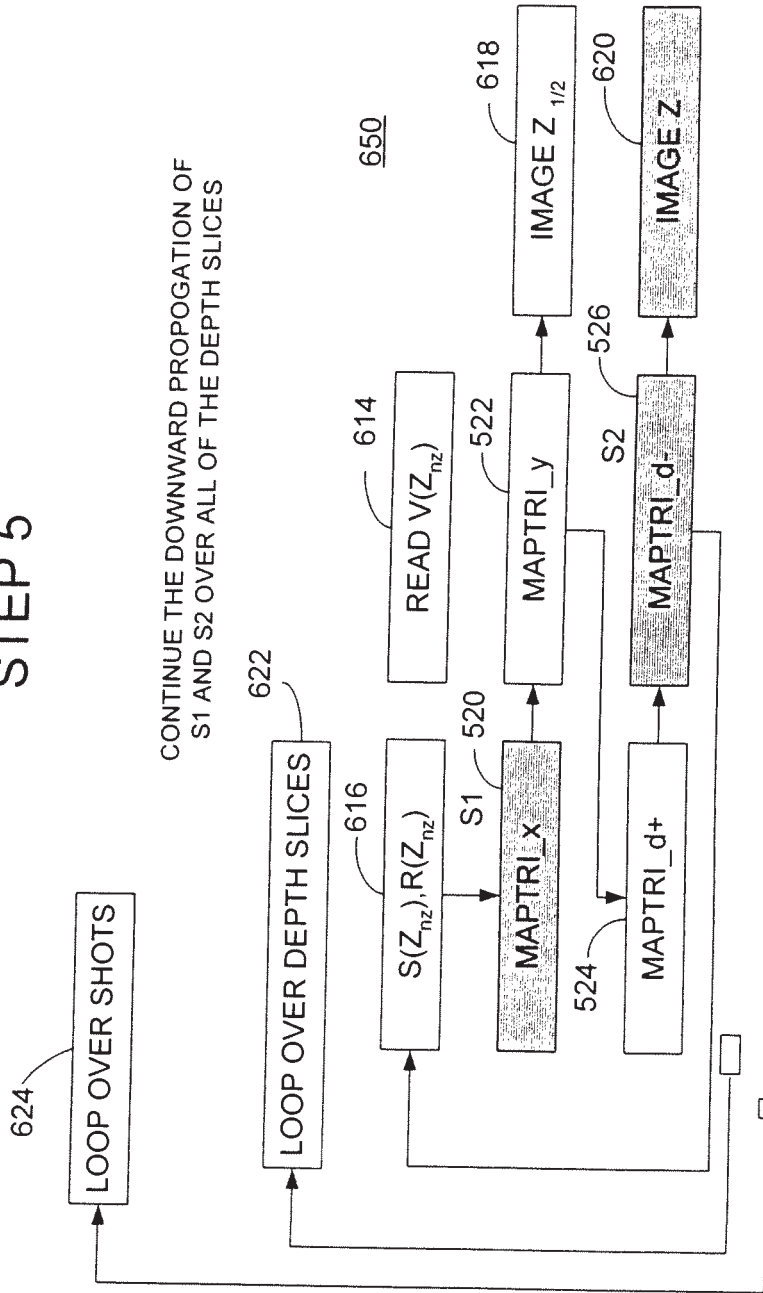

Fig. 6G

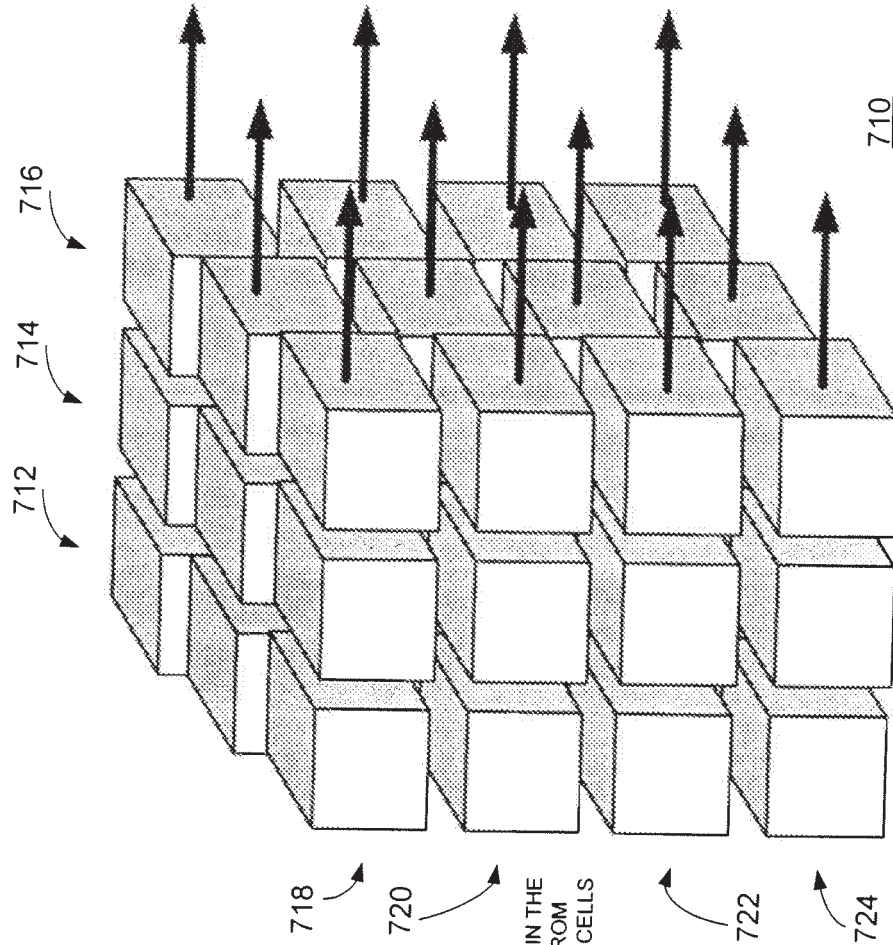

Fig. 7A

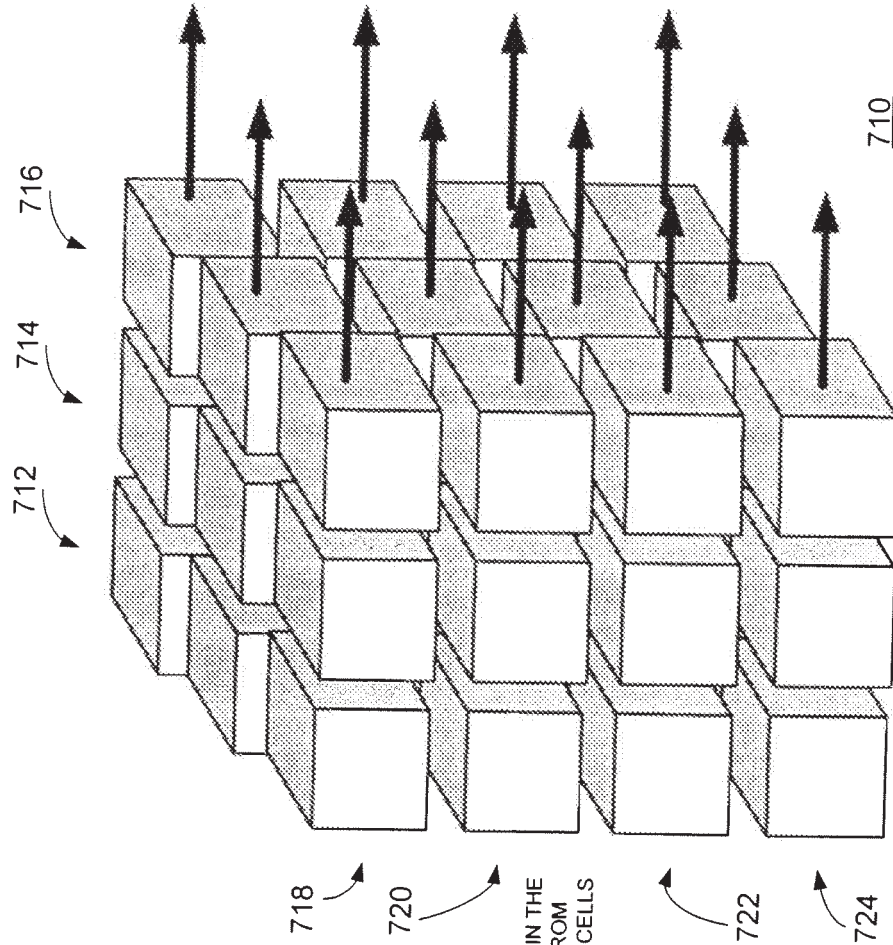
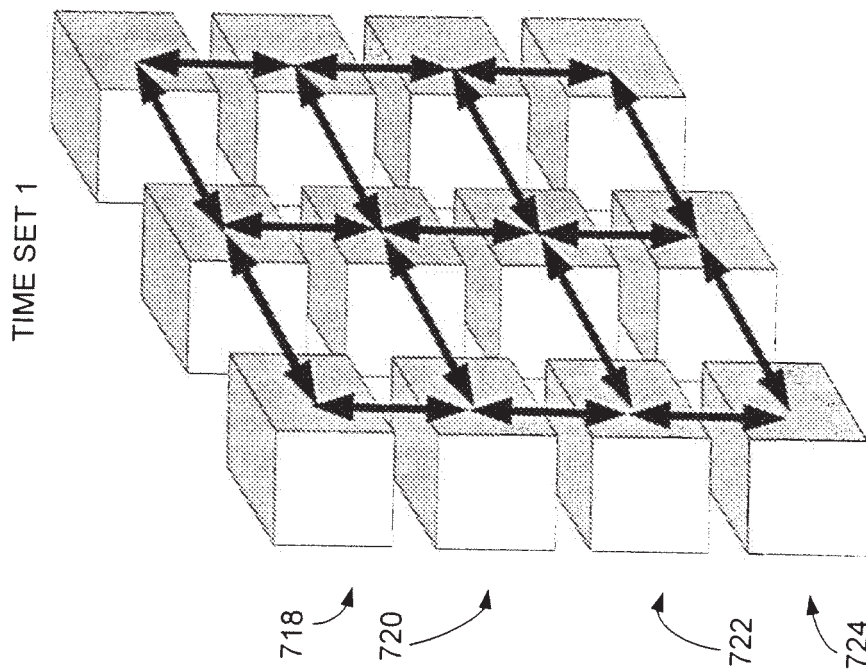

Fig. 7B



712

Fig.7C

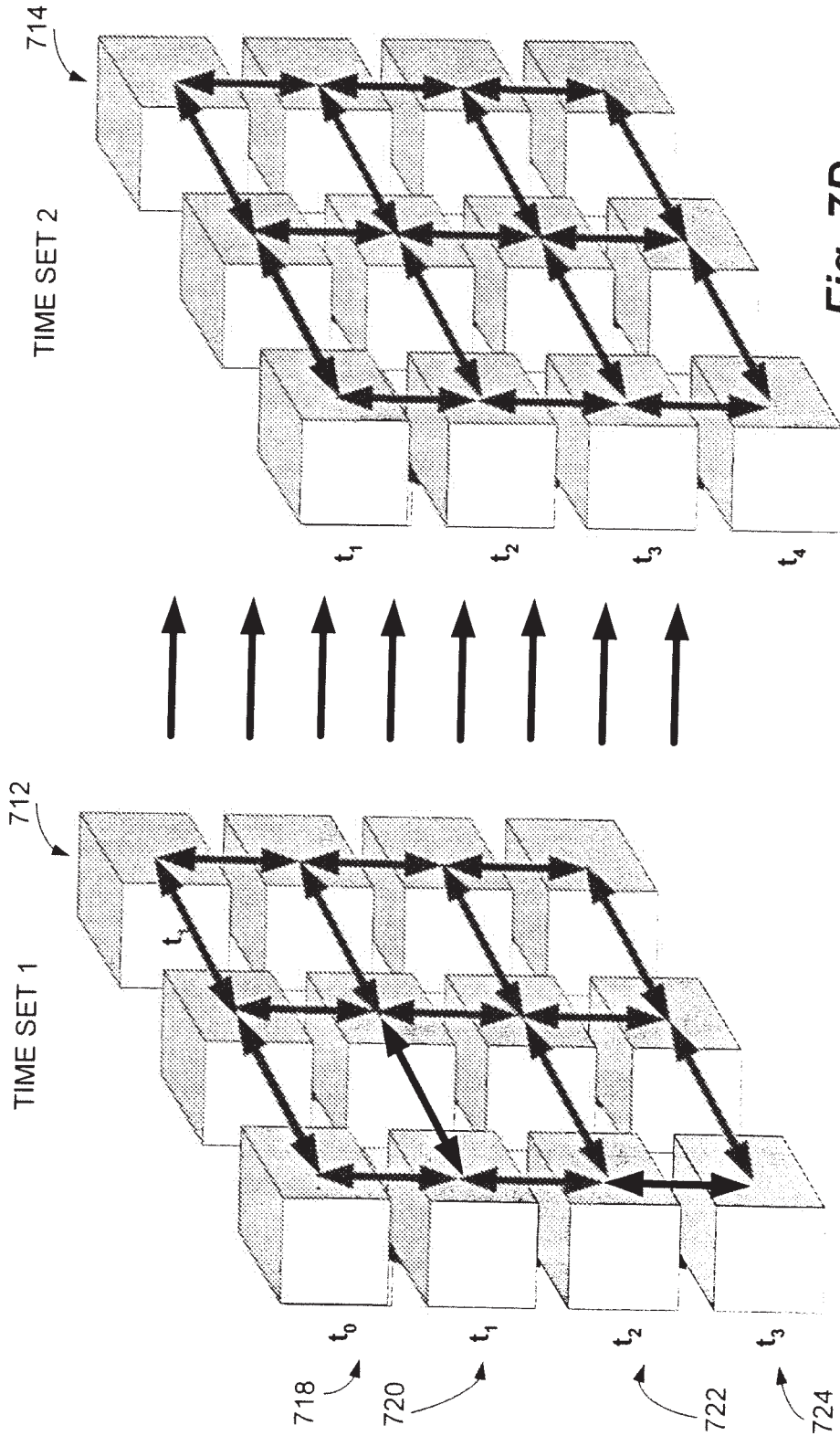

Fig. 7D

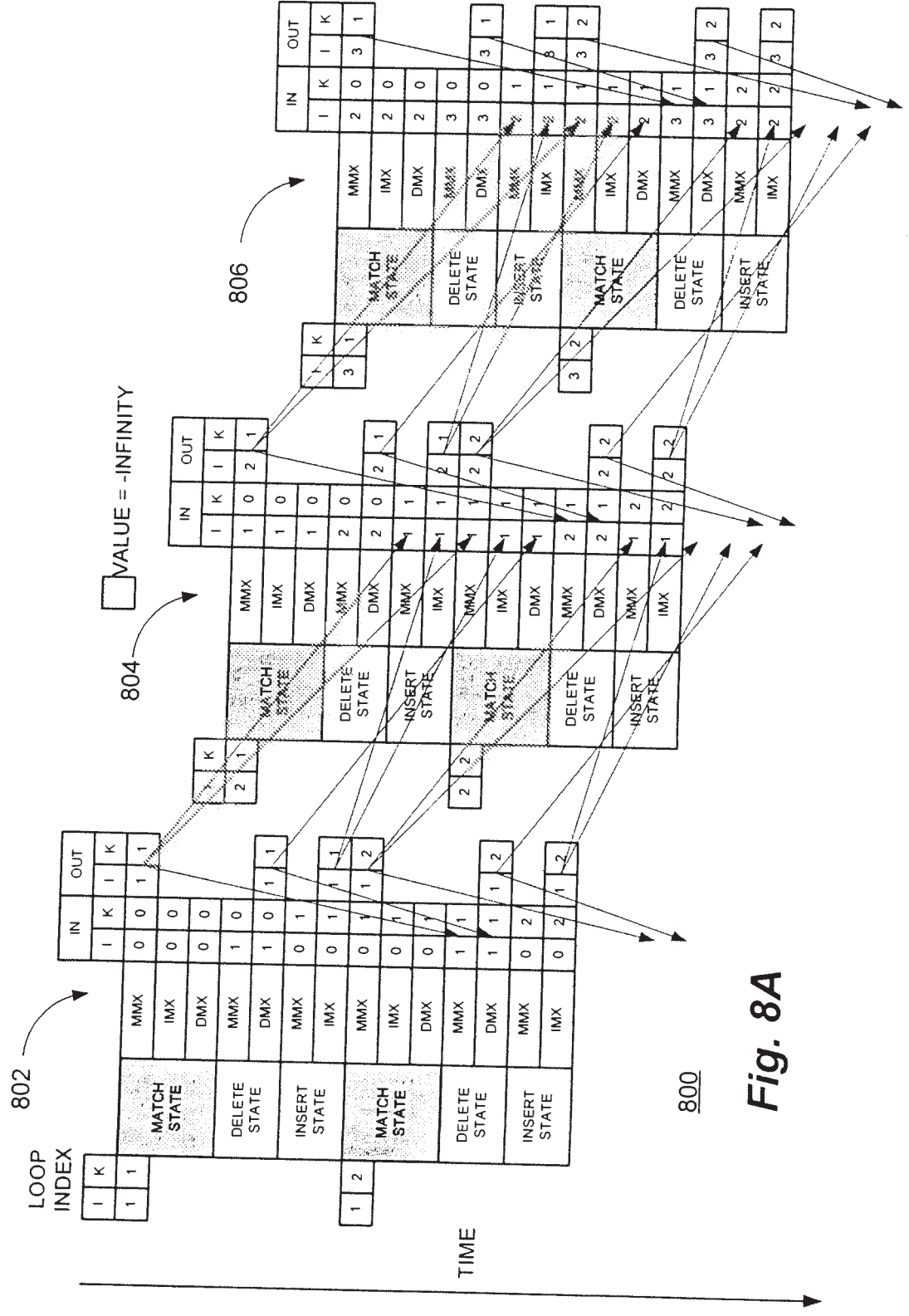

Fig. 8A

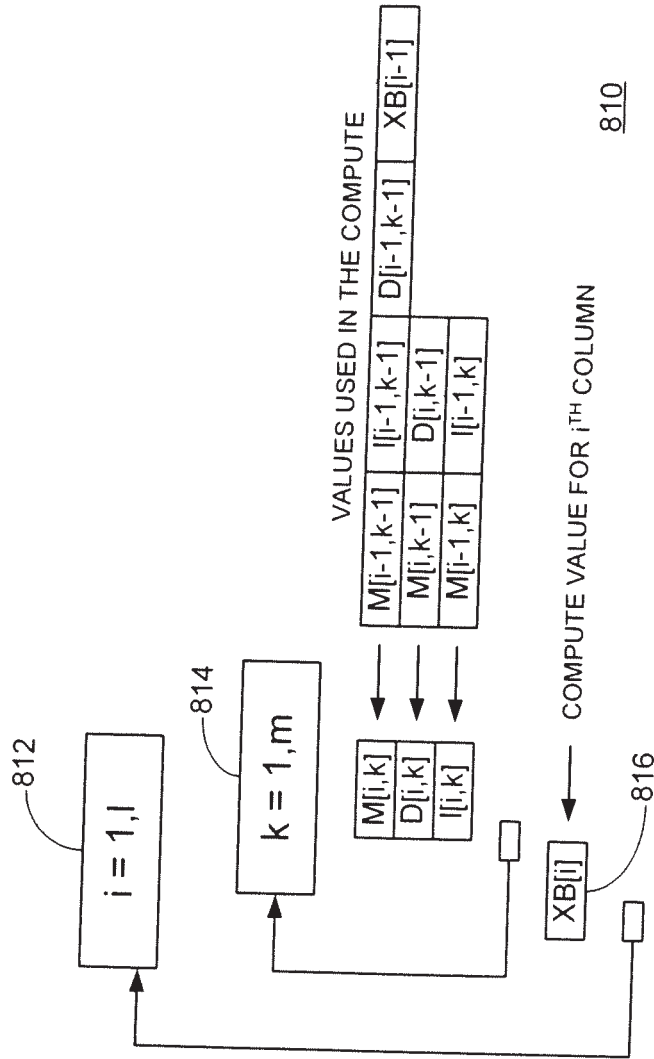
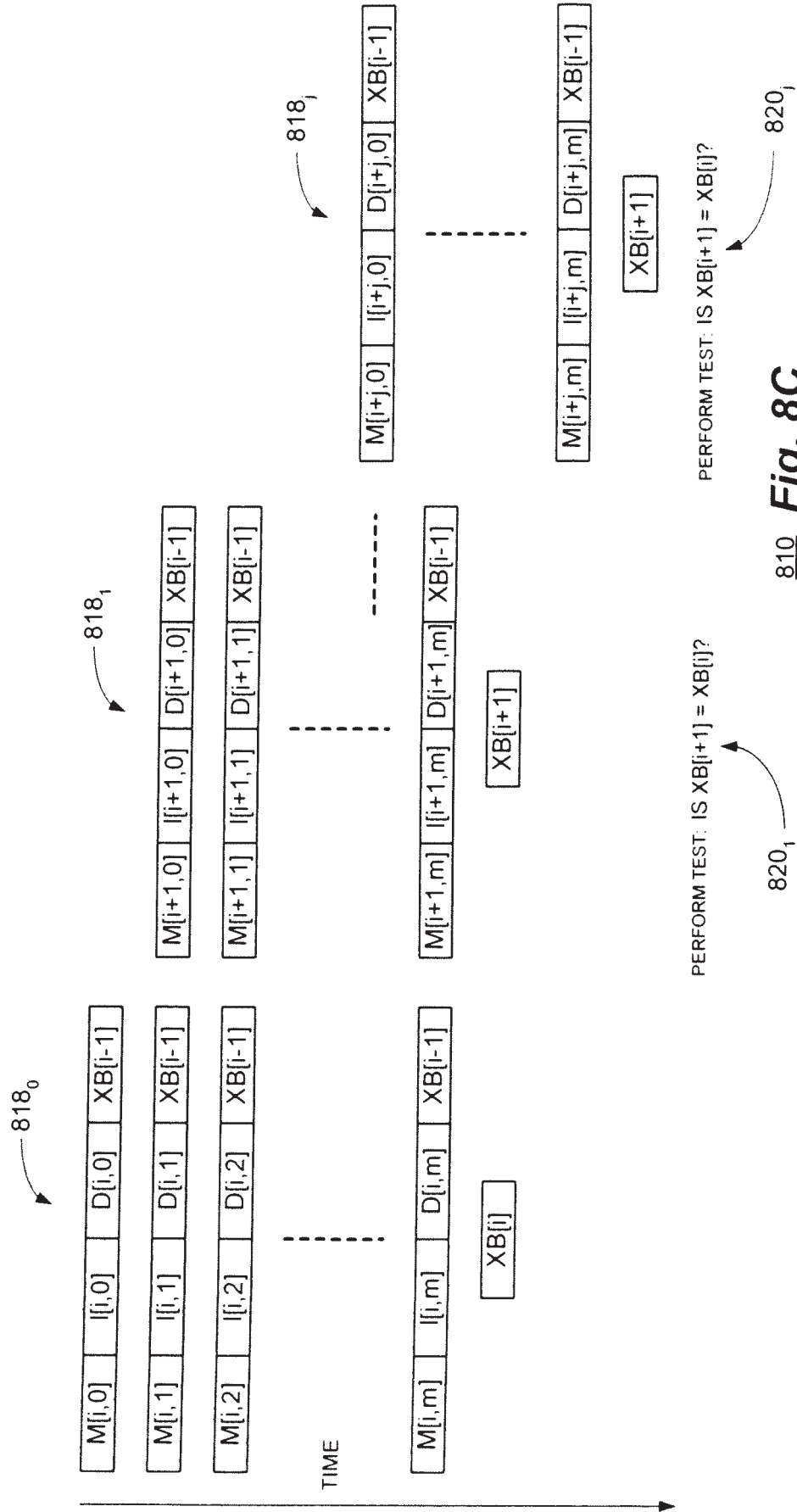

Fig. 8B



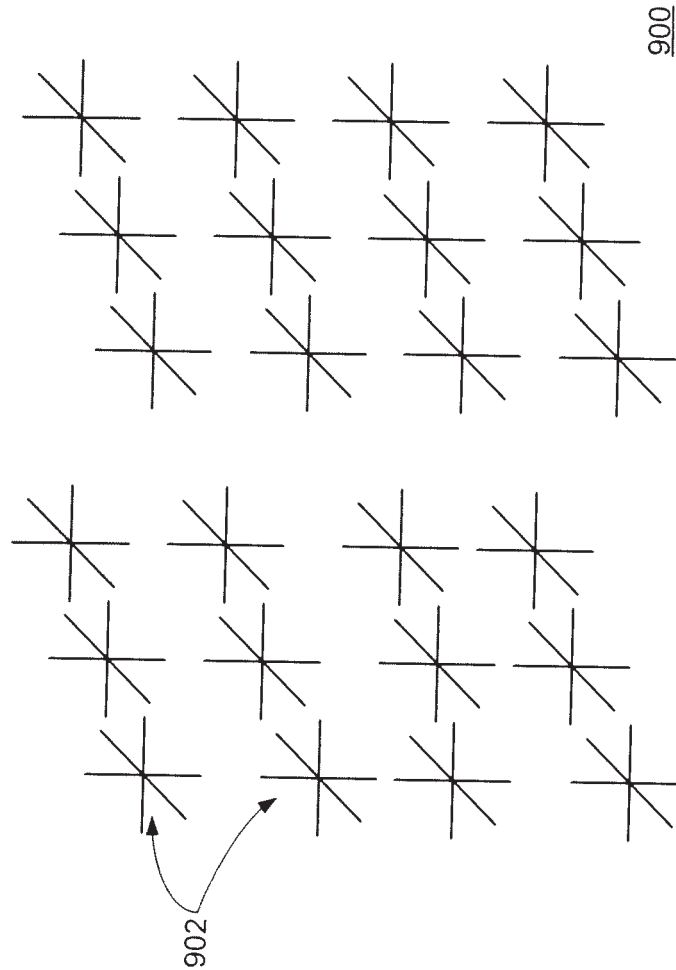

Fig. 9A

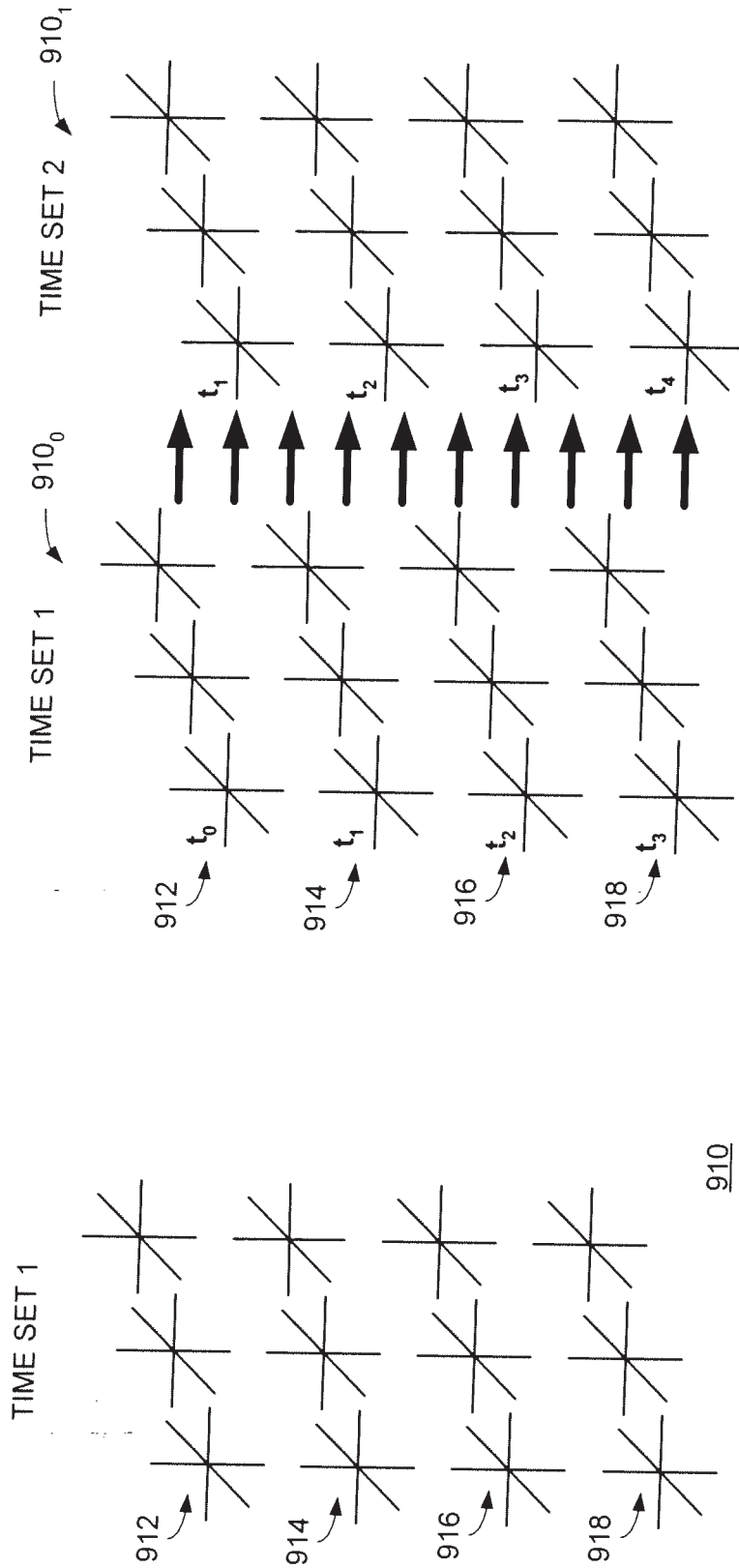

Fig. 9B

Fig. 9C

Electronic Acknowledgement Receipt

EFS ID:	1666458
Application Number:	11733064
International Application Number:	
Confirmation Number:	7527
Title of Invention:	MULTI-ADAPTIVE PROCESSING SYSTEMS AND TECHNIQUES FOR ENHANCING PARALLELISM AND PERFORMANCE OF COMPUTATIONAL FUNCTIONS
First Named Inventor/Applicant Name:	Jon M. Huppenthal
Customer Number:	25235
Filer:	Michael Christian Martensen/Julie Lange
Filer Authorized By:	Michael Christian Martensen
Attorney Docket Number:	SRC015 CON
Receipt Date:	09-APR-2007
Filing Date:	
Time Stamp:	18:04:50
Application Type:	Utility

Payment information:

Submitted with Payment	no
------------------------	----

File Listing:

Document Number	Document Description	File Name	File Size(Bytes)	Multi Part /.zip	Pages (if appl.)
1		DOC090.PDF	215641	yes	39

Multipart Description/PDF files in .zip description					
Document Description			Start	End	
Transmittal of New Application			1	1	
Specification			2	29	
Claims			30	38	
Abstract			39	39	
Warnings:					
Information:					
2	Oath or Declaration filed	DOC093.PDF	92982	no	3
Warnings:					
Information:					
3		DOC094.PDF	209537	yes	9
Multipart Description/PDF files in .zip description					
Document Description			Start	End	
Miscellaneous Incoming Letter			1	1	
Information Disclosure Statement (IDS) Filed			2	9	
Warnings:					
Information:					
4	Application Data Sheet	SRC015CONADS.pdf	984957	no	4
Warnings:					
Information:					
5	Drawings	DOC095.PDF	362633	no	20
Warnings:					
Information:					
Total Files Size (in bytes):			1865750		

This Acknowledgement Receipt evidences receipt on the noted date by the USPTO of the indicated documents, characterized by the applicant, and including page counts, where applicable. It serves as evidence of receipt similar to a Post Card, as described in MPEP 503.

New Applications Under 35 U.S.C. 111

If a new application is being filed and the application includes the necessary components for a filing date (see 37 CFR 1.53(b)-(d) and MPEP 506), a Filing Receipt (37 CFR 1.54) will be issued in due course and the date shown on this Acknowledgement Receipt will establish the filing date of the application.

National Stage of an International Application under 35 U.S.C. 371

If a timely submission to enter the national stage of an international application is compliant with the conditions of 35 U.S.C. 371 and other applicable requirements a Form PCT/DO/EO/903 indicating acceptance of the application as a national stage submission under 35 U.S.C. 371 will be issued in addition to the Filing Receipt, in due course.

New International Application Filed with the USPTO as a Receiving Office

If a new international application is being filed and the international application includes the necessary components for an international filing date (see PCT Article 11 and MPEP 1810), a Notification of the International Application Number and of the International Filing Date (Form PCT/RO/105) will be issued in due course, subject to prescriptions concerning national security, and the date shown on this Acknowledgement Receipt will establish the international filing date of the application.

Under the Paperwork Reduction Act of 1995, no persons are required to respond to a collection of information unless it displays a valid OMB control number.

PATENT APPLICATION FEE DETERMINATION RECORD Substitute for Form PTO-875	Application or Docket Number 11/733,064
---	---

APPLICATION AS FILED – 04/09/07			SMALL ENTITY	OR	OTHER THAN SMALL ENTITY	
(Column 1)	(Column 2)					
FOR	NUMBER FILED	NUMBER EXTRA	RATE (\$)	FEE (\$)	RATE (\$)	FEE (\$)
BASIC FEE (37 CFR 1.16(a), (b), or (c))	N/A	N/A	N/A		N/A	300
SEARCH FEE (37 CFR 1.16(k), (l), or (m))	N/A	N/A	N/A		N/A	500
EXAMINATION FEE (37 CFR 1.16(o), (p), or (q))	N/A	N/A	N/A		N/A	200
TOTAL CLAIMS (37 CFR 1.16(i))	52	minus 20 = * 32	X\$ 25=		X\$50=	1600
INDEPENDENT CLAIMS (37 CFR 1.16(h))	3	minus 3 = *	X\$100=		X\$200=	
APPLICATION SIZE FEE (37 CFR 1.16(s))	If the specification and drawings exceed 100 sheets of paper, the application size fee due is \$250 (\$125 for small entity) for each additional 50 sheets or fraction thereof. See 35 U.S.C. 41(a)(1)(G) and 37 CFR					
MULTIPLE DEPENDENT CLAIM PRESENT (37 CFR 1.16(j))			N/A		N/A	
			TOTAL		TOTAL	2600

* If the difference in column 1 is less than zero, enter "0" in column 2.

APPLICATION AS AMENDED – PART II					SMALL ENTITY	OR	OTHER THAN SMALL ENTITY		
	(Column 1)	(Column 2)	(Column 3)						
AMENDMENT A	CLAIMS REMAINING AFTER AMENDMENT		HIGHEST NUMBER PREVIOUSLY PAID FOR	PRESENT EXTRA	RATE (\$)	ADDI-TIONAL FEE (\$)	RATE (\$)	ADDI-TIONAL FEE (\$)	
	Total (37 CFR 1.16(i))	*	Minus **	=	X =		X =		
	Independent (37 CFR 1.16(h))	*	Minus ***	=	X =		X =		
	Application Size Fee (37 CFR 1.16(s))								
	FIRST PRESENTATION OF MULTIPLE DEPENDENT CLAIM (37 CFR 1.16(j))					N/A		N/A	
					TOTAL ADD'T FEE		TOTAL ADD'T FEE		

125,51

APPLICATION AS AMENDED – PART II					SMALL ENTITY	OR	OTHER THAN SMALL ENTITY		
	(Column 1)	(Column 2)	(Column 3)						
AMENDMENT B	CLAIMS REMAINING AFTER AMENDMENT		HIGHEST NUMBER PREVIOUSLY PAID FOR	PRESENT EXTRA	RATE (\$)	ADDI-TIONAL FEE (\$)	RATE (\$)	ADDI-TIONAL FEE (\$)	
	Total (37 CFR 1.16(i))	*	Minus **	=	X =		X =		
	Independent (37 CFR 1.16(h))	*	Minus ***	=	X =		X =		
	Application Size Fee (37 CFR 1.16(s))								
	FIRST PRESENTATION OF MULTIPLE DEPENDENT CLAIM (37 CFR 1.16(j))					N/A		N/A	
					TOTAL ADD'T FEE		TOTAL ADD'T FEE		

* If the entry in column 1 is less than the entry in column 2, write "0" in column 3.
 ** If the "Highest Number Previously Paid For" IN THIS SPACE is less than 20, enter "20".
 *** If the "Highest Number Previously Paid For" IN THIS SPACE is less than 3, enter "3".
 The "Highest Number Previously Paid For" (Total or Independent) is the highest number found in the appropriate box in column 1.

This collection of information is required by 37 CFR 1.16. The information is required to obtain or retain a benefit by the public which is to file (and by the USPTO to process) an application. Confidentiality is governed by 35 U.S.C. 122 and 37 CFR 1.14. This collection is estimated to take 12 minutes to complete, including gathering, preparing, and submitting the completed application form to the USPTO. Time will vary depending upon the individual case. Any comments on the amount of time you require to complete this form and/or suggestions for reducing this burden, should be sent to the Chief Information Officer, U.S. Patent and Trademark Office, U.S. Department of Commerce, P.O. Box 1450, Alexandria, VA 22313-1450. DO NOT SEND FEES OR COMPLETED FORMS TO THIS ADDRESS. **SEND TO: Commissioner for Patents, P.O. Box 1450, Alexandria, VA 22313-1450.**

If you need assistance in completing the form, call 1-800-PTO-9199 and select option 2.



UNITED STATES PATENT AND TRADEMARK OFFICE

UNITED STATES DEPARTMENT OF COMMERCE
United States Patent and Trademark Office
Address: COMMISSIONER FOR PATENTS
P.O. Box 1450
Alexandria, Virginia 22313-1450
www.uspto.gov

Table with 7 columns: APPLICATION NUMBER, FILING or 371(c) DATE, GRP ART UNIT, FIL FEE REC'D, ATTY.DOCKET.NO, TOT CLAIMS, IND CLAIMS. Row 1: 11/733,064, 04/09/2007, 2183, 0.00, SRC015 CON, 52, 3

CONFIRMATION NO. 7527

FILING RECEIPT

25235
HOGAN & HARTSON LLP
ONE TABOR CENTER, SUITE 1500
1200 SEVENTEENTH ST
DENVER, CO80202

Date Mailed: 04/23/2007

Receipt is acknowledged of this regular Patent Application. It will be considered in its order and you will be notified as to the results of the examination. Be sure to provide the U.S. APPLICATION NUMBER, FILING DATE, NAME OF APPLICANT, and TITLE OF INVENTION when inquiring about this application. Fees transmitted by check or draft are subject to collection. Please verify the accuracy of the data presented on this receipt. If an error is noted on this Filing Receipt, please mail to the Commissioner for Patents P.O. Box 1450 Alexandria Va 22313-1450. Please provide a copy of this Filing Receipt with the changes noted thereon. If you received a "Notice to File Missing Parts" for this application, please submit any corrections to this Filing Receipt with your reply to the Notice. When the USPTO processes the reply to the Notice, the USPTO will generate another Filing Receipt incorporating the requested corrections (if appropriate).

Applicant(s)

Jon M. Huppenthal, Colorado Springs, CO;
David E. Caliga, Colorado Springs, CO;

Assignment For Published Patent Application

SRC COMPUTERS, INC., Colorado Springs, CO

Power of Attorney: The patent practitioners associated with Customer Number 25235

Domestic Priority data as claimed by applicant

This application is a CON of 10/285,318 10/31/2002

Foreign Applications

If Required, Foreign Filing License Granted: 04/20/2007

The country code and number of your priority application, to be used for filing abroad under the Paris Convention, is US11/733,064

Projected Publication Date: To Be Determined - pending completion of Missing Parts

Non-Publication Request: No

Early Publication Request: No

Title

MULTI-ADAPTIVE PROCESSING SYSTEMS AND TECHNIQUES FOR ENHANCING

Preliminary Class

712

PROTECTING YOUR INVENTION OUTSIDE THE UNITED STATES

Since the rights granted by a U.S. patent extend only throughout the territory of the United States and have no effect in a foreign country, an inventor who wishes patent protection in another country must apply for a patent in a specific country or in regional patent offices. Applicants may wish to consider the filing of an international application under the Patent Cooperation Treaty (PCT). An international (PCT) application generally has the same effect as a regular national patent application in each PCT-member country. The PCT process **simplifies** the filing of patent applications on the same invention in member countries, but **does not result** in a grant of "an international patent" and does not eliminate the need of applicants to file additional documents and fees in countries where patent protection is desired.

Almost every country has its own patent law, and a person desiring a patent in a particular country must make an application for patent in that country in accordance with its particular laws. Since the laws of many countries differ in various respects from the patent law of the United States, applicants are advised to seek guidance from specific foreign countries to ensure that patent rights are not lost prematurely.

Applicants also are advised that in the case of inventions made in the United States, the Director of the USPTO must issue a license before applicants can apply for a patent in a foreign country. The filing of a U.S. patent application serves as a request for a foreign filing license. The application's filing receipt contains further information and guidance as to the status of applicant's license for foreign filing.

Applicants may wish to consult the USPTO booklet, "General Information Concerning Patents" (specifically, the section entitled "Treaties and Foreign Patents") for more information on timeframes and deadlines for filing foreign patent applications. The guide is available either by contacting the USPTO Contact Center at 800-786-9199, or it can be viewed on the USPTO website at <http://www.uspto.gov/web/offices/pac/doc/general/index.html>.

For information on preventing theft of your intellectual property (patents, trademarks and copyrights), you may wish to consult the U.S. Government website, <http://www.stopfakes.gov>. Part of a Department of Commerce initiative, this website includes self-help "toolkits" giving innovators guidance on how to protect intellectual property in specific countries such as China, Korea and Mexico. For questions regarding patent enforcement issues, applicants may call the U.S. Government hotline at 1-866-999-HALT (1-866-999-4158).

LICENSE FOR FOREIGN FILING UNDER

Title 35, United States Code, Section 184

Title 37, Code of Federal Regulations, 5.11 & 5.15

GRANTED

The applicant has been granted a license under 35 U.S.C. 184, if the phrase "IF REQUIRED, FOREIGN FILING LICENSE GRANTED" followed by a date appears on this form. Such licenses are issued in all applications where the conditions for issuance of a license have been met, regardless of whether or not a license may be required as set forth in 37 CFR 5.15. The scope and limitations of this license are set forth in 37 CFR 5.15(a) unless an earlier license has been issued under 37 CFR 5.15(b). The license is subject to revocation upon written notification. The date indicated is the effective date of the license, unless an earlier license of similar scope has been granted under 37 CFR 5.13 or 5.14.

This license is to be retained by the licensee and may be used at any time on or after the effective date thereof unless it is revoked. This license is automatically transferred to any related applications(s) filed under 37 CFR 1.53(d). This license is not retroactive.

The grant of a license does not in any way lessen the responsibility of a licensee for the security of the subject matter as imposed by any Government contract or the provisions of existing laws relating to espionage and the national security or the export of technical data. Licensees should apprise themselves of current regulations especially with respect to certain countries, of other agencies, particularly the Office of Defense Trade Controls, Department of State (with respect to Arms, Munitions and Implements of War (22 CFR 121-128)); the Bureau of Industry and Security, Department of Commerce (15 CFR parts 730-774); the Office of Foreign Assets Control, Department of Treasury (31 CFR Parts 500+) and the Department of Energy.

NOT GRANTED

No license under 35 U.S.C. 184 has been granted at this time, if the phrase "IF REQUIRED, FOREIGN FILING LICENSE GRANTED" DOES NOT appear on this form. Applicant may still petition for a license under 37 CFR 5.12, if a license is desired before the expiration of 6 months from the filing date of the application. If 6 months has lapsed from the filing date of this application and the licensee has not received any indication of a secrecy order under 35 U.S.C. 181, the licensee may foreign file the application pursuant to 37 CFR 5.15(b).



UNITED STATES PATENT AND TRADEMARK OFFICE

UNITED STATES DEPARTMENT OF COMMERCE
 United States Patent and Trademark Office
 Address: COMMISSIONER FOR PATENTS
 P.O. Box 1459
 Alexandria, Virginia 22313-1450
 www.uspto.gov

APPLICATION NUMBER	FILING OR 371 (c) DATE	FIRST NAMED APPLICANT	ATTORNEY DOCKET NUMBER
11/733,064	04/09/2007	Jon M. Huppenthal	SRC015 CON

CONFIRMATION NO. 7527
FORMALITIES
LETTER

25235
 HOGAN & HARTSON LLP
 ONE TABOR CENTER, SUITE 1500
 1200 SEVENTEENTH ST
 DENVER, CO 80202

Date Mailed: 04/23/2007

NOTICE TO FILE MISSING PARTS OF NONPROVISIONAL APPLICATION

FILED UNDER 37 CFR 1.53(b)

Filing Date Granted

Items Required To Avoid Abandonment:

An application number and filing date have been accorded to this application. The item(s) indicated below, however, are missing. Applicant is given **TWO MONTHS** from the date of this Notice within which to file all required items and pay any fees required below to avoid abandonment. Extensions of time may be obtained by filing a petition accompanied by the extension fee under the provisions of 37 CFR 1.136(a).

- The statutory basic filing fee is missing.
Applicant must submit \$ 300 to complete the basic filing fee for a non-small entity. If appropriate, applicant may make a written assertion of entitlement to small entity status and pay the small entity filing fee (37 CFR 1.27).

The applicant needs to satisfy supplemental fees problems indicated below.

The required item(s) identified below must be timely submitted to avoid abandonment:

- Additional claim fees of **\$1600** as a non-small entity, including any required multiple dependent claim fee, are required. Applicant must submit the additional claim fees or cancel the additional claims for which fees are due.
- To avoid abandonment, a surcharge (for late submission of filing fee, search fee, examination fee or oath or declaration) as set forth in 37 CFR 1.16(f) of \$130 for a non-small entity, must be submitted with the missing items identified in this letter.

SUMMARY OF FEES DUE:

Total additional fee(s) required for this application is **\$2730** for a non-small entity

- **\$300** Statutory basic filing fee.
- **\$130** Surcharge.
- The application search fee has not been paid. Applicant must submit **\$500** to complete the search fee.

- The application examination fee has not been paid. Applicant must submit **\$200** to complete the examination fee for a non-small entity.
- Total additional claim fee(s) for this application is **\$1600**
 - **\$1600** for **32** total claims over 20.

Replies should be mailed to: Mail Stop Missing Parts
 Commissioner for Patents
 P.O. Box 1450
 Alexandria VA 22313-1450

Registered users of EFS-Web may alternatively submit their reply to this notice via EFS-Web.
<https://sportal.uspto.gov/authenticate/AuthenticateUserLocalEPF.html>

For more information about EFS-Web please call the USPTO Electronic Business Center at **1-866-217-9197** or visit our website at <http://www.uspto.gov/ebc>.

If you are not using EFS-Web to submit your reply, you must include a copy of this notice.

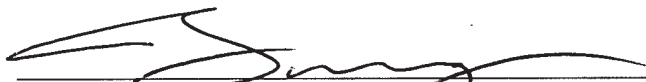

Office of Initial Patent Examination (571) 272-4000, or 1-800-PTO-9199

PART 3 - OFFICE COPY

IN THE UNITED STATES PATENT AND TRADEMARK OFFICE

Serial No. 11/733,064	Confirmation No.: 7527
Application of: Jon M. Huppenthal and David E. Caliga	Art Unit: 2183
Filed: April 9, 2007	Examiner: Not Yet Assigned
Attorney Docket No. SRC015 CON	Customer No.: 25235
For: MULTI-ADAPTIVE PROCESSING SYSTEMS AND TECHNIQUES FOR ENHANCING PARALLELISM AND PERFORMANCE OF COMPUTATIONAL FUNCTIONS	

RESPONSE TO NOTICE TO FILE MISSING PARTS

Mail Stop Missing Parts
Commissioner for Patents
P.O. Box 1450
Alexandria, VA 22313-1450

In response to the Notice to File Missing Parts of Application, Filing Date Granted, mailed April 23, 2007, submitted herewith is the filing fee of \$2,600 and a copy of the PTO Notice form. In addition, please charge deposit account no. 50-1123 \$130 to cover the surcharge for a large entity.

Any fee deficiency associated with this communication may be charged to Deposit Account No. 50-1123.

Date: 17 May 2007

Michael C. Martensen, Reg. No. 46901
HOGAN & HARTSON LLP
One Tabor Center
1200 17th Street, Suite 1500
Denver, Colorado 80202
(719) 448-5910 Tel
(303) 899-7333 Fax



UNITED STATES PATENT AND TRADEMARK OFFICE

UNITED STATES DEPARTMENT OF COMMERCE
 United States Patent and Trademark Office
 Address: COMMISSIONER FOR PATENTS
 P.O. Box 1450
 Alexandria, Virginia 22313-1450
 www.uspto.gov

APPLICATION NUMBER	FILING OR 371 (c) DATE	FIRST NAMED APPLICANT	ATTORNEY DOCKET NUMBER
11/733,064	04/09/2007	Jon M. Huppenthal	SRC015 CON

25235
 HOGAN & HARTSON LLP
 ONE TABOR CENTER, SUITE 1500
 1200 SEVENTEENTH ST
 DENVER, CO 80202

CONFIRMATION NO. 7527
FORMALITIES
LETTER

Date Mailed: 04/23/2007

NOTICE TO FILE MISSING PARTS OF NONPROVISIONAL APPLICATION

FILED UNDER 37 CFR 1.53(b)

Filing Date Granted

Items Required To Avoid Abandonment:

An application number and filing date have been accorded to this application. The item(s) indicated below, however, are missing. Applicant is given **TWO MONTHS** from the date of this Notice within which to file all required items and pay any fees required below to avoid abandonment. Extensions of time may be obtained by filing a petition accompanied by the extension fee under the provisions of 37 CFR 1.136(a).

- The statutory basic filing fee is missing.
Applicant must submit \$ 300 to complete the basic filing fee for a non-small entity. If appropriate, applicant may make a written assertion of entitlement to small entity status and pay the small entity filing fee (37 CFR 1.27).

The applicant needs to satisfy supplemental fees problems indicated below.

The required item(s) identified below must be timely submitted to avoid abandonment:

- Additional claim fees of **\$1600** as a non-small entity, including any required multiple dependent claim fee, are required. Applicant must submit the additional claim fees or cancel the additional claims for which fees are due.
- To avoid abandonment, a surcharge (for late submission of filing fee, search fee, examination fee or oath or declaration) as set forth in 37 CFR 1.16(f) of \$130 for a non-small entity, must be submitted with the missing items identified in this letter.

SUMMARY OF FEES DUE:

Total additional fee(s) required for this application is **\$2730** for a non-small entity

- **\$300** Statutory basic filing fee.
- **\$130** Surcharge.
- The application search fee has not been paid. Applicant must submit **\$500** to complete the search fee.

- The application examination fee has not been paid. Applicant must submit **\$200** to complete the examination fee for a non-small entity.
- Total additional claim fee(s) for this application is **\$1600**
 - **\$1600** for **32** total claims over 20.

Replies should be mailed to: Mail Stop Missing Parts
 Commissioner for Patents
 P.O. Box 1450
 Alexandria VA 22313-1450

Registered users of EFS-Web may alternatively submit their reply to this notice via EFS-Web.
<https://portal.uspto.gov/authenticate/AuthenticateUserLocalEPF.html>

For more information about EFS-Web please call the USPTO Electronic Business Center at **1-866-217-9197** or visit our website at <http://www.uspto.gov/ebc>.

If you are not using EFS-Web to submit your reply, you must include a copy of this notice.



Office of Initial Patent Examination (571) 272-4000, or 1-800-PTO-9199

PART 2 - COPY TO BE RETURNED WITH RESPONSE

Electronic Patent Application Fee Transmittal

Application Number:	11733064
Filing Date:	09-Apr-2007
Title of Invention:	MULTI-ADAPTIVE PROCESSING SYSTEMS AND TECHNIQUES FOR ENHANCING PARALLELISM AND PERFORMANCE OF COMPUTATIONAL FUNCTIONS
First Named Inventor/Applicant Name:	Jon M. Huppenthal
Filer:	Michael Christian Martensen/Julie Lange
Attorney Docket Number:	SRC015 CON

Filed as Large Entity

Utility Filing Fees

Description	Fee Code	Quantity	Amount	Sub-Total in USD(\$)
Basic Filing:				
Utility application filing	1011	1	300	300
Utility Search Fee	1111	1	500	500
Utility Examination Fee	1311	1	200	200

Pages:

Claims:

Claims in excess of 20	1202	32	50	1600
------------------------	------	----	----	------

Miscellaneous-Filing:

Late filing fee for oath or declaration	1051	1	130	130
---	------	---	-----	-----

Description	Fee Code	Quantity	Amount	Sub-Total in USD(\$)
Petition:				
Patent-Appeals-and-Interference:				
Post-Allowance-and-Post-Issuance:				
Extension-of-Time:				
Miscellaneous:				
			Total in USD (\$)	2730

Electronic Acknowledgement Receipt

EFS ID:	1792246
Application Number:	11733064
International Application Number:	
Confirmation Number:	7527
Title of Invention:	MULTI-ADAPTIVE PROCESSING SYSTEMS AND TECHNIQUES FOR ENHANCING PARALLELISM AND PERFORMANCE OF COMPUTATIONAL FUNCTIONS
First Named Inventor/Applicant Name:	Jon M. Huppenthal
Customer Number:	25235
Filer:	Michael Christian Martensen/Julie Lange
Filer Authorized By:	Michael Christian Martensen
Attorney Docket Number:	SRC015 CON
Receipt Date:	19-MAY-2007
Filing Date:	09-APR-2007
Time Stamp:	11:00:11
Application Type:	Utility

Payment information:

Submitted with Payment	yes
Payment was successfully received in RAM	\$2730
RAM confirmation Number	1465
Deposit Account	501123

The Director of the USPTO is hereby authorized to charge indicated fees and credit any overpayment as follows:
Charge any Additional Fees required under 37 C.F.R. Section 1.16 and 1.17

File Listing:

Document Number	Document Description	File Name	File Size(Bytes)	Multi Part /.zip	Pages (if appl.)
1		DOC020.PDF	34966	yes	3
Multipart Description/PDF files in .zip description					
Document Description			Start	End	
Miscellaneous Incoming Letter			1	1	
Examination support document			2	3	
Warnings:					
Information:					
2	Fee Worksheet (PTO-06)	fee-info.pdf	8689	no	2
Warnings:					
Information:					
Total Files Size (in bytes):			43655		
<p>This Acknowledgement Receipt evidences receipt on the noted date by the USPTO of the indicated documents, characterized by the applicant, and including page counts, where applicable. It serves as evidence of receipt similar to a Post Card, as described in MPEP 503.</p> <p><u>New Applications Under 35 U.S.C. 111</u> If a new application is being filed and the application includes the necessary components for a filing date (see 37 CFR 1.53(b)-(d) and MPEP 506), a Filing Receipt (37 CFR 1.54) will be issued in due course and the date shown on this Acknowledgement Receipt will establish the filing date of the application.</p> <p><u>National Stage of an International Application under 35 U.S.C. 371</u> If a timely submission to enter the national stage of an international application is compliant with the conditions of 35 U.S.C. 371 and other applicable requirements a Form PCT/DO/EO/903 indicating acceptance of the application as a national stage submission under 35 U.S.C. 371 will be issued in addition to the Filing Receipt, in due course.</p> <p><u>New International Application Filed with the USPTO as a Receiving Office</u> If a new international application is being filed and the international application includes the necessary components for an international filing date (see PCT Article 11 and MPEP 1810), a Notification of the International Application Number and of the International Filing Date (Form PCT/RO/105) will be issued in due course, subject to prescriptions concerning national security, and the date shown on this Acknowledgement Receipt will establish the international filing date of the application.</p>					



UNITED STATES PATENT AND TRADEMARK OFFICE

UNITED STATES DEPARTMENT OF COMMERCE
United States Patent and Trademark Office
Address: COMMISSIONER FOR PATENTS
P.O. Box 1450
Alexandria, Virginia 22313-1450
www.uspto.gov

Table with 7 columns: APPLICATION NUMBER, FILING or 371(c) DATE, GRP ART UNIT, FIL FEE REC'D, ATTY.DOCKET.NO, TOT CLAIMS, IND CLAIMS. Row 1: 11/733,064, 04/09/2007, 2183, 2730, SRC015 CON, 52, 3

CONFIRMATION NO. 7527

UPDATED FILING RECEIPT

25235
HOGAN & HARTSON LLP
ONE TABOR CENTER, SUITE 1500
1200 SEVENTEENTH ST
DENVER, CO80202

Date Mailed: 05/24/2007

Receipt is acknowledged of this regular Patent Application. It will be considered in its order and you will be notified as to the results of the examination. Be sure to provide the U.S. APPLICATION NUMBER, FILING DATE, NAME OF APPLICANT, and TITLE OF INVENTION when inquiring about this application. Fees transmitted by check or draft are subject to collection. Please verify the accuracy of the data presented on this receipt. If an error is noted on this Filing Receipt, please mail to the Commissioner for Patents P.O. Box 1450 Alexandria Va 22313-1450. Please provide a copy of this Filing Receipt with the changes noted thereon. If you received a "Notice to File Missing Parts" for this application, please submit any corrections to this Filing Receipt with your reply to the Notice. When the USPTO processes the reply to the Notice, the USPTO will generate another Filing Receipt incorporating the requested corrections (if appropriate).

Applicant(s)

Jon M. Huppenthal, Colorado Springs, CO;
David E. Caliga, Colorado Springs, CO;

Assignment For Published Patent Application

SRC COMPUTERS, INC., Colorado Springs, CO

Power of Attorney: The patent practitioners associated with Customer Number 25235

Domestic Priority data as claimed by applicant

This application is a CON of 10/285,318 10/31/2002 PAT 7,225,324

Foreign Applications

If Required, Foreign Filing License Granted: 04/20/2007

The country code and number of your priority application, to be used for filing abroad under the Paris Convention, is US11/733,064

Projected Publication Date: 08/30/2007

Non-Publication Request: No

Early Publication Request: No

Title

MULTI-ADAPTIVE PROCESSING SYSTEMS AND TECHNIQUES FOR ENHANCING

Preliminary Class

712

PROTECTING YOUR INVENTION OUTSIDE THE UNITED STATES

Since the rights granted by a U.S. patent extend only throughout the territory of the United States and have no effect in a foreign country, an inventor who wishes patent protection in another country must apply for a patent in a specific country or in regional patent offices. Applicants may wish to consider the filing of an international application under the Patent Cooperation Treaty (PCT). An international (PCT) application generally has the same effect as a regular national patent application in each PCT-member country. The PCT process **simplifies** the filing of patent applications on the same invention in member countries, but **does not result** in a grant of "an international patent" and does not eliminate the need of applicants to file additional documents and fees in countries where patent protection is desired.

Almost every country has its own patent law, and a person desiring a patent in a particular country must make an application for patent in that country in accordance with its particular laws. Since the laws of many countries differ in various respects from the patent law of the United States, applicants are advised to seek guidance from specific foreign countries to ensure that patent rights are not lost prematurely.

Applicants also are advised that in the case of inventions made in the United States, the Director of the USPTO must issue a license before applicants can apply for a patent in a foreign country. The filing of a U.S. patent application serves as a request for a foreign filing license. The application's filing receipt contains further information and guidance as to the status of applicant's license for foreign filing.

Applicants may wish to consult the USPTO booklet, "General Information Concerning Patents" (specifically, the section entitled "Treaties and Foreign Patents") for more information on timeframes and deadlines for filing foreign patent applications. The guide is available either by contacting the USPTO Contact Center at 800-786-9199, or it can be viewed on the USPTO website at <http://www.uspto.gov/web/offices/pac/doc/general/index.html>.

For information on preventing theft of your intellectual property (patents, trademarks and copyrights), you may wish to consult the U.S. Government website, <http://www.stopfakes.gov>. Part of a Department of Commerce initiative, this website includes self-help "toolkits" giving innovators guidance on how to protect intellectual property in specific countries such as China, Korea and Mexico. For questions regarding patent enforcement issues, applicants may call the U.S. Government hotline at 1-866-999-HALT (1-866-999-4158).

LICENSE FOR FOREIGN FILING UNDER

Title 35, United States Code, Section 184

Title 37, Code of Federal Regulations, 5.11 & 5.15

GRANTED

The applicant has been granted a license under 35 U.S.C. 184, if the phrase "IF REQUIRED, FOREIGN FILING LICENSE GRANTED" followed by a date appears on this form. Such licenses are issued in all applications where the conditions for issuance of a license have been met, regardless of whether or not a license may be required as set forth in 37 CFR 5.15. The scope and limitations of this license are set forth in 37 CFR 5.15(a) unless an earlier license has been issued under 37 CFR 5.15(b). The license is subject to revocation upon written notification. The date indicated is the effective date of the license, unless an earlier license of similar scope has been granted under 37 CFR 5.13 or 5.14.

This license is to be retained by the licensee and may be used at any time on or after the effective date thereof unless it is revoked. This license is automatically transferred to any related applications(s) filed under 37 CFR 1.53(d). This license is not retroactive.

The grant of a license does not in any way lessen the responsibility of a licensee for the security of the subject matter as imposed by any Government contract or the provisions of existing laws relating to espionage and the national security or the export of technical data. Licensees should apprise themselves of current regulations especially with respect to certain countries, of other agencies, particularly the Office of Defense Trade Controls, Department of State (with respect to Arms, Munitions and Implements of War (22 CFR 121-128)); the Bureau of Industry and Security, Department of Commerce (15 CFR parts 730-774); the Office of Foreign Assets Control, Department of Treasury (31 CFR Parts 500+) and the Department of Energy.

NOT GRANTED

No license under 35 U.S.C. 184 has been granted at this time, if the phrase "IF REQUIRED, FOREIGN FILING LICENSE GRANTED" DOES NOT appear on this form. Applicant may still petition for a license under 37 CFR 5.12, if a license is desired before the expiration of 6 months from the filing date of the application. If 6 months has lapsed from the filing date of this application and the licensee has not received any indication of a secrecy order under 35 U.S.C. 181, the licensee may foreign file the application pursuant to 37 CFR 5.15(b).



APPLICATION NUMBER	FILING OR 371(c) DATE	FIRST NAMED APPLICANT	ATTY. DOCKET NO./TITLE
11/733,064	04/09/2007	Jon M. Huppenthal	SRC015 CON

CONFIRMATION NO. 7527

25235
HOGAN & HARTSON LLP
ONE TABOR CENTER, SUITE 1500
1200 SEVENTEENTH ST
DENVER, CO80202

Title: MULTI-ADAPTIVE PROCESSING SYSTEMS AND TECHNIQUES FOR ENHANCING PARALLELISM AND PERFORMANCE OF COMPUTATIONAL FUNCTIONS

Publication No. US-2007-0204131-A1

Publication Date: 08/30/2007

NOTICE OF PUBLICATION OF APPLICATION

The above-identified application will be electronically published as a patent application publication pursuant to 37 CFR 1.211, et seq. The patent application publication number and publication date are set forth above.

The publication may be accessed through the USPTO's publicly available Searchable Databases via the Internet at www.uspto.gov. The direct link to access the publication is currently <http://www.uspto.gov/patft/>.

The publication process established by the Office does not provide for mailing a copy of the publication to applicant. A copy of the publication may be obtained from the Office upon payment of the appropriate fee set forth in 37 CFR 1.19(a)(1). Orders for copies of patent application publications are handled by the USPTO's Office of Public Records. The Office of Public Records can be reached by telephone at (703) 308-9726 or (800) 972-6382, by facsimile at (703) 305-8759, by mail addressed to the United States Patent and Trademark Office, Office of Public Records, Alexandria, VA 22313-1450 or via the Internet.

In addition, information on the status of the application, including the mailing date of Office actions and the dates of receipt of correspondence filed in the Office, may also be accessed via the Internet through the Patent Electronic Business Center at www.uspto.gov using the public side of the Patent Application Information and Retrieval (PAIR) system. The direct link to access this status information is currently <http://pair.uspto.gov/>. Prior to publication, such status information is confidential and may only be obtained by applicant using the private side of PAIR.

Further assistance in electronically accessing the publication, or about PAIR, is available by calling the Patent Electronic Business Center at 1-866-217-9197.

Pre-Grant Publication Division, 703-605-4283

INFORMATION DISCLOSURE STATEMENT BY APPLICANT (Not for submission under 37 CFR 1.99)	Application Number	11733064
	Filing Date	2007-04-09
	First Named Inventor	Jon M. Huppenthal et al.
	Art Unit	2183
	Examiner Name	Not Yet Assigned
	Attorney Docket Number	SRC015CON

U.S. PATENTS							Remove
Examiner Initial*	Cite No	Patent Number	Kind Code ¹	Issue Date	Name of Patentee or Applicant of cited Document	Pages, Columns, Lines where Relevant Passages or Relevant Figures Appear	
	1						

If you wish to add additional U.S. Patent citation information please click the Add button.

Add

U.S. PATENT APPLICATION PUBLICATIONS							Remove
Examiner Initial*	Cite No	Publication Number	Kind Code ¹	Publication Date	Name of Patentee or Applicant of cited Document	Pages, Columns, Lines where Relevant Passages or Relevant Figures Appear	
	1						

If you wish to add additional U.S. Published Application citation information please click the Add button.

Add

FOREIGN PATENT DOCUMENTS								Remove
Examiner Initial*	Cite No	Foreign Document Number ³	Country Code ² j	Kind Code ⁴	Publication Date	Name of Patentee or Applicant of cited Document	Pages, Columns, Lines where Relevant Passages or Relevant Figures Appear	T ⁵
	1	63-086079			1988-04-16	Nippon Telegr & Teleph Corp.		<input type="checkbox"/>
	2	59-206972			1984-11-22	Toshiba Corp.		<input type="checkbox"/>

If you wish to add additional Foreign Patent Document citation information please click the Add button

Add

NON-PATENT LITERATURE DOCUMENTS							Remove
---------------------------------	--	--	--	--	--	--	--------

INFORMATION DISCLOSURE STATEMENT BY APPLICANT (Not for submission under 37 CFR 1.99)	Application Number	11733064
	Filing Date	2007-04-09
	First Named Inventor	Jon M. Huppenthal et al.
	Art Unit	2183
	Examiner Name	Not Yet Assigned
	Attorney Docket Number	SRC015CON

Examiner Initials*	Cite No	Include name of the author (in CAPITAL LETTERS), title of the article (when appropriate), title of the item (book, magazine, journal, serial, symposium, catalog, etc), date, pages(s), volume-issue number(s), publisher, city and/or country where published.	T ⁵
	1		<input type="checkbox"/>

If you wish to add additional non-patent literature document citation information please click the Add button

EXAMINER SIGNATURE

Examiner Signature	Date Considered
--------------------	-----------------

*EXAMINER: Initial if reference considered, whether or not citation is in conformance with MPEP 609. Draw line through a citation if not in conformance and not considered. Include copy of this form with next communication to applicant.

¹ See Kind Codes of USPTO Patent Documents at www.USPTO.GOV or MPEP 901.04. ² Enter office that issued the document, by the two-letter code (WIPO Standard ST.3). ³ For Japanese patent documents, the indication of the year of the reign of the Emperor must precede the serial number of the patent document. ⁴ Kind of document by the appropriate symbols as indicated on the document under WIPO Standard ST.16 if possible. ⁵ Applicant is to place a check mark here if English language translation is attached.

INFORMATION DISCLOSURE STATEMENT BY APPLICANT (Not for submission under 37 CFR 1.99)	Application Number	11733064
	Filing Date	2007-04-09
	First Named Inventor	Jon M. Huppenthal et al.
	Art Unit	2183
	Examiner Name	Not Yet Assigned
	Attorney Docket Number	SRC015CON

CERTIFICATION STATEMENT

Please see 37 CFR 1.97 and 1.98 to make the appropriate selection(s):

That each item of information contained in the information disclosure statement was first cited in any communication from a foreign patent office in a counterpart foreign application not more than three months prior to the filing of the information disclosure statement. See 37 CFR 1.97(e)(1).

OR

That no item of information contained in the information disclosure statement was cited in a communication from a foreign patent office in a counterpart foreign application, and, to the knowledge of the person signing the certification after making reasonable inquiry, no item of information contained in the information disclosure statement was known to any individual designated in 37 CFR 1.56(c) more than three months prior to the filing of the information disclosure statement. See 37 CFR 1.97(e)(2).

- See attached certification statement.
- Fee set forth in 37 CFR 1.17 (p) has been submitted herewith.
- None

SIGNATURE

A signature of the applicant or representative is required in accordance with CFR 1.33, 10.18. Please see CFR 1.4(d) for the form of the signature.

Signature	/william j. kubida/	Date (YYYY-MM-DD)	2008-03-19
Name/Print	William J. Kubida	Registration Number	29664

This collection of information is required by 37 CFR 1.97 and 1.98. The information is required to obtain or retain a benefit by the public which is to file (and by the USPTO to process) an application. Confidentiality is governed by 35 U.S.C. 122 and 37 CFR 1.14. This collection is estimated to take 1 hour to complete, including gathering, preparing and submitting the completed application form to the USPTO. Time will vary depending upon the individual case. Any comments on the amount of time you require to complete this form and/or suggestions for reducing this burden, should be sent to the Chief Information Officer, U.S. Patent and Trademark Office, U.S. Department of Commerce, P.O. Box 1450, Alexandria, VA 22313-1450. **DO NOT SEND FEES OR COMPLETED FORMS TO THIS ADDRESS. SEND TO: Commissioner for Patents, P.O. Box 1450, Alexandria, VA 22313-1450.**

Privacy Act Statement

The Privacy Act of 1974 (P.L. 93-579) requires that you be given certain information in connection with your submission of the attached form related to a patent application or patent. Accordingly, pursuant to the requirements of the Act, please be advised that: (1) the general authority for the collection of this information is 35 U.S.C. 2(b)(2); (2) furnishing of the information solicited is voluntary; and (3) the principal purpose for which the information is used by the U.S. Patent and Trademark Office is to process and/or examine your submission related to a patent application or patent. If you do not furnish the requested information, the U.S. Patent and Trademark Office may not be able to process and/or examine your submission, which may result in termination of proceedings or abandonment of the application or expiration of the patent.

The information provided by you in this form will be subject to the following routine uses:

1. The information on this form will be treated confidentially to the extent allowed under the Freedom of Information Act (5 U.S.C. 552) and the Privacy Act (5 U.S.C. 552a). Records from this system of records may be disclosed to the Department of Justice to determine whether the Freedom of Information Act requires disclosure of these records.
2. A record from this system of records may be disclosed, as a routine use, in the course of presenting evidence to a court, magistrate, or administrative tribunal, including disclosures to opposing counsel in the course of settlement negotiations.
3. A record in this system of records may be disclosed, as a routine use, to a Member of Congress submitting a request involving an individual, to whom the record pertains, when the individual has requested assistance from the Member with respect to the subject matter of the record.
4. A record in this system of records may be disclosed, as a routine use, to a contractor of the Agency having need for the information in order to perform a contract. Recipients of information shall be required to comply with the requirements of the Privacy Act of 1974, as amended, pursuant to 5 U.S.C. 552a(m).
5. A record related to an International Application filed under the Patent Cooperation Treaty in this system of records may be disclosed, as a routine use, to the International Bureau of the World Intellectual Property Organization, pursuant to the Patent Cooperation Treaty.
6. A record in this system of records may be disclosed, as a routine use, to another federal agency for purposes of National Security review (35 U.S.C. 181) and for review pursuant to the Atomic Energy Act (42 U.S.C. 218(c)).
7. A record from this system of records may be disclosed, as a routine use, to the Administrator, General Services, or his/her designee, during an inspection of records conducted by GSA as part of that agency's responsibility to recommend improvements in records management practices and programs, under authority of 44 U.S.C. 2904 and 2906. Such disclosure shall be made in accordance with the GSA regulations governing inspection of records for this purpose, and any other relevant (i.e., GSA or Commerce) directive. Such disclosure shall not be used to make determinations about individuals.
8. A record from this system of records may be disclosed, as a routine use, to the public after either publication of the application pursuant to 35 U.S.C. 122(b) or issuance of a patent pursuant to 35 U.S.C. 151. Further, a record may be disclosed, subject to the limitations of 37 CFR 1.14, as a routine use, to the public if the record was filed in an application which became abandoned or in which the proceedings were terminated and which application is referenced by either a published application, an application open to public inspections or an issued patent.
9. A record from this system of records may be disclosed, as a routine use, to a Federal, State, or local law enforcement agency, if the USPTO becomes aware of a violation or potential violation of law or regulation.

Electronic Acknowledgement Receipt

EFS ID:	3025628
Application Number:	11733064
International Application Number:	
Confirmation Number:	7527
Title of Invention:	MULTI-ADAPTIVE PROCESSING SYSTEMS AND TECHNIQUES FOR ENHANCING PARALLELISM AND PERFORMANCE OF COMPUTATIONAL FUNCTIONS
First Named Inventor/Applicant Name:	Jon M. Huppenthal
Customer Number:	25235
Filer:	William J. Kubida/Julie Lange
Filer Authorized By:	William J. Kubida
Attorney Docket Number:	SRC015 CON
Receipt Date:	19-MAR-2008
Filing Date:	09-APR-2007
Time Stamp:	18:41:53
Application Type:	Utility under 35 USC 111(a)

Payment information:

Submitted with Payment	no
------------------------	----

File Listing:

Document Number	Document Description	File Name	File Size(Bytes) /Message Digest	Multi Part /.zip	Pages (if appl.)
1	Foreign Reference	DOC096.PDF	133819 <small>34a5f972325e1b3b52830326361a61b4562e42da</small>	no	7

Warnings:

Information:

2	Information Disclosure Statement (IDS) Filed	SRC015CONIDSform.pdf	573642	no	4
			a27be57325830cb005b243a5f381eae8c90bf449		

Warnings:

Information:

A U.S. Patent Number Citation or a U.S. Publication Number Citation is required in the Information Disclosure Statement (IDS) form for autoloading of data into USPTO systems. You may remove the form to add the required data in order to correct the Informational Message if you are citing U.S. References. If you chose not to include U.S. References, the image of the form will be processed and be made available within the Image File Wrapper (IFW) system. However, no data will be extracted from this form. Any additional data such as Foreign Patent Documents or Non Patent Literature will be manually reviewed and keyed into USPTO systems.

Total Files Size (in bytes):	707461
-------------------------------------	--------

This Acknowledgement Receipt evidences receipt on the noted date by the USPTO of the indicated documents, characterized by the applicant, and including page counts, where applicable. It serves as evidence of receipt similar to a Post Card, as described in MPEP 503.

New Applications Under 35 U.S.C. 111

If a new application is being filed and the application includes the necessary components for a filing date (see 37 CFR 1.53(b)-(d) and MPEP 506), a Filing Receipt (37 CFR 1.54) will be issued in due course and the date shown on this Acknowledgement Receipt will establish the filing date of the application.

National Stage of an International Application under 35 U.S.C. 371

If a timely submission to enter the national stage of an international application is compliant with the conditions of 35 U.S.C. 371 and other applicable requirements a Form PCT/DO/EO/903 indicating acceptance of the application as a national stage submission under 35 U.S.C. 371 will be issued in addition to the Filing Receipt, in due course.

New International Application Filed with the USPTO as a Receiving Office

If a new international application is being filed and the international application includes the necessary components for an international filing date (see PCT Article 11 and MPEP 1810), a Notification of the International Application Number and of the International Filing Date (Form PCT/RO/105) will be issued in due course, subject to prescriptions concerning national security, and the date shown on this Acknowledgement Receipt will establish the international filing date of the application.

Mailed January 8, 2008

NOTICE OF GROUNDS OF REJECTION

Patent Application No.	539441/2000
Drafting Date	December 26, 2007
Patent Office Examiner	Masanori KUBO (9642 5B00)
Attorney	Mr. Hisao Fukami (et al.)
Applied Provision	Paragraph 2 of Article 29, Article 36

The present application is recognized as rejected on the following ground. It is required that any remarks be submitted within three months from the date on which the present NOTICE was mailed.

GROUND(S)

1. It is recognized that, because the invention described in Claim(s) of SCOPE OF CLAIMS FOR PATENT of the present application could have been invented readily by a person having ordinary knowledge in the field of the art to which the present invention pertains prior to the filing of the present application based on the invention as described in the following publication(s) distributed or the invention as made available to the public through electric telecommunication lines in Japan and/or foreign countries prior to the filing of the present application, a patent cannot be granted thereto under the provision of Paragraph 2 of Article 29 of the Patent Law.
2. It is recognized that the present application does not satisfy the conditions prescribed in Paragraph 6 (ii) of Article 36 of the Patent Law because of the defectiveness of the description in SCOPE OF CLAIMS FOR PATENT on the following point.

REMARKS (See the list of the cited references.)

With regard to Ground 1

- Claims 1-81
- Cited References 1-2
- Note

Cited references 1 and 2 each describe that the processing instruction is given from a main control unit to a plurality of processors through a memory. Cited reference 1 also describes that the processing result is transferred to a different processor. There is no particular difficulty in constructing each processor with a well-known reconfigurable circuit and providing a plurality of main control units.

With regard to Ground 2

The description of the "improvement" in claims 1 to 7 is unclear since it cannot be specified whether it is the "product invention" or the "method invention".

Therefore, the invention according to claims 1 to 7 is unclear.

If any grounds of rejection are newly found, the grounds of rejection will be noticed.

LIST OF CITED REFERENCES

- (1) Japanese Patent Laying-Open No. 63-086079
- (2) Japanese Patent Laying-Open No. 59-206972

Record of Search for Prior Art Documents

* Searched Technical Field IPC G06F15/80
 G06F15/16-15/177

* Prior Art Documents

Japanese Patent Laying-Open No. 11-015773

This record of search for prior art documents does not form any grounds of rejection.

PATENT ABSTRACTS OF JAPAN

(11)Publication number : 59-206972
 (43)Date of publication of application : 22.11.1984

(51)Int.Cl. G06F 15/16

(21)Application number : 58-081318 (71)Applicant : TOSHIBA CORP
 (22)Date of filing : 10.05.1983 (72)Inventor : FUJII MAKOTO

(54) SHARED MEMORY

(57)Abstract:

PURPOSE: To eliminate interruption of processors at the time of data transfer between processors by providing plural write-only memories in the input port of a public memory and plural read-only memories in the output port.

CONSTITUTION: Write-only memories 51, 52 that write data from a processor 10 are provided in the input port of a shared memory 100, and read-only memories 61, 62 that read data to processors 21W2N are provided in output ports. Gates 81, 82 that determine transfer mode of data are provided in an A port 100A and a B port 100B. The gate 81 is connected to a change-over signal generating circuit 86, and the gate 82 is connected to a mode changing signal generating circuit 86 through a controlling line 84 and an inverter 85 for inverting signals. By this way, transfer mode of the A port 100A and B port 100B become reverse.

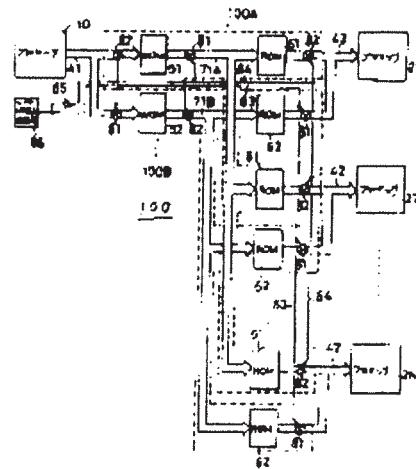

LEGAL STATUS

- [Date of request for examination]
- [Date of sending the examiner's decision of rejection]
- [Kind of final disposal of application other than the examiner's decision of rejection or application converted registration]
- [Date of final disposal for application]
- [Patent number]
- [Date of registration]
- [Number of appeal against examiner's decision of rejection]
- [Date of requesting appeal against examiner's

decision of rejection]

[Date of extinction of right]

PATENT ABSTRACTS OF JAPAN

(11)Publication number : 63-086079
 (43)Date of publication of application : 16.04.1988

(51)Int.Cl. G06F 15/60
 G06F 15/16
 G06F 15/347

(21)Application number : 61-232436 (71)Applicant : NIPPON TELEGR & TELEPH CORP
 <NTT>
 (22)Date of filing : 30.09.1986 (72)Inventor : TAMAMURA YOSHIAKI
 MITSUYA EIJI
 AKIMOTO TAKAAKI

(54) THREE-DIMENSIONAL SHADOW IMAGE FORMING PROCESSING DEVICE

(57)Abstract:

PURPOSE: To attain a highly speedy three-dimensional shadow image forming processing by executing a three-dimensional vector operation and a matrix operation with 3W4 floating point arithmetic units in parallel and in a pipeline way.

CONSTITUTION: Object shape data and a processing parameter used for image forming processing are stored into data memories DBM#1W#4. By floating point arithmetic units FPU#1W#3 and an arithmetic unit FAPU to combine a floating point computing element and an arithmetic and logic computing element in parallel, the three-dimensional vector operation and the matrix operation are executed in parallel and in a pipeline way. The prepared image data are written through a data collector DC to a display memory.

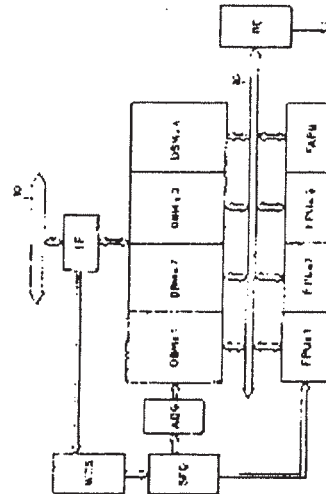

LEGAL STATUS

- [Date of request for examination]
- [Date of sending the examiner's decision of rejection]
- [Kind of final disposal of application other than the examiner's decision of rejection or application converted registration]
- [Date of final disposal for application]
- [Patent number]

[Date of registration]

[Number of appeal against examiner's decision of rejection]

[Date of requesting appeal against examiner's decision of rejection]

[Date of extinction of right]



UNITED STATES PATENT AND TRADEMARK OFFICE

UNITED STATES DEPARTMENT OF COMMERCE
United States Patent and Trademark Office
Address: COMMISSIONER FOR PATENTS
P.O. Box 1450
Alexandria, Virginia 22313-1450
www.uspto.gov

Table with columns: APPLICATION NO., FILING DATE, FIRST NAMED INVENTOR, ATTORNEY DOCKET NO., CONFIRMATION NO., EXAMINER, ART UNIT, PAPER NUMBER, MAIL DATE, DELIVERY MODE. Includes application details for 11/733,064 and examiner information for Eric Coleman.

Please find below and/or attached an Office communication concerning this application or proceeding.

The time period for reply, if any, is set in the attached communication.

Office Action Summary	Application No. 11/733,064	Applicant(s) HUPPENTHAL ET AL.	
	Examiner Eric Coleman	Art Unit 2183	

-- The MAILING DATE of this communication appears on the cover sheet with the correspondence address --

Period for Reply

A SHORTENED STATUTORY PERIOD FOR REPLY IS SET TO EXPIRE 3 MONTH(S) OR THIRTY (30) DAYS, WHICHEVER IS LONGER, FROM THE MAILING DATE OF THIS COMMUNICATION.

- Extensions of time may be available under the provisions of 37 CFR 1.136(a). In no event, however, may a reply be timely filed after SIX (6) MONTHS from the mailing date of this communication.
- If NO period for reply is specified above, the maximum statutory period will apply and will expire SIX (6) MONTHS from the mailing date of this communication.
- Failure to reply within the set or extended period for reply will, by statute, cause the application to become ABANDONED (35 U.S.C. § 133). Any reply received by the Office later than three months after the mailing date of this communication, even if timely filed, may reduce any earned patent term adjustment. See 37 CFR 1.704(b).

Status

- 1) Responsive to communication(s) filed on ____.
- 2a) This action is **FINAL**. 2b) This action is non-final.
- 3) Since this application is in condition for allowance except for formal matters, prosecution as to the merits is closed in accordance with the practice under *Ex parte Quayle*, 1935 C.D. 11, 453 O.G. 213.

Disposition of Claims

- 4) Claim(s) 1-52 is/are pending in the application.
4a) Of the above claim(s) ____ is/are withdrawn from consideration.
- 5) Claim(s) ____ is/are allowed.
- 6) Claim(s) 1-52 is/are rejected.
- 7) Claim(s) ____ is/are objected to.
- 8) Claim(s) ____ are subject to restriction and/or election requirement.

Application Papers

- 9) The specification is objected to by the Examiner.
- 10) The drawing(s) filed on ____ is/are: a) accepted or b) objected to by the Examiner.
Applicant may not request that any objection to the drawing(s) be held in abeyance. See 37 CFR 1.85(a).
Replacement drawing sheet(s) including the correction is required if the drawing(s) is objected to. See 37 CFR 1.121(d).
- 11) The oath or declaration is objected to by the Examiner. Note the attached Office Action or form PTO-152.

Priority under 35 U.S.C. § 119

- 12) Acknowledgment is made of a claim for foreign priority under 35 U.S.C. § 119(a)-(d) or (f).
a) All b) Some * c) None of:
1. Certified copies of the priority documents have been received.
2. Certified copies of the priority documents have been received in Application No. ____.
3. Copies of the certified copies of the priority documents have been received in this National Stage application from the International Bureau (PCT Rule 17.2(a)).

* See the attached detailed Office action for a list of the certified copies not received.

Attachment(s)

- | | |
|--|---|
| 1) <input checked="" type="checkbox"/> Notice of References Cited (PTO-892) | 4) <input type="checkbox"/> Interview Summary (PTO-413)
Paper No(s)/Mail Date. ____. |
| 2) <input type="checkbox"/> Notice of Draftsperson's Patent Drawing Review (PTO-948) | 5) <input type="checkbox"/> Notice of Informal Patent Application |
| 3) <input checked="" type="checkbox"/> Information Disclosure Statement(s) (PTO/SB/08)
Paper No(s)/Mail Date <u>4/9/07, 3/19/08</u> . | 6) <input type="checkbox"/> Other: ____. |

DETAILED ACTION

Claim Rejections - 35 USC § 112

The following is a quotation of the second paragraph of 35 U.S.C. 112:

The specification shall conclude with one or more claims particularly pointing out and distinctly claiming the subject matter which the applicant regards as his invention.

Claim 30 is rejected under 35 U.S.C. 112, second paragraph, as being indefinite for failing to particularly point out and distinctly claim the subject matter which applicant regards as the invention. Claim 20 recites the limitation "said first systolic wall" in line 3. There is insufficient antecedent basis for this limitation in the claim.

Double Patenting

The nonstatutory double patenting rejection is based on a judicially created doctrine grounded in public policy (a policy reflected in the statute) so as to prevent the unjustified or improper timewise extension of the "right to exclude" granted by a patent and to prevent possible harassment by multiple assignees. A nonstatutory obviousness-type double patenting rejection is appropriate where the conflicting claims are not identical, but at least one examined application claim is not patentably distinct from the reference claim(s) because the examined application claim is either anticipated by, or would have been obvious over, the reference claim(s). See, e.g., *In re Berg*, 140 F.3d 1428, 46 USPQ2d 1226 (Fed. Cir. 1998); *In re Goodman*, 11 F.3d 1046, 29 USPQ2d 2010 (Fed. Cir. 1993); *In re Longi*, 759 F.2d 887, 225 USPQ 645 (Fed. Cir. 1985); *In re Van Ornum*, 686 F.2d 937, 214 USPQ 761 (CCPA 1982); *In re Vogel*, 422 F.2d 438, 164 USPQ 619 (CCPA 1970); and *In re Thorington*, 418 F.2d 528, 163 USPQ 644 (CCPA 1969).

A timely filed terminal disclaimer in compliance with 37 CFR 1.321(c) or 1.321(d) may be used to overcome an actual or provisional rejection based on a nonstatutory double patenting ground provided the conflicting application or patent either is shown to be commonly owned with this application, or claims an invention made as a result of activities undertaken within the scope of a joint research agreement.

Effective January 1, 1994, a registered attorney or agent of record may sign a terminal disclaimer. A terminal disclaimer signed by the assignee must fully comply with 37 CFR 3.73(b).

Claims 1-52 are rejected on the ground of nonstatutory obviousness-type double patenting as being unpatentable over claims 1-52 of U.S. Patent No. 7,225,324 in view of Gaudiot IEEE article entitled Data Driven Multicomputers in Digital Signal processing. The side by showing of the corresponding independent claims 1,25,51 show that the corresponding independent claims are substantially similar.

Instant application	Patent No. 7,225, 324
<p>1. A method for data processing in a reconfigurable computing system, the reconfigurable computing system comprising at least one reconfigurable processor, the reconfigurable processor comprising a plurality of functional units, said method comprising: transforming an algorithm into a data driven calculation that is implemented by said reconfigurable computing system at the at least one reconfigurable processor; forming at least two of said functional units at the at least one reconfigurable processor to perform said calculation wherein only functional units needed to solve the calculation are formed and wherein each formed functional unit at the at least one reconfigurable processor interconnects with each other formed functional unit at the at least one reconfigurable processor based</p>	<p>1. A method for data processing in a reconfigurable computing system, the reconfigurable computing system comprising at least one reconfigurable processor, the reconfigurable processor comprising a plurality of functional units, said method comprising: transforming an algorithm into a calculation that is systolically implemented by said reconfigurable computing system at the at least one reconfigurable processor; instantiating at least two of said functional units at the at least one reconfigurable processor to perform said calculation wherein only functional units needed to solve the calculation are instantiated and wherein each instantiated functional unit at the at least one reconfigurable processor interconnects with each other instantiated functional unit at the at least one reconfigurable processor based</p>

Art Unit: 2183

<p>on reconfigurable routing resources within the at least one reconfigurable processor as established at formation, and wherein lines of code of said calculation are formed as clusters of functional units within the at least one reconfigurable processor; utilizing a first of said instantiated functional units to operate upon a subsequent data dimension of said calculation forming a first computational loop; and substantially concurrently utilizing a second of said formed functional units to operate upon a previous data dimension of said calculation generating a second computational loop wherein said implementation of said calculation enables said first computational loop and said second computational loop execute concurrently and pass computed data seamlessly between said computational loops.</p>	<p>on reconfigurable routing resources within the at least one reconfigurable processor as established at instantiation, and wherein systolically linked lines of code of said calculation are instantiated as clusters of functional units within the at least one reconfigurable processor; utilizing a first of said instantiated functional units to operate upon a subsequent data dimension of said calculation forming a first computational loop; and substantially concurrently utilizing a second of said instantiated functional units to operate upon a previous data dimension of said calculation forming a second computational loop wherein said systolic implementation of said calculation enables said first computational loop and said second computational loop execute concurrently and pass computed data seamlessly between said computational loops.</p>
<p>25. A method for data processing in a reconfigurable computing system, the reconfigurable computing system comprising at least one</p>	<p>25. A method for data processing in a reconfigurable computing system, the reconfigurable computing system comprising at least one</p>

Art Unit: 2183

<p>reconfigurable processor comprising a plurality of functional units, said method comprising: transforming an algorithm into a data driven calculation that is implemented by said reconfigurable computing system at the at least one reconfigurable processor wherein linked lines of code of said calculation are fashioned as walls of functional units within the at least one reconfigurable processor; defining a first wall comprising rows of cells forming a subset of said plurality of functional units; computing at the at least one reconfigurable processor a value at each of said cells in at least a first row of said first substantially concurrently; communicating said values between cells in said first row of said cells to produce updated values, wherein communicating said values is based on reconfigurable routing resources within the at least one reconfigurable processor; communicating said updated values substantially concurrently to a second row of said first wall, wherein communicating said updated values is based on reconfigurable routing</p>	<p>reconfigurable processor comprising a plurality of functional units, said method comprising: transforming an algorithm into a calculation that is systolically implemented by said reconfigurable computing system at the at least one reconfigurable processor wherein systolically linked lines of code of said calculation are instantiated as walls of functional units within the at least one reconfigurable processor; defining a first systolic wall comprising rows of cells forming a subset of said plurality of functional units; computing at the at least one reconfigurable processor a value at each of said cells in at least a first row of said first systolic wall substantially concurrently; communicating said values between cells in said first row of said cells to produce updated values, wherein communicating said values is based on reconfigurable routing resources within the at least one reconfigurable processor; communicating said updated values substantially concurrently to a second row of said first systolic wall, wherein communicating said updated values is based on reconfigurable routing</p>
---	---

Art Unit: 2183

<p>resources within the at least one reconfigurable processor; and communicating said updated values substantially concurrently to a first row of a second wall of rows of cells in said subset of said plurality of functional units, wherein communicating said updated values is based on reconfigurable routing resources within the at least one reconfigurable processor and wherein said first wall of rows of cells and said second wall of rows of cells execute substantially concurrently and pass computed data seamlessly between said walls.</p>	<p>resources within the at least one reconfigurable processor; and communicating said updated values substantially concurrently to a first row of a second systolic wall of rows of cells in said subset of said plurality of functional units, wherein communicating said updated values is based on reconfigurable routing resources within the at least one reconfigurable processor and wherein said first systolic wall of rows of cells and said second wall of rows of systolic cells execute substantially concurrently and pass computed data seamlessly between said systolic walls.</p>
<p>51. A method for data processing in a reconfigurable computing system, the reconfigurable computer system comprising at least one reconfigurable processor comprising a plurality of functional units, said method comprising: transforming an algorithm into a calculation that is implemented by said reconfigurable computing system at the at least one reconfigurable processor and driven by data propagation wherein lines of code of said calculation are</p>	<p>51. A method for data processing in a reconfigurable computing system, the reconfigurable computer system comprising at least one reconfigurable processor comprising a plurality of functional units, said method comprising: transforming an algorithm into a calculation that is systolically implemented by said reconfigurable computing system at the at least one reconfigurable processor wherein systolically linked lines of code of said calculation are</p>

Art Unit: 2183

<p>linked based on said data propagation and fashioned as subsets of said plurality of functional units within the at least one reconfigurable processor forming columns of said calculation; performing said calculation at the at least one reconfigurable processor by said subsets of said plurality of functional units to produce computed data; exchanging said computed data between a first column of said calculation and a next column in said calculation, wherein said exchanging is based on reconfigurable routing resources within the at least one reconfigurable processor and wherein execution of said subsets of said plurality of function units occurs concurrently and said computed data is seamlessly passed between said first column of said calculation and said second column of said calculation; evaluating a rate of change in at least one variable for each of said columns in said calculation; continuing said calculation when said variable does not change for a particular column of said calculation; and restarting said calculation at said column of said calculation where said variable does change.</p>	<p>instantiated as subsets of said plurality of functional units within the at least one reconfigurable processor forming columns of said calculation; performing said calculation at the at least one reconfigurable processor by said subsets of said plurality of functional units to produce computed data; exchanging said computed data between a first column of said calculation and a next column in said calculation, wherein said exchanging is based on reconfigurable routing resources within the at least one reconfigurable processor and wherein execution of said subsets of said plurality of function units occurs concurrently and said computed data is seamlessly passed between said first column of said calculation and said second column of said calculation; evaluating a rate of change in at least one variable for each of said columns in said calculation; continuing said calculation when said variable does not change for a particular column of said calculation; and restarting said calculation at said column of said calculation where said variable does change.</p>
--	---

--	--

The claims in the 7,722,324 patent did not expressly detail that the method included *data driven* calculation or propagation of data. However Gaudiot taught that data driven processing and calculations includes systolic processing (e.g., see page 1224 (section IV) and page 1230 (section H)). Therefore since patent 7,722,324 claims systolic calculation and propagation and linking of data and the instant application claims data driven calculation and data propagation it would have been obvious to one of ordinary skill in the DP system that the claimed calculation and data propagation are of the same type. Gaudiot taught that the use of one of the several types of data driven processing or calculation would have been more advantageous depending on the features of the calculation however each is considered data driven (e.g., see page 1230 (section H)). The patent 722,324 used forms of the word “instantiate” versus forms of the words “form” or “fashioned” in the instant claims . The claimed instantiating or representing by a concrete instance is not different from the claimed forming because the fashioning or forming (claimed in the instant application) is done by representing data or functional unit by concrete references to data or functional units or other system elements. Claims 2-24, 25-50 and 52 provide the same corresponding limitations in the Patent 7,224,324 and the instant application and therefore are also rejected. It would have been obvious to one of ordinary skill in the DP art to combine the claims of patent No. 7,722,324 and Gaudiot. Both references were directed toward processing data parallel processing of data in a DP system. The addition of the Gaudiot teaching

Art Unit: 2183

would have provided ways for optimizing the processing of calculations depending on the attributes of the calculation that was performed by systolic means considering that the systolic processing is a subset of data driven processing. Also the addition of the Gaudiot teachings would have yielded predictable results.

Conclusion

The prior art made of record and not relied upon is considered pertinent to applicant's disclosure.

Dennis, J.B. (IEEE Computer chapter on DataFlow Supercomputers).

Quinn, M et al., (IEEE article entitled Data-Parallel Programming on Multicomputers).

Treleaven, P.C et al., Computing Surveys article entitled Data-Driven and Demand-Driven Computer Architecture.

Webster's Ninth New Collegiate Dictionary, (definition of instantiate), p. 627.

Any inquiry concerning this communication or earlier communications from the examiner should be directed to Eric Coleman whose telephone number is (571) 272-4163. The examiner can normally be reached on Monday-Thursday.

If attempts to reach the examiner by telephone are unsuccessful, the examiner's supervisor, Eddie Chan can be reached on (571) 272-4162. The fax phone number for the organization where this application or proceeding is assigned is 571-273-8300.

Art Unit: 2183

Information regarding the status of an application may be obtained from the Patent Application Information Retrieval (PAIR) system. Status information for published applications may be obtained from either Private PAIR or Public PAIR. Status information for unpublished applications is available through Private PAIR only. For more information about the PAIR system, see <http://pair-direct.uspto.gov>. Should you have questions on access to the Private PAIR system, contact the Electronic Business Center (EBC) at 866-217-9197 (toll-free). If you would like assistance from a USPTO Customer Service Representative or access to the automated information system, call 800-786-9199 (IN USA OR CANADA) or 571-272-1000.

EC
/Eric Coleman/
Primary Examiner, Art Unit 2183

Notice of References Cited	Application/Control No. 11/733,064	Applicant(s)/Patent Under Reexamination HUPPENTHAL ET AL.	
	Examiner Eric Coleman	Art Unit 2183	Page 1 of 2

U.S. PATENT DOCUMENTS

*	Document Number Country Code-Number-Kind Code	Date MM-YYYY	Name	Classification
	A	US-		
	B	US-		
	C	US-		
	D	US-		
	E	US-		
	F	US-		
	G	US-		
	H	US-		
	I	US-		
	J	US-		
	K	US-		
	L	US-		
	M	US-		

FOREIGN PATENT DOCUMENTS

*	Document Number Country Code-Number-Kind Code	Date MM-YYYY	Country	Name	Classification
	N				
	O				
	P				
	Q				
	R				
	S				
	T				

NON-PATENT DOCUMENTS

*	Include as applicable: Author, Title Date, Publisher, Edition or Volume, Pertinent Pages)
U	Gaudiot, Jean-Luc, Data-Driven Multicomputers in Digital Signal Processing, 1987, IEEE, Proceedings of the IEEE, vol. 75, No. 9, pp. 1220-1234.
V	Dennis, J. B., Data Flow Supercomputers, November 1980, IEEE, Computer, pp. 48-56.
W	Qunnn M.J., et al., Data-Parallel Programming on Multicomputers, Sept. 1990, IEEE, pp 69-76.
X	Trevleaven, P.C., et al., Data-Driven and Demand-Driven Computer Architecture, 1982, ACM, Computing Surveys Vol. 14, No. 1, pp. 93-143.

*A copy of this reference is not being furnished with this Office action. (See MPEP § 707.05(a).)
Dates in MM-YYYY format are publication dates. Classifications may be US or foreign.

Notice of References Cited	Application/Control No. 11/733,064	Applicant(s)/Patent Under Reexamination HUPPENTHAL ET AL.	
	Examiner Eric Coleman	Art Unit 2183	Page 2 of 2

U.S. PATENT DOCUMENTS

*	Document Number Country Code-Number-Kind Code	Date MM-YYYY	Name	Classification
	A US-			
	B US-			
	C US-			
	D US-			
	E US-			
	F US-			
	G US-			
	H US-			
	I US-			
	J US-			
	K US-			
	L US-			
	M US-			

FOREIGN PATENT DOCUMENTS

*	Document Number Country Code-Number-Kind Code	Date MM-YYYY	Country	Name	Classification
	N				
	O				
	P				
	Q				
	R				
	S				
	T				

NON-PATENT DOCUMENTS

*	Include as applicable: Author, Title Date, Publisher, Edition or Volume, Pertinent Pages)
U	Webster. M., Webster's Ninth New Collegiate Dictionary, 1985, Merriam-Webster pub., p. 627.
V	
W	
X	

*A copy of this reference is not being furnished with this Office action. (See MPEP § 707.05(a).)
Dates in MM-YYYY format are publication dates. Classifications may be US or foreign.

EAST Search History

Ref #	Hits	Search Query	DBs	Default Operator	Plurals	Time Stamp
L1	68701	data adj (driven or flow)	US-PGPUB; USPAT	OR	OFF	2009/01/08 17:24
L2	16456	systolic	US-PGPUB; USPAT	OR	OFF	2009/01/08 17:24
L3	84354	1 or 2	US-PGPUB; USPAT	OR	OFF	2009/01/08 17:24
L4	76322	process\$3 adj element\$1 or (function\$2 adj unit \$1)	US-PGPUB; USPAT	OR	OFF	2009/01/08 17:25
L5	30708	multiple or plural\$3 near3 dimens\$5	US-PGPUB; USPAT	OR	OFF	2009/01/08 17:26
L6	43135	(multiple or plural \$3) near3 dimens \$5	US-PGPUB; USPAT	OR	OFF	2009/01/08 17:26
L7	1465	4 and 6	US-PGPUB; USPAT	OR	OFF	2009/01/08 17:26
L8	1410	(concurrent\$3 or simultaneous\$1) near3 loop\$3	US-PGPUB; USPAT	OR	OFF	2009/01/08 17:27
L9	4	7 and 8	US-PGPUB; USPAT	OR	OFF	2009/01/08 17:27
L10	3	1 and 9	US-PGPUB; USPAT	OR	OFF	2009/01/08 17:27
L11	559	712/226.ccls.	US-PGPUB; USPAT	OR	OFF	2009/01/08 17:28
L12	267	712/15.ccls.	US-PGPUB; USPAT	OR	OFF	2009/01/08 17:28
L13	56	712/19.ccls.	US-PGPUB; USPAT	OR	OFF	2009/01/08 17:28

L15	580	712/215.ccls.	US- PGPUB; USPAT	OR	OFF	2009/01/08 17:28
L16	1435	11 or 12 or 13 or 15	US- PGPUB; USPAT	OR	OFF	2009/01/08 17:29
L17	289	1 and 16	US- PGPUB; USPAT	OR	OFF	2009/01/08 17:29
L18	3	8 and 17	US- PGPUB; USPAT	OR	OFF	2009/01/08 17:29

1/8/2009 5:31:11 PM

C:\Documents and Settings\EColeman\My Documents\EAST\Workspaces
\xredspace.wsp

<i>Index of Claims</i> 	Application/Control No. 11733064	Applicant(s)/Patent Under Reexamination HUPPENTHAL ET AL.
	Examiner Eric Coleman	Art Unit 2183

✓	Rejected
=	Allowed

-	Cancelled
÷	Restricted

N	Non-Elected
I	Interference

A	Appeal
O	Objected

Claims renumbered in the same order as presented by applicant
 CPA
 T.D.
 R.1.47

CLAIM		DATE							
Final	Original	01/08/2009							
	1	✓							
	2	✓							
	3	✓							
	4	✓							
	5	✓							
	6	✓							
	7	✓							
	8	✓							
	9	✓							
	10	✓							
	11	✓							
	12	✓							
	13	✓							
	14	✓							
	15	✓							
	16	✓							
	17	✓							
	18	✓							
	19	✓							
	20	✓							
	21	✓							
	22	✓							
	23	✓							
	24	✓							
	25	✓							
	26	✓							
	27	✓							
	28	✓							
	29	✓							
	30	✓							
	31	✓							
	32	✓							
	33	✓							
	34	✓							
	35	✓							
	36	✓							

<i>Index of Claims</i> 	Application/Control No. 11733064	Applicant(s)/Patent Under Reexamination HUPPENTHAL ET AL.
	Examiner Eric Coleman	Art Unit 2183

✓	Rejected
=	Allowed

-	Cancelled
÷	Restricted

N	Non-Elected
I	Interference

A	Appeal
O	Objected

Claims renumbered in the same order as presented by applicant
 CPA
 T.D.
 R.1.47

CLAIM		DATE							
Final	Original	01/08/2009							
	37	✓							
	38	✓							
	39	✓							
	40	✓							
	41	✓							
	42	✓							
	43	✓							
	44	✓							
	45	✓							
	46	✓							
	47	✓							
	48	✓							
	49	✓							
	50	✓							
	51	✓							
	52	✓							

INFORMATION DISCLOSURE STATEMENT BY APPLICANT (Not for submission under 37 CFR 1.99)	Application Number		11733064	
	Filing Date		2007-04-09	
	First Named Inventor	Jon M. Huppenthal et al.		
	Art Unit		2183	
	Examiner Name	Not Yet Assigned		
	Attorney Docket Number		SRC015CON	

U.S. PATENTS							Remove
Examiner Initial*	Cite No	Patent Number	Kind Code ¹	Issue Date	Name of Patentee or Applicant of cited Document	Pages, Columns, Lines where Relevant Passages or Relevant Figures Appear	
	1						

If you wish to add additional U.S. Patent citation information please click the Add button.

Add

U.S. PATENT APPLICATION PUBLICATIONS							Remove
Examiner Initial*	Cite No	Publication Number	Kind Code ¹	Publication Date	Name of Patentee or Applicant of cited Document	Pages, Columns, Lines where Relevant Passages or Relevant Figures Appear	
	1						

If you wish to add additional U.S. Published Application citation information please click the Add button.

Add

FOREIGN PATENT DOCUMENTS								Remove
Examiner Initial*	Cite No	Foreign Document Number ³	Country Code ² j	Kind Code ⁴	Publication Date	Name of Patentee or Applicant of cited Document	Pages, Columns, Lines where Relevant Passages or Relevant Figures Appear	T ⁵
/E.C./	1	63-086079			1988-04-16	Nippon Telegr & Teleph Corp.		<input type="checkbox"/>
/E.C./	2	59-206972			1984-11-22	Toshiba Corp.		<input type="checkbox"/>

If you wish to add additional Foreign Patent Document citation information please click the Add button

Add

NON-PATENT LITERATURE DOCUMENTS							Remove
---------------------------------	--	--	--	--	--	--	--------

INFORMATION DISCLOSURE STATEMENT BY APPLICANT (Not for submission under 37 CFR 1.99)	Application Number		11733064
	Filing Date		2007-04-09
	First Named Inventor	Jon M. Huppenthal et al.	
	Art Unit		2183
	Examiner Name	Not Yet Assigned	
	Attorney Docket Number		SRC015CON

Examiner Initials*	Cite No	Include name of the author (in CAPITAL LETTERS), title of the article (when appropriate), title of the item (book, magazine, journal, serial, symposium, catalog, etc), date, pages(s), volume-issue number(s), publisher, city and/or country where published.	T ⁵
	1		<input type="checkbox"/>

If you wish to add additional non-patent literature document citation information please click the Add button

EXAMINER SIGNATURE

Examiner Signature	/Eric Coleman/	Date Considered	01/08/2009
--------------------	----------------	-----------------	------------

*EXAMINER: Initial if reference considered, whether or not citation is in conformance with MPEP 609. Draw line through a citation if not in conformance and not considered. Include copy of this form with next communication to applicant.

¹ See Kind Codes of USPTO Patent Documents at www.USPTO.GOV or MPEP 901.04. ² Enter office that issued the document, by the two-letter code (WIPO Standard ST.3). ³ For Japanese patent documents, the indication of the year of the reign of the Emperor must precede the serial number of the patent document. ⁴ Kind of document by the appropriate symbols as indicated on the document under WIPO Standard ST.16 if possible. ⁵ Applicant is to place a check mark here if English language translation is attached.

IN THE UNITED STATES PATENT AND TRADEMARK OFFICE

Serial No. ----- Application of: Jon M. Huppenthal and David E. Caliga Filed: Herewith Attorney Docket No. SRC015 CON For: MULTI-ADAPTIVE PROCESSING SYSTEMS AND TECHNIQUES FOR ENHANCING PARALLELISM AND PERFORMANCE OF COMPUTATIONAL FUNCTIONS	Art Unit: Confirmation No.: Examiner: Customer No.: 25235
---	---

INFORMATION DISCLOSURE STATEMENT
UNDER 37 C.F.R. § 1.97

Commissioner for Patents
P.O. Box 1450
Alexandria, VA 22313-1450

Sir:

Pursuant to 37 C.F.R. § 1.97, the Examiner may wish to consider the references listed on the attached Form PTO/SB/08A. In submitting these references, no representation is made or implied that the references are or are not material to the examination of this application. Pursuant to 37 C.F.R. 1.98(d), copies of the references are not enclosed, as each reference was either provided or cited in U.S. Patent Application Serial No. 10/285,318, which is related to U.S. Patent Application Serial No. 09/755,744, which is related to U.S. Patent Application Serial No. 09/888,276, now U.S. Patent No. 6,434,687, from which priority under 35 U.S.C. 120 was claimed.

This Information Disclosure Statement is filed before mailing of a first Office Action in the above case. Accordingly, no fee is believed due. However, any fee associated herewith may be charged to Deposit Account No. 50-1123.

Respectfully submitted,

9 April 2009
Date

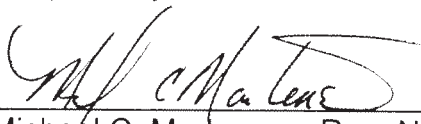
Michael C. Martensen, Reg. No. 46901
HOGAN & HARTSON LLP
One Tabor Center
1200 17th Street, Suite 1500
Denver, Colorado 80202
(719) 448-5910 Tel
(303) 899-7333 Fax

Under the Paperwork Reduction Act of 1995, no persons are required to respond to a collection of information unless it displays a valid OMB control number.

Substitute for form 1449A/PTO INFORMATION DISCLOSURE STATEMENT BY APPLICANT <i>(Use as many sheets as necessary)</i>				Application Number	
				Filing Date	Herewith
				First Named Inventor	Jon M. Huppenthal et al.
				Art Unit	
				Examiner Name	
Sheet	1	of	8	Attorney Docket No.	SRC015 CON

U.S. PATENT DOCUMENTS						
Examiner Initials	Cite No. ¹	Document No. No. – Kind Code ²	Publication Date MM-DD-YYYY	Name of Patentee or Applicant of Cited Doc	Pages, Columns, Lines, Where Relevant Passages or Relevant Figures Appear	
/E.C./		US-6,215,898	04/10/2001	Woodfill et al.	Fig. 3 and col. 9, line 32-col. 16, line 45, and col. 57, line 6-col. 67, line 23.	
/E.C./		US-5,020,059	05/28/1991	Gorin et al.	Figs. 5, 9 and col. 7, line 28-col. 9, line 53.	
/E.C./		US-5,471,627	11/28/1995	Means et al.	Fig. 3 and col. 4, line 40- col. 12, line 42.	
/E.C./		US-4,727,503	02/23/1988	McWhirter	Column 3, line 49-col. 4, line 64.	
/E.C./		US-5,477,221	12/19/1995	Chang et al.	Fig. 5 and col. 6, line 48-col. 9, line 9.	
		US-				
		US-				
		US-				
		US-				
		US-				
		US-				
FOREIGN PATENT DOCUMENTS						
Examiner Initials	Cite No. ¹	Foreign Patent Document	Publication Date MM-DD-YYYY	Name of Patentee or Applicant of Cited Doc	Pages, Columns, Lines Where Relevant Passages or Relevant Figures Appear	T ⁶
		Country Code ³ Number ⁴ Kind Code ⁵				

EXAMINER SIGNATURE	/Eric Coleman/	DATE CONSIDERED	01/08/2009
<p>EXAMINER: Initial if reference considered, whether or not citation is in conformance with MPEP 609. Draw line through citation if not in conformance and not considered. Include copy of this form with next communication to applicant. ¹ Applicant's unique citation designation number (optional). ² See Kinds Codes of USPTO Patent Documents at www.uspto.gov or MPEP 901.04. ³ Enter Office that issued the document, by the two-letter code (WIPO Standard ST.3). ⁴ For Japanese patent documents, the indication of the year of the reign of the Emperor must precede the serial number of the patent document. ⁵ Kind of document by the appropriate symbols as indicated on the document under WIPO Standard ST. 16 if possible. ⁶ Applicant is to place a check mark here if English language Translation is attached.</p> <p>This collection of information is required by 37 CFR 1.97 and 1.98. The information is required to obtain or retain a benefit by the public which is to file (and by the USPTO to process) and application. Confidentiality is governed by 35 U.S.C. 122 and 37 CFR 1.14. This collection is estimated to take 2 hours to complete, including gathering, preparing, and submitting the completed application form to the USPTO. Time will vary depending upon the individual case. Any comments on the amount of time you require to complete this form and/or suggestions for reducing this burden, should be sent to the Chief Information Officer, U.S. Patent and Trademark Office, U.S. Department of Commerce, P.O. Box 1450, Alexandria, VA 22313-1450. DO NOT SEND FEES OR COMPLETED FORMS TO THIS ADDRESS. SEND TO: Commissioner for Patents, P.O. Box 1450, Alexandria, VA 22313-1450.</p>			

Under the Paperwork Reduction Act of 1995, no persons are required to respond to a collection of information unless it displays a valid OMB control number.

Substitute for form 1449A/PTO INFORMATION DISCLOSURE STATEMENT BY APPLICANT (Use as many sheets as necessary)				Application Number	
				Filing Date	Herewith
				First Named Inventor	Jon M. Huppenthal et al.
				Art Unit	
				Examiner Name	
Sheet	2	of	8	Attorney Docket No.	SRC015 CON

U.S. PATENT DOCUMENTS					
Examiner Initials	Cite No. ¹	Document No. No. - Kind Code ²	Publication Date MM-DD-YYYY	Name of Patentee or Applicant of Cited Doc	Pages, Columns, Lines, Where Relevant Passages or Relevant Figures Appear
/E.C./		US-6,385,757	05/07/2002	Gupta et al.	
/E.C./		US-4,872,133	10/03/1989	Leeland	
/E.C./		US-5,274,832	12/28/1993	Khan	
/E.C./		US-5,072,371	12/10/1991	Benner et al.	
/E.C./		US-5,072,371	12-1991	Benner et al.	
/E.C./		US-4,962,381	10-1990	Helbig, Sr., Walter A.	
/E.C./		US-5,784,108	07-1998	Skaletzky et al.	
/E.C./		US-6,061,706	05-2000	Gai et al.	
/E.C./		US-5,956,518	09-1999	DeHon et al.	
/E.C./		US-5,640,586	06-1997	Pechanek et al.	
/E.C./		US5,915,123	06-1999	Miirsky et al.	
/E.C./		US-6,289,440-	09-2001	Casselman, Steven	

FOREIGN PATENT DOCUMENTS								
Examiner Initials	Cite No. ¹	Foreign Patent Document			Publication Date MM-DD-YYYY	Name of Patentee or Applicant of Cited Doc	Pages, Columns, Lines Where Relevant Passages or Relevant Figures Appear	T ⁶
		Country Code ³	Number ⁴	Kind Code ⁵				

EXAMINER SIGNATURE	/Eric Coleman/	DATE CONSIDERED	01/08/2009
---------------------------	----------------	------------------------	------------

EXAMINER: Initial if reference considered, whether or not citation is in conformance with MPEP 609. Draw line through citation if not in conformance and not considered. Include copy of this form with next communication to applicant. ¹ Applicant's unique citation designation number (optional). ² See Kinds Codes of USPTO Patent Documents at www.uspto.gov or MPEP 901.04. ³ Enter Office that issued the document, by the two-letter code (WIPO Standard ST.3). ⁴ For Japanese patent documents, the indication of the year of the reign of the Emperor must precede the serial number of the patent document. ⁵ Kind of document by the appropriate symbols as indicated on the document under WIPO Standard ST. 16 if possible. ⁶ Applicant is to place a check mark here if English language Translation is attached.

This collection of information is required by 37 CFR 1.97 and 1.98. The information is required to obtain or retain a benefit by the public which is to file (and by the USPTO to process) and application. Confidentiality is governed by 35 U.S.C. 122 and 37 CFR 1.14. This collection is estimated to take 2 hours to complete, including gathering, preparing, and submitting the completed application form to the USPTO. Time will vary depending upon the individual case. Any comments on the amount of time you require to complete this form and/or suggestions for reducing this burden, should be sent to the Chief Information Officer, U.S. Patent and Trademark Office, U.S. Department of Commerce, P.O. Box 1450, Alexandria, VA 22313-1450. DO NOT SEND FEES OR COMPLETED FORMS TO THIS ADDRESS. SEND TO: Commissioner for Patents, P.O. Box 1450, Alexandria, VA 22313-1450.

Under the Paperwork Reduction Act of 1995, no persons are required to respond to a collection of information unless it displays a valid OMB control number.

Substitute for form 1449A/PTO INFORMATION DISCLOSURE STATEMENT BY APPLICANT (Use as many sheets as necessary)				Application Number	
				Filing Date	Herewith
				First Named Inventor	Jon M. Huppenthal et al.
				Art Unit	
				Examiner Name	
Sheet	3	of	8	Attorney Docket No.	SRC015 CON

NON PATENT LITERATURE DOCUMENTS			
Examiner Initials*	Cite No. ¹	Include name of the author (in CAPITAL LETTERS), title of the article (when appropriate), title of the item (book, magazine, journal, serial, symposium, catalog, etc.), date, page(s), volume-issue number(s) publisher, city and/or country where published	T ²
/E.C./		MIYAMORI, TAKASHI, "REMARC: Reconfigurable Multimedia Array Coprocessor", IEICE Transactions on Information and Systems, Information & Systems Society, Tokyo, JP, vol. E82-D, no. 2, February 1999 (1999-02), pgs. 389-397, XP000821922.	
/E.C./		GROSS THOMAS, et al., "Compilation for a High-performance Systolic Array", Sigplan Notices USA, vol. 21, no. 7, July 1986, (1986-07), pgs. 27-38, XP002418625.	
/E.C./		RAUCHWERGER, LAWRENCE, et al., "The LRPD Test: Speculative Run-Time Parallelization of Loops with Privatization and Reduction Parallelization", IEEE Transactions on Parallel and Distributed Systems, IEEE Service Center, Los Alamitos, CA, vol. 10, no. 2, February 1999 (1999-02), pgs. 160-180, XP000908318.	
/E.C./		ARNOLD JEFFREY M. et al., "The Splash 2 Processor and Applications", Computer Design: VLSI in Computers and Processors, 1993, ICCD '93 Proceedings, 1993 IEEE International Conference on Cambridge, MA, 3-6 Oct. 1993, Los Alamitos, CA, IEEE Comput. Soc., 3 October 1993 (1993-10-03), pgs. 482-485, XP010134571.	
/E.C./		HWANG, KAI, "Computer Architecture and Parallel Processing", Data Flow Computers and VLSI Computations, 1985, McGraw Hill, Chapter 10, pgs. 732-807, XP-002418655	
/E.C./		HARTENSTEIN, REINER W., et al. "A Synthesis System for Bus-based Wavefront Array Architectures", Proceedings, International Conference on Application-Specific Systems, Architectures and Processors, 1996, pgs 274-283, XP002132819.	
/E.C./		ALEXANDER, THOMAS, et al. "A Reconfigurable Approach To A Systolic Sorting Architecture", ISCAS 89, 8 May 1989, (1989-05-08), pgs. 1178-1182, XP010084477.	
/E.C./		WU, YOUFENG, et al. "Better Exploration of Region-Level Value Locality with Integrated Computation Reuse and Value Prediction", Proceedings of the 28th International Symposium on Computer Architecture, ISCA 2001, Goteborg, Sweden, June 30-July 4, 2001, International Symposium on Computer Architecture, (ISCA), Los Alamitos, CA, IEEE Comp. Soc, US, 30 June 2001 (2001-06-30), pgs. 93-103, XP010552866.	

EXAMINER SIGNATURE	/Eric Coleman/	DATE CONSIDERED	01/08/2009
EXAMINER: Initial if reference considered, whether or not citation is in conformance with MPEP 609. Draw line through citation if not in conformance and not considered. Include copy of this form with next communication to applicant.			
¹ Applicant's unique citation designation number (optional). ² Applicant is to place a check mark here if English language Translation is attached. This collection of information is required by 37 CFR 1.97 and 1.98. The information is required to obtain or retain a benefit by the public which is to file (and by the USPTO to process) and application. Confidentiality is governed by 35 U.S.C. 122 and 37 CFR 1.14. This collection is estimated to take 2 hours to complete, including gathering, preparing, and submitting the completed application form to the USPTO. Time will vary depending upon the individual case. Any comments on the amount of time you require to complete this form and/or suggestions for reducing this burden, should be sent to the Chief Information Officer, U.S. Patent and Trademark Office, U.S. Department of Commerce, P.O. Box 1450, Alexandria, VA 22313-1450. DO NOT SEND FEES OR COMPLETED FORMS TO THIS ADDRESS. SEND TO: Commissioner for Patents, P.O. Box 1450, Alexandria, VA 22313-1450.			

Substitute for form 1449A/PTO INFORMATION DISCLOSURE STATEMENT BY APPLICANT <i>(Use as many sheets as necessary)</i>				Application Number	
				Filing Date	Herewith
				First Named Inventor	Jon M. Huppenthal et al.
				Art Unit	
				Examiner Name	
Sheet	4	of	8	Attorney Docket No.	SRC015 CON

NON PATENT LITERATURE DOCUMENTS				
Examiner Initials ¹	Cite No. ¹	Include name of the author (in CAPITAL LETTERS), title of the article (when appropriate), title of the item (book, magazine, journal, serial, symposium, catalog, etc.), date, page(s), volume-issue number(s) publisher, city and/or country where published	T ²	
/E.C./		BABB, JONATHAN, et al., "Parallelizing applications into silicon", © 1999 IEEE.		
/E.C./		DESHPANDE, DEEPAI, et al., "Hybrid data/configuration caching for striped FPGAs" © 1999 IEEE.		
/E.C./		PURNA, KARTHIKEYA, et al., "Temporal partitioning and scheduling data flow graphs for reconfigurable computers", © 1999 IEEE, Publ. No. 0018-9340/99, Pages 579-590.		
/E.C./		GIBBS, W. WAYT, "Blitzing bits", © 1999 Scientific American Presents, Pages 57-61.		
/E.C./		GONZALEZ, RICARDO, "Configurable and extensible processors change system design", August 15-17, 1999, Hot Chips 11 Tutorials, Pages 135-146.		
/E.C./		GRAHAM, PAUL, et al., "FPGA-based sonar processing", © 1998 ACM 0-89791-978-5/98, Pages 201-208.		
/E.C./		HASEBE, A., et al., "Architecture of SIPS, a real time image processing system," © 1988 IEEE, Publ. No. CH2603-9/88/0000/0621, Pages 621-630.		
/E.C./		HAMMOND, LANCE, et al., "The Stanford Hydra CMP", August 15-17, 1999 Hot Chips 11 Tutorials, Pages 23-31.		
/E.C./		JEAN, JACK, et al., "Dynamic reconfiguration to support concurrent applications", © 1999 IEEE, Publ. No. 0018-9340/99, Pages 591-602.		
/E.C./		KASTRUP, BERNARDO, et al., "Concise: a compiler-driven CPLD-based instruction set accelerator", © 1999 IEEE.		
/E.C./		MOTOMURA, MASATO, et al., "An embedded DRAM-FPGA chip with instantaneous logic reconfiguration", © 1998 IEEE, Publ. No. 0-8186-8900-5/98, Pages 284-266.		
/E.C./		MCCONNELL, RAY, "Massively parallel computing on the FUZION chip", August 15-17, 1999, Hot Chips 11 Tutorials, Pages 83-84.		
/E.C./		MCSHANE, ERIK, et al., "Functionally integrated systems on a chip: technologies, architectures, CAD tools, and applications", © 1998 IEEE, Publ. No. 8-8186-8424-0/98, Pages 67-75.		
/E.C./		RUPP, CHARLEY, et al., "The NAPA adaptive processing architecture", © 1998 the Authors, Pages 1-10.		
/E.C./		SAITO, OSAMU, et al., "A 1M synapse self learning digital neural network chip", © 1998 IEEE, Publ. No. 0-7803-4344/1/98, Pages 94-95.		
/E.C./		SCHOTT, BRIAN, et al., "Architectures for system-level applications of adaptive computing", © 1999 IEEE.		
/E.C./		MENCER, OSKAR, et al., "PAM-Blox: High Performance FPGA Design for Adaptive Computing", © 1998 IEEE, Conference Paper, INSPEC Abstract Nos. B9811-1265B-044, C9811-5210-009.		
/E.C./		MIYAMORI, TAKASHI, et al., "A quantitative analysis of reconfigurable coprocessors for multimedia applications", © 1998 IEEE, Conference Paper, INSPEC Abstract Nos. B9811-1265F-011, C 9811-5310-010.		
EXAMINER SIGNATURE		/Eric Coleman/	DATE CONSIDERED	01/08/2009

EXAMINER: Initial if reference considered, whether or not citation is in conformance with MPEP 609. Draw line through citation if not in conformance and not considered. Include copy of this form with next communication to applicant.

¹ Applicant's unique citation designation number (optional). ² Applicant is to place a check mark here if English language Translation is attached. This collection of information is required by 37 CFR 1.97 and 1.98. The information is required to obtain or retain a benefit by the public which is to file (and by the USPTO to process) and application. Confidentiality is governed by 35 U.S.C. 122 and 37 CFR 1.14. This collection is estimated to take 2 hours to complete, including gathering, preparing, and submitting the completed application form to the USPTO. Time will vary depending upon the individual case. Any comments on the amount of time you require to complete this form and/or suggestions for reducing this burden, should be sent to the Chief Information Officer, U.S. Patent and Trademark Office, U.S. Department of Commerce, P.O. Box 1450, Alexandria, VA 22313-1450. DO NOT SEND FEES OR COMPLETED FORMS TO THIS ADDRESS. SEND TO: Commissioner for Patents, P.O. Box 1450, Alexandria, VA 22313-1450.

PTO/SB/08A (10/01) (Substitute for form 1449A/PTO) INFORMATION DISCLOSURE STATEMENT BY APPLICANT (Use several sheets if necessary) Sheet <u>5</u> of <u>8</u>	ATTY. DOCKET NO. SRC015 CON Client/Matter No. 80404.0018.001	APPLICATION NO.
	FIRST NAMED INVENTOR Jon M. Huppenthal et al.	
	FILING DATE Herewith	ART UNIT

U.S. PATENT DOCUMENTS

Examiner Initials	Cite No.	Document No. No. - Kind Code	Publication Date MM-DD-YYYY	Name of Patentee or Applicant of Cited Doc	Pages, Columns, Lines, Where Relevant Passages or Relevant Figures Appear
/E.C./		US-5,230,057	07/20/93	Shido, et al.	
/E.C./		US-5,892,962	04/06/99	Cloutier	
/E.C./		US-5,903,771	05/11/1999	Sgro et al.	Figs 1 & 6, col. 3, lines 30-67, col 4, lines 1-51, col 7, lines 1-27.
/E.C./		US-6,192,439	02/20/2001	Grunewald et al.	Fig 3, col 3, lines 53-67, col 4, lines 1-64.
/E.C./		US-6,076,152	06/13/2000	Huppenthal et al.	
/E.C./		US-6,052,773	04/18/2000	DeHon et al.	
/E.C./		US-6,226,776	05/01/2001	Panchul et al.	
/E.C./		US-6,023,755	02/08/2000	Casselmann	
/E.C./		US-5,737,766	04/07/1998	Tan	
/E.C./		US-5,570,040	10/29/1996	Lytle et al.	

FOREIGN PATENT DOCUMENTS

Examiner Initials	Cite No.	Foreign Patent Doc cntry code - No. - Kind Code	Publication Date MM-DD-YYYY	Name of Patentee or Applicant of Cited Doc	Pages, Columns, Lines Where Relevant Passages or Relevant Figures Appear	TRANSLATION
						YES

OTHER PRIOR ART - NON PATENT LITERATURE DOCUMENTS

Examiner Initials	Cite No.	Include name of the author (in CAPITAL LETTERS), title of the article (when appropriate), title of the item (book, magazine, journal, serial, symposium, catalog, etc.), date, page(s), volume-issue number(s) publisher, city and/or country where published
/E.C./		AGARWAL, A., et al., "The Raw Compiler Project", pages 1-12, http://cag-www.lcs.mit.edu/raw , Proceedings of the Second SUIF Compiler Workshop, Augs. 21-23, 1997.
/E.C./		ALBAHARNA, OSAMA, et al., "On the viability of FPGA-based integrated coprocessors", © 1996 IEEE, Publ. No. 0-8186-7548-9/96, Pages 206-215.
/E.C./		AMERSON, RICK, et al., "Teramac---Configurable Custom Computing", © 1995 IEEE, Publ. No. 0-8186-7086-X/95, Pages 32-38.

/E.C./	BARTHEL, DOMINIQUE August 25-26, 1997, "PVP a Parallel Video coProcessor", Hot Chips IX, Pages 203-210.
/E.C./	BERTIN, PATRICE, et al., "Programmable active memories: a performance assessment", © 1993 Massachusetts Institute of Technology, Pages 88-102.
/E.C./	BITTNER, RAY, et al., "Computing kernels implemented with a wormhole RTR CCM", © 1997 IEEE, Publ. No. 0-8186-8159-4/97, Pages 98-105.
/E.C./	BUELL, D., et al. "Splash 2: FPGAs in a Custom Computing Machine – Chapter 1 -- Custom Computing Machines: An Introduction", Pages 1-11, http://www.computer.org/espress/catalog/bp07413/spls-ch1.html (originally believed published in J. of Supercomputing, Vol. IX, 1995, PP. 219-230.
/E.C./	CASSELMAN, STEVEN, "Virtual Computing and The Virtual Computer", © 1993 IEEE, Publ. No. 0-8186-3890-7/93, Pages 43-48.
/E.C./	CHAN, PAK, et al., "Architectural tradeoffs in field-programmable-device-based computing systems", © 1993 IEEE, Publ. No. 0-8186-3890-7/93, Pages 152-161.
/E.C./	CLARK, DAVID, et al., "Supporting FPGA microprocessors through retargetable software tools", © 1996 IEEE, Publ. No. 0-8186-7548-9/96, Pages 195-103.
/E.C./	CUCCARO, STEVEN, et al., "The CM-2X: a hybrid CM-2/Xilinx prototype", © 1993 IEEE, Publ. No. 0-8186-3890-7/93, Pages 121-130.
/E.C./	CULBERTSON, W. BRUCE, et al., "Exploring architectures for volume visualization on the Teramac custom computer", © 1996 IEEE, Publ. No. 0-8186-7548-9/96, Pages 80-88.
/E.C./	CULBERTSON, W. BRUCE, et al., "Defect tolerance on the Teramac custom computer", © 1997 IEEE, Publ. No. 0-8186-8159-4/97, Pages 116-123.
/E.C./	DEHON, ANDRE, "DPGA-Coupled microprocessors: commodity IC for the early 21 st century", © 1994 IEEE, Publ. No. 0-8186-5490-2/94, Pages 31-39.
/E.C./	DEHON, A., et al., "MATRIX A Reconfigurable Computing Device with Configurable Instruction Distribution", Hot Chips IX, August 25-26, 1997, Stanford, California, MIT Artificial Intelligence Laboratory.
/E.C./	DHAUSSY, PHILIPPE, et al., "Global control synthesis for an MIMD/FPGA machine", © 1994 IEEE, Publ. No. 0-8186-5490-2/94, Pages 72-81.
/E.C./	ELLIOTT, DUNCAN, et al., "Computational Ram: a memory-SIMD hybrid and its application to DSP", © 1992 IEEE, Publ. No. 0-7803-0246-X/92, Pages 30.6.1-30.6.4.
/E.C./	FORTES, JOSE, et al., "Systolic arrays, a survey of seven projects", © 1987 IEEE, Publ. No. 0018-9162/87/0700-0091, Pages 91-103.
/E.C./	GOKHALE, M., et al., "Processing in Memory: The Terasys Massively Parallel PIM Array" © April 1995, IEEE, Pages 23-31.
/E.C./	GUNTHER, BERNARD, et al., "Assessing Document Relevance with Run-Time Reconfigurable Machines", © 1996 IEEE, Publ. No. 0-8186-7548-9/96, Pages 10-17.
/E.C./	HAGIWARA, HIROSHI, et al., "A dynamically microprogrammable computer with low-level parallelism", © 1980 IEEE, Publ. No. 0018-9340/80/07000-0577, Pages 577-594.
/E.C./	HARTENSTEIN, R. W., et al. "A General Approach in System Design Integrating Reconfigurable Accelerators," http://xputers.informatik.uni-kl.de/papers/paper026-1.html , IEEE 1996 Conference, Austin, TX, Oct. 9-11, 1996.
/E.C./	HARTENSTEIN, REINER, et al., "A reconfigurable data-driven ALU for Xputers", © 1994 IEEE, Publ. No. 0-8186-5490-2/94, Pages 139-146.
/E.C./	HAUSER, JOHN, et al.: "GARP: a MIPS processor with a reconfigurable co-processor", © 1997 IEEE, Publ. No. 0-8186-8159-4/97, Pages 12-21.
/E.C./	HAYES, JOHN, et al., "A microprocessor-based hypercube, supercomputer", © 1986 IEEE, Publ. No. 0272-1732/86/1000-0006, Pages 6-17.
/E.C./	HERPEL, H. -J., et al., "A Reconfigurable Computer for Embedded Control Applications", © 1993 IEEE, Publ. No. 0-8186-3890-7/93, Pages 111-120.
/E.C./	HOGL, H., et al., "Enable++: A second generation FPGA processor", © 1995 IEEE, Publ. No. 0-8186-7086-X/95, Pages 45-53.
/E.C./	KING, WILLIAM, et al., "Using MORRPH in an industrial machine vision system". © 1996 IEEE, Publ. No. 08186-7548-9/96, Pages 18-26.

/E.C./	MANOHAR, SWAMINATHAN, et al., "A pragmatic approach to systolic design", © 1988 IEEE, Publ. No. CH2603-9/88/0000/0463, Pages 463-472.
/E.C./	MAUDUIT, NICOLAS, et al., "Lneuro 1.0: a piece of hardware LEGO for building neural network systems," © 1992 IEEE, Publ. No. 1045-9227/92, Pages 414-422.
/E.C./	MIRSKY, ETHAN A., "Coarse-Grain Reconfigurable Computing", Massachusetts Institute of Technology, June 1996.
/E.C./	MIRSKY, ETHAN, et al., "MATRIX: A Reconfigurable Computing Architecture with Configurable Instruction Distribution and Deployable Resources", © 1996 IEEE, Publ. No. 0-8186-7548-9/96, Pages 157-166.
/E.C./	MORLEY, ROBERT E., Jr., et al., "A Massively Parallel Systolic Array Processor System", © 1988 IEEE, Publ. No. CH2603-9/88/0000/0217, Pages 217-225.
/E.C./	PATTERSON, DAVID, et al., "A case for Intelligent DRAM: IRAM", Hot Chips VIII, August 19-20, 1996, Pages 75-94.
/E.C./	PETERSON, JANES, et al., "Scheduling and partitioning ANSI-C programs onto multi-FPGA CCM architectures", © 1996 IEEE, Publ. No. 0-8186-7548-9/96, Pages 178-187.
/E.C./	SCHMIT, HERMAN, "Incremental reconfiguration for pipelined applications," © 1997 IEEE, Publ. No. 0-8186-8159-4/97, Pages 47-55.
/E.C./	SITKOFF, NATHAN, et al., "Implementing a Genetic Algorithm on a Parallel Custom Computing Machine", Publ. No. 0-8186-7086-X/95, Pages 180-187.
/E.C./	STONE, HAROLD, "A logic-in-memory computer", © 1970 IEEE, IEEE Transactions on Computers, Pages 73-78, January 1990.
/E.C./	TANGEN, UWE, et al., "A parallel hardware evolvable computer POLYP extended abstract", © 1997 IEEE, Publ. No. 0-8186-8159/4/97, Pages 238-239.
/E.C./	THORNBURG, MIKE, et al., "Transformable Computers", © 1994 IEEE, Publ. No. 0-8186-5602-6/94, Pages 674-679.
/E.C./	TOMITA, SHINJI, et al., "A computer low-level parallelism QA-2", © 1986 IEEE, Publ. No. 0-0384-7495/86/0000/0280, Pages 280-289.
/E.C./	TRIMBERGER, STEVE, et al., "A time-multiplexed FPGA", © 1997 IEEE, Publ. No. 0-8186-8159-4/97, Pages 22-28.
/E.C./	UEDA, HIROTADA, et al., "A multiprocessor system utilizing enhanced DSP's for Image processing", © 1988 IEEE, Publ. No. CH2603-9/88/0000/0611, Pages 611-620.
/E.C./	VILLASENOR, JOHN, et al., "Configurable computing", © 1997 Scientific American, June 1997.
/E.C./	WANG, QUIANG, et al., "Automated field-programmable compute accelerator design using partial evaluation", © 1997 IEEE, Publ. No. 0-8186-8159-4/97, Pages 145-154.
/E.C./	W.H. Mangione-Smith and B.L. Hutchings. Configurable computing: The Road Ahead. In Proceedings of the Reconfigurable Architectures Workshop (RAW'97), pages 81-96, 1997.
/E.C./	WIRTHLIN, MICHAEL, et al., "The Nano processor: a low resource reconfigurable processor", © 1994 IEEE, Publ. No. 0-8186-5490-2/94, Pages 23-30.
/E.C./	WIRTHLIN, MICHAEL, et al., "A dynamic instruction set computer", © 1995 IEEE, Publ. No. 0-8186-7086-X/95, Pages 99-107.
/E.C./	WITTIG, RALPH, et al., "One Chlp: An FPGA processor with reconfigurable logic", © 1996 IEEE, Publ. No. 0-8186-7548-9/96, Pages 126-135.
/E.C./	YAMAUCHI, TSUKASA, et al., "SOP: A reconfigurable massively parallel system and its control-data flow based compiling method", © 1996 IEEE, Publ. No. 0-8186-7548-9/96, Pages 148-156.
/E.C./	"Information Brief", PCI Bus Technology, © IBM Personal Computer Company, 1997, Pages 1-3.
/E.C./	YUN, HYUN-KYU AND SILVERMAN, H. F.; "A distributed memory MIMD multi-computer with reconfigurable custom computing capabilities", Brown University, 10-13 Dec. 1997, pp. 7-13.
/E.C./	HOOVER, CHRIS AND HART, DAVID; "San Diego Supercomputer Center, Timelogic and Sun Validate Ultra-Fast Hidden Markov Model Analysis-One DeCypher-accelerated Sun Fire 6800 beats 2,600 CPUs running Linux-", San Diego Supercomputer Center, http://www.sdsc.edu/Press/02/050802_markovmodel.html , May 8, 2002, pp. 1-3.

/E.C./	CALIGA, DAVID AND BARKER, DAVID PETER, "Delivering Acceleration: The Potential for Increased HPC Application Performance Using Reconfigurable Logic", SRC Computers, Inc., November 2001, pp. 20.	
/E.C./	HAMMES, J.P., RINKER, R. E., MCCLURE, D. M., BÖHM, A. P. W., NAJJAR, W. A., "The SA-C Compiler Dataflow Description", Colorado State University, June 21, 2001, pp. 1-25.	
/E.C./	CALLAHAN, TIMOTHY J. AND WAWRZYNEK, JOHN, "Adapting Software Pipelining for Reconfigurable Computing", University of California at Berkeley, November 17-19, 2000, pp. 8.	
/E.C./	RATHA, NALINI K., JAIN, ANIL K. AND ROVER, DIANE T., "An FPGA-based Point Pattern Matching Processor with Application to Fingerprint Matching", Michigan State University, Department of Computer Science, pp. 8.	
/E.C./	DEHON, ANDRÉ, "Comparing Computing Machines", University of California at Berkeley, Proceedings of SPIE Vol. 3526, November 2-3, 1998, pp. 11.	
/E.C./	YEMURI, RANGA R. AND HARR, RANDOLPH E., "Configurable Computing: Technology and Applications", University of Cincinnati and Synopsys Inc., IEEE, April 2000, pp. 39-40.	
/E.C./	DEHON, ANDRÉ, "The Density Advantage of Configurable Computing", California Institute of Technology, IEEE, April 2000, pp. 41-49.	
/E.C./	HAYNES, SIMON D., STONE, JOHN, CHEUNG, PETER Y.K. AND LUK, WAYNE, "Video Image Processing with the Sonic Architecture", Sony Broadcast & Professional Europe, Imperial College, University of London, IEEE, April 2000, pp. 50-57.	
/E.C./	PLATZNER, MARCO, "Reconfigurable Accelerators for Combinatorial Problems", Swiss Federal Institute of Technology (ETH) Zurich, IEEE, April 2000, pp. 58-60.	
/E.C./	CALLAHAN, TIMOTHY J., HAUSER, JOHN R. AND WAWRZYNEK, JOHN, "The Garp Architecture and C Compiler", University of California, Berkeley, IEEE, April 2000, pp. 62-69.	
/E.C./	GOLDSTEIN, SETH COPEN, SCHMIT, HERMAN, BUDIU, MIHAI, CADAMBI, SRIHARI, MOE, MATT AND TAYLOR, R. REED, "PipeRench: A Reconfigurable Architecture and Compiler", Carnegie Mellon University, IEEE, April 2000, pp. 70-76.	
/E.C./	MUCHNICK, STEVEN S., "Advanced Compiler Design and Implementation", Morgan Kaufmann Publishers, pp. 217.	
/E.C./	HAMMES, JEFFREY P., Dissertation "Compiling SA-C To Reconfigurable Computing Systems", Colorado State University, Department of Computer Science, Summer 2000, pp. 179.	
/E.C./	Automatic Target Recognition, Colorado State University & USAF, http://www.cs.colostate.edu/cameron/applications.html , pp. 1-3.	
/E.C./	CHODOWIEC, PAWEL, KHUON, PO, GAJ, KRIS, Fast Implementations of Secret-Key Block Ciphers Using Mixed Inner- and Outer-Round Pipelining, George Mason University, February 11-13, 2001, pp.9.	
EXAMINER	/Eric Coleman/	DATE CONSIDERED 01/08/2009
EXAMINER: Initial if citation considered, whether or not citation is in conformance with MPEP 609; Draw line through citation if not in conformance and not considered. Include copy of this form with next communication to applicant.		

Search Notes 	Application/Control No. 11733064	Applicant(s)/Patent Under Reexamination HUPPENTHAL ET AL.
	Examiner Eric Coleman	Art Unit 2183

SEARCHED			
Class	Subclass	Date	Examiner
712	226,15,19,215	1/8/09	EC

SEARCH NOTES		
Search Notes	Date	Examiner
Searched East US Pat file US PG pub file	1/8/09	EC
inventor name search	1/8/09	EC
Searched Google Scholar	1/8/09	EC
Consulted WQAS Padmanabhan Mano on possible 101 (mathematical algorithm)	1/8/09	EC

INTERFERENCE SEARCH			
Class	Subclass	Date	Examiner

--	--

IN THE UNITED STATES PATENT AND TRADEMARK OFFICE

Serial No. 11/733,064 Application of: Jon M. Huppenthal and David E. Caliga Filed: April 9, 2007 Attorney Docket No. SRC015 CON For: MULTI-ADAPTIVE PROCESSING SYSTEMS AND TECHNIQUES FOR ENHANCING PARALLELISM AND PERFORMANCE OF COMPUTATIONAL FUNCTIONS	Confirmation No.: 7527 Art Unit: 2183 Examiner: Coleman, Eric Customer No.: 25235
---	---

AMENDMENT

MAIL STOP AMENDMENT
Commissioner for Patents
P.O. Box 1450
Alexandria, VA 22313-1450

Sir:

In response to the office communication mailed January 12, 2009, please amend the above-identified application as follows:

Amendments to the Claims are reflected in the listing of claims which begins on page 2 of this paper.

Remarks/Arguments begin on page 10 of this paper.

A **Terminal Disclaimer** is attached following page 11 of this paper.

Amendments to the Claims:

This listing of claims will replace all prior versions and listings of claims in the application:

Listing of Claims:

1. (original) A method for data processing in a reconfigurable computing system, the reconfigurable computing system comprising at least one reconfigurable processor, the reconfigurable processor comprising a plurality of functional units, said method comprising:
 - transforming an algorithm into a data driven calculation that is implemented by said reconfigurable computing system at the at least one reconfigurable processor;
 - forming at least two of said functional units at the at least one reconfigurable processor to perform said calculation wherein only functional units needed to solve the calculation are formed and wherein each formed functional unit at the at least one reconfigurable processor interconnects with each other formed functional unit at the at least one reconfigurable processor based on reconfigurable routing resources within the at least one reconfigurable processor as established at formation, and wherein lines of code of said calculation are formed as clusters of functional units within the at least one reconfigurable processor;
 - utilizing a first of said formed functional units to operate upon a subsequent data dimension of said calculation forming a first computational loop; and
 - substantially concurrently utilizing a second of said formed functional units to operate upon a previous data dimension of said calculation generating a

second computational loop wherein said implementation of said calculation enables said first computational loop and said second computational loop execute concurrently and pass computed data seamlessly between said computational loops.

2. (original) The method of claim 1 wherein said subsequent and previous data dimensions of said calculation comprise multiple vectors in said calculation.
3. (original) The method of claim 1 wherein said subsequent and previous data dimensions of said calculation comprise multiple planes in said calculation.
4. (original) The method of claim 1 wherein said subsequent and previous data dimensions of said calculation comprise multiple time steps in said calculation.
5. (original) The method of claim 1 wherein said subsequent an previous data dimensions of said calculation comprise multiple grid points in said calculation.
6. (original) The method of claim 1 wherein said calculation comprises a seismic imaging calculation.
7. (original) The method of claim 1 wherein said calculation comprises a synthetic aperture radar imaging calculation.
8. (original) The method of claim 1 wherein said calculation comprises a JPEG image compression calculation.
9. (original) The method of claim 1 wherein said calculation comprises an MPEG image compression calculation.

10. (original) The method of claim 1 wherein said calculation comprises a fluid flow calculation for a reservoir simulation.
11. (original) The method of claim 1 wherein said calculation comprises a fluid flow calculation for weather prediction.
12. (original) The method of claim 1 wherein said calculation comprises a fluid flow calculation for automotive applications.
13. (original) The method of claim 1 wherein said calculation comprises a fluid flow calculation for aerospace applications.
14. (original) The method of claim 1 wherein said calculation comprises a fluid flow calculation for an injection molding application.
15. (original) The method of claim 1 wherein instantiating includes establishing a stream communication connection between functional units.
16. (original) The method of claim 1 wherein said calculation is comprises a structures calculation for structural analysis.
17. (original) The method of claim 1 wherein said calculation comprises a search algorithm for an image search.
18. (original) The method of claim 1 wherein said calculation comprises a search algorithm for data mining.
19. (original) The method of claim 1 wherein said calculation comprises a financial modeling application.

20. (original) The method of claim 1 wherein said calculation comprises an encryption algorithm.

21. (original) The method of claim 1 wherein said calculation comprises a genetic pattern matching function.

22. (original) The method of claim 1 wherein said calculation comprises a protein folding function.

23. (original) The method of claim 1 wherein said calculation comprises an organic structure interaction function.

24. (original) The method of claim 1 wherein said calculation comprises a signal filtering application.

25. (original) A method for data processing in a reconfigurable computing system, the reconfigurable computing system comprising at least one reconfigurable processor comprising a plurality of functional units, said method comprising:

transforming an algorithm into a data driven calculation that is implemented by said reconfigurable computing system at the at least one reconfigurable processor wherein linked lines of code of said calculation are fashioned as walls of functional units within the at least one reconfigurable processor;

defining a first wall comprising rows of cells forming a subset of said plurality of functional units;

computing at the at least one reconfigurable processor a value at each of said cells in at least a first row of said first wall substantially concurrently;

communicating said values between cells in said first row of said cells to produce updated values, wherein communicating said values is based on reconfigurable routing resources within the at least one reconfigurable processor;

communicating said updated values substantially concurrently to a second row of said first wall, wherein communicating said updated values is based on reconfigurable routing resources within the at least one reconfigurable processor;
and

communicating said updated values substantially concurrently to a first row of a second wall of rows of cells in said subset of said plurality of functional units, wherein communicating said updated values is based on reconfigurable routing resources within the at least one reconfigurable processor and wherein said first wall of rows of cells and said second wall of rows of cells execute substantially concurrently and pass computed data seamlessly between said walls.

26. (original) The method of claim 25 wherein said values correspond to vectors in a computation.

27. (original) The method of claim 25 wherein said values correspond to planes in a computation.

28. (original) The method of claim 25 wherein said values correspond to time steps in a computation.

29. (original) The method of claim 25 wherein said values correspond to grid points in a computation.

30. (currently amended) The method of claim 25 wherein said step of communicating said updated values to a second row of said first systolic wall is carried out without storing said updated values in an extrinsic memory.
31. (original) The method of claim 25 wherein said values correspond to a seismic imaging calculation.
32. (original) The method of claim 25 wherein said values correspond to a synthetic aperture radar imaging calculation.
33. (original) The method of claim 25 wherein said values correspond to a JPEG image compression calculation.
34. (original) The method of claim 25 wherein said values correspond to an MPEG image compression calculation.
35. (original) The method of claim 25 wherein said values correspond to a fluid flow calculation for a reservoir simulation.
36. (original) The method of claim 25 wherein said values correspond to a fluid flow calculation for weather prediction.
37. (original) The method of claim 25 wherein said values correspond to a fluid flow calculation for automotive applications.
38. (original) The method of claim 25 wherein said values correspond to a fluid flow calculation for aerospace applications.
39. (original) The method of claim 25 wherein said values correspond to a fluid flow calculation for an injection molding application.

40. (original) The method of claim 25 wherein defining includes establishing a stream communication connection between functional units and wherein only functional units needed to solve the calculations are instantiated.
41. (original) The method of claim 25 wherein said values correspond to a structures calculation for structural analysis.
42. (original) The method of claim 25 wherein said values correspond to a search algorithm for an image search.
43. (original) The method of claim 25 wherein said values correspond to a search algorithm for data mining.
44. (original) The method of claim 25 wherein said values correspond to a financial modeling application.
45. (original) The method of claim 25 wherein said values correspond to an encryption algorithm.
46. (original) The method of claim 25 wherein said values correspond to a genetic pattern matching function.
47. (original) The method of claim 25 wherein said values correspond to a protein folding function.
48. (original) The method of claim 25 wherein said values correspond to an organic structure interaction function.
49. (original) The method of claim 25 wherein said values correspond to a signal filtering application.

50. (original) The method of claim 25 wherein said reconfigurable computing system comprises at least one microprocessor.

51. (original) A method for data processing in a reconfigurable computing system, the reconfigurable computer system comprising at least one reconfigurable processor comprising a plurality of functional units, said method comprising:

transforming an algorithm into a calculation implemented by said reconfigurable computing system at the at least one reconfigurable processor and driven by data propagation wherein lines of code of said calculation are linked based on said data propagation and fashioned as subsets of said plurality of functional units within the at least one reconfigurable processor forming columns of said calculation;

performing said calculation at the at least one reconfigurable processor by said subsets of said plurality of functional units to produce computed data;

exchanging said computed data between a first column of said calculation and a next column in said calculation, wherein said exchanging is based on reconfigurable routing resources within the at least one reconfigurable processor and wherein execution of said subsets of said plurality of function units occurs concurrently and said computed data is seamlessly passed between said first column of said calculation and said second column of said calculation;

evaluating a rate of change in at least one variable for each of said columns in said calculation;

continuing said calculation when said variable does not change for a particular column of said calculation; and

restarting said calculation at said column of said calculation where said variable does change.

52. (original) The method of claim 51 wherein how many functional units comprise the subset and functional type of each functional unit in said subset is based on the calculation.

REMARKS/ARGUMENTS

Claims 1-52 were presented for examination and are pending in this application. In an Official Office Action dated January 12, 2009, claims 1-52 were rejected. The Applicant thanks the Examiner for his consideration and addresses the Examiner's comments concerning the claims pending in this application below.

Applicant herein amends claim 30 and respectfully traverses the Examiner's rejections. No claims are presently cancelled and no new claims are added. These changes are believed not to introduce new matter, and their entry is respectfully requested. The claims have been amended to expedite the prosecution and issuance of the application. In making this amendment, the Applicant has not and is not narrowing the scope of the protection to which the Applicant considers the claimed invention to be entitled and does not concede, directly or by implication, that the subject matter of such claims was in fact disclosed or taught by the cited prior art. Rather, the Applicant reserves the right to pursue such protection at a later point in time and merely seeks to pursue protection for the subject matter presented in this submission.

Based on the above amendment and the following remarks, Applicant respectfully requests that the Examiner reconsider all outstanding rejections and withdraw them.

35 U.S.C. §112 Rejection of Claims

Claim 30 was rejected under 35 U.S.C. § 112, second paragraph, as being indefinite for failing to particularly point out and distinctly claim the subject matter which the Applicant regards as the invention. Specifically claim 30 refers to "said first systolic wall" which lacks proper antecedent basis. Claim 30 is herein amended deleting the reference to "systolic." The Applicant contends that

claim 30 now possesses proper antecedent basis for all claim elements and meets the requirements set forth in 35 U.S.C. § 112 second paragraph.

Double Patenting.

Claims 1-52 were rejected under the judicially created doctrine of obviousness-type double patenting over commonly owned U.S. Patent No. 7,225,324.

Although the claims as presented are believed to be distinct with respect to U.S. Patent 7,225,324, a Terminal Disclaimer is herein supplied together with the required fee to expedite the allowance of patentable subject matter.

Conclusion

In view of all of the above, the claims are now believed to be allowable and the case in condition for allowance which action is respectfully requested. Should the Examiner be of the opinion that a telephone conference would expedite the prosecution of this case, the Examiner is requested to contact Applicant's attorney at the telephone number listed below.

Other than the Terminal Disclaimer fee, no fee is believed due for this submittal. However, any fee deficiency associated with this submittal may be charged to Deposit Account No. 50-1123.

Respectfully submitted,

13 April, 2009



Michael C. Martensen, No. 46901
Hogan & Hartson LLP
One Tabor Center
1200 17th Street, Suite 1500
Denver, Colorado 80202
(719) 448-5910 Tel
(303) 899-7333 Fax

**TERMINAL DISCLAIMER TO OBIVATE A DOUBLE PATENTING
REJECTION OVER A "PRIOR" PATENT**

Docket Number (optional)
SRC015 CON

In re Application of:

Application Number: 11/733,064

Filed: April 9, 2007

For: MULTI-ADAPTIVE PROCESSING SYSTEMS AND TECHNIQUES FOR ENHANCING PARALLELISM AND PERFORMANCE OF COMPUTATIONAL FUNCTIONS

The owner*, SRC Computers, Inc., of 100% percent interest in the instant application hereby disclaims, except as provided below, the terminal part of the statutory term of any patent granted on the instant application which would extend beyond the expiration date of the full statutory term prior patent No. 7,225,324 as the term of said prior patent is defined in 35 U.S.C. 154 and 173, and as the term of said prior patent is presently shortened by any terminal disclaimer. The owner hereby agrees that any patent so granted on the instant application shall be enforceable only for and during such period that it and the prior patent are commonly owned. This agreement runs with any patent granted on the instant application and is binding upon the grantee, its successors or assigns.

In making the above disclaimer, the owner does not disclaim the terminal part of the term of any patent granted on the instant application that would extend to the expiration date of the full statutory term as defined in 35 U.S.C. 154 and 173 of the prior patent, "as the term of said prior patent is presently shortened by any terminal disclaimer," in the event that said prior patent later:

- expires for failure to pay a maintenance fee;
- is held unenforceable;
- is found invalid by a court of competent jurisdiction;
- is statutorily disclaimed in whole or terminally disclaimed under 37 CFR 1.321;
- has all claims canceled by a reexamination certificate;
- is reissued; or
- is in any manner terminated prior to the expiration of its full statutory term as presently shortened by any terminal disclaimer.

Check either box 1 or 2 below, if appropriate.

- 1. For submissions on behalf of a business/organization (e.g., corporation, partnership, university, government agency, etc.), the undersigned is empowered to act on behalf of the business/organization.

I hereby declare that all statements made herein of my own knowledge are true and that all statements made on information and belief are believed to be true; and further that these statements were made with the knowledge that willful false statements and the like so made are punishable by fine or imprisonment, or both, under Section 1001 of Title 18 of the United States Code and that such willful false statements may jeopardize the validity of the application or any patent issued thereon.

- 2. The undersigned is an attorney or agent of record. Reg. No. 46,901

 Signature

 Date

Michael C. Martensen
Typed or printed name

(719) 448-5910
Telephone

- Terminal disclaimer fee under 37 CFR 1.20(d) is included.

WARNING: Information in this form may become public. Credit card information should not be included on this form. Provide credit card information and authorization on PTO-2038.

*Statement under 37 CFR 3.73(b) is required if terminal disclaimer is signed by the assignee (owner).
Form PTO/SB/96 may be used for making this certification. See MPEP § 324.

SEND TO: Commissioner for Patents, P.O. Box 1450, Alexandria, VA 22313-1450.

Electronic Patent Application Fee Transmittal

Application Number:	11733064
Filing Date:	09-Apr-2007
Title of Invention:	MULTI-ADAPTIVE PROCESSING SYSTEMS AND TECHNIQUES FOR ENHANCING PARALLELISM AND PERFORMANCE OF COMPUTATIONAL FUNCTIONS
First Named Inventor/Applicant Name:	Jon M. Huppenthal
Filer:	Michael Christian Martensen/Julie Lange
Attorney Docket Number:	SRC015 CON

Filed as Large Entity

Utility under 35 USC 111(a) Filing Fees

Description	Fee Code	Quantity	Amount	Sub-Total in USD(\$)
Basic Filing:				
Pages:				
Claims:				
Miscellaneous-Filing:				
Petition:				
Patent-Appeals-and-Interference:				
Post-Allowance-and-Post-Issuance:				
Extension-of-Time:				

Description	Fee Code	Quantity	Amount	Sub-Total in USD(\$)
Miscellaneous:				
Statutory disclaimer	1814	1	140	140
Total in USD (\$)				140

Electronic Acknowledgement Receipt

EFS ID:	5145907
Application Number:	11733064
International Application Number:	
Confirmation Number:	7527
Title of Invention:	MULTI-ADAPTIVE PROCESSING SYSTEMS AND TECHNIQUES FOR ENHANCING PARALLELISM AND PERFORMANCE OF COMPUTATIONAL FUNCTIONS
First Named Inventor/Applicant Name:	Jon M. Huppenthal
Customer Number:	25235
Filer:	Michael Christian Martensen/Julie Lange
Filer Authorized By:	Michael Christian Martensen
Attorney Docket Number:	SRC015 CON
Receipt Date:	13-APR-2009
Filing Date:	09-APR-2007
Time Stamp:	18:46:46
Application Type:	Utility under 35 USC 111(a)

Payment information:

Submitted with Payment	yes
Payment Type	Deposit Account
Payment was successfully received in RAM	\$140
RAM confirmation Number	4482
Deposit Account	501123
Authorized User	

The Director of the USPTO is hereby authorized to charge indicated fees and credit any overpayment as follows:

Charge any Additional Fees required under 37 C.F.R. Section 1.17 (Patent application and reexamination processing fees)

Charge any Additional Fees required under 37 C.F.R. Section 1.21 (Miscellaneous fees and charges)

File Listing:					
Document Number	Document Description	File Name	File Size(Bytes)/ Message Digest	Multi Part /.zip	Pages (if appl.)
1		DOC059.PDF	431122 4955d43acbdba2ac2c5324e477a23eeca6c2607c6	yes	13
Multipart Description/PDF files in .zip description					
Document Description			Start	End	
Amendment/Req. Reconsideration-After Non-Final Reject			1	1	
Claims			2	10	
Applicant Arguments/Remarks Made in an Amendment			11	12	
Terminal Disclaimer Filed			13	13	
Warnings:					
The page size in the PDF is too large. The pages should be 8.5 x 11 or A4. If this PDF is submitted, the pages will be resized upon entry into the Image File Wrapper and may affect subsequent processing					
Information:					
2	Fee Worksheet (PTO-06)	fee-info.pdf	30439 4c9a2e695917ec3783ba4f74aa0ae3eb1c243091	no	2
Warnings:					
Information:					
Total Files Size (in bytes):			461561		
<p>This Acknowledgement Receipt evidences receipt on the noted date by the USPTO of the indicated documents, characterized by the applicant, and including page counts, where applicable. It serves as evidence of receipt similar to a Post Card, as described in MPEP 503.</p> <p><u>New Applications Under 35 U.S.C. 111</u> If a new application is being filed and the application includes the necessary components for a filing date (see 37 CFR 1.53(b)-(d) and MPEP 506), a Filing Receipt (37 CFR 1.54) will be issued in due course and the date shown on this Acknowledgement Receipt will establish the filing date of the application.</p> <p><u>National Stage of an International Application under 35 U.S.C. 371</u> If a timely submission to enter the national stage of an international application is compliant with the conditions of 35 U.S.C. 371 and other applicable requirements a Form PCT/DO/EO/903 indicating acceptance of the application as a national stage submission under 35 U.S.C. 371 will be issued in addition to the Filing Receipt, in due course.</p> <p><u>New International Application Filed with the USPTO as a Receiving Office</u> If a new international application is being filed and the international application includes the necessary components for an international filing date (see PCT Article 11 and MPEP 1810), a Notification of the International Application Number and of the International Filing Date (Form PCT/RO/105) will be issued in due course, subject to prescriptions concerning national security, and the date shown on this Acknowledgement Receipt will establish the international filing date of the application.</p>					

Under the Paperwork Reduction Act of 1995, no persons are required to respond to a collection of information unless it displays a valid OMB control number.

PATENT APPLICATION FEE DETERMINATION RECORD Substitute for Form PTO-875	Application or Docket Number 11/733,064	Filing Date 04/09/2007	<input type="checkbox"/> To be Mailed
---	---	----------------------------------	---------------------------------------

APPLICATION AS FILED – PART I			OTHER THAN SMALL ENTITY			
	(Column 1)	(Column 2)	SMALL ENTITY <input type="checkbox"/>	OR		
FOR	NUMBER FILED	NUMBER EXTRA	RATE (\$)	FEE (\$)	RATE (\$)	FEE (\$)
<input type="checkbox"/> BASIC FEE <small>(37 CFR 1.16(a), (b), or (c))</small>	N/A	N/A	N/A		N/A	
<input type="checkbox"/> SEARCH FEE <small>(37 CFR 1.16(k), (l), or (m))</small>	N/A	N/A	N/A		N/A	
<input type="checkbox"/> EXAMINATION FEE <small>(37 CFR 1.16(o), (p), or (q))</small>	N/A	N/A	N/A		N/A	
TOTAL CLAIMS <small>(37 CFR 1.16(i))</small>	minus 20 =	*	X \$ =	OR	X \$ =	
INDEPENDENT CLAIMS <small>(37 CFR 1.16(h))</small>	minus 3 =	*	X \$ =		X \$ =	
<input type="checkbox"/> APPLICATION SIZE FEE <small>(37 CFR 1.16(s))</small>	If the specification and drawings exceed 100 sheets of paper, the application size fee due is \$250 (\$125 for small entity) for each additional 50 sheets or fraction thereof. See 35 U.S.C. 41(a)(1)(G) and 37 CFR 1.16(s).					
<input type="checkbox"/> MULTIPLE DEPENDENT CLAIM PRESENT <small>(37 CFR 1.16(j))</small>						
* If the difference in column 1 is less than zero, enter "0" in column 2.			TOTAL		TOTAL	

APPLICATION AS AMENDED – PART II					OTHER THAN SMALL ENTITY			
	(Column 1)	(Column 2)	(Column 3)		SMALL ENTITY	OR		
AMENDMENT	04/13/2009	CLAIMS REMAINING AFTER AMENDMENT	HIGHEST NUMBER PREVIOUSLY PAID FOR	PRESENT EXTRA	RATE (\$)	ADDITIONAL FEE (\$)	RATE (\$)	ADDITIONAL FEE (\$)
	Total <small>(37 CFR 1.16(i))</small>	* 52	Minus	** 52 = 0	X \$ =		OR	X \$52= 0
	Independent <small>(37 CFR 1.16(h))</small>	* 3	Minus	***3 = 0	X \$ =		OR	X \$220= 0
	<input type="checkbox"/> Application Size Fee <small>(37 CFR 1.16(s))</small>						OR	
	<input type="checkbox"/> FIRST PRESENTATION OF MULTIPLE DEPENDENT CLAIM <small>(37 CFR 1.16(j))</small>						OR	
					TOTAL ADD'L FEE		OR	TOTAL ADD'L FEE 0

	(Column 1)	(Column 2)	(Column 3)		SMALL ENTITY	OR		
AMENDMENT		CLAIMS REMAINING AFTER AMENDMENT	HIGHEST NUMBER PREVIOUSLY PAID FOR	PRESENT EXTRA	RATE (\$)	ADDITIONAL FEE (\$)	RATE (\$)	ADDITIONAL FEE (\$)
	Total <small>(37 CFR 1.16(i))</small>	*	Minus	** =	X \$ =		OR	X \$ =
	Independent <small>(37 CFR 1.16(h))</small>	*	Minus	*** =	X \$ =		OR	X \$ =
	<input type="checkbox"/> Application Size Fee <small>(37 CFR 1.16(s))</small>						OR	
	<input type="checkbox"/> FIRST PRESENTATION OF MULTIPLE DEPENDENT CLAIM <small>(37 CFR 1.16(j))</small>						OR	
					TOTAL ADD'L FEE		OR	TOTAL ADD'L FEE

* If the entry in column 1 is less than the entry in column 2, write "0" in column 3.
 ** If the "Highest Number Previously Paid For" IN THIS SPACE is less than 20, enter "20".
 *** If the "Highest Number Previously Paid For" IN THIS SPACE is less than 3, enter "3".
 The "Highest Number Previously Paid For" (Total or Independent) is the highest number found in the appropriate box in column 1.

Legal Instrument Examiner:
 /FREDERICK E. BRISCOE/

This collection of information is required by 37 CFR 1.16. The information is required to obtain or retain a benefit by the public which is to file (and by the USPTO to process) an application. Confidentiality is governed by 35 U.S.C. 122 and 37 CFR 1.14. This collection is estimated to take 12 minutes to complete, including gathering, preparing, and submitting the completed application form to the USPTO. Time will vary depending upon the individual case. Any comments on the amount of time you require to complete this form and/or suggestions for reducing this burden, should be sent to the Chief Information Officer, U.S. Patent and Trademark Office, U.S. Department of Commerce, P.O. Box 1450, Alexandria, VA 22313-1450. DO NOT SEND FEES OR COMPLETED FORMS TO THIS ADDRESS. **SEND TO: Commissioner for Patents, P.O. Box 1450, Alexandria, VA 22313-1450.**
 If you need assistance in completing the form, call 1-800-PTO-9199 and select option 2.

Application Number 	Application/Control No. 11/733,064	Applicant(s)/Patent under Reexamination HUPPENTHAL ET AL.

Document Code - DISQ	Internal Document – DO NOT MAIL
-----------------------------	--

TERMINAL DISCLAIMER	<input checked="" type="checkbox"/> APPROVED	<input type="checkbox"/> DISAPPROVED
Date Filed : 4/13/09	This patent is subject to a Terminal Disclaimer	

Approved/Disapproved by:
debbie

IN THE UNITED STATES PATENT AND TRADEMARK OFFICE

In re Application of: Jon M. Huppenthal and David E. Caliga

Serial No. 11/733,064

Filed: April 9, 2007

For: MULTI-ADAPTIVE PROCESSING SYSTEMS AND
TECHNIQUES FOR ENHANCING PARALLELISM AND
PERFORMANCE OF COMPUTATIONAL FUNCTIONS

Art Unit: 2183

Examiner: Eric Coleman

Confirmation No.: 7527

2nd SUPPLEMENTAL INFORMATION DISCLOSURE STATEMENT

Mail Stop Amendment
Commissioner for Patents
P.O. Box 1450
Alexandria, VA 22313-1450

Sir:

The Applicant submits the additional references noted on the enclosed forms PTO/SB/08A and PTO/SB/08B for the Examiner's consideration pursuant to the Applicant's duty of disclosure under 37 C.F.R. 1.97(b)(3). Because an office action has been mailed in this case, please charge deposit account no 50-1123 \$180, the fee believed required. Authorization is hereby granted to credit any overpayment or debit any underpayment of any fee required pursuant to this Supplemental Information Disclosure Statement to Deposit Account No. 50-1123.

Submission of the instant Supplemental Information Disclosure Statement is not a representation that a search has been made or that the cited information is, or is considered to be, material to patentability of the above application. A copy of the references listed on the enclosed form are attached.

Respectfully submitted,



Michael C. Martensen, Reg. No. 46901
HOGAN & HARTSON
One Tabor Center
1200 17th Street, Suite 1500
Denver, Colorado 80202
(719) 448-59XX Tel
(303) 899-7333 Fax

Date

13 April 2009

INFORMATION DISCLOSURE STATEMENT BY APPLICANT (Not for submission under 37 CFR 1.99)	Application Number		11733064
	Filing Date		2007-04-09
	First Named Inventor	Jon M. Huppenthal et al.	
	Art Unit		2183
	Examiner Name	Eric Coleman	
	Attorney Docket Number		SRC015 CON

U.S.PATENTS						
Examiner Initial*	Cite No	Patent Number	Kind Code ¹	Issue Date	Name of Patentee or Applicant of cited Document	Pages, Columns, Lines where Relevant Passages or Relevant Figures Appear
	1	5802290		1998-09-01	Casselman, Steven M.	
	2	4763294		1998-08-09	Fong, Anthony S.	
	3	5966534		1999-10-12	Cooke, et al.	
	4	6721884		2004-04-13	De Oliveira Kastrup Pereira, et al.	
	5	6704816		2004-03-09	Burke, David	
	6	5509134		1996-04-16	Fandrich, et al.	
	7	5953502		1999-09-14	Helbig, Sr., Walter A.	
	8	6128663		2000-10-03	Thomas	

INFORMATION DISCLOSURE STATEMENT BY APPLICANT (Not for submission under 37 CFR 1.99)	Application Number	11733064
	Filing Date	2007-04-09
	First Named Inventor	Jon M. Huppenthal et al.
	Art Unit	2183
	Examiner Name	Eric Coleman
	Attorney Docket Number	SRC015 CON

9	5715453	1998-02-03	Stewart
---	---------	------------	---------

If you wish to add additional U.S. Patent citation information please click the Add button.

U.S. PATENT APPLICATION PUBLICATIONS

Examiner Initial*	Cite No	Publication Number	Kind Code ¹	Publication Date	Name of Patentee or Applicant of cited Document	Pages, Columns, Lines where Relevant Passages or Relevant Figures Appear
	1					

If you wish to add additional U.S. Published Application citation information please click the Add button.

FOREIGN PATENT DOCUMENTS

Examiner Initial*	Cite No	Foreign Document Number ³	Country Code ² j	Kind Code ⁴	Publication Date	Name of Patentee or Applicant of cited Document	Pages, Columns, Lines where Relevant Passages or Relevant Figures Appear	T ⁵
	1							<input type="checkbox"/>

If you wish to add additional Foreign Patent Document citation information please click the Add button

NON-PATENT LITERATURE DOCUMENTS

Examiner Initials*	Cite No	Include name of the author (in CAPITAL LETTERS), title of the article (when appropriate), title of the item (book, magazine, journal, serial, symposium, catalog, etc), date, pages(s), volume-issue number(s), publisher, city and/or country where published.	T ⁵
	1	HASTIE, NEIL, et al., "The Implementation of Hardware Subroutines on Field Programmable Gate Arrays", XP010005485, Plessey Semiconductors, Tamerton Rd., Plymouth, Devon, England, IEEE, 13 MAY 1990, Custom Integrated Circuits Conference, pgs. 314. 1-4. *the whole document*	<input type="checkbox"/>
	2	HARBAUM, TILL, et al., "Design of a Flexible Coprocessor Unit", Institute of Operating Systems and Computer Networks, XP000879556TU Braunschweig, Germany, Proceedings of the Euromicro Conference, September 1999, pgs. 335-342. *whole document*	<input type="checkbox"/>
	3	MATHIAS P C; PATNAIK L M: "Systolic Evaluation of Polynomial Expressions," IEEE Transactions on Computers, vol. 39, no. 5, 1 May 1990, pgs. 653-665, XP000116659	<input type="checkbox"/>

Electronic Patent Application Fee Transmittal

Application Number:	11733064
Filing Date:	09-Apr-2007
Title of Invention:	MULTI-ADAPTIVE PROCESSING SYSTEMS AND TECHNIQUES FOR ENHANCING PARALLELISM AND PERFORMANCE OF COMPUTATIONAL FUNCTIONS
First Named Inventor/Applicant Name:	Jon M. Huppenthal
Filer:	Michael Christian Martensen/Julie Lange
Attorney Docket Number:	SRC015 CON

Filed as Large Entity

Utility under 35 USC 111(a) Filing Fees

Description	Fee Code	Quantity	Amount	Sub-Total in USD(\$)
Basic Filing:				
Pages:				
Claims:				
Miscellaneous-Filing:				
Petition:				
Patent-Appeals-and-Interference:				
Post-Allowance-and-Post-Issuance:				
Extension-of-Time:				

Description	Fee Code	Quantity	Amount	Sub-Total in USD(\$)
Miscellaneous:				
Submission- Information Disclosure Stmt	1806	1	180	180
Total in USD (\$)				180

Electronic Acknowledgement Receipt

EFS ID:	5176625
Application Number:	11733064
International Application Number:	
Confirmation Number:	7527
Title of Invention:	MULTI-ADAPTIVE PROCESSING SYSTEMS AND TECHNIQUES FOR ENHANCING PARALLELISM AND PERFORMANCE OF COMPUTATIONAL FUNCTIONS
First Named Inventor/Applicant Name:	Jon M. Huppenthal
Customer Number:	25235
Filer:	Michael Christian Martensen/Julie Lange
Filer Authorized By:	Michael Christian Martensen
Attorney Docket Number:	SRC015 CON
Receipt Date:	17-APR-2009
Filing Date:	09-APR-2007
Time Stamp:	17:30:06
Application Type:	Utility under 35 USC 111(a)

Payment information:

Submitted with Payment	yes
Payment Type	Deposit Account
Payment was successfully received in RAM	\$180
RAM confirmation Number	3472
Deposit Account	501123
Authorized User	

The Director of the USPTO is hereby authorized to charge indicated fees and credit any overpayment as follows:

Charge any Additional Fees required under 37 C.F.R. Section 1.17 (Patent application and reexamination processing fees)

Charge any Additional Fees required under 37 C.F.R. Section 1.21 (Miscellaneous fees and charges)

File Listing:					
Document Number	Document Description	File Name	File Size(Bytes)/ Message Digest	Multi Part /.zip	Pages (if appl.)
1	Information Disclosure Statement (IDS) Filed (SB/08)	DOC069.PDF	103559 d83626f7b43997221f68befdde46a15771d78256	no	3
Warnings:					
Information:					
This is not an USPTO supplied IDS fillable form					
2	NPL Documents	DOC070.PDF	224326 cf07ff87ac69101d9a0c957de82acee30d024654	no	4
Warnings:					
Information:					
3	NPL Documents	DOC071.PDF	400966 8624b0f51a9ef8aed94c0bdcb934c438c272a097	no	8
Warnings:					
Information:					
4	NPL Documents	DOC072.PDF	687215 6e1393f62664463b2ec734407045f66d1bd0bbac	no	13
Warnings:					
Information:					
5	Fee Worksheet (PTO-06)	fee-info.pdf	30689 ff12f71b751cd5d07957786c01cf2820de3ca5dd	no	2
Warnings:					
Information:					
Total Files Size (in bytes):			1446755		

This Acknowledgement Receipt evidences receipt on the noted date by the USPTO of the indicated documents, characterized by the applicant, and including page counts, where applicable. It serves as evidence of receipt similar to a Post Card, as described in MPEP 503.

New Applications Under 35 U.S.C. 111

If a new application is being filed and the application includes the necessary components for a filing date (see 37 CFR 1.53(b)-(d) and MPEP 506), a Filing Receipt (37 CFR 1.54) will be issued in due course and the date shown on this Acknowledgement Receipt will establish the filing date of the application.

National Stage of an International Application under 35 U.S.C. 371

If a timely submission to enter the national stage of an international application is compliant with the conditions of 35 U.S.C. 371 and other applicable requirements a Form PCT/DO/EO/903 indicating acceptance of the application as a national stage submission under 35 U.S.C. 371 will be issued in addition to the Filing Receipt, in due course.

New International Application Filed with the USPTO as a Receiving Office

If a new international application is being filed and the international application includes the necessary components for an international filing date (see PCT Article 11 and MPEP 1810), a Notification of the International Application Number and of the International Filing Date (Form PCT/RO/105) will be issued in due course, subject to prescriptions concerning national security, and the date shown on this Acknowledgement Receipt will establish the international filing date of the application.



NOTICE OF ALLOWANCE AND FEE(S) DUE

25235 7590 06/30/2009

HOGAN & HARTSON LLP
ONE TABOR CENTER, SUITE 1500
1200 SEVENTEENTH ST
DENVER, CO 80202

EXAMINER: COLEMAN, ERIC
ART UNIT: 2183
PAPER NUMBER:
DATE MAILED: 06/30/2009

Table with 5 columns: APPLICATION NO., FILING DATE, FIRST NAMED INVENTOR, ATTORNEY DOCKET NO., CONFIRMATION NO.

11/733,064 04/09/2007 Jon M. Huppenthal SRC015 CON 7527

TITLE OF INVENTION: MULTI-ADAPTIVE PROCESSING SYSTEMS AND TECHNIQUES FOR ENHANCING PARALLELISM AND PERFORMANCE OF COMPUTATIONAL FUNCTIONS

Table with 7 columns: APPLN. TYPE, SMALL ENTITY, ISSUE FEE DUE, PUBLICATION FEE DUE, PREV. PAID ISSUE FEE, TOTAL FEE(S) DUE, DATE DUE

nonprovisional NO \$1510 \$300 \$0 \$1810 09/30/2009

THE APPLICATION IDENTIFIED ABOVE HAS BEEN EXAMINED AND IS ALLOWED FOR ISSUANCE AS A PATENT. PROSECUTION ON THE MERITS IS CLOSED. THIS NOTICE OF ALLOWANCE IS NOT A GRANT OF PATENT RIGHTS. THIS APPLICATION IS SUBJECT TO WITHDRAWAL FROM ISSUE AT THE INITIATIVE OF THE OFFICE OR UPON PETITION BY THE APPLICANT. SEE 37 CFR 1.313 AND MPEP 1308.

THE ISSUE FEE AND PUBLICATION FEE (IF REQUIRED) MUST BE PAID WITHIN THREE MONTHS FROM THE MAILING DATE OF THIS NOTICE OR THIS APPLICATION SHALL BE REGARDED AS ABANDONED. THIS STATUTORY PERIOD CANNOT BE EXTENDED. SEE 35 U.S.C. 151. THE ISSUE FEE DUE INDICATED ABOVE DOES NOT REFLECT A CREDIT FOR ANY PREVIOUSLY PAID ISSUE FEE IN THIS APPLICATION. IF AN ISSUE FEE HAS PREVIOUSLY BEEN PAID IN THIS APPLICATION (AS SHOWN ABOVE), THE RETURN OF PART B OF THIS FORM WILL BE CONSIDERED A REQUEST TO REAPPLY THE PREVIOUSLY PAID ISSUE FEE TOWARD THE ISSUE FEE NOW DUE.

HOW TO REPLY TO THIS NOTICE:

I. Review the SMALL ENTITY status shown above.

If the SMALL ENTITY is shown as YES, verify your current SMALL ENTITY status:

A. If the status is the same, pay the TOTAL FEE(S) DUE shown above.

B. If the status above is to be removed, check box 5b on Part B - Fee(s) Transmittal and pay the PUBLICATION FEE (if required) and twice the amount of the ISSUE FEE shown above, or

If the SMALL ENTITY is shown as NO:

A. Pay TOTAL FEE(S) DUE shown above, or

B. If applicant claimed SMALL ENTITY status before, or is now claiming SMALL ENTITY status, check box 5a on Part B - Fee(s) Transmittal and pay the PUBLICATION FEE (if required) and 1/2 the ISSUE FEE shown above.

II. PART B - FEE(S) TRANSMITTAL, or its equivalent, must be completed and returned to the United States Patent and Trademark Office (USPTO) with your ISSUE FEE and PUBLICATION FEE (if required). If you are charging the fee(s) to your deposit account, section "4b" of Part B - Fee(s) Transmittal should be completed and an extra copy of the form should be submitted. If an equivalent of Part B is filed, a request to reapply a previously paid issue fee must be clearly made, and delays in processing may occur due to the difficulty in recognizing the paper as an equivalent of Part B.

III. All communications regarding this application must give the application number. Please direct all communications prior to issuance to Mail Stop ISSUE FEE unless advised to the contrary.

IMPORTANT REMINDER: Utility patents issuing on applications filed on or after Dec. 12, 1980 may require payment of maintenance fees. It is patentee's responsibility to ensure timely payment of maintenance fees when due.

PART B - FEE(S) TRANSMITTAL

Complete and send this form, together with applicable fee(s), to: Mail Mail Stop ISSUE FEE
Commissioner for Patents
P.O. Box 1450
Alexandria, Virginia 22313-1450
or Fax (571)-273-2885

INSTRUCTIONS: This form should be used for transmitting the ISSUE FEE and PUBLICATION FEE (if required). Blocks 1 through 5 should be completed where appropriate. All further correspondence including the Patent, advance orders and notification of maintenance fees will be mailed to the current correspondence address as indicated unless corrected below or directed otherwise in Block 1, by (a) specifying a new correspondence address; and/or (b) indicating a separate "FEE ADDRESS" for maintenance fee notifications.

CURRENT CORRESPONDENCE ADDRESS (Note: Use Block 1 for any change of address)

25235 7590 06/30/2009
HOGAN & HARTSON LLP
ONE TABOR CENTER, SUITE 1500
1200 SEVENTEENTH ST
DENVER, CO 80202

Note: A certificate of mailing can only be used for domestic mailings of the Fee(s) Transmittal. This certificate cannot be used for any other accompanying papers. Each additional paper, such as an assignment or formal drawing, must have its own certificate of mailing or transmission.

Certificate of Mailing or Transmission

I hereby certify that this Fee(s) Transmittal is being deposited with the United States Postal Service with sufficient postage for first class mail in an envelope addressed to the Mail Stop ISSUE FEE address above, or being facsimile transmitted to the USPTO (571) 273-2885, on the date indicated below.

Form with fields for Depositor's name, Signature, and Date.

Table with 5 columns: APPLICATION NO., FILING DATE, FIRST NAMED INVENTOR, ATTORNEY DOCKET NO., CONFIRMATION NO.

11/733,064 04/09/2007 Jon M. Huppenthal SRC015 CON 7527
TITLE OF INVENTION: MULTI-ADAPTIVE PROCESSING SYSTEMS AND TECHNIQUES FOR ENHANCING PARALLELISM AND PERFORMANCE OF COMPUTATIONAL FUNCTIONS

Table with 7 columns: APPLN. TYPE, SMALL ENTITY, ISSUE FEE DUE, PUBLICATION FEE DUE, PREV. PAID ISSUE FEE, TOTAL FEE(S) DUE, DATE DUE.

Table with 3 columns: EXAMINER, ART UNIT, CLASS-SUBCLASS.

1. Change of correspondence address or indication of "Fee Address" (37 CFR 1.363).
2. For printing on the patent front page, list
(1) the names of up to 3 registered patent attorneys or agents OR, alternatively,
(2) the name of a single firm (having as a member a registered attorney or agent) and the names of up to 2 registered patent attorneys or agents. If no name is listed, no name will be printed.

3. ASSIGNEE NAME AND RESIDENCE DATA TO BE PRINTED ON THE PATENT (print or type)
PLEASE NOTE: Unless an assignee is identified below, no assignee data will appear on the patent. If an assignee is identified below, the document has been filed for recordation as set forth in 37 CFR 3.11. Completion of this form is NOT a substitute for filing an assignment.
(A) NAME OF ASSIGNEE (B) RESIDENCE: (CITY AND STATE OR COUNTRY)

Please check the appropriate assignee category or categories (will not be printed on the patent): Individual Corporation or other private group entity Government

4a. The following fee(s) are submitted: Issue Fee, Publication Fee, Advance Order.
4b. Payment of Fee(s): A check is enclosed, Payment by credit card, The Director is hereby authorized to charge the required fee(s), any deficiency, or credit any overpayment, to Deposit Account Number.

5. Change in Entity Status (from status indicated above)
a. Applicant claims SMALL ENTITY status. See 37 CFR 1.27.
b. Applicant is no longer claiming SMALL ENTITY status. See 37 CFR 1.27(g)(2).

NOTE: The Issue Fee and Publication Fee (if required) will not be accepted from anyone other than the applicant; a registered attorney or agent; or the assignee or other party in interest as shown by the records of the United States Patent and Trademark Office.

Authorized Signature Date
Typed or printed name Registration No.

This collection of information is required by 37 CFR 1.311. The information is required to obtain or retain a benefit by the public which is to file (and by the USPTO to process) an application. Confidentiality is governed by 35 U.S.C. 122 and 37 CFR 1.14. This collection is estimated to take 12 minutes to complete, including gathering, preparing, and submitting the completed application form to the USPTO. Time will vary depending upon the individual case. Any comments on the amount of time you require to complete this form and/or suggestions for reducing this burden, should be sent to the Chief Information Officer, U.S. Patent and Trademark Office, U.S. Department of Commerce, P.O. Box 1450, Alexandria, Virginia 22313-1450. DO NOT SEND FEES OR COMPLETED FORMS TO THIS ADDRESS. SEND TO: Commissioner for Patents, P.O. Box 1450, Alexandria, Virginia 22313-1450.

Under the Paperwork Reduction Act of 1995, no persons are required to respond to a collection of information unless it displays a valid OMB control number.



UNITED STATES PATENT AND TRADEMARK OFFICE

UNITED STATES DEPARTMENT OF COMMERCE
United States Patent and Trademark Office
Address: COMMISSIONER FOR PATENTS
P. O. Box 1450
Alexandria, Virginia 22313-1450
www.uspto.gov

Table with columns: APPLICATION NO., FILING DATE, FIRST NAMED INVENTOR, ATTORNEY DOCKET NO., CONFIRMATION NO.
11/733,064 04/09/2007 Jon M. Huppenthal SRC015 CON 7527
25235 7590 06/30/2009
HOGAN & HARTSON LLP
ONE TABOR CENTER, SUITE 1500
1200 SEVENTEENTH ST
DENVER, CO 80202
EXAMINER COLEMAN, ERIC
ART UNIT 2183 PAPER NUMBER
DATE MAILED: 06/30/2009

Determination of Patent Term Adjustment under 35 U.S.C. 154 (b)
(application filed on or after May 29, 2000)

The Patent Term Adjustment to date is 212 day(s). If the issue fee is paid on the date that is three months after the mailing date of this notice and the patent issues on the Tuesday before the date that is 28 weeks (six and a half months) after the mailing date of this notice, the Patent Term Adjustment will be 212 day(s).

If a Continued Prosecution Application (CPA) was filed in the above-identified application, the filing date that determines Patent Term Adjustment is the filing date of the most recent CPA.

Applicant will be able to obtain more detailed information by accessing the Patent Application Information Retrieval (PAIR) WEB site (http://pair.uspto.gov).

Any questions regarding the Patent Term Extension or Adjustment determination should be directed to the Office of Patent Legal Administration at (571)-272-7702. Questions relating to issue and publication fee payments should be directed to the Customer Service Center of the Office of Patent Publication at 1-(888)-786-0101 or (571)-272-4200.

Interview Summary	Application No. 11/733,064	Applicant(s) HUPPENTHAL ET AL.	
	Examiner Eric Coleman	Art Unit 2183	

All participants (applicant, applicant's representative, PTO personnel):

(1) Eric Coleman. (3)_____.

(2) Michael C. Martensen (Reg. No. 46,901). (4)_____.

Date of Interview: 24 June 2009.

Type: a) Telephonic b) Video Conference
c) Personal [copy given to: 1) applicant 2) applicant's representative]

Exhibit shown or demonstration conducted: d) Yes e) No.
If Yes, brief description: _____.

Claim(s) discussed: None.

Identification of prior art discussed: NA.

Agreement with respect to the claims f) was reached. g) was not reached. h) N/A.

Substance of Interview including description of the general nature of what was agreed to if an agreement was reached, or any other comments: Examiner indicated that the text of literal legends of drawing figure 1 were not aligned. Counsel indicated the problem was probably due to a problem with the electronic submission of the drawing and agreed to resubmit the drawing.

(A fuller description, if necessary, and a copy of the amendments which the examiner agreed would render the claims allowable, if available, must be attached. Also, where no copy of the amendments that would render the claims allowable is available, a summary thereof must be attached.)

THE FORMAL WRITTEN REPLY TO THE LAST OFFICE ACTION MUST INCLUDE THE SUBSTANCE OF THE INTERVIEW. (See MPEP Section 713.04). If a reply to the last Office action has already been filed, APPLICANT IS GIVEN A NON-EXTENDABLE PERIOD OF THE LONGER OF ONE MONTH OR THIRTY DAYS FROM THIS INTERVIEW DATE, OR THE MAILING DATE OF THIS INTERVIEW SUMMARY FORM, WHICHEVER IS LATER, TO FILE A STATEMENT OF THE SUBSTANCE OF THE INTERVIEW. See Summary of Record of Interview requirements on reverse side or on attached sheet.

/Eric Coleman/
Primary Examiner, Art Unit 2183

Notice of Allowability

Application No.

11/733,064

Examiner

Eric Coleman

Applicant(s)

HUPPENTHAL ET AL.

Art Unit

2183

-- The MAILING DATE of this communication appears on the cover sheet with the correspondence address--

All claims being allowable, PROSECUTION ON THE MERITS IS (OR REMAINS) CLOSED in this application. If not included herewith (or previously mailed), a Notice of Allowance (PTOL-85) or other appropriate communication will be mailed in due course. **THIS NOTICE OF ALLOWABILITY IS NOT A GRANT OF PATENT RIGHTS.** This application is subject to withdrawal from issue at the initiative of the Office or upon petition by the applicant. See 37 CFR 1.313 and MPEP 1308.

- 1. This communication is responsive to terminal disclaimer filed 4/13/09.
- 2. The allowed claim(s) is/are 1-52.
- 3. Acknowledgment is made of a claim for foreign priority under 35 U.S.C. § 119(a)-(d) or (f).
 - a) All b) Some* c) None of the:
 - 1. Certified copies of the priority documents have been received.
 - 2. Certified copies of the priority documents have been received in Application No. _____.
 - 3. Copies of the certified copies of the priority documents have been received in this national stage application from the International Bureau (PCT Rule 17.2(a)).

* Certified copies not received: _____.

Applicant has THREE MONTHS FROM THE "MAILING DATE" of this communication to file a reply complying with the requirements noted below. Failure to timely comply will result in ABANDONMENT of this application.

THIS THREE-MONTH PERIOD IS NOT EXTENDABLE.

- 4. A SUBSTITUTE OATH OR DECLARATION must be submitted. Note the attached EXAMINER'S AMENDMENT or NOTICE OF INFORMAL PATENT APPLICATION (PTO-152) which gives reason(s) why the oath or declaration is deficient.
 - 5. CORRECTED DRAWINGS (as "replacement sheets") must be submitted.
 - (a) including changes required by the Notice of Draftsperson's Patent Drawing Review (PTO-948) attached
 - 1) hereto or 2) to Paper No./Mail Date _____.
 - (b) including changes required by the attached Examiner's Amendment / Comment or in the Office action of Paper No./Mail Date _____.
- Identifying indicia such as the application number (see 37 CFR 1.84(c)) should be written on the drawings in the front (not the back) of each sheet. Replacement sheet(s) should be labeled as such in the header according to 37 CFR 1.121(d).**
- 6. DEPOSIT OF and/or INFORMATION about the deposit of BIOLOGICAL MATERIAL must be submitted. Note the attached Examiner's comment regarding REQUIREMENT FOR THE DEPOSIT OF BIOLOGICAL MATERIAL.

Attachment(s)

- 1. Notice of References Cited (PTO-892)
- 2. Notice of Draftsperson's Patent Drawing Review (PTO-948)
- 3. Information Disclosure Statements (PTO/SB/08), Paper No./Mail Date 4/17/09
- 4. Examiner's Comment Regarding Requirement for Deposit of Biological Material
- 5. Notice of Informal Patent Application
- 6. Interview Summary (PTO-413), Paper No./Mail Date _____.
- 7. Examiner's Amendment/Comment
- 8. Examiner's Statement of Reasons for Allowance
- 9. Other _____.

/Eric Coleman/
Primary Examiner, Art Unit 2183

EXAMINER'S AMENDMENT

An examiner's amendment to the record appears below. Should the changes and/or additions be unacceptable to applicant, an amendment may be filed as provided by 37 CFR 1.312. To ensure consideration of such an amendment, it **MUST** be submitted no later than the payment of the issue fee.

The following changes to the drawings have been approved by the examiner and agreed upon by applicant: Correction of the alignment of the text of literal legends in figure 1 is required. In order to avoid abandonment of the application, applicant must make these above agreed upon drawing changes.

Any inquiry concerning this communication or earlier communications from the examiner should be directed to Eric Coleman whose telephone number is (571) 272-4163. The examiner can normally be reached on Monday-Thursday.

If attempts to reach the examiner by telephone are unsuccessful, the examiner's supervisor, Eddie Chan can be reached on (571) 272-4162. The fax phone number for the organization where this application or proceeding is assigned is 571-273-8300.

Art Unit: 2183

Information regarding the status of an application may be obtained from the Patent Application Information Retrieval (PAIR) system. Status information for published applications may be obtained from either Private PAIR or Public PAIR. Status information for unpublished applications is available through Private PAIR only. For more information about the PAIR system, see <http://pair-direct.uspto.gov>. Should you have questions on access to the Private PAIR system, contact the Electronic Business Center (EBC) at 866-217-9197 (toll-free). If you would like assistance from a USPTO Customer Service Representative or access to the automated information system, call 800-786-9199 (IN USA OR CANADA) or 571-272-1000.

EC

/Eric Coleman/
Primary Examiner, Art Unit 2183

Issue Classification 	Application/Control No. 11733064	Applicant(s)/Patent Under Reexamination HUPPENTHAL ET AL.
	Examiner Eric Coleman	Art Unit 2183

ORIGINAL					INTERNATIONAL CLASSIFICATION														
CLASS		SUBCLASS			CLAIMED					NON-CLAIMED									
712		226			G	0	6	F	15 / 82 (2006.01.01)										
CROSS REFERENCE(S)																			
CLASS	SUBCLASS (ONE SUBCLASS PER BLOCK)																		

<input checked="" type="checkbox"/> Claims renumbered in the same order as presented by applicant <input type="checkbox"/> CPA <input checked="" type="checkbox"/> T.D. <input type="checkbox"/> R.1.47															
Final	Original	Final	Original	Final	Original	Final	Original	Final	Original	Final	Original	Final	Original	Final	Original
1	1	17	17	33	33	49	49								
2	2	18	18	34	34	50	50								
3	3	19	19	35	35	51	51								
4	4	20	20	36	36	52	52								
5	5	21	21	37	37										
6	6	22	22	38	38										
7	7	23	23	39	39										
8	8	24	24	40	40										
9	9	25	25	41	41										
10	10	26	26	42	42										
11	11	27	27	43	43										
12	12	28	28	44	44										
13	13	29	29	45	45										
14	14	30	30	46	46										
15	15	31	31	47	47										
16	16	32	32	48	48										

NONE		Total Claims Allowed:	
		52	
(Assistant Examiner)	(Date)	O.G. Print Claim(s)	O.G. Print Figure
/Eric Coleman/ Primary Examiner.Art Unit 2183	6/24/09	1	2
(Primary Examiner)	(Date)		

EAST Search History

Ref #	Hits	Search Query	DBs	Default Operator	Plurals	Time Stamp
L1	72759	data adj (driven or flow)	US-PGPUB; USPAT	OR	OFF	2009/06/23 17:23
L2	17352	systolic	US-PGPUB; USPAT	OR	OFF	2009/06/23 17:23
L3	89264	1 or 2	US-PGPUB; USPAT	OR	OFF	2009/06/23 17:23
L4	81191	process\$3 adj element\$1 or (function\$2 adj unit \$1)	US-PGPUB; USPAT	OR	OFF	2009/06/23 17:24
L5	1922448	multiple or plural \$3 near3 dimens \$5	US-PGPUB; USPAT	OR	OFF	2009/06/23 17:24
L6	45503	(multiple or plural \$3) near3 dimens \$5	US-PGPUB; USPAT	OR	OFF	2009/06/23 17:24
L7	1551	4 and 6	US-PGPUB; USPAT	OR	OFF	2009/06/23 17:25
L8	1450	(concurrent\$3 or simultaneous\$1) near3 loop\$3	US-PGPUB; USPAT	OR	OFF	2009/06/23 17:25
L9	4	7 and 8	US-PGPUB; USPAT	OR	OFF	2009/06/23 17:25
L10	3	1 and 9	US-PGPUB; USPAT	OR	OFF	2009/06/23 17:25
L11	591	712/226.ccls.	US-PGPUB; USPAT	OR	OFF	2009/06/23 17:25
L12	282	712/15.ccls.	US-PGPUB; USPAT	OR	OFF	2009/06/23 17:26
L13	57	712/19.ccls.	US-PGPUB; USPAT	OR	OFF	2009/06/23 17:26
L14	588	712/215.ccls.	US-PGPUB; USPAT	OR	OFF	2009/06/23 17:26
L15	1490	11 or 12 or 13 or 14	US-PGPUB; USPAT	OR	OFF	2009/06/23 17:26
L16	297	1 and 15	US-PGPUB; USPAT	OR	OFF	2009/06/23 17:27
L17	3	8 and 16	US-PGPUB; USPAT	OR	OFF	2009/06/23 17:27

L18	8453	cluster\$3 and 1	US-PGPUB; USPAT	OR	OFF	2009/06/23 17:27
L19	3812	column\$3 and 18	US-PGPUB; USPAT	OR	OFF	2009/06/23 17:28
L20	34	wavefront and 19	US-PGPUB; USPAT	OR	OFF	2009/06/23 17:28
L21	4971	routing near3 resource\$1	US-PGPUB; USPAT	OR	OFF	2009/06/23 17:29
L22	8	20 and 21	US-PGPUB; USPAT	OR	OFF	2009/06/23 17:29
L23	0	variable adj2 "not" adj change	US-PGPUB; USPAT	OR	OFF	2009/06/23 17:30
L24	31	16 and 19	US-PGPUB; USPAT	OR	OFF	2009/06/23 17:31
L25	113600	column\$1	EPO; JPO; IBM_TDB	OR	OFF	2009/06/23 17:33
L26	3184	data adj (driven or flow)	EPO; JPO; IBM_TDB	OR	OFF	2009/06/23 17:33
L27	62	25 and 26	EPO; JPO; IBM_TDB	OR	OFF	2009/06/23 17:33
L28	4	rout\$3 and 27	EPO; JPO; IBM_TDB	OR	OFF	2009/06/23 17:34
L29	0	variable and 28	EPO; JPO; IBM_TDB	OR	OFF	2009/06/23 17:34

6/ 23/ 2009 5:36:11 PM

INFORMATION DISCLOSURE STATEMENT BY APPLICANT (Not for submission under 37 CFR 1.99)	Application Number		11733064
	Filing Date		2007-04-09
	First Named Inventor	Jon M. Huppenthal et al.	
	Art Unit		2183
	Examiner Name	Eric Coleman	
	Attorney Docket Number		SRC015 CON

U.S.PATENTS

Examiner Initial*	Cite No	Patent Number	Kind Code ¹	Issue Date	Name of Patentee or Applicant of cited Document	Pages, Columns, Lines where Relevant Passages or Relevant Figures Appear
/E.C./	1	5802290		1998-09-01	Casselman, Steven M.	
/E.C./	2	4763294		1998-08-09	Fong, Anthony S.	
/E.C./	3	5966534		1999-10-12	Cooke, et al.	
/E.C./	4	6721884		2004-04-13	De Oliveira Kastrup Pereira, et al.	
/E.C./	5	6704816		2004-03-09	Burke, David	
/E.C./	6	5509134		1996-04-16	Fandrich, et al.	
/E.C./	7	5953502		1999-09-14	Helbig, Sr., Walter A.	
/E.C./	8	6128663		2000-10-03	Thomas	

INFORMATION DISCLOSURE STATEMENT BY APPLICANT (Not for submission under 37 CFR 1.99)	Application Number	11733064
	Filing Date	2007-04-09
	First Named Inventor	Jon M. Huppenthal et al.
	Art Unit	2183
	Examiner Name	Eric Coleman
	Attorney Docket Number	SRC015 CON

/E.C./	9	5715453		1998-02-03	Stewart	
--------	---	---------	--	------------	---------	--

If you wish to add additional U.S. Patent citation information please click the Add button.

U.S.PATENT APPLICATION PUBLICATIONS

Examiner Initial*	Cite No	Publication Number	Kind Code ¹	Publication Date	Name of Patentee or Applicant of cited Document	Pages, Columns, Lines where Relevant Passages or Relevant Figures Appear
	1					

If you wish to add additional U.S. Published Application citation information please click the Add button.

FOREIGN PATENT DOCUMENTS

Examiner Initial*	Cite No	Foreign Document Number ³	Country Code ² j	Kind Code ⁴	Publication Date	Name of Patentee or Applicant of cited Document	Pages, Columns, Lines where Relevant Passages or Relevant Figures Appear	T ⁵
	1							<input type="checkbox"/>

If you wish to add additional Foreign Patent Document citation information please click the Add button

NON-PATENT LITERATURE DOCUMENTS

Examiner Initials*	Cite No	Include name of the author (in CAPITAL LETTERS), title of the article (when appropriate), title of the item (book, magazine, journal, serial, symposium, catalog, etc), date, pages(s), volume-issue number(s), publisher, city and/or country where published.	T ⁵
/E.C./	1	HASTIE, NEIL, et al., "The Implementation of Hardware Subroutines on Field Programmable Gate Arrays", XP010005485, Plessey Semiconductors, Tamerton Rd., Plymouth, Devon, England, IEEE, 13 MAY 1990, Custom Integrated Circuits Conference, pgs. 314. 1-4. *the whole document*	<input type="checkbox"/>
/E.C./	2	HARBAUM, TILL, et al., "Design of a Flexible Coprocessor Unit", Institute of Operating Systems and Computer Networks, XP000879556TU Braunschweig, Germany, Proceedings of the Euromicro Conference, September 1999, pgs. 335-342. *whole document*	<input type="checkbox"/>
/E.C./	3	MATHIAS P C; PATNAIK L M: "Systolic Evaluation of Polynomial Expressions," IEEE Transactions on Computers, vol. 39, no. 5, 1 May 1990, pgs. 653-665, XP000116659	<input type="checkbox"/>



UNITED STATES PATENT AND TRADEMARK OFFICE

UNITED STATES DEPARTMENT OF COMMERCE
 United States Patent and Trademark Office
 Address: COMMISSIONER FOR PATENTS
 P.O. Box 1450
 Alexandria, Virginia 22313-1450
 www.uspto.gov

BIB DATA SHEET

CONFIRMATION NO. 7527

SERIAL NUMBER 11/733,064	FILING or 371(c) DATE 04/09/2007 RULE	CLASS 712	GROUP ART UNIT 2183	ATTORNEY DOCKET NO. SRC015 CON	
APPLICANTS Jon M. Huppenthal, Colorado Springs, CO; David E. Caliga, Colorado Springs, CO; ** CONTINUING DATA ***** This application is a CON of 10/285,318 10/31/2002 PAT 7,225,324 ** FOREIGN APPLICATIONS ***** ** IF REQUIRED, FOREIGN FILING LICENSE GRANTED ** 04/20/2007					
Foreign Priority claimed <input type="checkbox"/> Yes <input checked="" type="checkbox"/> No 35 USC 119(a-d) conditions met <input type="checkbox"/> Yes <input checked="" type="checkbox"/> No Verified and Acknowledged <u>/ERIC COLEMAN/</u> Examiner's Signature	<input type="checkbox"/> Met after Allowance Initials _____	STATE OR COUNTRY CO	SHEETS DRAWINGS 20	TOTAL CLAIMS 52	INDEPENDENT CLAIMS 3
ADDRESS HOGAN & HARTSON LLP ONE TABOR CENTER, SUITE 1500 1200 SEVENTEENTH ST DENVER, CO 80202 UNITED STATES					
TITLE MULTI-ADAPTIVE PROCESSING SYSTEMS AND TECHNIQUES FOR ENHANCING PARALLELISM AND PERFORMANCE OF COMPUTATIONAL FUNCTIONS					
FILING FEE RECEIVED 2730	FEES: Authority has been given in Paper No. _____ to charge/credit DEPOSIT ACCOUNT No. _____ for following:		<input type="checkbox"/> All Fees <input type="checkbox"/> 1.16 Fees (Filing) <input type="checkbox"/> 1.17 Fees (Processing Ext. of time) <input type="checkbox"/> 1.18 Fees (Issue) <input type="checkbox"/> Other _____ <input type="checkbox"/> Credit		

Search Notes 	Application/Control No. 11733064	Applicant(s)/Patent Under Reexamination HUPPENTHAL ET AL.
	Examiner Eric Coleman	Art Unit 2183

SEARCHED			
Class	Subclass	Date	Examiner
712	226,15,19,215 (partial search via East classification search and key word search)	1/8/09	EC
updated above		6/23/09	EC

SEARCH NOTES			
Search Notes	Date	Examiner	
Searched East US Pat file US PG pub file	1/8/09	EC	
inventor name search	1/8/09	EC	
Searched Google Scholar	1/8/09	EC	
Consulted WQAS Padmanabhan Mano on possible 101 (mathematical algorithm)	1/8/09	EC	
Searched East US Pat file US PG Pub file EPO file JPO file IBM_TDB file	6/23/09	EC	
Searched Google Scholar (search terms data driven data flow wavefront systolic rate of change derivative column)	6/23/09	EC	
inventor name search	6/23/09	EC	

INTERFERENCE SEARCH			
Class	Subclass	Date	Examiner
712	226 (via East US PG pub file)	6/23/09	EC

--	--

Index of Claims 	Application/Control No. 11733064	Applicant(s)/Patent Under Reexamination HUPPENTHAL ET AL.
	Examiner Eric Coleman	Art Unit 2183

✓	Rejected
=	Allowed

-	Cancelled
÷	Restricted

N	Non-Elected
I	Interference

A	Appeal
O	Objected

Claims renumbered in the same order as presented by applicant
 CPA
 T.D.
 R.1.47

CLAIM		DATE							
Final	Original	01/08/2009	06/24/2009						
1	1	✓	=						
2	2	✓	=						
3	3	✓	=						
4	4	✓	=						
5	5	✓	=						
6	6	✓	=						
7	7	✓	=						
8	8	✓	=						
9	9	✓	=						
10	10	✓	=						
11	11	✓	=						
12	12	✓	=						
13	13	✓	=						
14	14	✓	=						
15	15	✓	=						
16	16	✓	=						
17	17	✓	=						
18	18	✓	=						
19	19	✓	=						
20	20	✓	=						
21	21	✓	=						
22	22	✓	=						
23	23	✓	=						
24	24	✓	=						
25	25	✓	=						
26	26	✓	=						
27	27	✓	=						
28	28	✓	=						
29	29	✓	=						
30	30	✓	=						
31	31	✓	=						
32	32	✓	=						
33	33	✓	=						
34	34	✓	=						
35	35	✓	=						
36	36	✓	=						

<i>Index of Claims</i> 	Application/Control No. 11733064	Applicant(s)/Patent Under Reexamination HUPPENTHAL ET AL.
	Examiner Eric Coleman	Art Unit 2183

✓	Rejected
=	Allowed

-	Cancelled
÷	Restricted

N	Non-Elected
I	Interference

A	Appeal
O	Objected

Claims renumbered in the same order as presented by applicant
 CPA
 T.D.
 R.1.47

CLAIM		DATE							
Final	Original	01/08/2009	06/24/2009						
37	37	✓	=						
38	38	✓	=						
39	39	✓	=						
40	40	✓	=						
41	41	✓	=						
42	42	✓	=						
43	43	✓	=						
44	44	✓	=						
45	45	✓	=						
46	46	✓	=						
47	47	✓	=						
48	48	✓	=						
49	49	✓	=						
50	50	✓	=						
51	51	✓	=						
52	52	✓	=						

IN THE UNITED STATES PATENT AND TRADEMARK OFFICE

Serial No. 11/733,064	Confirmation No.: 7527
Application of: Jon M. Huppenthal and David E. Caliga	Art Unit: 2183
Filed: April 9, 2007	Examiner: Coleman, Eric
Attorney Docket No. SRC015 CON	Customer No.: 25235
For: MULTI-ADAPTIVE PROCESSING SYSTEMS AND TECHNIQUES FOR ENHANCING PARALLELISM AND PERFORMANCE OF COMPUTATIONAL FUNCTIONS	

RE-SUBMISSION OF DRAWING FIG. 1

MAIL STOP ISSUE FEE
Commissioner for Patents
P.O. Box 1450
Alexandria, VA 22313-1450

Dear Sir:

The attached Fig. 1 drawing sheet should replace the previously filed Fig. 1as required by the Notice of Allowance. An annotated drawing is not included as no new matter has been added.

Attachment: Replacement Sheet

27 July 2009
Date

Michael C. Martensen, Reg. No. 46,901
HOGAN & HARTSON LLP
One Tabor Center
1200 17th Street, Suite 1500
Denver, Colorado 80202
(719) 448-5910 Tel
(303) 899-7333 Fax

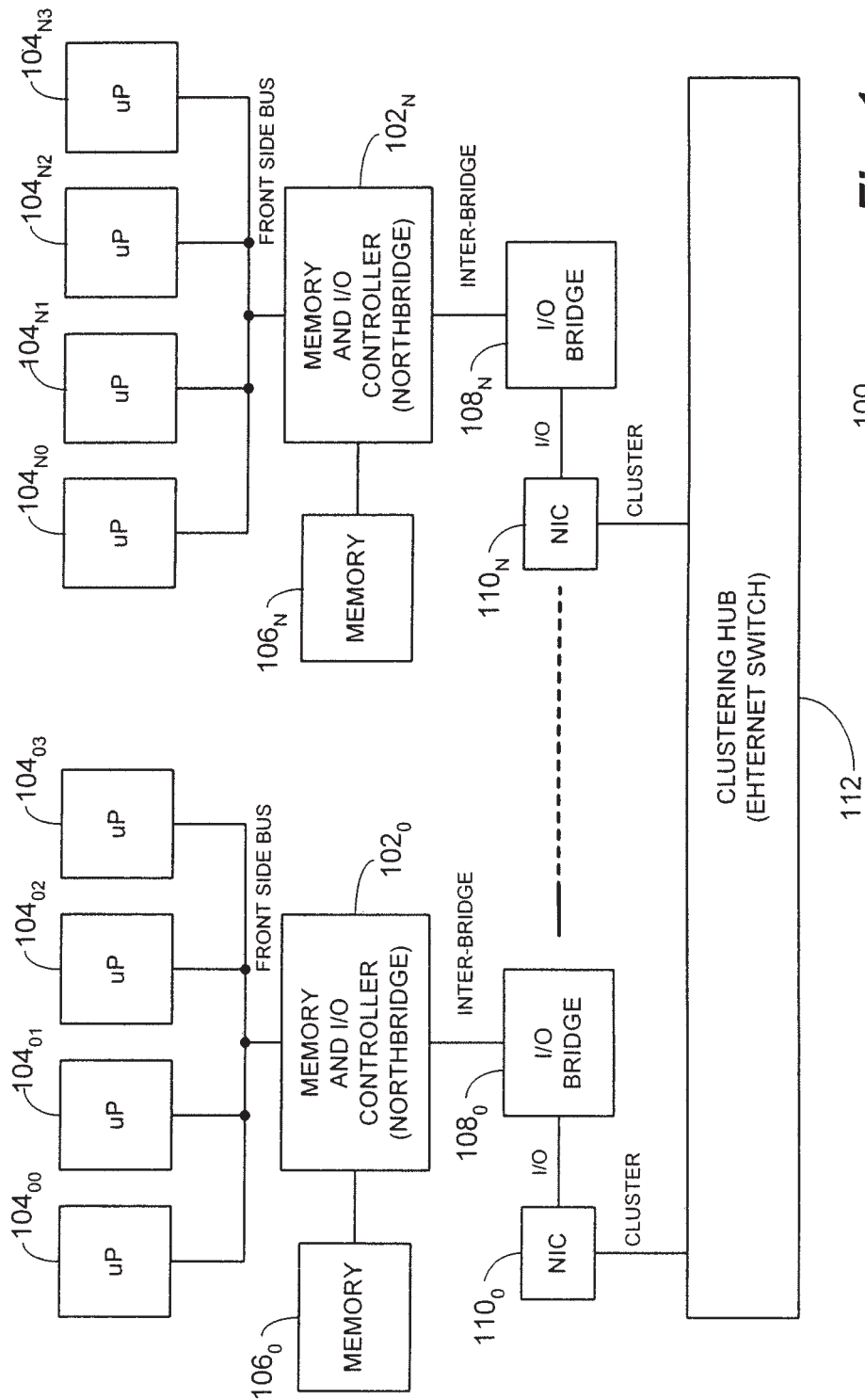

Fig. 1
 Prior Art

100

112

IN THE UNITED STATES PATENT AND TRADEMARK OFFICE

Serial No. 11/733,064 Application of: Jon M. Huppenthal and David E. Caliga Filed: April 9, 2007 Attorney Docket No. SRC015 CON For: MULTI-ADAPTIVE PROCESSING SYSTEMS AND TECHNIQUES FOR ENHANCING PARALLELISM AND PERFORMANCE OF COMPUTATIONAL FUNCTIONS	Confirmation No.: 7527 Art Unit: 2183 Examiner: Coleman, Eric Customer No.: 25235
---	---

INTERVIEW SUMMARY IN ACCORDANCE WITH 37 CFR 1.133

MAIL STOP ISSUE FEE
Commissioner for Patents
P.O. Box 1450
Alexandria, VA 22313-1450

Sir:

In response to the Interview Summary request mailed June 30, 2009, please enter the formal reply as follows:

On June 24, 2009 at approximately 10:45 AM EDT, a telephonic interview was conducted among Examiner Eric Coleman of the USPTO, and Michael C. Martensen, attorney representing the Applicant. The interview lasted about 15 minutes and concluded at approximately 11:00 AM EDT.

The Examiner's Interview Summary of June 30, 2009 is deemed to be substantially correct as to all of the pertinent facts regarding the interview.

No fee is believed due for this submittal. However, any fee deficiency associated with this submittal may be charged to Deposit Account No. 50-1123.

Respectfully submitted,

24 July, 2009



Michael C. Martensen, No. 46901
Hogan & Hartson LLP
One Tabor Center
1200 17th Street, Suite 1500
Denver, Colorado 80202
(719) 448-5910 Tel
(303) 899-7333 Fax

Electronic Acknowledgement Receipt

EFS ID:	5768920
Application Number:	11733064
International Application Number:	
Confirmation Number:	7527
Title of Invention:	MULTI-ADAPTIVE PROCESSING SYSTEMS AND TECHNIQUES FOR ENHANCING PARALLELISM AND PERFORMANCE OF COMPUTATIONAL FUNCTIONS
First Named Inventor/Applicant Name:	Jon M. Huppenthal
Customer Number:	25235
Filer:	Michael Christian Martensen/Julie Lange
Filer Authorized By:	Michael Christian Martensen
Attorney Docket Number:	SRC015 CON
Receipt Date:	24-JUL-2009
Filing Date:	09-APR-2007
Time Stamp:	18:58:44
Application Type:	Utility under 35 USC 111(a)

Payment information:

Submitted with Payment	no
------------------------	----

File Listing:

Document Number	Document Description	File Name	File Size(Bytes)/ Message Digest	Multi Part /.zip	Pages (if appl.)
1		DOC136.PDF	40398 <small>87f7d9546445c78f6d1d80e856543f4259b5f321</small>	yes	2

Multipart Description/PDF files in .zip description			
	Document Description	Start	End
	Miscellaneous Incoming Letter	1	1
	Drawings-only black and white line drawings	2	2

Warnings:

Information:

2	Applicant summary of interview with examiner	DOC137.PDF	33456 a0290e2674faea7ef9f0b0dfee9c5596e36796f2	no	1
---	--	------------	---	----	---

Warnings:

Information:

Total Files Size (in bytes):		73854
-------------------------------------	--	-------

This Acknowledgement Receipt evidences receipt on the noted date by the USPTO of the indicated documents, characterized by the applicant, and including page counts, where applicable. It serves as evidence of receipt similar to a Post Card, as described in MPEP 503.

New Applications Under 35 U.S.C. 111

If a new application is being filed and the application includes the necessary components for a filing date (see 37 CFR 1.53(b)-(d) and MPEP 506), a Filing Receipt (37 CFR 1.54) will be issued in due course and the date shown on this Acknowledgement Receipt will establish the filing date of the application.

National Stage of an International Application under 35 U.S.C. 371

If a timely submission to enter the national stage of an international application is compliant with the conditions of 35 U.S.C. 371 and other applicable requirements a Form PCT/DO/EO/903 indicating acceptance of the application as a national stage submission under 35 U.S.C. 371 will be issued in addition to the Filing Receipt, in due course.

New International Application Filed with the USPTO as a Receiving Office

If a new international application is being filed and the international application includes the necessary components for an international filing date (see PCT Article 11 and MPEP 1810), a Notification of the International Application Number and of the International Filing Date (Form PCT/RO/105) will be issued in due course, subject to prescriptions concerning national security, and the date shown on this Acknowledgement Receipt will establish the international filing date of the application.

Under the Paperwork Reduction Act of 1995, no persons are required to respond to a collection of information unless it contains a valid OMB control number.

INFORMATION DISCLOSURE STATEMENT BY APPLICANT (Not for submission under 37 CFR 1.99)	Application Number		11733064	
	Filing Date		2007-04-09	
	First Named Inventor	Jon M. Huppenthal et al.		
	Art Unit		2183	
	Examiner Name	Not Yet Assigned		
	Attorney Docket Number		SRC015CON	

U.S. PATENTS[Remove](#)

Examiner Initial*	Cite No	Patent Number	Kind Code ¹	Issue Date	Name of Patentee or Applicant of cited Document	Pages, Columns, Lines where Relevant Passages or Relevant Figures Appear
	1					

If you wish to add additional U.S. Patent citation information please click the Add button.

[Add](#)**U.S. PATENT APPLICATION PUBLICATIONS**[Remove](#)

Examiner Initial*	Cite No	Publication Number	Kind Code ¹	Publication Date	Name of Patentee or Applicant of cited Document	Pages, Columns, Lines where Relevant Passages or Relevant Figures Appear
	1					

If you wish to add additional U.S. Published Application citation information please click the Add button.

[Add](#)**FOREIGN PATENT DOCUMENTS**[Remove](#)

Examiner Initial*	Cite No	Foreign Document Number ³	Country Code ² j	Kind Code ⁴	Publication Date	Name of Patentee or Applicant of cited Document	Pages, Columns, Lines where Relevant Passages or Relevant Figures Appear	T ⁵
/E.C./	1	63-086079	JPX		1988-04-16	Nippon Telegr & Teleph Corp.		<input type="checkbox"/>
/E.C./	2	59-206972	JPX		1984-11-22	Toshiba Corp.		<input type="checkbox"/>

If you wish to add additional Foreign Patent Document citation information please click the Add button

[Add](#)**NON-PATENT LITERATURE DOCUMENTS**[Remove](#)

PART B - FEE(S) TRANSMITTAL

Complete and send this form, together with applicable fee(s), to: **Mail** Mail Stop ISSUE FEE
Commissioner for Patents
P.O. Box 1450
Alexandria, Virginia 22313-1450
or Fax (571)-273-2885

INSTRUCTIONS: This form should be used for transmitting the ISSUE FEE and PUBLICATION FEE (if required). Blocks 1 through 5 should be completed where appropriate. All further correspondence including the Patent, advance orders and notification of maintenance fees will be mailed to the current correspondence address as indicated unless corrected below or directed otherwise in Block 1, by (a) specifying a new correspondence address; and/or (b) indicating a separate "FEE ADDRESS" for maintenance fee notifications.

CURRENT CORRESPONDENCE ADDRESS (Note: Use Block 1 for any change of address)

Note: A certificate of mailing can only be used for domestic mailings of the Fee(s) Transmittal. This certificate cannot be used for any other accompanying papers. Each additional paper, such as an assignment or formal drawing, must have its own certificate of mailing or transmission.

25235 7590 06/30/2009

HOGAN & HARTSON LLP
 ONE TABOR CENTER, SUITE 1500
 1200 SEVENTEENTH ST
 DENVER, CO 80202

EFS-Web

Certificate of Mailing or Transmission

I hereby certify that this Fee(s) Transmittal is being deposited with the United States Postal Service with sufficient postage for first class mail in an envelope addressed to the Mail Stop ISSUE FEE address above, or being facsimile transmitted to the USPTO (571) 273-2885, on the date indicated below.

<u>Julie Lange</u>	(Depositor's name)
	(Signature)
14 September 2009	(Date)

APPLICATION NO.	FILING DATE	FIRST NAMED INVENTOR	ATTORNEY DOCKET NO.	CONFIRMATION NO.
11/733,064	04/09/2007	Jon M. Huppenthal	SRC015 CON	7527

TITLE OF INVENTION: MULTI-ADAPTIVE PROCESSING SYSTEMS AND TECHNIQUES FOR ENHANCING PARALLELISM AND PERFORMANCE OF COMPUTATIONAL FUNCTIONS

APPLN. TYPE	SMALL ENTITY	ISSUE FEE DUE	PUBLICATION FEE DUE	PREV. PAID ISSUE FEE	TOTAL FEE(S) DUE	DATE DUE
nonprovisional	NO	\$1510	\$300	\$0	\$1810	09/30/2009

EXAMINER	ART UNIT	CLASS-SUBCLASS
COLEMAN, ERIC	2183	712-226000

1. Change of correspondence address or indication of "Fee Address" (37 CFR 1.363).
 Change of correspondence address (or Change of Correspondence Address Form PTO/SB/122) attached.
 "Fee Address" indication (or "Fee Address" Indication form PTO/SB/47; Rev 03-02 or more recent) attached. **Use of a Customer Number is required.**

2. For printing on the patent front page, list
 (1) the names of up to 3 registered patent attorneys or agents OR, alternatively,
 (2) the name of a single firm (having as a member a registered attorney or agent) and the names of up to 2 registered patent attorneys or agents. If no name is listed, no name will be printed.

- 1 Michael C. Martensen
- 2 William J. Kubida
- 3 Hogan & Hartson LLP

3. ASSIGNEE NAME AND RESIDENCE DATA TO BE PRINTED ON THE PATENT (print or type)

PLEASE NOTE: Unless an assignee is identified below, no assignee data will appear on the patent. If an assignee is identified below, the document has been filed for recordation as set forth in 37 CFR 3.11. Completion of this form is NOT a substitute for filing an assignment.

(A) NAME OF ASSIGNEE: **SRC Computers, Inc.**
 (B) RESIDENCE: (CITY and STATE OR COUNTRY) **Colorado Springs, Colorado**

Please check the appropriate assignee category or categories (will not be printed on the patent): Individual Corporation or other private group entity Government

4a. The following fee(s) are submitted:

- Issue Fee
- Publication Fee (No small entity discount permitted)
- Advance Order - # of Copies _____

4b. Payment of Fee(s): (Please first reapply any previously paid issue fee shown above)

- A check is enclosed.
- Payment by credit card. Form PTO-2038 is attached.
- The Director is hereby authorized to charge the required fee(s), any deficiency, or credit any overpayment, to Deposit Account Number 50-1123 (enclose an extra copy of this form).

5. Change in Entity Status (from status indicated above)

- a. Applicant claims SMALL ENTITY status. See 37 CFR 1.27.
- b. Applicant is no longer claiming SMALL ENTITY status. See 37 CFR 1.27(g)(2).

NOTE: The Issue Fee and Publication Fee (if required) will not be accepted from anyone other than the applicant; a registered attorney or agent; or the assignee or other party in interest as shown by the records of the United States Patent and Trademark Office.

Authorized Signature
 Typed or printed name **Michael C. Martensen**

Date 14 Sep 2009
 Registration No. 46,901

This collection of information is required by 37 CFR 1.311. The information is required to obtain or retain a benefit by the public which is to file (and by the USPTO to process) an application. Confidentiality is governed by 35 U.S.C. 122 and 37 CFR 1.14. This collection is estimated to take 12 minutes to complete, including gathering, preparing, and submitting the completed application form to the USPTO. Time will vary depending upon the individual case. Any comments on the amount of time you require to complete this form and/or suggestions for reducing this burden, should be sent to the Chief Information Officer, U.S. Patent and Trademark Office, U.S. Department of Commerce, P.O. Box 1450, Alexandria, Virginia 22313-1450. DO NOT SEND FEES OR COMPLETED FORMS TO THIS ADDRESS. SEND TO: Commissioner for Patents, P.O. Box 1450, Alexandria, Virginia 22313-1450.

Under the Paperwork Reduction Act of 1995, no persons are required to respond to a collection of information unless it displays a valid OMB control number.

Electronic Patent Application Fee Transmittal

Application Number:	11733064
Filing Date:	09-Apr-2007
Title of Invention:	MULTI-ADAPTIVE PROCESSING SYSTEMS AND TECHNIQUES FOR ENHANCING PARALLELISM AND PERFORMANCE OF COMPUTATIONAL FUNCTIONS
First Named Inventor/Applicant Name:	Jon M. Huppenthal
Filer:	Peter John Meza/Julie Lange
Attorney Docket Number:	SRC015 CON

Filed as Large Entity

Utility under 35 USC 111(a) Filing Fees

Description	Fee Code	Quantity	Amount	Sub-Total in USD(\$)
Basic Filing:				
Pages:				
Claims:				
Miscellaneous-Filing:				
Petition:				
Patent-Appeals-and-Interference:				
Post-Allowance-and-Post-Issuance:				
Utility Appl issue fee	1501	1	1510	1510
Publ. Fee- early, voluntary, or normal	1504	1	300	300

Description	Fee Code	Quantity	Amount	Sub-Total in USD(\$)
Extension-of-Time:				
Miscellaneous:				
Total in USD (\$)				1810

Electronic Acknowledgement Receipt

EFS ID:	6070336
Application Number:	11733064
International Application Number:	
Confirmation Number:	7527
Title of Invention:	MULTI-ADAPTIVE PROCESSING SYSTEMS AND TECHNIQUES FOR ENHANCING PARALLELISM AND PERFORMANCE OF COMPUTATIONAL FUNCTIONS
First Named Inventor/Applicant Name:	Jon M. Huppenthal
Customer Number:	25235
Filer:	Peter John Meza/Julie Lange
Filer Authorized By:	Peter John Meza
Attorney Docket Number:	SRC015 CON
Receipt Date:	14-SEP-2009
Filing Date:	09-APR-2007
Time Stamp:	18:50:39
Application Type:	Utility under 35 USC 111(a)

Payment information:

Submitted with Payment	yes
Payment Type	Deposit Account
Payment was successfully received in RAM	\$1810
RAM confirmation Number	5089
Deposit Account	501123
Authorized User	

The Director of the USPTO is hereby authorized to charge indicated fees and credit any overpayment as follows:

Charge any Additional Fees required under 37 C.F.R. Section 1.17 (Patent application and reexamination processing fees)

Charge any Additional Fees required under 37 C.F.R. Section 1.21 (Miscellaneous fees and charges)

File Listing:					
Document Number	Document Description	File Name	File Size(Bytes)/ Message Digest	Multi Part /.zip	Pages (if appl.)
1	Issue Fee Payment (PTO-85B)	DOC029.PDF	90419 204e99d9938dfbb1b9d5416cc3f00e29c553c78a	no	1
Warnings:					
Information:					
2	Fee Worksheet (PTO-875)	fee-info.pdf	32096 b667285eb43931d06d2154cd5c933f7e7542a33e	no	2
Warnings:					
Information:					
Total Files Size (in bytes):			122515		
<p>This Acknowledgement Receipt evidences receipt on the noted date by the USPTO of the indicated documents, characterized by the applicant, and including page counts, where applicable. It serves as evidence of receipt similar to a Post Card, as described in MPEP 503.</p> <p><u>New Applications Under 35 U.S.C. 111</u> If a new application is being filed and the application includes the necessary components for a filing date (see 37 CFR 1.53(b)-(d) and MPEP 506), a Filing Receipt (37 CFR 1.54) will be issued in due course and the date shown on this Acknowledgement Receipt will establish the filing date of the application.</p> <p><u>National Stage of an International Application under 35 U.S.C. 371</u> If a timely submission to enter the national stage of an international application is compliant with the conditions of 35 U.S.C. 371 and other applicable requirements a Form PCT/DO/EO/903 indicating acceptance of the application as a national stage submission under 35 U.S.C. 371 will be issued in addition to the Filing Receipt, in due course.</p> <p><u>New International Application Filed with the USPTO as a Receiving Office</u> If a new international application is being filed and the international application includes the necessary components for an international filing date (see PCT Article 11 and MPEP 1810), a Notification of the International Application Number and of the International Filing Date (Form PCT/RO/105) will be issued in due course, subject to prescriptions concerning national security, and the date shown on this Acknowledgement Receipt will establish the international filing date of the application.</p>					

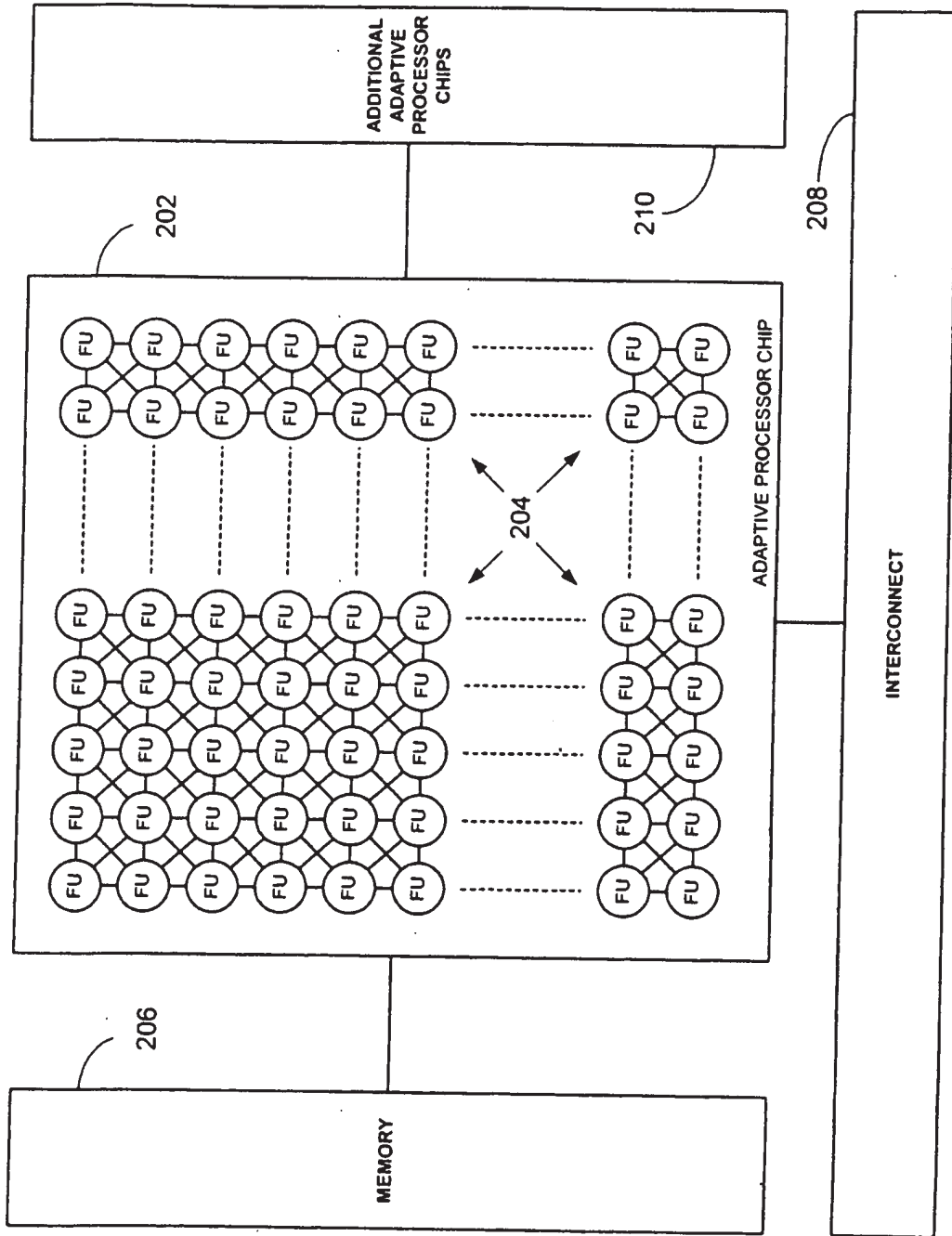

200 Fig. 2

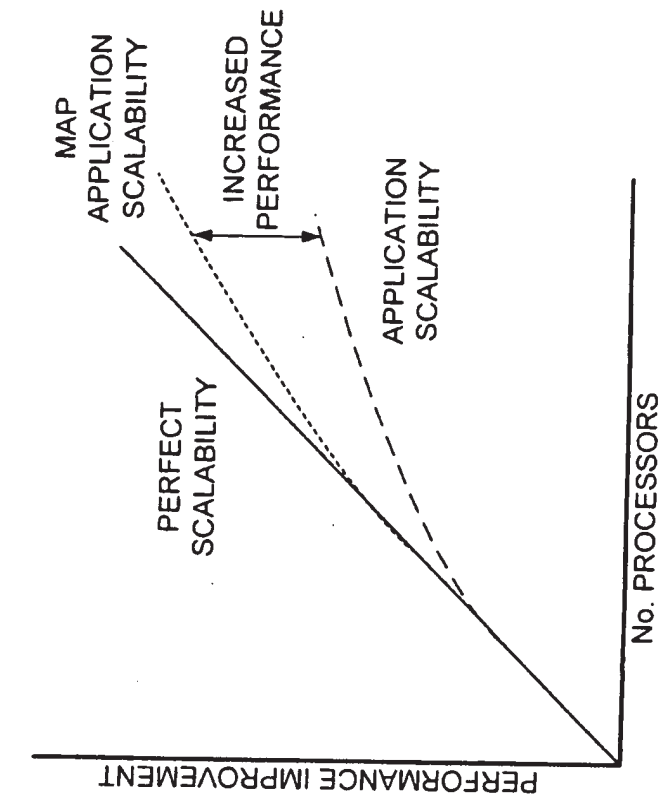

Fig. 3A
PRIOR ART

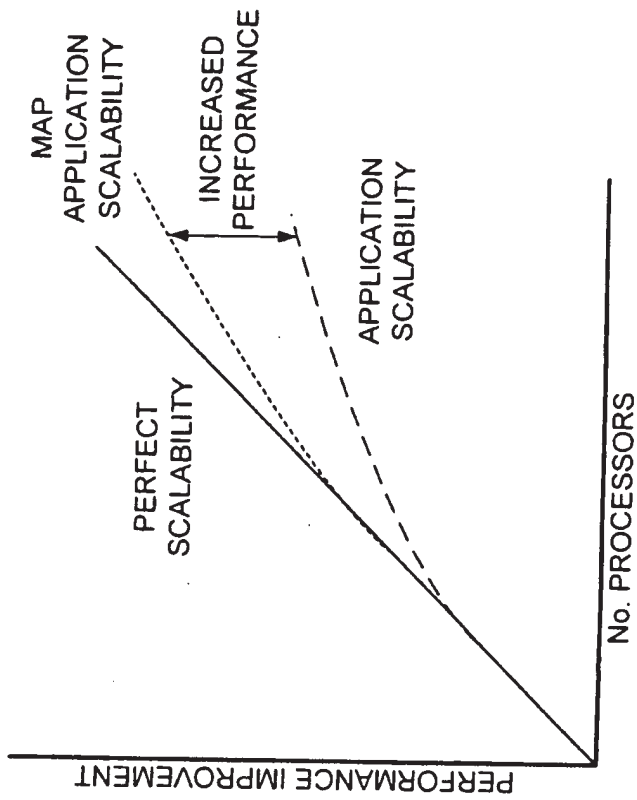
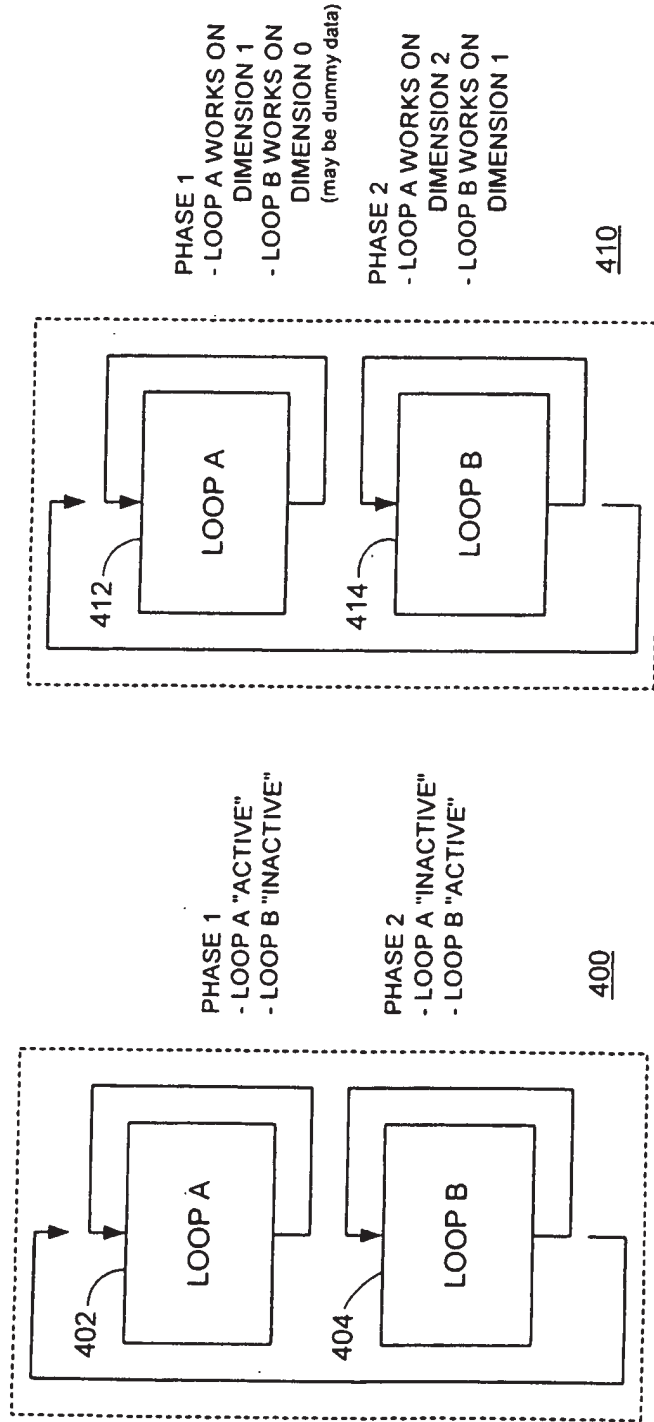

Fig. 3B



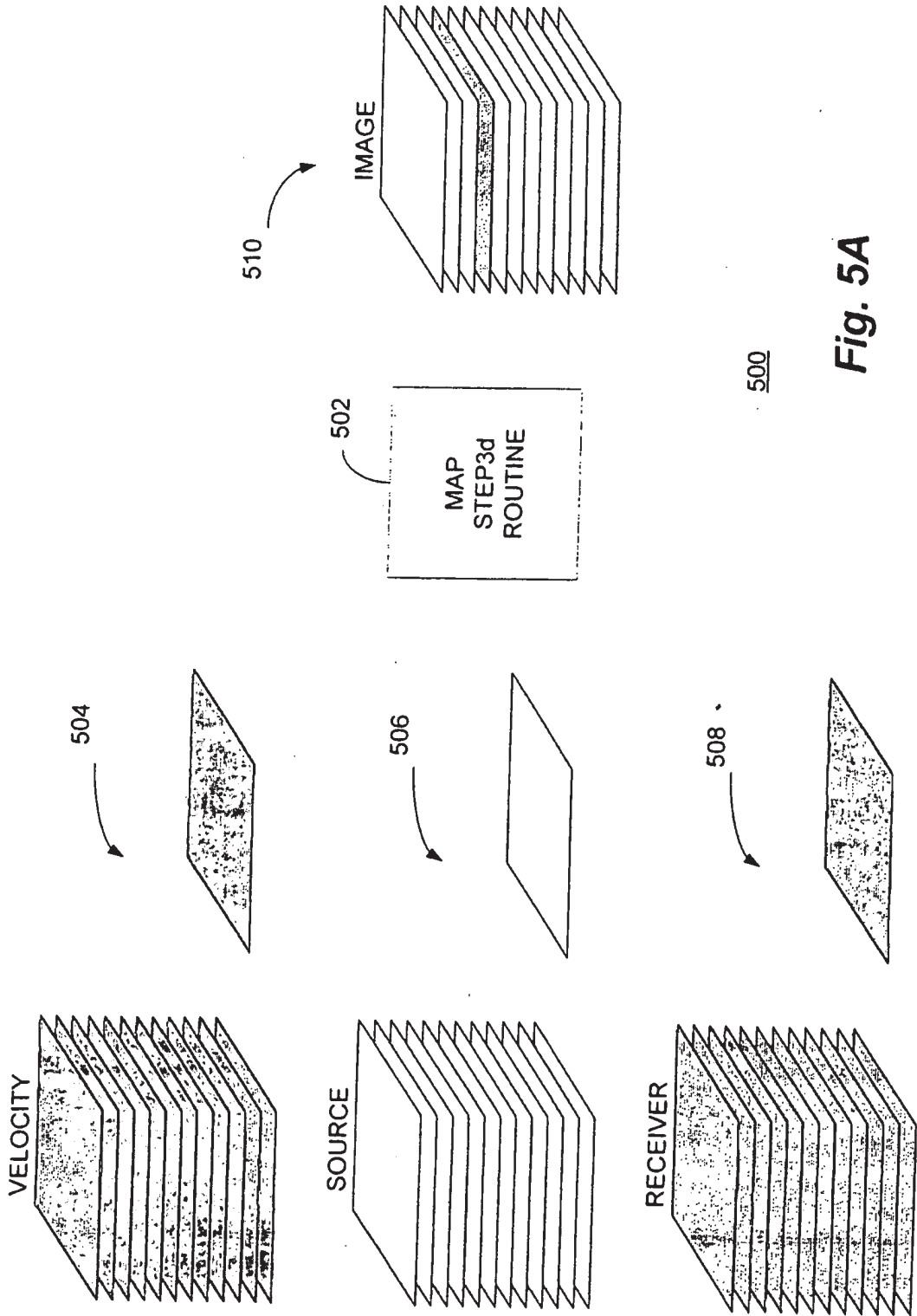

Fig. 5A

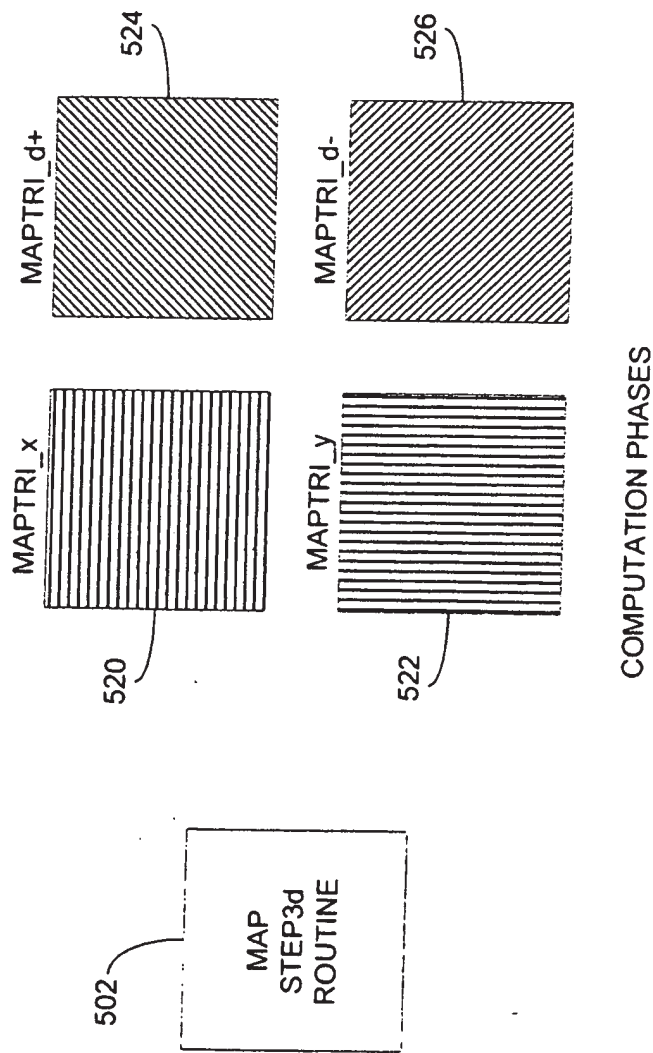

Fig. 5B

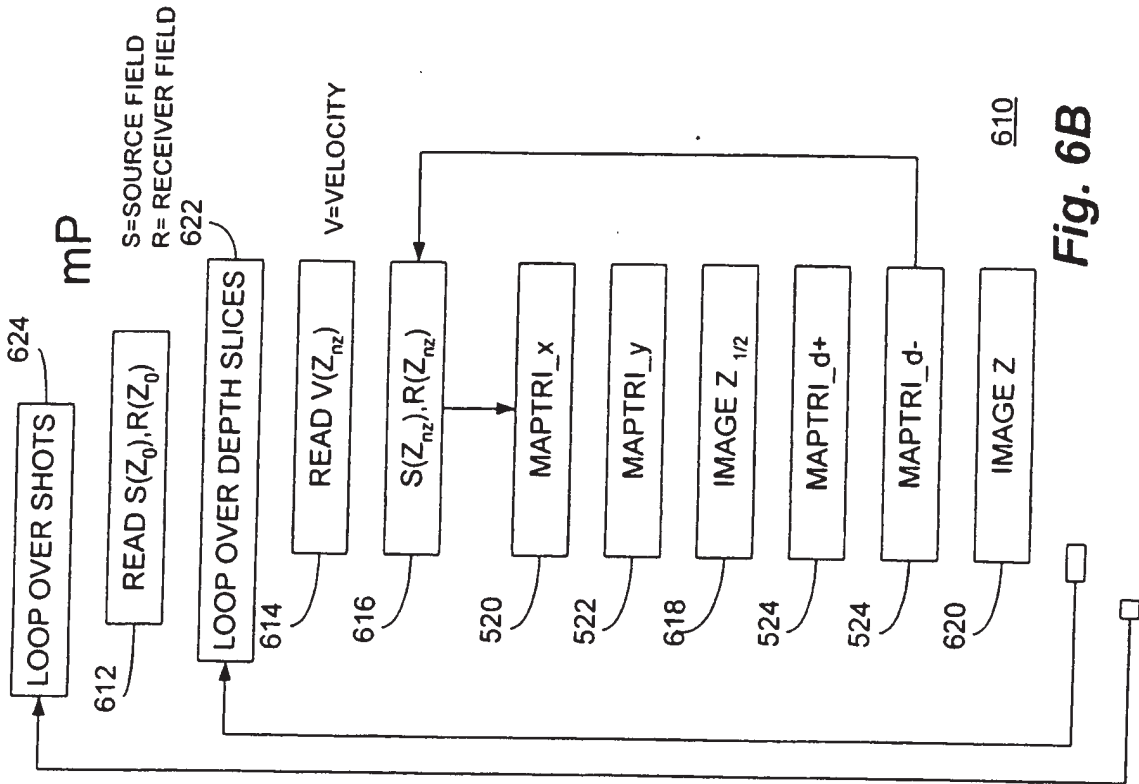
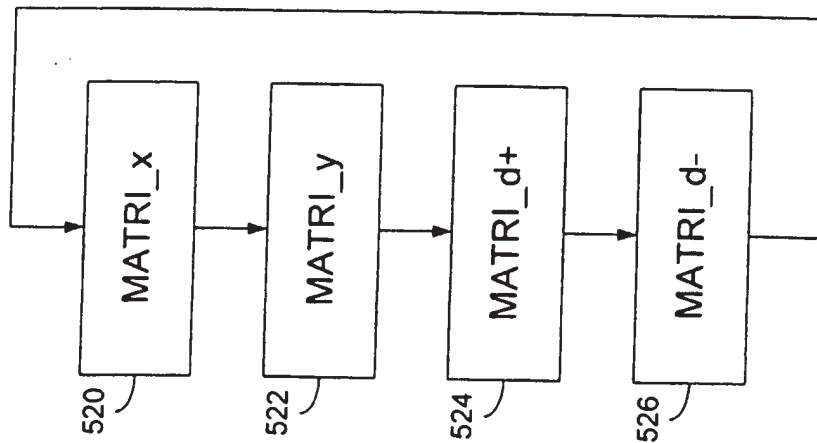

Fig. 6B



600

Fig. 6A

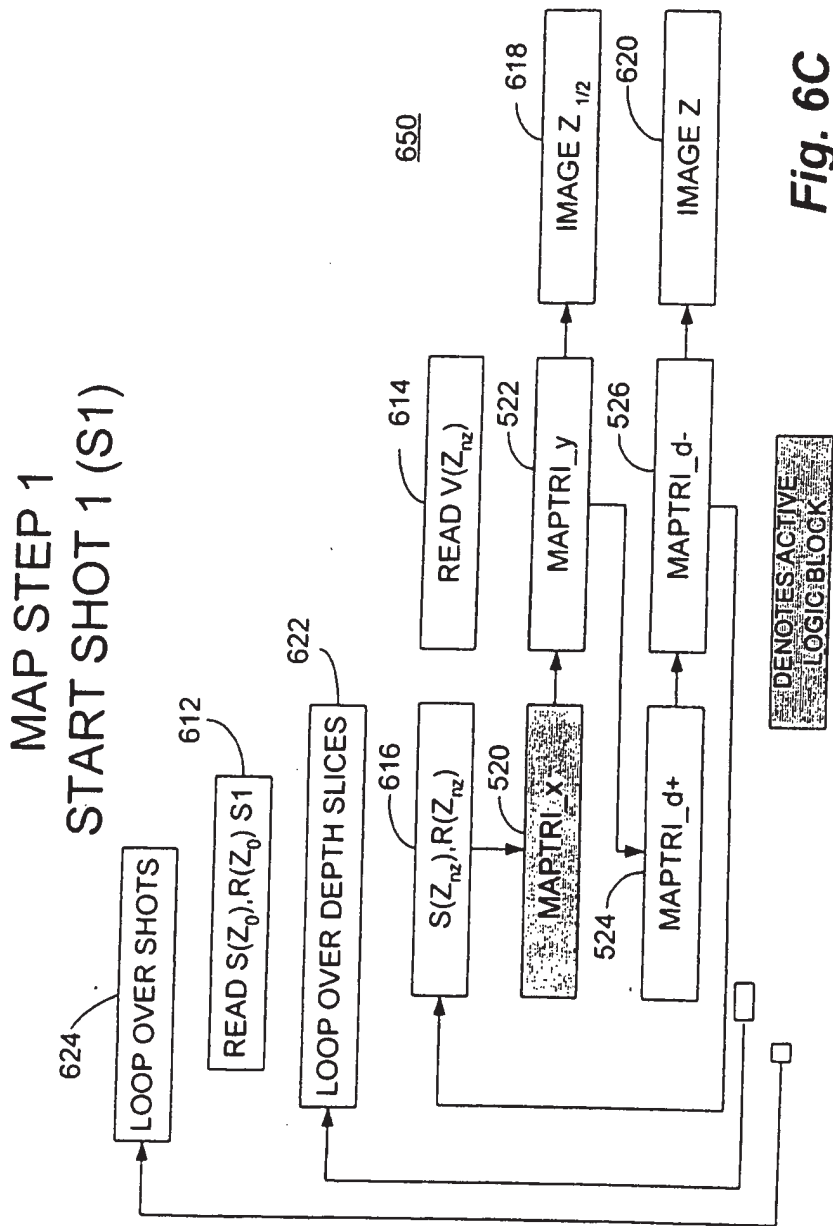

Fig. 6C

MAP STEP 2
 START SHOT 2 (S2)

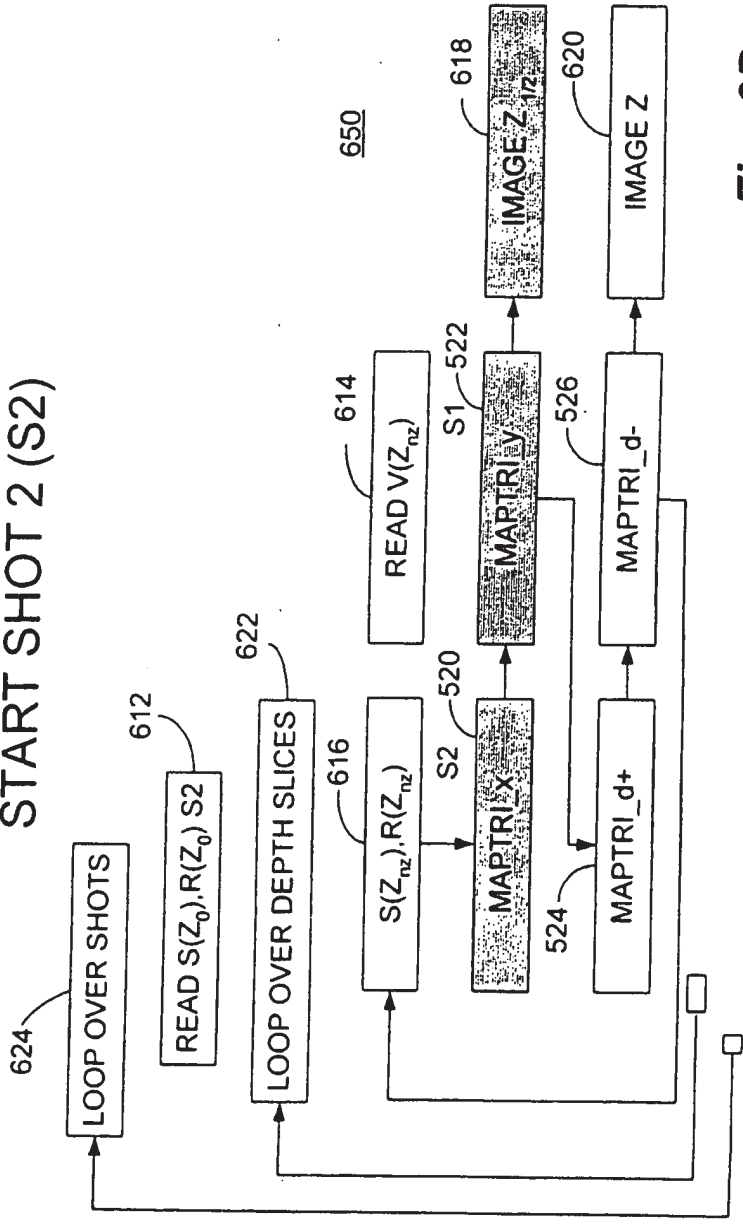

Fig. 6D

CONTINUE S1 AND S2 THROUGH COMPUTE

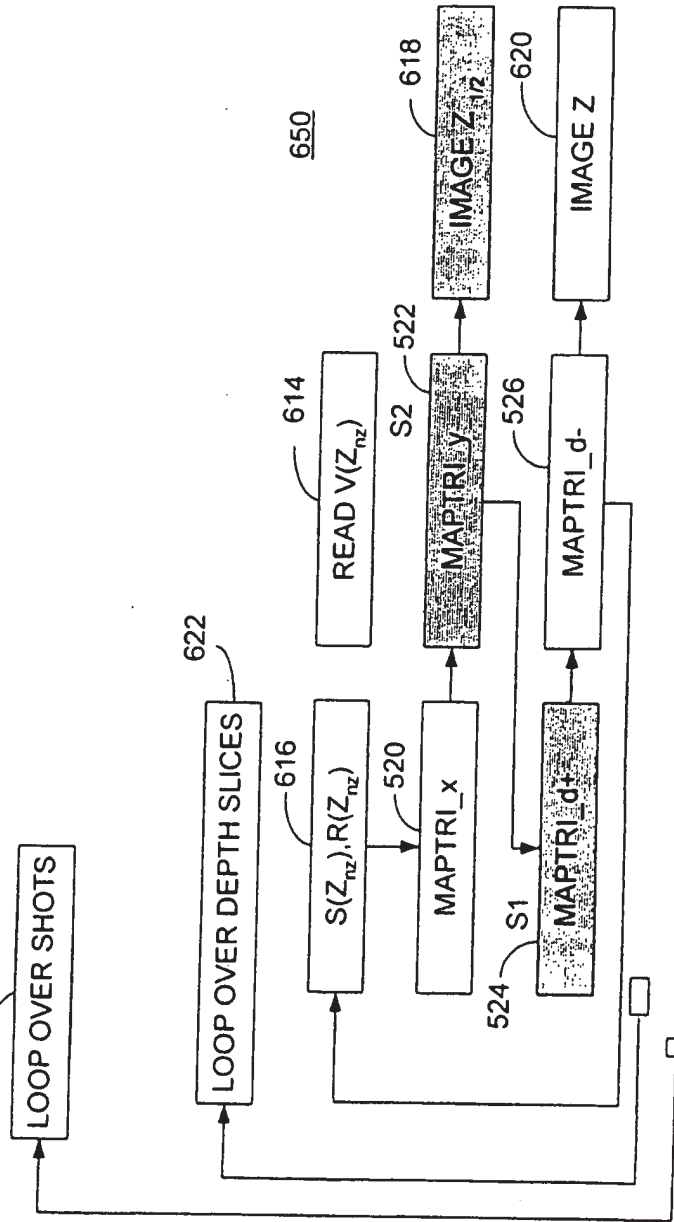

Fig. 6E

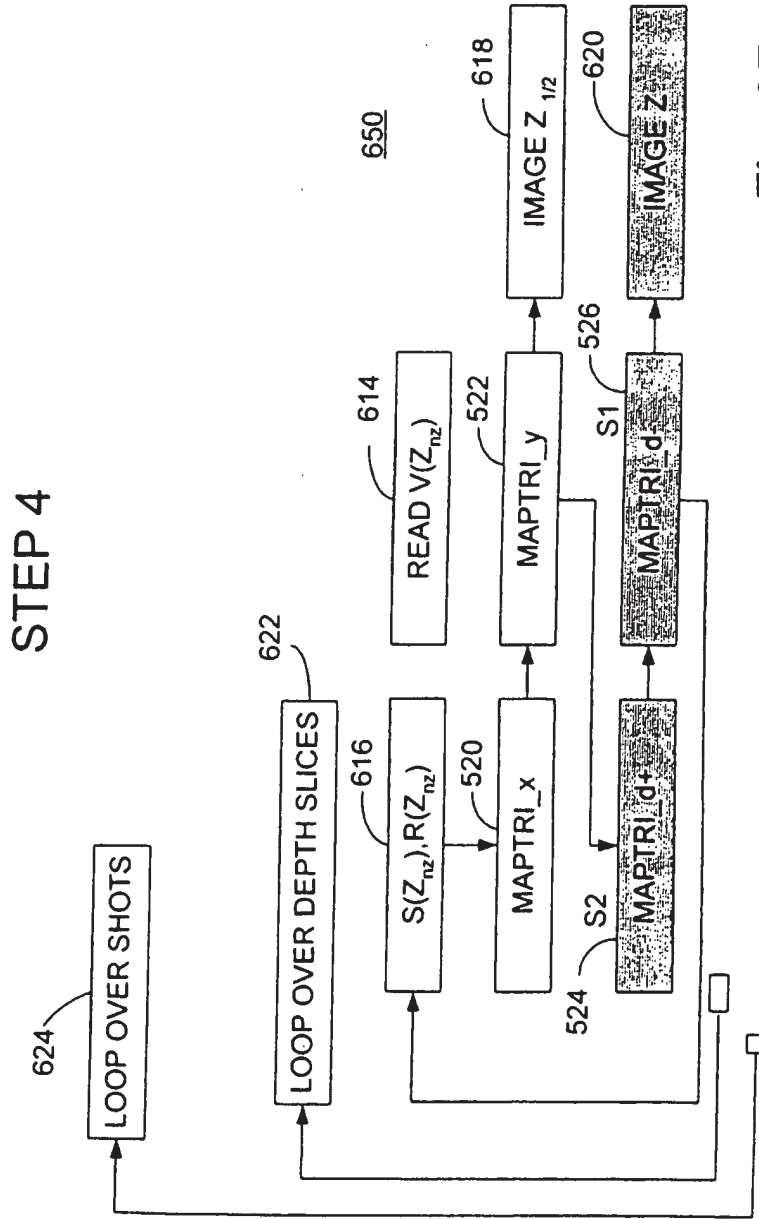

Fig. 6F

STEP 5

CONTINUE THE DOWNWARD PROPOGATION OF
 S1 AND S2 OVER ALL OF THE DEPTH SLICES

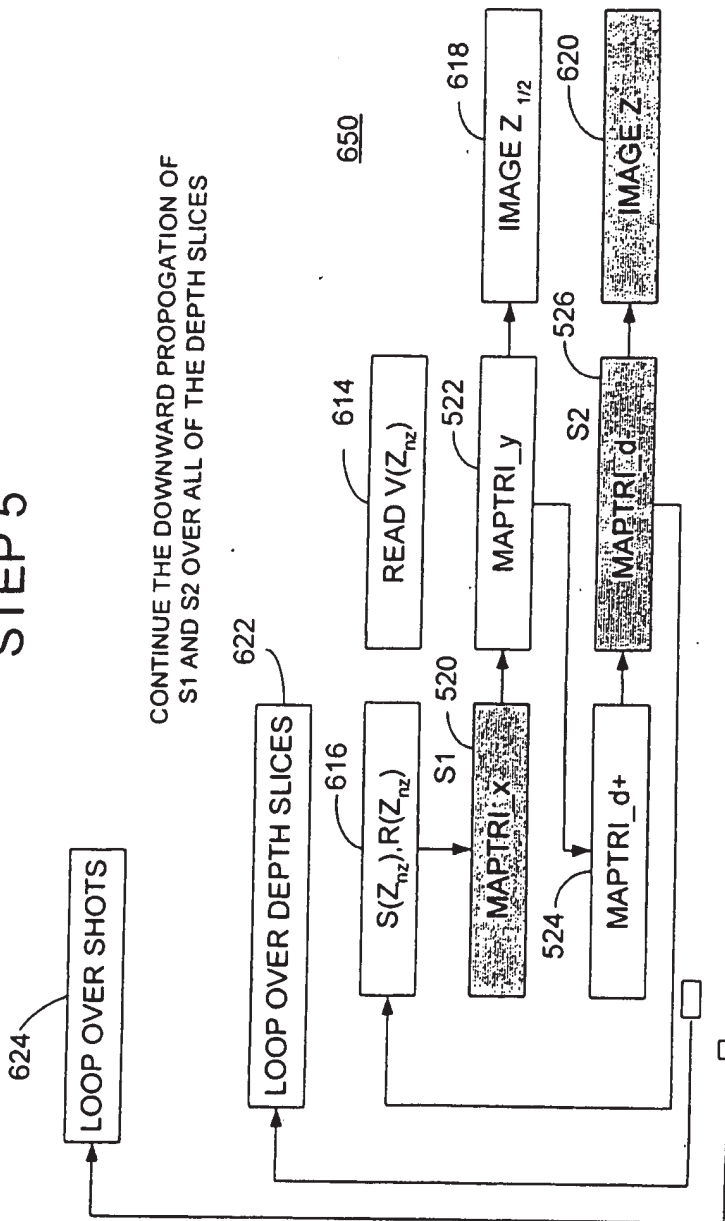

Fig. 6G

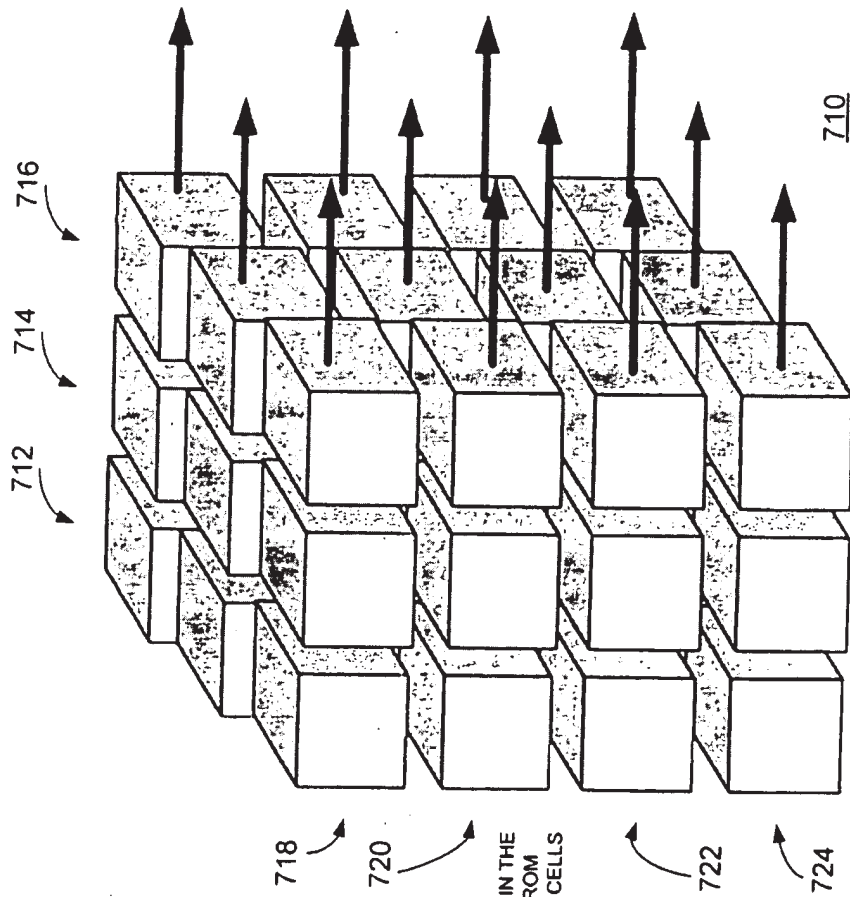

Fig. 7A

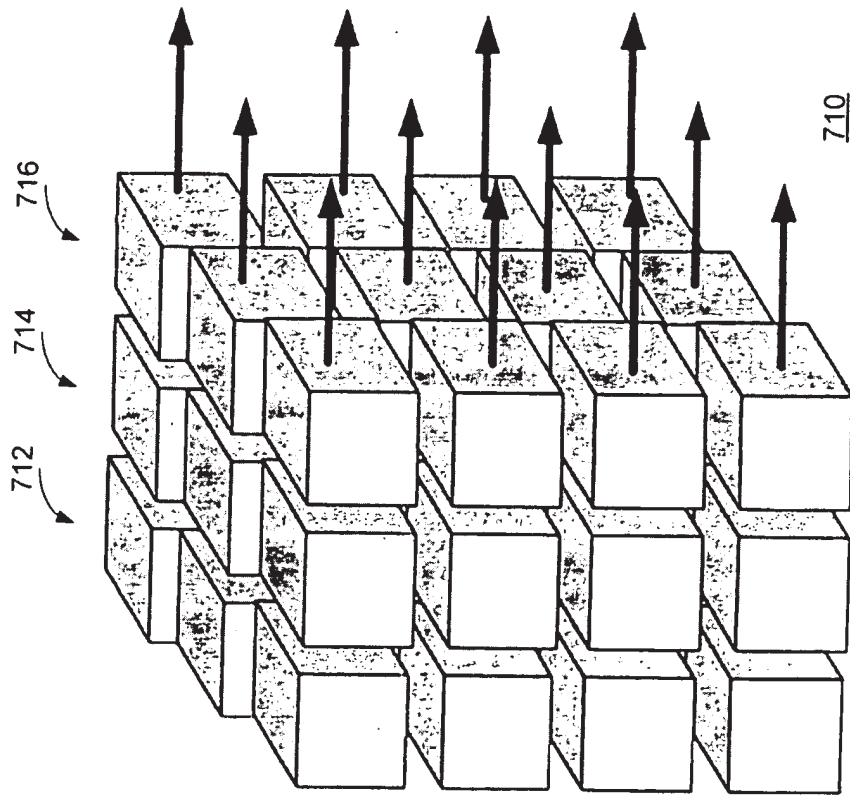

Fig. 7B

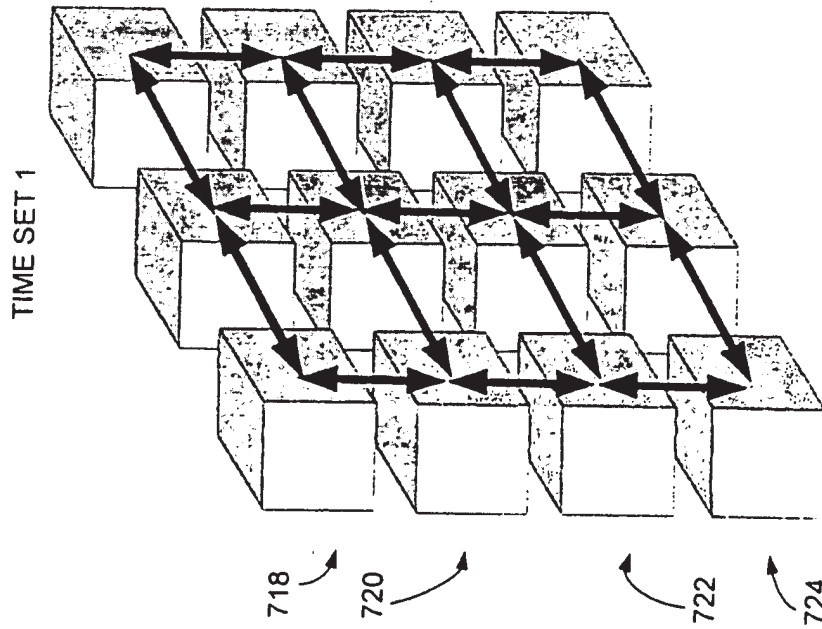

Fig.7C

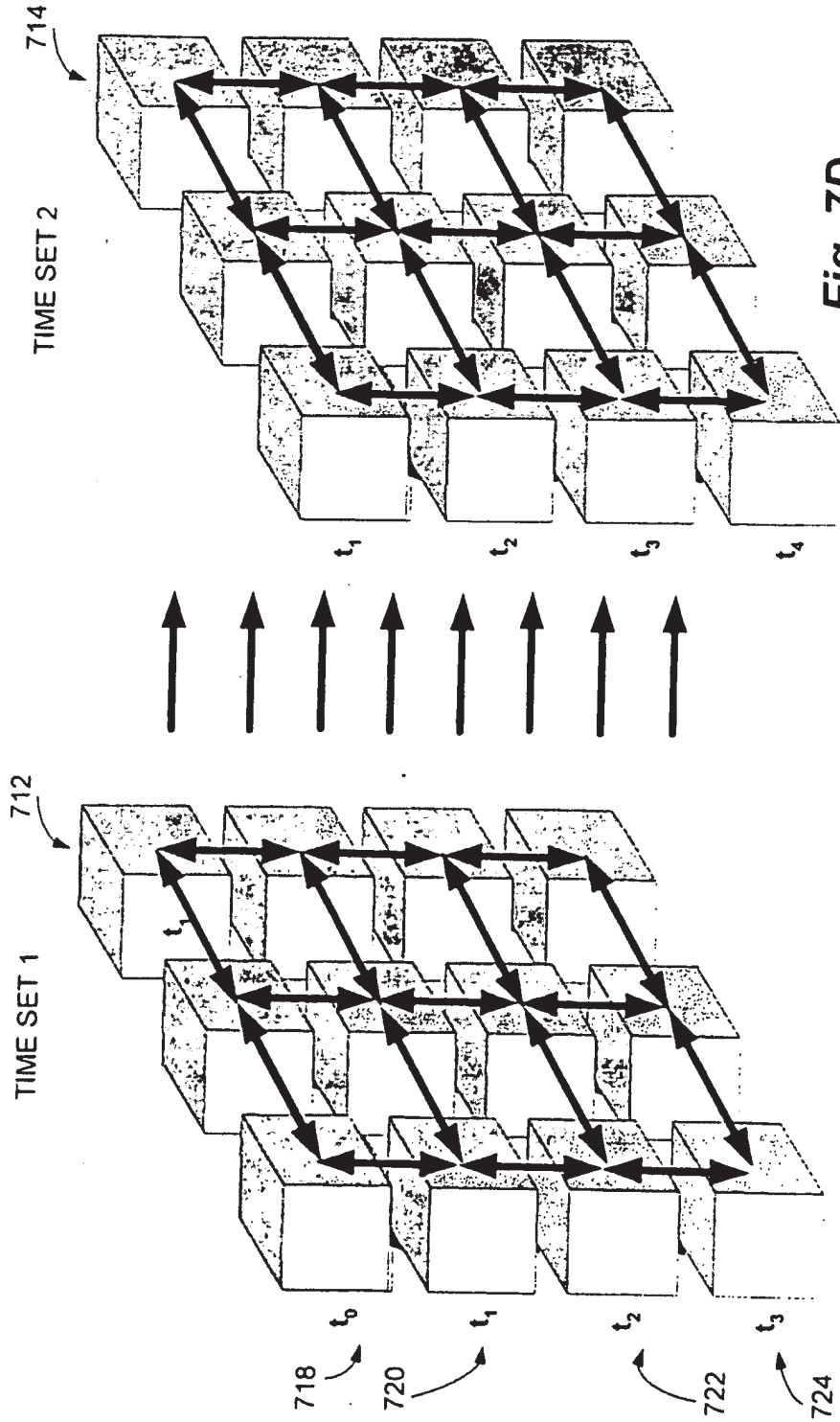

Fig. 7D

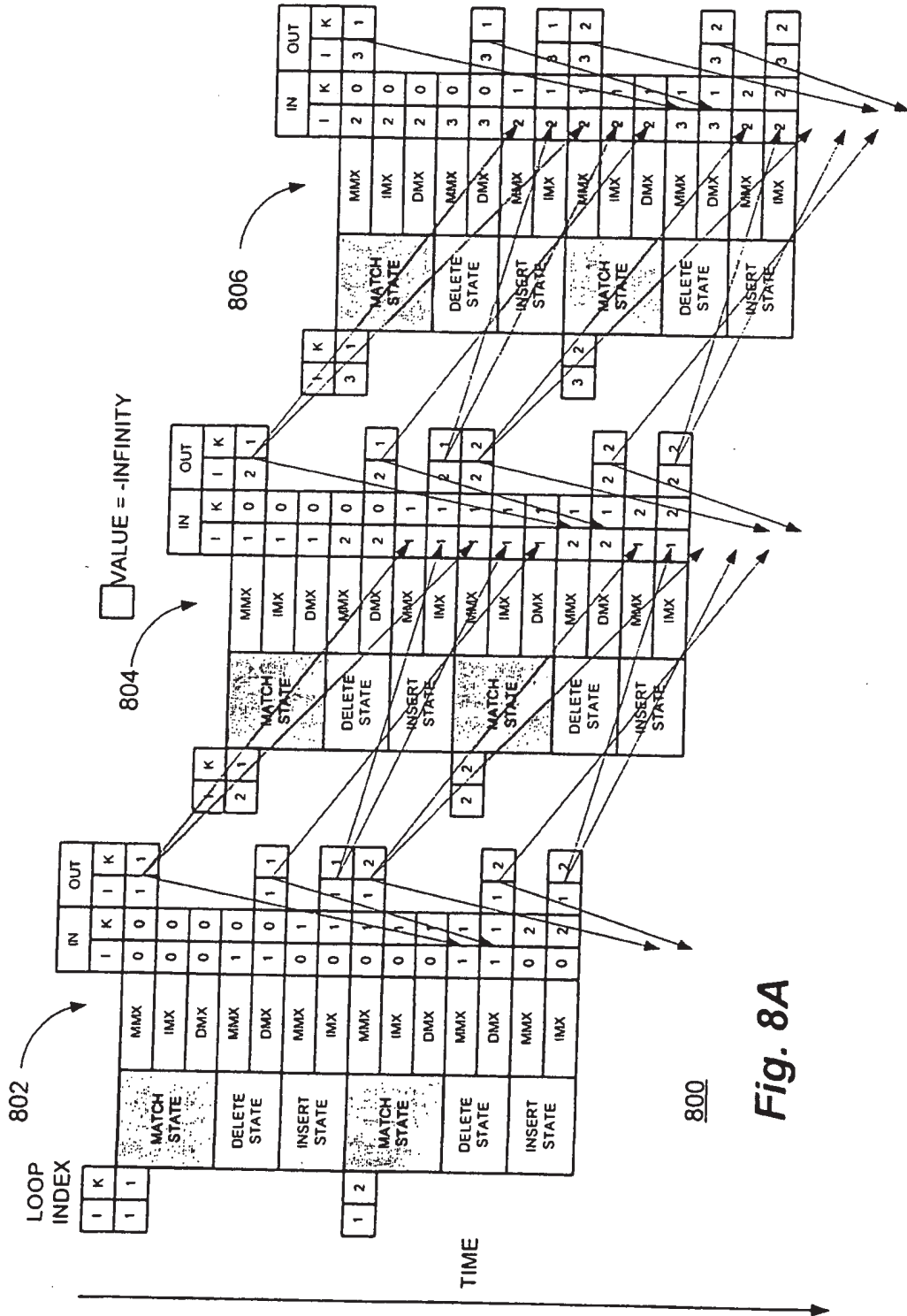

Fig. 8A

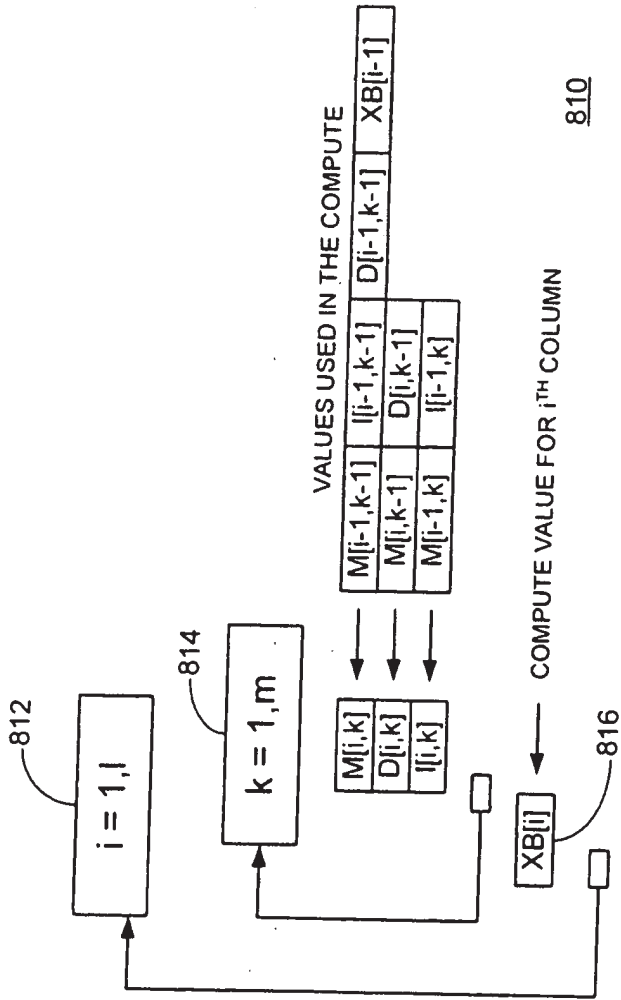
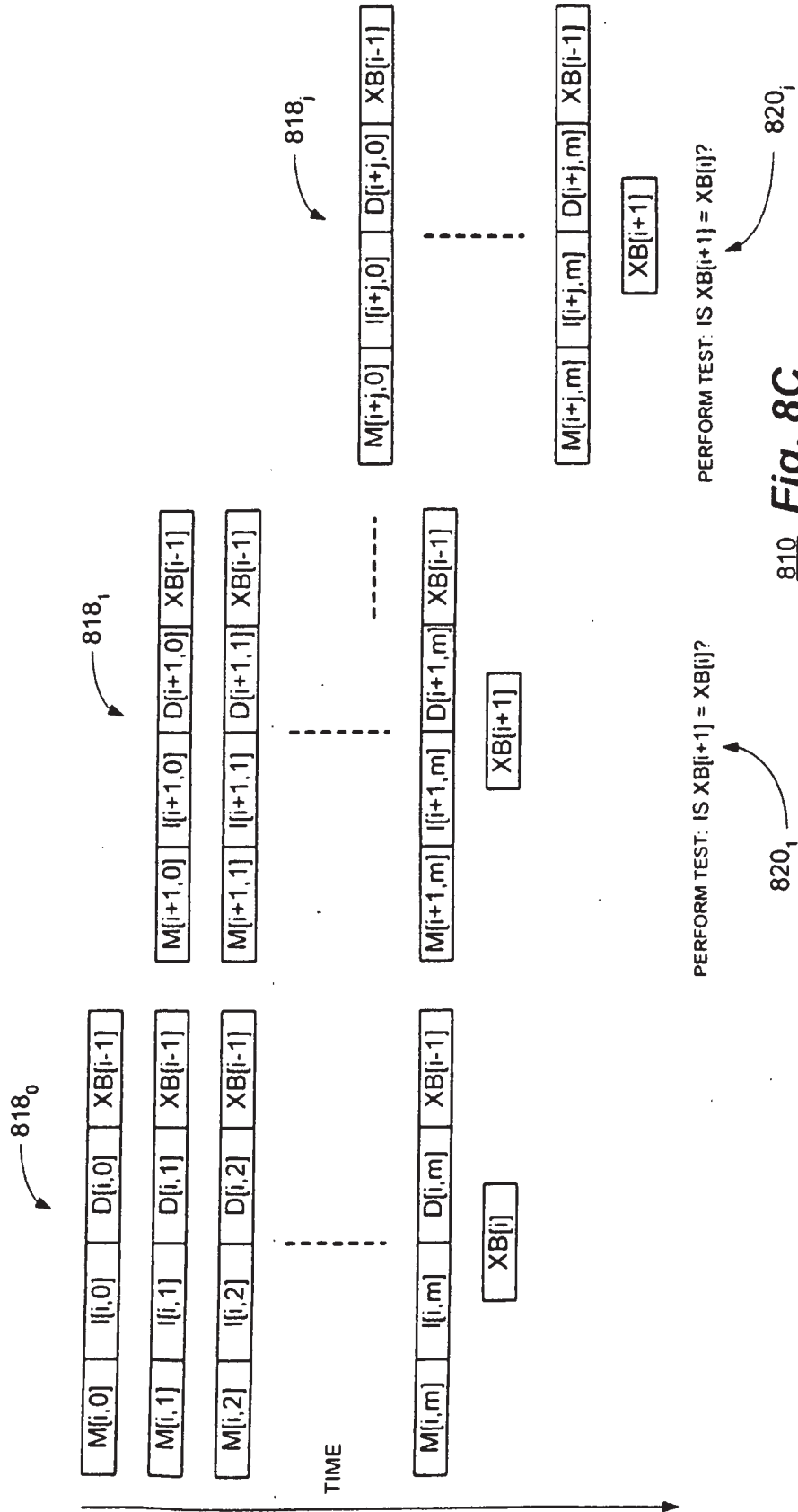

Fig. 8B



810 Fig. 8C

S/N: -----
Docket No.: SRC015 CON
Title: MULTI-ADAPTIVE PROCESSING SYSTEMS
AND TECHNIQUES FOR ENHANCING PARALLELISM
AND PERFORMANCE OF COMPUTATIONAL FUNCTIONS
Inv: Jon M. Huppenthal and David E. Caliga

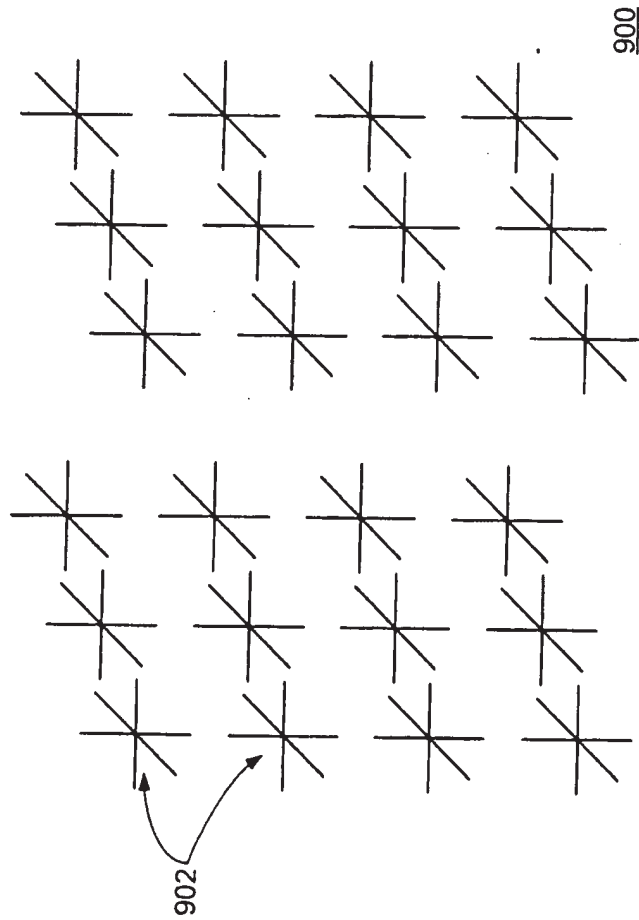

Fig. 9A

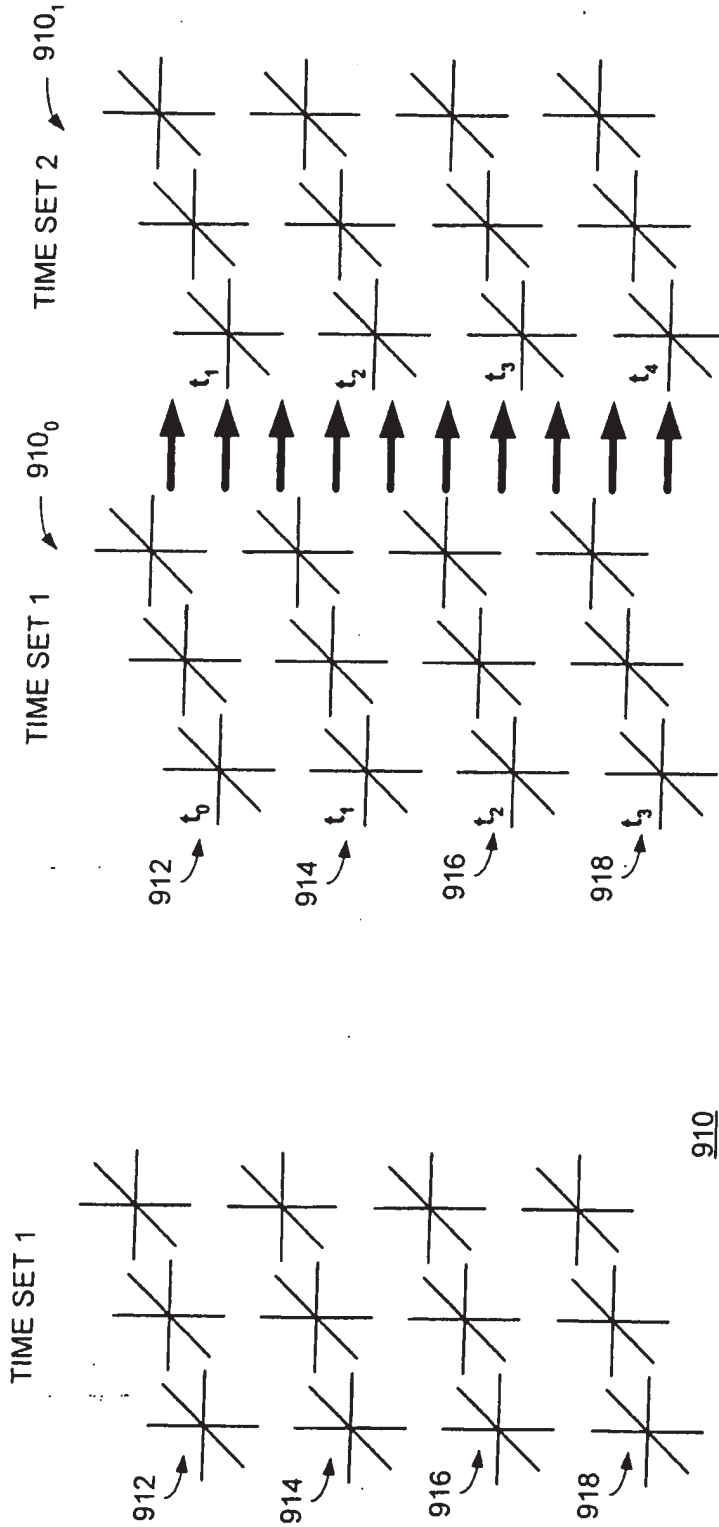

Fig. 9C

Fig. 9B

SCORE Placeholder Sheet for IFW Content

Application Number: **11733064**

Document Date: **10/20/2009**

The presence of this form in the IFW record indicates that the following document type was received in paper and is scanned and stored in the SCORE database.

- Drawings

Images of the original documents are scanned in gray scale or color and stored in SCORE. Bi-tonal images are also stored in IFW. Defects visible in both IFW and SCORE are indicative of defects in the original paper documents.

To access the documents in the SCORE database, refer to instructions developed by SIRA.

At the time of document entry (noted above):

- Examiners may access SCORE content via the eDAN interface.
- Other USPTO employees can bookmark the current SCORE URL (<http://es/ScoreAccessWeb/>).
- External customers may access SCORE content via the Public and Private PAIR interfaces.

Form Revision Date: December 8, 2006



APPLICATION NO.	ISSUE DATE	PATENT NO.	ATTORNEY DOCKET NO.	CONFIRMATION NO.
11/733,064	11/17/2009	7620800	SRC015 CON	7527

25235 7590 10/28/2009
HOGAN & HARTSON LLP
ONE TABOR CENTER, SUITE 1500
1200 SEVENTEENTH ST
DENVER, CO 80202

ISSUE NOTIFICATION

The projected patent number and issue date are specified above.

Determination of Patent Term Adjustment under 35 U.S.C. 154 (b) (application filed on or after May 29, 2000)

The Patent Term Adjustment is 95 day(s). Any patent to issue from the above-identified application will include an indication of the adjustment on the front page.

If a Continued Prosecution Application (CPA) was filed in the above-identified application, the filing date that determines Patent Term Adjustment is the filing date of the most recent CPA.

Applicant will be able to obtain more detailed information by accessing the Patent Application Information Retrieval (PAIR) WEB site (<http://pair.uspto.gov>).

Any questions regarding the Patent Term Extension or Adjustment determination should be directed to the Office of Patent Legal Administration at (571)-272-7702. Questions relating to issue and publication fee payments should be directed to the Application Assistance Unit (AAU) of the Office of Data Management (ODM) at (571)-272-4200.

APPLICANT(s) (Please see PAIR WEB site <http://pair.uspto.gov> for additional applicants):

Jon M. Huppenthal, Colorado Springs, CO;
David E. Caliga, Colorado Springs, CO;

IN THE UNITED STATES PATENT AND TRADEMARK OFFICE

Serial No. 11/733,064 Application of: Jon M. Huppenthal and David E. Caliga Filed: April 9, 2007 Attorney Docket No. SRC015 CON For: MULTI-ADAPTIVE PROCESSING SYSTEMS AND TECHNIQUES FOR ENHANCING PARALLELISM AND PERFORMANCE OF COMPUTATIONAL FUNCTIONS	Art Unit: 2183 Confirmation No.: 7527 Examiner: Eric Coleman Customer No.: 25235
--	--

INFORMATION DISCLOSURE STATEMENT
UNDER 37 C.F.R. § 1.97

Commissioner for Patents
P.O. Box 1450
Alexandria, VA 22313-1450

Sir:

Pursuant to 37 C.F.R. § 1.97(i), please place the attached Form 1449 and the enclosed copy of the listed patent references in the above-referenced file. In submitting this reference, no representation is made or implied that the references are or are not material.

This Information Disclosure Statement is filed with no request for consideration of this reference. Accordingly, no fee is believed due. However, any fee associated herewith may be charged to Deposit Account No. 50-1123.

Respectfully submitted,

15 March 2011
Date

William J. Kubida, Reg. No. 29,664
HOGAN LOVELLS US LLP
One Tabor Center
1200 17th Street, Suite 1500
Denver, Colorado 80202
(719) 448-5909 Tel
(303) 899-7333 Fax

INFORMATION DISCLOSURE STATEMENT BY APPLICANT (Not for submission under 37 CFR 1.99)	Application Number		11733064	
	Filing Date		2007-04-09	
	First Named Inventor	Jon M. Huppenthal		
	Art Unit	2183		
	Examiner Name	Coleman, Eric		
	Attorney Docket Number	SRC015 CON		

U.S.PATENTS

Examiner Initial*	Cite No	Patent Number	Kind Code ¹	Issue Date	Name of Patentee or Applicant of cited Document	Pages, Columns, Lines where Relevant Passages or Relevant Figures Appear
	1					

If you wish to add additional U.S. Patent citation information please click the Add button.

U.S.PATENT APPLICATION PUBLICATIONS

Examiner Initial*	Cite No	Publication Number	Kind Code ¹	Publication Date	Name of Patentee or Applicant of cited Document	Pages, Columns, Lines where Relevant Passages or Relevant Figures Appear
	1					

If you wish to add additional U.S. Published Application citation information please click the Add button.

FOREIGN PATENT DOCUMENTS

Examiner Initial*	Cite No	Foreign Document Number ³	Country Code ² i	Kind Code ⁴	Publication Date	Name of Patentee or Applicant of cited Document	Pages, Columns, Lines where Relevant Passages or Relevant Figures Appear	T ⁵
	1							<input type="checkbox"/>

If you wish to add additional Foreign Patent Document citation information please click the Add button

NON-PATENT LITERATURE DOCUMENTS

Examiner Initials*	Cite No	Include name of the author (in CAPITAL LETTERS), title of the article (when appropriate), title of the item (book, magazine, journal, serial, symposium, catalog, etc), date, pages(s), volume-issue number(s), publisher, city and/or country where published.	T ⁵

**INFORMATION DISCLOSURE
STATEMENT BY APPLICANT**
(Not for submission under 37 CFR 1.99)

Application Number		11733064
Filing Date		2007-04-09
First Named Inventor	Jon M. Huppenthal	
Art Unit	2183	
Examiner Name	Coleman, Eric	
Attorney Docket Number	SRC015 CON	

1	EPO EXAMINATION REPORT, App. No. 10183862.1-2211/2278495, mailing date January 11, 2011, pps. 11.	<input type="checkbox"/>
---	---	--------------------------

If you wish to add additional non-patent literature document citation information please click the Add button

EXAMINER SIGNATURE

Examiner Signature	Date Considered
--------------------	-----------------

*EXAMINER: Initial if reference considered, whether or not citation is in conformance with MPEP 609. Draw line through a citation if not in conformance and not considered. Include copy of this form with next communication to applicant.

¹ See Kind Codes of USPTO Patent Documents at www.USPTO.GOV or MPEP 901.04. ² Enter office that issued the document, by the two-letter code (WIPO Standard ST.3). ³ For Japanese patent documents, the indication of the year of the reign of the Emperor must precede the serial number of the patent document. ⁴ Kind of document by the appropriate symbols as indicated on the document under WIPO Standard ST.16 if possible. ⁵ Applicant is to place a check mark here if English language translation is attached.

**INFORMATION DISCLOSURE
STATEMENT BY APPLICANT**
(Not for submission under 37 CFR 1.99)

Application Number		11733064
Filing Date		2007-04-09
First Named Inventor	Jon M. Huppenthal	
Art Unit	2183	
Examiner Name	Coleman, Eric	
Attorney Docket Number	SRC015 CON	

CERTIFICATION STATEMENT

Please see 37 CFR 1.97 and 1.98 to make the appropriate selection(s):

That each item of information contained in the information disclosure statement was first cited in any communication from a foreign patent office in a counterpart foreign application not more than three months prior to the filing of the information disclosure statement. See 37 CFR 1.97(e)(1).

OR

That no item of information contained in the information disclosure statement was cited in a communication from a foreign patent office in a counterpart foreign application, and, to the knowledge of the person signing the certification after making reasonable inquiry, no item of information contained in the information disclosure statement was known to any individual designated in 37 CFR 1.56(c) more than three months prior to the filing of the information disclosure statement. See 37 CFR 1.97(e)(2).

- See attached certification statement.
- The fee set forth in 37 CFR 1.17 (p) has been submitted herewith.
- A certification statement is not submitted herewith.

SIGNATURE

A signature of the applicant or representative is required in accordance with CFR 1.33, 10.18. Please see CFR 1.4(d) for the form of the signature.

Signature	/william j. kubida/	Date (YYYY-MM-DD)	2011-03-15
Name/Print	William J. Kubida	Registration Number	29664

This collection of information is required by 37 CFR 1.97 and 1.98. The information is required to obtain or retain a benefit by the public which is to file (and by the USPTO to process) an application. Confidentiality is governed by 35 U.S.C. 122 and 37 CFR 1.14. This collection is estimated to take 1 hour to complete, including gathering, preparing and submitting the completed application form to the USPTO. Time will vary depending upon the individual case. Any comments on the amount of time you require to complete this form and/or suggestions for reducing this burden, should be sent to the Chief Information Officer, U.S. Patent and Trademark Office, U.S. Department of Commerce, P.O. Box 1450, Alexandria, VA 22313-1450. **DO NOT SEND FEES OR COMPLETED FORMS TO THIS ADDRESS. SEND TO: Commissioner for Patents, P.O. Box 1450, Alexandria, VA 22313-1450.**

Electronic Acknowledgement Receipt

EFS ID:	9701787
Application Number:	11733064
International Application Number:	
Confirmation Number:	7527
Title of Invention:	MULTI-ADAPTIVE PROCESSING SYSTEMS AND TECHNIQUES FOR ENHANCING PARALLELISM AND PERFORMANCE OF COMPUTATIONAL FUNCTIONS
First Named Inventor/Applicant Name:	Jon M. Huppenthal
Customer Number:	25235
Filer:	William J. Kubida/Julie Lange
Filer Authorized By:	William J. Kubida
Attorney Docket Number:	SRC015 CON
Receipt Date:	21-MAR-2011
Filing Date:	09-APR-2007
Time Stamp:	16:15:23
Application Type:	Utility under 35 USC 111(a)

Payment information:

Submitted with Payment	no
------------------------	----

File Listing:

Document Number	Document Description	File Name	File Size(Bytes)/ Message Digest	Multi Part /.zip	Pages (if appl.)
1		DOC289.PDF	558525 db82905f7e94f262b9ebd148a4bb87ba5d00f4d0	yes	15

Multipart Description/PDF files in .zip description		
Document Description	Start	End
Information Disclosure Statement (IDS) Filed (SB/08)	1	4
Foreign Reference	5	15
Warnings:		
Information:		
Total Files Size (in bytes):	558525	
<p>This Acknowledgement Receipt evidences receipt on the noted date by the USPTO of the indicated documents, characterized by the applicant, and including page counts, where applicable. It serves as evidence of receipt similar to a Post Card, as described in MPEP 503.</p> <p><u>New Applications Under 35 U.S.C. 111</u> If a new application is being filed and the application includes the necessary components for a filing date (see 37 CFR 1.53(b)-(d) and MPEP 506), a Filing Receipt (37 CFR 1.54) will be issued in due course and the date shown on this Acknowledgement Receipt will establish the filing date of the application.</p> <p><u>National Stage of an International Application under 35 U.S.C. 371</u> If a timely submission to enter the national stage of an international application is compliant with the conditions of 35 U.S.C. 371 and other applicable requirements a Form PCT/DO/EO/903 indicating acceptance of the application as a national stage submission under 35 U.S.C. 371 will be issued in addition to the Filing Receipt, in due course.</p> <p><u>New International Application Filed with the USPTO as a Receiving Office</u> If a new international application is being filed and the international application includes the necessary components for an international filing date (see PCT Article 11 and MPEP 1810), a Notification of the International Application Number and of the International Filing Date (Form PCT/RO/105) will be issued in due course, subject to prescriptions concerning national security, and the date shown on this Acknowledgement Receipt will establish the international filing date of the application.</p>		

IN THE UNITED STATES PATENT AND TRADEMARK OFFICE

Serial No. 11/733,064 Filed: April 9, 2007 Attorney Docket No. SRC015 CON For: MULTI-ADAPTIVE PROCESSING SYSTEMS AND TECHNIQUES FOR ENHANCING PARALLELISM AND PERFORMANCE OF COMPUTATIONAL FUNCTIONS	Confirmation No.: 7527 Art Unit: 2183 Examiner: Coleman, Eric Customer No.: 25235
--	---

TRANSMITTAL OF NOTIFICATION OF ENTITLEMENT TO SMALL ENTITY STATUS
PURSUANT TO 37 C.F.R. § 1.27(c)(2)

MAIL STOP - OFFICE OF PETITIONS
Commissioner for Patents
P.O. Box 1450
Alexandria, VA 22313-1450

Sir:

By this communication, Applicant hereby notifies the Commissioner of Patents that large entity status is no longer appropriate for the above-identified application, and we assert that Applicant is entitled to small entity status.

A **Certification of Small Entity Status**, signed by Applicant, is attached.

Respectfully submitted,



Peter J. Meza, No. 32,920
Hogan Lovells US LLP
2 North Cascade Avenue, Suite 1300
Colorado Springs, Colorado 80903
(719) 448-5906 Tel
(719) 448-5922 Fax

December 17, 2014

SMALL ENTITY STATUS

The Patent Office allows "Small Entities" to pay lower Patent Office fees. However, improperly claiming small entity status can invalidate your patent. Section A below will help you determine if you or your business qualify as a small entity. Section B includes a certification for small entity status. If after reviewing the following materials you determine that you qualify for small entity status, please complete the certification and return it to us. If we do not receive the signed certification from you, we will not claim small entity status for the application identified below, and you will not qualify for the lower Patent Office fees. If you do complete the certification, we may ask you to confirm your small entity status at various points during the prosecution of the application and the life of the issued patent.

A. Definition of Small Entity

A small entity means any "person," "small business concern," "nonprofit organization," or a combination of these, that holds the rights in the invention and (a) has not assigned or licensed the rights to another who is not a small entity, and (b) is not obligated to assign or license the rights to another who is not a small entity.

- (1) *Person.* An inventor or other individuals who hold the rights in an invention.
- (2) *Nonprofit organization.* A nonprofit organization is either:
 - (i) A university or institution of higher education in any country;
 - (ii) An organization described in section 501(c)(3), and exempt from taxation under section 501(a) of the Internal Revenue Code;
 - (iii) Any nonprofit scientific or educational organization qualified under a state's nonprofit organization statute; or
 - (iv) Any nonprofit organization located in a foreign country, that would otherwise qualify as a "nonprofit organization" if it were located in the U.S.A.
- (3) *Small business concern.* Any business concern whose number of employees, (part-time and full-time), including affiliates, does not exceed 500 persons.

B. Certification

Applicant or Patentee: SRC Computers, LLC

Assignee: SRC Computers, LLC

Application No(s). SEE EXHIBIT A

SRC Computers, LLC

STATEMENT CONCERNING SMALL ENTITY STATUS

I hereby certify that the owner of the application/patent identified above qualifies for small entity status because the owner has not assigned or licensed the rights in the invention to another who is not a small entity, and is not obligated to assign or license the rights in the invention to another who is not a small entity, and because:

The owner is a small business concern:

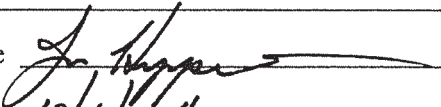
Business Name SRC Computers, LLC
Signor's Name Jon Huppenthal Signature 
Title President and CEO Date 10/19/14
Business Address 4240 N. Nevada Avenue, Colorado Springs, CO 80907

SRC Computers, LLC
EXHIBIT A

Docket Number	Application Date	Application Number	Grant Date	Patent Number	Title
SRC001	12/17/1997	08/992,763	06/13/2000	6,076,152	MULTIPROCESSOR COMPUTER ARCHITECTURE
SRC001 CON	01/12/2000	09/481,902	06/12/2001	6,247,110	MULTIPROCESSOR COMPUTER ARCHITECTURE
SRC001 CON/DIV	01/05/2001	09/755,744			MULTIPROCESSOR COMPUTER ARCHITECTURE
SRC001 CON2	01/08/2003	10/339,133	11/01/2005	6,961,841	MULTIPROCESSOR COMPUTER ARCHITECTURE
SRC001 CON3	10/20/2004	10/969,635	06/26/2007	7,237,091	MULTIPROCESSOR COMPUTER ARCHITECTURE
SRC002	01/20/1998	09/008,871			SCALABLE SINGLE SYSTEM IMAGE OPERATING
SRC003	02/03/1998	09/018,032	02/15/2000	6,026,459	SYSTEM AND METHOD FOR DYNAMIC PRIORITY
SRC004	06/30/1998	09/108,088	09/25/2001	6,295,598	SPLIT DIRECTORY-BASED CACHE COHERENCY
SRC006	07/25/2000	09/624,788	03/12/2002	6,356,983	SYSTEM AND METHOD PROVIDING CACHE
SRC007	08/15/2000	09/638,365	07/15/2003	6,594,736	SYSTEM AND METHOD FOR SEMAPHORE AND
SRC008	05/03/2000	09/563,561	01/15/2002	6,339,819	MULTIPROCESSOR WITH EACH PROCESSOR
SRC009	11/05/2001	10/008,128	12/28/2004	6,836,823	BANDWIDTH ENHANCEMENT FOR UNCACHED
SRC010	06/22/2001	09/888,276	08/13/2002	6,434,687	SYSTEM AND METHOD FOR ACCELERATING WEB
SRC011	12/05/2001	10/011,835	12/26/2006	7,155,602	INTERFACE FOR INTEGRATING
SRC011 CON	05/31/2005	11/140,718	01/23/2007	7,167,976	AN INTERFACE FOR INTEGRATING
SRC011 PRO	04/30/2001	60/286,979			DELIVERING ACCELERATION: THE POTENTIAL
SRC012	08/17/2001	09/932,330	05/13/2008	7,373,440	SWITCH/NETWORK ADAPTER PORT FOR
SRC012 CIP	01/10/2003	10/340,390	03/27/2007	7,197,575	SWITCH/NETWORK ADAPTER PORT COUPLING A
SRC012 CIP2	08/15/2005	11/203,983	07/21/2009	7,565,461	SWITCH/NETWORK ADAPTER PORT COUPLING A
SRC012 DIV	11/23/2004	10/996,016	09/02/2008	7,421,524	SWITCH/NETWORK ADAPTER PORT FOR
SRC013	10/23/2002	10/278,345	10/17/2006	7,124,211	SYSTEM AND METHOD FOR EXPLICIT
SRC014	05/09/2002	10/142,045			ADAPTIVE PROCESSOR ARCHITECTURE
SRC014 DIV	05/02/2005	11/119,598			ADAPTIVE PROCESSOR ARCHITECTURE
SRC014 DIV/CIP	09/08/2005	11/222,417	07/29/2008	7,406,573	RECONFIGURABLE PROCESSOR ELEMENT
SRC015	10/31/2002	10/285,318	05/29/2007	7,225,324	MULTI-ADAPTIVE PROCESSING SYSTEMS AND
→SRC015 CON	04/09/2007	11/733,064	11/17/2009	7,620,800	MULTI-ADAPTIVE PROCESSING SYSTEMS AND
SRC016	10/29/2002	10/282,986	02/21/2006	7,003,593	COMPUTER SYSTEM ARCHITECTURE AND
SRC017	10/31/2002	10/284,994	02/07/2006	6,996,656	SYSTEM AND METHOD FOR PROVIDING AN
SRC017 CON	07/22/2005	11/187,534			SYSTEM AND METHOD FOR PROVIDING AN
SRC018	10/31/2002	10/285,401	09/06/2005	6,941,539	EFFICIENCY OF RECONFIGURABLE HARDWARE
SRC019	10/31/2002	10/285,299	01/03/2006	6,983,456	PROCESS FOR CONVERTING PROGRAMS IN
SRC019 CON	10/04/2005	11/243,498	04/20/2010	7,703,085	PROCESS FOR CONVERTING PROGRAMS IN
SRC020 PRO	10/31/2002	60/422,722			GENERAL PURPOSE RECONFIGURABLE
SRC021	10/31/2002	10/285,399	11/20/2007	7,299,458	SYSTEM AND METHOD FOR CONVERTING
SRC022	10/31/2002	10/285,298	11/08/2005	6,964,029	SYSTEM AND METHOD FOR PARTITIONING
SRC023	10/31/2002	10/285,389	12/26/2006	7,155,708	DEBUGGING AND PERFORMANCE PROFILING
SRC024	01/10/2003	10/340,400			SYSTEM AND METHOD FOR SCALABLE
SRC025	01/14/2003	10/345,082	11/07/2006	7,134,120	MAP COMPILER PIPELINED LOOP STRUCTURE
SRC026					HANDLING OF NON-NUMERIC VARIABLES
SRC027	07/11/2003	10/618,041	09/09/2008	7,424,552	SWITCH/NETWORK ADAPTER PORT
SRC027 CIP	06/16/2004	10/869,199			SWITCH/NETWORK ADAPTER PORT
SRC027 CIP/DIV	08/06/2007	11/834,439	03/16/2010	7,680,968	SWITCH/NETWORK ADAPTER PORT
SRC028	06/16/2004	10/869,200	12/12/2006	7,149,867	SYSTEM AND METHOD OF ENHANCING
SRC028 PRO	06/18/2003	60/479,339			BANDWIDTH EFFICIENCY AND UTILIZATION
SRC029	10/17/2005	11/252,341	02/15/2011	7,890,686	DYNAMIC PRIORITY CONFLICT RESOLUTION IN A
SRC030	07/10/2006	11/456,466	11/19/2013	8,589,666	ELIMINATION OF STREAM CONSUMER LOOP

SRC Computers, LLC
EXHIBIT A

SRC031 PRO	11/05/2010	61/410,676			SNAP INTERFACE USING MEMORY BUFFERS
SRC032 PRO	11/10/2010	61/412,124			COMPUTATIONAL UNIFICATION
SRC033 PRO	12/16/2011	61/576,846			MOBILE DEVICE UTILITIZING RECONFIGURABLE
SRC031	11/01/2011	13/286,996			HETEROGENEOUS COMPUTING SYSTEM
SRC032	11/02/2011	13/287,322	04/29/2014	8,713,518	SYSTEM AND METHOD FOR COMPUTATIONAL
SRC033	02/02/2012	13/365,090			MOBILE ELECTRONIC DEVICES UTILIZING
SRC036	05/27/2014	14/288,094			SYSTEM AND METHOD FOR RETAINING DRAM
SRC037	05/22/2014	14/284,616			SYSTEM AND METHOD FOR THERMALLY
SRC035	05/28/2013	13/903,720			MULTI-PROCESSOR COMPUTER ARCHITECTURE
SRC032 CON	03/10/2014	14/203,035			SYSTEM AND METHOD FOR COMPUTATIONAL

Electronic Acknowledgement Receipt

EFS ID:	21123730
Application Number:	11733064
International Application Number:	
Confirmation Number:	7527
Title of Invention:	MULTI-ADAPTIVE PROCESSING SYSTEMS AND TECHNIQUES FOR ENHANCING PARALLELISM AND PERFORMANCE OF COMPUTATIONAL FUNCTIONS
First Named Inventor/Applicant Name:	Jon M. Huppenthal
Customer Number:	25235
Filer:	Peter John Meza/Joyce Medrano-Paywa
Filer Authorized By:	Peter John Meza
Attorney Docket Number:	SRC015 CON
Receipt Date:	05-JAN-2015
Filing Date:	09-APR-2007
Time Stamp:	18:49:56
Application Type:	Utility under 35 USC 111(a)

Payment information:

Submitted with Payment	no
------------------------	----

File Listing:

Document Number	Document Description	File Name	File Size(Bytes)/ Message Digest	Multi Part /.zip	Pages (if appl.)
1	Assertion of entitlement to small entity status	DOC025.pdf	216980 e0704d457ba398982cd176e26d8be54671fe73fd	no	5

Warnings:

Information:

This Acknowledgement Receipt evidences receipt on the noted date by the USPTO of the indicated documents, characterized by the applicant, and including page counts, where applicable. It serves as evidence of receipt similar to a Post Card, as described in MPEP 503.

New Applications Under 35 U.S.C. 111

If a new application is being filed and the application includes the necessary components for a filing date (see 37 CFR 1.53(b)-(d) and MPEP 506), a Filing Receipt (37 CFR 1.54) will be issued in due course and the date shown on this Acknowledgement Receipt will establish the filing date of the application.

National Stage of an International Application under 35 U.S.C. 371

If a timely submission to enter the national stage of an international application is compliant with the conditions of 35 U.S.C. 371 and other applicable requirements a Form PCT/DO/EO/903 indicating acceptance of the application as a national stage submission under 35 U.S.C. 371 will be issued in addition to the Filing Receipt, in due course.

New International Application Filed with the USPTO as a Receiving Office

If a new international application is being filed and the international application includes the necessary components for an international filing date (see PCT Article 11 and MPEP 1810), a Notification of the International Application Number and of the International Filing Date (Form PCT/RO/105) will be issued in due course, subject to prescriptions concerning national security, and the date shown on this Acknowledgement Receipt will establish the international filing date of the application.

Under the Paperwork Reduction Act of 1995 no persons are required to respond to a collection of information unless it displays a valid OMB control number

PATENT - POWER OF ATTORNEY OR REVOCAION OF POWER OF ATTORNEY WITH A NEW POWER OF ATTORNEY AND CHANGE OF CORRESPONDENCE ADDRESS	Patent Number	7,620,800
	Issue Date	11-17-2009
	First Named Inventor	Jon M. Huppenthal
	Title	MULTI-ADAPTIVE PROCESSING SYSTEMS AND TECHNIQUES FOR ENHANCING PARALLELISM AND PERFORMANCE OF COMPUTATIONAL FUNCTIONS
	Attorney Docket No.	

I hereby revoke all previous powers of attorney given in the above-identified patent.

 A Power of Attorney is submitted herewith.**OR** I hereby appoint Practitioner(s) associated with the Customer Number identified in the box at right as my/our attorney(s) or agent(s) with respect to the patent identified above, and to transact all business in the United States Patent and Trademark Office connected therewith:

23452

OR I hereby appoint Practitioner(s) named below as my/our attorney(s) or agent(s) with respect to the patent identified above, and to transact all business in the United States Patent and Trademark Office connected therewith:

Practitioner(s) Name	Registration Number

Please recognize or change the correspondence address for the above-identified patent to:

 The address associated with the above-identified Customer Number.**OR** The address associated with the Customer Number identified in the box at right:
OR Firm or
Individual Name

Address

City

State

Zip

Country

Telephone

Email

I am the:

 Applicant.**OR** Patent owner.

Statement under 37 CFR 3.73(c) (Form PTO/AIA/96) submitted herewith or filed on _____.

SIGNATURE of Applicant or Patent Owner

Signature	/Todd Rooke/	Date	February 24, 2016
Name	Todd Rooke	Telephone	
Title and Company	CEO, SRC Labs, LLC		

NOTE: Signatures of all the applicants or patent owners of the entire interest or their representative(s) are required. If more than one signature is required, submit multiple forms, check the box below, and identify the total number of forms submitted in the blank below. A total of 1 forms are submitted.

This collection of information is required by 37 CFR 1.31, 1.32, and 1.33. The information is required to obtain or retain a benefit by the public, which is to update (and by the USPTO to process) the file of a patent or reexamination proceeding. Confidentiality is governed by 35 U.S.C. 122 and 37 CFR 1.14. This collection is estimated to take 3 minutes to complete, including gathering, preparing, and submitting the completed application form to the USPTO. Time will vary depending upon the individual case. Any comments on the amount of time you require to complete this form and/or suggestions for reducing this burden, should be sent to the Chief Information Officer, U.S. Patent and Trademark Office, U.S. Department of Commerce, P.O. Box 1450, Alexandria, VA 22313-1450. DO NOT SEND FEES OR COMPLETED FORMS TO THIS ADDRESS. **SEND TO: Commissioner for Patents, P.O. Box 1450, Alexandria, VA 22313-1450.**

If you need assistance in completing the form, call 1-800-PTO-9199 and select option 2.

Privacy Act Statement

The **Privacy Act of 1974 (P.L. 93-579)** requires that you be given certain information in connection with your submission of the attached form related to a patent application or patent. Accordingly, pursuant to the requirements of the Act, please be advised that: (1) the general authority for the collection of this information is 35 U.S.C. 2(b)(2); (2) furnishing of the information solicited is voluntary; and (3) the principal purpose for which the information is used by the U.S. Patent and Trademark Office is to process and/or examine your submission related to a patent application or patent. If you do not furnish the requested information, the U.S. Patent and Trademark Office may not be able to process and/or examine your submission, which may result in termination of proceedings or abandonment of the application or expiration of the patent.

The information provided by you in this form will be subject to the following routine uses:

1. The information on this form will be treated confidentially to the extent allowed under the Freedom of Information Act (5 U.S.C. 552) and the Privacy Act (5 U.S.C. 552a). Records from this system of records may be disclosed to the Department of Justice to determine whether disclosure of these records is required by the Freedom of Information Act.
2. A record from this system of records may be disclosed, as a routine use, in the course of presenting evidence to a court, magistrate, or administrative tribunal, including disclosures to opposing counsel in the course of settlement negotiations.
3. A record in this system of records may be disclosed, as a routine use, to a Member of Congress submitting a request involving an individual, to whom the record pertains, when the individual has requested assistance from the Member with respect to the subject matter of the record.
4. A record in this system of records may be disclosed, as a routine use, to a contractor of the Agency having need for the information in order to perform a contract. Recipients of information shall be required to comply with the requirements of the Privacy Act of 1974, as amended, pursuant to 5 U.S.C. 552a(m).
5. A record related to an International Application filed under the Patent Cooperation Treaty in this system of records may be disclosed, as a routine use, to the International Bureau of the World Intellectual Property Organization, pursuant to the Patent Cooperation Treaty.
6. A record in this system of records may be disclosed, as a routine use, to another federal agency for purposes of National Security review (35 U.S.C. 181) and for review pursuant to the Atomic Energy Act (42 U.S.C. 218(c)).
7. A record from this system of records may be disclosed, as a routine use, to the Administrator, General Services, or his/her designee, during an inspection of records conducted by GSA as part of that agency's responsibility to recommend improvements in records management practices and programs, under authority of 44 U.S.C. 2904 and 2906. Such disclosure shall be made in accordance with the GSA regulations governing inspection of records for this purpose, and any other relevant (*i.e.*, GSA or Commerce) directive. Such disclosure shall not be used to make determinations about individuals.
8. A record from this system of records may be disclosed, as a routine use, to the public after either publication of the application pursuant to 35 U.S.C. 122(b) or issuance of a patent pursuant to 35 U.S.C. 151. Further, a record may be disclosed, subject to the limitations of 37 CFR 1.14, as a routine use, to the public if the record was filed in an application which became abandoned or in which the proceedings were terminated and which application is referenced by either a published application, an application open to public inspection or an issued patent.
9. A record from this system of records may be disclosed, as a routine use, to a Federal, State, or local law enforcement agency, if the USPTO becomes aware of a violation or potential violation of law or regulation.

Under the Paperwork Reduction Act of 1995, no persons are required to respond to a collection of information unless it displays a valid OMB control number.

STATEMENT UNDER 37 CFR 3.73(c)

Applicant/Patent Owner: SRC Labs, LLC

Application No./Patent No.: 7,620,800 Filed/Issue Date: 11-17-2009

Titled: MULTI-ADAPTIVE PROCESSING SYSTEMS AND TECHNIQUES FOR ENHANCING PARALLELISM AND PERFORMANCE OF COMPUTATIONAL FUNCTIONS

SRC Labs, LLC, a Limited Liability Company

(Name of Assignee) (Type of Assignee, e.g., corporation, partnership, university, government agency, etc.)

states that, for the patent application/patent identified above, it is (choose **one** of options 1, 2, 3 or 4 below):

- 1. The assignee of the entire right, title, and interest.
- 2. An assignee of less than the entire right, title, and interest (check applicable box):
 - The extent (by percentage) of its ownership interest is _____%. Additional Statement(s) by the owners holding the balance of the interest must be submitted to account for 100% of the ownership interest.
 - There are unspecified percentages of ownership. The other parties, including inventors, who together own the entire right, title and interest are:

Additional Statement(s) by the owner(s) holding the balance of the interest must be submitted to account for the entire right, title, and interest.

- 3. The assignee of an undivided interest in the entirety (a complete assignment from one of the joint inventors was made). The other parties, including inventors, who together own the entire right, title, and interest are:

Additional Statement(s) by the owner(s) holding the balance of the interest must be submitted to account for the entire right, title, and interest.

- 4. The recipient, via a court proceeding or the like (e.g., bankruptcy, probate), of an undivided interest in the entirety (a complete transfer of ownership interest was made). The certified document(s) showing the transfer is attached.

The interest identified in option 1, 2 or 3 above (not option 4) is evidenced by either (choose **one** of options A or B below):

- A. An assignment from the inventor(s) of the patent application/patent identified above. The assignment was recorded in the United States Patent and Trademark Office at Reel 037820, Frame 0147, or for which a copy thereof is attached.
- B. A chain of title from the inventor(s), of the patent application/patent identified above, to the current assignee as follows:
 - 1. From: _____ To: _____
The document was recorded in the United States Patent and Trademark Office at Reel _____, Frame _____, or for which a copy thereof is attached.
 - 2. From: _____ To: _____
The document was recorded in the United States Patent and Trademark Office at Reel _____, Frame _____, or for which a copy thereof is attached.

This collection of information is required by 37 CFR 3.73(b). The information is required to obtain or retain a benefit by the public which is to file (and by the USPTO to process) an application. Confidentiality is governed by 35 U.S.C. 122 and 37 CFR 1.11 and 1.14. This collection is estimated to take 12 minutes to complete, including gathering, preparing, and submitting the completed application form to the USPTO. Time will vary depending upon the individual case. Any comments on the amount of time you require to complete this form and/or suggestions for reducing this burden, should be sent to the Chief Information Officer, U.S. Patent and Trademark Office, U.S. Department of Commerce, P.O. Box 1450, Alexandria, VA 22313-1450. DO NOT SEND FEES OR COMPLETED FORMS TO THIS ADDRESS. **SEND TO: Commissioner for Patents, P.O. Box 1450, Alexandria, VA 22313-1450.**

If you need assistance in completing the form, call 1-800-PTO-9199 and select option 2.

Under the Paperwork Reduction Act of 1995, no persons are required to respond to a collection of information unless it displays a valid OMB control number.

STATEMENT UNDER 37 CFR 3.73(c)

3. From: _____ To: _____

The document was recorded in the United States Patent and Trademark Office at
Reel _____, Frame _____, or for which a copy thereof is attached.

4. From: _____ To: _____

The document was recorded in the United States Patent and Trademark Office at
Reel _____, Frame _____, or for which a copy thereof is attached.

5. From: _____ To: _____

The document was recorded in the United States Patent and Trademark Office at
Reel _____, Frame _____, or for which a copy thereof is attached.

6. From: _____ To: _____

The document was recorded in the United States Patent and Trademark Office at
Reel _____, Frame _____, or for which a copy thereof is attached.

Additional documents in the chain of title are listed on a supplemental sheet(s).

As required by 37 CFR 3.73(c)(1)(i), the documentary evidence of the chain of title from the original owner to the assignee was, or concurrently is being, submitted for recordation pursuant to 37 CFR 3.11.

[NOTE: A separate copy (i.e., a true copy of the original assignment document(s)) must be submitted to Assignment Division in accordance with 37 CFR Part 3, to record the assignment in the records of the USPTO. See MPEP 302.08]

The undersigned (whose title is supplied below) is authorized to act on behalf of the assignee.

/Todd R. Fronek/

March 4, 2016

Signature

Date

Todd R. Fronek

48516

Printed or Typed Name

Title or Registration Number

Privacy Act Statement

The **Privacy Act of 1974 (P.L. 93-579)** requires that you be given certain information in connection with your submission of the attached form related to a patent application or patent. Accordingly, pursuant to the requirements of the Act, please be advised that: (1) the general authority for the collection of this information is 35 U.S.C. 2(b)(2); (2) furnishing of the information solicited is voluntary; and (3) the principal purpose for which the information is used by the U.S. Patent and Trademark Office is to process and/or examine your submission related to a patent application or patent. If you do not furnish the requested information, the U.S. Patent and Trademark Office may not be able to process and/or examine your submission, which may result in termination of proceedings or abandonment of the application or expiration of the patent.

The information provided by you in this form will be subject to the following routine uses:

1. The information on this form will be treated confidentially to the extent allowed under the Freedom of Information Act (5 U.S.C. 552) and the Privacy Act (5 U.S.C. 552a). Records from this system of records may be disclosed to the Department of Justice to determine whether disclosure of these records is required by the Freedom of Information Act.
2. A record from this system of records may be disclosed, as a routine use, in the course of presenting evidence to a court, magistrate, or administrative tribunal, including disclosures to opposing counsel in the course of settlement negotiations.
3. A record in this system of records may be disclosed, as a routine use, to a Member of Congress submitting a request involving an individual, to whom the record pertains, when the individual has requested assistance from the Member with respect to the subject matter of the record.
4. A record in this system of records may be disclosed, as a routine use, to a contractor of the Agency having need for the information in order to perform a contract. Recipients of information shall be required to comply with the requirements of the Privacy Act of 1974, as amended, pursuant to 5 U.S.C. 552a(m).
5. A record related to an International Application filed under the Patent Cooperation Treaty in this system of records may be disclosed, as a routine use, to the International Bureau of the World Intellectual Property Organization, pursuant to the Patent Cooperation Treaty.
6. A record in this system of records may be disclosed, as a routine use, to another federal agency for purposes of National Security review (35 U.S.C. 181) and for review pursuant to the Atomic Energy Act (42 U.S.C. 218(c)).
7. A record from this system of records may be disclosed, as a routine use, to the Administrator, General Services, or his/her designee, during an inspection of records conducted by GSA as part of that agency's responsibility to recommend improvements in records management practices and programs, under authority of 44 U.S.C. 2904 and 2906. Such disclosure shall be made in accordance with the GSA regulations governing inspection of records for this purpose, and any other relevant (*i.e.*, GSA or Commerce) directive. Such disclosure shall not be used to make determinations about individuals.
8. A record from this system of records may be disclosed, as a routine use, to the public after either publication of the application pursuant to 35 U.S.C. 122(b) or issuance of a patent pursuant to 35 U.S.C. 151. Further, a record may be disclosed, subject to the limitations of 37 CFR 1.14, as a routine use, to the public if the record was filed in an application which became abandoned or in which the proceedings were terminated and which application is referenced by either a published application, an application open to public inspection or an issued patent.
9. A record from this system of records may be disclosed, as a routine use, to a Federal, State, or local law enforcement agency, if the USPTO becomes aware of a violation or potential violation of law or regulation.

Electronic Acknowledgement Receipt

EFS ID:	25103906
Application Number:	11733064
International Application Number:	
Confirmation Number:	7527
Title of Invention:	MULTI-ADAPTIVE PROCESSING SYSTEMS AND TECHNIQUES FOR ENHANCING PARALLELISM AND PERFORMANCE OF COMPUTATIONAL FUNCTIONS
First Named Inventor/Applicant Name:	Jon M. Huppenthal
Customer Number:	25235
Filer:	Todd Ryan Fronck/Kathryn Becker
Filer Authorized By:	Todd Ryan Fronck
Attorney Docket Number:	SRC015 CON
Receipt Date:	04-MAR-2016
Filing Date:	09-APR-2007
Time Stamp:	13:03:44
Application Type:	Utility under 35 USC 111(a)

Payment information:

Submitted with Payment	no
------------------------	----

File Listing:

Document Number	Document Description	File Name	File Size(Bytes)/ Message Digest	Multi Part /.zip	Pages (if appl.)
1	Power of Attorney	800.pdf	137729 e96b8e906a7858250c510ce903bbb2affb20f435	no	2

Warnings:

Information:

2	Assignee showing of ownership per 37 CFR 3.73	800_373c.pdf	110592 a60d7851ccda4449f8ebce9a507051ab59f178e	no	3
---	---	--------------	---	----	---

Warnings:

Information:

Total Files Size (in bytes):	248321
-------------------------------------	--------

This Acknowledgement Receipt evidences receipt on the noted date by the USPTO of the indicated documents, characterized by the applicant, and including page counts, where applicable. It serves as evidence of receipt similar to a Post Card, as described in MPEP 503.

New Applications Under 35 U.S.C. 111

If a new application is being filed and the application includes the necessary components for a filing date (see 37 CFR 1.53(b)-(d) and MPEP 506), a Filing Receipt (37 CFR 1.54) will be issued in due course and the date shown on this Acknowledgement Receipt will establish the filing date of the application.

National Stage of an International Application under 35 U.S.C. 371

If a timely submission to enter the national stage of an international application is compliant with the conditions of 35 U.S.C. 371 and other applicable requirements a Form PCT/DO/EO/903 indicating acceptance of the application as a national stage submission under 35 U.S.C. 371 will be issued in addition to the Filing Receipt, in due course.

New International Application Filed with the USPTO as a Receiving Office

If a new international application is being filed and the international application includes the necessary components for an international filing date (see PCT Article 11 and MPEP 1810), a Notification of the International Application Number and of the International Filing Date (Form PCT/RO/105) will be issued in due course, subject to prescriptions concerning national security, and the date shown on this Acknowledgement Receipt will establish the international filing date of the application.



UNITED STATES PATENT AND TRADEMARK OFFICE

UNITED STATES DEPARTMENT OF COMMERCE
United States Patent and Trademark Office
Address: COMMISSIONER FOR PATENTS
P.O. Box 1450
Alexandria, Virginia 22313-1450
www.uspto.gov

APPLICATION NUMBER	FILING OR 371(C) DATE	FIRST NAMED APPLICANT	ATTY. DOCKET NO./TITLE
11/733,064	04/09/2007	Jon M. Huppenthal	SRC015 CON

CONFIRMATION NO. 7527

POA ACCEPTANCE LETTER



25235
HOGAN LOVELLS US LLP - Colorado Springs
TWO NORTH CASCADE AVENUE
SUITE 1300
COLORADO SPRINGS, CO 80903

Date Mailed: 03/18/2016

NOTICE OF ACCEPTANCE OF POWER OF ATTORNEY

This is in response to the Power of Attorney filed 03/04/2016.

The Power of Attorney in this application is accepted. Correspondence in this application will be mailed to the above address as provided by 37 CFR 1.33.

Questions about the contents of this notice and the requirements it sets forth should be directed to the Office of Data Management, Application Assistance Unit, at (571) 272-4000 or (571) 272-4200 or 1-888-786-0101.

/fstephanos/



UNITED STATES PATENT AND TRADEMARK OFFICE

UNITED STATES DEPARTMENT OF COMMERCE
United States Patent and Trademark Office
Address: COMMISSIONER FOR PATENTS
P.O. Box 1450
Alexandria, Virginia 22313-1450
www.uspto.gov

APPLICATION NUMBER	FILING OR 371(C) DATE	FIRST NAMED APPLICANT	ATTY. DOCKET NO./TITLE
11/733,064	04/09/2007	Jon M. Huppenthal	SRC015 CON

CONFIRMATION NO. 7527

POA ACCEPTANCE LETTER



23452
LARKIN HOFFMAN DALY & LINDGREN, LTD.
8300 Norman Center Drive
Suite 1000
Minneapolis, MN 55437

Date Mailed: 05/02/2016

NOTICE OF ACCEPTANCE OF POWER OF ATTORNEY

This is in response to the Power of Attorney filed 03/04/2016.

The Power of Attorney in this application is accepted. Correspondence in this application will be mailed to the above address as provided by 37 CFR 1.33.

Questions about the contents of this notice and the requirements it sets forth should be directed to the Office of Data Management, Application Assistance Unit, at (571) 272-4000 or (571) 272-4200 or 1-888-786-0101.

/fstephanos/



UNITED STATES PATENT AND TRADEMARK OFFICE

UNITED STATES DEPARTMENT OF COMMERCE
United States Patent and Trademark Office
Address: COMMISSIONER FOR PATENTS
P.O. Box 1450
Alexandria, Virginia 22313-1450
www.uspto.gov

APPLICATION NUMBER	FILING OR 371(C) DATE	FIRST NAMED APPLICANT	ATTY. DOCKET NO./TITLE
11/733,064	04/09/2007	Jon M. Huppenthal	SRC015 CON

CONFIRMATION NO. 7527

POWER OF ATTORNEY NOTICE



25235
HOGAN LOVELLS US LLP - Colorado Springs
TWO NORTH CASCADE AVENUE
SUITE 1300
COLORADO SPRINGS, CO 80903

Date Mailed: 05/02/2016

NOTICE REGARDING CHANGE OF POWER OF ATTORNEY

This is in response to the Power of Attorney filed 03/04/2016.

- The Power of Attorney to you in this application has been revoked by the assignee who has intervened as provided by 37 CFR 3.71. Future correspondence will be mailed to the new address of record(37 CFR 1.33).

Questions about the contents of this notice and the requirements it sets forth should be directed to the Office of Data Management, Application Assistance Unit, at (571) 272-4000 or (571) 272-4200 or 1-888-786-0101.

/fstephanos/