



US 20100070730A1

(19) **United States**

(12) **Patent Application Publication**

Pop et al.

(10) **Pub. No.: US 2010/0070730 A1**

(43) **Pub. Date: Mar. 18, 2010**

(54) **MINIMIZING MEMORY ACCESS
CONFLICTS OF PROCESS
COMMUNICATION CHANNELS**

Publication Classification

(51) **Int. Cl.**
G06F 12/00 (2006.01)

(52) **U.S. Cl.** 711/167; 711/E12.001

(57) **ABSTRACT**

(76) Inventors: **Sebastian Pop**, Austin, TX (US);
Jan Sjodin, Austin, TX (US);
Harsha Jagasia, Austin, TX (US)

A system and method for minimizing cache conflicts and synchronization support for generated parallel tasks within a compiler framework. A compiler comprises library functions to generate a queue for parallel applications and divides it into windows. A window may be sized to fit within a first-level cache of a processor. Application code with producer and consumer patterns within a loop construct has these patterns split into producer and consumer tasks. Within a producer task loop, a function call is placed for a push operation that modifies a memory location within a producer sliding window without a check for concurrent accesses. A consumer task loop has a similar function call. At the time a producer or consumer task is ready to move, or slide, to an adjacent window, its corresponding function call determines if the adjacent window is available.

Correspondence Address:
**MEYERTONS, HOOD, KIVLIN, KOWERT &
GOETZEL (AMD)**
P.O. BOX 398
AUSTIN, TX 78767-0398 (US)

(21) Appl. No.: **12/212,370**

(22) Filed: **Sep. 17, 2008**

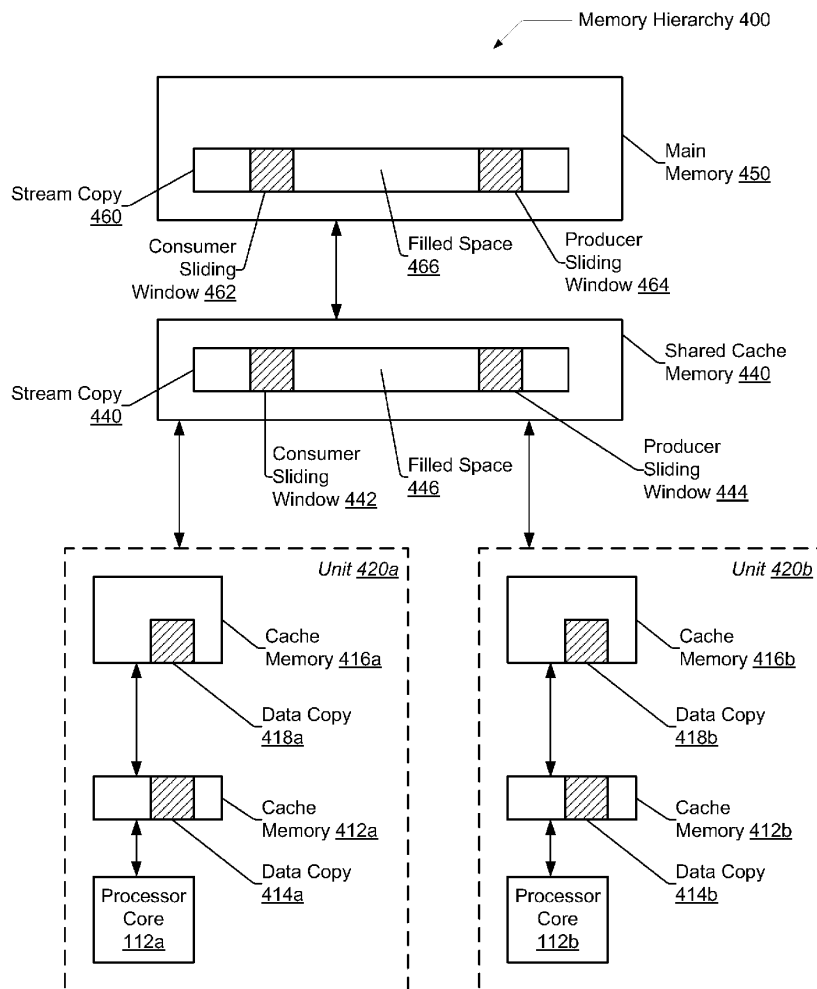

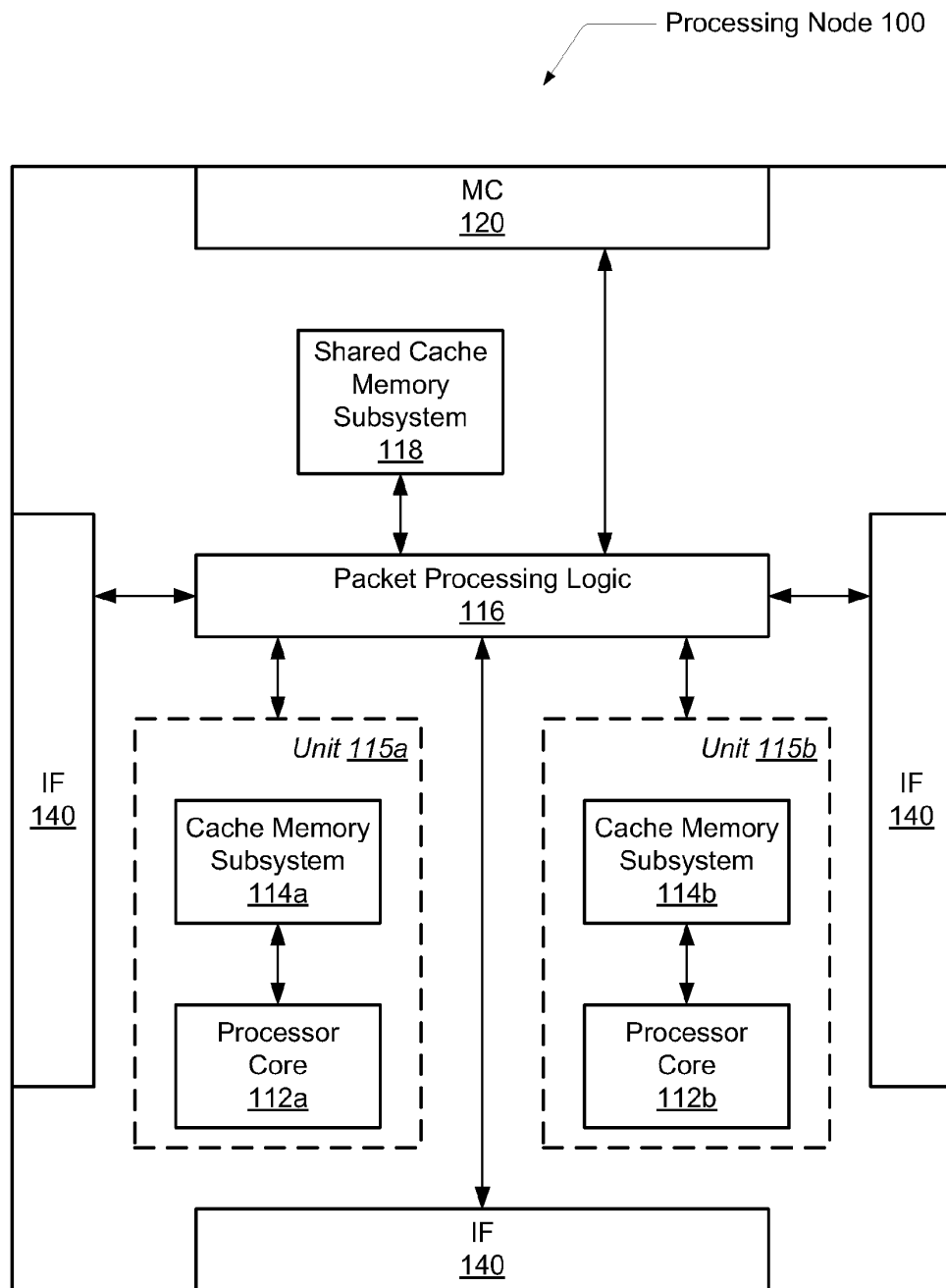



Fig. 1

Method 200 

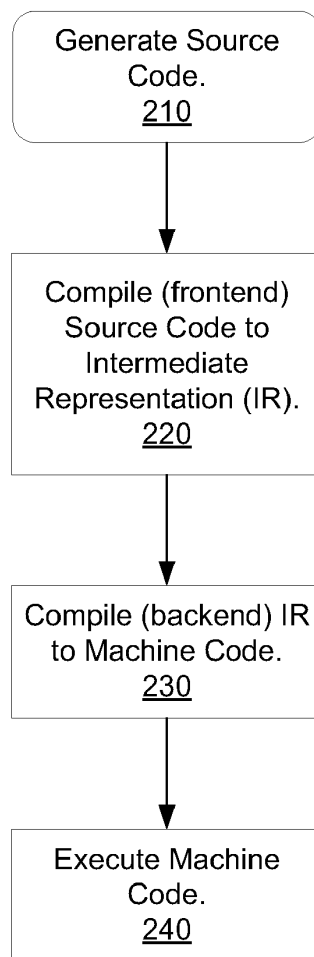

FIG. 2

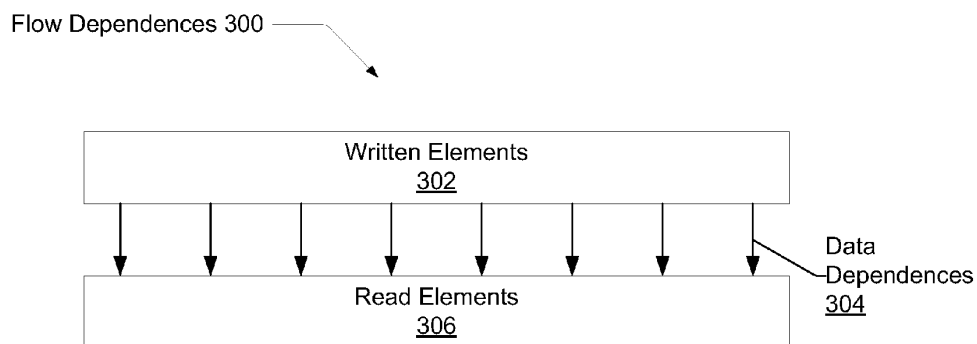

FIG. 3A

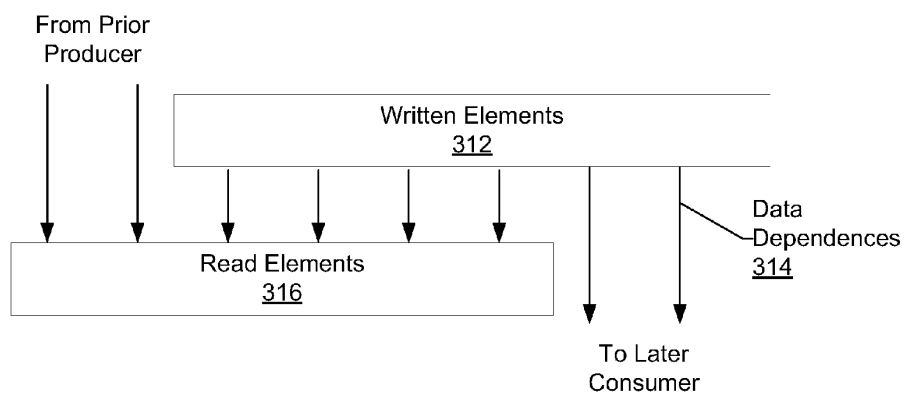

FIG. 3B

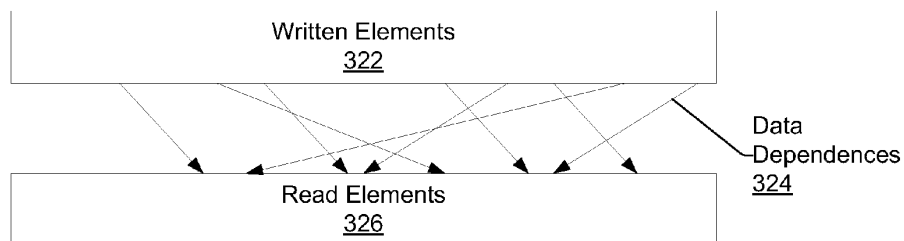

FIG. 3C

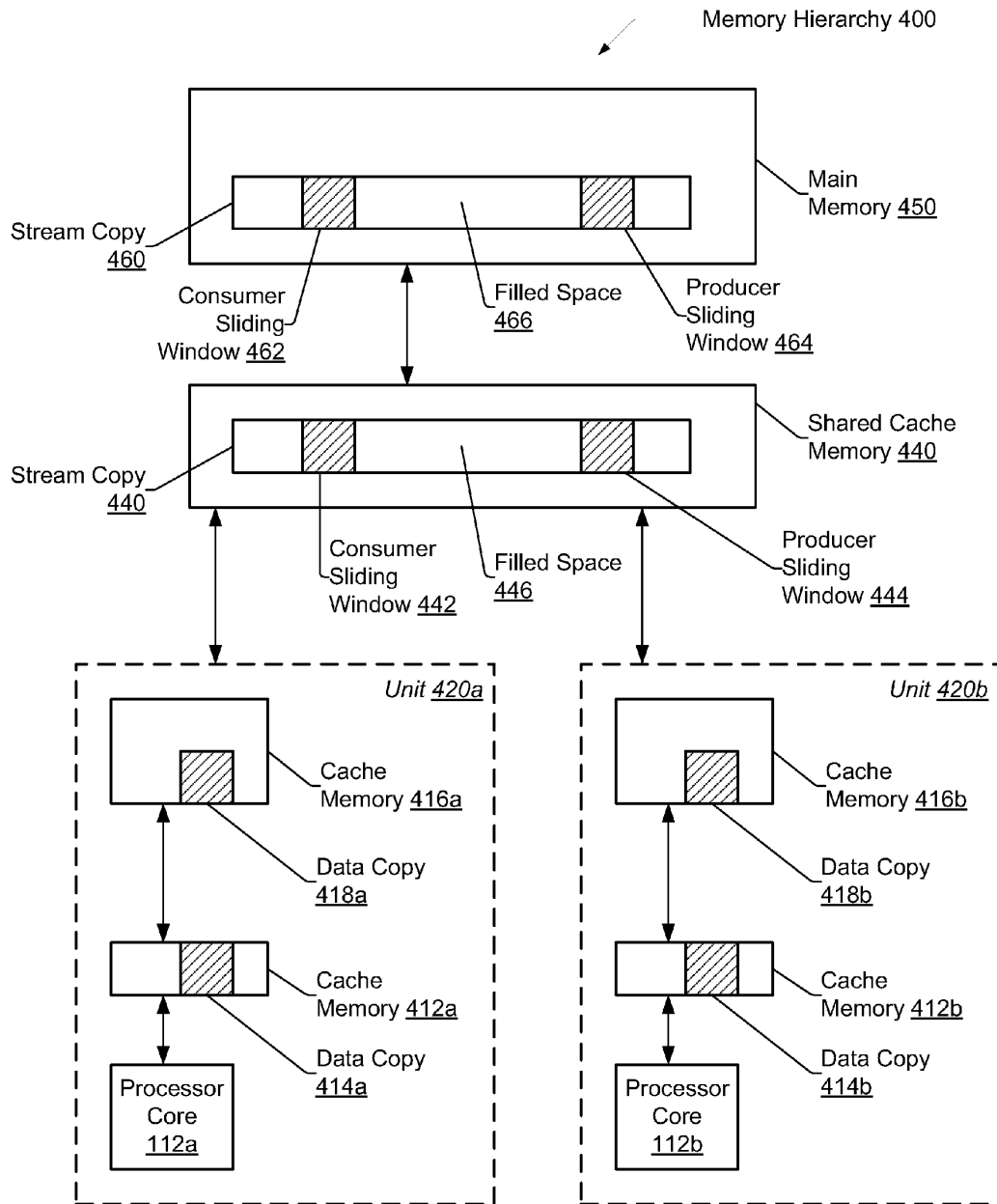

Fig. 4

Explore Litigation Insights

Docket Alarm provides insights to develop a more informed litigation strategy and the peace of mind of knowing you're on top of things.

Real-Time Litigation Alerts



Keep your litigation team up-to-date with **real-time alerts** and advanced team management tools built for the enterprise, all while greatly reducing PACER spend.

Our comprehensive service means we can handle Federal, State, and Administrative courts across the country.

Advanced Docket Research



With over 230 million records, Docket Alarm's cloud-native docket research platform finds what other services can't. Coverage includes Federal, State, plus PTAB, TTAB, ITC and NLRB decisions, all in one place.

Identify arguments that have been successful in the past with full text, pinpoint searching. Link to case law cited within any court document via Fastcase.

Analytics At Your Fingertips



Learn what happened the last time a particular judge, opposing counsel or company faced cases similar to yours.

Advanced out-of-the-box PTAB and TTAB analytics are always at your fingertips.

API

Docket Alarm offers a powerful API (application programming interface) to developers that want to integrate case filings into their apps.

LAW FIRMS

Build custom dashboards for your attorneys and clients with live data direct from the court.

Automate many repetitive legal tasks like conflict checks, document management, and marketing.

FINANCIAL INSTITUTIONS

Litigation and bankruptcy checks for companies and debtors.

E-DISCOVERY AND LEGAL VENDORS

Sync your system to PACER to automate legal marketing.