

AO 120 (Rev. 08/10)

TO: Mail Stop 8 Director of the U.S. Patent and Trademark Office P.O. Box 1450 Alexandria, VA 22313-1450	REPORT ON THE FILING OR DETERMINATION OF AN ACTION REGARDING A PATENT OR TRADEMARK
-----------------------------------------------------------------------------------------------------------------------------------------------	-------------------------------------------------------------------------------------------------------------------------

In Compliance with 35 U.S.C. § 290 and/or 15 U.S.C. § 1116 you are hereby advised that a court action has been filed in the U.S. District Court District of Delaware on the following

Trademarks or Patents. (the patent action involves 35 U.S.C. § 292.):

DOCKET NO.	DATE FILED 2/24/2017	U.S. DISTRICT COURT District of Delaware
PLAINTIFF Inventergy, Inc.		DEFENDANT Apple Inc.
PATENT OR TRADEMARK NO.	DATE OF PATENT OR TRADEMARK	HOLDER OF PATENT OR TRADEMARK
1 See Attached Sheet		
2		
3		
4		
5		

In the above—entitled case, the following patent(s)/ trademark(s) have been included:

DATE INCLUDED	INCLUDED BY	
		<input type="checkbox"/> Amendment <input type="checkbox"/> Answer <input type="checkbox"/> Cross Bill <input type="checkbox"/> Other Pleading
PATENT OR TRADEMARK NO.	DATE OF PATENT OR TRADEMARK	HOLDER OF PATENT OR TRADEMARK
1		
2		
3		
4		
5		

In the above—entitled case, the following decision has been rendered or judgement issued:

DECISION/JUDGEMENT Case voluntarily dismissed 5/25/2017.

CLERK John A. Cerino	(BY) DEPUTY CLERK Deborah L. Benyo	DATE 5/25/2017
-------------------------	---------------------------------------	-------------------

Copy 1—Upon initiation of action, mail this copy to Director Copy 3—Upon termination of action, mail this copy to Director
 Copy 2—Upon filing document adding patent(s), mail this copy to Director Copy 4—Case file copy

PATENT OR TRADEMARK NO.	DATE OF PATENT OR TRADEMARK	HOLDER OF PATENT OR TRADEMARK
1 US 6,466,563 B1	10/15/2002	Inventergy, Inc.
2 US 6,611,676 B2	8/26/2003	Inventergy, Inc.
3 US 7,206,587 B2	4/17/2007	Inventergy, Inc.
4 US 7,760,815 B2	7/20/2010	Inventergy, Inc.
5 US 7,764,711 B2	7/27/2010	Inventergy, Inc.
6 US 7,848,439 B2	12/7/2010	Inventergy, Inc.
7 US 6,760,590 B2	7/6/2004	Inventergy, Inc.



UNITED STATES PATENT AND TRADEMARK OFFICE

UNITED STATES DEPARTMENT OF COMMERCE
United States Patent and Trademark Office
Address: COMMISSIONER FOR PATENTS
P.O. Box 1450
Alexandria, Virginia 22313-1450
www.uspto.gov

APPLICATION NUMBER	FILING OR 371(C) DATE	FIRST NAMED APPLICANT	ATTY. DOCKET NO./TITLE
11/719,611	05/17/2007	Xiaoming She	20008.46a.3

CONFIRMATION NO. 9253

POWER OF ATTORNEY NOTICE



22913
Workman Nydegger
60 East South Temple
Suite 1000
Salt Lake City, UT 84111

Date Mailed: 08/15/2017

NOTICE REGARDING CHANGE OF POWER OF ATTORNEY

This is in response to the Power of Attorney filed 08/09/2017.

- The Power of Attorney to you in this application has been revoked by the assignee who has intervened as provided by 37 CFR 3.71. Future correspondence will be mailed to the new address of record(37 CFR 1.33).

Questions about the contents of this notice and the requirements it sets forth should be directed to the Office of Data Management, Application Assistance Unit, at (571) 272-4000 or (571) 272-4200 or 1-888-786-0101.

/mabebe/



UNITED STATES PATENT AND TRADEMARK OFFICE

UNITED STATES DEPARTMENT OF COMMERCE
United States Patent and Trademark Office
Address: COMMISSIONER FOR PATENTS
P.O. Box 1450
Alexandria, Virginia 22313-1450
www.uspto.gov

APPLICATION NUMBER	FILING OR 371(C) DATE	FIRST NAMED APPLICANT	ATTY. DOCKET NO./TITLE
11/719,611	05/17/2007	Xiaoming She	20008.46a.3

CONFIRMATION NO. 9253

POA ACCEPTANCE LETTER



146691
Daylight Law, P.C.
626 Jefferson Avenue
Suite 7
Redwood City, CA 94063

Date Mailed: 08/15/2017

NOTICE OF ACCEPTANCE OF POWER OF ATTORNEY

This is in response to the Power of Attorney filed 08/09/2017.

The Power of Attorney in this application is accepted. Correspondence in this application will be mailed to the above address as provided by 37 CFR 1.33.

Questions about the contents of this notice and the requirements it sets forth should be directed to the Office of Data Management, Application Assistance Unit, at (571) 272-4000 or (571) 272-4200 or 1-888-786-0101.

/mabebe/

Under the Paperwork Reduction Act of 1995, no persons are required to respond to a collection of information unless it displays a valid OMB control number.

POWER OF ATTORNEY TO PROSECUTE APPLICATIONS BEFORE THE USPTO

I hereby revoke all previous powers of attorney given in the application identified in the attached statement under 37 CFR 3.73(b).

I hereby appoint:

Practitioners associated with the Customer Number:

146691

OR

Practitioner(s) named below (if more than ten patent practitioners are to be named, then a customer number must be used):

Name	Registration Number		Name	Registration Number

as attorney(s) or agent(s) to represent the undersigned before the United States Patent and Trademark Office (USPTO) in connection with any and all patent applications assigned only to the undersigned according to the USPTO assignment records or assignment documents attached to this form in accordance with 37 CFR 3.73(b).

Please change the correspondence address for the application identified in the attached statement under 37 CFR 3.73(b) to:

The address associated with Customer Number:

OR

<input type="checkbox"/>	Firm or Individual Name
Address	
City	State
Country	Zip
Telephone	Email

Assignee Name and Address:

INVT SPE LLC
 One Market Plaza, Spear Tower, 42nd Floor
 San Francisco, CA 94105

A copy of this form, together with a statement under 37 CFR 3.73(b) (Form PTO/SB/96 or equivalent) is required to be filed in each application in which this form is used. The statement under 37 CFR 3.73(b) may be completed by one of the practitioners appointed in this form if the appointed practitioner is authorized to act on behalf of the assignee, and must identify the application in which this Power of Attorney is to be filed.

SIGNATURE of Assignee of Record

The individual whose signature and title is supplied below is authorized to act on behalf of the assignee

Signature		Date	5/8/2017
Name	Eran Zur	Telephone	415-234-7400
Title	Authorized Signatory		

This collection of information is required by 37 CFR 1.31, 1.32 and 1.33. The information is required to obtain or retain a benefit by the public which is to file (and by the USPTO to process) an application. Confidentiality is governed by 35 U.S.C. 122 and 37 CFR 1.11 and 1.14. This collection is estimated to take 3 minutes to complete, including gathering, preparing, and submitting the completed application form to the USPTO. Time will vary depending upon the individual case. Any comments on the amount of time you require to complete this form and/or suggestions for reducing this burden, should be sent to the Chief Information Officer, U.S. Patent and Trademark Office, U.S. Department of Commerce, P.O. Box 1450, Alexandria, VA 22313-1450. DO NOT SEND FEES OR COMPLETED FORMS TO THIS ADDRESS. SEND TO: Commissioner for Patents, P.O. Box 1450, Alexandria, VA 22313-1450.

If you need assistance in completing the form, call 1-800-PTO-9199 and select option 2.

Under the Paperwork Reduction Act of 1995, no persons are required to respond to a collection of information unless it displays a valid OMB control number.

STATEMENT UNDER 37 CFR 3.73(c)Applicant/Patent Owner: INVT SPE LLCApplication No./Patent No.: 7,848,439 Filed/Issue Date: 12-07-2010Titled: COMMUNICATION APPARATUS, COMMUNICATION SYSTEM, AND COMMUNICATION METHODINVT SPE LLC, a Corporation

(Name of Assignee)

(Type of Assignee, e.g., corporation, partnership, university, government agency, etc.)

states that, for the patent application/patent identified above, it is (choose **one** of options 1, 2, 3 or 4 below):

1. The assignee of the entire right, title, and interest.
2. An assignee of less than the entire right, title, and interest (check applicable box):
- The extent (by percentage) of its ownership interest is _____%. Additional Statement(s) by the owners holding the balance of the interest must be submitted to account for 100% of the ownership interest.
- There are unspecified percentages of ownership. The other parties, including inventors, who together own the entire right, title and interest are:

Additional Statement(s) by the owner(s) holding the balance of the interest must be submitted to account for the entire right, title, and interest.

3. The assignee of an undivided interest in the entirety (a complete assignment from one of the joint inventors was made). The other parties, including inventors, who together own the entire right, title, and interest are:

Additional Statement(s) by the owner(s) holding the balance of the interest must be submitted to account for the entire right, title, and interest.

4. The recipient, via a court proceeding or the like (e.g., bankruptcy, probate), of an undivided interest in the entirety (a complete transfer of ownership interest was made). The certified document(s) showing the transfer is attached.

The interest identified in option 1, 2 or 3 above (not option 4) is evidenced by either (choose **one** of options A or B below):

- A. An assignment from the inventor(s) of the patent application/patent identified above. The assignment was recorded in the United States Patent and Trademark Office at Reel _____, Frame _____, or for which a copy thereof is attached.
- B. A chain of title from the inventor(s), of the patent application/patent identified above, to the current assignee as follows:

1. From: SHE, XIAOMING and LI, JIFENG To: MATSUSHITA ELECTRIC INDUSTRIAL CO., LTD.The document was recorded in the United States Patent and Trademark Office at
Reel 019967, Frame 0735, or for which a copy thereof is attached.2. From: MATSUSHITA ELECTRIC INDUSTRIAL CO., LTD. To: PANASONIC CORPORATIONThe document was recorded in the United States Patent and Trademark Office at
Reel 021832, Frame 0197, or for which a copy thereof is attached.

[Page 1 of 2]

This collection of information is required by 37 CFR 3.73(b). The information is required to obtain or retain a benefit by the public which is to file (and by the USPTO to process) an application. Confidentiality is governed by 35 U.S.C. 122 and 37 CFR 1.11 and 1.14. This collection is estimated to take 12 minutes to complete, including gathering, preparing, and submitting the completed application form to the USPTO. Time will vary depending upon the individual case. Any comments on the amount of time you require to complete this form and/or suggestions for reducing this burden, should be sent to the Chief Information Officer, U.S. Patent and Trademark Office, U.S. Department of Commerce, P.O. Box 1450, Alexandria, VA 22313-1450. DO NOT SEND FEES OR COMPLETED FORMS TO THIS ADDRESS. **SEND TO: Commissioner for Patents, P.O. Box 1450, Alexandria, VA 22313-1450.**

Under the Paperwork Reduction Act of 1995, no persons are required to respond to a collection of information unless it displays a valid OMB control number.

STATEMENT UNDER 37 CFR 3.73(c)

3. From: PANASONIC CORPORATION To: INVENTERGY, INC.

The document was recorded in the United States Patent and Trademark Office at
Reel 031911, Frame 0911, or for which a copy thereof is attached.

4. From: INVENTERGY, INC. To: INVT SPE LLC

The document was recorded in the United States Patent and Trademark Office at
Reel 042885, Frame 0685, or for which a copy thereof is attached.

5. From: _____ To: _____

The document was recorded in the United States Patent and Trademark Office at
Reel _____, Frame _____, or for which a copy thereof is attached.

6. From: _____ To: _____

The document was recorded in the United States Patent and Trademark Office at
Reel _____, Frame _____, or for which a copy thereof is attached.

Additional documents in the chain of title are listed on a supplemental sheet(s).

As required by 37 CFR 3.73(c)(1)(i), the documentary evidence of the chain of title from the original owner to the assignee was, or concurrently is being, submitted for recordation pursuant to 37 CFR 3.11.

[NOTE: A separate copy (i.e., a true copy of the original assignment document(s)) must be submitted to Assignment Division in accordance with 37 CFR Part 3, to record the assignment in the records of the USPTO. See MPEP 302.08]

The undersigned (whose title is supplied below) is authorized to act on behalf of the assignee.

/Eric Scheuerlein/

08-09-2017

Signature

Date

Eric Scheuerlein

61234

Printed or Typed Name

Title or Registration Number

Privacy Act Statement

The **Privacy Act of 1974 (P.L. 93-579)** requires that you be given certain information in connection with your submission of the attached form related to a patent application or patent. Accordingly, pursuant to the requirements of the Act, please be advised that: (1) the general authority for the collection of this information is 35 U.S.C. 2(b)(2); (2) furnishing of the information solicited is voluntary; and (3) the principal purpose for which the information is used by the U.S. Patent and Trademark Office is to process and/or examine your submission related to a patent application or patent. If you do not furnish the requested information, the U.S. Patent and Trademark Office may not be able to process and/or examine your submission, which may result in termination of proceedings or abandonment of the application or expiration of the patent.

The information provided by you in this form will be subject to the following routine uses:

1. The information on this form will be treated confidentially to the extent allowed under the Freedom of Information Act (5 U.S.C. 552) and the Privacy Act (5 U.S.C. 552a). Records from this system of records may be disclosed to the Department of Justice to determine whether disclosure of these records is required by the Freedom of Information Act.
2. A record from this system of records may be disclosed, as a routine use, in the course of presenting evidence to a court, magistrate, or administrative tribunal, including disclosures to opposing counsel in the course of settlement negotiations.
3. A record in this system of records may be disclosed, as a routine use, to a Member of Congress submitting a request involving an individual, to whom the record pertains, when the individual has requested assistance from the Member with respect to the subject matter of the record.
4. A record in this system of records may be disclosed, as a routine use, to a contractor of the Agency having need for the information in order to perform a contract. Recipients of information shall be required to comply with the requirements of the Privacy Act of 1974, as amended, pursuant to 5 U.S.C. 552a(m).
5. A record related to an International Application filed under the Patent Cooperation Treaty in this system of records may be disclosed, as a routine use, to the International Bureau of the World Intellectual Property Organization, pursuant to the Patent Cooperation Treaty.
6. A record in this system of records may be disclosed, as a routine use, to another federal agency for purposes of National Security review (35 U.S.C. 181) and for review pursuant to the Atomic Energy Act (42 U.S.C. 218(c)).
7. A record from this system of records may be disclosed, as a routine use, to the Administrator, General Services, or his/her designee, during an inspection of records conducted by GSA as part of that agency's responsibility to recommend improvements in records management practices and programs, under authority of 44 U.S.C. 2904 and 2906. Such disclosure shall be made in accordance with the GSA regulations governing inspection of records for this purpose, and any other relevant (*i.e.*, GSA or Commerce) directive. Such disclosure shall not be used to make determinations about individuals.
8. A record from this system of records may be disclosed, as a routine use, to the public after either publication of the application pursuant to 35 U.S.C. 122(b) or issuance of a patent pursuant to 35 U.S.C. 151. Further, a record may be disclosed, subject to the limitations of 37 CFR 1.14, as a routine use, to the public if the record was filed in an application which became abandoned or in which the proceedings were terminated and which application is referenced by either a published application, an application open to public inspection or an issued patent.
9. A record from this system of records may be disclosed, as a routine use, to a Federal, State, or local law enforcement agency, if the USPTO becomes aware of a violation or potential violation of law or regulation.

Electronic Acknowledgement Receipt

EFS ID:	30024520
Application Number:	11719611
International Application Number:	
Confirmation Number:	9253
Title of Invention:	COMMUNICATION APPARATUS, COMMUNICATION SYSTEM, AND COMMUNICATION METHOD
First Named Inventor/Applicant Name:	Xiaoming She
Customer Number:	22913
Filer:	Ricky Quoc Lam
Filer Authorized By:	
Attorney Docket Number:	20008.46a.3
Receipt Date:	09-AUG-2017
Filing Date:	17-MAY-2007
Time Stamp:	05:51:13
Application Type:	U.S. National Stage under 35 USC 371

Payment information:

Submitted with Payment	no
------------------------	----

File Listing:

Document Number	Document Description	File Name	File Size(Bytes)/ Message Digest	Multi Part /.zip	Pages (if appl.)
1	Power of Attorney	20170809_INVE_POA.pdf	768768 <small>78db457b0ec765e945ca829dd13f82573c60f4ea</small>	no	1

Warnings:

Information:					
2	Assignee showing of ownership per 37 CFR 3.73	20170809_US7848439_statement_cfr.pdf	77347 c3a881d4e631e5d4cc29e250fa561463d5dbed783	no	3
Warnings:					
Information:					
Total Files Size (in bytes):				846115	
<p>This Acknowledgement Receipt evidences receipt on the noted date by the USPTO of the indicated documents, characterized by the applicant, and including page counts, where applicable. It serves as evidence of receipt similar to a Post Card, as described in MPEP 503.</p> <p><u>New Applications Under 35 U.S.C. 111</u> If a new application is being filed and the application includes the necessary components for a filing date (see 37 CFR 1.53(b)-(d) and MPEP 506), a Filing Receipt (37 CFR 1.54) will be issued in due course and the date shown on this Acknowledgement Receipt will establish the filing date of the application.</p> <p><u>National Stage of an International Application under 35 U.S.C. 371</u> If a timely submission to enter the national stage of an international application is compliant with the conditions of 35 U.S.C. 371 and other applicable requirements a Form PCT/DO/EO/903 indicating acceptance of the application as a national stage submission under 35 U.S.C. 371 will be issued in addition to the Filing Receipt, in due course.</p> <p><u>New International Application Filed with the USPTO as a Receiving Office</u> If a new international application is being filed and the international application includes the necessary components for an international filing date (see PCT Article 11 and MPEP 1810), a Notification of the International Application Number and of the International Filing Date (Form PCT/RO/105) will be issued in due course, subject to prescriptions concerning national security, and the date shown on this Acknowledgement Receipt will establish the international filing date of the application.</p>					

AO 120 (Rev. 08/10)

TO: Mail Stop 8 Director of the U.S. Patent and Trademark Office P.O. Box 1450 Alexandria, VA 22313-1450	REPORT ON THE FILING OR DETERMINATION OF AN ACTION REGARDING A PATENT OR TRADEMARK
-----------------------------------------------------------------------------------------------------------------------------------------------	-------------------------------------------------------------------------------------------------------------------------

In Compliance with 35 U.S.C. § 290 and/or 15 U.S.C. § 1116 you are hereby advised that a court action has been filed in the U.S. District Court District of Delaware on the following

Trademarks or Patents. (the patent action involves 35 U.S.C. § 292.):

DOCKET NO.	DATE FILED 2/24/2017	U.S. DISTRICT COURT District of Delaware
PLAINTIFF Inventergy, Inc.		DEFENDANT Apple Inc.
PATENT OR TRADEMARK NO.	DATE OF PATENT OR TRADEMARK	HOLDER OF PATENT OR TRADEMARK
1 See Attached Sheet		
2		
3		
4		
5		

In the above—entitled case, the following patent(s)/ trademark(s) have been included:

DATE INCLUDED	INCLUDED BY	<input type="checkbox"/> Amendment <input type="checkbox"/> Answer <input type="checkbox"/> Cross Bill <input type="checkbox"/> Other Pleading
PATENT OR TRADEMARK NO.	DATE OF PATENT OR TRADEMARK	HOLDER OF PATENT OR TRADEMARK
1		
2		
3		
4		
5		

In the above—entitled case, the following decision has been rendered or judgement issued:

DECISION/JUDGEMENT

CLERK	(BY) DEPUTY CLERK	DATE
-------	-------------------	------

Copy 1—Upon initiation of action, mail this copy to Director Copy 3—Upon termination of action, mail this copy to Director
 Copy 2—Upon filing document adding patent(s), mail this copy to Director Copy 4—Case file copy

PATENT OR TRADEMARK NO.	DATE OF PATENT OR TRADEMARK	HOLDER OF PATENT OR TRADEMARK
1 US 6,466,563 B1	10/15/2002	Inventergy, Inc.
2 US 6,611,676 B2	8/26/2003	Inventergy, Inc.
3 US 7,206,587 B2	4/17/2007	Inventergy, Inc.
4 US 7,760,815 B2	7/20/2010	Inventergy, Inc.
5 US 7,764,711 B2	7/27/2010	Inventergy, Inc.
6 US 7,848,439 B2	12/7/2010	Inventergy, Inc.
7 US 6,760,590 B2	7/6/2004	Inventergy, Inc.

PATENT ASSIGNMENT COVER SHEET

Electronic Version v1.1
 Stylesheet Version v1.2

EPAS ID: PAT3092617

SUBMISSION TYPE:	NEW ASSIGNMENT
NATURE OF CONVEYANCE:	RELEASE OF SECURITY INTEREST

CONVEYING PARTY DATA

Name	Execution Date
HUDSON BAY IP OPPORTUNITIES MASTER FUND, LP, FOR ITSELF AND AS COLLATERAL AGENT FOR CERTAIN BUYERS	09/30/2014

RECEIVING PARTY DATA

Name:	INVENTERGY, INC.
Street Address:	900 E. HAMILTON AVE.
Internal Address:	SUITE 180
City:	CAMPBELL
State/Country:	CALIFORNIA
Postal Code:	95008

PROPERTY NUMBERS Total: 156

Property Type	Number
Patent Number:	7925762
Patent Number:	7623529
Patent Number:	7065339
Patent Number:	7991894
Patent Number:	7304966
Patent Number:	6885828
Patent Number:	6801542
Patent Number:	8681751
Patent Number:	6904035
Patent Number:	7900242
Patent Number:	7917620
Patent Number:	7560102
Patent Number:	7796990
Patent Number:	7822035
Patent Number:	6726297
Patent Number:	8009549
Patent Number:	8416810
Patent Number:	7646702
Patent Number:	8238226

Property Type	Number
Patent Number:	7593317
Patent Number:	7929627
Patent Number:	7826557
Patent Number:	7792084
Patent Number:	8064393
Patent Number:	8270332
Patent Number:	8582573
Patent Number:	6400929
Patent Number:	6381445
Patent Number:	6366763
Patent Number:	6370359
Patent Number:	6487394
Patent Number:	6597894
Patent Number:	6505035
Patent Number:	6973289
Patent Number:	6611676
Patent Number:	7636551
Patent Number:	6637001
Patent Number:	6813323
Patent Number:	6734810
Patent Number:	6940428
Patent Number:	6922159
Patent Number:	6069884
Patent Number:	6119004
Patent Number:	6069924
Patent Number:	6636723
Patent Number:	6628630
Patent Number:	6404778
Patent Number:	6611509
Patent Number:	6807162
Patent Number:	6973065
Patent Number:	7778224
Patent Number:	6765894
Patent Number:	7656844
Patent Number:	8437316
Patent Number:	6839335
Patent Number:	7072416
Patent Number:	7760815
Patent Number:	6868056

Property Type	Number
Patent Number:	6944208
Patent Number:	6781973
Patent Number:	7145886
Patent Number:	6847828
Patent Number:	7386321
Patent Number:	7266118
Patent Number:	7133379
Patent Number:	7392019
Patent Number:	7339949
Patent Number:	7702025
Patent Number:	7460502
Patent Number:	7269774
Patent Number:	7385934
Patent Number:	7114121
Patent Number:	7162206
Patent Number:	7746762
Patent Number:	7693140
Patent Number:	7299027
Patent Number:	8775890
Patent Number:	7251469
Patent Number:	7764711
Patent Number:	8086270
Patent Number:	7848439
Patent Number:	8175604
Patent Number:	7860184
Patent Number:	8073070
Patent Number:	8249132
Patent Number:	8576784
Patent Number:	8218681
Patent Number:	8249178
Patent Number:	5583851
Patent Number:	5873027
Patent Number:	6336040
Patent Number:	5757870
Patent Number:	5818869
Patent Number:	6175558
Patent Number:	6301237
Patent Number:	6529492
Patent Number:	6370131

Property Type	Number
Patent Number:	6584088
Patent Number:	6549526
Patent Number:	7136367
Patent Number:	RE41444
Patent Number:	6295301
Patent Number:	6697384
Patent Number:	6466563
Patent Number:	6370134
Patent Number:	7035233
Patent Number:	7535864
Patent Number:	5677929
Patent Number:	RE37420
Patent Number:	RE39954
Patent Number:	6738646
Patent Number:	7460880
Patent Number:	7761113
Patent Number:	6760590
Patent Number:	6799053
Patent Number:	7206587
Patent Number:	8582766
Patent Number:	7349693
Patent Number:	7583612
Patent Number:	7653076
Patent Number:	7693141
Patent Number:	7710880
Patent Number:	7764953
Patent Number:	7787608
Patent Number:	7787878
Patent Number:	7792116
Patent Number:	7835352
Patent Number:	7881317
Patent Number:	7898943
Patent Number:	7899065
Patent Number:	7920579
Patent Number:	7948955
Patent Number:	7986775
Patent Number:	8085712
Patent Number:	8108526
Patent Number:	8116322

Property Type	Number
Patent Number:	8125995
Patent Number:	8149824
Patent Number:	8185105
Patent Number:	8195942
Patent Number:	8213419
Patent Number:	8224325
Patent Number:	8335221
Patent Number:	8335487
Patent Number:	8417240
Application Number:	11691417
Application Number:	10901380
Application Number:	11134448
Application Number:	10419089
Application Number:	11859550
Application Number:	13478996
Application Number:	13532576
Application Number:	13554748
Application Number:	10235918
Application Number:	10322425
Application Number:	11698891

CORRESPONDENCE DATA

Fax Number: (408)389-3518
Correspondence will be sent to the e-mail address first; if that is unsuccessful, it will be sent using a fax number, if provided; if that is unsuccessful, it will be sent via US Mail.
Phone: 4083893518
Email: paul@inventergy.com
Correspondent Name: INVENTERGY, INC.
Address Line 1: 900 E. HAMILTON AVE.
Address Line 2: SUITE 180
Address Line 4: CAMPBELL, CALIFORNIA 95008

NAME OF SUBMITTER:	PAUL A. ROBERTS
SIGNATURE:	/Paul A. Roberts/
DATE SIGNED:	11/03/2014
	This document serves as an Oath/Declaration (37 CFR 1.63).

Total Attachments: 61
source=Hudson-INVT - USPTO Patent Release_Clean_09.30.2014 FINAL-ALL#page1.tif
source=Hudson-INVT - USPTO Patent Release_Clean_09.30.2014 FINAL-ALL#page2.tif
source=Hudson-INVT - USPTO Patent Release_Clean_09.30.2014 FINAL-ALL#page3.tif
source=Hudson-INVT - USPTO Patent Release_Clean_09.30.2014 FINAL-ALL#page4.tif
source=Hudson-INVT - USPTO Patent Release_Clean_09.30.2014 FINAL-ALL#page5.tif

source=Hudson-INVT - USPTO Patent Release_Clean_09.30.2014 FINAL-ALL#page54.tif
source=Hudson-INVT - USPTO Patent Release_Clean_09.30.2014 FINAL-ALL#page55.tif
source=Hudson-INVT - USPTO Patent Release_Clean_09.30.2014 FINAL-ALL#page56.tif
source=Hudson-INVT - USPTO Patent Release_Clean_09.30.2014 FINAL-ALL#page57.tif
source=Hudson-INVT - USPTO Patent Release_Clean_09.30.2014 FINAL-ALL#page58.tif
source=Hudson-INVT - USPTO Patent Release_Clean_09.30.2014 FINAL-ALL#page59.tif
source=Hudson-INVT - USPTO Patent Release_Clean_09.30.2014 FINAL-ALL#page60.tif
source=Hudson-INVT - USPTO Patent Release_Clean_09.30.2014 FINAL-ALL#page61.tif

RELEASE

This Release of Security Interest is dated as of September 30, 2014, is by Hudson Bay IP Opportunities Master Fund, LP for itself and as collateral agent for certain buyers ("**Lender**").

- A. Several Security Agreements have been filed in the United States Patent and Trademark Office (the "**Security Agreements**").
- B. In connection with the Security Agreements, Inventergy, Inc. ("**Grantor**") granted to Lender a security interest (the "Security Interest") in certain of its now existing or hereafter acquired intellectual property (collectively, the "**Collateral**").
- C. Grantor has requested Lender to release the Security Interest in and to the Collateral, including the Patent Rights (as defined below) and Lender wishes to release the Security Interest

NOW, THEREFORE, FOR VALUE RECEIVED, Lender does hereby irrevocably and unconditionally release the Security Interest in and to the following intellectual property held as Collateral and all rights therein of any type or description including, without limitation: (a) the patents and patent applications listed on **Exhibit A** attached hereto (the "**Patents**"); (b) all patents and patent applications (i) to which any of the Patents directly or indirectly claims priority, (ii) for which any of the Patents directly or indirectly forms a basis for priority, or (iii) that were co-owned applications that incorporate by reference, or are incorporated by reference into, the Patents; (c) all reissues, reexaminations, extensions, continuations, continuations in part, continuing prosecution applications, requests for continuing examinations, divisions, registrations of any item in any of the foregoing categories (a) and (b); (d) all foreign patents, patent applications, and counterparts relating to any item in any of the foregoing categories (a) through (c), including, without limitation, certificates of invention, utility models, industrial design protection, design patent protection, and other governmental grants or issuances; (e) all items in any of the foregoing in categories (b) through (d), whether or not expressly listed as Patents above and whether or not claims in any of the foregoing have been rejected, withdrawn, cancelled, or the like; (f) inventions, invention disclosures, and discoveries described in any of the Patents or any item in the foregoing categories (b) through (e) that (i) are included in any claim in the Patents or any item in the foregoing categories (b) through (e), (ii) are subject matter capable of being reduced to a patent claim in a reissue or reexamination proceeding brought on any of the Patents or any item in the foregoing categories (b) through (e), or (iii) could have been included as a claim in any of the Patents or any item in the foregoing categories (b) through (e); (g) all rights to apply in any or all countries of the world for patents, certificates of invention, utility models, industrial design protections, design patent protections, or other governmental grants or issuances of any type related to any item in any of the foregoing categories (a) through (f), including, without limitation, under the Paris Convention for the Protection of Industrial Property, the International Patent Cooperation Treaty, or any other convention, treaty, agreement, or understanding; (h) all causes of action (whether known or unknown or whether currently pending, filed, or otherwise) and other enforcement rights under, or on account of, any of the Patents or any item in any of the foregoing categories (b) through (g), including, without limitation, all causes of action and other enforcement rights for (1) damages, (2) injunctive relief, and (3) any other remedies of any kind for past, current, and future infringement; and (i) all rights to collect royalties and other payments under or on account of any of the Patents or any item in any of the foregoing categories (b) through (h) (the "**Patent Rights**").

Lender hereby authorizes Grantor or Grantor's authorized representative to (i) record this Release with the United States Patent and Trademark Office, and in other patent offices in the world, (ii) file UCC Financing Statement Amendments with the applicable filing office in order to terminate UCC financing statements filed on behalf of Lender against the Grantor and/or (iii) otherwise file this Release.

This Release is governed by and in accordance with the laws of the State of New York without regard to its rules of conflict of law, except Section 5-1401 of the New York General Obligations Law. This Release will be binding upon Lender and its successors and assigns and inures to the benefit of Grantor, any acquirer of the Patents and their respective successors and assigns.

To the extent a court of competent jurisdiction would apply the law of the State of California notwithstanding the express selection of the laws of New York, Lender acknowledges that it is aware that it may hereafter discover facts different from or in addition to what it now knows, believes or suspects to be true with respect to the matters herein released, and the releases in this Release will be and remain in effect in all respects as complete, general releases, notwithstanding any such different or additional facts. Lender acknowledges that it has been informed of Section 1542 of the Civil Code of the State of California, and does hereby expressly waive and relinquish all rights and benefits, if any, which it has or may have under said Section 1542, which reads as follows:

A general release does not extend to claims which the creditor does not know or suspect to exist in his favor at the time of executing the release, which if known by him must have materially affected his settlement with the debtor.

IN WITNESS WHEREOF, Lender has caused this Release to be executed as of the date set forth above.

Hudson Bay Master Fund Ltd

By:  _____

Name: George Antonopoulos _____

Title: Authorized Signatory _____

EXHIBIT A

Unique ID	Patent Number	Country	Portfolio Status	Title	Issue / Publication Date	Application Number	Filing Date
13HU01-001-01	BRPI0614848	BR	Pending	Method, system and equipment for processing sip requests in IMS network	2011/04/19	BRPI614848A	2006/07/26
13HU01-001-02	CN100502402	CN	Granted	Method and device for processing session message in IMS network	2009/06/17	CN200510119756.9	2005/11/04
13HU01-001-03	CN101189850	CN	Granted	Method, system and device in IMS network processing SIP message	2012/02/22	CN200680011706.1	2006/07/26
13HU01-001-04	EP1755310	DE	Granted	Methods and apparatuses for processing SIP requests in an IMS network comprising an AS	2011/06/08	EP2006254341A	2006/08/18
13HU01-001-05	EP1755310	EP	PreCursor(EP)	Methods and apparatuses for processing SIP requests in an IMS network comprising an AS	2011/06/08	EP2006254341A	2006/08/18
13HU01-001-06	EP1755310	ES	Granted	Methods and apparatuses for processing SIP requests in an IMS network comprising an AS	2011/06/08	EP2006254341A	2006/08/18
13HU01-001-07	EP1755310	FR	Granted	Methods and apparatuses for processing SIP requests in an IMS network comprising an AS	2011/06/08	EP2006254341A	2006/08/18
13HU01-001-08	EP1755310	GB	Granted	Methods and apparatuses for processing SIP requests in an IMS network comprising an AS	2011/06/08	EP2006254341A	2006/08/18
13HU01-001-10	EP1755310	IT	Granted	Methods and apparatuses for processing SIP requests in an IMS network comprising an AS	2011/06/08	EP2006254341A	2006/08/18
13HU01-001-09	IN254557	IN	Granted	Method, system and equipment for processing sip requests in IMS network	2012/11/23	IN2008CN454A	2008/01/28
13HU01-001-11	US7835352	US	Granted	Method, system and equipment for processing sip requests in IMS network	2010/11/16	US2006506581A 11/506,581	2006/08/18
13HU01-002-01	CN100551148	CN	Granted	Method for realizing system switch in encryption mode	2007/03/07	CN200510093678.X	2005/09/01
13HU01-002-02	CN101156498	CN	Granted	Method for implementing inter-system switch-over	2011/10/26	CN200680011893.3	2006/09/01
13HU01-002-03	EP1871134	DE	Granted	METHOD FOR HANDOVER BETWEEN SYSTEMS	2009/12/16	EP2006775581A	2006/09/01
13HU01-002-04	EP1871134	EP	PreCursor(EP)	METHOD FOR HANDOVER BETWEEN SYSTEMS	2009/12/16	EP2006775581A	2006/09/01
13HU01-002-05	EP1871134	FR	Granted	METHOD FOR HANDOVER BETWEEN SYSTEMS	2009/12/16	EP2006775581A	2006/09/01
13HU01-002-06	EP1871134	GB	Granted	METHOD FOR HANDOVER BETWEEN SYSTEMS	2009/12/16	EP2006775581A	2006/09/01
13HU01-002-07	WO2007025487	WO	Lapsed	A METHOD FOR REALIZING HANDOVER BETWEEN SYSTEMS	2007/03/08	WO2006CN2264A	2006/09/01

13HU01-003-01	CN101031004	CN	Granted	Method for realizing on-hook triggering service	2010/05/12	CN200610058041.1	2006/02/28
13HU01-003-02	CN101160940	CN	Granted	Method for implementing service triggered by off-hook	2010/08/11	CN200680012256.8	2006/10/31
13HU01-003-03	EP1993274	EP	Lapsed	METHOD FOR REALIZING SERVICE TRIGGERING WHEN PICKED-UP	2008/11/19	EP2006805125A	2006/10/31
13HU01-003-04	US8149824	US	Granted	Method and system for implementing service triggered by off-hook	2012/04/03	US2007668532A 11/668,523	2007/01/30
13HU01-003-05	WO2007098654	WO	Lapsed	METHOD FOR REALIZING SERVICE TRIGGERING WHEN PICKED-UP	2007/09/07	WO2006CN2924A	2006/10/31
13HU01-004-02	CN101156398	CN	Granted	Method and system for switching terminal state of media gateway	2010/10/27	CN200680011910.3	2006/10/24
13HU01-004-01	CN1964365	CN	Granted	Method for switching terminal status in media gateway	2011/06/22	CN200510101368.8	2005/11/11
13HU01-004-03	EP1786216	DE	Granted	Method and system for switching the state of a termination in a media gateway	2009/12/30	EP2006023462A	2006/11/10
13HU01-004-04	EP1786216	EP	PreCursor(EP)	Method and system for switching the state of a termination in a media gateway	2009/12/30	EP2006023462A	2006/11/10
13HU01-004-05	EP1786216	FR	Granted	Method and system for switching the state of a termination in a media gateway	2009/12/30	EP2006023462A	2006/11/10
13HU01-004-06	US7693141	US	Granted	Method and system for switching the state of a termination in a media gateway	2010/04/06	US2006595768A 11/595,768	2006/11/10
13HU01-004-07	WO2007054011	WO	Lapsed	A METHOD FOR SWITCHING THE TERMINATION STATE IN THE MEDIA GATEWAY	2007/05/18	WO2006CN2841A	2006/10/24
13HU01-005-02	CN1901550	CN	Granted	Subscribing method based on conversation start protocol and its system and device	2011/08/10	CN200610106654.8	2006/07/21
13HU01-005-01	CN200510028074.7	CN	Lapsed	Subscribing Method Based On Conversation Start Protocol and Its System and Device		CN200510028074.7	2005/07/22
13HU01-005-03	EP1909434	EP	Lapsed	SUBSCRIBING METHOD AND DEVICE	2008/04/09	EP20060761541A	2006/07/21
13HU01-005-04	EP2086203	EP	Lapsed	Subscribing method and device	2009/10/28	EP2009160916A	2006/07/21
13HU01-005-05	US7948955	US	Granted	Subscription method and device	2011/05/24	US200817423A [08/0113,669] 12/017,423	2008/01/22
13HU01-005-06	WO2007009396	WO	Lapsed	SUBSCRIBING METHOD AND DEVICE	2007/01/25	WO2006CN1806A	2006/07/21

13HU01-006-02	CN1764140	CN	Granted	Method for realizing application server communication	2007/03/07	CN200510103571.9	2005/09/21
13HU01-006-01	CN200410078266.4	CN	Lapsed	Method for realizing application server communication		CN200410078266.4	2005/09/21
13HU01-006-03	EP1796326	DE	Granted	A METHOD FOR ENABLING COMMUNICATION IN APPLICATION SERVERS	2012/01/18	EP2005791501A	2005/09/21
13HU01-006-04	EP1796326	EP	PreCursor(EP)	A METHOD FOR ENABLING COMMUNICATION IN APPLICATION SERVERS	2012/01/18	EP2005791501A	2005/09/21
13HU01-006-05	EP1796326	FR	Granted	A METHOD FOR ENABLING COMMUNICATION IN APPLICATION SERVERS	2012/01/18	EP2005791501A	2005/09/21
13HU01-006-06	EP1796326	GB	Granted	A METHOD FOR ENABLING COMMUNICATION IN APPLICATION SERVERS	2012/01/18	EP2005791501A	2005/09/21
13HU01-006-07	EP1796326	IT	Granted	A METHOD FOR ENABLING COMMUNICATION IN APPLICATION SERVERS	2012/01/18	EP2005791501A	2005/09/21
13HU01-006-08	EP1796326	NL	Granted	A METHOD FOR ENABLING COMMUNICATION IN APPLICATION SERVERS	2012/01/18	EP2005791501A	2005/09/21
13HU01-006-09	EP1796326	SE	Granted	A METHOD FOR ENABLING COMMUNICATION IN APPLICATION SERVERS	2012/01/18	EP2005791501A	2005/09/21
13HU01-006-10	WO2006032204	WO	Lapsed	A METHOD FOR ENABLING COMMUNICATION IN THE APPLICATION SERVERS	2006/03/30	WO2005CN1523A	2005/09/21
13HU01-007-01	CN1929627	CN	Granted	A kind of realizing public user identification in IMS network of method that decreases pneumococcus nasal carriage and system	2012/02/01	CN200510098402.0	2005/09/06
13HU01-007-03	CN1941739	CN	Granted	Method and system for allocating and using user mark	2010/06/23	CN200510108129.5	2005/09/29
13HU01-007-02	CN1941774	CN	Granted	Method and system for realizing public user mark carrier	2012/07/04	CN200510108128.0	2005/09/29
13HU01-007-04	EP1761077	DE	Granted	Method and system for enabling number portability in IMS networks	2008/08/27	EP2006018705A	2006/09/06
13HU01-007-05	EP1761077	EP	PreCursor(EP)	Method and system for enabling number portability in IMS networks	2008/08/27	EP2006018705A	2006/09/06
13HU01-007-06	EP1761077	FR	Granted	Method and system for enabling number portability in IMS networks	2008/08/27	EP2006018705A	2006/09/06
13HU01-007-07	EP1761077	SE	Granted	Method and system for enabling number portability in IMS networks	2008/08/27	EP2006018705A	2006/09/06

13HU01-007-08	US7787878	US	Granted	Method and system for enabling number portability in IMS networks	2010/08/31	US2006516946A 11/516,946	2006/09/06
13HU01-007-09	WO2007028332	WO	Lapsed	METHOD AND SYSTEM FOR ENABLING NUMBER PORTABILITY IN IMS NETWORKS	2007/03/15	WO2006CN2299A	2006/09/06
13HU01-008-01	CN1758649	CN	Lapsed	Method of interconnected protocol network communicating between different edition network	2010/04/28	CN200410079321.1	2004/10/05
13HU01-008-02	CN200710167705.2	CN	Lapsed	Inter-network interconnection protocol network intercommunicating method of different version		CN200710167705.2	2004/10/05
13HU01-008-03	EP1798918	EP	Lapsed	A METHOD FOR INTERCOMMUNICATION BETWEEN NETWORKS HAVING DIFFERENT VERSION OF INTERNET PROTOCOL	2007/06/20	EP2005795754A	2005/10/08
13HU01-008-04	US7792116	US	Granted	Method and device for interworking between internet protocol networks	2010/09/07	US2007703709A 11/703,709	2007/02/08
13HU01-008-05	WO2006037276	WO	Lapsed	A METHOD FOR INTERCOMMUNICATION BETWEEN NETWORKS HAVING DIFFERENT VERSION OF INTERNET PROTOCOL	2006/04/13	WO2005CN1640A	2005/10/08
13HU01-009-07r	US14/323165	US	Reissuing	Interworking network element, interworking system between the CSI terminal and the IMS terminal and the method thereof		14/323165	2014/07/03
13HU01-009-01	CN100563235	CN	Granted	Network element with interconnecting function, CSI terminal, IMS terminal interconnecting system and method	2009/11/25	CN200610077923.2	2006/04/26
13HU01-009-02	CN101313543	CN	Granted	Exchange functional network element, CSI terminal, IMS terminal exchange system and method	2011/07/20	CN200780000211.3	2007/01/09
13HU01-009-03	EP1973283	DE	Granted	INTERWORKING NETWORK ELEMENT, INTERWORKING SYSTEM BETWEEN THE CSI TERMINAL AND THE IMS TERMINAL AND THE METHOD THEREOF	2010/09/29	EP2007702010A	2007/01/09
13HU01-009-04	EP1973283	EP	PreCursor(EP)	INTERWORKING NETWORK ELEMENT, INTERWORKING SYSTEM BETWEEN THE CSI TERMINAL AND THE IMS	2010/09/29	EP2007702010A	2007/01/09

				TERMINAL AND THE METHOD THEREOF			
13HU01-009-05	EP1973283	FR	Granted	INTERWORKING NETWORK ELEMENT, INTERWORKING SYSTEM BETWEEN THE CSI TERMINAL AND THE IMS TERMINAL AND THE METHOD THEREOF	2010/09/29	EP2007702010A	2007/01/09
13HU01-009-06	EP1973283	GB	Granted	INTERWORKING NETWORK ELEMENT, INTERWORKING SYSTEM BETWEEN THE CSI TERMINAL AND THE IMS TERMINAL AND THE METHOD THEREOF	2010/09/29	EP2007702010A	2007/01/09
13HU01-009-07	US8213419	US	Granted	Interworking network element, interworking system between the CSI terminal and the IMS terminal and the method thereof	2012/07/03	US2008170227A '12/170,227	2008/07/09
13HU01-009-08	WO2007079679	WO	Lapsed	INTERWORKING NETWORK ELEMENT, INTERWORKING SYSTEM BETWEEN THE CSI TERMINAL AND THE IMS TERMINAL AND THE METHOD THEREOF	2007/07/19	WO2007CN78A	2007/01/09
13HU01-010-01	CN100411398	CN	Granted	Edge or packet gateway controlling method in next generation network and its system	2006/12/20	CN200510026714.0	2005/06/13
13HU01-010-02	CN100426805	CN	Granted	Edge or packet gateway control system in next generation network and its method	2006/12/20	CN200510026736.7	2005/06/14
13HU01-010-03	CN100438515	CN	Granted	Edge or packet gateway controlling method in next generation network and its system	2006/12/20	CN200510026737.1	2005/06/14
13HU01-010-04	CN101160799	CN	Granted	Fringe or packet gateway control system and control method thereof	2011/04/20	CN200680012195.5	2006/05/25
13HU01-010-05	EP1796312	EP	Lapsed	AN EDGE/PACKET GATEWAY CONTROL SYSTEM AND A METHOD FOR ACHIEVING THE CONTROL BY THE EDGE/PACKET GATEWAY	2007/06/13	EP20060741982	2006/05/26
13HU01-010-06	US7881317	US	Granted	Border/packet gateway control system and control method	2011/02/01	US2007680234A 11/680,234	2007/02/28
13HU01-010-07	WO2006133622	WO	Lapsed	AN EDGE/PACKET GATEWAY CONTROL SYSTEM AND A METHOD FOR ACHIEVING THE CONTROL BY THE EDGE/PACKET GATEWAY	2006/12/21	WO2006CN1094A	2006/05/25
13HU01-	CN100563282	CN	Lapsed	Method for listening dailed	2009/11/25	CN200510034992.0	2005/05/29

011-01				signal sound at dail line terminal when network communicating			
13HU01-011-02	EP1786162	DE	Granted	METHOD FOR THE CALLING USER TERMINAL LISTENING TO THE SIGNAL TONE OF THE CALLED USER TERMINAL WHEN INTER-NETWORKING	2009/09/30	EP2006741937A	2006/05/22
13HU01-011-03	EP1786162	EP	PreCursor(EP)	METHOD FOR THE CALLING USER TERMINAL LISTENING TO THE SIGNAL TONE OF THE CALLED USER TERMINAL WHEN INTER-NETWORKING	2009/09/30	EP2006741937A	2006/05/22
13HU01-011-04	EP1786162	GB	Granted	METHOD FOR THE CALLING USER TERMINAL LISTENING TO THE SIGNAL TONE OF THE CALLED USER TERMINAL WHEN INTER-NETWORKING	2009/09/30	EP2006741937A	2006/05/22
13HU01-011-05	US8335221	US	Granted	Method for listening to signal tone from a called party by a calling party during network interworking	2012/12/18	US2007707759A 11/707,759	2007/02/16
13HU01-011-06	WO2006128356	WO	Lapsed	METHOD FOR THE CALLING USER TERMINAL LISTENING TO THE SIGNAL TONE OF THE CALLED USER TERMINAL WHEN INTER-NETWORKING	2006/12/07	WO2006CN1049A	2006/05/22
13HU01-012-01	BRPI0613589	BR	Lapsed	método e sistema para implementação de roteamento de sinalização dinâmica	2011/01/18	BRPI0613589A2	2006/08/10
13HU01-012-03	CN101161011	CN	Lapsed	Method and system of improving network reliability through implementing dynamic routing of signaling	2011/08/10	CN200680012205.5	2006/08/10
13HU01-012-02	CN1921459	CN	Lapsed	Method for improving reliability of network by realizing dynamic route of signal	2007/02/28	CN200510093052.9	2005/08/25
13HU01-012-04	EP1816887	DE	Granted	METHOD AND SYSTEM FOR IMPROVING NETWORK RELIABILITY BY REALIZING DYMANIC ROUTE OF SIGNALING	2010/05/05	EP2006775336A	2006/08/10
13HU01-012-05	EP1816887	EP	PreCursor(EP)	METHOD AND SYSTEM FOR IMPROVING NETWORK RELIABILITY BY REALIZING DYMANIC ROUTE OF SIGNALING	2010/05/05	EP2006775336A	2006/08/10
13HU01-012-06	EP1816887	FR	Granted	METHOD AND SYSTEM FOR IMPROVING NETWORK RELIABILITY BY REALIZING DYMANIC ROUTE OF	2010/05/05	EP2006775336A	2006/08/10

				SIGNALING			
13HU01-012-07	IN200704950	IN	Lapsed	METHOD AND SYSTEM FOR IMPROVING NETWORK RELIABILITY BY REALIZING DYNAMIC ROUTE OF SIGNALING	2008/08/01	IN2007KN4950A	2007/12/20
13HU01-012-08	JP04619441	JP	Granted	The method and system which implement	2011/01/26	JP2008527289A	2006/08/10
13HU01-012-09	RU2408154	RU	Granted	METHOD AND SYSTEM FOR REALISATION OF DYNAMIC ROUTING OF CALL SIGNALS	2010/12/27	RU2008101969A	2006/08/10
13HU01-012-10	US8125995	US	Granted	Method and system for implementing dynamic signaling routing	2012/02/28	US2007821113A 11/821,113	2007/06/21
13HU01-012-11	WO2007022692	WO	Lapsed	METHOD AND SYSTEM FOR IMPROVING NETWORK RELIABILITY BY REALIZING DYNAMIC ROUTE OF SIGNALING	2007/03/01	WO2006CN2018A	2006/08/10
13HU01-013-01	CN100459569	CN	Granted	Quick route switching method and apparatus for network node devices	2009/02/04	CN200510032840.7	2005/01/14
13HU01-013-02	EP1718014	EP	PreCursor(EP)	A ROUTE SWITCHING METHOD AND A NETWORK NODE DEVICE	2008/10/15	EP2006705441A	2006/01/09
13HU01-013-03	EP1718014	FR	Granted	A ROUTE SWITCHING METHOD AND A NETWORK NODE DEVICE	2008/10/15	EP2006705441A	2006/01/09
13HU01-013-04	EP1718014	SE	Granted	A ROUTE SWITCHING METHOD AND A NETWORK NODE DEVICE	2008/10/15	EP2006705441A	2006/01/09
13HU01-013-05	US7898943	US	Granted	Method for switching route and network device thereof	2011/03/01	US2003591218A 10/591,218	2007/11/21
13HU01-013-06	WO2006074596	WO	Lapsed	A ROUTE SWITCHING METHOD AND A NETWORK NODE DEVICE	2006/07/20	WO2006CN18A	2006/01/09
13HU01-014-01	CN100479417	CN	Granted	Communication method preventing circumbendibus of media-flow	2009/04/15	CN200510098546.6	2005/09/02
13HU01-014-02	CN101164290	CN	Lapsed	Communication method and equipment for preventing media stream circuitry	2008/04/16	CN200680013147.8	2006/06/14
13HU01-014-03	EP1760986	DE	EP-Designated	Communication method and device for preventing media stream circuitry (tromboning)	2007/03/07	EP2006119909A	2006/08/31
13HU01-014-11	EP1760986	EP	EP-Pending	Communication method and device for preventing media stream circuitry (tromboning)	2007/03/07	EP2006119909A	2006/08/31
13HU01-014-04	EP1760986	EP	PreCursor(EP)	Communication method and device for preventing media stream circuitry (tromboning)	2007/03/07	EP2006119909A	2006/08/31

13HU01-014-05	EP1760986	FI	EP-Designated	Communication method and device for preventing media stream circuitry (tromboning)	2007/03/07	EP2006119909A	2006/08/31
13HU01-014-06	EP1760986	FR	EP-Designated	Communication method and device for preventing media stream circuitry (tromboning)	2007/03/07	EP2006119909A	2006/08/31
13HU01-014-07	EP1760986	GB	EP-Designated	Communication method and device for preventing media stream circuitry (tromboning)	2007/03/07	EP2006119909A	2006/08/31
13HU01-014-08	EP1760986	SE	EP-Designated	Communication method and device for preventing media stream circuitry (tromboning)	2007/03/07	EP2006119909A	2006/08/31
13HU01-014-09	US8108526	US	Granted	Communication method and device for preventing media stream circuitry	2012/01/31	US2006469796A 11/469,796	2006/09/01
13HU01-014-10	WO2007025429	WO	Lapsed	A METHOD FOR PREVENTING THE MEDIA STREAM FROM BYPASSING AND THE DEVICE THEREOF	2007/03/08	WO2006CN1325A	2006/06/14
13HU01-015-01	CN101212309	CN	Granted	Method for controlling time stamp of reported event	2011/06/15	CN200610170447.9	2006/12/30
13HU01-015-02	EP2037627	DE	Granted	METHOD AND DEVICE FOR CONTROLLING REPORTING TIMESTAMP OF EVENT	2012/03/14	EP2007846226A	2007/12/29
13HU01-015-03	EP2037627	EP	PreCursor(EP)	METHOD AND DEVICE FOR CONTROLLING REPORTING TIMESTAMP OF EVENT	2012/03/14	EP2007846226A	2007/12/29
13HU01-015-04	EP2037627	FR	Granted	METHOD AND DEVICE FOR CONTROLLING REPORTING TIMESTAMP OF EVENT	2012/03/14	EP2007846226A	2007/12/29
13HU01-015-05	EP2037627	IT	Granted	METHOD AND DEVICE FOR CONTROLLING REPORTING TIMESTAMP OF EVENT	2012/03/14	EP2007846226A	2007/12/29
13HU01-015-06	US8116322	US	Granted	Method and apparatus for controlling reporting of an event timestamp	2012/02/14	US2009354289A 12/354289	2009/01/15
13HU01-015-07	WO2008083606	WO	Lapsed	METHOD AND DEVICE FOR CONTROLLING REPORTING TIMESTAMP OF EVENT	2008/07/17	WO2007CN71400A	2007/12/29
13HU01-016-01	CN1996968	CN	Granted	Decision method for the media gateway controller to distribute the resource	2010/04/14	CN200610093956.6	2006/06/26
13HU01-016-02	CN200810189659.0	CN	Lapsed	Method for down distributing resource and providing decision for medium gateway by medium gateway controller	1900/01/00	CN200810189659.0	2006/06/26
13HU01-016-03	EP2034670	DE	Granted	METHOD, APPARATUS, AND SYSTEM FOR THE MGC DISTRIBUTING A RESOURCE PROVISION DECISION TO THE MG	2012/06/15	EP2007721793A	2007/06/25
13HU01-	EP2034670	EP	PreCursor(EP)	METHOD, APPARATUS, AND	2012/06/13	EP2007721793A	2007/06/25

016-04				SYSTEM FOR THE MGC DISTRIBUTING A RESOURCE PROVISION DECISION TO THE MG			
13HU01-016-05	EP2034670	FR	Granted	METHOD, APPARATUS, AND SYSTEM FOR THE MGC DISTRIBUTING A RESOURCE PROVISION DECISION TO THE MG	2012/06/14	EP2007721793A	2007/06/25
13HU01-016-06	EP2034670	IT	Granted	METHOD, APPARATUS, AND SYSTEM FOR THE MGC DISTRIBUTING A RESOURCE PROVISION DECISION TO THE MG	2012/06/16	EP2007721793A	2007/06/25
13HU01-016-07	US7899065	US	Granted	Method, apparatus and system for a media gateway controller to deliver a resource provision decision to a media gateway	2011/03/01	US2008342546A 12/342,546	2008/12/23
13HU01-016-08	WO2008003252	WO	Lapsed	METHOD, APPARATUS, AND SYSTEM FOR THE MGC DISTRIBUTING A RESOURCE PROVISION DECISION TO THE MG	2008/01/10	WO2007CN70177A	2007/06/25
13HU01-017-01	CN100442930	CN	Granted	Mobile exchanging center and called parner processing method	1900/01/00	CN200510110891.7	2005/11/29
13HU01-017-02	CN101161019	CN	Lapsed	Mobile switching centre and called process method thereof	2008/04/09	CN200680012331.0	2006/08/22
13HU01-017-03	EP1898658	DE	Granted	MSC AND CALLED PROCESS METHOD THEREOF	2009/12/02	EP2006775455A	2006/08/22
13HU01-017-04	EP1898658	EP	PreCursor(EP)	MSC AND CALLED PROCESS METHOD THEREOF	2009/12/02	EP2006775455A	2006/08/22
13HU01-017-05	WO2007062560	WO	Lapsed	MSC AND CALLED PROCESS METHOD THEREOF	2007/06/07	WO2006CN2137A	2006/08/22
13HU01-018-01	CN100471140	CN	Granted	Method for detecting QoS	2009/03/18	CN200610062951.7	2006/09/29
13HU01-018-02	CN101001208	CN	Granted	Method for detecting QoS	2007/07/18	CN200610165838.1	2006/12/13
13HU01-018-03	CN101052014	CN	Granted	Method for detecting QoS	2007/10/10	CN200710107595.0	2007/05/21
13HU01-018-05	EP07871768.3	EP	Lapsed	Method for detecting QoS		EP07871768.3	2007/12/12
13HU01-018-04	EP1983688	DE	Granted	METHOD FOR DETECTING QOS	2012/04/25	EP2007817016A	2007/09/29
13HU01-018-06	EP1983688	EP	PreCursor(EP)	METHOD FOR DETECTING QOS	2012/04/25	EP2007817016A	2007/09/29
13HU01-018-07	EP1983688	FR	Granted	METHOD FOR DETECTING QOS	2012/04/25	EP2007817016A	2007/09/29
13HU01-018-08	EP1983688	GB	Granted	METHOD FOR DETECTING QOS	2012/04/25	EP2007817016A	2007/09/29
13HU01-018-09	US20090016233	US	Lapsed	Method for detecting QoS	2009/01/15	US2008211555A 12/211555	2008/09/16

13HU01-018-10	WO2008/086720	WO	Lapsed	Method for detecting QoS		PCT/CN2007/071220	2007/12/12
13HU01-018-11	WO2008/141580	WO	Lapsed	Method for detecting QoS		PCT/CN2008/071008	2008/05/19
13HU01-018-12	WO2008043304	WO	Lapsed	METHOD FOR DETECTING QOS	2008/04/17	WO2007CN70825A	2007/09/29
13HU01-019-01	CN1905472	CN	Granted	Method for implementing IMS network reliability	2010/05/05	CN200510085400.8	2005/07/27
13HU01-019-02	EP1914937	DE	Granted	METHOD AND SYSTEM FOR REALIZING IMS NETWORK RELIABILITY	2013/01/26	EP2006761564A	2006/07/28
13HU01-019-03	EP1914937	EP	PreCursor(EP)	METHOD AND SYSTEM FOR REALIZING IMS NETWORK RELIABILITY	2013/01/23	EP2006761564A	2006/07/25
13HU01-019-04	EP1914937	FR	Granted	METHOD AND SYSTEM FOR REALIZING IMS NETWORK RELIABILITY	2013/01/23	EP2006761564A	2006/07/25
13HU01-019-05	EP1914937	GB	Granted	METHOD AND SYSTEM FOR REALIZING IMS NETWORK RELIABILITY	2013/01/23	EP2006761564A	2006/07/25
13HU01-019-06	WO2007012270	WO	Lapsed	A METHOD FOR REALIZING THE IMS NETWORK RELIABILITY	2007/02/01	WO2006CN1834A	2006/07/25
13HU01-020-01	CN100546308	CN	Granted	Gateway control protocol message transmission method	2009/09/30	CN200510034409.6	2005/04/22
13HU01-020-02	US7653076	US	Granted	Method and apparatus for gateway control protocol message transmission	2010/01/26	US2007856152A 11/856,152	2007/09/17
13HU01-020-03	WO2006111104	WO	Lapsed	A GATEWAY CONTROL PROTOCOL MESSAGE TRANSFERRING METHOD AND THE APPARATUS THEREOF	2006/10/26	WO2006CN780A	2006/04/24
13HU01-021-02	CN100349411	CN	Granted	Medium flow service quality reporting method	2007/11/14	CN200410062978.7	2004/06/30
13HU01-021-01	CN100493069	CN	Lapsed	Method for detecting medium flow service quality	2006/01/04	CN200410062977.2	2004/06/30
13HU01-021-03	EP1739900	EP	PreCursor(EP)	A METHOD FOR ACQUIRING THE QOS OF THE MULTIMEDIA STREAM PERIODICALLY	2008/10/29	EP2005759437A	2005/06/30
13HU01-021-04	EP1739900	ES	Lapsed	A METHOD FOR ACQUIRING THE QOS OF THE MULTIMEDIA STREAM PERIODICALLY	2008/10/29	EP2005759437A	2005/06/30
13HU01-021-05	EP1739900	FR	Lapsed	A METHOD FOR ACQUIRING THE QOS OF THE MULTIMEDIA STREAM PERIODICALLY	2008/10/29	EP2005759437A	2005/06/30
13HU01-021-06	EP1739900	PT	Granted	A METHOD FOR ACQUIRING THE QOS OF THE MULTIMEDIA STREAM PERIODICALLY	2008/10/29	EP2005759437A	2005/06/30
13HU01-021-07	EP1739900	SE	Lapsed	A METHOD FOR ACQUIRING THE QOS OF THE MULTIMEDIA STREAM PERIODICALLY	2008/10/29	EP2005759437A	2005/06/30
13HU01-021-08	US7583612	US	Granted	Method for periodically acquiring the QoS of media	2009/09/01	US2006558619A	2006/11/10

				stream and system thereof			
13HU01-021-09	WO2006002597	WO	Lapsed	A METHOD FOR ACQUIRING THE QOS OF THE MULTIMEDIA STREAM PERIODICALLY	2006/01/12	WO2005CN958A	2005/06/30
13HU01-022-01	CN100499656	CN	Granted	Method for implementing medium gateway function, wireless access controlling apparatus and access system	2009/06/10	CN200510051044.8	2005/02/25
13HU01-022-02	US8085712	US	Granted	Method for implementing media gateway function, radio access control device and access system	2011/12/27	US20080049705A1 US2007844481A	2006/02/27
13HU01-022-03	WO2006089491	WO	Lapsed	METHOD FOR REALIZING MEDIA-GATEWAY FUNCTION, EQUIPMENT FOR WIRELESS ACCESS CONTROL AND ACCESS SYSTEM	2006/08/31	WO2006CN281A	2006/02/27
13HU01-023-01	CN100583918	CN	Granted	Safety protection method for service interruption of exchange network and its device	2010/01/20	CN200610065066.4	2006/03/16
13HU01-023-02	CN101160869	CN	Lapsed	Method and apparatus for security protection of service interruption in switch network	2008/04/09	CN200680012823.X	2006/11/22
13HU01-023-03	US7710880	US	Granted	Method and apparatus for security protection of service interruption in switch network	2010/05/04	US2006618597A	2006/12/29
13HU01-023-04	WO2007104199	WO	Lapsed	A SECURITY PROTECTING METOD USED FOR SERVICE INTERRUPTION IN THE SWITCHING NETWORK AND A SYSTEM THEREOF	2007/09/20	WO2006CN3144A	2006/11/22
13HU01-024-01	CN101841888	CN	Granted	Resource control method, related equipment and related system	2012/06/27	CN200910118794.0	2009/03/16
13HU01-024-02	EP2439979	DE	EP-Designated	RESOURCE CONTROL METHOD, RELEVANT DEVIDE AND SYSTEM	2012/04/11	EP2010753112A EP10753112.1	2010/03/16
13HU01-024-03	EP2439979	EP	EP-Pending	RESOURCE CONTROL METHOD, RELEVANT DEVIDE AND SYSTEM	2012/04/11	EP2010753112A EP10753112.1	2010/03/16
13HU01-024-04	EP2439979	FI	EP-Designated	RESOURCE CONTROL METHOD, RELEVANT DEVIDE AND SYSTEM	2012/04/11	EP2010753112A EP10753112.1	2010/03/16
13HU01-024-05	EP2439979	FR	EP-Designated	RESOURCE CONTROL METHOD, RELEVANT DEVIDE AND SYSTEM	2012/04/11	EP2010753112A EP10753112.1	2010/03/16
13HU01-024-06	EP2439979	GB	EP-Designated	RESOURCE CONTROL METHOD, RELEVANT DEVIDE AND SYSTEM	2012/04/11	EP2010753112A EP10753112.1	2010/03/16
13HU01-024-07	EP2439979	SE	EP-Designated	RESOURCE CONTROL METHOD, RELEVANT DEVIDE AND	2012/04/11	EP2010753112A EP10753112.1	2010/03/16

				SYSTEM			
13HU01-024-08	US8224325	US	Granted	Resource control method, relevant device, and system	2012/07/17	US13235062A	2011/09/16
13HU01-024-09	WO2010105545	WO	Lapsed	RESOURCE CONTROL METHOD, RELEVANT DEVIDE AND SYSTEM	2010/09/23	WO2010CN71057A	2010/03/16
13HU01-025-01	AU2003271027	AU	Lapsed	A network security authentication method	2007/08/09	AU2003271027A	2003/09/22
13HU01-025-02	CN1275419	CN	Lapsed	Network safety authentication method	2006/09/13	CN2002144191A	2002/10/18
13HU01-025-03	US8195942	US	Granted	Network security authentication method	2012/06/05	US2003531569A	2005/04/18
13HU01-025-04	WO2004036828	WO	Lapsed	A NETWORK SECURITY AUTHENTICATION METHOD	2004/04/29	WO2003CN801A	2003/09/22
13HU01-026-01	CN100574185	CN	Granted	Method for ensuring media stream safety in IP multimedia service subsystem network	2009/12/23	CN200510000097.7	2005/01/07
13HU01-026-02	EP1835652	DE	Granted	A METHOD FOR ENSURING THE SAFETY OF THE MEDIA-FLOW IN IP MULTIMEDIA SUB-SYSTEM	2010/06/16	EP2005848163A	2005/12/31
13HU01-026-03	EP1835652	EP	PreCursor(EP)	A METHOD FOR ENSURING THE SAFETY OF THE MEDIA-FLOW IN IP MULTIMEDIA SUB-SYSTEM	2010/06/16	EP2005848163A	2005/12/31
13HU01-026-04	EP1835652	GB	Granted	A METHOD FOR ENSURING THE SAFETY OF THE MEDIA-FLOW IN IP MULTIMEDIA SUB-SYSTEM	2010/06/16	EP2005848163A	2005/12/31
13HU01-026-05	US20140169563	US	Pending	METHOD FOR ENSURING MEDIA STREAM SECURITY IN IP MULTIMEDIA SUB-SYSTEM	2007/12/20	14/050,768	2013/10/10
13HU01-026-06	US8582766	US	Granted	METHOD FOR ENSURING MEDIA STREAM SECURITY IN IP MULTIMEDIA SUB-SYSTEM	2007/12/20	US2007774271A 11774271	2007/07/06
13HU01-026-07	WO2006072212	WO	Lapsed	A METHOD FOR ENSURING THE SAFETY OF THE MEDIA-FLOW IN IP MULTIMEDIA SUB-SYSTEM	2006/07/13	WO2005CN2429A	2005/12/31
13HU01-027.1-01	AR053615	AR	Granted	Method for Implementing Access Domain Security of IP Multimedia Subsystem	2007/05/07	ARP20060102194A	2006/05/26
13HU01-027.1-02	CN100461942	CN	Granted	Method for selecting safety mechanism of IP multimedia subsystem access field	2009/02/11	CN200510071538.2	2005/05/27
13HU01-027.1-03	DE602006007648.7	DE	Granted	VERFAHREN ZUR IMPLEMENTIERUNG DER ZUGRIFFSBEREICHS	2009/08/20	DE602006007648T	2006/04/03
13HU01-027.1-04	EP1755311	DE	Duplicate	A METHOD FOR IMPLEMENTING THE ACCESS DOMAIN SECURITY OF AN IP MULTIMEDIA SUBSYSTEM	2009/07/08	EP2006722247A	2006/04/03

13HU01-027.1-05	EP1755311	EP	PreCursor(EP)	A METHOD FOR IMPLEMENTING THE ACCESS DOMAIN SECURITY OF AN IP MULTIMEDIA SUBSYSTEM	2009/07/08	EP2006722247A	2006/04/03
13HU01-027.1-06	EP1755311	FR	Granted	A METHOD FOR IMPLEMENTING THE ACCESS DOMAIN SECURITY OF AN IP MULTIMEDIA SUBSYSTEM	2009/07/08	EP2006722247A	2006/04/03
13HU01-027.1-07	EP1755311	GB	Granted	A METHOD FOR IMPLEMENTING THE ACCESS DOMAIN SECURITY OF AN IP MULTIMEDIA SUBSYSTEM	2009/07/08	EP2006722247A	2006/04/03
13HU01-027.1-08	TWI314414	TW	Granted	A METHOD FOR IMPLEMENTING THE ACCESS DOMAIN SECURITY OF AN IP MULTIMEDIA SUBSYSTEM	2009/09/01	TW2006118609A	2006/05/25
13HU01-027.1-09	US20080209532	US	Lapsed	Method for Implementing Access Domain Security of IP Multimedia Subsystem	2008/08/28	US2006629346A 11/629,346	2007/05/07
13HU01-027.1-10	WO2006125359	WO	Lapsed	A METHOD FOR IMPLEMENTING THE ACCESS DOMAIN SECURITY OF AN IP MULTIMEDIA SUBSYSTEM	2006/11/30	WO2006CN595A	2006/04/03
13HU01-027.2-01	CN100571134	CN	Granted	Method for verifying user terminal in IP multimedia subsystem	2009/12/16	CN200510070351.0	2005/04/30
13HU01-027.2-02	EP1879324	DE	Granted	A METHOD FOR AUTHENTICATING USER TERMINAL IN IP MULTIMEDIA SUB-SYSTEM	2012/08/01	EP2006741743A	2006/04/27
13HU01-027.2-03	EP1879324	EP	PreCursor(EP)	A METHOD FOR AUTHENTICATING USER TERMINAL IN IP MULTIMEDIA SUB-SYSTEM	2012/08/01	EP2006741743A	2006/04/27
13HU01-027.2-04	EP1879324	ES	Granted	A METHOD FOR AUTHENTICATING USER TERMINAL IN IP MULTIMEDIA SUB-SYSTEM	2012/08/01	EP2006741743A	2006/04/27
13HU01-027.2-05	EP1879324	FR	Granted	A METHOD FOR AUTHENTICATING USER TERMINAL IN IP MULTIMEDIA SUB-SYSTEM	2012/08/01	EP2006741743A	2006/04/27
13HU01-027.2-06	EP1879324	GB	Granted	A METHOD FOR AUTHENTICATING USER TERMINAL IN IP MULTIMEDIA SUB-SYSTEM	2012/08/01	EP2006741743A	2006/04/27
13HU01-027.2-07	EP1879324	IT	Granted	A METHOD FOR AUTHENTICATING USER TERMINAL IN IP MULTIMEDIA SUB-SYSTEM	2012/08/01	EP2006741743A	2006/04/27
13HU01-027.2-08	US8335487	US	Granted	Method for authenticating user terminal in IP multimedia sub-	2012/12/18	US11/896389	2007/08/31

				system			
13HU01-027.2-09	WO2006116921	WO	Lapsed	A METHOD FOR AUTHENTICATING USER TERMINAL IN IP MULTIMEDIA SUB-SYSTEM	2006/11/09	WO2006CN822A	2006/04/27
13HU01-028-02	CN101128049	CN	Granted	Method and system for providing circuit domain service and service control node SCP	2012/07/04	CN200610141030.X	2006/09/28
13HU01-028-01	CN200610111254.6	CN	Lapsed	Method and system for providing circuit domain service and service control node SCP		CN200610111254.6	2006/08/17
13HU01-028-03	EP2056536	DE	Granted	A METHOD, A SYSTEM AND A SERVICE CONTROL POINT FOR PROVIDING CIRCUIT DOMAIN SERVICE	2012/01/25	EP2007785297A	2007/08/09
13HU01-028-04	EP2056536	EP	PreCursor(EP)	A METHOD, A SYSTEM AND A SERVICE CONTROL POINT FOR PROVIDING CIRCUIT DOMAIN SERVICE	2012/01/25	EP2007785297A	2007/08/09
13HU01-028-05	EP2056536	FR	Granted	A METHOD, A SYSTEM AND A SERVICE CONTROL POINT FOR PROVIDING CIRCUIT DOMAIN SERVICE	2012/01/25	EP2007785297A	2007/08/09
13HU01-028-06	EP2056536	GB	Granted	A METHOD, A SYSTEM AND A SERVICE CONTROL POINT FOR PROVIDING CIRCUIT DOMAIN SERVICE	2012/01/25	EP2007785297A	2007/08/09
13HU01-028-07	WO2008022536	WO	Lapsed	A METHOD, A SYSTEM AND A SERVICE CONTROL POINT FOR PROVIDING CIRCUIT DOMAIN SERVICE	2008/02/28	WO2007CN2390A	2007/08/09
13HU01-029-01	AR50123	AR	Lapsed	SISTEMA DE RED DE COMUNICACIONES PARA IMPLEMENTAR SERVICIOS COMBINADOS Y SUS METODOS.	2006/09/27	ARP20050103360A	2005/08/11
13HU01-029-02	BR200507677	BR	Lapsed	sistema de rede de comunicações para implementação de serviços mistos e seu método	2007/07/17	BRPI507677A	2005/08/11
13HU01-029-04	CN100349473	CN	Lapsed	Method and system for realizing short message intercommunication based on mixed telephone number		CN200410059165.2	2004/08/11
13HU01-029-03	CN1735268	CN	Lapsed	Method for realizing mixed telephone number and communications network system	2006/02/15	CN200410059164.8	2004/08/11
13HU01-029-05	EP1713241	EP	Lapsed	A COMMUNICATION NETWORK SYSTEM AND	2006/10/18	EP2005774458A	2005/08/11

				METHOD OF ACHIEVING MIXED SERVICE			
13HU01-029-06	ID0024111	ID	Lapsed	Method and system for realizing short message intercommunication based on mixed telephone number		IDW-00200602090	2005/08/11
13HU01-029-07	IN246930	IN	Lapsed	Method and system for realizing short message intercommunication based on mixed telephone number	2011/03/25	IN2006CN4422A	2006/12/01
13HU01-029-08	RU2370904	RU	Granted	TELECOMMUNICATION NETWORK SYSTEM FOR IMPLEMENTING VARIOUS SERVICES AND METHOD OF IMPLEMENTING THEREOF	2009/10/20	RU2006130835A	2005/08/11
13HU01-029-09	US7787608	US	Granted	Communications network system for implementing mixed services and method thereof	2010/08/31	US11/489208	2006/07/19
13HU01-029-10	WO2006015551	WO	Lapsed	A COMMUNICATION NETWORK SYSTEM AND METHOD OF ACHIEVING MIXED SERVICE	2006/02/16	WO2005CN1241A	2005/08/11
13HU01-030-01	CN101247632	CN	Granted	Method, system and device for using IMS communication service identification in communication system	2008/08/20	CN200710079246.2	2007/02/13
13HU01-030-02	CN101517960	CN	Lapsed	Method, system and device for application IMS communication service identification in communication system	2009/08/26	CN200780000599.7	2007/11/19
13HU01-030-03	EP1959632	DE	EP-Designated	Method, system and apparatus for using IMS communication service identifier	2008/08/20	EP2008101535A	2008/02/12
13HU01-030-04	EP1959632	EP	EP-Pending	Method, system and apparatus for using IMS communication service identifier	2008/08/20	EP2008101535A	2008/02/12
13HU01-030-05	EP1959632	FI	EP-Designated	Method, system and apparatus for using IMS communication service identifier	2008/08/20	EP2008101535A	2008/02/12
13HU01-030-06	EP1959632	FR	EP-Designated	Method, system and apparatus for using IMS communication service identifier	2008/08/20	EP2008101535A	2008/02/12
13HU01-030-07	EP1959632	GB	EP-Designated	Method, system and apparatus for using IMS communication service identifier	2008/08/20	EP2008101535A	2008/02/12
13HU01-030-10	EP1959632	SE	EP-Designated	Method, system and apparatus for using IMS communication service identifier	2008/08/20	EP2008101535A	2008/02/12
13HU01-030-08	IN5391/DELNP/2009	IN	Pending	Method, System and Apparatus for Using IMS	1900/01/00	IN5391/DELNP/2009	2007/11/19

				Communication Service Identifiers in a Communication System			
13HU01-030-09	RU2434351	RU	Granted	METHOD, SYSTEM AND APPARATUS FOR USING IMS COMMUNICATION SERVICE IDENTIFIER IN COMMUNICATION SYSTEM	2011/11/20	RU2009134133A	2007/11/19
13HU01-030-12	US8185105	US	Granted	METHOD, SYSTEM AND APPARATUS FOR USING IMS COMMUNICATION SERVICE IDENTIFIER	2012/05/22	US12/539890	2009/08/12
13HU01-030-11	US8417240	US	Granted	METHOD, SYSTEM AND APPARATUS FOR USING IMS COMMUNICATION SERVICE IDENTIFIER	2013/04/09	US13/414770	2012/03/08
13HU01-030-11r	US14/285524	US	Reissuing	METHOD, SYSTEM AND APPARATUS FOR USING IMS COMMUNICATION SERVICE IDENTIFIER		US14/285524	2014/05/22
13HU01-030-13	WO2008098459	WO	Lapsed	METHOD, SYSTEM AND MEANS FOR APPLYING IMS COMMUNICATION SERVICE IDENTIFIERS IN A COMMUNICATION SYSTEM	2008/08/21	WO2007CN71090A	2007/11/19
13HU01-031-02	CN101064661	CN	Granted	Method and apparatus for notifying user to complement service	2011/08/24	CN200610099533.5	2006/07/28
13HU01-031-03	CN101317438	CN	Granted	Method and device for perceiving supplementary service executed by user	2012/04/25	CN200780000297.X	2007/02/08
13HU01-031-01	CN200610079107.5	CN	Lapsed	Method and apparatus for notifying user to complement service	1900/01/00	CN200610079107.5	2006/04/29
13HU01-031-04	EP1881689	DE	Granted	A METHOD AND DEVICE FOR PERCEIVING THE USER TRIGGERING A SUPPLEMENTARY SERVICE	2010/06/02	EP2007702308A	2007/02/08
13HU01-031-05	EP1881689	EP	PreCursor(EP)	A METHOD AND DEVICE FOR PERCEIVING THE USER TRIGGERING A SUPPLEMENTARY SERVICE	2010/06/02	EP2007702308A	2007/02/08
13HU01-031-06	EP1881689	FR	Granted	A METHOD AND DEVICE FOR PERCEIVING THE USER TRIGGERING A SUPPLEMENTARY SERVICE	2010/06/02	EP2007702308A	2007/02/08
13HU01-031-07	EP1881689	GB	Granted	A METHOD AND DEVICE FOR PERCEIVING THE USER TRIGGERING A SUPPLEMENTARY SERVICE	2010/06/02	EP2007702308A	2007/02/08
13HU01-031-08	US20080032686	US	Lapsed	Method and device for making awareness of occurrence of a	2008/02/07	US2007881806A	2007/07/27

				supplementary service			
13HU01-031-09	WO2007124641	WO	Lapsed	A METHOD AND DEVICE FOR PERCEIVING THE USER TRIGGERING A SUPPLEMENTARY SERVICE	2007/11/08	WO2007CN435A	2007/02/08
13HU01-032-01	CN101056452	CN	Granted	Method and system for negotiating the voice encoding and decoding format in the communication system	2010/05/12	CN200610035050.9	2006/04/18
13HU01-032-02	CN101167374	CN	Granted	Method, system and device for negotiating voice coding/decoding in communication system	2011/02/09	CN200680013004.7	2006/11/29
13HU01-032-03	EP1848190	DE	EP-Designated	Method, system and device for speech codec negotiation in communication system	2007/10/24	EP20077802A	2007/04/17
13HU01-032-04	EP1848190	EP	EP-Pending	Method, system and device for speech codec negotiation in communication system	2007/10/24	EP20077802A	2007/04/17
13HU01-032-05	EP1848190	FI	EP-Designated	Method, system and device for speech codec negotiation in communication system	2007/10/24	EP20077802A	2007/04/17
13HU01-032-06	EP1848190	FR	EP-Designated	Method, system and device for speech codec negotiation in communication system	2007/10/24	EP20077802A	2007/04/17
13HU01-032-07	EP1848190	GB	EP-Designated	Method, system and device for speech codec negotiation in communication system	2007/10/24	EP20077802A	2007/04/17
13HU01-032-08	EP1848190	SE	EP-Designated	Method, system and device for speech codec negotiation in communication system	2007/10/24	EP20077802A	2007/04/17
13HU01-032-09	US7764953	US	Granted	Method, system and device for speech Codec negotiation in communication system	2010/07/27	US2007787527A	2007/04/17
13HU01-032-10	WO2007118380	WO	Lapsed	METHOD, SYSTEM AND DEVICE FOR NEGOTIATING VOICE CODING/DECODING IN COMMUNICATION SYSTEM	2007/10/25	WO2006CN3214A	2006/11/29
13HU01-033-01	CN101026653	CN	Granted	System and method for realizing colour image business	2011/08/24	CN200610057699.0	2006/02/24
13HU01-033-02	CN101156426	CN	Granted	System and method for implementing polychrome service	2011/02/16	CN200680011755.5	2006/11/01
13HU01-033-03	CN102394863	CN	Pending	System and method for realizing colour image business	2012/03/28	CN201110266055.3	2006/02/24
13HU01-033-04	EP1826985	DE	Granted	System and method for implementing multimedia calling line identification presentation service	2009/10/28	EP2007101173A	2007/01/25
13HU01-033-05	EP1826985	EP	PreCursor(EP)	System and method for implementing multimedia calling line identification	2009/10/28	EP2007101173A	2007/01/25

				presentation service			
13HU01-033-06	EP1826985	FR	Granted	System and method for implementing multimedia calling line identification presentation service	2009/10/28	EP2007101173A	2007/01/25
13HU01-033-07	EP1826985	GB	Granted	System and method for implementing multimedia calling line identification presentation service	2009/10/28	EP2007101173A	2007/01/25
13HU01-033-08	US20070201635	US	Pending	System and method for implementing multimedia calling line identification presentation service	2007/08/30	US11/698891	2007/01/29
13HU01-033-09	WO2007095802	WO	Lapsed	SYSTEM AND METHOD FOR REALIZING COLOR-IMAGE SERVICE	2007/08/30	WO2006CN2933A	2006/11/01
13HU01-034-01	CN100487788	CN	Granted	A method to realize the function of text-to-speech convert	2009/05/13	CN200510114277.8	2005/10/21
13HU01-034-02	EP1950737	DE	Granted	A METHOD, DEVICE AND SYSTEM FOR ACCOMPLISHING THE FUNCTION OF TEXT-TO-SPEECH CONVERSION	2010/05/26	EP2006805015A	2006/10/20
13HU01-034-03	EP1950737	EP	PreCursor(EP)	A METHOD, DEVICE AND SYSTEM FOR ACCOMPLISHING THE FUNCTION OF TEXT-TO-SPEECH CONVERSION	2010/05/26	EP2006805015A	2006/10/20
13HU01-034-04	EP1950737	GB	Granted	A METHOD, DEVICE AND SYSTEM FOR ACCOMPLISHING THE FUNCTION OF TEXT-TO-SPEECH CONVERSION	2010/05/26	EP2006805015A	2006/10/20
13HU01-034-05	US20080205279	US	Lapsed	Method, Apparatus and System for Accomplishing the Function of Text-to-Speech Conversion	2008/08/28	US2008106693A	2008/04/21
13HU01-034-06	WO2007045187	WO	Lapsed	A METHOD, APPARATUS AND SYSTEM FOR ACCOMPLISHING THE FUNCTION OF TEXT-TO-SPEECH CONVERSION	2007/04/26	WO2006CN2806A	2006/10/20
13HU01-035-01	CN101155148	CN	Granted	Media gateway issuing receiving multicast data to method, system and device	2012/02/22	CN200610140147.6	2006/09/30
13HU01-035-02	EP2068513	DE	Granted	METHOD, SYSTEM AND DEVICE FOR DISTRUBUTING AND RECEIVING THE MULTICAST DATA IN THE MEDIA GATEWAY	2010/11/24	EP2007816481A	2007/09/29
13HU01-035-03	EP2068513	EP	PreCursor(EP)	METHOD, SYSTEM AND DEVICE FOR DISTRUBUTING AND RECEIVING THE MULTICAST DATA IN THE MEDIA GATEWAY	2010/11/24	EP2007816481A	2007/09/29
13HU01-035-04	EP2068513	IT	Granted	METHOD, SYSTEM AND DEVICE FOR DISTRUBUTING AND	2010/11/24	EP2007816481A	2007/09/29

				RECEIVING THE MULTICAST DATA IN THE MEDIA GATEWAY			
13HU01-035-05	US7920579	US	Granted	Method, system and apparatus for media gateway to transmit and receive multicast data	2011/04/05	US2009413015A 12/413,015	2009/03/27
13HU01-035-06	WO2008040191	WO	Lapsed	METHOD, SYSTEM AND DEVICE FOR DISTRUBUTING AND RECEIVING THE MULTICAST DATA IN THE MEDIA GATEWAY	2008/04/10	WO2007CN2867A	2007/09/29
13HU01-036-01	CN101277343	CN	Granted	Method, terminal and system for implementing video binding in voice communication network	2012/01/04	CN200710095931.4	2007/03/30
13HU01-036-02	EP2120440	DE	Granted	A METHOD, TERMINAL AND SYSTEM FOR IMPLEMENTING VIDEO BINDING IN A VOICE COMMUNICATION NETWORK	2011/10/19	EP2008706632A	2008/02/03
13HU01-036-03	EP2120440	EP	PreCursor(EP)	A METHOD, TERMINAL AND SYSTEM FOR IMPLEMENTING VIDEO BINDING IN A VOICE COMMUNICATION NETWORK	2011/10/19	EP2008706632A	2008/02/03
13HU01-036-04	EP2120440	FR	Granted	A METHOD, TERMINAL AND SYSTEM FOR IMPLEMENTING VIDEO BINDING IN A VOICE COMMUNICATION NETWORK	2011/10/19	EP2008706632A	2008/02/03
13HU01-036-05	EP2120440	GB	Granted	A METHOD, TERMINAL AND SYSTEM FOR IMPLEMENTING VIDEO BINDING IN A VOICE COMMUNICATION NETWORK	2011/10/19	EP2008706632A	2008/02/03
13HU01-036-06	WO2008119272	WO	Lapsed	A METHOD, TERMINAL AND SYSTEM FOR IMPLEMENTING VIDEO BINDING IN A VOICE COMMUNICATION NETWORK	2008/10/09	WO2008CN70257A	2008/02/03
13HU01-037-01	CN101064680	CN	Granted	Method, system and apparatus for realizing multimedia calling service	2010/04/21	CN200610079110.7	2006/04/29
13HU01-037-02	EP2015592	DE	Granted	REALIZING A MULTIMEDIA CALL SERVICE	2012/07/11	EP2007720936A	2007/04/24
13HU01-037-03	EP2015592	EP	PreCursor(EP)	REALIZING A MULTIMEDIA CALL SERVICE	2012/07/11	EP2007720936A	2007/04/24
13HU01-037-04	EP2015592	GB	Granted	REALIZING A MULTIMEDIA CALL SERVICE	2012/07/11	EP2007720936A	2007/04/24
13HU01-037-05	WO2007124684	WO	Lapsed	A METHOD, SYSTEM AND APPARATUS FOR REALIZING MULTIMEDIA CALLING SERVICE	2007/11/08	WO2007CN1363A	2007/04/24
13HU01-038-01	CN100531267	CN	Granted	Method for realizing echo in communication system	2009/08/19	CN200510034345.X	2005/04/21
13HU01-038-02	EP1874016	EP	Lapsed	A METHOD FOR REALIZING RING BACK TONE IN COMMUNICATION SYSTEM	2008/01/02	EP2006741698A	2006/04/21
13HU01-038-03	US7986775	US	Granted	Method for realizing ring back tone in communication system	2011/07/26	US11/875195	2007/10/19

13HU01-038-04	WO2006111100	WO	Lapsed	A METHOD FOR REALIZING RING BACK TONE IN COMMUNICATION SYSTEM	2006/10/26	WO2006CN754A	2006/04/21
13HU01-039-01	CN1177508	CN	Granted	Method for implementing long-distance intelligent user roam calling	2004/11/24	CN2001123948A	2001/08/07
13HU01-039-02	CN1400843	CN	Lapsed	Method for implementing long-distance intelligent user roam calling	2003/03/05	CN2001123948A	2001/08/07
13HU01-039-03	EP1420605	EP	Lapsed	Implementing roaming call to foreign intelligent client	2007/11/28	EP2002719621A	2002/03/29
13HU01-039-04	RU2267865	RU	Lapsed	METHOD FOR CALLING EXTERNAL CLIENT OF INTELLECTUAL NETWORK IN ROAMING MODE	2006/01/10	RU2004104321A	2002/03/29
13HU01-039-05	US7349693	US	Granted	Method for implementing a call connection between a non-local calling subscriber and a local called subscriber who is an intelligent network subscriber	2008/03/25	US2003486322A 10486322	2002/03/29
13HU01-039-06	WO2003015437	WO	Lapsed	METHOD FOR ROAMING CALL IMPLEMENT TO FOREIGN INTELLIGENT CLIENT	2003/02/20	WO2002CN219A	2002/03/29

Unique ID	Patent Number	Country	Portfolio Status	Title	Issue / Publication Date	Application Number	Filing Date
13PA01-001-01	CN1173499	CN	Granted	Ofdma signal transmitting apparatus and method	2004/10/27	CN99800972	1999/05/28
13PA01-001-03	EP1001566	DE	EP-Designated	Ofdma signal transmitting apparatus and method	2000/05/17	EP99922578	1999/05/28
13PA01-001-02	EP1001566	EP	EP-Pending	Ofdma signal transmitting apparatus and method	2000/05/17	EP99922578	1999/05/28
13PA01-001-04	EP1001566	FR	EP-Designated	Ofdma signal transmitting apparatus and method	2000/05/17	EP99922578	1999/05/28
13PA01-001-05	EP1001566	GB	EP-Designated	Ofdma signal transmitting apparatus and method	2000/05/17	EP99922578	1999/05/28
13PA01-001-06	EP1001566	IT	EP-Designated	Ofdma signal transmitting apparatus and method	2000/05/17	EP99922578	1999/05/28
13PA01-001-07	EP1001566	NL	EP-Designated	Ofdma signal transmitting apparatus and method	2000/05/17	EP99922578	1999/05/28
13PA01-001-08	JP3515690	JP	Granted	Ofdma signal transmitter and its method	2004/04/05	JP15321498	1998/06/02
13PA01-001-09	US6726297	US	Granted	Ofdma signal transmission apparatus and method	2004/04/27	US09/462491	2000/01/20
13PA01-002-01	JP4864008	JP	Granted	Method of the carrier allotment in the multiple cell orthogonal frequency division multiple access system	2012/01/25	JP2007545294	2006/11/16
13PA01-002-02	US8009549	US	Granted	Carrier allocation method in multi cell orthogonal frequency division multiple access system	2011/08/30	US12/092950	2006/11/16
13PA01-003-01	EP1968335	DE	Granted	Radio communication base station device and pilot transmission method	2011/10/05	EP07706996	2007/01/18
13PA01-003-02	EP1968335	FR	Granted	Radio communication base station device and pilot transmission method	2011/10/05	EP07706996	2007/01/18
13PA01-003-03	EP1968335	GB	Granted	Radio communication base station device and pilot transmission method	2011/10/05	EP07706996	2007/01/18
13PA01-003-04	JP4832450	JP	Granted	Radio communication base station device and pilot transmission method	2011/12/07	JP2007554946	2007/01/18
13PA01-003-05	US8416810	US	Granted	Radio communication base station apparatus and pilot transmission method	2013/04/09	US12/160872	2007/01/18
13PA01-004-01	CN100440762	CN	Granted	Ofdm communication device	2008/12/03	CN01803504	2001/11/14
13PA01-004-02	DE60143934	DE	Granted	Ofdm nachrichtenÃfAbertragungsvorrichtung	2011/03/10	DE60143934	2001/11/14
13PA01-004-03	DE60143978	DE	Granted	Ofdm-kommunikationsvorrichtung	2011/03/10	DE60143978	2001/11/14
13PA01-004-05	EP1249955	FR	Granted	Ofdm communication device	2011/01/26	EP01982773	2001/11/14

13PA01-004-04	EP1249955	GB	Granted	Ofdm communication device	2011/01/26	EP01982773	2001/11/14
13PA01-004-07	EP2161867	FR	Granted	Ofdm communication device	2010/03/10	EP09178209	2001/11/14
13PA01-004-06	EP2161867	GB	Granted	Ofdm communication device	2010/03/10	EP09178209	2001/11/14
13PA01-004-08	JP4000057	JP	Granted	Ofdm communication device	2007/10/31	JP2002543837	2001/11/14
13PA01-004-09	US7646702	US	Granted	Ofdm communication apparatus	2010/01/12	US10/169716	2002/07/09
13PA01-004-10	US8238226	US	Granted	Ofdm communication apparatus	2012/08/07	US12/505420	2009/07/17
13PA01-005-01	CN100544237	CN	Granted	Radio base station apparatus	2009/09/23	CN03804886	2003/08/01
13PA01-005-02	DE60325861	DE	Granted	Funkbasisstationsvorrichtung	2009/03/05	DE60325861	2003/08/01
13PA01-005-03	EP1525687	FR	Granted	Radio base station apparatus	2009/01/14	EP03766690	2003/08/01
13PA01-005-04	EP1525687	GB	Granted	Radio base station apparatus	2009/01/14	EP03766690	2003/08/01
13PA01-005-05	JP4098027	JP	Granted	Radio base station apparatus	2008/06/11	JP2002224571	2002/08/01
13PA01-005-06	US7593317	US	Granted	Radio base station apparatus	2009/09/22	US10/503010	2004/07/29
13PA01-006-01	CN101133614	CN	Lapsed	Ofdm receiver, integrated circuit and receiving method	2011/06/29	CN200680006764	2006/02/28
13PA01-006-02	DE602006004975	DE	Lapsed	Ofdm-empfänger und empfangsverfahren	2009/03/12	DE602006004975	2006/02/28
13PA01-006-03	EP1861977	FR	Lapsed	Ofdm receiver and receiving method	2009/01/21	EP06728642	2006/02/28
13PA01-006-04	EP1861977	GB	Lapsed	Ofdm receiver and receiving method	2009/01/21	EP06728642	2006/02/28
13PA01-006-05	EP1861977	IT	Lapsed	Ofdm receiver and receiving method	2009/01/21	EP06728642	2006/02/28
13PA01-006-06	JP4971172	JP	Granted	Receiving device, integrated circuit and reception method	2012/07/11	JP2007539403	2006/02/28
13PA01-006-07	US7929627	US	Granted	Ofdm receiver, integrated circuit and receiving method	2011/04/19	US11/885042	2006/02/28
13PA01-007-01	CN101080893	CN	Granted	Re-transmission method and transmitting device for multi-antenna transmission	2010/12/29	CN200580043160	2005/12/14
13PA01-007-02	EP1821440	EP	Lapsed	Retransmitting method and transmitting method in multi-antenna transmission	2007/08/22	EP05816694	2005/12/14
13PA01-007-03	JP4863884	JP	Granted	The retransmission method in multiple antenna transmitting	2012/01/25	JP2006548891	2005/12/14
13PA01-007-04	KR100912762	KR	Granted	Retransmitting method and transmitting method in multi-antenna transmission	2009/08/18	KR20077013565	2007/06/15
13PA01-007-05	US7826557	US	Granted	Retransmitting method and transmitting method in multi-antenna transmission	2010/11/02	US11/721911	2005/12/14

13PA01-008-01	EP1895679	DE	Granted	Mimo antenna apparatus controlling number of streams and modulation and demodulation method	2012/07/11	EP07115147	2007/08/29
13PA01-008-02	EP1895679	GB	Granted	Mimo antenna apparatus controlling number of streams and modulation and demodulation method	2012/07/11	EP07115147	2007/08/29
13PA01-008-03	JP4837638	JP	Granted	Mimo antenna apparatus and wireless communication apparatus having it	2011/12/14	JP2007222315	2007/08/29
13PA01-008-04	US7792084	US	Granted	Mimo antenna apparatus controlling number of streams and modulation and demodulation method	2010/09/07	US11/892886	2007/08/28
13PA01-009-01	JP4864000	JP	Granted	The radio communication base station device and the radio communication method in multiple carrier communicating	2012/01/25	JP2007529557	2006/08/04
13PA01-009-02	KR20080031377	KR	Lapsed	Wireless communication base station apparatus and wireless communication method in multicarrier communication	2008/04/08	KR20087002994	2008/02/04
13PA01-009-03	US8064393	US	Granted	Wireless communication base station apparatus and wireless communication method in multicarrier communication	2011/11/22	US11/997841	2006/08/04
13PA01-010-01	CN101502025	CN	Granted	Wireless communication base station device and wireless communication method	2012/11/28	CN200780028893	2007/10/12
13PA01-010-03	EP2051410	DE	EP-Designated	Wireless communication base station device and wireless communication method	2009/04/22	EP07829721	2007/10/12
13PA01-010-02	EP2051410	EP	EP-Pending	Wireless communication base station device and wireless communication method	2009/04/22	EP07829721	2007/10/12
13PA01-010-06	EP2051410	FI	EP-Designated	Wireless communication base station device and wireless communication method	2009/04/22	EP07829721	2007/10/12
13PA01-010-04	EP2051410	FR	EP-Designated	Wireless communication base station device and wireless communication method	2009/04/22	EP07829721	2007/10/12
13PA01-010-05	EP2051410	GB	EP-Designated	Wireless communication base station device and wireless communication method	2009/04/22	EP07829721	2007/10/12
13PA01-010-07	EP2051410	SE	EP-Designated	Wireless communication base station device and wireless communication method	2009/04/22	EP07829721	2007/10/12
13PA01-010-08	JP4903033	JP	Granted	Wireless communication base station device and wireless communication method	2012/03/21	JP2006344925	2006/12/21
13PA01-	US8270332	US	Granted	Wireless communication base	2012/09/18	US12/377373	2007/10/12

010-09				station device and wireless communication method			
13PA01-010-10	US8582573	US	Granted	Radio communication base station apparatus and radio communication method	2012/12/13	US13/590841	2012/08/21
13PA01-011-01	BR9906339	BR	Pending	"aparelho de comunicaçãoe de rãdio e mãtodo de controle de coeficiente de transmissãoe"	2000/09/19	BR9906339	1999/04/19
13PA01-011-02	CA2293606	CA	Granted	Radio communication apparatus and transmission rate control method	2005/02/08	CA2293606	1999/04/19
13PA01-011-03	CN1130944	CN	Granted	Radio communication device and method for controlling transmission rate	2003/12/10	CN99800567	1999/04/19
13PA01-011-04	DE69903110	DE	Granted	Funkãbertragungsgerãt und verfahren zur kontrolle derãbertragungsrate	2003/01/23	DE69903110	1999/04/19
13PA01-011-05	DE69914351	DE	Granted	Funkkommunikationsgerãt und verfahren zur einstellung derãbertragungsrate	2004/06/24	DE69914351	1999/04/19
13PA01-011-12	EP0986282	FI	Granted	Radio communication device and method of controlling transmission rate	2002/09/25	EP99913715	1999/04/19
13PA01-011-11	EP0986282	FR	Granted	Radio communication device and method of controlling transmission rate	2002/09/25	EP99913715	1999/04/19
13PA01-011-13	EP0986282	GB	Granted	Radio communication device and method of controlling transmission rate	2002/09/25	EP99913715	1999/04/19
13PA01-011-14	EP0986282	IT	Granted	Radio communication device and method of controlling transmission rate	2002/09/25	EP99913715	1999/04/19
13PA01-011-15	EP0986282	NL	Granted	Radio communication device and method of controlling transmission rate	2002/09/25	EP99913715	1999/04/19
13PA01-011-07	EP1122965	FI	Granted	Radio communication device and method of controlling transmission rate	2004/01/21	EP01106695	1999/04/19
13PA01-011-06	EP1122965	FR	Granted	Radio communication device and method of controlling transmission rate	2004/01/21	EP01106695	1999/04/19
13PA01-011-08	EP1122965	GB	Granted	Radio communication device and method of controlling transmission rate	2004/01/21	EP01106695	1999/04/19
13PA01-011-09	EP1122965	IT	Granted	Radio communication device and method of controlling transmission rate	2004/01/21	EP01106695	1999/04/19
13PA01-011-10	EP1122965	NL	Granted	Radio communication device and method of controlling transmission rate	2004/01/21	EP01106695	1999/04/19
13PA01-	ES2184430	ES	Granted	Dispositivo de comunicacion por	2003/04/01	ES99913715	1999/04/19

011-17				radio y procedimiento que permite ajustar la velocidad de transmision.			
13PA01-011-16	ES2214356	ES	Granted	Dispositivo de comunicacion por radio y metodo para controlar la velocidad de transmision.	2004/09/16	ES01106695	1999/04/19
13PA01-011-18	JP4738451	JP	Granted	Communication terminal apparatus and communication method therefor	2011/08/03	JP2008194038	2008/07/28
13PA01-011-21	US6366763	US	Granted	Radio communication device and method of controlling transmission rate	2002/04/02	US09/648756	2000/08/28
13PA01-011-22	US6370359	US	Granted	Radio communication device and method of controlling transmission rate	2002/04/09	US09/648757	2000/08/28
13PA01-011-20	US6381445	US	Granted	Radio communication device and method of controlling transmission rate	2002/04/30	US09/648742	2000/08/28
13PA01-011-19	US6400929	US	Granted	Radio communication device and method of controlling transmission rate	2002/06/04	US09/424843	1999/12/06
13PA01-011-23	US6487394	US	Granted	Radio communication device and method of controlling transmission rate	2002/11/26	US09/649003	2000/08/28
13PA01-011-25	US6505035	US	Granted	Radio communication apparatus and transmission rate control method	2003/01/07	US10/052261	2002/01/23
13PA01-011-24	US6597894	US	Granted	Radio communication device and method of controlling transmission rate	2003/07/22	US09/649006	2000/08/28
13PA01-011-27	US6611676	US	Granted	Radio communication apparatus and transmission rate control method	2003/08/26	US10/083553	2002/02/27
13PA01-011-26	US6973289	US	Granted	Radio communication device and method of controlling transmission rate	2005/12/06	US10/057897	2002/01/29
13PA01-011-28	US7636551	US	Granted	Radio communication device and method of controlling transmission rate	2009/12/22	US11/228339	2005/09/19
13PA01-012-01	US6637001	US	Granted	Apparatus and method for image/voice transmission	2003/10/21	US09/650743	2000/08/30
13PA01-013-01	AU2407202	AU	Lapsed	Decoder and decoding method	2002/06/11	AU2407202	2001/11/22
13PA01-013-02	CN1266868	CN	Granted	Communication terminal device and decoding method	2006/07/26	CN01804109	2001/11/22
13PA01-013-03	JP3399923	JP	Granted	Decoding device and decoding method	2003/04/28	JP2000362431	2000/11/29
13PA01-013-05	US20050002477	US	Lapsed	Decoding apparatus and decoding method	2005/01/06	US10/901380	2004/07/29
13PA01-013-04	US6813323	US	Granted	Decoding method and communication terminal apparatus	2004/11/02	US10/182270	2002/07/25

13PA01-014-03	JP3492637	JP	Granted	Decoding device and decoding method	2004/02/03	JP2001046559	2001/02/22
13PA01-014-01	JP3522700	JP	Granted	Channel detecting apparatus and method therefor	2004/04/26	JP2001023713	2001/01/31
13PA01-014-02	JP3526271	JP	Granted	Decoding device and decoding method	2004/05/10	JP2001031850	2001/02/08
13PA01-014-04	KR100727732	KR	Granted	Decoding device and decoding method	2007/06/13	KR20057021280	2005/11/09
13PA01-014-08	US20050219071	US	Lapsed	Apparatus and method for decoding	2005/10/06	US11/134448	2005/05/23
13PA01-014-05	US6734810	US	Granted	Apparatus and method for decoding	2004/05/11	US10/221267	2002/09/10
13PA01-014-07	US6922159	US	Granted	Apparatus and method for decoding	2005/07/26	US10/793766	2004/03/08
13PA01-014-06	US6940428	US	Granted	Apparatus and method for decoding	2005/09/06	US10/793737	2004/03/08
13PA01-015-01	CN1114324	CN	Granted	Base station, mobile unit communication apparatus and method of communication between them	2003/07/09	CN97119237	1997/09/30
13PA01-015-02	DE69708823	DE	Granted	Spreizspektrum-verfahren und system zur "bertragung zwischen einer basisstation und einer vielzahl von mobilen stationen	2002/06/20	DE69708823	1997/10/01
13PA01-015-03	EP0836288	FI	Granted	Spread-spectrum method and system for communication between a base station and a plurality of mobile units	2001/12/05	EP97307725	1997/10/01
13PA01-015-04	EP0836288	FR	Granted	Spread-spectrum method and system for communication between a base station and a plurality of mobile units	2001/12/05	EP97307725	1997/10/01
13PA01-015-05	EP0836288	GB	Granted	Spread-spectrum method and system for communication between a base station and a plurality of mobile units	2001/12/05	EP97307725	1997/10/01
13PA01-015-06	EP0836288	SE	Granted	Spread-spectrum method and system for communication between a base station and a plurality of mobile units	2001/12/05	EP97307725	1997/10/01
13PA01-015-07	JP3720141	JP	Granted	Mobile communication method and its system	2005/11/24	JP26062596	1996/10/01
13PA01-015-08	US6069884	US	Granted	Method of communication between a base station and a plurality of mobile unit communication apparatus, a base station, and mobile unit communication apparatus	2000/05/30	US08/937005	1997/09/24
13PA01-016-01	AU710430	AU	Granted	Base station equipment for mobile communication	1999/09/23	AU4320797	1997/09/25
13PA01-	CA2238358	CA	Granted	Base station apparatus for	2001/12/04	CA2238358	1997/09/25

016-02				mobile communication			
13PA01-016-03	CN1175592	CN	Granted	Base station equipment for mobile communication	2004/11/10	CN97191312	1997/09/25
13PA01-016-04	DE69721224	DE	Granted	Verfahren fÄœr sanftes weiterreichen in einer basisstation mit sektoren und basisstation dafÄœr	2003/11/13	DE69721224	1997/09/25
13PA01-016-05	EP0869629	FR	Granted	Soft handover method in a sectored base station and base station therefor	2003/04/23	EP97941232	1997/09/25
13PA01-016-06	EP0869629	GB	Granted	Soft handover method in a sectored base station and base station therefor	2003/04/23	EP97941232	1997/09/25
13PA01-016-07	EP0869629	IT	Granted	Soft handover method in a sectored base station and base station therefor	2003/04/23	EP97941232	1997/09/25
13PA01-016-08	EP0869629	NL	Granted	Soft handover method in a sectored base station and base station therefor	2003/04/23	EP97941232	1997/09/25
13PA01-016-09	JP4098833	JP	Granted	Mobile communication base station device	2008/06/11	JP51549798	1997/09/25
13PA01-016-10	US6119004	US	Granted	Base station equipment for mobile communication	2000/09/12	US09/068541	1998/05/13
13PA01-017-01	CN1100464	CN	Granted	Differential detector with error correcting function	2003/01/29	CN98105319	1998/02/20
13PA01-017-02	DE69818323	DE	Granted	Differential-detektor mit fehlerkorrekturfunktion	2004/07/01	DE69818323	1998/02/11
13PA01-017-03	EP0860964	FR	Granted	Differential detector with error correcting function	2003/09/24	EP98301000	1998/02/11
13PA01-017-04	EP0860964	GB	Granted	Differential detector with error correcting function	2003/09/24	EP98301000	1998/02/11
13PA01-017-05	JP3468657	JP	Lapsed	Delay detector with error correction	2003/11/17	JP5251497	1997/02/21
13PA01-017-06	US6069924	US	Granted	Differential detector with error correcting function	2000/05/30	US09/027510	1998/02/20
13PA01-018-01	CN1262083	CN	Granted	Cdma radio communication system and its method	2006/06/28	CN99110630	1999/07/23
13PA01-018-02	DE69936019	DE	Granted	Cdma-funkÄ¼bertragungssystem und -verfahren	2007/08/30	DE69936019	1999/07/21
13PA01-018-04	EP0975118	ES	Lapsed	Cdma radio communication system and method	2007/05/09	EP99114151	1999/07/21
13PA01-018-05	EP0975118	FR	Granted	Cdma radio communication system and method	2007/05/09	EP99114151	1999/07/21
13PA01-018-06	EP0975118	GB	Granted	Cdma radio communication system and method	2007/05/09	EP99114151	1999/07/21
13PA01-018-07	EP0975118	IT	Lapsed	Cdma radio communication system and method	2007/05/09	EP99114151	1999/07/21
13PA01-018-08	EP0975118	SE	Lapsed	Cdma radio communication system and method	2007/05/09	EP99114151	1999/07/21
13PA01-	EP1826938 - DIV	EP	Lapsed	Cdma radio communication	2007/08/29	EP07105867	1999/07/21

018-03				system and method			
13PA01-018-10	JP3411850	JP	Granted	Cdma radio communication system	2003/06/03	JP9142999	1999/03/31
13PA01-018-09	JP3411854	JP	Granted	Cdma radio communication system and method	2003/06/03	JP19480599	1999/07/08
13PA01-018-12	US20040048578	US	Lapsed	Cdma radio transmission apparatus, cdma radio reception apparatus, and cdma radio communication method	2004/03/11	US10/419089	2003/04/21
13PA01-018-11	US6636723	US	Granted	Cdma radio communication system using chip interleaving	2003/10/21	US09/359020	1999/07/22
13PA01-019-02	CN1086524	CN	Granted	Switching over method for cdma system and base station of mobile station	2002/06/19	CN98106939	1998/04/15
13PA01-019-01	CN1170388	CN	Granted	Commutation method in cdma	2004/10/06	CN02105576	1998/04/15
13PA01-019-03	DE69817904	DE	Granted	Weiterreichen verfahren in einem spreizspektrum-Ä¼betragungseinrichtung	2004/05/19	DE69817904	1998/04/14
13PA01-019-04	DE69824054	DE	Granted	Spreizspektrumkommunikations system	2004/09/09	DE69824054	1998/04/14
13PA01-019-09	EP0873034	FR	Granted	Handover method in a spread spectrum communication system	2003/09/10	EP98106758	1998/04/14
13PA01-019-10	EP0873034	GB	Granted	Handover method in a spread spectrum communication system	2003/09/10	EP98106758	1998/04/14
13PA01-019-11	EP0873034	NL	Granted	Handover method in a spread spectrum communication system	2003/09/10	EP98106758	1998/04/14
13PA01-019-12	EP0873034	SE	Granted	Handover method in a spread spectrum communication system	2003/09/10	EP98106758	1998/04/14
13PA01-019-05	EP1304899	FR	Granted	Spread spectrum communication system	2004/05/19	EP02026952	1998/04/14
13PA01-019-06	EP1304899	GB	Granted	Spread spectrum communication system	2004/05/19	EP02026952	1998/04/14
13PA01-019-07	EP1304899	NL	Granted	Spread spectrum communication system	2004/05/19	EP02026952	1998/04/14
13PA01-019-08	EP1304899	SE	Granted	Spread spectrum communication system	2004/05/19	EP02026952	1998/04/14
13PA01-019-13	KR100371837	KR	Granted	Hand-over method, mobile station apparatus and base station apparatus	2003/01/28	KR20020030497	2002/05/31
13PA01-019-14	US6628630	US	Granted	Spread spectrum communication method	2003/09/30	US09/058881	1998/04/13
13PA01-020-01	JP9271070	JP	Non-applicable	Digital mobile object communication equipment	1997/10/14	JP7642396	1996/03/29
13PA01-020-02	US6404778	US	Granted	Radio communication apparatus	2002/06/11	US09/159602	1998/09/24

13PA01-021-01	CN1134128	CN	Granted	Cdma/tdd mobile communication system and method	2004/01/07	CN99103968	1999/03/09
13PA01-021-02	DE69927200	DE	Granted	Cdma/tdd mobiles kommunikationssystem und verfahren	2006/01/12	DE69927200	1999/03/04
13PA01-021-03	DE69942350	DE	Granted	Cdma/tdd mobilstation und verfahren	2010/06/17	DE69942350	1999/03/04
13PA01-021-07	EP0948221	FR	Granted	Cdma/tdd mobile communication system and method	2005/09/14	EP99102882	1999/03/04
13PA01-021-08	EP0948221	GB	Granted	Cdma/tdd mobile communication system and method	2005/09/14	EP99102882	1999/03/04
13PA01-021-09	EP0948221	IT	Granted	Cdma/tdd mobile communication system and method	2005/09/14	EP99102882	1999/03/04
13PA01-021-04	EP1578163	FR	Granted	Cdma/tdd mobile station and method	2010/05/05	EP05013391	1999/03/04
13PA01-021-05	EP1578163	GB	Granted	Cdma/tdd mobile station and method	2010/05/05	EP05013391	1999/03/04
13PA01-021-06	EP1578163	IT	Granted	Cdma/tdd mobile station and method	2010/05/05	EP05013391	1999/03/04
13PA01-021-11	ES2248932	ES	Granted	Sistema de comunicacion movil cdma/tdd y metodo.	2006/03/16	ES99102882	1999/03/04
13PA01-021-10	ES2343414	ES	Granted	Estacion movil cdma/tdd y metodo.	2010/07/30	ES05013391	1999/03/04
13PA01-021-12	JP3881770	JP	Granted	System and method for time division duplex cdma mobile communication	2007/02/14	JP7831798	1998/03/10
13PA01-021-13	US6611509	US	Granted	Cdma/tdd mobile communication system and method	2003/08/26	US09/264826	1999/03/09
13PA01-021-14	US6807162	US	Granted	Cdma/tdd mobile communication system and method	2004/10/19	US10/166268	2002/06/11
13PA01-021-15	US6973065	US	Granted	Cdma/tdd mobile communication system and method	2005/12/06	US10/419733	2003/04/22
13PA01-021-16	US7778224	US	Granted	Cdma/tdd mobile communication system and method	2010/08/17	US10/885684	2004/07/08
13PA01-022-01	CN100413233	CN	Granted	Communication terminal device and base station device	2008/08/20	CN00131890	2000/07/05
13PA01-022-02	DE60026907	DE	Granted	KommunikationsendgerÄtvorrichtung und basisstationvorrichtung	2006/08/17	DE60026907	2000/07/04
13PA01-022-03	DE60043953	DE	Granted	Cdma-sender und -empfÄnger unter verwendung von midambles	2010/04/15	DE60043953	2000/07/04
13PA01-022-04	EP1067723	FR	Granted	Communication terminal apparatus and base station	2006/03/29	EP00114318	2000/07/04

				apparatus			
13PA01-022-05	EP1067723	GB	Granted	Communication terminal apparatus and base station apparatus	2006/03/29	EP00114318	2000/07/04
13PA01-022-06	EP1067723	SE	Lapsed	Communication terminal apparatus and base station apparatus	2006/03/29	EP00114318	2000/07/04
13PA01-022-07	EP1667337	FR	Granted	Cdma transmitter and receiver using midambles	2010/03/03	EP06001107	2000/07/04
13PA01-022-08	EP1667337	GB	Granted	Cdma transmitter and receiver using midambles	2010/03/03	EP06001107	2000/07/04
13PA01-022-09	EP1667337	SE	Granted	Cdma transmitter and receiver using midambles	2010/03/03	EP06001107	2000/07/04
13PA01-022-10	JP2001024556	JP	Lapsed	Communication device	2001/01/26	JP19005099	1999/07/05
13PA01-022-11	JP2001257626	JP	Lapsed	Communication unit and communication method	2001/09/21	JP2000068426	2000/03/13
13PA01-022-12	JP3748351	JP	Granted	Communication equipment and communication method	2006/02/22	JP33139199	1999/11/22
13PA01-022-13	KR20010015160	KR	Non-applicable	Communication device	2001/02/26	KR20000037971	2000/07/04
13PA01-022-14	US6765894	US	Granted	Communication terminal apparatus and base station apparatus	2004/07/20	US09/606906	2000/06/30
13PA01-022-15	US7656844	US	Granted	Radio transmission apparatus and radio reception apparatus in a cdma communication system	2010/02/02	US10/868029	2004/06/16
13PA01-022-16	US8437316	US	Granted	Radio transmission apparatus and radio reception apparatus in a cdma communication system	2013/05/07	US12/641177	2009/12/17
13PA01-023-01	CN1233119	CN	Granted	Wireless communication device and wireless communication method	2005/12/21	CN00119928	2000/07/03
13PA01-023-02	EP1065804	EP	Lapsed	Transmission/reception apparatus	2001/01/03	EP00113933	2000/06/30
13PA01-023-03	JP3678944	JP	Granted	Transmitter-receiver	2005/08/03	JP18952099	1999/07/02
13PA01-023-04	KR20010015127	KR	Granted	Transmitter-receiver	2001/02/26	KR20000037494	2000/07/01
13PA01-023-05	US6839335	US	Granted	Radio communication apparatus and radio communication method	2005/01/04	US09/605862	2000/06/29
13PA01-024-01	CA2316782	CA	Granted	Apparatus and method for transmission/reception	2012/08/21	CA2316782	1999/11/08
13PA01-024-02	CN1248438	CN	Granted	Transmitting / receiving device and transmitting / receiving method	2006/03/29	CN99801989	1999/11/08
13PA01-024-03	EP1043858	DE	Granted	Transmitting/receiving device and transmitting/receiving method	2011/08/17	EP99954417	1999/11/08
13PA01-	EP1043858	FR	Granted	Transmitting/receiving device	2011/08/17	EP99954417	1999/11/08

024-04				and transmitting/receiving method			
13PA01-024-05	EP1043858	GB	Granted	Transmitting/receiving device and transmitting/receiving method	2011/08/17	EP99954417	1999/11/08
13PA01-024-06	IL137058	IL	Granted	Apparatus and method for transmission/reception	2001/06/14	IL13705899	1999/11/08
13PA01-024-07	JP2000201132	JP	Lapsed	Transmitter-receiver	2000/07/18	JP22082799	1999/08/04
13PA01-024-11	KR388400	KR	Granted	Apparatus and method for transmission/reception	2003/06/09	KR2000-7007459	1999/11/08
13PA01-024-12	KR611866	KR	Granted	Apparatus and method for transmission/reception	2006/08/04	KR2003-7000348	2003/01/10
13PA01-024-08	NO332385	NO	Granted	Fremgangsmate og apparat for sending/mottaking	2012/09/10	NO20003476	2000/07/05
13PA01-024-09	US7072416	US	Granted	Transmitting/receiving device and transmitting/receiving method	2006/07/04	US09/582558	2000/06/29
13PA01-024-10	US7760815	US	Granted	Apparatus and method for transmission/reception	2010/07/20	US11/431606	2006/05/11
13PA01-025-01	CN1281009	CN	Granted	Apparatus and method for orthogonal frequency division multiplexing communication	2006/10/18	CN00126839	2000/09/06
13PA01-025-02	DE60041618	DE	Granted	MehrtrÃ¤gerempfÃ¤nger mit auswÃ¤hlbaren demodulatoren	2009/04/09	DE60041618	2000/09/06
13PA01-025-03	EP1083718	FR	Granted	Multicarrier receiver with selectable demodulators	2009/02/25	EP00119285	2000/09/06
13PA01-025-04	EP1083718	GB	Granted	Multicarrier receiver with selectable demodulators	2009/02/25	EP00119285	2000/09/06
13PA01-025-05	EP1083718	SE	Granted	Multicarrier receiver with selectable demodulators	2009/02/25	EP00119285	2000/09/06
13PA01-025-06	JP2001077790	JP	Precursor	Ofdm communication equipment	2001/03/23	JP25363399	1999/09/07
13PA01-025-07	JP3796076	JP	Granted	Ofdm communication equipment	2006/07/12	JP25363399	1999/09/07
13PA01-025-08	KR20010050345	KR	Non-applicable	Ofdm communication equipment	2001/06/15	KR20000052621	2000/09/06
13PA01-025-09	US6868056	US	Granted	Apparatus and method for ofdm communication	2005/03/15	US09/635096	2000/08/09
13PA01-026-01	CN1153392	CN	Granted	Interference signal removing device and interference signal removing method	2004/06/09	CN01800054	2001/01/15
13PA01-026-02	DE60114511	DE	Granted	Verfahren und vorrichtung zur beseitigung von stÃ¶rsignalen	2006/06/01	DE60114511	2001/01/15
13PA01-026-03	EP1164735	FR	Granted	Interference signal removing device and interference signal removing method	2005/11/02	EP01900770	2001/01/15
13PA01-026-04	EP1164735	GB	Granted	Interference signal removing device and interference signal removing method	2005/11/02	EP01900770	2001/01/15

13PA01-026-05	JP3515033	JP	Granted	Interference signal elimination device and interference signal elimination method	2004/04/05	JP2000010877	2000/01/19
13PA01-026-06	US6944208	US	Granted	Interference signal canceling apparatus and interference signal canceling method	2005/09/13	US09/936727	2001/09/17
13PA01-027-01	CN1174643	CN	Granted	Combined signalling and signal interference ratio internal ring power control	2004/11/03	CN01102993	2001/02/13
13PA01-027-02	CN1315810	CN	Lapsed	Combined signalling and signal interference ratio internal ring power control	2001/10/03	CN01102993	2001/02/13
13PA01-027-03	DE60045506	DE	Granted	Sendeleistungsregelung mittels einer inneren schleife	2011/02/24	DE60045506	2000/11/21
13PA01-027-04	EP1139580	FR	Granted	Inner-loop power control	2011/01/12	EP00310315	2000/11/21
13PA01-027-05	EP1139580	GB	Granted	Inner-loop power control	2011/01/12	EP00310315	2000/11/21
13PA01-027-06	EP1139580	IT	Granted	Inner-loop power control	2011/01/12	EP00310315	2000/11/21
13PA01-027-07	ES2358388	ES	Granted	Control de potencia de lazo interno.	2011/05/10	ES00310315	2000/11/21
13PA01-027-08	US6781973	US	Granted	Combined signaling and sir inner-loop power control	2004/08/24	US09/538888	2000/03/30
13PA01-028-01	CN1181625	CN	Granted	Communication terminal device and transmit power control method	2004/12/22	CN00802695	2000/11/27
13PA01-028-03	EP1146668	DE	EP-Designated	Communication terminal, base station system, and method of controlling transmission power	2001/10/17	EP00977949	2000/11/27
13PA01-028-02	EP1146668	EP	EP-Pending	Communication terminal, base station system, and method of controlling transmission power	2001/10/17	EP00977949	2000/11/27
13PA01-028-04	EP1146668	FR	EP-Designated	Communication terminal, base station system, and method of controlling transmission power	2001/10/17	EP00977949	2000/11/27
13PA01-028-05	EP1146668	GB	EP-Designated	Communication terminal, base station system, and method of controlling transmission power	2001/10/17	EP00977949	2000/11/27
13PA01-028-06	JP3583343	JP	Granted	Communication terminal, base station unit and transmission power control method	2004/11/04	JP2000076032	2000/03/17
13PA01-028-07	US7145886	US	Granted	Communication terminal, base station system, and method of controlling transmission power	2006/12/05	US09/889919	2001/07/25
13PA01-029-01	AU6789101	AU	Lapsed	Base station unit and method for radio communication	2002/01/14	AU6789101	2001/07/02
13PA01-029-02	CN1148895	CN	Granted	Base station unit and method for radio communication	2004/05/05	CN01801884	2001/07/02
13PA01-029-03	CN1276596	CN	Granted	Base station apparatus and radio communication method	2006/09/20	CN200410007371	2001/07/02

13PA01-029-04	DE60117263	DE	Granted	Basisstationseinheit und verfahren zur funkkommunikation	2006/07/27	DE60117263	2001/07/02
13PA01-029-05	DE60121055	DE	Granted	Basisstationsvorrichtung und funkkommunikationsverfahren zur hochgeschwindigkeitsdaten-ertragung	2006/11/09	DE60121055	2001/07/02
13PA01-029-06	EP1209824	FR	Granted	Base station unit and method for radio communication	2006/02/15	EP01945745	2001/07/02
13PA01-029-07	EP1209824	GB	Granted	Base station unit and method for radio communication	2006/02/15	EP01945745	2001/07/02
13PA01-029-08	EP1437841	FR	Granted	Base station apparatus and radio communication method for high-speed data communication	2006/06/21	EP04003162	2001/07/02
13PA01-029-09	EP1437841	GB	Granted	Base station apparatus and radio communication method for high-speed data communication	2006/06/21	EP04003162	2001/07/02
13PA01-029-11	JP4359218	JP	Granted	Base station system and radio communication method	2009/11/04	JP2004293911	2004/10/06
13PA01-029-10	JP4409793	JP	Granted	Base station equipment and method for radio communication	2010/02/03	JP2001200184	2001/06/29
13PA01-029-12	US6847828	US	Granted	Base station apparatus and radio communication method	2005/01/25	US10/069484	2002/02/27
13PA01-029-13	US7386321	US	Granted	Base station apparatus and radio communication method	2008/06/10	US10/793738	2004/03/08
13PA01-030-01	CN1174588	CN	Granted	Grouping receiver and transmission method thereof	2004/11/03	CN02119390	2002/05/15
13PA01-030-02	DE60208466	DE	Granted	Verfahren und vorrichtung zur fehlerkorrektur der statischen informationen im kopffeld eines empfangenen packets	2006/07/13	DE60208466	2002/05/15
13PA01-030-03	EP1261184	FR	Granted	Method and device for error correction in the static header information of a received packet	2006/01/04	EP02010884	2002/05/15
13PA01-030-04	EP1261184	GB	Granted	Method and device for error correction in the static header information of a received packet	2006/01/04	EP02010884	2002/05/15
13PA01-030-05	JP3512177	JP	Granted	Packet receiver and packet transmission method	2004/03/29	JP2001146281	2001/05/16
13PA01-030-06	US7266118	US	Granted	Packet receiving apparatus and packet transmission method	2007/09/04	US10/143989	2002/05/14
13PA01-031-01	AT279085	AT	Lapsed	Funkkommunikationssystem, basisstationsgerät sowie ein in dem system aufgenommenes kommunikationsendgerät	2004/10/15	AT01999126	2001/11/27
13PA01-031-02	AT308864	AT	Lapsed	Funkkommunikationssystem, basisstation und kommunikationsendgerät	2005/11/15	AT03025316	2001/11/27

13PA01-031-03	AU2410802	AU	Lapsed	Radio communication system, base station device and communication terminal accommodated in the system	2002/06/11	AU2410802	2001/11/27
13PA01-031-04	CN1288939	CN	Granted	Radio communication system, base station device and communication terminal accommodated in the system	2006/12/06	CN01804070	2001/11/27
13PA01-031-05	CZ20022591	CZ	Lapsed	Wireless communication system and apparatus for a base station and communication terminal apparatus applied within the system	2003/03/12	CZ20022591	2001/11/27
13PA01-031-06	DE60106196	DE	Granted	Funkkommunikationssystem, basisstationsgerÄ„t sowie ein in dem system aufgenommenes kommunikationsendgerÄ„t	2005/02/17	DE60106196	2001/11/27
13PA01-031-07	DE60114671	DE	Granted	Funkkommunikationssystem, basisstation und kommunikationsendgerÄ„t	2006/04/20	DE60114671	2001/11/27
13PA01-031-13	EP1246492	FI	Granted	Radio communication system, base station device and communication terminal accommodated in the system	2004/10/06	EP01999126	2001/11/27
13PA01-031-12	EP1246492	FR	Granted	Radio communication system, base station device and communication terminal accommodated in the system	2004/10/06	EP01999126	2001/11/27
13PA01-031-11	EP1246492	GB	Granted	Radio communication system, base station device and communication terminal accommodated in the system	2004/10/06	EP01999126	2001/11/27
13PA01-031-10	EP1246492	IT	Granted	Radio communication system, base station device and communication terminal accommodated in the system	2004/10/06	EP01999126	2001/11/27
13PA01-031-09	EP1246492	NL	Granted	Radio communication system, base station device and communication terminal accommodated in the system	2004/10/06	EP01999126	2001/11/27
13PA01-031-08	EP1246492	SE	Granted	Radio communication system, base station device and communication terminal accommodated in the system	2004/10/06	EP01999126	2001/11/27
13PA01-031-14	EP1387597	FR	Granted	Radio communication system, base station and communication terminal	2005/11/02	EP03025316	2001/11/27
13PA01-031-15	EP1387597	GB	Granted	Radio communication system, base station and communication terminal	2005/11/02	EP03025316	2001/11/27
13PA01-031-16	ES2230395	ES	Granted	Sistema de radiocomunicacion que comprende un dispositivo	2005/05/01	ES01999126	2001/11/27

				de estacion base y un terminal de comunicacion.			
13PA01-031-17	JP3691383	JP	Granted	Radio communication system, base station device and communication terminal accommodated in the system	2005/09/07	JP2000363649	2000/11/29
13PA01-031-18	US7133379	US	Granted	Wireless communication system, and base station apparatus and communication terminal apparatus accommodated in the system	2006/11/07	US10/181349	2002/07/17
13PA01-032-01	AU1745202	AU	Lapsed	Radio base station apparatus and radio communication method	2002/07/01	AU1745202	2001/12/19
13PA01-032-02	BR0108503	BR	Lapsed	Aparelho de estaçãŁo de base sem fio e mŁtodo de comunicaçãŁo sem fio	2002/12/24	BR0108503	2001/12/19
13PA01-032-03	CA2400990	CA	Lapsed	Wireless base station apparatus and wireless communication method	2010/10/19	CA2400990	2001/12/19
13PA01-032-05	CN100534005	CN	Granted	Wireless base station apparatus and wireless communication method	2009/08/26	CN200510088453	2001/12/19
13PA01-032-04	CN1162989	CN	Granted	Radio base station device and radio communication method	2004/08/18	CN01805368	2001/12/19
13PA01-032-06	CZ20022827	CZ	Lapsed	Apparatus for wireless base station and wireless communication method	2003/02/12	CZ20022827	2001/12/19
13PA01-032-07	DE60117694	DE	Lapsed	Funk-basisstationsvorrichtung und funk-kommunikationsverfahren	2006/10/05	DE60117694	2001/12/19
13PA01-032-08	EP1249949	FR	Lapsed	Radio base station apparatus and radio communication method	2006/03/08	EP01271705	2001/12/19
13PA01-032-09	EP1249949	GB	Lapsed	Radio base station apparatus and radio communication method	2006/03/08	EP01271705	2001/12/19
13PA01-032-10	JP2002190757	JP	Precursor	Radio base station equipment and radio communication method	2002/07/05	JP2000389473	2000/12/21
13PA01-032-11	JP3679000	JP	Granted	Radio base station equipment and radio communication method	2005/08/03	JP2000389473	2000/12/21
13PA01-032-12	KR100567502	KR	Lapsed	Radio transmission apparatus and radio transmission method	2006/04/03	KR20057005182	2005/03/25
13PA01-032-13	US7392019	US	Granted	Wireless base station apparatus and wireless communication method	2008/06/24	US11/053837	2005/02/10
13PA01-033-01	CN1224207	CN	Granted	Method and apparatus for automatic request repeat of sending and receiving	2005/10/19	CN02142556	2002/08/22
13PA01-	DE60104113	DE	Granted	ÄfÄbertragungsverfahren und	2004/10/28	DE60104113	2001/08/22

033-02				ÄfÄ"bertragungsgerÄfÄt mit mehrkanal-arq			
13PA01-033-03	EP1286491	FR	Granted	Multichannel arq method and apparatus	2004/06/30	EP01120182	2001/08/22
13PA01-033-04	EP1286491	GB	Granted	Multichannel arq method and apparatus	2004/06/30	EP01120182	2001/08/22
13PA01-033-05	JP3650383	JP	Granted	Transmitter, receiver and arq transmitting and receiving method	2005/05/18	JP2002241027	2002/08/21
13PA01-033-06	KR100494251	KR	Granted	Arq transmission and reception methods and apparatus	2005/06/13	KR20020049754	2002/08/22
13PA01-033-07	US7339949	US	Granted	Arq transmission and reception methods and apparatus	2008/03/04	US10/222989	2002/08/19
13PA01-034-01	CN1319307	CN	Granted	Transmission/reception apparatus and transmission/reception method	2007/05/30	CN02820398	2002/08/07
13PA01-034-02	DE60239543	DE	Granted	Sende-empfangs-vorrichtung und sende-empfangs-verfahren	2011/05/05	DE60239543	2002/08/07
13PA01-034-03	EP1422861	FR	Granted	Transmission / reception apparatus and transmission / reception method	2011/03/23	EP02755868	2002/08/07
13PA01-034-04	EP1422861	GB	Granted	Transmission / reception apparatus and transmission / reception method	2011/03/23	EP02755868	2002/08/07
13PA01-034-05	JP3880437	JP	Granted	Transmission/reception apparatus and transmission/reception method	2007/02/14	JP2002113607	2002/04/16
13PA01-034-06	US7702025	US	Granted	Transmission/reception apparatus and transmission/reception method	2010/04/20	US10/487574	2004/02/25
13PA01-035-01	CN1224293	CN	Granted	Dispatching device, base station device and wireless communication method	2005/10/19	CN02804809	2002/11/11
13PA01-035-03	EP1365617	DE	Granted	Schedule creation apparatus, base station apparatus, and radio communication method	2012/05/09	EP02780065	2002/11/11
13PA01-035-02	EP1365617	FR	Granted	Schedule creation apparatus, base station apparatus, and radio communication method	2012/05/09	EP02780065	2002/11/11
13PA01-035-04	EP1365617	GB	Granted	Schedule creation apparatus, base station apparatus, and radio communication method	2012/05/09	EP02780065	2002/11/11
13PA01-035-05	JP3576525	JP	Granted	Schedule maker, base station device, and radio communication method	2004/10/13	JP2001345444	2001/11/09
13PA01-035-06	US7460502	US	Granted	Scheduling creation apparatus, base station apparatus, and radio communication method	2008/12/02	US10/250487	2003/07/03
13PA01-036-01	CN100514895	CN	Granted	Method of data retransmission in multi-carrier transmission and communication apparatus having data retransmission	2009/07/15	CN03800915	2003/03/19

				control device			
13PA01-036-03	EP1492258	DE	EP-Designated	Method of data retransmission in multi-carrier transmission and communication apparatus having data retransmission control device	2010/08/11	EP03710414	2003/03/19
13PA01-036-02	EP1492258	EP	EP-Pending	Method of data retransmission in multi-carrier transmission and communication apparatus having data retransmission control device	2010/08/11	EP03710414	2003/03/19
13PA01-036-06	EP1492258	FI	EP-Designated	Method of data retransmission in multi-carrier transmission and communication apparatus having data retransmission control device	2010/08/11	EP03710414	2003/03/19
13PA01-036-04	EP1492258	FR	EP-Designated	Method of data retransmission in multi-carrier transmission and communication apparatus having data retransmission control device	2010/08/11	EP03710414	2003/03/19
13PA01-036-05	EP1492258	GB	EP-Designated	Method of data retransmission in multi-carrier transmission and communication apparatus having data retransmission control device	2010/08/11	EP03710414	2003/03/19
13PA01-036-07	EP1492258	SE	EP-Designated	Method of data retransmission in multi-carrier transmission and communication apparatus having data retransmission control device	2010/08/11	EP03710414	2003/03/19
13PA01-036-08	JP4287751	JP	Granted	The data retransmission method in multiple carrier transmitting and the communication device which has the data retransmission control control equipment	2009/07/01	JP2003581390	2003/03/19
13PA01-036-09	US7269774	US	Granted	Data receiving apparatus, data transmitting apparatus and retransmission request method	2007/09/11	US10/484951	2004/01/28
13PA01-037-01	CN1266982	CN	Granted	Radio communication apparatus and transfer rate decision method	2006/07/26	CN03800365	2003/02/06
13PA01-037-02	DE60314588	DE	Granted	Funkkommunikationsvorrichtung und transferratenentscheidungsverfahren	2007/10/25	DE60314588	2003/02/06
13PA01-037-03	EP1424869	FR	Granted	Radio communication apparatus and transfer rate decision method	2007/06/27	EP03705051	2003/02/06
13PA01-037-04	EP1424869	GB	Granted	Radio communication apparatus and transfer rate decision	2007/06/27	EP03705051	2003/02/06

				method			
13PA01-037-06	JP2005260992	JP	Lapsed	Wireless communication apparatus and transmission rate decision method	2005/09/22	JP2005112396	2005/04/08
13PA01-037-05	JP3686614	JP	Granted	Wireless communication apparatus and transmission rate decision method	2005/08/24	JP2002030942	2002/02/07
13PA01-037-07	US7385934	US	Granted	Radio communication apparatus and transfer rate decision method	2008/06/10	US10/476845	2003/11/06
13PA01-038-01	CN100514973	CN	Granted	Rate matching device and rate matching method	2009/07/15	CN03800419	2003/01/30
13PA01-038-02	EP1388992	EP	Lapsed	Rate matching device and rate matching method	2008/04/02	EP03734892	2003/01/30
13PA01-038-03	JP3629241	JP	Granted	Device and method for rate matching	2005/03/16	JP2002021499	2002/01/30
13PA01-038-04	US7114121	US	Granted	Rate matching device and rate matching method	2006/09/26	US10/478139	2003/11/20
13PA01-039-01	CN100502273	CN	Granted	Test device, mobile terminal device and test method	2009/06/17	CN200310102691	2003/10/29
13PA01-039-02	CN1964243	CN	Granted	Test apparatus, mobile terminal apparatus and wireless transmission property test method	2012/11/07	CN200610073263	2003/10/29
13PA01-039-04	EP1441554	CH	Granted	Test apparatus, mobile terminal apparatus and test method	2013/03/13	EP04000733	2004/01/15
13PA01-039-05	EP1441554	DE	Granted	Test apparatus, mobile terminal apparatus and test method	2013/03/13	EP04000733	2004/01/15
13PA01-039-03	EP1441554	EP	PreCursor(E P)	Test apparatus, mobile terminal apparatus and test method	2013/03/13	EP04000733	2004/01/15
13PA01-039-06	EP1441554	FR	Granted	Test apparatus, mobile terminal apparatus and test method	2013/03/13	EP04000733	2004/01/15
13PA01-039-07	EP1441554	GB	Granted	Test apparatus, mobile terminal apparatus and test method	2013/03/13	EP04000733	2004/01/15
13PA01-039-08	EP1441554	IE	Granted	Test apparatus, mobile terminal apparatus and test method	2013/03/13	EP04000733	2004/01/15
13PA01-039-09	EP1441554	LI	Granted	Test apparatus, mobile terminal apparatus and test method	2013/03/13	EP04000733	2004/01/15
13PA01-039-10	EP1441554	LU	Granted	Test apparatus, mobile terminal apparatus and test method	2013/03/13	EP04000733	2004/01/15
13PA01-039-11	EP1441554	MC	Granted	Test apparatus, mobile terminal apparatus and test method	2013/03/13	EP04000733	2004/01/15
13PA01-039-12	JP2004228762	JP	Lapsed	Test apparatus, mobile terminal apparatus and test method	2004/08/12	JP2003012312	2003/01/21
13PA01-039-13	KR20040067911	KR	Lapsed	Testing device, mobile terminal and testing method, particularly for testing radio transmission characteristics with certain transmission power	2004/07/30	KR20040002903	2004/01/15
13PA01-039-14	US7162206	US	Granted	Test apparatus, mobile terminal apparatus, test method	2007/01/09	US10/612289	2003/07/03

13PA01-040-01	DE60332146	DE	Granted	Sendervorrichtung und sendeverfahren	2010/05/27	DE60332146	2003/11/13
13PA01-040-02	EP1564920	FR	Granted	Transmitter apparatus and transmitting method	2010/04/14	EP03774003	2003/11/13
13PA01-040-03	EP1564920	GB	Granted	Transmitter apparatus and transmitting method	2010/04/14	EP03774003	2003/11/13
13PA01-040-04	JP3796211	JP	Granted	Transmitter and transmitting method	2006/07/12	JP2002333448	2002/11/18
13PA01-040-05	JP4163937	JP	Granted	Ofdm-cdma transmitter and ofdm-cdma transmission method	2008/10/08	JP2002355079	2002/12/06
13PA01-040-06	US7746762	US	Granted	Transmitting apparatus and transmitting method	2010/06/29	US10/534987	2005/05/16
13PA01-041-01	CN1692592	CN	Granted	Cdma transmitting apparatus and cdma receiving apparatus	2010/07/14	CN200380100629	2003/11/14
13PA01-041-02	DE60325751	DE	Granted	Cdma mimo system	2009/02/26	DE60325751	2003/11/14
13PA01-041-03	EP1551124	FR	Granted	Cdma mimo system	2009/01/07	EP03772765	2003/11/14
13PA01-041-04	EP1551124	GB	Granted	Cdma mimo system	2009/01/07	EP03772765	2003/11/14
13PA01-041-05	JP3583414	JP	Granted	Code division multiple access transmitter and code division multiple access receiver	2004/11/04	JP2002330453	2002/11/14
13PA01-041-06	US7693140	US	Granted	Cdma transmitting apparatus and cdma receiving apparatus	2010/04/06	US10/527199	2005/03/10
13PA01-042-01	CN1714519	CN	Granted	Radio reception device and radio reception method	2011/05/04	CN200380103837	2003/11/26
13PA01-042-02	EP1569362	DE	Granted	Radio reception device and radio reception method	2011/10/26	EP03775882	2003/11/26
13PA01-042-03	EP1569362	FR	Granted	Radio reception device and radio reception method	2011/10/26	EP03775882	2003/11/26
13PA01-042-04	EP1569362	GB	Granted	Radio reception device and radio reception method	2011/10/26	EP03775882	2003/11/26
13PA01-042-05	JP3629261	JP	Granted	Apparatus and method for radio reception	2005/03/16	JP2002341741	2002/11/26
13PA01-042-07	US20080020802	US	Lapsed	Wireless receiver and wireless reception method	2008/01/24	US11/859550	2007/09/21
13PA01-042-06	US7299027	US	Granted	Mimo receiver and mimo reception method for selection of mimo separation and channel variation compensation	2007/11/20	US10/536010	2005/05/23
13PA01-043-01	CN101019360	CN	Granted	Automatic retransmission request control system and method in mimo-ofdm system	2012/06/13	CN200480043975	2004/09/13
13PA01-043-03	EP1788742	DE	Granted	Automatic retransmission request control system and retransmission method in mimo-ofdm system	2007/05/23	EP04772990	2004/09/13
13PA01-043-02	EP1788742	EP	PreCursor(E P)	Automatic retransmission request control system and retransmission method in	2007/05/23	EP04772990	2004/09/13

				mimo-ofdm system			
13PA01-043-04	EP1788742	FR	Granted	Automatic retransmission request control system and retransmission method in mimo-ofdm system	2007/05/23	EP04772990	2004/09/13
13PA01-043-05	EP1788742	GB	Granted	Automatic retransmission request control system and retransmission method in mimo-ofdm system	2007/05/23	EP04772990	2004/09/13
13PA01-043-06	EP2518920	EP	Lapsed	Automatic retransmission request control system and retransmission method in mimo-ofdm system	2012/10/31	EP12173393	2004/09/13
13PA01-043-07	EP2518921	EP	Lapsed	Automatic retransmission request (arq) control system and retransmission method in mimo-ofdm system	2012/10/31	EP12173394	2004/09/13
13PA01-043-08	JP4384668	JP	Granted	The automatic request for repetition control system and the retransmission method in the mimo-ofdm system	2009/12/16	JP2006534962	2004/09/13
13PA01-043-09c2	US14/321117	US	Pending	Automatic retransmission request control system and retransmission method in memo-ofdm system		US14/321117	2014/07/01
13PA01-043-09c1	US14/321185	US	Pending	Automatic retransmission request control system and retransmission method in memo-ofdm system		US14/321185	2014/07/01
13PA01-043-10	US20120230257	US	Lapsed	Retransmission method and transmitter	2012/09/13	US13/478996	2012/05/23
13PA01-043-11	US20120263250	US	Lapsed	Retransmission method, transmitter, and communication system	2012/10/18	US13/532576	2012/06/25
13PA01-043-12	US20120287775	US	Pending	Automatic retransmission request control system and retransmission method in mimo-ofdm system	2012/11/15	US13/554748	2012/07/20
13PA01-043-09	US8775890	US	Granted	Automatic retransmission request control system and retransmission method in memo-ofdm system	2007/11/01	US11/575015	2007/03/30
13PA01-044-01	CN100578989	CN	Granted	Cdma transmitting apparatus, base station device usings the same and cdma transmitting method	2010/01/06	CN200480000627	2004/04/28
13PA01-044-03	EP1630993	DE	EP-Designated	Cdma transmitting apparatus and cdma transmitting method	2006/03/01	EP04730067	2004/04/28
13PA01-044-02	EP1630993	EP	EP-Pending	Cdma transmitting apparatus and cdma transmitting method	2006/03/01	EP04730067	2004/04/28
13PA01-044-07	EP1630993	FI	EP-Designated	Cdma transmitting apparatus and cdma transmitting method	2006/03/01	EP04730067	2004/04/28

13PA01-044-04	EP1630993	FR	EP-Designated	Cdma transmitting apparatus and cdma transmitting method	2006/03/01	EP04730067	2004/04/28
13PA01-044-05	EP1630993	GB	EP-Designated	Cdma transmitting apparatus and cdma transmitting method	2006/03/01	EP04730067	2004/04/28
13PA01-044-06	EP1630993	SE	EP-Designated	Cdma transmitting apparatus and cdma transmitting method	2006/03/01	EP04730067	2004/04/28
13PA01-044-08	JP3799030	JP	Granted	Device and method for cdma transmission	2006/07/19	JP2003132133	2003/05/09
13PA01-044-09	US7251469	US	Granted	Cdma transmitting apparatus and cdma transmitting method	2007/07/31	US10/522980	2005/02/02
13PA01-044-10	US7764711	US	Granted	Cdma transmission apparatus and cdma transmission method	2010/07/27	US11/767124	2007/06/22
13PA01-045-02	CN100591000	CN	Granted	Classifying-synthesizing transmission method of multi-user feedback information at base station	2010/02/17	CN200580029870	2005/09/05
13PA01-045-03	CN101015161	CN	Granted	Classifying-synthesizing transmission method of multi-user feedback information at base station	2007/08/08	CN200580029870	2005/09/05
13PA01-045-01	CN1747568	CN	Lapsed	Method for base station to transmitting feedback data of multiple clients by sorted combinations	2006/03/15	CN200410068800	2004/09/06
13PA01-045-04	EP1777855	EP	Lapsed	Classifying-synthesizing transmission method of multi-user feedback information at base station	2007/04/25	EP05777044	2005/09/05
13PA01-045-05	JP4675904	JP	Granted	Taxonomic synthetic transmission method of feedback information multi user in base station	2011/04/27	JP2006535743	2005/09/05
13PA01-045-06	US20070254715	US	Precursor	Classifying-synthesizing transmission method of multi-user feedback information at base station	2007/11/01	US11/574636	2005/09/06
13PA01-045-07	US8086270	US	Granted	Classifying-synthesizing transmission method of multi-user feedback information at base station	2011/12/27	US11/574636	2005/09/05
13PA01-046-02	EP1811700	DE	EP-Designated	Communication apparatus, communication system, and communication method	2007/07/25	EP05807089	2005/11/18
13PA01-046-01	EP1811700	EP	EP-Pending	Communication apparatus, communication system, and communication method	2007/07/25	EP05807089	2005/11/18
13PA01-046-03	EP1811700	FR	EP-Designated	Communication apparatus, communication system, and communication method	2007/07/25	EP05807089	2005/11/18
13PA01-046-04	EP1811700	GB	EP-Designated	Communication apparatus, communication system, and communication method	2007/07/25	EP05807089	2005/11/18

13PA01-046-05	JP4838144	JP	Granted	Communication device, communication system and communication method	2011/12/14	JP2006545166	2005/11/18
13PA01-046-06	US7848439	US	Granted	Communication apparatus, communication system, and communication method	2010/12/07	US11/719611	2005/11/18
13PA01-047-01	BRPI0515242	BR	Pending	Método para a comunicação das informações que estão relacionadas com a programação de transmissão de dados de ligação superior, sistema de comunicação móvel, esta base em um sistema de comunicação móvel, controlador de rede de rádio em um sistema de c	2008/07/15	BRPI0515242	2005/08/31
13PA01-047-02	CN101053272	CN	Granted	Efficient rise over thermal (rot) control during soft handover	2012/05/23	CN200580037780	2005/08/31
13PA01-047-03	DE602004008068	DE	Granted	Effiziente "rise over thermal (rot)" steuerung während eines sanften weiterreichens	2007/11/22	DE602004008068	2004/08/31
13PA01-047-04	DE602004021447	DE	Granted	Effiziente rise-over-thermal-steuerung während eines sanften handovers	2009/07/16	DE602004021447	2004/08/31
13PA01-047-08	EP1631104	FI	Granted	Efficient rise over thermal (rot) control during soft handover	2007/08/08	EP04020647	2004/08/31
13PA01-047-05	EP1631104	FR	Granted	Efficient rise over thermal (rot) control during soft handover	2007/08/08	EP04020647	2004/08/31
13PA01-047-07	EP1631104	GB	Granted	Efficient rise over thermal (rot) control during soft handover	2007/08/08	EP04020647	2004/08/31
13PA01-047-09	EP1631104	IT	Granted	Efficient rise over thermal (rot) control during soft handover	2007/08/08	EP04020647	2004/08/31
13PA01-047-06	EP1631104	SE	Granted	Efficient rise over thermal (rot) control during soft handover	2007/08/08	EP04020647	2004/08/31
13PA01-047-13	EP1838125	FI	Granted	Efficient rise over thermal (rot) control during soft handover	2009/06/03	EP07011278	2004/08/31
13PA01-047-10	EP1838125	FR	Granted	Efficient rise over thermal (rot) control during soft handover	2009/06/03	EP07011278	2004/08/31
13PA01-047-12	EP1838125	GB	Granted	Efficient rise over thermal (rot) control during soft handover	2009/06/03	EP07011278	2004/08/31
13PA01-047-14	EP1838125	IT	Granted	Efficient rise over thermal (rot) control during soft handover	2009/06/03	EP07011278	2004/08/31
13PA01-047-11	EP1838125	SE	Granted	Efficient rise over thermal (rot) control during soft handover	2009/06/03	EP07011278	2004/08/31
13PA01-047-15	ES2291786	ES	Granted	Control eficaz del aumento de sobreexplotacion termica (rot) durante una transferencia flexible.	2008/03/01	ES04020647	2004/08/31
13PA01-047-16	ES2327008	ES	Granted	Control eficiente del rot durante transferencia blanda.	2009/10/22	ES07011278	2004/08/31

13PA01-047-20	IN200700601P2	IN	Granted	Efficient rise over thermal (rot) control during soft handover	2007/07/06	IN601/KOLNP/2007	2007/02/19
13PA01-047-17	JP2007151146	JP	Lapsed	Method for communicating information relating to scheduling of uplink data transmissions, mobile communication system, base station, wireless network controller, and mobile terminal	2007/06/14	JP2006348525	2006/12/25
13PA01-047-18	JP4041531	JP	Granted	The method of communicating the information which it is related to the scheduling of uplink data transmission, the portable communication system, base station, the radio network controller, and the portable terminal	2008/01/30	JP2007512130	2005/08/31
13PA01-047-19	KR20070051353	KR	Lapsed	Efficient rise over thermal(rot) control during soft handover	2007/05/17	KR20077007354	2007/03/30
13PA01-047-21	US8175604	US	Granted	Efficient rise over thermal (rot) control during soft handover	2012/05/08	US10/588073	2005/08/31
13PA01-048-01	CN101103575	CN	Granted	Multi-antenna communication method and multi-antenna communication device	2012/02/01	CN200680002338	2006/01/10
13PA01-048-02	JP4769201	JP	Granted	Multiple antenna communication method and multiple antenna communication device	2011/09/07	JP2006552910	2006/01/10
13PA01-048-03	US7860184	US	Granted	Multi-antenna communication method and multi-antenna communication apparatus	2010/12/28	US11/813650	2006/01/10
13PA01-049-01	CN101283535	CN	Granted	Method for generating and detecting multiple pilot frequencies in multi-antenna communication system	2012/04/04	CN200680037602	2006/11/22
13PA01-049-02	EP1940067	EP	Lapsed	Multi-pilot generation method and detection method in multi-antenna communication system	2008/07/02	EP06823520	2006/11/22
13PA01-049-03	JP4981682	JP	Granted	Multiple pilot formation method and the method of detection in the multiple antenna communication system	2012/07/25	JP2007546481	2006/11/22
13PA01-049-04	US8073070	US	Granted	Multi-pilot generation method and detection method in multi-antenna communication system	2011/12/06	US12/092944	2006/11/22
13PA01-050-01	CN101151832	CN	Lapsed	Communication terminal, base station, and receiving method	2008/03/26	CN200680010719	2006/03/03
13PA01-050-02	EP1855406	EP	Lapsed	Communication terminal, base station, and receiving method	2007/11/14	EP06715227	2006/03/03
13PA01-050-03	JP4914352	JP	Granted	Communication terminal unit and base station device	2012/04/11	JP2007521121	2006/03/03
13PA01-	US8249132	US	Granted	Communication terminal and	2012/08/21	US11/909425	2006/03/03

050-04				receiving method			
13PA01-051-01	CN101411240	CN	Granted	Uplink resource allocation in a mobile communication system	2011/05/25	CN200680054042	2006/11/02
13PA01-051-02	CN102202414	CN	Granted	Uplink resource allocation in a mobile communication system	2011/09/28	CN201110084678	2006/11/02
13PA01-051-04	EP1816883	DE	EP-Designated	Uplink resource allocation in a mobile communication system	2007/08/08	EP06002248	2006/02/03
13PA01-051-03	EP1816883	EP	EP-Pending	Uplink resource allocation in a mobile communication system	2007/08/08	EP06002248	2006/02/03
13PA01-051-07	EP1816883	FI	EP-Designated	Uplink resource allocation in a mobile communication system	2007/08/08	EP06002248	2006/02/03
13PA01-051-05	EP1816883	FR	EP-Designated	Uplink resource allocation in a mobile communication system	2007/08/08	EP06002248	2006/02/03
13PA01-051-06	EP1816883	GB	EP-Designated	Uplink resource allocation in a mobile communication system	2007/08/08	EP06002248	2006/02/03
13PA01-051-08	EP1816883	SE	EP-Designated	Uplink resource allocation in a mobile communication system	2007/08/08	EP06002248	2006/02/03
13PA01-051-10	JP2012157036	JP	Granted	Uplink resource allocation in mobile communication system	2012/08/16	JP2012060156	2012/03/16
13PA01-051-11	JP2012213206	JP	Precursor	Uplink resource allocation in mobile communication system	2012/11/01	JP2012132803	2012/06/12
13PA01-051-09	JP5020263	JP	Granted	Allotment of the uplink resource in the portable communication system	2012/09/05	JP2008552689	2006/11/02
13PA01-051-12	JP5059982	JP	Granted	Uplink resource allocation in mobile communication system	2012/10/31	JP2012132803	2012/06/12
13PA01-051-13	US8576784	US	Granted	Uplink resource allocation in a mobile communication system	2009/05/07	US12/162592	2006/11/02
13PA01-052-02	EP2061170	DE	EP-Designated	Ofdm transmitter and ofdm receiver	2009/05/20	EP06783262	2006/09/11
13PA01-052-01	EP2061170	EP	EP-Pending	Ofdm transmitter and ofdm receiver	2009/05/20	EP06783262	2006/09/11
13PA01-052-03	EP2061170	FR	EP-Designated	Ofdm transmitter and ofdm receiver	2009/05/20	EP06783262	2006/09/11
13PA01-052-04	EP2061170	GB	EP-Designated	Ofdm transmitter and ofdm receiver	2009/05/20	EP06783262	2006/09/11
13PA01-052-05	JP4654298	JP	Granted	Ofdm transmitting device and ofdm receiving device	2011/03/16	JP2008534161	2006/09/11
13PA01-052-06	US8218681	US	Granted	Ofdm transmitter and ofdm receiver	2012/07/10	US12/440894	2009/03/11
13PA01-052-06r	US14/328576	US	Reissuing	Ofdm transmitter and ofdm receiver		US14/328576	2014/07/10
13PA01-053-01	CN101636946	CN	Lapsed	Multicarrier transmitter and multicarrier receiver	2010/01/27	CN200780052347	2007/05/25
13PA01-053-02	EP2151933	EP	Lapsed	Multicarrier transmitter and multicarrier receiver	2010/02/10	EP07744158	2007/05/25
13PA01-053-03	JP5009982	JP	Granted	Multiple carrier transmitting device	2012/08/29	JP2009516088	2007/05/25
13PA01-053-04	US8249178	US	Granted	Multicarrier transmitter and multicarrier receiver	2012/08/21	US12/601804	2007/05/25
13PA01-	CA2127616	CA	Granted	Mobile communication unit	1999/02/09	CA2127616	1994/07/07

054-01							
13PA01-054-03	CN1074875	CN	Granted	Mobile communication unit	2001/11/14	CN94108731	1994/07/16
13PA01-054-02	CN1128555	CN	Granted	Mobile communication unit and method	2003/11/19	CN00135098	2000/12/11
13PA01-054-04	KR0126874	KR	Granted	Mobile communication system	1998/04/01	KR19940017210	1994/07/16
13PA01-054-05	US5583851	US	Granted	Mobile communication apparatus having multi-codes allocating function	1996/12/10	US08/272158	1994/07/08
13PA01-055-01	CA2127672	CA	Granted	Mobile radio system	2000/02/01	CA2127672	1994/07/08
13PA01-055-02	CN1068164	CN	Granted	Mobile radio system	2001/07/04	CN94107859	1994/07/15
13PA01-055-03	JP2942977	JP	Granted	Mobile communication equipment	1999/08/30	JP19901893	1993/07/16
13PA01-055-04	KR960016641	KR	Granted	Mobile communication equipment	1996/12/19	KR19940017085	1994/07/15
13PA01-055-05	US5873027	US	Granted	Mobile radio system with control over radio wave output if a malfunction is detected	1999/02/16	US08/761552	1996/12/06
13PA01-055-06	US6336040	US	Granted	Mobile radio system with control over radio wave output if a malfunction is detected	2002/01/01	US09/207662	1998/12/09
13PA01-056-01	DE69534524	DE	Granted	Verfahren und gerät zur synchronisierung in einem direktsequenzspreizspektrumkommunikationssystem	2005/11/24	DE69534524	1995/08/16
13PA01-056-02	EP0701333	FR	Granted	Synchronisation method and apparatus for a direct sequence spread spectrum communications system	2005/10/19	EP95305717	1995/08/16
13PA01-056-03	EP0701333	GB	Granted	Synchronisation method and apparatus for a direct sequence spread spectrum communications system	2005/10/19	EP95305717	1995/08/16
13PA01-056-04	JP3142222	JP	Granted	Synchronization method and device for spread spectrum communication	2001/03/07	JP13494595	1995/06/01
13PA01-056-05	US5757870	US	Granted	Spread spectrum communication synchronizing method and its circuit	1998/05/26	US08/517408	1995/08/21
13PA01-056-06	US5818869	US	Granted	Spread spectrum communication synchronizing method and its circuit	1998/10/06	US08/858146	1997/05/15
13PA01-057-01	JP2863993	JP	Granted	Cdma radio multiplex sender and cdma radio multiplex transmitter	1999/03/03	JP15585595	1995/06/22
13PA01-057-02	US6175558	US	Granted	Cdma radio multiplex transmitting device and a cdma radio multiplex receiving device	2001/01/16	US09/000947	1997/12/30

13PA01-057-03	US6301237	US	Granted	Cdma radio multiplex transmitting device and a cdma radio multiplex receiving device	2001/10/09	US09/562921	2000/05/02
13PA01-057-05	US6370131	US	Granted	Cdma radio multiplex transmitting device and a cdma radio multiplex receiving device	2002/04/09	US09/576250	2000/05/24
13PA01-057-04	US6529492	US	Granted	Cdma radio multiplex transmitting device and a cdma radio multiplex receiving device	2003/03/04	US09/562922	2000/05/02
13PA01-057-07	US6549526	US	Granted	Cdma radio multiplex transmitting device and a cdma multiplex receiving device	2003/04/15	US09/826005	2001/04/05
13PA01-057-06	US6584088	US	Granted	Cdma radio multiplex transmitting device and cdma radio multiplex receiving device	2003/06/24	US09/825998	2001/04/05
13PA01-057-08	US7136367	US	Granted	Cdma radio multiplex transmitting device and a cdma radio multiplex receiving device	2006/11/14	US10/335916	2003/01/03
13PA01-057-09	USRE41444	US	Granted	Cdma radio multiplex transmitting device and a cdma radio multiplex receiving device	2010/07/20	US12/270499	2008/11/13
13PA01-058-01	CA2246168	CA	Granted	Pn code generating apparatus and mobile radio communication system	2002/11/19	CA2246168	1998/08/31
13PA01-058-02	CA2246168A1	CA	Precursor	Pn code generating apparatus and mobile radio communication system	1999/03/02	CA2246168	1998/08/31
13PA01-058-03	CN100379299	CN	Granted	Pn code producing method and device	2008/04/02	CN02127365	1998/08/27
13PA01-058-04	CN1094019	CN	Granted	Pn code generating device and mobile radio communication system	2002/11/06	CN98118564	1998/08/27
13PA01-058-05	DE69838572	DE	Granted	Pn-kodegenerator	2007/11/29	DE69838572	1998/08/27
13PA01-058-12	EP0901236	FI	Granted	Pn code generator	2007/10/17	EP98116233	1998/08/27
13PA01-058-13	EP0901236	FR	Granted	Pn code generator	2007/10/17	EP98116233	1998/08/27
13PA01-058-14	EP0901236	GB	Granted	Pn code generator	2007/10/17	EP98116233	1998/08/27
13PA01-058-15	EP0901236	SE	Granted	Pn code generator	2007/10/17	EP98116233	1998/08/27
13PA01-058-07	EP1835617	DE	EP-Designated	Pn code generation apparatus and method thereof	2007/10/31	EP07108762	1998/08/27
13PA01-058-06	EP1835617	EP	EP-Pending	Pn code generation apparatus and method thereof	2007/10/31	EP07108762	1998/08/27
13PA01-058-10	EP1835617	FI	EP-Designated	Pn code generation apparatus and method thereof	2007/10/31	EP07108762	1998/08/27
13PA01-058-08	EP1835617	FR	EP-Designated	Pn code generation apparatus and method thereof	2007/10/31	EP07108762	1998/08/27

13PA01-058-09	EP1835617	GB	EP-Designated	Pn code generation apparatus and method thereof	2007/10/31	EP07108762	1998/08/27
13PA01-058-11	EP1835617	SE	EP-Designated	Pn code generation apparatus and method thereof	2007/10/31	EP07108762	1998/08/27
13PA01-058-16	JP3329705	JP	Granted	Pn code generator and mobile radio communication system	2002/09/30	JP25287297	1997/09/02
13PA01-058-17	US6295301	US	Granted	Pn code generating apparatus and mobile radio communication system	2001/09/25	US09/139325	1998/08/25
13PA01-058-18	US6697384	US	Granted	Method and apparatus for calculating a state of starting a pn code generating operation	2004/02/24	US09/916284	2001/07/30
13PA01-059-01	AU8243498	AU	Lapsed	Cdma mobile station and cdma transmission method	1999/02/10	AU8243498	1998/07/16
13PA01-059-02	CA2266104	CA	Granted	Cdma mobile station and cdma transmission method	2003/09/30	CA2266104	1998/07/16
13PA01-059-03	CA2429736	CA	Lapsed	Cdma mobile station apparatus and cdma transmission method	1999/01/28	CA2429736	1998/07/16
13PA01-059-04	CN100442686	CN	Granted	Cdma mobile station equipment and cdma transmitting method	2008/12/10	CN03108352	1998/07/16
13PA01-059-05	CN1109476	CN	Granted	Cdma mobile station apparatus and cdma transmission method	2003/05/21	CN98801017	1998/07/16
13PA01-059-06	DE69831726	DE	Granted	Cdma mobile station und cdma Übertragungsverfahren	2006/02/09	DE69831726	1998/07/16
13PA01-059-07	EP0936831	FR	Granted	Cdma mobile station and cdma transmission method	2005/09/28	EP98932553	1998/07/16
13PA01-059-08	EP0936831	GB	Granted	Cdma mobile station and cdma transmission method	2005/09/28	EP98932553	1998/07/16
13PA01-059-09	EP0936831	IT	Granted	Cdma mobile station and cdma transmission method	2005/09/28	EP98932553	1998/07/16
13PA01-059-10	EP0936831	NL	Granted	Cdma mobile station and cdma transmission method	2005/09/28	EP98932553	1998/07/16
13PA01-059-11	ES2251091	ES	Granted	Estacion movil cdma y procedimiento de transmision cdma.	2006/04/16	ES98932553	1998/07/16
13PA01-059-12	JP3655057	JP	Granted	Cdma mobile transmitting device and transmitting method using the device	2005/06/02	JP20964297	1997/07/19
13PA01-059-14	US20030007472	US	Lapsed	Cdma mobile station apparatus and cdma transmission method	2003/01/09	US10/235918	2002/09/06
13PA01-059-13	US6466563	US	Granted	Cdma mobile station and cdma transmission method	2002/10/15	US09/147831	1999/03/16
13PA01-060-02	CN100353693	CN	Granted	Cdma radio communication apparatus	2007/12/05	CN200410059002	1998/07/17
13PA01-060-03	CN1113497	CN	Granted	Radio communication terminal apparatus	2003/07/02	CN98116336	1998/07/17
13PA01-060-01	CN1167219	CN	Granted	Cdma radio communication equipment	2004/09/15	CN02102800	1998/07/17
13PA01-060-04	DE69825370	DE	Granted	Cdma funknachrichtenÜbertragungsgesamt	2004/09/09	DE69825370	1998/07/15

13PA01-060-05	DE69839197	DE	Granted	Synchronisationsverfahren in einem kodemultiplexvielfachzugriffssystem	2008/04/10	DE69839197	1998/07/15
13PA01-060-15	EP0892503	FR	Granted	Cdma radio communication apparatus	2005/01/05	EP98113191	1998/07/15
13PA01-060-16	EP0892503	GB	Granted	Cdma radio communication apparatus	2005/01/05	EP98113191	1998/07/15
13PA01-060-17	EP0892503	IT	Granted	Cdma radio communication apparatus	2005/01/05	EP98113191	1998/07/15
13PA01-060-06	EP1447918	FR	Granted	A synchronization method for a cdma system	2008/02/27	EP04012123	1998/07/15
13PA01-060-07	EP1447918	GB	Granted	A synchronization method for a cdma system	2008/02/27	EP04012123	1998/07/15
13PA01-060-08	EP1447918	IT	Granted	A synchronization method for a cdma system	2008/02/27	EP04012123	1998/07/15
13PA01-060-10	EP1914904	DE	EP-Designated	A cdma radio communication system and a transmission apparatus for such a system	2008/04/23	EP08100709 (DE69843248)	1998/07/15
13PA01-060-09	EP1914904	EP	EP-Pending	A cdma radio communication system and a transmission apparatus for such a system	2008/04/23	EP08100709	1998/07/15
13PA01-060-13	EP1914904	ES	EP-Designated	A cdma radio communication system and a transmission apparatus for such a system	2008/04/23	EP08100709	1998/07/15
13PA01-060-11	EP1914904	FR	EP-Designated	A cdma radio communication system and a transmission apparatus for such a system	2008/04/23	EP08100709	1998/07/15
13PA01-060-12	EP1914904	GB	EP-Designated	A cdma radio communication system and a transmission apparatus for such a system	2008/04/23	EP08100709	1998/07/15
13PA01-060-14	EP1914904	IT	EP-Designated	A cdma radio communication system and a transmission apparatus for such a system	2008/04/23	EP08100709	1998/07/15
13PA01-060-19	ES2226037	ES	Granted	Aparato de comunicacion por radio cdma.	2005/03/16	ES98113191	1998/07/15
13PA01-060-18	ES2301896	ES	Granted	Procedimiento de sincronizacion para un sistema cdma.	2008/07/01	ES04012123	1998/07/15
13PA01-060-20	US6370134	US	Granted	Cdma radio communication apparatus	2002/04/09	US09/115502	1998/07/15
13PA01-060-21	US7035233	US	Granted	Radio communication terminal apparatus and radio communication base station apparatus	2006/04/25	US10/014352	2001/12/14
13PA01-060-22	US7535864	US	Granted	Radio communication terminal apparatus and radio communication base station apparatus	2009/05/19	US11/372152	2006/03/10
13PA01-061-01	CA2127606	CA	Granted	Code-division multiple-access mobile telephone system	2001/12/18	CA2127606	1994/07/07
13PA01-061-02	CN1075911	CN	Granted	Automobile on-board and/or portable telephone system	2001/12/05	CN94108729	1994/07/16

13PA01-061-03	CN1102022	CN	Granted	Automobile on-board and/or portable telephone system	1995/04/26	CN94108729	1994/07/16
13PA01-061-04	JP2863975	JP	Granted	Automobile-portable telephone system	1999/03/03	JP19901393	1993/07/16
13PA01-061-05	KR0126628	KR	Granted	Mobile communications system	1998/04/03	KR19940017209	1994/07/16
13PA01-061-06	US5677929	US	Reissue-Surrendered	Automobile on-board and/or portable telephone system	1997/10/14	US08/272156	1994/07/08
13PA01-061-07	USRE37420	US	Granted	Automobile on-board and/or portable telephone system	2001/10/23	US09/337403	1999/06/21
13PA01-061-08	USRE39954	US	Granted	Automobile on-board and/or portable telephone system	2007/12/25	US09/887042	2001/06/25
13PA01-062-02	CN100364247	CN	Granted	Method for controlling transmission power	2008/01/23	CN200410045794	2001/06/25
13PA01-062-01	CN1158790	CN	Granted	Communication terminal apparatus	2004/07/21	CN01802160	2001/06/25
13PA01-062-03	DE60110020	DE	Granted	KommunikationsendgerÄ„t	2005/09/08	DE60110020	2001/06/25
13PA01-062-04	DE60116907	DE	Granted	KommunikationsendgerÄ„t	2006/07/20	DE60116907	2001/06/25
13PA01-062-11	DE60147140	DE	Granted	Communication terminal apparatus	2012/09/19	EP05025574	2001/06/25
13PA01-062-05	EP1204225	FR	Granted	Communication terminal apparatus	2005/04/13	EP01941209	2001/06/25
13PA01-062-06	EP1204225	GB	Granted	Communication terminal apparatus	2005/04/13	EP01941209	2001/06/25
13PA01-062-07	EP1523111	FR	Granted	Communication terminal apparatus	2006/01/25	EP05000430	2001/06/25
13PA01-062-08	EP1523111	GB	Granted	Communication terminal apparatus	2006/01/25	EP05000430	2001/06/25
13PA01-062-09	EP1630972	FR	Granted	Communication terminal apparatus	2012/09/19	EP05025574	2001/06/25
13PA01-062-10	EP1630972	GB	Granted	Communication terminal apparatus	2012/09/19	EP05025574	2001/06/25
13PA01-062-14	JP2003298510	JP	Lapsed	Method for controlling transmission power	2003/10/17	JP2003064021	2003/03/10
13PA01-062-12	JP3426194	JP	Granted	Base station device, communication terminal device, and communication method	2003/07/14	JP2000231256	2000/07/31
13PA01-062-15	JP4431189	JP	Granted	Radio communication device, radio communication method, and radio communication system	2010/03/10	JP2009197228	2009/08/27
13PA01-062-16	JP4431190	JP	Granted	Radio communication device, radio communication method, and radio communication system	2010/03/10	JP2009197229	2009/08/27
13PA01-062-17	JP4431191	JP	Granted	Radio communication system and radio communication method	2010/03/10	JP2009197230	2009/08/27
13PA01-062-13	JP4511783	JP	Granted	Base station equipment, communication terminal unit,	2010/07/28	JP2002367259	2002/12/18

				and communication method			
13PA01-062-19	US20030087644	US	Lapsed	Communication terminal apparatus and base station apparatus	2003/05/08	US10/322425	2002/12/19
13PA01-062-20	US20060121930	US	Precursor	Communication terminal apparatus and base station apparatus	2006/06/08	US11/341430	2006/01/30
13PA01-062-22	US20080261545	US	Precursor	Communication terminal apparatus and base station apparatus	2008/10/23	US12/132992	2008/06/04
13PA01-062-18	US6738646	US	Granted	Base station device and method for communication	2004/05/18	US10/069267	2002/02/25
13PA01-062-21	US7460880	US	Granted	Communication terminal apparatus and base station apparatus	2008/12/02	US11/341430	2006/01/30
13PA01-062-23	US7761113	US	Granted	Communication terminal apparatus and base station apparatus	2010/07/20	US12/132992	2008/06/04
13PA01-063-01	AU7769801	AU	Lapsed	Communication terminal, base station device, and radio communication method	2002/02/18	AU2001277698	2001/08/02
13PA01-063-02	CN100469169	CN	Granted	Communication terminal device and radio communication method	2009/03/11	CN01802181	2001/08/02
13PA01-063-03	CN1386388	CN	Granted	Communication terminal, base station device, and radio communication method	2002/12/18	CN01802181	2001/08/02
13PA01-063-04	DE60134208	DE	Granted	Nkkommunikationsverfahren	2008/07/10	DE60134208	2001/08/02
13PA01-063-05	EP1217861	FR	Granted	Communication terminal, base station device, and radio communication method	2008/05/28	EP01955557	2001/08/02
13PA01-063-06	EP1217861	GB	Granted	Communication terminal, base station device, and radio communication method	2008/05/28	EP01955557	2001/08/02
13PA01-063-08	EP1976141	DE	EP-Designated	Communication terminal apparatus, base station apparatus, and radio communication method	2008/10/01	EP08004604	2001/08/02
13PA01-063-07	EP1976141	EP	EP-Pending	Communication terminal apparatus, base station apparatus, and radio communication method	2008/10/01	EP08004604	2001/08/02
13PA01-063-09	EP1976141	FR	EP-Designated	Communication terminal apparatus, base station apparatus, and radio communication method	2008/10/01	EP08004604	2001/08/02
13PA01-063-10	EP1976141	GB	EP-Designated	Communication terminal apparatus, base station apparatus, and radio communication method	2008/10/01	EP08004604	2001/08/02

13PA01-063-13	JP2003224516	JP	Granted	Communication terminal apparatus, base station apparatus and radio communication method	2003/08/08	JP2002367213	2002/12/18
13PA01-063-12	JP2003224888	JP	Non-applicable	Communication terminal	2003/08/08	JP2002367212	2002/12/18
13PA01-063-14	JP2009284537	JP	Granted	Transmission method, receiving method, and radio communication method	2009/12/03	JP2009197375	2009/08/27
13PA01-063-11	JP3426200	JP	Granted	Communication terminal device, base station device and radio communication method	2003/07/14	JP2000285405	2000/09/20
13PA01-063-15	JP4536821	JP	Granted	Transmission apparatus, receiving apparatus and wireless communication system	2010/09/01	JP2009197376	2009/08/27
13PA01-063-16	US6760590	US	Granted	Communication terminal apparatus, base station apparatus, and radio communication method	2004/07/06	US10/089605	2002/04/01
13PA01-063-17	US6799053	US	Granted	Communication terminal apparatus	2004/09/28	US10/321500	2002/12/18
13PA01-063-18	US7206587	US	Granted	Communication terminal apparatus, base station apparatus, and radio communication method	2007/04/17	US10/321623	2002/12/18

Unique ID	Patent Number	Country	Portfolio Status	Title	Issue / Publication Date	Application Number	Filing Date
14NC01-001-01	CN1262139	CN	Granted	SERVICE & OTHER INFORMATION TRANSFER FROM E.G. VISITED NETWORK TO HOME NETWORK INR00 REFERENCE ARCHITECTURE	2006/06/28	CN00819795.4	2000/08/10
14NC01-001-02	DE60023359	DE	Granted	SERVICE & OTHER INFORMATION TRANSFER FROM E.G. VISITED NETWORK TO HOME NETWORK INR00 REFERENCE ARCHITECTURE	2006/07/06	EP00956419.6	2000/08/10
14NC01-001-03	FR1310129	FR	Granted	SERVICE & OTHER INFORMATION TRANSFER FROM E.G. VISITED NETWORK TO HOME NETWORK INR00 REFERENCE ARCHITECTURE	2005/10/19	EP00956419.6	2000/08/10
14NC01-001-04	GB1310129	GB	Granted	SERVICE & OTHER INFORMATION TRANSFER FROM E.G. VISITED NETWORK TO HOME NETWORK INR00 REFERENCE ARCHITECTURE	2005/10/19	EP00956419.6	2000/08/10
14NC01-001-05	KR693394	KR	Granted	SERVICE & OTHER INFORMATION TRANSFER FROM E.G. VISITED NETWORK TO HOME NETWORK INR00 REFERENCE ARCHITECTURE	2007/03/12	KR7001821/2003	2000/08/10
14NC01-001-08	PCT/EP00/07779	WO	Precursor			PCT/EP00/07779	2000/08/10
14NC01-001-06	RU2262213	RU	Granted	SERVICE & OTHER INFORMATION TRANSFER FROM E.G. VISITED NETWORK TO HOME NETWORK INR00 REFERENCE ARCHITECTURE	2005/10/10	RU2003103593	2000/08/10
14NC01-001-07	US7925762	US	Granted	SERVICE & OTHER INFORMATION TRANSFER FROM E.G. VISITED NETWORK TO HOME NETWORK INR00 REFERENCE ARCHITECTURE	2011/04/12	US10/343707	2000/08/10
14NC01-002-02	CN100473217	CN	Granted	Communication network system and network device thereof and method of providing communication	2009/03/25	CN01817056	2001/10/09
14NC01-002-04	PCT/EP00/09886	WO	Precursor			PCT/EP00/09886	2000/10/09
14NC01-002-03	PCT/EP01/11656	WO	Precursor			PCT/EP01/11656	2001/10/09
14NC01-002-01	US7623529	US	Granted	NETWORK INITIATED DEREGISTRATION FROM IP MULTIMEDIA SERVICES	2009/11/24	US10/398575	2001/10/09
14NC01-003-01	AT1346558	AT	Granted	PREPAID SERVER	2007/08/15	EP00987457.9	2000/12/22
14NC01-003-02	BRPI0017382	BR	Pending	PREPAID SERVER	2003/10/21	BRPI0017382.7	2000/12/22
14NC01-003-03	CA2428329	CA	Granted	PREPAID SERVER	2007/05/29	CA2428329	2000/12/22
14NC01-003-04	CH1346558	CH	Granted	PREPAID SERVER	2007/07/11	EP00987457.9	2000/12/22

14NC01-003-05	CN1279741	CN	Granted	PREPAID SERVER	2007/07/11	CN00820083.1	2000/12/22
14NC01-003-06	DE60035531	DE	Granted	PREPAID SERVER	2007/07/11	EP00987457.9	2000/12/22
14NC01-003-07	ES1346558	ES	Granted	PREPAID SERVER	2008/01/16	EP00987457.9	2000/12/22
14NC01-003-08	FR1346558	FR	Granted	PREPAID SERVER	2007/07/11	EP00987457.9	2000/12/22
14NC01-003-09	GB1346558	GB	Granted	PREPAID SERVER	2007/07/11	EP00987457.9	2000/12/22
14NC01-003-10	IT1346558	IT	Granted	PREPAID SERVER	2007/07/11	EP00987457.9	2000/12/22
14NC01-003-11	NL1346558	NL	Granted	PREPAID SERVER	2007/07/11	EP00987457.9	2000/12/22
14NC01-003-16	PCT/EP00/013248	WO	Precursor			PCT/EP00/013248	2000/12/22
14NC01-003-12	SE1346558	SE	Granted	PREPAID SERVER	2007/07/11	EP00987457.9	2000/12/22
14NC01-003-13	TR200706776T4	TR	Granted	PREPAID SERVER	2007/07/11	TR00987457.9	2000/12/22
14NC01-003-14	US11/448122	US	Not owned by INVT	PREPAID SERVER		US11/448122	2006/06/07
14NC01-003-15	US7065339	US	Granted	PREPAID SERVER	2006/06/20	US10/451236	2000/12/22
14NC01-004-01	DE60109066	DE	Granted	MULTIPLEXING SIP CALL CONTROL CONTENT OVER SUCCESSIVE SIP MESSAGES	2006/04/13	EP01929406.5	2001/03/05
14NC01-004-02	GB1368946	GB	Granted	MULTIPLEXING SIP CALL CONTROL CONTENT OVER SUCCESSIVE SIP MESSAGES	2005/02/23	EP01929406.5	2001/03/05
14NC01-004-04	PCT/EP01/02473	WO	Precursor			PCT/EP01/02473	2001/03/05
14NC01-004-03	US7991894	US	Granted	MULTIPLEXING SIP CALL CONTROL CONTENT OVER SUCCESSIVE SIP MESSAGES	2011/08/02	US10/469787	2001/03/05
14NC01-005-02	PCT/EP01/06517	WO	Precursor			PCT/EP01/06517	2002/12/20
14NC01-005-01	US7304966	US	Granted	Accessing ip multimedia subsystem	2007/12/04	US10/479457	2003/12/02
14NC01-006-02	PCT/IB02/04029	WO	Precursor			PCT/IB02/04029	2002/01/10
14NC01-006-01	US6888828	US	Granted	SERVICE EXECUTION SERVER CHAINING	2005/05/03	US09/967927	2001/10/02
14NC01-007-01	DE60046674	DE	Granted	AN INTER-WORKING UNIT (GATEWAY) BETWEEN AAL2 (ATM) BASED RAN AND RTP MULTIPLEXING (IP) BASED RAN IN 3G CELLULAR ACCESS NETWORKS	2011/11/16	EP00965599.4	2000/08/09
14NC01-007-02	JP2003507936	JP	Lapsed	AN INTER-WORKING UNIT (GATEWAY) BETWEEN AAL2 (ATM) BASED RAN AND RTP MULTIPLEXING	2003/02/25	JP2001-517771	2000/08/09

				(IP) BASED RAN IN 3G CELLULAR ACCESS NETWORKS			
14NC01-007-04	PCT/US00/40606	WO	Precursor			PCT/US00/40606	2000/09/08
14NC01-007-03	US6801542	US	Granted	AN INTER-WORKING UNIT (GATEWAY) BETWEEN AAL2 (ATM) BASED RAN AND RTP MULTIPLEXING (IP) BASED RAN IN 3G CELLULAR ACCESS NETWORKS	2004/10/05	US09/377263	1999/08/19
14NC01-008-01	BRPI0614221	BR	Pending	EXTENDING <STATUS> PRESENCE ATTRIBUTE TO DEFINE REASONING FOR AVAILABILITY CHANGE	2011/03/15	BRPI0614221.4	2006/07/11
14NC01-008-02	CN101223756B	CN	Granted	EXTENDING <STATUS> PRESENCE ATTRIBUTE TO DEFINE REASONING FOR AVAILABILITY CHANGE	2011/11/30	CN200680025371.9	2006/07/11
14NC01-008-13	EP1905212	DE	Granted	EXTENDING <STATUS> PRESENCE ATTRIBUTE TO DEFINE REASONING FOR AVAILABILITY CHANGE	2011/04/20	EP06795099.8	2006/07/11
14NC01-008-03	EP1905212	EP	PreCursor (EP)	EXTENDING <STATUS> PRESENCE ATTRIBUTE TO DEFINE REASONING FOR AVAILABILITY CHANGE	2011/04/20	EP06795099.8	2006/07/11
14NC01-008-14	EP1905212	FR	Granted	EXTENDING <STATUS> PRESENCE ATTRIBUTE TO DEFINE REASONING FOR AVAILABILITY CHANGE	2011/04/20	EP06795099.8	2006/07/11
14NC01-008-15	EP1905212	GB	Granted	EXTENDING <STATUS> PRESENCE ATTRIBUTE TO DEFINE REASONING FOR AVAILABILITY CHANGE	2011/04/20	EP06795099.8	2006/07/11
14NC01-008-04	IDW00200800123	ID	Pending	EXTENDING <STATUS> PRESENCE ATTRIBUTE TO DEFINE REASONING FOR AVAILABILITY CHANGE	2007/01/18	IDW00200800123	2006/07/11
14NC01-008-05	KR1026155	KR	Granted	EXTENDING <STATUS> PRESENCE ATTRIBUTE TO DEFINE REASONING FOR AVAILABILITY CHANGE	2011/04/05	KR2008-7003214	2006/07/11
14NC01-008-06	MX282232	MX	Granted	EXTENDING <STATUS> PRESENCE ATTRIBUTE TO DEFINE REASONING FOR AVAILABILITY CHANGE	2008/03/14	MXMX/a/2008/000568	2006/07/11
14NC01-008-16	PCT/IB06/001915	WO	Precursor			PCT/IB06/001915	2006/07/11
14NC01-008-07	PH1-2007-502943	PH	Granted	EXTENDING <STATUS> PRESENCE ATTRIBUTE TO DEFINE REASONING FOR AVAILABILITY CHANGE	2007/01/18	PH1-2007-502943	2006/07/11
14NC01-008-08	RU2384004	RU	Granted	EXTENDING <STATUS> PRESENCE ATTRIBUTE TO DEFINE REASONING FOR AVAILABILITY CHANGE	2010/03/10	RU2008100148	2006/07/11
14NC01-008-09	SG139065	SG	Granted	EXTENDING <STATUS> PRESENCE ATTRIBUTE TO DEFINE REASONING FOR AVAILABILITY CHANGE	2011/04/15	SG200800268.5	2006/07/11
14NC01-008-10	US8681751	US	Granted	EXTENDING <STATUS> PRESENCE ATTRIBUTE TO DEFINE REASONING FOR AVAILABILITY CHANGE	2014/03/25	US11/348896	2006/02/07
14NC01-008-11	VN1-2008-00326	VN	Pending	EXTENDING <STATUS> PRESENCE ATTRIBUTE TO DEFINE REASONING	2007/04/05	VN1-2008-00326	2006/07/11

				FOR AVAILABILITY CHANGE			
14NC01-008-12	ZA200800233	ZA	Granted	EXTENDING <STATUS> PRESENCE ATTRIBUTE TO DEFINE REASONING FOR AVAILABILITY CHANGE	2008/12/31	ZA2008/0233	2006/07/11
14NC01-009-01	EP1338152	FR	Granted	3RD GEN MOBILITY USING SIP	2008/11/19	EP1338152	2001/11/21
14NC01-009-03	PCT/IB01/02196	WO	Precursor			PCT/IB01/02196	2001/11/21
14NC01-009-02	US6904035	US	Granted	3RD GEN MOBILITY USING SIP	2005/06/07	US09/991540	2001/11/14
14NC01-010-01	CN1539106	CN	Granted	THREE-PARTY AUTHENTICATION AND AUTHORIZATION SCHEME FOR INTERNET PROTOCLVERSION 6.	2010/05/12	CN02815394.4	2002/07/11
14NC01-010-04	EP1415212	DE	EP-Designated	THREE-PARTY AUTHENTICATION AND AUTHORIZATION SCHEME FOR INTERNET PROTOCLVERSION 6.	2009/12/09	EP02749143.0	2002/07/11
14NC01-010-02	EP1415212	EP	EP-Pending	THREE-PARTY AUTHENTICATION AND AUTHORIZATION SCHEME FOR INTERNET PROTOCLVERSION 6.	2009/12/09	EP02749143.0	2002/07/11
14NC01-010-05	EP1415212	FR	EP-Designated	THREE-PARTY AUTHENTICATION AND AUTHORIZATION SCHEME FOR INTERNET PROTOCLVERSION 6.	2009/12/09	EP02749143.0	2002/07/11
14NC01-010-06	EP1415212	GB	EP-Designated	THREE-PARTY AUTHENTICATION AND AUTHORIZATION SCHEME FOR INTERNET PROTOCLVERSION 6.	2009/12/09	EP02749143.0	2002/07/11
14NC01-010-07	PCT/IB02/02702	WO	Precursor			PCT/IB02/02702	2002/07/11
14NC01-010-03	US7900242	US	Granted	THREE-PARTY AUTHENTICATION AND AUTHORIZATION SCHEME FOR INTERNET PROTOCLVERSION 6.	2011/03/01	US10/192753	2002/07/09
14NC01-011-01	CN100571461	CN	Granted	EXTENDING THE TRUSTED NETWORK CONCEPT IN IMS	2009/12/16	CN200480000385.6	2004/02/17
14NC01-011-07	EP1595418	DE	EP-Designated	EXTENDING THE TRUSTED NETWORK CONCEPT IN IMS	2005/11/16	EP04711676.9	2004/02/17
14NC01-011-02	EP1595418	EP	EP-Pending	EXTENDING THE TRUSTED NETWORK CONCEPT IN IMS	2005/11/16	EP04711676.9	2004/02/17
14NC01-011-08	EP1595418	FR	EP-Designated	EXTENDING THE TRUSTED NETWORK CONCEPT IN IMS	2005/11/16	EP04711676.9	2004/02/17
14NC01-011-09	EP1595418	GB	EP-Designated	EXTENDING THE TRUSTED NETWORK CONCEPT IN IMS	2005/11/16	EP04711676.9	2004/02/17
14NC01-011-03	IDP0030947	ID	Granted	EXTENDING THE TRUSTED NETWORK CONCEPT IN IMS	2004/09/02	IDW00200501937	2004/02/17
14NC01-011-04	IN200403049	IN	Pending	EXTENDING THE TRUSTED NETWORK CONCEPT IN IMS	2006/02/17	IN03049/CHENP/2004	2004/02/17
14NC01-011-10	PCT/IB04/000551	WO	Precursor			PCT/IB04/000551	2004/02/17
14NC01-011-05	SG115865	SG	Granted	EXTENDING THE TRUSTED NETWORK CONCEPT IN IMS	2007/08/31	SG200406163.6	2004/02/17

14NC01-011-06	US7917620	US	Granted	EXTENDING THE TRUSTED NETWORK CONCEPT IN IMS	2011/03/29	US10/614343	2003/07/08
14NC01-012-01	AU2005232140	AU	Granted	SESSION PROGRESS INDICATION IN POC FOR MANUAL ANSWER MODE	2009/10/01	AU2005232140	2005/03/17
14NC01-012-02	CN1961595	CN	Granted	SESSION PROGRESS INDICATION IN POC FOR MANUAL ANSWER MODE	2011/12/21	CN200580017529.3	2005/03/17
14NC01-012-03	IN200605988	IN	Pending	SESSION PROGRESS INDICATION IN POC FOR MANUAL ANSWER MODE	2007/08/24	IN5988/DELNP/2006	2005/03/17
14NC01-012-04	KR0924513	KR	Granted	SESSION PROGRESS INDICATION IN POC FOR MANUAL ANSWER MODE	2009/11/02	KR2006-7023181	2005/03/17
14NC01-012-05	PCT/IB05/000694	WO	Precursor			PCT/IB05/000694	2005/03/17
14NC01-013-01	CN101385313	CN	Granted	IMS-CS INTERWORKING FOR VIDEO CALLS	2012/09/05	CN200780005866.X	2007/01/22
14NC01-013-02	DE602007033333	DE	Granted	IMS-CS INTERWORKING FOR VIDEO CALLS	2013/10/16	EP07700656.7	2007/01/22
14NC01-013-10	EP1987649	CH	Granted	IMS-CS INTERWORKING FOR VIDEO CALLS	2013/10/16	EP07700656.7	2007/01/22
14NC01-013-03	EP1987649	EP	Precursor(EP)	IMS-CS INTERWORKING FOR VIDEO CALLS	2013/10/16	EP07700656.7	2007/01/22
14NC01-013-12	EP1987649	FR	Granted	IMS-CS INTERWORKING FOR VIDEO CALLS	2013/10/16	EP07700656.7	2007/01/22
14NC01-013-04	EP1987649	GB	Granted	IMS-CS INTERWORKING FOR VIDEO CALLS	2013/10/16	EP07700656.7	2007/01/22
14NC01-013-11	EP1987649	IE	Granted	IMS-CS INTERWORKING FOR VIDEO CALLS	2013/10/16	EP07700656.7	2007/01/22
14NC01-013-14	EP1987649	LI	Granted	IMS-CS INTERWORKING FOR VIDEO CALLS	2013/10/16	EP07700656.7	2007/01/22
14NC01-013-13	EP1987649	LU	Granted	IMS-CS INTERWORKING FOR VIDEO CALLS	2013/10/16	EP07700656.7	2007/01/22
14NC01-013-06	EP1987649	NL	Granted	IMS-CS INTERWORKING FOR VIDEO CALLS	2013/10/16	EP07700656.7	2007/01/22
14NC01-013-05	IN200806684	IN	Pending	IMS-CS INTERWORKING FOR VIDEO CALLS	2008/10/24	IN6684/DELNP/2008	2007/01/22
14NC01-013-16	PCT/IB07/050209	WO	Precursor			PCT/IB07/050209	2007/01/22
14NC01-013-15	RU2408998	RU	Granted	IMS-CS INTERWORKING FOR VIDEO CALLS		RU2008132295A	2007/01/22
14NC01-013-07	SG145112	SG	Granted	IMS-CS INTERWORKING FOR VIDEO CALLS	2008/09/29	SG200805775.4	2007/01/22
14NC01-013-08	TH0701000284	TH	Pending	IMS-CS INTERWORKING FOR VIDEO CALLS	2007/11/15	TH0701000284	2007/01/23
14NC01-013-09	US7860102	US	Granted	IMS-CS INTERWORKING FOR VIDEO CALLS	2010/12/28	US11/508258	2006/08/23
14NC01-014-01	CN101444062	CN	Granted	CARRYING TRUSTED NETWORK PROVIDED ACCESS NETWORK INFO IN SIP	2012/03/21	CN200780010857.X	2007/03/27
14NC01-014-04	EP1999929	DE	EP-Designated	CARRYING TRUSTED NETWORK PROVIDED ACCESS NETWORK INFO IN SIP	2008/12/10	EP7734087.5	2007/03/26
14NC01-014-02	EP1999929	EP	EP-Pending	CARRYING TRUSTED NETWORK PROVIDED ACCESS NETWORK INFO	2008/12/10	EP7734087.5	2007/03/26

				IN SIP			
14NC01-014-05	EP1999929	FR	EP-Designated	CARRYING TRUSTED NETWORK PROVIDED ACCESS NETWORK INFO IN SIP	2008/12/10	EP7734087.5	2007/03/26
14NC01-014-06	EP1999929	GB	EP-Designated	CARRYING TRUSTED NETWORK PROVIDED ACCESS NETWORK INFO IN SIP	2008/12/10	EP7734087.5	2007/03/26
14NC01-014-07	PCT/IB07/000758	WO	Precursor			PCT/IB07/000758	2007/03/26
14NC01-014-03	US20080039085	US	Pending	CARRYING TRUSTED NETWORK PROVIDED ACCESS NETWORK INFO IN SIP	2008/02/14	US11/691417	2007/03/26
14NC01-015-01	CN101523858	CN	Pending	DHT-BASED CORE IMS NETWORK	2014/03/26	CN200780038286.0	2007/09/11
14NC01-015-04	EP2062422	DE	EP-Designated	DHT-BASED CORE IMS NETWORK	2014/03/26	EP07803743.9	2007/09/11
14NC01-015-02	EP2062422	EP	EP-Pending	DHT-BASED CORE IMS NETWORK	2014/03/26	EP07803743.9	2007/09/11
14NC01-015-05	EP2062422	FR	EP-Designated	DHT-BASED CORE IMS NETWORK	2014/03/26	EP07803743.9	2007/09/11
14NC01-015-06	EP2062422	GB	EP-Designated	DHT-BASED CORE IMS NETWORK	2014/03/26	EP07803743.9	2007/09/11
14NC01-015-07	PCT/FI07/050482	WO	Precursor			PCT/FI07/050482	2007/09/11
14NC01-015-03	US7796990	US	Granted	DHT-BASED CORE IMS NETWORK	2010/09/14	US11/520655	2006/09/14
14NC01-016-01	US7822035	US	Granted	SIP COMMUNICATION SERVICE IDENTIFIERS	2010/10/26	US11/715209	2007/03/07



UNITED STATES PATENT AND TRADEMARK OFFICE

UNITED STATES DEPARTMENT OF COMMERCE
United States Patent and Trademark Office
Address: COMMISSIONER FOR PATENTS
P.O. Box 1450
Alexandria, Virginia 22313-1450
www.uspto.gov

APPLICATION NUMBER	FILING OR 371(C) DATE	FIRST NAMED APPLICANT	ATTY. DOCKET NO./TITLE
11/719,611	05/17/2007	Xiaoming She	L9289.07161

CONFIRMATION NO. 9253

POA ACCEPTANCE LETTER



22913
Workman Nydegger
60 East South Temple
Suite 1000
Salt Lake City, UT 84111

Date Mailed: 05/06/2014

NOTICE OF ACCEPTANCE OF POWER OF ATTORNEY

This is in response to the Power of Attorney filed 04/29/2014.

The Power of Attorney in this application is accepted. Correspondence in this application will be mailed to the above address as provided by 37 CFR 1.33.

/tkim/

Office of Data Management, Application Assistance Unit (571) 272-4000, or (571) 272-4200, or 1-888-786-0101



UNITED STATES PATENT AND TRADEMARK OFFICE

UNITED STATES DEPARTMENT OF COMMERCE
United States Patent and Trademark Office
Address: COMMISSIONER FOR PATENTS
P.O. Box 1450
Alexandria, Virginia 22313-1450
www.uspto.gov

APPLICATION NUMBER	FILING OR 371(C) DATE	FIRST NAMED APPLICANT	ATTY. DOCKET NO./TITLE
11/719,611	05/17/2007	Xiaoming She	L9289.07161

CONFIRMATION NO. 9253

POWER OF ATTORNEY NOTICE



52989
James Edward Ledbetter
1875 Eye Street
Suite 1200
Washington, DC 20006

Date Mailed: 05/06/2014

NOTICE REGARDING CHANGE OF POWER OF ATTORNEY

This is in response to the Power of Attorney filed 04/29/2014.

- The Power of Attorney to you in this application has been revoked by the assignee who has intervened as provided by 37 CFR 3.71. Future correspondence will be mailed to the new address of record(37 CFR 1.33).

/tkim/

Office of Data Management, Application Assistance Unit (571) 272-4000, or (571) 272-4200, or 1-888-786-0101

Under the Paperwork Reduction Act of 1995, no persons are required to respond to a collection of information unless it displays a valid OMB control number.

POWER OF ATTORNEY TO PROSECUTE APPLICATIONS BEFORE THE USPTO

I hereby revoke all previous powers of attorney given in the application identified in the attached statement under 37 CFR 3.73(b).

I hereby appoint:

 Practitioners associated with the Customer Number:

22913

OR

 Practitioner(s) named below (if more than ten patent practitioners are to be named, then a customer number must be used):

Name	Registration Number	Name	Registration Number

as attorney(s) or agent(s) to represent the undersigned before the United States Patent and Trademark Office (USPTO) in connection with any and all patent applications assigned only to the undersigned according to the USPTO assignment records or assignment documents attached to this form in accordance with 37 CFR 3.73(b).

Please change the correspondence address for the application identified in the attached statement under 37 CFR 3.73(b) to:

 The address associated with Customer Number:

22913

OR

<input type="checkbox"/> Firm or Individual Name			
Address			
City	State	Zip	
Country			
Telephone	Email		

Assignee Name and Address:

Inventergy, Inc.
19925 Stevens Creek Blvd, Suite 100
Cupertino, California 95014

A copy of this form, together with a statement under 37 CFR 3.73(b) (Form PTO/SB/98 or equivalent) is required to be filed in each application in which this form is used. The statement under 37 CFR 3.73(b) may be completed by one of the practitioners appointed in this form if the appointed practitioner is authorized to act on behalf of the assignee, and must identify the application in which this Power of Attorney is to be filed.

SIGNATURE of Assignee of Record

The individual whose signature and title is supplied below is authorized to act on behalf of the assignee

Signature	<i>Paul C. Roberts</i> Reg # 40289	Date	11/19/2013
Name	Paul Roberts	Telephone	408-973-7896
Title	Vice President, IP Licensing		

This collection of information is required by 37 CFR 1.31, 1.32 and 1.33. The information is required to obtain or retain a benefit by the public which is to file (and by the USPTO to process) an application. Confidentiality is governed by 35 U.S.C. 422 and 37 CFR 1.11 and 1.14. This collection is estimated to take 3 minutes to complete, including gathering, preparing, and submitting the completed application form to the USPTO. Time will vary depending upon the individual case. Any comments on the amount of time you require to complete this form and/or suggestions for reducing this burden, should be sent to the Chief Information Officer, U.S. Patent and Trademark Office, U.S. Department of Commerce, P.O. Box 1450, Alexandria, VA 22313-1450. DO NOT SEND FEES OR COMPLETED FORMS TO THIS ADDRESS. SEND TO: Commissioner for Patents, P.O. Box 1450, Alexandria, VA 22313-1450.

If you need assistance in completing the form, call 1-800-PTO-9199 and select option 2.

Under the Paperwork Reduction Act of 1995, no persons are required to respond to a collection of information unless it displays a valid OMB control number.

STATEMENT UNDER 37 CFR 3.73(b)

Applicant/Patent Owner: Inventergy, Inc.

Application No./Patent No.: 7848439 Filed/Issue Date: 12/07/2010

Titled: Communication Apparatus, Communication System, and Communication Method

Inventergy, Inc., a Corporation
(Name of Assignee) (Type of Assignee, e.g., corporation, partnership, university, government agency, etc.)

states that it is:

- 1. the assignee of the entire right, title, and interest in;
- 2. an assignee of less than the entire right, title, and interest in
(The extent (by percentage) of its ownership interest is _____ %); or
- 3. the assignee of an undivided interest in the entirety of (a complete assignment from one of the joint inventors was made)

the patent application/patent identified above, by virtue of either:

A. An assignment from the inventor(s) of the patent application/patent identified above. The assignment was recorded in the United States Patent and Trademark Office at Reel _____, Frame _____, or for which a copy therefore is attached.

OR

B. A chain of title from the inventor(s), of the patent application/patent identified above, to the current assignee as follows:

1. From: She, Xiaoming et al. To: Matsushita Electric Industrial Co., Ltd.

The document was recorded in the United States Patent and Trademark Office at
Reel 019967, Frame 0735, or for which a copy thereof is attached.

2. From: Matsushita Electric Industrial Co., Ltd. To: Panasonic Corporation

The document was recorded in the United States Patent and Trademark Office at
Reel 021832, Frame 0197, or for which a copy thereof is attached.

3. From: Panasonic Corporation To: Inventergy, Inc.

The document was recorded in the United States Patent and Trademark Office at
Reel 031911, Frame 0911, or for which a copy thereof is attached.

Additional documents in the chain of title are listed on a supplemental sheet(s).

As required by 37 CFR 3.73(b)(1)(i), the documentary evidence of the chain of title from the original owner to the assignee was, or concurrently is being, submitted for recordation pursuant to 37 CFR 3.11.

[NOTE: A separate copy (i.e., a true copy of the original assignment document(s)) must be submitted to Assignment Division in accordance with 37 CFR Part 3, to record the assignment in the records of the USPTO. See MPEP 302.08]

The undersigned (whose title is supplied below) is authorized to act on behalf of the assignee.

/Rick D. Nydegger 28651/
Signature

April 29, 2014
Date

Rick D. Nydegger
Printed or Typed Name

Attorney for Applicant
Title

Privacy Act Statement

The **Privacy Act of 1974 (P.L. 93-579)** requires that you be given certain information in connection with your submission of the attached form related to a patent application or patent. Accordingly, pursuant to the requirements of the Act, please be advised that: (1) the general authority for the collection of this information is 35 U.S.C. 2(b)(2); (2) furnishing of the information solicited is voluntary; and (3) the principal purpose for which the information is used by the U.S. Patent and Trademark Office is to process and/or examine your submission related to a patent application or patent. If you do not furnish the requested information, the U.S. Patent and Trademark Office may not be able to process and/or examine your submission, which may result in termination of proceedings or abandonment of the application or expiration of the patent.

The information provided by you in this form will be subject to the following routine uses:

1. The information on this form will be treated confidentially to the extent allowed under the Freedom of Information Act (5 U.S.C. 552) and the Privacy Act (5 U.S.C. 552a). Records from this system of records may be disclosed to the Department of Justice to determine whether disclosure of these records is required by the Freedom of Information Act.
2. A record from this system of records may be disclosed, as a routine use, in the course of presenting evidence to a court, magistrate, or administrative tribunal, including disclosures to opposing counsel in the course of settlement negotiations.
3. A record in this system of records may be disclosed, as a routine use, to a Member of Congress submitting a request involving an individual, to whom the record pertains, when the individual has requested assistance from the Member with respect to the subject matter of the record.
4. A record in this system of records may be disclosed, as a routine use, to a contractor of the Agency having need for the information in order to perform a contract. Recipients of information shall be required to comply with the requirements of the Privacy Act of 1974, as amended, pursuant to 5 U.S.C. 552a(m).
5. A record related to an International Application filed under the Patent Cooperation Treaty in this system of records may be disclosed, as a routine use, to the International Bureau of the World Intellectual Property Organization, pursuant to the Patent Cooperation Treaty.
6. A record in this system of records may be disclosed, as a routine use, to another federal agency for purposes of National Security review (35 U.S.C. 181) and for review pursuant to the Atomic Energy Act (42 U.S.C. 218(c)).
7. A record from this system of records may be disclosed, as a routine use, to the Administrator, General Services, or his/her designee, during an inspection of records conducted by GSA as part of that agency's responsibility to recommend improvements in records management practices and programs, under authority of 44 U.S.C. 2904 and 2906. Such disclosure shall be made in accordance with the GSA regulations governing inspection of records for this purpose, and any other relevant (*i.e.*, GSA or Commerce) directive. Such disclosure shall not be used to make determinations about individuals.
8. A record from this system of records may be disclosed, as a routine use, to the public after either publication of the application pursuant to 35 U.S.C. 122(b) or issuance of a patent pursuant to 35 U.S.C. 151. Further, a record may be disclosed, subject to the limitations of 37 CFR 1.14, as a routine use, to the public if the record was filed in an application which became abandoned or in which the proceedings were terminated and which application is referenced by either a published application, an application open to public inspection or an issued patent.
9. A record from this system of records may be disclosed, as a routine use, to a Federal, State, or local law enforcement agency, if the USPTO becomes aware of a violation or potential violation of law or regulation.

Electronic Acknowledgement Receipt

EFS ID:	18895301
Application Number:	11719611
International Application Number:	
Confirmation Number:	9253
Title of Invention:	COMMUNICATION APPARATUS, COMMUNICATION SYSTEM, AND COMMUNICATION METHOD
First Named Inventor/Applicant Name:	Xiaoming She
Customer Number:	52989
Filer:	Rick D. Nydegger/Michelle Stringham
Filer Authorized By:	Rick D. Nydegger
Attorney Docket Number:	L9289.07161
Receipt Date:	29-APR-2014
Filing Date:	17-MAY-2007
Time Stamp:	17:44:00
Application Type:	U.S. National Stage under 35 USC 371

Payment information:

Submitted with Payment	no
------------------------	----

File Listing:

Document Number	Document Description	File Name	File Size(Bytes)/ Message Digest	Multi Part /.zip	Pages (if appl.)
1	Power of Attorney	POA.pdf	400685 <small>059a63d9ad366b82fd7b53a2d0d597e303c966a6</small>	no	1

Warnings:

Information:

IPR2018-1555

HTC EX1002, Page 86

2	Assignee showing of ownership per 37 CFR 3.73.	20008_46a_3373b.pdf	430688	no	2
			979acfad249850e119caee49f5f2ec34874c5c18		

Warnings:

Information:

Total Files Size (in bytes):	831373
-------------------------------------	--------

This Acknowledgement Receipt evidences receipt on the noted date by the USPTO of the indicated documents, characterized by the applicant, and including page counts, where applicable. It serves as evidence of receipt similar to a Post Card, as described in MPEP 503.

New Applications Under 35 U.S.C. 111

If a new application is being filed and the application includes the necessary components for a filing date (see 37 CFR 1.53(b)-(d) and MPEP 506), a Filing Receipt (37 CFR 1.54) will be issued in due course and the date shown on this Acknowledgement Receipt will establish the filing date of the application.

National Stage of an International Application under 35 U.S.C. 371

If a timely submission to enter the national stage of an international application is compliant with the conditions of 35 U.S.C. 371 and other applicable requirements a Form PCT/DO/EO/903 indicating acceptance of the application as a national stage submission under 35 U.S.C. 371 will be issued in addition to the Filing Receipt, in due course.

New International Application Filed with the USPTO as a Receiving Office

If a new international application is being filed and the international application includes the necessary components for an international filing date (see PCT Article 11 and MPEP 1810), a Notification of the International Application Number and of the International Filing Date (Form PCT/RO/105) will be issued in due course, subject to prescriptions concerning national security, and the date shown on this Acknowledgement Receipt will establish the international filing date of the application.

PATENT ASSIGNMENT COVER SHEET

Electronic Version v1.1
Stylesheet Version v1.2

EPAS ID: PAT2782882

SUBMISSION TYPE:	NEW ASSIGNMENT
NATURE OF CONVEYANCE:	RELEASE BY SECURED PARTY
CONVEYING PARTY DATA	
Name	Execution Date
JOSEPH BEYERS	03/24/2014
RECEIVING PARTY DATA	
Name:	INVENTERGY, INC.
Street Address:	19925 STEVENS CREEK BOULEVARD
City:	CUPERTINO
State/Country:	CALIFORNIA
Postal Code:	95014
PROPERTY NUMBERS Total: 111	
Property Type	Number
Patent Number:	6726297
Patent Number:	8009549
Patent Number:	8416810
Patent Number:	7646702
Patent Number:	8238226
Patent Number:	7593317
Patent Number:	7929627
Patent Number:	7826557
Patent Number:	7792084
Patent Number:	8064393
Patent Number:	8270332
Patent Number:	8582573
Patent Number:	6400929
Patent Number:	6381445
Patent Number:	6366763
Patent Number:	6370359
Patent Number:	6487394
Patent Number:	6597894
Patent Number:	6505035
Patent Number:	6973289
Patent Number:	6611676

Property Type	Number
Patent Number:	7636551
Patent Number:	6637001
Patent Number:	6813323
Patent Number:	6734810
Patent Number:	6940428
Patent Number:	6922159
Patent Number:	6069884
Patent Number:	6119004
Patent Number:	6069924
Patent Number:	6636723
Patent Number:	6628630
Patent Number:	6404778
Patent Number:	6611509
Patent Number:	6807162
Patent Number:	6973065
Patent Number:	7778224
Patent Number:	6765894
Patent Number:	7656844
Patent Number:	8437316
Patent Number:	6839335
Patent Number:	7072416
Patent Number:	7760815
Patent Number:	6868056
Patent Number:	6944208
Patent Number:	6781973
Patent Number:	7145886
Patent Number:	6847828
Patent Number:	7386321
Patent Number:	7266118
Patent Number:	7133379
Patent Number:	7392019
Patent Number:	7339949
Patent Number:	7702025
Patent Number:	7460502
Patent Number:	7269774
Patent Number:	7385934
Patent Number:	7114121
Patent Number:	7162206
Patent Number:	7746762

Property Type	Number
Patent Number:	7693140
Patent Number:	7299027
Patent Number:	7251469
Patent Number:	7764711
Patent Number:	8086270
Patent Number:	7848439
Patent Number:	8175604
Patent Number:	7860184
Patent Number:	8073070
Patent Number:	8249132
Patent Number:	8576784
Patent Number:	8218681
Patent Number:	8249178
Patent Number:	5583851
Patent Number:	5873027
Patent Number:	6336040
Patent Number:	5757870
Patent Number:	5818869
Patent Number:	6175558
Patent Number:	6301237
Patent Number:	6529492
Patent Number:	6370131
Patent Number:	6584088
Patent Number:	6549526
Patent Number:	7136367
Patent Number:	RE41444
Patent Number:	6295301
Patent Number:	6697384
Patent Number:	6466563
Patent Number:	6370134
Patent Number:	7035233
Patent Number:	7535864
Patent Number:	5677929
Patent Number:	RE37420
Patent Number:	RE39954
Patent Number:	6738646
Patent Number:	7460880
Patent Number:	7761113
Patent Number:	6760590

Property Type	Number
Patent Number:	6799053
Patent Number:	7206587
Application Number:	10901380
Application Number:	11134448
Application Number:	10419089
Application Number:	11859550
Application Number:	11575015
Application Number:	13478996
Application Number:	13532576
Application Number:	13554748
Application Number:	10235918
Application Number:	10322425

CORRESPONDENCE DATA

Fax Number:

Correspondence will be sent to the e-mail address first; if that is unsuccessful, it will be sent via US Mail.

Phone: 4089737896

Email: paul@inventergy.com

Correspondent Name: WAYNE P. SOBON

Address Line 1: 19925 STEVENS CREEK BOULEVARD

Address Line 2: SUITE 100

Address Line 4: CUPERTINO, CALIFORNIA 95014

NAME OF SUBMITTER:	PAUL A. ROBERTS
SIGNATURE:	/Paul A. Roberts/
DATE SIGNED:	03/25/2014
	This document serves as an Oath/Declaration (37 CFR 1.63).

Total Attachments: 18

- source=Inventergy Termination and Release of Security Interest in Patents - Beyers 2014-03-24#page1.tif
- source=Inventergy Termination and Release of Security Interest in Patents - Beyers 2014-03-24#page2.tif
- source=Inventergy Termination and Release of Security Interest in Patents - Beyers 2014-03-24#page3.tif
- source=Inventergy Termination and Release of Security Interest in Patents - Beyers 2014-03-24#page4.tif
- source=Inventergy Termination and Release of Security Interest in Patents - Beyers 2014-03-24#page5.tif
- source=Inventergy Termination and Release of Security Interest in Patents - Beyers 2014-03-24#page6.tif
- source=Inventergy Termination and Release of Security Interest in Patents - Beyers 2014-03-24#page7.tif
- source=Inventergy Termination and Release of Security Interest in Patents - Beyers 2014-03-24#page8.tif
- source=Inventergy Termination and Release of Security Interest in Patents - Beyers 2014-03-24#page9.tif
- source=Inventergy Termination and Release of Security Interest in Patents - Beyers 2014-03-24#page10.tif
- source=Inventergy Termination and Release of Security Interest in Patents - Beyers 2014-03-24#page11.tif
- source=Inventergy Termination and Release of Security Interest in Patents - Beyers 2014-03-24#page12.tif
- source=Inventergy Termination and Release of Security Interest in Patents - Beyers 2014-03-24#page13.tif
- source=Inventergy Termination and Release of Security Interest in Patents - Beyers 2014-03-24#page14.tif

source=Inventergy Termination and Release of Security Interest in Patents - Beyers 2014-03-24#page15.tif
source=Inventergy Termination and Release of Security Interest in Patents - Beyers 2014-03-24#page16.tif
source=Inventergy Termination and Release of Security Interest in Patents - Beyers 2014-03-24#page17.tif
source=Inventergy Termination and Release of Security Interest in Patents - Beyers 2014-03-24#page18.tif

**TERMINATION AND RELEASE OF
SECURITY INTEREST IN PATENTS**

This **TERMINATION AND RELEASE OF SECURITY INTEREST IN PATENTS** (this “**Release**”), dated as of March 24, 2014, is made by Joseph Beyers, in its capacity as Assignee for Security.

Reference is made to (a) that certain promissory note dated December 19, 2013 as amended on February 6, 2014 by Inventergy, Inc., a Delaware corporation in favor Joseph Beyers, and (b) that Assignment for Security-Patents made by Inventergy, Inc. in favor of Joseph Beyers dated January 24, 2014;

WHEREAS, the Assignment for Security-Patents was recorded in the U.S. Patent and Trademark Office on January 27, 2014 at Reel/Frame No.032127/0234 ; and

NOW THEREFORE, Joseph Beyers does hereby **RELEASE** his security interest in, to and under the collateral covered by the Assignment for Security-Patents, and Joseph Beyers hereby reassigns, without representation, recourse or warranty whatsoever, such collateral to Inventergy, Inc. Joseph Beyers agrees to make appropriate filings with the U.S. Patent and Trademark Office and other necessary filings, in each case reasonably requested by Inventergy, Inc. at the expense of Inventergy, Inc., to evidence the release and termination of such security interests covering the collateral.

IN WITNESS WHEREOF, the Joseph Beyers has executed this Release, to take effect as of the date first set forth above.

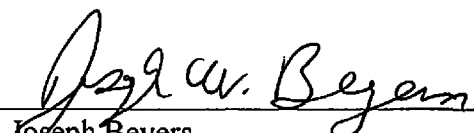

Joseph Beyers

ANNEX I

RELEASE TO ASSIGNMENT FOR SECURITY

Internal Family ID	Country	Inventergy Understood status 1/14/2014	Publication Number	Publication Date	Title	Application Number	File Date
Inv-01	USA	Granted	US6726297	4/27/2004	Ofdma signal transmission apparatus and method	US10/462491	1/20/2000
Inv-03	USA	Granted	US8009549	8/30/2011	Carrier allocation method in multi cell orthogonal frequency division multiple access system	US12/092950	11/16/2006
Inv-04	USA	Granted	US8416810	4/9/2013	Radio communication base station apparatus and pilot transmission method	US12/160872	1/18/2007
Inv-08	USA	Granted	US7646702	1/12/2010	Ofdm communication apparatus	US10/169716	7/9/2002
Inv-08	USA	Granted	US8238226	8/7/2012	Ofdm communication apparatus	US12/505420	7/17/2009
Inv-09	USA	Granted	US7593317	9/22/2009	Radio base station apparatus	US10/503010	7/29/2004
Inv-15	USA	Granted	US7929627	4/19/2011	Ofdm receiver, integrated circuit and receiving method	US11/885042	2/28/2006

Inv-16	USA	Granted	US7826557	11/2/2010	Retransmitting method and transmitting method in multi-antenna transmission	US11/721911	12/14/2005
Inv-21	USA	Granted	US7792084	9/7/2010	Mimo antenna apparatus controlling number of streams and modulation and demodulation method	US11/892886	8/28/2007
Inv-23	USA	Granted	US8064393	11/22/2011	Wireless communication base station apparatus and wireless communication method in multicarrier communication	US11/997841	8/4/2006
Inv-26	USA	Granted	US8270332	9/18/2012	Wireless communication base station device and wireless communication method	US12/377373	10/12/2007
Inv-26	USA	Granted	US8582573	12/13/2012	Radio communication base station apparatus and radio communication method	US13/590841	8/21/2012
Pana-01	USA	Granted	US6400929	6/4/2002	Radio communication device and method of controlling transmission rate	US09/424843	12/6/1999

Pana-01	USA	Granted	US6381445	4/30/2002	Radio communication device and method of controlling transmission rate	US09/648742	8/28/2000
Pana-01	USA	Granted	US6366763	4/2/2002	Radio communication device and method of controlling transmission rate	US09/648756	8/28/2000
Pana-01	USA	Granted	US6370359	4/9/2002	Radio communication device and method of controlling transmission rate	US09/648757	8/28/2000
Pana-01	USA	Granted	US6487394	11/26/2002	Radio communication device and method of controlling transmission rate	US09/649003	8/28/2000
Pana-01	USA	Granted	US6597894	7/22/2003	Radio communication device and method of controlling transmission rate	US09/649006	8/28/2000
Pana-01	USA	Granted	US6505035	1/7/2003	Radio communication apparatus and transmission rate control method	US10/052261	1/23/2002
Pana-01	USA	Granted	US6973289	12/6/2005	Radio communication device and method of controlling transmission rate	US10/057897	1/29/2002

Pana-01	USA	Granted	US6611676	8/26/2003	Radio communication apparatus and transmission rate control method	US10/083553	2/27/2002
Pana-01	USA	Granted	US7636551	12/22/2009	Radio communication device and method of controlling transmission rate	US11/228339	9/19/2005
Pana-02	USA	Granted	US6637001	10/21/2003	Apparatus and method for image/voice transmission	US09/650743	8/30/2000
Pana-03	USA	Granted	US6813323	11/2/2004	Decoding method and communication terminal apparatus	US10/182270	7/25/2002
Pana-03	USA	Lapsed	US20050002477	1/6/2005	Decoding apparatus and decoding method	10901380	7/29/2004
Pana-04	USA	Granted	US6734810	5/11/2004	Apparatus and method for decoding	US10/221267	9/10/2002
Pana-04	USA	Granted	US6940428	9/6/2005	Apparatus and method for decoding	US10/793737	3/8/2004
Pana-04	USA	Granted	US6922159	7/26/2005	Apparatus and method for decoding	US10/793766	3/8/2004
Pana-04	USA	Lapsed	US20050219071	10/6/2005	Apparatus and method for decoding	11134448	5/23/2005

Pana-05	USA	Granted	US6069884	5/30/2000	Method of communication between a base station and a plurality of mobile unit communication apparatus, a base station, and mobile unit communication apparatus	US08/937005	9/24/1997
Pana-06	USA	Granted	US6119004	9/12/2000	Base station equipment for mobile communication	US09/068541	5/13/1998
Pana-07	USA	Granted	US6069924	5/30/2000	Differential detector with error correcting function	US09/027510	2/20/1998
Pana-08	USA	Granted	US6636723	10/21/2003	Cdma radio communication system using chip interleaving	US09/359020	7/22/1999
Pana-08	USA	Lapsed	US20040048578	3/11/2004	Cdma radio transmission apparatus, cdma radio reception apparatus, and cdma radio communication method	10419089	4/21/2003
Pana-09	USA	Granted	US6628630	9/30/2003	Spread spectrum communication method	US09/058881	4/13/1998
Pana-10	USA	Granted	US6404778	6/11/2002	Radio communication apparatus	US09/159602	9/24/1998

Pana-11	USA	Granted	US6611509	8/26/2003	Cdma/tdd mobile communication system and method	US09/264826	3/9/1999
Pana-11	USA	Granted	US6807162	10/19/2004	Cdma/tdd mobile communication system and method	US10/166268	6/11/2002
Pana-11	USA	Granted	US6973065	12/6/2005	Cdma/tdd mobile communication system and method	US10/419733	4/22/2003
Pana-11	USA	Granted	US7778224	8/17/2010	Cdma/tdd mobile communication system and method	US10/885684	7/8/2004
Pana-12	USA	Granted	US6765894	7/20/2004	Communication terminal apparatus and base station apparatus	US09/606906	6/30/2000
Pana-12	USA	Granted	US7656844	2/2/2010	Radio transmission apparatus and radio reception apparatus in a cdma communication system	US10/868029	6/16/2004
Pana-12	USA	Granted	US8437316	5/7/2013	Radio transmission apparatus and radio reception apparatus in a cdma communication system	US12/641177	12/17/2009

Pana-13	USA	Granted	US6839335	1/4/2005	Radio communication apparatus and radio communication method	US09/605862	6/29/2000
Pana-14	USA	Granted	US7072416	7/4/2006	Transmitting/receiving device and transmitting/receiving method	US09/582558	6/29/2000
Pana-14	USA	Granted	US7760815	7/20/2010	Apparatus and method for transmission/reception	US11/431606	5/11/2006
Pana-15	USA	Granted	US6868056	3/15/2005	Apparatus and method for ofdm communication	US09/635096	8/9/2000
Pana-16	USA	Granted	US6944208	9/13/2005	Interference signal canceling apparatus and interference signal canceling method	US09/936727	9/17/2001
Pana-17	USA	Granted	US6781973	8/24/2004	Combined signaling and sir inner-loop power control	US09/538888	3/30/2000
Pana-18	USA	Granted	US7145886	12/5/2006	Communication terminal, base station system, and method of controlling transmission power	US09/889919	7/25/2001
Pana-19	USA	Granted	US6847828	1/25/2005	Base station apparatus and radio communication method	US10/069484	2/27/2002

Pana-19	USA	Granted	US7386321	6/10/2008	Base station apparatus and radio communication method	US10/793738	3/8/2004
Pana-20	USA	Granted	US7266118	9/4/2007	Packet receiving apparatus and packet transmission method	US10/143989	5/14/2002
Pana-21	USA	Granted	US7133379	11/7/2006	Wireless communication system, and base station apparatus and communication terminal apparatus accommodated in the system	US10/181349	7/17/2002
Pana-22	USA	Granted	US7392019	6/24/2008	Wireless base station apparatus and wireless communication method	US11/053837	2/10/2005
Pana-23	USA	Granted	US7339949	3/4/2008	Arq transmission and reception methods and apparatus	US10/222989	8/19/2002
Pana-24	USA	Granted	US7702025	4/20/2010	Transmission/reception apparatus and transmission/reception method	US10/487574	2/25/2004
Pana-25	USA	Granted	US7460502	12/2/2008	Scheduling creation apparatus, base station apparatus, and radio communication method	US10/250487	7/3/2003

Pana-26	USA	Granted	US7269774	9/11/2007	Data receiving apparatus, data transmitting apparatus and retransmission request method	US10/484951	1/28/2004
Pana-27	USA	Granted	US7385934	6/10/2008	Radio communication apparatus and transfer rate decision method	US10/476845	11/6/2003
Pana-28	USA	Granted	US7114121	9/26/2006	Rate matching device and rate matching method	US10/478139	11/20/2003
Pana-29	USA	Granted	US7162206	1/9/2007	Test apparatus, mobile terminal apparatus, test method	US10/612289	7/3/2003
Pana-30	USA	Granted	US7746762	6/29/2010	Transmitting apparatus and transmitting method	US10/534987	5/16/2005
Pana-31	USA	Granted	US7693140	4/6/2010	Cdma transmitting apparatus and cdma receiving apparatus	US10/527199	3/10/2005
Pana-32	USA	Granted	US7299027	11/20/2007	Mimo receiver and mimo reception method for selection of mimo separation and channel variation compensation	US10/536010	5/23/2005
Pana-32	USA	Lapsed	US20080020802	1/24/2008	Wireless receiver and wireless reception method	11859550	9/21/2007

Pana-33	USA	Pending	US20070255993	11/1/2007	Automatic retransmission request control system and retransmission method in memo-ofdm system	11575015	3/30/2007
Pana-33	USA	Lapsed	US20120230257	9/13/2012	Retransmission method and transmitter	13478996	5/23/2012
Pana-33	USA	Lapsed	US20120263250	10/18/2012	Retransmission method, transmitter, and communication system	13532576	6/25/2012
Pana-33	USA	Lapsed	US20120287775	11/15/2012	Automatic retransmission request control system and retransmission method in mimo-ofdm system	13554748	7/20/2012
Pana-34	USA	Granted	US7251469	7/31/2007	Cdma transmitting apparatus and cdma transmitting method	US10/522980	2/2/2005
Pana-34	USA	Granted	US7764711	7/27/2010	Cdma transmission apparatus and cdma transmission method	US11/767124	6/22/2007
Pana-35	USA	Granted	US8086270	12/27/2011	Classifying-synthesizing transmission method of multi-user feedback information at base station	US11/574636	9/5/2005

Pana-36	USA	Granted	US7848439	12/7/2010	Communication apparatus, communication system, and communication method	US11/719611	11/18/2005
Pana-37	USA	Granted	US8175604	5/8/2012	Efficient rise over thermal (rot) control during soft handover	US10/588073	8/31/2005
Pana-38	USA	Granted	US7860184	12/28/2010	Multi-antenna communication method and multi-antenna communication apparatus	US11/813650	1/10/2006
Pana-39	USA	Granted	US8073070	12/6/2011	Multi-pilot generation method and detection method in multi-antenna communication system	US12/092944	11/22/2006
Pana-40	USA	Granted	US8249132	8/21/2012	Communication terminal and receiving method	US11/909425	3/3/2006
Pana-41	USA	Granted	US8576784	5/7/2009	Uplink resource allocation in a mobile communication system	US12/162592	11/2/2006
Pana-42	USA	Granted	US8218681	7/10/2012	Ofdm transmitter and ofdm receiver	US12/440894	3/11/2009
Pana-43	USA	Granted	US8249178	8/21/2012	Multicarrier transmitter and multicarrier receiver	US12/601804	5/25/2007

Pana-44	USA	Granted	US5583851	12/10/1996	Mobile communication apparatus having multi-codes allocating function	US08/272158	7/8/1994
Pana-45	USA	Granted	US5873027	2/16/1999	Mobile radio system with control over radio wave output if a malfunction is detected	US08/761552	12/6/1996
Pana-45	USA	Granted	US6336040	1/1/2002	Mobile radio system with control over radio wave output if a malfunction is detected	US09/207662	12/9/1998
Pana-46	USA	Granted	US5757870	5/26/1998	Spread spectrum communication synchronizing method and its circuit	US08/517408	8/21/1995
Pana-46	USA	Granted	US5818869	10/6/1998	Spread spectrum communication synchronizing method and its circuit	US08/858146	5/15/1997
Pana-47	USA	Granted	US6175558	1/16/2001	Cdma radio multiplex transmitting device and a cdma radio multiplex receiving device	US09/000947	12/30/1997

Pana-47	USA	Granted	US6301237	10/9/2001	Cdma radio multiplex transmitting device and a cdma radio multiplex receiving device	US09/562921	5/2/2000
Pana-47	USA	Granted	US6529492	3/4/2003	Cdma radio multiplex transmitting device and a cdma radio multiplex receiving device	US09/562922	5/2/2000
Pana-47	USA	Granted	US6370131	4/9/2002	Cdma radio multiplex transmitting device and a cdma radio multiplex receiving device	US09/576250	5/24/2000
Pana-47	USA	Granted	US6584088	6/24/2003	Cdma radio multiplex transmitting device and cdma radio multiplex receiving device	US09/825998	4/5/2001
Pana-47	USA	Granted	US6549526	4/15/2003	Cdma radio multiplex transmitting device and a cdma multiplex receiving device	US09/826005	4/5/2001
Pana-47	USA	Granted	US7136367	11/14/2006	Cdma radio multiplex transmitting device and a cdma radio multiplex receiving device	US10/335916	1/3/2003

Pana-47	USA	Granted	USRE41444	7/20/2010	Cdma radio multiplex transmitting device and a cdma radio multiplex receiving device	US12/270499	11/13/2008
Pana-48	USA	Granted	US6295301	9/25/2001	Pn code generating apparatus and mobile radio communication system	US09/139325	8/25/1998
Pana-48	USA	Granted	US6697384	2/24/2004	Method and apparatus for calculating a state of starting a pn code generating operation	US09/916284	7/30/2001
Pana-49	USA	Granted	US6466563	10/15/2002	Cdma mobile station and cdma transmission method	US10/147831	3/16/1999
Pana-49	USA	Lapsed	US20030007472	1/9/2003	Cdma mobile station apparatus and cdma transmission method	10235918	9/6/2002
Pana-50	USA	Granted	US6370134	4/9/2002	Cdma radio communication apparatus	US09/115502	7/15/1998
Pana-50	USA	Granted	US7035233	4/25/2006	Radio communication terminal apparatus and radio communication base station apparatus	US10/014352	12/14/2001

Pana-50	USA	Granted	US7535864	5/19/2009	Radio communication terminal apparatus and radio communication base station apparatus	US11/372152	3/10/2006
WCDMA (pool) 01	USA	Granted	US5677929	10/14/1997	Automobile on-board and/or portable telephone system	US08/272156	7/8/1994
WCDMA (pool) 01	USA	Granted	USRE37420	10/23/2001	Automobile on-board and/or portable telephone system	US09/337403	6/21/1999
WCDMA (pool) 01	USA	Granted	USRE39954	12/25/2007	Automobile on-board and/or portable telephone system	US09/887042	6/25/2001
WCDMA (pool) 07	USA	Granted	US6738646	5/18/2004	Base station device and method for communication	US10/069267	2/25/2002
WCDMA (pool) 07	USA	Lapsed	US20030087644	5/8/2003	Communication terminal apparatus and base station apparatus	10322425	12/19/2002
WCDMA (pool) 07	USA	Granted	US7460880	12/2/2008	Communication terminal apparatus and base station apparatus	US11/341430	1/30/2006
WCDMA (pool) 07	USA	Granted	US7761113	7/20/2010	Communication terminal apparatus and base station apparatus	US12/132992	6/4/2008

WCDMA (pool) 09	USA	Granted	US6760590	7/6/2004	Communication terminal apparatus, base station apparatus, and radio communication method	US10/089605	4/1/2002
WCDMA (pool) 09	USA	Granted	US6799053	9/28/2004	Communication terminal apparatus	US10/321500	12/18/2002
WCDMA (pool) 09	USA	Granted	US7206587	4/17/2007	Communication terminal apparatus, base station apparatus, and radio communication method	US10/321623	12/18/2002

PATENT ASSIGNMENT COVER SHEET

Electronic Version v1.1
 Stylesheet Version v1.2

EPAS ID: PAT2785017

SUBMISSION TYPE:	NEW ASSIGNMENT
NATURE OF CONVEYANCE:	SECURITY AGREEMENT

CONVEYING PARTY DATA

Name	Execution Date
INVENTERGY, INC.	03/25/2014

RECEIVING PARTY DATA

Name:	HUDSON BAY IP OPPORTUNITIES MASTER FUND, LP, AS COLLATERAL AGENT FOR CERTAIN BUYERS
Street Address:	777 THIRD AVENUE, 30TH FLOOR
Internal Address:	ATTENTION: YOAV ROTH
City:	NEW YORK
State/Country:	NEW YORK
Postal Code:	10017

PROPERTY NUMBERS Total: 111

Property Type	Number
Application Number:	10901380
Application Number:	11134448
Application Number:	10419089
Application Number:	11859550
Application Number:	11575015
Application Number:	13478996
Application Number:	13532576
Application Number:	13554748
Application Number:	10235918
Application Number:	10322425
Patent Number:	6726297
Patent Number:	8009549
Patent Number:	8416810
Patent Number:	7646702
Patent Number:	8238226
Patent Number:	7593317
Patent Number:	7929627
Patent Number:	7826557
Patent Number:	7792084

Property Type	Number
Patent Number:	8064393
Patent Number:	8270332
Patent Number:	8582573
Patent Number:	6400929
Patent Number:	6381445
Patent Number:	6366763
Patent Number:	6370359
Patent Number:	6487394
Patent Number:	6597894
Patent Number:	6505035
Patent Number:	6973289
Patent Number:	6611676
Patent Number:	7636551
Patent Number:	6637001
Patent Number:	6813323
Patent Number:	6734810
Patent Number:	6940428
Patent Number:	6922159
Patent Number:	6069884
Patent Number:	6119004
Patent Number:	6069924
Patent Number:	6636723
Patent Number:	6628630
Patent Number:	6404778
Patent Number:	6611509
Patent Number:	6807162
Patent Number:	6973065
Patent Number:	7778224
Patent Number:	6765894
Patent Number:	7656844
Patent Number:	8437316
Patent Number:	6839335
Patent Number:	7072416
Patent Number:	7760815
Patent Number:	6868056
Patent Number:	6944208
Patent Number:	6781973
Patent Number:	7145886
Patent Number:	6847828

Property Type	Number
Patent Number:	7386321
Patent Number:	7266118
Patent Number:	7133379
Patent Number:	7392019
Patent Number:	7339949
Patent Number:	7702025
Patent Number:	7460502
Patent Number:	7269774
Patent Number:	7385934
Patent Number:	7114121
Patent Number:	7162206
Patent Number:	7746762
Patent Number:	7693140
Patent Number:	7299027
Patent Number:	7251469
Patent Number:	7764711
Patent Number:	8086270
Patent Number:	7848439
Patent Number:	8175604
Patent Number:	7860184
Patent Number:	8073070
Patent Number:	8249132
Patent Number:	8576784
Patent Number:	8218681
Patent Number:	8249178
Patent Number:	5583851
Patent Number:	5873027
Patent Number:	6336040
Patent Number:	5757870
Patent Number:	5818869
Patent Number:	6175558
Patent Number:	6301237
Patent Number:	6529492
Patent Number:	6370131
Patent Number:	6584088
Patent Number:	6549526
Patent Number:	7136367
Patent Number:	RE41444
Patent Number:	6295301

Property Type	Number
Patent Number:	6697384
Patent Number:	6466563
Patent Number:	6370134
Patent Number:	7035233
Patent Number:	7535864
Patent Number:	5677929
Patent Number:	RE37420
Patent Number:	RE39954
Patent Number:	6738646
Patent Number:	7460880
Patent Number:	7761113
Patent Number:	6760590
Patent Number:	6799053
Patent Number:	7206587

CORRESPONDENCE DATA

Fax Number:

Correspondence will be sent to the e-mail address first; if that is unsuccessful, it will be sent via US Mail.

Phone: 4089737896
Email: paul@inventergy.com
Correspondent Name: WAYNE P. SOBON
Address Line 1: 19925 STEVENS CREEK BOULEVARD
Address Line 2: SUITE 100
Address Line 4: CUPERTINO, CALIFORNIA 95014

NAME OF SUBMITTER:	PAUL A. ROBERTS
SIGNATURE:	/Paul A. Roberts/
DATE SIGNED:	03/25/2014
	This document serves as an Oath/Declaration (37 CFR 1.63).

Total Attachments: 18
source=Inventergy Assignment for Security Patents - Hudson First on Mobile Broadband 03-25-14#page1.tif
source=Inventergy Assignment for Security Patents - Hudson First on Mobile Broadband 03-25-14#page2.tif
source=Inventergy Assignment for Security Patents - Hudson First on Mobile Broadband 03-25-14#page3.tif
source=Inventergy Assignment for Security Patents - Hudson First on Mobile Broadband 03-25-14#page4.tif
source=Inventergy Assignment for Security Patents - Hudson First on Mobile Broadband 03-25-14#page5.tif
source=Inventergy Assignment for Security Patents - Hudson First on Mobile Broadband 03-25-14#page6.tif
source=Inventergy Assignment for Security Patents - Hudson First on Mobile Broadband 03-25-14#page7.tif
source=Inventergy Assignment for Security Patents - Hudson First on Mobile Broadband 03-25-14#page8.tif
source=Inventergy Assignment for Security Patents - Hudson First on Mobile Broadband 03-25-14#page9.tif
source=Inventergy Assignment for Security Patents - Hudson First on Mobile Broadband 03-25-14#page10.tif
source=Inventergy Assignment for Security Patents - Hudson First on Mobile Broadband 03-25-14#page11.tif
source=Inventergy Assignment for Security Patents - Hudson First on Mobile Broadband 03-25-14#page12.tif

source=Inventergy Assignment for Security Patents - Hudson First on Mobile Broadband 03-25-14#page13.tif
source=Inventergy Assignment for Security Patents - Hudson First on Mobile Broadband 03-25-14#page14.tif
source=Inventergy Assignment for Security Patents - Hudson First on Mobile Broadband 03-25-14#page15.tif
source=Inventergy Assignment for Security Patents - Hudson First on Mobile Broadband 03-25-14#page16.tif
source=Inventergy Assignment for Security Patents - Hudson First on Mobile Broadband 03-25-14#page17.tif
source=Inventergy Assignment for Security Patents - Hudson First on Mobile Broadband 03-25-14#page18.tif

ASSIGNMENT FOR SECURITY
PATENTS

WHEREAS, **Inventergy, Inc.** (the "Assignor") holds all right, title and interest in the letter patents, design patents and utility patents listed on the annexed Schedule 1, which patents are issued or applied for in the United States Patent and Trademark Office (the "Patents");

WHEREAS, the Assignor has entered into a Pledge and Security Agreement, dated as of May 10, 2013 (as amended, restated or otherwise modified from time to time the "Security Agreement"), in favor of **Hudson Bay IP Opportunities Master Fund, LP**, as collateral agent for certain buyers (the "Assignee");

WHEREAS, pursuant to the Security Agreement, the Assignor has assigned to the Assignee and granted to the Assignee for the benefit of the Buyers (as defined in the Security Agreement) a continuing security interest in all right, title and interest of the Assignor in, to and under the Patents and the applications and registrations thereof, and all proceeds thereof, including, without limitation, any and all causes of action which may exist by reason of infringement thereof and any and all damages arising from past, present and future violations thereof (the "Collateral"), to secure the payment, performance and observance of the "Obligations" (as defined in the Security Agreement);

NOW, THEREFORE, for good and valuable consideration, the receipt and sufficiency of which are hereby acknowledged, the Assignor does hereby pledge, convey, sell, assign, transfer and set over unto the Assignee and grants to the Assignee for the benefit of the Buyers a continuing security interest in the Collateral to secure the prompt payment, performance and for the benefit of the Buyers observance of the Obligations.

The Assignor does hereby further acknowledge and affirm that the rights and remedies of the Assignee with respect to the Collateral are more fully set forth in the Security Agreement, the terms and provisions of which are hereby incorporated herein by reference as if fully set forth herein.

IN WITNESS WHEREOF, the Assignor has caused this Assignment to be duly executed by its officer thereunto duly authorized as of March 25, 2014.

Inventergy, Inc.

By: Joseph W. Beyers
Name: Joseph W. Beyers
Title: Chairman and CEO

State of California
County of Santa Clara

On March 25, 2014 before me, Sheila Meinecke Notary Public
(insert name and title of the officer) personally appeared **Joseph W. Beyers**, who proved to me on the basis of satisfactory evidence to be the person whose name is subscribed to the within instrument and acknowledged to me that he executed the same in his authorized capacity, and that by his signature on the instrument the person, or the entity upon behalf of which the person acted, executed the instrument.

I certify under PENALTY OF PERJURY under the laws of the State of California that the foregoing paragraph is true and correct.

WITNESS my hand and official seal.

Signature

Sheila Meinecke

(Seal)

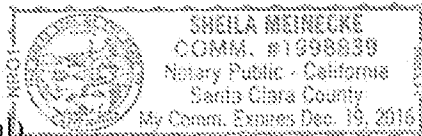

SCHEDULE 1 TO ASSIGNMENT FOR SECURITY

Patents and Patent Applications
Owned by: **Inventergy, Inc.**

Internal Family ID	Country	Inventergy Understood status 1/14/2014	Publication Number	Publication Date	Title	Application Number	File Date
Inv-01	USA	Granted	US6726297	4/27/2004	Ofdma signal transmission apparatus and method	US10/462491	1/20/2000
Inv-03	USA	Granted	US8009549	8/30/2011	Carrier allocation method in multi cell orthogonal frequency division multiple access system	US12/092950	11/16/2006
Inv-04	USA	Granted	US8416810	4/9/2013	Radio communication base station apparatus and pilot transmission method	US12/160872	1/18/2007
Inv-08	USA	Granted	US7646702	1/12/2010	Ofdm communication apparatus	US10/169716	7/9/2002
Inv-08	USA	Granted	US8238226	8/7/2012	Ofdm communication apparatus	US12/505420	7/17/2009
Inv-09	USA	Granted	US7593317	9/22/2009	Radio base station apparatus	US10/503010	7/29/2004
Inv-15	USA	Granted	US7929627	4/19/2011	Ofdm receiver, integrated circuit and receiving method	US11/885042	2/28/2006

Inv-16	USA	Granted	US7826557	11/2/2010	Retransmitting method and transmitting method in multi-antenna transmission	US11/721911	12/14/2005
Inv-21	USA	Granted	US7792084	9/7/2010	Mimo antenna apparatus controlling number of streams and modulation and demodulation method	US11/892886	8/28/2007
Inv-23	USA	Granted	US8064393	11/22/2011	Wireless communication base station apparatus and wireless communication method in multicarrier communication	US11/997841	8/4/2006
Inv-26	USA	Granted	US8270332	9/18/2012	Wireless communication base station device and wireless communication method	US12/377373	10/12/2007
Inv-26	USA	Granted	US8582573	12/13/2012	Radio communication base station apparatus and radio communication method	US13/590841	8/21/2012
Pana-01	USA	Granted	US6400929	6/4/2002	Radio communication device and method of controlling transmission rate	US09/424843	12/6/1999

Pana-01	USA	Granted	US6381445	4/30/2002	Radio communication device and method of controlling transmission rate	US09/648742	8/28/2000
Pana-01	USA	Granted	US6366763	4/2/2002	Radio communication device and method of controlling transmission rate	US09/648756	8/28/2000
Pana-01	USA	Granted	US6370359	4/9/2002	Radio communication device and method of controlling transmission rate	US09/648757	8/28/2000
Pana-01	USA	Granted	US6487394	11/26/2002	Radio communication device and method of controlling transmission rate	US09/649003	8/28/2000
Pana-01	USA	Granted	US6597894	7/22/2003	Radio communication device and method of controlling transmission rate	US09/649006	8/28/2000
Pana-01	USA	Granted	US6505035	1/7/2003	Radio communication apparatus and transmission rate control method	US10/052261	1/23/2002
Pana-01	USA	Granted	US6973289	12/6/2005	Radio communication device and method of controlling transmission rate	US10/057897	1/29/2002

Pana-01	USA	Granted	US6611676	8/26/2003	Radio communication apparatus and transmission rate control method	US10/083553	2/27/2002
Pana-01	USA	Granted	US7636551	12/22/2009	Radio communication device and method of controlling transmission rate	US11/228339	9/19/2005
Pana-02	USA	Granted	US6637001	10/21/2003	Apparatus and method for image/voice transmission	US09/650743	8/30/2000
Pana-03	USA	Granted	US6813323	11/2/2004	Decoding method and communication terminal apparatus	US10/182270	7/25/2002
Pana-03	USA	Lapsed	US20050002477	1/6/2005	Decoding apparatus and decoding method	10901380	7/29/2004
Pana-04	USA	Granted	US6734810	5/11/2004	Apparatus and method for decoding	US10/221267	9/10/2002
Pana-04	USA	Granted	US6940428	9/6/2005	Apparatus and method for decoding	US10/793737	3/8/2004
Pana-04	USA	Granted	US6922159	7/26/2005	Apparatus and method for decoding	US10/793766	3/8/2004
Pana-04	USA	Lapsed	US20050219071	10/6/2005	Apparatus and method for decoding	11134448	5/23/2005

Pana-05	USA	Granted	US6069884	5/30/2000	Method of communication between a base station and a plurality of mobile unit communication apparatus, a base station, and mobile unit communication apparatus	US08/937005	9/24/1997
Pana-06	USA	Granted	US6119004	9/12/2000	Base station equipment for mobile communication	US09/068541	5/13/1998
Pana-07	USA	Granted	US6069924	5/30/2000	Differential detector with error correcting function	US09/027510	2/20/1998
Pana-08	USA	Granted	US6636723	10/21/2003	Cdma radio communication system using chip interleaving	US09/359020	7/22/1999
Pana-08	USA	Lapsed	US20040048578	3/11/2004	Cdma radio transmission apparatus, cdma radio reception apparatus, and cdma radio communication method	10419089	4/21/2003
Pana-09	USA	Granted	US6628630	9/30/2003	Spread spectrum communication method	US09/058881	4/13/1998
Pana-10	USA	Granted	US6404778	6/11/2002	Radio communication apparatus	US09/159602	9/24/1998

Pana-11	USA	Granted	US6611509	8/26/2003	Cdma/tdd mobile communication system and method	US09/264826	3/9/1999
Pana-11	USA	Granted	US6807162	10/19/2004	Cdma/tdd mobile communication system and method	US10/166268	6/11/2002
Pana-11	USA	Granted	US6973065	12/6/2005	Cdma/tdd mobile communication system and method	US10/419733	4/22/2003
Pana-11	USA	Granted	US7778224	8/17/2010	Cdma/tdd mobile communication system and method	US10/885684	7/8/2004
Pana-12	USA	Granted	US6765894	7/20/2004	Communication terminal apparatus and base station apparatus	US09/606906	6/30/2000
Pana-12	USA	Granted	US7656844	2/2/2010	Radio transmission apparatus and radio reception apparatus in a cdma communication system	US10/868029	6/16/2004
Pana-12	USA	Granted	US8437316	5/7/2013	Radio transmission apparatus and radio reception apparatus in a cdma communication system	US12/641177	12/17/2009

Pana-13	USA	Granted	US6839335	1/4/2005	Radio communication apparatus and radio communication method	US09/605862	6/29/2000
Pana-14	USA	Granted	US7072416	7/4/2006	Transmitting/receiving device and transmitting/receiving method	US09/582558	6/29/2000
Pana-14	USA	Granted	US7760815	7/20/2010	Apparatus and method for transmission/reception	US11/431606	5/11/2006
Pana-15	USA	Granted	US6868056	3/15/2005	Apparatus and method for ofdm communication	US09/635096	8/9/2000
Pana-16	USA	Granted	US6944208	9/13/2005	Interference signal canceling apparatus and interference signal canceling method	US09/936727	9/17/2001
Pana-17	USA	Granted	US6781973	8/24/2004	Combined signaling and sir inner-loop power control	US09/538888	3/30/2000
Pana-18	USA	Granted	US7145886	12/5/2006	Communication terminal, base station system, and method of controlling transmission power	US09/889919	7/25/2001
Pana-19	USA	Granted	US6847828	1/25/2005	Base station apparatus and radio communication method	US10/069484	2/27/2002

Pana-19	USA	Granted	US7386321	6/10/2008	Base station apparatus and radio communication method	US10/793738	3/8/2004
Pana-20	USA	Granted	US7266118	9/4/2007	Packet receiving apparatus and packet transmission method	US10/143989	5/14/2002
Pana-21	USA	Granted	US7133379	11/7/2006	Wireless communication system, and base station apparatus and communication terminal apparatus accommodated in the system	US10/181349	7/17/2002
Pana-22	USA	Granted	US7392019	6/24/2008	Wireless base station apparatus and wireless communication method	US11/053837	2/10/2005
Pana-23	USA	Granted	US7339949	3/4/2008	Arq transmission and reception methods and apparatus	US10/222989	8/19/2002
Pana-24	USA	Granted	US7702025	4/20/2010	Transmission/reception apparatus and transmission/reception method	US10/487574	2/25/2004
Pana-25	USA	Granted	US7460502	12/2/2008	Scheduling creation apparatus, base station apparatus, and radio communication method	US10/250487	7/3/2003

Pana-26	USA	Granted	US7269774	9/11/2007	Data receiving apparatus, data transmitting apparatus and retransmission request method	US10/484951	1/28/2004
Pana-27	USA	Granted	US7385934	6/10/2008	Radio communication apparatus and transfer rate decision method	US10/476845	11/6/2003
Pana-28	USA	Granted	US7114121	9/26/2006	Rate matching device and rate matching method	US10/478139	11/20/2003
Pana-29	USA	Granted	US7162206	1/9/2007	Test apparatus, mobile terminal apparatus, test method	US10/612289	7/3/2003
Pana-30	USA	Granted	US7746762	6/29/2010	Transmitting apparatus and transmitting method	US10/534987	5/16/2005
Pana-31	USA	Granted	US7693140	4/6/2010	Cdma transmitting apparatus and cdma receiving apparatus	US10/527199	3/10/2005
Pana-32	USA	Granted	US7299027	11/20/2007	Mimo receiver and mimo reception method for selection of mimo separation and channel variation compensation	US10/536010	5/23/2005
Pana-32	USA	Lapsed	US20080020802	1/24/2008	Wireless receiver and wireless reception method	11859550	9/21/2007

Pana-33	USA	Pending	US20070255993	11/1/2007	Automatic retransmission request control system and retransmission method in memo-ofdm system	11575015	3/30/2007
Pana-33	USA	Lapsed	US20120230257	9/13/2012	Retransmission method and transmitter	13478996	5/23/2012
Pana-33	USA	Lapsed	US20120263250	10/18/2012	Retransmission method, transmitter, and communication system	13532576	6/25/2012
Pana-33	USA	Lapsed	US20120287775	11/15/2012	Automatic retransmission request control system and retransmission method in mimo-ofdm system	13554748	7/20/2012
Pana-34	USA	Granted	US7251469	7/31/2007	Cdma transmitting apparatus and cdma transmitting method	US10/522980	2/2/2005
Pana-34	USA	Granted	US7764711	7/27/2010	Cdma transmission apparatus and cdma transmission method	US11/767124	6/22/2007
Pana-35	USA	Granted	US8086270	12/27/2011	Classifying-synthesizing transmission method of multi-user feedback information at base station	US11/574636	9/5/2005

Pana-36	USA	Granted	US7848439	12/7/2010	Communication apparatus, communication system, and communication method	US11/719611	11/18/2005
Pana-37	USA	Granted	US8175604	5/8/2012	Efficient rise over thermal (rot) control during soft handover	US10/588073	8/31/2005
Pana-38	USA	Granted	US7860184	12/28/2010	Multi-antenna communication method and multi-antenna communication apparatus	US11/813650	1/10/2006
Pana-39	USA	Granted	US8073070	12/6/2011	Multi-pilot generation method and detection method in multi-antenna communication system	US12/092944	11/22/2006
Pana-40	USA	Granted	US8249132	8/21/2012	Communication terminal and receiving method	US11/909425	3/3/2006
Pana-41	USA	Granted	US8576784	5/7/2009	Uplink resource allocation in a mobile communication system	US12/162592	11/2/2006
Pana-42	USA	Granted	US8218681	7/10/2012	Ofdm transmitter and ofdm receiver	US12/440894	3/11/2009
Pana-43	USA	Granted	US8249178	8/21/2012	Multicarrier transmitter and multicarrier receiver	US12/601804	5/25/2007

Pana-44	USA	Granted	US5583851	12/10/1996	Mobile communication apparatus having multi-codes allocating function	US08/272158	7/8/1994
Pana-45	USA	Granted	US5873027	2/16/1999	Mobile radio system with control over radio wave output if a malfunction is detected	US08/761552	12/6/1996
Pana-45	USA	Granted	US6336040	1/1/2002	Mobile radio system with control over radio wave output if a malfunction is detected	US09/207662	12/9/1998
Pana-46	USA	Granted	US5757870	5/26/1998	Spread spectrum communication synchronizing method and its circuit	US08/517408	8/21/1995
Pana-46	USA	Granted	US5818869	10/6/1998	Spread spectrum communication synchronizing method and its circuit	US08/858146	5/15/1997
Pana-47	USA	Granted	US6175558	1/16/2001	Cdma radio multiplex transmitting device and a cdma radio multiplex receiving device	US09/000947	12/30/1997

Pana-47	USA	Granted	US6301237	10/9/2001	Cdma radio multiplex transmitting device and a cdma radio multiplex receiving device	US09/562921	5/2/2000
Pana-47	USA	Granted	US6529492	3/4/2003	Cdma radio multiplex transmitting device and a cdma radio multiplex receiving device	US09/562922	5/2/2000
Pana-47	USA	Granted	US6370131	4/9/2002	Cdma radio multiplex transmitting device and a cdma radio multiplex receiving device	US09/576250	5/24/2000
Pana-47	USA	Granted	US6584088	6/24/2003	Cdma radio multiplex transmitting device and cdma radio multiplex receiving device	US09/825998	4/5/2001
Pana-47	USA	Granted	US6549526	4/15/2003	Cdma radio multiplex transmitting device and a cdma multiplex receiving device	US09/826005	4/5/2001
Pana-47	USA	Granted	US7136367	11/14/2006	Cdma radio multiplex transmitting device and a cdma radio multiplex receiving device	US10/335916	1/3/2003

Pana-47	USA	Granted	USRE41444	7/20/2010	Cdma radio multiplex transmitting device and a cdma radio multiplex receiving device	US12/270499	11/13/2008
Pana-48	USA	Granted	US6295301	9/25/2001	Pn code generating apparatus and mobile radio communication system	US09/139325	8/25/1998
Pana-48	USA	Granted	US6697384	2/24/2004	Method and apparatus for calculating a state of starting a pn code generating operation	US09/916284	7/30/2001
Pana-49	USA	Granted	US6466563	10/15/2002	Cdma mobile station and cdma transmission method	US10/147831	3/16/1999
Pana-49	USA	Lapsed	US20030007472	1/9/2003	Cdma mobile station apparatus and cdma transmission method	10235918	9/6/2002
Pana-50	USA	Granted	US6370134	4/9/2002	Cdma radio communication apparatus	US09/115502	7/15/1998
Pana-50	USA	Granted	US7035233	4/25/2006	Radio communication terminal apparatus and radio communication base station apparatus	US10/014352	12/14/2001

Pana-50	USA	Granted	US7535864	5/19/2009	Radio communication terminal apparatus and radio communication base station apparatus	US11/372152	3/10/2006
WCDMA (pool) 01	USA	Granted	US5677929	10/14/1997	Automobile on-board and/or portable telephone system	US08/272156	7/8/1994
WCDMA (pool) 01	USA	Granted	USRE37420	10/23/2001	Automobile on-board and/or portable telephone system	US09/337403	6/21/1999
WCDMA (pool) 01	USA	Granted	USRE39954	12/25/2007	Automobile on-board and/or portable telephone system	US09/887042	6/25/2001
WCDMA (pool) 07	USA	Granted	US6738646	5/18/2004	Base station device and method for communication	US10/069267	2/25/2002
WCDMA (pool) 07	USA	Lapsed	US20030087644	5/8/2003	Communication terminal apparatus and base station apparatus	10322425	12/19/2002
WCDMA (pool) 07	USA	Granted	US7460880	12/2/2008	Communication terminal apparatus and base station apparatus	US11/341430	1/30/2006
WCDMA (pool) 07	USA	Granted	US7761113	7/20/2010	Communication terminal apparatus and base station apparatus	US12/132992	6/4/2008

WCDMA (pool) 09	USA	Granted	US6760590	7/6/2004	Communication terminal apparatus, base station apparatus, and radio communication method	US10/089605	4/1/2002
WCDMA (pool) 09	USA	Granted	US6799053	9/28/2004	Communication terminal apparatus	US10/321500	12/18/2002
WCDMA (pool) 09	USA	Granted	US7206587	4/17/2007	Communication terminal apparatus, base station apparatus, and radio communication method	US10/321623	12/18/2002

PATENT ASSIGNMENT COVER SHEET

Electronic Version v1.1
 Stylesheet Version v1.2

EPAS ID: PAT2704390

SUBMISSION TYPE:	NEW ASSIGNMENT
NATURE OF CONVEYANCE:	SECURITY AGREEMENT

CONVEYING PARTY DATA	
Name	Execution Date
INVENTERGY, INC.	01/28/2014

RECEIVING PARTY DATA	
Name:	HUDSON BAY IP OPPORTUNITIES MASTER FUND, LP, AS COLLATERAL AGENT
Street Address:	777 THIRD AVENUE
Internal Address:	30TH FLOOR
City:	NEW YORK
State/Country:	NEW YORK
Postal Code:	10017

PROPERTY NUMBERS Total: 111

Property Type	Number
Patent Number:	6726297
Patent Number:	8009549
Patent Number:	8416810
Patent Number:	7646702
Patent Number:	8238226
Patent Number:	7593317
Patent Number:	7929627
Patent Number:	7826557
Patent Number:	7792084
Patent Number:	8064393
Patent Number:	8270332
Patent Number:	8582573
Patent Number:	6400929
Patent Number:	6381445

Patent Number:	6366763
Patent Number:	6370359
Patent Number:	6487394
Patent Number:	6597894
Patent Number:	6505035
Patent Number:	6973289
Patent Number:	6611676
Patent Number:	7636551
Patent Number:	6637001
Patent Number:	6813323
Patent Number:	6734810
Patent Number:	6940428
Patent Number:	6922159
Patent Number:	6069884
Patent Number:	6119004
Patent Number:	6069924
Patent Number:	6636723
Patent Number:	6628630
Patent Number:	6404778
Patent Number:	6611509
Patent Number:	6807162
Patent Number:	6973065
Patent Number:	7778224
Patent Number:	6765894
Patent Number:	7656844
Patent Number:	8437316
Patent Number:	6839335
Patent Number:	7072416
Patent Number:	7760815
Patent Number:	6868056
Patent Number:	6944208
Patent Number:	6781973
Patent Number:	7145886
Patent Number:	6847828
Patent Number:	7386321

	7266118
Patent Number:	7133379
Patent Number:	7392019
Patent Number:	7339949
Patent Number:	7702025
Patent Number:	7460502
Patent Number:	7269774
Patent Number:	7385934
Patent Number:	7114121
Patent Number:	7162206
Patent Number:	7746762
Patent Number:	7693140
Patent Number:	7299027
Patent Number:	7251469
Patent Number:	7764711
Patent Number:	8086270
Patent Number:	7848439
Patent Number:	8175604
Patent Number:	7860184
Patent Number:	8073070
Patent Number:	8249132
Patent Number:	8576784
Patent Number:	8218681
Patent Number:	8249178
Patent Number:	5583851
Patent Number:	5873027
Patent Number:	6336040
Patent Number:	5757870
Patent Number:	5818869
Patent Number:	6175558
Patent Number:	6301237
Patent Number:	6529492
Patent Number:	6370131
Patent Number:	6584088
Patent Number:	6549526

	7136367
Patent Number:	RE41444
Patent Number:	6295301
Patent Number:	6697384
Patent Number:	6466563
Patent Number:	6370134
Patent Number:	7035233
Patent Number:	7535864
Patent Number:	5677929
Patent Number:	RE37420
Patent Number:	RE39954
Patent Number:	6738646
Patent Number:	7460880
Patent Number:	7761113
Patent Number:	6760590
Patent Number:	6799053
Patent Number:	7206587
Application Number:	10901380
Application Number:	11134448
Application Number:	10419089
Application Number:	11859550
Application Number:	11575015
Application Number:	13478996
Application Number:	13532576
Application Number:	13554748
Application Number:	10235918
Application Number:	10322425

CORRESPONDENCE DATA

Fax Number:

Phone: 4089737896

Email: paul@inventergy.com

Correspondence will be sent via US Mail when the email attempt is unsuccessful.

Correspondent Name: WAYNE P. SOBON

Address Line 1: 19925 STEVENS CREEK BOULEVARD

Address Line 2: SUITE 100

Address Line 4: CUPERTINO, CALIFORNIA 95014

WAYNE P. SOBON

Signature:

/Wayne P. Sobon/

Date:

01/29/2014

This document serves as an Oath/Declaration (37 CFR 1.63).

Total Attachments: 18

source=Hudson Security 2d priority in patents from Panasonic (2014-01-28US) executed#page1.tif
source=Hudson Security 2d priority in patents from Panasonic (2014-01-28US) executed#page2.tif
source=Hudson Security 2d priority in patents from Panasonic (2014-01-28US) executed#page3.tif
source=Hudson Security 2d priority in patents from Panasonic (2014-01-28US) executed#page4.tif
source=Hudson Security 2d priority in patents from Panasonic (2014-01-28US) executed#page5.tif
source=Hudson Security 2d priority in patents from Panasonic (2014-01-28US) executed#page6.tif
source=Hudson Security 2d priority in patents from Panasonic (2014-01-28US) executed#page7.tif
source=Hudson Security 2d priority in patents from Panasonic (2014-01-28US) executed#page8.tif
source=Hudson Security 2d priority in patents from Panasonic (2014-01-28US) executed#page9.tif
source=Hudson Security 2d priority in patents from Panasonic (2014-01-28US) executed#page10.tif
source=Hudson Security 2d priority in patents from Panasonic (2014-01-28US) executed#page11.tif
source=Hudson Security 2d priority in patents from Panasonic (2014-01-28US) executed#page12.tif
source=Hudson Security 2d priority in patents from Panasonic (2014-01-28US) executed#page13.tif
source=Hudson Security 2d priority in patents from Panasonic (2014-01-28US) executed#page14.tif
source=Hudson Security 2d priority in patents from Panasonic (2014-01-28US) executed#page15.tif
source=Hudson Security 2d priority in patents from Panasonic (2014-01-28US) executed#page16.tif
source=Hudson Security 2d priority in patents from Panasonic (2014-01-28US) executed#page17.tif
source=Hudson Security 2d priority in patents from Panasonic (2014-01-28US) executed#page18.tif

ASSIGNMENT FOR SECURITY
PATENTS

WHEREAS, **Inventergy, Inc.** (the "Assignor") holds all right, title and interest in the letter patents, design patents and utility patents listed on the annexed Schedule 1, which patents are issued or applied for in the United States Patent and Trademark Office (the "Patents");

WHEREAS, the Assignor has entered into a Pledge and Security Agreement, dated as of May 10, 2013 (as amended, restated or otherwise modified from time to time the "Security Agreement"), in favor of **Hudson Bay IP Opportunities Master Fund, LP**, as collateral agent for certain buyers (the "Assignee");

WHEREAS, the Assignor has entered into a Secured Promissory Note, dated as of December 19, 2013 (as amended, restated or otherwise modified from time to time the "Secured Promissory Note"), in favor of **Joseph Beyers** ("Beyers"), as Permitted Indebtedness under the Security Agreement for the purchase of the Patents;

WHEREAS, the Assignor has assigned a continuing first priority security interest in favor of Beyers as a Permitted Lien under the Security Agreement; and

WHEREAS, pursuant to the Security Agreement, the Assignor has assigned to the Assignee and granted to the Assignee for the benefit of the Buyers (as defined in the Security Agreement) a **continuing second priority security interest**, expressly subject to that first priority security interest in favor of Beyers, in all right, title and interest of the Assignor in, to and under the Patents and the applications and registrations thereof, and all proceeds thereof, including, without limitation, any and all causes of action which may exist by reason of infringement thereof and any and all damages arising from past, present and future violations thereof (the "Collateral"), to secure the payment, performance and observance of the "Obligations" (as defined in the Security Agreement).

NOW, THEREFORE, for good and valuable consideration, the receipt and sufficiency of which are hereby acknowledged, the Assignor does hereby pledge, convey, sell, assign, transfer and set over unto the Assignee and grants to the Assignee for the benefit of the Buyers a **continuing second priority security interest**, expressly subject to a first priority security interest in favor of Joseph Beyers, in the Collateral to secure the prompt payment, performance and for the benefit of the Buyers observance of the Obligations.

The Assignor does hereby further acknowledge and affirm that the rights and remedies of the Assignee with respect to the Collateral are more fully set forth in the Security Agreement, the terms and provisions of which are hereby incorporated herein by reference as if fully set forth herein.

IN WITNESS WHEREOF, the Assignor has caused this Assignment to be
duly executed by its officer thereunto duly authorized as of January 28, 2014.

Inventergy, Inc.

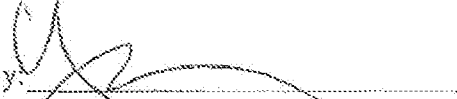
By: 
Name: Wayne P. Sobon
Title: SVP and General Counsel

SCHEDULE 1 TO ASSIGNMENT FOR SECURITY

Patents and Patent Applications
Owned by: Inventergy, Inc.

Internal Family ID	Country	Inventergy Understood status 1/14/2014	Publication Number	Publication Date	Title	Application Number	File Date
Inv-01	USA	Granted	US6726297	4/27/2004	Ofdma signal transmission apparatus and method	US10/462491	1/20/2000
Inv-03	USA	Granted	US8009549	8/30/2011	Carrier allocation method in multi cell orthogonal frequency division multiple access system	US12/092950	11/16/2006
Inv-04	USA	Granted	US8416810	4/9/2013	Radio communication base station apparatus and pilot transmission method	US12/160872	1/18/2007
Inv-08	USA	Granted	US7646702	1/12/2010	Ofdm communication apparatus	US10/169716	7/9/2002
Inv-08	USA	Granted	US8238236	8/7/2012	Ofdm communication apparatus	US12/505420	7/17/2009
Inv-09	USA	Granted	US7593317	9/22/2009	Radio base station apparatus	US10/503010	7/29/2004
Inv-15	USA	Granted	US7929627	4/19/2011	Ofdm receiver, integrated circuit and receiving method	US11/885042	2/28/2006

Inv-16	USA	Granted	US7826557	11/2/2010	Retransmitting method and transmitting method in multi-antenna transmission	US11/721911	12/14/2005
Inv-21	USA	Granted	US7792084	9/7/2010	Mimo antenna apparatus controlling number of streams and modulation and demodulation method	US11/892886	8/28/2007
Inv-23	USA	Granted	US8064393	11/22/2011	Wireless communication base station apparatus and wireless communication method in multicarrier communication	US11/997841	8/4/2006
Inv-26	USA	Granted	US8270332	9/18/2012	Wireless communication base station device and wireless communication method	US12/377373	10/12/2007
Inv-26	USA	Granted	US8582573	12/13/2012	Radio communication base station apparatus and radio communication method	US13/590841	8/21/2012
Pana-01	USA	Granted	US6400929	6/4/2002	Radio communication device and method of controlling transmission rate	US09/424843	12/6/1999

Pana-01	USA	Granted	US6381445	4/30/2002	Radio communication device and method of controlling transmission rate	US09/648742	8/28/2000
Pana-01	USA	Granted	US6366763	4/2/2002	Radio communication device and method of controlling transmission rate	US09/648756	8/28/2000
Pana-01	USA	Granted	US6370359	4/9/2002	Radio communication device and method of controlling transmission rate	US09/648757	8/28/2000
Pana-01	USA	Granted	US6487394	11/26/2002	Radio communication device and method of controlling transmission rate	US09/649003	8/28/2000
Pana-01	USA	Granted	US6597894	7/22/2003	Radio communication device and method of controlling transmission rate	US09/649006	8/28/2000
Pana-01	USA	Granted	US6505035	1/7/2003	Radio communication apparatus and transmission rate control method	US10/052261	1/23/2002
Pana-01	USA	Granted	US6973289	12/6/2005	Radio communication device and method of controlling transmission rate	US10/057897	1/29/2002

Pana-01	USA	Granted	US6611675	8/26/2003	Radio communication apparatus and transmission rate control method	US10/083553	2/27/2002
Pana-01	USA	Granted	US7636551	12/22/2009	Radio communication device and method of controlling transmission rate	US11/228339	9/19/2005
Pana-02	USA	Granted	US6637001	10/21/2003	Apparatus and method for image/voice transmission	US09/650743	8/30/2000
Pana-03	USA	Granted	US6813323	11/2/2004	Decoding method and communication terminal apparatus	US10/182270	7/25/2002
Pana-03	USA	Lapsed	US20050002477	1/6/2005	Decoding apparatus and decoding method	10901380	7/29/2004
Pana-04	USA	Granted	US6734810	5/11/2004	Apparatus and method for decoding	US10/221267	9/10/2002
Pana-04	USA	Granted	US6940428	9/6/2005	Apparatus and method for decoding	US10/793737	3/8/2004
Pana-04	USA	Granted	US6922159	7/26/2005	Apparatus and method for decoding	US10/793766	3/8/2004
Pana-04	USA	Lapsed	US20050219071	10/6/2005	Apparatus and method for decoding	11134448	5/23/2005

Pana-05	USA	Granted	US6069884	5/30/2000	Method of communication between a base station and a plurality of mobile unit communication apparatus, a base station, and mobile unit communication apparatus	US08/937005	9/24/1997
Pana-06	USA	Granted	US6119004	9/12/2000	Base station equipment for mobile communication	US09/068541	5/13/1998
Pana-07	USA	Granted	US6069924	5/30/2000	Differential detector with error correcting function	US09/027510	2/20/1998
Pana-08	USA	Granted	US6636723	10/21/2003	Cdma radio communication system using chip interleaving	US09/359020	7/22/1999
Pana-08	USA	Lapsed	US20040048578	3/11/2004	Cdma radio transmission apparatus, cdma radio reception apparatus, and cdma radio communication method	10419089	4/21/2003
Pana-09	USA	Granted	US6628630	9/30/2003	Spread spectrum communication method	US09/058881	4/13/1998
Pana-10	USA	Granted	US6404778	6/11/2002	Radio communication apparatus	US09/159602	9/24/1998

Pana-11	USA	Granted	US6611509	8/26/2003	Cdma/tdd mobile communication system and method	US09/264826	3/9/1999
Pana-11	USA	Granted	US6807162	10/19/2004	Cdma/tdd mobile communication system and method	US10/166268	6/11/2002
Pana-11	USA	Granted	US6973065	12/6/2005	Cdma/tdd mobile communication system and method	US10/419733	4/22/2003
Pana-11	USA	Granted	US7778224	8/17/2010	Cdma/tdd mobile communication system and method	US10/885684	7/8/2004
Pana-12	USA	Granted	US6765894	7/20/2004	Communication terminal apparatus and base station apparatus	US09/606906	6/30/2000
Pana-12	USA	Granted	US7656844	2/2/2010	Radio transmission apparatus and radio reception apparatus in a cdma communication system	US10/868029	6/16/2004
Pana-12	USA	Granted	US8437316	5/7/2013	Radio transmission apparatus and radio reception apparatus in a cdma communication system	US12/641177	12/17/2009

Pana-13	USA	Granted	US6839335	1/4/2005	Radio communication apparatus and radio communication method	US09/605862	6/29/2000
Pana-14	USA	Granted	US7072416	7/4/2006	Transmitting/receiving device and transmitting/receiving method	US09/582558	6/29/2000
Pana-14	USA	Granted	US7760815	7/20/2010	Apparatus and method for transmission/reception	US11/431606	5/11/2006
Pana-15	USA	Granted	US6868056	3/15/2005	Apparatus and method for ofdm communication	US09/635096	8/9/2000
Pana-16	USA	Granted	US6944208	9/13/2005	Interference signal canceling apparatus and interference signal canceling method	US09/936727	9/17/2001
Pana-17	USA	Granted	US6781973	8/24/2004	Combined signaling and sir inner-loop power control	US09/538888	3/30/2000
Pana-18	USA	Granted	US7145886	12/5/2006	Communication terminal, base station system, and method of controlling transmission power	US09/889919	7/25/2001
Pana-19	USA	Granted	US6847828	1/25/2005	Base station apparatus and radio communication method	US10/069484	2/27/2002

Pana-19	USA	Granted	US7386321	6/10/2008	Base station apparatus and radio communication method	US10/793738	3/8/2004
Pana-20	USA	Granted	US7266118	9/4/2007	Packet receiving apparatus and packet transmission method	US10/143989	5/14/2002
Pana-21	USA	Granted	US7133379	11/7/2006	Wireless communication system, and base station apparatus and communication terminal apparatus accommodated in the system	US10/181349	7/17/2002
Pana-22	USA	Granted	US7392019	6/24/2008	Wireless base station apparatus and wireless communication method	US11/053837	2/10/2005
Pana-23	USA	Granted	US7339949	3/4/2008	Arq transmission and reception methods and apparatus	US10/222989	8/19/2002
Pana-24	USA	Granted	US7702025	4/20/2010	Transmission/reception apparatus and transmission/reception method	US10/487574	2/25/2004
Pana-25	USA	Granted	US7460502	12/2/2008	Scheduling creation apparatus, base station apparatus, and radio communication method	US10/250487	7/3/2003

Pana-26	USA	Granted	US7269774	9/11/2007	Data receiving apparatus, data transmitting apparatus and retransmission request method	US10/484951	1/28/2004
Pana-27	USA	Granted	US7385934	6/10/2008	Radio communication apparatus and transfer rate decision method	US10/476845	11/6/2003
Pana-28	USA	Granted	US7114121	9/26/2006	Rate matching device and rate matching method	US10/478139	11/20/2003
Pana-29	USA	Granted	US7162206	1/9/2007	Test apparatus, mobile terminal apparatus, test method	US10/612289	7/3/2003
Pana-30	USA	Granted	US7746762	6/29/2010	Transmitting apparatus and transmitting method	US10/534987	5/16/2005
Pana-31	USA	Granted	US7693140	4/6/2010	Cdma transmitting apparatus and cdma receiving apparatus	US10/527199	3/10/2005
Pana-32	USA	Granted	US7299027	11/20/2007	Mimo receiver and mimo reception method for selection of mimo separation and channel variation compensation	US10/536010	5/23/2005
Pana-32	USA	Lapsed	US20080020802	1/24/2008	Wireless receiver and wireless reception method	11859550	9/21/2007

Pana-33	USA	Pending	US20070255993	11/1/2007	Automatic retransmission request control system and retransmission method in memo-ofdm system	11575015	3/30/2007
Pana-33	USA	Lapsed	US20120230257	9/13/2012	Retransmission method and transmitter	13478996	5/23/2012
Pana-33	USA	Lapsed	US20120263250	10/18/2012	Retransmission method, transmitter, and communication system	13532576	6/25/2012
Pana-33	USA	Lapsed	US20120287775	11/15/2012	Automatic retransmission request control system and retransmission method in mimo-ofdm system	13554748	7/20/2012
Pana-34	USA	Granted	US7251469	7/31/2007	Cdma transmitting apparatus and cdma transmitting method	US10/522980	2/2/2005
Pana-34	USA	Granted	US7764711	7/27/2010	Cdma transmission apparatus and cdma transmission method	US11/767124	6/22/2007
Pana-35	USA	Granted	US8086270	12/27/2011	Classifying-synthesizing transmission method of multi-user feedback information at base station	US11/574636	9/5/2005

Pana-36	USA	Granted	US7848439	12/7/2010	Communication apparatus, communication system, and communication method	US11/719611	11/18/2005
Pana-37	USA	Granted	US8175604	5/8/2012	Efficient rise over thermal (rot) control during soft handover	US10/588073	8/31/2005
Pana-38	USA	Granted	US7860184	12/28/2010	Multi-antenna communication method and multi-antenna communication apparatus	US11/813650	1/10/2006
Pana-39	USA	Granted	US8073070	12/6/2011	Multi-pilot generation method and detection method in multi-antenna communication system	US12/092944	11/22/2006
Pana-40	USA	Granted	US8249132	8/21/2012	Communication terminal and receiving method	US11/909425	3/3/2006
Pana-41	USA	Granted	US8576784	5/7/2009	Uplink resource allocation in a mobile communication system	US12/162592	11/2/2006
Pana-42	USA	Granted	US8218681	7/10/2012	Ofdm transmitter and ofdm receiver	US12/440894	3/11/2009
Pana-43	USA	Granted	US8249178	8/21/2012	Multicarrier transmitter and multicarrier receiver	US12/601804	5/25/2007

Pana-44	USA	Granted	US5583851	12/10/1996	Mobile communication apparatus having multi-codes allocating function	US08/272158	7/8/1994
Pana-45	USA	Granted	US5873027	2/16/1999	Mobile radio system with control over radio wave output if a malfunction is detected	US08/761552	12/6/1996
Pana-45	USA	Granted	US6336040	1/1/2002	Mobile radio system with control over radio wave output if a malfunction is detected	US09/207662	12/9/1998
Pana-46	USA	Granted	US5757870	5/26/1998	Spread spectrum communication synchronizing method and its circuit	US08/517408	8/21/1995
Pana-46	USA	Granted	US5818869	10/6/1998	Spread spectrum communication synchronizing method and its circuit	US08/858146	5/15/1997
Pana-47	USA	Granted	US6175558	1/16/2001	Cdma radio multiplex transmitting device and a cdma radio multiplex receiving device	US09/000947	12/30/1997

Pana-47	USA	Granted	US6301237	10/9/2001	Cdma radio multiplex transmitting device and a cdma radio multiplex receiving device	US09/562921	5/2/2000
Pana-47	USA	Granted	US6529492	3/4/2003	Cdma radio multiplex transmitting device and a cdma radio multiplex receiving device	US09/562922	5/2/2000
Pana-47	USA	Granted	US6370131	4/9/2002	Cdma radio multiplex transmitting device and a cdma radio multiplex receiving device	US09/576250	5/24/2000
Pana-47	USA	Granted	US6584088	6/24/2003	Cdma radio multiplex transmitting device and cdma radio multiplex receiving device	US09/825998	4/5/2001
Pana-47	USA	Granted	US6549526	4/15/2003	Cdma radio multiplex transmitting device and a cdma multiplex receiving device	US09/826005	4/5/2001
Pana-47	USA	Granted	US7136367	11/14/2006	Cdma radio multiplex transmitting device and a cdma radio multiplex receiving device	US10/335916	1/3/2003

Pana-47	USA	Granted	USRE41444	7/20/2010	Cdma radio multiplex transmitting device and a cdma radio multiplex receiving device	US12/270499	11/13/2008
Pana-48	USA	Granted	US6295301	9/25/2001	Pn code generating apparatus and mobile radio communication system	US09/139325	8/25/1998
Pana-48	USA	Granted	US6697384	2/24/2004	Method and apparatus for calculating a state of starting a pn code generating operation	US09/916284	7/30/2001
Pana-49	USA	Granted	US6466563	10/15/2002	Cdma mobile station and cdma transmission method	US10/147831	3/16/1999
Pana-49	USA	Lapsed	US20030007472	1/9/2003	Cdma mobile station apparatus and cdma transmission method	10235918	9/6/2002
Pana-50	USA	Granted	US6370134	4/9/2002	Cdma radio communication apparatus	US09/115502	7/15/1998
Pana-50	USA	Granted	US7035233	4/25/2006	Radio communication terminal apparatus and radio communication base station apparatus	US10/014352	12/14/2001

Pana-50	USA	Granted	US7535864	5/19/2009	Radio communication terminal apparatus and radio communication base station apparatus	US11/372152	3/10/2006
WCDMA (pool) 01	USA	Granted	US5677929	10/14/1997	Automobile on-board and/or portable telephone system	US08/272156	7/8/1994
WCDMA (pool) 01	USA	Granted	USRE37420	10/23/2001	Automobile on-board and/or portable telephone system	US09/337403	6/21/1999
WCDMA (pool) 01	USA	Granted	USRE39954	12/25/2007	Automobile on-board and/or portable telephone system	US09/887042	6/25/2001
WCDMA (pool) 07	USA	Granted	US6738646	5/18/2004	Base station device and method for communication	US10/069267	2/25/2002
WCDMA (pool) 07	USA	Lapsed	US20030087644	5/8/2003	Communication terminal apparatus and base station apparatus	10322425	12/19/2002
WCDMA (pool) 07	USA	Granted	US7460880	12/2/2008	Communication terminal apparatus and base station apparatus	US11/341430	1/30/2006
WCDMA (pool) 07	USA	Granted	US7761113	7/20/2010	Communication terminal apparatus and base station apparatus	US12/132992	6/4/2008

WCDMA (pool) 09	USA	Granted	US6760590	7/6/2004	Communication terminal apparatus, base station apparatus, and radio communication method	US10/089605	4/1/2002
WCDMA (pool) 09	USA	Granted	US6799053	9/28/2004	Communication terminal apparatus	US10/321500	12/18/2002
WCDMA (pool) 09	USA	Granted	US7206587	4/17/2007	Communication terminal apparatus, base station apparatus, and radio communication method	US10/321623	12/18/2002

PATENT ASSIGNMENT COVER SHEET

Electronic Version v1.1
 Stylesheet Version v1.2

EPAS ID: PAT2699760

SUBMISSION TYPE:	NEW ASSIGNMENT
NATURE OF CONVEYANCE:	SECURITY AGREEMENT

CONVEYING PARTY DATA	
Name	Execution Date
INVENTERGY, INC.	12/19/2013

RECEIVING PARTY DATA	
Name:	JOSEPH BEYERS
Street Address:	19925 STEVENS CREEK BOULEVARD
Internal Address:	SUITE 100
City:	CUPERTINO
State/Country:	CALIFORNIA
Postal Code:	95014

PROPERTY NUMBERS Total: 111	
Property Type	Number
Patent Number:	6726297
Patent Number:	8009549
Patent Number:	8416810
Patent Number:	7646702
Patent Number:	8238226
Patent Number:	7593317
Patent Number:	7929627
Patent Number:	7826557
Patent Number:	7792084
Patent Number:	8064393
Patent Number:	8270332
Patent Number:	8582573
Patent Number:	6400929
Patent Number:	6381445

Patent Number:	6366763
Patent Number:	6370359
Patent Number:	6487394
Patent Number:	6597894
Patent Number:	6505035
Patent Number:	6973289
Patent Number:	6611676
Patent Number:	7636551
Patent Number:	6637001
Patent Number:	6813323
Patent Number:	6734810
Patent Number:	6940428
Patent Number:	6922159
Patent Number:	6069884
Patent Number:	6119004
Patent Number:	6069924
Patent Number:	6636723
Patent Number:	6628630
Patent Number:	6404778
Patent Number:	6611509
Patent Number:	6807162
Patent Number:	6973065
Patent Number:	7778224
Patent Number:	6765894
Patent Number:	7656844
Patent Number:	8437316
Patent Number:	6839335
Patent Number:	7072416
Patent Number:	7760815
Patent Number:	6868056
Patent Number:	6944208
Patent Number:	6781973
Patent Number:	7145886
Patent Number:	6847828
Patent Number:	7386321

	7266118
Patent Number:	7133379
Patent Number:	7392019
Patent Number:	7339949
Patent Number:	7702025
Patent Number:	7460502
Patent Number:	7269774
Patent Number:	7385934
Patent Number:	7114121
Patent Number:	7162206
Patent Number:	7746762
Patent Number:	7693140
Patent Number:	7299027
Patent Number:	7251469
Patent Number:	7764711
Patent Number:	8086270
Patent Number:	7848439
Patent Number:	8175604
Patent Number:	7860184
Patent Number:	8073070
Patent Number:	8249132
Patent Number:	8576784
Patent Number:	8218681
Patent Number:	8249178
Patent Number:	5583851
Patent Number:	5873027
Patent Number:	6336040
Patent Number:	5757870
Patent Number:	5818869
Patent Number:	6175558
Patent Number:	6301237
Patent Number:	6529492
Patent Number:	6370131
Patent Number:	6584088
Patent Number:	6549526

	7136367
Patent Number:	RE41444
Patent Number:	6295301
Patent Number:	6697384
Patent Number:	6466563
Patent Number:	6370134
Patent Number:	7035233
Patent Number:	7535864
Patent Number:	5677929
Patent Number:	RE37420
Patent Number:	RE39954
Patent Number:	6738646
Patent Number:	7460880
Patent Number:	7761113
Patent Number:	6760590
Patent Number:	6799053
Patent Number:	7206587
Application Number:	10901380
Application Number:	11134448
Application Number:	10419089
Application Number:	11859550
Application Number:	11575015
Application Number:	13478996
Application Number:	13532576
Application Number:	13554748
Application Number:	10235918
Application Number:	10322425

CORRESPONDENCE DATA

Fax Number:

Phone: 4089737896

Email: wayne@inventergy.com

Correspondence will be sent via US Mail when the email attempt is unsuccessful.

Correspondent Name: WAYNE P. SOBON

Address Line 1: 19925 STEVENS CREEK BOULEVARD

Address Line 2: SUITE 100

Address Line 4: CUPERTINO, CALIFORNIA 95014

WAYNE P. SOBON

Signature:

/Wayne P. Sobon/

Date:

01/27/2014

This document serves as an Oath/Declaration (37 CFR 1.63).

Total Attachments: 18

source=ASSIGNMENT FOR SECURITY BEYERS-PANASONIC PATENTS (2014-01-27-1553) WPS executed#page1.tif
source=ASSIGNMENT FOR SECURITY BEYERS-PANASONIC PATENTS (2014-01-27-1553) WPS executed#page2.tif
source=ASSIGNMENT FOR SECURITY BEYERS-PANASONIC PATENTS (2014-01-27-1553) WPS executed#page3.tif
source=ASSIGNMENT FOR SECURITY BEYERS-PANASONIC PATENTS (2014-01-27-1553) WPS executed#page4.tif
source=ASSIGNMENT FOR SECURITY BEYERS-PANASONIC PATENTS (2014-01-27-1553) WPS executed#page5.tif
source=ASSIGNMENT FOR SECURITY BEYERS-PANASONIC PATENTS (2014-01-27-1553) WPS executed#page6.tif
source=ASSIGNMENT FOR SECURITY BEYERS-PANASONIC PATENTS (2014-01-27-1553) WPS executed#page7.tif
source=ASSIGNMENT FOR SECURITY BEYERS-PANASONIC PATENTS (2014-01-27-1553) WPS executed#page8.tif
source=ASSIGNMENT FOR SECURITY BEYERS-PANASONIC PATENTS (2014-01-27-1553) WPS executed#page9.tif
source=ASSIGNMENT FOR SECURITY BEYERS-PANASONIC PATENTS (2014-01-27-1553) WPS executed#page10.tif
source=ASSIGNMENT FOR SECURITY BEYERS-PANASONIC PATENTS (2014-01-27-1553) WPS executed#page11.tif
source=ASSIGNMENT FOR SECURITY BEYERS-PANASONIC PATENTS (2014-01-27-1553) WPS executed#page12.tif
source=ASSIGNMENT FOR SECURITY BEYERS-PANASONIC PATENTS (2014-01-27-1553) WPS executed#page13.tif
source=ASSIGNMENT FOR SECURITY BEYERS-PANASONIC PATENTS (2014-01-27-1553) WPS executed#page14.tif
source=ASSIGNMENT FOR SECURITY BEYERS-PANASONIC PATENTS (2014-01-27-1553) WPS executed#page15.tif
source=ASSIGNMENT FOR SECURITY BEYERS-PANASONIC PATENTS (2014-01-27-1553) WPS executed#page16.tif
source=ASSIGNMENT FOR SECURITY BEYERS-PANASONIC PATENTS (2014-01-27-1553) WPS executed#page17.tif
source=ASSIGNMENT FOR SECURITY BEYERS-PANASONIC PATENTS (2014-01-27-1553) WPS executed#page18.tif

ASSIGNMENT FOR SECURITY
PATENTS

WHEREAS, **Inventergy, Inc.** (the "Assignor") holds all right, title and interest in the letter patents, design patents and utility patents listed on the annexed Schedule 1, which patents are issued or applied for (the "Patents");

WHEREAS, the Assignor has entered into a Secured Promissory Note, dated as of December 19, 2013 (as amended, restated or otherwise modified from time to time the "Secured Promissory Note"), in favor of **Joseph Beyers** (the "Assignee");

WHEREAS, pursuant to the Secured Promissory Note, the Assignor has assigned to the Assignee and granted to the Assignee a **first priority security interest** in all right, title and interest of the Assignor in, to and under the Patents and the applications and registrations thereof, and all proceeds thereof, including, without limitation, any and all causes of action which may exist by reason of infringement thereof and any and all damages arising from past, present and future violations thereof (the "Collateral"), to secure the payment, performance and observance of the "Obligations" (as defined in "Section 2. Secured Obligation" in the Secured Promissory Note);

NOW, THEREFORE, for good and valuable consideration, the receipt and sufficiency of which are hereby acknowledged, the Assignor does hereby pledge, convey, sell, assign, transfer and set over unto the Assignee and grants to the Assignee a **first priority security interest** in the Collateral to secure the prompt payment, performance and for the benefit of the Buyers observance of the Obligations.

The Assignor does hereby further acknowledge and affirm that the rights and remedies of the Assignee with respect to the Collateral are more fully set forth in the Secured Promissory Note, the terms and provisions of which are hereby incorporated herein by reference as if fully set forth herein.

IN WITNESS WHEREOF, the Assignor has caused this Assignment to be
duly executed by its officer thereunto duly authorized as of January 24, 2014.

Inventergy, Inc.

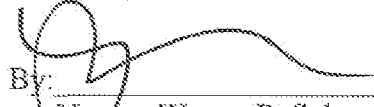
By: 
Name: Wayne P. Sobon
Title: SVP and General Counsel

SCHEDULE 1 TO ASSIGNMENT FOR SECURITY

Patents and Patent Applications
Owned by: Inventergy, Inc.

Internal Family ID	Country	Inventergy Understood status 1/14/2014	Publication Number	Publication Date	Title	Application Number	File Date
Inv-01	USA	Granted	US6726297	4/27/2004	Ofdma signal transmission apparatus and method	US10/462491	1/20/2000
Inv-03	USA	Granted	US8009549	8/30/2011	Carrier allocation method in multi cell orthogonal frequency division multiple access system	US12/092950	11/16/2006
Inv-04	USA	Granted	US8416810	4/9/2013	Radio communication base station apparatus and pilot transmission method	US12/160872	1/18/2007
Inv-08	USA	Granted	US7646702	1/12/2010	Ofdm communication apparatus	US10/169716	7/9/2002
Inv-08	USA	Granted	US8238226	8/7/2012	Ofdm communication apparatus	US12/505420	7/17/2009
Inv-09	USA	Granted	US7593317	9/22/2009	Radio base station apparatus	US10/503010	7/29/2004
Inv-15	USA	Granted	US7929627	4/19/2011	Ofdm receiver, integrated circuit and receiving method	US11/885042	2/28/2006

Inv-16	USA	Granted	US7826557	11/2/2010	Retransmitting method and transmitting method in multi-antenna transmission	US11/721911	12/14/2005
Inv-21	USA	Granted	US7792084	9/7/2010	Mimo antenna apparatus controlling number of streams and modulation and demodulation method	US11/892886	8/28/2007
Inv-23	USA	Granted	US8064393	11/22/2011	Wireless communication base station apparatus and wireless communication method in multicarrier communication	US11/997841	8/4/2006
Inv-26	USA	Granted	US8270332	9/18/2012	Wireless communication base station device and wireless communication method	US12/377373	10/12/2007
Inv-26	USA	Granted	US8582573	12/13/2012	Radio communication base station apparatus and radio communication method	US13/590841	8/21/2012
Pana-01	USA	Granted	US6400929	6/4/2002	Radio communication device and method of controlling transmission rate	US09/424843	12/6/1999

Pana-01	USA	Granted	US6381445	4/30/2002	Radio communication device and method of controlling transmission rate	US09/648742	8/28/2000
Pana-01	USA	Granted	US6366763	4/2/2002	Radio communication device and method of controlling transmission rate	US09/648756	8/28/2000
Pana-01	USA	Granted	US6370359	4/9/2002	Radio communication device and method of controlling transmission rate	US09/648757	8/28/2000
Pana-01	USA	Granted	US6487394	11/26/2002	Radio communication device and method of controlling transmission rate	US09/649003	8/28/2000
Pana-01	USA	Granted	US6597894	7/22/2003	Radio communication device and method of controlling transmission rate	US09/649006	8/28/2000
Pana-01	USA	Granted	US6505035	1/7/2003	Radio communication apparatus and transmission rate control method	US10/052261	1/23/2002
Pana-01	USA	Granted	US6973289	12/6/2005	Radio communication device and method of controlling transmission rate	US10/057897	1/29/2002

Pana-01	USA	Granted	US6611676	8/26/2003	Radio communication apparatus and transmission rate control method	US10/083553	2/27/2002
Pana-01	USA	Granted	US7636551	12/22/2009	Radio communication device and method of controlling transmission rate	US11/228339	9/19/2005
Pana-02	USA	Granted	US6637001	10/21/2003	Apparatus and method for image/voice transmission	US09/650743	8/30/2000
Pana-03	USA	Granted	US6813323	11/2/2004	Decoding method and communication terminal apparatus	US10/182270	7/25/2002
Pana-03	USA	Lapsed	US20050002477	1/6/2005	Decoding apparatus and decoding method	10901380	7/29/2004
Pana-04	USA	Granted	US6734810	5/11/2004	Apparatus and method for decoding	US10/221267	9/10/2002
Pana-04	USA	Granted	US6940428	9/6/2005	Apparatus and method for decoding	US10/793737	3/8/2004
Pana-04	USA	Granted	US6922159	7/26/2005	Apparatus and method for decoding	US10/793766	3/8/2004
Pana-04	USA	Lapsed	US20050219071	10/6/2005	Apparatus and method for decoding	11134448	5/23/2005

Pana-05	USA	Granted	US6069884	5/30/2000	Method of communication between a base station and a plurality of mobile unit communication apparatus, a base station, and mobile unit communication apparatus	US08/937005	9/24/1997
Pana-06	USA	Granted	US6119004	9/12/2000	Base station equipment for mobile communication	US09/068541	5/13/1998
Pana-07	USA	Granted	US6069924	5/30/2000	Differential detector with error correcting function	US09/027510	2/20/1998
Pana-08	USA	Granted	US6636723	10/21/2003	Cdma radio communication system using chip interleaving	US09/359020	7/22/1999
Pana-08	USA	Lapsed	US20040048578	3/11/2004	Cdma radio transmission apparatus, cdma radio reception apparatus, and cdma radio communication method	10419089	4/21/2003
Pana-09	USA	Granted	US6628630	9/30/2003	Spread spectrum communication method	US09/058881	4/13/1998
Pana-10	USA	Granted	US6404778	6/11/2002	Radio communication apparatus	US09/159602	9/24/1998

Pana-11	USA	Granted	US6611509	8/26/2003	Cdma/tdd mobile communication system and method	US09/264826	3/9/1999
Pana-11	USA	Granted	US6807162	10/19/2004	Cdma/tdd mobile communication system and method	US10/166268	6/11/2002
Pana-11	USA	Granted	US6973065	12/6/2005	Cdma/tdd mobile communication system and method	US10/419733	4/22/2003
Pana-11	USA	Granted	US7778224	8/17/2010	Cdma/tdd mobile communication system and method	US10/885684	7/8/2004
Pana-12	USA	Granted	US6765894	7/20/2004	Communication terminal apparatus and base station apparatus	US09/606906	6/30/2000
Pana-12	USA	Granted	US7656844	2/2/2010	Radio transmission apparatus and radio reception apparatus in a cdma communication system	US10/868029	6/16/2004
Pana-12	USA	Granted	US8437316	5/7/2013	Radio transmission apparatus and radio reception apparatus in a cdma communication system	US12/641177	12/17/2009

Pana-13	USA	Granted	US6839335	1/4/2005	Radio communication apparatus and radio communication method	US09/605862	6/29/2000
Pana-14	USA	Granted	US7072416	7/4/2006	Transmitting/receiving device and transmitting/receiving method	US09/582558	6/29/2000
Pana-14	USA	Granted	US7760815	7/20/2010	Apparatus and method for transmission/reception	US11/431606	5/11/2006
Pana-15	USA	Granted	US6868056	3/15/2005	Apparatus and method for ofdm communication	US09/635096	8/9/2000
Pana-16	USA	Granted	US6944208	9/13/2005	Interference signal canceling apparatus and interference signal canceling method	US09/936727	9/17/2001
Pana-17	USA	Granted	US6781973	8/24/2004	Combined signaling and sir inner-loop power control	US09/538888	3/30/2000
Pana-18	USA	Granted	US7145886	12/5/2006	Communication terminal, base station system, and method of controlling transmission power	US09/889919	7/25/2001
Pana-19	USA	Granted	US6847828	1/25/2005	Base station apparatus and radio communication method	US10/069484	2/27/2002

Pana-19	USA	Granted	US7386321	6/10/2008	Base station apparatus and radio communication method	US10/793738	3/8/2004
Pana-20	USA	Granted	US7266118	9/4/2007	Packet receiving apparatus and packet transmission method	US10/143989	5/14/2002
Pana-21	USA	Granted	US7133379	11/7/2006	Wireless communication system, and base station apparatus and communication terminal apparatus accommodated in the system	US10/181349	7/17/2002
Pana-22	USA	Granted	US7392019	6/24/2008	Wireless base station apparatus and wireless communication method	US11/053837	2/10/2005
Pana-23	USA	Granted	US7339949	3/4/2008	Arq transmission and reception methods and apparatus	US10/222989	8/19/2002
Pana-24	USA	Granted	US7702025	4/20/2010	Transmission/reception apparatus and transmission/reception method	US10/487574	2/25/2004
Pana-25	USA	Granted	US7460502	12/2/2008	Scheduling creation apparatus, base station apparatus, and radio communication method	US10/250487	7/3/2003

Pana-26	USA	Granted	US7269774	9/11/2007	Data receiving apparatus, data transmitting apparatus and retransmission request method	US10/484951	1/28/2004
Pana-27	USA	Granted	US7385934	6/10/2008	Radio communication apparatus and transfer rate decision method	US10/476845	11/6/2003
Pana-28	USA	Granted	US7114121	9/26/2006	Rate matching device and rate matching method	US10/478139	11/20/2003
Pana-29	USA	Granted	US7162206	1/9/2007	Test apparatus, mobile terminal apparatus, test method	US10/612289	7/3/2003
Pana-30	USA	Granted	US7746762	6/29/2010	Transmitting apparatus and transmitting method	US10/534987	5/16/2005
Pana-31	USA	Granted	US7693140	4/6/2010	Cdma transmitting apparatus and cdma receiving apparatus	US10/527199	3/10/2005
Pana-32	USA	Granted	US7299027	11/20/2007	Mimo receiver and mimo reception method for selection of mimo separation and channel variation compensation	US10/536010	5/23/2005
Pana-32	USA	Lapsed	US20080020802	1/24/2008	Wireless receiver and wireless reception method	11859550	9/21/2007

Pana-33	USA	Pending	US20070255993	11/1/2007	Automatic retransmission request control system and retransmission method in memo-ofdm system	11575015	3/30/2007
Pana-33	USA	Lapsed	US20120230257	9/13/2012	Retransmission method and transmitter	13478996	5/23/2012
Pana-33	USA	Lapsed	US20120263250	10/18/2012	Retransmission method, transmitter, and communication system	13532576	6/25/2012
Pana-33	USA	Lapsed	US20120287775	11/15/2012	Automatic retransmission request control system and retransmission method in mimo-ofdm system	13554748	7/20/2012
Pana-34	USA	Granted	US7251469	7/31/2007	Cdma transmitting apparatus and cdma transmitting method	US10/522980	2/2/2005
Pana-34	USA	Granted	US7764711	7/27/2010	Cdma transmission apparatus and cdma transmission method	US11/767124	6/22/2007
Pana-35	USA	Granted	US8086270	12/27/2011	Classifying-synthesizing transmission method of multi-user feedback information at base station	US11/574636	9/5/2005

Pana-36	USA	Granted	US7848439	12/7/2010	Communication apparatus, communication system, and communication method	US11/719611	11/18/2005
Pana-37	USA	Granted	US8175604	5/8/2012	Efficient rise over thermal (rot) control during soft handover	US10/588073	8/31/2005
Pana-38	USA	Granted	US7860184	12/28/2010	Multi-antenna communication method and multi-antenna communication apparatus	US11/813650	1/10/2006
Pana-39	USA	Granted	US8073070	12/6/2011	Multi-pilot generation method and detection method in multi-antenna communication system	US12/092944	11/22/2006
Pana-40	USA	Granted	US8249132	8/21/2012	Communication terminal and receiving method	US11/909425	3/3/2006
Pana-41	USA	Granted	US8576784	5/7/2009	Uplink resource allocation in a mobile communication system	US12/162592	11/2/2006
Pana-42	USA	Granted	US8218681	7/10/2012	Ofdm transmitter and ofdm receiver	US12/440894	3/11/2009
Pana-43	USA	Granted	US8249178	8/21/2012	Multicarrier transmitter and multicarrier receiver	US12/601804	5/25/2007

Pana-44	USA	Granted	US5583851	12/10/1996	Mobile communication apparatus having multi-codes allocating function	US08/272158	7/8/1994
Pana-45	USA	Granted	US5873027	2/16/1999	Mobile radio system with control over radio wave output if a malfunction is detected	US08/761552	12/6/1996
Pana-45	USA	Granted	US6336040	1/1/2002	Mobile radio system with control over radio wave output if a malfunction is detected	US09/207662	12/9/1998
Pana-46	USA	Granted	US5757870	5/26/1998	Spread spectrum communication synchronizing method and its circuit	US08/517408	8/21/1995
Pana-46	USA	Granted	US5818869	10/6/1998	Spread spectrum communication synchronizing method and its circuit	US08/858146	5/15/1997
Pana-47	USA	Granted	US6175558	1/16/2001	Cdma radio multiplex transmitting device and a cdma radio multiplex receiving device	US09/000947	12/30/1997

Pana-47	USA	Granted	US6301237	10/9/2001	Cdma radio multiplex transmitting device and a cdma radio multiplex receiving device	US09/562921	5/2/2000
Pana-47	USA	Granted	US6529492	3/4/2003	Cdma radio multiplex transmitting device and a cdma radio multiplex receiving device	US09/562922	5/2/2000
Pana-47	USA	Granted	US6370131	4/9/2002	Cdma radio multiplex transmitting device and a cdma radio multiplex receiving device	US09/576250	5/24/2000
Pana-47	USA	Granted	US6584088	6/24/2003	Cdma radio multiplex transmitting device and cdma radio multiplex receiving device	US09/825998	4/5/2001
Pana-47	USA	Granted	US6549526	4/15/2003	Cdma radio multiplex transmitting device and a cdma multiplex receiving device	US09/826005	4/5/2001
Pana-47	USA	Granted	US7136367	11/14/2006	Cdma radio multiplex transmitting device and a cdma radio multiplex receiving device	US10/335916	1/3/2003

Pana-47	USA	Granted	USRE41444	7/20/2010	Cdma radio multiplex transmitting device and a cdma radio multiplex receiving device	US12/270499	11/13/2008
Pana-48	USA	Granted	US6295301	9/25/2001	Pn code generating apparatus and mobile radio communication system	US09/139325	8/25/1998
Pana-48	USA	Granted	US6697384	2/24/2004	Method and apparatus for calculating a state of starting a pn code generating operation	US09/916284	7/30/2001
Pana-49	USA	Granted	US6466563	10/15/2002	Cdma mobile station and cdma transmission method	US10/147831	3/16/1999
Pana-49	USA	Lapsed	US20030007472	1/9/2003	Cdma mobile station apparatus and cdma transmission method	10235918	9/6/2002
Pana-50	USA	Granted	US6370134	4/9/2002	Cdma radio communication apparatus	US09/115502	7/15/1998
Pana-50	USA	Granted	US7035233	4/25/2006	Radio communication terminal apparatus and radio communication base station apparatus	US10/014352	12/14/2001

Pana-5D	USA	Granted	US7535864	5/19/2009	Radio communication terminal apparatus and radio communication base station apparatus	US11/372152	3/10/2006
WCDMA (pool) 01	USA	Granted	US5677929	10/14/1997	Automobile on-board and/or portable telephone system	US08/272156	7/8/1994
WCDMA (pool) 01	USA	Granted	USRE37420	10/23/2001	Automobile on-board and/or portable telephone system	US09/337403	6/21/1999
WCDMA (pool) 01	USA	Granted	USRE39954	12/25/2007	Automobile on-board and/or portable telephone system	US09/887042	6/25/2001
WCDMA (pool) 07	USA	Granted	US6738646	5/18/2004	Base station device and method for communication	US10/069267	2/25/2002
WCDMA (pool) 07	USA	Lapsed	US20030087644	5/8/2003	Communication terminal apparatus and base station apparatus	10322425	12/19/2002
WCDMA (pool) 07	USA	Granted	US7460880	12/2/2008	Communication terminal apparatus and base station apparatus	US11/341430	1/30/2006
WCDMA (pool) 07	USA	Granted	US7761113	7/20/2010	Communication terminal apparatus and base station apparatus	US12/132992	6/4/2008

WCDMA (pool) 09	USA	Granted	US6760590	7/6/2004	Communication terminal apparatus, base station apparatus, and radio communication method	US10/089605	4/1/2002
WCDMA (pool) 09	USA	Granted	US6799053	9/28/2004	Communication terminal apparatus	US10/321500	12/18/2002
WCDMA (pool) 09	USA	Granted	US7206587	4/17/2007	Communication terminal apparatus, base station apparatus, and radio communication method	US10/321623	12/18/2002

PATENT ASSIGNMENT COVER SHEET

Electronic Version v1.1
 Stylesheet Version v1.2

EPAS ID: PAT2667260

SUBMISSION TYPE:	NEW ASSIGNMENT
NATURE OF CONVEYANCE:	ASSIGNMENT

CONVEYING PARTY DATA	
Name	Execution Date
PANASONIC CORPORATION	12/20/2013

RECEIVING PARTY DATA	
Name:	INVENTERGY, INC.
Street Address:	19925 STEVENS CREEK BOULEVARD
Internal Address:	SUITE 100
City:	CUPERTINO
State/Country:	CALIFORNIA
Postal Code:	95014

PROPERTY NUMBERS Total: 115	
Property Type	Number
Patent Number:	6726297
Patent Number:	8009549
Patent Number:	8416810
Patent Number:	7646702
Patent Number:	8238226
Patent Number:	7593317
Patent Number:	7929627
Patent Number:	7826557
Patent Number:	7792084
Patent Number:	8064393
Patent Number:	8270332
Patent Number:	8582573
Patent Number:	6400929
Patent Number:	6381445

Patent Number:	6366763
Patent Number:	6370359
Patent Number:	6487394
Patent Number:	6597894
Patent Number:	6505035
Patent Number:	6973289
Patent Number:	6611676
Patent Number:	7636551
Patent Number:	6637001
Patent Number:	6813323
Patent Number:	6734810
Patent Number:	6940428
Patent Number:	6922159
Patent Number:	6069884
Patent Number:	6119004
Patent Number:	6069924
Patent Number:	6636723
Patent Number:	6628630
Patent Number:	6404778
Patent Number:	6611509
Patent Number:	6807162
Patent Number:	6973065
Patent Number:	7778224
Patent Number:	6765894
Patent Number:	7656844
Patent Number:	8437316
Patent Number:	6839335
Patent Number:	7072416
Patent Number:	7760815
Patent Number:	6868056
Patent Number:	6944208
Patent Number:	6781973
Patent Number:	7145886
Patent Number:	6847828
Patent Number:	7386321

	7266118
Patent Number:	7133379
Patent Number:	7392019
Patent Number:	7339949
Patent Number:	7702025
Patent Number:	7460502
Patent Number:	7269774
Patent Number:	7385934
Patent Number:	7114121
Patent Number:	7162206
Patent Number:	7746762
Patent Number:	7693140
Patent Number:	7299027
Patent Number:	7251469
Patent Number:	7764711
Patent Number:	8086270
Patent Number:	7848439
Patent Number:	8175604
Patent Number:	7860184
Patent Number:	8073070
Patent Number:	8249132
Patent Number:	8576784
Patent Number:	8218681
Patent Number:	8249178
Patent Number:	5583851
Patent Number:	5873027
Patent Number:	6336040
Patent Number:	5757870
Patent Number:	5818869
Patent Number:	6175558
Patent Number:	6301237
Patent Number:	6529492
Patent Number:	6370131
Patent Number:	6584088
Patent Number:	6549526

	7136367
Patent Number:	6295301
Patent Number:	6697384
Patent Number:	6466563
Patent Number:	6370134
Patent Number:	7035233
Patent Number:	7535864
Patent Number:	5677929
Patent Number:	6738646
Patent Number:	7460880
Patent Number:	7761113
Patent Number:	6760590
Patent Number:	6799053
Patent Number:	7206587
Patent Number:	RE37420
Patent Number:	RE39954
Patent Number:	RE41444
Application Number:	11575015
Application Number:	10901380
Application Number:	11134448
Application Number:	10419089
Application Number:	11859550
Application Number:	13478996
Application Number:	13532576
Application Number:	13554748
Application Number:	10235918
Application Number:	10322425
Application Number:	13590841
Patent Number:	6876870
Application Number:	11574636
Application Number:	12162592

CORRESPONDENCE DATA

Fax Number:

Phone:

4089737896

Email:

wayne@inventergy.com

Correspondence will be sent via US Mail when the email attempt is unsuccessful.

Correspondent Name: WAYNE P. SOBON
Address Line 1: 19925 STEVENS CREEK BOULEVARD
Address Line 2: SUITE 100
Address Line 4: CUPERTINO, CALIFORNIA 95014

NAME OF SUBMITTER:	WAYNE P. SOBON
Signature:	/Wayne P. Sobon/
Date:	01/03/2014
	This document serves as an Oath/Declaration (37 CFR 1.63).

Total Attachments: 5

source=Panasonic Inventergy Appendix B - Transfer Documents 12-20-13#page1.tif
source=Panasonic Inventergy Appendix A - Appendix Patents#page1.tif
source=Panasonic Inventergy Appendix A - Appendix Patents#page2.tif
source=Panasonic Inventergy Appendix A - Appendix Patents#page3.tif
source=Panasonic Inventergy Appendix A - Appendix Patents#page4.tif

Appendix B – Transfer Documents

Panasonic Corporation, a Japanese corporation having its principal place of business at 1006, Oaza Kadoma, Kadoma-shi, Osaka 571-8501, Japan (“Assignor”), hereby irrevocably assigns to Inventergy, Inc., a Delaware corporation with a business address at 19925 Stevens Creek Boulevard, Suite 100, Cupertino, California 95014, USA (“Assignee”), as of the date set forth below, the entire Assignor’s right, title, and interest in and to (a) all US patents as listed in Appendix A (“Appendix Patents”), and (b) all of their related families, including all counterpart patents and applications in any geography or jurisdiction, pending applications and lapsed or otherwise abandoned patents or patent applications which: (i) claim priority to the Appendix Patents, (ii) to which the Appendix Patents claimed priority (“Priority Patents”), or (iii) which claim priority to the Priority Patents (collectively, (a) and (b) are the “Patent Assets”), and any patents or patent applications subject to any terminal disclaimer with regard to such patents and/or patent applications, and all causes of action, rights, and remedies arising under any such Patent Assets prior to, on or after the Effective Date of this Agreement and all claims for damages by reason of past, present or future infringement or other unauthorized use of such Patent Assets with the right to sue for and collect such damages.

Assignor also hereby authorizes the respective patent office of governmental agency in each jurisdiction to issue any and all patents or certificates of invention which may be granted upon any of the Patent Assets in the name of Assignee, as the assignee to the entire interest therein.

The terms and conditions of this assignment shall inure to the benefit of Assignee, its successors, assigns, and other legal representatives, and shall be binding upon Assignor, its successors, assigns, and other legal representatives.

IN WITNESS WHEREOF, Assignor have caused their duly authorized representatives to execute this Assignment.

ASSIGNOR

Panasonic Corporation

By: 

Name: Ikuo Terauchi

Title: Authorized Signing Officer

Date: December 20, 2013

CONFIDENTIAL

Appendix A - Appendix Patents

Subtotal	101	
Internal Family ID	Publication Number	Patent Status
Inv-01	US6726297	Granted
Inv-03	US8009549	Granted
Inv-04	US8416810	Granted
Inv-08	US7646702	Granted
Inv-08	US8238226	Granted
Inv-09	US7593317	Granted
Inv-15	US7929627	Granted
Inv-16	US7826557	Granted
Inv-21	US7792084	Granted
Inv-23	US8064393	Granted
Inv-26	US20120314645	Pending
Inv-26	US8270332	Granted
Pana-01	US6366763	Granted
Pana-01	US6370359	Granted
Pana-01	US6381445	Granted
Pana-01	US6400929	Granted
Pana-01	US6487394	Granted
Pana-01	US6505035	Granted
Pana-01	US6597894	Granted
Pana-01	US6611676	Granted
Pana-01	US6973289	Granted
Pana-01	US7636551	Granted
Pana-02	US6637001	Granted
Pana-02	US20050002477	lapsed
Pana-03	US6813323	Granted
Pana-03	US20050219071	lapsed
Pana-04	US6734810	Granted
Pana-04	US6922159	Granted
Pana-04	US6940428	Granted
Pana-05	US6069884	Granted
Pana-06	US6119004	Granted
Pana-07	US6069924	Granted
Pana-08	US20040048578	lapsed

CONFIDENTIAL

Pana-08	US6636723	Granted
Pana-09	US6628630	Granted
Pana-10	US6404778	Granted
Pana-11	US6611509	Granted
Pana-11	US6807162	Granted
Pana-11	US6973065	Granted
Pana-11	US7778224	Granted
Pana-12	US6765894	Granted
Pana-12	US7656844	Granted
Pana-12	US8437316	Granted
Pana-13	US6839335	Granted
Pana-14	US7072416	Granted
Pana-14	US7760815	Granted
Pana-15	US6868056	Granted
Pana-16	US6944208	Granted
Pana-17	US6781973	Granted
Pana-18	US7145886	Granted
Pana-19	US6847828	Granted
Pana-19	US7386321	Granted
Pana-20	US7266118	Granted
Pana-21	US7133379	Granted
Pana-22	US6876870	Lapsed
Pana-22	US7392019	Granted
Pana-23	US7339949	Granted
Pana-24	US7702025	Granted
Pana-25	US7460502	Granted
Pana-26	US7269774	Granted
Pana-27	US7385934	Granted
Pana-28	US7114121	Granted
Pana-29	US7162206	Granted
Pana-30	US7746762	Granted
Pana-31	US7693140	Granted
Pana-32	US20080020802	lapsed
Pana-32	US7299027	Granted
Pana-33	US20070255993	Pending
Pana-33	US20120230257	lapsed

CONFIDENTIAL

Pana-33	US20120263250	lapsed
Pana-33	US20120287775	lapsed
Pana-34	US7251469	lapsed
Pana-34	US7764711	Granted
Pana-35	US20070254715	Pending
Pana-35	US8086270	Granted
Pana-36	US7848439	Granted
Pana-37	US8175604	Granted
Pana-38	US7860184	Granted
Pana-39	US8073070	Granted
Pana-40	US8249132	Granted
Pana-41	US20090116434	Pending
Pana-42	US8218681	Granted
Pana-43	US8249178	Granted
Pana-44	US5583851	Granted
Pana-45	US5873027	Granted
Pana-45	US6336040	Granted
Pana-46	US5757870	Granted
Pana-46	US5818869	Granted
Pana-46	US7136367	lapsed
Pana-47	US6175558	Granted
Pana-47	US6301237	Granted
Pana-47	US6529492	Granted
Pana-47	US6370131	Granted
Pana-47	US6584088	Granted
Pana-47	US6549526	Granted
Pana-47	USRE41444	Granted
Pana-48	US6295301	Granted
Pana-48	US6697384	Granted
Pana-49	US20030007472	lapsed
Pana-49	US6466563	Granted
Pana-50	US7535864	Granted
Pana-50	US6370134	Granted
Pana-50	US7035233	Granted
WCDMA (pool) 01	US5677929	lapsed
WCDMA (pool) 01	USRE37420	Granted

CONFIDENTIAL

WCDMA (pool) 01	USRE39954	Granted
WCDMA (pool) 01	US20030087644	lapsed
WCDMA (pool) 01	US20060121930	lapsed
WCDMA (pool) 01	US20080261545	lapsed
WCDMA (pool) 07	US6738646	Granted
WCDMA (pool) 07	US7460880	Granted
WCDMA (pool) 07	US7761113	Granted
WCDMA (pool) 09	US6760590	Granted
WCDMA (pool) 09	US6799053	Granted
WCDMA (pool) 09	US7206587	Granted



APPLICATION NO.	ISSUE DATE	PATENT NO.	ATTORNEY DOCKET NO.	CONFIRMATION NO.
11/719,611	12/07/2010	7848439	L9289.07161	9253

52989 7590 11/17/2010
Dickinson Wright PLLC
James E. Ledbetter, Esq.
International Square
1875 Eye Street, N.W., Suite 1200
Washington, DC 20006

ISSUE NOTIFICATION

The projected patent number and issue date are specified above.

Determination of Patent Term Adjustment under 35 U.S.C. 154 (b) (application filed on or after May 29, 2000)

The Patent Term Adjustment is 769 day(s). Any patent to issue from the above-identified application will include an indication of the adjustment on the front page.

If a Continued Prosecution Application (CPA) was filed in the above-identified application, the filing date that determines Patent Term Adjustment is the filing date of the most recent CPA.

Applicant will be able to obtain more detailed information by accessing the Patent Application Information Retrieval (PAIR) WEB site (<http://pair.uspto.gov>).

Any questions regarding the Patent Term Extension or Adjustment determination should be directed to the Office of Patent Legal Administration at (571)-272-7702. Questions relating to issue and publication fee payments should be directed to the Application Assistance Unit (AAU) of the Office of Data Management (ODM) at (571)-272-4200.

APPLICANT(s) (Please see PAIR WEB site <http://pair.uspto.gov> for additional applicants):

Xiaoming She, Beijing, CHINA;
Jifeng Li, Kanagawa, JAPAN;

PART B - FEE(S) TRANSMITTAL

Complete and send this form, together with applicable fee(s), to: **Mail** Mail Stop ISSUE FEE
 Commissioner for Patents
 P.O. Box 1450
 Alexandria, Virginia 22313-1450
 or **Fax** (571)-273-2885

INSTRUCTIONS: This form should be used for transmitting the ISSUE FEE and PUBLICATION FEE (if required). Blocks 1 through 5 should be completed where appropriate. All further correspondence including the Patent, advance orders and notification of maintenance fees will be mailed to the current correspondence address as indicated unless corrected below or directed otherwise in Block 1, by (a) specifying a new correspondence address; and/or (b) indicating a separate "FEE ADDRESS" for maintenance fee notifications.

CURRENT CORRESPONDENCE ADDRESS (Note: Use Block 1 for any change of address)

Note: A certificate of mailing can only be used for domestic mailings of the Fee(s) Transmittal. This certificate cannot be used for any other accompanying papers. Each additional paper, such as an assignment or formal drawing, must have its own certificate of mailing or transmission.

52989 7590 08/04/2010

Dickinson Wright PLLC
 James E. Ledbetter, Esq.
 International Square
 1875 Eye Street, N.W., Suite 1200
 Washington, DC 20006

Certificate of Mailing or Transmission

I hereby certify that this Fee(s) Transmittal is being deposited with the United States Postal Service with sufficient postage for first class mail in an envelope addressed to the Mail Stop ISSUE FEE address above, or being facsimile transmitted to the USPTO (571) 273-2885, on the date indicated below.

(Depositor's name)
(Signature)
(Date)

APPLICATION NO.	FILING DATE	FIRST NAMED INVENTOR	ATTORNEY DOCKET NO.	CONFIRMATION NO.
11/719,611	05/17/2007	Xiaoming She	L9289.07161	9253

TITLE OF INVENTION: COMMUNICATION APPARATUS, COMMUNICATION SYSTEM, AND COMMUNICATION METHOD

APPLN. TYPE	SMALL ENTITY	ISSUE FEE DUE	PUBLICATION FEE DUE	PREV. PAID ISSUE FEE	TOTAL FEE(S) DUE	DATE DUE
nonprovisional	NO	\$1510	\$300	\$0	\$1810	11/04/2010

EXAMINER	ART UNIT	CLASS-SUBCLASS
TIMORY, KABIR A	2611	375-260000

1. Change of correspondence address or indication of "Fee Address" (37 CFR 1.363).

- Change of correspondence address (or Change of Correspondence Address form PTO/SB/122) attached.
- "Fee Address" indication (or "Fee Address" Indication form PTO/SB/47; Rev 03-02 or more recent) attached. Use of a Customer Number is required.

2. For printing on the patent front page, list
- (1) the names of up to 3 registered patent attorneys or agents OR, alternatively,
 - (2) the name of a single firm (having as a member a registered attorney or agent) and the names of up to 2 registered patent attorneys or agents. If no name is listed, no name will be printed.

1. DICKINSON WRIGHT PLLC
 2.
 3.

3. ASSIGNEE NAME AND RESIDENCE DATA TO BE PRINTED ON THE PATENT (print or type)

PLEASE NOTE: Unless an assignee is identified below, no assignee data will appear on the patent. If an assignee is identified below, the document has been filed for recordation as set forth in 37 CFR 3.11. Completion of this form is NOT a substitute for filing an assignment.

(A) NAME OF ASSIGNEE
 PANASONIC CORPORATION

(B) RESIDENCE: (CITY and STATE OR COUNTRY)
 OSAKA, JAPAN

Please check the appropriate assignee category or categories (will not be printed on the patent): Individual Corporation or other private group entity Government

4a. The following fee(s) are submitted:

- Issue Fee
- Publication Fee (No small entity discount permitted)
- Advance Order - # of Copies _____

4b. Payment of Fee(s): (Please first reapply any previously paid issue fee shown above)

- A check is enclosed.
- Payment by credit card. Form PTO-2038 is attached.
- The Director is hereby authorized to charge the required fee(s), any deficiency, or credit any overpayment, to Deposit Account Number 04-1061 (enclose an extra copy of this form).

5. Change in Entity Status (from status indicated above)

- a. Applicant claims SMALL ENTITY status. See 37 CFR 1.27.
- b. Applicant is no longer claiming SMALL ENTITY status. See 37 CFR 1.27(g)(2).

NOTE: The Issue Fee and Publication Fee (if required) will not be accepted from anyone other than the applicant, a registered attorney or agent, or the assignee or other party in interest as shown by the records of the United States Patent and Trademark Office.

Authorized Signature /James Edward Ledbetter/

Date October 28, 2010

Typed or printed name James E. Ledbetter

Registration No. 28,732

This collection of information is required by 37 CFR 1.311. The information is required to obtain or retain a benefit by the public which is to file (and by the USPTO to process) an application. Confidentiality is governed by 35 U.S.C. 122 and 37 CFR 1.14. This collection is estimated to take 12 minutes to complete, including gathering, preparing, and submitting the completed application form to the USPTO. Time will vary depending upon the individual case. Any comments on the amount of time you require to complete this form and/or suggestions for reducing this burden, should be sent to the Chief Information Officer, U.S. Patent and Trademark Office, U.S. Department of Commerce, P.O. Box 1450, Alexandria, Virginia 22313-1450. DO NOT SEND FEES OR COMPLETED FORMS TO THIS ADDRESS. SEND TO: Commissioner for Patents, P.O. Box 1450, Alexandria, Virginia 22313-1450.

Under the Paperwork Reduction Act of 1995, no persons are required to respond to a collection of information unless it displays a valid OMB control number.

IPR2018-1555

HTC EX1002, Page 191

Electronic Patent Application Fee Transmittal

Application Number:	11719611
Filing Date:	17-May-2007
Title of Invention:	COMMUNICATION APPARATUS, COMMUNICATION SYSTEM, AND COMMUNICATION METHOD
First Named Inventor/Applicant Name:	Xiaoming She
Filer:	James Edward Ledbetter/Jacqueline Black
Attorney Docket Number:	L9289.07161

Filed as Large Entity

U.S. National Stage under 35 USC 371 Filing Fees

Description	Fee Code	Quantity	Amount	Sub-Total in USD(\$)
Basic Filing:				
Pages:				
Claims:				
Miscellaneous-Filing:				
Petition:				
Patent-Appeals-and-Interference:				
Post-Allowance-and-Post-Issuance:				
Utility Appl issue fee	1501	1	1510	1510
Publ. Fee- early, voluntary, or normal	1504	1	300	300

PR2018-1555

Description	Fee Code	Quantity	Amount	Sub-Total in USD(\$)
Extension-of-Time:				
Miscellaneous:				
Total in USD (\$)				1810

Electronic Acknowledgement Receipt

EFS ID:	8725956
Application Number:	11719611
International Application Number:	
Confirmation Number:	9253
Title of Invention:	COMMUNICATION APPARATUS, COMMUNICATION SYSTEM, AND COMMUNICATION METHOD
First Named Inventor/Applicant Name:	Xiaoming She
Customer Number:	52989
Filer:	James Edward Ledbetter
Filer Authorized By:	
Attorney Docket Number:	L9289.07161
Receipt Date:	28-OCT-2010
Filing Date:	17-MAY-2007
Time Stamp:	18:06:44
Application Type:	U.S. National Stage under 35 USC 371

Payment information:

Submitted with Payment	yes
Payment Type	Credit Card
Payment was successfully received in RAM	\$1810
RAM confirmation Number	6454
Deposit Account	
Authorized User	IPR2018-1555

File Listing:

HTC EX1002, Page 194

Document Number	Document Description	File Name	File Size(Bytes)/ Message Digest	Multi Part /.zip	Pages (if appl.)
-----------------	----------------------	-----------	----------------------------------	------------------	------------------

1	Issue Fee Payment (PTO-85B)	FEE.pdf	99695	no	1
			2ef54f4d1092ad3edf1672cba58d70ab5b263725		

Warnings:

Information:

2	Fee Worksheet (PTO-875)	fee-info.pdf	32492	no	2
			183e6c5f7d3a2bfd068da2424e32f26d4d6842b		

Warnings:

Information:

Total Files Size (in bytes):			132187		
-------------------------------------	--	--	--------	--	--

This Acknowledgement Receipt evidences receipt on the noted date by the USPTO of the indicated documents, characterized by the applicant, and including page counts, where applicable. It serves as evidence of receipt similar to a Post Card, as described in MPEP 503.

New Applications Under 35 U.S.C. 111

If a new application is being filed and the application includes the necessary components for a filing date (see 37 CFR 1.53(b)-(d) and MPEP 506), a Filing Receipt (37 CFR 1.54) will be issued in due course and the date shown on this Acknowledgement Receipt will establish the filing date of the application.

National Stage of an International Application under 35 U.S.C. 371

If a timely submission to enter the national stage of an international application is compliant with the conditions of 35 U.S.C. 371 and other applicable requirements a Form PCT/DO/EO/903 indicating acceptance of the application as a national stage submission under 35 U.S.C. 371 will be issued in addition to the Filing Receipt, in due course.

New International Application Filed with the USPTO as a Receiving Office

If a new international application is being filed and the international application includes the necessary components for an international filing date (see PCT Article 11 and MPEP 1810), a Notification of the International Application Number and of the International Filing Date (Form PCT/RO/105) will be issued in due course, subject to prescriptions concerning national security, and the date shown on this Acknowledgement Receipt will establish the international filing date of the application.



NOTICE OF ALLOWANCE AND FEE(S) DUE

52989 7590 08/04/2010

Dickinson Wright PLLC
James E. Ledbetter, Esq.
International Square
1875 Eye Street, N.W., Suite 1200
Washington, DC 20006

EXAMINER: TIMORY, KABIR A
ART UNIT: 2611
PAPER NUMBER:
DATE MAILED: 08/04/2010

Table with 5 columns: APPLICATION NO., FILING DATE, FIRST NAMED INVENTOR, ATTORNEY DOCKET NO., CONFIRMATION NO.

11/719,611 05/17/2007 Xiaoming She L9289.07161 9253

TITLE OF INVENTION: COMMUNICATION APPARATUS, COMMUNICATION SYSTEM, AND COMMUNICATION METHOD

Table with 7 columns: APPLN. TYPE, SMALL ENTITY, ISSUE FEE DUE, PUBLICATION FEE DUE, PREV. PAID ISSUE FEE, TOTAL FEE(S) DUE, DATE DUE

nonprovisional NO \$1510 \$300 \$0 \$1810 11/04/2010

THE APPLICATION IDENTIFIED ABOVE HAS BEEN EXAMINED AND IS ALLOWED FOR ISSUANCE AS A PATENT. PROSECUTION ON THE MERITS IS CLOSED. THIS NOTICE OF ALLOWANCE IS NOT A GRANT OF PATENT RIGHTS. THIS APPLICATION IS SUBJECT TO WITHDRAWAL FROM ISSUE AT THE INITIATIVE OF THE OFFICE OR UPON PETITION BY THE APPLICANT. SEE 37 CFR 1.313 AND MPEP 1308.

THE ISSUE FEE AND PUBLICATION FEE (IF REQUIRED) MUST BE PAID WITHIN THREE MONTHS FROM THE MAILING DATE OF THIS NOTICE OR THIS APPLICATION SHALL BE REGARDED AS ABANDONED. THIS STATUTORY PERIOD CANNOT BE EXTENDED. SEE 35 U.S.C. 151. THE ISSUE FEE DUE INDICATED ABOVE DOES NOT REFLECT A CREDIT FOR ANY PREVIOUSLY PAID ISSUE FEE IN THIS APPLICATION. IF AN ISSUE FEE HAS PREVIOUSLY BEEN PAID IN THIS APPLICATION (AS SHOWN ABOVE), THE RETURN OF PART B OF THIS FORM WILL BE CONSIDERED A REQUEST TO REAPPLY THE PREVIOUSLY PAID ISSUE FEE TOWARD THE ISSUE FEE NOW DUE.

HOW TO REPLY TO THIS NOTICE:

I. Review the SMALL ENTITY status shown above.

If the SMALL ENTITY is shown as YES, verify your current SMALL ENTITY status:

A. If the status is the same, pay the TOTAL FEE(S) DUE shown above.

B. If the status above is to be removed, check box 5b on Part B - Fee(s) Transmittal and pay the PUBLICATION FEE (if required) and twice the amount of the ISSUE FEE shown above, or

If the SMALL ENTITY is shown as NO:

A. Pay TOTAL FEE(S) DUE shown above, or

B. If applicant claimed SMALL ENTITY status before, or is now claiming SMALL ENTITY status, check box 5a on Part B - Fee(s) Transmittal and pay the PUBLICATION FEE (if required) and 1/2 the ISSUE FEE shown above.

II. PART B - FEE(S) TRANSMITTAL, or its equivalent, must be completed and returned to the United States Patent and Trademark Office (USPTO) with your ISSUE FEE and PUBLICATION FEE (if required). If you are charging the fee(s) to your deposit account, section "4b" of Part B - Fee(s) Transmittal should be completed and an extra copy of the form should be submitted. If an equivalent of Part B is filed, a request to reapply a previously paid issue fee must be clearly made, and delays in processing may occur due to the difficulty in recognizing the paper as an equivalent of Part B.

III. All communications regarding this application must give the application number. Please direct all communications prior to issuance to Mail Stop ISSUE FEE unless advised to the contrary.

IMPORTANT REMINDER: Utility patents issuing on applications filed on or after Dec. 12, 1980 may require payment of maintenance fees. It is patentee's responsibility to ensure timely payment of maintenance fees when due.

PART B - FEE(S) TRANSMITTAL

**Complete and send this form, together with applicable fee(s), to: Mail Mail Stop ISSUE FEE
 Commissioner for Patents
 P.O. Box 1450
 Alexandria, Virginia 22313-1450
 or Fax (571)-273-2885**

INSTRUCTIONS: This form should be used for transmitting the ISSUE FEE and PUBLICATION FEE (if required). Blocks 1 through 5 should be completed where appropriate. All further correspondence including the Patent, advance orders and notification of maintenance fees will be mailed to the current correspondence address as indicated unless corrected below or directed otherwise in Block 1, by (a) specifying a new correspondence address; and/or (b) indicating a separate "FEE ADDRESS" for maintenance fee notifications.

CURRENT CORRESPONDENCE ADDRESS (Note: Use Block 1 for any change of address)

52989 7590 08/04/2010

Dickinson Wright PLLC
 James E. Ledbetter, Esq.
 International Square
 1875 Eye Street, N.W., Suite 1200
 Washington, DC 20006

Note: A certificate of mailing can only be used for domestic mailings of the Fee(s) Transmittal. This certificate cannot be used for any other accompanying papers. Each additional paper, such as an assignment or formal drawing, must have its own certificate of mailing or transmission.

Certificate of Mailing or Transmission

I hereby certify that this Fee(s) Transmittal is being deposited with the United States Postal Service with sufficient postage for first class mail in an envelope addressed to the Mail Stop ISSUE FEE address above, or being facsimile transmitted to the USPTO (571) 273-2885, on the date indicated below.

(Depositor's name)
(Signature)
(Date)

APPLICATION NO.	FILING DATE	FIRST NAMED INVENTOR	ATTORNEY DOCKET NO.	CONFIRMATION NO.
-----------------	-------------	----------------------	---------------------	------------------

11/719,611 05/17/2007 Xiaoming She L9289.07161 9253

TITLE OF INVENTION: COMMUNICATION APPARATUS, COMMUNICATION SYSTEM, AND COMMUNICATION METHOD

APPLN. TYPE	SMALL ENTITY	ISSUE FEE DUE	PUBLICATION FEE DUE	PREV. PAID ISSUE FEE	TOTAL FEE(S) DUE	DATE DUE
-------------	--------------	---------------	---------------------	----------------------	------------------	----------

nonprovisional NO \$1510 \$300 \$0 \$1810 11/04/2010

EXAMINER	ART UNIT	CLASS-SUBCLASS
----------	----------	----------------

TIMORY, KABIR A 2611 375-260000

<p>1. Change of correspondence address or indication of "Fee Address" (37 CFR 1.363).</p> <p><input type="checkbox"/> Change of correspondence address (or Change of Correspondence Address form PTO/SB/122) attached.</p> <p><input type="checkbox"/> "Fee Address" indication (or "Fee Address" Indication form PTO/SB/47; Rev 03-02 or more recent) attached. Use of a Customer Number is required.</p>	<p>2. For printing on the patent front page, list</p> <p>(1) the names of up to 3 registered patent attorneys or agents OR, alternatively, 1 _____</p> <p>(2) the name of a single firm (having as a member a registered attorney or agent) and the names of up to 2 registered patent attorneys or agents. If no name is listed, no name will be printed. 2 _____</p> <p>3 _____</p>
-------------------------------------------------------------------------------------------------------------------------------------------------------------------------------------------------------------------------------------------------------------------------------------------------------------------------------------------------------------------------------------------------------------------	---------------------------------------------------------------------------------------------------------------------------------------------------------------------------------------------------------------------------------------------------------------------------------------------------------------------------------------------------------------------------------------

3. ASSIGNEE NAME AND RESIDENCE DATA TO BE PRINTED ON THE PATENT (print or type)

PLEASE NOTE: Unless an assignee is identified below, no assignee data will appear on the patent. If an assignee is identified below, the document has been filed for recordation as set forth in 37 CFR 3.11. Completion of this form is NOT a substitute for filing an assignment.

(A) NAME OF ASSIGNEE (B) RESIDENCE: (CITY AND STATE OR COUNTRY)

Please check the appropriate assignee category or categories (will not be printed on the patent) : Individual Corporation or other private group entity Government

<p>4a. The following fee(s) are submitted:</p> <p><input type="checkbox"/> Issue Fee</p> <p><input type="checkbox"/> Publication Fee (No small entity discount permitted)</p> <p><input type="checkbox"/> Advance Order - # of Copies _____</p>	<p>4b. Payment of Fee(s); (Please first reapply any previously paid issue fee shown above)</p> <p><input type="checkbox"/> A check is enclosed.</p> <p><input type="checkbox"/> Payment by credit card. Form PTO-2038 is attached.</p> <p><input type="checkbox"/> The Director is hereby authorized to charge the required fee(s), any deficiency, or credit any overpayment, to Deposit Account Number _____ (enclose an extra copy of this form).</p>
-------------------------------------------------------------------------------------------------------------------------------------------------------------------------------------------------------------------------------------------------	----------------------------------------------------------------------------------------------------------------------------------------------------------------------------------------------------------------------------------------------------------------------------------------------------------------------------------------------------------------------------------------------------------------------------------------------------------

5. Change in Entity Status (from status indicated above)

a. Applicant claims SMALL ENTITY status. See 37 CFR 1.27. b. Applicant is no longer claiming SMALL ENTITY status. See 37 CFR 1.27(g)(2).

NOTE: The Issue Fee and Publication Fee (if required) will not be accepted from anyone other than the applicant; a registered attorney or agent; or the assignee or other party in interest as shown by the records of the United States Patent and Trademark Office.

Authorized Signature _____ Date _____
 Typed or printed name _____ Registration No. _____

This collection of information is required by 37 CFR 1.311. The information is required to obtain or retain a benefit by the public which is to file (and by the USPTO to process) an application. Confidentiality is governed by 35 U.S.C. 122 and 37 CFR 1.14. This collection is estimated to take 12 minutes to complete, including gathering, preparing, and submitting the completed application form to the USPTO. Time will vary depending upon the individual case. Any comments on the amount of time you require to complete this form and/or suggestions for reducing this burden, should be sent to the Chief Information Officer, U.S. Patent and Trademark Office, U.S. Department of Commerce, P.O. Box 1450, Alexandria, Virginia 22313-1450. DO NOT SEND FEES OR COMPLETED FORMS TO THIS ADDRESS. SEND TO: Commissioner for Patents, P.O. Box 1450, Alexandria, Virginia 22313-1450.

Under the Paperwork Reduction Act of 1995, no persons are required to respond to a collection of information unless it displays a valid OMB control number.

IPR2018-1555

HTC EX1002, Page 197



UNITED STATES PATENT AND TRADEMARK OFFICE

UNITED STATES DEPARTMENT OF COMMERCE
United States Patent and Trademark Office
Address: COMMISSIONER FOR PATENTS
P. O. Box 1450
Alexandria, Virginia 22313-1450
www.uspto.gov

Table with 5 columns: APPLICATION NO., FILING DATE, FIRST NAMED INVENTOR, ATTORNEY DOCKET NO., CONFIRMATION NO.
11/719,611 05/17/2007 Xiaoming She L9289.07161 9253

52989 7590 08/04/2010
Dickinson Wright PLLC
James E. Ledbetter, Esq.
International Square
1875 Eye Street, N.W., Suite 1200
Washington, DC 20006

Table with 2 columns: EXAMINER, ART UNIT, PAPER NUMBER
EXAMINER: TIMORY, KABIR A
ART UNIT: 2611
PAPER NUMBER: DATE MAILED: 08/04/2010

Determination of Patent Term Adjustment under 35 U.S.C. 154 (b)
(application filed on or after May 29, 2000)

The Patent Term Adjustment to date is 565 day(s). If the issue fee is paid on the date that is three months after the mailing date of this notice and the patent issues on the Tuesday before the date that is 28 weeks (six and a half months) after the mailing date of this notice, the Patent Term Adjustment will be 565 day(s).

If a Continued Prosecution Application (CPA) was filed in the above-identified application, the filing date that determines Patent Term Adjustment is the filing date of the most recent CPA.

Applicant will be able to obtain more detailed information by accessing the Patent Application Information Retrieval (PAIR) WEB site (http://pair.uspto.gov).

Any questions regarding the Patent Term Extension or Adjustment determination should be directed to the Office of Patent Legal Administration at (571)-272-7702. Questions relating to issue and publication fee payments should be directed to the Customer Service Center of the Office of Patent Publication at 1-(888)-786-0101 or (571)-272-4200.

Notice of Allowability

Application No. 11/719,611	Applicant(s) SHE ET AL.	
Examiner KABIR A. TIMORY	Art Unit 2611	

-- The MAILING DATE of this communication appears on the cover sheet with the correspondence address--

All claims being allowable, PROSECUTION ON THE MERITS IS (OR REMAINS) CLOSED in this application. If not included herewith (or previously mailed), a Notice of Allowance (PTOL-85) or other appropriate communication will be mailed in due course. **THIS NOTICE OF ALLOWABILITY IS NOT A GRANT OF PATENT RIGHTS.** This application is subject to withdrawal from issue at the initiative of the Office or upon petition by the applicant. See 37 CFR 1.313 and MPEP 1308.

- 1. This communication is responsive to 04/29/2010.
- 2. The allowed claim(s) is/are 2-10, 12 and 13.
- 3. Acknowledgment is made of a claim for foreign priority under 35 U.S.C. § 119(a)-(d) or (f).
 - a) All b) Some* c) None of the:
 - 1. Certified copies of the priority documents have been received.
 - 2. Certified copies of the priority documents have been received in Application No. _____.
 - 3. Copies of the certified copies of the priority documents have been received in this national stage application from the International Bureau (PCT Rule 17.2(a)).

* Certified copies not received: _____.

Applicant has THREE MONTHS FROM THE "MAILING DATE" of this communication to file a reply complying with the requirements noted below. Failure to timely comply will result in ABANDONMENT of this application.

THIS THREE-MONTH PERIOD IS NOT EXTENDABLE.

- 4. A SUBSTITUTE OATH OR DECLARATION must be submitted. Note the attached EXAMINER'S AMENDMENT or NOTICE OF INFORMAL PATENT APPLICATION (PTO-152) which gives reason(s) why the oath or declaration is deficient.
 - 5. CORRECTED DRAWINGS (as "replacement sheets") must be submitted.
 - (a) including changes required by the Notice of Draftsperson's Patent Drawing Review (PTO-948) attached
 - 1) hereto or 2) to Paper No./Mail Date _____.
 - (b) including changes required by the attached Examiner's Amendment / Comment or in the Office action of Paper No./Mail Date _____.
- Identifying indicia such as the application number (see 37 CFR 1.84(c)) should be written on the drawings in the front (not the back) of each sheet. Replacement sheet(s) should be labeled as such in the header according to 37 CFR 1.121(d).**
- 6. DEPOSIT OF and/or INFORMATION about the deposit of BIOLOGICAL MATERIAL must be submitted. Note the attached Examiner's comment regarding REQUIREMENT FOR THE DEPOSIT OF BIOLOGICAL MATERIAL.

Attachment(s)

- 1. Notice of References Cited (PTO-892)
- 2. Notice of Draftsperson's Patent Drawing Review (PTO-948)
- 3. Information Disclosure Statements (PTO/SB/08), Paper No./Mail Date _____
- 4. Examiner's Comment Regarding Requirement for Deposit of Biological Material
- 5. Notice of Informal Patent Application
- 6. Interview Summary (PTO-413), Paper No./Mail Date _____.
- 7. Examiner's Amendment/Comment
- 8. Examiner's Statement of Reasons for Allowance
- 9. Other _____.

/Kabir A Timory/
Examiner, Art Unit 2611

DETAILED ACTION

1. Acknowledgement is made of the amendment received on 04/29/2010.

EXAMINER'S AMENDMENT

1. An examiner's amendment to the record appears below. Should the changes and/or additions be unacceptable to applicant, an amendment may be filed as provided by 37 CFR 1.312. To ensure consideration of such an amendment, it **MUST** be submitted no later than the payment of the issue fee.

The application has been amended as follows:

In claims:

(1) In claim 2, line 10: replace "a" with **--the--** between "at" and **"communicating"**.

(2) In claim 8, line 10: replace "a" with **--the--** between "at" and **"communicating"**.

(3) In claim 9, line 3: replace "**modulation/coding**" with **--modulation and coding--** at the beginning of the line.

Art Unit: 2611

(4) In claim 9, line 7: replace “**modulation/coding**” with **--modulation and coding--** at the beginning of the line.

(5) In claim 10, line 22: replace “**modulation/coding**” with **--modulation and coding--** between “adaptive” and “section”.

(6) In claim 10, line 26: replace “**modulation/coding**” with **--modulation and coding--** between “adaptive” and “section”.

(7) In claim 13, line 20: replace “**modulation/coding**” with **--modulation and coding--** between “adaptive” and “section”.

(8) In claim 13, line 24: replace “**modulation/coding**” with **--modulation and coding--** between “adaptive” and “section”.

Allowable Subject Matter

3. Claims 2-10, 12-13 are allowed.
4. The following is a statement of reasons for allowable subject matter:

The prior art of record, AAPA does not teach or suggest a pattern storage section that stores in advance patterns for selecting subbands constituting the subband groups wherein the parameter deciding section decides the modulation parameters and the

Art Unit: 2611

coding parameters per subband group comprised of the subbands selected based on the patterns stored in the pattern storage section.

The prior art of record, AAPA also does not teach or suggest wherein the parameter deciding section decides the coding parameters in such a manner that a ~ number of information bits obtained by assigning a weight per subband group to a sum of the information bits that are able to be assigned to all of the subbands within the subband group, is assigned to the subband group.

5. Any inquiry concerning this communication or earlier communications from the examiner should be directed to Kabir A. Timory whose telephone number is 571-270-1674. The examiner can normally be reached on 6:30 AM - 3:00 PM Monday-Friday.

If attempts to reach the examiner by telephone are unsuccessful, the examiner's supervisor, Shuwang Liu can be reached on 571-272-3036. The fax phone number for the organization where this application or proceeding is assigned is 571-273-8300.

Information regarding the status of an application may be obtained from the Patent Application Information Retrieval (PAIR) system. Status information for published applications may be obtained from either Private PAIR or Public PAIR. Status information for unpublished applications is available through Private PAIR only. For more information about the PAIR system, see <http://pair-direct.uspto.gov>. Should you have questions on access to the Private PAIR system, contact the Electronic Business Center (EBC) at 866-217-9197 (toll-free). If you would like assistance from a

Application/Control Number: 11/719,611

Page 5

Art Unit: 2611

USPTO Customer Service Representative or access to the automated information system, call 800-786-9199 (IN USA OR CANADA) or 571-272-1000.

/Kabir A Timory/

Examiner, Art Unit 2611

/Shuwang Liu/

Supervisory Patent Examiner, Art Unit 2611

Issue Classification 	Application/Control No. 11719611	Applicant(s)/Patent Under Reexamination SHE ET AL.
	Examiner KABIR A TIMORY	Art Unit 2611

ORIGINAL						INTERNATIONAL CLASSIFICATION												
CLASS		SUBCLASS				CLAIMED					NON-CLAIMED							
375		260				H	0	4	K	1 / 10 (2006.0)								
CROSS REFERENCE(S)																		
CLASS	SUBCLASS (ONE SUBCLASS PER BLOCK)																	
375	260	267	299	324	349													

<input type="checkbox"/> Claims renumbered in the same order as presented by applicant <input type="checkbox"/> CPA <input type="checkbox"/> T.D. <input type="checkbox"/> R.1.47															
Final	Original	Final	Original	Final	Original	Final	Original	Final	Original	Final	Original	Final	Original	Final	Original
	1														
1	2														
2	3														
3	4														
4	5														
5	6														
6	7														
8	8														
7	9														
9	10														
	11														
10	12														
11	13														

/KABIR A TIMORY/ Examiner.Art Unit 2611 (Assistant Examiner)	7/7/10 (Date)	Total Claims Allowed: 11	
/SHUWANG LIU/ Supervisory Patent Examiner.Art Unit 2611 (Primary Examiner)	07/16/2010 (Date)	O.G. Print Claim(s) 1	O.G. Print Figure 4B

Search Notes 	Application/Control No. 11719611	Applicant(s)/Patent Under Reexamination SHE ET AL.
	Examiner KABIR A TIMORY	Art Unit 2611

SEARCHED			
Class	Subclass	Date	Examiner
375	260	1/29/2010	KT
375	267	1/29/2010	KT
375	299	1/29/2010	KT
375	324	1/29/2010	KT
375	349	1/29/2010	KT

SEARCH NOTES		
Search Notes	Date	Examiner
EAST - US-PGPUB; USPAT; USOCR; FPRS; EPO; JPO; DERWENT; IBM_TDB	1/29/2010	KT
INVENTOR'S NAME SEARCH	1/29/2010	KT
CO-INVENTOR'S NAME SEARCH	1/29/2010	KT
PALM SEARCH	1/29/2010	KT
SHUWANG LIU (2611 - SPE)	1/29/2010	KT
EAST - US-PGPUB; USPAT; USOCR; FPRS; EPO; JPO; DERWENT; IBM_TDB	7/7/2010	KT
INVENTOR'S NAME SEARCH	7/7/2010	KT
CO-INVENTOR'S NAME SEARCH	7/7/2010	KT
PALM SEARCH	7/7/2010	KT
SHUWANG LIU (2611 - SPE)	7/7/2010	KT

INTERFERENCE SEARCH			
Class	Subclass	Date	Examiner
375	260	7/7/2010	KT
375	267	7/7/2010	KT
375	299	7/7/2010	KT
375	324	7/7/2010	KT
375	349	7/7/2010	KT

--	--

Index of Claims 	Application/Control No. 11719611	Applicant(s)/Patent Under Reexamination SHE ET AL.
	Examiner KABIR A TIMORY	Art Unit 2611

✓	Rejected
=	Allowed

-	Cancelled
÷	Restricted

N	Non-Elected
I	Interference

A	Appeal
O	Objected

Claims renumbered in the same order as presented by applicant
 CPA
 T.D.
 R.1.47

CLAIM		DATE							
Final	Original	01/29/2010	07/07/2010	07/07/2010					
	1	✓	-						
1	2	○	=						
2	3	○	=						
3	4	○	=						
4	5	○	=						
5	6	✓	=						
6	7	✓	=						
8	8	○	=						
7	9	✓	=						
9	10	✓	=						
	11	✓	-						
10	12	○	=						
11	13		=						

EAST Search History

EAST Search History (Prior Art)

Ref #	Hits	Search Query	DBs	Default Operator	Plurals	Time Stamp
L1	28	((She near Xiaoming) or (Li near Jifeng)) and ofdm	US-PGPUB; USPAT; USOCR; FPRS; EPO; JPO; DERWENT; IBM_TDB	AND	ON	2010/07/07 14:01
L2	2	((She near Xiaoming) or (Li near Jifeng)) and ofdm and amc	US-PGPUB; USPAT; USOCR; FPRS; EPO; JPO; DERWENT; IBM_TDB	AND	ON	2010/07/07 14:01
L3	321	ofdm and ((AMC) or (adaptive near modulation near cod\$4)) and (memory or stor \$4 or table) WITH (cod\$4 or ecod\$4 or decod \$4 or demodulat \$4) and ((subcarrier\$1) or (sub near carrier\$1) or (tone\$1) or (sub-band\$1) or (sub near band\$1) or (sub-carrier\$1))	US-PGPUB; USPAT; USOCR; FPRS; EPO; JPO; DERWENT; IBM_TDB	AND	ON	2010/07/07 14:01
L4	66	((375/260.ccls.) or (375/267.ccls.) or (375/299.ccls.) or (375/324.ccls.) or (375/349.ccls.)) and L3	US-PGPUB; USPAT; USOCR; FPRS; EPO; JPO; DERWENT; IBM_TDB	AND	ON	2010/07/07 14:01

L5	9	ofdm and ((AMC) or (adaptive near modulation near cod\$4)) and (cod\$4 or ecod\$4 or decod\$4 or demodulat\$4) SAME (value or parameter\$1) with weight\$1 same ((subcarrier\$1) or (sub near carrier\$1) or (tone\$1) or (sub-band\$1) or (sub near band\$1) or (sub-carrier\$1))	US-PGPUB; USPAT; USOCR; FPRS; EPO; JPO; DERWENT; IBM_TDB	AND	ON	2010/07/07 14:02
L6	17	ofdm and ((AMC) or (adaptive near modulation near cod\$4)) and (memory or stor\$4) with modulat\$4 same ((subcarrier\$1) or (sub near carrier\$1) or (tone\$1) or (sub-band\$1) or (sub near band\$1) or (sub-carrier\$1))	US-PGPUB; USPAT; USOCR; FPRS; EPO; JPO; DERWENT; IBM_TDB	AND	ON	2010/07/07 14:15
L7	46	ofdm and ((AMC) or (adaptive near modulation near cod\$4)) and (memory or stor\$4 or table) WITH (cod\$4 or ecod\$4 or decod\$4 or demodulat\$4) SAME parameter\$1 and ((subcarrier\$1) or (sub near carrier\$1) or (tone\$1) or (sub-	US-PGPUB; USPAT; USOCR; FPRS; EPO; JPO; DERWENT; IBM_TDB	AND	ON	2010/07/07 14:19

		band\$1) or (sub near band\$1) or (sub-carrier\$1))				
L8	7	ofdm and ((AMC) or (adaptive near modulation near cod\$4)) same (memory or stor \$4 or table) WITH (cod\$4 or ecod\$4 or decod \$4 or demodulat \$4) SAME parameter\$1 and ((subcarrier \$1) or (sub near carrier\$1) or (tone\$1) or (sub-band\$1) or (sub near band\$1) or (sub-carrier\$1))	US-PGPUB; USPAT; USOCR; FPRS; EPO; JPO; DERWENT; IBM_TDB	AND	ON	2010/07/07 14:20
L9	28	ofdm and ((AMC) or (adaptive near modulation near cod\$4)) and (memory or stor \$4) SAME cod\$4 same ((subcarrier\$1) or (sub near carrier\$1) or (tone\$1) or (sub-band\$1) or (sub near band\$1) or (sub-carrier\$1))	US-PGPUB; USPAT; USOCR; FPRS; EPO; JPO; DERWENT; IBM_TDB	AND	ON	2010/07/07 14:21
L10	15	ofdm and ((AMC) or (adaptive near modulation near cod\$4)) and (memory or stor \$4) SAME cod\$4 WITH ((subcarrier\$1) or (sub near carrier\$1) or (tone\$1) or (sub-band\$1) or (sub	US-PGPUB; USPAT; USOCR; FPRS; EPO; JPO; DERWENT; IBM_TDB	AND	ON	2010/07/07 14:21

		near band\$1) or (sub-carrier\$1))				
L11	32	ofdm and ((AMC) or (adaptive near modulation near cod\$4)) and (cod \$4 or ecod\$4 or decod\$4 or demodulat\$4) AND (value or parameter\$1) SAME weight\$1 same ((subcarrier\$1) or (sub near carrier\$1) or (tone\$1) or (sub- band\$1) or (sub near band\$1) or (sub-carrier\$1))	US-PGPUB; USPAT; USOCR; FPRS; EPO; JPO; DERWENT; IBM_TDB	AND	ON	2010/07/07 14:22
L12	10	ofdm and ((AMC) or (adaptive near modulation near cod\$4)) and (cod \$4 or ecod\$4 or decod\$4 or demodulat\$4) SAME (value or parameter\$1) SAME weight\$1 same ((subcarrier\$1) or (sub near carrier\$1) or (tone\$1) or (sub- band\$1) or (sub near band\$1) or (sub-carrier\$1))	US-PGPUB; USPAT; USOCR; FPRS; EPO; JPO; DERWENT; IBM_TDB	AND	ON	2010/07/07 14:23

L13	2	ofdm and ((AMC) or (adaptive near modulation near cod\$4)) and (cod\$4 or ecod\$4 or decod\$4 or demodulat\$4) SAME (value or parameter\$1) SAME weight\$1 with ((subcarrier\$1) or (sub near carrier\$1) or (tone\$1) or (sub-band\$1) or (sub near band\$1) or (sub-carrier\$1))	US-PGPUB; USPAT; USOCR; FPRS; EPO; JPO; DERWENT; IBM_TDB	AND	ON	2010/07/07 14:23
L14	18	ofdm and ((AMC) or (adaptive near modulation near cod\$4)) same (memory or stor\$4) with modulat\$4 with cod\$4	US-PGPUB; USPAT; USOCR; FPRS; EPO; JPO; DERWENT; IBM_TDB	AND	ON	2010/07/07 14:24
L15	19	ofdm and ((AMC) or (adaptive near modulation near cod\$4)) and (cod\$4 or ecod\$4 or decod\$4 or demodulat\$4) SAME weight\$1 WITH ((subcarrier\$1) or (sub near carrier\$1) or (tone\$1) or (sub-band\$1) or (sub near band\$1) or (sub-carrier\$1))	US-PGPUB; USPAT; USOCR; FPRS; EPO; JPO; DERWENT; IBM_TDB	AND	ON	2010/07/07 14:30

7/ 7/ 2010 2:33:09 PM

C:\ Documents and Settings\ atimory\ My Documents\ EAST\ Workspaces\ 11719611.
wsp

IN THE UNITED STATES PATENT AND TRADEMARK OFFICE

In re the Application of

Inventor:	Xiaoming SHE, et al.	Art Unit: 2611
Appln. No.:	11/719,611	Exr. K. Timory
Filed:	May 17, 2007	Conf. No. 9253
For:	COMMUNICATION APPARATUS, COMMUNICATION SYSTEM, AND COMMUNICATION METHOD	

AMENDMENT UNDER 37 C.F.R. § 1.111

Commissioner for Patents
P.O. Box 1450
Alexandria, VA 22313-1450

Sir:

In response to the non-final rejection dated February 2, 2010, the following amendments and remarks are respectfully submitted:

IN THE DRAWINGS

A replacement sheet for FIG. 3B which amends the label “SUBBAND AMC
PARAMETER 316” to read “SUBBAND AMC PARAMETER 318” is submitted herewith.

IN THE CLAIMS

Please amend the claims to read as follows:

Listing of Claims

1. (Cancelled)

2. (Currently Amended) A communication apparatus comprising:

a channel estimating section that carries out a channel estimation per subband;

a parameter deciding section that decides modulation parameters and coding parameters per subband group comprised of a plurality of the subbands, based on a result of the channel estimation per subband;

a parameter information transmission section that transmits, to a communicating party, parameter information indicating the modulation parameters and the coding parameters decided at the parameter deciding section;

a receiving section that receives a signal containing data modulated and encoded on a per subband group basis at a communicating party using the modulation parameters and the coding parameters of the parameter information transmitted at the parameter information transmission section;

a data obtaining section that demodulates and decodes the received signal received at the receiving section on a per subband group basis using the modulation parameters and the coding parameters decided at the parameter deciding section, and obtains the data contained in the received signal; and

~~The communication apparatus of claim 1, further comprising a pattern storage section that stores in advance patterns for selecting subbands constituting the subband groups in~~

~~advance~~, wherein the parameter deciding section decides the modulation parameters and the coding parameters per subband group comprised of the subbands selected based on the patterns stored in the pattern storage section.

3. (Currently Amended) The communication apparatus of claim 2, wherein the parameter deciding section decides the modulation parameters and the coding parameters per subband group constituted from a pattern, among the patterns, for selecting a plurality of the subbands neighboring on a ~~the~~ frequency axis.

4. (Currently Amended) The communication apparatus of claim 2, wherein the parameter deciding section decides the modulation parameters and the coding parameters per subband group constituted from a pattern, among the patterns, for selecting a ~~the~~ plurality of the subbands at predetermined intervals from subbands arranged on a ~~the~~ frequency axis.

5. (Currently Amended) The communication apparatus of claim 2, wherein the parameter deciding section decides the modulation parameters and the coding parameters per subband group constituted from a pattern, among the patterns, for selecting all of the subbands per predetermined time domain.

6. (Currently Amended) The communication apparatus of claim 2 ~~[[1]]~~, wherein the parameter deciding section finds the modulation parameters per subband within the subband group, and decides ~~[[a]]~~ modulation parameters with a highest classification within the found modulation parameters as the modulation parameters for the subband group.

7. (Currently Amended) The communication apparatus of claim 2 [[1]], wherein the parameter deciding section decides the coding parameters in such a manner that a the number of information bits that are able to be assigned to all of the subbands within the subband group is assigned to the subband group.

8. (Currently Amended) A communication apparatus comprising:
a channel estimating section that carries out a channel estimation per subband;
a parameter deciding section that decides modulation parameters and coding parameters per subband group comprised of a plurality of the subbands based on a result of the channel estimation per subband;
a parameter information transmission section that transmits to a communicating party, parameter information indicating the modulation parameters and the coding parameters decided at the parameter deciding section;
a receiving section that receives a signal containing data modulated and encoded per subband group at a communicating party, using the modulation parameters and coding parameters of the parameter information transmitted at the parameter information transmission section; and
a data obtaining section that demodulates and decodes the received signal received at the receiving section on a per subband group basis, using the modulation parameters and the coding parameters decided at the parameter deciding section, and obtains the data contained in the received signal;

~~The communication apparatus of claim 1~~, wherein the parameter deciding section decides the coding parameters in such a manner that ~~a the~~ number of information bits obtained by assigning a weight per subband group to ~~a the~~ sum of ~~the number of~~ information bits that are able to be assigned to all of the subbands within the subband group, is assigned to the subband group.

9. (Currently Amended) A base station apparatus that is the ~~are a~~ communicating party of the communication apparatus of claim 2 ~~[[1]]~~, the base station apparatus comprising an adaptive modulating/coding section that modulates and encodes the data in accordance with the modulation parameters and the coding parameters of the parameter information transmitted by the transmission section, and a data transmission section that transmits the ~~modulated and encoded data~~ modulated and encoded ~~subjected to modulation and coding~~ at the adaptive modulating/coding section.

10. (Currently Amended) A communication system comprising a base station apparatus transmitting modulated and encoded data and a communication terminal apparatus receiving the data, wherein

the communication terminal apparatus comprises ~~comprising~~:

a channel estimating section that carries out a channel estimation per subband;

a parameter deciding section that decides modulation parameters and coding parameters per subband group comprised of a plurality of the subbands based on a result of the channel estimation per subband ~~results~~;

a parameter information transmission section that transmits parameter information indicating that is information for the modulation parameters and the coding parameters decided at the parameter deciding section to the base station apparatus;

a receiving section that receives a ~~received~~ signal containing the data modulated and encoded on a per subband group basis at the base station apparatus using parameters of the parameter information transmitted at the parameter information transmission section; and

a data extracting section that ~~demodulates modulates~~ and decodes the [[a]] received signal received at the receiving section on a per subband group basis using the modulation parameters and the coding parameters of the parameter information, and extracts the data contained in the received signal; and

a pattern storage section that stores in advance patterns for selecting subbands constituting the subband groups; and

~~wherein~~ the base station apparatus comprises;

an adaptive modulating/coding section that modulates and encodes the data in accordance with the modulation parameters and the coding parameters of the parameter information transmitted by the transmission section; and

a data transmission section that transmits the data modulated and encoded at the adaptive modulating/coding section; and [[.]]

the parameter deciding section decides the modulation parameters and the coding parameters per subband group comprised of the subbands selected based on the patterns stored in the pattern storage section.

11. (Cancelled)

12. (Currently Amended) A communication method comprising:
a channel estimating step of carrying out a channel estimation per subband;
a parameter deciding step of deciding modulation parameters and coding parameters per subband group comprised of a plurality of the subbands, based on a result of the channel estimation per subband;
a parameter information transmitting step of, at a communication terminal apparatus, transmitting parameter information indicating the decided modulation parameters and coding parameters;
an information receiving step of, at a base station apparatus, receiving the parameter information transmitted by the communication terminal apparatus;
a modulating and encoding step of modulating and coding data in accordance with the modulation parameters and the coding parameters of the received parameter information;
a data transmitting step of, at the base station apparatus, transmitting the modulated and encoded data;
a signal receiving step of, at the communication terminal apparatus, receiving a signal containing the data transmitted by the base station apparatus; and
a data extracting step of demodulating ~~modulating~~ and decoding the received signal on a per subband group basis, using the modulation parameters and the coding parameters of the parameter information, and extracting data contained in the received signal.
The communication method of claim 11, further comprising storing patterns for selecting subbands constituting the subband groups in advance;

wherein the parameter deciding step decides the modulation parameters and the coding parameters ~~are decided~~ per subband group comprised of the ~~selected~~ subbands selected based on the ~~stored~~ patterns stored in a storage section for selecting the subbands constituting the subband group.

13. (New) A communication system comprising a base station apparatus transmitting modulated and encoded data and a communication terminal apparatus receiving the data, wherein:

the communication terminal apparatus comprises:

a channel estimating section that carries out a channel estimation per subband;

a parameter deciding section that decides modulation parameters and coding parameters per subband group comprised of a plurality of the subbands, based on a result of the channel estimation per subband;

a parameter information transmission section that transmits parameter information indicating the modulation parameters and the coding parameters decided at the parameter deciding section, to the base station apparatus,

a receiving section that receives a signal containing data modulated and encoded on a per subband group basis at the base station apparatus using parameters of the parameter information transmitted at the parameter information transmission section; and

a data extracting section that demodulates and decodes the received signal received at the receiving section on a per subband group basis, using the modulation parameters and the coding parameters of the parameter information, and extracts the data contained in the received signal, and

the base station apparatus comprises:

an adaptive modulating/coding section that modulates and encodes the data in accordance with the modulation parameters and the coding parameters of the parameter information transmitted by the transmission section; and

a data transmission section that transmits the data modulated and encoded at the adaptive modulating/coding section; and

the parameter deciding section decides the coding parameters in such a manner that a number of information bits obtained by assigning a weight per subband group to a sum of information bits that are able to be assigned to all of the subbands within the subband group, is assigned to the subband group.

REMARKS

Reconsideration and allowance of the application are respectfully requested in light of the above amendments and the following remarks.

The Applicants acknowledge with appreciation the indication that claims 2-5, 8 and 12 are directed to allowable subject matter and would be allowed if amended to be in independent form.

Claims 2-10 and 12 have been amended, claim 13 has been added, and claims 1 and 11 have been cancelled without prejudice or disclaimer. No new matter is added.

Claims 2, 8 and 12 have been rewritten in independent form, and claims 1 and 11 have been cancelled without prejudice or disclaimer. Accordingly, it is respectfully submitted that the rejections of claims 2, 8 and 12 should be withdrawn.

Claims 3-7 and 9 depend on claim 2. Accordingly, it is respectfully submitted that the rejections of claims 3-7 and 9 should be withdrawn.

Claim 10 has been amended to include the subject matter of allowable claim 2. Accordingly, it is respectfully submitted that the rejection of claim 10 should also be withdrawn.

New claim 13 incorporates the features of allowable claim 8 and original claim 10. Accordingly, it is respectfully submitted that claim 13 recites allowable subject matter.

A replacement sheet for FIG. 3B which amends the label "SUBBAND AMC PARAMETER 316" to read "SUBBAND AMC PARAMETER 318" is submitted herewith. Accordingly, it is respectfully submitted that the objection to the drawings at item 1, page 2 of the Office Action should be withdrawn.

In view of the above, it is submitted that this application is in condition for allowance and a notice to that effect is respectfully solicited.

If any issues remain which may best be resolved through a personal communication, the Examiner is requested to telephone the undersigned at the address listed below.

Respectfully submitted,

/James Edward Ledbetter/

Date: April 29, 2010
JEL/DEA/att

James E. Ledbetter
Registration No. 28,732

Attorney Docket No. L9289.07161
DICKINSON WRIGHT, PLLC
International Square
1875 Eye Street, NW
Suite 1200
Washington, D.C. 20006
Telephone: (202)-457-0160
Facsimile: (202)-659-1559

DC 9289-7161 153461

SUBMISSION OF PROPOSED DRAWING AMENDMENT FOR APPROVAL BY EXAMINER (37 CFR 1.121(a) or 37 CFR 1.121(b)(3)(ii))

Docket No.

009289-07161

In Re Application Of: Xiaoming SHE, et al.

Application No.	Filing Date	Examiner	Customer No.	Group Art Unit	Confirmation No.
11/719,611	May 17, 2007	K. Timory	52989	2611	9253

Invention: **COMMUNICATION APPARATUS, COMMUNICATION SYSTEM, AND COMMUNICATION METHOD**

Address to:
Commissioner for Patents
P.O. Box 1450
Alexandria, VA 22313-1450

Attached please find:

(check applicable items)

- a sketch in permanent ink
- a copy of the original drawing(s) with red ink

showing proposed changes to the drawing(s) in this application for which the approval of the examiner is requested.

/James Edward Ledbetter/

Signature

James E. Ledbetter, Reg. No. 28732
Dickinson Wright PLLC
1875 Eye Street, N.W., Suite 1200
Washington, D.C. 20006
Telephone: 202.457.0160
Facsimile: 202.659.1559

Dated: April 29, 2010

I hereby certify that this correspondence is being deposited with the United States Postal Service with sufficient postage as first class mail in an envelope addressed to "Commissioner for Patents, P.O. Box 1450, Alexandria, VA 22313-1450" [37 CFR 1.8(a)] on

(Date)

Signature of Person Mailing Correspondence

Typed or Printed Name of Person Mailing Correspondence

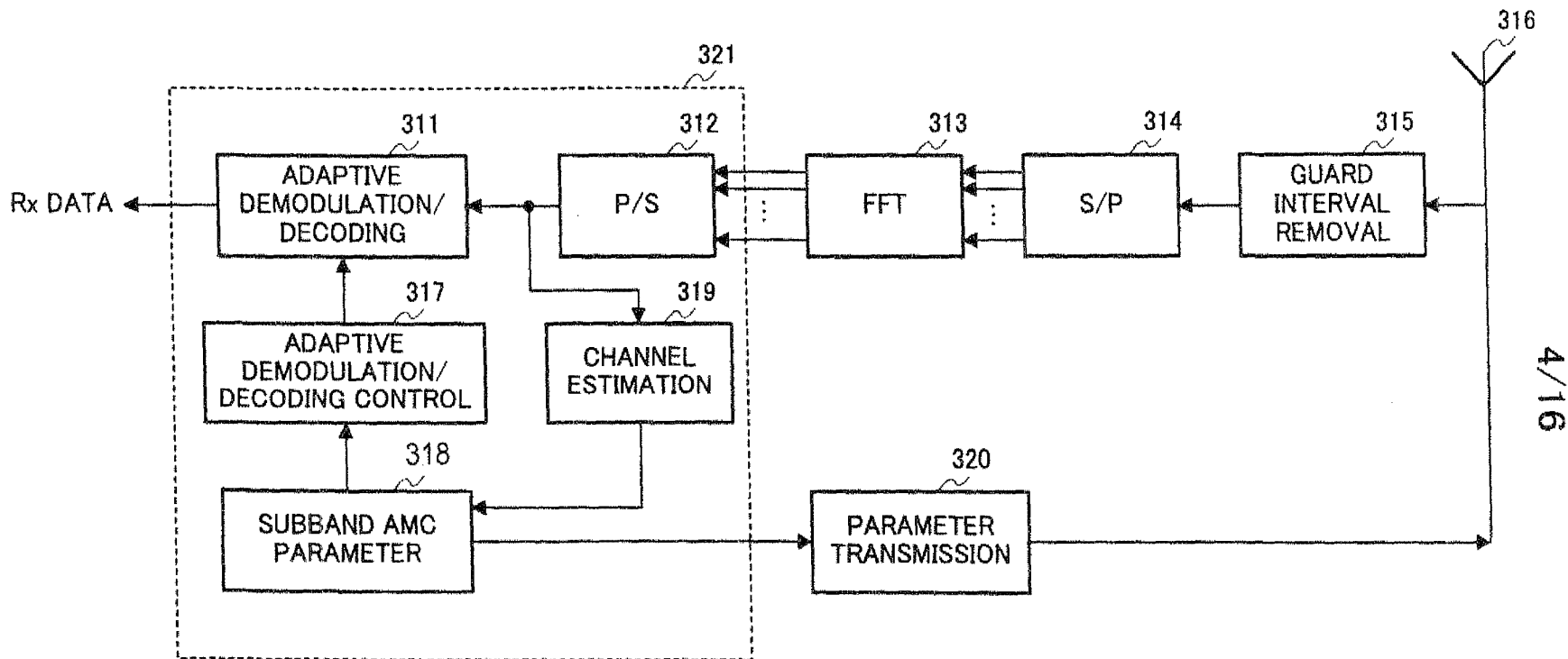

4/16

REPLACEMENT SHEET

PRIOR ART
FIG.3B

Electronic Patent Application Fee Transmittal

Application Number:	11719611
Filing Date:	17-May-2007
Title of Invention:	COMMUNICATION APPARATUS, COMMUNICATION SYSTEM, AND COMMUNICATION METHOD
First Named Inventor/Applicant Name:	Xiaoming She
Filer:	James Edward Ledbetter/Erika Satterwhite
Attorney Docket Number:	L9289.07161

Filed as Large Entity

U.S. National Stage under 35 USC 371 Filing Fees

Description	Fee Code	Quantity	Amount	Sub-Total in USD(\$)
Basic Filing:				
Pages:				
Claims:				
Independent claims in excess of 3	1614	2	220	440

Miscellaneous-Filing:

Petition:

Patent-Appeals-and-Interference:

Post-Allowance-and-Post-Issuance:

Extension-of-Time:

Description	Fee Code	Quantity	Amount	Sub-Total in USD(\$)
Miscellaneous:				
Total in USD (\$)				440

Electronic Acknowledgement Receipt

EFS ID:	7517952
Application Number:	11719611
International Application Number:	
Confirmation Number:	9253
Title of Invention:	COMMUNICATION APPARATUS, COMMUNICATION SYSTEM, AND COMMUNICATION METHOD
First Named Inventor/Applicant Name:	Xiaoming She
Customer Number:	52989
Filer:	James Edward Ledbetter
Filer Authorized By:	
Attorney Docket Number:	L9289.07161
Receipt Date:	29-APR-2010
Filing Date:	17-MAY-2007
Time Stamp:	17:49:09
Application Type:	U.S. National Stage under 35 USC 371

Payment information:

Submitted with Payment	yes
Payment Type	Credit Card
Payment was successfully received in RAM	\$440
RAM confirmation Number	4325
Deposit Account	
Authorized User	

File Listing:

Document Number	Document Description	File Name	File Size(Bytes)/ Message Digest	Multi Pages HTC EX1002 Page 228 Ram.zip @ Appl
				IPR2018-1555

1	Transmittal Letter	aTRANS.pdf	53299	no	1
			a138a47bbc8ec27bb0a2999d9454e1d766ab65f4		
Warnings:					
Information:					
2	Amendment/Req. Reconsideration-After Non-Final Reject	aAMEND.pdf	308584	no	12
			49a5555b22ef9a275ef8d830f1f49b869adc7537		
Warnings:					
Information:					
3	Transmittal Letter	aLOD.pdf	34027	no	1
			0e54842f6b8f6831e4d958594d44d5d90264d94e		
Warnings:					
Information:					
4	Drawings-only black and white line drawings	aDRAW.pdf	21110	no	1
			56935a8a8a459056e146a19ee7ce100b4dcde252		
Warnings:					
Information:					
5	Fee Worksheet (PTO-875)	fee-info.pdf	30591	no	2
			abd0e74454448a9b5228e178b4d386f3c569e1a8		
Warnings:					
Information:					
Total Files Size (in bytes):			447611		

This Acknowledgement Receipt evidences receipt on the noted date by the USPTO of the indicated documents, characterized by the applicant, and including page counts, where applicable. It serves as evidence of receipt similar to a Post Card, as described in MPEP 503.

New Applications Under 35 U.S.C. 111

If a new application is being filed and the application includes the necessary components for a filing date (see 37 CFR 1.53(b)-(d) and MPEP 506), a Filing Receipt (37 CFR 1.54) will be issued in due course and the date shown on this Acknowledgement Receipt will establish the filing date of the application.

National Stage of an International Application under 35 U.S.C. 371

If a timely submission to enter the national stage of an international application is compliant with the conditions of 35 U.S.C. 371 and other applicable requirements a Form PCT/DO/EO/903 indicating acceptance of the application as a national stage submission under 35 U.S.C. 371 will be issued in addition to the Filing Receipt, in due course.

New International Application Filed with the USPTO as a Receiving Office

If a new international application is being filed and the international application includes the necessary components for an international filing date (see PCT Article 11 and MPEP 1810), a Notification of the International Application Number and of the International Filing Date (Form PCT/RO/105) will be issued in due course, subject to prescriptions concerning national security, and the date shown on this Acknowledgement Receipt will establish the international filing date of the application.

AMENDMENT TRANSMITTAL LETTER (Large Entity)

Applicant(s): **Xiaoming SHE, et al.**

Docket No.

009289-07161

Application No. 11/719,611	Filing Date May 17, 2007	Examiner K. Timory	Customer No. 52989	Group Art Unit 2611	Confirmation No. 9253
--------------------------------------	------------------------------------	------------------------------	------------------------------	-------------------------------	---------------------------------

Invention: **COMMUNICATION APPARATUS, COMMUNICATION SYSTEM, AND COMMUNICATION METHOD**

COMMISSIONER FOR PATENTS:

Transmitted herewith is an amendment in the above-identified application.

The fee has been calculated and is transmitted as shown below.

CLAIMS AS AMENDED

	CLAIMS REMAINING AFTER AMENDMENT	HIGHEST # PREV. PAID FOR	NUMBER EXTRA CLAIMS PRESENT	RATE	ADDITIONAL FEE
TOTAL CLAIMS	11 -	20 =	0	x \$52.00	\$0.00
INDEP. CLAIMS	5 -	3 =	2	x \$220.00	\$440.00
Multiple Dependent Claims (check if applicable) <input type="checkbox"/>					\$0.00
TOTAL ADDITIONAL FEE FOR THIS AMENDMENT					\$440.00

- No additional fee is required for amendment.
- Please charge Deposit Account No. **04-1061** in the amount of **\$440.00**
- A check in the amount of _____ to cover the filing fee is enclosed.
- The Director is hereby authorized to charge payment of the following fees associated with this communication or credit any overpayment to Deposit Account **04-1061**
 - Any additional filing fees required under 37 C.F.R. 1.16.
 - Any patent application processing fees under 37 CFR 1.17.
- Payment by credit card. Form PTO-2038.

WARNING: Information on this form may become public. Credit card information should not be included on this form. Provide credit card information and authorization on PTO-2038.

/James Edward Ledbetter/

Signature

Dated: **April 29, 2010**

**James E. Ledbetter, Reg. No. 28732
Dickinson Wright PLLC
1875 Eye Street, N.W., Suite 1200
Washington, D.C. 20006
Telephone: 202.457.0160
Facsimile: 202.659.1559**

I hereby certify that this correspondence is being deposited with the United States Postal Service with sufficient postage as first class mail in an envelope addressed to "Commissioner for Patents, P.O. Box 1450, Alexandria, VA 22313-1450" [37 CFR 1.8(a)] on

(Date)

Signature of Person Mailing Correspondence

Typed or Printed Name of Person Mailing Correspondence

cc:

IPR2018-1555

Under the Paperwork Reduction Act of 1995, no persons are required to respond to a collection of information unless it displays a valid OMB control number.

PATENT APPLICATION FEE DETERMINATION RECORD Substitute for Form PTO-875	Application or Docket Number 11/719,611	Filing Date 05/17/2007	<input type="checkbox"/> To be Mailed
-----------------------------------------------------------------------------------	---------------------------------------------------	----------------------------------	---------------------------------------

APPLICATION AS FILED – PART I			OTHER THAN SMALL ENTITY			
	(Column 1)	(Column 2)	SMALL ENTITY <input type="checkbox"/>	OR		
FOR	NUMBER FILED	NUMBER EXTRA	RATE (\$)	FEE (\$)	RATE (\$)	FEE (\$)
<input type="checkbox"/> BASIC FEE <small>(37 CFR 1.16(a), (b), or (c))</small>	N/A	N/A	N/A		N/A	
<input type="checkbox"/> SEARCH FEE <small>(37 CFR 1.16(k), (l), or (m))</small>	N/A	N/A	N/A		N/A	
<input type="checkbox"/> EXAMINATION FEE <small>(37 CFR 1.16(o), (p), or (q))</small>	N/A	N/A	N/A		N/A	
TOTAL CLAIMS <small>(37 CFR 1.16(i))</small>	minus 20 =	*	X \$ =		X \$ =	
INDEPENDENT CLAIMS <small>(37 CFR 1.16(h))</small>	minus 3 =	*	X \$ =		X \$ =	
<input type="checkbox"/> APPLICATION SIZE FEE <small>(37 CFR 1.16(s))</small>	If the specification and drawings exceed 100 sheets of paper, the application size fee due is \$250 (\$125 for small entity) for each additional 50 sheets or fraction thereof. See 35 U.S.C. 41(a)(1)(G) and 37 CFR 1.16(s).					
<input type="checkbox"/> MULTIPLE DEPENDENT CLAIM PRESENT <small>(37 CFR 1.16(j))</small>						
* If the difference in column 1 is less than zero, enter "0" in column 2.			TOTAL		TOTAL	

APPLICATION AS AMENDED – PART II					OTHER THAN SMALL ENTITY			
	(Column 1)	(Column 2)	(Column 3)		SMALL ENTITY	OR		
AMENDMENT	04/29/2010	CLAIMS REMAINING AFTER AMENDMENT	HIGHEST NUMBER PREVIOUSLY PAID FOR	PRESENT EXTRA	RATE (\$)	ADDITIONAL FEE (\$)	RATE (\$)	ADDITIONAL FEE (\$)
	Total <small>(37 CFR 1.16(i))</small>	* 11	Minus ** 20	= 0	X \$ =		OR X \$52=	0
	Independent <small>(37 CFR 1.16(h))</small>	* 5	Minus *** 3	= 2	X \$ =		OR X \$220=	440
	<input type="checkbox"/> Application Size Fee <small>(37 CFR 1.16(s))</small>						OR	
	<input type="checkbox"/> FIRST PRESENTATION OF MULTIPLE DEPENDENT CLAIM <small>(37 CFR 1.16(j))</small>						OR	
					TOTAL ADD'L FEE		OR TOTAL ADD'L FEE	440

APPLICATION AS AMENDED – PART II					OTHER THAN SMALL ENTITY			
	(Column 1)	(Column 2)	(Column 3)		SMALL ENTITY	OR		
AMENDMENT		CLAIMS REMAINING AFTER AMENDMENT	HIGHEST NUMBER PREVIOUSLY PAID FOR	PRESENT EXTRA	RATE (\$)	ADDITIONAL FEE (\$)	RATE (\$)	ADDITIONAL FEE (\$)
	Total <small>(37 CFR 1.16(i))</small>	*	Minus **	=	X \$ =		OR X \$ =	
	Independent <small>(37 CFR 1.16(h))</small>	*	Minus ***	=	X \$ =		OR X \$ =	
	<input type="checkbox"/> Application Size Fee <small>(37 CFR 1.16(s))</small>						OR	
	<input type="checkbox"/> FIRST PRESENTATION OF MULTIPLE DEPENDENT CLAIM <small>(37 CFR 1.16(j))</small>						OR	
					TOTAL ADD'L FEE		OR TOTAL ADD'L FEE	

* If the entry in column 1 is less than the entry in column 2, write "0" in column 3.
 ** If the "Highest Number Previously Paid For" IN THIS SPACE is less than 20, enter "20".
 *** If the "Highest Number Previously Paid For" IN THIS SPACE is less than 3, enter "3".
 The "Highest Number Previously Paid For" (Total or Independent) is the highest number found in the appropriate box in column 1.

Legal Instrument Examiner:
 /KIM WATSON SAUNDERS/

This collection of information is required by 37 CFR 1.16. The information is required to obtain or retain a benefit by the public which is to file (and by the USPTO to process) an application. Confidentiality is governed by 35 U.S.C. 122 and 37 CFR 1.14. This collection is estimated to take 12 minutes to complete, including gathering, preparing, and submitting the completed application form to the USPTO. Time will vary depending upon the individual case. Any comments on the amount of time you require to complete this form and/or suggestions for reducing this burden, should be sent to the Chief Information Officer, U.S. Patent and Trademark Office, U.S. Department of Commerce, P.O. Box 1450, Alexandria, VA 22313-1450. DO NOT SEND FEES OR COMPLETED FORMS TO THIS ADDRESS. **SEND TO: Commissioner for Patents, P.O. Box 1450, Alexandria, VA 22313-1450.**

If you need assistance in completing the form, call 1-800-PTO-9199 and select option 2.



UNITED STATES PATENT AND TRADEMARK OFFICE

UNITED STATES DEPARTMENT OF COMMERCE
United States Patent and Trademark Office
Address: COMMISSIONER FOR PATENTS
P.O. Box 1450
Alexandria, Virginia 22313-1450
www.uspto.gov

Table with 5 columns: APPLICATION NO., FILING DATE, FIRST NAMED INVENTOR, ATTORNEY DOCKET NO., CONFIRMATION NO.
11/719,611 05/17/2007 Xiaoming She L9289.07161 9253

52989 7590 02/02/2010

Dickinson Wright PLLC
James E. Ledbetter, Esq.
International Square
1875 Eye Street, N.W., Suite 1200
Washington, DC 20006

EXAMINER

TIMORY, KABIR A

ART UNIT PAPER NUMBER

2611

MAIL DATE DELIVERY MODE

02/02/2010

PAPER

Please find below and/or attached an Office communication concerning this application or proceeding.

The time period for reply, if any, is set in the attached communication.

Office Action Summary	Application No. 11/719,611	Applicant(s) SHE ET AL.	
	Examiner KABIR A. TIMORY	Art Unit 2611	

-- The MAILING DATE of this communication appears on the cover sheet with the correspondence address --

Period for Reply

A SHORTENED STATUTORY PERIOD FOR REPLY IS SET TO EXPIRE 3 MONTH(S) OR THIRTY (30) DAYS, WHICHEVER IS LONGER, FROM THE MAILING DATE OF THIS COMMUNICATION.

- Extensions of time may be available under the provisions of 37 CFR 1.136(a). In no event, however, may a reply be timely filed after SIX (6) MONTHS from the mailing date of this communication.
- If NO period for reply is specified above, the maximum statutory period will apply and will expire SIX (6) MONTHS from the mailing date of this communication.
- Failure to reply within the set or extended period for reply will, by statute, cause the application to become ABANDONED (35 U.S.C. § 133). Any reply received by the Office later than three months after the mailing date of this communication, even if timely filed, may reduce any earned patent term adjustment. See 37 CFR 1.704(b).

Status

- 1) Responsive to communication(s) filed on 17 May 2007.
- 2a) This action is **FINAL**. 2b) This action is non-final.
- 3) Since this application is in condition for allowance except for formal matters, prosecution as to the merits is closed in accordance with the practice under *Ex parte Quayle*, 1935 C.D. 11, 453 O.G. 213.

Disposition of Claims

- 4) Claim(s) 1-12 is/are pending in the application.
4a) Of the above claim(s) _____ is/are withdrawn from consideration.
- 5) Claim(s) _____ is/are allowed.
- 6) Claim(s) 1,6,7 and 9-11 is/are rejected.
- 7) Claim(s) 2-5,8 and 12 is/are objected to.
- 8) Claim(s) _____ are subject to restriction and/or election requirement.

Application Papers

- 9) The specification is objected to by the Examiner.
- 10) The drawing(s) filed on 12 May 2007 is/are: a) accepted or b) objected to by the Examiner.
Applicant may not request that any objection to the drawing(s) be held in abeyance. See 37 CFR 1.85(a).
Replacement drawing sheet(s) including the correction is required if the drawing(s) is objected to. See 37 CFR 1.121(d).
- 11) The oath or declaration is objected to by the Examiner. Note the attached Office Action or form PTO-152.

Priority under 35 U.S.C. § 119

- 12) Acknowledgment is made of a claim for foreign priority under 35 U.S.C. § 119(a)-(d) or (f).
a) All b) Some * c) None of:
1. Certified copies of the priority documents have been received.
2. Certified copies of the priority documents have been received in Application No. _____.
3. Copies of the certified copies of the priority documents have been received in this National Stage application from the International Bureau (PCT Rule 17.2(a)).

* See the attached detailed Office action for a list of the certified copies not received.

Attachment(s)

- | | | |
|-----------------------------------------------------------------------------------------------------------------------|-----------------------------------------------------------------------------------------|-----------------------------|
| 1) <input checked="" type="checkbox"/> Notice of References Cited (PTO-892) | 4) <input type="checkbox"/> Interview Summary (PTO-413)
Paper No(s)/Mail Date. _____ | IPR2018-1555 |
| 2) <input type="checkbox"/> Notice of Draftperson's Patent Drawing Review (PTO-948) | 5) <input type="checkbox"/> Notice of Informal Patent Application | |
| 3) <input checked="" type="checkbox"/> Information Disclosure Statement(s) (PTO/SB/08)
Paper No(s)/Mail Date _____ | 6) <input type="checkbox"/> Other: _____ | HTC EX1002, Page 233 |

DETAILED ACTION

Drawings

1. The drawings are objected to because block 316 (SUBBAND AMC PARAMETER) is mislabeled as 316. **The correct label number for block (SUBBAND AMC PARAMETER) is 318 (see specification, paragraph 0016, page 7, line 11).** Corrected drawing sheets in compliance with 37 CFR 1.121(d) are required in reply to the Office action to avoid abandonment of the application. Any amended replacement drawing sheet should include all of the figures appearing on the immediate prior version of the sheet, even if only one figure is being amended. The figure or figure number of an amended drawing should not be labeled as “amended.” If a drawing figure is to be canceled, the appropriate figure must be removed from the replacement sheet, and where necessary, the remaining figures must be renumbered and appropriate changes made to the brief description of the several views of the drawings for consistency. Additional replacement sheets may be necessary to show the renumbering of the remaining figures. Each drawing sheet submitted after the filing date of an application must be labeled in the top margin as either “Replacement Sheet” or “New Sheet” pursuant to 37 CFR 1.121(d). If the changes are not accepted by the examiner, the applicant will be notified and informed of any required corrective action in the next Office action. The objection to the drawings will not be held in abeyance.

Claim Rejections - 35 USC § 102

2. The following is a quotation of the appropriate paragraphs of 35 U.S.C. 102 that form the basis for the rejections under this section made in this Office action:

A person shall be entitled to a patent unless –

(a) the invention was known or used by others in this country, or patented or described in a printed publication in this or a foreign country, before the invention thereof by the applicant for a patent.

3. **Claims 1, 6-7, and 9-11 are rejected under 35 U.S.C. 102(a) as being anticipated by Applicant Admitted Prior Art (AAPA), Specification, paragraphs 0002-0025, pages 1-12, paragraphs 0035-0038, pages 18-20).**

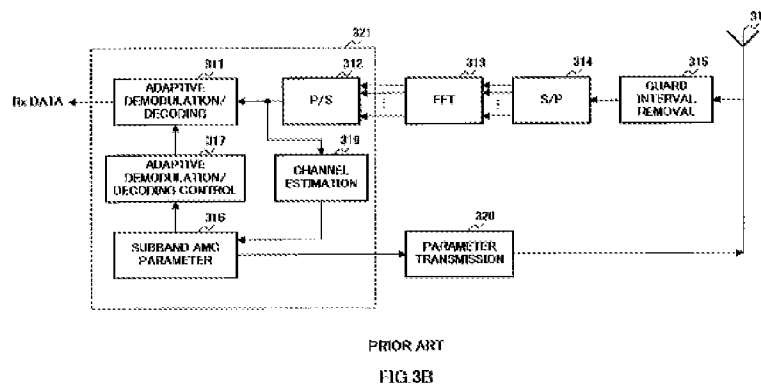

Regarding claim 1:

As shown in figures 1-4, AAPA disclose a communication apparatus (**see figures 3A-B**) comprising:

- a channel estimating section (**319 in figure 3B**) that carries out channel estimation per subband (**specification, par 0016, page 7, lines 2-7**);
- a parameter deciding section (**318 in figure 3B**) (*please note in figure 3B block 318 is mislabeled as 316. See specification, par 0016, page 7, line 11*) that decides modulation parameters and coding parameters per subband group comprised of a plurality of

Art Unit: 2611

subbands based on the channel estimation result (**specification, par 0016, page 7, lines 7-14**);

- a parameter information transmission section (**320 in figure 3B**) that transmits to a communicating party, parameter information that is information for the modulation parameters and the coding parameters (**specification, table 1 in par 001**) decided at the parameter deciding section (**318 in figure 3B**) (**specification, par 0017, page 7, lines 15-25**);
- a receiving section (**317 in figure 3B**) that receives a received signal containing data modulated and encoded per subband group at a communicating party using the modulation parameters and coding parameters of the parameter information transmitted at the parameter information transmission section (**specification, par 0018, page 8, lines 1-14**); and
- a data obtaining section (**311 in figure 3B**) that demodulates and decodes the received signal (**Rx Data in figure 3B**) received at the receiving section per subband (**see figure 2**) group using the modulation parameters and coding parameters decided at the parameter deciding section and obtains the data contained in the received signal (**specification, par 0015, page 6, lines 11-15, par 0016, page 6, lines 16-26**).

Regarding claim 6:

AAPA further disclose wherein the parameter deciding section (**318 in figure 3B**) finds the modulation parameters per subband within the subband group (**see figure 2**), and decides a modulation parameters with a highest classification within the found

Art Unit: 2611

modulation parameters as the modulation parameters for the subband group

(specification, par 0010-0012, pages 4-5).

Regarding claim 7:

AAPA further disclose wherein the parameter deciding section **(318 in figure 3B)** decides the coding parameters in such a manner that the number of information bits that are able to be assigned to all of the subbands within the subband group **(see figure 2)** is assigned to the subband group **(specification, par 0016, page 7, lines 7-14).**

Regarding claim 9:

AAPA further disclose a base station apparatus **(figure 3A)** that are a communicating party of the communication apparatus of claim 1 **(figure 3B)** **(specification, par 0014, page 5)**, the base station apparatus **(figure 3A)** comprising an adaptive modulating/coding section **(301 in figure 3A)** that modulates and encodes data in accordance with the modulation parameters and the coding parameters of the parameter information transmitted by the transmission section **(302-306 in figure 3A)**, and a data transmission section that transmits the modulated and encoded data subjected to modulation and coding at the adaptive modulating/coding section **(301 in figure 3A)** **(specification, par 0015, page 5).**

Regarding claims 10 and 11:

As shown in figures 1-4, AAPA disclose a communication system comprising a base station apparatus **(figure 3A)** transmitting modulated and encoded data and a communication terminal apparatus **(figure 3B)** receiving the data, the communication terminal apparatus comprising:

Art Unit: 2611

- a channel estimating section (**319 in figure 3B**) that carries out channel estimation per subband (**specification, par 0016, page 7, lines 2-7**);
- a parameter deciding section (**318 in figure 3B**) (*please note in figure 3B block 318 is mislabeled as 316. See specification, par 0016, page 7, line 11*) that decides modulation parameters and coding parameters per subband group comprised of a plurality of subbands based on channel estimation results (**specification, par 0016, page 7, lines 7-14**);
- a parameter information transmission section (**320 in figure 3B**) that transmits parameter information that is information for the modulation parameters and the coding parameters decided at the parameter deciding section (**318 in figure 3B**) (**specification, par 0017, page 7, lines 15-25**);
- a receiving section (**317 in figure 3B**) that receives a received signal containing data modulated and encoded per subband group at the base station apparatus using parameters of parameter information transmitted at the parameter information transmission section (**specification, par 0018, page 8, lines 1-14**); and
- a data extracting section that modulates and decodes a received signal received at the receiving section (**307 in figure 3A**) per subband group using the modulation parameters and the coding parameters (**specification, table 1 in par 001**) of the parameter information and extracts the data contained in the received signal, wherein the base station apparatus (**figure 3A**) comprises an adaptive modulating/coding section (**301 in figure 3A**) that modulates and encodes data in accordance with the modulation parameters and coding parameters of the

Art Unit: 2611

parameter information transmitted by the transmission section (**specification, par 0017, page 7, lines 24-26, par 0021, page 9, lines 1-7**); and

- a data transmission section (**302-306 in figure 3A**) that transmits data modulated and encoded at the adaptive modulating/coding section (**301 in figure 3A**) (**specification, par 0015, page 5**).

Allowable Subject Matter

4. Claim 2-5, 8, and 12 are objected to as being dependent upon a rejected base claim, but would be allowable if rewritten in independent form including all of the limitations of the base claim and any intervening claims.

5. The following is a statement of reasons for the indication of allowable subject matter:

The prior art of record, AAPA et al. does not teach or suggest a pattern storage section that stores patterns for selecting subbands constituting the subband groups in advance, wherein the parameter deciding section decides the modulation parameters and the coding parameters per subband group comprised of the subbands selected based on the patterns stored in the pattern storage section.

The prior art of record, AAPA et al. also does not teach or suggest wherein the parameter deciding section decides the coding parameters in such a manner that the number of information bits obtained by assigning a weight to the sum of the number of information bits that are able to be assigned to all of the subbands within the subband group, is assigned to the subband group.

Conclusion

6. The prior art made of record and not relied upon is considered pertinent to applicant's disclosure.

- **Blankenship et al. (US 20060008020) disclose a method and apparatus for determining channel quality and performing adaptive modulation/coding within a multicarrier communication system.**
- **Paulraj et al. (US 6351499) disclose a method and wireless systems using multiple antennas and adaptive control for maximizing a communication parameter.**
- **Kwak et al. (US 7505529) disclose method and apparatus for implementing space frequency block coding in an orthogonal frequency division multiplexing wireless communication system.**

7. Any inquiry concerning this communication or earlier communications from the examiner should be directed to KABIR A. TIMORY whose telephone number is (571)270-1674. The examiner can normally be reached on 6:30 AM - 3:00 PM Monday-Friday.

If attempts to reach the examiner by telephone are unsuccessful, the examiner's supervisor, Shuwang Liu can be reached on 571-272-3036. The fax phone number for the organization where this application or proceeding is assigned is 571-273-8300.

Information regarding the status of an application may be obtained from the Patent Application Information Retrieval (PAIR) system. Status information for

Art Unit: 2611

published applications may be obtained from either Private PAIR or Public PAIR.

Status information for unpublished applications is available through Private PAIR only.

For more information about the PAIR system, see <http://pair-direct.uspto.gov>. Should

you have questions on access to the Private PAIR system, contact the Electronic

Business Center (EBC) at 866-217-9197 (toll-free). If you would like assistance from a

USPTO Customer Service Representative or access to the automated information

system, call 800-786-9199 (IN USA OR CANADA) or 571-272-1000.

/Kabir A Timory/

Examiner, Art Unit 2611

/Shuwang Liu/

Supervisory Patent Examiner, Art Unit 2611

Notice of References Cited	Application/Control No. 11/719,611	Applicant(s)/Patent Under Reexamination SHE ET AL.	
	Examiner KABIR A. TIMORY	Art Unit 2611	Page 1 of 1

U.S. PATENT DOCUMENTS

*		Document Number Country Code-Number-Kind Code	Date MM-YYYY	Name	Classification
*	A	US-6,351,499 B1	02-2002	Paulraj et al.	375/267
*	B	US-2006/0008020 A1	01-2006	Blankenship et al.	375/261
*	C	US-7,505,529 B2	03-2009	Kwak et al.	375/295
	D	US-			
	E	US-			
	F	US-			
	G	US-			
	H	US-			
	I	US-			
	J	US-			
	K	US-			
	L	US-			
	M	US-			

FOREIGN PATENT DOCUMENTS

*		Document Number Country Code-Number-Kind Code	Date MM-YYYY	Country	Name	Classification
	N					
	O					
	P					
	Q					
	R					
	S					
	T					

NON-PATENT DOCUMENTS

*		Include as applicable: Author, Title Date, Publisher, Edition or Volume, Pertinent Pages)
	U	
	V	
	W	
	X	

*A copy of this reference is not being furnished with this Office action. (See MPEP § 707.05(a).)
Dates in MM-YYYY format are publication dates. Classifications may be US or foreign.

Index of Claims 	Application/Control No. 11719611	Applicant(s)/Patent Under Reexamination SHE ET AL.
	Examiner KABIR A TIMORY	Art Unit 2611

✓	Rejected
=	Allowed

-	Cancelled
÷	Restricted

N	Non-Elected
I	Interference

A	Appeal
O	Objected

Claims renumbered in the same order as presented by applicant
 CPA
 T.D.
 R.1.47

CLAIM		DATE							
Final	Original	01/29/2010							
	1	✓							
	2	○							
	3	○							
	4	○							
	5	○							
	6	✓							
	7	✓							
	8	○							
	9	✓							
	10	✓							
	11	✓							
	12	○							

Search Notes 	Application/Control No. 11719611	Applicant(s)/Patent Under Reexamination SHE ET AL.
	Examiner KABIR A TIMORY	Art Unit 2611

SEARCHED			
Class	Subclass	Date	Examiner
375	260	1/29/2010	KT
375	267	1/29/2010	KT
375	299	1/29/2010	KT
375	324	1/29/2010	KT
375	349	1/29/2010	KT

SEARCH NOTES		
Search Notes	Date	Examiner
EAST - US-PGPUB; USPAT; USOCR; FPRS; EPO; JPO; DERWENT; IBM_TDB	1/29/2010	KT
INVENTOR'S NAME SEARCH	1/29/2010	KT
CO-INVENTOR'S NAME SEARCH	1/29/2010	KT
PALM SEARCH	1/29/2010	KT
SHUWANG LIU (2611 - SPE)	1/29/2010	KT

INTERFERENCE SEARCH			
Class	Subclass	Date	Examiner

	IPR2018-1555 HTC EX1002, Page 244
--	--------------------------------------

EAST Search History

EAST Search History (Prior Art)

Ref #	Hits	Search Query	DBs	Default Operator	Plurals	Time Stamp
L1	0	ofdm and ((AMC) or (adaptive near modulation near cod \$4)) and (cod\$4 or ecod\$4 or decod\$4 or demodulat\$4) with parameter\$1 with weight\$1 same ((subcarrier\$1) or (sub near carrier\$1) or (tone \$1) or (sub-band\$1) or (sub near band\$1) or (sub-carrier\$1))	US-PGPUB; USPAT; USOCR; FPRS; EPO; JPO; DERWENT; IBM_TDB	AND	ON	2010/01/29 10:32
L2	0	ofdm and ((AMC) or (adaptive near modulation near cod \$4)) and (cod\$4 or ecod\$4 or decod\$4 or demodulat\$4) SAME parameter\$1 with weight\$1 same ((subcarrier\$1) or (sub near carrier\$1) or (tone \$1) or (sub-band\$1) or (sub near band\$1) or (sub-carrier\$1))	US-PGPUB; USPAT; USOCR; FPRS; EPO; JPO; DERWENT; IBM_TDB	AND	ON	2010/01/29 10:32
L3	3	ofdm and ((AMC) or (adaptive near modulation near cod \$4)) and (cod\$4 or ecod\$4 or decod\$4 or demodulat\$4) SAME (value or parameter \$1) with weight\$1 same ((subcarrier\$1) or (sub near carrier\$1) or (tone\$1) or (sub-band\$1) or (sub near band\$1) or (sub-carrier \$1))	US-PGPUB; USPAT; USOCR; FPRS; EPO; JPO; DERWENT; IBM_TDB	AND	ON	2010/01/29 10:33

L9	3	ofdm and ((AMC) or (adaptive near modulation near cod \$4)) and (cod\$4 or ecod\$4 or decod\$4 or demodulat\$4) SAME (value or parameter \$1) SAME weight\$1 same ((subcarrier\$1) or (sub near carrier\$1) or (tone\$1) or (sub-band\$1) or (sub near band\$1) or (sub-carrier \$1))	US-PGPUB; USPAT; USOCR; FPRS; EPO; JPO; DERWENT; IBM_TDB	AND	ON	2010/01/29 11:01
L10	19	ofdm and ((AMC) or (adaptive near modulation near cod \$4)) and (cod\$4 or ecod\$4 or decod\$4 or demodulat\$4) AND (value or parameter \$1) SAME weight\$1 same ((subcarrier\$1) or (sub near carrier\$1) or (tone\$1) or (sub-band\$1) or (sub near band\$1) or (sub-carrier \$1))	US-PGPUB; USPAT; USOCR; FPRS; EPO; JPO; DERWENT; IBM_TDB	AND	ON	2010/01/29 11:02
L11	24	ofdm and ((AMC) or (adaptive near modulation near cod \$4)) and (cod\$4 or ecod\$4 or decod\$4 or demodulat\$4) SAME weight\$1 same ((subcarrier\$1) or (sub near carrier\$1) or (tone \$1) or (sub-band\$1) or (sub near band\$1) or (sub-carrier\$1))	US-PGPUB; USPAT; USOCR; FPRS; EPO; JPO; DERWENT; IBM_TDB	AND	ON	2010/01/29 11:04
L12	54	ofdm and ((AMC) or (adaptive near modulation near cod \$4)) and (cod\$4 or ecod\$4 or decod\$4 or demodulat\$4) AND weight\$1 same ((subcarrier\$1) or (sub near carrier\$1) or (tone \$1) or (sub-band\$1) or (sub near band\$1) or (sub-carrier\$1))	US-PGPUB; USPAT; USOCR; FPRS; EPO; JPO; DERWENT; IBM_TDB	AND	ON	2010/01/29 11:07

L13	260	ofdm and ((AMC) or (adaptive near modulation near cod \$4)) and (memory or stor\$4 or table) WITH (cod\$4 or ecod\$4 or decod\$4 or demodulat \$4) and ((subcarrier \$1) or (sub near carrier \$1) or (tone\$1) or (sub-band\$1) or (sub near band\$1) or (sub-carrier\$1))	US-PGPUB; USPAT; USOCR; FPRS; EPO; JPO; DERWENT; IBM_TDB	AND	ON	2010/01/29 11:13
L14	47	((375/260.ccls.) or (375/267.ccls.) or (375/299.ccls.) or (375/324.ccls.) or (375/349.ccls.)) and L13	US-PGPUB; USPAT; USOCR; FPRS; EPO; JPO; DERWENT; IBM_TDB	AND	ON	2010/01/29 11:13
S1	1	11/719611	US-PGPUB; USPAT; USOCR; FPRS; EPO; JPO; DERWENT; IBM_TDB	AND	ON	2010/01/17 19:56
S2	27	((She near Xiaoming) or (Li near Jifeng)) and ofdm	US-PGPUB; USPAT; USOCR; FPRS; EPO; JPO; DERWENT; IBM_TDB	AND	ON	2010/01/17 20:10
S3	2	((She near Xiaoming) or (Li near Jifeng)) and ofdm and amc	US-PGPUB; USPAT; USOCR; FPRS; EPO; JPO; DERWENT; IBM_TDB	AND	ON	2010/01/17 20:11
S4	45	ofdm and ((AMC) or (adaptive near modulation near cod \$4)) and (memory or stor\$4) with modulat \$4 with cod\$4	US-PGPUB; USPAT; USOCR; FPRS; EPO; JPO; DERWENT; IBM_TDB	AND	ON	2010/01/20 10:18

S5	13	ofdm and ((AMC) or (adaptive near modulation near cod \$4)) and (memory or stor\$4) with modulat \$4 same ((subcarrier \$1) or (sub near carrier \$1) or (tone\$1) or (sub-band\$1) or (sub near band\$1) or (sub-carrier\$1))	US-PGPUB; USPAT; USOCR; FPRS; EPO; JPO; DERWENT; IBM_TDB	AND	ON	2010/01/20 10:28
S6	24	ofdm and ((AMC) or (adaptive near modulation near cod \$4)) and (memory or stor\$4) SAME modulat \$4 same ((subcarrier \$1) or (sub near carrier \$1) or (tone\$1) or (sub-band\$1) or (sub near band\$1) or (sub-carrier\$1))	US-PGPUB; USPAT; USOCR; FPRS; EPO; JPO; DERWENT; IBM_TDB	AND	ON	2010/01/20 10:28
S7	25	ofdm and ((AMC) or (adaptive near modulation near cod \$4)) and (memory or stor\$4) SAME cod\$4 same ((subcarrier\$1) or (sub near carrier\$1) or (tone\$1) or (sub-band\$1) or (sub near band\$1) or (sub-carrier \$1))	US-PGPUB; USPAT; USOCR; FPRS; EPO; JPO; DERWENT; IBM_TDB	AND	ON	2010/01/20 10:30
S8	30	ofdm and ((AMC) or (adaptive near modulation near cod \$4)) and (memory or stor\$4) SAME (cod\$4 or ecod\$4 or decod\$4) same ((subcarrier\$1) or (sub near carrier\$1) or (tone\$1) or (sub-band\$1) or (sub near band\$1) or (sub-carrier \$1))	US-PGPUB; USPAT; USOCR; FPRS; EPO; JPO; DERWENT; IBM_TDB	AND	ON	2010/01/20 10:32

S9	65	ofdm and ((AMC) or (adaptive near modulation near cod \$4)) and (memory or stor\$4 or table) SAME (cod\$4 or ecod\$4 or decod\$4 or demodulat \$4) same ((subcarrier \$1) or (sub near carrier \$1) or (tone\$1) or (sub-band\$1) or (sub near band\$1) or (sub-carrier\$1))	US-PGPUB; USPAT; USOCR; FPRS; EPO; JPO; DERWENT; IBM_TDB	AND	ON	2010/01/20 10:34
S10	31	ofdm and ((AMC) or (adaptive near modulation near cod \$4)) and (memory or stor\$4 or table) WITH (cod\$4 or ecod\$4 or decod\$4 or demodulat \$4) same ((subcarrier \$1) or (sub near carrier \$1) or (tone\$1) or (sub-band\$1) or (sub near band\$1) or (sub-carrier\$1))	US-PGPUB; USPAT; USOCR; FPRS; EPO; JPO; DERWENT; IBM_TDB	AND	ON	2010/01/20 10:34
S11	79	timory	US-PGPUB; USPAT; USOCR; FPRS; EPO; JPO; DERWENT; IBM_TDB	AND	ON	2010/01/20 12:32
S12	3	"20040132496"	US-PGPUB; USPAT; USOCR; FPRS; EPO; JPO; DERWENT; IBM_TDB	AND	ON	2010/01/20 12:36
S13	13	("20030228850" "20040141566" "20050220211" "20050243942" "20060120476" "6351499").PN. OR ("7123887").URPN.	US-PGPUB; USPAT; USOCR	AND	ON	2010/01/20 12:39

S14	257	ofdm and ((AMC) or (adaptive near modulation near cod \$4)) and (memory or stor\$4 or table) WITH (cod\$4 or ecod\$4 or decod\$4 or demodulat \$4) and ((subcarrier \$1) or (sub near carrier \$1) or (tone\$1) or (sub-band\$1) or (sub near band\$1) or (sub-carrier\$1))	US-PGPUB; USPAT; USOCR; FPRS; EPO; JPO; DERWENT; IBM_TDB	AND	ON	2010/01/20 12:50
S15	45	ofdm and ((AMC) or (adaptive near modulation near cod \$4)) same (memory or stor\$4 or table) WITH (cod\$4 or ecod\$4 or decod\$4 or demodulat \$4) and ((subcarrier \$1) or (sub near carrier \$1) or (tone\$1) or (sub-band\$1) or (sub near band\$1) or (sub-carrier\$1))	US-PGPUB; USPAT; USOCR; FPRS; EPO; JPO; DERWENT; IBM_TDB	AND	ON	2010/01/20 12:51
S16	30	ofdm and ((AMC) or (adaptive near modulation near cod \$4)) and (memory or stor\$4 or table) WITH (cod\$4 or ecod\$4 or decod\$4 or demodulat \$4) with parameter\$1 and ((subcarrier\$1) or (sub near carrier\$1) or (tone\$1) or (sub-band \$1) or (sub near band \$1) or (sub-carrier\$1))	US-PGPUB; USPAT; USOCR; FPRS; EPO; JPO; DERWENT; IBM_TDB	AND	ON	2010/01/20 12:56
S17	40	ofdm and ((AMC) or (adaptive near modulation near cod \$4)) and (memory or stor\$4 or table) WITH (cod\$4 or ecod\$4 or decod\$4 or demodulat \$4) SAME parameter\$1 and ((subcarrier\$1) or (sub near carrier\$1) or (tone\$1) or (sub-band \$1) or (sub near band \$1) or (sub-carrier\$1))	US-PGPUB; USPAT; USOCR; FPRS; EPO; JPO; DERWENT; IBM_TDB	AND	ON	2010/01/20 12:58

S18	3	US-1021329-\$.DID. OR US-6810084-\$. DID. OR MX-20030922- \$.DID. OR MX- 20041202-\$.DID.	US-PGPUB; USPAT; USOCR; FPRS; EPO; JPO	AND	ON	2010/01/20 14:30
S19	22	US-6836484-\$.DID. OR US-4122004-\$. DID. OR US-2003023- \$.DID. OR US- 1212003-\$.DID. OR US-2004040-\$.DID. OR WO-2004040-\$. DID. OR WO- 20040408-\$.DID. OR WO-200404081-\$.DID. OR WO-2004040813-\$. DID. OR US-3032004- \$.DID. OR WO- 2004104-\$.DID. OR WO-20041042-\$.DID. OR WO-200410429-\$. DID. OR WO- 2004104293-\$.DID. OR JP-2003169-\$.DID. OR JP-20031690-\$. DID. OR JP- 200316903-\$.DID. OR JP-2003169036-\$.DID. OR US-6062003-\$. DID. OR JP-2001238-\$. DID. OR JP-20012382- \$.DID. OR JP- 200123826-\$.DID. OR JP-2001238269-\$.DID. OR JP-1466297-\$.DID. OR US-7012004-\$. DID. OR US-1469662- \$.DID. OR US- 1496623-\$.DID. OR US-3052004-\$.DID.	US-PGPUB; USPAT; USOCR; FPRS; EPO; JPO	AND	ON	2010/01/20 14:50

1/ 29/ 2010 11:34:20 AM

C:\ Documents and Settings\ atimory\ My Documents\ EAST\ Workspaces\ 11719611.wsp

UNITED STATES PATENT AND TRADEMARK OFFICE

UNITED STATES DEPARTMENT OF COMMERCE
United States Patent and Trademark Office
 Address: COMMISSIONER FOR PATENTS
 P.O. Box 1450
 Alexandria, Virginia 22313-1450
 www.uspto.gov

BIB DATA SHEET
CONFIRMATION NO. 9253

SERIAL NUMBER	FILING or 371(c) DATE	CLASS	GROUP ART UNIT	ATTORNEY DOCKET NO.		
11/719,611	05/17/2007	375	2611	L9289.07161		
APPLICANTS Xiaoming She, Beijing, CHINA; Jifeng Li, Kanagawa, JAPAN;						
** CONTINUING DATA ***** This application is a 371 of PCT/JP05/21246 11/18/2005						
** FOREIGN APPLICATIONS ***** JAPAN 200410094967.7 11/19/2004						
** IF REQUIRED, FOREIGN FILING LICENSE GRANTED ** 02/26/2009						
Foreign Priority claimed <input checked="" type="checkbox"/> Yes <input type="checkbox"/> No	35 USC 119(a-d) conditions met <input checked="" type="checkbox"/> Yes <input type="checkbox"/> No	<input type="checkbox"/> Met after Allowance Initials	STATE OR COUNTRY CHINA	SHEETS DRAWINGS 16	TOTAL CLAIMS 12	INDEPENDENT CLAIMS 3
Verified and Acknowledged <u>/KABIR A TIMORY/</u> Examiner's Signature						
ADDRESS Dickinson Wright PLLC James E. Ledbetter, Esq. International Square 1875 Eye Street, N.W., Suite 1200 Washington, DC 20006 UNITED STATES						
TITLE COMMUNICATION APPARATUS, COMMUNICATION SYSTEM, AND COMMUNICATION METHOD						
FILING FEE RECEIVED 900	FEES: Authority has been given in Paper No. _____ to charge/credit DEPOSIT ACCOUNT No. _____ for following:		<input type="checkbox"/> All Fees <input type="checkbox"/> 1.16 Fees (Filing) <input type="checkbox"/> 1.17 Fees (Processing Ext. of time) <input type="checkbox"/> 1.18 Fees (Issue) <input type="checkbox"/> Other _____ <input type="checkbox"/> Credit			

IN THE UNITED STATES PATENT AND TRADEMARK OFFICE

In re the Application of

Inventors: Xiaoming SHE, et al.

Appln. No.: 11/719,611

Filed: May 17, 2007

For: COMMUNICATION APPARATUS, COMMUNICATION
SYSTEM, AND COMMUNICATION METHODINFORMATION DISCLOSURE STATEMENTAssistant Commissioner of Patents
Washington, DC 20231

Dear Sir:

Pursuant to Rules 56 and 99, Applicants hereby call the attention of the Patent Office to the art listed on the attached Form PTO 1449. Copies of the art cited in the International Search Report (ISR), which issued by the JPO, are made available to the U.S. examiner in the national stage application, pursuant to MPEP 1893.03(g), and therefore copies of such art are not submitted herewith. The art cited in the ISR is listed on the attached PTO-1449 for an indication of consideration by the examiner. Copies of any other references listed on the PTO-1449, besides those cited in the ISR, are submitted herewith. US '484 corresponds to JP '269 and US '706 corresponds to CN '662.

Applicants present this art so that the Patent Office may, in the first instance, determine any relevancy thereof to the presently claimed invention, see Beckman Instruments, Inc. v.

ALL REFERENCES CONSIDERED EXCEPT WHERE LINED THROUGH. /K.T./

Chemtronics, Inc., 439 F.2d 1369, 1380, 165 USPQ 355, 364 (5th Cir. 1970). Also see Patent Office Rules 104 and 106. Applicants respectfully request that this art be expressly considered during the prosecution of this application and made of record herein and appear among the "References Cited" on any patent to issue herefrom.

Respectfully submitted,

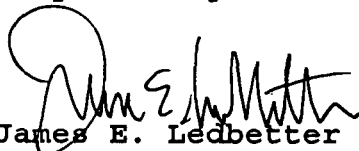

James E. Ledbetter
Registration No. 28,732

Date: May 22, 2007

JEL/spp

ATTORNEY DOCKET NO. L9289.07161

STEVENS, DAVIS, MILLER & MOSHER, L.L.P.
1615 L STREET, NW, Suite 850
WASHINGTON, DC 20043-4387
Telephone: (202) 785-0100
Facsimile: (202) 408-5200

Receipt date: 05/22/2007

11719611 - SHEET 011

FORM PTO-1449 U.S. Department of Commerce
(Rev. 4/92) Patent and Trademark Office

**INFORMATION DISCLOSURE
STATEMENT BY APPLICANT**

(Use several sheets if necessary)

ATTY. DOCKET NO.

L9289.07161

SERIAL NO.

11/719,611

APPLICANT

Xiaoming SHE, et al.

FILING DATE

May 17, 2007

GROUP

Unassigned

U.S. PATENT DOCUMENTS

EXAMINER INITIAL	DOCUMENT NUMBER	DATE	NAME	CLASS	SUBCLASS	FILING DATE IF APPROPRIATE	
						YES	NO
	6 8 3 6 4 8 4	12/2004	Suzuki				
2003	0 2 3 1 7 0 6	12/2003	Hwang				

FOREIGN PATENT DOCUMENTS

EXAMINER INITIAL	DOCUMENT NUMBER	DATE	COUNTRY	CLASS	SUBCLASS	TRANSLATION	
						YES	NO
	2004 0 4 0 8 2 7	03/2004	WO				
	2004 0 4 0 8 1 3	03/2004	WO				
	2004 1 0 4 2 9 3	04/2004	JP				
	2003 1 6 9 0 3 6	06/2003	JP				
	2001 2 3 8 2 6 9	08/2001	JP				
	1 4 6 6 2 9 7	01/2004	CN				Abstract
	1 4 6 9 6 6 2	01/2004	CN				Abstract
	1 4 9 6 6 2 3	05/2004	CN				Abstract

OTHER DOCUMENTS (Including Author, Title, Date, Pertinent Pages, Etc.)

PCT International Search Report dated February 14, 2006.

Sharath B. Reddy, et al.: "An Efficient Blind Modulation Detection Algorithm for Adaptive OFDM Systems," Vehicular Technology Conference, 2003, VTC 2003-Fall, 2003 IEEE 58th, Aug. 9, 2003, pp. 1895-1899.

Yuanrun Teng, et al.: "Grouping Adaptive Modulation Method for Burst Mode OFDM Transmission System," Technical Report of IEICE, Aug. 31, 2003, vol. 101, no. 280, pp. 51-57.

EXAMINER: Initial if citation is considered, draw line through citation if not in conformance and not considered. Include copy of this form with next communication to applicant.

(Form PTO-1449 [6-4])

/Kabir Timory/

01/19/2010

IPR2018-1555

HTC EX1002, Page 255

ALL REFERENCES CONSIDERED EXCEPT WHERE LINED THROUGH. /K.T./



UNITED STATES PATENT AND TRADEMARK OFFICE

UNITED STATES DEPARTMENT OF COMMERCE
United States Patent and Trademark Office
Address: COMMISSIONER FOR PATENTS
P.O. Box 1450
Alexandria, Virginia 22313-1450
www.uspto.gov

Table with 4 columns: APPLICATION NUMBER (11/719,611), FILING OR 371(C) DATE (05/17/2007), FIRST NAMED APPLICANT (Xiaoming She), ATTY. DOCKET NO./TITLE (L9289.07161)

CONFIRMATION NO. 9253

PUBLICATION NOTICE



52989
Dickinson Wright PLLC
James E. Ledbetter, Esq.
International Square
1875 Eye Street, N.W., Suite 1200
Washington, DC 20006

Title: COMMUNICATION APPARATUS, COMMUNICATION SYSTEM, AND COMMUNICATION METHOD

Publication No. US-2009-0147866-A1

Publication Date: 06/11/2009

NOTICE OF PUBLICATION OF APPLICATION

The above-identified application will be electronically published as a patent application publication pursuant to 37 CFR 1.211, et seq. The patent application publication number and publication date are set forth above.

The publication may be accessed through the USPTO's publically available Searchable Databases via the Internet at www.uspto.gov. The direct link to access the publication is currently http://www.uspto.gov/patft/.

The publication process established by the Office does not provide for mailing a copy of the publication to applicant. A copy of the publication may be obtained from the Office upon payment of the appropriate fee set forth in 37 CFR 1.19(a)(1). Orders for copies of patent application publications are handled by the USPTO's Office of Public Records. The Office of Public Records can be reached by telephone at (703) 308-9726 or (800) 972-6382, by facsimile at (703) 305-8759, by mail addressed to the United States Patent and Trademark Office, Office of Public Records, Alexandria, VA 22313-1450 or via the Internet.

In addition, information on the status of the application, including the mailing date of Office actions and the dates of receipt of correspondence filed in the Office, may also be accessed via the Internet through the Patent Electronic Business Center at www.uspto.gov using the public side of the Patent Application Information and Retrieval (PAIR) system. The direct link to access this status information is currently http://pair.uspto.gov/. Prior to publication, such status information is confidential and may only be obtained by applicant using the private side of PAIR.

Further assistance in electronically accessing the publication, or about PAIR, is available by calling the Patent Electronic Business Center at 1-866-217-9197.

Office of Data Management, Application Assistance Unit (571) 272-4000, or (571) 272-4200, or 1-888-786-0101



UNITED STATES PATENT AND TRADEMARK OFFICE

UNITED STATES DEPARTMENT OF COMMERCE
United States Patent and Trademark Office
Address: COMMISSIONER FOR PATENTS
P.O. Box 1450
Alexandria, Virginia 22313-1450
www.uspto.gov

Table with 3 columns: U.S. APPLICATION NUMBER NO. (11/719,611), FIRST NAMED APPLICANT (Xiaoming She), ATTY. DOCKET NO. (L9289.07161)

52989
Dickinson Wright PLLC
James E. Ledbetter, Esq.
International Square
1875 Eye Street, N.W., Suite 1200
Washington, DC 20006

INTERNATIONAL APPLICATION NO.

PCT/JP05/21246

Table with 2 columns: I.A. FILING DATE (11/18/2005), PRIORITY DATE (11/19/2004)

CONFIRMATION NO. 9253
371 ACCEPTANCE LETTER



Date Mailed: 03/03/2009

NOTICE OF ACCEPTANCE OF APPLICATION UNDER 35 U.S.C 371 AND 37 CFR 1.495

The applicant is hereby advised that the United States Patent and Trademark Office in its capacity as a Designated / Elected Office (37 CFR 1.495), has determined that the above identified international application has met the requirements of 35 U.S.C. 371, and is ACCEPTED for national patentability examination in the United States Patent and Trademark Office.

The United States Application Number assigned to the application is shown above and the relevant dates are:

Table with 2 columns: DATE OF RECEIPT OF 35 U.S.C. 371(c)(1), (c)(2) and (c)(4) REQUIREMENTS (05/17/2007), DATE OF COMPLETION OF ALL 35 U.S.C. 371 REQUIREMENTS (05/17/2007)

A Filing Receipt (PTO-103X) will be issued for the present application in due course. THE DATE APPEARING ON THE FILING RECEIPT AS THE " FILING DATE" IS THE DATE ON WHICH THE LAST OF THE 35 U.S.C. 371 (c)(1), (c)(2) and (c)(4) REQUIREMENTS HAS BEEN RECEIVED IN THE OFFICE. THIS DATE IS SHOWN ABOVE. The filing date of the above identified application is the international filing date of the international application (Article 11(3) and 35 U.S.C. 363). Once the Filing Receipt has been received, send all correspondence to the Group Art Unit designated thereon.

The following items have been received:

- Copy of the International Application filed on 05/17/2007
• Copy of the International Search Report filed on 05/17/2007
• Copy of IPE Report filed on 05/17/2007
• Information Disclosure Statements filed on 05/22/2007
• Oath or Declaration filed on 05/17/2007
• Request for Immediate Examination filed on 05/17/2007
• U.S. Basic National Fees filed on 05/17/2007
• Assignment filed on 10/16/2007
• Early Pre-Grant Publication Request filed on 05/17/2007
• Priority Documents filed on 05/17/2007

The following defects have been observed:

SUMMARY OF FEES DUE:

Total additional fee(s) for this application is \$ 300 for a large entity.

- \$ 300 Early Pre-GRANT Publication Fee.

Applicant is reminded that any communications to the United States Patent and Trademark Office must be mailed to the address given in the heading and include the U.S. application no. shown above (37 CFR 1.5)

PATRICIA A BOOKER

Telephone: (703) 308-9140 EXT 204



UNITED STATES PATENT AND TRADEMARK OFFICE

UNITED STATES DEPARTMENT OF COMMERCE
United States Patent and Trademark Office
Address: COMMISSIONER FOR PATENTS
P.O. Box 1450
Alexandria, Virginia 22313-1450
www.uspto.gov

Table with 7 columns: APPLICATION NUMBER, FILING or 371(c) DATE, GRP ART UNIT, FIL FEE REC'D, ATTY. DOCKET NO, TOT CLAIMS, IND CLAIMS. Row 1: 11/719,611, 05/17/2007, 2611, 900, L9289.07161, 12, 3

CONFIRMATION NO. 9253

FILING RECEIPT



52989
Dickinson Wright PLLC
James E. Ledbetter, Esq.
International Square
1875 Eye Street, N.W., Suite 1200
Washington, DC 20006

Date Mailed: 03/03/2009

Receipt is acknowledged of this non-provisional patent application. The application will be taken up for examination in due course. Applicant will be notified as to the results of the examination. Any correspondence concerning the application must include the following identification information: the U.S. APPLICATION NUMBER, FILING DATE, NAME OF APPLICANT, and TITLE OF INVENTION. Fees transmitted by check or draft are subject to collection. Please verify the accuracy of the data presented on this receipt. If an error is noted on this Filing Receipt, please submit a written request for a Filing Receipt Correction. Please provide a copy of this Filing Receipt with the changes noted thereon. If you received a "Notice to File Missing Parts" for this application, please submit any corrections to this Filing Receipt with your reply to the Notice. When the USPTO processes the reply to the Notice, the USPTO will generate another Filing Receipt incorporating the requested corrections

Applicant(s)

Xiaoming She, Beijing, CHINA;
Jifeng Li, Kanagawa, JAPAN;

Assignment For Published Patent Application

MATSUSHITA ELECTRIC INDUSTRIAL CO., LTD., OSAKA, JP

Power of Attorney: The patent practitioners associated with Customer Number 52989

Domestic Priority data as claimed by applicant

This application is a 371 of PCT/JP05/21246 11/18/2005

Foreign Applications

JAPAN 200410094967.7 11/19/2004

If Required, Foreign Filing License Granted: 02/26/2009

The country code and number of your priority application, to be used for filing abroad under the Paris Convention, is US 11/719,611

Projected Publication Date: 06/11/2009

Non-Publication Request: No

Early Publication Request: No

Title

COMMUNICATION APPARATUS, COMMUNICATION SYSTEM, AND COMMUNICATION METHOD

Preliminary Class

375

PROTECTING YOUR INVENTION OUTSIDE THE UNITED STATES

Since the rights granted by a U.S. patent extend only throughout the territory of the United States and have no effect in a foreign country, an inventor who wishes patent protection in another country must apply for a patent in a specific country or in regional patent offices. Applicants may wish to consider the filing of an international application under the Patent Cooperation Treaty (PCT). An international (PCT) application generally has the same effect as a regular national patent application in each PCT-member country. The PCT process **simplifies** the filing of patent applications on the same invention in member countries, but **does not result** in a grant of "an international patent" and does not eliminate the need of applicants to file additional documents and fees in countries where patent protection is desired.

Almost every country has its own patent law, and a person desiring a patent in a particular country must make an application for patent in that country in accordance with its particular laws. Since the laws of many countries differ in various respects from the patent law of the United States, applicants are advised to seek guidance from specific foreign countries to ensure that patent rights are not lost prematurely.

Applicants also are advised that in the case of inventions made in the United States, the Director of the USPTO must issue a license before applicants can apply for a patent in a foreign country. The filing of a U.S. patent application serves as a request for a foreign filing license. The application's filing receipt contains further information and guidance as to the status of applicant's license for foreign filing.

Applicants may wish to consult the USPTO booklet, "General Information Concerning Patents" (specifically, the section entitled "Treaties and Foreign Patents") for more information on timeframes and deadlines for filing foreign patent applications. The guide is available either by contacting the USPTO Contact Center at 800-786-9199, or it can be viewed on the USPTO website at <http://www.uspto.gov/web/offices/pac/doc/general/index.html>.

For information on preventing theft of your intellectual property (patents, trademarks and copyrights), you may wish to consult the U.S. Government website, <http://www.stopfakes.gov>. Part of a Department of Commerce initiative, this website includes self-help "toolkits" giving innovators guidance on how to protect intellectual property in specific countries such as China, Korea and Mexico. For questions regarding patent enforcement issues, applicants may call the U.S. Government hotline at 1-866-999-HALT (1-866-999-4158).

LICENSE FOR FOREIGN FILING UNDER**Title 35, United States Code, Section 184****Title 37, Code of Federal Regulations, 5.11 & 5.15****GRANTED**

The applicant has been granted a license under 35 U.S.C. 184, if the phrase "IF REQUIRED, FOREIGN FILING LICENSE GRANTED" followed by a date appears on this form. Such licenses are issued in all applications where

the conditions for issuance of a license have been met, regardless of whether or not a license may be required as set forth in 37 CFR 5.15. The scope and limitations of this license are set forth in 37 CFR 5.15(a) unless an earlier license has been issued under 37 CFR 5.15(b). The license is subject to revocation upon written notification. The date indicated is the effective date of the license, unless an earlier license of similar scope has been granted under 37 CFR 5.13 or 5.14.

This license is to be retained by the licensee and may be used at any time on or after the effective date thereof unless it is revoked. This license is automatically transferred to any related applications(s) filed under 37 CFR 1.53(d). This license is not retroactive.

The grant of a license does not in any way lessen the responsibility of a licensee for the security of the subject matter as imposed by any Government contract or the provisions of existing laws relating to espionage and the national security or the export of technical data. Licensees should apprise themselves of current regulations especially with respect to certain countries, of other agencies, particularly the Office of Defense Trade Controls, Department of State (with respect to Arms, Munitions and Implements of War (22 CFR 121-128)); the Bureau of Industry and Security, Department of Commerce (15 CFR parts 730-774); the Office of Foreign Assets Control, Department of Treasury (31 CFR Parts 500+) and the Department of Energy.

NOT GRANTED

No license under 35 U.S.C. 184 has been granted at this time, if the phrase "IF REQUIRED, FOREIGN FILING LICENSE GRANTED" DOES NOT appear on this form. Applicant may still petition for a license under 37 CFR 5.12, if a license is desired before the expiration of 6 months from the filing date of the application. If 6 months has lapsed from the filing date of this application and the licensee has not received any indication of a secrecy order under 35 U.S.C. 181, the licensee may foreign file the application pursuant to 37 CFR 5.15(b).

Patricia Booker

DO/EO WORKSHEET

Patent Application Specialist/ National Stage Division

U.S. Appl. No. 11/719611

International Appl. No. PCT JP05/21246

WIPO PUBLICATION INFORMATION :

Publication No.: WO2006054697

Publication Language : English (IA used as specification) German Chinese Korean French Spanish Russian Other

Publication Date: 26 May 2006

Not Published : U.S. only Early Pub. Request

Published : Early Pub.

INTERNATIONAL APPLICATION PAPERS IN THE APPLICATION FILE :

International Application (RECORD COPY)

PCT/HB/306

Article 19 Amendments

Request form PCT/RO/101

PCT/IPEA/409 - IPER (check Examination Authority):

PCT/ISA/210 - Search Report (check Searching Authority):

EP JP SE AU US FR CN ES
 RU AT CA KR _____

EP JP SE AU US FR CN ES
 RU AT CA KR _____ NONE

Annexes to 409

Search Report References

PCT/ISA/237 (check Searching Authority):

Priority Document (s) No. 1

EP JP SE AU US FR CN ES
 RU AT CA KR _____

N/A

Priority Document was NOT AVAILABLE at the time of paralegal review

Other : 373

Other : _____

RECEIPTS FROM THE APPLICANT (filed with the application unless noted otherwise):

Basic National Fee (or authorization to charge)

Express Request to Begin Nat'l Examination Procedures

Description Claims Abstract 12/3

Preliminary Amendment(s) Filed on:

1. same as 371 request date - 2. _____ 3. _____

Number of Drawing Sheets : 16

Information Disclosure Statement(s) Filed on:

1. same as 371 request date 22 May 07

Translation of Article 19 Amendments

Assignee Statement Under 37 CFR 5.73(b) 16 Oct 07

entered not entered :

Assignee PG Publication Notice

not a page for page substitution
 replaced by Article 34 Amendment

Substitute Specification Filed on :

1. same as 371 request date 2. _____ 3. _____

Annexes to 409

entered not entered :

Verified Small Status Statement

not a page for page substitution
 no translation other : _____

Oath/ Declaration (executed)

Application Data Sheet

Defective Oath/ Declaration unsigned no citizenship other

Power of Attorney

DNA Diskette Sequence Listing

Change of Address

Other : _____

PG Pub Early Publication Request

Other : _____

NOTES :

35 U.S.C. 371 - Receipt of Request (PTO-1390)

Date Acceptable Oath/ Declaration Received

Date of Completion of requirements under 35 U.S.C. 371

Date of Completion of DO/ EO 903 - Notification of Acceptance

Date of Completion of DO/ EO 905 - Notification of Missing Requirements

Date of Completion of DO/ EO 909 - Notification of Abandonment

Date of Completion of DO/ EO 916 - Notification of Defective Response

Date of Completion of DO/ EO 922 - Notification to Comply w/ Requirements for Patent

Applications Containing Nucleotide and/or Amino Acid Sequence Disclosures

Date of Completion of DO/ EO 923

IPR2018-1555

HTC EX1002, Page 262

PATENT APPLICATION FEE DETERMINATION RECORD

Effective December 8, 2004

Application or Docket Number

U 719611

CLAIMS AS FILED - PART I

SMALL ENTITY TYPE OR

OTHER THAN SMALL ENTITY

(Column 1)

(Column 2)

U.S. NATIONAL STAGE FEES		
BASIC FEE		
EXAMINATION FEE		
SEARCH FEE		
FEE FOR EXTRA SPEC. PGS.	minus 100 =	/ 50 =
TOTAL CHARGEABLE CLAIMS	12 minus 20 = *	
INDEPENDENT CLAIMS	3 minus 3 = *	
MULTIPLE DEPENDENT CLAIM PRESENT <input type="checkbox"/>		

RATE	FEE
BASIC FEE	
EXAM. FEE	
SEARCH FEE	
X \$ 125 =	
X \$ 25 =	
X \$ 100 =	
+ \$ 180 =	
TOTAL	

RATE	FEE
BASIC FEE	
EXAM. FEE	
SEARCH FEE	
X \$ 250 =	
X \$ 50 =	
X \$ 200 =	
+ \$ 360 =	
TOTAL	

* If the difference in column 1 is less than zero, enter "0" in column 2

CLAIMS AS AMENDED - PART II

(Column 1)

(Column 2)

(Column 3)

AMENDMENT A		CLAIMS REMAINING AFTER AMENDMENT		HIGHEST NUMBER PREVIOUSLY PAID FOR	PRESENT EXTRA
	Total	*	Minus	**	=
	Independent	*	Minus	***	=
FIRST PRESENTATION OF MULTIPLE DEPENDENT CLAIM <input type="checkbox"/>					

SMALL ENTITY OR

OTHER THAN SMALL ENTITY

RATE	ADDITIONAL FEE
X \$ 25 =	
X \$ 100 =	
+ \$ 180 =	
TOTAL ADDIT. FEE	

RATE	ADDITIONAL FEE
X \$ 50 =	
X \$ 200 =	
+ \$ 360 =	
TOTAL ADDIT. FEE	

(Column 1)

(Column 2)

(Column 3)

AMENDMENT B		CLAIMS REMAINING AFTER AMENDMENT		HIGHEST NUMBER PREVIOUSLY PAID FOR	PRESENT EXTRA
	Total	*	Minus	**	=
	Independent	*	Minus	***	=
FIRST PRESENTATION OF MULTIPLE DEPENDENT CLAIM <input type="checkbox"/>					

RATE	ADDITIONAL FEE
X \$ 25 =	
X \$ 100 =	
+ \$ 180 =	
TOTAL ADDIT. FEE	

RATE	ADDITIONAL FEE
X \$ 50 =	
X \$ 200 =	
+ \$ 360 =	
TOTAL ADDIT. FEE	

* If the entry in column 1 is less than the entry in column 2, write "0" in column 3.

** If the "Highest Number Previously Paid For" IN THIS SPACE is less than '20', enter "20".

*** If the "Highest Number Previously Paid For" IN THIS SPACE is less than '3', enter "3".

The "Highest Number Previously Paid For" (Total or Independent) is the highest number found in the appropriate box in column 1.

Patricia Booker

MULTIPLE DEPENDENT CLAIM
FEE CALCULATION SHEET
(FOR USE WITH FORM PTO-875)

SERIAL NO.

11/7/96/11

FILING DATE

APPLICANT(S)

CLAIMS

	AS FILED		AFTER 1 st AMENDMENT		AFTER 2 nd AMENDMENT	
	IND.	DEP.	IND.	DEP.	IND.	DEP.
1	1					
2		1				
3		1				
4		1				
5		1				
6		1				
7		1				
8		1				
9		1				
10	1					
11	1					
12		1				
13						
14						
15						
16						
17						
18						
19						
20						
21						
22						
23						
24						
25						
26						
27						
28						
29						
30						
31						
32						
33						
34						
35						
36						
37						
38						
39						
40						
41						
42						
43						
44						
45						
46						
47						
48						
49						
50						
TOTAL IND.	3	↓		↓		↓
TOTAL DEP.	9	←		←		←

	AS FILED		AFTER 1 st AMENDMENT		AFTER 2 nd AMENDMENT	
	IND.	DEP.	IND.	DEP.	IND.	DEP.
51						
52						
53						
54						
55						
56						
57						
58						
59						
60						
61						
62						
63						
64						
65						
66						
67						
68						
69						
70						
71						
72						
73						
74						
75						
76						
77						
78						
79						
80						
81						
82						
83						
84						
85						
86						
87						
88						
89						
90						
91						
92						
93						
94						
95						
96						
97						
98						
99						
100						
TOTAL IND.		↓		↓		↓
TOTAL DEP.		←		←		←

IPR2018-1555

HTO EX1002, Page 264

Document made available under the Patent Cooperation Treaty (PCT)

International application number: PCT/JP2005/021246

International filing date: 18 November 2005 (18.11.2005)

Document type: Certified copy of priority document

Document details: Country/Office: CN
Number: 200410094967.7
Filing date: 19 November 2004 (19.11.2004)

Date of receipt at the International Bureau: 02 March 2006 (02.03.2006)

Remark: Priority document submitted or transmitted to the International Bureau in compliance with Rule 17.1(a) or (b)



World Intellectual Property Organization (WIPO) - Geneva, Switzerland
Organisation Mondiale de la Propriété Intellectuelle (OMPI) - Genève, Suisse

PCT/JP 2005/021246

10.02.2006

10.02.06

证 明

本证明之附件是向本局提交的下列专利申请副本

申 请 日： 2004.11.19

申 请 号： 200410094967.7

申 请 类 别： 发明

发明创造名称： 子载波通信系统中自适应调制与编码方法和设备

申 请 人： 松下电器产业株式会社

发明人或设计人： 余小明、李继峰

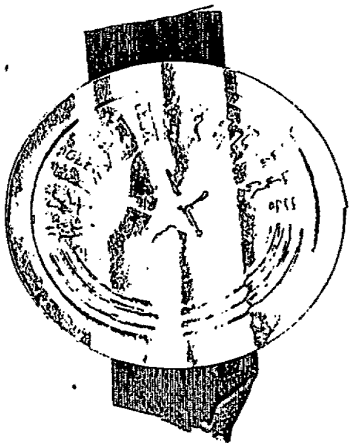

中华人民共和国
国家知识产权局局长

田力普

2005 年 12 月 30 日

权 利 要 求 书

5 1. 一种在子载波通信系统中执行子带组自适应调制与编码的方法，所述方法包括步骤：

在接收端，
进行信道估计；

根据信道估计的结果，选择子带组自适应调制与编码参数，并将
所述参数反馈回发送端；

10

在发送端，

提取反馈信号中的子带组自适应调制与编码参数，

根据所述子带组自适应调制与编码参数，对子带组进行自适应调
制与编码。

15

2. 根据权利要求1所述的方法，其特征在于所述方法还包括步骤：

在接收端，

提取接收到的各个子带组内的数据；

根据各个子带组所对应的子带组自适应调制与编码参数，对各子
带组内的数据进行子带组自适应解调和译码，以得到原始数据。

20

3. 根据权利要求1或2所述的方法，其特征在于所述子带组具有
子带组合图案，所述子带是在特定数目的子载波调制符号内的、频域
上相邻位置的相同数量的子载波组成的子载波组。

4. 根据权利要求3所述的方法，其特征在于所述子带组合图案是
采用相邻子带组合、间隔子带组合、全部子带组合方式对子带进行组
合所获得的子带组图案。

25

5. 根据权利要求1所述的方法，其特征在于：所述根据信道估计
的结果来选择子带组自适应调制与编码参数的步骤包括步骤：

确定子带组内分配的信息比特数；

确定子带组内的每个子带的调制和编码参数；

30

比较子带组内的所有子带的调制参数；

选择等级最高的调制参数作为整个子带组内统一的调制参数；
根据所述信息比特数和调制参数，确定编码参数。

6. 根据权利要求5所述的方法，其特征在于：确定子带组内分配的信息比特数的步骤包括以下子步骤：

- 5 计算子带组包含的每一个子带内可分配的信息比特数；
对所述子带组内的每一个子带的信息比特数进行求和，作为所述子带组内可分配的信息比特数。

7. 根据权利要求5所述的方法，其特征在于：确定子带组内分配的信息比特数的步骤包括以下子步骤：

- 10 计算子带组包含的每一个子带内可分配的信息比特数；
对所述子带组内的每一个子带的信息比特数进行求和，并对所述求和结果进行加权，作为所述子带组内可分配的信息比特数。

8. 根据权利要求1所述的方法，其特征在于：对同一子带组内的所有子载波按相同的自适应调制与编码参数进行编码和调制。

- 15 9. 根据权利要求1所述的方法，其特征在于：所述根据信道估计的结果来选择子带组自适应调制与编码参数的步骤通过基于最低信噪比方法、基于平均信噪比方法、基于容量估计的方法来实现。

10. 一种在子载波通信系统中执行子带组自适应调制与编码的发送端设备，所述发送端设备包括：

- 20 天线，用于向接收端设备发送信号和从接收端设备接收信号；
参数接收与提取装置，从天线接收子带组自适应调制与编码反馈信号，从所述信号中提取子带组自适应调制与编码参数；

自适应发送控制装置，根据接收到的所述子带组自适应调制与编码参数，控制自适应调制与编码装置和串并变换装置；

- 25 自适应调制与编码装置，在自适应发送控制装置的控制下，对输入的数据进行子带组自适应调制与编码，并且将自适应调制与编码后的数据输出到串并变换装置；

串/并转换装置，在自适应发送控制装置的控制下，对自适应调制与编码后的数据进行串/并变换。

- 30 11. 根据权利要求10所述的发送端设备，其特征在于：所述自适

应发送控制装置包括：自适应调制与编码控制装置，用于根据接收到的子带组自适应编码与调制参数，控制所述自适应编码与调制装置，以对输入的数据进行自适应编码与调制；组合图案控制装置，用于根据子带组的组合图案，控制所述串/并变换装置，对自适应调制与编码后的数据进行串/并变换。

12. 根据权利要求10或11所述的发送端设备，其特征在于：所述子带组具有子带组合图案，所述子带是在特定数目的子载波调制符号内的、频域上相邻位置的相同数量的子载波组成的子载波组。

13. 根据权利要求12所述的发送端设备，其特征在于所述子带组合图案是采用相邻子带组合、间隔子带组合、全部子带组合方式对子带进行组合所获得的子带组图案。

14. 一种在子载波通信系统中执行子带组自适应调制与编码的接收端设备，所述接收端设备包括：

天线，用于向发送端设备发送信号和从发送端设备接收信号；

信道估计装置，用于对信道的传输性能进行估计；

自适应调制与编码参数选择装置，用于根据信道估计的结果，选择子带组自适应调制与编码参数；

自适应接收控制装置，用于根据子带组自适应调制与编码参数，控制自适应解调和译码装置；

自适应解调与译码装置，用于在自适应接收控制装置的控制下，控制子带组的自适应解调与译码；

发送装置，用于通过天线，向发送端发送包含子带组自适应调制与编码参数信息的信号。

15. 根据权利要求14所述的接收端设备，其特征在于：所述自适应接收控制装置包括：自适应解调与译码控制装置，用于根据组合图案控制装置中的组合图案信息和参数存储装置所存储的子带组自适应调制与编码参数，控制自适应解调与译码装置，以便进行子带组自适应解调与译码操作；组合图案控制装置，用于存储子带组的组合图案信息；以及参数存储装置，用于存储子带组自适应调制与编码参数。

16. 根据权利要求14所述的接收端设备，其特征在于：所述自适

应调制与编码参数选择装置包括：子带性能分析装置，对子带组的各子带的性能进行分析；子带参数选择装置，根据子带的性能分析，选择各子带的自适应调制与编码参数；子带组参数选取装置，根据子带参数选择装置的选择结果，选择子带组的参数；参数集合装置，存储所选择的子带组的各子带的自适应调制与编码参数；以及组合图案控制装置，用于存储子带组的组合图案。

17. 根据权利要求14所述的接收端设备，其特征在于：所述子带组具有子带组合图案，所述子带是在特定数目的子载波调制符号内的、频域上相邻位置的相同数量的子载波组成的子载波组。

18. 根据权利要求17所述的接收端设备，其特征在于所述子带组合图案是采用相邻子带组合、间隔子带组合、全部子带组合方式对子带进行组合所获得的子带组图案。

19. 根据权利要求14所述的接收端设备，其特征在于：所述自适应调制与编码参数选择装置根据信道估计的结果，确定子带组内分配的信息比特数；确定子带组内的每个子带的调制和编码参数；比较子带组内的所有子带的调制参数；选择等级最高的调制参数作为整个子带组内统一的调制参数；以及根据所述信息比特数和调制参数，确定编码参数。

20. 根据权利要求19所述的接收端设备，其特征在于：所述自适应调制与编码参数选择装置还根据信道估计的结果，计算子带组包含的每一个子带内可分配的信息比特数；以及对所述子带组内的每一个子带的信息比特数进行求和，作为所述子带组内可分配的信息比特数。

21. 根据权利要求19所述的接收端设备，其特征在于：所述自适应调制与编码参数选择装置还根据信道估计的结果，计算子带组包含的每一个子带内可分配的信息比特数；以及对所述子带组内的每一个子带的信息比特数进行求和，并对所述求和结果进行加权，作为所述子带组内可分配的信息比特数。

22. 根据权利要求14所述的接收端设备，其特征在于：所述自适应调制与编码参数选择装置基于最低信噪比方法、基于平均信噪比方法、基于容量估计的方法来实现子带组自适应调制与编码参数的选择。

子载波通信系统中自适应调制与编码方法和设备

5

技术领域

本发明涉及一种在子载波通信系统中的自适应传输技术。具体地,涉及一种在子载波通信系统,特别是无线通信正交频分复用(OFDM)系统中的自适应调制与编码方法和设备。

10

背景技术

OFDM技术是目前解决高速无线数据传输的主流技术。OFDM技术的原理是即将要传输的高速数据用许多个正交的子载波来传输,每个子载波上的数据速率相对较低。与通常的频分复用系统相比,OFDM中子载波的正交交迭使得系统有更高的频谱利用率。OFDM中将整个信号带宽划分为多个很窄的子载波频带,由于每个子载波带宽小于信道的相干带宽,从而使平坦衰落。这样,与单载波系统相比,OFDM中的均衡要容易实现的多。目前,OFDM技术已成功应用于非对称用户数据环路(ADSL)、数字视频广播(DVB)以及无线异步传输模式(WATM)系统之中。

15

20

为了提高无线系统的频谱利用率,衰落信道的高速无线数据传输要求采用自适应、高频谱利用率的传输技术。在衰落信道中,与固定编码调制相比,自适应调制与编码(AMC)技术可以有效地提高系统的吞吐和误码率(BER)性能。这里所谓的吞吐指的就是系统的频谱利用率,也就是单位频谱带宽在单位时间内传输的信息量。AMC技术的基本思路是根据当前的信道特性自适应地变化发送功率、符号传输速率、星座大小、编码效率和编码机制中的一种或者多种,在信道条件好时多传一些信息,提高频谱利用率,在信道条件差时少传一些信息来保证一定的接收BER要求。

25

30

在介绍OFDM中的AMC方法之前，首先简单介绍一下OFDM传输中的信道特性。

图1所示为OFDM的信道特性示例。

其中，两个横轴分别表示时域上OFDM符号和频域上子载波的标号，纵轴为对应OFDM符号和子载波上的信道增益。由于信道在传输中的时域色散和频域色散，使得OFDM的信道在时域和频域上都有波动。

前面提到，AMC的思想是根据当前信道特性变化发送的调制和编码参数。对于OFDM来说，此时的自适应是时域和频域两个域上的自适应。目前从自适应结构上来说，OFDM中的AMC可以分为基于子载波的AMC和基于子带的AMC两种。所谓基于子载波的AMC指的是每个子载波为最小的自适应单位，OFDM每个子载波采用不同的调制和编码方式进行传输。它的缺点是实现复杂度过高，另外还有反馈开销过大的问题。一般说来，基于子载波AMC的方法在实际系统中很难实现。OFDM中另外一种自适应结构是目前比较常用的是采用独立编码的子带AMC结构，也即传统的子带自适应方法，具体参见图2。

图2所示为传统的子带自适应调制与编码示意图。

在该结构中，将OFDM频域上所有子载波划分为若干子带。所谓子带，指的是由频域上相邻位置的子载波组成的子载波组。比如在图2中，子带总数为N。然后，由相邻若干（图2中，该数值为M）OFDM符号内的同一子带组成一个编码调制块。在图2的传统子带自适应中，每个编码调制块根据各自的信道特性进行编码调制参数的估计、以及独立的编码。图2中每个编码调制块内的数字表示该编码调制块内编码调制参数所属的等级。

一般来说，各编码调制参数等级所对应的编码调制参数在系统初始时就已定好，比如表1举例示出了其中的一种方式，但是本发明并不局限于此。

等级	编码参数	调制参数
0	不传	不传
1	1/2 Turbo	BPSK

2	1/2 Turbo	QPSK
3	3/4 Turbo	QPSK
4	2/3 Turbo	8PSK
5	3/4 Turbo	16QAM
6	2/3 Turbo	64QAM

表1 参数等级及其对应编码调制参数示例

接下来，图3中给出了OFDM中采用传统子带自适应方法的实现框图。

图3所示为传统的OFDM与AMC相结合的框图。

- 5 假设A点和B点之间进行通信，典型的实例为A是基站端（AP），B是移动终端（UE）。同时假设A→B的传输采用AMC机制。

如图3中所示，要传输的信息比特首先经过自适应调制与编码模块301，输出的串行调制符号再分别通过串/并变换器302，反快速傅立叶变换（IFFT）器303将频域符号变换到时域，再经并/串变换器304后插入保护间隔，这由插入保护间隔装置305来完成。之后，通过天线306发送出去。B端通过接收天线316接收到A端的发送信号之后，首先去除发送端加入的保护间隔，这由去除保护间隔装置315来完成，再分别经过串/并变换器314，快速傅立叶变换（FFT）器313将时域符号变换到频域，然后经过并/串变换器312进行并/串变换处理，最后经自适应解调与译码模块311输出得到接收数据。

10

15

A→B的自适应传输主要体现在A端中的自适应调制和编码模块301，以及B端接收机中的自适应解调和译码模块311。前面提到，自适应调制与编码的含义是根据当前信道特性在发送端自适应的调节调制和编码的参数，并在接收端采用与发送端相对应的参数进行解调和译码。在一般系统中，自适应调制与编码模块311所需的自适应参数来自于接收端的反馈。在每个数据块发送之前，B端都首先由信道估计模块319来估计当前A→B传输的信道，得到OFDM中每个子载波上的信道特性。然后，接收端根据这些信道特性，由参数选取模块318来确定当前发送端发送数据时在OFDM中每个子带上所采用的调制和编码参数。参数选取模块318所得的每个子带上的自适应调制与编码参数有两个用

20

25

途:

(1) 作为当前发送端发送数据时OFDM每个子带上的调制和编码参数。接收端318模块在选取得到OFDM各个子带上的调制与编码参数之后,通过B端的参数发送模块320→B端天线316→A端天线306→A端参数接收与提取模块307这样一个反馈路径,将这些参数发送回A端。A端在提取得到这些参数之后,通过AMC控制模块308对自适应调制与编码301进行控制。

(2) 作为接收端解调和译码时所采用的参数。在AMC传输中,接收端必须按照与发送端相一致的调制和编码参数,对接收数据进行解调和译码才能得到正确的信息比特。因此,子带AMC参数选取模块318在得到AMC参数之后,还需要将其送给自适应解调和译码模块317,由自适应解调和译码模块317暂存,用作接收端对自适应解调和译码311的控制。

为了更清晰的描述传统的OFDM中采用子带AMC的方法,图4中将图3中的309模块和321模块进行了细化。

图4所示为传统的子带自适应调制与编码的实现结构。

在发送端A端,自适应调制与编码模块301包括自适应编码模块401,交织模块402和自适应调制模块403,301输出的数据经串并变换模块302后送往IFFT模块。A端的AMC控制模块308根据图3中参数提取模块307从反馈信道中得到的各子带的调制与编码参数对AMC模块301进行控制。传统的子带自适应中,对OFDM中每个子带进行独立的编码调制,也就是说每个子带都有一套自己的调制与编码参数。AMC控制模块308通过得到的每个子带的编码参数C和调制参数M对301进行控制。同时,AMC控制模块还可以根据C和M得到每个子带内传输的信息比特数,从而产生相应的交织矩阵 Π ,并对301中的交织模块402进行控制。A端在AMC之后,得到串行的数据流404,其按次序包含了子带1,2,...N内发送的数据,其调制和编码方式分别为 (C_1, M_1) , (C_2, M_2) , ..., (C_N, M_N) 。之后,将这些数据串并变换后依次映射到OFDM中相应子带内进行发送。

A端发送每个数据块所需的AMC参数均来自于接收端的反馈,也就

说，在A端发送每个数据块之前，都必须首先由B端为A端发送的数据块选取AMC参数。B端选取参数的过程是这样的：首先通过接收到的信号进行信道估计319，信道估计可以有多种方法，包括基于导频的方法、盲信道估计等等。之后，信道估计319将得到的OFDM各个子载波上的信道特性送给参数选取模块318。参数选取模块318中首先据此对OFDM中各子带的性能进行分析412，再在备选的AMC参数集合413中为各子带选取合适的AMC参数411。由此得到的AMC参数一方面通过反馈信道发送回发送端，用于发送端在发送时实际的自适应调制与编码操作，另一方面用于本接收端的自适应解调与译码控制409。同时出于时延上的考虑，还需要一个存储模块410，用于存储当前所获得的这些参数。B端自适应调制和译码模块311包括了自适应解调模块408，解交织模块407和自适应译码模块406。

与子载波自适应相比，图3和图4所示的这种现有的基于子带独立编码的自适应方法可以有效的降低自适应的实现复杂度，同时还可以有效降低系统的反馈开销。然而，这种方法仍有一定的缺点：没有有效的利用各子带之间的分集能力。

分集是一种改善无线传输质量的重要方法。所谓分集，概括地说，就是发送端利用某一种资源来增加信息冗余度并尽量使得相互冗余的信息经历尽量独立的畸变或衰减，并在接收端综合利用合并其信息从而获得一定系统性能增益的技术。简单说来，就是同时利用多个通道进行传输，在接收端一个通道性能的损失可以通过其他通道来进行补偿。

本发明专利申请在传统的OFDM自适应调制与编码中采用子带的独立编码方法的基础上，增加了将子带按一定方法组合成子带组，再对各个子带组进行联合编码的方法。这一方法看似与传统的AMC思想背道而驰，因为传统的AMC方法要求为每个子带独立的选取参数和进行编码。但是，该方法中引入了子带间的分集，从而可以获得更大的编码增益。另外，再按照我们给出的方法进行子带组内调制编码参数的选取，与传统方法相比并不会带来传输吞吐量的损失。两者结合来看，采用该专利申请的方法将会有助于提高OFDM中自适应传输的性能。

发明内容

本发明的目的在于，提供一种用于子载波通信系统中自适应调制与编码的方法和设备，在该方法和设备中，首先将子载波通信系统中频域上的所有子带按照一定规则组合成若干子带组，然后再对各个子带组进行联合编码。而且，该发明还给出了将子带组合成子带组的方法，以及子带组内联合编码时采用的调制与编码参数的选取方法。

本发明的目的还在于，提供一种用于子载波通信系统中自适应调制与编码的方法和设备，与传统的子带自适应方法相比，该方法和设备可以提高系统频谱利用率，尤其是快衰落和信道估计误差下的频谱利用率，同时降低自适应实现复杂度和反馈开销。

为了实现上述目的，提出了一种在子载波通信系统中执行子带组自适应调制与编码的方法，所述方法包括步骤：在接收端，进行信道估计；根据信道估计的结果，选择子带组自适应调制与编码参数，并将所述参数反馈回发送端。在发送端，提取反馈信号中的子带组自适应调制与编码参数，根据所述子带组自适应调制与编码参数，对子带组进行自适应调制与编码。

优选地，所述方法还包括步骤：在接收端，提取接收到的各个子带组内的数据；根据各个子带组所对应的子带组自适应调制与编码参数，对各子带组内的数据进行子带组自适应解调和译码，以得到原始数据。

优选地，所述子带组具有子带组合图案，所述子带是在特定数目的子载波调制符号内的、频域上相邻位置的相同数量的子载波组成的子载波组。

优选地，所述子带组合图案是采用相邻子带组合、间隔子带组合、全部子带组合方式对子带进行组合所获得的子带组图案。

优选地，所述根据信道估计的结果来选择子带组自适应调制与编码参数的步骤包括步骤：确定子带组内分配的信息比特数；确定子带组内的每个子带的调制和编码参数；比较子带组内的所有子带的调制参数；选择等级最高的调制参数作为整个子带组内统一的调制参数；

根据所述信息比特数和调制参数，确定编码参数。

优选地，确定子带组内分配的信息比特数的步骤包括以下子步骤：计算子带组包含的每一个子带内可分配的信息比特数；对所述子带组内的每一个子带的信息比特数进行求和，作为所述子带组内可分配的信息比特数。

5

优选地，确定子带组内分配的信息比特数的步骤包括以下子步骤：计算子带组包含的每一个子带内可分配的信息比特数；对所述子带组内的每一个子带的信息比特数进行求和，并对所述求和结果进行加权，作为所述子带组内可分配的信息比特数。

10

优选地，对同一子带组内的所有子载波按相同的自适应调制与编码参数进行编码和调制。

优选地，所述根据信道估计的结果来选择子带组自适应调制与编码参数的步骤通过基于最低信噪比方法、基于平均信噪比方法、基于容量估计的方法来实现。

15

根据本发明，还提出了一种在子载波通信系统中执行子带组自适应调制与编码的发送端设备，所述发送端设备包括：天线，用于向接收端设备发送信号和从接收端设备接收信号；参数接收与提取装置，从天线接收子带组自适应调制与编码反馈信号，从所述信号中提取子带组自适应调制与编码参数；自适应发送控制装置，根据接收到的所述子带组自适应调制与编码参数，控制自适应调制与编码装置和串并变换装置；自适应调制与编码装置，在自适应发送控制装置的控制下，对输入的数据进行子带组自适应调制与编码，并且将自适应调制与编码后的数据输出到串并变换装置；串/并转换装置，在自适应发送控制装置的控制下，对自适应调制与编码后的数据进行串/并变换。

20

25

优选地，根据本发明，所述自适应发送控制装置包括：自适应调制与编码控制装置，用于根据接收到的子带组自适应编码与调制参数，控制所述自适应编码与调制装置，以对输入的数据进行自适应编码与调制；组合图案控制装置，用于根据子带组的组合图案，控制所述串/并变换装置，对自适应调制与编码后的数据进行串/并变换。

30

根据本发明，还提出了一种在子载波通信系统中执行子带组自适

应调制与编码的接收端设备，所述接收端设备包括：天线，用于向发送端设备发送信号和从发送端设备接收信号；信道估计装置，用于对信道的传输性能进行估计；自适应调制与编码参数选择装置，用于根据信道估计的结果，选择子带组自适应调制与编码参数；自适应接收控制装置，用于根据子带组自适应调制与编码参数，控制自适应解调和译码装置；自适应解调与译码装置，用于在自适应接收控制装置的控制下，控制子带组的自适应解调与译码；发送装置，用于通过天线，向发送端发送包含子带组自适应调制与编码参数信息的信号。

10 优选地，根据本发明，所述自适应接收控制装置包括：自适应解调与译码控制装置，用于根据组合图案控制装置中的组合图案信息和参数存储装置所存储的子带组自适应调制与编码参数，控制自适应解调与译码装置，以便进行子带组自适应解调与译码操作；组合图案控制装置，用于存储子带组的组合图案信息；以及参数存储装置，用于存储子带组自适应调制与编码参数。

15 优选地，根据本发明，所述自适应调制与编码参数选择装置包括：子带性能分析装置，对子带组的各子带的性能进行分析；子带参数选择装置，根据子带的性能分析，选择各子带的自适应调制与编码参数；子带组参数选取装置，根据子带参数选择装置的选择结果，选择子带组的参数；参数集合装置，存储所选择的子带组的各子带的自适应调制与编码参数；以及组合图案控制装置，用于存储子带组的组合图案。

附图说明

通过参考以下结合附图所采用的优选实施例的详细描述，本发明的上述目的、优点和特征将变得显而易见，其中：

25 图1所示为OFDM的信道特性示例，在前面已经进行了描述；

图2所示为现有技术的子带自适应调制与编码示意图，在前面已经进行了描述；

图3所示为现有技术的OFDM与AMC相结合的框图，在前面已经进行了描述；

30 图4所示为现有技术的子带自适应调制与编码的实现结构示意图

图，在前面已经进行了描述；

图5所示为用于实现本发明方法的OFDM-AMC系统结构示意图；

图6所示为用于实现本发明方法的OFDM-AMC系统结构的更详细
的结构图；

5 图7示出了用于实现根据本发明实施例的自适应编码和调制方法
的处理流程图；

图8为在本发明的实施例中所使用的对相邻子带组合获得的子带
组的示例的示意图；

10 图9为在本发明的实施例中所使用的对间隔子带组合获得的子带
组的示例的示意图；

图10为在本发明的实施例中所使用的对全部子带组合获得的子
带组的示例的示意图；

图11示出了在不同反馈延时下，本发明方法与传统方法性能比较
结果的示意图；

15 图12示出了在不同信道估计误差下，本发明方法与传统方法性能
比较结果的示意图。

具体实施方式

20 下面结合附图来说明本发明的具体实施方式。为了清楚地描述本
发明，本发明采用了OFDM系统作为示例来进行描述，应该意识到，本
发明的自适应调制和编码的方法同样适合于其他利用子载波进行通信
的任何子载波通信系统。

25 本发明是在传统的OFDM自适应调制与编码中采用子带的独立编
码方法的基础上，通过将子带按一定方式组合成子带组，再对各个子
带组进行联合编码的方法。而且，该发明还给出了将子带组合成子带
组的各种方式，以及子带组内联合编码时采用的调制与编码参数的选
取方式，稍后将对其进行描述。

图5所示为用于实现本发明方法的OFDM-AMC系统结构。

30 为了使本发明的描述更为清楚，省略了与如图1到4中的现有技术
的已知结构的详细描述，而仅描述了本发明与现有技术的区别结构。

与图3所示的传统的OFDM-AMC结构相比，应用本发明的OFDM-AMC系统的有以下几点不同之处：

5 (1) 图5中的模块505中所包含的参数选取模块504是对子带组的AMC参数进行选取，而图3中318模块是选取每个子带的AMC参数。这是由于传统系统中进行子带自适应调制与编码的单位为子带，而在本发明所应用系统中，进行自适应调制与编码的单位为子带组。在本发明中，将OFDM中频域上的所有子带通过组合图案组合成若干子带组，再对各个子带组进行自适应调制与编码。与此变化相对应的是，图5中参数发送模块320→B端天线316→A端天线306→A端参数接收与提取模块
10 307这样一个反馈链路里传输的是关于子带组的AMC参数，而不是如图3中的关于子带的AMC参数。

(2) 发送端A中自适应发送控制模块501替换了图3中的AMC控制模块308。在本发明技术中，发送端对OFDM中子带组进行自适应调制与编码，子带组由OFDM中各子带按照组合图案组合而成。因此，自适应
15 发送控制模块501一方面需要对自适应调制和编码模块301中子带组的AMC进行控制，另一方面，系统中还要求对自适应调制与编码之后的串/并转换模块进行控制，使得每个子带组内发送的信息比特在编码和调制后能映射到OFDM中相应的子带内来，以进行传输。

(3) 接收端B中的自适应接收控制模块503替换了图3中的自适应解调与控制模块317。自适应接收控制模块503一方面需要对自适应解调
20 和译码模块311进行控制，另一方面，还对自适应解调与译码之前的并串转换模块312进行控制，将同一子带组内的接收符号合并到一起进行解调和译码。

图5中的虚线部分，即模块502和505可以细化为图6。

25 图6所示为本发明提出方法的实现结构的示意图。

在发送端A，与图4中传统子带自适应的不同之处在于：自适应调制与编码的单位为子带组而非子带，此时自适应调制和编码模块301的输出603按次序包含了子带组1, 2, ..., K内发送的数据，其调制和编码方式分别为 (C_1, M_1) , (C_2, M_2) , ..., (C_K, M_K) ，其中K为OFDM内划分的子带组总数。另外，发送端除了对AMC操作进行控制之外，还需要根据子
30 带组总数。另外，发送端除了对AMC操作进行控制之外，还需要根据子

带的组合图案601对串/并变换进行控制，从而将每个子带组内发送的信息比特在编码和调制后能映射到OFDM中相应的子带内来进行传输。

在接收端B，与图4中传统子带自适应的不同之处在于：自适应解调与译码的单位为子带组而非子带。另外，接收端除了对自适应解调

5 和译码操作进行控制之外，还需要根据子带的组合图案605对并/串变换进行控制，从而将OFDM同一子带组内的接收符号合并到一起进行解调和译码。除此之外，图6中在参数选取部分与图4也不同。图6中在图4中选取得到OFDM各子带的参数621基础之上，还要再根据组合图案607选取OFDM各子带组的自适应参数606。

10 具体说来，本发明技术的实现流程参见图7所示。

图7示出了用于实现根据本发明实施例的自适应编码和调制方法的处理流程图。

具体说来，本发明技术的实现过程如下：

第一步，由接收端来确定发送端OFDM中各个子带组内的自适应调

15 制与编码参数，并将其反馈回发送端。这一过程包括接收端信道估计（步骤901），OFDM各子带自适应参数选取（步骤902），OFDM各子带组自适应参数选取（步骤903），以及参数反馈（步骤921）。

（1）信道估计（步骤901）：这里的信道估计可以采用现有的一般方法，比如基于导频的信道估计，盲信道估计等等。

20 （2）OFDM各子带自适应参数选取（步骤902）：

这里指的是考虑在传统的每个子带独立编码的情况下，OFDM中每个子带进行自适应传输时所采用的调制编码参数。由于是独立编码，因此各个子带内的参数根据其信道特性的不同而不同。

在这一步操作里，首先需要确定备选的自适应参数集合，比如表

25 1和表2中的参数集合。然后，根据当前每个子带内的信道特性为其选取合适的调制和编码参数，同时确定相应的传输信息比特数。这里，根据信道特性选取参数的现有方法有很多种，如基于子带最低信噪比的方法，基于子带平均信噪比的方法，基于容量的方法，基于平均信噪比结合其他统计特性的方法，等等。在本实施示例中，我们以基于

30 平均信噪比的方法为例作一下简要说明。

- 基于平均信噪比的方法是这样的：首先通过理论分析或者仿真的方法确定每种调制编码参数所需的信噪比门限值（如表2所示），其中的吞吐能力也即各种编码调制参数对应的频谱利用率，其数值上等于编码效率与每个符号包含比特数的乘积。然后，对每个子带来说，计算其内部子载波上的平均信噪比。最后，为该子带选取门限值低于该平均信噪比，且吞吐能力最高的调制与编码参数作为该子带内的调制与编码参数。比如，子带内平均信噪比为0, 2, 4, 6, 8情况下，按表2所示的参数，选取的调制与编码参数对应的等级分别为1, 1, 2, 3, 4。相应的，该子带内分配的信息比特数也就确定下来了（其数值上等于该子带内的子载波总数与选取编码调制参数所对应吞吐能力的乘积）。

等级	编码参数	调制参数	信噪比门限 (dB)	吞吐能力 (bps/Hz)
0	不传	不传	$-\infty$	0
1	1/2 Turbo	BPSK	-0.4	0.5
2	1/2 Turbo	QPSK	2.2	1
3	3/4 Turbo	QPSK	5.2	1.5
4	2/3 Turbo	8PSK	7.6	2
5	3/4 Turbo	16QAM	10.9	3
6	2/3 Turbo	64QAM	14.5	4

表2 调制与编码参数集合及其对应信噪比门限和吞吐

(3) OFDM各子带组自适应参数选取（步骤903）

传统的自适应方法中对OFDM每个子带进行独立的调制和编码。而

在本发明申请的方法中，自适应传输的单位是子带组而非子带。因此，首先按照一定的组合方法（或称组合图案），将OFDM频域所有子带组合成若干个子带组。组合的方法可以是：

5 相邻子带组合，指的是将位置上相邻的若干个子带组合成一个子带组，参见图8；

图8为相邻子带组合示例。

图8中，将OFDM中时域同一位置，频域上的N个子带组合成若干个子带组，其中，频域位置相邻的子带组合成一个子带组，即图中相同阴影图案下的子带同属一个子带组。

10 间隔子带组合，指的是间隔的选取若干子带组合成一个子带组，参见图9；

图9为间隔子带组合示例。

图9中，间隔的在OFDM频域上选取子带合并为同一个子带组，即图中相同阴影图案下的子带同属一个子带组。

15 全部子带组合，指的是将频域所有子带合并为一个子带组，参见图10；

图10为全部子带组合示例。

图10中，将OFDM中时域同一位置，频域上的全部N个子带合并为一个子带组。

20 按其他规律进行组合。

在子带组内每个子带的调制与编码参数、分配的信息比特数确定下来之后，子带组内分配的信息比特数以及联合编码参数可以这样确定：（1）将各个子带内分配的信息比特数求和作为整个子带组内分配的信息比特数；（2）选取各子带中最大的调制等级作为该子带组内统一调制采用的调制方式，再由子带组内分配的信息比特数和调制方式
25 确定编码效率。

这一过程示例如下：假设一个子带组包含A，B，C，D四个子带，每个子带内包含的子载波数为512，经过上一步操作a）以后确定的各个子带对应的编码和调制参数等级分别为：0，1，2，3。则可得：ABCD
30 内分配的信息比特数分别为 $512*0=0$ ， $512*0.5=256$ ， $512*1=512$ ，

512*1.5=768。由此，该子带组内总的信息比特数为0+256+512+768=1536。之后，选取ABCD内最高的调制等级（这里，子带D对应的调制等级最高）8PSK作为整个子带组内统一的调制参数，相应的，该子带组内统一编码所采用的编码效率为1536/(512*3*4)=1/4。

5 这里，将估计所得的ABCD四个子带内各自的传输信息比特数求和后作为子带组内传输的信息比特数。实际操作中，还可以对该数值做一个加权运算。比如，考虑信道变化比较快，估计的信道特性误差会较大，则对ABCD四个子带内的传输信息比特数求和后作一个0.9的加权，即得：子带组内总的信息比特数为

10 (0+256+512+768)*0.9=1536*0.9≈1382。

(4) 参数反馈（步骤921）

在接收端获得OFDM每个子带组的自适应参数之后，将其通过反馈信道发送回发送端，用于发送端按此参数进行实际的操作。

15 第二步，发送端根据接收端反馈回的OFDM各子带组内的自适应参数之后，为每个子带组分配相应数目的待传输的信息比特，并按相应参数对每个子带组内进行联合编码和调制（步骤911）。比如按前面假设的情况，对由ABCD四个子带组成的子带组采用联合的调制和编码，其调制和编码参数分别为8PSK和1/4 Turbo码。接下来，再根据子带组合图案将调制后的符号分配到OFDM中相应子带内进行发送（步骤912），

20 具体包括串/并变换302，IFFT303，并/串变换304，以及插入保护间隔305。

第三步，在接收端，首先去除保护间隔315，串/并变换314，FFT313，并/串变换312，同时通过控制312根据子带组合图案将接收到OFDM各子带组内的数据提取出来（步骤904），然后，再依据第一步中

25 所得的各子带组内的自适应参数，对每个子带组进行自适应解调和接收，并得到最终发送的原始数据（步骤905）。

30 本发明对OFDM中的各个子带进行组合和联合编码，有效地利用了子带间的分集能力，从而有效地提高了系统频谱利用率，尤其是衰落和信道估计误差下的频谱利用率，同时降低自适应实现复杂度和反馈开销。

图11示出了在不同反馈延时下，本发明方法与传统方法性能比较结果的图。

图12示出了在不同信道估计误差下，本发明方法与传统方法性能比较结果的示意图。

- 5 其中，仿真采用的OFDM系统信号带宽为10MHz，子载波总数为1024，划分为16个子带，每个子带在时域上跨越8个OFDM符号。Turbo码的分量递归系统卷积（RSC）多项式为（13，11）_{oct}，译码采用4次迭代，最大后验概率（MAP）算法。系统采用ARQ。仿真中采用的信道模型为M.1225车载信道模型A。在具体实施时，采用子带全部组合的方法，
- 10 单个子带采用基于平均信噪比的参数估计方法。图11和图12中的 $f_d\tau$ 和MSE分别表示最大多普勒频移与反馈时延的乘积，以及信道估计误差。传统的方法参见图2。从图11和图12的结果可见，无论是在理想的情况下（ $f_d\tau=0$ ，无MSE），还是快衰落（存在 $f_d\tau$ ）或者信道估计误差（存在MSE）的情况下，与传统方法相比，本发明提出的方法均有一定的性能增益。另外，此时将16个子带全部合并为1个子带组，反馈开销降为原来的1/16。
- 15

20 尽管以上已经结合本发明的优选实施例示出了本发明，但是本领域的技术人员能够理解，在不脱离本发明的精神和范围的情况下，可以对本发明进行各种修改、替换和改变。因此，本发明不应由上述实施例来限定，而应由所附权利要求及其等同物来限定。



图 1



图 2

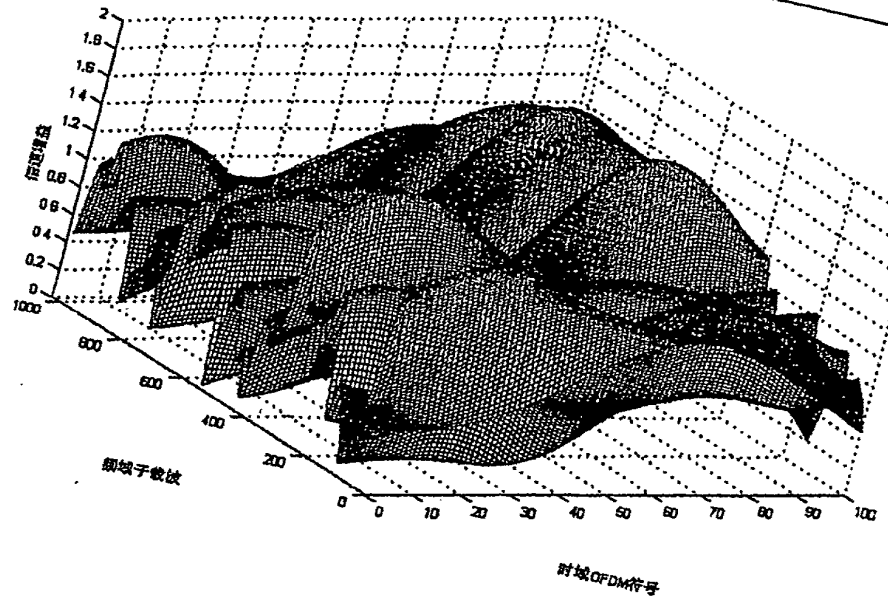

图 3

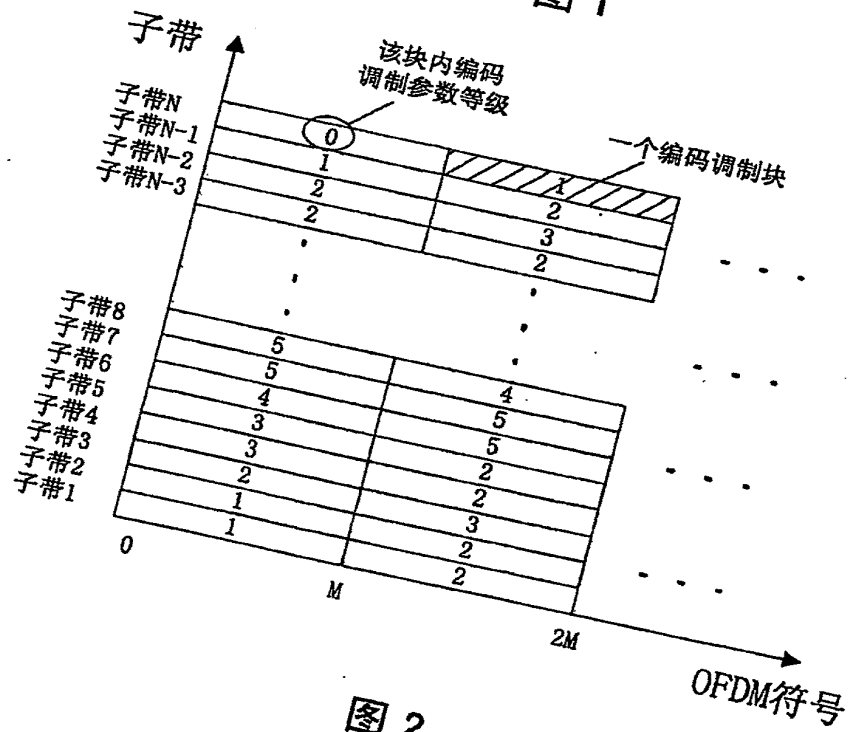

图 4

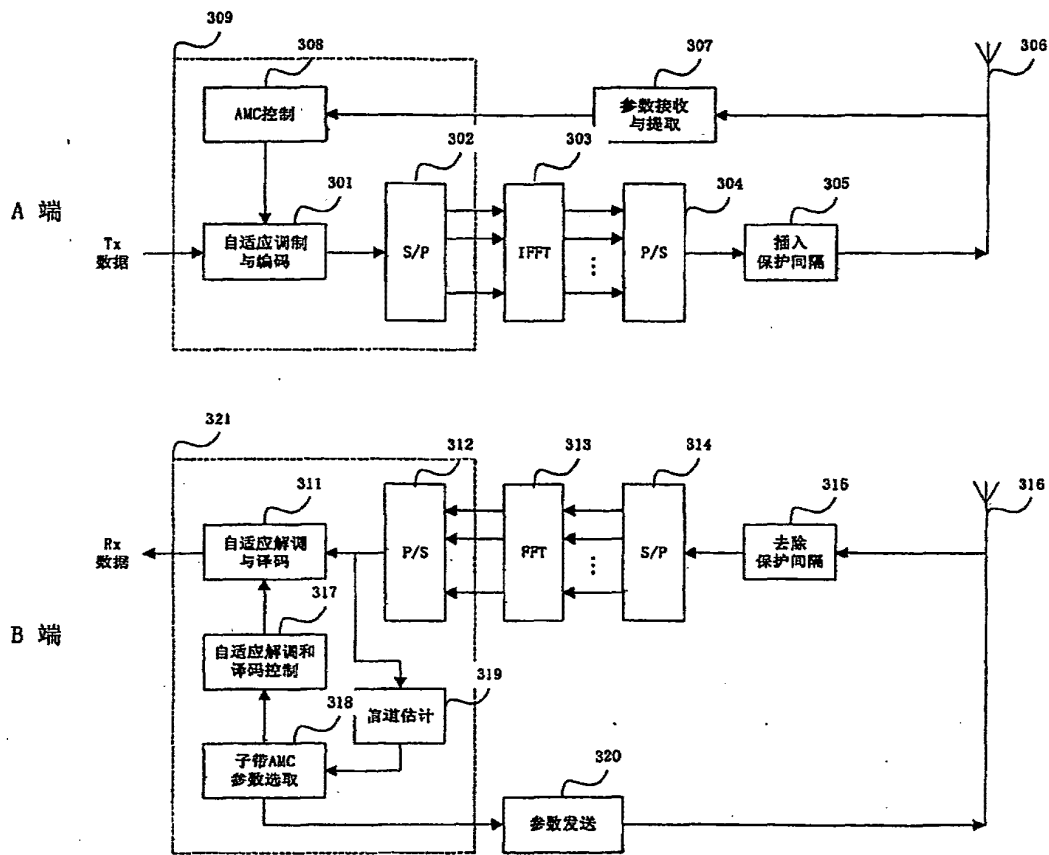

图 5

27

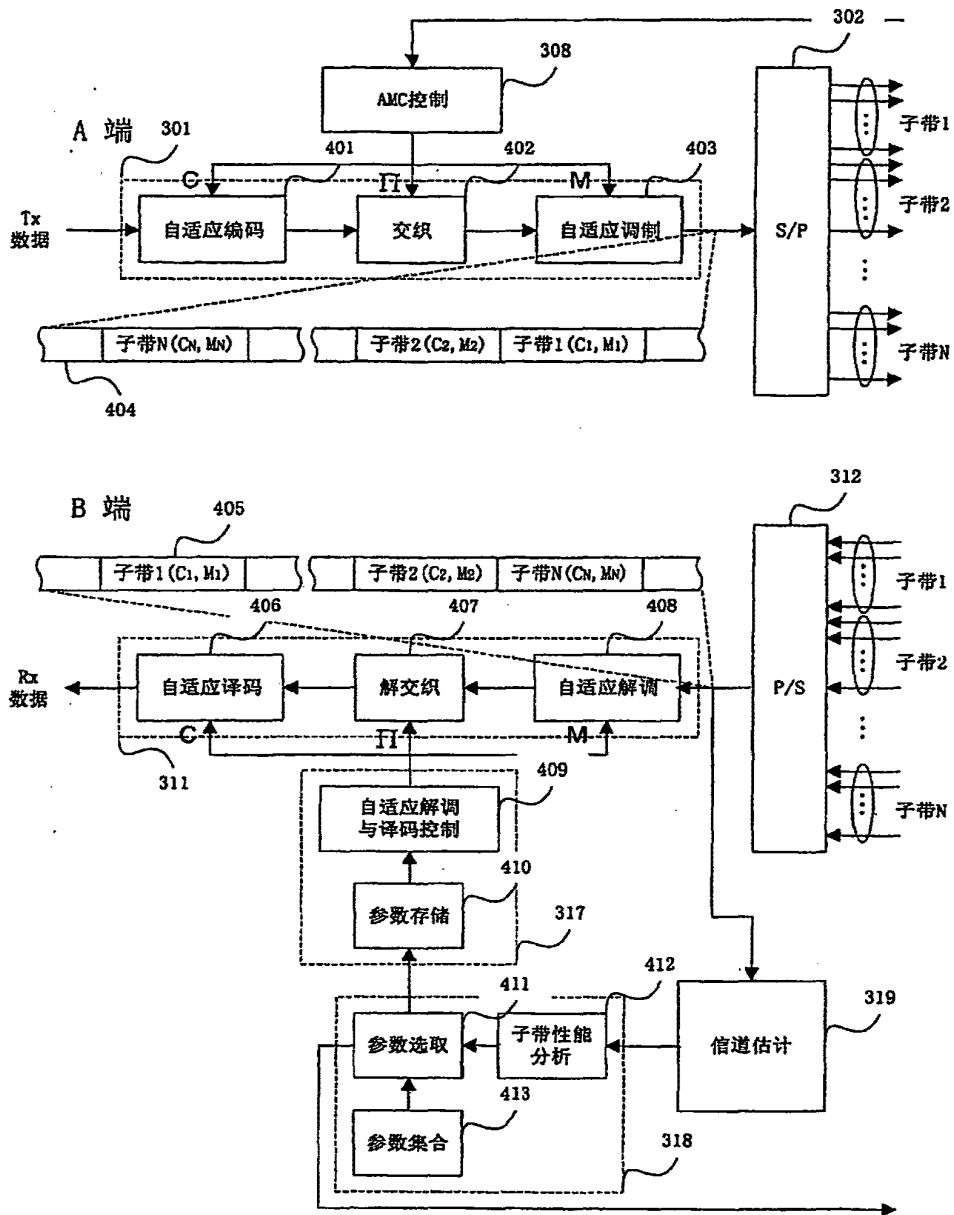

图 6

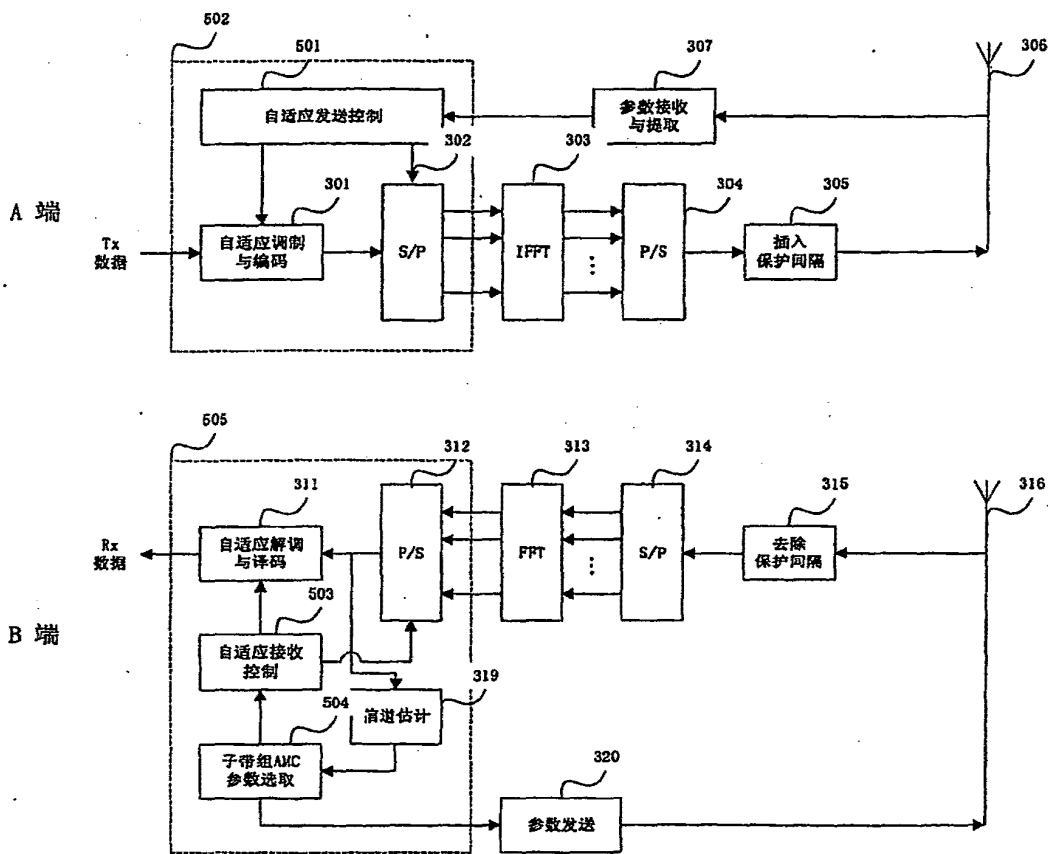

图 7

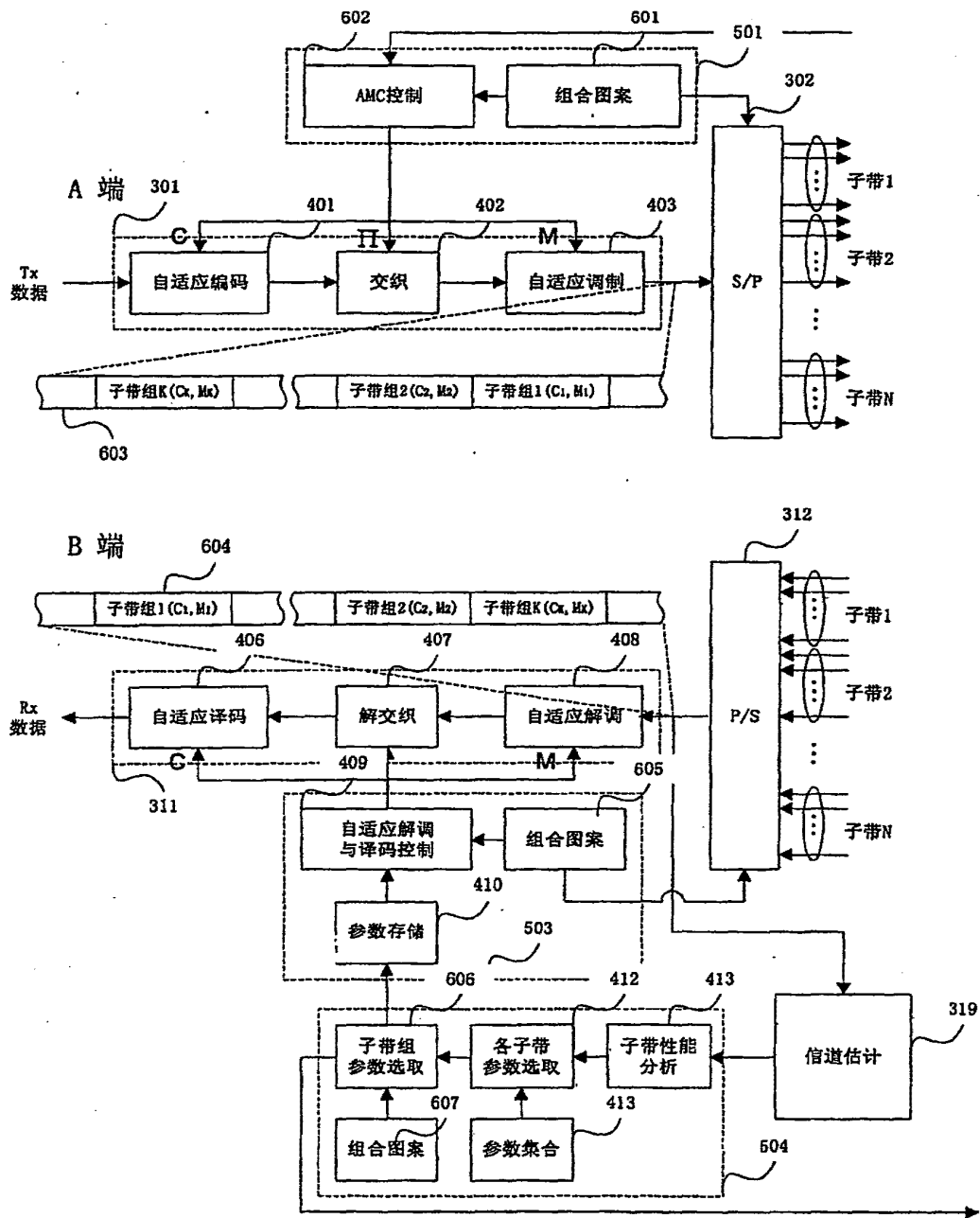

图 8

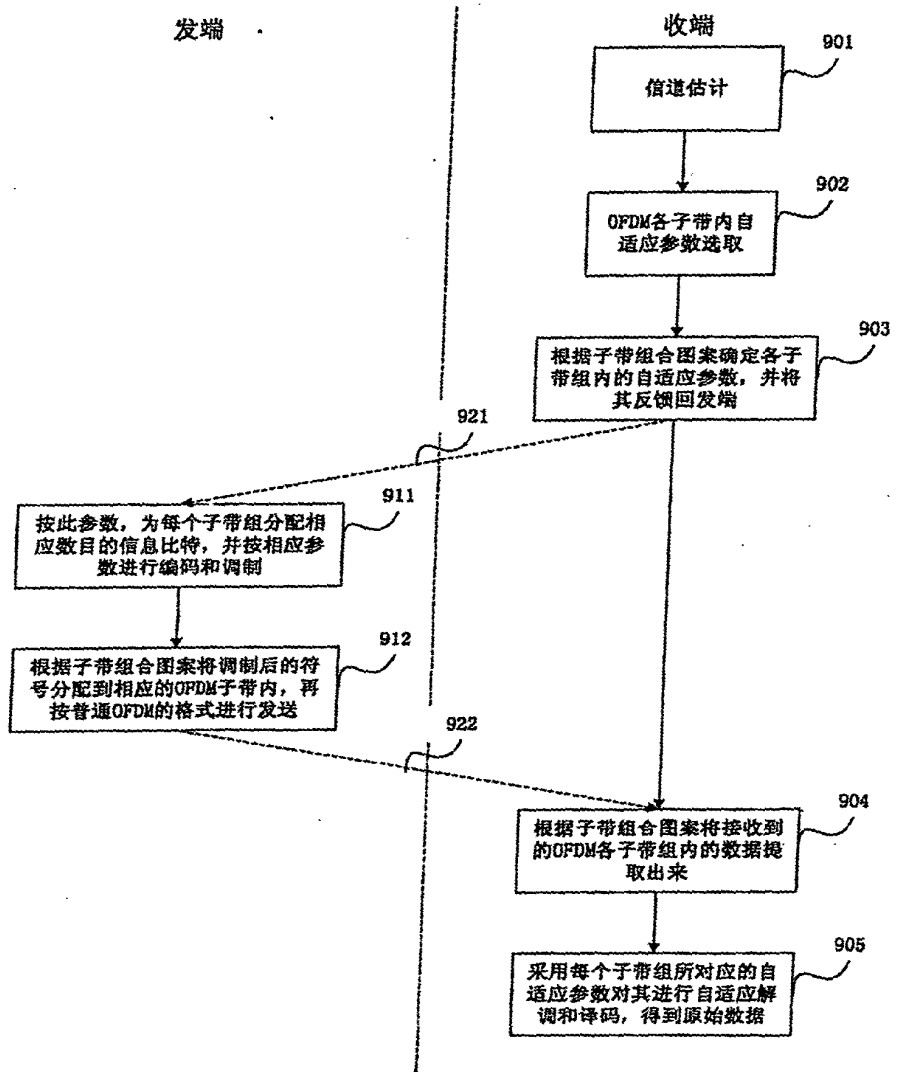

图 9

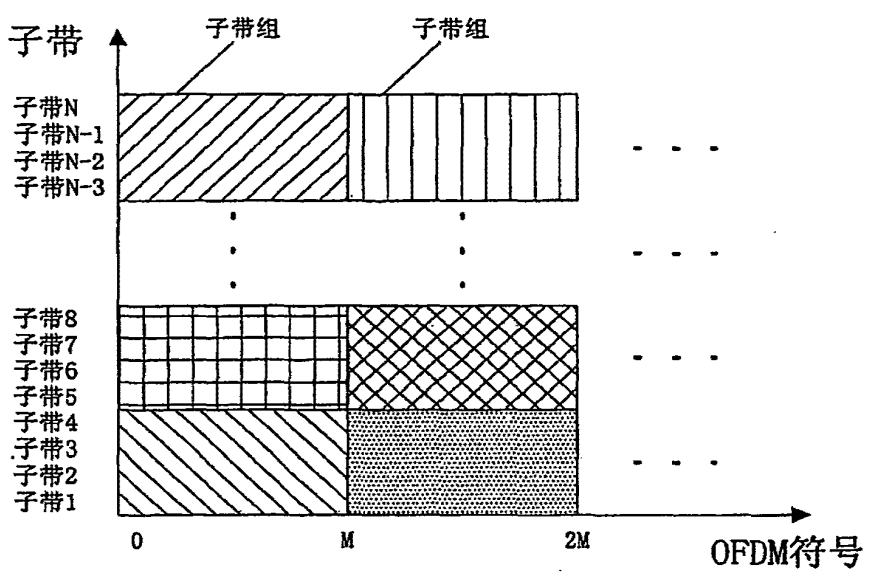

图 10

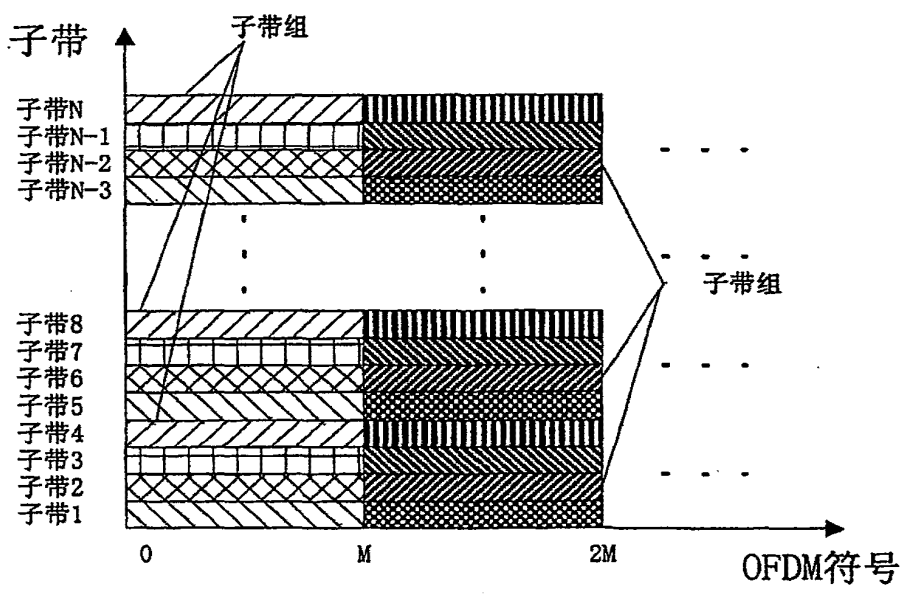

图 11

33

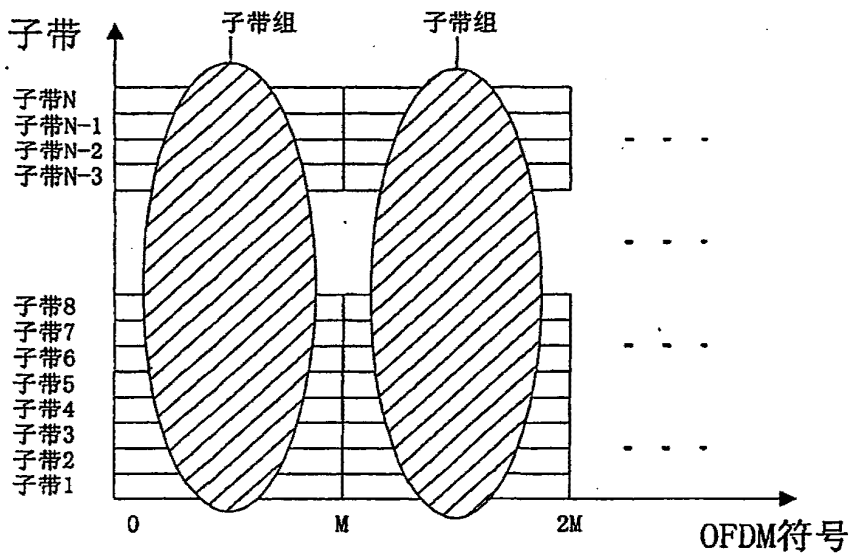

图 12

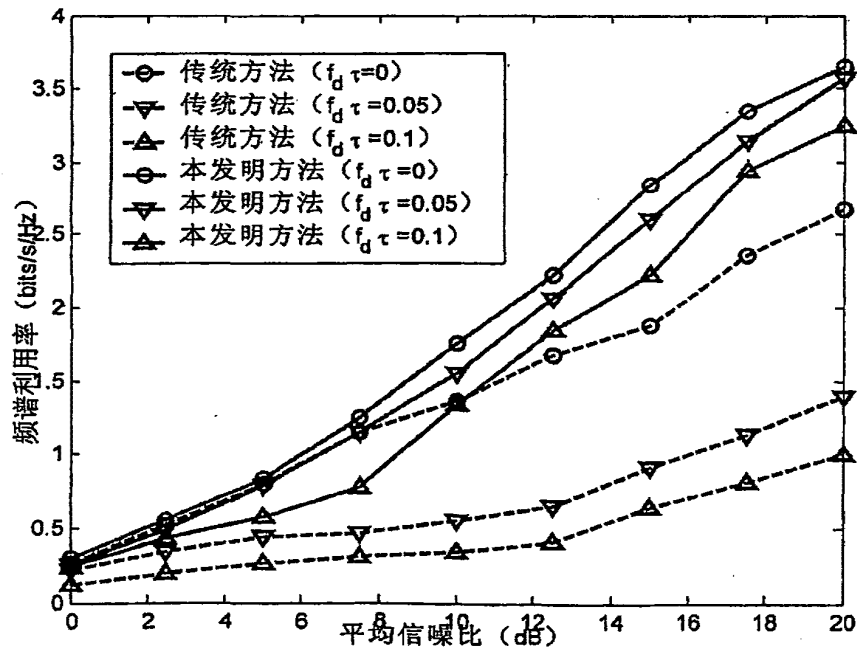
From the INTERNATIONAL BUREAU

PCT

NOTIFICATION CONCERNING
SUBMISSION OR TRANSMITTAL
OF PRIORITY DOCUMENT

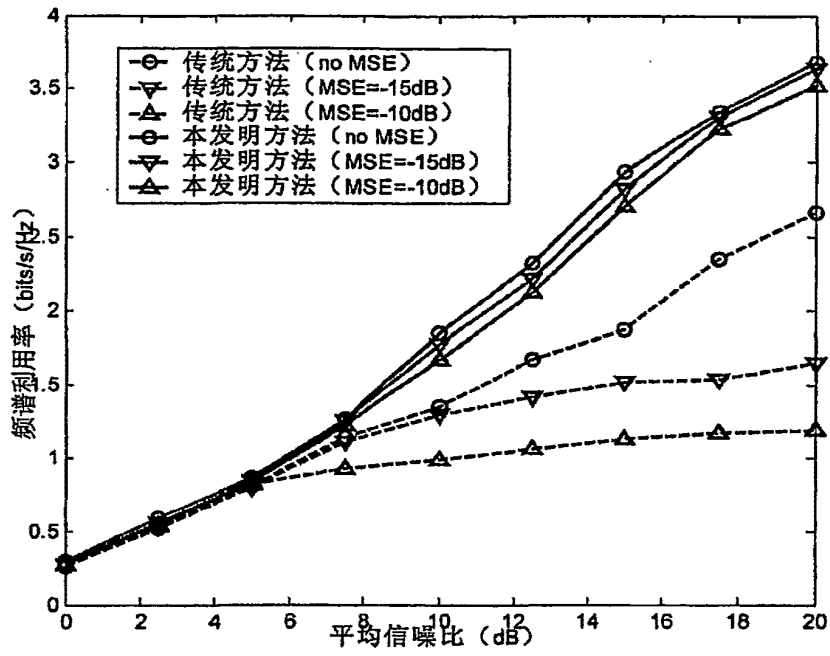
To:

WASHIDA, Kimihito
5th Floor, Shintoshicenter Bldg., 24-1,
Tsurumaki1-chome,
Tama-shi,
Tokyo2060034
JAPON

(PCT Administrative Instructions, Section 411)

Date of mailing (day/month/year) 23 March 2006 (23.03.2006)	IMPORTANT NOTIFICATION		
Applicant's or agent's file reference P035889P0			
International application No. PCT/JP2005/021246	International filing date (day/month/year) 18 November 2005 (18.11.2005)		
International publication date (day/month/year) Not yet published	Priority date (day/month/year) 19 November 2004 (19.11.2004)		
Applicant MATSUSHITA ELECTRIC INDUSTRIAL CO., LTD. et al			

- By means of this Form, which replaces any previously issued notification concerning submission or transmittal of priority documents, the applicant is hereby notified of the date of receipt by the International Bureau of the priority document(s) relating to all earlier application(s) whose priority is claimed. Unless otherwise indicated by the letters "NR", in the right-hand column or by an asterisk appearing next to a date of receipt, the priority document concerned was submitted or transmitted to the International Bureau in compliance with Rule 17.1(a) or (b).
- (If applicable)* The letters "NR" appearing in the right-hand column denote a priority document which, on the date of mailing of this Form, had not yet been received by the International Bureau under Rule 17.1(a) or (b). Where, under Rule 17.1(a), the priority document must be submitted by the applicant to the receiving Office or the International Bureau, but the applicant fails to submit the priority document within the applicable time limit under that Rule, the attention of the applicant is directed to Rule 17.1(c) which provides that no designated Office may disregard the priority claim concerned before giving the applicant an opportunity, upon entry into the national phase, to furnish the priority document within a time limit which is reasonable under the circumstances.
- (If applicable)* An asterisk (*) appearing next to a date of receipt, in the right-hand column, denotes a priority document submitted or transmitted to the International Bureau but not in compliance with Rule 17.1(a) or (b) (the priority document was received after the time limit prescribed in Rule 17.1(a) or the request to prepare and transmit the priority document was submitted to the receiving Office after the applicable time limit under Rule 17.1(b)). Even though the priority document was not furnished in compliance with Rule 17.1(a) or (b), the International Bureau will nevertheless transmit a copy of the document to the designated Offices, for their consideration. In case such a copy is not accepted by the designated Office as the priority document, Rule 17.1(c) provides that no designated Office may disregard the priority claim concerned before giving the applicant an opportunity, upon entry into the national phase, to furnish the priority document within a time limit which is reasonable under the circumstances.

Priority date	Priority application No.	Country or regional Office or PCT receiving Office	Date of receipt of priority document
19 November 2004 (19.11.2004)	200410094967.7	CN	02 March 2006 (02.03.2006)

The International Bureau of WIPO 34, chemin des Colombettes 1211 Geneva 20, Switzerland	Authorized officer Gijsbertus Beijer
Facsimile No. +41 22 338 82 70	Facsimile No. +41 22 740 14 35 Telephone No. +41 22 338 95 61

(19) 世界知的所有権機関
国際事務局



(43) 国際公開日
2006年5月26日 (26.05.2006)

PCT

(10) 国際公開番号
WO 2006/054697 A1

- (51) 国際特許分類:
H04J 11/00 (2006.01)
- (21) 国際出願番号: PCT/JP2005/021246
- (22) 国際出願日: 2005年11月18日 (18.11.2005)
- (25) 国際出願の言語: 日本語
- (26) 国際公開の言語: 日本語
- (30) 優先権データ:
200410094967.7
2004年11月19日 (19.11.2004) CN
- (71) 出願人 (米国を除く全ての指定国について): 松下電器産業株式会社 (MATSUSHITA ELECTRIC INDUSTRIAL CO., LTD.) [JP/JP]; 〒5718501 大阪府門真市大字門真1006番地 Osaka (JP).
- (72) 発明者; および
- (75) 発明者/出願人 (米国についてのみ): ▼余▲ 小明 (SHE, Xiaoming). 李 繼峰 (LI, Jifeng).
- (74) 代理人: 鷺田 公一 (WASHIDA, Kimihito); 〒2060034 東京都多摩市鶴牧1丁目24-1 新都市センタービル5階 Tokyo (JP).
- (81) 指定国 (表示のない限り、全ての種類の国内保護が可能): AE, AG, AL, AM, AT, AU, AZ, BA, BB, BG, BR, BW, BY, BZ, CA, CH, CN, CO, CR, CU, CZ, DE, DK, DM, DZ, EC, EE, EG, ES, FI, GB, GD, GE, GH, GM, HR, HU, ID, IL, IN, IS, JP, KE, KG, KM, KN, KP, KR, KZ, LC, LK, LR, LS, LT, LU, LV, LY, MA, MD, MG, MK, MN, MW, MX, MZ, NA, NG, NI, NO, NZ, OM, PG, PH, PL, PT, RO, RU, SC, SD, SE, SG, SK, SL, SM, SY, TJ, TM, TN, TR, TT, TZ, UA, UG, US, UZ, VC, VN, YU, ZA, ZM, ZW.

[続葉有]

(54) Title: COMMUNICATION APPARATUS, COMMUNICATION SYSTEM, AND COMMUNICATION METHOD

(54) 発明の名称: 通信装置、通信システム及び通信方法

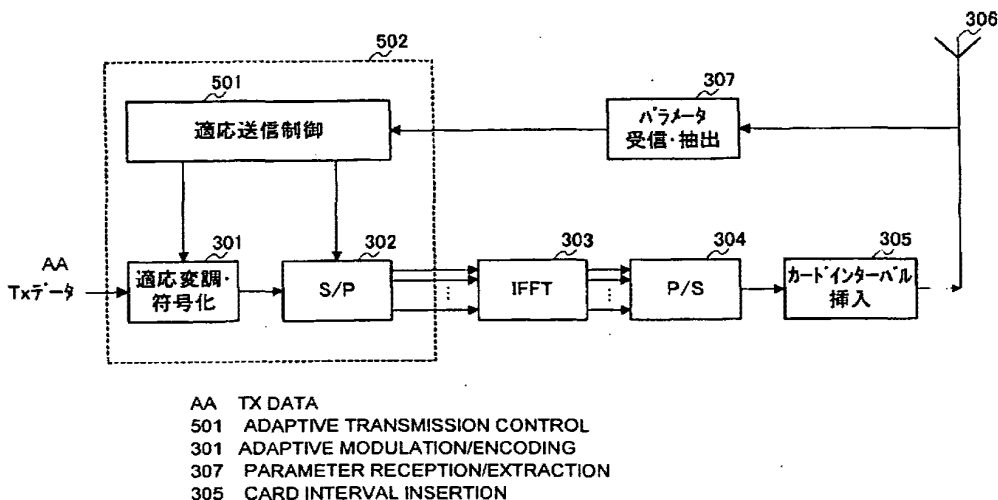

(57) Abstract: A communication apparatus capable of improving the spectrum usage rate of a system, especially, the spectrum usage rate in connection with both a fast fading and a channel estimation error as compared with the conventional sub-band adaptive method, while reducing the degree of the difficulty in achieving the adaptation, and further reducing the feedback overhead. In this apparatus, a sub-band group AMC parameter selecting part (318) selects an AMC parameter of each sub-band. An adaptive reception control part (503) must control an adaptive demodulating/decoding part (311), while controlling a parallel/serial converter (312) in a stage preceding the adaptive demodulation and decoding processes, and combining received symbols in the same sub-band group for demodulation and decoding.

(57) 要約: 従来のサブバンド適応方法と比較して、システムのスペクトル利用率、特に高速フェージング及びチャネル推定誤差のもとでのスペクトル利用率を向上させることができるとともに、適応の実現難易度を低下させ、フィードバックオーバーヘッドの減少を実現することができる通信装置。この装置では、サブバンドグループAMCパラメータ

[続葉有]

WO 2006/054697 A1



(84) 指定国 (表示のない限り、全ての種類の広域保護が可能): ARIPO (BW, GH, GM, KE, LS, MW, MZ, NA, SD, SL, SZ, TZ, UG, ZM, ZW), ユーラシア (AM, AZ, BY, KG, KZ, MD, RU, TJ, TM), ヨーロッパ (AT, BE, BG, CH, CY, CZ, DE, DK, EE, ES, FI, FR, GB, GR, HU, IE, IS, IT, LT, LU, LV, MC, NL, PL, PT, RO, SE, SI, SK, TR), OAPI (BF, BJ, CF, CG, CI, CM, GA, GN, GQ, GW, ML, MR, NE, SN, TD, TG).

2文字コード及び他の略語については、定期発行される各PCTガゼットの巻頭に掲載されている「コードと略語のガイダンスノート」を参照。

添付公開書類:

— 国際調査報告書

タ選択部 (318) は、各サブバンドのAMCパラメータを選択する。適応受信制御部 (503) は、適応復調・復号部 (311) に対して制御を行わなければならない一方で、適応復調及び復号の前段であるパラレル/シリアル変換器 (312) に対しても制御を行ない、同一のサブバンドグループ内の受信シンボルを合成して復調及び復号を行う。

明 細 書

通信装置、通信システム及び通信方法

技術分野

- [0001] 本発明は、通信装置、通信システム及び通信方法に関し、特にサブキャリア通信システムにおける適応伝送技術、即ち無線通信直交周波数分割多重(OFDM)システムにて適応変調及び符号化を行う通信装置、通信システム及び通信方法に関する。

背景技術

- [0002] OFDM技術は、現在、高速無線データ伝送を解決するために主流となっている技術である。OFDM技術の原理は、伝送する高速データを直交する多数のサブキャリアを用いて伝送するというものであり、各サブキャリア上のデータレートは相対的に低い。一般の周波数分割多重システムと比較すると、OFDMにおけるサブキャリアの直交性はシステムのスペクトル利用率を向上させる。OFDMでは信号帯域幅全体を複数の狭いサブキャリア周波数帯域に区分するため、各サブキャリアの帯域幅がチャンネルの帯域幅よりも小さくなることによってフラットフェージングとなる。このように、モノキャリアシステムと比較して、OFDMにおけるフラットフェージングは、より容易に実現が可能である。現在、OFDM技術の非対称デジタル加入者線(ADSL)、デジタルテレビ放送(DVB)、及びワイヤレスATM(WATM)システムへの応用が成功している。
- [0003] 無線システムのスペクトル利用率を向上させるために、フェージングチャンネルの高速無線データ伝送には適応型、高スペクトル利用率の伝送技術の採用が求められている。フェージングチャンネルにおいて、固定符号化変調と比較して、適応変調・符号化(AMC)の技術はシステムのスループット及び誤り率(BER)性能を有効に向上させることができる。ここで言うスループットとは、システムのスペクトル利用率であって、すなわち単位スペクトル帯域幅、単位時間内で伝送する情報量である。AMC技術の基本的な考え方は、現時点のチャンネル特性に基づいて、送信電力、シンボル伝送レート、座標サイズ、符号化率及び符号化メカニズムのうちいずれか1種類または数種類を適応的に変更するというものであり、チャンネル条件が良好な場合には多くの情

報を伝送してスペクトル利用率を高める一方、チャンネル条件が悪い場合には少ない情報を伝送して一定の受信BER要求を保証する。

- [0004] OFDMにおけるAMC方法を紹介する前に、まずOFDM伝送におけるチャンネル特性について簡単に紹介する。
- [0005] 図1はOFDMのチャンネル特性の一例を示す図である。
- [0006] ここで、2つの横軸はそれぞれ時間領域上のOFDMシンボルと周波数領域上のサブキャリアの番号を示し、縦軸はOFDMシンボル及びサブキャリアに対応するチャンネル利得である。伝送中のチャンネルの時間領域拡散及び時間領域拡散により、OFDMのチャンネルは時間領域及び周波数領域いずれにおいても変動している。
- [0007] 上述の通り、AMCの考え方は現時点のチャンネル特性に基づいて送信の変調及び符号化のパラメータを変更するというものである。OFDMについては、この場合の適応的とは時間領域及び周波数領域という2つの領域において適応的ということである。現在、適応的な構成としては、OFDMにおけるAMCは、サブキャリアに基づいたAMCとサブバンドに基づいたAMCの2通りに分けられる。ここで言うサブキャリアに基づいたAMCは各サブキャリアを適応の最小単位とし、OFDMの各サブキャリアで異なる変調方式及び符号化方式を用いて伝送を行うことである。サブキャリアに基づいたAMCには、実現の難易度が高いという点に加えて、フィードバックのオーバーヘッドが大きすぎるという問題点がある。一般に、実際のシステムにおいてサブキャリアに基づいたAMC方法を実現することは困難である。OFDMにおけるもう一つの適応構成として現在比較的一般的に用いられているのは、独立符号化を用いたサブバンドAMC構成、すなわち従来のサブバンド適応方法である。
- [0008] 図2に従来のサブバンド適応変調及び符号化を示す。
- [0009] この構成において、OFDM周波数領域上の全てのサブキャリアはいくつかのサブバンドに区分される。ここで言うサブバンドとは、周波数領域上で隣接する位置にあるサブキャリアにより形成されたサブキャリアグループを示す。例えば図2では、サブバンドの総数はNである。そして、隣接するいくつか(図2の場合、M個)のOFDMシンボルにおける同一のサブバンドにより一つの変調符号化ブロックを形成する。図2の従来のサブバンド適応においては、各変調符号化ブロックはそれぞれのチャンネル特

性に基づいて符号化変調パラメータの推定、及び独立した符号化を行う。図2の各符号化変調ブロック内の数字は当該符号化変調ブロックの符号化変調パラメータが属する等級を表す。

[0010] 一般に、各符号化変調パラメータの等級に対応する符号化変調パラメータはシステムの初期段階で決定される。例えば、表1にその一例として等級と符号化パラメータと変調パラメータの関係を示す。なお、本発明は表1に限定されるものではない。

[0011] [表1]

等級	符号化パラメータ	変調パラメータ
0	伝送せず	伝送せず
1	1/2 Turbo	BPSK
2	1/2 Turbo	QPSK
3	3/4 Turbo	QPSK
4	2/3 Turbo	8PSK
5	3/4 Turbo	16QAM
6	2/3 Turbo	64QAM

[0012] 次に、図3にOFDMに従来のサブバンド適応方法を実現するブロック図を示す。

[0013] 図3A及び図3Bは従来のOFDMとAMCとを結合したOFDM-AMCシステムを示すブロック図である。

[0014] 図3Aの通信装置(送信側)と図3Bの通信装置(受信側)との間で通信を行うと仮定した場合、典型的な例としては図3Aが基地局(AP)、図3Bが移動端末(UE)である。また、図3Aから図3Bへの伝送にはAMCメカニズムを用いると仮定する。

[0015] 図3Aの送信側において、伝送する情報ビットはまず適応変調・符号化部301を経て、出力されたシリアル変調シンボルは更にそれぞれシリアル/パラレル変換(S/P)器302、逆高速フーリエ変換(IFFT)器303を通過して周波数帯域のシンボルが時間領域に変換され、更にパラレル/シリアル変換(P/S)器304を経た後にガードインターバル挿入部305によってガードインターバルが挿入される。そして、アンテナ306を介して送信される。図3Bの受信側では、受信アンテナ316を介して送信側から送信された送信信号を受信した後、まずガードインターバル除去部315によって送信側において挿入されたガードインターバルが除去され、更にそれぞれシリアル/パラレル変換(S/P)器314、高速フーリエ変換(FFT)器313を通過して時間領域

シンボルから周波数領域に変換され、そしてパラレル/シリアル変換(P/S)器312によってパラレル/シリアル変換処理が施されて、最後に適応復調・復号部311により出力されて受信データが得られる。

- [0016] 図3Aの送信側から図3Bの受信側への適応伝送は、主に送信側の適応変調・符号化部301及び受信側における適応復調・復号部311により実現される。先に述べたように、適応変調及び符号化の意味は、現時点のチャネル特性に基づいて送信側で変調及び符号化のパラメータを適応的に調節し、受信側で送信側に対応するパラメータを用いて復調及び復号を行うということである。一般的なシステムにおいては、適応復調・復号部311が必要とする適応パラメータは、受信側からのフィードバックによるものである。各データブロックを送信する前に、受信側は、必ずまずチャネル推定部319によって現時点の送信側から受信側への伝送のチャネルを推定し、OFDMの各サブキャリアにおけるチャネル特性を取得する。そして、受信側はこれらのチャネル特性に基づいて、パラメータ選択部318によって現時点で送信側がデータを送信する場合のOFDMの各サブバンドに用いる変調及び符号化のパラメータを決定する。パラメータ選択部318によって得られた各サブバンドにおける適応変調及び符号化のパラメータには2通りの用途がある。
- [0017] 1つ目の用途は、送信側が現時点でデータを送信する場合のOFDMの各サブバンドにおける変調及び符号化のパラメータとして用いる。受信側のサブバンドAMCパラメータ選択部318は、OFDM各サブバンドの変調及び符号化のパラメータを選択した後、受信側のパラメータ送信部320、受信側のアンテナ316、送信側のアンテナ306、送信側のパラメータ受信・抽出部307というフィードバック経路によって、これらのパラメータを送信側に送り返す。送信側はこれらのパラメータを抽出した後、AMC制御部308によって適応変調・符号化部301を制御する。
- [0018] 2つ目の用途は、受信側が復調及び復号を行う場合のパラメータとして用いる。AMC伝送では、受信側は必ず送信側と一致する変調及び符号化のパラメータに基づいて受信データの復調及び復号を行うことによって、はじめて正確な情報ビットを得ることができる。従って、サブバンドAMCパラメータ選択部318がAMCパラメータを取得した後、更にそれを適応復調・復号部317に送り、適応復調・復号部317に一

時的に保存して、受信側の適応復調・復号部311の制御に用いなければならない。

[0019] 従来のOFDMにおいてサブバンドAMCを用いる方法についてより明確に記述するために、図4A及び図4Bでは図3Aのモジュール309及び図3Bのモジュール321を細分化している。

[0020] 図4A及び図4Bは、従来のサブバンド適応変調・符号化を実現する構成を示す図である。

[0021] 図3Aの送信側では、適応変調・符号化部301は適応符号化部401、インタリーブ部402及び適応変調部403を有し、適応変調・符号化部301から出力されたデータはシリアル/パラレル変換(S/P)器302を経て逆高速フーリエ変換(IFFT)器303に送られる。送信側のAMC制御部308は、図3Aのパラメータ受信・抽出部307がフィードバックチャネルから取得した各サブバンドの変調及び符号化のパラメータに基づいて、適応変調・符号化部301を制御する。従来のサブバンド適応においては、OFDMの各サブバンドに対して独立した符号化変調を行う。すなわち、全てのサブバンドはそれぞれ独自の変調及び符号化のパラメータを有する。AMC制御部308は取得した各サブバンドの符号化パラメータC及び変調パラメータMによって適応変調・符号化部301を制御する。また、AMC制御部308は、さらに符号化パラメータCと変調パラメータMとに基づいて各サブバンドにおいて伝送する情報ビット数を取得し、それによって対応するインタリーブ行列ITを生成し、適応変調・符号化部301のインタリーブ部402を制御する。送信側では、AMCの後に、シリアルなデータストリーム404が得られる。これは順番にサブバンド1,2,……Nにおいて送信するデータを含み、その変調及び符号化方式はそれぞれ、 $(C_1, M_1), (C_2, M_2), \dots, (C_N, M_N)$ である。その後、これらのデータをシリアル/パラレル変換した後にOFDMの対応するサブバンドに順次マッピングして送信する。

[0022] 送信側が各データブロックを送信するために必要なAMCパラメータはいずれも受信側からフィードバックされる。すなわち、送信側で各データブロックを送信する前に、必ず先に受信側によって送信側の送信するデータブロック用にAMCパラメータを選択しなければならない。受信側がパラメータを選択する手順は、まず受信した信号によって、チャンネル推定を行なう。チャンネル推定の方法としては、パイロットに基づい

た方法や、ブラインドチャンネル推定等が挙げられる。その後、チャンネル推定部319は取得したOFDMの各サブキャリアのチャンネル特性をサブバンドAMCパラメータ選択部318に送る。サブバンドAMCパラメータ選択部318では、まずこれによりOFDMにおける各サブバンドの性能について分析を行ない、更に選択されたAMCパラメータの集合の中からそれぞれのサブバンドに適するAMCパラメータを選択する。このようにして取得されたAMCパラメータは、フィードバックチャンネルを通じて送信側に送り返され、送信側が送信を行う場合に実際の適応変調及び符号化の動作に用いられる一方で、当該受信側の適応復調・復号制御部409に用いられる。同時に、時間遅延を考慮すると、現時点で取得したパラメータを記憶するためのパラメータ記憶部410が必要となる。受信側の適応復調・復号部311は、適応復調部408、デインタリーブ部407及び適応復号部406を有する。

- [0023] サブキャリアの適応と比較して、図3A～図4Bに示すような従来のサブバンドの独立符号化による適応方法は、適応の実現難易度を効果的に低減させることができるとともに、システムのフィードバックオーバーヘッドを効果的に減少させることもできる。しかしながら、このような方法にも依然として、各サブバンド間のダイバーシチ能力を有効に利用することができないという欠点が存在する。
- [0024] ダイバーシチは無線伝送品質を改善するために重要な方法である。ここで言うダイバーシチについて概括的に述べると、送信側があるリソースを用いて情報の冗長度を増加させ、互いに冗長な情報を可能な限り独立して変形または減衰させて、受信側でその情報を総合的に利用して合成し、一定のシステム利得を得るといった技術である。簡単に述べると、同時に複数の経路を利用して伝送を行ない、受信側でのある経路の欠損が他の経路により補償されるという技術である。
- [0025] 本願は従来のOFDM適応変調及び符号化におけるサブバンドを用いた独立符号化方式の基礎に加えて、サブバンドを一定の方法で組み合わせてサブバンドグループとし、各サブバンドグループに対してジョイント符号化を行うという方法の特許を求める。従来のAMC方法では各サブバンドが独立してパラメータを選択して符号化を行うため、本願の方法は一見従来のAMCの考え方に逆行しているように見受けられる。しかしながら、この方法にはサブバンド間のダイバーシチを適用しているため、よ

り大きな符号化利得を得ることができる。また、ここで提起する方法によってサブバンドグループ内の変調符号化パラメータの選択を行えば、従来の方法と比較して伝送スループットの損失を招くことはない。両者を組み合わせることにより、本願が特許を求める方法はOFDMにおける適応伝送の性能の向上を促進する。

発明の開示

発明が解決しようとする課題

[0026] 本発明の目的は、サブキャリア通信システムの周波数領域上の全てのサブバンドを一定の規則に基づいて組み合わせていくつかのサブバンドグループとした後、各サブバンドグループに対してジョイント符号化を行う際に用いる変調及び符号化のパラメータを選択することにより、従来サブバンド適応方法と比較して、システムのスペクトル利用率、特に高速フェージング及びチャネル推定誤差のもとでのスペクトル利用率を向上させることができるとともに、適応の実現難易度を低下させ、フィードバックオーバーヘッドの減少を実現することができる通信装置、通信システム及び通信方法を提供することである。

課題を解決するための手段

[0027] 本発明の通信装置は、サブバンド毎にチャネル推定を行うチャネル推定手段と、前記チャネル推定の結果に基づいて変調パラメータ及び符号化パラメータを複数のサブバンドからなるサブバンドグループ毎に決定するパラメータ決定手段と、前記パラメータ決定手段で決定された前記変調パラメータ及び前記符号化パラメータの情報であるパラメータ情報を通信相手に送信するパラメータ情報送信手段と、前記パラメータ情報送信手段にて送信したパラメータ情報の前記変調パラメータ及び前記符号化パラメータで通信相手にて前記サブバンドグループ毎に変調及び符号化されたデータを含む受信信号を受信する受信手段と、前記受信手段にて受信した受信信号を前記パラメータ決定手段で決定された前記変調パラメータ及び前記符号化パラメータで前記サブバンドグループ毎に復調及び復号して前記受信信号に含まれる前記データを取得するデータ取得手段と、を具備する構成を採る。

[0028] 本発明の通信システムは、変調及び符号化したデータを送信する基地局装置と、前記データを受信する通信端末装置と、を具備する通信システムであって、前記通

信端末装置は、サブバンド毎にチャンネル推定を行うチャンネル推定手段と、前記チャンネル推定の結果に基づいて変調パラメータ及び符号化パラメータを複数のサブバンドからなるサブバンドグループ毎に決定するパラメータ決定手段と、前記パラメータ決定手段で決定された前記変調パラメータ及び前記符号化パラメータの情報であるパラメータ情報を前記基地局装置へ送信するパラメータ情報送信手段と、前記パラメータ情報送信手段にて送信したパラメータ情報のパラメータで前記基地局装置にて前記サブバンドグループ毎に変調及び符号化されたデータを含む受信信号を受信する受信手段と、前記受信手段にて受信した受信信号を前記パラメータ情報の前記変調パラメータ及び前記符号化パラメータで前記サブバンドグループ毎に復調及び復号して前記受信信号に含まれる前記データを抽出するデータ抽出手段と、を具備し、前記基地局装置は、前記送信手段にて送信された前記パラメータ情報の前記変調パラメータ及び符号化パラメータに従って変調及び符号化する適応変調・符号化手段と、前記適応変調・符号化手段で変調及び符号化されたデータを送信するデータ送信手段と、を具備する構成を採る。

- [0029] 本発明の通信方法は、サブバンド毎にチャンネル推定を行うステップと、前記チャンネル推定の結果に基づいて変調パラメータ及び符号化パラメータを複数のサブバンドからなるサブバンドグループ毎に決定するステップと、決定された前記変調パラメータ及び前記符号化パラメータの情報であるパラメータ情報を通信端末装置が送信するステップと、前記通信端末装置が送信した前記パラメータ情報を基地局装置が受信するステップと、受信した前記パラメータ情報の前記変調パラメータ及び符号化パラメータに従ってデータを変調及び符号化するステップと、変調及び符号化されたデータを前記基地局装置が送信するステップと、前記基地局装置が送信した前記データを含む受信信号を通信端末装置が受信するステップと、受信した前記受信信号を前記パラメータ情報の前記変調パラメータ及び前記符号化パラメータで前記サブバンドグループ毎に復調及び復号して前記受信信号に含まれる前記データを抽出するステップと、を具備するようにした。

図面の簡単な説明

- [0030] [図1]OFDMのチャンネル特性の例を示す図

[図2]従来の適応変調及び符号化を示す図

[図3A]従来のOFDM-AMCシステムの送信側の構成を示すブロック図

[図3B]従来のOFDM-AMCシステムの受信側の構成を示すブロック図

[図4A]従来の送信側の適応変調・符号化部を含むモジュールを示す図

[図4B]従来の受信側の適応復調・復号部を含むモジュールを示す図

[図5A]本発明の実施の形態に係るOFDM-AMCシステムの送信側の構成を示すブロック図

[図5B]本発明の実施の形態に係るOFDM-AMCシステムの受信側の構成を示すブロック図

[図6A]本発明の実施の形態に係る送信側の適応変調・符号化部を含むモジュールを示す図

[図6B]本発明の実施の形態に係る受信側の適応復調・復号部を含むモジュールを示す図

[図7]本発明の実施の形態に係る適応変調及び符号化の方法を示す図

[図8]本発明の実施の形態に係るサブバンドグループの例を示す図

[図9]本発明の実施の形態に係るサブバンドグループの例を示す図

[図10]本発明の実施の形態に係るサブバンドグループの例を示す図

[図11]本発明の実施の形態に係る適応変調及び符号化と従来の適応変調及び符号化との性能の比較結果を示す図

[図12]本発明の実施の形態に係る適応変調及び符号化と従来の適応変調及び符号化との性能の比較結果を示す図

発明を実施するための最良の形態

[0031] (実施の形態)

以下、本発明の実施の形態について、図面を用いて詳細に説明する。本発明を明確に説明するために、ここではOFDMシステムを例に記述する。本発明の適応変調方式及び符号化方式はサブキャリアを用いて通信を行う他のいかなるサブキャリア通信システムにも適用可能である。

[0032] 本発明は従来のOFDM適応変調・符号化においてサブバンドの独立符号化変調

を用いた基礎の上に、サブバンドを一定の方式で組み合わせてサブバンドグループとし、各サブバンドグループに対してジョイント符号化を行うことである。また、当該発明はサブバンドをサブバンドグループとする各種の方法を提起するとともに、サブバンド内でジョイント符号化を行う際に用いる変調及び符号化のパラメータの選択方法も提起する。なお、これらについては後述する。

[0033] 図5A及び図5Bは本発明の方法を実現するOFDM-AMCシステム構成を示す図である。

[0034] 本発明についてより明確に記述するために、図1～図4Bに示した従来技術において既知の構成については同一の符号を付してその説明を省略し、本発明と従来技術の区別し得る構成についてのみ記載している。

[0035] 図3A及び図3Bに示す従来のOFDM-AMCシステム構成と比較して、本発明のOFDM-AMCを応用したシステムは以下の相違点を有する。

[0036] 図5Bに示すモジュール505に含まれる、パラメータ決定手段であるサブバンドグループAMCパラメータ選択部504はサブバンドグループのAMCパラメータを選択し、図3Bのモジュール321に含まれるサブバンドAMCパラメータ選択部316は各サブバンドのAMCパラメータを選択する。これは、従来のOFDM-AMCシステムではサブバンド適応変調及び符号化の単位はサブバンドであるのに対し、本発明のOFDM-AMCシステムにおいては、適応変調及び符号化の単位はサブバンドグループであるためである。本発明では、OFDMにおける周波数領域の全てのサブバンドを組み合わせパターンによっていくつかのサブバンドグループとし、更に各サブバンドグループに対して適応変調及び符号化を行っている。また、本発明のOFDM-AMCシステムは、図5Bのパラメータ送信部320、受信側のアンテナ316、送信側のアンテナ306及び送信側のパラメータ受信・抽出部307の順の一連のフィードバックループにおいて、伝送されるのは、変調パラメータ及び符号化パラメータの情報であるパラメータ情報としての、サブバンドグループに関するAMCパラメータであって、図3に示す従来のOFDM-AMCシステムのようなサブバンドに関するAMCパラメータではないという点である。

[0037] また、送信側においては、適応送信制御部501が図3Aに示すAMC制御部308と

置き換えられている。本発明の技術では、送信側がOFDMにおいてサブバンドグループに対して適応変調及び符号化を行い、サブバンドグループはOFDMの各サブバンドを組み合わせパターンに基づいて組み合わせることによって形成される。従って、適応送信制御部501は、適応変調・符号化部301内のサブバンドグループのAMCに対して制御を行わなければならない一方で、各サブバンドグループにて送信する情報ビットを、符号化及び変調後にOFDM内の対応するサブバンドにマッピングして伝送を行うように、適応変調及び符号化後のシリアル/パラレル変換(S/P)器302に対しても制御を行わなければならない。

[0038] また、受信側においては、適応受信制御部503が図3Bに示す適応復調・制御部317に置き換えられている。適応受信制御部503は、データ取得手段である適応復調・復号部311に対して制御を行わなければならない一方で、適応復調及び復号の前段であるパラレル/シリアル変換(P/S)器312に対しても制御を行ない、同一のサブバンドグループ内の受信シンボルを合成して復調及び復号を行う。

[0039] 図5Aのモジュール502及び図5Bのモジュール505を細分化して図6A及び図6Bに示す。

[0040] 図6A及び図6Bは本発明の提起する方法を実現するための構成を示す図である。

[0041] 送信側において、図4Aに示す従来のサブバンド適応との相違点は、適応変調及び符号化の単位がサブバンドではなくサブバンドグループであるということであり、この場合に適応変調・符号化部301の出力603は、順次サブバンドグループ1,2,……,Kにおける送信データを含み、その変調方式及び符号化方式はそれぞれ、 (C_1, M_1) , (C_2, M_2) , …… , (C_K, M_K) であって、このKはOFDM内で分割されたサブバンドグループの総数である。また、送信側は、AMC操作に対して制御を行う以外に、組み合わせパターン記憶部601に記憶されている、サブバンドの組み合わせパターンに基づいて、シリアル/パラレル変換(S/P)部302におけるシリアル/パラレル変換に対しても制御を行わなければならない、それによって各サブバンドグループで送信する情報ビットを符号化及び変調後にOFDM中の対応するサブバンドにマッピングして伝送する。

[0042] 受信側において、図4Bに示す従来のサブバンド適応との相違点は、適応復調及

び符号化の単位がサブバンドではなくサブバンドグループであることである。また、受信側は、適応復調及び復号に対して制御を行う以外に、組み合わせパターン記憶部605に記憶されている、サブバンドの組み合わせパターンに基づいて、パラレル/シリアル変換(P/S)部312におけるパラレル/シリアル変換に対しても制御を行わなければならない、それによってOFDMの同一サブバンドグループ内の受信シンボルを合成して復調及び復号を行う。更に、図6Bに示すように、サブバンドグループAMCパラメータ選択部504も図4Bと異なる。図6Bでは、パラメータ選択部411にて、OFDMの各サブバンドのパラメータを選択・取得した上で、更に組み合わせパターン記憶部607に記憶されている組み合わせパターンに基づいて、サブバンドグループのパラメータ選択部606にて、OFDMの各サブバンドグループの適応パラメータを選択しなければならない。

- [0043] 図7は本発明の実施の形態の適応符号化方式及び変調方式を実現するための処理を示すフロー図である。具体的には、本発明の技術の実現過程は以下の通りである。
- [0044] 第一段階として、受信側によって送信側OFDMにおける各サブバンドグループ内の適応変調及び符号化のパラメータを決定し、決定したパラメータを送信側にフィードバックする。この過程は受信側のチャンネル推定(ステップ901)、OFDM各サブバンドの適応パラメータ選択(ステップ902)、OFDM各サブバンドグループの適応パラメータ選択(ステップ903)、及びパラメータのフィードバック(ステップ921)を含む。
- [0045] ステップ901におけるチャンネル推定は、パイロットに基づいたチャンネル推定やブラインドチャンネル推定等の既存の一般的な方法を用いることができる。
- [0046] ステップ902におけるOFDM各サブバンドの適応パラメータ選択は、従来の各サブバンドの独立した符号化の場合に、OFDMの各サブバンドにおいて適応伝送を行う際に用いる変調及び符号のパラメータを示す。独立した符号化であるため、各サブバンド内のパラメータはチャンネル特性の違いによって異なる。
- [0047] この操作においては、まず表1及び表2に示すパラメータの集合のように、選択の候補となる適応パラメータの集合を決定する必要がある。その後、現時点の各サブバンドにおけるチャンネル特性に基づいて適合する変調及び符号化のパラメータを選択し

、同時にそれに対応する伝送情報ビット数を決定する。ここで、チャンネル特性に基づいてパラメータを選択する既存の方法は、サブバンドの最低信号対雑音比に基づく方法、サブバンドの平均信号対雑音比に基づく方法、容量に基づく方法、平均信号対雑音比と他の統計的特性との組み合わせに基づく方法等、多岐にわたる。本実施の形態においては、平均信号対雑音比に基づく方法を例に簡単に説明を行う。

[0048] 平均信号対雑音比に基づく方法は、まず理論分析またはシミュレーションといった方法により各種の変調及び符号化のパラメータが必要とする信号対雑音比の閾値(表2参照)を決定し、その場合のスループット能力、すなわち各種の変調及び符号化のパラメータに対応するスペクトル利用率は、数値上は符号化率と各シンボルに含まれるビット数の積に等しい。その後、各サブバンドについて、内部のサブキャリア上の平均信号対雑音比を計算する。最後に、当該サブバンドに閾値がその平均信号対雑音比より低く、かつスループット能力が最高となる変調及び符号化のパラメータを当該サブバンドにおける変調及び符号化のパラメータとして選択する。表2は、各等級における、符号化パラメータと変調パラメータと信号対雑音比閾値とスループット能力の関係を示すものである。例えば、サブバンド内の平均信号対雑音比が0,2,4,6,8である場合に、表2に示すパラメータによれば、選択する変調及び符号化のパラメータに対応する等級はそれぞれ1,1,2,3,4である。それに対応して、当該サブバンド内に割り当てられる情報ビット数が決定される(数値上は当該サブバンド内のサブキャリアの総数と、選択された符号化及び変調のパラメータに対応するスループット能力との積に等しい)。

[0049] [表2]

等級	符号化パラメータ	変調パラメータ	信号対雑音比 閾値 (dB)	スループット 能力 (bps/Hz)
0	伝送せず	伝送せず	$-\infty$	0
1	1/2 Turb o	BPSK	-0.4	0.5
2	1/2 Turb o	QPSK	2.2	1
3	3/4 Turb o	QPSK	5.2	1.5
4	2/3 Turb o	8PSK	7.6	2
5	3/4 Turb o	16QAM	10.9	3
6	2/3 Turb o	64QAM	14.5	4

[0050] ステップ903におけるOFDM各サブバンドグループの適応パラメータ選択は、従来の適応方法においては、OFDMの各サブバンドに対して独立して変調及び符号化を行っていたのに対し、本願の方法では、適応伝送の単位はサブバンドではなくサブバンドグループである。従って、まず一定の組み合わせ方法(または組み合わせパターン)に基づいてOFDM周波数領域の全てのサブバンドをいくつかのサブバンドグループとする。組み合わせの方法としては、隣接するサブバンドを組み合わせる方法、間隔の開いたサブバンドを組み合わせる方法、全てのサブバンドを組み合わせる方法及びその他の規則により組み合わせる方法がある。隣接するサブバンドを組み合わせる方法、即ち周波数軸上で隣接する複数のサブバンドを選択する方法は、図8に示すように、隣接する位置にあるいくつかのサブバンドを一つのサブバンドグループとする方法である。図8は隣接するサブバンドを組み合わせる例を示す図である。また、サブバンドグループは、サブバンドの組み合わせパターンを有し、サブバンドは特定の数のサブキャリア変調シンボル内の、周波数上隣接する位置にある同数のサブキャリアにより形成される。

[0051] 図8において、OFDMの時間領域が同一の位置の、周波数領域上のN個のサブバンドをいくつかのサブバンドグループとする。ここで、周波数上隣接する位置にあるサブバンドを一つのサブバンドグループとする。すなわち、図中の同一の網掛けパターンにあるサブバンドは同一のサブバンドグループに属している。

[0052] また、間隔の開いたサブバンドを組み合わせる方法、即ち周波数軸上に配列した

サブバンドの中から所定の間隔で複数のサブバンドを選択する方法は、図9に示すように、間隔の開いたいくつかのサブバンドを選択して一つのサブバンドグループとする方法である。図9は間隔の開いたサブバンドを組み合わせる例を示す図である。

- [0053] 図9において、OFDMの周波数領域上で間隔の開いたサブバンドを選択し、合成して一つのサブバンドグループとする。すなわち、図中の同一の網掛けパターンにあるサブバンドは同一のサブバンドグループに属している。
- [0054] また、全てのサブバンドを組み合わせる方法、即ち所定の時間領域毎に全てのサブバンドを選択する方法は、図10に示すように、周波数領域の全てのサブバンドを一つのサブバンドグループに合成する方法である。図10は全てのサブバンドを組み合わせる例である。
- [0055] 図10において、OFDMの時間領域が同一の位置の、周波数領域上の全てのN個のサブバンドを合成して一つのサブバンドグループとする。
- [0056] また、その他の規則により組み合わせる方法は、サブバンドグループにおいて各サブバンドの変調及び符号化のパラメータ、割り当てられる情報ビット数が決定した後、サブバンドグループ内で割り当てられる情報ビット数及びジョイント符号化パラメータが以下の通り決定される。まず、各サブバンド内に割り当てられる情報ビット数の和を求めてサブバンドグループ全体に割り当てられる情報ビット数とし、次いで各サブバンド内で最大の変調等級を当該サブバンドグループで統一して変調に用いる変調方式とし、次いでサブバンドグループ内に割り当てられる情報ビット数と変調方式から符号化率を求める。
- [0057] この過程は、例えば一つのサブバンドグループにA、B、C、Dという4つのサブバンドがあり、各サブバンドに含まれるサブキャリア数は512であって、各サブバンドに対応する符号化及び変調のパラメータの等級はそれぞれ、0、1、2、3となると仮定する。これにより、A、B、C、Dの各サブバンドグループ内に割り当てられる情報ビット数はそれぞれ、Aについては $512 * 0 = 0$ になり、Bについては $512 * 0.5 = 256$ になり、Cについては $512 * 1 = 512$ になり、Dについては $512 * 1.5 = 768$ になる。そのため、当該サブバンドグループ内の情報ビット数の総計は、 $0 + 256 + 512 + 768 = 1536$ である。そして、A、B、C、Dの各サブバンドグループにおいて最高の変調等級

を選択し(ここではサブバンドDに対応する変調等級が最高である)、8PSKをサブバンドグループ全体で統一の変調パラメータとする。それに対応して、当該サブバンドグループで統一して符号化に用いる符号化率は $1536 / (512 * 3 * 4) = 1/4$ となる。

- [0058] ここで、推定によって求められるA、B、C、Dの4つのサブバンドそれぞれにおける伝送情報ビット数の和を求めてサブバンドグループ内で伝送する情報ビット数とする。実際の動作では、この数値に対して重み付け演算を行っても良い。例えば、チャンネル変動が比較的早い場合を考えると、推定したチャンネル特性の誤差が比較的大きくなるので、A、B、C、Dの4つのサブバンドにおける伝送情報ビット数の和を求めた後に0.9による重み付けを行って、サブバンド内の情報ビット数の総和として、 $(0 + 256 + 512 + 768) * 0.9 \doteq 1382$ とする。
- [0059] ステップ921におけるパラメータのフィードバックは、受信側でOFDMの各サブバンドグループの適応パラメータを取得した後、フィードバックチャンネルを通じて送信側に返送し、送信側でこのパラメータに基づいて実際の動作を行う。
- [0060] 第二段階として、送信側は受信側からフィードバックされたOFDM各サブバンドグループ内の適応パラメータに基づいて、各サブバンドグループに対応する数の伝送用情報ビットを割り当てるとともに、対応するパラメータごとに各サブバンドグループ内でジョイント符号化及び変調を行う(ステップ911)。例えば、上述の仮定に基づくと、A、B、C、Dの4つのサブバンドにより形成されたサブバンドグループにジョイント変調及び符号化を行うが、その場合の変調及び符号化のパラメータは8PSK及び1/4 Turboコードである。続いて、サブバンドの組み合わせパターンに基づいて、変調後のシンボルをOFDMの対応するサブバンドに割り当てて送信を行う(ステップ912)。具体的には、シリアル/パラレル変換器302でのシリアル/パラレル変換、逆高速フーリエ変換部303での逆高速フーリエ変換、パラレル/シリアル変換器304でのパラレル/シリアル変換及びガードインターバル挿入部305でのガードインターバルの挿入を含む。
- [0061] 第三段階として、受信側では、まずガードインターバル除去315でのガードインターバルの除去、シリアル/パラレル変換器314でのパラレル/シリアル変換、高速フー

リエ変換部313での高速フーリエ変換、パラレル/シリアル変換器312でのパラレル/シリアル変換を経るとともに、パラレル/シリアル変換器312を制御することによって、受信したOFDMの各サブバンドグループ内のデータをサブバンドの組み合わせパターンに基づいて抽出し(ステップ904)、その後第一段階において取得した各サブバンドグループ内の適応パラメータによって、各サブバンドグループに対して適応復調及び復号を行なうとともに、最終的に送信する元のデータを取得する(ステップ905)。

- [0062] 本発明はOFDMの各サブバンドに対して組み合わせ及びジョイント符号化を行ない、サブバンド間のダイバーシチ能力を効率良く利用することによって、システムのスペクトル利用率、特に高速フェージング及びチャネル推定誤差のもとでのスペクトル利用率を効果的に向上させるとともに、適応の実現難易度とフィードバックのオーバーヘッドを減少させる。
- [0063] 図11は異なるフィードバック遅延時間の下での、本発明の方法と従来の方法の性能の比較結果を示す図である。
- [0064] 図12は異なるチャネル推定誤差の下での、本発明の方法と従来の方法の性能の比較結果を示す図である。
- [0065] ここで、シミュレーションとしてOFDMシステムの信号帯域幅が10MHz、サブキャリアの総数が1024であって16のサブバンドに分割され、各サブバンドが時間領域上で8つのOFDMシンボルを跨いでいると仮定する。Turboコードの分量の循環システム畳み込み(RSC)多項式は $(13,11)_{\text{OCT}}$ 、復号には4次反復、及び最大事後確率(MAP)アルゴリズムを採用するとする。システムにはARQを採用する。シミュレーションに用いるチャネルモデルはM. 1225車載チャネルモデルAとする。具体的に実施する場合、サブバンド全体を組み合わせる方法を用いて、1つのサブバンドは平均信号対雑音比パラメータ推定方法を用いる。図11及び図12における $f_d \tau$ とMSEとはそれぞれ最大ドップラー周波数偏移とフィードバック時間遅延との積、及びチャネル推定誤差を表す。従来の方法については図2に示す通りである。図11及び図12の結果から理解できるように、理想的な場合($f_d \tau = 0$, MSEなし)であるか高速フェージング($f_d \tau$ が存在する)またはチャネル推定誤差(MSEが存在する)の場合であ

るかに関わらず、従来の方法と比較して、本発明が提起する方法はいずれも一定の性能利得を有する。また、この場合16個のサブバンドすべてを1つのサブバンドグループに合成すれば、フィードバックのオーバーヘッドは元の1/16となる。

[0066] 上述のように、好ましい実施の形態とあわせて本発明について説明した。しかしながら、本発明の思想及び範囲内で種々修正、置換及び変更して実施することができることは当業者にとって自明である。従って、本発明は上述の実施の形態に限られない。

請求の範囲

- [1] サブバンド毎にチャンネル推定を行うチャンネル推定手段と、
前記チャンネル推定の結果に基づいて変調パラメータ及び符号化パラメータを複数のサブバンドからなるサブバンドグループ毎に決定するパラメータ決定手段と、
前記パラメータ決定手段で決定された前記変調パラメータ及び前記符号化パラメータの情報であるパラメータ情報を通信相手に送信するパラメータ情報送信手段と、
前記パラメータ情報送信手段にて送信したパラメータ情報の前記変調パラメータ及び前記符号化パラメータで通信相手にて前記サブバンドグループ毎に変調及び符号化されたデータを含む受信信号を受信する受信手段と、
前記受信手段にて受信した受信信号を前記パラメータ決定手段で決定された前記変調パラメータ及び前記符号化パラメータで前記サブバンドグループ毎に復調及び復号して前記受信信号に含まれる前記データを取得するデータ取得手段と、
を具備する通信装置。
- [2] 前記サブバンドグループを構成するサブバンドを選択するためのパターンをあらかじめ記憶するパターン記憶手段を具備し、
前記パラメータ決定手段は、前記パターン記憶手段に記憶されている前記パターンに基づいて選択されたサブバンドからなる前記サブバンドグループ毎の前記変調パラメータ及び前記符号化パラメータを決定する請求項1記載の通信装置。
- [3] 前記パラメータ決定手段は、周波数軸上で隣接する複数のサブバンドを選択する前記パターンにより構成される前記サブバンドグループ毎に前記変調パラメータ及び前記符号化パラメータを決定する請求項2記載の通信装置。
- [4] 前記パラメータ決定手段は、周波数軸上に配列したサブバンドの中から所定の間隔で複数のサブバンドを選択する前記パターンにより構成される前記サブバンドグループ毎に前記変調パラメータ及び前記符号化パラメータを決定する請求項2記載の通信装置。
- [5] 前記パラメータ決定手段は、所定の時間領域毎に全てのサブバンドを選択する前記パターンにより構成される前記サブバンドグループ毎に前記変調パラメータ及び前記符号化パラメータを決定する請求項2記載の通信装置。

- [6] 前記パラメータ決定手段は、前記サブバンドグループ内のサブバンド毎に前記変調パラメータを求めるとともに、求めた前記変調パラメータの中で最も等級が高い前記変調パラメータを前記サブバンドグループの前記変調パラメータとして決定する請求項1記載の通信装置。
- [7] 前記パラメータ決定手段は、前記サブバンドグループ内の全てのサブバンドに割り当て可能な情報ビット数が前記サブバンドグループに割り当てられるように前記符号化パラメータを決定する請求項1記載の通信装置。
- [8] 前記パラメータ決定手段は、前記サブバンドグループ内の全てのサブバンドに割り当て可能な情報ビット数の和に前記サブバンドグループ毎の重み付けした結果の情報ビット数が前記サブバンドグループに割り当てられるように前記符号化パラメータを決定する請求項1記載の通信装置。
- [9] 請求項1記載の通信装置の通信相手である基地局装置であって、前記基地局装置は、前記送信手段にて送信された前記パラメータ情報の前記変調パラメータ及び符号化パラメータに従ってデータを変調及び符号化する適応変調・符号化手段と、前記適応変調・符号化手段で変調及び符号化されたデータを送信するデータ送信手段と、を具備する基地局装置。
- [10] 変調及び符号化したデータを送信する基地局装置と、前記データを受信する通信端末装置と、を具備する通信システムであって、前記通信端末装置は、サブバンド毎にチャンネル推定を行うチャンネル推定手段と、前記チャンネル推定の結果に基づいて変調パラメータ及び符号化パラメータを複数のサブバンドからなるサブバンドグループ毎に決定するパラメータ決定手段と、前記パラメータ決定手段で決定された前記変調パラメータ及び前記符号化パラメータの情報であるパラメータ情報を前記基地局装置へ送信するパラメータ情報送信手段と、前記パラメータ情報送信手段にて送信したパラメータ情報のパラメータで前記基地局装置にて前記サブバンドグループ毎に変調及び符号化されたデータを含む受信信号を受信する受信手段と、前記受信手段にて受信した受信信号を前記パラメータ情報の前記変調パラメータ及び前記符号化パラメータで前記サブバンドグループ毎に復調及び復号して前記受信信号に含まれる前記データを抽出するデータ抽出手段と、を具備し、前記基地局装置は、

前記送信手段にて送信された前記パラメータ情報の前記変調パラメータ及び符号化パラメータに従って変調及び符号化する適応変調・符号化手段と、前記適応変調・符号化手段で変調及び符号化されたデータを送信するデータ送信手段と、を具備する通信システム。

- [11] サブバンド毎にチャンネル推定を行うステップと、前記チャンネル推定の結果に基づいて変調パラメータ及び符号化パラメータを複数のサブバンドからなるサブバンドグループ毎に決定するステップと、決定された前記変調パラメータ及び前記符号化パラメータの情報であるパラメータ情報を通信端末装置が送信するステップと、前記通信端末装置が送信した前記パラメータ情報を基地局装置が受信するステップと、受信した前記パラメータ情報の前記変調パラメータ及び符号化パラメータに従ってデータを変調及び符号化するステップと、変調及び符号化されたデータを前記基地局装置が送信するステップと、前記基地局装置が送信した前記データを含む受信信号を通信端末装置が受信するステップと、受信した前記受信信号を前記パラメータ情報の前記変調パラメータ及び前記符号化パラメータで前記サブバンドグループ毎に復調及び復号して前記受信信号に含まれる前記データを抽出するステップと、を具備する通信方法。
- [12] 前記サブバンドグループを構成するサブバンドを選択するためのパターンをあらかじめ記憶するステップを具備し、
記憶されている前記パターンに基づいて選択されたサブバンドからなる前記サブバンドグループ毎の前記変調パラメータ及び前記符号化パラメータを決定する請求項11記載の通信方法。

[図1]

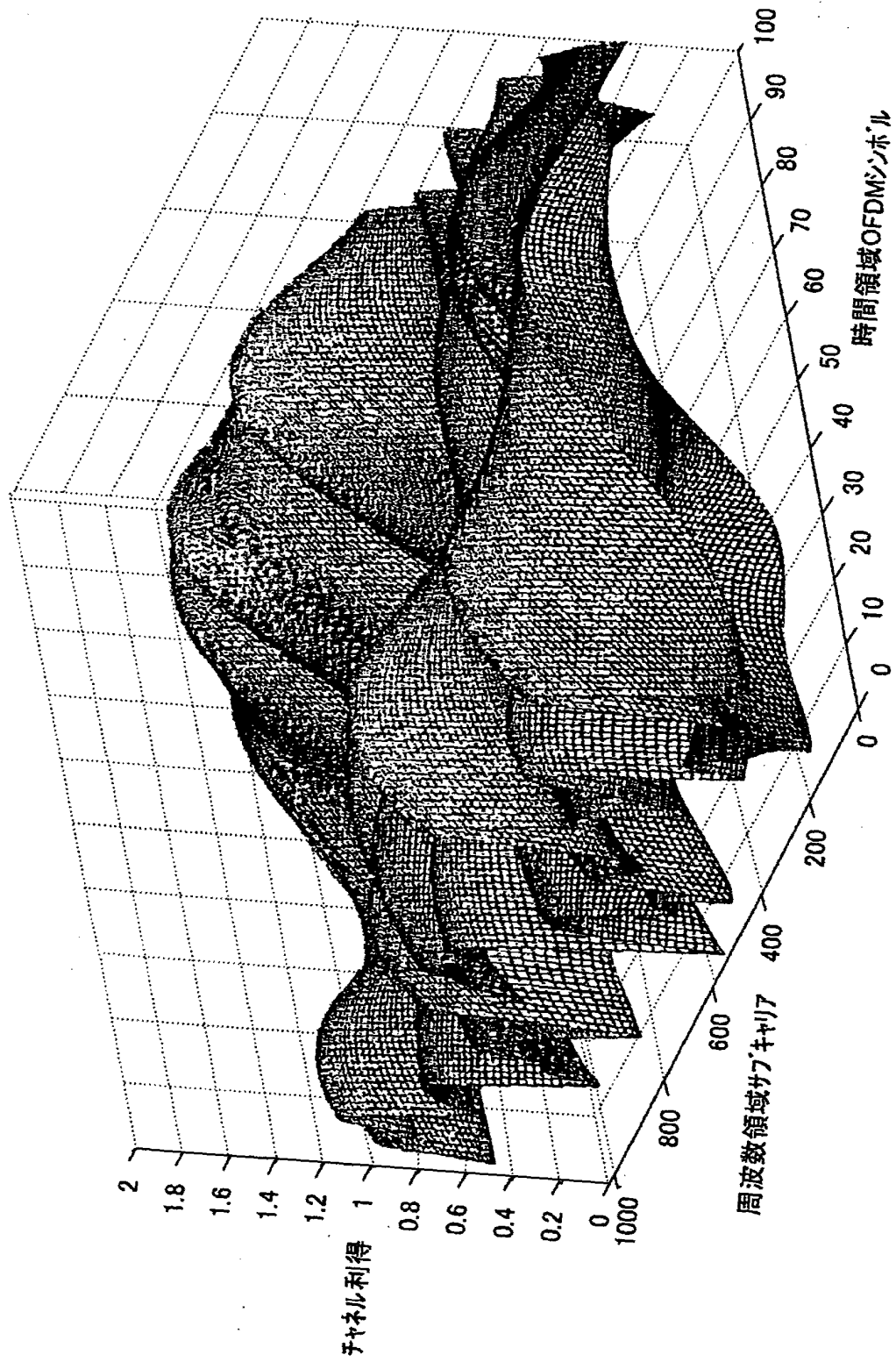

PRIOR ART

[図2]

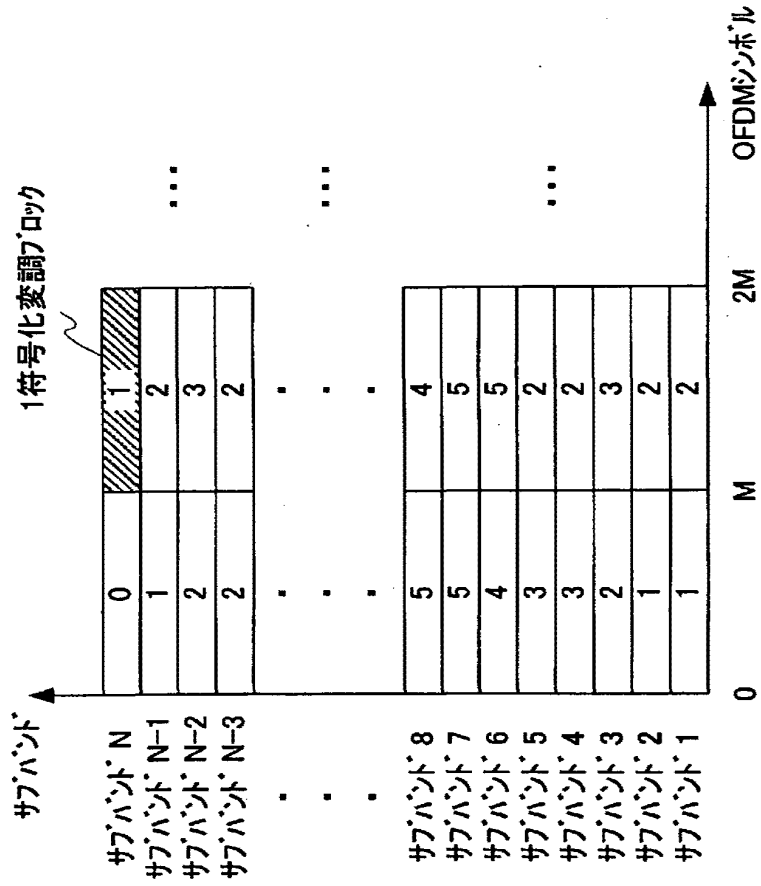

PRIOR ART

[図3A]

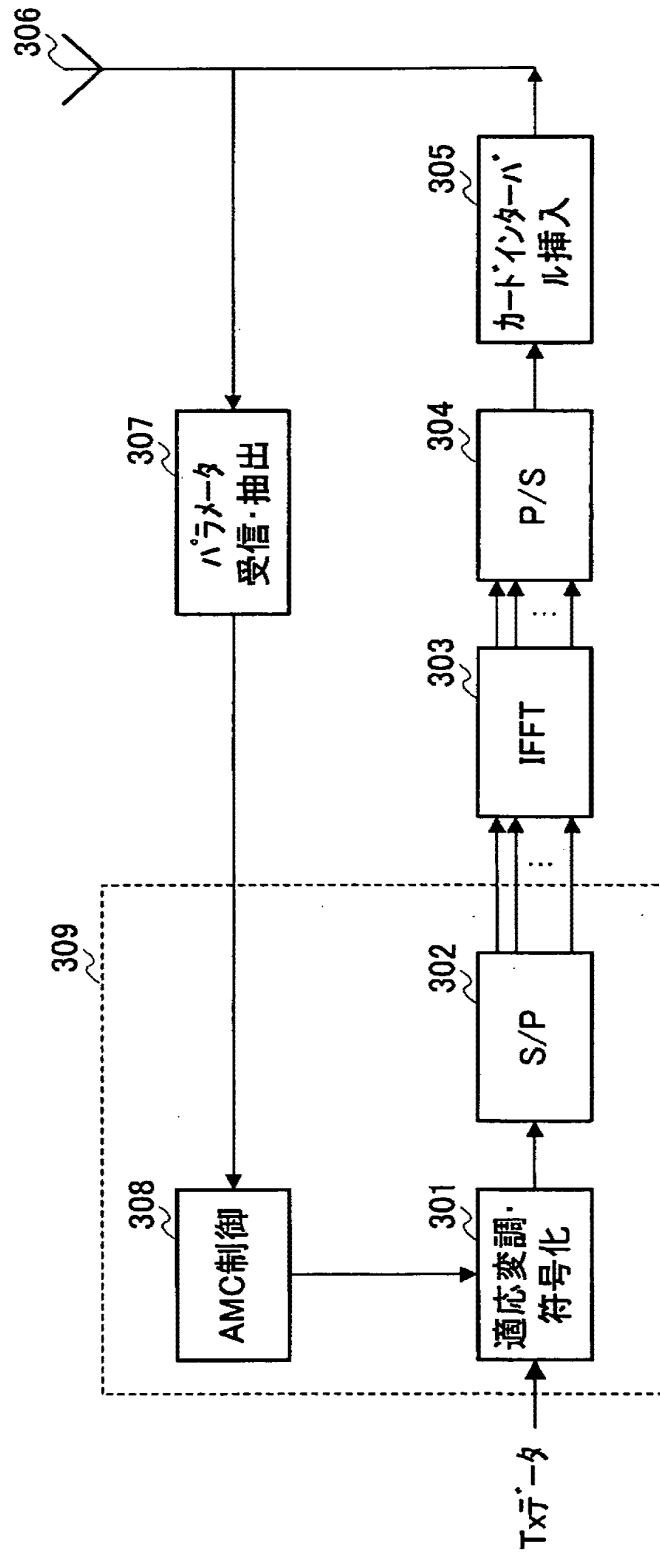

PRIOR ART

[図3B]

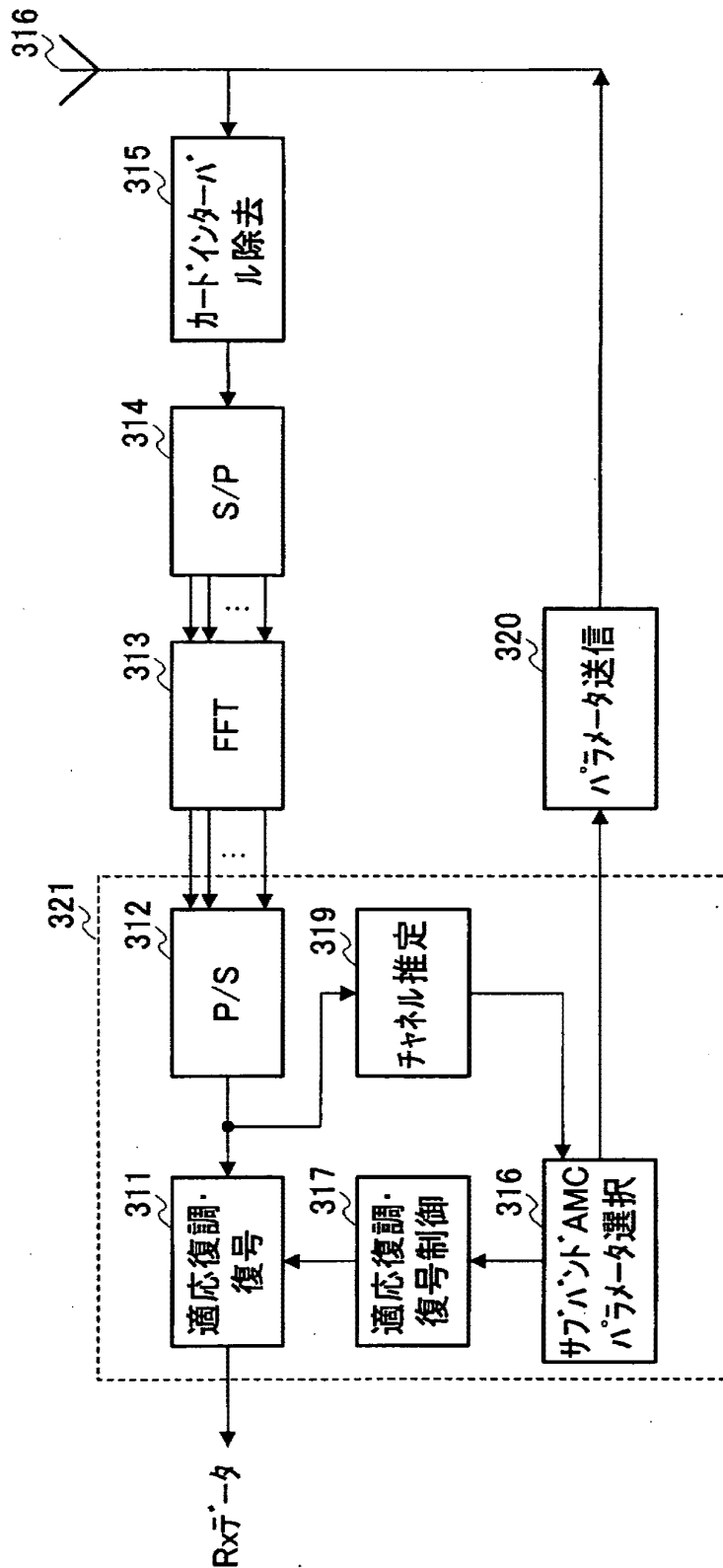

PRIOR ART

[図4A]

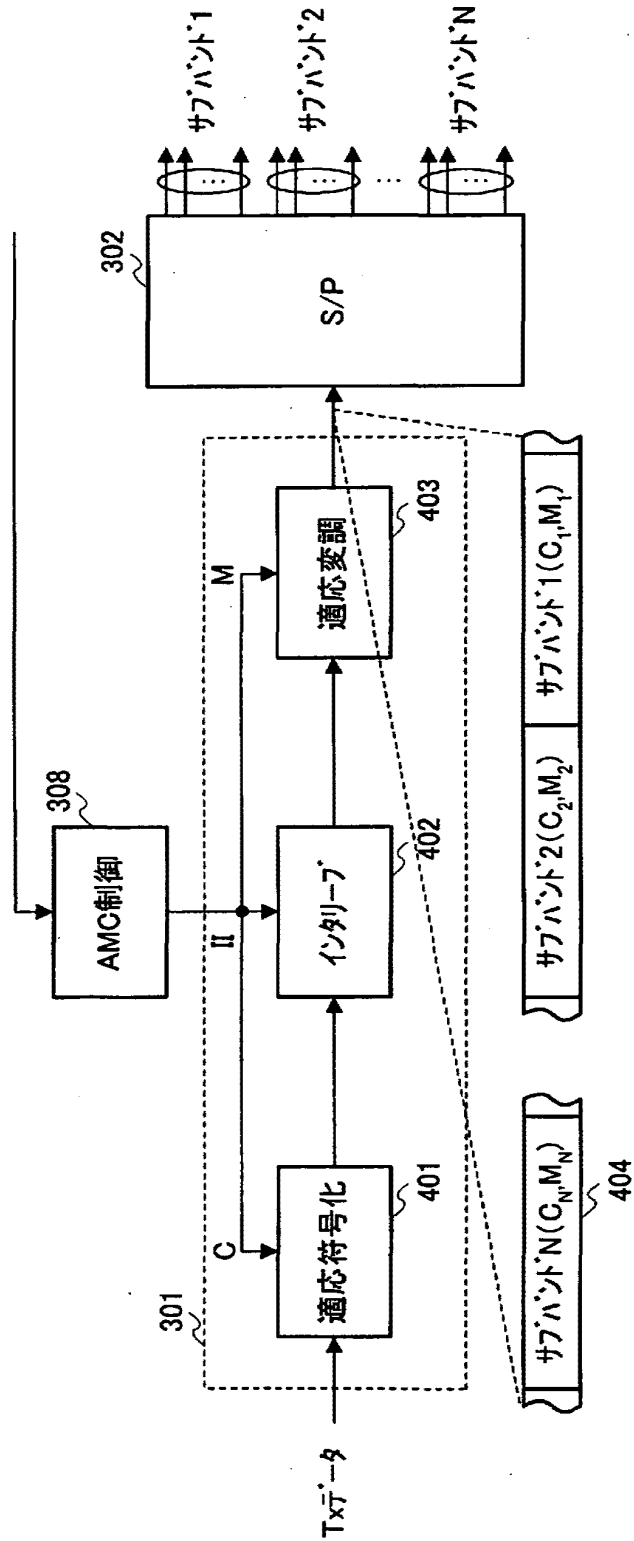

PRIOR ART

[図4B]

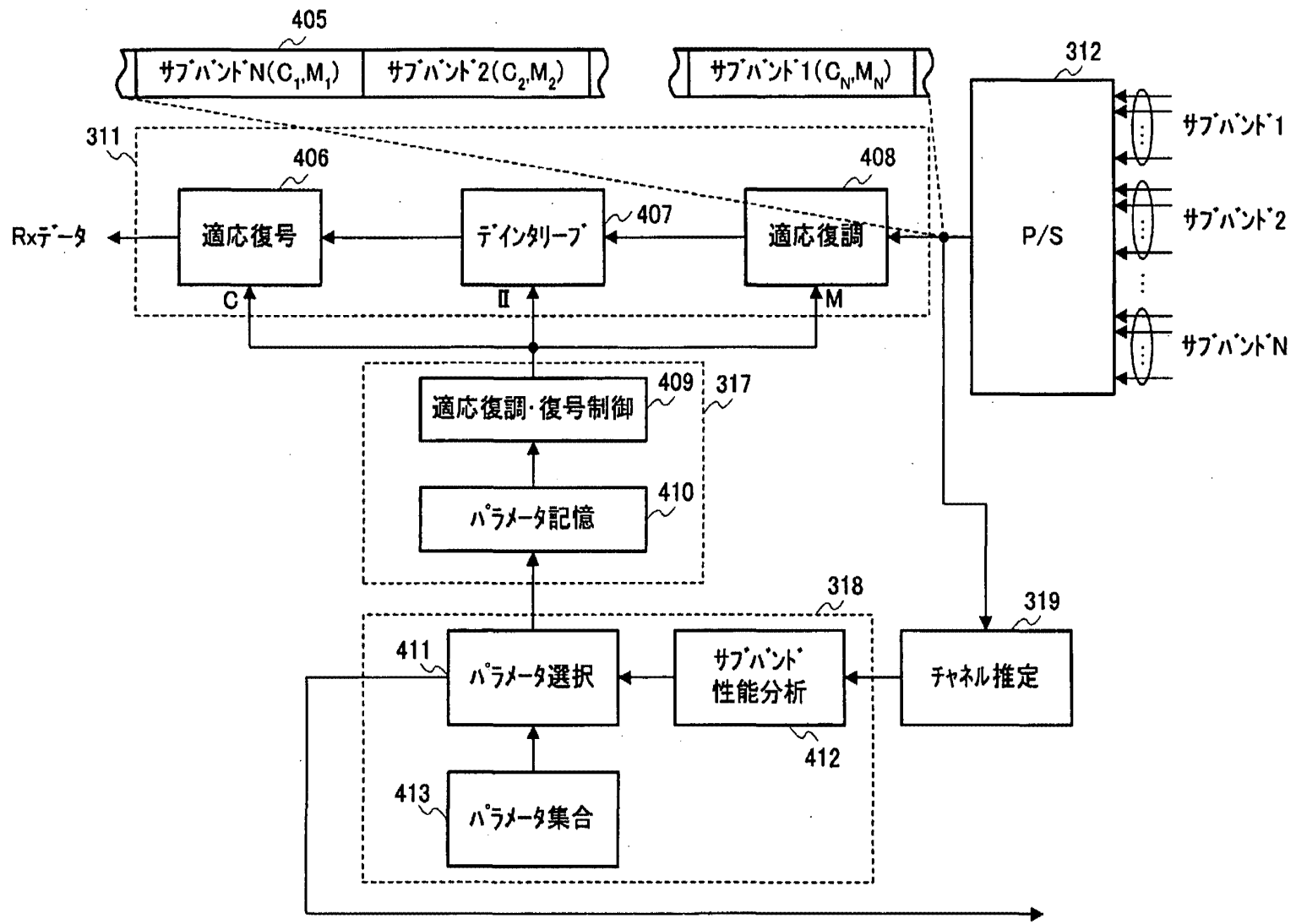

PRIOR ART

[図5A]

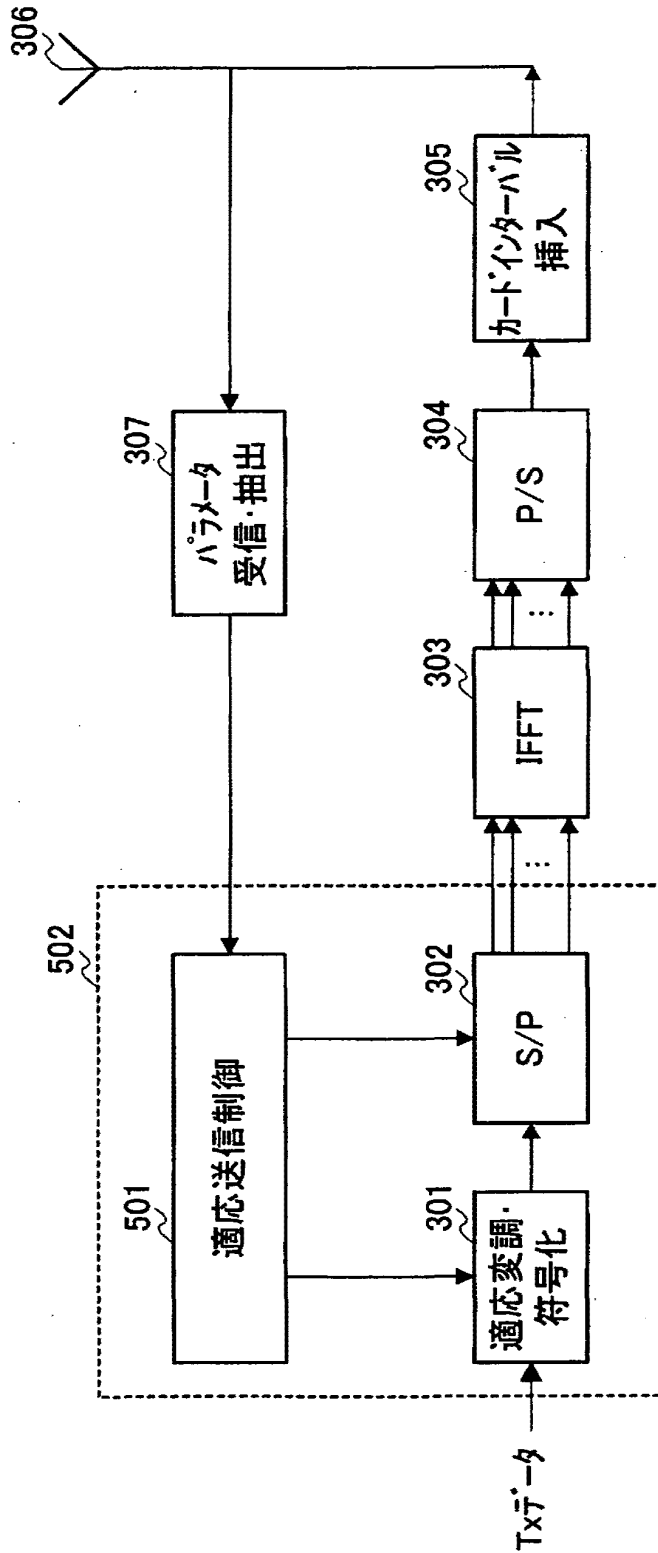

[図5B]

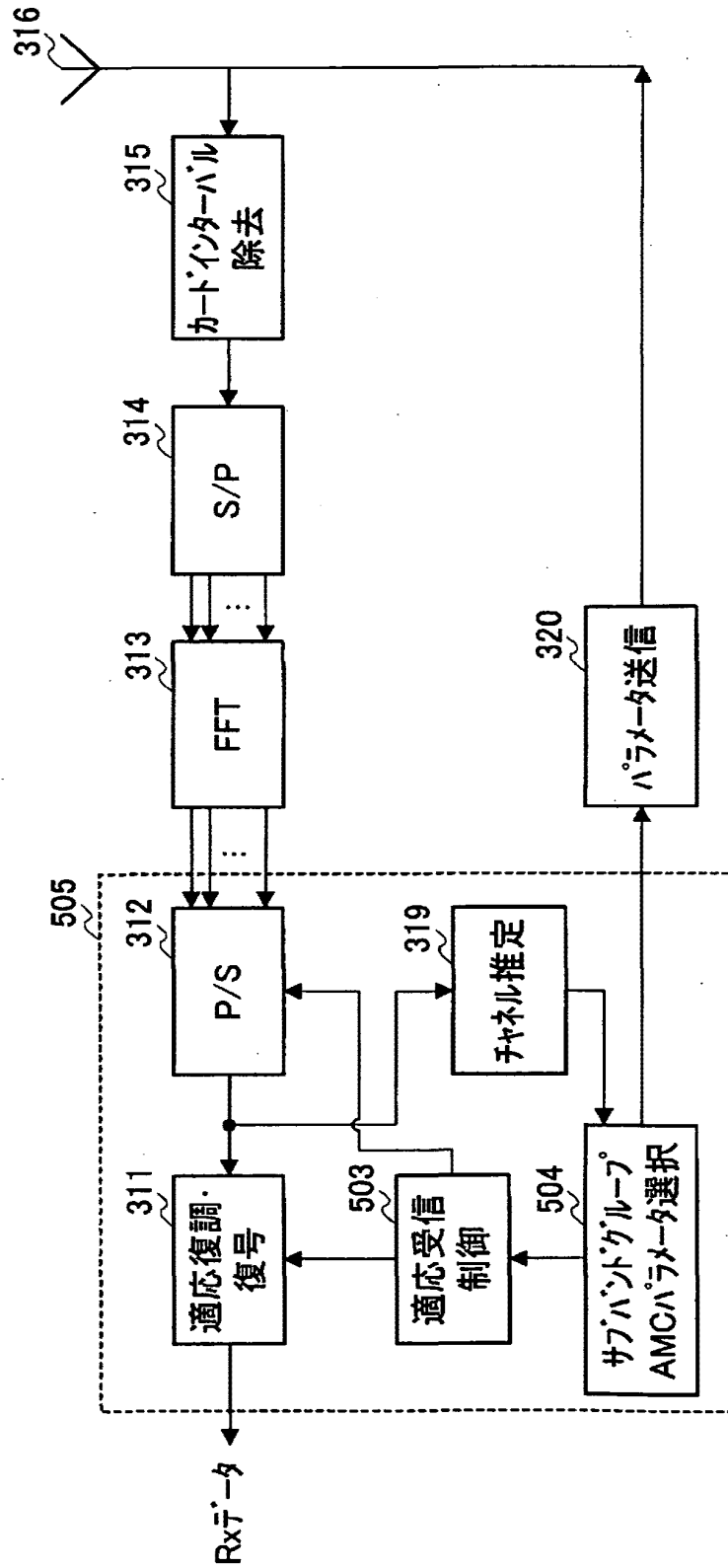

[図6A]

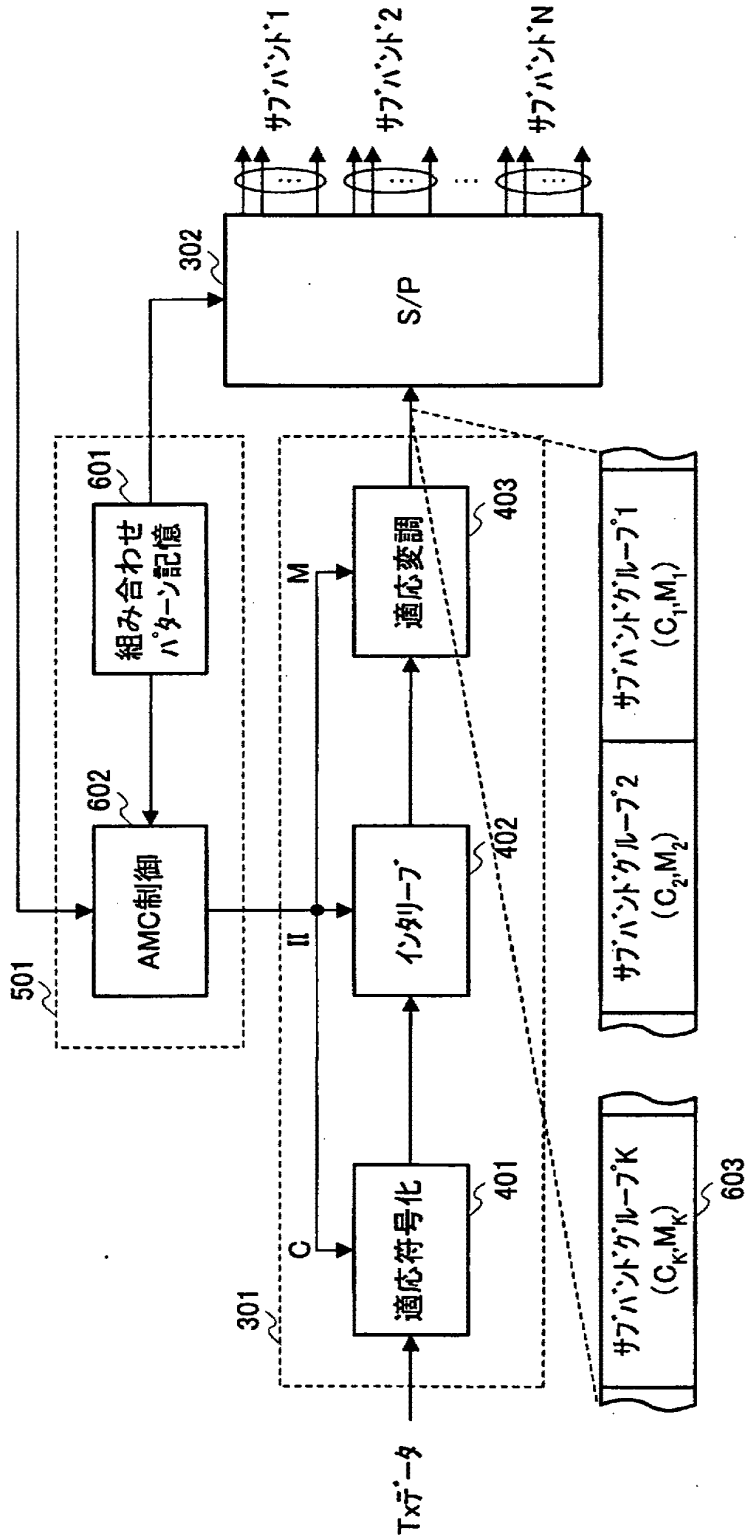

[図6B]

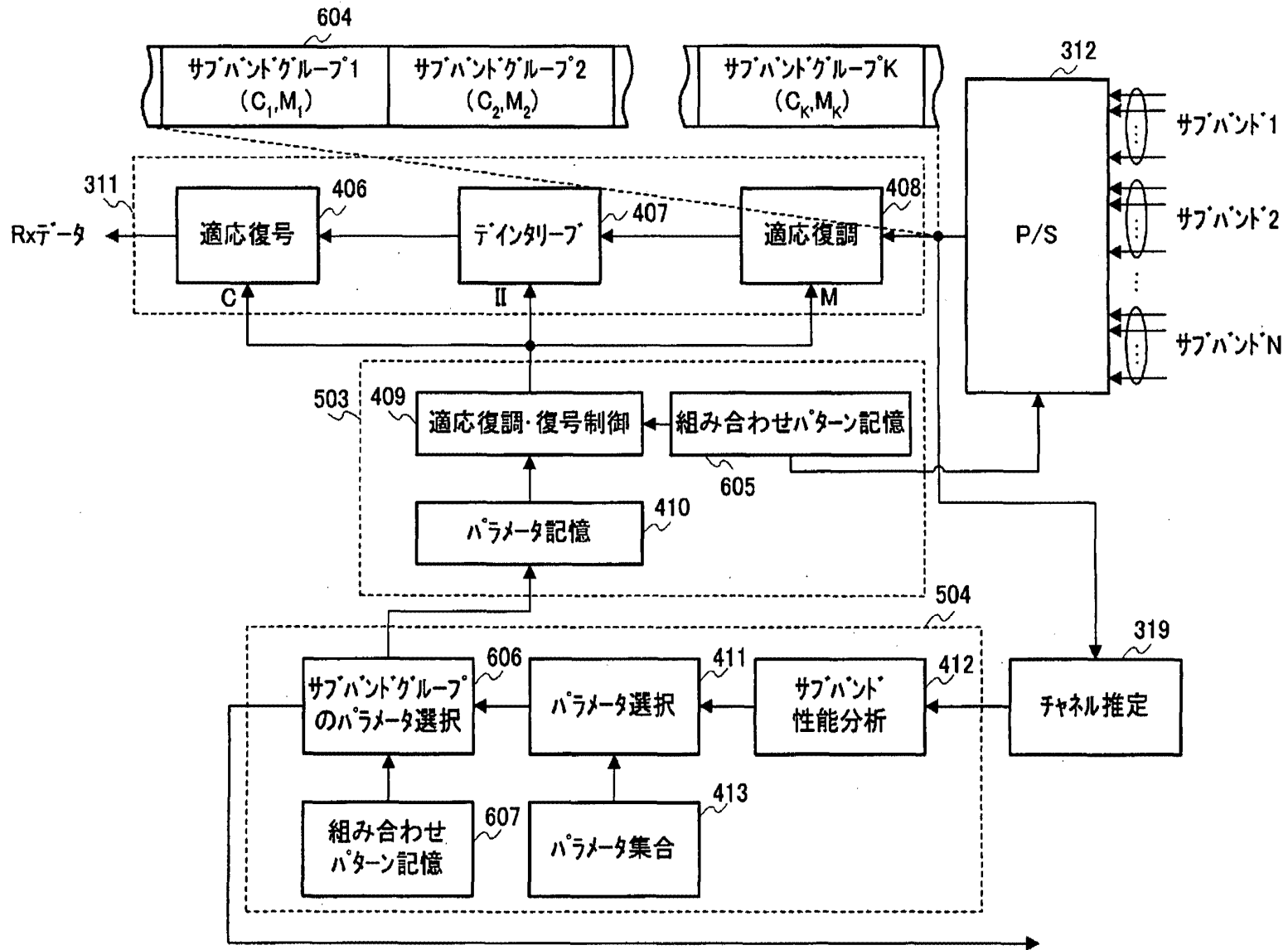

[図7]

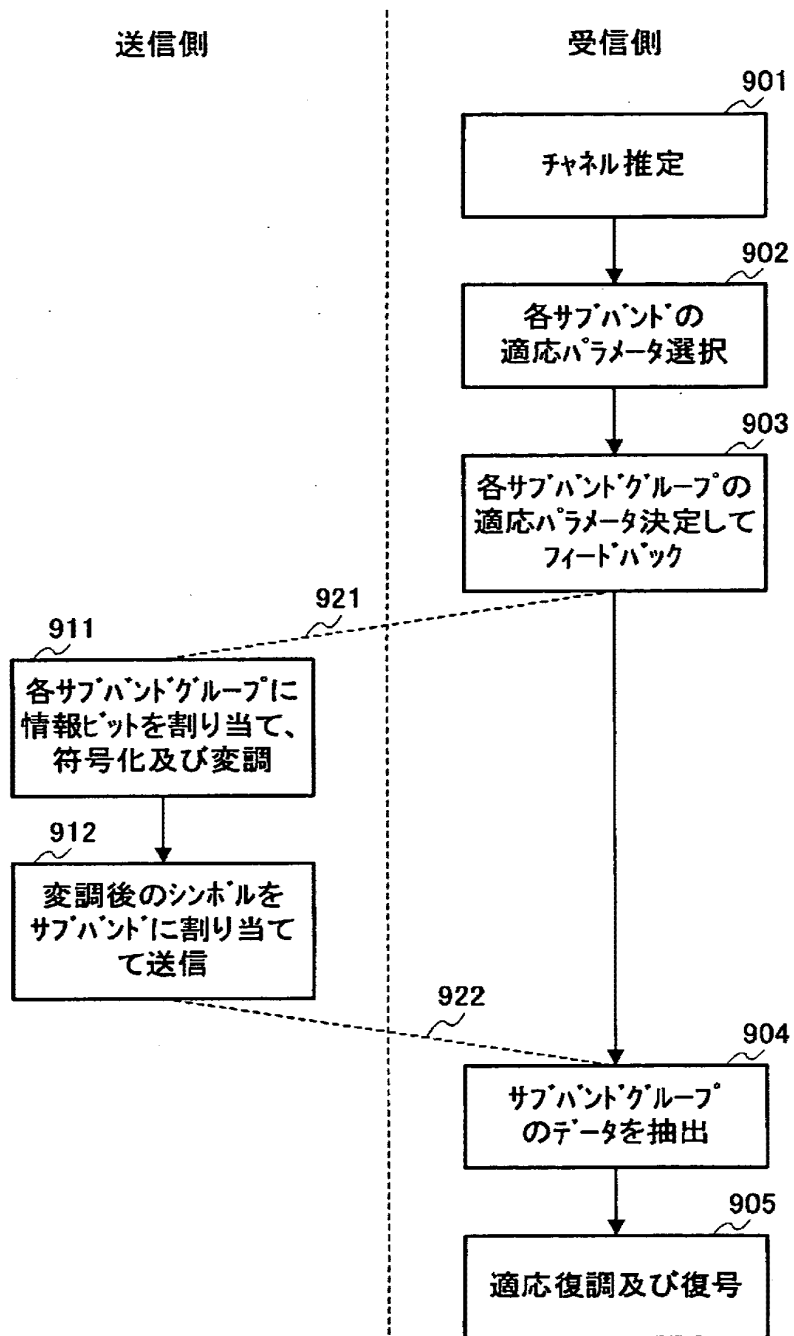

[図8]

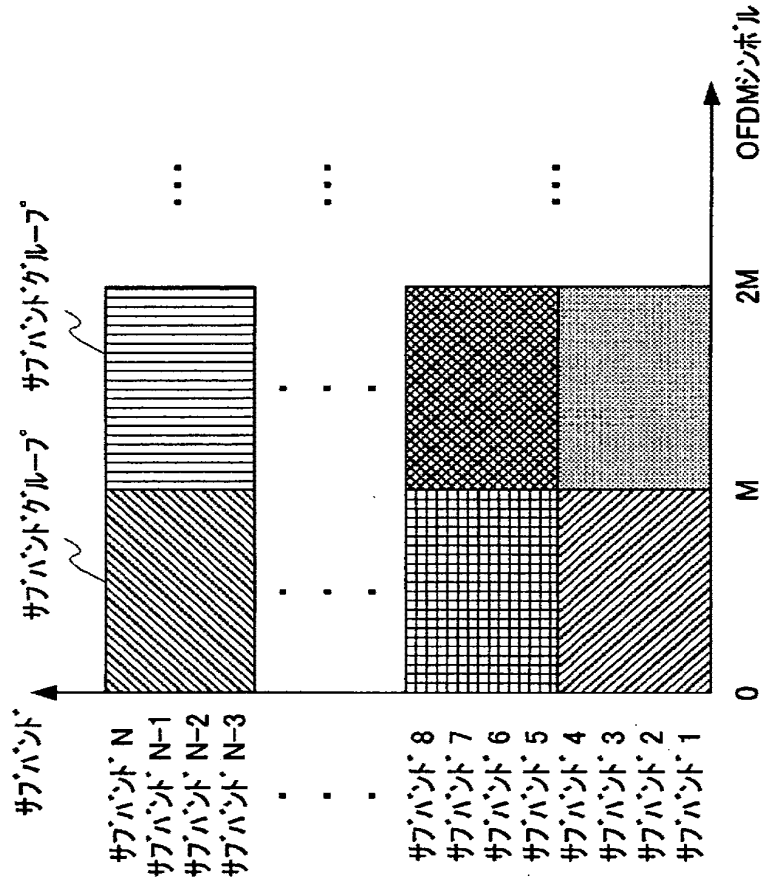

[図9]

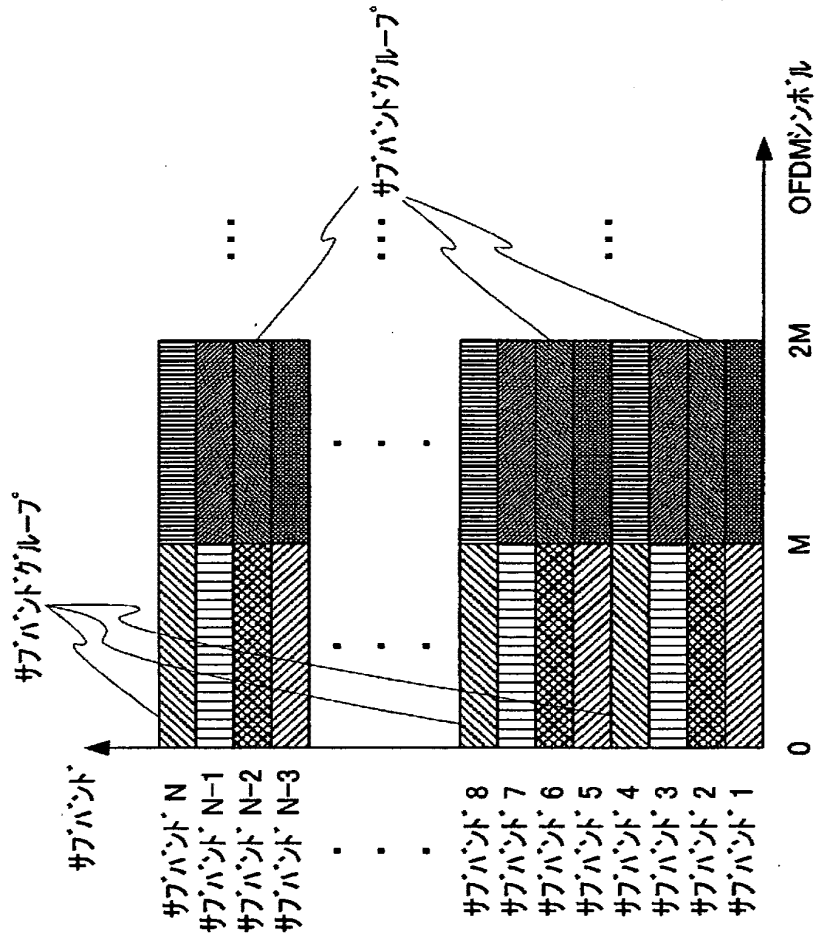

[図10]

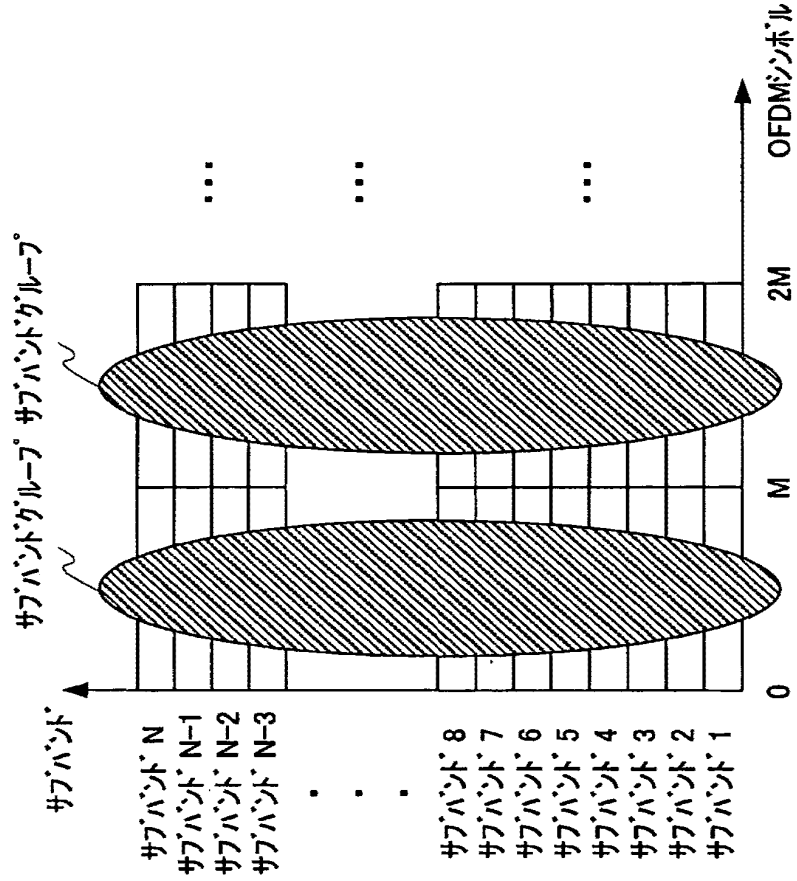

[図11]

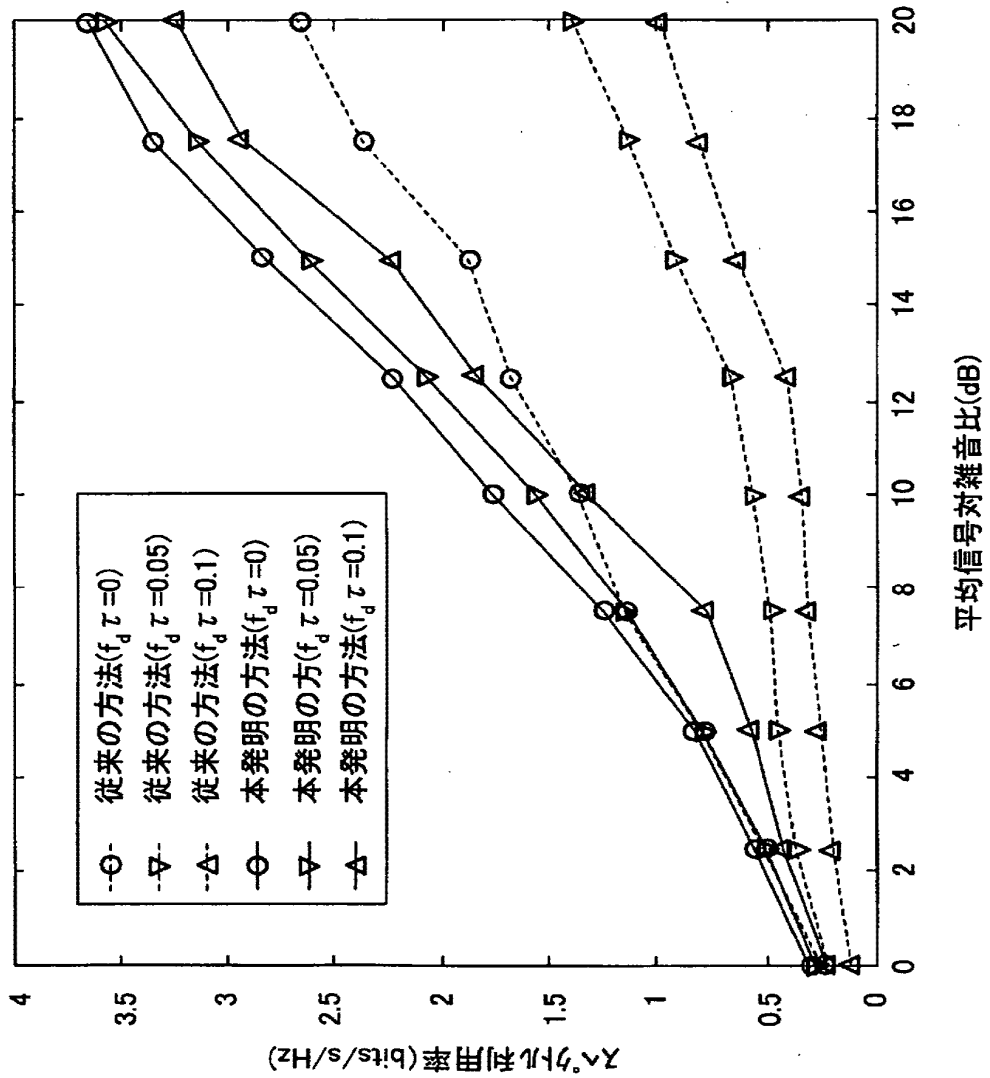

[図12]

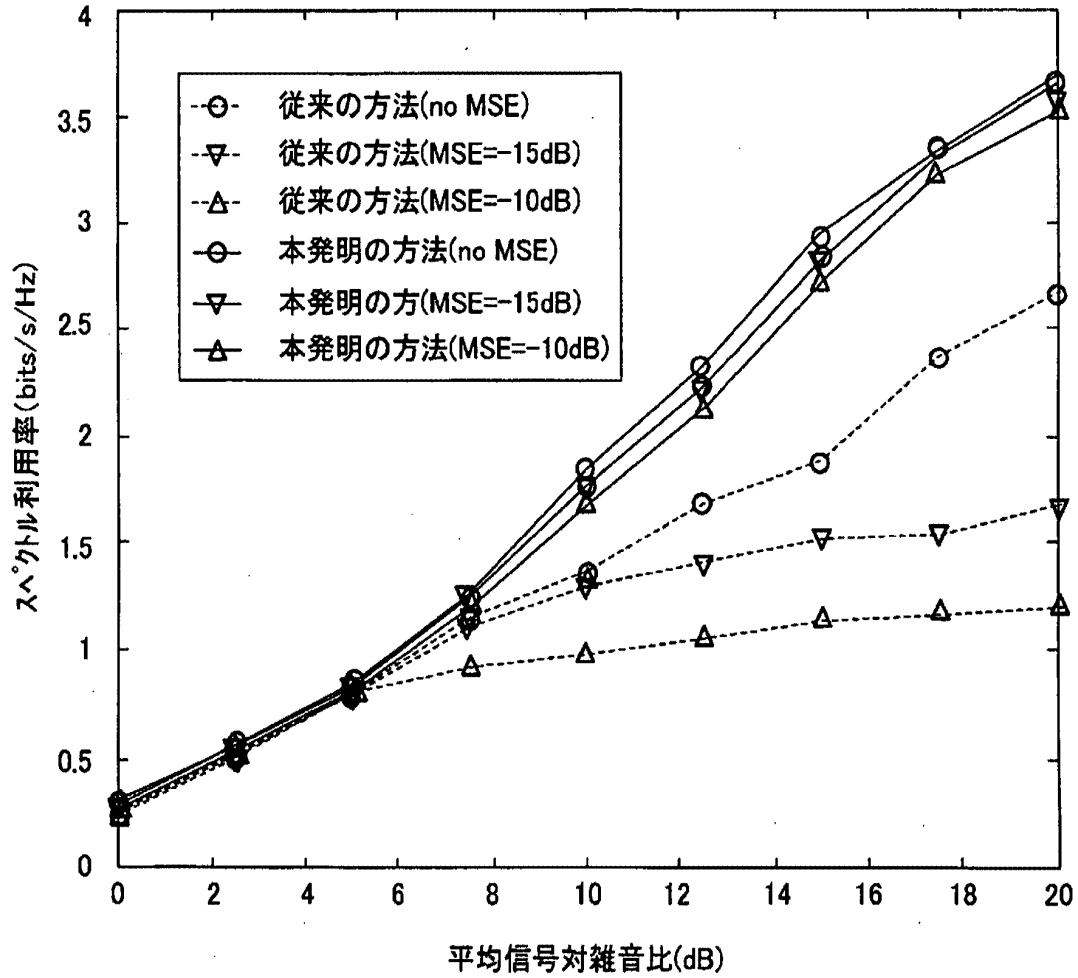

INTERNATIONAL SEARCH REPORT

International application No.

PCT/JP2005/021246

A. CLASSIFICATION OF SUBJECT MATTER

H04J11/00 (2006.01)

According to International Patent Classification (IPC) or to both national classification and IPC

B. FIELDS SEARCHED

Minimum documentation searched (classification system followed by classification symbols)

H04J11/00

Documentation searched other than minimum documentation to the extent that such documents are included in the fields searched

Jitsuyo Shinan Koho 1922-1996 Jitsuyo Shinan Toroku Koho 1996-2006
 Kokai Jitsuyo Shinan Koho 1971-2006 Toroku Jitsuyo Shinan Koho 1994-2006

Electronic data base consulted during the international search (name of data base and, where practicable, search terms used)

C. DOCUMENTS CONSIDERED TO BE RELEVANT

Category*	Citation of document, with indication, where appropriate, of the relevant passages	Relevant to claim No.
A	WO 2004/040827 A2 (QUALCOMM INCORPORATED), 13 March, 2004 (13.03.04), Fig. 4 & US 2004/0081123 A1 & AU 2003287286 A1 & US 6928062 B2 & EP 1563696 A2 & BR 200315788 A	1-12
A	WO 2004/040813 A1 (QUALCOMM INCORPORATED), 13 March, 2004 (13.03.04), Fig. 5 & AU 2003287285 A1 & US 2004/0203442 A1 & EP 1563622 A1 & BR 200315773 A	1-12

Further documents are listed in the continuation of Box C. See patent family annex.

* Special categories of cited documents:	"T" later document published after the international filing date or priority date and not in conflict with the application but cited to understand the principle or theory underlying the invention
"A" document defining the general state of the art which is not considered to be of particular relevance	"X" document of particular relevance; the claimed invention cannot be considered novel or cannot be considered to involve an inventive step when the document is taken alone
"E" earlier application or patent but published on or after the international filing date	"Y" document of particular relevance; the claimed invention cannot be considered to involve an inventive step when the document is combined with one or more other such documents, such combination being obvious to a person skilled in the art
"L" document which may throw doubts on priority claim(s) or which is cited to establish the publication date of another citation or other special reason (as specified)	"&" document member of the same patent family
"O" document referring to an oral disclosure, use, exhibition or other means	
"P" document published prior to the international filing date but later than the priority date claimed	

Date of the actual completion of the international search 06 February, 2006 (06.02.06)	Date of mailing of the international search report 14 February, 2006 (14.02.06)
-------------------------------------------------------------------------------------------	------------------------------------------------------------------------------------

Name and mailing address of the ISA/ Japanese Patent Office	Authorized officer
Facsimile No.	Telephone No.

INTERNATIONAL SEARCH REPORT

International application No.

PCT/JP2005/021246

C (Continuation). DOCUMENTS CONSIDERED TO BE RELEVANT

Category*	Citation of document, with indication, where appropriate, of the relevant passages	Relevant to claim No.
A	JP 2004-104293 A (Mitsubishi Electric Corp.), 02 April, 2004 (02.04.04), Full text; all drawings (Family: none)	1-12
A	JP 2003-169036 A (Nippon Terekomu Kabushiki Kaisha), 13 June, 2003 (13.06.03), Full text; all drawings (Family: none)	1-12
A	Sharath B. Reddy, Trvfik Yucek, Husein Arslan, "An Efficient Blind Modulation Detection Algorithm for Adaptive OFDM Systems", Vehicular Technology Conference, 2003. VTC 2003-Fall. 2003 IEEE 58th, 09 August, 2003 (09.08.03), pages 1895-1899	1-12
A	Yuanrun Teng, Tomotaka Nagaosa, Kazuo Mori, Hideo Kobayashi, "Grouping Adaptive Modulation Method for Burst Mode OFDM Transmission System", TECHNICAL REPORT OF IEICE., 31 August, 2003 (31.08.03), Vol.101, No.280, pages 51-57	1-12
A	JP 2001-238269 A (KDDI Corp.), 31 August, 2001 (31.08.01), Par. Nos. [0014], [0017], [0018], [0035] to [0044] & US 2001/0024427 A1 & US 6836484 B2	1-12

IPR2018-1555

A. 発明の属する分野の分類 (国際特許分類 (IPC)) Int.Cl. H04J11/00(2006.01)										
B. 調査を行った分野 調査を行った最小限資料 (国際特許分類 (IPC)) Int.Cl. H04J11/00										
最小限資料以外の資料で調査を行った分野に含まれるもの <table border="0"> <tr> <td>日本国実用新案公報</td> <td>1922-1996年</td> </tr> <tr> <td>日本国公開実用新案公報</td> <td>1971-2006年</td> </tr> <tr> <td>日本国実用新案登録公報</td> <td>1996-2006年</td> </tr> <tr> <td>日本国登録実用新案公報</td> <td>1994-2006年</td> </tr> </table>			日本国実用新案公報	1922-1996年	日本国公開実用新案公報	1971-2006年	日本国実用新案登録公報	1996-2006年	日本国登録実用新案公報	1994-2006年
日本国実用新案公報	1922-1996年									
日本国公開実用新案公報	1971-2006年									
日本国実用新案登録公報	1996-2006年									
日本国登録実用新案公報	1994-2006年									
国際調査で使用した電子データベース (データベースの名称、調査に使用した用語)										
C. 関連すると認められる文献										
引用文献の カテゴリー*	引用文献名 及び一部の箇所が関連するときは、その関連する箇所の表示	関連する 請求の範囲の番号								
A	WO 2004/040827 A2 (QUALCOMM INCORPORATED) 2004.03.13, Fig. 4 & US 2004/0081123 A1 & AU 2003287286 A1 & US 6928062 B2 & EP 1563696 A2 & BR 200315788 A	1-12								
A	WO 2004/040813 A1 (QUALCOMM INCORPORATED) 2004.03.13, Fig. 5 & AU 2003287285 A1 & US 2004/0203442 A1 & EP 1563622 A1 & BR 200315773 A	1-12								
<input checked="" type="checkbox"/> C欄の続きにも文献が列挙されている。 <input type="checkbox"/> パテントファミリーに関する別紙を参照。										
* 引用文献のカテゴリー 「A」 特に関連のある文献ではなく、一般的技術水準を示すもの 「E」 国際出願日前の出願または特許であるが、国際出願日以後に公表されたもの 「L」 優先権主張に疑義を提起する文献又は他の文献の発行日若しくは他の特別な理由を確立するために引用する文献 (理由を付す) 「O」 口頭による開示、使用、展示等に言及する文献 「P」 国際出願日前で、かつ優先権の主張の基礎となる出願日の後に公表された文献 「T」 国際出願日又は優先日後に公表された文献であって出願と矛盾するものではなく、発明の原理又は理論の理解のために引用するもの 「X」 特に関連のある文献であって、当該文献のみで発明の新規性又は進歩性がないと考えられるもの 「Y」 特に関連のある文献であって、当該文献と他の1以上の文献との、当業者にとって自明である組合せによって進歩性がないと考えられるもの 「&」 同一パテントファミリー文献										
国際調査を完了した日 06.02.2006	国際調査報告の発送日 14.02.2006									
国際調査機関の名称及びあて先 日本国特許庁 (ISA/JP) 郵便番号100-8915 東京都千代田区霞が関三丁目4番3号	特許庁審査官 (権限のある職員) 高野 洋 電話番号 03-3581-1101 内線 3556	5K 9647								

C (続き) . 関連すると認められる文献		
引用文献の カテゴリー*	引用文献名 及び一部の箇所が関連するときは、その関連する箇所の表示	関連する 請求の範囲の番号
A	JP 2004-104293 A (三菱電機株式会社) 2004.04.02, 全文, 全図 (ファミリーなし)	1-12
A	JP 2003-169036 A (日本テレコム株式会社) 2003.06.13, 全文, 全図 (ファミリーなし)	1-12
A	Sharath B. Reddy, Trvfik Yucek, Husein Arslan, "An Efficient Blind Modulation Detection Algorithm for Adaptive OFDM Systems", Vehicular Technology Conference, 2003. VTC 2003-Fall. 2003 IEEE 58th, 2003.08.09, p.1895-1899	1-12
A	Yuanrun Teng, Tomotaka Nagaosa, Kazuo Mori, Hideo Kobayashi, "Grouping Adaptive Modulation Method for Burst Mode OFDM Transmission System", TECHNICAL REPORT OF IEICE., 2003.08.31, Vol.101, No.280, p.51-57	1-12
A	JP 2001-238269 A (ケイディーディーアイ株式会社) 2001.08.31, 第00014段落, 第0017段落, 第0018段落, 第0035段落-第0044段落 & US 2001/0024427 A1 & US 6836484 B2	1-12

PATENT COOPERATION TREATY

PCT

INTERNATIONAL PRELIMINARY REPORT ON PATENTABILITY
(Chapter I of the Patent Cooperation Treaty)

(PCT Rule 44bis)

Applicant's or agent's file reference P035889P0	FOR FURTHER ACTION		See item 4 below
International application No. PCT/JP2005/021246	International filing date (<i>day/month/year</i>) 18 November 2005 (18.11.2005)	Priority date (<i>day/month/year</i>) 19 November 2004 (19.11.2004)	
International Patent Classification (8th edition unless older edition indicated) See relevant information in Form PCT/ISA/237			
Applicant MATSUSHITA ELECTRIC INDUSTRIAL CO., LTD.			

1. This international preliminary report on patentability (Chapter I) is issued by the International Bureau on behalf of the International Searching Authority under Rule 44 bis.1(a).

2. This REPORT consists of a total of 4 sheets, including this cover sheet.

In the attached sheets, any reference to the written opinion of the International Searching Authority should be read as a reference to the international preliminary report on patentability (Chapter I) instead.

3. This report contains indications relating to the following items:

<input checked="" type="checkbox"/>	Box No. I	Basis of the report
<input type="checkbox"/>	Box No. II	Priority
<input type="checkbox"/>	Box No. III	Non-establishment of opinion with regard to novelty, inventive step and industrial applicability
<input type="checkbox"/>	Box No. IV	Lack of unity of invention
<input checked="" type="checkbox"/>	Box No. V	Reasoned statement under Article 35(2) with regard to novelty, inventive step or industrial applicability; citations and explanations supporting such statement
<input type="checkbox"/>	Box No. VI	Certain documents cited
<input type="checkbox"/>	Box No. VII	Certain defects in the international application
<input type="checkbox"/>	Box No. VIII	Certain observations on the international application

4. The International Bureau will communicate this report to designated Offices in accordance with Rules 44bis.3(c) and 93bis.1 but not, except where the applicant makes an express request under Article 23(2), before the expiration of 30 months from the priority date (Rule 44bis .2).

The International Bureau of WIPO 34, chemin des Colombettes 1211 Geneva 20, Switzerland Facsimile No. +41 22 338 82 70	Date of issuance of this report 22 May 2007 (22.05.2007)
	Authorized officer <p align="center">Yoshiko Kuwahara</p> e-mail: pt07.pct@wipo.int

Form PCT/IB/373 (January 2004)

PATENT COOPERATION TREATY

TRANSLATION

From the
INTERNATIONAL SEARCHING AUTHORITY

PCT

WRITTEN OPINION OF THE
INTERNATIONAL SEARCHING AUTHORITY

(PCT Rule 43bis.1)

To:

Date of mailing
(day/month/year)

Applicant's or agent's file reference
P035889P0

FOR FURTHER ACTION
See paragraph 2 below

International application No.
PCT/JP2005/021246

International filing date (day/month/year)
18.11.2005

Priority date (day/month/year)
19.11.2004

International Patent Classification (IPC) or both national classification and IPC

Applicant
MATSUSHITA ELECTRIC INDUSTRIAL CO., LTD.

1. This opinion contains indications relating to the following items:

- Box No. I Basis of the opinion
- Box No. II Priority
- Box No. III Non-establishment of opinion with regard to novelty, inventive step and industrial applicability
- Box No. IV Lack of unity of invention
- Box No. V Reasoned statement under Rule 43bis.1(a)(i) with regard to novelty, inventive step or industrial applicability; citations and explanations supporting such statement
- Box No. VI Certain documents cited
- Box No. VII Certain defects in the international application
- Box No. VIII Certain observations on the international application

2. **FURTHER ACTION**

If a demand for international preliminary examination is made, this opinion will be considered to be a written opinion of the International Preliminary Examining Authority ("IPEA") except that this does not apply where the applicant chooses an Authority other than this one to be the IPEA and the chosen IPEA has notified the International Bureau under Rule 66.1bis(b) that written opinions of this International Searching Authority will not be so considered.

If this opinion is, as provided above, considered to be a written opinion of the IPEA, the applicant is invited to submit to the IPEA a written reply together, where appropriate, with amendments, before the expiration of 3 months from the date of mailing of Form PCT/ISA/220 or before the expiration of 22 months from the priority date, whichever expires later.

For further options, see Form PCT/ISA/220.

3. For further details, see notes to Form PCT/ISA/220.

Name and mailing address of the ISA/JP	Date of completion of this opinion	Authorized officer
Facsimile No.		Telephone No.

WRITTEN OPINION OF THE
INTERNATIONAL SEARCHING AUTHORITY

International application No.

PCT/JP2005/021246

Box No. I Basis of this opinion

1. With regard to the language, this opinion has been established on the basis of:
 - the international application in the language in which it was filed
 - the translation of the international application into _____, which is the language of a translation furnished for the purposes of international search (Rule 12.3(a) and 23.1(b)).

2. With regard to any nucleotide and/or amino acid sequence disclosed in the international application and necessary to the claimed invention, this opinion has been established on the basis of:
 - a. type of material
 - a sequence listing
 - table(s) related to the sequence listing
 - b. format of material
 - on paper
 - in electronic form
 - c. time of filing/furnishing
 - contained in the international application as filed
 - filed together with the international application in electronic form
 - furnished subsequently to this Authority for the purposes of search

3. In addition, in the case that more than one version or copy of a sequence listing and/or table(s) relating thereto has been filed or furnished, the required statements that the information in the subsequent or additional copies is identical to that in the application as filed or does not go beyond the application as filed, as appropriate, were furnished.

4. Additional comments:

WRITTEN OPINION OF THE
INTERNATIONAL SEARCHING AUTHORITY

International application No.

PCT/JP2005/021246

Box No. V	Reasoned statement under Rule 43bis.1(a)(i) with regard to novelty, inventive step or industrial applicability; citations and explanations supporting such statement		
1. Statement			
Novelty (N)	Claims	1-12	YES
	Claims		NO
Inventive step (IS)	Claims	1-12	YES
	Claims		NO
Industrial applicability (IA)	Claims	1-12	YES
	Claims		NO
2. Citations and explanations:			
	Document 1: WO 2004/040827 A2 (QUALCOMM INCORPORATED), 13 March 2004		
	Document 2: WO 2004/040813 A1 (QUALCOMM INCORPORATED), 13 March 2004		
	Document 3: JP 2004-104293 A (Mitsubishi Electric Corp.), 02 April 2004		
	Document 4: JP 203-169036 A (Nippon Terekomu Kabushiki Kaisha), 13 June 2003		
	Document 5: Sharath B. Reddy, Trvfik Yucek, Husein Arslan, "An Efficient Blind Modulation Detection Algorithm for Adaptive OFDM Systems", Vehicular Technology Conference, 2003. VTC 2003-Fall. 2003 IEEE 58 th , 09 August 2003, pages 1895 to 1899		
	Document 6: Yuanrun Teng, Tomotaka Nagaosa, Kazuo Mori, Hideo Kobayashi, "Grouping Adaptive Modulation Method for Burst Mode OFDM Transmission System", TECHNICAL REPORT OF IEICE., 31 August 2003, Vol. 101, No. 280, pages 51 to 57		
	Document 7: JP 2001-238269 A (KDDI Corp.), 31 August 2001		
	The inventions of claims 1 to 12 are neither described in any of the documents cited in the ISR nor obvious to a party skilled in the art.		

PATENT COOPERATION TREATY

PCT

INTERNATIONAL PRELIMINARY REPORT ON PATENTABILITY
(Chapter I of the Patent Cooperation Treaty)

(PCT Rule 44bis)

Applicant's or agent's file reference P035889P0	FOR FURTHER ACTION		See item 4 below
International application No. PCT/JP2005/021246	International filing date (<i>day/month/year</i>) 18 November 2005 (18.11.2005)	Priority date (<i>day/month/year</i>) 19 November 2004 (19.11.2004)	
International Patent Classification (8th edition unless older edition indicated) See relevant information in Form PCT/ISA/237			
Applicant MATSUSHITA ELECTRIC INDUSTRIAL CO., LTD.			

1. This international preliminary report on patentability (Chapter I) is issued by the International Bureau on behalf of the International Searching Authority under Rule 44 bis.1(a).

2. This REPORT consists of a total of 4 sheets, including this cover sheet.

In the attached sheets, any reference to the written opinion of the International Searching Authority should be read as a reference to the international preliminary report on patentability (Chapter I) instead.

3. This report contains indications relating to the following items:

<input checked="" type="checkbox"/>	Box No. I	Basis of the report
<input type="checkbox"/>	Box No. II	Priority
<input type="checkbox"/>	Box No. III	Non-establishment of opinion with regard to novelty, inventive step and industrial applicability
<input type="checkbox"/>	Box No. IV	Lack of unity of invention
<input checked="" type="checkbox"/>	Box No. V	Reasoned statement under Article 35(2) with regard to novelty, inventive step or industrial applicability; citations and explanations supporting such statement
<input type="checkbox"/>	Box No. VI	Certain documents cited
<input type="checkbox"/>	Box No. VII	Certain defects in the international application
<input type="checkbox"/>	Box No. VIII	Certain observations on the international application

4. The International Bureau will communicate this report to designated Offices in accordance with Rules 44bis.3(c) and 93bis.1 but not, except where the applicant makes an express request under Article 23(2), before the expiration of 30 months from the priority date (Rule 44bis .2).

The International Bureau of WIPO 34, chemin des Colombettes 1211 Geneva 20, Switzerland Facsimile No. +41 22 338 82 70	Date of issuance of this report 22 May 2007 (22.05.2007)
	Authorized officer <p align="center">Yoshiko Kuwahara</p> e-mail: pt07.pct@wipo.int

Form PCT/IB/373 (January 2004)

特許協力条約

発信人 日本国特許庁 (国際調査機関)

REC'D 17 FEB 2006

WIPO PCT

代理人 鷗田 公一 様 あて名 〒206-0034 日本国東京都多摩市鶴牧1丁目24-1 新都市センタービル5階

PCT
 国際調査機関の見解書
 (法施行規則第40条の2)
 [PCT規則43の2.1]

発送日 (日.月.年) 14. 02. 2006

出願人又は代理人の書類記号 P035889P0	今後の手続きについては、下記2を参照すること。	
国際出願番号 PCT/JP2005/021246	国際出願日 (日.月.年) 18. 11. 2005	優先日 (日.月.年) 19. 11. 2004
国際特許分類 (IPC) Int.Cl. H04J11/00(2006.01)		
出願人 (氏名又は名称) 松下電器産業株式会社		

1. この見解書は次の内容を含む。

- 第I欄 見解の基礎
- 第II欄 優先権
- 第III欄 新規性、進歩性又は産業上の利用可能性についての見解の不作成
- 第IV欄 発明の単一性の欠如
- 第V欄 PCT規則43の2.1(a)(i)に規定する新規性、進歩性又は産業上の利用可能性についての見解、それを裏付けるための文献及び説明
- 第VI欄 ある種の引用文献
- 第VII欄 国際出願の不備
- 第VIII欄 国際出願に対する意見

2. 今後の手続き

国際予備審査の請求がされた場合は、出願人がこの国際調査機関とは異なる国際予備審査機関を選択し、かつ、その国際予備審査機関がPCT規則66.1の2(b)の規定に基づいて国際調査機関の見解書を国際予備審査機関の見解書とみなさない旨を国際事務局に通知していた場合を除いて、この見解書は国際予備審査機関の最初の見解書とみなされる。

この見解書が上記のように国際予備審査機関の見解書とみなされる場合、様式PCT/ISA/220を送付した日から3月又は優先日から22月のうちいずれか遅く満了する期限が経過するまでに、出願人は国際予備審査機関に、適当な場合は補正書とともに、答弁書を提出することができる。

さらなる選択肢は、様式PCT/ISA/220を参照すること。

3. さらなる詳細は、様式PCT/ISA/220の備考を参照すること。

見解書を作成した日 06. 02. 2006		
名称及びあて先 日本国特許庁 (ISA/JP) 郵便番号100-8915 東京都千代田区鍛が関三丁目4番3号	特許庁審査官 (権限のある職員) 高野 洋 電話番号 03-3581-1101 内線 3556	5K 9647

様式PCT/ISA/237 (表紙) (2005年4月)

第I欄 見解の基礎

1. 言語に関し、この見解書は以下のものに基づき作成した。

- 出願時の言語による国際出願
 出願時の言語から国際調査のための言語である _____ 語に翻訳された、この国際出願の翻訳文
(PCT規則12.3(a)及び23.1(b))

2. この国際出願で開示されかつ請求の範囲に係る発明に不可欠なヌクレオチド又はアミノ酸配列に関して、以下に基づき見解書を作成した。

- a. タイプ 配列表
 配列表に関連するテーブル
- b. フォーマット 紙形式
 電子形式
- c. 提出時期 出願時の国際出願に含まれていたもの
 この国際出願と共に電子形式により提出されたもの
 出願後に、調査のために、この国際調査機関に提出されたもの

3. さらに、配列表又は配列表に関連するテーブルを提出した場合に、出願後に提出した配列若しくは追加して提出した配列が出願時に提出した配列と同一である旨、又は、出願時の開示を超える事項を含まない旨の陳述書の提出があった。

4. 補足意見:

第V欄 新規性、進歩性又は産業上の利用可能性についてのPCT規則43の2.1(a)(i)に定める見解、それを裏付ける文献及び説明

1. 見解

新規性 (N)	請求の範囲	1 - 1 2	有
	請求の範囲		無
進歩性 (IS)	請求の範囲	1 - 1 2	有
	請求の範囲		無
産業上の利用可能性 (IA)	請求の範囲	1 - 1 2	有
	請求の範囲		無

2. 文献及び説明

文献 1 : WO 2004/040827 A2 (QUALCOMM INCORPORATED) 2004. 03. 13

文献 2 : WO 2004/040813 A1 (QUALCOMM INCORPORATED) 2004. 03. 13

文献 3 : JP 2004-104293 A (三菱電機株式会社) 2004. 04. 02

文献 4 : JP 2003-169036 A (日本テレコム株式会社) 2003. 06. 13

文献 5 : Sharath B. Reddy, Trvfik Yucek, Husein Arslan, "An Efficient Blind Modulation Detection Algorithm for Adaptive OFDM Systems", Vehicular Technology Conference, 2003. VTC 2003-Fall. 2003 IEEE 58th, 2003. 08. 09, p. 1895-1899

文献 6 : Yuanrun Teng, Tomotaka Nagaosa, Kazuo Mori, Hideo Kobayashi, "Grouping Adaptive Modulation Method for Burst Mode OFDM Transmission System", TECHNICAL REPORT OF IEICE., 2003. 08. 31, Vol. 101, No. 280, p. 51-57

文献 7 : JP 2001-238269 A (ケイディーディーアイ株式会社) 2001. 08. 31

請求の範囲 1 - 1 2に係る発明は、国際調査報告に引用されたいずれの文献にも記載されておらず、当業者にとって自明なものでもない。

特許協力条約

発信人 日本国特許庁 (国際調査機関)

REC'D 17 FEB 2006

WIPO PCT

代理人 鷺田 公一 様
あて名 〒206-0034 日本国東京都多摩市鶴牧1丁目24-1 新都市センタービル5階

PCT
 国際調査機関の見解書
 (法施行規則第40条の2)
 [PCT規則43の2.1]

発送日 (日.月.年)	14. 02. 2006
今後の手続きについては、下記2を参照すること。	

出願人又は代理人 の書類記号	P035889P0
-------------------	-----------

国際出願番号 PCT/J P 2005/021246	国際出願日 (日.月.年) 18. 11. 2005	優先日 (日.月.年) 19. 11. 2004
-------------------------------	-------------------------------	-----------------------------

国際特許分類 (IPC) Int.Cl. <i>H04J11/00(2006.01)</i>

出願人 (氏名又は名称) 松下電器産業株式会社

<p>1. この見解書は次の内容を含む。</p> <ul style="list-style-type: none"> <input checked="" type="checkbox"/> 第I欄 見解の基礎 <input type="checkbox"/> 第II欄 優先権 <input type="checkbox"/> 第III欄 新規性、進歩性又は産業上の利用可能性についての見解の不作成 <input type="checkbox"/> 第IV欄 発明の単一性の欠如 <input checked="" type="checkbox"/> 第V欄 PCT規則43の2.1(a)(i)に規定する新規性、進歩性又は産業上の利用可能性についての見解、それを裏付けるための文献及び説明 <input type="checkbox"/> 第VI欄 ある種の引用文献 <input type="checkbox"/> 第VII欄 国際出願の不備 <input type="checkbox"/> 第VIII欄 国際出願に対する意見 <p>2. 今後の手続き</p> <p>国際予備審査の請求がされた場合は、出願人がこの国際調査機関とは異なる国際予備審査機関を選択し、かつ、その国際予備審査機関がPCT規則66.1の2(b)の規定に基づいて国際調査機関の見解書を国際予備審査機関の見解書とみなさない旨を国際事務局に通知していた場合を除いて、この見解書は国際予備審査機関の最初の見解書とみなされる。</p> <p>この見解書が上記のように国際予備審査機関の見解書とみなされる場合、様式PCT/ISA/220を送付した日から3月又は優先日から22月のうちいずれか遅く満了する期限が経過するまでに、出願人は国際予備審査機関に、適当な場合は補正書とともに、答弁書を提出することができる。</p> <p>さらなる選択肢は、様式PCT/ISA/220を参照すること。</p> <p>3. さらなる詳細は、様式PCT/ISA/220の備考を参照すること。</p>

見解書を作成した日 06. 02. 2006

名称及びあて先 日本国特許庁 (ISA/J P) 郵便番号100-8915 東京都千代田区霞が関三丁目4番3号	特許庁審査官 (権限のある職員) 高野 洋 電話番号 03-3581-1101 内線 3556	5K 9647
------------------------------------------------------------------	-------------------------------------------------------	---------

様式PCT/ISA/237 (表紙) (2005年4月)

第 I 欄 見解の基礎

1. 言語に関し、この見解書は以下のものに基づき作成した。

- 出願時の言語による国際出願
 出願時の言語から国際調査のための言語である _____ 語に翻訳された、この国際出願の翻訳文
(PCT規則12.3(a)及び23.1(b))

2. この国際出願で開示されかつ請求の範囲に係る発明に不可欠なヌクレオチド又はアミノ酸配列に関して、以下に基づき見解書を作成した。

- a. タイプ 配列表
 配列表に関連するテーブル
- b. フォーマット 紙形式
 電子形式
- c. 提出時期 出願時の国際出願に含まれていたもの
 この国際出願と共に電子形式により提出されたもの
 出願後に、調査のために、この国際調査機関に提出されたもの

3. さらに、配列表又は配列表に関連するテーブルを提出した場合に、出願後に提出した配列若しくは追加して提出した配列が出願時に提出した配列と同一である旨、又は、出願時の開示を超える事項を含まない旨の陳述書の提出があった。

4. 補足意見：

第V欄 新規性、進歩性又は産業上の利用可能性についてのPCT規則43の2.1(a)(i)に定める見解、それを裏付ける文献及び説明

1. 見解

新規性 (N)	請求の範囲	1-12	有
	請求の範囲		無
進歩性 (IS)	請求の範囲	1-12	有
	請求の範囲		無
産業上の利用可能性 (IA)	請求の範囲	1-12	有
	請求の範囲		無

2. 文献及び説明

文献1 : WO 2004/040827 A2 (QUALCOMM INCORPORATED) 2004.03.13

文献2 : WO 2004/040813 A1 (QUALCOMM INCORPORATED) 2004.03.13

文献3 : JP 2004-104293 A (三菱電機株式会社) 2004.04.02

文献4 : JP 2003-169036 A (日本テレコム株式会社) 2003.06.13

文献5 : Sharath B. Reddy, Trvfik Yucek, Husein Arslan, "An Efficient Blind Modulation Detection Algorithm for Adaptive OFDM Systems", Vehicular Technology Conference, 2003. VTC 2003-Fall. 2003 IEEE 58th, 2003.08.09, p.1895-1899

文献6 : Yuanrun Teng, Tomotaka Nagaosa, Kazuo Mori, Hideo Kobayashi, "Grouping Adaptive Modulation Method for Burst Mode OFDM Transmission System", TECHNICAL REPORT OF IEICE., 2003.08.31, Vol.101, No.280, p.51-57

文献7 : JP 2001-238269 A (ケイディーディーアイ株式会社) 2001.08.31

請求の範囲1-12に係る発明は、国際調査報告に引用されたいずれの文献にも記載されておらず、当業者にとって自明なものでもない。

特許協力条約

発信人 日本国特許庁 (国際調査機関)

REC'D 17 FEB 2006

WIPO PCT

代理人 鷺田 公一 様
あて名 〒206-0034 日本国東京都多摩市鶴牧1丁目24-1 新都市センタービル5階

PCT
 国際調査機関の見解書
 (法施行規則第40条の2)
 [PCT規則43の2.1]

発送日 (日.月.年) 14.02.2006

出願人又は代理人の書類記号 P035889P0	今後の手続きについては、下記2を参照すること。	
国際出願番号 PCT/JP2005/021246	国際出願日 (日.月.年) 18.11.2005	優先日 (日.月.年) 19.11.2004
国際特許分類 (IPC) Int.Cl. H04J11/00(2006.01)		
出願人 (氏名又は名称) 松下電器産業株式会社		

1. この見解書は次の内容を含む。

- 第I欄 見解の基礎
- 第II欄 優先権
- 第III欄 新規性、進歩性又は産業上の利用可能性についての見解の不作成
- 第IV欄 発明の単一性の欠如
- 第V欄 PCT規則43の2.1(a)(i)に規定する新規性、進歩性又は産業上の利用可能性についての見解、それを裏付けるための文献及び説明
- 第VI欄 ある種の引用文献
- 第VII欄 国際出願の不備
- 第VIII欄 国際出願に対する意見

2. 今後の手続き

国際予備審査の請求がされた場合は、出願人がこの国際調査機関とは異なる国際予備審査機関を選択し、かつ、その国際予備審査機関がPCT規則66.1の2(b)の規定に基づいて国際調査機関の見解書を国際予備審査機関の見解書とみなさない旨を国際事務局に通知していた場合を除いて、この見解書は国際予備審査機関の最初の見解書とみなされる。

この見解書が上記のように国際予備審査機関の見解書とみなされる場合、様式PCT/ISA/220を送付した日から3月又は優先日から22月のうちいずれか遅く満了する期限が経過するまでに、出願人は国際予備審査機関に、適当な場合は補正書とともに、答弁書を提出することができる。

さらなる選択肢は、様式PCT/ISA/220を参照すること。

3. さらなる詳細は、様式PCT/ISA/220の備考を参照すること。

見解書を作成した日 06.02.2006		
名称及びあて先 日本国特許庁 (ISA/JP) 郵便番号100-8915 東京都千代田区霞が関三丁目4番3号	特許庁審査官 (権限のある職員) 高野 洋 電話番号 03-3581-1101 内線 3556	5K 9647

様式PCT/ISA/237 (表紙) (2005年4月)

第 I 欄 見解の基礎

1. 言語に関し、この見解書は以下のものに基づき作成した。

- 出願時の言語による国際出願
 出願時の言語から国際調査のための言語である _____ 語に翻訳された、この国際出願の翻訳文
(PCT規則12.3(a)及び23.1(b))

2. この国際出願で開示されかつ請求の範囲に係る発明に不可欠なヌクレオチド又はアミノ酸配列に関して、以下に基づき見解書を作成した。

- a. タイプ 配列表
 配列表に関連するテーブル
- b. フォーマット 紙形式
 電子形式
- c. 提出時期 出願時の国際出願に含まれていたもの
 この国際出願と共に電子形式により提出されたもの
 出願後に、調査のために、この国際調査機関に提出されたもの

3. さらに、配列表又は配列表に関連するテーブルを提出した場合に、出願後に提出した配列若しくは追加して提出した配列が出願時に提出した配列と同一である旨、又は、出願時の開示を超える事項を含まない旨の陳述書の提出があった。

4. 補足意見：

第V欄 新規性、進歩性又は産業上の利用可能性についてのPCT規則43の2.1(a)(i)に定める見解、それを裏付ける文献及び説明

1. 見解

新規性 (N)	請求の範囲	1-12	有
	請求の範囲		無
進歩性 (IS)	請求の範囲	1-12	有
	請求の範囲		無
産業上の利用可能性 (IA)	請求の範囲	1-12	有
	請求の範囲		無

2. 文献及び説明

文献1 : WO 2004/040827 A2 (QUALCOMM INCORPORATED) 2004.03.13

文献2 : WO 2004/040813 A1 (QUALCOMM INCORPORATED) 2004.03.13

文献3 : JP 2004-104293 A (三菱電機株式会社) 2004.04.02

文献4 : JP 2003-169036 A (日本テレコム株式会社) 2003.06.13

文献5 : Sharath B. Reddy, Trvfik Yucek, Husein Arslan, "An Efficient Blind Modulation Detection Algorithm for Adaptive OFDM Systems", Vehicular Technology Conference, 2003. VTC 2003-Fall. 2003 IEEE 58th, 2003.08.09, p.1895-1899

文献6 : Yuanrun Teng, Tomotaka Nagaosa, Kazuo Mori, Hideo Kobayashi, "Grouping Adaptive Modulation Method for Burst Mode OFDM Transmission System", TECHNICAL REPORT OF IEICE., 2003.08.31, Vol.101, No.280, p.51-57

文献7 : JP 2001-238269 A (ケイディーディーアイ株式会社) 2001.08.31

請求の範囲1-12に係る発明は、国際調査報告に引用されたいずれの文献にも記載されておらず、当業者にとって自明なものでもない。

PATENT COOPERATION TREATY

TRANSLATION

From the
INTERNATIONAL SEARCHING AUTHORITY

PCT

WRITTEN OPINION OF THE
INTERNATIONAL SEARCHING AUTHORITY

(PCT Rule 43bis.1)

To:

Date of mailing
(day/month/year)

Applicant's or agent's file reference
P035889P0

FOR FURTHER ACTION
See paragraph 2 below

International application No.
PCT/JP2005/021246

International filing date (day/month/year)
18.11.2005

Priority date (day/month/year)
19.11.2004

International Patent Classification (IPC) or both national classification and IPC

Applicant
MATSUSHITA ELECTRIC INDUSTRIAL CO., LTD.

1. This opinion contains indications relating to the following items:

- Box No. I Basis of the opinion
- Box No. II Priority
- Box No. III Non-establishment of opinion with regard to novelty, inventive step and industrial applicability
- Box No. IV Lack of unity of invention
- Box No. V Reasoned statement under Rule 43bis.1(a)(i) with regard to novelty, inventive step or industrial applicability; citations and explanations supporting such statement
- Box No. VI Certain documents cited
- Box No. VII Certain defects in the international application
- Box No. VIII Certain observations on the international application

2. **FURTHER ACTION**

If a demand for international preliminary examination is made, this opinion will be considered to be a written opinion of the International Preliminary Examining Authority ("IPEA") except that this does not apply where the applicant chooses an Authority other than this one to be the IPEA and the chosen IPEA has notified the International Bureau under Rule 66.1bis(b) that written opinions of this International Searching Authority will not be so considered.

If this opinion is, as provided above, considered to be a written opinion of the IPEA, the applicant is invited to submit to the IPEA a written reply together, where appropriate, with amendments, before the expiration of 3 months from the date of mailing of Form PCT/ISA/220 or before the expiration of 22 months from the priority date, whichever expires later.

For further options, see Form PCT/ISA/220.

3. For further details, see notes to Form PCT/ISA/220.

Name and mailing address of the ISA/JP	Date of completion of this opinion	Authorized officer
Facsimile No.		Telephone No.

WRITTEN OPINION OF THE
INTERNATIONAL SEARCHING AUTHORITY

International application No.

PCT/JP2005/021246

Box No. I	Basis of this opinion
1.	<p>With regard to the language, this opinion has been established on the basis of:</p> <p><input checked="" type="checkbox"/> the international application in the language in which it was filed</p> <p><input type="checkbox"/> the translation of the international application into _____, which is the language of a translation furnished for the purposes of international search (Rule 12.3(a) and 23.1(b)).</p>
2.	<p>With regard to any nucleotide and/or amino acid sequence disclosed in the international application and necessary to the claimed invention, this opinion has been established on the basis of:</p> <p>a. type of material</p> <p><input type="checkbox"/> a sequence listing</p> <p><input type="checkbox"/> table(s) related to the sequence listing</p> <p>b. format of material</p> <p><input type="checkbox"/> on paper</p> <p><input type="checkbox"/> in electronic form</p> <p>c. time of filing/furnishing</p> <p><input type="checkbox"/> contained in the international application as filed</p> <p><input type="checkbox"/> filed together with the international application in electronic form</p> <p><input type="checkbox"/> furnished subsequently to this Authority for the purposes of search</p>
3.	<p><input type="checkbox"/> In addition, in the case that more than one version or copy of a sequence listing and/or table(s) relating thereto has been filed or furnished, the required statements that the information in the subsequent or additional copies is identical to that in the application as filed or does not go beyond the application as filed, as appropriate, were furnished.</p>
4.	<p>Additional comments:</p>

WRITTEN OPINION OF THE
INTERNATIONAL SEARCHING AUTHORITY

International application No.

PCT/JP2005/021246

Box No. V	Reasoned statement under Rule 43bis.1(a)(i) with regard to novelty, inventive step or industrial applicability; citations and explanations supporting such statement		
1. Statement			
Novelty (N)	Claims	<u>1-12</u>	YES
	Claims	_____	NO
Inventive step (IS)	Claims	<u>1-12</u>	YES
	Claims	_____	NO
Industrial applicability (IA)	Claims	<u>1-12</u>	YES
	Claims	_____	NO
2. Citations and explanations:			
Document 1: WO 2004/040827 A2 (QUALCOMM INCORPORATED), 13 March 2004			
Document 2: WO 2004/040813 A1 (QUALCOMM INCORPORATED), 13 March 2004			
Document 3: JP 2004-104293 A (Mitsubishi Electric Corp.), 02 April 2004			
Document 4: JP 203-169036 A (Nippon Terekomu Kabushiki Kaisha), 13 June 2003			
Document 5: Sharath B. Reddy, Trvfik Yucek, Husein Arslan, "An Efficient Blind Modulation Detection Algorithm for Adaptive OFDM Systems", Vehicular Technology Conference, 2003. VTC 2003-Fall. 2003 IEEE 58 th , 09 August 2003, pages 1895 to 1899			
Document 6: Yuanrun Teng, Tomotaka Nagaosa, Kazuo Mori, Hideo Kobayashi, "Grouping Adaptive Modulation Method for Burst Mode OFDM Transmission System", TECHNICAL REPORT OF IEICE., 31 August 2003, Vol. 101, No. 280, pages 51 to 57			
Document 7: JP 2001-238269 A (KDDI Corp.), 31 August 2001			
The inventions of claims 1 to 12 are neither described in any of the documents cited in the ISR nor obvious to a party skilled in the art.			



IN THE UNITED STATES PATENT AND TRADEMARK OFFICE

In re the Application of

Inventors: Xiaoming SHE, et al.

Appln. No.: 11/719,611

Filed: May 17, 2007

For: COMMUNICATION APPARATUS, COMMUNICATION
SYSTEM, AND COMMUNICATION METHOD

CLAIM FOR PRIORITY

Assistant Commissioner of Patents
Washington, D.C. 20231

Dear Sir:

The benefit of the filing date of the following prior foreign application filed in the following foreign country is hereby requested for the above-identified application and the priority provided in 35 USC 119 is hereby claimed:

Chinese Appln. No. 200410094967.7, filed November 19, 2004.

The International Bureau received the priority document within the time limit, as evidenced by the attached copy of the PCT/IB/304.

It is requested that the file of this application be marked to indicate that the requirements of 35 USC 119 have been fulfilled and that the Patent and Trademark Office kindly acknowledge receipt of this document.

Respectfully submitted,

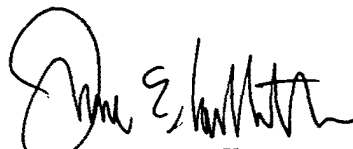

James E. Ledbetter
Registration No. 28,732

Date: May 22, 2007

JEL/spp

Attorney Docket No. L9289.07161

STEVENS DAVIS, MILLER & MOSHER, L.L.P.
1615 L STREET, NW, Suite 850
P.O. Box 34387
WASHINGTON, DC 20043-4387
Telephone: (202) 785-0100
Facsimile: (202) 408-5200

IN THE UNITED STATES PATENT AND TRADEMARK OFFICE

In re the Application of

Inventors: Xiaoming SHE, et al.

Appln. No.: 11/719,611

Filed: May 17, 2007

For: COMMUNICATION APPARATUS, COMMUNICATION
SYSTEM, AND COMMUNICATION METHOD

INFORMATION DISCLOSURE STATEMENT

Assistant Commissioner of Patents
Washington, DC 20231

Dear Sir:

Pursuant to Rules 56 and 99, Applicants hereby call the attention of the Patent Office to the art listed on the attached Form PTO 1449. Copies of the art cited in the International Search Report (ISR), which issued by the JPO, are made available to the U.S. examiner in the national stage application, pursuant to MPEP 1893.03(g), and therefore copies of such art are not submitted herewith. The art cited in the ISR is listed on the attached PTO-1449 for an indication of consideration by the examiner. Copies of any other references listed on the PTO-1449, besides those cited in the ISR, are submitted herewith. US '484 corresponds to JP '269 and US '706 corresponds to CN '662.

Applicants present this art so that the Patent Office may, in the first instance, determine any relevancy thereof to the presently claimed invention, see Beckman Instruments, Inc. v.

Chemtronics, Inc., 439 F.2d 1369, 1380, 165 USPQ 355, 364 (5th Cir. 1970). Also see Patent Office Rules 104 and 106. Applicants respectfully request that this art be expressly considered during the prosecution of this application and made of record herein and appear among the "References Cited" on any patent to issue herefrom.

Respectfully submitted,

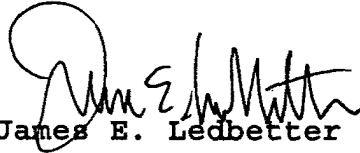

James E. Ledbetter
Registration No. 28,732

Date: May 22, 2007

JEL/spp

ATTORNEY DOCKET NO. L9289.07161

STEVENS, DAVIS, MILLER & MOSHER, L.L.P.
1615 L STREET, NW, Suite 850
WASHINGTON, DC 20043-4387
Telephone: (202) 785-0100
Facsimile: (202) 408-5200

FORM PTO-1449 U.S. Department of Commerce
(Rev. 4/92) Patent and Trademark Office

**INFORMATION DISCLOSURE
STATEMENT BY APPLICANT**

(Use several sheets if necessary)

ATTY. DOCKET NO.

L9289.07161

SERIAL NO.

11/719,611

APPLICANT

Xiaoming SHE, et al.

FILING DATE

May 17, 2007

GROUP

Unassigned

U.S. PATENT DOCUMENTS

EXAMINER INITIAL	DOCUMENT NUMBER	DATE	NAME	CLASS	SUBCLASS	FILING DATE IF APPROPRIATE	
						YES	NO
	6 8 3 6 4 8 4	12/2004	Suzuki				
2003	0 2 3 1 7 0 6	12/2003	Hwang				

FOREIGN PATENT DOCUMENTS

EXAMINER INITIAL	DOCUMENT NUMBER	DATE	COUNTRY	CLASS	SUBCLASS	TRANSLATION	
						YES	NO
	2004 0 4 0 8 2 7	03/2004	WO				
	2004 0 4 0 8 1 3	03/2004	WO				
	2004 1 0 4 2 9 3	04/2004	JP				
	2003 1 6 9 0 3 6	06/2003	JP				
	2001 2 3 8 2 6 9	08/2001	JP				
	1 4 6 6 2 9 7	01/2004	CN				Abstract
	1 4 6 9 6 6 2	01/2004	CN				Abstract
	1 4 9 6 6 2 3	05/2004	CN				Abstract

OTHER DOCUMENTS (Including Author, Title, Date, Pertinent Pages, Etc.)

PCT International Search Report dated February 14, 2006.

Sharath B. Reddy, et al.: "An Efficient Blind Modulation Detection Algorithm for Adaptive OFDM Systems," Vehicular Technology Conference, 2003, VTC 2003-Fall, 2003 IEEE 58th, Aug. 9, 2003, pp. 1895-1899.

Yuanrun Teng, et al.: "Grouping Adaptive Modulation Method for Burst Mode OFDM Transmission System," Technical Report of IEICE, Aug. 31, 2003, vol. 101, no. 280, pp. 51-57.



EXAMINER: Initial if citation is considered, draw line through citation if not in conformance and not considered. Include copy of this form with next communication to applicant.

(Form PTO-1449 [6-4])

A adaptive modulation and encoding method for high speed data transmission

Publication number: CN1496623
Publication date: 2004-05-12
Inventor: JIANGBO DONG (US); PING WANG (US); YONGSHENG ZHANG (US)
Applicant: LINKAIR COMM INC (US)
Classification:
 - international: **H04L1/00; H04L1/00; (IPC1-7): H04L1/00**
 - European: **H04L1/00A1M; H04L1/00A5**
Application number: CN20028006459 20020208
Priority number(s): WO2002CN00072 20020208

Also published as:

 WO03067802 (A1)
 AU2002233136 (A1)

Report a data error here

Abstract of CN1496623

A adaptive modulation and encoding method for high speed data speed data transmission, characterized in that: the invention adopts Turbo product code to perform adaptive modulation and encode for high speed data. According to real time channel quality, proper encode and modulation mode are selected to encode transmitted information bits at transmitting terminal-The coding includes at least encoding with Turbo product code; encoded bits are modulated in accordance with real time channel quality at transmitting terminal; after encoding and modulating, produced transmitting signal is generated with the transmitted information bits, and the signal and control signal are multiplexed and then transmitted over channel; the received signal is demodulated and decoded at receiving terminal. The decoding includes at least decoding with Turbo product code.

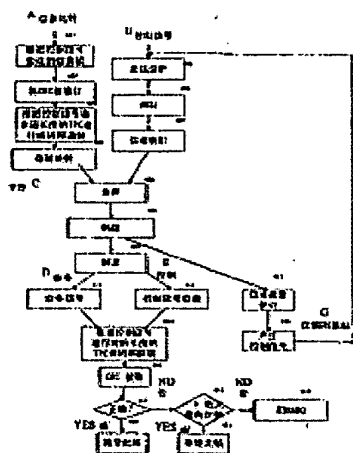

401... INFORMATION FRAMES IN ACCORDANCE WITH CURRENT SIGNAL
 402... ADD CRC CHECK BIT
 403... PROPER LENGTH TPC ARE SELECTED TO ENCODE AND MODULATE
 404... CHANNEL MAPPIING
 405... ERROR PROTECT
 406... MODULATION
 407... CHANNEL MAPPIING
 408... ADDRESS
 409... CODE RATE
 410... SERIAL INDEX
 411... TRAFFIC SIGNAL
 412... CONTROL SIGNAL
 413... CHANNEL QUALITY ESTIMATION
 414... CORRESPONDING LENGTH TPC ARE DECODED AND MODULATED BY ACCORDANCE WITH ESTIMATION SIGNAL
 415... GENERATE CONTROL SIGNAL
 416... CRC CHECK
 417... ROUTE
 418... TRANSMITTED SIGNAL
 419... ACCEPT TIME FRAME
 420... ACCEPT TIME FRAME
 421... POPULATE TIME FRAME

A... INFORMATION BIT
 B... CONTROL SIGNAL
 C... CHANNEL MAPPIING
 D... TRAFFIC SIGNAL
 E... TRANSMITTED SIGNAL
 F... ERROR
 G... FEED TO BASE STATION

Data supplied from the esp@cenet database - Worldwide



[12] 发明专利申请公开说明书

[21] 申请号 02806459.3

[43] 公开日 2004年5月12日

[11] 公开号 CN 1496623A

[22] 申请日 2002.2.8 [21] 申请号 02806459.3
 [86] 国际申请 PCT/CN2002/000072 2002.2.8
 [87] 国际公布 WO03/067802 中 2003.8.14
 [85] 进入国家阶段日期 2003.9.12
 [71] 申请人 连宇通信有限公司
 地址 美国加利福尼亚州
 [72] 发明人 董江波 王 萍 张永生 邹永忠

[74] 专利代理机构 北京三友知识产权代理有限公司
 代理人 马娅佳

[54] 发明名称 一种用于高速数据传输的自适应调制与编码方法

[57] 摘要

一种用于高速数据传输的自适应调制与编码方法，其特征是，采用 TURBO 乘积码完成对高速数据的自适应调制与编码。其中，发射端依据实时信道质量选择适当的编码与调制方式对发送的信息比特进行编码，该编码至少包括 TURBO 乘积码编码；发射端依据实时信道质量对编码后的比特进行调制；所述的发送的信息比特经所述的编码和所述的调制后生成发送信号，该发送信号与控制信号复用，并经信道传输；接收端对所接收的信号进行解调、译码，该译码至少包括 TURBO 乘积码译码。

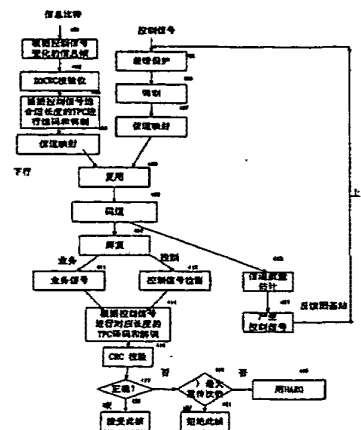

一种用于高速数据传输的自适应调制与编码方法

技术领域

本发明属于电通信技术领域，特别涉及一种用于高速数据传输的自适应调制与编码(Adaptive Modulation and Coding)的链路自适应技术。具体的讲是一种用于高速数据传输的自适应调制与编码方法。

背景技术

任何一种通信系统都是围绕着通信传输的数量和质量两个类型的三种指标：有效性、可靠性和安全性进行不断的优化。所谓有效性是指占用尽可能少的信道资源（如频段、时隙和功率）传输尽可能多的信源信息，它是通信的数量指标；所谓可靠性，主要是指在传输中，抵抗各类客观自然干扰的能力，但是在军事通信中它也包含电子对抗，即抵抗人为设置干扰的能力；所谓安全性，主要是指在传输中的安全保密性能，即收端防窃听、发端防伪造和篡改的能力等。

自适应调制与编码技术（AMC）是提高通信系统有效性的一种方法。使用自适应调制与编码的增强型 GSM 系统可以提供高至 384Kbps 的数据速率，而如果不用自适应调制与编码，只能提供 100Kbps 的数据速率。另外，1.25M 的 CDMA 系统使用自适应调制与编码，可以提供高达 5Mbps 的峰值数据速率，而如果不用自适应调制与编码，一般来说，仅可以提供 460Kbps 的峰值数据速率。使用 AMC 技术的主要优点有（1）在信道质量良好位置的用户可以进行较高速率的数据传输，从而提高小区的平均吞吐量；（2）可以降低干扰变化的影响，因为 AMC 的链路自适应是建立在改变调制/编码方案基础上的，而不是建立在改变传输功率基础上。

自适应调制与编码就是通信系统可以根据信道质量的变化为每个用户选择适当的调制方式和前向纠错编码方案，即选择不同级别的MCS(Modulation and Coding Schemes)，从而使系统在信道质量较高时选择较高的调制方式和较高码率的编码方案而在信道质量较低时选择较低的调制方式和较低码率的编码方案。这样既保证了系统具有较低的误帧率（即错误接收的帧在所发送的帧中所占的比率），又使系统能达到较高的吞吐量（所谓吞吐量是指用户在一段时间内，如在一个子帧内，能够正确接收的信息比特数）。

具体的讲：自适应调制与编码系统中，在信道质量良好位置的用户，比如说靠近基站的用户，系统通常会分配较高级别的调制方式和较高码率的编码方案，即较高级别的MCS；而在信道质量较差的用户，比如说在小区边缘位置的用户，系统通常会分配较低级别的调制方式和较低码率的编码方案，即较低级别的MCS。这样就能够提高系统的平均数据传输速率。

自适应调制与编码也存在缺点。它对信道估计误差和时延比较敏感。为了选择合适的调制与编码，必须准确知道信道质量。信道估计的错误会导致系统选择不恰当的调制与编码方案，从而会出现下列两种情形：1) 信道质量较好时却选择了较低级别的MCS方式，从而浪费了系统资源；2) 信道质量较低时却选择了较高级别的MCS方式，从而增加了系统的误帧率，降低了传输可靠性，也降低了系统的有效性。在进行信道估计时的时延也会因为移动信道的不停变化而降低信道质量估计的可靠性。自适应调制与编码技术常与自动重传(ARQ)技术结合在一起，来改善自适应调制与编码的性能，可以有效的提高系统的吞吐量，增强链路的可靠性，支持高速数据速率的要求。

自适应调制与编码技术中的编码技术可以采用多种编码结构。目前使用较多的是 3GPP 中采用的并行级联卷积码，也即：PCCC(Parallel Concatenated Convolutional Codes)编码结构的 Turbo 码。其不同码率可以采用码率匹配截短 RCPT(Rate Compatible Punctured Turbo)方法实现。此方法采用码率 $1/M$ 的 Turbo 码经过截位 (Puncturing)，形成一组码率的截短 Turbo 码，来满足自适应调制与编码技术中不同 MCS 级别码率的要求。RCPT 的优点是仅需要一个编码器和一个译码器，可以适应不同 AMC 中不同码率的要求。目前自适应调制与编码技术中的编码技术除了采用 PCCC 编码结构外，也有采用其他结构的编码方式，如 Qualcomm 公司的 HDR 系统中采用 SCCC(Serial Concatenated Convolutional Codes)编码结构，其不同码率采用 QCTC(Quasi-Complementary Turbo Codes)实现。

乘积码(Product Coding)，或称 n 维乘积码，是一类由 n 个子码（一般为较简单的分组码）构成的特殊的复合码，可以看作是对 n 个 $n-1$ 维乘积码再进行一维编码所获得的码字。在实际应用中，乘积码是一类能同时纠正随机错误和突发错误、码构造简单的好码，特别适用于信道干扰复杂的差错控制系统。系统可以通过合理地选取子码，以及对其进行适当地截短，获得比较灵活的码率。

在 J. Hagenauer, E. Offer 和 L. Papke 的文章，“Iterative Decoding of Binary Block and Convolutional Codes,” *IEEE Trans. Infom. Theory*, vol. 42, pp. 429-445, Mar 1996. 中指出，当码率大于 $2/3$ 时，TPC 方案的性能优于 PCCC 方案。此外，TPC 更适用于短帧结构。

乘积码是香农信息理论提出后第一个在非零码率时可以实现无误码传输的纠错编码。当时由于硬件水平所限，其优越性得不到有效应用。近年

来，迭代译码由于其强有力的纠错性能和较低的复杂度得到广泛应用。迭代译码是利用软输入值和外部信息值译码并产生软输出值，根据软输出值计算出新的外部信息值并反馈到译码器的输入端再次译码。该过程重复直到完成预定的迭代次数或达到预定的译码性能时停止。其中，软输入值包含接收序列的硬判决值和可靠值；软输出值包含译码序列的硬判决值和可靠值；外部信息值是译码后译码序列可靠值的变化值，它表示为软输出值和软输入值的差值。随着迭代译码算法的应用，乘积码由于它独特的优点再次得到关注。同理，更高维数乘积码的译码结构可根据二维乘积码的译码结构而类推。

10 发明内容

本发明的目的是提供一种用于高速数据传输的自适应调制与编码方法，将 Turbo 乘积码 (TPC) 应用于自适应调制与编码(AMC)技术中。由于 TPC 码所具有的支持高码率、译码算法复杂度较低等优点，将 TPC 用于自适应调制与编码各级 MCS 的编码方案中，可以在自适应调制与编码技术中充分发挥 TPC 的优点，增强自适应调制与编码技术在高速数据传输领域中的效果。

本发明的技术方案为：

一种用于高速数据传输的自适应调制与编码方法，其特征是，采用 TURBO 乘积码完成对高速数据的自适应调制与编码。

20 其中，发射端依据实时信道质量选择适当的编码与调制方式对发送的信息比特进行编码，该编码至少包括 TURBO 乘积码编码；发射端依据实时信道质量对编码后的比特进行调制；

所述的发送的信息比特经所述的编码和所述的调制后生成发送信号，

该发送信号与控制信号复用，并经信道传输；

接收端对所接收的信号进行解调、译码，该译码至少包括 TURBO 乘积码译码。

所述的 TURBO 乘积码可为分组码与分组码的级联。

5 所述的 TURBO 乘积码可为卷积码与分组码的级联。

所述的乘积码可为 n 维乘积码。

所述的乘积码可为二维乘积码。

所述的编码可为采用以汉明码或者扩展汉明码为成员码的 TURBO 乘积码编码。

10 所述的调制方式可为相移键控调制、幅度键控调制或者幅度和相位联合调制。

所述的相移键控调制可为 BPSK, QPSK, DQPSK, 8PSK, D8PSK, 16PSK。

所述的幅度调制可为 2ASK, 4ASK, 6ASK, 8ASK。

15 所述的幅度和相位联合调制可为 4QAM, 8QAM, 16QAM, 32QAM, 64QAM, 16APSK, 16DAPSK, 32APSK, 64APSK, 32DAPSK, 64DAPSK。

所述的控制信号可为 MCS 级别控制信号，所述的控制信号可根据专用导频信道而测得的信道质量来确定。

20 所述的 MCS 级别控制信号的确定包括：所述的 MCS 级别控制信号可由移动站进行信道质量测量和计算后得出，并将所得到的 MCS 级别控制信号经上行链路发送到基站。

所述的 MCS 级别控制信号的确定包括：移动站进行信道质量测量，并将该信道质量测量的报告经上行链路发送到基站，基站根据收到的信道质

量测量的报告确定所需的 MCS 级别。

所述的 MCS 级别控制信号的确定包括：所述的 MCS 级别控制信号可由高层直接给出。

所述的译码可为 TURBO 乘积码迭代译码。

5 所述的译码可为基于子码伴随式译码的 TURBO 乘积码迭代译码。

所述的一种用于高速数据传输的自适应调制与编码方法，其步骤包括：发射端依据实时信道质量对发送的信息比特进行编码，该编码至少包括 TURBO 乘积码编码；

发射端依据实时信道质量对发送的编码后的比特进行调制；

10 发送的信息比特经编码和调制后生成发送信号，该发送信号与控制信号复用，并经信道传输；

接收端对控制信号进行检测；

接收端对所接收的信号进行解调、译码，该译码至少包括 TURBO 乘积码译码。

15 所述的一种用于高速数据传输的自适应调制与编码方法，其步骤可进一步包括：

发射端依据实时信道质量对发送的信息比特进行编码，该编码至少包括 TURBO 乘积码编码；

发射端依据实时信道质量对发送的编码后的比特进行调制；

20 发送的信息比特经编码和调制后生成发送信号，该发送信号与 MCS 级别控制信号复用，并经信道传输；

接收端对 MCS 级别控制信号进行检测；

接收端采用与发射端相对应的星座图对所接收的信号进行解调；

接收端采用与发射端相对应的 TURBO 乘积码结构进行迭代译码。

所述的一种用于高速数据传输的自适应调制与编码方法，其具体步骤包括：

在下行链路的发送端：

5 步骤 401，基站依据反馈回来的 MCS 级别控制信号确定信息帧长度，并开始信息比特的发送；

步骤 402，对发送的信息比特加上 CRC 校验位；

步骤 403，根据 MCS 级别控制信号确定 TURBO 乘积码长度并进行编码，根据 MCS 级别控制信号确定调制方式；

10 步骤 404，经所述编码和调制后生成业务信号；

步骤 405，对反馈至基站的 MCS 级别控制信号进行检测后，对检测到的 MCS 级别控制信号进行差错保护；

步骤 406，对经过差错保护后的基站检测到的 MCS 级别控制信号进行调制；

15 步骤 407，对调制后的基站检测到的 MCS 级别控制信号进行信道映射；

步骤 408，将业务信号与控制信号进行复用；

步骤 409，将业务信号与控制信号进行复用后共同送至码道中；

在下行链路的接收端：

20 步骤 410，对接收的信号进行解复；

步骤 411，步骤 412，将解复后的信号分成业务信号和控制信号；

步骤 414，解复后的业务信号根据检测到的 MCS 级别控制信号选择与发送端相对应的 MCS 级别，即相应的调制方式和编码结构，进行相应的解

调和译码;

步骤 416, 对接收帧进行 CRC 校验;

步骤 417, 对接收帧进行判断;

5 步骤 418, 如果接收帧不正确, 则判断重传次数是否小于最大重传次数;

步骤 419, 如果重传次数小于最大重传次数时, 使用 HARQ 进行重传;

步骤 421, 当重传次数已达最大重传次数时, 放弃该坏帧;

步骤 420, 如果接收帧正确, 则接受此帧;

根据步骤 409 中码道传送的复用信号:

10 步骤 413, 在用户端进行信道质量估计;

步骤 415, 依据估计的信道质量产生 MCS 级别控制信号, 并经上行链路反馈至基站, 用来作为下一帧的 AMC 控制信号。

本发明的有益效果为:

15 本发明提高了通信系统的有效性, 使得在信道质量良好位置的用户可以进行较高速率的数据传输, 从而提高小区的平均吞吐量; 可以降低干扰变化的影响, 进而使系统具有较低的误帧率, 并达到较高的吞吐量。同时可增强链路的可靠性, 支持高速数据速率的要求。

20 本发明采用的乘积码是一类能同时纠正随机错误和突发错误、码构造简单的好码, 其特别适用于信道干扰复杂的差错控制系统。将 TPC 用于自适应调制与编码各级 MCS 的编码方案中, 可以在自适应调制与编码技术中充分发挥 TPC 的优点, 增强自适应调制与编码技术在高速数据传输领域中的效果。本发明采用的迭代译码方案还以尽可能低的系统复杂性获得了尽可能高的编码增益和传输速率。

附图说明

- 图 1 是二维乘积码的编码器结构框图；
- 图 2 示出了本发明方法所采用的 TPC 的码构造图；
- 图 3 是二维乘积码的译码器结构框图；
- 5 图 4 是依本发明方法的采用 TPC 的 AMC 流程图；
- 图 5 是本发明实例中选择 TPC 不同长度成员码时的错误率仿真结果；
- 图 6 是本发明实例中选择 TPC 不同长度成员码时的吞吐量仿真结果；
- 图 7 是本发明实施例中采用 TPC 的 AMC 的系统吞吐量仿真结果。

具体实施方式

- 10 如图 1 所示，本发明为一种用于高速数据传输的自适应调制与编码方法，其特征是，采用 TURBO 乘积码完成对高速数据的自适应调制与编码。

其中，发射端依据实时信道质量选择适当的编码与调制方式对发送的信息比特进行编码，该编码至少包括 TURBO 乘积码编码；发射端依据实时信道质量对编码后的比特进行调制；

- 15 所述的发送的信息比特经所述的编码和所述的调制后生成发送信号，该发送信号与控制信号复用，并经信道传输；

接收端对所接收的信号进行解调、译码，该译码至少包括 TURBO 乘积码译码。

- 在本发明的较佳实施例中，发射端可采用由行编码器 11 和列编码器 12
- 20 构成的二维乘积码编码结构对输入的信息比特进行行编码和列编码，其所构成的码字是一个矩阵，由行子码和列子码构成。

如图 2 所示，在本发明的较佳实施例中，可选用两个系统线性分组码 $C_1(n_1, k_1, d_1)$ 和 $C_2(n_2, k_2, d_2)$ 作为 TPC 子码， $C_2(n_2, k_2, d_2)$ 用来对 k_1 行信息位编

码, $C_1(n_1, k_1, d_1)$ 用来对 n_2 列信息位编码。由线性分组码的结构可知, TPC 中的 n_1 行是 $C_2(n_2, k_2, d_2)$ 的码字, 所有 n_2 列是 $C_1(n_1, k_1, d_1)$ 的码字。

如图 3 所示, 在本发明的较佳实施例中, 接收端可采用由行译码器 31、列译码器 32 和判决器 33 构成的二维乘积码迭代译码结构。在迭代译码的过程中, 行译码器 31 和列译码器 32 不断交换利用外信息值, 在完成一定的译码次数或达到预定的译码性能后将所得到的软信息值通过判决器 33 输出译码比特。在本发明的较佳实施例中还可选用一种较好的 TPC 译码方法, 所述的该方法在申请号是 PCT-CN01-01289, 发明名称为“基于子码伴随式译码的级联分组码的迭代译码方法”中进行了详细的公开。依据该 TPC 译码方法, 能提供一种适用于级联分组码及其特殊形式乘积码的迭代译码方法, 即将一种减少复杂度的线性块码译码算法应用于乘积码的迭代译码这种方法能够保证子码产生优化的码字列表, 因而具有良好的译码性能, 并且在不增加算法复杂度的同时获取较好的译码性能, 并能支持更多类型的子码。该方法的选用使本发明方法以尽可能低的系统复杂性获得了尽可能高的编码增益和传输效率。

如图 4 所示, 所述的调制方式可为相移键控调制、幅度键控调制或者幅度和相位联合调制。

所述的相移键控调制可为 BPSK, QPSK, DQPSK, 8PSK, D8PSK, 16PSK。

所述的幅度调制可为 2ASK, 4ASK, 6ASK, 8ASK。

所述的幅度和相位联合调制可为 4QAM, 8QAM, 16QAM, 32QAM, 64QAM, 16APSK, 16DAPSK, 32APSK, 64APSK, 32DAPSK, 64DAPSK。在本发明的较佳实施例中 AMC 调制方案可从 QPSK, 16QAM, 64QAM 中选择。

所述的编码还可为采用以汉明码或者扩展汉明码为成员码的 TURBO 乘积码编码。在本发明的较佳实施例中，AMC 中编码方式可采用以扩展汉明码为成员码的 TPC，其成员码的长度是从(16,11)*(8,4)，(16,11)*(16,11)，(32,26)*(16,11)，(32,26)*(32,26)，(64,57)*(32,26)，(64,57)*(64,57)中选出，共
5 从中选出 4 级 MCS。其中，所述的控制信号可为 MCS 级别控制信号，所述的 MCS 级别控制信号可根据专用导频而测得的信道质量来确定。

所述的 MCS 级别控制信号的确定还可由移动站进行信道质量测量和计算后得出，并将所得到的 MCS 级别控制信号经上行链路发送到基站。

所述的 MCS 级别控制信号的确定还可包括：移动站进行信道质量测
10 量，并将该信道质量测量的报告经上行链路发送到基站，基站根据收到的信道质量测量的报告确定所需的 MCS 级别。

所述的 MCS 级别控制信号的确定还可包括：所述的 MCS 级别控制信号可由高层直接给出。

本发明较佳实施例可采用，移动站 MS 根据接收到的下行链路的信号
15 进行信道质量测量，然后计算出适当的 MCS 级别信号，进而完成 Turbo 乘积码的自适应调制与编码。

本发明较佳实施例的具体步骤如下：

在下行链路的发送端，在步骤 401 中，基站 BS 依据反馈回来的 MCS
级别的控制信号选择合适的信息帧长度，开始信息比特的发送；步骤 402
20 中，对发送的信息比特加上 CRC 校验位；之后在步骤 403 中，根据 MCS 级别控制信号选择合适的调制方式和相应的编码方案。而同时反馈至基站的 MCS 级别控制信号也要进行差错保护步骤 405 和调制步骤 406，所得信号完成信道映射步骤 407。然后与编码和调制后的业务信号 404 进行复用

步骤 408, 共同送至码道中步骤 409。

在下行链路的接收端, 首先进行信号的解复步骤 410, 解复后的信号分成业务信号步骤 411 和控制信号步骤 412。解复后的业务信号根据检测到的 MCS 级别控制信号选择与发送端相对应的 MCS 级别, 即相应的调制方式和编码结构, 进行相应的解调和译码步骤 414。然后进行 CRC 校验步骤 416, 判断接收帧是否正确步骤 417。如果不正确则在步骤 418, 进一步判断重传次数是否小于最大重传次数, 如果重传次数小于最大重传次数时, 使用 HARQ(Hybrid-ARQ)进行重传步骤 419, 当重传次数已达最大重传次数时, 放弃该坏帧步骤 421。另外, 根据步骤 409 中码道传送的复用信号, 在用户端进行信道质量估计步骤 413, 依据估计的信道质量产生 MCS 级别控制信号步骤 415 经上行链路反馈至基站, 用来作为下一帧的 AMC 控制信号。

TPC 码的编码可以由各种分组码/卷积码进行高维编码完成, 译码可以由迭代译码完成。

图 5 是不同调制方式和编码码率的组合方式下, 在 AWGN 信道中仿真所得到的对应的 BLER (Block Error Rate)。仿真参数如表 1 所示。

表 1

码片速率	1.28Mchip/s
MCS 级别的变换周期	1 sub-frame(2387 chips)
信道环境	AWGN
编码方式	TPC
TPC 译码器的输入	软判决信息

图 6 是与图 5 相对应的编码与调制的组合方式下，系统所能达到的吞吐量性能曲线。仿真参数仍如表 1 所示。本发明的实例中选择 MCS 的原则是由错误率和吞吐量共同决定。在特定的信噪比和调制方式下，依据错误率尽可能小，吞吐量尽可能大的原则，在吞吐量相差不大时选择错误率较小的 TPC 成员码，在错误率相差不大时选择吞吐量较大的 TPC 成员码，根据图 5 错误率和图 6 吞吐量的仿真结果，选择一组可能的 MCS 如下（但不仅此一种选择）：

MCS1: 以(16,11)*(16,11)扩展汉明码为成员码的 TPC 编码；QPSK 调制；

10 MCS2: 以(16,11)*(16,11)扩展汉明码为成员码的 TPC 编码；16QAM 调制；

MCS3: 以(32,26)*(16,11)扩展汉明码为成员码的 TPC 编码；16QAM 调制；

15 MCS4: 以(32,26)*(32,26)扩展汉明码为成员码的 TPC 编码；64QAM 调制；

选定各级 MCS 后，根据具体的帧结构经过速率匹配后成帧。

图 7 是实施例中采用上述四级 MCS 后系统吞吐量以及采用 AMC 技术后系统吞吐量的仿真曲线。

在得到采用 AMC 技术后系统吞吐量曲线之前，首先需要从图 7 所示的四种 MCS 级别所得到的吞吐量曲线来确定各级 MCS 转换的门限值。所得到的各级门限值如表 2 所示。最后在采用 AMC 技术后，系统根据此时信道质量状况和所得到的门限值比较来实时地改变系统的 MCS 级别。

表 2

MCS 级别转换	门限值
MCS1 到 MCS2	6.6dB
MCS2 到 MCS3	8dB
MCS3 到 MCS4	18.9dB

从图 7 中可以看出，采用 AMC 技术后，所得到的系统吞吐量是仅采用其中某一种 MCS 所得到的吞吐量曲线的外包络。因此，采用 AMC 技术可以使系统的吞吐量最大化。

- 5 本发明提高了通信系统的有效性，使得在信道质量良好位置的用户可以进行较高速率的数据传输，从而提高小区的平均吞吐量；可以降低干扰变化的影响，进而使系统具有较低的误帧率，并达到较高的吞吐量。同时可增强链路的可靠性，支持高速数据速率的要求。

10 本发明采用的乘积码是一类能同时纠正随机错误和突发错误、码构造简单的好码，其特别适用于信道干扰复杂的差错控制系统。将 TPC 用于自适应调制与编码各级 MCS 的编码方案中，可以在自适应调制与编码技术中充分发挥 TPC 的优点，增强自适应调制与编码技术在高速数据传输领域中的效果。本发明采用的迭代译码方案还以尽可能低的系统复杂性获得了尽可能高的编码增益和传输速率。

15

权 利 要 求

1. 一种用于高速数据传输的自适应调制与编码方法，其特征是，采用 TURBO 乘积码完成对高速数据的自适应调制与编码。

2. 根据权利要求 1 所述的方法，其特征在于：发射端依据实时信道质量选择适当的编码与调制方式对发送的信息比特进行编码，该编码至少包括 TURBO 乘积码编码；发射端依据实时信道质量对编码后的比特进行调制；

所述的发送的信息比特经所述的编码和所述的调制后生成发送信号，该发送信号与控制信号复用，并经信道传输；

10 接收端对所接收的信号进行解调、译码，该译码至少包括 TURBO 乘积码译码。

3. 根据权利要求 1 或者 2 所述的方法，其特征在于：所述的 TURBO 乘积码可为分组码与分组码的级联。

4. 根据权利要求 1 或者 2 所述的方法，其特征在于：所述的 TURBO 乘积码可为卷积码与分组码的级联。

5. 根据权利要求 1 或者 2 所述的方法，其特征在于：所述的乘积码可为 n 维乘积码。

6. 根据权利要求 1 或者 2 所述的方法，其特征在于：所述的乘积码可为二维乘积码。

20 7. 根据权利要求 1 或者 2 所述的方法，其特征在于：所述的编码可为采用以汉明码或者扩展汉明码为成员码的 TURBO 乘积码编码。

8. 根据权利要求 1 或者 2 所述的方法，其特征在于：所述的调制方式

可为相移键控调制、幅度键控调制或者幅度和相位联合调制。

9. 根据权利要求 1 或者 2 或者 8 所述的方法，其特征在于：所述的相移键控调制可为 BPSK，QPSK，DQPSK，8PSK，D8PSK，16PSK。

10. 根据权利要求 1 或者 2 或者 8 所述的方法，其特征在于：所述的幅度调制可为 2ASK，4ASK，6ASK，8ASK。

11. 根据权利要求 1 或者 2 或者 8 所述的方法，其特征在于：所述的幅度和相位联合调制可为 4QAM，8QAM，16QAM，32QAM，64QAM，16APSK，16DAPSK，32APSK，64APSK，32DAPSK，64DAPSK。

12. 根据权利要求 2 所述的方法，其特征在于，所述的控制信号可为 MCS 级别控制信号；所述的控制信号可由基站根据专用导频而测得的信道质量来确定。

13. 根据权利要求 2 所述的方法，其特征在于，所述的控制信号可为 MCS 级别控制信号；所述的控制信号可由移动站进行信道质量测量和计算后得出，并将所得到的 MCS 级别控制信号经上行链路发送到基站。

14. 根据权利要求 2 所述的方法，其特征在于，所述的控制信号可为 MCS 级别控制信号；所述的控制信号可由移动站进行信道质量测量，并将该信道质量测量的报告经上行链路发送到基站，基站根据收到的信道质量测量的报告确定所需的 MCS 级别。

15. 根据权利要求 2 所述的方法，其特征在于，所述的控制信号可为 MCS 级别控制信号；所述的控制信号可由高层直接给出。

16. 根据权利要求 2 所述的方法，其特征在于：所述的译码可为 TURBO 乘积码迭代译码。

17. 根据权利要求 2 所述的方法, 其特征在于: 所述的译码可为基于子码伴随式译码的 TURBO 乘积码迭代译码。

18. 根据权利要求 1 所述的方法, 其步骤包括:

5 发射端依据实时信道质量对发送的信息比特进行编码, 该编码至少包括 TURBO 乘积码编码;

发射端依据实时信道质量对发送的比特进行调制;

发送的信息比特经编码和调制后生成发送信号, 该发送信号与控制信号复用, 并经信道传输;

接收端对控制信号进行检测;

10 接收端对所接收的信号进行解调、译码, 该译码至少包括 TURBO 乘积码译码。

19. 根据权利要求 1 或者 2 所述的方法, 其步骤包括:

发射端依据实时信道质量对发送的信息比特进行编码, 该编码至少包括 TURBO 乘积码编码;

15 发射端依据实时信道质量对编码后的比特进行调制;

发送的信息比特经编码和调制后生成发送信号, 该发送信号与 MCS 级别控制信号复用, 并经信道传输;

接收端对 MCS 级别控制信号进行检测;

接收端采用与发射端相对应的星座图对所接收的信号进行解调;

20 接收端采用与发射端相对应的 TURBO 乘积码结构进行迭代译码。

20. 根据权利要求 1 或者 2 所述的方法, 其步骤包括:

在下行链路的发送端:

步骤 401, 基站依据反馈回来的 MCS 级别控制信号确定信息帧长度, 并开始信息比特的发送;

步骤 402, 对发送的信息比特加上 CRC 校验位;

步骤 403, 根据 MCS 级别控制信号确定 TURBO 乘积码长度并进行编
5 码, 根据 MCS 级别控制信号确定调制方式;

步骤 404, 经所述编码和调制后生成业务信号;

步骤 405, 对反馈至基站的 MCS 级别控制信号进行检测后, 对检测到
的 MCS 级别控制信号进行差错保护;

步骤 406, 对经过差错保护后的基站检测到的 MCS 级别控制信号进行
10 调制;

步骤 407, 对调制后的基站检测到的 MCS 级别控制信号进行信道映
射;

步骤 408, 将业务信号与控制信号进行复用;

步骤 409, 将业务信号与控制信号进行复用后共同送至码道中;

15 在下行链路的接收端:

步骤 410, 对接收的信号进行解复;

步骤 411, 步骤 412, 将解复后的信号分成业务信号和控制信号;

步骤 414, 解复后的业务信号根据检测到的 MCS 级别控制信号选择与
发送端相对应的 MCS 级别, 即相应的调制方式和编码结构, 进行相应的解
20 调和译码;

步骤 416, 对接收帧进行 CRC 校验;

步骤 417, 对接收帧进行判断;

步骤 418, 如果接收帧不正确, 则判断重传次数是否小于最大重传次数;

步骤 419, 如果重传次数小于最大重传次数时, 使用 HARQ 进行重传;

步骤 421, 当重传次数已达最大重传次数时, 放弃该坏帧;

5 步骤 420, 如果接收帧正确, 则接受此帧;

根据步骤 409 中码道传送的复用信号:

步骤 413, 在用户端进行信道质量估计;

步骤 415, 依据估计的信道质量产生 MCS 级别控制信号, 并经上行链路反馈至基站, 用来作为下一帧的 AMC 控制信号。

10

1/6



图 1



图 2

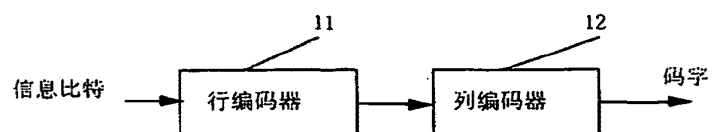

图 3

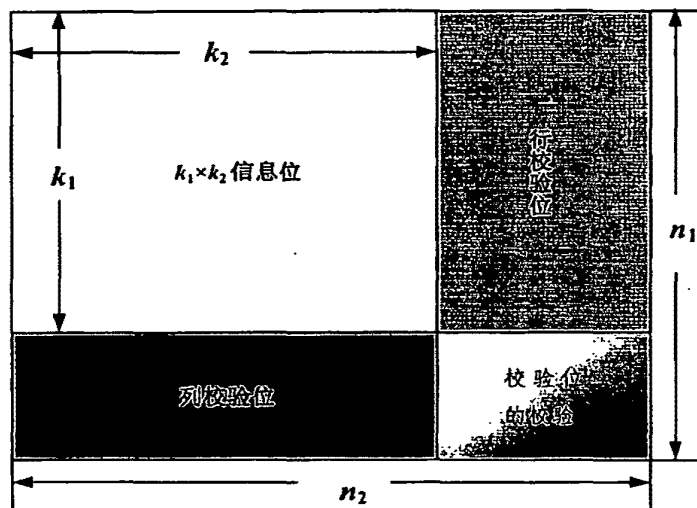

图 4

4/6

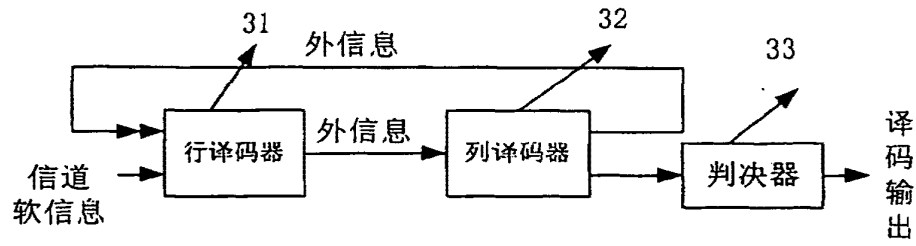

图 5

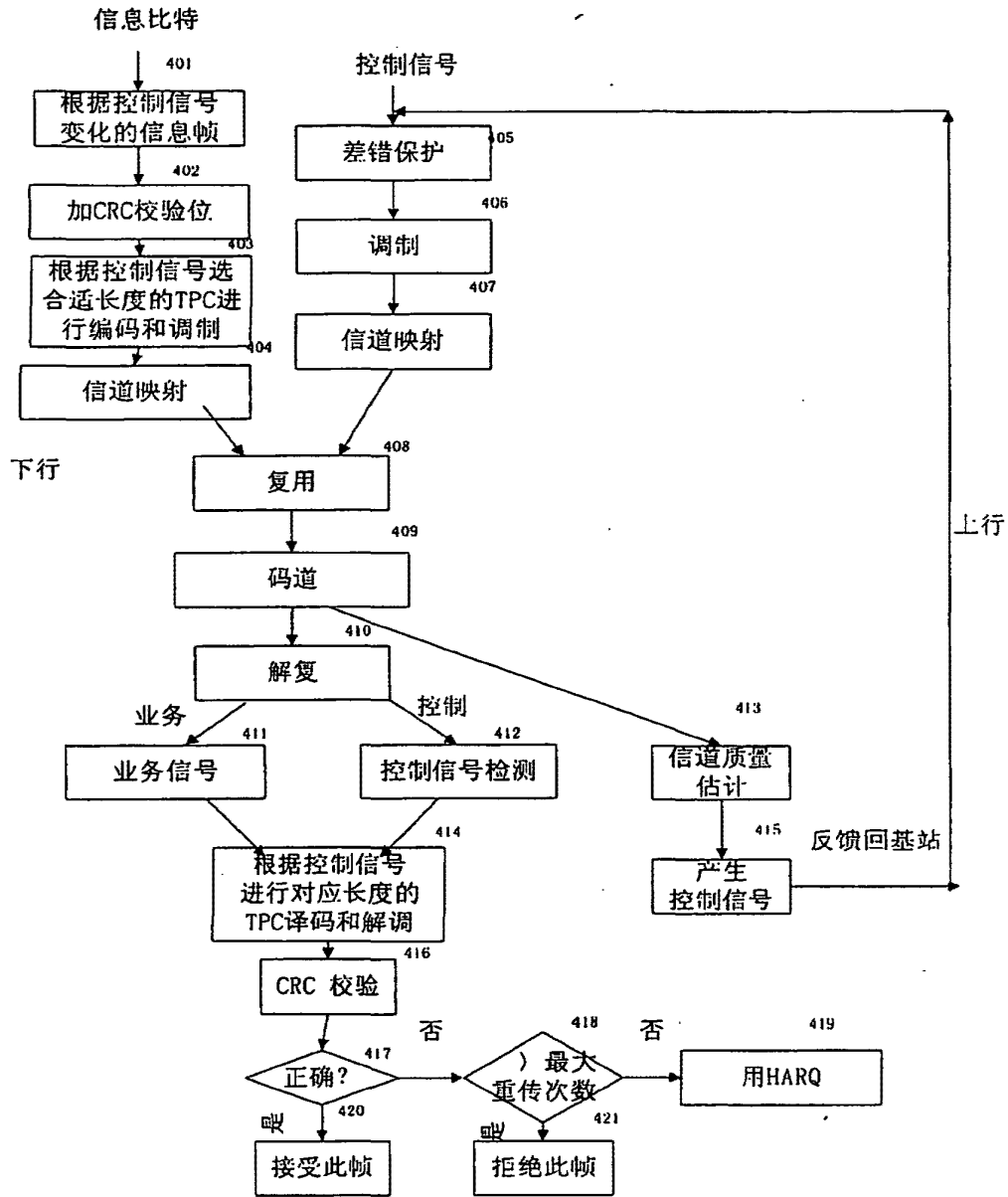
Throughput, in AWGN Channel, TPC+AMC



图 6

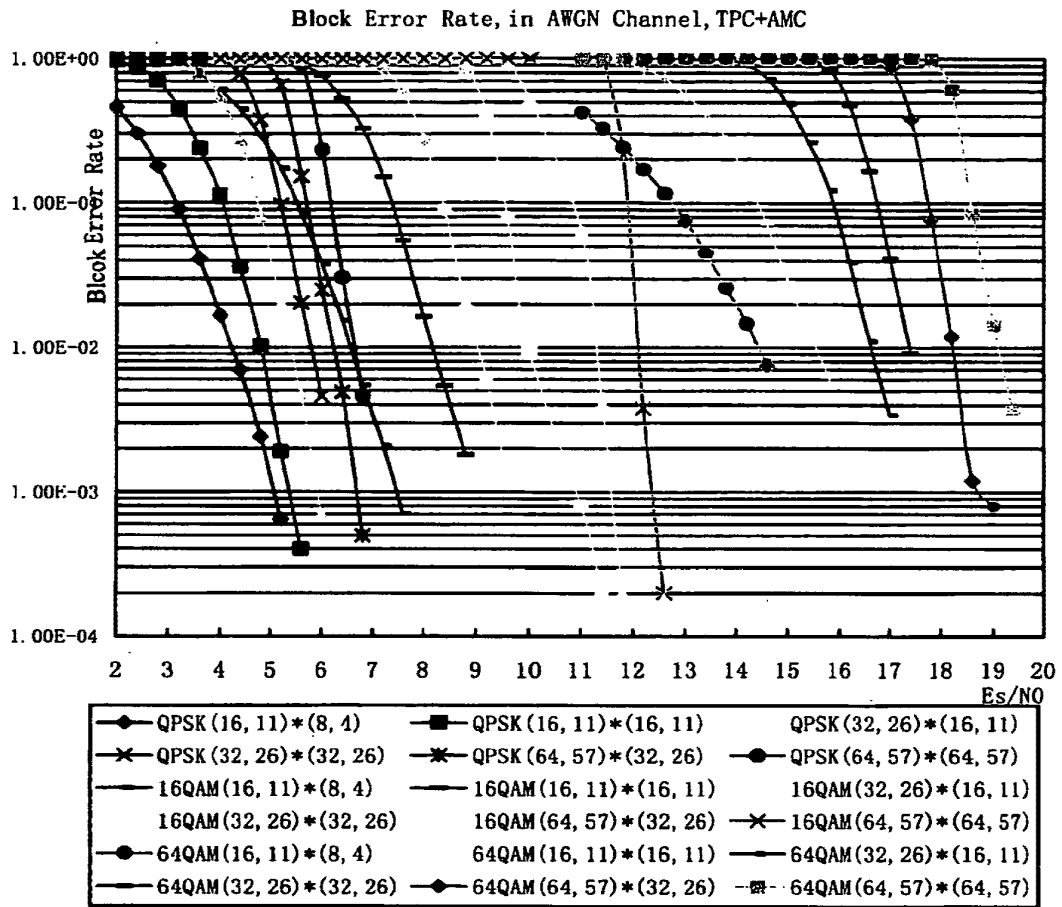

图 7

INTERNATIONAL SEARCH REPORT

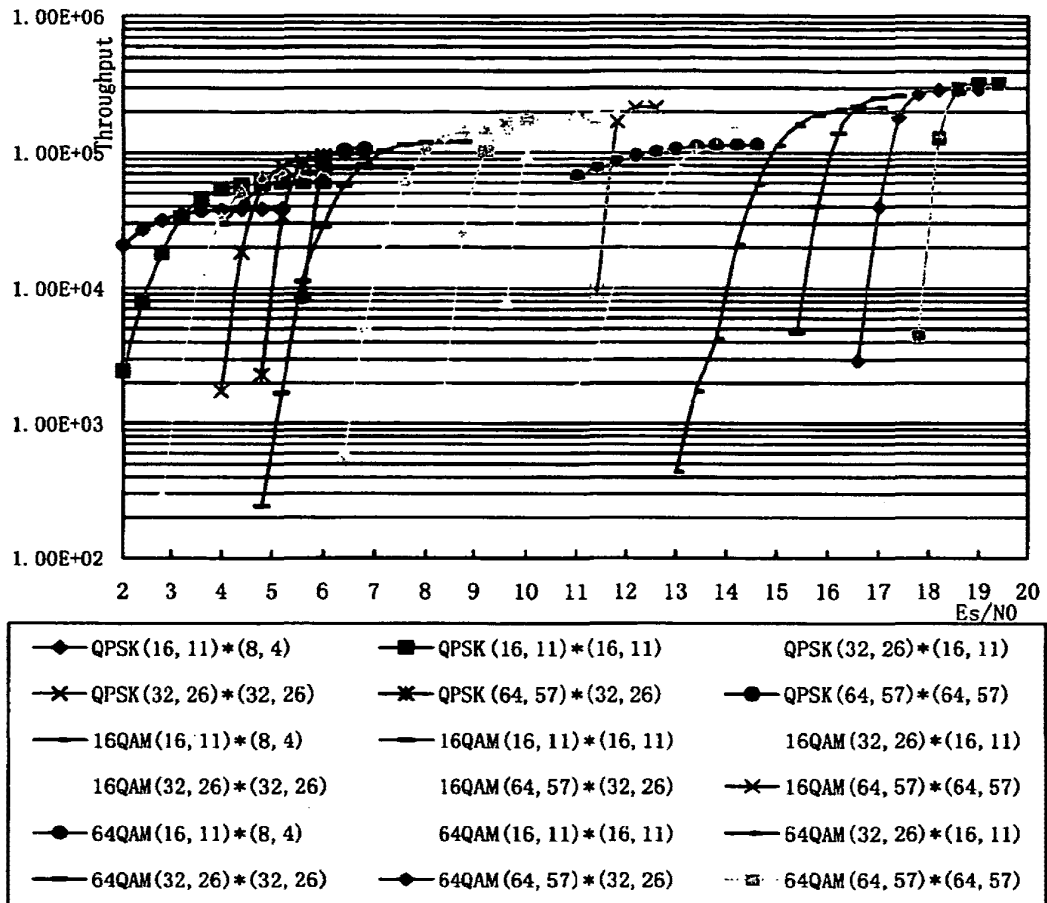
International application No.
PCT/CN02/00072

A. CLASSIFICATION OF SUBJECT MATTER		
H04L 1/00		
According to International Patent Classification (IPC) or to both national classification and IPC		
B. FIELDS SEARCHED		
Minimum documentation searched (classification system followed by classification symbols)		
IPC ⁷ : H04L 1/00 H03M 3/00		
Documentation searched other than minimum documentation to the extent that such documents are included in the fields searched		
Electronic data base consulted during the international search (name of data base and, where practicable, search terms used)		
WPI,EPODOC,PAJ,CNPAT: AMC Product Code Speed Data 自适应调制和编码 乘积码 高速数据		
C. DOCUMENTS CONSIDERED TO BE RELEVANT		
Category*	Citation of document, with indication, where appropriate, of the relevant passages	Relevant to claim No.
X	TELECOMMUNICATION TECHNOLOGY Issue 1, 2002 31.JAN 2002 Gao Lu, Niu Kai, Wu Wei-Ling "Adaptive Modulation and Coding System and its Application in WCDMA"	1、3-11
A	WO0072496 A 30.Nov 2000 whole document	1-20
A	JP11298369 A 29.OCT 1999 whole document	1-20
A	CA2243013 A 14.JAN 2000 whole document	1-20
<input type="checkbox"/> Further documents are listed in the continuation of Box C. <input type="checkbox"/> See patent family annex.		
<p>* Special categories of cited documents:</p> <p>"A" document defining the general state of the art which is not considered to be of particular relevance</p> <p>"E" earlier application or patent but published on or after the international filing date</p> <p>"L" document which may throw doubts on priority claim (S) or which is cited to establish the publication date of another citation or other special reason (as specified)</p> <p>"O" document referring to an oral disclosure, use, exhibition or other means</p> <p>"P" document published prior to the international filing date but later than the priority date claimed</p> <p>"T" later document published after the international filing date or priority date and not in conflict with the application but cited to understand the principle or theory underlying the invention</p> <p>"X" document of particular relevance; the claimed invention cannot be considered novel or cannot be considered to involve an inventive step when the document is taken alone</p> <p>"Y" document of particular relevance; the claimed invention cannot be considered to involve an inventive step when the document is combined with one or more other such documents, such combination being obvious to a person skilled in the art</p> <p>"&" document member of the same patent family</p>		
Date of the actual completion of the international search 29.OCT 2002 (29.10.02)		Date of mailing of the international search report 21 NOV 2002 (21.11.02)
Name and mailing address of the ISA/CN 6 Xitucheng Rd., Jimen Bridge, Haidian District, 100088 Beijing, China Facsimile No. 86-10-62019451		Authorized officer  Telephone No. 86-10-62095300

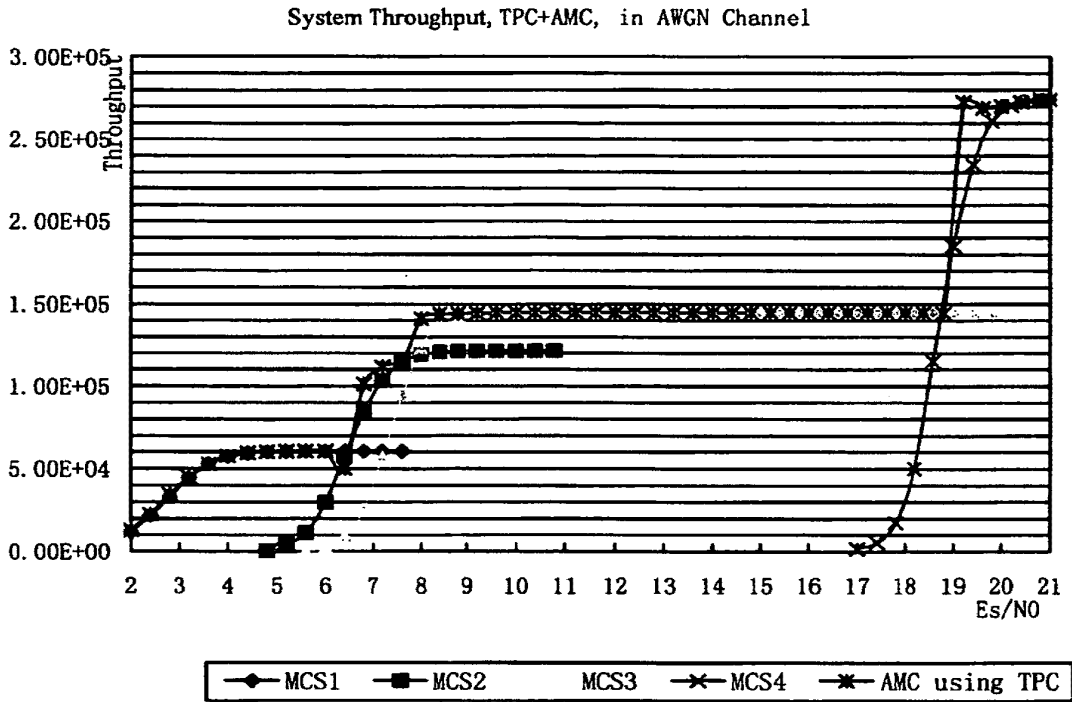
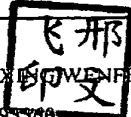
INTERNATIONAL SEARCH REPORT
 Information patent family members

Search request No.
 PCT/CN02/00072

Patent document cited in search report	Publication date	Patent family member(s)	Publication date
WO0072496 A	30.Nov 2001	AU200045987 A	12.DEC 2000
JP11298369 A	29.OCT 1999	NONE	
CA2243013 A	14.JAN 2000	NONE	

国际检索报告

国际申请号
PCT/CN02/00072

A. 主题的分类		
H04L 1/00		
按照国际专利分类表(IPC)或者同时按照国家分类和 IPC 两种分类		
B. 检索领域		
检索的最低限度文献(标明分类体系和分类号)		
<i>IPC</i> ⁷ : H04L 1/00 H03M 3/00		
包含在检索领域中的除最低限度文献以外的检索文献		
在国际检索时查阅的电子数据库(数据库的名称和, 如果实际可行的, 使用的检索词)		
WPI,EPODOC,PAJ,CNPAT: AMC Product Code Speed Data 自适应调制和编码 乘积码 高速数据		
C. 相关文件		
类 型*	引用文件, 必要时, 指明相关段落	相关的权利要求编号
X	电讯技术 2002 年第一期, 31.1 月.2002 高路、牛凯、 吴伟陵 “自适应调制与编码系统及其在 WCDMA 中的应用”	1、3-11
A	WO0072496 A 30.11 月 2000 全文	1-20
A	JP11298369 A 29.10 月 1999 全文	1-20
A	CA2243013 A 14.1 月 2000 全文	1-20
<input type="checkbox"/> 其余文件在 C 栏的续页中列出。 <input checked="" type="checkbox"/> 见同族专利附件。		
* 引用文件的专用类型: “A” 明确叙述了被认为不是特别相关的一般现有技术的文件 “E” 在国际申请日的当天或之后公布的在先的申请或专利 “L” 可能引起对优先权要求的怀疑的文件, 为确定另一篇引用文件的公布日而引用的或者因其他特殊理由而引用的文件 “O” 涉及口头公开、使用、展览或其他方式公开的文件 “P” 公布日先于国际申请日但迟于所要求的优先权日的文件		“T” 在申请日或优先权日之后公布的在后文件, 它与申请不相抵触, 但是引用它是为了理解构成发明基础的理论或原理 “X” 特别相关的文件, 仅仅考虑该文件, 权利要求所记载的发明就不能认为是新颖的或不能认为是有创造性 “Y” 特别相关的文件, 当该文件与另一篇或者多篇该类文件结合并且这种结合对于本领域技术人员为显而易见时, 权利要求记载的发明不具有创造性 “&” 同族专利成员的文件
国际检索实际完成的日期 29.10 月 2002 (29.10.02)		国际检索报告邮寄日期 21. 11 月 2002 (21. 11. 02)
国际检索单位名称和邮寄地址 ISA/CN 中国北京市海淀区西土城路 6 号(100088) 传真号: 86-10-62019451		受权官员 邢文飞 电话号码: 86-10-62093360 

PCT/ISA/210 表(第 2 页)(1998 年 7 月)

国际检索报告
关于同族专利成员的情报

国际申请号
PCT/CN02/00072



检索报告中引用的 专利文件	公布日期	同族专利成员	公布日期
WO0072496 A	30.11 月 2001	AU200045987 A	12.12 月 2000
JP11298369 A	29.10 月 1999	无	
CA2243013 A	14.1 月 2000	无	

PCT/ISA/210 表(同族专利附件)(1998 年 7 月)

APPARATUS FOR ADAPTIVE MODULATION CODING OF MOBILE COMMUNICATION TERMINAL

Publication number: KR20030096927
Publication date: 2003-12-31
Inventor: HWANG IN TAE (KR)
Applicant: LG ELECTRONICS INC (KR)
Classification:
 - international: **H04L1/00; H04L1/00; (IPC1-7): H04B14/04**
 - European: H04L1/00A1M
Application number: KR20020034025 20020618
Priority number(s): KR20020034025 20020618

Also published as:

 US2003231706 (A1)
 CN1469662 (A)
 CN1275481C (C)

Report a data error here

Abstract of KR20030096927

PURPOSE: An apparatus for adaptive modulation coding of a mobile communication terminal is provided to improve the error performance and a forward link transmission rate by combing adaptive modulation coding with BLAST. **CONSTITUTION:** A bell-lab layered space time(BLAST) decoder(50) BLAST-decodes data received through an antenna for applying the decoded data to a channel estimator(60) and a demodulator(70). The channel estimator(60) receives the data output from the blast decoder(50) for estimating channel state information and applying a channel state estimated value to the demodulator(70) and a modulation code scheme(MCS) level selector (100). The level selector(100) applies controls signals for selecting the optimum method and coding scheme in an MCS threshold to an encoder(10), a channel interleaver(20), and a modulator(30). The encoder(10) encodes transmission data. The channel interleaver (20) interleaves the encoded data. The modulator(30) modulates the interleaved data. A BLAST processor (40) sequentially receives data output from the modulator(30) for paralleling the data as many as transmitting antennas.

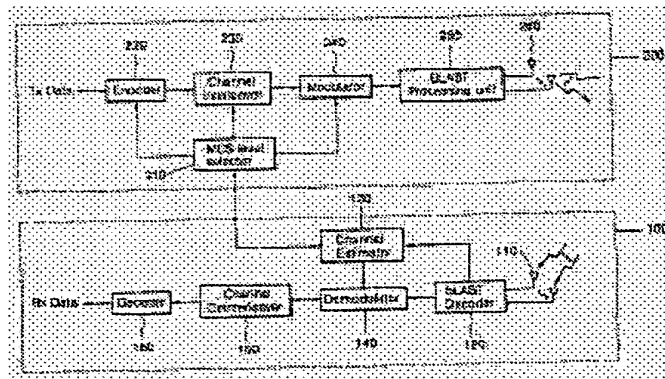

Data supplied from the *esp@cenet* database - Worldwide

[19] 中华人民共和国国家知识产权局

[51] Int. Cl⁷

H04Q 7/20

H04Q 7/30 H04Q 7/32

H04B 7/26



[12] 发明专利申请公开说明书

[21] 申请号 03149138.3

[43] 公开日 2004 年 1 月 21 日

[11] 公开号 CN 1469662A

[22] 申请日 2003.6.18 [21] 申请号 03149138.3

[30] 优先权

[32] 2002. 6. 18 [33] KR [31] 34025/2002

[71] 申请人 LG 电子株式会社

地址 韩国汉城

[72] 发明人 黄仁泰

[74] 专利代理机构 中原信达知识产权代理有限责

任公司

代理人 张天舒 袁炳泽

权利要求书 3 页 说明书 11 页 附图 8 页

[54] 发明名称 移动通信系统的自适应调制编码设备及其方法

[57] 摘要

在一种移动通信系统的自适应调制编码 (AMC) 设备和方法中, 通过对通过多个接收天线在移动终端接收的信号进行 BLAST 解码, 通过发射天线来估计前向信道特性, 并根据估计的前向信道特性来选择前向信道的最佳编码速率和调制方法。基站根据所选的编码速率和调制方法来对按照发射天线数形成的发射数据层进行编码和调制, 并通过 BLAST 解码来把这些发射数据发射到各发射天线。因此, 可根据前向信道特性进行最佳编码和调制, 并可通过多个天线进行多路发射。因此, 可提高发射速率。

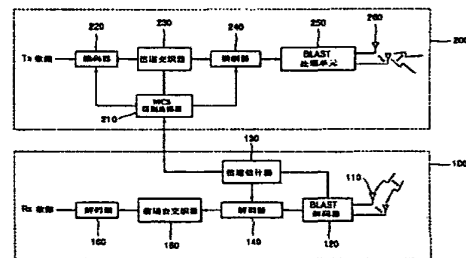

知识产权出版社出版

1. 一种移动通信系统的自适应调制编码(AMC)设备, 该设备包括:

5 AMC 接收机, 其对来自多个接收天线的接收信号进行 BLAST 解码, 并通过发射天线来估计前向信道特性; 以及

 AMC 发射机, 其根据估计的前向信道特性来自适应选择编码速率和调制方法, 根据所选的编码速率和调制方法, 通过发射天线来对按照发射天线数生成的发射信号层进行编码和调制, 并通过 BLAST
10 编码来把发射信号层同时发射到多个发射天线。

2. 根据权利要求 1 所述的设备, 其中, AMC 接收机被包括在移动终端内, 并且 AMC 发射机被包括在基站内。

15 3. 根据权利要求 2 所述的设备, 其中, AMC 接收机包括:
 多个接收天线;

 BLAST 解码器, 它对通过多个接收天线接收的接收信号进行 BLAST 解码, 通过发射天线来检测码元; 以及

 信道估计器, 用于通过使用发射天线进行 BLAST 解码的码元,
20 通过发射天线来估计前向信道特性。

4. 根据权利要求 3 所述的设备, 该编码器进一步包括:

 解调器, 用于根据在信道估计器中通过发射天线估计的前向信道特性来检测解调方法, 并根据解调方法, 通过发射天线来对来自 BLAST
25 解码器的码元进行解调;

 信道去交织器, 用于通过发射天线来对在解调器中解调的码元进行信道去交织; 以及

 解码器, 用于通过发射天线来对从信道去交织器输出的数据进行解码。
30

5. 根据权利要求 2 所述的设备, 其中, 所述 AMC 发射机包括:
MCS 级别选择器, 用于根据通过发射天线估计的前向信道特性,
通过发射天线来选择前向信道的最佳编码速率和调制方法;
编码器, 用于根据编码速率, 通过发射天线来对按照发射天线数
5 形成的发射数据层进行编码;
信道交织器, 用于根据编码速率, 通过发射天线来对编码的发射
数据层进行信道交织;
调制器, 用于根据调制方法, 通过发射天线来对从信道交织器输
出的发射数据层进行调制;
10 多个发射天线; 以及
BLAST 处理单元, 用于通过 BLAST 编码来把各层发射码元同时
发射到多个发射天线, 以使发射码元在时空轴线上具有垂直形式。
6. 一种移动通信系统的自适应调制编码(AMC)方法, 该方法包
15 括:
对通过多个接收天线接收的信号进行 BLAST 解码;
通过使用由发射天线进行 BLAST 解码的码元, 通过发射天线来
估计前向信道特性;
根据通过发射天线估计的前向信道特性, 通过发射天线来自适应
20 选择前向信道的编码速率和调制方法;
根据所选的编码速率和调制方法来对按照发射天线数形成的发射
数据层进行编码和调制; 以及
对这些层的发射数据进行 V-BLAST 编码。
7. 根据权利要求 6 所述的方法, 其中, 用于选择前向信道的编
25 码速率和调制方法的选择步骤可由移动终端或基站来执行。
8. 根据权利要求 6 所述的方法, 其中, 所述选择步骤包括:
当前向信道的 SNR 不大于第一阈值时, 选择 1/3 编码速率和 QPSK
30 方法;

当前向信道的 SNR 不小于第一阈值并不大于第二阈值时,选择 2/3 编码速率和 QPSK 方法;

当前向信道的 SNR 不小于第二阈值并不大于第三阈值时,选择 2/3 编码速率和 8PSK 方法; 以及

5 当前向信道的 SNR 不小于第三阈值时,选择 2/3 编码速率和 16QAM 方法。

9. 根据权利要求 6 所述的方法,其中,在选择步骤中选择共同应用于所有发射天线的编码速率和调制方法。

10

10. 根据权利要求 6 所述的方法,其中,在选择步骤中选择应用于每个发射天线的每个编码速率和调制方法。

11. 根据权利要求 6 所述的方法,其中,所述 BLAST 解码包括:

15 形成通过多个接收天线接收的接收信号作为接收矢量;

 在检测某个码元时,通过把其他码元视为干扰信号来估计该某个码元; 以及

 从接收矢量中减去第一检测的信号分量。

20

12. 根据权利要求 6 所述的方法,其中,所述 V-BLAST 编码包括:

 把各层发射数据同时发射到每个发射天线,以使各层发射数据在空时轴线上具有垂直形式。

移动通信系统的自适应调制编码设备及其方法

5 技术领域

本发明涉及移动通信系统，特别涉及用于在移动通信系统中提供无线电多媒体通信服务的自适应调制编码设备和方法。

背景技术

10 在无线电移动通信中，根据对各种多媒体服务的需求，需要大量的发射数据和加快数据发射速度。因此，急需确定用于有效使用有限频率的方法。其中一种方法是 AMC(自适应调制及编码)方案。AMC 方案用于根据前向信道特性的变化来改变编码和调制方法。

15 图 1 是示出通用移动通信系统的自适应调制编码(AMC)设备的方框图。

自适应调制编码(AMC)设备包括：AMC 接收机 10，用于通过使用通过接收天线接收的接收信号来估计前向信道特性，根据估计的前向信道特性来选择 MCS(调制编码方案)级别，对估计的前向信道特性进行反馈，对接收信号进行解调和解码；以及还包括 AMC 发射机 20，其根据反馈的前向信道特性来选择 MCS(调制编码方案)级别，并根据所选的 MCS 级别来对发射数据进行编码和调制。

25 该 AMC 接收机 10 包括：信道估计器 12，用于通过使用通过接收天线 11 接收的接收信号来估计前向信道特性，并发射估计的前向信道特性；解调器 13，用于根据在信道估计器 12 中估计的前向信道特性来检测解调方法，并根据解调方法来对接收信号进行解调；信道去交织器 14，用于对在解调器 13 中解调的接收数据进行信道去交织；
30 以及解码器 15，用于对从信道去交织器 14 输出的接收数据进行解码。

AMC 发射机 20 包括：MCS 级别选择器 21，用于根据从 AMC 接收机 10 发射的前向信道特性来选择 MCS 级别；编码器 22，用于根据从 AMC 接收机 10 反馈的 MCS 级别所指的编码速率来对发射数据进行编码；信道交织器 23，用于根据 MCS 级别来对在编码器 22 中编码的发射数据进行信道交织；以及调制器 24，用于根据 MCS 级别所指的调制方法来对从信道交织器 23 输出的发射数据进行调制，并把该发射数据发射到发射天线 25。

AMC 接收机 10 被包括在移动终端内，而 AMC 发射机 20 被包括在基站内。

基站可通过反馈接收的来自移动终端的前向信道的 SNR 来进行 MCS 级别选择。或者，移动终端可根据估计的前向信道的 SNR 来进行 MCS 级别选择，并可进行到基站的反馈。

首先，将对一种用于根据信道特性来对 MCS 级别进行分类的方法进行说明。

图 2 示出了一种根据有关 SNR(信噪比)级别的帧误码率和吞吐量来对各 MCS 级别进行分类的方法。

例如，当信道 SNR 不小于 3.25dB 并不大于 7.25dB 时，2/3 编码速率-QPSK(四相移相键控)调制方法具有的吞吐量比 1/3 编码速率-QPSK 调制方法大。此外，当信道 SNR 不小于 7.25dB 并不大于 9.25dB 时，2/3 编码速率-8PSK(相移键控)调制方法具有的吞吐量比 2/3 编码速率-QPSK 调制方法大。当信道 SNR 不小于 9.25dB 时，2/3 编码速率-16QAM(正交幅度调制)方法具有的吞吐量比 1/3 编码速率-QPSK 调制方法大。

30

因此，当信道 SNR 不大于 3.25dB 时，选择 1/3 编码速率-QPSK 调制方法，当信道 SNR 不小于 3.25dB 并不大于 7.25dB 时，选择 2/3 编码速率-QPSK 调制方法，当信道 SNR 不小于 7.25dB 并不大于 9.25dB 时，选择 2/3 编码速率-8PSK 调制方法，当信道 SNR 不小于 9.25dB 时，选择 2/3 编码速率-16QAM 调制方法。

图 3 是示出参照图 2 的 MCS 级别的表。

如图 3 所示，MCS 级别 1 表示 1/3 编码速率-QPSK 调制方法，MCS 级别 2 表示 2/3 编码速率-QPSK 调制方法，MCS 级别 3 表示 2/3 编码速率-8PSK 调制方法，以及 MCS 级别 4 表示 2/3 编码速率-16QAM 调制方法。

以下将对通用移动通信系统的自适应调制编码(AMC)设备的操作进行说明。

AMC 接收机 10 的信道估计器 12 通过使用来自接收天线 11 的接收信号来估计前向信道特性，并且将估计的前向信道特性从移动终端反馈到基站的 AMC 发射机 20。

AMC 接收机 10 的解调器 14 根据估计的前向信道特性来检测解调方法，并根据检测的解调方法来对接收信号进行解调。解调的接收信号通过信道去交织器 14 和解码器 15 被解码。

当 AMC 发射机 20 接收从 AMC 接收机 10 发射的 MCS 级别时，AMC 发射机 20 的 MCS 级别选择器 21 根据前向信道特性来选择最佳 MCS 级别，并且根据所选的 MCS 级别来对前向信道进行编码、信道交织和调制。

AMC 发射机 20 的编码器 22 根据 MCS 级别的指定编码速率来

对发射数据进行编码，信道交织器 23 根据 MCS 级别来对编码的发射数据进行信道交织，并且调制器根据 MCS 级别的相关调制方法来对发射数据进行调制，并通过发射天线 25 来发射调制的发射信号(发射码元)。

5

如上所述，在通用多媒体通信系统的自适应调制编码(AMC)设备中，可简单地通过根据信道特性改变调制和编码方案来提高发射性能。

10

然而，在采用 AMC 方案来实现发射性能提高的情况下，其数据发射速度的提高难以与为提供各种快速多媒体服务所需的数据发射速度的加快一致。

发明内容

15

为了解决上述问题，本发明的一个目的是提供一种能通过把 AMC(自适应调制编码)与针对每个发射天线均具有独立分层结构的 BLAST(贝尔实验室分层空时)进行组合来提高前向链路的发射速率的移动通信系统的 AMC 设备及其方法。

20

为了实现上述目的，根据本发明的一种移动通信系统的 AMC 设备包括：AMC 接收机，其对来自多个接收天线的接收信号进行 BLAST 解码，并通过发射天线来估计前向信道特性；以及 AMC 发射机，其根据估计的前向信道特性来自适应选择编码速率和调制方法，根据所选的编码速率和调制方法，通过发射天线来对按照发射天线数生成的发射信号层进行编码和调制，并通过 BLAST 编码来把发射信号层同时发射到多个发射天线。

25

30

为了实现上述目的，根据本发明的一种移动通信系统的自适应调制编码(AMC)方法，包括：对通过多个接收天线接收的信号进行 BLAST 解码；通过使用通过发射天线进行 BLAST 解码的码元，利用发射天

线来估计前向信道特性；根据通过发射天线估计的前向信道特性，利用发射天线来自适应地选择前向信道的编码速率和调制方法；根据所选的编码速率和调制方法来对按照发射天线数形成的发射数据层进行编码和调制；以及对这些层的发射数据进行 V-BLAST 编码。

5

附图说明

附图是为了能进一步了解本发明而包含的，并且被纳入本说明书中构成本说明书的一部分，这些附图示出了本发明的实施例，并与本说明书一起用于对本发明的原理进行说明。

10

在附图中：

图 1 是示出通用移动通信系统的 AMC 设备构成的方框图；

图 2 示出了根据信道的 SNR 级别的每个 MCS 级别的通用解释方法；

图 3 是示出通用 MCS 级别的表；

15

图 4 示出了通用 D-BLAST 传输系统的示意性操作方法；

图 5 示出了根据本发明的 D-BLAST 传输系统的示意性操作方法；

图 6 示出了根据具有两个发射天线的 QPSK 中的通用 BLAST 的误码性能；

20

图 7 示出了根据具有四个发射天线的 QPSK 中的通用 BLAST 的误码性能；

图 8 是示出根据本发明的移动通信系统的 AMC 设备构成的方框图；以及

图 9 示出了根据本发明的移动通信系统的 AMC 设备的性能。

25

具体实施方式

首先，将对 BLAST(贝尔实验室分层空时)进行说明。

30

在 BLAST 中，存在多个发射天线和接收天线，各发射天线均发射彼此不同的数据，并且接收天线检测彼此不同的数据。与使用一个天线的情况相比，可通过增加按照天线数同时发射的数据数目来提高

传输性能。

BLAST 被分为 D(对角)-BLAST 和 V(垂直的)-BLAST。这两个 BLAST 对按照发射天线数目顺次输入的发射数据共同进行同时处理，
5 并对这些发射数据进行调制和编码。由于连续输入发射数据，因而形成位串，即层。D-BLAST 和 V-BLAST 之间的区别是用于发射各层的发射天线是否在形成层之后周期性变更。

图 4 示出了 D-BLAST 传输系统的示意性操作方法。

10

该 D-BLAST 传输系统通过另一发射天线周期性发射从某一层输出的数据。因此，每个层的数据在时空轴线上对角传输。

图 5 示出了 V-BLAST 传输系统的示意性操作方法。

15

V-BLAST 传输系统通过特定发射天线来发射各层的数据。因此，每个层的数据在时空轴线上 (spital and temporal axes) 具有垂直形式。

图 6 示出了根据具有两个发射天线的 QPSK 中的通用 BLAST 的
20 误码性能。

使用 BLAST 的接收系统可通过使用诸如 ZF(迫零)、MMSE(最小均方误差)和 INV 等那样的方法来检测从各发射天线发射的传输数据。

25 当接收系统在接收信号检测中补偿信道影响时，在通过使信道应答矩阵的伪逆矩阵与接收信号相乘来仅进行调零(nulling)的 INV 方法，以及进行调零和取消(MMSE, ZF)的方法中，按照接收天线数来改变误码性能。接收天线数越多，误码性能表现就越好。

30 图 7 示出了根据具有四个发射天线的 QPSK 中的 BLAST 的误码

性能。如图 7 所示，接收天线数越多，误码性能表现就越好。

如上所述，在 BLAST 中，采用通过多个天线来独立发送彼此不同的数据的方式，可提高发射速率。

5

在本发明中，为了提高数据传输容量，将提出一种用于把 AMC 与 BLAST 进行组合，并根据 BLAST 组合来使用有关各前向信道的自适应调制编码方案的方法。

10

以下将参照附图，对本发明的优选实施例进行说明。

图 8 是示出根据本发明的移动通信系统的 AMC 设备构成的方框图。

15

如图 8 所示，根据本发明的移动通信系统的 AMC 设备包括：AMC 接收机 100，用于通过检测通过多个接收天线 110 接收的接收信号，通过发射天线来估计前向信道特性，并对估计的前向信道特性进行反馈；以及包括 AMC 发射机 200，用于根据反馈的前向信道特性，通过发射天线来选择 MCS 级别，按照发射天线数来形成传输数据层，

20 根据 MCS 级别，通过发射天线来对发射数据进行编码和调制，并把这些发射数据同时发射到发射天线。

20

AMC 接收机 100 被包括在移动终端内，并且 AMC 发射机 200 被包括在基站内。

25

AMC 接收机 100 包括：BLAST 解码器 120，用于通过使用通过多个接收天线接收的接收信号，通过发射天线对符号进行 BLAST 解码；信道估计器 130，用于通过使用从 BLAST 解码器 120 输出的码元，通过发射天线来估计前向信道特性；解调器 140，用于根据在信道估计器 130 中估计的前向信道特性来检测解调方法，并根据解调方法，

30

通过发射天线来对来自 BLAST 解码器 120 的码元进行解调；信道去交织器 150，用于通过发射天线来对在解调器 140 中解调的数据进行信道去交织；以及解码器 160，用于通过发射天线来对从信道去交织器 150 输出的数据进行解码。

5

AMC 发射机 200 包括：MCS 级别选择器 210，用于根据从 AMC 接收机 100 反馈的前向信道特性来选择发射天线的 MCS 级别；编码器 220，用于根据所选的 MCS 级别的相关编码速率，通过发射天线来对发射数据进行编码；信道交织器 230，用于根据 MCS 级别，通过发射天线来对在编码器 220 中编码的发射数据进行信道交织；调制器 240，用于根据 MCS 级别的相关调制方法，通过发射天线来对从信道交织器 230 输出的发射数据进行调制；以及 BLAST 处理单元 250，用于把在调制器 240 中调制的各层传输码元并行发射到相关发射天线 260，以使这些传输码元在空时轴线上具有垂直形式。

15

MCS 级别选择器 210 可包括在基站的 AMC 发射机 200 或者移动终端的 AMC 接收机 100 内。当 MCS 级别选择器 210 可包括在移动终端的 AMC 接收机 100 内时，移动终端的 AMC 接收机 100 根据估计的前向信道质量来选择发射天线的最佳 MCS 级别，并把所选的 MCS 级别反馈到基站。在本发明的本实施例中，MCS 级别选择器 210 被包括在基站的 AMC 发射机 200 内。

20

在根据本发明的使用多个发射天线 250 和接收天线 110 的移动通信系统中，自适应调制编码方法可单独应用于每个前向信道，也可共同应用于前向信道。

25

在此，AMC 模式用于使自适应调制编码方法应用于多个前向信道，而且它可分为共同 MCS 模式和单独 MCS 模式。该 AMC 模式可在运行时间中更改。

30

共同 MCS 模式使 MCS 级别共同应用于 AMC 发射机 200 的所有发射天线 250，即：使自适应调制编码方法共同应用于前向信道。相反，单独 MCS 模式使各 MCS 级别应用于 AMC 发射机 200 的各发射天线 250，即：使每个 MCS 级别适用于各个前向信道。

5

在共同 MCS 模式中，移动终端把有关前向信道特性中的质量最低的前向信道特性的 MCS 级别反馈到基站。然后，基站选择质量最低的前向信道特性的 MCS 级别，并把所选的 MCS 级别共同应用于所有前向信道。

10

在单独 MCS 模式中，移动终端估计有关每个前向信道的信道质量，并且基站根据估计的前向信道的信道质量来选择每个 MCS 级别，并把每个 MCS 级别应用于每个前向信道。

15

以下将对根据本发明的移动通信系统的 AMC 设备的操作进行说明。

该 AMC 模式是在移动终端和基站之间同时操作的。

20

AMC 接收机 100 的 BLAST 解码器 120 把通过多个接收天线 110 接收的接收信号构成为接收矢量，在检测特定码元的同时，把其他码元视为干扰信号，估计特定码元，并从接收矢量中减去事先检测的信号分量，因此它在使每个码元的影响最小的同时，通过发射天线来估计每个码元。

25

AMC 接收机 100 的信道估计器 130 通过使用从 BLAST 解码器 120 输出的码元，通过发射天线来估计前向信道特性，并且 AMC 接收机 100 把估计的前向信道特性反馈到基站的 AMC 发射机 200。

30

AMC 接收机 100 的解调器 140 根据在信道估计器 130 中估计的

前向信道特性来检测每个前向信道的解调方法，并根据解调方法，通过发射天线来对来自 BLAST 解码器 120 的码元进行解调。通过发射天线解调的码元在顺次通过信道去交织器 150 和解码器 160 时被解码。

5

同时，基站的 AMC 发射机 200 根据从移动终端反馈的前向信道特性来选择最佳 MCS 级别。例如，在共同 MCS 模式中，AMC 发射机 200 根据质量最低的前向信道特性来选择最佳 MCS 级别，并把所选的 MCS 级别共同应用于所有前向信道。在单独 MCS 模式中，AMC 发射机 200 选择有关每个前向信道特性的最佳 MCS 级别，并把每个 MCS 级别适用于相关前向信道。

10

此处，将对根据前向信道特性的 MCS 级别选择方法进行说明。

15

参照附图 2 和 3，当前向信道的 SNR 在 3.25dB~7.25dB 的范围内时，该 MCS 级别选择器 210 选择 MCS 级别 2。当前向信道的 SNR 在 7.25dB~9.25dB 的范围内时，MCS 级别选择器 210 选择 MCS 级别 3。

20

AMC 发射机 200 的编码器 220 按照发射天线数来对传输数据进行解复用，并对按照发射天线数生成的层的发射数据进行编码。

25

例如，参照附图 3，当选择 MCS 级别 2 时，AMC 发射机 200 的编码器 220 根据 MCS 级别 2 的编码速率，对各层的传输数据(通过发射天线的发射数据)进行编码，信道交织器 230 根据 MCS 级别 2，通过发射天线来对编码的发射数据进行信道交织，并且调制器 240 根据 MCS 级别 2 的调制方法(QPSK)，通过发射天线来对信道交织的发射数据进行调制。

30

BLAST 处理单元 250 通过发射天线来把发射码元并行发射到各

发射天线 260，以使通过发射天线调制的发射码元在时空轴线上具有垂直形式。例如，当存在四个发射天线时，通过同时发射四个发射码元，可使发射速率与具有一个发射天线的情况相比快四倍。

5 如上所述，基站包括多个发射天线，通过按照发射天线数对发射数据进行解复用，通过发射天线来形成 3 个数据层，根据由移动终端估计的前向信道特性来选择前向信道的 MCS 级别，根据所选的前向信道的 MCS 级别来对发射数据层进行编码和调制，并通过多个发射天线来同时发送发射数据层，因此可进一步提高发射速率。

10

图 9 示出了根据本发明的移动通信系统的 AMC 设备的性能。

与包括一个发射天线和一个接收天线在内并使用有关一个前向信道的自适应调制编码方法的常规 AMC 设备相比，根据本发明的 AMC 15 设备对于相同 SNR 表现为吞吐量好得多。

此外，在根据本发明的 AMC 设备中，当与两个发射天线(2Tx)相比，在四个发射天线(4Tx)中获得的吞吐量要好得多时，发射天线数越多，根据本发明的 AMC 设备的发射性能提高得就越大。

20

如上所述，在本发明中，通过把多个发射天线和接收天线包括在移动终端内；通过对通过接收天线在移动终端接收的信号进行 BLAST 解码，通过发射天线来估计前向信道特性；根据估计的前向信道特性来选择前向信道的最佳 MCS 级别；按照发射天线数对将从基站发射到移动终端的发射数据进行解复用；根据所选的 MCS 级别，通过 25 发射天线来对解复用的发射数据进行编码和调制；以及通过多个发射天线来同时发射通过发射天线调制的发射码元，可进一步提高数据发射速率。

图1
现有技术



图2

现有技术

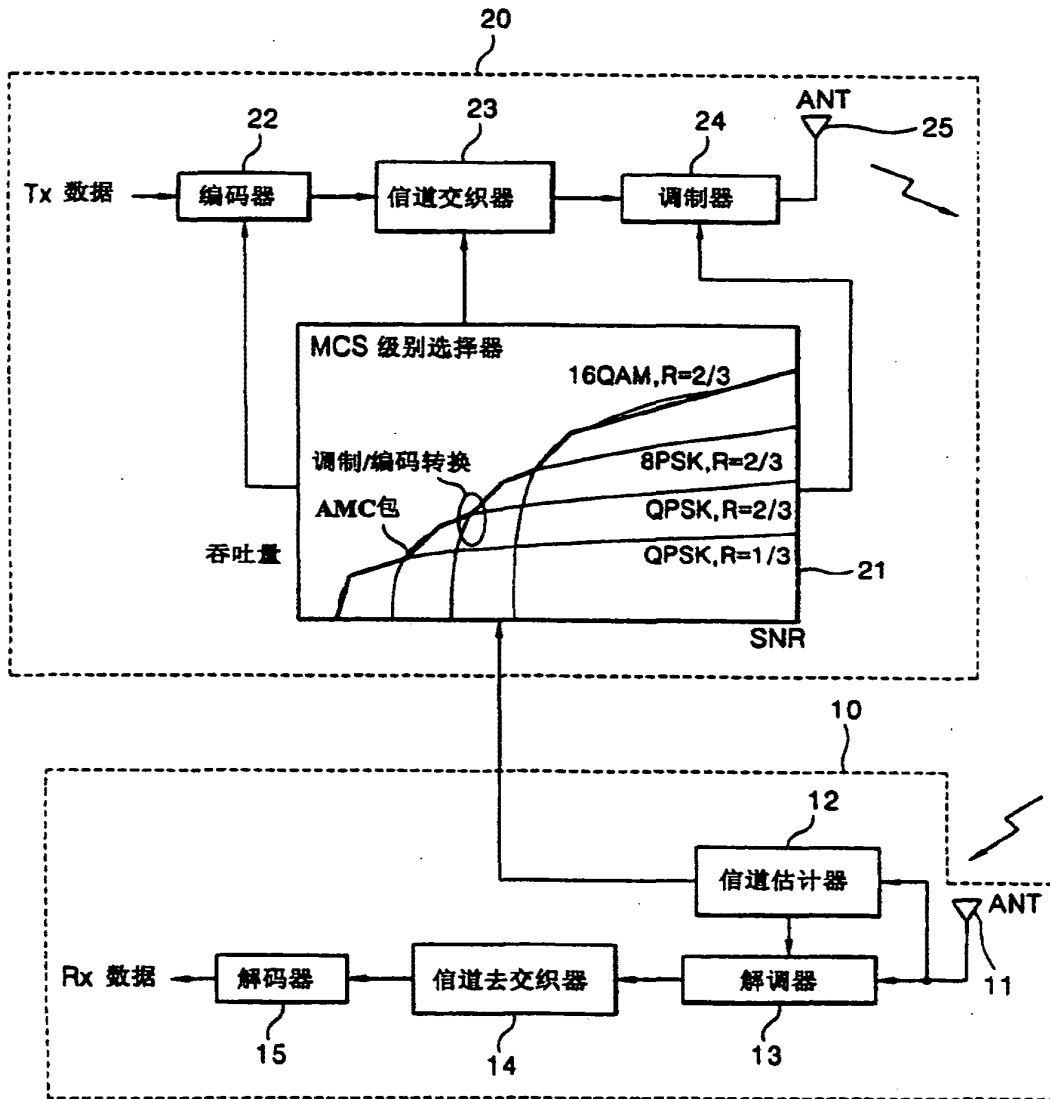

图3
现有技术

MCS	编码率	调制
1	1/3	QPSK
2	2/3	QPSK
3	2/3	8PSK
4	2/3	16QAM

图4
现有技术

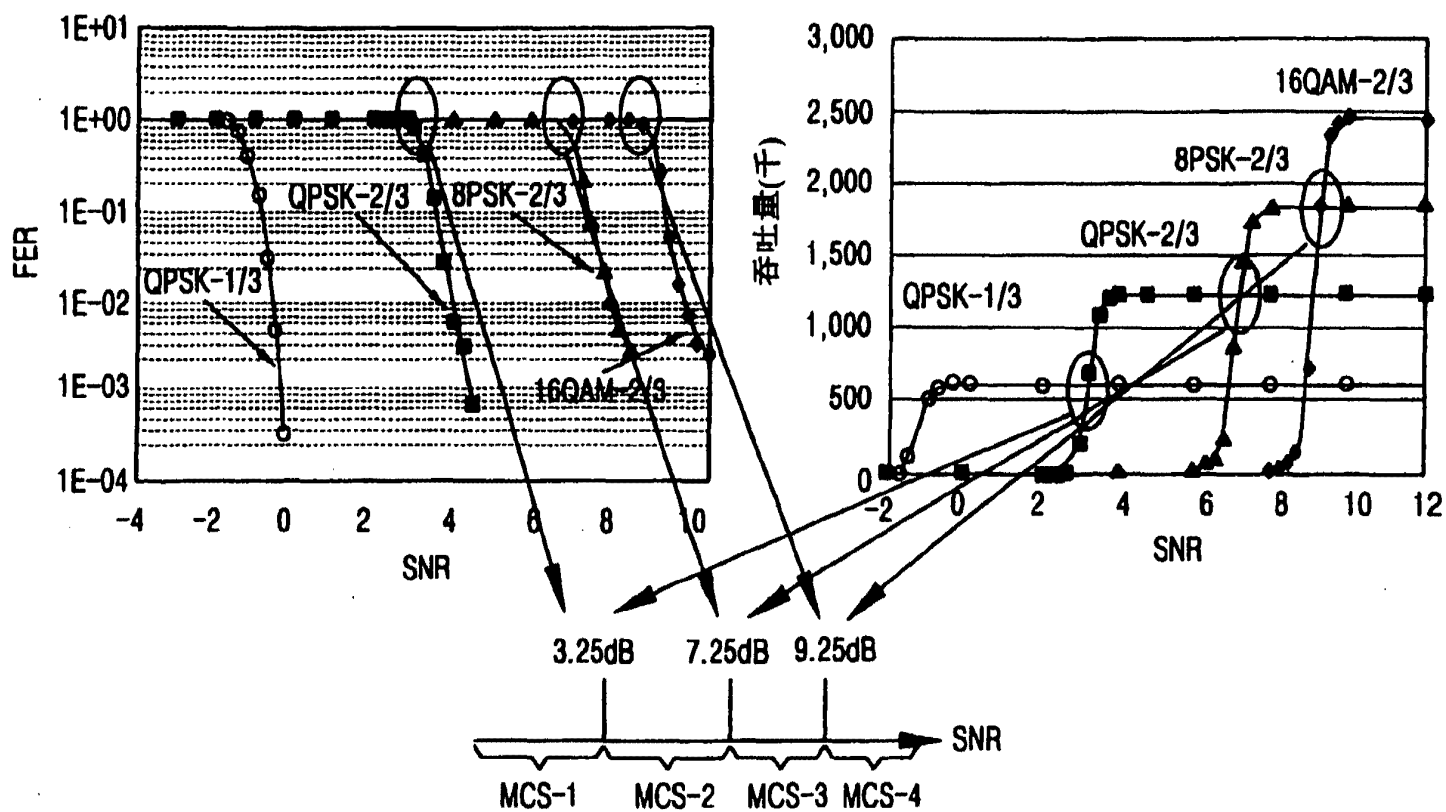

图5
现有技术



图6
现有技术

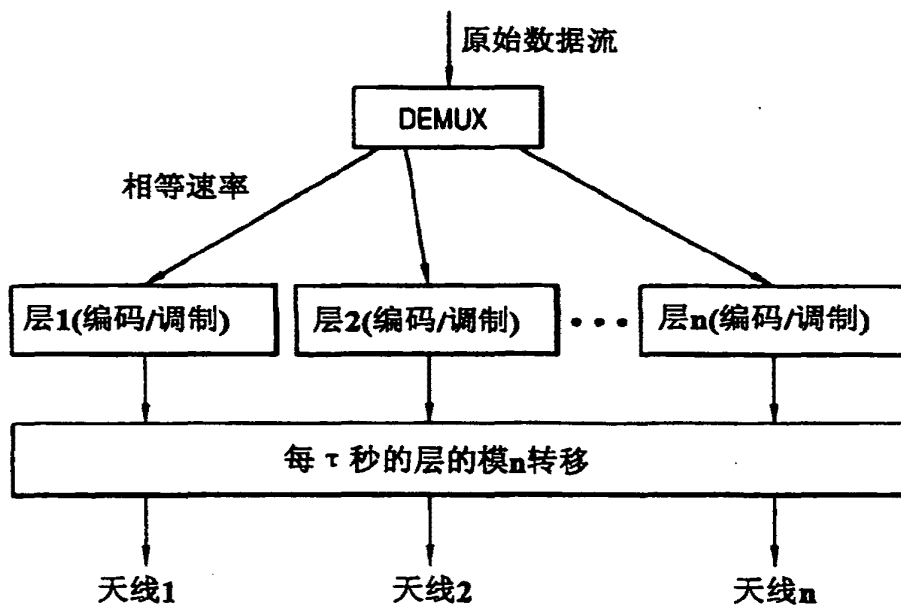

图7
现有技术

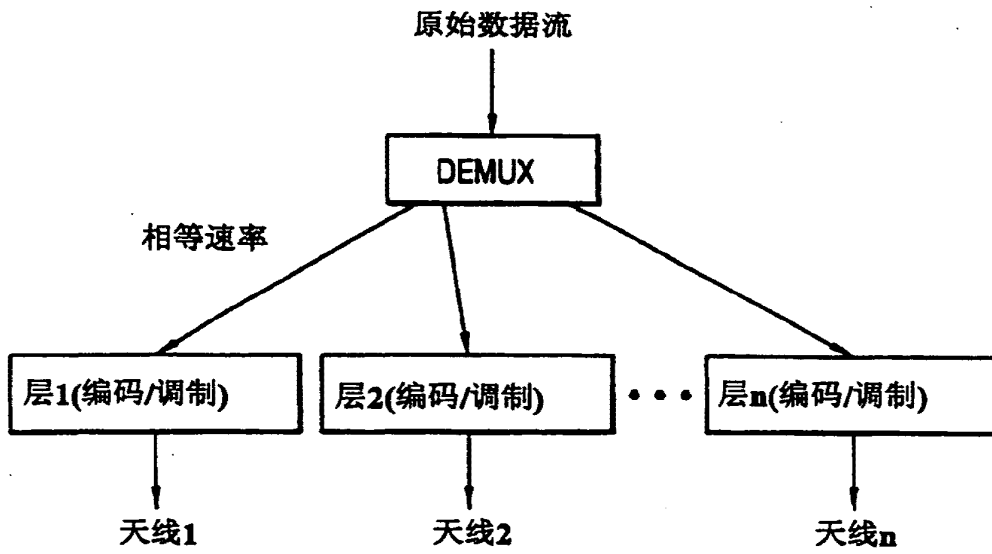

图8



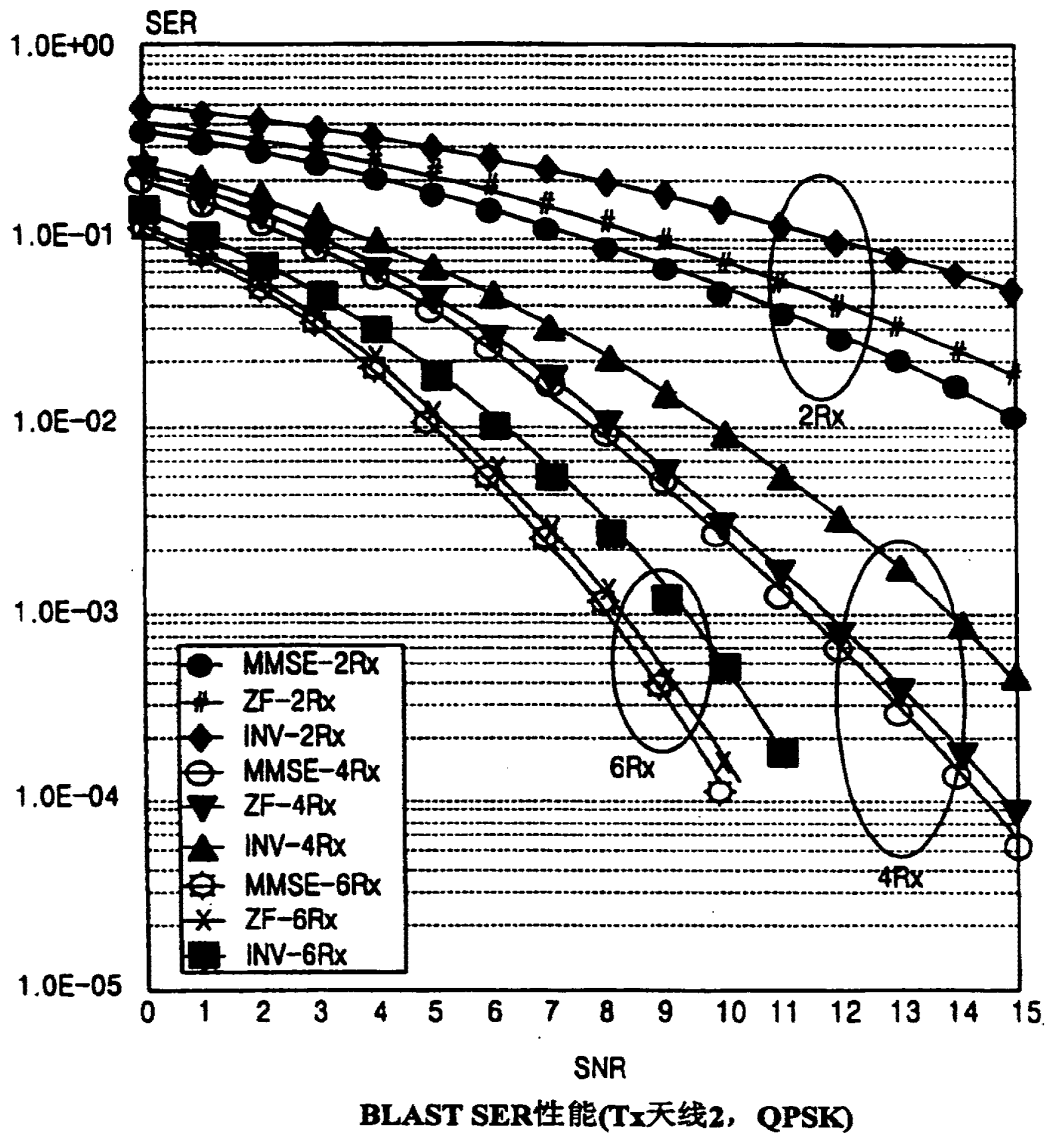

图9

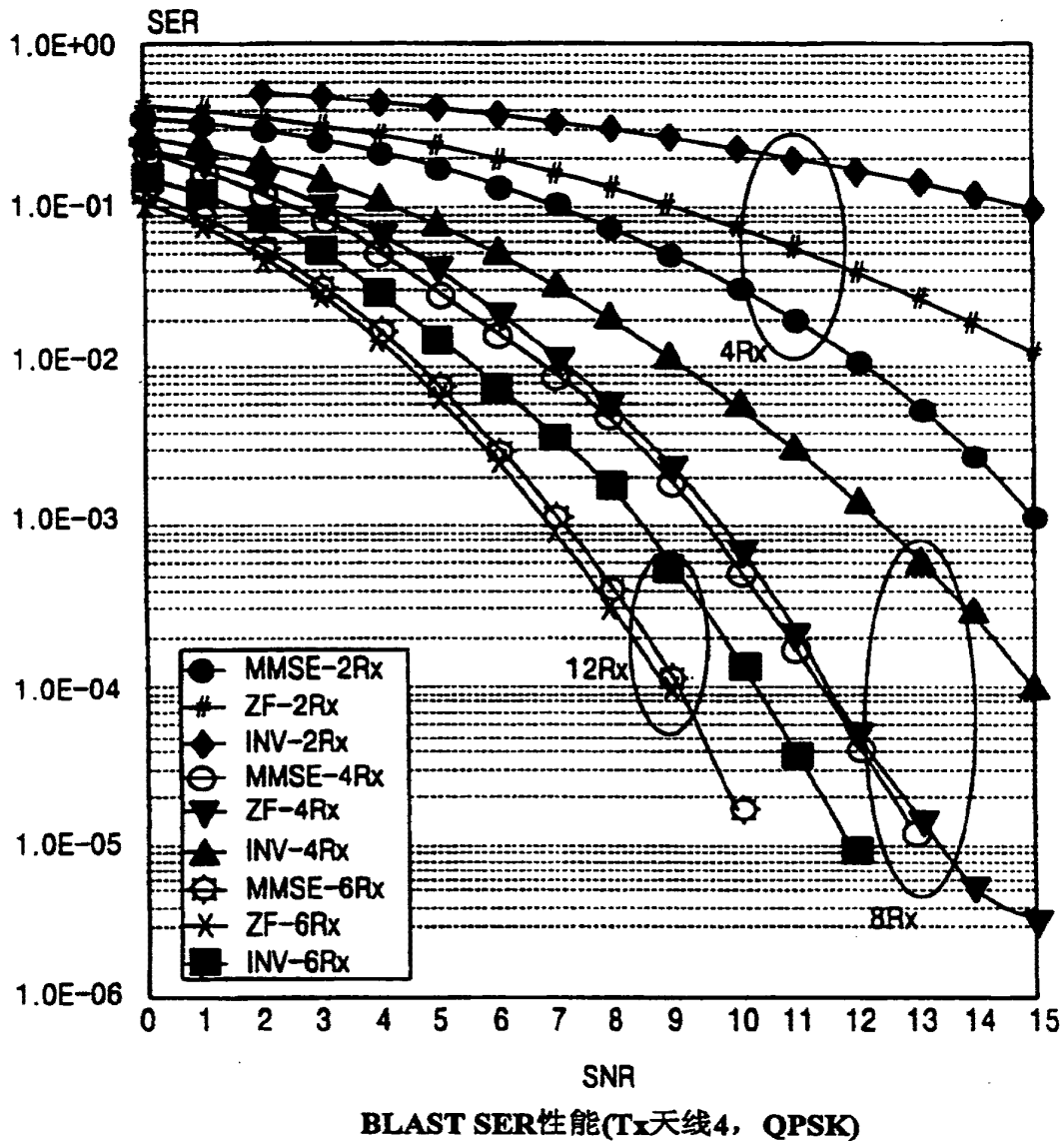

Self-adaptive modulating and coding method**Publication number:** CN1466297**Publication date:** 2004-01-07**Inventor:** WEI YUEJUN (CN)**Applicant:** HUAWEI TECH CO LTD (CN)**Classification:****- International:** *H03M13/35; H04J13/00; H04Q7/20; H03M13/00; H04J13/00; H04Q7/20; (IPC1-7): H04J13/00; H03M13/35; H04Q7/20***- European:****Application number:** CN20021022970 20020613**Priority number(s):** CN20021022970 20020613**Also published as:** CN1225854C (C)**Report a data error here****Abstract of CN1466297**

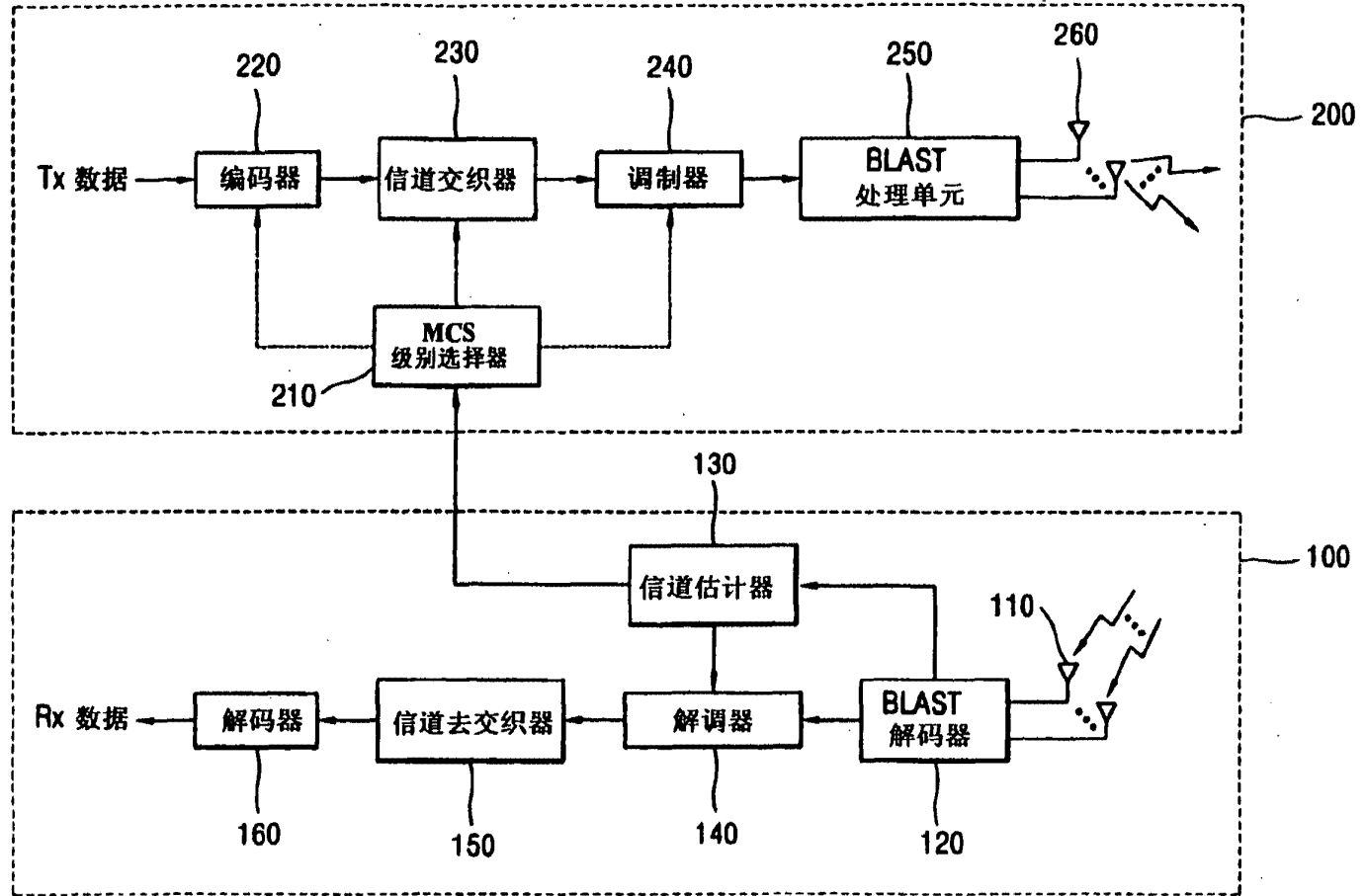
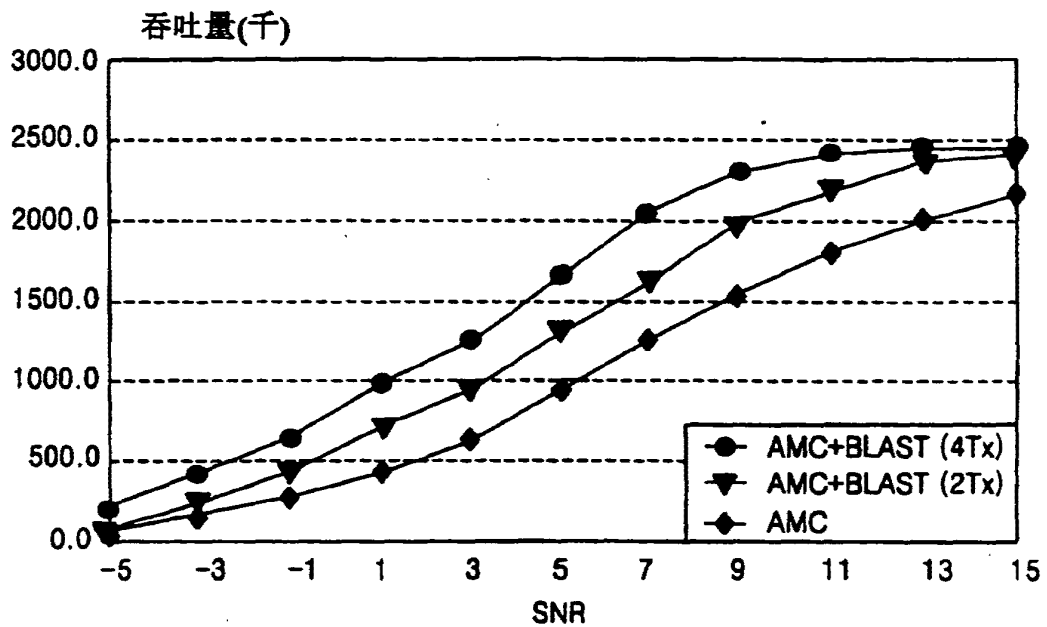
This invention relates to a modulation coding technology for radio or wire communication, solving the problem of misdelivery and low efficiency resulted by channel fluctuation in multicarrier and changeable single carrier system. A self adaptive modulation and coding method includes: a. before delivery, the sending terminal predicts a signal-to-noise ratio and channel fluctuation parameter in a transmission unit to be sent by a forward channel, b. the sending uses the predicted SN ratio and channel fluctuation to determine the modulation way and code rate c. to modulated and code to make themmore reasonable.

Data supplied from the *esp@cenet* database - Worldwide



[12] 发明专利申请公开说明书

[21] 申请号 02122970.8

[43] 公开日 2004 年 1 月 7 日

[11] 公开号 CN1466297A

[22] 申请日 2002.6.13 [21] 申请号 02122970.8

[71] 申请人 华为技术有限公司

地址 518057 广东省深圳市科技园科发路华为用户服务中心大厦

[72] 发明人 魏岳军

权利要求书 2 页 说明书 8 页 附图 3 页

[54] 发明名称 一种自适应调制与编码方法

[57] 摘要

本发明涉及无线或者有线通信中的调制编码技术，解决了多载波系统以及快变的单载波系统中信道波动造成的误发送和效率低下的问题。一种自适应调制与编码方法，其特征在于包括以下步骤：

- a. 发送端在发送前预测前向信道要发送的传输单元内的信噪比和信道波动参数；
- b. 使用该预测到的信噪比及信道波动两个参数来共同确定调制方式与编码率；
- c. 发送端根据确定的调制方式与编码率进行调制与编码。通过本技术方案，使得在多载波系统或者快变单载波系统中的编码与调制更趋于合理化，从而有效的提高了系统的频谱效率。

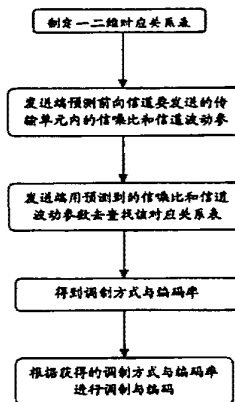

ISSN 1008-4274

- 1、一种自适应调制与编码方法，其特征在于包括以下步骤：
 - a、发送端在发送前预测前向信道要发送的传输单元内的信噪比和信道波动参数；
 - 5 b、使用该预测到的信噪比及信道波动两个参数来共同确定调制方式与编码率；
 - c、发送端根据确定的调制方式与编码率进行调制与编码。

- 2、如权利要求 1 所述的自适应调制与编码方法，其特征在于进一步还包括以下步骤：
 - 10 a1、制定一个二维调制编码方法与信噪比及信道波动参数相对应的关系式，该关系式中至少包括预先制定好的信噪比及信道波动参数与相对应调制编码方法数据；
 - b1、发送端用预测到的信噪比和信道波动参数去查找该对应关系式，获得调制方式与编码率。

- 15 3、如权利要求 2 所述的自适应调制与编码方法，其特征在于，所述二维调制编码方法与信噪比及信道波动参数的对应关系式的描述形式可以是一个二维自适应调制与编码 AMC (adaptive modulation/coding) 表。

- 4、如权利要求 2 所述的自适应调制与编码方法，其特征在于，所述二维调制编码方法与信噪比及信道波动参数的对应关系式的描述形式可以是一个函
20 数图或曲线图。

- 5、如权利要求 2、3 或 4 所述的自适应调制与编码方法，其特征在于所述预先制定好的信噪比及信道波动参数与相对应的编码方法数据，可以通过仿真获得。

- 6、如权利要求 2 所述的自适应调制与编码方法，其特征在于所述的信噪比和信道波动参数是发生在一个发送单元内的信噪比和信道波动参数。
- 7、如权利要求 2 或 6 所述的自适应调制与编码方法，其特征在于所述的信噪比和信道波动为平均信噪比和平均信道波动参数。
- 5 8、如权利要求 7 所述的自适应调制与编码方法，其特征在于所述的信道波动参数可以是符号信噪比的标准差、峰谷比或者等效线性斜率。
- 9、如权利要求 2 所述的自适应调制与编码方法，其特征在于步骤 b 中所述的发送端预测前向信道要发送的传输单元内的平均信噪比和信道波动参数，是通过接收端估计前次前向信道的信噪比和信道波动参数并反馈给发送端
10 的方式完成的。
- 10、 如权利要求 2 所述的自适应调制与编码方法，其特征在于步骤 b 中所述的发送端预测前向信道要发送的传输单元内的平均信噪比和信道波动参数，是通过发送端估计前次后向信道的信噪比和信道波动参数的方式完成的。

一种自适应调制与编码方法

技术领域

- 5 本发明涉及通信技术领域，尤其涉及无线或有线通讯中的调制编码技术。

技术背景

目前，第三代移动通信中的高速数据业务，如 WCDMA 中高速下行包数据接入 (HSDPA, high speed downlink packet access) 及 cdma2000 中增强数据
10 与音频业务 (1xEV-DV)，都采用了自适应调制编码技术 (AMC, adaptive modulation/coding)，它利用信道信息自适应地决定当前发送数据包的调制与编码方式。自适应调制编码通过改变调制和编码方案来动态地调整发送信号，以适应发送端与接收端之间的信道变化。系统不断检查当前信道状况，为每个用户设定最佳的调制编码方案。在衰落信道中，采用 AMC 可以显著增加系统的
15 吞吐量。

以下是现有 AMC 技术的具体描述：

假设 A、B 两点进行通信，考虑 A 到 B 使用 AMC 的情形，称 A→B 为前向信道，B→A 为后向信道，典型的实例如 A 是基站端，B 是用户端 (UE)，但 AMC 的应用情景不限于此。

- 20 (1) A 端在某次发送之前，首先预测前向信道当前的信噪比 (一个发送单元内的平均信噪比)，其预测依据可以是：
- a、在频分双工 FDD 系统中，B 端估计信噪比并将结果通过某种方式反馈给 A 端作为预测依据；
 - b、在时分双工 TDD 系统中，A 端认为前后向有相同的信道特性，因而 A 端
25 估计后向信道的信噪比，以此作为预测前向信道的依据。

其预测方法包括但不限于：

- a、对 FDD, 最简单的方法是认为将要发送的信道的信息近似等于前次发送时的信道信息, 此信息已经被 B 端估计出且已返回到 A 端;
- b、对 TDD, 最简单的方法是认为将要发送的前向信道的信息近似等于刚刚接收的后向信道的信息, 此信息已经被 A 端估计出。
- 5 (2) A 端用预测的信噪比去查事先制定的 AMC 表, 得知合适的编码及调制方式。

(3) AMC 表列出了给定信道信噪比时, 在保证错误率不高于某个特定值的前提下, 选择频谱效率最好的调制、编码方式。AMC 表一般是通过事先的仿真建立的。

- 10 表 1 是 AMC 表的示例, 本表是按 5% 的目标误帧率设计的。表中假设信噪比 SNR 只取整数值。由于预测得到的 SNR 不可能相当精确, 故此将 SNR 表示成整数就足够了。例如预测的信噪比是 10dB, 那么查表 1 可知适合的调制方式为 16QAM, 编码率为 1/3。

SNR 范围(dB)	≤2	3~5	6~7	8~11	12~15	16~20	21~22	≥23
调制方式	QPSK	QPSK	16QAM	16QAM	16QAM	64QAM	64QAM	64QAM
编码率	1/4	1/3	1/4	1/3	1/2	1/2	2/3	3/4
频谱效率 (bps/Hz)	1/2	2/3	1	4/3	2	3	4	4.5

15

表 1 AMC 表示例

- 上述的 AMC 只考虑了当前的信噪比, 没有考虑信道波动情况。对于多载波系统如正交频分多路系统 (OFDM, Orthogonal Frequency Division
- 20 Multiplexing) 以及快变的单载波系统, 信道波动是一个不可忽视的问题。某一次发送的错误率不仅取决于此次发送时的信噪比, 还同此次发送时的信道波动情况有关, 此处所说的信道波动是指发生在一个发送单元内的信道波动,

对于 OFDM 系统，它就是频率选择性衰落；对于时间快变的单载波系统，它是时间选择性衰落。

图 1 是信道波动的示例，横坐标代表一个调制编码块（数据发送单元）中的各符号。图 1 中一个调制编码块共有 192 个符号，序号从 1 至 192；纵坐标代表各符号的信噪比。根据该曲线图，可以计算出该调制编码块的各符号的信噪比均值 SNR 和标准差 σ ，对于 OFDM 系统，横坐标代表频率（子载波）；对于单载波系统，横坐标代表时间，对于 OFDM 系统，信道被划分为多个子信道（载波），符号序号（横坐标）就代表了某个时刻各的子信道（载波），符号信噪比方差 σ 代表某时刻各子信道之间的波动大小；而对于单载波系统，符号序号则代表了信道（载波）的不同时刻，因此 σ 代表了该信道的不同时刻的波动大小，可以从图中查得，不管在何种系统中， σ 都体现了信道的波动，只是信道的具体形式不同。

图 2 是几种调制编码（turbo 码）组合在有信道波动的情形下，达到接收误帧率 FER = 5% 所需的信噪比。图中波动是以各符号功率的标准差衡量的。从图中可见波动的影响是不可忽视的。以 64QAM 为例，无波动和波动为 6dB 所对应的所需 SNR 相差达 6dB 之巨。

在这种情况下，如果 AMC 表按无波动来设计，那么当信道有波动时等于系统在使用一个错误设计的 AMC 表，系统运行时将由于首次发送的错误率过高而导致效率下降。如果按波动最大来设计，则在波动较小时，系统设计过于保守。造成的后果是，本来可以使用高频谱效率的调制编码方式，但因 AMC 表设计过于保守，使得系统被迫运行在较低频谱效率的调制编码方式上。

发明内容

本发明就是针对这种情况提出的，目的在于通过引入信道波动参数，而改进、完善调制编码方法与相关参数的对应关系表的设计，从而在确定调制编码方式时，可以得到更精确合理的结果。

本发明的技术方案是这样的：

一种自适应调制与编码方法，其特征在于包括以下步骤：

- a、发送端在发送前预测前向信道要发送的传输单元内的信噪比和信道波动参数；
- b、使用该预测到的信噪比及信道波动两个参数来共同确定调制方式与编码率；
- c、发送端根据确定的调制方式与编码率进行调制与编码。

所述的方法进一步还包括以下步骤：

- a1、制定一个二维调制编码方法与信噪比及信道波动参数相对应的关系式，该关系式中至少包括预先制定好的信噪比及信道波动参数与相对应调制编码方法数据；
- b1、发送端用预测到的信噪比和信道波动参数去查找该对应关系式，获得调制方式与编码率。

所述二维调制编码方法与信噪比及信道波动参数的对应关系式的描述形式可以是一个二维自适应调制与编码 AMC (adaptive modulation/coding) 表。

所述二维调制编码方法与信噪比及信道波动参数的对应关系式的描述形式可以是一个函数图或曲线图。

所述预先制定好的信噪比及信道波动参数与相对应的编码方法数据，可以通过仿真获得。

所述的信噪比和信道波动参数是发生在一个发送单元内的信噪比和信道波动参数。

所述的信噪比和信道波动为平均信噪比和平均信道波动参数。

所述的信道波动参数可以是符号信噪比的标准差、峰谷比或者等效线性斜率。

所述的步骤 b 中所述的发送端预测前向信道要发送的传输单元内的平均信噪比和信道波动参数，是通过接收端估计前次前向信道的信噪比和信道波动参数并反馈给发送端的方式完成的。

所述的步骤 b 中所述的发送端预测前向信道要发送的传输单元内的平均信噪比和信道波动参数，是通过发送端估计前次后向信道的信噪比和信道波动参数的方式完成的。

传统的调制编码方法与信噪比及信道波动参数的对应关系表仅根据信噪比一个参数来选择编码、调制方式。本发明是在一维 AMC 的基础上，把信道波动这一因素也加进去，这样，得到的编码率及调制方式更为合理，误差也大为减小。

通过使用本发明的一种自适应调制与编码方法，使得在多载波系统或者快变单载波系统中的编码与调制更趋于合理化，大大提高了系统的频谱效率同时减少了错误率。

附图说明

图1是信道波动的示例图；

图2是信道波动对自适应调制、编码所需信噪比的影响曲线图；

图3是本发明使用二维AMC的系统构成图；

图4是一个使用一维AMC和二维AMC的频谱比较图；

图5是本发明使用后，频谱改善对比量图；

图6是本发明的流程图。

具体实施方式

下面结合附图来说明本发明的具体实施方式。

本发明是在传统的配置调制方式及编码率只使用一个信噪比参数的基础上，增加一个信道波动参数，通过发送端在发送前预测前项信道要发送的传输单元内的信噪比及信道波动参数，进而再使用该预测到的信噪比及信道波动两个参数来共同确定调制方式与编码率，发送端则根据确定的调制方式与编码率进行调制与编码。

首先，制定一个调制编码方法与信噪比及信道波动的对应关系式，该关系式除了传统的信噪比参数以外，还加入信道波动参数。该关系式的形式可以有多种，可以是一个 AMC 表，也可以是一个函数或曲线图，这可随设计者的不同喜好而选择，在本实施例中，选取一个二维的 AMC 表，这与传统的习惯相符，其中纵向方向数据为信噪比，横向方向数据为信道波动。该预先制定好的相对应的信噪比和信道波动参数及调制编码方法数据，可以通过仿真来获得。

在本发明中，该信道波动是发生在一个发送单元内的信道波动，具体可以是符号信噪比的标准差、峰谷比或者是等效线性斜率等，在本实施例中选用符号信噪比的标准差（以 σ 表示）。

为了方便，我们把不同的调制编码组合用一个数字 MCS 表示，MCS 的定义见表 2。

MCS	调制 M	编码率 cr	频谱效率 (bps/Hz)
1	QPSK	1/4	0.5
2	QPSK	1/3	0.67
3	QPSK	1/2	1
4	16QAM	1/4	1
5	QPSK	2/3	1.33
6	16QAM	1/3	1.33
7	16QAM	1/2	2
8	16QAM	3/4	3
9	64QAM	1/2	3
10	64QAM	2/3	4
11	64QAM	3/4	4.5

表 2 AMC 档次定义

表 3 是本发明实际设计的一个二维 AMC 表。

MCS	σ (dB)						
	0	1	2	3	4	5	6

SNR (dB)	-2	1	1	1	1	1	1	1
	-1	1	1	1	1	1	1	1
	0	2	2	2	1	1	1	1
	1	2	2	2	2	2	1	1
	2	3	3	2	2	2	2	1
	3	3	3	3	3	2	2	2
	4	5	5	3	3	3	2	2
	5	5	5	6	6	4	4	2
	6	5	5	6	6	6	4	4
	7	7	7	6	6	6	6	4
	8	7	7	7	7	6	6	6
	9	7	7	7	7	7	6	6
	10	7	7	7	7	7	7	6
	11	8	8	7	7	7	7	6
	12	8	8	8	7	7	7	7
	13	8	8	8	9	9	7	7
	14	8	8	8	9	9	7	7
	15	10	10	9	9	9	9	7
	16	11	11	10	10	9	9	9
	17	11	11	11	10	10	9	9
	18	11	11	11	11	10	9	9
	19	11	11	11	11	11	10	9
	20	11	11	11	11	11	10	9
	21	11	11	11	11	11	11	10
	22	11	11	11	11	11	11	10
23	11	11	11	11	11	11	11	
24	11	11	11	11	11	11	11	

表 3 二维 AMC 表示例

- 5 如图 3 所示, 本发明的二维 AMC 表和传统一维 AMC 表的差别在于把原来的一维 AMC 表换成二维 AMC 表, 增加了一个信道波动参数。在二维 AMC 表中, 如果不使用信道波动参数, 则自动变成一个一维 AMC 表, 因此, 该信道波动参数也可以不使用, 这样, 本发明的二维对应关系表, 实际上就是传统意义上的一维 AMC 表。
- 10 如图 3 所示, 系统预测前向信道要发送的一个传输单元内的平均信噪比和信道波动, 如果是在频分双工 FDD 系统中, 可以由接收端估计信噪比和信道波动参数, 并以一定的方式反馈给发送端作为测试依据; 如果是在时分双工的 TDD

系统中，可以通过发送端估计前次后向信道的信噪比和信道波动参数的方式完成的，在本实施例中，可以选择一个 FDD 系统。

其次，使用该预测到的信噪比及信道波动两个参数来共同确定调制方式与编码率，发送端用预测到的信噪比和信道波动参数去查找该对应关系式，获得
5 调制方式与编码率。

在本实施例中，可以做一个具体的查询，如平均信噪比为 10dB，信道波动为 5dB，那么在 AMC 表中查找可得，应使用的调制方法为 MCS7，即使用 16QAM，编码率为 1/2，频谱效率为 2bps/Hz 的调制编码方法。

最后，发送端根据确定的调制方式与编码率进行调制与编码，即可完成本
10 发明一种自适应调制与编码方法。

通过本发明一种自适应调制与编码方法的使用，使得在多载波系统或者快变单载波系统中的编码与调制更趋于合理化，大大提高了系统的频谱效率同时减少了错误率。

如图 4 所示，是根据前述的 AMC 设计，在 3GPP CASE1 信道，OFDM 系统中
15 通过仿真得到的一维 AMC 和二维 AMC 的频谱效率比较（也即吞吐量）。系统带宽为 5MHz，分为 192 个子载波，一个调制编码块占两个 OFDM 符号。系统采用 I 类混合 ARQ，最大重发次数为 16。

图 5 是二维 AMC 相对于一维 AMC 的频谱效率改善量，最大可改善 50%。
20 信噪比特别高及特别低时，因为 AMC 选择处在最高和最低的档次，故二者性能相当。

图 6 即是本发明一具体实施方式的流程图。

以上所述，仅为本发明较佳的具体实施方式，但本发明的保护范围并不局限于此，任何熟悉该技术的人在本发明所揭露的技术范围内，可轻易想到的变化或替换，都应涵盖在本发明的保护范围之内。因此，本发明的保护范围
25 应该以权利要求书的保护范围为准。

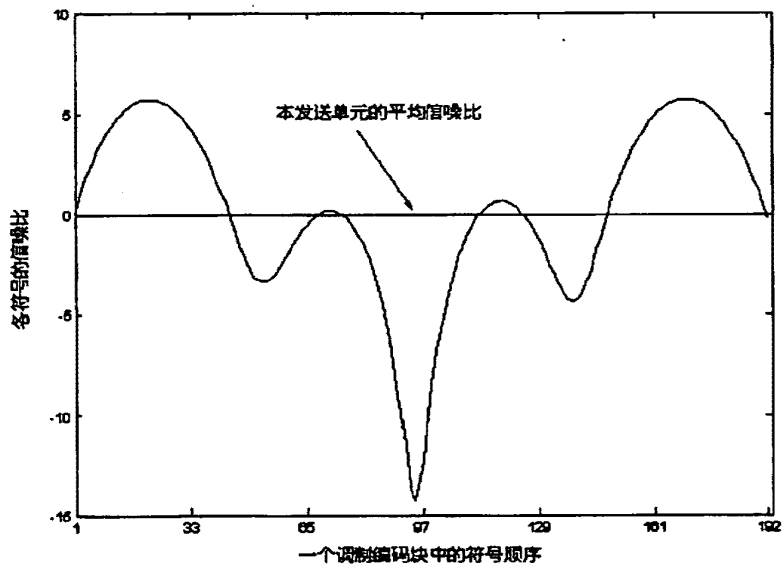

5

图 1

10

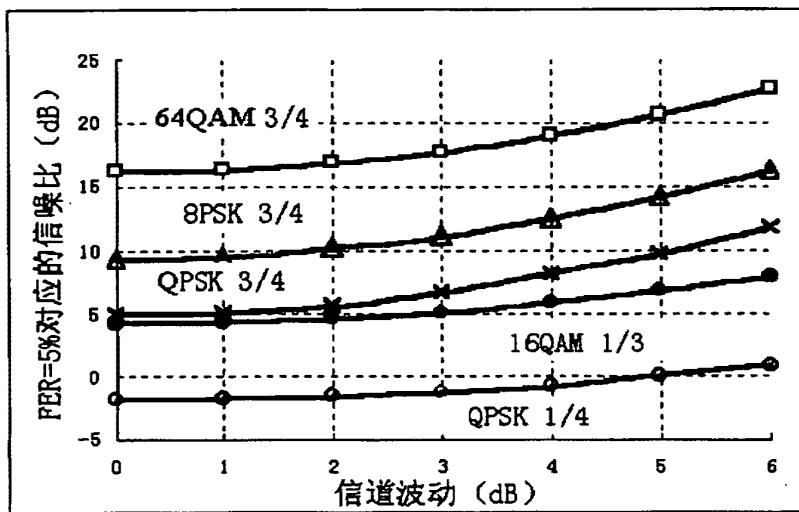

15

图 2

5

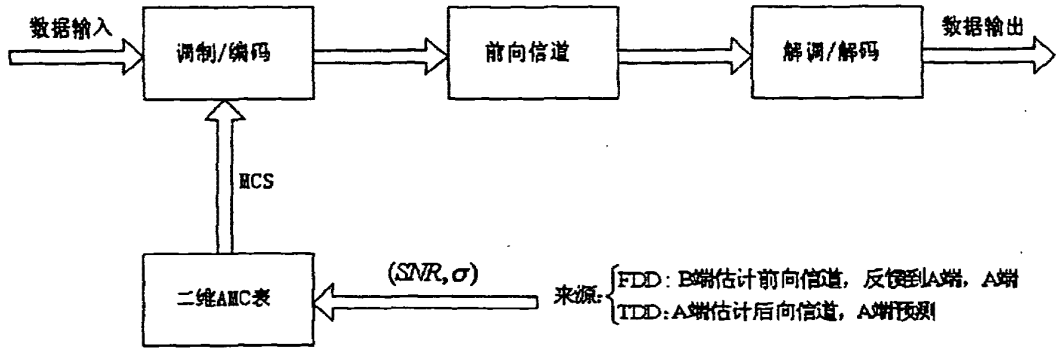

10

图 3

15



图 4



图 5

5

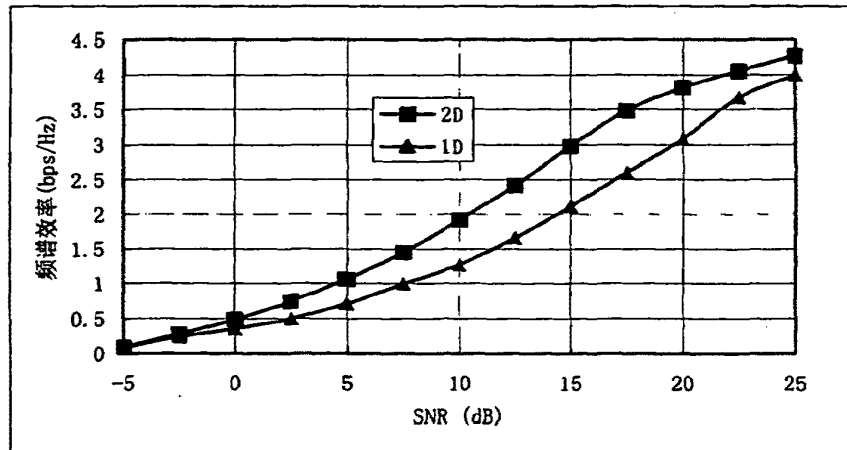
10

15

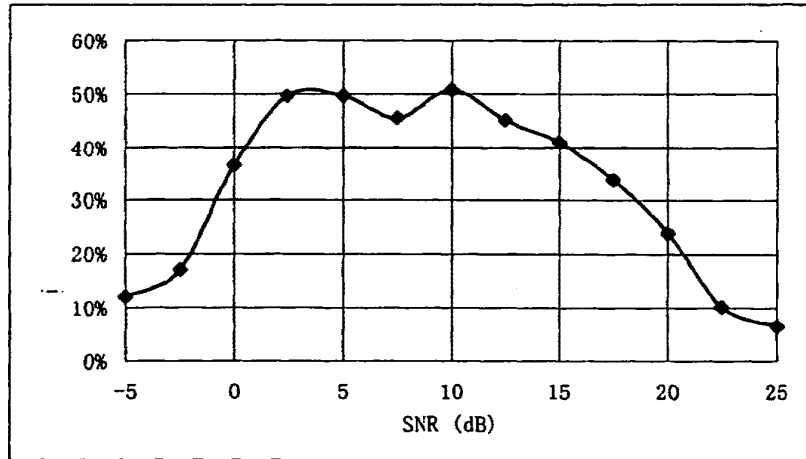
20



图 6

FORM PTO-1390 (Modified) U.S. PATENT AND TRADEMARK OFFICE; U.S. DEPARTMENT OF COMMERCE (REV. 9-2006)		ATTORNEY'S DOCKET NUMBER L9289.07161
TRANSMITTAL LETTER TO THE UNITED STATES DESIGNATED/ELECTED OFFICE (DO/EO/US) CONCERNING A SUBMISSION UNDER 35 U.S.C. 371		U.S. APPLICATION NO. (If known, see 37 CFR 1.5)
INTERNATIONAL APPLICATION NO. PCT/JP2005/021246	INTERNATIONAL FILING DATE November 18, 2005	PRIORITY DATE CLAIMED November 19, 2004
TITLE OF INVENTION COMMUNICATION APPARATUS, COMMUNICATION SYSTEM, AND COMMUNICATION METHOD		
APPLICANT(S) FOR DO/EO/US Xiaoming SHE Jifeng LI		
Applicant herewith submits to the United States Designated/Elected Office (DO/EO/US) the following items and other information:		
1. <input checked="" type="checkbox"/> This is a FIRST submission of items concerning a submission under 35 U.S.C. 371. 2. <input type="checkbox"/> This is a SECOND or SUBSEQUENT submission of items concerning a submission under 35 U.S.C. 371. 3. <input checked="" type="checkbox"/> This is an express request to begin national examination procedures (35 U.S.C. 371(f)). The submission must include items (5), (6), (9) and (25) indicated below. 4. <input type="checkbox"/> The US has been elected (Article 31). 5. <input checked="" type="checkbox"/> A copy of the International Application as filed (35 U.S.C. 371 (c)(2)) a. <input type="checkbox"/> is attached hereto (required only if not communicated by the International Bureau). b. <input checked="" type="checkbox"/> has been communicated by the International Bureau. c. <input type="checkbox"/> is not required, as the application was filed in the United States Receiving Office (RO/US). 6. <input checked="" type="checkbox"/> An English language translation of the International Application as filed (35 U.S.C. 371(c)(2)). a. <input checked="" type="checkbox"/> is attached hereto. b. <input type="checkbox"/> has been previously submitted under 35 U.S.C. 154(d)(4). 7. <input type="checkbox"/> Amendments to the claims of the International Application under PCT Article 19 (35 U.S.C. 371 (c)(3)) a. <input type="checkbox"/> are attached hereto (required only if not communicated by the International Bureau). b. <input type="checkbox"/> have been communicated by the International Bureau. c. <input type="checkbox"/> have not been made; however, the time limit for making such amendments has NOT expired. d. <input type="checkbox"/> have not been made and will not be made. 8. <input type="checkbox"/> An English language translation of the amendments to the claims under PCT Article 19 (35 U.S.C. 371(c)(3)). 9. <input checked="" type="checkbox"/> An oath or declaration of the inventor(s) (35 U.S.C. 371 (c)(4)). 10. <input type="checkbox"/> An English language translation of the annexes to the International Preliminary Examination Report under PCT Article 36 (35 U.S.C. 371 (c)(5)). 11. <input type="checkbox"/> A copy of the International Preliminary Examination Report (PCT/IPEA/409). 12. <input type="checkbox"/> A copy of the International Search Report (PCT/ISA/210). Items 13 to 23 below concern document(s) or information included: 13. <input type="checkbox"/> An Information Disclosure Statement under 37 CFR 1.97 and 1.98. 14. <input type="checkbox"/> An assignment document for recording. A separate cover sheet in compliance with 37 CFR 3.28 and 3.31 is included. 15. <input type="checkbox"/> A FIRST preliminary amendment. 16. <input type="checkbox"/> A SECOND or SUBSEQUENT preliminary amendment. 17. <input checked="" type="checkbox"/> An Application Data Sheet under 37 CFR 1.76. 18. <input type="checkbox"/> A substitute specification. 19. <input type="checkbox"/> A power of attorney and/or change of address letter. 20. <input type="checkbox"/> A computer-readable form of the sequence listing in accordance with PCT Rule 13 ^{ter} .2 and 37 CFR 1.821 - 1.825. 21. <input type="checkbox"/> A second copy of the published International Application under 35 U.S.C. 154(d)(4). 22. <input type="checkbox"/> A second copy of the English language translation of the International Application under 35 U.S.C. 154(d)(4). 23. <input type="checkbox"/> Express Mail Label No.		

Under the Paperwork Reduction Act of 1995, no persons are required to respond to a collection of information unless it displays a valid OMB control number.

U.S. APPLICATION NO (if known, see 37 CFR 1.5)	INTERNATIONAL APPLICATION NO. PCT/JP2005/021246	ATTORNEY'S DOCKET NUMBER L9289.07161
24. Other items or information: PCT/RO/101		
The following fees have been submitted:		CALCULATIONS PTO USE
25. <input checked="" type="checkbox"/> Basic national fee (37 CFR 1.492(a)) \$300		\$ \$300.00
26. <input checked="" type="checkbox"/> Examination fee (37 CFR 1.492(c)) If the written opinion prepared by ISA/US or the international preliminary examination report prepared by IPEA/US indicates all claims satisfy provisions of PCT Article as an International Searching Authority. \$0 All other situations. \$200		\$ \$200.00
27. <input checked="" type="checkbox"/> Search fee (37 CFR 1.492(b)) If the written opinion of the ISA/US or the International preliminary examination report prepared by IPEA/US indicates all claims satisfy provisions of PCT Article 33(1)-(4). . . \$0 Search fee (37 CFR 1.445(a)(2)) has been paid on the international application to the USPTO as an International Searching Authority. \$100 International Search Report prepared by an ISA other than the US and provided to the Office or previously communicated to the US by the IB. \$400 All other situations. \$500		\$ \$400.00
TOTAL OF 25, 26 and 27 =		\$ \$900.00
<input type="checkbox"/> Additional fee for specification and drawings filed in paper over 100 sheets (excluding sequence listing in compliance with 37 CFR 1.821(c) or (e) in an electronic medium or computer program listing in an electronic medium) (37 CFR 1.492(j)). The fee is \$250 for each additional 50 sheets of paper or fraction thereof.		
Total Sheets	Extra Sheets	Number of each additional 50 or fraction thereof (round up to a whole)
- 100 =	0 /50 =	0
		x \$250.00
		\$ \$0.00
Surcharge of \$130.00 for furnishing any of the search fee, examination fee, or the oath or declaration after the date of commencement of the national stage (37 CFR 1.492(h)).		
CLAIMS	NUMBER FILED	NUMBER EXTRA
Total claims	12 - 20 =	0
Independent claims	3 - 3 =	0
		x \$50.00
		\$ \$0.00
		x \$200.00
		\$ \$0.00
MULTIPLE DEPENDENT CLAIMS (if applicable) <input type="checkbox"/> + \$360.00		\$ 0
TOTAL OF ABOVE CALCULATIONS =		\$ \$900.00
<input type="checkbox"/> Applicant claims small entity status. See 37 CFR 1.27. Fees above are reduced by 1/2.		
SUBTOTAL =		\$ \$900.00
Processing fee of \$130.00 for furnishing the English translation later than 30 months from the earliest claimed priority date (37 CFR 1.492(i)).		
		\$ \$0.00
TOTAL NATIONAL FEE =		\$ \$900.00
Fee for recording the enclosed assignment (37 CFR 1.21(h)). The assignment must be accompanied by an appropriate cover sheet (37 CFR 3.28, 3.31). \$40 per property +		
		\$ \$0.00
TOTAL FEES ENCLOSED =		\$ \$900.00
		Amount to be \$
		Amount to be \$

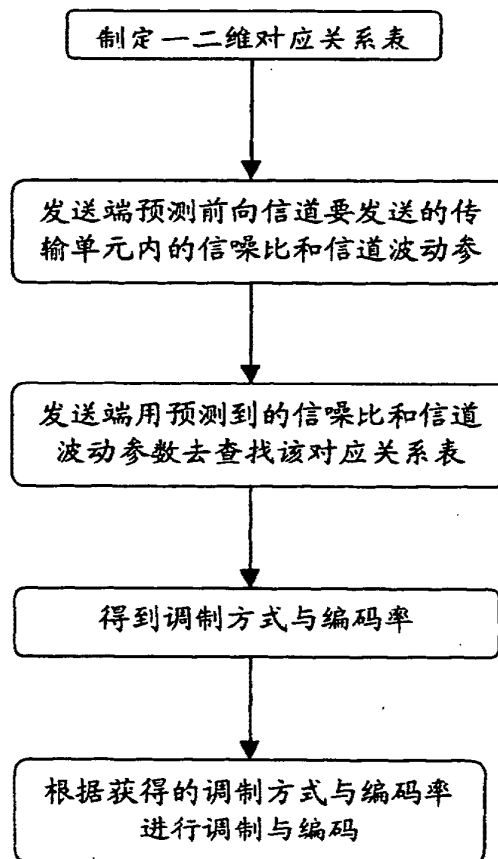
Under the Paperwork Reduction Act of 1995, no persons are required to respond to a collection of information unless it displays a valid OMB control number.

- a. A check in the amount of \$ _____ to cover the above fees is enclosed.
- b. Please charge my Deposit Account No. _____ in the amount of \$ _____ to cover the above fees. A duplicate copy of this sheet is enclosed.
- c. The Commissioner is hereby authorized to charge any additional fees which may be required, or credit any overpayment to Deposit Account No. 19-4375. A duplicate copy of this sheet is enclosed.
- d. Fees are to be charged to a credit card. **WARNING:** Information on this form may become public. **Credit card information should not be included on this form.** Provide credit card information and authorization on PTO-2038. The PTO-2038 should only be mailed or faxed to the USPTO. However, when paying the basic national fee, the PTO-2038 may NOT be faxed to the USPTO.

ADVISORY: If filing by EFS-Web, do **NOT** attach the PTO-2038 form as a PDF along with your EFS-Web submission. Please be advised that this is **not** recommended and by doing so your **credit card information may be displayed via PAIR.** To

NOTE: Where an appropriate time limit under 37 CFR 1.495 has not been met, a petition to revive (37 CFR 1.137(a) or (b)) must be filed and granted to restore the International Application to pending status.

SEND ALL CORRESPONDENCE TO:

James E. Ledbetter
 STEVENS, DAVIS, MILLER & MOSHER, LLP
 1615 L. STREET, NW, SUITE 850
 WASHINGTON, DC 20036

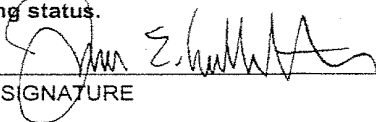

 SIGNATURE
 James E. Ledbetter

 NAME
 28,732

 REGISTRATION NUMBER
 May 17, 2007

 DATE

FORM PTO-1390 (Modified) U.S. PATENT AND TRADEMARK OFFICE; U.S. DEPARTMENT OF COMMERCE (REV. 9-2006)		ATTORNEY'S DOCKET NUMBER L9289.07161
TRANSMITTAL LETTER TO THE UNITED STATES DESIGNATED/ELECTED OFFICE (DO/EO/US) CONCERNING A SUBMISSION UNDER 35 U.S.C. 371		U.S. APPLICATION NO. (If known, see 37 CFR 1.5)
INTERNATIONAL APPLICATION NO. PCT/JP2005/021246	INTERNATIONAL FILING DATE November 18, 2005	PRIORITY DATE CLAIMED November 19, 2004
TITLE OF INVENTION COMMUNICATION APPARATUS, COMMUNICATION SYSTEM, AND COMMUNICATION METHOD		
APPLICANT(S) FOR DO/EO/US Xiaoming SHE Jifeng LI		
Applicant herewith submits to the United States Designated/Elected Office (DO/EO/US) the following items and other information:		
1. <input checked="" type="checkbox"/> This is a FIRST submission of items concerning a submission under 35 U.S.C. 371. 2. <input type="checkbox"/> This is a SECOND or SUBSEQUENT submission of items concerning a submission under 35 U.S.C. 371. 3. <input checked="" type="checkbox"/> This is an express request to begin national examination procedures (35 U.S.C. 371(f)). The submission must include items (5), (6), (9) and (25) indicated below. 4. <input type="checkbox"/> The US has been elected (Article 31). 5. <input checked="" type="checkbox"/> A copy of the International Application as filed (35 U.S.C. 371 (c)(2)) a. <input type="checkbox"/> is attached hereto (required only if not communicated by the International Bureau). b. <input checked="" type="checkbox"/> has been communicated by the International Bureau. c. <input type="checkbox"/> is not required, as the application was filed in the United States Receiving Office (RO/US). 6. <input checked="" type="checkbox"/> An English language translation of the International Application as filed (35 U.S.C. 371(c)(2)). a. <input checked="" type="checkbox"/> is attached hereto. b. <input type="checkbox"/> has been previously submitted under 35 U.S.C. 154(d)(4). 7. <input type="checkbox"/> Amendments to the claims of the International Application under PCT Article 19 (35 U.S.C. 371 (c)(3)) a. <input type="checkbox"/> are attached hereto (required only if not communicated by the International Bureau). b. <input type="checkbox"/> have been communicated by the International Bureau. c. <input type="checkbox"/> have not been made; however, the time limit for making such amendments has NOT expired. d. <input type="checkbox"/> have not been made and will not be made. 8. <input type="checkbox"/> An English language translation of the amendments to the claims under PCT Article 19 (35 U.S.C. 371(c)(3)). 9. <input checked="" type="checkbox"/> An oath or declaration of the inventor(s) (35 U.S.C. 371 (c)(4)). 10. <input type="checkbox"/> An English language translation of the annexes to the International Preliminary Examination Report under PCT Article 36 (35 U.S.C. 371 (c)(5)). 11. <input type="checkbox"/> A copy of the International Preliminary Examination Report (PCT/IPEA/409). 12. <input type="checkbox"/> A copy of the International Search Report (PCT/ISA/210). Items 13 to 23 below concern document(s) or information included: 13. <input type="checkbox"/> An Information Disclosure Statement under 37 CFR 1.97 and 1.98. 14. <input type="checkbox"/> An assignment document for recording. A separate cover sheet in compliance with 37 CFR 3.28 and 3.31 is included. 15. <input type="checkbox"/> A FIRST preliminary amendment. 16. <input type="checkbox"/> A SECOND or SUBSEQUENT preliminary amendment. 17. <input checked="" type="checkbox"/> An Application Data Sheet under 37 CFR 1.76. 18. <input type="checkbox"/> A substitute specification. 19. <input type="checkbox"/> A power of attorney and/or change of address letter. 20. <input type="checkbox"/> A computer-readable form of the sequence listing in accordance with PCT Rule 13 ^{ter} .2 and 37 CFR 1.821 - 1.825. 21. <input type="checkbox"/> A second copy of the published International Application under 35 U.S.C. 154(d)(4). 22. <input type="checkbox"/> A second copy of the English language translation of the International Application under 35 U.S.C. 154(d)(4). 23. <input type="checkbox"/> Express Mail Label No.		

Under the Paperwork Reduction Act of 1995, no persons are required to respond to a collection of information unless it displays a valid OMB control number.

U.S. APPLICATION NO (if known, see 37 CFR 1.5)	INTERNATIONAL APPLICATION NO. PCT/JP2005/021246	ATTORNEY'S DOCKET NUMBER L9289.07161
24. Other items or information: PCT/RO/101		
The following fees have been submitted:		CALCULATIONS
25. <input checked="" type="checkbox"/> Basic national fee (37 CFR 1.492(a))	\$300	PTO USE
26. <input checked="" type="checkbox"/> Examination fee (37 CFR 1.492(c))		
If the written opinion prepared by ISA/US or the international preliminary examination report prepared by IPEA/US indicates all claims satisfy provisions of PCT Article	\$0	\$
All other situations	\$200	\$300.00
27. <input checked="" type="checkbox"/> Search fee (37 CFR 1.492(b))		
If the written opinion of the ISA/US or the International preliminary examination report prepared by IPEA/US indicates all claims satisfy provisions of PCT Article 33(1)-(4)	\$0	
Search fee (37 CFR 1.445(a)(2)) has been paid on the international application to the USPTO as an International Searching Authority	\$100	\$
International Search Report prepared by an ISA other than the US and provided to the Office or previously communicated to the US by the IB	\$400	\$400.00
All other situations	\$500	
TOTAL OF 25, 26 and 27 =		\$900.00
<input type="checkbox"/> Additional fee for specification and drawings filed in paper over 100 sheets (excluding sequence listing in compliance with 37 CFR 1.821(c) or (e) in an electronic medium or computer program listing in an electronic medium) (37 CFR 1.492(j)). The fee is \$250 for each additional 50 sheets of paper or fraction thereof.		
Total Sheets	Extra Sheets	Number of each additional 50 or fraction thereof (round up to a whole)
- 100 =	0 /50 =	0
		x \$250.00
		\$0.00
Surcharge of \$130.00 for furnishing any of the search fee, examination fee, or the oath or declaration after the date of commencement of the national stage (37 CFR 1.492(h)).		
CLAIMS	NUMBER FILED	NUMBER EXTRA
Total claims	12 - 20 =	0
Independent claims	3 - 3 =	0
		x \$50.00
		\$0.00
		x \$200.00
		\$0.00
MULTIPLE DEPENDENT CLAIMS (if applicable) <input type="checkbox"/> + \$360.00		
TOTAL OF ABOVE CALCULATIONS =		\$900.00
<input type="checkbox"/> Applicant claims small entity status. See 37 CFR 1.27. Fees above are reduced by 1/2.		
SUBTOTAL =		\$900.00
Processing fee of \$130.00 for furnishing the English translation later than 30 months from the earliest claimed priority date (37 CFR 1.492(i)).		
TOTAL NATIONAL FEE =		\$900.00
Fee for recording the enclosed assignment (37 CFR 1.21(h)). The assignment must be accompanied by an appropriate cover sheet (37 CFR 3.28, 3.31). \$40 per property +		
TOTAL FEES ENCLOSED =		\$900.00
Amount to be		\$
Amount to be		\$

Under the Paperwork Reduction Act of 1995, no persons are required to respond to a collection of information unless it displays a valid OMB control number.

- a. A check in the amount of \$ _____ to cover the above fees is enclosed.
- b. Please charge my Deposit Account No. _____ in the amount of \$ _____ to cover the above fees. A duplicate copy of this sheet is enclosed.
- c. The Commissioner is hereby authorized to charge any additional fees which may be required, or credit any overpayment to Deposit Account No. 19-4375. A duplicate copy of this sheet is enclosed.
- d. Fees are to be charged to a credit card. **WARNING:** Information on this form may become public. **Credit card information should not be included on this form.** Provide credit card information and authorization on PTO-2038. The PTO-2038 should only be mailed or faxed to the USPTO. However, when paying the basic national fee, the PTO-2038 may NOT be faxed to the USPTO.

ADVISORY: If filing by EFS-Web, do **NOT** attach the PTO-2038 form as a PDF along with your EFS-Web submission. Please be advised that this is **not** recommended and by doing so your **credit card information may be displayed via PAIR.** To

NOTE: Where an appropriate time limit under 37 CFR 1.495 has not been met, a petition to revive (37 CFR 1.137(a) or (b)) must be filed and granted to restore the International Application to pending status.

SEND ALL CORRESPONDENCE TO:

James E. Ledbetter
 STEVENS, DAVIS, MILLER & MOSHER, LLP
 1615 L. STREET, NW, SUITE 850
 WASHINGTON, DC 20036

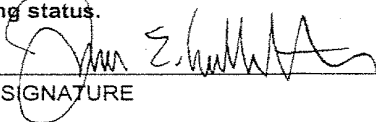

 SIGNATURE
 James E. Ledbetter

 NAME
 28,732

 REGISTRATION NUMBER
 May 17, 2007

 DATE

Under the Paperwork Reduction Act of 1995, no persons are required to respond to a collection of information unless it contains a valid OMB control number.

Application Data Sheet 37 CFR 1.76	Attorney Docket Number	L9289.07161
	Application Number	
Title of Invention	COMMUNICATION APPARATUS, COMMUNICATION SYSTEM, AND COMMUNICATION METHOD	
<p>The application data sheet is part of the provisional or nonprovisional application for which it is being submitted. The following form contains the bibliographic data arranged in a format specified by the United States Patent and Trademark Office as outlined in 37 CFR 1.76. This document may be completed electronically and submitted to the Office in electronic format using the Electronic Filing System (EFS) or the document may be printed and included in a paper filed application.</p>		

Secrecy Order 37 CFR 5.2

Portions or all of the application associated with this Application Data Sheet may fall under a Secrecy Order pursuant to 37 CFR 5.2 (Paper filers only. Applications that fall under Secrecy Order may not be filed electronically.)

Applicant Information:

Applicant 1					<input type="button" value="Remove"/>
Applicant Authority <input checked="" type="radio"/> Inventor		<input type="radio"/> Legal Representative under 35 U.S.C. 117		<input type="radio"/> Party of Interest under 35 U.S.C. 118	
Prefix	Given Name	Middle Name	Family Name	Suffix	
	Xiaoming		SHE		
Residence Information (Select One) <input type="radio"/> US Residency <input checked="" type="radio"/> Non US Residency <input type="radio"/> Active US Military Service					
City	BEIJING	Country Of Residenceⁱ	CN		
Citizenship under 37 CFR 1.41(b)ⁱ	CN				
Mailing Address of Applicant:					
Address 1	c/o Panasonic R&D Center Co., Ltd.				
Address 2	18th Fl., No27 Zhongguancun St., Haidian District				
City	BEIJING	State/Province			
Postal Code	100080	Countryⁱ	CN		
Applicant 2					<input type="button" value="Remove"/>
Applicant Authority <input checked="" type="radio"/> Inventor		<input type="radio"/> Legal Representative under 35 U.S.C. 117		<input type="radio"/> Party of Interest under 35 U.S.C. 118	
Prefix	Given Name	Middle Name	Family Name	Suffix	
	Jifeng		LI		
Residence Information (Select One) <input type="radio"/> US Residency <input checked="" type="radio"/> Non US Residency <input type="radio"/> Active US Military Service					
City	KANAGAWA	Country Of Residenceⁱ	JP		
Citizenship under 37 CFR 1.41(b)ⁱ	JP				
Mailing Address of Applicant:					
Address 1	c/o Panasonic Mobile Communications Co., Ltd.				
Address 2	600, Saedo-cho, Tsuzuki-ku, Yokohama-shi				
City	KANAGAWA	State/Province			
Postal Code	224-8539	Countryⁱ	JP		
All Inventors Must Be Listed - Additional Inventor Information blocks may be generated within this form by selecting the Add button.					<input type="button" value="Add"/>

Correspondence Information:

Enter either Customer Number or complete the Correspondence Information section below.
For further information see 37 CFR 1.33(a).

IPR2018-1555

An Address is being provided for the correspondence Information of this application.

PTC EX1002, Page 437

Application Data Sheet 37 CFR 1.76		Attorney Docket Number	L9289.07161
		Application Number	
Title of Invention	COMMUNICATION APPARATUS, COMMUNICATION SYSTEM, AND COMMUNICATION METHOD		
Customer Number	52989		
Email Address	ledbetter@stevensdavis.com	<input type="button" value="Add Email"/>	<input type="button" value="Remove Email"/>

Application Information:

Title of the Invention	COMMUNICATION APPARATUS, COMMUNICATION SYSTEM, AND COMMUNICATION METHOD		
Attorney Docket Number	L9289.07161	Small Entity Status Claimed	<input type="checkbox"/>
Application Type	Nonprovisional		
Subject Matter	Utility		
Suggested Class (if any)		Sub Class (if any)	
Suggested Technology Center (if any)			
Total Number of Drawing Sheets (if any)		Suggested Figure for Publication (if any)	
Publication Information:			
<input checked="" type="checkbox"/>	Request Early Publication (Fee required at time of Request 37 CFR 1.219)		
<input type="checkbox"/>	Request Not to Publish. I hereby request that the attached application not be published under 35 U.S.C. 122(b) and certify that the invention disclosed in the attached application has not been and will not be the subject of an application filed in another country, or under a multilateral agreement, that requires publication at eighteen months after filing.		

Representative Information:

Representative information should be provided for all practitioners having a power of attorney in the application. Providing this information in the Application Data Sheet does not constitute a power of attorney in the application (see 37 CFR 1.32). Enter either Customer Number or complete the Representative Name section below. If both sections are completed the Customer Number will be used for the Representative Information during processing.			
Please Select One:	<input checked="" type="radio"/> Customer Number	<input type="radio"/> US Patent Practitioner	<input type="radio"/> US Representative (37 CFR 11.9)
Customer Number	52989		

Domestic Priority Information:

This section allows for the applicant to claim benefit under 35 U.S.C. 119(e), 120, 121, or 365(c). Providing this information in the application data sheet constitutes the specific reference required by 35 U.S.C. 119(e) or 120, and 37 CFR 1.78(a)(2) or CFR 1.78(a)(4), and need not otherwise be made part of the specification.			
Prior Application Status		<input type="button" value="Remove"/>	
Application Number	Continuity Type	Prior Application Number	Filing Date (YYYY-MM-DD)
	a 371 of international	PCT/JP2005/021246	2005-11-18
Additional Domestic Priority Data may be generated within this form by selecting the Add button.			<input type="button" value="Add"/>

Foreign Priority Information:

IPR2018-1555

HTC EX1002, Page 438

Under the Paperwork Reduction Act of 1995, no persons are required to respond to a collection of information unless it contains a valid OMB control number.

Application Data Sheet 37 CFR 1.76	Attorney Docket Number	L9289.07161
	Application Number	
Title of Invention	COMMUNICATION APPARATUS, COMMUNICATION SYSTEM, AND COMMUNICATION METHOD	

This section allows for the applicant to claim benefit of foreign priority and to identify any prior foreign application for which priority is not claimed. Providing this information in the application data sheet constitutes the claim for priority as required by 35 U.S.C. 119(b) and 37 CFR 1.55(a).

<input type="button" value="Remove"/>			
Application Number	Country ⁱ	Parent Filing Date (YYYY-MM-DD)	Priority Claimed
200410094967.7	JP	2004-11-19	<input checked="" type="radio"/> Yes <input type="radio"/> No
Additional Foreign Priority Data may be generated within this form by selecting the Add button.			<input type="button" value="Add"/>

Assignee Information:

Providing this information in the application data sheet does not substitute for compliance with any requirement of part 3 of Title 37 of the CFR to have an assignment recorded in the Office.

<input type="button" value="Remove"/>			
Assignee 1			
If the Assignee is an Organization check here. <input checked="" type="checkbox"/>			
Organization Name	MATSUSHITA ELECTRIC INDUSTRIAL CO., LTD.		
Mailing Address Information:			
Address 1	1006, OAZA KADOMA, KADOMA-SHI		
Address 2			
City	OSAKA	State/Province	
Country ⁱ	JP	Postal Code	571-8501
Phone Number		Fax Number	
Email Address			
Additional Assignee Data may be generated within this form by selecting the Add button.			<input type="button" value="Add"/>

Signature:

A signature of the applicant or representative is required in accordance with 37 CFR 1.33 and 10.18. Please see 37 CFR 1.4(d) for the form of the signature.

Signature	James/Edward/Ledbetter		Date (YYYY-MM-DD)	2007-05-17	
First Name	James	Last Name	Ledbetter	Registration Number	28732

This collection of information is required by 37 CFR 1.76. The information is required to obtain or retain a benefit by the public which is to file (and by the USPTO to process) an application. Confidentiality is governed by 35 U.S.C. 122 and 37 CFR 1.14. This collection is estimated to take 23 minutes to complete, including gathering, preparing, and submitting the completed application data sheet form to the USPTO. Time will vary depending upon the individual case. Any comments on the amount of time you require to complete this form and/or suggestions for reducing this burden, should be sent to the Chief Information Officer, U.S. Patent and Trademark Office, U.S. Department of Commerce, P.O. Box 1450, Alexandria, VA 22313-1450. DO NOT SEND FEES OR COMPLETED FORMS TO THIS ADDRESS. **SEND TO: Commissioner for Patents, P.O. Box 1450, Alexandria, VA 22313-1450.**

Privacy Act Statement

The Privacy Act of 1974 (P.L. 93-579) requires that you be given certain information in connection with your submission of the attached form related to a patent application or patent. Accordingly, pursuant to the requirements of the Act, please be advised that: (1) the general authority for the collection of this information is 35 U.S.C. 2(b)(2); (2) furnishing of the information solicited is voluntary; and (3) the principal purpose for which the information is used by the U.S. Patent and Trademark Office is to process and/or examine your submission related to a patent application or patent. If you do not furnish the requested information, the U.S. Patent and Trademark Office may not be able to process and/or examine your submission, which may result in termination of proceedings or abandonment of the application or expiration of the patent.

The information provided by you in this form will be subject to the following routine uses:

1. The information on this form will be treated confidentially to the extent allowed under the Freedom of Information Act (5 U.S.C. 552) and the Privacy Act (5 U.S.C. 552a). Records from this system of records may be disclosed to the Department of Justice to determine whether the Freedom of Information Act requires disclosure of these records.
2. A record from this system of records may be disclosed, as a routine use, in the course of presenting evidence to a court, magistrate, or administrative tribunal, including disclosures to opposing counsel in the course of settlement negotiations.
3. A record in this system of records may be disclosed, as a routine use, to a Member of Congress submitting a request involving an individual, to whom the record pertains, when the individual has requested assistance from the Member with respect to the subject matter of the record.
4. A record in this system of records may be disclosed, as a routine use, to a contractor of the Agency having need for the information in order to perform a contract. Recipients of information shall be required to comply with the requirements of the Privacy Act of 1974, as amended, pursuant to 5 U.S.C. 552a(m).
5. A record related to an International Application filed under the Patent Cooperation Treaty in this system of records may be disclosed, as a routine use, to the International Bureau of the World Intellectual Property Organization, pursuant to the Patent Cooperation Treaty.
6. A record in this system of records may be disclosed, as a routine use, to another federal agency for purposes of National Security review (35 U.S.C. 181) and for review pursuant to the Atomic Energy Act (42 U.S.C. 218(c)).
7. A record from this system of records may be disclosed, as a routine use, to the Administrator, General Services, or his/her designee, during an inspection of records conducted by GSA as part of that agency's responsibility to recommend improvements in records management practices and programs, under authority of 44 U.S.C. 2904 and 2906. Such disclosure shall be made in accordance with the GSA regulations governing inspection of records for this purpose, and any other relevant (i.e., GSA or Commerce) directive. Such disclosure shall not be used to make determinations about individuals.
8. A record from this system of records may be disclosed, as a routine use, to the public after either publication of the application pursuant to 35 U.S.C. 122(b) or issuance of a patent pursuant to 35 U.S.C. 151. Further, a record may be disclosed, subject to the limitations of 37 CFR 1.14, as a routine use, to the public if the record was filed in an application which became abandoned or in which the proceedings were terminated and which application is referenced by either a published application, an application open to public inspections or an issued patent.
9. A record from this system of records may be disclosed, as a routine use, to a Federal, State, or local law enforcement agency, if the USPTO becomes aware of a violation or potential violation of law or regulation.

特許協力条約に基づく国際出願願書

紙面による写し (注意 電子データが原本となります)

0	受理官庁記入欄	
0-1	国際出願番号	
0-2	国際出願日	
0-3	(受付印)	
0-4	様式 PCT/RO/101 この特許協力条約に基づく国際出願願書は、	
0-4-1	右記によって作成された。	JPO-PAS 0330
0-5	申立て 出願人は、この国際出願が特許協力条約に従って処理されることを請求する。	
0-6	出願人によって指定された受理官庁	日本国特許庁 (RO/JP)
0-7	出願人又は代理人の書類記号	P035889P0
I	発明の名称	通信装置、通信システム及び通信方法
II	出願人	
II-1	この欄に記載した者は	出願人である (applicant only)
II-2	右の指定国についての出願人である。	米国を除く全ての指定国 (all designated States except US)
II-4ja	名称	松下電器産業株式会社
II-4en	Name:	MATSUSHITA ELECTRIC INDUSTRIAL CO., LTD.
II-5ja	あて名	5718501 日本国
II-5en	Address:	大阪府門真市大字門真 1006 番地 1006, Oaza Kadoma, Kadoma-shi, Osaka 5718501 Japan
II-6	国籍(国名)	日本国 JP
II-7	住所(国名)	日本国 JP
II-8	電話番号	06-6908-1473
II-9	ファクシミリ番号	06-6909-0053
II-11	出願人登録番号	000005821
III-1	その他の出願人又は発明者	
III-1-1	この欄に記載した者は	出願人及び発明者である (applicant and inventor)
III-1-2	右の指定国についての出願人である。	米国のみ (US only)
III-1-4ja	氏名(姓名)	▼余▲ 小明
III-1-4en	Name (LAST, First):	SHE, Xiaoming
III-1-5ja	あて名	
III-1-5en	Address:	
III-1-6	国籍(国名)	
III-1-7	住所(国名)	

特許協力条約に基づく国際出願願書

紙面による写し(注意 電子データが原本となります)

III-2	その他の出願人又は発明者	
III-2-1	この欄に記載した者は	出願人及び発明者である (applicant and inventor)
III-2-2	右の指定国についての出願人である。	米国のみ (US only)
III-2-4ja	氏名(姓名)	李 継峰
III-2-4en	Name (LAST, First):	LI, Jifeng
III-2-5ja	あて名	
III-2-5en	Address:	
III-2-6	国籍(国名)	
III-2-7	住所(国名)	
IV-1	代理人又は共通の代表者、通知のあて名 下記の者は国際機関において右記のごとく出願人のために行動する。	代理人 (agent)
IV-1-1ja	氏名(姓名)	鷲田 公一
IV-1-1en	Name (LAST, First):	WASHIDA, Kimihito
IV-1-2ja	あて名	2060034 日本国 東京都多摩市鶴牧1丁目24-1 新都市センタービル 5階
IV-1-2en	Address:	5th Floor, Shintoshicenter Bldg., 24-1, Tsurumaki 1-chome, Tama-shi, Tokyo 2060034 Japan
IV-1-3	電話番号	042-338-4600
IV-1-4	ファクシミリ番号	042-338-4605
IV-1-6	代理人登録番号	100105050
V	国の指定	
V-1	この願書を用いてされた国際出願は、規則4.9(a)に基づき、国際出願の時点で拘束される全てのPCT締約国を指定し、取得しうるあらゆる種類の保護を求め、及び該当する場合には広域と国内特許の両方を求める国際出願となる。	
VI-1	先の国内出願に基づく優先権主張	
VI-1-1	出願日	2004年 11月 19日 (19.11.2004)
VI-1-2	出願番号	200410094967.7
VI-1-3	国名	中華人民共和国 CN
VII-1	特定された国際調査機関(ISA)	日本国特許庁 (ISA/JP)
VIII	申立て	申立て数
VIII-1	発明者の特定に関する申立て	-
VIII-2	出願し及び特許を与えられる国際出願日における出願人の資格に関する申立て	-
VIII-3	先の出願の優先権を主張する国際出願日における出願人の資格に関する申立て	-
VIII-4	発明者である旨の申立て(米国を指定国とする場合)	-
VIII-5	不利にならない開示又は新規性喪失の例外に関する申立て	-

特許協力条約に基づく国際出願願書

紙面による写し(注意 電子データが原本となります)

IX	照合欄	用紙の枚数	添付された電子データ
IX-1	願書(申立てを含む)	3	✓
IX-2	明細書	18	✓
IX-3	請求の範囲	3	✓
IX-4	要約	1	✓
IX-5	図面	16	✓
IX-7	合計	41	
	添付書類	添付	添付された電子データ
IX-8	手数料計算用紙	-	✓
IX-11	包括委任状の写し	-	✓
IX-17	PCT-SAFE 電子出願	-	-
IX-19	要約書とともに提示する図の番号	5A	
IX-20	国際出願の使用言語名	日本語	
X-1	出願人、代理人又は代表者の記名押印	/100105050/	
X-1-1	氏名(姓名)	鷲田 公一	
X-1-2	署名者の氏名		
X-1-3	権限		

受理官庁記入欄

10-1	国際出願として提出された書類 の実際の受理の日	
10-2	図面	
10-2-1	受理された	
10-2-2	不足図面がある	
10-3	国際出願として提出された書類 を補完する書類又は図面であつ てその後期間内に提出されたも のの実際の受理の日(訂正日)	
10-4	特許協力条約第11条(2)に基づ く必要な補完の期間内の受理の日	
10-5	出願人により特定された国際調査機関	ISA/JP
10-6	調査手数料未払いにつき、国際 調査機関に調査用写しを送付していない	

国際事務局記入欄

11-1	記録原本の受理の日	
------	-----------	--

DESCRIPTION

COMMUNICATION APPARATUS, COMMUNICATION SYSTEM, AND
COMMUNICATION METHOD

5

Technical Field

[0001] The present invention relates to a communication apparatus, communication system, and communication method, and particularly relates to a communication apparatus, communication system and communication method carrying out adaptive modulation and coding in adaptive transmission technology in subcarrier communication systems--that is, in wireless communication orthogonal frequency division multiplexing (OFDM) system.

15

Background Art

[0002] OFDM technology is mainstream technology for implementing high-speed wireless data transmission. OFDM technology theory is transmitting high-speed data using a large number of subcarriers that are orthogonal, and data rates of the subcarriers are relatively low. Compared to a typical frequency division multiplexing system, orthogonality of a subcarrier in OFDM improves spectral efficiency of the system. In OFDM, the whole signal bandwidth is divided into a plurality of narrow subcarrier frequency bandwidths, and flat fading occurs when the subcarrier bandwidths are smaller than the

channel bandwidth. In this way, compared to the monocarrier system, flat fading in OFDM can be implemented in a more straightforward manner. Currently, OFDM technology is successfully applied to asynchronous digital subscriber lines (ADSL), digital television broadcasts (DVB) and wireless ATM (WATM) systems.

[0003] In order to improve a spectrum utilization rate in wireless systems, adaptive and high spectrum utilization rate-transmission technology has been requested for high-speed wireless data transmission for fading channels. In fading channels, compared to fixed coding modulation, adaptive modulation/coding technology is capable of effectively improving a throughput and an error rate (BER) of a system. Here, the throughput referred to is the spectrum utilization rate of the system--that is, the amount of information transmitted within a unit spectrum bandwidth and a unit time. The basic concept of AMC technology is adaptively changing one or more types of transmission power, symbol transmission rate, coordinate size, coding rate and coding mechanism based on channel characteristics at the current point and, when channel conditions are good, transmitting a large amount of information to increase spectrum utilization rate, and, when channel conditions are poor, transmitting a small amount of information to ensure a certain receiving BER request.

[0004] Before introducing an AMC method in OFDM, first,

channel characteristics in OFDM transmission will be introduced briefly.

[0005] FIG.1 shows an example of OFDM channel characteristics.

5 [0006] Here, two horizontal axes respectively indicate OFDM symbols on the time domain and subcarrier numbers on the frequency domain, and the vertical axis indicates channel gains corresponding to OFDM symbols and subcarriers. OFDM channels fluctuates in both time
10 domain and frequency domain as a result of time domain spreading and time domain spreading of channels in transmission.

[0007] As described above, the concept of AMC is to change modulation and coding parameters in transmission based
15 on channel characteristics at this current time. With OFDM, adaptivity in this case refers to adaptivity at two domains of time domain and frequency domain. Currently, as an adaptive configuration, AMC in OFDM is divided into two, AMC based on subcarriers and AMC based
20 on subbands. The AMC based on subcarriers referred to here refers to carrying out transmission using a modulation method and a coding method that are different per OFDM subcarrier taking each subcarrier as a minimum unit of adaptivity. However, AMC based on subcarriers
25 is very difficult to be implemented, and, in addition, has the problem that feedback overhead is too large. Typically, it is difficult to implement an AMC method

based on subcarriers in an actual system. As another adaptive configuration in OFDM, a subband configuration using independent coding, namely, a subband adaptive method of the related art is, relatively, typically used.

5 [0008] FIG.2 shows subband adaptive modulation and coding of the related art.

[0009] In this configuration, all of the subcarriers on the OFDM frequency domain are divided into several subbands. Here, a subband indicates a subcarrier group
10 comprised of subcarriers in neighboring positions on the frequency domain. For example, in FIG.2, the total number of subbands is N. One modulation coding block is then formed by the same subbands at several (in the case of FIG.2, M) neighboring OFDM symbols. In subband
15 adaptivity of the related art of FIG.2, the modulation coding blocks carry out estimation of coding modulation parameters based on the channel characteristics and carry out independent coding. The numbers within the coding modulation blocks of FIG.2 denote the classification
20 coding modulation parameters of encoded modulation blocks belong to.

[0010] Typically, coding modulation parameters corresponding to classifications for the coding modulation parameters are decided in initial stages of
25 a system. For example, the relationships between a classification, coding parameter, and modulation parameter are shown in Table 1 as an example. The present

invention is by no means limited to Table 1.

[0011]

[Table 1]

Classification	Coding parameter	Modulation parameter
0	Not transmitted	Not transmitted
1	1/2Turbo	BPSK
2	1/2Turbo	QPSK
3	3/4Turbo	QPSK
4	2/3Turbo	8PSK
5	3/4Turbo	16QAM
6	2/3Turbo	64QAM

[0012] Next, a block view implementing a subband adaptive
5 method of the related art is shown in OFDM in FIG.3.

[0013] FIG.3A and FIG.3B are block views showing an OFDM-AMC system combining OFDM and AMC of the related art.

[0014] When communication between a communication
10 apparatus of FIG.3A (transmission side) and communication apparatus of FIG.3B (receiving side) is assumed to be carried out, typical examples are given by a base station (AP) of FIG.3A and a mobile terminal (UE) of FIG.3B. Further, assume that an AMC mechanism
15 is used in transmission from FIG.3A to FIG.3B.

[0015] On the transmission side of FIG.3A, information bits to be transmitted first pass through adaptive modulation/coding section 301. The output serial modulation symbols then pass through serial/parallel
20 converter (S/P) 302 and inverse fast Fourier transformer (IFFT) 303 so that symbols in the frequency band are converted to the time domain. The symbols then pass

through parallel/serial converter (P/S) 304 and have guard intervals inserted by guard interval insertion section 305. The bits are then transmitted via antenna 306. On the receiving side in FIG.3B, after receiving
5 transmission signals transmitted from the transmission side via receiving antenna 316, guard interval removing section 315 removes the guard intervals inserted on the transmission side. Further, the signal then passes through serial/parallel converter (S/P) 314 and fast
10 Fourier transformer (FFT) 313 to be converted from time domain to frequency domain symbols. The signals are then subjected to parallel/serial conversion processing by parallel/serial converter (P/S) 312 and are finally outputted by adaptive demodulating/decoding section 311
15 to obtain received data.

[0016] Adaptive transmission from the transmission side of FIG.3A to the receiving side of FIG.3B is implemented mainly by adaptive modulation/coding section 301 on the transmission side and adaptive demodulating/decoding
20 section 311 on the receiving side. As described above, the meaning of adaptive modulation and coding is to adaptively adjust modulation and coding parameters on the transmission side based on channel characteristics at the current time and to carry out demodulation and
25 decoding using parameters corresponding to the transmission side on the receiving side. In a typical system, adaptive parameters required by adaptive

demodulating/decoding section 311 depend on feedback from the receiving side. Before transmitting each data block, the receiving side always first estimates transmission channel from the transmission side to the receiving side at the current time by channel estimating section 319, and obtains channel characteristics of the subcarriers of the OFDM. Based on these channel characteristics, the receiving side then decides modulation and coding parameters used for the OFDM subbands in the case of transmitting data from the transmission side at the current point by parameter selecting section 318. Parameters for adaptive modulation and coding at the subbands obtained by parameter selecting section 318 have two uses.

[0017] The first use is the use as a parameter for modulation and coding at each OFDM subband when the transmission side transmits data at the current time. After selecting modulation and coding parameters of the OFDM subbands, subband AMC parameter selecting section 318 on the receiving side then transmits these parameters back to the transmission side via a feedback path of receiving side parameter transmitting section 320, antenna 316 on the receiving side, antenna 306 on the transmission side, and parameter receiving/extracting section 307 on the transmission side. After extracting these parameters, the transmission side controls adaptive modulation/coding section 301 using AMC control section

308.

[0018] The second use is the use as a parameter when the receiving side carries out demodulation and decoding. In AMC transmission, the receiving side is able to obtain accurate information bits for the first time by carrying out demodulation and decoding of received data based on modulation and coding parameters that are always the same as in the transmitting side. Subband AMC parameter selecting section 318 obtains and then transmits AMC parameters to adaptive demodulating/decoding section 317, and adaptive demodulating/decoding section 317 temporarily saves the AMC parameter. The AMC parameter needs to be used in control of adaptive demodulating/decoding section 311 on the receiving side.

[0019] In FIG.4A and FIG.4B, module 309 of FIG.3A and module 321 of FIG.3B are segmented to describe a method for employing subband AMC in OFDM of the related art in a clearer manner.

[0020] FIG.4A and FIG.4B show configurations for implementing subband adaptive modulation/coding of the related art.

[0021] On the transmission side of FIG.3A, adaptive modulating/coding section 301 is comprised of adaptive coding section 401, interleave section 402, and adaptive modulation section 403. Data outputted from adaptive modulating/ coding section 301 is transmitted to inverse fast Fourier transformer (IFFT) 303 via serial/parallel

converter (S/P) 302. Transmission side AMC control section 308 controls adaptive modulating/coding section 301 based on modulation and coding parameters for the subbands obtained from parameter receiving/extracting section 307 of FIG.3A. In subband adaptivity of the related art, coding modulation is carried out independently for the OFDM subbands. Namely, all subbands have respective independent modulation and coding parameters. AMC control section 308 controls adaptive modulating/coding section 301 using the obtained coding parameters C and modulation parameters M for the subbands. Further, AMC control section 308 obtains the number of information bits transmitted at the subbands based on the coding parameters C and modulation parameters M, generates a corresponding interleave matrix IT as a result, and controls interleave section 402 of adaptive modulating/coding section 301. On the transmission side, after AMC, a serial data stream 404 is obtained. This contains data transmitted in the order of subband 1, 2, ... N, with modulation and coding methods of (C_1, M_1) , (C_2, M_2) , ... , (C_N, M_N) , respectively. After this, this data is subjected to serial/parallel conversion and is then sequentially mapped to subbands corresponding to OFDM and is transmitted.

[0022] All of the AMC parameters necessary in transmission of the data blocks on the transmission side are fed back from the receiving side. Namely, before the

transmission side transmits the data blocks, the receiving side first needs to select AMC parameters for use in the data blocks that the transmission side transmits. In the procedure where the receiving side selects parameters first, channel estimation is carried out using the received signal. A method based on a pilot or blind channel estimation etc. may be given as a method of channel estimation. After this, channel estimation section 319 transmits channel characteristics of the obtained OFDM subcarriers to subband AMC parameter selecting section 318. Subband AMC parameter selecting section 318 first carries out analysis of the performance of the subbands in OFDM in this way, and selects AMC parameters appropriate for the respective subbands from the selected set of AMC parameters. AMC parameters obtained in this way are then transmitted back to the transmission side via a feedback channel, and are used in actual adaptive modulation and coding operations when the transmission side carries out transmission, and also used at adaptive demodulating/decoding control section 409 on the receiving side. At the same time, taking time delay into consideration, parameter storing section 410 is necessary for storing parameters obtained at the current time. Adaptive demodulating/decoding section 311 on the receiving side is comprised of adaptive decoding section 408, deinterleaving section 407 and adaptive decoding section 406.

[0023] Compared to subcarrier adaptivity, the adaptive method using independent coding of subbands of the related art shown in FIG. 3A to FIG. 4B is able to effectively reduce the difficulty of implementation of adaptivity and is able to effectively reduce feedback overhead of the system. However, even in this kind of method, there is the drawback that it is not possible to effectively utilize diversity performance between the subbands.

[0024] Diversity is an important method for improving wireless transmission quality. The diversity referred to here is generally described as technology where the transmitting side increases redundancy of information using a certain resource and modifies or attenuates redundant information on both of the receiving side and the transmission side independently as much as possible, and, the receiving side utilizes and synthesizes the information in a collective manner, thereby obtaining a certain system gain. To summarize, this is technology where transmission is carried out simultaneously by utilizing a plurality of paths, and deficiencies in certain paths on the receiving side is compensated for by other paths.

[0025] In addition to the foundation of an independent coding method using subbands in OFDM adaptive modulation and coding of the related art, the present application is to obtain a patent for a method for combining subbands using a certain method, assuming the subbands as a subband

group, then carrying out joint coding for subband groups. With AMC methods of the related art, a parameter is selected and coding is carried out for each subband independently, and, the method of the present application therefore seems
5 to run counter to the concept of AMC of the related art in appearance. However, this method adopts diversity between subbands and is therefore able to obtain a larger coding gain. Further, if selection of modulation coding parameters is carried out within subband groups using
10 the method proposed here, loss in transmission throughput is not generated compared with the method of the related art. By combining both, the method for which the present application seek a patent promotes improvement of adaptive transmission performance in OFDM.

15

Disclosure of the Invention

Problems to be Solved by the Invention

[0026] The object of the present invention is therefore
to provide communication apparatus, a communication
20 system and a communication method capable of increasing spectrum utilization rate of a system and particularly increasing spectrum utilization rate based on high-speed fading and channel estimation error, reducing the degree of difficulty of adaptivity, and reducing the feedback
25 overhead compared with subband adaptive methods of the related art by combining all of the subbands on a frequency domain of a subcarrier communication system based on a

fixed rule to as to give several subband groups, and then selecting modulation and coding parameters for use during joint coding with respect to each subband group.

5 Means for Solving the Problem

[0027] A communication apparatus of the present invention adopts a configuration having: a channel estimating section that carries out channel estimation per subband; a parameter deciding section that decides
10 modulation parameters and coding parameters per subband group comprised of a plurality of subbands based on the channel estimation result; a parameter information transmission section that transmits to a communicating party, parameter information that is information for the
15 modulation parameters and the coding parameters decided at the parameter deciding section; a receiving section that receives a received signal containing data modulated and encoded per subband group at a communicating party using the modulation parameters and coding parameters
20 of the parameter information transmitted at the parameter information transmission section; and a data obtaining section that demodulates and decodes the received signal received at the receiving section per subband group using the modulation parameters and coding parameters decided
25 at the parameter deciding section and obtains the data contained in the received signal.

[0028] A communication system of the present invention

is a communication system having a base station apparatus transmitting modulated and encoded data and a communication terminal apparatus receiving the data, and adopting a configuration having :the communication terminal apparatus comprising: a channel estimating section that carries out channel estimation per subband; a parameter deciding section that decides modulation parameters and coding parameters per subband group comprised of a plurality of subbands based on channel estimation results; a parameter information transmission section that transmits parameter information that is information for the modulation parameters and the coding parameters decided at the parameter deciding section; a receiving section that receives a received signal containing data modulated and encoded per subband group at the base station apparatus using parameters of parameter information transmitted at the parameter information transmission section; and a data extracting section that modulates and decodes a received signal received at the receiving section per subband group using the modulation parameters and the coding parameters of the parameter information and extracts the data contained in the received signal, and, in this system, the base station apparatus comprises an adaptive modulating/coding section that modulates and encodes data in accordance with the modulation parameters and coding parameters of the parameter information transmitted by

the transmission section; and a data transmission section that transmits data modulated and encoded at the adaptive modulating/coding section.

[0029] A communication method of the present invention
5 having the steps of: carrying out channel estimation per subband; deciding modulation parameters and coding parameters per subband group comprised of a plurality of subbands based on the channel estimation results; at a communication terminal apparatus, transmitting
10 parameter information that is information for the decided modulation parameters and coding parameters; at a base station apparatus, receiving the parameter information transmitted by the communication terminal apparatus; modulating and coding data in accordance with the
15 modulation parameters and the coding parameters of the received parameter information; at the base station apparatus, transmitting the modulated and encoded data; at the communication terminal apparatus, receiving a received signal containing the data transmitted by the
20 base station apparatus; and modulating and decoding the received signal per subband group using the modulation parameters and the coding parameters of the parameter information, and extracting data contained in the received signal.

25

Brief Description of the Drawings

[0030]

FIG.1 shows an example of OFDM channel characteristics;

FIG.2 shows adaptive modulation and coding of the related art;

5 FIG.3A is a block view showing a configuration for the transmission side of an OFDM-AMC system of the related art;

FIG.3B is a block view showing a configuration for the receiving side of an OFDM-AMC system of the related
10 art;

FIG.4A shows a module containing an adaptive modulating/coding section on a transmission side of the related art;

FIG.4B shows a module containing an adaptive
15 demodulating/decoding section on a receiving side of the related art;

FIG.5A is a block view showing a configuration for the transmission side of an OFDM-AMC system of an embodiment of the present invention;

20 FIG.5B is a block view showing a configuration for the receiving side of an OFDM-AMC system of an embodiment of the present invention;

FIG.6A shows a module containing an adaptive modulating/coding section on a transmission side of an
25 embodiment of the present invention;

FIG.6B shows a module containing an adaptive demodulating/decoding section on a receiving side of an

embodiment of the present invention;

FIG.7 shows an adaptive modulation and coding method of an embodiment of the present invention;

FIG.8 shows an example of a subband group of an
5 embodiment of the present invention;

FIG.9 shows another example of a subband group of an embodiment of the present invention;

FIG.10 shows yet another example of a subband group of an embodiment of the present invention;

10 FIG.11 shows the comparison results of performance of adaptive modulation and coding of an embodiment of the present invention and adaptive modulation and coding of the related art; and

FIG.12 shows other comparison results of performance
15 of adaptive modulation and coding of an embodiment of the present invention and adaptive modulation and coding of the related art.

Best Mode for Carrying Out the Invention

20 [0031] (Embodiment)

An embodiment of the present invention will be described in detail below using the drawings. To accurately describe the present invention, an example of an OFDM system will be described here. The adaptive
25 modulation method and coding method of the present invention can be applied to every other subcarrier communication systems carrying out communication using

subcarriers.

[0032] The present invention is to provide subband groups by combining subbands using a certain scheme and perform joint coding, on the basis that independent coding and modulation of subbands is used in OFDM adaptive modulation/coding of the related art. Further, the invention proposes various methods for putting subbands into subband groups, and proposes methods for selecting modulation and coding parameters used in joint coding within subbands. These will be described later.

[0033] FIG.5A and FIG.5B show OFDM-AMC system configurations implementing the method of the present invention.

[0034] To more accurately describe the present invention, known configurations in the related art as shown in FIG.1 to FIG.4B are assigned the same codes and their description will be omitted, and only a configuration for which the present invention and the related art are different from each other will be described.

[0035] Compared to the OFDM-AMC system configuration of the related art shown in FIG.3A and FIG.3B, the system to which OFDM-AMC of the present invention is applied has differences below.

[0036] Subband group AMC parameter selection section 504 that is a parameter deciding section contained in module 505 shown in FIG.5B selects AMC parameters for the subband group, and subband AMC parameter selection section 316

contained in module 321 of FIG.3B selects AMC parameters for the subbands. This is because in the OFDM-SMC system of the present invention, the adaptive modulation and coding units are subband groups whereas in the OFDM-AMC system of the related art the units of the subband adaptive modulation and coding are subbands. With The present invention, all of the subbands in the frequency domain in OFDM are made into several subband groups using combination patterns, and adaptive modulation and coding then are performed on the subband groups. Further, with the OFDM-AMC system of the present invention, AMC parameters relating to subband groups as parameter information that is information for modulation parameters and coding parameters, are transmitted in a feedback route of a series in the order of parameter transmitting section 320, receiving side antenna 316, transmission side antenna 306 and transmission side parameter receiving/extracting section 307, rather than the AMC parameters relating to subbands as in the OFDM-AMC system of the related art shown in FIG.3.

[0037] Further, on the transmission side, AMC control section 308 shown in FIG.3A replaces with adaptive transmission control section 501. In the technology of the present invention, the transmission side carries out adaptive modulation and coding on subband groups in OFDM, and the subband groups are formed by combining the OFDM subbands based on combination patterns. Adaptive

transmission control section 501 has to control AMC for subband groups within adaptive modulation/coding section 301, and also has to control serial/parallel converter (S/P) 302 after adaptive modulation and coding so as to
5 perform mapping information bits transmitted for the subband groups to corresponding subbands within OFDM after coding and modulation and transmission.

[0038] Further, on the receiving side, adaptive modulating/control section 317 as shown in FIG.3B is
10 replaced with receiving control section 503. Adaptive receiving control section 503 has to control adaptive demodulating/decoding section 311 that is the data obtaining section, also controls parallel/serial converter (P/S) 312 that is prior to adaptive demodulation
15 and decoding, synthesizes received symbols within the same subband group, and carries out demodulation and decoding.

[0039] Module 502 of FIG.5A and module 505 of FIG.5B are segmented and shown in FIG.6A and FIG.6B.

20 [0040] FIG.6A and FIG.6B show configurations for implementing a method proposed by the present invention.

[0041] On the transmission side, a point of distinction with subband adaptivity of the related art shown in FIG.4A is that the units for adaptive modulation and coding are
25 subband groups rather than subbands. In this event, output 603 of adaptive modulating/coding section 301 contains transmission data in the order of subband groups

1, 2,K, where the modulation methods and coding methods are $(C_1, M_1), (C_2, M_2), \dots, (C_K, M_K)$, where K is the total number of subband groups divided within OFDM. Further, the transmission side has to control the AMC operation, and, in addition, control serial/parallel conversion at serial/parallel (S/P) section 302 based on subband combination patterns stored in combination pattern storage section 601. By this means, the transmission side maps and transmits information bits transmitted using the subband groups to corresponding subbands within OFDM after coding and modulation.

[0042] On the receiving side, differences with subband adaptivity of the related art shown in FIG.4B is that the unit of adaptive demodulation and coding is a subband group rather than a subband. Further, the receiving side has to control adaptive demodulation and decoding, and, in addition, control parallel/serial conversion at parallel/serial converter (P/S) section 312 based on subband combination patterns stored in combination pattern storage section 605. By this means, the receiving side synthesizes receiving symbols within the same subband groups of the OFDM and carries out demodulation and decoding. Moreover, as shown in FIG.6B, subband group AMC parameter selection section 504 is also different from FIG.4B. In FIG.6B, parameter selecting section 411 selects and obtains parameters for the OFDM subbands, and parameter selecting section 606 of the subband group

then has to select adaptive parameters for the OFDM subband groups based on combination patterns stored in combination pattern storage section 607.

[0043] FIG.7 is a flowchart showing processing for
5 implementing an adaptive coding method and modulation method of an embodiment of the present invention. Specifically, the processing for implementing the technology of the present invention is as described below.

[0044] As the first stage, the receiving side decides
10 adaptive modulation and coding parameters within the subband groups in the transmission side OFDM, and feeds the decided parameters back to the transmission side. This process includes estimating channels (step 901), selecting adaptive parameters for the OFDM subbands (step
15 902), selecting adaptive parameter for the OFDM subband groups (step 903), and feeding parameter back (step 921) on the receiving side.

[0045] A typical existing method including, for example,
20 channel estimation based on a pilot and blind channel estimation may be used for the channel estimation in step 901.

[0046] In the case of independent coding for the subbands in the related art, adaptive parameter selection for the OFDM subbands in step 902 indicates modulation and coding
25 parameters used in carrying out adaptive transmissions at the OFDM subbands. This is independent coding, parameters within the subbands differ according to

differences in channel characteristics.

[0047] In this operation, it is necessary to decide sets of adaptive parameters constituting selection candidates, like in the sets of parameters shown in Table 1 and Table 5 2. After this, appropriate modulation and coding parameters are selected based on the channel characteristics at the subbands at the current time, and, at the same time, the number of corresponding transmission information bits is decided. Here, various methods may 10 be used as existing methods for selecting parameters based on channel characteristics, including, for example, a method based on a minimum signal to noise ratio of subbands, a method based on an average signal to noise ratio of subbands, a method based on capacity, or a method based 15 on combinations of an average signal to noise ratio and other statistical characteristics. With this embodiment, an example of a method based on an average signal to noise ratio will be briefly described.

[0048] The method based on an average signal to noise 20 ratio decides signal to noise ratio threshold values (refer to Table 2) necessary for parameters for various types of modulation and coding using a method referred to as logical analysis or simulation. The throughput performance in this case, that is, spectrum utilization 25 rate corresponding to parameters for various types of modulation and coding is, in terms of a numeric value, equal to the product of the coding rate and the number

of bits contained in the symbols. After this, an average signal to noise ratio is calculated for subcarriers inside the subbands. Finally, a modulation and coding parameter having a threshold value lower than the average signal to noise ratio and a maximum throughput performance are then selected as modulation and coding parameters at the subbands. Table 2 shows the relationship of the coding parameters, modulation parameters, signal to noise ratio threshold values and throughput performance at the classifications. For example, when average signal to noise ratios within a subband are 0, 2, 4, 6, and 8, according to the parameters shown in Table 2, the classifications corresponding to the selected modulation and coding parameters are 1, 1, 2, 3, and 4, respectively. The number of information bits assigned within the subband is decided in a manner corresponding to this (in terms of a numeric value, this is equal to the product of the total number of subcarriers within the subband and the throughput performance corresponding to selected coding and modulation parameters).

[0049]

[Table 2]

25

Classification	Coding parameter	Modulation parameter	SNR threshold value (dB)	Throughput performance (bps/Hz)

0	Not transmitted	Not transmitted	$-\infty$	0
1	1/2Turbo	BPSK	-0.4	0.5
2	1/2Turbo	QPSK	2.2	1
3	3/4Turbo	QPSK	5.2	1.5
4	2/3Turbo	8PSK	7.6	2
5	3/4Turbo	16QAM	10.9	3
6	2/3Turbo	64QAM	14.5	4

[0050] Although modulation and coding are carried out independently per OFDM subband in adaptive methods of the related art, with the method of the present application, selection of adaptive parameters for the OFDM subband groups in step 903 is achieved by providing subband groups as the units of adaptive transmission rather than subbands. All of the subbands in an OFDM frequency domain are first taken to be several subband groups based on a certain combination method (or combination pattern). A method of combining neighboring subbands, a method of combining subbands spaced at intervals, a method of combining all of the subbands, or a method of combining in accordance with another rule may be given as methods of combining. The method of combining neighboring subbands, that is, the method of selecting a plurality of subbands neighboring on the frequency axis, is a method taking several subbands at neighboring positions to be one subband group, as shown in FIG.8. FIG.8 shows an example of combining neighboring subbands. Further, the subband group has a subband combination patterns, and a subband is formed from the same number of subcarriers at positions neighboring with respect to frequency within a specific

number of subcarrier modulation symbols.

[0051] In FIG.8, N subbands on a frequency domain that have the same positions an the OFDM time domain are taken to be several subband groups. Here, subbands at positions
5 neighboring with respect to frequency are taken to be one subband group. Namely, subbands at patterns with the same shading in the drawings belong to the same subband group.

[0052] Further, the method of combining subbands spaced
10 at intervals, that is, the method of selecting a plurality of subbands at predetermined intervals from subbands arranged on the frequency axis is a method of selecting several subbands spaced at intervals and take these subbands to be one subband group as shown in FIG.9. FIG.9
15 shows an example of combining subbands spaced at intervals.

[0053] In FIG.9, subbands spaced at intervals on the OFDM frequency domain are selected, synthesized, and taken to be one subband group. Namely, subbands at patterns
20 with the same shading in the drawings belong to the same subband group.

[0054] Further, the method of combining all of the subbands, namely, the method of selecting all of the subbands every predetermined time domain, as shown in
25 FIG.10, is a method of synthesizing all of the subbands in the frequency domain into a single subband group. FIG.10 is an example of combining all of the subbands.

[0055] In FIG.10, all N subbands on the frequency domain that have the same positions on the OFDM time domain are synthesized and are taken to be one subband group.

[0056] Further, with a method of combining using another rule, after the modulation and coding parameters of the subbands at the subband groups and the number of bits of assigned bits information are decided, the number of information bits and joint coding parameters assigned within a subband group are decided as follows. First, a modulation method where the sum of the number of information bits assigned within the subbands is obtained and the obtained number is taken to be the number of information bits assigned to the entire subband group. Next, the maximum modulation classifications within the subbands are made uniform in the subband groups and the result is used as a modulation scheme in modulation. Next, the coding rate is obtained from the number of information bits assigned within the subband group and the modulation method.

[0057] In this process, it is assumed that, for example, there are four subbands A, B, C and D at one subband group, the number of subcarriers included at the subbands is 512, and that the classifications of coding and modulation corresponding to the subbands are 0, 1, 2, and 3 respectively. As a result, the number of information bits assigned within the subband groups of A, B, C and D are $512 \times 0 = 0$ for A, $512 \times 0.5 = 256$ for B, $512 \times 1 = 512$

for C, and $512 \times 1.5 = 768$ for D. Because of this, the total number of information bits within the subband group is $0 + 256 + 512 + 768 = 1536$. The highest modulation classification is then selected for the subband groups of A, B, C and D (here, the modulation classification corresponding to subband D is the highest), and 8PSK is taken to be a modulation parameter uniform over the whole of the subband group. Correspondingly, the coding rate used in coding in a uniform manner for the subband group is $1536 / (512 \times 3 \times 4) = 1/4$.

[0058] The sum of the number of bits of transmission information at the four subbands of A, B, C and D obtained through estimation is then obtained and taken to be the number of information bits to be transmitted within the subband group. In this actual operation, weighting calculations may also be carried out on this numeric value. For example, considering the case where channel fluctuation is relatively early, the sum of the number of transmission information bits at the four subbands of A, B, C and D is obtained, and weighting is then carried out using 0.9, thereby taking $(0 + 256 + 512 + 768) \times 0.9 \doteq 1382$ to be the total number of information bits within the subband.

[0059] The feedback of parameters in step 921 is transmitted back to the transmission side via a feedback channel after adaptive parameters for the OFDM subbands group are obtained on the receiving side, and an actual

operation is carried out on the transmission side based on this parameters.

[0060] In a second stage, the transmission side assigns the number of information bits for transmission use
5 corresponding to each subband group based on adaptive parameters within the OFDM subband group fed back from the receiving side, and carries out joint coding and modulation within the subband groups per corresponding parameter(step 911). For example, joint modulation and
10 coding is carried out on the subband groups comprised of the four subbands of A, B, C and D based on the above assumptions, and, in this case, the modulation and coding parameters are 8PSK and 1/4 Turbo code. The modulated symbols are then assigned to corresponding OFDM subbands
15 based on subband combination patterns and the result is transmitted (step 912). Specifically, this includes serial/parallel conversion at serial/parallel converter 302, inverse fast Fourier transform at inverse fast Fourier transform section 303, parallel/serial
20 conversion at parallel/serial converter 304, and guard interval insertion at guard interval insertion section 305.

[0061] In the third stage, the receiving side first removes guard intervals at guard interval removing
25 section 315, carries out parallel/serial conversion at serial/parallel converter 314, carries out fast Fourier conversion at fast Fourier converting section 313, and

carries out parallel/serial conversion at parallel/serial converter 312. The receiving side extracts data within the received OFDM subband groups based on the subband combination patterns by controlling
5 parallel/serial converter 312 (step 904), and, after this, carries out adaptive demodulation and decoding on the subband groups using the adaptive parameters within the subband groups obtained in the first stage, and obtains original data to be transmitted finally(step 905).

10 [0062] The present invention effectively improves spectrum utilization efficiency of a system and in particular spectrum utilization efficiency under high-speed fading and channel estimation error, and reduces the degree of difficulty in implementing
15 adaptivity and feedback overhead by carrying out combination and joint coding on the OFDM subbands and effectively utilizing diversity performance between subbands.

[0063] FIG.11 shows the comparison results of the
20 performance of the method of the present invention and the method of the related art under different feedback delay times.

[0064] FIG.12 shows the comparison results of the
25 performance of the method of the present invention and the method of the related art under different channel estimation errors.

[0065] Here, as a simulation, it is assumed that signal

bandwidth of the OFDM system is 10MHz, the total number of subcarriers is 1024, and subbands divided into 16 are provided, and each subband is over eight OFDM symbols on the time domain. Assume that a recursive system convolution (RSC) polynomial for the quantity of the Turbo code adopts (13, 11)_{OCT}, fourth order recursion decoding, and a maximum a posterior probability (MAP) algorithm. ARQ is adopted in the system. Assume that the channel model used in the simulation is an M.1225 mounted channel model A.

5 For specific implementation, one subband uses an average signal to noise ratio parameter estimating method using a method of combining the entire subband. Here, f_{dt} and MSE in FIG.11 and FIG.12 denote the product of maximum Doppler frequency deviation and feedback time delays, and a channel estimation error, respectively. The method of the related art is as shown in FIG.2. As is understood from the results of FIG.11 and FIG.12, the methods proposed by the present invention have a certain performance gain when compared to methods of the related art, regardless of whether this is an ideal case ($f_{dt} = 0$, no MSE), or whether there is high-speed fading (f_{dt} exists) or whether a channel estimation error exists (MSE exists). Further, in this case, if all 16 sixteen subbands are synthesized into a single subband group, the feedback overhead becomes

10 1/16 of the original.

[0066] As described above, the present invention has been described in line with preferred embodiments. However,

it is obvious for those skilled in the art that the present invention may be implemented with various modifications, replacements, and additions within the spirit and the scope of the present invention. The present invention
5 is therefore by no means limited to the embodiments described above.

CLAIM

1. A communication apparatus comprising:

a channel estimating section that carries out channel estimation per subband;

5 a parameter deciding section that decides modulation parameters and coding parameters per subband group comprised of a plurality of subbands based on the channel estimation result;

a parameter information transmission section that
10 transmits to a communicating party, parameter information that is information for the modulation parameters and the coding parameters decided at the parameter deciding section;

a receiving section that receives a received signal
15 containing data modulated and encoded per subband group at a communicating party using the modulation parameters and coding parameters of the parameter information transmitted at the parameter information transmission section; and

20 a data obtaining section that demodulates and decodes the received signal received at the receiving section per subband group using the modulation parameters and coding parameters decided at the parameter deciding section and obtains the data contained in the received
25 signal.

2. The communication apparatus of claim 1, further

comprising a pattern storage section that stores patterns for selecting subbands constituting the subband groups in advance, wherein the parameter deciding section decides the modulation parameters and the coding parameters per subband group comprised of the subbands selected based on the patterns stored in the pattern storage section.

3. The communication apparatus of claim 2, wherein the parameter deciding section decides the modulation parameters and the coding parameters per subband group constituted from the patterns for selecting a plurality of subbands neighboring on the frequency axis.

4. The communication apparatus of claim 2, wherein the parameter deciding section decides the modulation parameters and the coding parameters per subband group constituted from the patterns for selecting the plurality of subbands at predetermined intervals from subbands arranged on the frequency axis.

5. The communication apparatus of claim 2, wherein the parameter deciding section decides the modulation parameters and the coding parameters per subband group constituted from the patterns selecting all subbands per predetermined time domain.

6. The communication apparatus of claim 1, wherein the parameter deciding section finds the modulation parameters per subband within the subband group, and decides a modulation parameters with a highest classification within the found modulation parameters as the modulation parameters for the subband group.

7. The communication apparatus of claim 1, wherein the parameter deciding section decides the coding parameters in such a manner that the number of information bits that are able to be assigned to all of the subbands within the subband group is assigned to the subband group.

8. The communication apparatus of claim 1, wherein the parameter deciding section decides the coding parameters in such a manner that the number of information bits obtained by assigning a weight to the sum of the number of information bits that are able to be assigned to all of the subbands within the subband group, is assigned to the subband group.

9. A base station apparatus that are a communicating party of the communication apparatus of claim 1, the base station apparatus comprising an adaptive modulating/coding section that modulates and encodes data in accordance with the modulation parameters and the coding parameters of the parameter information

transmitted by the transmission section, and a data transmission section that transmits the modulated and encoded data subjected to modulation and coding at the adaptive modulating/coding section.

5

10. A communication system comprising a base station apparatus transmitting modulated and encoded data and a communication terminal apparatus receiving the data, the communication terminal apparatus comprising:

10 a channel estimating section that carries out channel estimation per subband;

a parameter deciding section that decides modulation parameters and coding parameters per subband group comprised of a plurality of subbands based on channel estimation results;

15 a parameter information transmission section that transmits parameter information that is information for the modulation parameters and the coding parameters decided at the parameter deciding section;

20 a receiving section that receives a received signal containing data modulated and encoded per subband group at the base station apparatus using parameters of parameter information transmitted at the parameter information transmission section; and

25 a data extracting section that modulates and decodes a received signal received at the receiving section per subband group using the modulation parameters and the

coding parameters of the parameter information and extracts the data contained in the received signal, wherein the base station apparatus comprises an adaptive modulating/coding section that modulates and encodes data
5 in accordance with the modulation parameters and coding parameters of the parameter information transmitted by the transmission section; and

10 a data transmission section that transmits data modulated and encoded at the adaptive modulating/coding section.

11. A communication method comprising the steps of:
carrying out channel estimation per subband;
deciding modulation parameters and coding
15 parameters per subband group comprised of a plurality of subbands based on the channel estimation results;
at a communication terminal apparatus, transmitting parameter information that is information for the decided modulation parameters and coding parameters;
20 at a base station apparatus, receiving the parameter information transmitted by the communication terminal apparatus;
modulating and coding data in accordance with the modulation parameters and the coding parameters of the
25 received parameter information;
at the base station apparatus, transmitting the modulated and encoded data;

at the communication terminal apparatus, receiving a received signal containing the data transmitted by the base station apparatus; and

5 modulating and decoding the received signal per subband group using the modulation parameters and the coding parameters of the parameter information, and extracting data contained in the received signal.

12. The communication method of claim 11, further comprising storing patterns for selecting subbands constituting the subband groups in advance,

10 wherein the modulation parameters and the coding parameters are decided per subband group comprised of the selected subbands based on the stored patterns.

ABSTRACT

A communication apparatus capable of improving the spectrum usage rate of a system, especially, the spectrum usage rate in connection with both a fast fading and a channel estimation error as compared with the conventional sub-band adaptive method, while reducing the degree of the difficulty in achieving the adaptation, and further reducing the feedback overhead. In this apparatus, a sub-band group AMC parameter selecting part (318) selects an AMC parameter of each sub-band. An adaptive reception control part (503) must control an adaptive demodulating/decoding part (311), while controlling a parallel/serial converter (312) in a stage preceding the adaptive demodulation and decoding processes, and combining received symbols in the same sub-band group for demodulation and decoding.

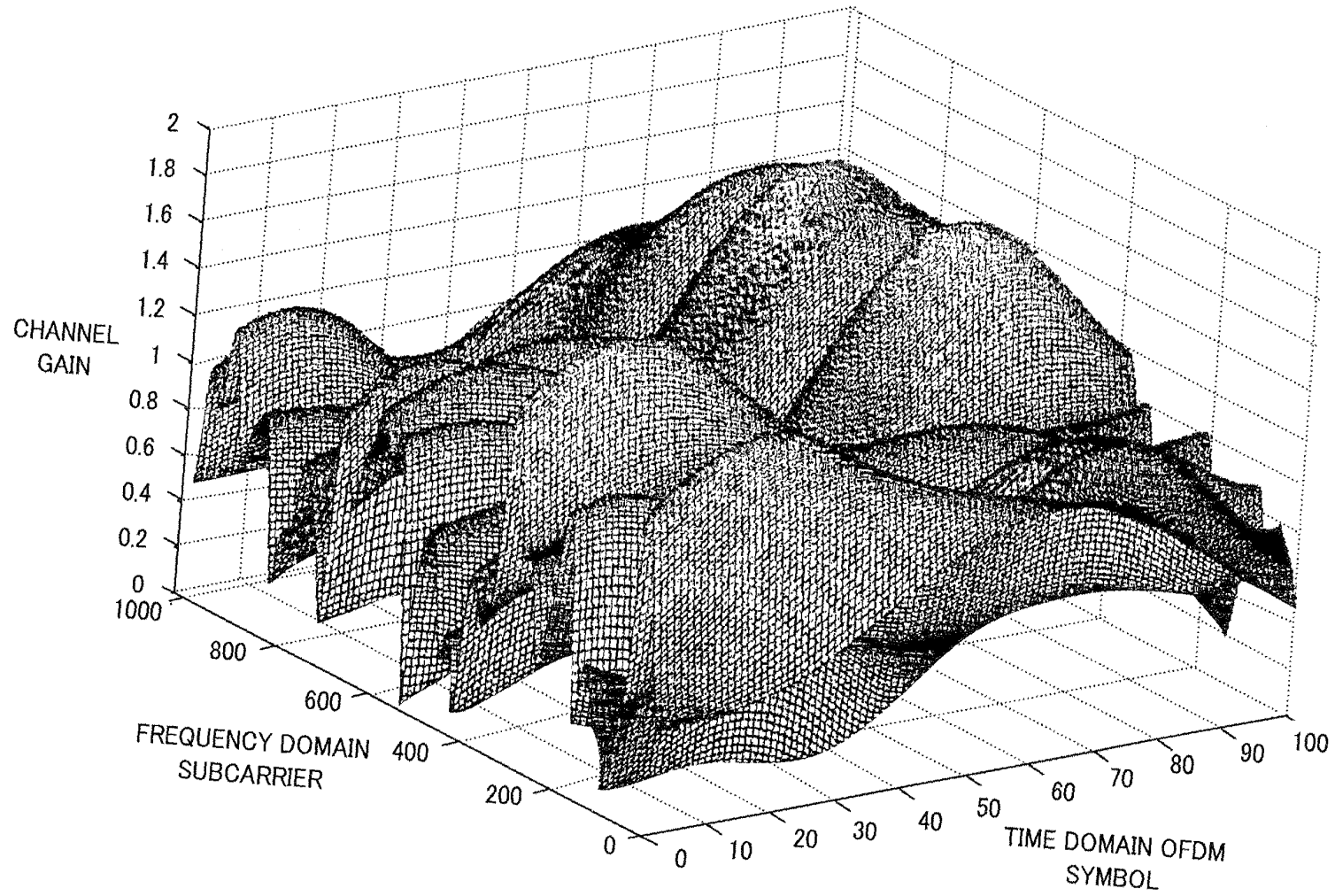

1/16

PRIOR ART
FIG.1

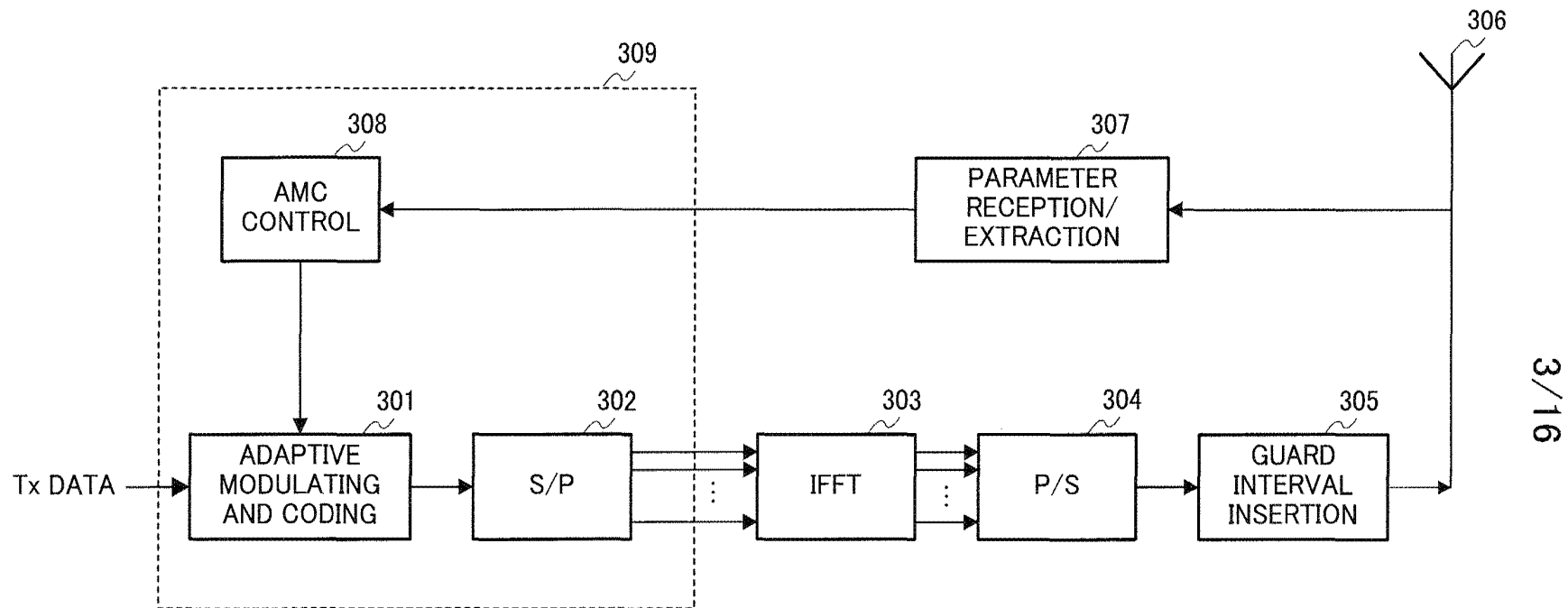

3/16

PRIOR ART

FIG.3A

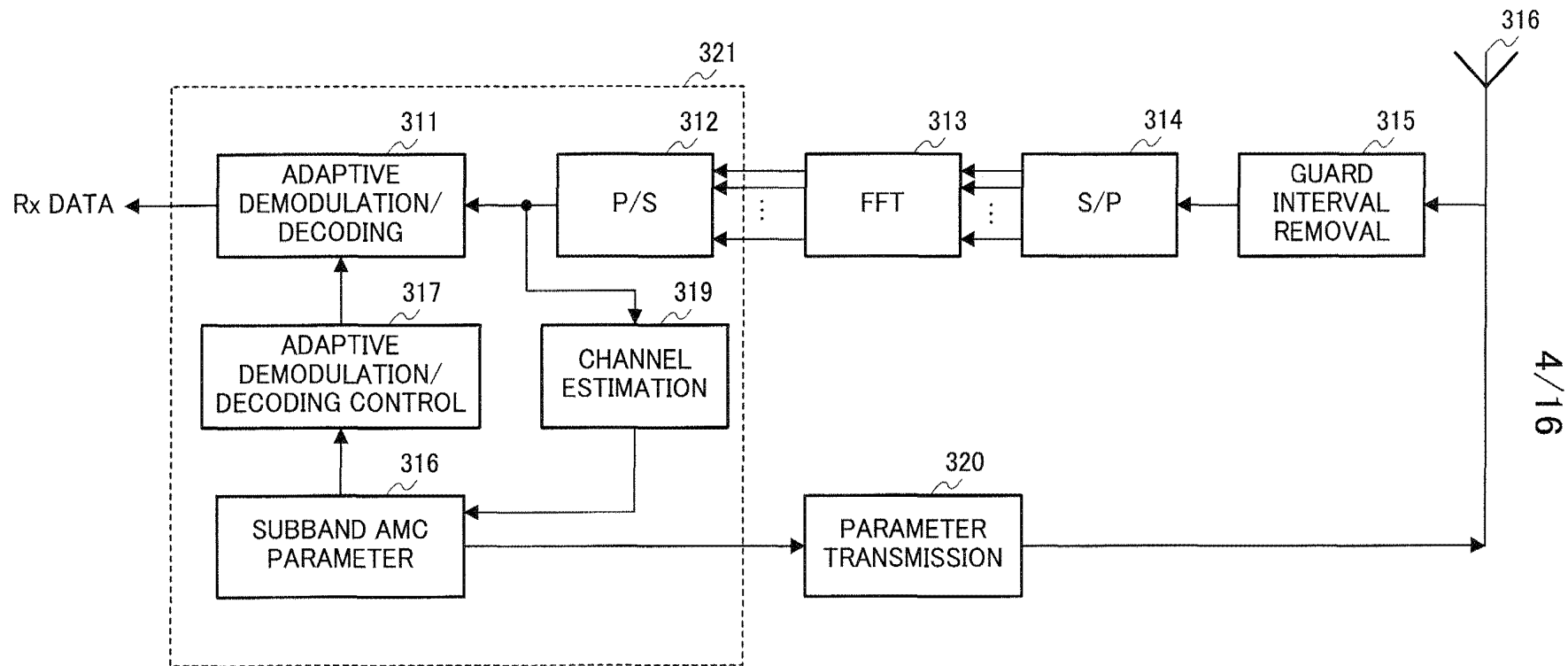

PRIOR ART

FIG.3B

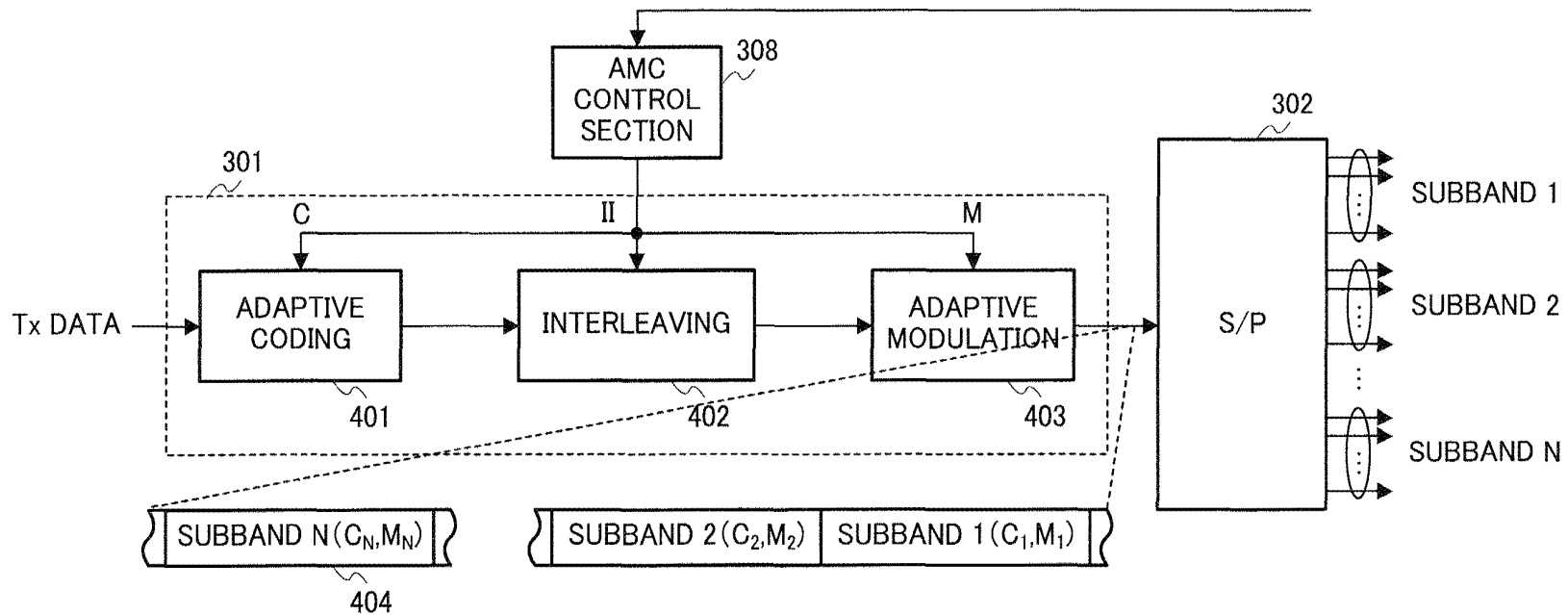

PRIOR ART

FIG.4A

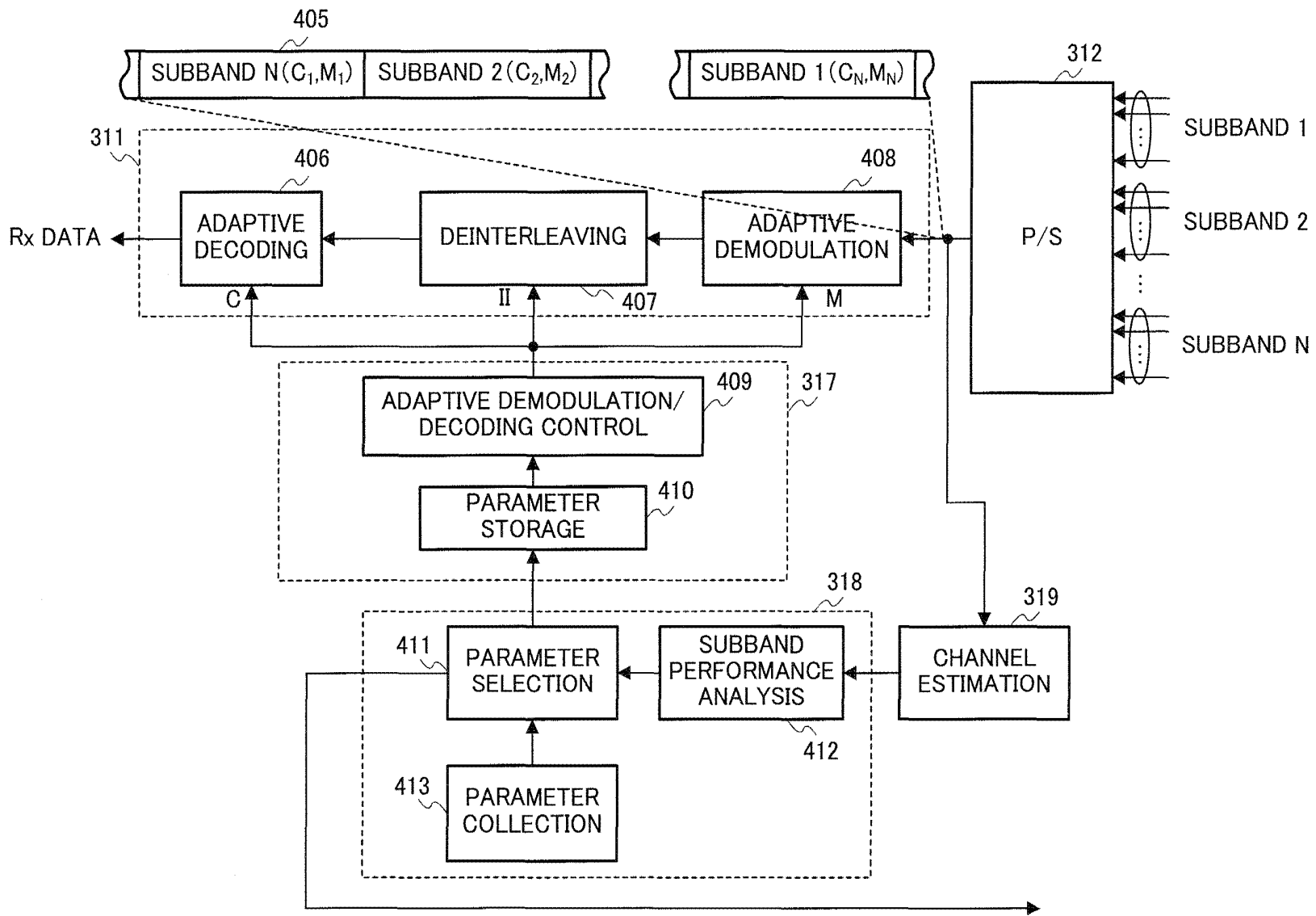

PRIOR ART

FIG.4B

6/16

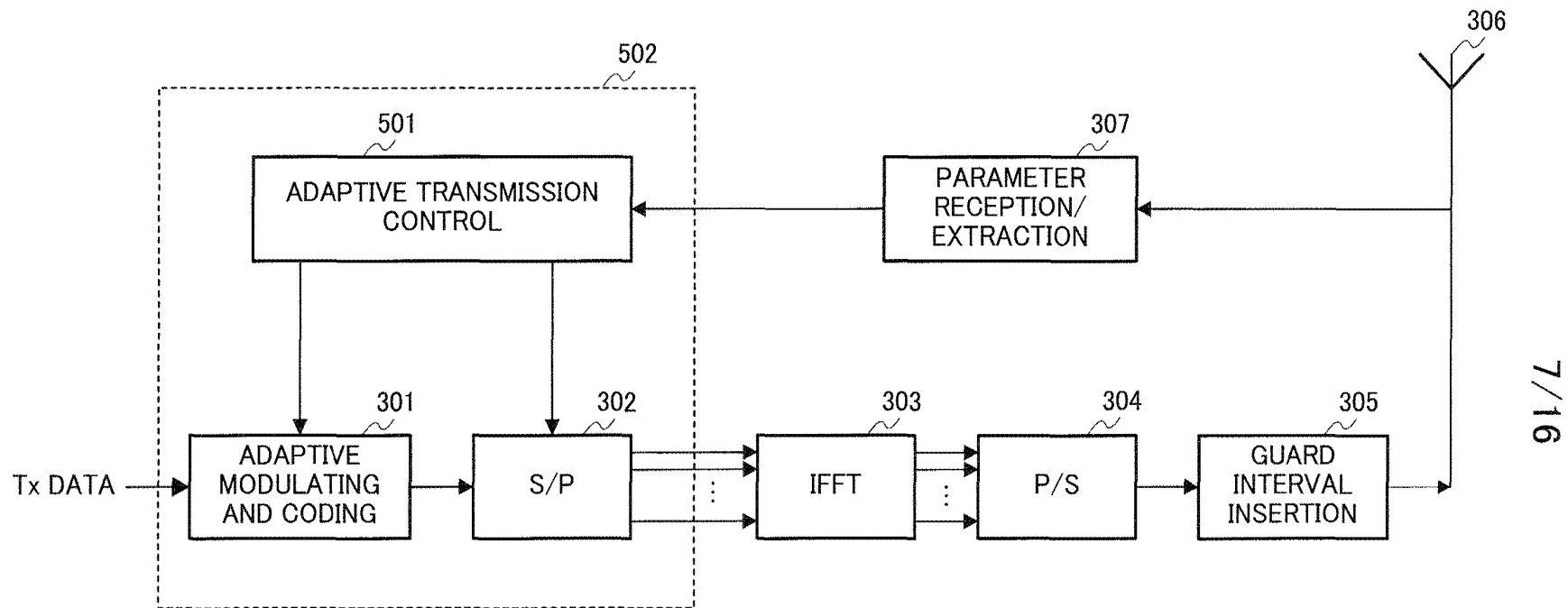

7/16

FIG.5A

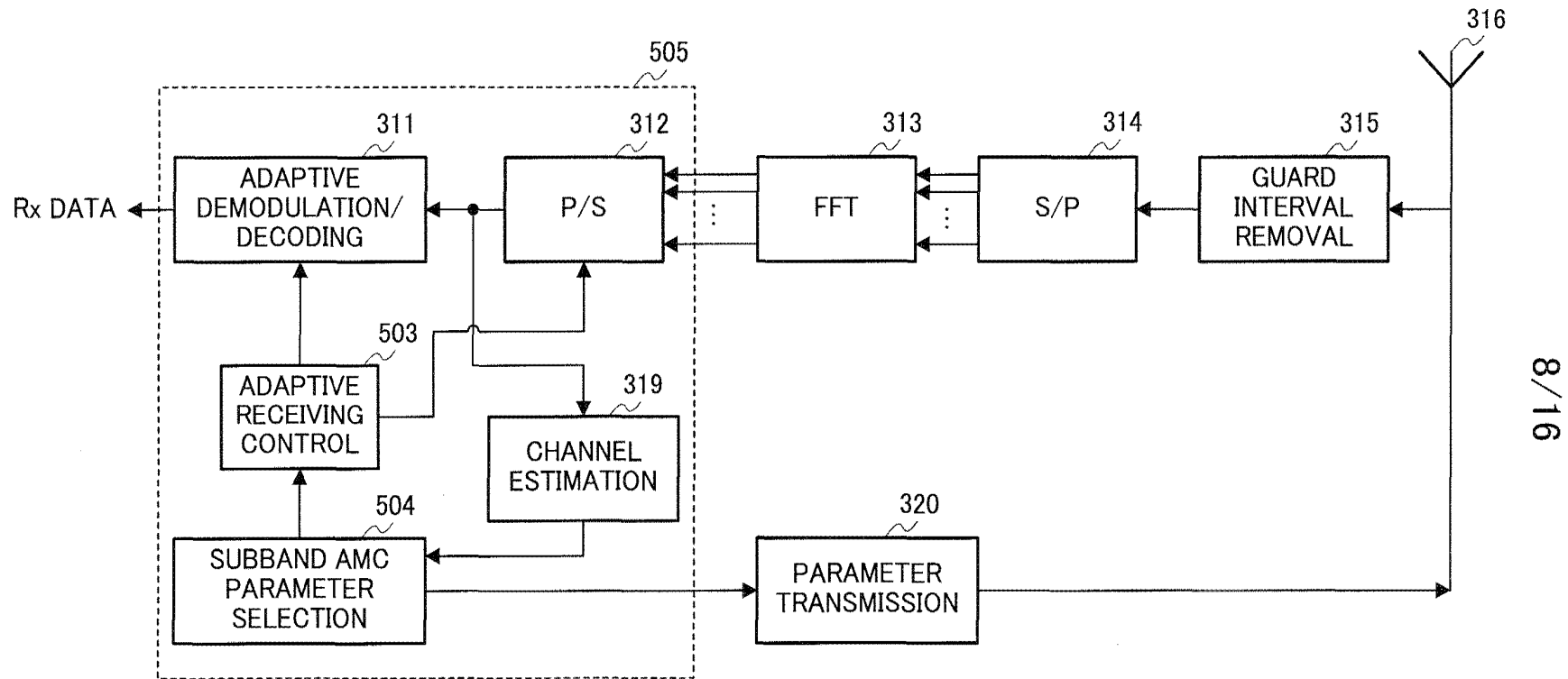

FIG.5B

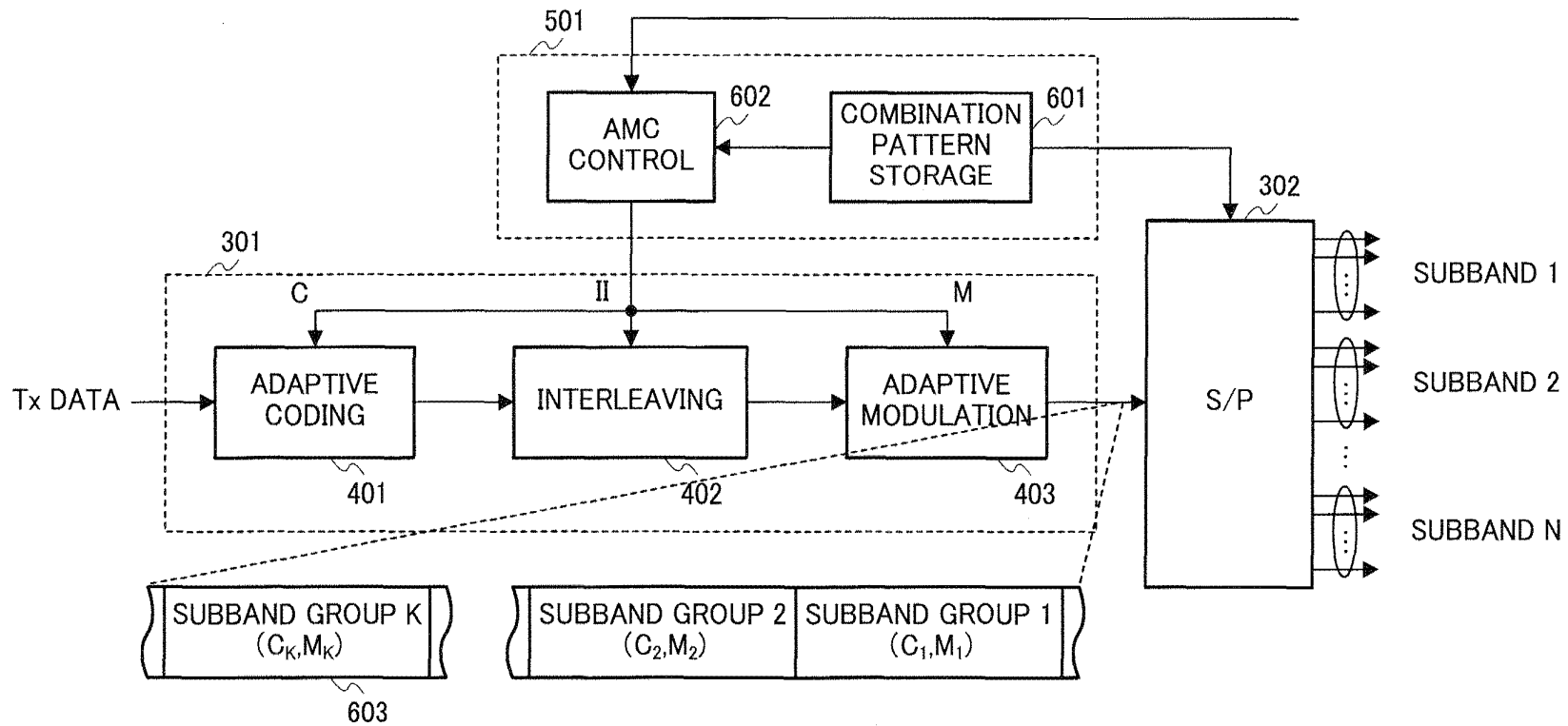
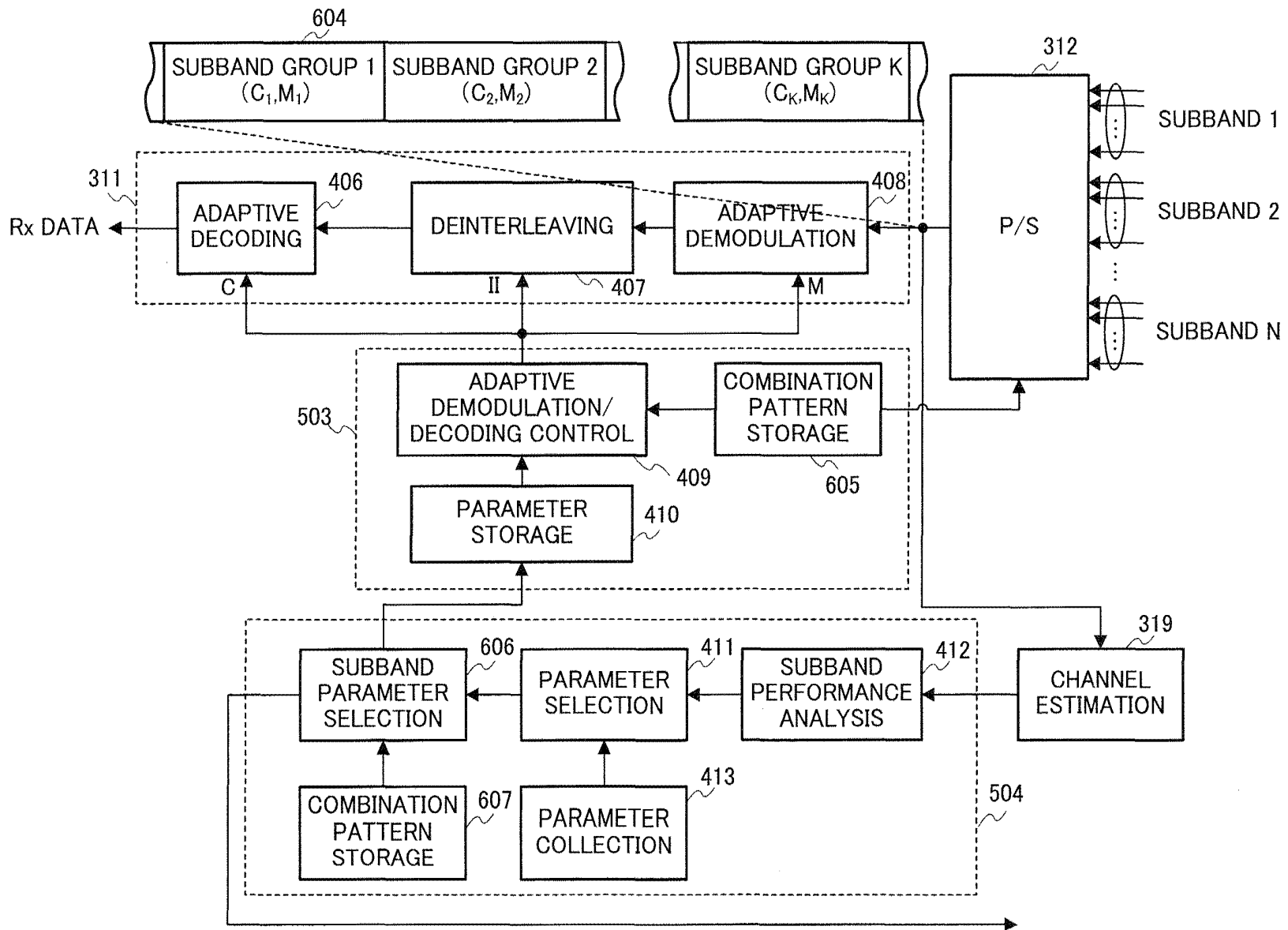

FIG.6A



10/16

FIG.6B

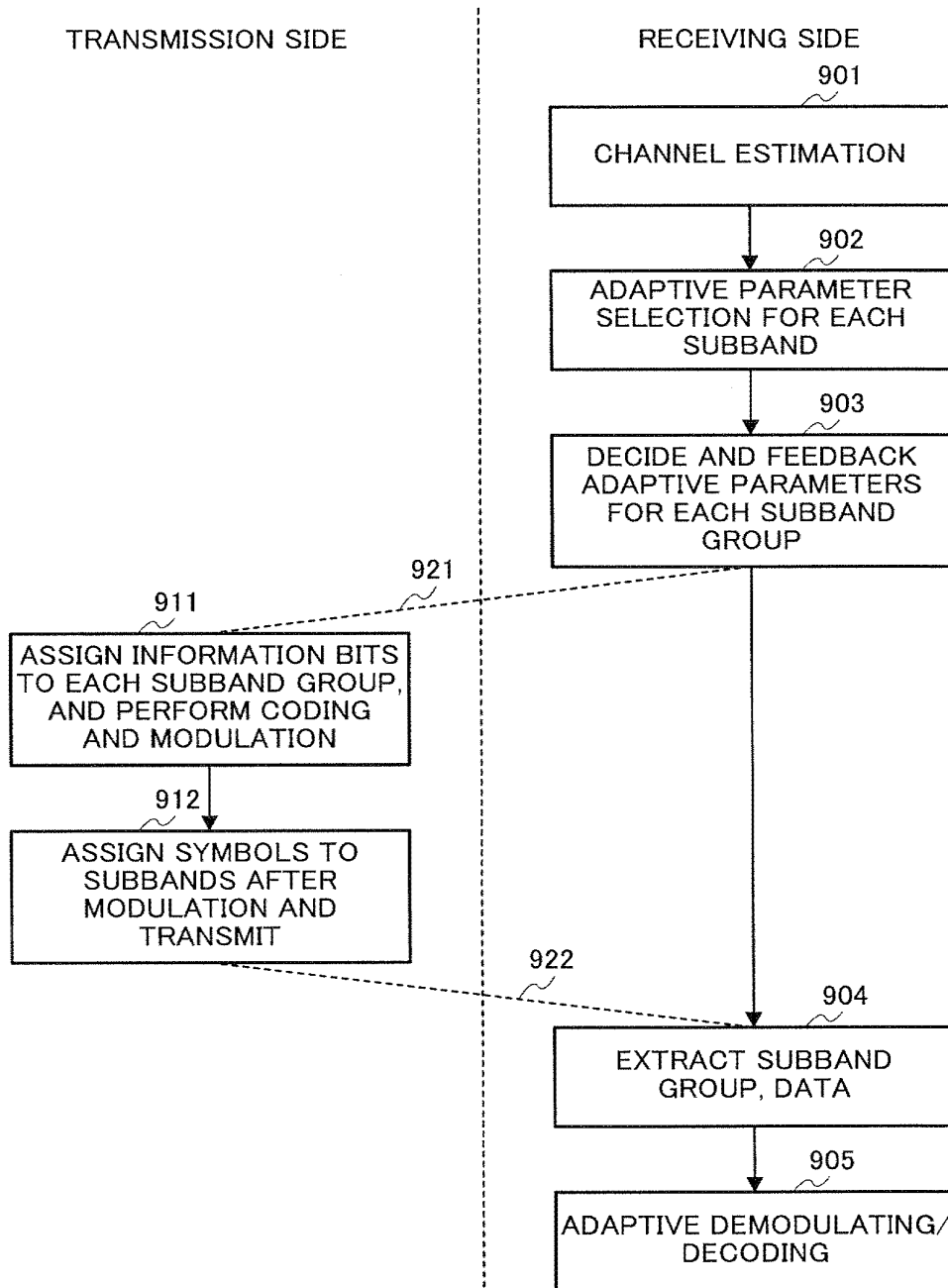

FIG.7

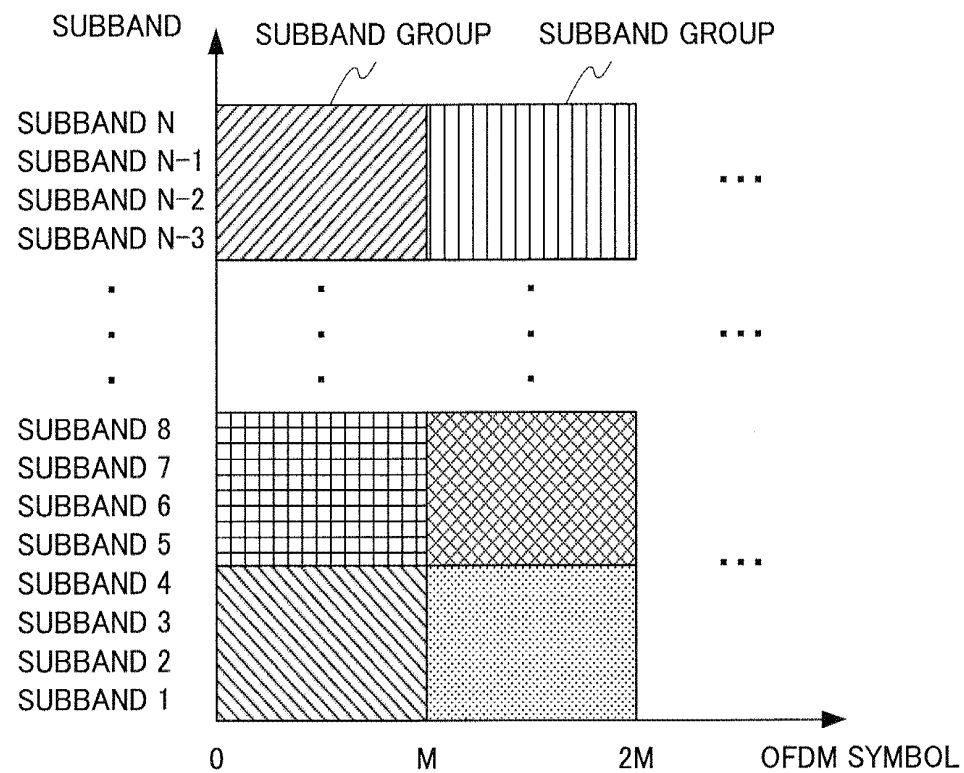

FIG.8

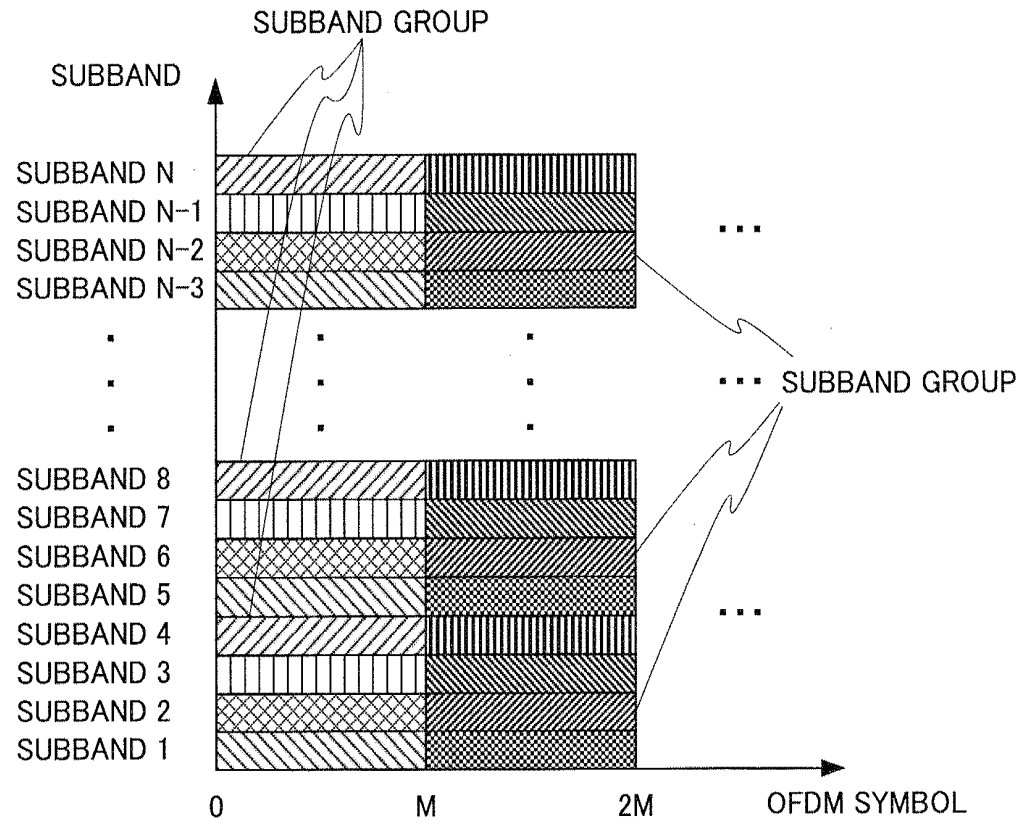

FIG.9

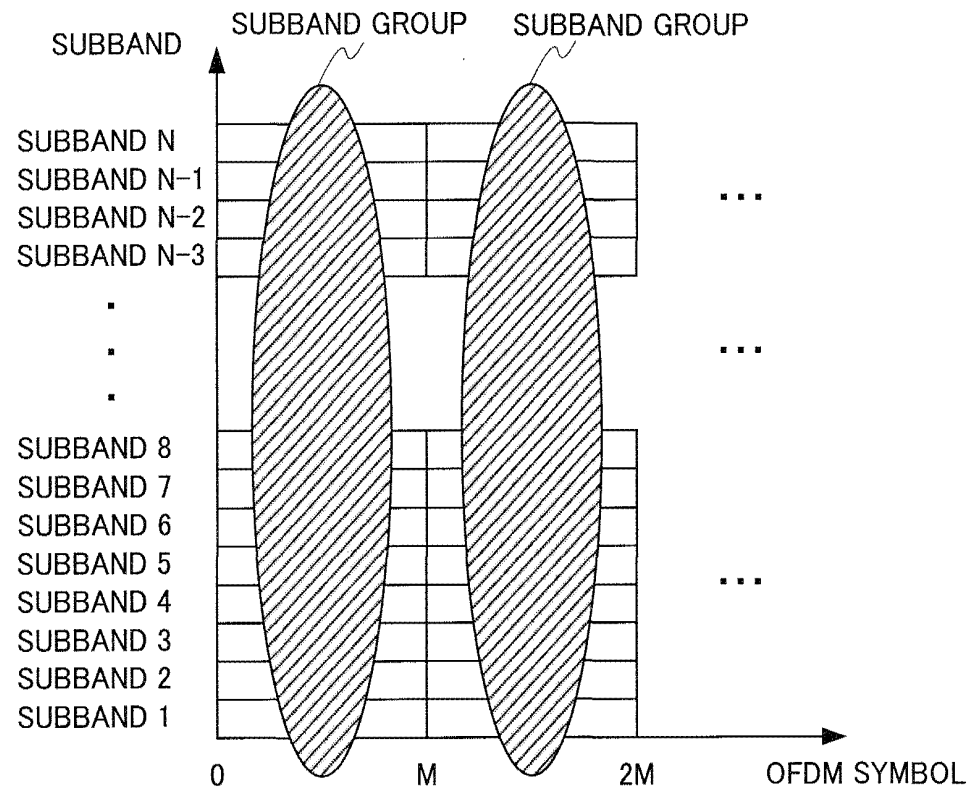

FIG.10

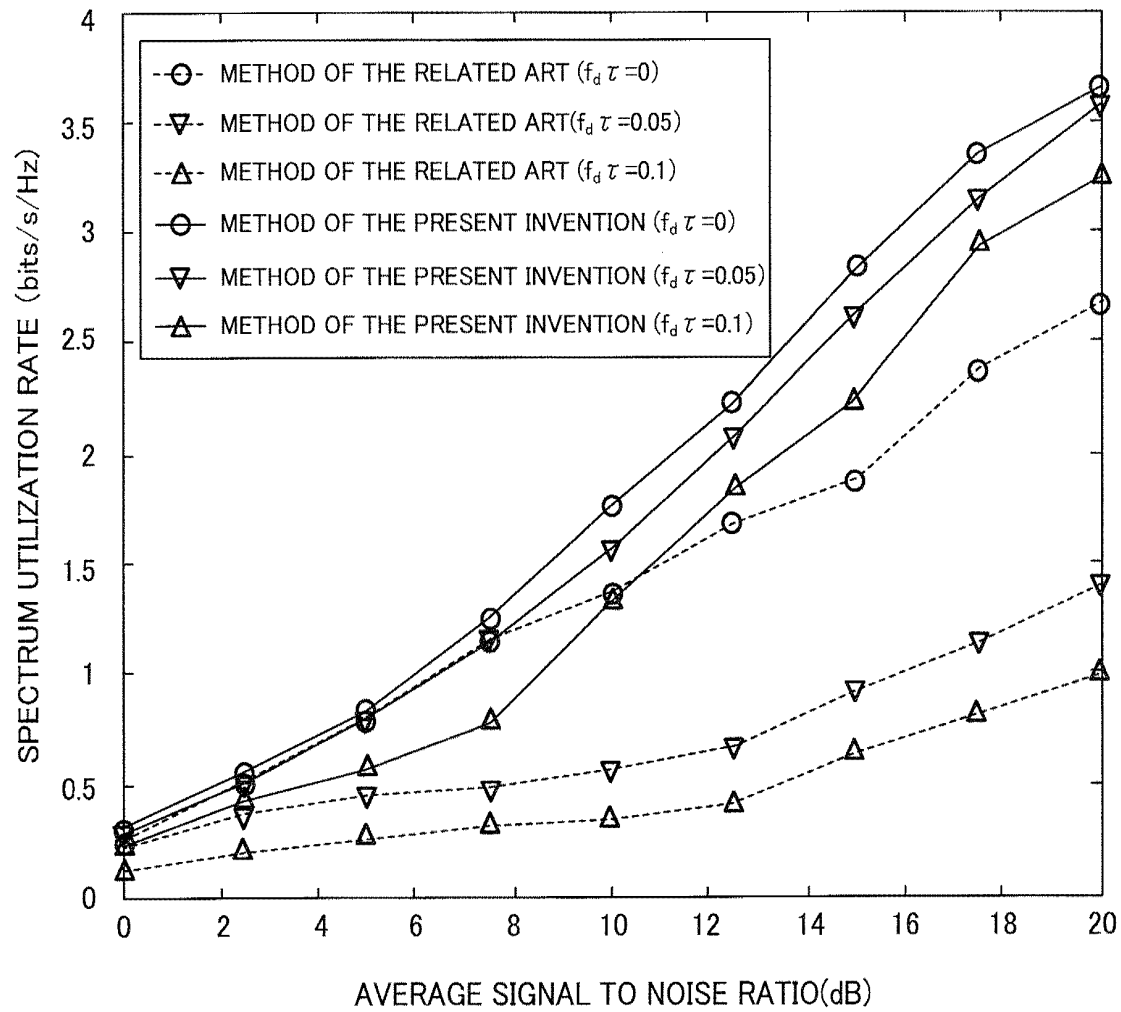

FIG.11

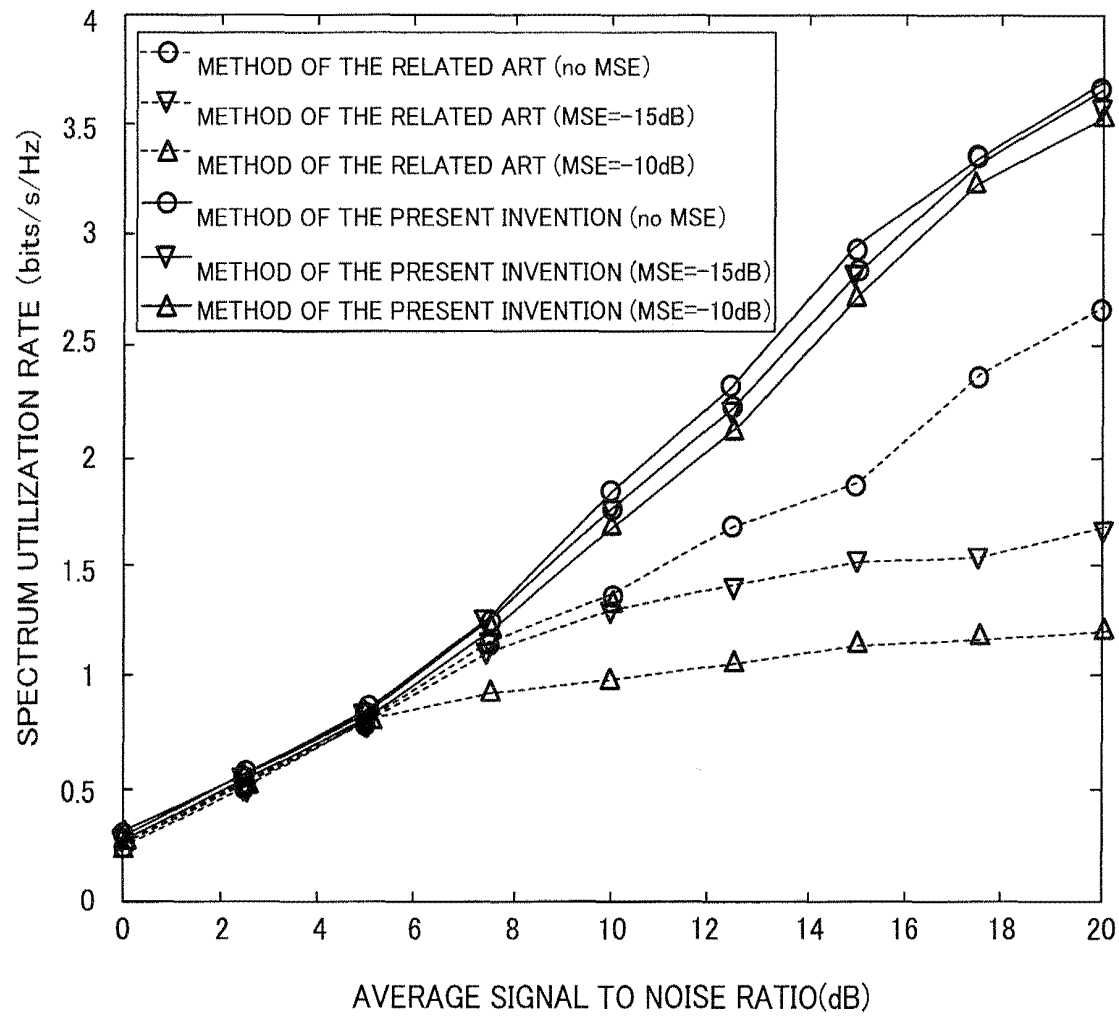

FIG.12

Matsushita Ref*: P035889-03
 (* must be filed)
 Japan Firm Name: WASHIDA & ASSOCIATES
 US Firm Name: SDM

Application Serial No. _____
 Japan Firm Ref: 2F05271-US-P
 US Firm Ref: _____

DECLARATION AND POWER OF ATTORNEY FOR U.S. PATENT APPLICATION

(a) Original (b) Supplemental (c) Substitute (d) PCT (e) Design

As a below named inventor, I hereby declare that: my residence, post office address and citizenship are as stated below next to my name; and I believe that I am the original, first and sole inventor (if only one name is listed below) or an original, first and joint inventor (if plural inventors are named below) of the subject matter which is claimed and for which a patent is sought on the invention entitled:

Title of Invention:
COMMUNICATION APPARATUS, COMMUNICATION SYSTEM, AND COMMUNICATION METHOD

which is described and claimed in (if the following box is not checked, the specification of which is attached hereto):

<i>1. For use when submitting this Declaration prior to U.S. application filing date</i>			
(f) <input type="checkbox"/> the attached specification, or			
<i>2. For use when submitting this Declaration after U.S. application filing date</i>			
(g) <input type="checkbox"/> the specification in the U.S. Application:	Application No. (if available)		filed on (must be filed)
	and with amendments (if applicable):		filed on _____, or
<i>3. For PCT-US national entry under 35 U.S.C. 371 (for use when filing this Declaration before and after the U.S. national entry date)</i>			
(h) <input checked="" type="checkbox"/> the specification in the International Application: <small>(Check here only for US national entry under 35 U.S.C. 371.)</small>	PCT Application No.	PCT/JP2005/021246	filed on (international filing date) November 18, 2005,
	and with amendments (if applicable):		filed on _____

I hereby state that I have reviewed and understand the contents of the above-identified specification, including the claims, as amended by any amendment(s) referred to above.

I acknowledge my duty to disclose to the U.S. Patent and Trademark Office all information known to me to be material to patentability as defined in Title 37, Code of Federal Regulations, §1.56.

I hereby claim foreign priority benefits under Title 35, United States Code, §119 (a-d), §172, or §365(b) of any foreign application(s) for patent or inventor's certificate, or §365(a) of any PCT international application which designated at least one country other than the United States of America, listed below, and have also identified below any foreign application for patent or inventor's certificate, or of any PCT international application having a filing date before that of the application on which priority is claimed:

(Foreign Priority Information)

COUNTRY	APPLICATION NO.	DATE OF FILING	PRIORITY CLAIMED
CHINA	200410094967.7	November 19, 2004	Yes

Additional foreign or international application numbers are listed on a supplemental priority sheet attached hereto.

MEI Form -2.0, (July, 2006)

I hereby claim the benefit under Title 35, United States Code §119(e) of any United States Provisional application(s) listed below.

(US Provisional Application Information)

APPLICATION NO.	U.S. PROVISIONAL APPLICATION FILING DATE

Additional U.S. provisional application numbers are listed on a supplemental priority sheet attached hereto.

I hereby claim the benefit under Title 35, United States Code §120 of any United States application(s), or §365(C) of any PCT international application designating the United States of America, listed below and, insofar as the subject matter of each of the claims of this application is not disclosed in the prior United States or PCT international application in the manner provided by the first paragraph of Title 35, United States Code §112, I acknowledge the duty to disclose information material to patentability as defined in Title 37, Code of Federal Regulations, §1.56 which occurred between the filing date of the prior application and the national or PCT international filing date of this application.

(Domestic Priority Information)

APPLICATION NO.	U.S. FILING DATE	STATUS: PATENTED, PENDING, ABANDONED

Additional U.S. or international application numbers are listed on a supplemental priority sheet attached hereto.

POWER OF ATTORNEY: As a named inventor, I hereby appoint the attorneys and agents associated with U.S. Patent and Trademark Office Customer Number identified below to prosecute this application and to transact all business in the U.S. Patent and Trademark Office connected therewith, and direct that all correspondence be addressed to that customer number.

I hereby authorize the U.S. attorneys and agents associated with the customer number to accept and follow instructions from Matsushita Electric Industrial Co., Ltd., and any affiliated or subsidiary company thereof, received via their corporate representatives and/or their foreign patent attorneys or agents, if any, as to any action to be taken in the U.S. Patent and Trademark Office regarding this application without direct communication between the U.S. attorneys or agents and myself.

Direct Correspondence to:

CUSTOMER NUMBER 52989

I further declare that all statements made herein of my own knowledge are true, and that all statements made on information and belief are believed to be true; and further that these statements were made with the knowledge that willful false statements and the like so made are punishable by fine or imprisonment, or both, under Section 1001 of Title 18 of the United States Code, and that such willful false statements may jeopardize the validity of the application or any patent issuing thereon.

INVENTOR (s)

Full Name of Sole or First Inventor	FIRST NAME Xiaoming SHE	LAST NAME	SIGNATURE <i>Xiaoming she</i>	DATE OF SIGNATURE April 10, 2007
Residence & Citizenship	CITY, STATE or COUNTRY Beijing, CHINA			CITIZENSHIP CHINA
Post office address	ADDRESS c/o Panasonic R&D Center China Co., Ltd. 18th Floor, No27 Zhongguancun Street, Haidian District, Beijing 100080, P.R.China	CITY	STATE OR COUNTRY	ZIP CODE

Full Name of Second Inventor	FIRST NAME Jifeng LI	LAST NAME	SIGNATURE <i>Jifeng Li</i>	DATE OF SIGNATURE April 20, 2007
Residence & Citizenship	CITY, STATE or COUNTRY Kanagawa, JAPAN			CITIZENSHIP JAPAN
Post office address	ADDRESS c/o Panasonic Mobile Communications Co., Ltd. 600, Saedo-cho, Tsuzuki-ku, Yokohama-shi, Kanagawa, Japan 224-8539	CITY	STATE OR COUNTRY	ZIP CODE

IPR2018-1555

HTC EX1002, Page 500

Electronic Patent Application Fee Transmittal

Application Number:	
Filing Date:	
Title of Invention:	COMMUNICATION APPARATUS, COMMUNICATION SYSTEM, AND COMMUNICATION METHOD
First Named Inventor/Applicant Name:	Xiaoming SHE
Filer:	James Edward Ledbetter
Attorney Docket Number:	L9289.07161

Filed as Large Entity

U.S. National Stage under 35 USC 371 Filing Fees

Description	Fee Code	Quantity	Amount	Sub-Total in USD(\$)
Basic Filing:				
National Stage Fee	1631	1	300	300
Natl Stage Search Fee - Report provided	1642	1	400	400
National Stage Exam - all other cases	1633	1	200	200

Pages:

Claims:

Miscellaneous-Filing:

Petition:

Patent-Appeals-and-Interference:

IPR2018-1555
HTC EX1002, Page 501

Description	Fee Code	Quantity	Amount	Sub-Total in USD(\$)
Post-Allowance-and-Post-Issuance:				
Extension-of-Time:				
Miscellaneous:				
Total in USD (\$)				900

Electronic Acknowledgement Receipt

EFS ID:	1784495
Application Number:	11719611
International Application Number:	PCT/JP05/21246
Confirmation Number:	9253
Title of Invention:	COMMUNICATION APPARATUS, COMMUNICATION SYSTEM, AND COMMUNICATION METHOD
First Named Inventor/Applicant Name:	Xiaoming SHE
Customer Number:	52989
Filer:	James Edward Ledbetter
Filer Authorized By:	
Attorney Docket Number:	L9289.07161
Receipt Date:	17-MAY-2007
Filing Date:	
Time Stamp:	15:01:56
Application Type:	U.S. National Stage under 35 USC 371

Payment information:

Submitted with Payment	yes
Payment was successfully received in RAM	\$ 900
RAM confirmation Number	93
Deposit Account	

File Listing:

Document Number	Document Description	File Name	File Size(Bytes)	Multi Part /.zip	Pages (if appl.)
-----------------	----------------------	-----------	------------------	------------------	------------------

1	PCT-Transmittal Letter	L9289_07161_TRNS.pdf	224300	no	3
Warnings:					
Information:					
2	Application Data Sheet	L9289_07161_ADS.pdf	953806	no	4
Warnings:					
Information:					
3	Documents submitted with 371 Applications	L9289_07161_RO101.pdf	180125	no	3
Warnings:					
Information:					
4		L9289_07161_APPN.pdf	2399632	yes	57
	Multipart Description/PDF files in .zip description				
	Document Description		Start	End	
	Specification		1	32	
	Claims		33	38	
	Abstract		39	39	
	Drawings		40	55	
	Oath or Declaration filed		56	57	
Warnings:					
Information:					
5	Fee Worksheet (PTO-06)	fee-info.pdf	8427	no	2
Warnings:					
Information:					
Total Files Size (in bytes):			3766290		

This Acknowledgement Receipt evidences receipt on the noted date by the USPTO of the indicated documents, characterized by the applicant, and including page counts, where applicable. It serves as evidence of receipt similar to a Post Card, as described in MPEP 503.

New Applications Under 35 U.S.C. 111

If a new application is being filed and the application includes the necessary components for a filing date (see 37 CFR 1.53(b)-(d) and MPEP 506), a Filing Receipt (37 CFR 1.54) will be issued in due course and the date shown on this Acknowledgement Receipt will establish the filing date of the application.

National Stage of an International Application under 35 U.S.C. 371

If a timely submission to enter the national stage of an international application is compliant with the conditions of 35 U.S.C. 371 and other applicable requirements a Form PCT/DO/EO/903 indicating acceptance of the application as a national stage submission under 35 U.S.C. 371 will be issued in addition to the Filing Receipt, in due course.

New International Application Filed with the USPTO as a Receiving Office

If a new international application is being filed and the international application includes the necessary components for an international filing date (see PCT Article 11 and MPEP 1810), a Notification of the International Application Number and of the International Filing Date (Form PCT/RO/105) will be issued in due course, subject to prescriptions concerning national security, and the date shown on this Acknowledgement Receipt will establish the international filing date of the application.