

(19) **United States**

(12) **Patent Application Publication** (10) **Pub. No.: US 2002/0193146 A1**

Wallace et al.

(43) **Pub. Date: Dec. 19, 2002**

(54) **METHOD AND APPARATUS FOR ANTENNA DIVERSITY IN A WIRELESS COMMUNICATION SYSTEM**

Publication Classification

(51) **Int. Cl.⁷ H04M 1/00**
(52) **U.S. Cl. 455/562; 455/101; 455/272; 375/347**

(76) Inventors: **Mark Wallace**, Bedford, MA (US); **Jay Rod Walton**, Westford, MA (US)

(57) **ABSTRACT**

Method and apparatus for negotiating a transmission scenario in a mixed mode spectrum wireless communication system capable of both MISO and SISO traffic. The transmitter determines an antenna diversity configuration for a given communication link and applies a transmission scenario. The base station queries the remote station for antenna diversity status. In response to the antenna diversity status information, the base station determines and applies a transmission scenario. In one embodiment, a base station generates composite MIMO transmissions to multiple SISO mobile stations.

Correspondence Address:
Sarah Kirkpatrick, Manager
Intellectual Property Administration
QUALCOMM Incorporated
5775 Morehouse Drive
San Diego, CA 92121-1714 (US)

(21) Appl. No.: **09/875,397**

(22) Filed: **Jun. 6, 2001**

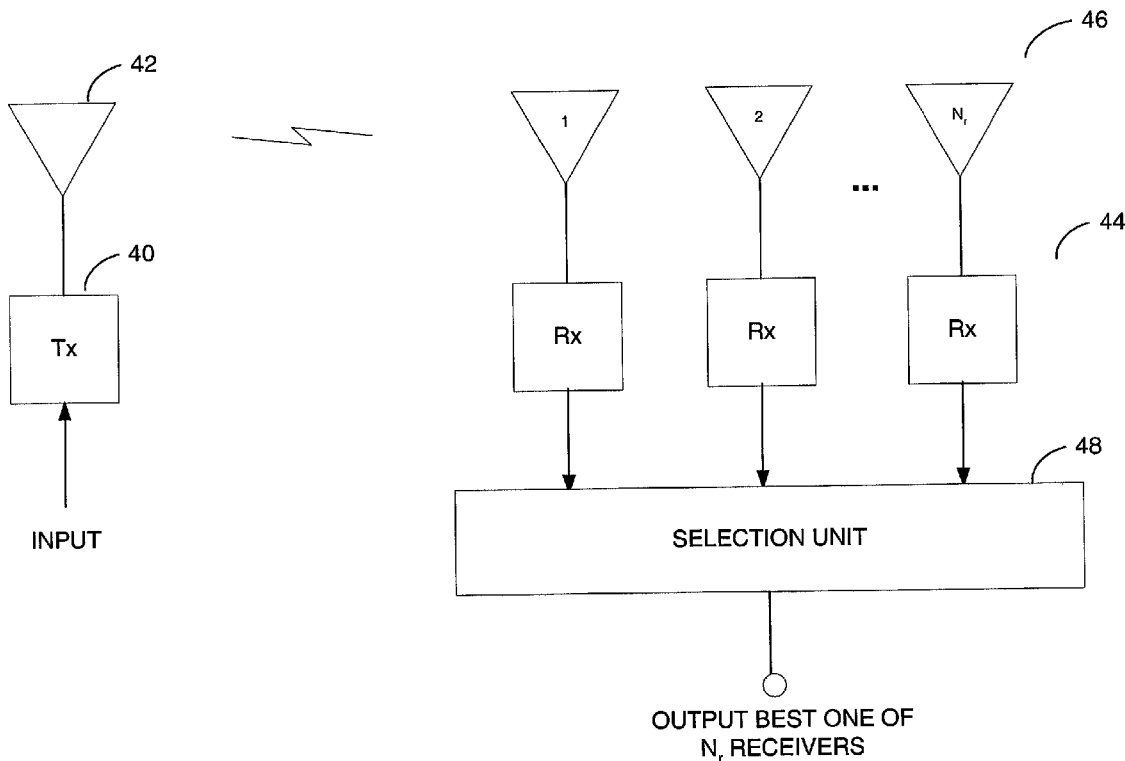

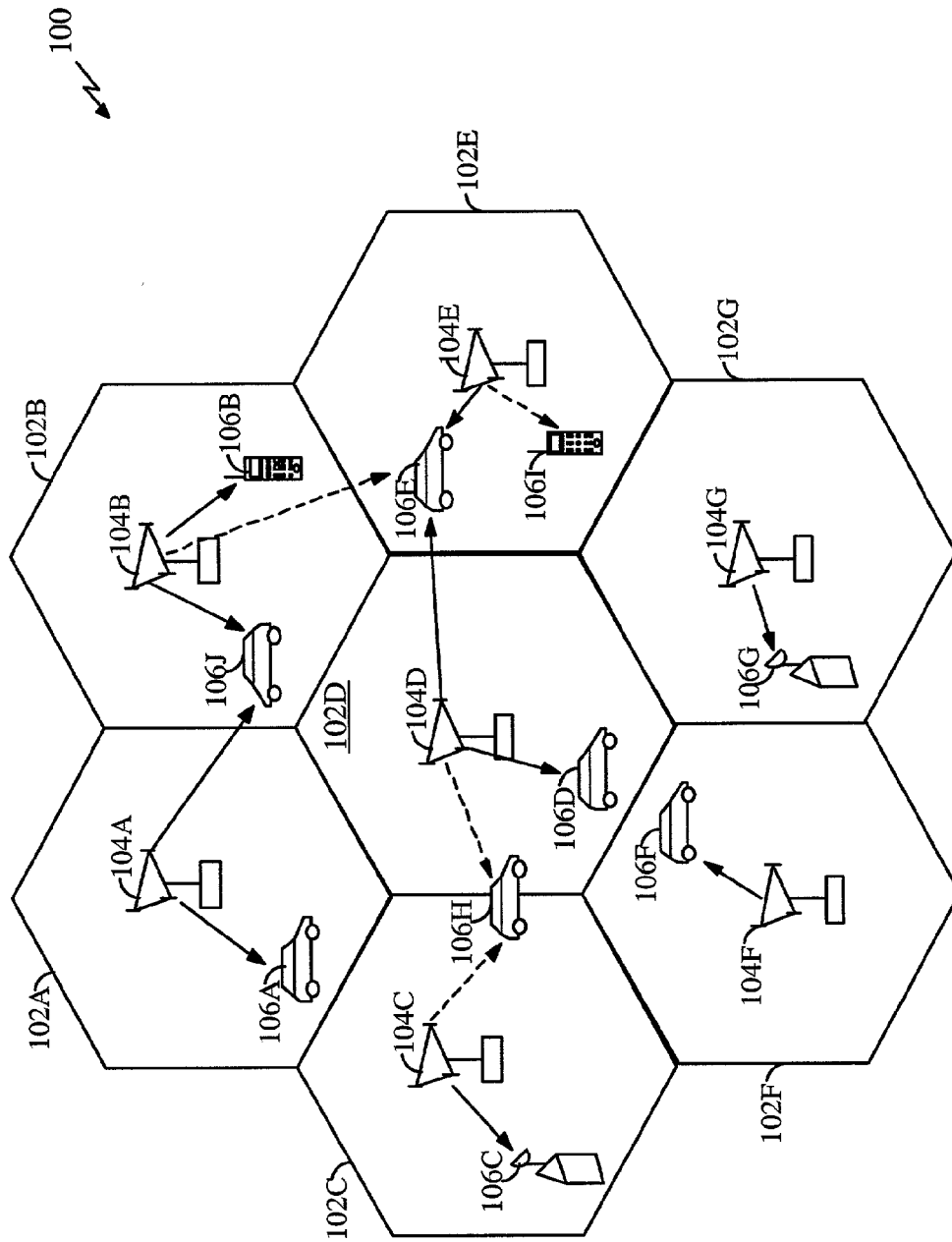

FIG. 1

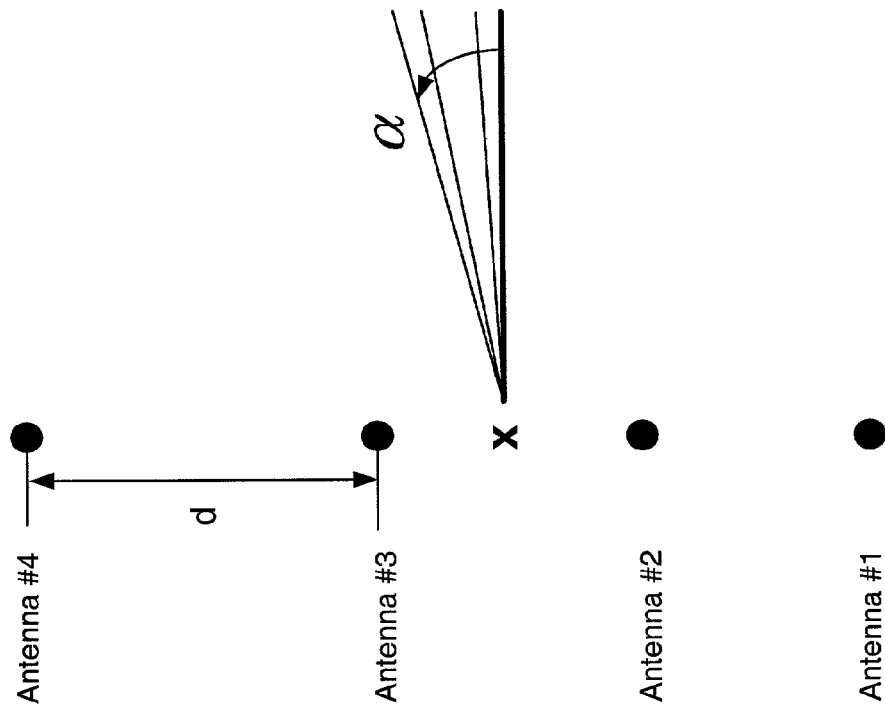

FIG. 2

Number of Receive Antennas

1	N_r
1	SISO
N_t	MISO
	MIMO

Number of Transmit Antennas

FIG. 3

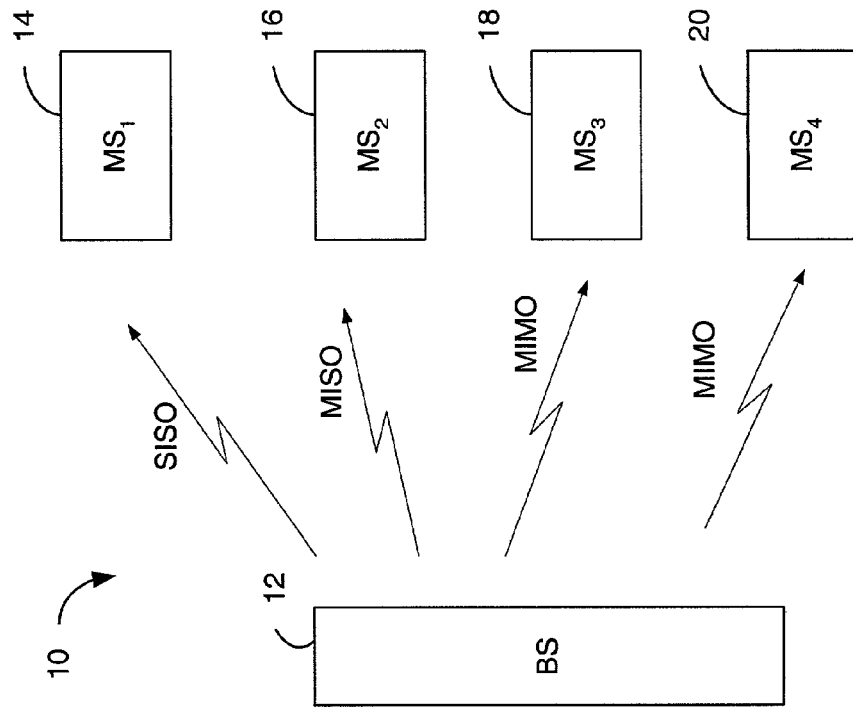

FIG. 5

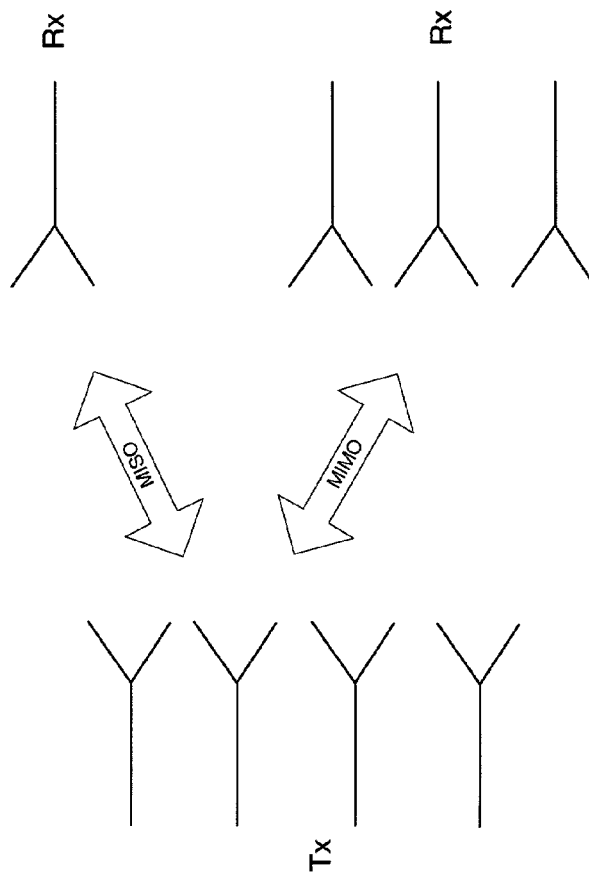

FIG. 4

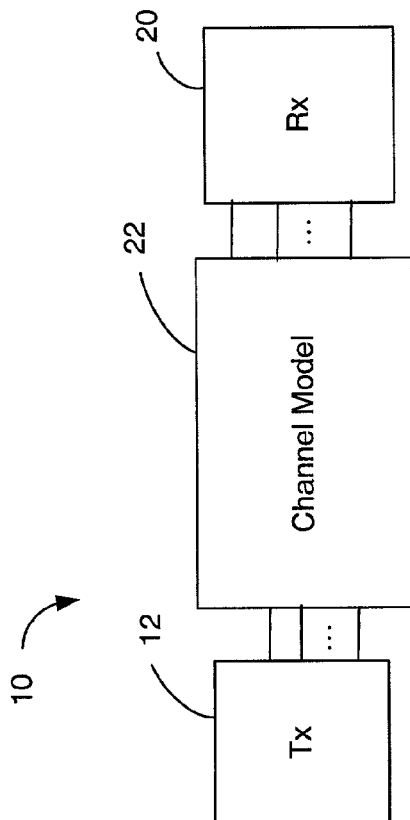

FIG. 6

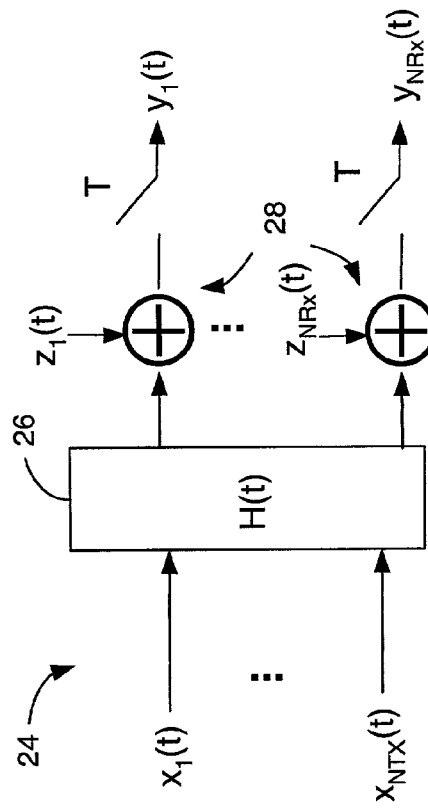

FIG. 7

Explore Litigation Insights

Docket Alarm provides insights to develop a more informed litigation strategy and the peace of mind of knowing you're on top of things.

Real-Time Litigation Alerts



Keep your litigation team up-to-date with **real-time alerts** and advanced team management tools built for the enterprise, all while greatly reducing PACER spend.

Our comprehensive service means we can handle Federal, State, and Administrative courts across the country.

Advanced Docket Research



With over 230 million records, Docket Alarm's cloud-native docket research platform finds what other services can't. Coverage includes Federal, State, plus PTAB, TTAB, ITC and NLRB decisions, all in one place.

Identify arguments that have been successful in the past with full text, pinpoint searching. Link to case law cited within any court document via Fastcase.

Analytics At Your Fingertips



Learn what happened the last time a particular judge, opposing counsel or company faced cases similar to yours.

Advanced out-of-the-box PTAB and TTAB analytics are always at your fingertips.

API

Docket Alarm offers a powerful API (application programming interface) to developers that want to integrate case filings into their apps.

LAW FIRMS

Build custom dashboards for your attorneys and clients with live data direct from the court.

Automate many repetitive legal tasks like conflict checks, document management, and marketing.

FINANCIAL INSTITUTIONS

Litigation and bankruptcy checks for companies and debtors.

E-DISCOVERY AND LEGAL VENDORS

Sync your system to PACER to automate legal marketing.