

Petitioner Bluehouse Global Ltd.

Ex. 1005



US 20070072439A1

(19) **United States**

(12) **Patent Application Publication** (10) **Pub. No.: US 2007/0072439 A1**
Akimoto et al. (43) **Pub. Date: Mar. 29, 2007**

(54) **SEMICONDUCTOR DEVICE AND MANUFACTURING METHOD THEREOF**

(30) **Foreign Application Priority Data**

Sep. 29, 2005 (JP) 2005-283782

(75) Inventors: **Kengo Akimoto**, Atsugi (JP); **Tatsuya Honda**, Isehara (JP); **Norihito Sone**, Atsugi (JP)

Publication Classification

(51) **Int. Cl.**
H01L 21/00 (2006.01)
(52) **U.S. Cl.** **438/795**

Correspondence Address:

COOK, ALEX, McFARRON, MANZO, CUMMINGS & MEHLER, LTD.
SUITE 2850
200 WEST ADAMS STREET
CHICAGO, IL 60606 (US)

(57) **ABSTRACT**

An object is to provide a semiconductor device of which a manufacturing process is not complicated and by which cost can be suppressed, by forming a thin film transistor using an oxide semiconductor film typified by zinc oxide, and a manufacturing method thereof. For the semiconductor device, a gate electrode is formed over a substrate; a gate insulating film is formed covering the gate electrode; an oxide semiconductor film is formed over the gate insulating film; and a first conductive film and a second conductive film are formed over the oxide semiconductor film. The oxide semiconductor film has at least a crystallized region in a channel region.

(73) Assignee: **Semiconductor Energy Laboratory Co., Ltd.**

(21) Appl. No.: **11/524,549**

(22) Filed: **Sep. 21, 2006**

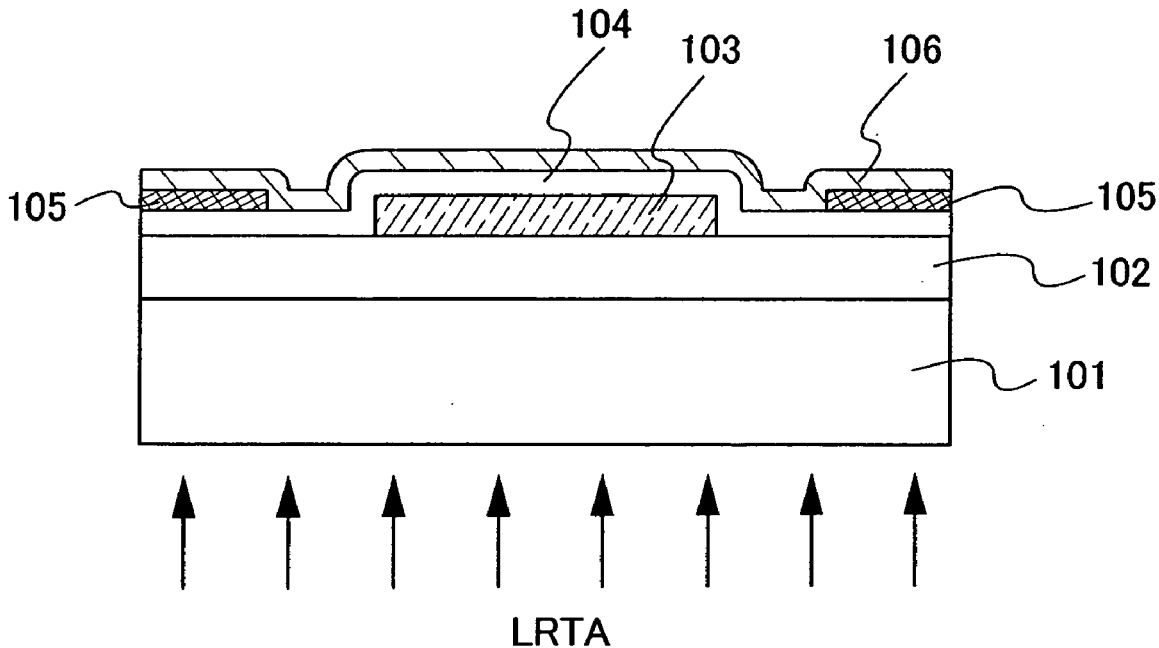

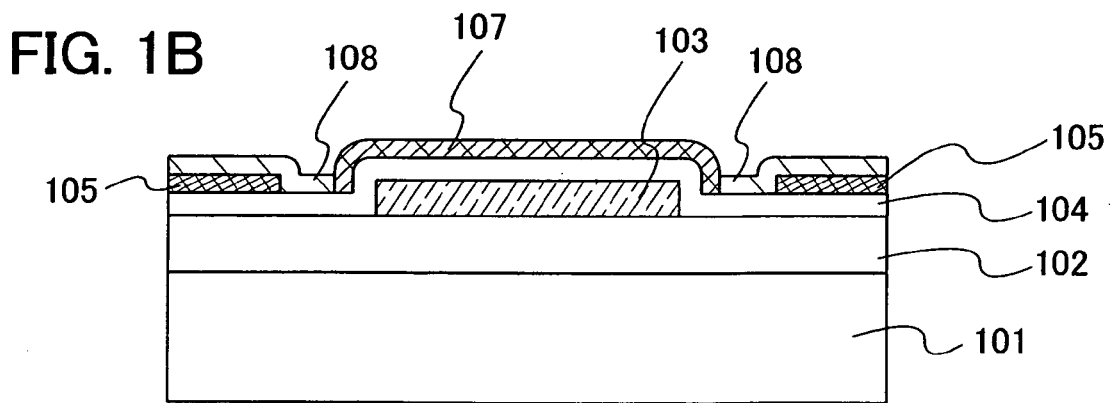
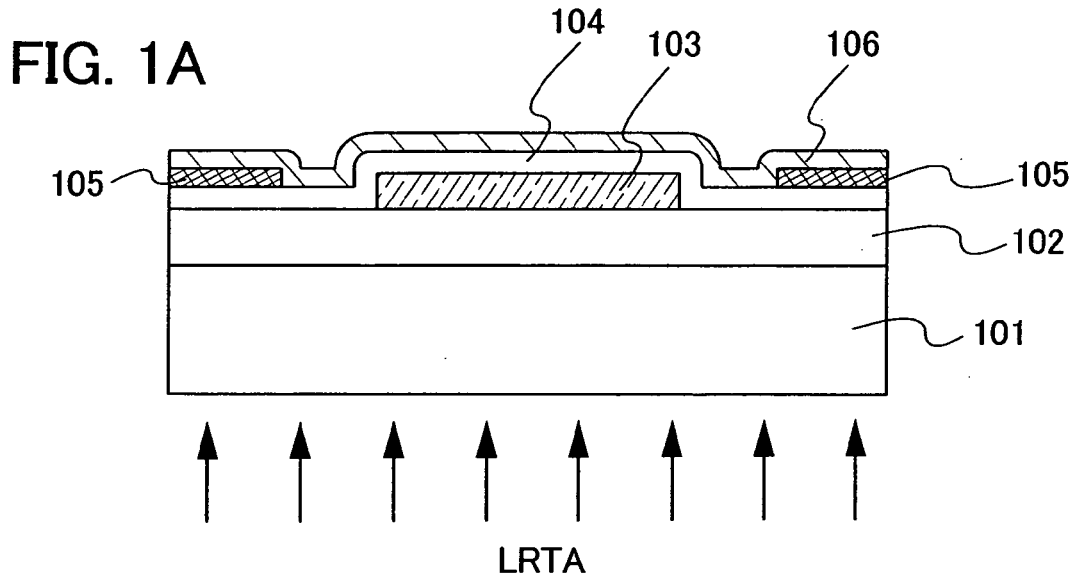

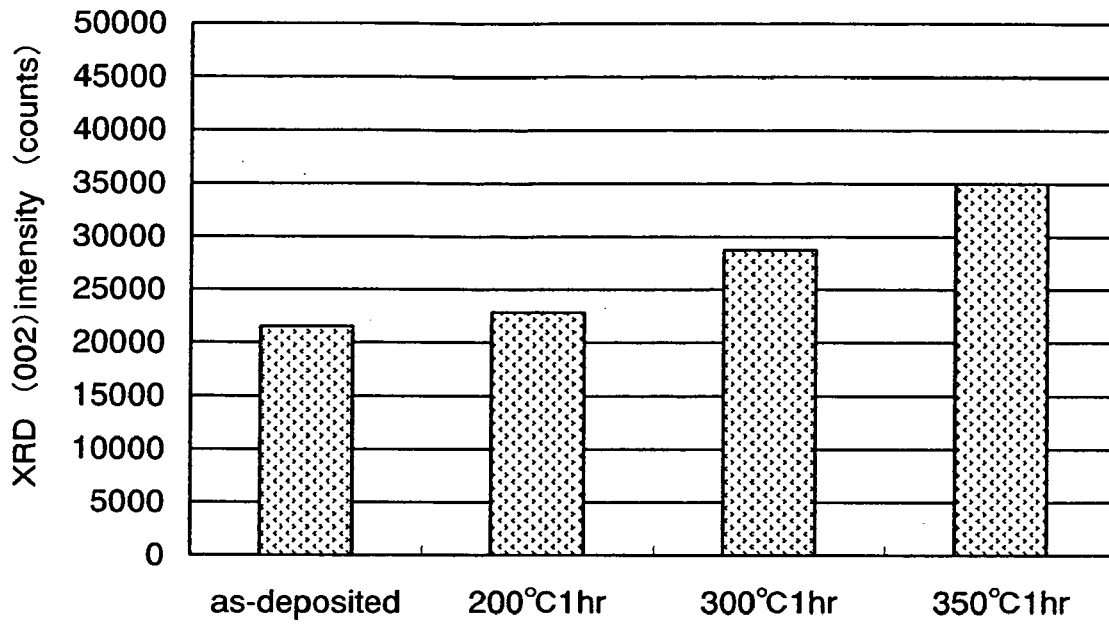

a heat treatment temperature dependency of a crystallinity of ZnO (XRD (002) intensity gas using for forming ZnO: Ar/O₂=50/5sccm)

FIG. 2

FIG. 3A

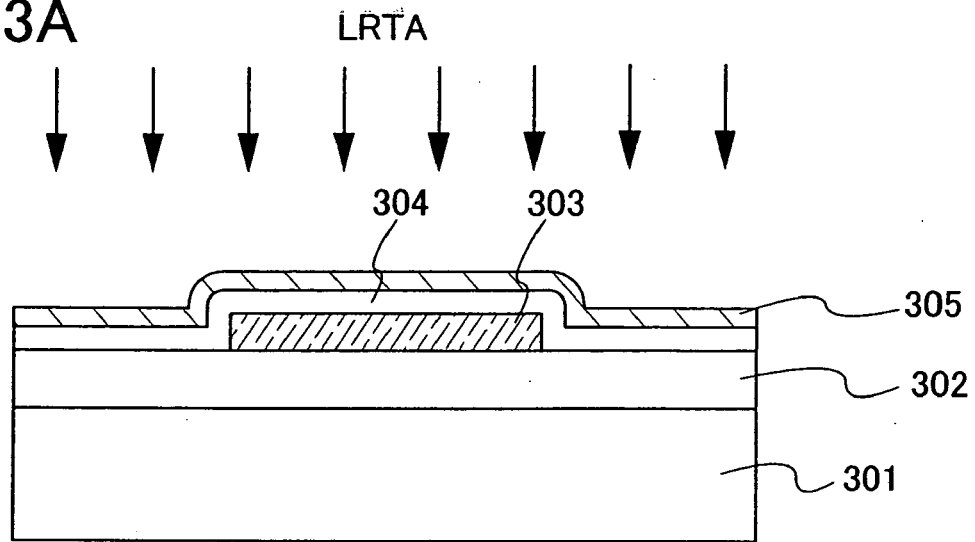

FIG. 3B

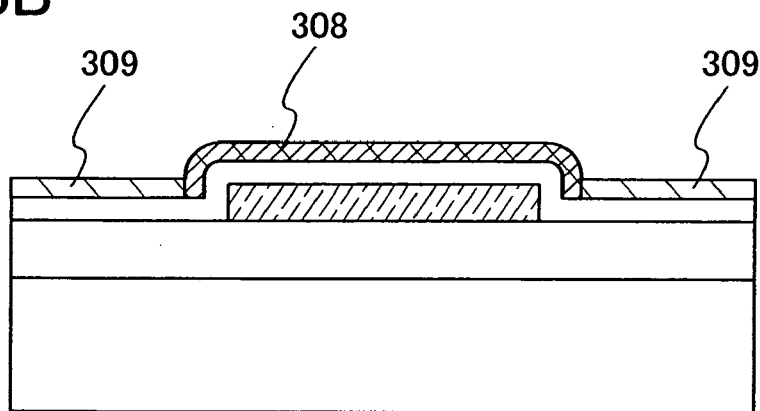
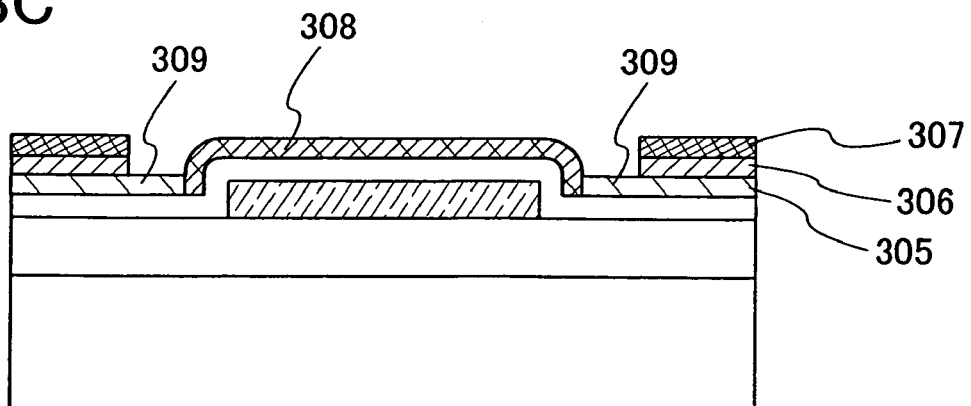

FIG. 3C



Explore Litigation Insights

Docket Alarm provides insights to develop a more informed litigation strategy and the peace of mind of knowing you're on top of things.

Real-Time Litigation Alerts



Keep your litigation team up-to-date with **real-time alerts** and advanced team management tools built for the enterprise, all while greatly reducing PACER spend.

Our comprehensive service means we can handle Federal, State, and Administrative courts across the country.

Advanced Docket Research



With over 230 million records, Docket Alarm's cloud-native docket research platform finds what other services can't. Coverage includes Federal, State, plus PTAB, TTAB, ITC and NLRB decisions, all in one place.

Identify arguments that have been successful in the past with full text, pinpoint searching. Link to case law cited within any court document via Fastcase.

Analytics At Your Fingertips



Learn what happened the last time a particular judge, opposing counsel or company faced cases similar to yours.

Advanced out-of-the-box PTAB and TTAB analytics are always at your fingertips.

API

Docket Alarm offers a powerful API (application programming interface) to developers that want to integrate case filings into their apps.

LAW FIRMS

Build custom dashboards for your attorneys and clients with live data direct from the court.

Automate many repetitive legal tasks like conflict checks, document management, and marketing.

FINANCIAL INSTITUTIONS

Litigation and bankruptcy checks for companies and debtors.

E-DISCOVERY AND LEGAL VENDORS

Sync your system to PACER to automate legal marketing.