

2015742

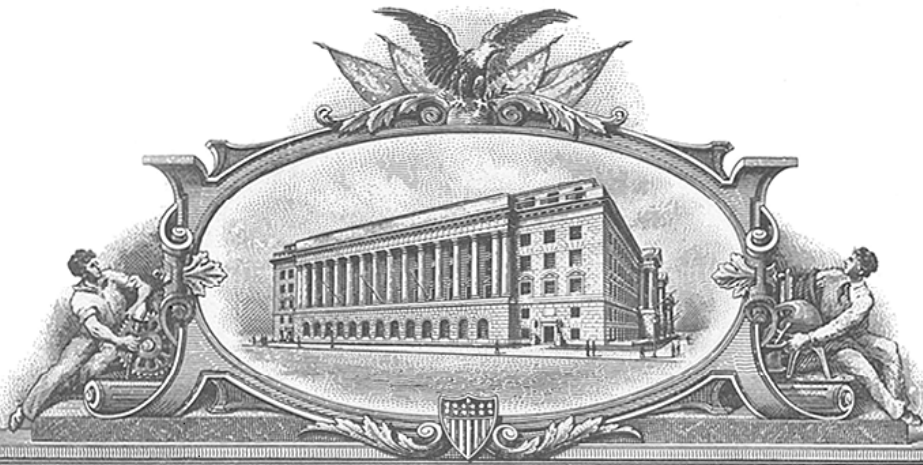

THE UNITED STATES OF AMERICA

TO ALL TO WHOM THESE PRESENTS SHALL COME:

UNITED STATES DEPARTMENT OF COMMERCE

United States Patent and Trademark Office

August 14, 2017

THIS IS TO CERTIFY THAT ANNEXED IS A TRUE COPY FROM THE RECORDS OF THIS OFFICE OF THE FILE WRAPPER AND CONTENTS OF:

APPLICATION NUMBER: *15/180,439*
FILING DATE: *June 13, 2016*
PATENT NUMBER: *9644170*
ISSUE DATE: *May 09, 2017*



Certified by

Michelle K. Lee

Under Secretary of Commerce
for Intellectual Property
and Director of the United States
Patent and Trademark Office

SCORE Placeholder Sheet for IFW Content

Application Number: 15180439

Document Date: 06/13/2016

The presence of this form in the IFW record indicates that the following document type was received in electronic format on the date identified above. This content is stored in the SCORE database.

Since this was an electronic submission, there is no physical artifact folder, no artifact folder is recorded in PALM, and no paper documents or physical media exist. The TIFF images in the IFW record were created from the original documents that are stored in SCORE.

- Drawing

At the time of document entry (noted above):

- USPTO employees may access SCORE content via eDAN using the Supplemental Content tab, or via the SCORE web page.
- External customers may access SCORE content via PAIR using the Supplemental Content tab.

**CERTIFICATION AND REQUEST FOR PRIORITIZED EXAMINATION
 UNDER 37 CFR 1.102(e)** (Page 1 of 1)

First Named Inventor:	Inge Bruheim	Nonprovisional Application Number (if known):	
Title of Invention:	BIOEFFECTIVE KRILL OIL COMPOSITIONS		

APPLICANT HEREBY CERTIFIES THE FOLLOWING AND REQUESTS PRIORITIZED EXAMINATION FOR THE ABOVE-IDENTIFIED APPLICATION.

1. The processing fee set forth in 37 CFR 1.17(i)(1) and the prioritized examination fee set forth in 37 CFR 1.17(c) have been filed with the request. The publication fee requirement is met because that fee, set forth in 37 CFR 1.18(d), is currently \$0. The basic filing fee, search fee, and examination fee are filed with the request or have been already been paid. I understand that any required excess claims fees or application size fee must be paid for the application.
2. I understand that the application may not contain, or be amended to contain, more than four independent claims, more than thirty total claims, or any multiple dependent claims, and that any request for an extension of time will cause an outstanding Track I request to be dismissed.
3. The applicable box is checked below:

I. Original Application (Track One) - Prioritized Examination under § 1.102(e)(1)

- i. (a) The application is an original nonprovisional utility application filed under 35 U.S.C. 111(a). This certification and request is being filed with the utility application via EFS-Web.
 ---OR---
 (b) The application is an original nonprovisional plant application filed under 35 U.S.C. 111(a). This certification and request is being filed with the plant application in paper.
- ii. An executed inventor's oath or declaration under 37 CFR 1.63 or 37 CFR 1.64 for each inventor, or the application data sheet meeting the conditions specified in 37 CFR 1.53(f)(3)(i) is filed with the application.

II. Request for Continued Examination - Prioritized Examination under § 1.102(e)(2)

- i. A request for continued examination has been filed with, or prior to, this form.
- ii. If the application is a utility application, this certification and request is being filed via EFS-Web.
- iii. The application is an original nonprovisional utility application filed under 35 U.S.C. 111(a), or is a national stage entry under 35 U.S.C. 371.
- iv. This certification and request is being filed prior to the mailing of a first Office action responsive to the request for continued examination.
- v. No prior request for continued examination has been granted prioritized examination status under 37 CFR 1.102(e)(2).

Signature <u>/J. Mitchell Jones/</u>	Date <u>June 13, 2016</u>
Name (Print/Typed) <u>J. Mitchell Jones</u>	Practitioner Registration Number <u>44174</u>

Note: This form must be signed in accordance with 37 CFR 1.33. See 37 CFR 1.4(d) for signature requirements and certifications. Submit multiple forms if more than one signature is required.*

*Total of 1 forms are submitted.

Privacy Act Statement

The **Privacy Act of 1974 (P.L. 93-579)** requires that you be given certain information in connection with your submission of the attached form related to a patent application or patent. Accordingly, pursuant to the requirements of the Act, please be advised that: (1) the general authority for the collection of this information is 35 U.S.C. 2(b)(2); (2) furnishing of the information solicited is voluntary; and (3) the principal purpose for which the information is used by the U.S. Patent and Trademark Office is to process and/or examine your submission related to a patent application or patent. If you do not furnish the requested information, the U.S. Patent and Trademark Office may not be able to process and/or examine your submission, which may result in termination of proceedings or abandonment of the application or expiration of the patent.

The information provided by you in this form will be subject to the following routine uses:

1. The information on this form will be treated confidentially to the extent allowed under the Freedom of Information Act (5 U.S.C. 552) and the Privacy Act (5 U.S.C. 552a). Records from this system of records may be disclosed to the Department of Justice to determine whether disclosure of these records is required by the Freedom of Information Act.
2. A record from this system of records may be disclosed, as a routine use, in the course of presenting evidence to a court, magistrate, or administrative tribunal, including disclosures to opposing counsel in the course of settlement negotiations.
3. A record in this system of records may be disclosed, as a routine use, to a Member of Congress submitting a request involving an individual, to whom the record pertains, when the individual has requested assistance from the Member with respect to the subject matter of the record.
4. A record in this system of records may be disclosed, as a routine use, to a contractor of the Agency having need for the information in order to perform a contract. Recipients of information shall be required to comply with the requirements of the Privacy Act of 1974, as amended, pursuant to 5 U.S.C. 552a(m).
5. A record related to an International Application filed under the Patent Cooperation Treaty in this system of records may be disclosed, as a routine use, to the International Bureau of the World Intellectual Property Organization, pursuant to the Patent Cooperation Treaty.
6. A record in this system of records may be disclosed, as a routine use, to another federal agency for purposes of National Security review (35 U.S.C. 181) and for review pursuant to the Atomic Energy Act (42 U.S.C. 218(c)).
7. A record from this system of records may be disclosed, as a routine use, to the Administrator, General Services, or his/her designee, during an inspection of records conducted by GSA as part of that agency's responsibility to recommend improvements in records management practices and programs, under authority of 44 U.S.C. 2904 and 2906. Such disclosure shall be made in accordance with the GSA regulations governing inspection of records for this purpose, and any other relevant (*i.e.*, GSA or Commerce) directive. Such disclosure shall not be used to make determinations about individuals.
8. A record from this system of records may be disclosed, as a routine use, to the public after either publication of the application pursuant to 35 U.S.C. 122(b) or issuance of a patent pursuant to 35 U.S.C. 151. Further, a record may be disclosed, subject to the limitations of 37 CFR 1.14, as a routine use, to the public if the record was filed in an application which became abandoned or in which the proceedings were terminated and which application is referenced by either a published application, an application open to public inspection or an issued patent.
9. A record from this system of records may be disclosed, as a routine use, to a Federal, State, or local law enforcement agency, if the USPTO becomes aware of a violation or potential violation of law or regulation.

Under the Paperwork Reduction Act of 1995, no persons are required to respond to a collection of information unless it contains a valid OMB control number.

Application Data Sheet 37 CFR 1.76		Attorney Docket Number	AKBM-14409/US-13/CON
		Application Number	
Title of Invention	BIOEFFECTIVE KRILL OIL COMPOSITIONS		
The application data sheet is part of the provisional or nonprovisional application for which it is being submitted. The following form contains the bibliographic data arranged in a format specified by the United States Patent and Trademark Office as outlined in 37 CFR 1.76. This document may be completed electronically and submitted to the Office in electronic format using the Electronic Filing System (EFS) or the document may be printed and included in a paper filed application.			

Secrecy Order 37 CFR 5.2:

Portions or all of the application associated with this Application Data Sheet may fall under a Secrecy Order pursuant to 37 CFR 5.2 (Paper filers only. Applications that fall under Secrecy Order may not be filed electronically.)

Inventor Information:

Inventor	1				Remove
Legal Name					
Prefix	Given Name	Middle Name	Family Name	Suffix	
	Inge		Bruheim		
Residence Information (Select One) US Residency <input type="radio"/> Non US Residency Active US Military Service					
City	Volda	Country of Residence ⁱ		NO	
Mailing Address of Inventor:					
Address 1		Storhagen 24			
Address 2					
City	Volda	State/Province			
Postal Code	6100	Country ⁱ	NO		
Inventor	2				Remove
Legal Name					
Prefix	Given Name	Middle Name	Family Name	Suffix	
	Snorre		Tilseth		
Residence Information (Select One) US Residency <input checked="" type="radio"/> Non US Residency Active US Military Service					
City	Bergen	Country of Residence ⁱ		NO	
Mailing Address of Inventor:					
Address 1		Fantoftasen 27 A			
Address 2					
City	Bergen	State/Province			
Postal Code	5027	Country ⁱ	NO		
Inventor	3				Remove
Legal Name					

Under the Paperwork Reduction Act of 1995, no persons are required to respond to a collection of information unless it contains a valid OMB control number.

Application Data Sheet 37 CFR 1.76		Attorney Docket Number	AKBM-14409/US-13/CON	
		Application Number		
Title of Invention	BIOEFFECTIVE KRILL OIL COMPOSITIONS			

Prefix	Given Name	Middle Name	Family Name	Suffix
	Daniele		Mancinelli	
Residence Information (Select One) US Residency <input checked="" type="radio"/> Non US Residency Active US Military Service				
City	Orsta	Country of Residence ⁱ	NO	

Mailing Address of Inventor:				
Address 1	Vikegeila 15			
Address 2				
City	Orsta	State/Province		
Postal Code	6150	Country ⁱ	NO	
All Inventors Must Be Listed - Additional Inventor Information blocks may be generated within this form by selecting the Add button. Add				

Correspondence Information:

Enter either Customer Number or complete the Correspondence Information section below. For further information see 37 CFR 1.33(a).				
<input type="checkbox"/> An Address is being provided for the correspondence information of this application.				
Customer Number	72960			
Email Address	docketing@casimirjones.com	Add Email	Remove Email	

Application Information:

Title of the Invention	BIOEFFECTIVE KRILL OIL COMPOSITIONS			
Attorney Docket Number	AKBM-14409/US-13/CON	Small Entity Status Claimed	<input type="checkbox"/>	
Application Type	Nonprovisional			
Subject Matter	Utility			
Total Number of Drawing Sheets (if any)	19	Suggested Figure for Publication (if any)		

Filing By Reference:

Only complete this section when filing an application by reference under 35 U.S.C. 111(c) and 37 CFR 1.57(a). Do not complete this section if application papers including a specification and any drawings are being filed. Any domestic benefit or foreign priority information must be provided in the appropriate section(s) below (i.e., "Domestic Benefit/National Stage Information" and "Foreign Priority Information").

For the purposes of a filing date under 37 CFR 1.53(b), the description and any drawings of the present application are replaced by this reference to the previously filed application, subject to conditions and requirements of 37 CFR 1.57(a).

Application number of the previously filed application	Filing date (YYYY-MM-DD)	Intellectual Property Authority or Country ⁱ

Under the Paperwork Reduction Act of 1995, no persons are required to respond to a collection of information unless it contains a valid OMB control number.

Application Data Sheet 37 CFR 1.76	Attorney Docket Number	AKBM-14409/US-13/CON
	Application Number	
Title of Invention	BIOEFFECTIVE KRILL OIL COMPOSITIONS	

Publication Information:

<input type="checkbox"/>	Request Early Publication (Fee required at time of Request 37 CFR 1.219)
<input type="checkbox"/>	Request Not to Publish. I hereby request that the attached application not be published under 35 U.S.C. 122(b) and certify that the invention disclosed in the attached application has not and will not be the subject of an application filed in another country, or under a multilateral international agreement, that requires publication at eighteen months after filing.

Representative Information:

Representative information should be provided for all practitioners having a power of attorney in the application. Providing this information in the Application Data Sheet does not constitute a power of attorney in the application (see 37 CFR 1.32). Either enter Customer Number or complete the Representative Name section below. If both sections are completed the customer number will be used for the Representative Information during processing.

Please Select One:	<input checked="" type="radio"/> Customer Number	<input type="radio"/> US Patent Practitioner	<input type="radio"/> Limited Recognition (37 CFR 11.9)
Customer Number	72960		

Domestic Benefit/National Stage Information:

This section allows for the applicant to either claim benefit under 35 U.S.C. 119(e), 120, 121, 365(c), or 386(c) or indicate National Stage entry from a PCT application. Providing benefit claim information in the Application Data Sheet constitutes the specific reference required by 35 U.S.C. 119(e) or 120, and 37 CFR 1.78. When referring to the current application, please leave the "Application Number" field blank.

Prior Application Status	Pending					Remove
Application Number	Continuity Type	Prior Application Number	Filing or 371(c) Date (YYYY-MM-DD)			
	Continuation of	14020162	2013-09-06			
Prior Application Status	Patented					Remove
Application Number	Continuity Type	Prior Application Number	Filing Date (YYYY-MM-DD)	Patent Number	Issue Date (YYYY-MM-DD)	
14020162	Continuation of	12057775	2008-03-28	9034388	2015-05-19	
Prior Application Status	Expired					Remove
Application Number	Continuity Type	Prior Application Number	Filing or 371(c) Date (YYYY-MM-DD)			
12057775	Claims benefit of provisional	60920483	2007-03-28			
Prior Application Status	Expired					Remove
Application Number	Continuity Type	Prior Application Number	Filing or 371(c) Date (YYYY-MM-DD)			
12057775	Claims benefit of provisional	60975058	RIMFROST EXHIBIT 1063 page 0007			

Under the Paperwork Reduction Act of 1995, no persons are required to respond to a collection of information unless it contains a valid OMB control number.

Application Data Sheet 37 CFR 1.76		Attorney Docket Number	AKBM-14409/US-13/CON
		Application Number	
Title of Invention	BIOEFFECTIVE KRILL OIL COMPOSITIONS		
Prior Application Status	Expired	<input type="button" value="Remove"/>	
Application Number	Continuity Type	Prior Application Number	Filing or 371(c) Date (YYYY-MM-DD)
12057775	Claims benefit of provisional	60983446	2007-10-29
Prior Application Status	Expired	<input type="button" value="Remove"/>	
Application Number	Continuity Type	Prior Application Number	Filing or 371(c) Date (YYYY-MM-DD)
12057775	Claims benefit of provisional	61024072	2008-01-28
Additional Domestic Benefit/National Stage Data may be generated within this form by selecting the Add button.			<input type="button" value="Add"/>

Foreign Priority Information:

This section allows for the applicant to claim priority to a foreign application. Providing this information in the application data sheet constitutes the claim for priority as required by 35 U.S.C. 119(b) and 37 CFR 1.55. When priority is claimed to a foreign application that is eligible for retrieval under the priority document exchange program (PDX)ⁱ the information will be used by the Office to automatically attempt retrieval pursuant to 37 CFR 1.55(i)(1) and (2). Under the PDX program, applicant bears the ultimate responsibility for ensuring that a copy of the foreign application is received by the Office from the participating foreign intellectual property office, or a certified copy of the foreign priority application is filed, within the time period specified in 37 CFR 1.55(g)(1).

			<input type="button" value="Remove"/>
Application Number	Country ⁱ	Filing Date (YYYY-MM-DD)	Access Code ⁱ (if applicable)
Additional Foreign Priority Data may be generated within this form by selecting the Add button.			<input type="button" value="Add"/>

Statement under 37 CFR 1.55 or 1.78 for AIA (First Inventor to File) Transition Applications

This application (1) claims priority to or the benefit of an application filed before March 16, 2013 and (2) also contains, or contained at any time, a claim to a claimed invention that has an effective filing date on or after March 16, 2013.

NOTE: By providing this statement under 37 CFR 1.55 or 1.78, this application, with a filing date on or after March 16, 2013, will be examined under the first inventor to file provisions of the AIA.

Application Data Sheet 37 CFR 1.76	Attorney Docket Number	AKBM-14409/US-13/CON
	Application Number	
Title of Invention	BIOEFFECTIVE KRILL OIL COMPOSITIONS	

Authorization or Opt-Out of Authorization to Permit Access:

When this Application Data Sheet is properly signed and filed with the application, applicant has provided written authority to permit a participating foreign intellectual property (IP) office access to the instant application-as-filed (see paragraph A in subsection 1 below) and the European Patent Office (EPO) access to any search results from the instant application (see paragraph B in subsection 1 below).

Should applicant choose not to provide an authorization identified in subsection 1 below, applicant **must opt-out** of the authorization by checking the corresponding box A or B or both in subsection 2 below.

NOTE: This section of the Application Data Sheet is **ONLY** reviewed and processed with the **INITIAL** filing of an application. After the initial filing of an application, an Application Data Sheet cannot be used to provide or rescind authorization for access by a foreign IP office(s). Instead, Form PTO/SB/39 or PTO/SB/69 must be used as appropriate.

1. Authorization to Permit Access by a Foreign Intellectual Property Office(s)

A. Priority Document Exchange (PDX) - Unless box A in subsection 2 (opt-out of authorization) is checked, the undersigned hereby **grants the USPTO authority** to provide the European Patent Office (EPO), the Japan Patent Office (JPO), the Korean Intellectual Property Office (KIPO), the State Intellectual Property Office of the People's Republic of China (SIPO), the World Intellectual Property Organization (WIPO), and any other foreign intellectual property office participating with the USPTO in a bilateral or multilateral priority document exchange agreement in which a foreign application claiming priority to the instant patent application is filed, access to: (1) the instant patent application-as-filed and its related bibliographic data, (2) any foreign or domestic application to which priority or benefit is claimed by the instant application and its related bibliographic data, and (3) the date of filing of this Authorization. See 37 CFR 1.14(h)(1).

B. Search Results from U.S. Application to EPO - Unless box B in subsection 2 (opt-out of authorization) is checked, the undersigned hereby **grants the USPTO authority** to provide the EPO access to the bibliographic data and search results from the instant patent application when a European patent application claiming priority to the instant patent application is filed. See 37 CFR 1.14(h)(2).

The applicant is reminded that the EPO's Rule 141(1) EPC (European Patent Convention) requires applicants to submit a copy of search results from the instant application without delay in a European patent application that claims priority to the instant application.

2. Opt-Out of Authorizations to Permit Access by a Foreign Intellectual Property Office(s)

A. Applicant **DOES NOT** authorize the USPTO to permit a participating foreign IP office access to the instant application-as-filed. If this box is checked, the USPTO will not be providing a participating foreign IP office with any documents and information identified in subsection 1A above.

B. Applicant **DOES NOT** authorize the USPTO to transmit to the EPO any search results from the instant patent application. If this box is checked, the USPTO will not be providing the EPO with search results from the instant application.

NOTE: Once the application has published or is otherwise publicly available, the USPTO may provide access to the application in accordance with 37 CFR 1.14.

Application Data Sheet 37 CFR 1.76	Attorney Docket Number	AKBM-14409/US-13/CON
	Application Number	
Title of Invention	BIOEFFECTIVE KRILL OIL COMPOSITIONS	

Applicant Information:

Providing assignment information in this section does not substitute for compliance with any requirement of part 3 of Title 37 of CFR to have an assignment recorded by the Office.

Applicant	1	<input type="button" value="Remove"/>
<p>If the applicant is the inventor (or the remaining joint inventor or inventors under 37 CFR 1.45), this section should not be completed. The information to be provided in this section is the name and address of the legal representative who is the applicant under 37 CFR 1.43; or the name and address of the assignee, person to whom the inventor is under an obligation to assign the invention, or person who otherwise shows sufficient proprietary interest in the matter who is the applicant under 37 CFR 1.46. If the applicant is an applicant under 37 CFR 1.46 (assignee, person to whom the inventor is obligated to assign, or person who otherwise shows sufficient proprietary interest) together with one or more joint inventors, then the joint inventor or inventors who are also the applicant should be identified in this section.</p>		
<input type="button" value="Clear"/>		
<input checked="" type="radio"/> Assignee	Legal Representative under 35 U.S.C. 117	Joint Inventor
Person to whom the inventor is obligated to assign.		Person who shows sufficient proprietary interest
If applicant is the legal representative, indicate the authority to file the patent application, the inventor is:		
<div style="border: 1px solid black; height: 20px; width: 100%;"></div>		
Name of the Deceased or Legally Incapacitated Inventor: <input style="width: 90%;" type="text"/>		
If the Applicant is an Organization check here. <input checked="" type="checkbox"/>		
Organization Name	AKER BIOMARINE ANTARCTIC AS	
Mailing Address Information For Applicant:		
Address 1	J.M. Johansens vei 99	
Address 2		
City	Stamsund	State/Province
Country	NO	Postal Code
Phone Number		Fax Number
Email Address		
Additional Applicant Data may be generated within this form by selecting the Add button. <input type="button" value="Add"/>		

Assignee Information including Non-Applicant Assignee Information:

Providing assignment information in this section does not substitute for compliance with any requirement of part 3 of Title 37 of CFR to have an assignment recorded by the Office.

Under the Paperwork Reduction Act of 1995, no persons are required to respond to a collection of information unless it contains a valid OMB control number.

Application Data Sheet 37 CFR 1.76	Attorney Docket Number	AKBM-14409/US-13/CON
	Application Number	
Title of Invention	BIOEFFECTIVE KRILL OIL COMPOSITIONS	

Assignee	1
-----------------	---

Complete this section if assignee information, including non-applicant assignee information, is desired to be included on the patent application publication. An assignee-applicant identified in the "Applicant Information" section will appear on the patent application publication as an applicant. For an assignee-applicant, complete this section only if identification as an assignee is also desired on the patent application publication.

Remove

If the Assignee or Non-Applicant Assignee is an Organization check here.

Prefix	Given Name	Middle Name	Family Name	Suffix

Mailing Address Information For Assignee including Non-Applicant Assignee:

Address 1				
Address 2				
City		State/Province		
Country ⁱ		Postal Code		
Phone Number		Fax Number		
Email Address				

Additional Assignee or Non-Applicant Assignee Data may be generated within this form by selecting the Add button.

Add

Signature:

Remove

NOTE: This Application Data Sheet must be signed in accordance with 37 CFR 1.33(b). However, if this Application Data Sheet is submitted with the **INITIAL** filing of the application and either box A or B is not checked in subsection 2 of the "Authorization or Opt-Out of Authorization to Permit Access" section, then this form must also be signed in accordance with 37 CFR 1.14(c).

This Application Data Sheet **must** be signed by a patent practitioner if one or more of the applicants is a **juristic entity** (e.g., corporation or association). If the applicant is two or more joint inventors, this form must be signed by a patent practitioner, **all** joint inventors who are the applicant, or one or more joint inventor-applicants who have been given power of attorney (e.g., see USPTO Form PTO/AIA/81) on behalf of **all** joint inventor-applicants.

See 37 CFR 1.4(d) for the manner of making signatures and certifications.

Signature	/J. Mitchell Jones/		Date (YYYY-MM-DD)	2016-06-13	
First Name	J. Mitchell	Last Name	Jones	Registration Number	44174

Additional Signature may be generated within this form by selecting the Add button.

Add

Under the Paperwork Reduction Act of 1995, no persons are required to respond to a collection of information unless it contains a valid OMB control number.

Application Data Sheet 37 CFR 1.76	Attorney Docket Number	AKBM-14409/US-13/CON
	Application Number	
Title of Invention	BIOEFFECTIVE KRILL OIL COMPOSITIONS	

This collection of information is required by 37 CFR 1.76. The information is required to obtain or retain a benefit by the public which is to file (and by the USPTO to process) an application. Confidentiality is governed by 35 U.S.C. 122 and 37 CFR 1.14. This collection is estimated to take 23 minutes to complete, including gathering, preparing, and submitting the completed application data sheet form to the USPTO. Time will vary depending upon the individual case. Any comments on the amount of time you require to complete this form and/or suggestions for reducing this burden, should be sent to the Chief Information Officer, U.S. Patent and Trademark Office, U.S. Department of Commerce, P.O. Box 1450, Alexandria, VA 22313-1450. DO NOT SEND FEES OR COMPLETED FORMS TO THIS ADDRESS. **SEND TO: Commissioner for Patents, P.O. Box 1450, Alexandria, VA 22313-1450.**

Privacy Act Statement

The Privacy Act of 1974 (P.L. 93-579) requires that you be given certain information in connection with your submission of the attached form related to a patent application or patent. Accordingly, pursuant to the requirements of the Act, please be advised that: (1) the general authority for the collection of this information is 35 U.S.C. 2(b)(2); (2) furnishing of the information solicited is voluntary; and (3) the principal purpose for which the information is used by the U.S. Patent and Trademark Office is to process and/or examine your submission related to a patent application or patent. If you do not furnish the requested information, the U.S. Patent and Trademark Office may not be able to process and/or examine your submission, which may result in termination of proceedings or abandonment of the application or expiration of the patent.

The information provided by you in this form will be subject to the following routine uses:

1. The information on this form will be treated confidentially to the extent allowed under the Freedom of Information Act (5 U.S.C. 552) and the Privacy Act (5 U.S.C. 552a). Records from this system of records may be disclosed to the Department of Justice to determine whether the Freedom of Information Act requires disclosure of these records.
2. A record from this system of records may be disclosed, as a routine use, in the course of presenting evidence to a court, magistrate, or administrative tribunal, including disclosures to opposing counsel in the course of settlement negotiations.
3. A record in this system of records may be disclosed, as a routine use, to a Member of Congress submitting a request involving an individual, to whom the record pertains, when the individual has requested assistance from the Member with respect to the subject matter of the record.
4. A record in this system of records may be disclosed, as a routine use, to a contractor of the Agency having need for the information in order to perform a contract. Recipients of information shall be required to comply with the requirements of the Privacy Act of 1974, as amended, pursuant to 5 U.S.C. 552a(m).
5. A record related to an International Application filed under the Patent Cooperation Treaty in this system of records may be disclosed, as a routine use, to the International Bureau of the World Intellectual Property Organization, pursuant to the Patent Cooperation Treaty.
6. A record in this system of records may be disclosed, as a routine use, to another federal agency for purposes of National Security review (35 U.S.C. 181) and for review pursuant to the Atomic Energy Act (42 U.S.C. 218(c)).
7. A record from this system of records may be disclosed, as a routine use, to the Administrator, General Services, or his/her designee, during an inspection of records conducted by GSA as part of that agency's responsibility to recommend improvements in records management practices and programs, under authority of 44 U.S.C. 2904 and 2906. Such disclosure shall be made in accordance with the GSA regulations governing inspection of records for this purpose, and any other relevant (i.e., GSA or Commerce) directive. Such disclosure shall not be used to make determinations about individuals.
8. A record from this system of records may be disclosed, as a routine use, to the public after either publication of the application pursuant to 35 U.S.C. 122(b) or issuance of a patent pursuant to 35 U.S.C. 151. Further, a record may be disclosed, subject to the limitations of 37 CFR 1.14, as a routine use, to the public if the record was filed in an application which became abandoned or in which the proceedings were terminated and which application is referenced by either a published application, an application open to public inspections or an issued patent.
9. A record from this system of records may be disclosed, as a routine use, to a Federal, State, or local law enforcement agency, if the USPTO becomes aware of a violation or potential violation of law or regulation.

Under the Paperwork Reduction Act of 1995, no persons are required to respond to a collection of information unless it displays a valid OMB control number.

DECLARATION (37 CFR 1.63) FOR UTILITY OR DESIGN APPLICATION USING AN APPLICATION DATA SHEET (37 CFR 1.76)Title of
Invention

BIOEFFECTIVE KRILL OIL COMPOSITIONS

As the below named inventor, I hereby declare that:

This declaration
is directed to:

The attached application, or

United States application or PCT international application number 14/020,162
filed on 06-Sep-2013

The above-identified application was made or authorized to be made by me.

I believe that I am the original inventor or an original joint inventor of a claimed invention in the application.

I hereby acknowledge that any willful false statement made in this declaration is punishable under 18 U.S.C. 1001 by fine or imprisonment of not more than five (5) years, or both.

WARNING:

Petitioner/applicant is cautioned to avoid submitting personal information in documents filed in a patent application that may contribute to identity theft. Personal information such as social security numbers, bank account numbers, or credit card numbers (other than a check or credit card authorization form PTO-2038 submitted for payment purposes) is never required by the USPTO to support a petition or an application. If this type of personal information is included in documents submitted to the USPTO, petitioners/applicants should consider redacting such personal information from the documents before submitting them to the USPTO. Petitioner/applicant is advised that the record of a patent application is available to the public after publication of the application (unless a non-publication request in compliance with 37 CFR 1.213(a) is made in the application) or issuance of a patent. Furthermore, the record from an abandoned application may also be available to the public if the application is referenced in a published application or an issued patent (see 37 CFR 1.14). Checks and credit card authorization forms PTO-2038 submitted for payment purposes are not retained in the application file and therefore are not publicly available.

LEGAL NAME OF INVENTOR

Inventor: Inge Bruheim

Date (Optional):

2013-13Signature: Inge Bruheim

Note: An application data sheet (PTO/SB/14 or equivalent), including naming the entire inventive entity, must accompany this form or must have been previously filed. Use an additional PTO/AIA/01 form for each additional inventor.

This collection of information is required by 35 U.S.C. 115 and 37 CFR 1.63. The information is required to obtain or retain a benefit by the public which is to file (and by the USPTO to process) an application. Confidentiality is governed by 35 U.S.C. 122 and 37 CFR 1.11 and 1.14. This collection is estimated to take 1 minute to complete, including gathering, preparing, and submitting the completed application form to the USPTO. Time will vary depending upon the individual case. Any comments on the amount of time you require to complete this form and/or suggestions for reducing this burden, should be sent to the Chief Information Officer, U.S. Patent and Trademark Office, U.S. Department of Commerce, P.O. Box 1450, Alexandria, VA 22313-1450. DO NOT SEND FEES OR COMPLETED FORMS TO THIS ADDRESS. **SEND TO: Commissioner for Patents, P.O. Box 1450, Alexandria, VA 22313-1450.**

If you need assistance in completing the form, call 1-800-PTO-9199 and select option 2.

Under the Paperwork Reduction Act of 1995, no persons are required to respond to a collection of information unless it displays a valid OMB control number.

DECLARATION (37 CFR 1.63) FOR UTILITY OR DESIGN APPLICATION USING AN APPLICATION DATA SHEET (37 CFR 1.76)

Title of Invention	BIOEFFECTIVE KRILL OIL COMPOSITIONS
---------------------------	--

As the below named inventor, I hereby declare that:

This declaration is directed to: The attached application, or
 United States application or PCT international application number 14/020,162
filed on 06-Sep-2013

The above-identified application was made or authorized to be made by me.

I believe that I am the original inventor or an original joint inventor of a claimed invention in the application.

I hereby acknowledge that any willful false statement made in this declaration is punishable under 18 U.S.C. 1001 by fine or imprisonment of not more than five (5) years, or both.

WARNING:

Petitioner/applicant is cautioned to avoid submitting personal information in documents filed in a patent application that may contribute to identity theft. Personal information such as social security numbers, bank account numbers, or credit card numbers (other than a check or credit card authorization form PTO-2038 submitted for payment purposes) is never required by the USPTO to support a petition or an application. If this type of personal information is included in documents submitted to the USPTO, petitioners/applicants should consider redacting such personal information from the documents before submitting them to the USPTO. Petitioner/applicant is advised that the record of a patent application is available to the public after publication of the application (unless a non-publication request in compliance with 37 CFR 1.213(a) is made in the application) or issuance of a patent. Furthermore, the record from an abandoned application may also be available to the public if the application is referenced in a published application or an issued patent (see 37 CFR 1.14). Checks and credit card authorization forms PTO-2038 submitted for payment purposes are not retained in the application file and therefore are not publicly available.

LEGAL NAME OF INVENTOR

Inventor: Daniele Mancinelli Date (Optional): 17/9/2013
Signature: Daniele Mancinelli

Note: An application data sheet (PTO/SB/14 or equivalent), including naming the entire inventive entity, must accompany this form or must have been previously filed. Use an additional PTO/AIA/01 form for each additional inventor.

This collection of information is required by 35 U.S.C. 115 and 37 CFR 1.63. The information is required to obtain or retain a benefit by the public which is to file (and by the USPTO to process) an application. Confidentiality is governed by 35 U.S.C. 122 and 37 CFR 1.11 and 1.14. This collection is estimated to take 1 minute to complete, including gathering, preparing, and submitting the completed application form to the USPTO. Time will vary depending upon the individual case. Any comments on the amount of time you require to complete this form and/or suggestions for reducing this burden, should be sent to the Chief Information Officer, U.S. Patent and Trademark Office, U.S. Department of Commerce, P.O. Box 1450, Alexandria, VA 22313-1450. DO NOT SEND FEES OR COMPLETED FORMS TO THIS ADDRESS. **SEND TO: Commissioner for Patents, P.O. Box 1450, Alexandria, VA 22313-1450.**

If you need assistance in completing the form, call 1-800-PTO-9199 and select option 2.

Under the Paperwork Reduction Act of 1995, no persons are required to respond to a collection of information unless it displays a valid OMB control number.

DECLARATION (37 CFR 1.63) FOR UTILITY OR DESIGN APPLICATION USING AN APPLICATION DATA SHEET (37 CFR 1.76)

Title of Invention	BIOEFFECTIVE KRILL OIL COMPOSITIONS
---------------------------	--

As the below named inventor, I hereby declare that:

This declaration is directed to: The attached application, or
 United States application or PCT international application number 14/020,162
filed on 06-Sep-2013

The above-identified application was made or authorized to be made by me.

I believe that I am the original inventor or an original joint inventor of a claimed invention in the application.

I hereby acknowledge that any willful false statement made in this declaration is punishable under 18 U.S.C. 1001 by fine or imprisonment of not more than five (5) years, or both.

WARNING:

Petitioner/applicant is cautioned to avoid submitting personal information in documents filed in a patent application that may contribute to identity theft. Personal information such as social security numbers, bank account numbers, or credit card numbers (other than a check or credit card authorization form PTO-2038 submitted for payment purposes) is never required by the USPTO to support a petition or an application. If this type of personal information is included in documents submitted to the USPTO, petitioners/applicants should consider redacting such personal information from the documents before submitting them to the USPTO. Petitioner/applicant is advised that the record of a patent application is available to the public after publication of the application (unless a non-publication request in compliance with 37 CFR 1.213(a) is made in the application) or issuance of a patent. Furthermore, the record from an abandoned application may also be available to the public if the application is referenced in a published application or an issued patent (see 37 CFR 1.14). Checks and credit card authorization forms PTO-2038 submitted for payment purposes are not retained in the application file and therefore are not publicly available.

LEGAL NAME OF INVENTOR

Inventor: Snorre Tilseth Date (Optional): 18. Sep-2013

Signature: 

Note: An application data sheet (PTO/SB/14 or equivalent), including naming the entire inventive entity, must accompany this form or must have been previously filed. Use an additional PTO/AIA/01 form for each additional inventor.

This collection of information is required by 35 U.S.C. 115 and 37 CFR 1.63. The information is required to obtain or retain a benefit by the public which is to file (and by the USPTO to process) an application. Confidentiality is governed by 35 U.S.C. 122 and 37 CFR 1.11 and 1.14. This collection is estimated to take 1 minute to complete, including gathering, preparing, and submitting the completed application form to the USPTO. Time will vary depending upon the individual case. Any comments on the amount of time you require to complete this form and/or suggestions for reducing this burden, should be sent to the Chief Information Officer, U.S. Patent and Trademark Office, U.S. Department of Commerce, P.O. Box 1450, Alexandria, VA 22313-1450. DO NOT SEND FEES OR COMPLETED FORMS TO THIS ADDRESS. **SEND TO: Commissioner for Patents, P.O. Box 1450, Alexandria, VA 22313-1450.**

If you need assistance in completing the form, call 1-800-PTO-9199 and select option 2.

BIOEFFECTIVE KRILL OIL COMPOSITIONS

CROSS-REFERENCE TO RELATED APPLICATIONS

This application is a continuation of U.S. Patent Application No. 14/020,162, filed
 5 September 6, 2013, which is a continuation of U.S. Patent Application No. 12/057,775, filed
 March 28, 2008, now U.S. Patent No. 9,034,388, which claims the benefit of expired U.S.
 Provisional Patent Application No. 60/920,483, filed March 28, 2007, expired U.S. Provisional
 Patent Application No. 60/975,058, filed September 25, 2007, expired U.S. Provisional Patent
 Application No. 60/983,446, filed October 29, 2007, and expired U.S. Provisional Patent
 10 Application No. 61/024,072, filed January 28, 2008, all of which are incorporated by reference
 herein in their entirety.

FIELD OF THE INVENTION

This invention relates to extracts from Antarctic krill that comprise bioactive fatty acids.
 15

BACKGROUND OF THE INVENTION

In the Southern Ocean, off the coast of Antarctica, Antarctic krill (*Euphausia superba*)
 can be found in large quantities, ranging from 300-500 million metric tons of biomass. It feeds on
 phytoplankton during the short Antarctic summer. During winter, however, its food supply is
 20 limited to ice algae, bacteria, marine detritus as well as depleting body protein for energy.

In order to isolate the krill oil from the krill, solvent extraction methods have been used.
 See, e.g., WO 00/23546. Krill lipids have been extracted by placing the material in a ketone
 solvent (e.g. acetone) in order to extract the lipid soluble fraction. This method involves
 separating the liquid and solid contents and recovering a lipid rich fraction from the liquid
 25 fraction by evaporation. Further processing steps include extracting and recovering by
 evaporation the remaining soluble lipid fraction from the solid contents by using a solvent such as
 ethanol. See, e.g., WO 00/23546. The compositions produced by these methods are characterized
 by containing at least 75 µg/g astaxanthin, preferably 90 µg/g astaxanthin. Another krill lipid
 extract disclosed contained at least 250 µg/g canastaxanthin, preferably 270 µg/g canastaxanthin.

30 Krill oil compositions have been described as being effective for decreasing cholesterol,
 inhibiting platelet adhesion, inhibiting artery plaque formation, preventing hypertension,

controlling arthritis symptoms, preventing skin cancer, enhancing transdermal transport, reducing the symptoms of premenstrual symptoms or controlling blood glucose levels in a patient. See, e.g., WO 02/102394. In yet another application, a krill oil composition has been disclosed comprising a phospholipid and/or a flavonoid. The phospholipid content in the krill lipid extract could be as high as 60% w/w and the EPA/DHA content as high as 35% (w/w). See, e.g., WO 03/011873.

Furthermore, nutraceuticals, pharmaceuticals and cosmetics comprising the phospholipid extract were disclosed. Previously, it was also shown that supercritical fluid extraction using neat CO₂ could be used to prevent the extraction of phospholipids in order to extract the neutral lipid fraction from krill, which comprised of esterified and free astaxanthin. See, e.g., Yamaguchi et al., *J. Agric. Food Chem.* (1986), 34(5), 904-7. Supercritical fluid extraction with solvent modifier has previously been used to extract marine phospholipids from salmon roe, but has not been previously used to extract phospholipids from krill meal. See, e.g., Tanaka et al., *J. Oleo Sci.* (2004), 53(9), 417-424.

The methods described above rely on the processing of frozen krill that are transported from the Southern Ocean to the processing site. This transportation is both expensive and can result in degradation of the krill starting material. Data in the literature showing a rapid decomposition of the oil in krill explains why some krill oil currently offered as an omega-3 supplement in the marketplace contains very high amounts of partly decomposed phosphatidylcholine and also partly decomposed glycerides. Saether et al., *Comp. Biochem Phys. B* 83B(1): 51-55 (1986). The products offered also contain high levels of free fatty acids.

What is needed in the art are methods for processing krill that do not require transport of frozen krill material over long distances and the products produced by those methods.

SUMMARY OF THE INVENTION

In a first aspect of the invention is a composition characterized by comprising at least 65% (w/w) phospholipids.

In another aspect of the invention is a composition obtained from aquatic or marine sources, characterized by comprising 65% (w/w) phospholipids.

In yet another aspect of the invention is a composition obtained from krill, characterized by comprising at least 65% (w/w) phospholipids.

In another aspect of the invention is a composition obtained from krill, characterized by comprising at least 65% (w/w) phospholipids and at least 39% omega-3 fatty acids (w/w).

In yet another aspect of the invention is a composition obtained from krill, characterized by comprising at least 65% (w/w) phospholipids, at least 39% omega-3 fatty acids (w/w) and at
5 least 580 mg/kg astaxanthin esters.

In another aspect of the invention is a composition obtained from krill, characterized by comprising at least 39% omega-3 fatty acids (w/w) and at least 580 mg/kg astaxanthin esters.

In yet another aspect of the invention is a composition obtained from krill, characterized by comprising at least 65% (w/w) phospholipids and at least 580mg/kg astaxanthin esters.

10 In yet another aspect, the present invention provides a krill oil effective for reducing insulin resistance, improving blood lipid profile, reducing inflammation or reducing oxidative stress.

In some embodiments, the present invention provides compositions comprising: from about 3% to 10% ether phospholipids on a w/w basis; from about 35% to 50% non-ether
15 phospholipids on w/w basis, so that the total amount of ether phospholipids and non-ether phospholipids in the composition is from about 48% to 60% on a w/w basis; from about 20% to 45% triglycerides on a w/w basis; and from about 400 to about 2500 mg/kg astaxanthin. In some embodiments, the ether phospholipids are selected from the group consisting of alkylacylphosphatidylcholine, lyso-alkylacylphosphatidylcholine,
20 alkylacylphosphatidylethanolamine, and combinations thereof. In some embodiments, the ether lipids are greater than 90% alkylacylphosphatidylcholine. In some embodiments, the non-ether phospholipids are selected from the group consisting of phosphatidylcholine, phosphatidylserine, phosphatidylethanolamine and combinations thereof. In some embodiments, krill oil composition comprises a blend of lipid fractions obtained from krill. In some preferred embodiments, krill is
25 *Euphausia superba*, although other krill species also find use in the present invention. Other krill species include, but are not limited to *E. pacifica*, *E. frigida*, *E. longirostris*, *E. triacantha*, *E. vallentini*, *Meganyctiphanes norvegica*, *Thysanoessa raschii* and *Thysanoessa inermis*. In some embodiments, the compositions comprise from about 25% to 30% omega-3 fatty acids as a percentage of total fatty acids and wherein from about 80% to 90% of said omega-3 fatty acids
30 are attached to said phospholipids. In some embodiments, the present invention provides a capsule containing the foregoing compositions.

In further embodiments, the present inventions provide compositions comprising: from about 3% to 10% ether phospholipids on a w/w basis; and from about 400 to about 2500 mg/kg astaxanthin. In some embodiments, the compositions further comprise from about 35% to 50% non-ether phospholipids on w/w basis, so that the total amount of ether phospholipids and non-ether phospholipids in the composition is from about 38% to 60% on a w/w basis. In some
5
embodiments, the compositions further comprise from about 20% to 45% triglycerides on a w/w basis. In some embodiments, the ether phospholipids are selected from the group consisting of alkylacylphosphatidylcholine, lyso-alkylacylphosphatidylcholine, alkylacylphosphatidylethanolamine, and combinations thereof. In some embodiments, the ether
10
lipids are greater than 90% alkylacylphosphatidylcholine. In some embodiments, the non-ether phospholipids are selected from the group consisting of phosphatidylcholine, phosphatidylserine, phosphatidylethanolamine and combinations thereof. In some embodiments, krill oil composition comprises a blend of lipid fractions obtained from krill. In some preferred embodiments, krill is *Euphausia superba*, although other krill species also find use in the present invention. Other krill
15
species include, but are not limited to *E. pacifica*, *E. frigida*, *E. longirostris*, *E. triacantha*, *E. vallentini*, *Meganyctiphanes norvegica*, *Thysanoessa raschii* and *Thysanoessa inermis*. In some embodiments, the compositions comprise about 25% to 30% omega-3 fatty acids as a percentage of total fatty acids and wherein from about 80% to 90% of said omega-3 fatty acids are attached to said phospholipids. In some embodiments, the present invention provides a capsule containing
20
the foregoing compositions.

In some embodiments, the present invention provides a composition comprising at least 65% (w/w) of phospholipids, said phospholipids characterized in containing at least 35% omega-3 fatty acid residues. In some preferred embodiments, the composition is derived from a marine or aquatic biomass. In some further preferred embodiments, the composition is derived from
25
krill. In some embodiments, the composition comprises less than 2% free fatty acids. In some embodiments, composition comprises less than 10% triglycerides. In some preferred embodiments, the phospholipids comprise greater than 50% phosphatidylcholine. In some embodiments, the composition comprises at least 500 mg/kg astaxanthin esters. In some embodiments, the composition comprises at least 500 mg/kg astaxanthin esters and at least 36%
30
(w/w) omega-3 fatty acids. In some embodiments, the composition comprises less than about

0.5g/100g total cholesterol. In some embodiments, the composition comprises less than about 0.45% arachidonic acid (w/w).

In some embodiments, the present invention provides a krill lipid extract comprising at least 500, 100, 1500, 2000, 2100, or 2200 mg/kg astaxanthin esters and at least 36% (w/w) omega-3 fatty acids. In further embodiments, the present invention provides a krill lipid extract comprising at least 100 mg/kg astaxanthin esters, at least 20% (w/w) omega-3 fatty acids, and less than about 0.45% arachidonic acid (w/w).

In some embodiments, the present invention provides methods comprising administering the foregoing compositions to a subject in an amount effective for reducing insulin resistance, reducing inflammation, improving blood lipid profile and reducing oxidative stress.

In some embodiments, the present invention provides a krill lipid extract comprising greater than about 80% triglycerides and greater than about 90, 100, 500, 1000, 1500, 200, 2100 or 2200 mg/kg astaxanthin esters. In some embodiments, the krill lipid extract is characterized in containing from about 5% to about 15% omega-3 fatty acid residues. In some embodiments, the krill lipid extract is characterized in containing less than about 5% phospholipids. In some embodiments, the krill lipid extract is characterized in comprising from about 5% to about 10% cholesterol.

In some embodiments, the present invention provides a krill meal composition comprising less than about 50g/kg total fat. In some embodiments, the krill meal composition comprises from about 5 to about 20 mg/kg astaxanthin esters. In some embodiments, the krill meal composition comprises greater than about 65% protein. In some embodiments, the krill meal composition of comprises greater than about 70% protein. In some further embodiments, the present invention provides an animal feed comprising the krill meal composition.

In some embodiments, the present invention provides methods of increasing flesh coloration in an aquatic species comprising feeding said aquatic species a composition comprising the krill meal described above. In some embodiments, the present invention provides methods of increasing growth and overall survival rate of aquatic species by feeding the krill meal described above.

In some embodiments, the present invention provides methods of producing krill oil comprising: a) providing krill meal; and b) extracting oil from said krill meal. In some embodiments, the krill meal is produced by heat-treating krill. In some embodiments, the krill

meal is stored prior to the extraction step. In some embodiments, the extracting step comprises extraction by supercritical fluid extraction. In some embodiments, the supercritical fluid extraction is a two step process comprising a first extraction step with carbon dioxide and a low concentration of a co-solvent (e.g., from about 1-10% co-solvent) and a second extraction step
5 with carbon dioxide and a high concentration of a co-solvent (e.g., from about 10-30% co-solvent). In preferred embodiments, the co-solvent is a C₁-C₃ monohydric alcohol, preferably ethanol. In some embodiments, the present invention provides oil produced by the foregoing method.

In some embodiments, the present invention provides methods of production of krill oil
10 comprising: a) providing fresh krill; b) treating said fresh krill to denature lipases and phospholipases in said fresh krill to provide a denatured krill product; and c) extracting oil from said denatured krill product. In some embodiments, the denaturation step comprises heating of said fresh krill. In some embodiments, the denaturation step comprises heating said fresh krill after grinding. In some embodiments, the methods further comprise storing said denatured krill
15 product at room temperature or below between the denaturation step and the extraction step. In some embodiments, the enzyme denaturation step is achieved by application of heat. In some embodiments, the extraction step comprises use of supercritical carbon dioxide, with or without use of a polar modifier. In some embodiments, the extraction step comprises use of ethanol. In some embodiments, the extraction step is comprises ethanol extraction followed by acetone to
20 precipitation of phospholipids. In some embodiments, the denatured krill product is a meal. In some embodiments, the present invention provides oil produced by the foregoing method.

In some embodiments, the present invention provides a composition comprising oil extracted from krill having a phosphatidylcholine content of greater than about 50% (w/w). In some embodiments, the oil has a phosphatidylcholine content of greater than about 70% (w/w).
25 In some embodiments, the oil has a phosphatidylcholine content of greater than about 80% (w/w). In some embodiments, the composition comprises less than 2% free fatty acids. In some embodiments, the composition comprises less than 10% triglycerides. In some embodiments, the composition comprises at least 500 mg/kg astaxanthin esters. In some embodiments, the composition comprises less than about 0.45% arachidonic acid (w/w).

30 In some embodiments, the present invention provides composition comprising odorless krill oil. In some embodiments, the odorless krill oil comprises less than about 10 mg/kg (w/w)

trimethylamine. In some further embodiments, the present invention provides an odorless krill oil produced by the method comprising: extracting a neutral krill oil from a krill oil containing material by supercritical fluid extraction to provide a deodorized krill material, wherein said neutral krill oil contains odor causing compounds and extracting a polar krill oil from said
5 deodorized krill material by supercritical fluid extraction with a polar entrainer to provide an essentially odorless krill oil.

In some embodiments, the present invention provides a composition comprising krill oil containing less than about 70 micrograms/kilogram (w/w) astaxanthin esters. In some
10 embodiments, the compositions comprise less than about 50 micrograms/kilogram (w/w) astaxanthin esters. In some embodiments, the compositions comprise less than about 20 micrograms/kilogram (w/w) astaxanthin esters. In some embodiments, the compositions comprise less than about 5 micrograms/kilogram (w/w) astaxanthin esters.

In some embodiments, the present invention provides a krill oil produced by the process comprising: pumping fresh krill from a trawl onto a ship, heating the krill to provide a krill
15 material, and extracting oil from the krill material.

In further embodiments, the present invention provides a blended krill oil composition comprising: from about 45% to 55% w/w phospholipids; from about 20% to 45% w/w triglycerides; and from about 400 to about 2500 mg/kg astaxanthin. In some embodiments, the blended krill oil product comprises a blend of lipid fractions obtained from *Euphausia superba*.
20 In some embodiments, the composition comprises from about 25% to 30% omega-3 fatty acids as a percentage of total fatty acids and wherein from about 80% to 90% of said omega-3 fatty acids are attached to said phospholipids.

In still other embodiments, the present invention provides a *Euphausia superba* krill oil composition comprising: from about 30% to 60% w/w phospholipids; from about 20% to 50%
25 triglycerides; from about 400 to about 2500 mg/kg astaxanthin; and from about 20% to 35% omega-3 fatty acids as a percentage of total fatty acids in said composition, wherein from about 70% to 95% of said omega-3 fatty acids are attached to said phospholipids.

In still further embodiments, the present invention provides a dietary supplement comprising encapsulated *Euphausia superba* krill oil comprising from about 30% to 60% w/w
30 phospholipids; from about 20% to 50% triglycerides; from about 400 to about 2500 mg/kg astaxanthin; and from about 20% to 35% omega-3 fatty acids as a percentage of total fatty acids

in said composition, wherein from about 70% to 95% of said omega-3 fatty acids are attached to said phospholipids.

In some embodiments, the present invention provides methods of making a *Euphausia superba* krill oil composition comprising: contacting *Euphausia superba* with a polar solvent to provide a polar extract comprising phospholipids; contacting *Euphausia superba* with a neutral solvent to provide a neutral extract comprising triglycerides and astaxanthin; combining said polar extract and said neutral extract to provide *Euphausia superba* krill oil comprising from about 30% to 60% w/w phospholipids; from about 20% to 50% triglycerides; from about 400 to about 2500 mg/kg astaxanthin; and from about 20% to 35% omega-3 fatty acids as a percentage of total fatty acids in said composition, wherein from about 70% to 95% of said omega-3 fatty acids are attached to said phospholipids. In some embodiments, the methods further comprise the step of encapsulating the *Euphausia superba* krill oil. In some embodiments, the present invention provides a *Euphausia superba* krill oil produced by the methods described above.

In some embodiments, the present invention provides methods of producing a dietary supplement comprising: contacting *Euphausia superba* with a polar solvent to provide an polar extract comprising phospholipids; contacting *Euphausia superba* with a neutral solvent to provide a neutral extract comprising triglycerides and astaxanthin; combining said polar extract and said neutral extract to provide *Euphausia superba* krill oil comprising from about 30% to 60% w/w phospholipids; from about 20% to 50% triglycerides; from about 400 to about 2500 mg/kg astaxanthin; and from about 20% to 35% omega-3 fatty acids as a percentage of total fatty acids in said composition, wherein from about 70% to 95% of said omega-3 fatty acids are attached to said phospholipids; and encapsulating said *Euphausia superba* krill oil.

In some embodiments, the present invention provides methods of reducing diet-induced hyperinsulinemia, insulin insensitivity, muscle mass hypertrophy, serum adiponectin reduction or hepatic steatosis comprising in a subject exposed to a high fat diet: administering to said subject exposed to a high fat diet an effective amount of a krill oil composition under conditions such that a condition selected from the group consisting of diet-induced hyperinsulinemia, insulin insensitivity, muscle mass hypertrophy, serum adiponectin reduction and hepatic steatosis is reduced. The present invention is not limited to any particular krill oil composition. In some embodiments, the krill oil composition is a *Euphausia superba* krill oil composition. The present invention is not limited to any particular formulation of krill oil. In some embodiments, the krill

oil composition is encapsulated. In some preferred embodiments, the effective amount of a krill oil composition is from 0.2 grams to 10 grams of said krill oil composition. In some embodiments, the krill oil composition comprises: from about 45% to 55% w/w phospholipids; from about 20% to 45% w/w triglycerides; and from about 400 to about 2500 mg/kg astaxanthin.

5 In some embodiments, the krill oil composition comprises a blend of lipid fractions obtained from *Euphausia superba*. In some embodiments, the krill oil composition comprises from about 25% to 30% omega-3 fatty acids as a percentage of total fatty acids and wherein from about 80% to 90% of said omega-3 fatty acids are attached to said phospholipids. In some embodiments, the krill oil composition comprises from about 30% to 60% w/w phospholipids; from about 20% to
10 50% triglycerides; from about 400 to about 2500 mg/kg astaxanthin; and from about 20% to 35% omega-3 fatty acids as a percentage of total fatty acids in said composition, and wherein from about 70% to 95% of said omega-3 fatty acids are attached to said phospholipids.

In some embodiments, the present invention provides methods of reducing diet-induced hyperinsulinemia, insulin insensitivity, muscle mass hypertrophy, serum adiponectin reduction or
15 hepatic steatosis comprising in a subject consuming a high fat diet or a normal fat diet: administering to said subject consuming a high fat diet or a normal fat diet an effective amount of a krill oil composition under conditions such that a condition selected from the group consisting of diet-induced hyperinsulinemia, insulin insensitivity, muscle mass hypertrophy, serum adiponectin reduction and hepatic steatosis is reduced. The present invention is not limited
20 to any particular krill oil composition. In some embodiments, the krill oil composition is a *Euphausia superba* krill oil composition. The present invention is not limited to any particular formulation of krill oil. In some embodiments, the krill oil composition is encapsulated. In some preferred embodiments, the effective amount of a krill oil composition is from 0.2 grams to 10 grams of said krill oil composition. In some embodiments, the krill oil composition comprises:
25 from about 45% to 55% w/w phospholipids; from about 20% to 45% w/w triglycerides; and from about 400 to about 2500 mg/kg astaxanthin. In some embodiments, the krill oil composition comprises a blend of lipid fractions obtained from *Euphausia superba*. In some embodiments, the krill oil composition comprises from about 25% to 30% omega-3 fatty acids as a percentage of total fatty acids and wherein from about 80% to 90% of said omega-3 fatty acids are attached
30 to said phospholipids. In some embodiments, the krill oil composition comprises from about 30% to 60% w/w phospholipids; from about 20% to 50% triglycerides; from about 400 to about

2500 mg/kg astaxanthin; and from about 20% to 35% omega-3 fatty acids as a percentage of total fatty acids in said composition, and wherein from about 70% to 95% of said omega-3 fatty acids are attached to said phospholipids.

In some embodiments, the present invention provides methods of inducing diuresis in a subject comprising: administering to said subject an effective amount of a krill oil composition under conditions such that diuresis is induced. In some embodiments, the present invention provides methods of increasing muscle mass in a subject, comprising: administering to said subject an effective amount of a krill oil composition under conditions such that muscle mass is increased. In some embodiments, the present invention provides methods of decreasing protein catabolism in a subject, comprising: administering to said subject an effective amount of a krill oil composition under conditions such that protein catabolism is decreased. In some embodiments, the present invention provides methods of decreasing lipid content in the heart of a subject, comprising: administering to said subject an effective amount of a krill oil composition under conditions such that lipid content in the heart of the subject is decreased. In some embodiments, the present invention provides methods of decreasing lipid content in the liver of a subject, comprising: administering to said subject an effective amount of a krill oil composition under conditions such that lipid content in the liver of the subject is decreased.

DESCRIPTION OF THE FIGURES

Figure 1. ³¹P NMR analysis of polar lipids in krill oil.

Figure 2. Blood lipid profiles in Zucker rats fed different forms of omega-3 fatty acids (TAG = FO, PL1 = NKO and PL2 = Superba).

Figure 3. Plasma glucose concentration in Zucker rats fed different forms of omega-3 fatty acids.

Figure 4. Plasma insulin concentration in Zucker rats fed different forms of omega-3 fatty acids.

Figure 5. Estimated HOMA-IR values in Zucker rats fed different forms of omega-3 fatty acids.

Figure 6. The effect of dietary omega-3 fatty acids on TNF α production by peritoneal macrophages.

Figure 7. The effect of dietary omega-3 fatty acids on lipid accumulation in the liver.

Figure 8. The effect of dietary omega-3 fatty acids on lipid accumulation in the muscle.

Figure 9. The effect of dietary omega-3 fatty acids on lipid accumulation in the heart.

Figure 10. Relative concentrations of DHA in the brain in Zucker rats supplemented with omega-3 fatty acids.

5 Figure 11. Mean group body weights (g) in the collagen-induced male DBA/1 arthritic mice. B - PL2 is the krill oil group. * $p < 0.05$, significantly different from Group A (Positive Control - Fish Oil) and Group C (Control).

Figure 12. Body weight for the various treatment groups.

Figure 13. Muscle weight for the various treatment groups.

10 Figure 14. Muscle to body weight ratio for the various treatment groups.

Figure 15. Serum adiponectin levels (ng/ml) for the various treatment groups.

Figure 16. Serum insulin levels for the various treatment groups.

Figure 17. Blood glucose (mmol/l) levels in the various treatment groups.

Figure 18. HOMA-IR values for the various treatment groups.

15 Figure 19. Liver triglyceride levels ($\mu\text{mol/g}$) for the various treatment groups.

DEFINITIONS

20 As used herein, "phospholipid" refers to an organic compound having the following general structure:

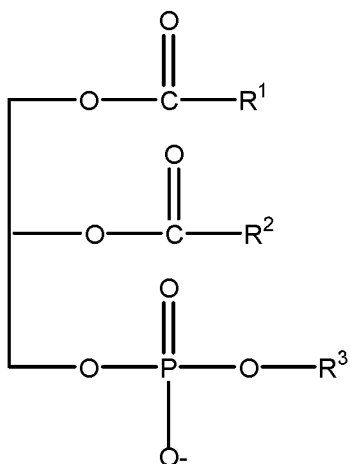

wherein R1 is a fatty acid residue, R2 is a fatty acid residue or –OH, and R3 is a –H or nitrogen containing compound choline (HOCH₂CH₂N⁺(CH₃)₃OH⁻), ethanolamine (HOCH₂CH₂NH₂), inositol or serine. R1 and R2 cannot simultaneously be OH. When R3 is an –OH, the compound is a diacylglycerophosphate, while when R3 is a nitrogen-containing compound, the compound is a phosphatide such as lecithin, cephalin, phosphatidyl serine or plasmalogen.

An “ether phospholipid” as used herein refers to a phospholipid having an ether bond at position 1 the glycerol backbone. Examples of ether phospholipids include, but are not limited to, alkylacylphosphatidylcholine (AAPC), lyso-alkylacylphosphatidylcholine (LAAPC), and alkylacylphosphatidylethanolamine (AAPE). A “non-ether phospholipid” is a phospholipid that does not have an ether bond at position 1 of the glycerol backbone.

As used herein, the term omega-3 fatty acid refers to polyunsaturated fatty acids that have the final double bond in the hydrocarbon chain between the third and fourth carbon atoms from the methyl end of the molecule. Non-limiting examples of omega-3 fatty acids include, 5,8,11,14,17-eicosapentaenoic acid (EPA), 4,7,10,13,16,19-docosahexanoic acid (DHA) and 7,10,13,16,19-docosapentanoic acid (DPA).

As used herein, astaxanthin refers to the following chemical structure:

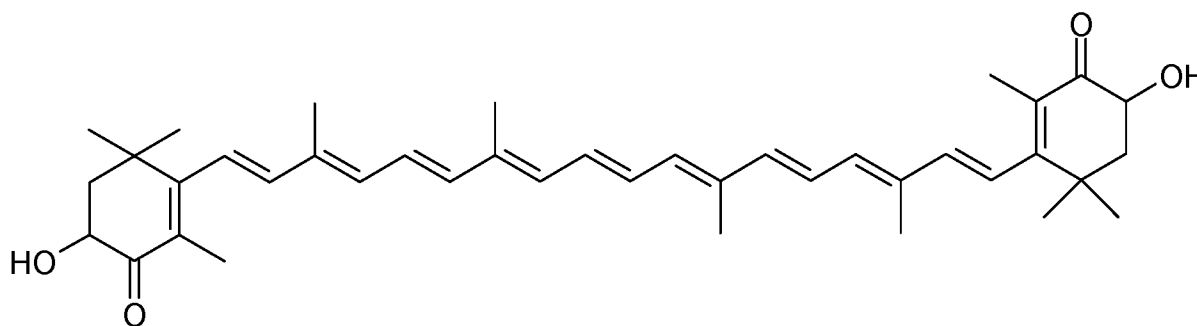

As used herein, astaxanthin esters refer to the fatty acids esterified to OH group in the astaxanthin molecule.

As used herein, the term w/w (weight/weight) refers to the amount of a given substance in a composition on weight basis. For example, a composition comprising 50% w/w phospholipids means that the mass of the phospholipids is 50% of the total mass of the composition (i.e., 50 grams of phospholipids in 100 grams of the composition, such as an oil).

DETAILED DESCRIPTION OF THE INVENTION

This invention discloses novel krill oil compositions characterized by containing high levels of astaxanthin, phospholipids, included an enriched quantities of ether phospholipids, and omega-3 fatty acids. The krill oils compositions are extracted from krill meal using supercritical fluid extraction (SFE) with a co-solvent modifier. The krill meal has been processed on board a ship in Antarctica using live krill as starting material in order to ensure the highest possible quality of the krill meal. The krill oils are extracted from the krill meal in two stages, in step 1 the neutral fraction is extracted using neat supercritical CO₂ or in combination with 5% ethanol. The neutral fraction consisted mostly of triglycerides and cholesterol. In stage 2, the polar lipids (phospholipids) are extracted by adding at least 20% ethanol to the supercritical CO₂ extraction medium.

The present invention provides methods to avoid decomposition of glycerides and phospholipids in krill oil and compositions produced by those methods. The product obtained by these new methods is virtually free of enzymatically decomposed oil constituents. The solution to the problem is to incorporate a protein denaturation step on fresh krill prior to use of any extraction technology. Denaturation can be achieved by thermal stress or by other means. After denaturation, the oil can be extracted by an optional selection of nonpolar and polar solvents including use of supercritical carbon dioxide. Krill is adapted to a very efficient nutrient digestion at very low temperatures. Therefore the enzymes are sensitive to heat and the step of applying thermal denaturation of lipases and phospholipases does not imply use of very high temperatures. Surprisingly, it has been found that the use of mild denaturation conditions can greatly enhance the quality of krill oil.

Additionally, a major obstacle of several processes of extraction is the cost of removing water. This is particularly true for methods feasible for extraction of highly unsaturated lipids where freeze drying has been regarded as the method of choice to avoid oxidative breakdown of lipids. However, the lipids in krill are surprisingly stable against oxidative deterioration. Therefore, a process including moderate use of heat in the water removing process is feasible provided that the enzymes have been inactivated.

30

A. Krill Processing

The present invention provides methods for processing freshly caught krill at the site of capture and preferably on board a ship. After processing on board, the krill can be further subjected to extraction processes on board the ship or at a remote location away from the ship.

5 The processing steps described herein also allow for the storage of krill material, preferably a krill meal for from about 1,2, 3, 4, 5, 6, 8, 9, 10, 11, or 12 months to about 24 to 36 months prior to processing.

In some preferred embodiments, freshly caught krill is first subjected to a protein denaturation step. The present invention is not limited to any particular method of protein
10 denaturation. In some embodiments, the denaturation is accomplished by application of chemicals, heat, or combinations thereof. In some embodiments, freshly caught krill is wet pressed to obtain oil and meal. In some embodiments, the meal is then heated to a temperature of about 50°C to about 100°C for about 20 minutes to about an hour, preferably about 40 minutes to denature the proteins. In some embodiments, this material is then pressed to yield a press cake.
15 When this method is used on krill, only a small amount of oil is released. Most of the oil is still present in the denatured meal. In some embodiments, antioxidants such as ethoxyquin or Vitamin E are added to the meal. However, as shown in the examples, the resulting meal is surprisingly stable. The stability can only partly be explained by addition of an antioxidant to the meal. This antioxidant can, after extraction of the oil from denatured meal, be removed by further
20 processing steps. Alternatively the oil can be extracted rather shortly after production of the meal without any addition of antioxidant in the process. Further, storage conditions at a low to very low temperature can be applied if addition of antioxidant is not desired.

Krill oil extracted from denatured krill meal by supercritical fluid extraction even 19
25 months after the production of the meal contained virtually no decomposed phospholipids. This product turned out to be substantially different from samples of krill oil available in the market today. Previously described commercial krill processing procedures utilize krill that has been frozen immediately after catching followed by freeze drying and extraction at low temperatures. However, these processes only yield a suitable product if the time the krill is kept frozen is very short or the temperature is extremely low (-60° to -80°C). However, data provided herein clearly
30 shows that if a step of denaturation of the proteins is added in front of an optional extraction method, an excellent krill oil can be produced even after a long time of storage. This

methodology also opens up for use of alternative methods to remove water prior to extraction, which in turn has a great impact on costs in full scale operation. If a long time of storage is desired, the denatured material should preferably be stored at low temperature preferably at -20°C.

5 In some embodiments, krill oil is extracted from the denatured krill meal. In some
embodiments, the krill oil is extracted by contacting the krill meal with ethanol. In some
embodiments, krill is then extracted with a ketone solvent such as acetone. In other embodiments,
the krill oil is extracted by one or two step supercritical fluid extraction. In some embodiments,
the supercritical fluid extraction uses carbon dioxide and neutral krill oil is produced. In some
10 embodiments, the supercritical fluid extraction uses carbon dioxide with the addition of a polar
entrainer, such as ethanol, to produce a polar krill oil. In some embodiments, the krill meal is
first extracted with carbon dioxide followed by carbon dioxide with a polar entrainer, or vice
versa. In some embodiments, the krill meal is first extracted with CO₂ supplemented with a low
amount of a polar co-solvent (e.g., from about 1% to about 10%, preferably about 5%) such a C₁-
15 C₃ monohydric alcohol, preferably ethanol, followed by extraction with CO₂ supplemented with a
high amount of a polar co-solvent (from about 10% to about 30%, preferably about 23%) such as
such a C₁-C₃ monohydric alcohol, preferably ethanol, or vice versa. Surprisingly, it has been
found that use of a low amount of polar solvent in the CO₂ as an entrainer facilitates the
extraction of neutral lipid components and astaxanthin in a single step. Use of the high of polar
20 solvent as an entrainer in the other step facilitates extraction of ether phospholipids, as well as
non-ether phospholipids.

 The present invention is distinguished from previously described krill oil products, such
as those described in U.S. Pat. No. 6,800,299 or WO 03/011873 and Neptune brand krill oil, by
having substantially higher levels of non-ether phospholipids, ether phospholipids, and
25 astaxanthin. The krill oils of the present invention also have unexpected and superior properties
as compared to previously available krill oils. In particular, the krill oil of the present invention
has been demonstrated to reduce blood LDL cholesterol levels, improve DHA transfer to the
brain as well as reduce lipid accumulation in the liver and muscle while the previously described
krill oil compositions do not have such a properties. Accordingly, in some embodiments, the
30 present invention provides a krill oil composition, preferably a *Euphausia superba* krill oil
composition, comprising from about 40% to about 60% w/w phospholipids, preferably from

about 45% to 55% w/w phospholipids and from about 300 mg/kg astaxanthin to about 2500 mg/kg astaxanthin, preferably from about 1000 to about 2200 mg/kg astaxanthin, more preferably from about 1500 to about 2200 mg/kg astaxanthin. In some preferred embodiments, the compositions comprise greater than about 1000, 1500, 1800, 1900, 2000, or 2100 mg/kg astaxanthin. In some preferred embodiments, the krill oil compositions of the present invention 5 comprise from about 1%, 2%, 3% or 4% to about 8%, 10%, 12% or 15% w/w ether phospholipids or greater than about 4%, 5%, 6%, 7%, 8%, 9% or 10% ether phospholipids. In some embodiments the ether phospholipids are preferably alkylacylphosphatidylcholine, lyso-alkylacylphosphatidylcholine, alkylacylphosphatidyl-ethanolamine or combinations thereof. In 10 some embodiments, the krill oil compositions comprise from about 1%, 2%, 3% or 4% to about 8%, 10%, 12% or 15% w/w ether phospholipids and from about 30%, 33%, 40%, 42%, 45%, 48%, 50%, 52%, 54%, 55% 56%, 58% to about 60% non-ether phospholipids so that the total amount of phospholipids (both ether and non-ether phospholipids) ranges from about 40% to about 60%. One of skill in the art will recognize that the range of 40% to 60% total 15 phospholipids, as well as the other ranges of ether and non-ether phospholipids, can include other values not specifically listed within the range.

In further embodiments, the compositions comprise from about 20% to 45% w/w triglycerides; and from about 400 to about 2500 mg/kg astaxanthin. In some embodiments, the compositions comprise from about 20% to 35%, preferably from about 25% to 35%, omega-3 20 fatty acids as a percentage of total fatty acids in the composition, wherein from about 70% to 95%, or preferably from about 80% to 90% of the omega-3 fatty acids are attached to the phospholipids. In some embodiments, the present invention provides encapsulated *Euphausia superba* krill oil compositions. In some embodiments, the present invention provides a method of making a *Euphausia superba* krill oil composition comprising contacting *Euphausia superba* 25 with a polar solvent to provide a polar extract comprising phospholipids, contacting *Euphausia superba* with a neutral solvent to provide a neutral extract comprising triglycerides and astaxanthin, and combining said polar extract and said neutral extract to provide the *Euphausia superba* krill oils described above. In some embodiments, fractions from polar and non-polar extractions are combined to provide a final product comprising the desired ether phospholipids, 30 non-ether phospholipids, omega-3 moieties and astaxanthin. In other embodiments, the present invention provides methods of making a *Euphausia superba* (or other krill species) krill oil

comprising contacting a *Euphausia superba* preparation such as *Euphausia superba* krill meal under supercritical conditions with CO₂ containing a low amount of a polar solvent such as ethanol to extract neutral lipids and astaxanthin; contacting meal remaining from the first extraction step under supercritical conditions with CO₂ containing a high amount of a polar solvent such as ethanol to extract a polar lipid fraction containing ether and non-ether phospholipids; and then blending the neutral and polar lipid extracts to provide the compositions described above.

The krill oil extracted by the methods of the present invention contains few enzymatic breakdown products. Examples of the krill oil compositions of the present invention are provided in Tables 9-24. In some embodiments, the present invention provides a polar krill oil comprising at least 65% (w/w) of phospholipids, wherein the phospholipids are characterized in containing at least 35% omega-3 fatty acid residues. The present invention is not limited to the presence of any particular omega-3 fatty acid residues in the krill oil composition. In some preferred embodiments, the krill oil comprises EPA and DHA residues. In some embodiments, the krill oil compositions comprise less than about 5%, 4%, 3% or preferably 2% free fatty acids on a weight/weight (w/w) basis. In some embodiments, the krill oil compositions comprise less than about 25%, 20%, 15%, 10% or 5% triglycerides (w/w). In some embodiments, the krill oil compositions comprise greater than about 30%, 40%, 45%, 50%, 55%, 60%, or 65% phosphatidyl choline (w/w). In some embodiments, the krill oil compositions comprise greater than about 100, 200, 300, 400, or 500 mg/kg astaxanthin esters and up to about 700 mg/kg astaxanthin esters. In some embodiments, the present invention provides krill oil compositions comprising at least 500, 1000, 1500, 2000, 2100, or 2200 mg/kg astaxanthin esters and at least 36% (w/w) omega-3 fatty acids. In some embodiments, the krill oil compositions of the present invention comprise less than about 1.0g/100g, 0.5g/100g, 0.2g/100g or 0.1g/100g total cholesterol. In some embodiments, the krill oil compositions of the present invention comprise less than about 0.45

In some embodiments, the present invention provides a neutral krill oil extract comprising greater than about 70%, 75% 80%, 85% or 90% triglycerides. In some embodiments, the krill oil compositions comprise from about 50 to about 2500 mg/kg astaxanthin esters. In some embodiments, the krill oil compositions comprise from about 50, 100, 200, or 500 to about 750, 1000, 1500 or 2500 mg/kg astaxanthin esters. In some embodiments, the compositions comprise

from about 1% to about 30% omega-3 fatty acid residues, and preferably from about 5%-15% omega-3 fatty acid residues. In some embodiments, the krill oil compositions comprise less than about 20%, 15%, 10% or 5% phospholipids.

5 In some embodiments, the present invention provides krill oil containing less than about 70, 60, 50, 40, 30, 20, 10, 5 or 1 micrograms/kilogram (w/w) astaxanthin esters. In some embodiments, the krill oil is clear or only has a pale red color. In some embodiments, the low-astaxanthin krill oil is obtained by first extracting a krill material, such as krill oil, by supercritical fluid extraction with neat carbon dioxide. It is contemplated that this step removes astaxanthin from the krill material. In some embodiments, the krill material is then subjected to supercritical
10 fluid extraction with carbon dioxide and a polar entrainer such as ethanol, preferably about 20% ethanol. The oil extracted during this step is characterized in containing low amounts of astaxanthin. In other embodiments, krill oil comprising astaxanthin is extracted by countercurrent supercritical fluid extraction with neat carbon dioxide to provide a low-astaxanthin krill oil.

15 In some embodiments, the present invention provides krill oil that is substantially odorless. By substantially odorless it is meant that the krill oil lacks an appreciable odor as determined by a test panel. In some embodiments, the substantially odorless krill oil comprises less than about 10, 5 or 1 milligrams/kilogram trimethylamine. In some preferred embodiments, the odorless krill oil is produced by first subjecting krill material to supercritical fluid extraction
20 with neat carbon dioxide to remove odor causing compounds such as trimethylamine, followed by extraction with carbon dioxide with a polar entrainer such as ethanol.

In some embodiments, the present invention provides a delipidated krill meal produced after extraction of lipids from the krill meal. In some embodiments, the delipidated krill meal comprises krill protein. In some embodiments, the delipidated krill meal comprises less than
25 about 200, 150, 120, 100, 75, 65, 60, 55, or 50 g/kg total fat. In some embodiments, the delipidated krill meal comprises from about 1 to about 100 mg/kg astaxanthin esters, and preferably from about 5 to about 20 mg/kg astaxanthin esters. In some embodiments, the delipidated krill meal comprises greater than about 60%, 65%, 70% or 75% krill protein. In some embodiments, the present invention provides animal feeds comprising the delipidated krill meal.
30 In some embodiments, the animal feed is a fish feed or aquatic organism feed, such as shrimp feed, crab feed, or crawfish feed. In preferred embodiments, the krill meal is incorporated into

complete ration for the target organism. In preferred embodiments, the feed is provided in pelleted form. In many instances, compounds such as astaxanthin are removed during delipidation. The methods of the present invention provide a delipidated krill meal that retains significant amounts of astaxanthin. Accordingly, in some embodiments, the present invention provides methods of feeding aquatic organisms, comprising providing to the aquatic organism a feed comprising the delipidated krill meal described above. In other embodiments, the present invention provides methods of increasing flesh coloration in an aquatic species comprising feeding the aquatic species a comprising the delipidated krill meal described above.

10 **B. Compositions Containing Krill Oil**

In some embodiments, the compositions of this invention (such as those described in the preceding sections) are contained in acceptable excipients and/or carriers for oral consumption. The actual form of the carrier, and thus, the composition itself, is not critical. The carrier may be a liquid, gel, gelcap, capsule, powder, solid tablet (coated or non-coated), tea, or the like. The composition is preferably in the form of a tablet or capsule and most preferably in the form of a soft gel capsule. Suitable excipient and/or carriers include maltodextrin, calcium carbonate, dicalcium phosphate, tricalcium phosphate, microcrystalline cellulose, dextrose, rice flour, magnesium stearate, stearic acid, croscarmellose sodium, sodium starch glycolate, crospovidone, sucrose, vegetable gums, lactose, methylcellulose, povidone, carboxymethylcellulose, corn starch, and the like (including mixtures thereof). Preferred carriers include calcium carbonate, magnesium stearate, maltodextrin, and mixtures thereof. The various ingredients and the excipient and/or carrier are mixed and formed into the desired form using conventional techniques. The tablet or capsule of the present invention may be coated with an enteric coating that dissolves at a pH of about 6.0 to 7.0. A suitable enteric coating that dissolves in the small intestine but not in the stomach is cellulose acetate phthalate. Further details on techniques for formulation for and administration may be found in the latest edition of Remington's Pharmaceutical Sciences (Maack Publishing Co., Easton, PA).

The dietary supplement may comprise one or more inert ingredients, especially if it is desirable to limit the number of calories added to the diet by the dietary supplement. For example, the dietary supplement of the present invention may also contain optional ingredients including, for example, herbs, vitamins, minerals, enhancers, colorants, sweeteners, flavorants,

inert ingredients, and the like. For example, the dietary supplement of the present invention may contain one or more of the following: ascorbates (ascorbic acid, mineral ascorbate salts, rose hips, acerola, and the like), dehydroepiandrosterone (DHEA), Fo-Ti or Ho Shu Wu (herb common to traditional Asian treatments), Cat's Claw (ancient herbal ingredient), green tea (polyphenols),
 5 inositol, kelp, dulse, bioflavinoids, maltodextrin, nettles, niacin, niacinamide, rosemary, selenium, silica (silicon dioxide, silica gel, horsetail, shavegrass, and the like), spirulina, zinc, and the like. Such optional ingredients may be either naturally occurring or concentrated forms.

In some embodiments, the dietary supplements further comprise vitamins and minerals including, but not limited to, calcium phosphate or acetate, tribasic; potassium phosphate, dibasic;
 10 magnesium sulfate or oxide; salt (sodium chloride); potassium chloride or acetate; ascorbic acid; ferric orthophosphate; niacinamide; zinc sulfate or oxide; calcium pantothenate; copper gluconate; riboflavin; beta-carotene; pyridoxine hydrochloride; thiamin mononitrate; folic acid; biotin; chromium chloride or picolonate; potassium iodide; sodium selenate; sodium molybdate; phyloquinone; vitamin D3; cyanocobalamin; sodium selenite; copper sulfate; vitamin A; vitamin
 15 C; inositol; potassium iodide. Suitable dosages for vitamins and minerals may be obtained, for example, by consulting the U.S. RDA guidelines.

In further embodiments, the compositions comprise at least one food flavoring such as acetaldehyde (ethanal), acetoin (acetyl methylcarbinol), anethole (parapropenyl anisole), benzaldehyde (benzoic aldehyde), N butyric acid (butanoic acid), d or l carvone (carvol),
 20 cinnamaldehyde (cinnamic aldehyde), citral (2,6 dimethyloctadien 2,6 al 8, gera nial, neral), decanal (N decylaldehyde, capraldehyde, capric aldehyde, caprinaldehyde, aldehyde C 10), ethyl acetate, ethyl butyrate, 3 methyl 3 phenyl glycidic acid ethyl ester (ethyl methyl phenyl glycidate, strawberry aldehyde, C 16 aldehyde), ethyl vanillin, geraniol (3,7 dimethyl 2,6 and 3,6 octadien 1
 25 ol), geranyl acetate (geraniol acetate), limonene (d , l , and dl), linalool (linalol, 3,7 dimethyl 1,6 octadien 3 ol), linalyl acetate (bergamol), methyl anthranilate (methyl 2 aminobenzoate), piperonal (3,4 methylenedioxy benzaldehyde, heliotropin), vanillin, alfalfa (*Medicago sativa* L.), allspice (*Pimenta officinalis*), ambrette seed (*Hibiscus abelmoschus*), angelic (*Angelica archangelica*), Angostura (*Galipea officinalis*), anise (*Pimpinella anisum*), star anise (*Illicium verum*), balm (*Melissa officinalis*), basil (*Ocimum basilicum*), bay (*Laurus nobilis*), calendula
 30 (*Calendula officinalis*), (*Anthemis nobilis*), capsicum (*Capsicum frutescens*), caraway (*Carum carvi*), cardamom (*Elettaria cardamomum*), cassia, (*Cinnamomum cassia*), cayenne pepper

(*Capsicum frutescens*), Celery seed (*Apium graveolens*), chervil (*Anthriscus cerefolium*), chives (*Allium schoenoprasum*), coriander (*Coriandrum sativum*), cumin (*Cuminum cyminum*), elder flowers (*Sambucus canadensis*), fennel (*Foeniculum vulgare*), fenugreek (*Trigonella foenum graecum*), ginger (*Zingiber officinale*), horehound (*Marrubium vulgare*), horseradish (*Armoracia lapathifolia*), hyssop (*Hyssopus officinalis*), lavender (*Lavandula officinalis*), mace (*Myristica fragrans*), marjoram (*Majorana hortensis*), mustard (*Brassica nigra*, *Brassica juncea*, *Brassica hirta*), nutmeg (*Myristica fragrans*), paprika (*Capsicum annuum*), black pepper (*Piper nigrum*), peppermint (*Mentha piperita*), poppy seed (*Papayer somniferum*), rosemary (*Rosmarinus officinalis*), saffron (*Crocus sativus*), sage (*Salvia officinalis*), savory (*Satureia hortensis*, *Satureia montana*), sesame (*Sesamum indicum*), spearmint (*Mentha spicata*), tarragon (*Artemisia dracunculus*), thyme (*Thymus vulgaris*, *Thymus serpyllum*), turmeric (*Curcuma longa*), vanilla (*Vanilla planifolia*), zedoary (*Curcuma zedoaria*), sucrose, glucose, saccharin, sorbitol, mannitol, aspartame. Other suitable flavoring are disclosed in such references as Remington's Pharmaceutical Sciences, 18th Edition, Mack Publishing, p. 1288-1300 (1990), and Furia and Pellanca, Fenaroli's Handbook of Flavor Ingredients, The Chemical Rubber Company, Cleveland, Ohio, (1971), known to those skilled in the art.

In other embodiments, the compositions comprise at least one synthetic or natural food coloring (e.g., annatto extract, astaxanthin, beet powder, ultramarine blue, canthaxanthin, caramel, carotenal, beta carotene, carmine, toasted cottonseed flour, ferrous gluconate, ferrous lactate, grape color extract, grape skin extract, iron oxide, fruit juice, vegetable juice, dried algae meal, tagetes meal, carrot oil, corn endosperm oil, paprika, paprika oleoresin, riboflavin, saffron, tumeric, tumeric and oleoresin).

In still further embodiments, the compositions comprise at least one phytonutrient (e.g., soy isoflavonoids, oligomeric proanthcyanidins, indol 3 carbinol, sulforaphane, fibrous ligands, plant phytosterols, ferulic acid, anthocyanocides, triterpenes, omega 3/6 fatty acids, conjugated fatty acids such as conjugated linoleic acid and conjugated linolenic acid, polyacetylene, quinones, terpenes, catechins, gallates, and quercitin). Sources of plant phytonutrients include, but are not limited to, soy lecithin, soy isoflavones, brown rice germ, royal jelly, bee propolis, acerola berry juice powder, Japanese green tea, grape seed extract, grape skin extract, carrot juice, bilberry, flaxseed meal, bee pollen, ginkgo biloba, primrose (evening primrose oil), red clover,

burdock root, dandelion, parsley, rose hips, milk thistle, ginger, Siberian ginseng, rosemary, curcumin, garlic, lycopene, grapefruit seed extract, spinach, and broccoli.

In still other embodiments, the compositions comprise at least one vitamin (e.g., vitamin A, thiamin (B1), riboflavin (B2), pyridoxine (B6), cyanocobalamin (B12), biotin, ascorbic acid (vitamin C), retinoic acid (vitamin D), vitamin E, folic acid and other folates, vitamin K, niacin, and pantothenic acid). In some embodiments, the particles comprise at least one mineral (e.g., sodium, potassium, magnesium, calcium, phosphorus, chlorine, iron, zinc, manganese, fluorine, copper, molybdenum, chromium, selenium, and iodine). In some particularly preferred embodiments, a dosage of a plurality of particles includes vitamins or minerals in the range of the recommended daily allowance (RDA) as specified by the United States Department of Agriculture. In still other embodiments, the particles comprise an amino acid supplement formula in which at least one amino acid is included (e.g., l-carnitine or tryptophan).

C. Uses of Krill Oil

Previously, it was disclosed that omega-3 fatty acids have anti-inflammatory properties. See, e.g., Calder. Am. J. Clin. Nutr. 83 (2006) 1505S. In addition, it was disclosed that a phospholipid emulsion derived from a marine and/or synthetic origin comprising polyunsaturated fatty acids have anti-inflammatory and/or immuno-suppressive effects. See, e.g., 5,434,183. An embodiment of this invention is a krill oil composition effective for reducing inflammation i.e. reducing the levels of TNF- α , IL-1 beta, IL-6, IL-10, TGF beta and fibrinogen in the blood.

Type 2 diabetes is a metabolic disorder characterized by impaired glycemic control (high blood glucose levels). In type 2 diabetes, it is the tissue wide insulin resistance that contributes to the development of the disease. Strategies reducing insulin resistance or improving tissue sensitivity to insulin are recognized as beneficial in preventing type 2 diabetes. In healthy humans, a 3-week supplementation with fish oil (1.1 g EPA/d and 0.7 g DHA/d) decreased the insulin response to an oral glucose load by 40%. Omega-3 PUFA dietary enrichment resulted in lower glucose oxidation, higher fat oxidation, and increased glycogen storage; the glycemic response was unchanged, however, which indicates an improved sensitivity to insulin. In another embodiment of this invention is a krill oil composition effective for reducing the insulin resistance.

Krill oil has not been disclosed as being effective in treating one of the most important life style problems of modern societies, i.e., excess weight gain and obesity. Excess adipose tissue mass (overweight and obesity) is associated with low grade inflammation in adipose tissue and in the whole body reflecting the inflammatory mediators “spilling over” from fat tissue. Trayhurn et al., *Br. J. Nutrition* (2004), 92(3), 347-355. Inflammation appears to be an important link between obesity and metabolic syndrome/type-II diabetes as well as cardiovascular disease. Libby et al., *J. Amer. Coll. Card.* (2006), 48(9, Suppl. A), A33-A46. Thus, excess adipose tissue is an unhealthy condition. Weight reduction will improve the inflammatory condition, but persistent weight reduction is difficult to achieve. Omega-3 fatty acid supplementation may alleviate the inflammatory condition in adipose tissue and thus ideally complement the principal strategies of weight reduction i.e. low calorie diet and exercise. There are clinical studies in humans that demonstrate that omega-3 enhance the effect of very low calorie diet and exercise in reducing body fat mass. Kunesova et al., *Physiological research / Academia Scientiarum Bohemoslovaca* (2006), 55(1), 63-72. Although diet and exercise regime may fail to result in consistent decrease in weight in long term, the effect of omega-3 fatty acids alleviating the inflammatory condition in the adipose tissue may persist generating a condition that can be described as "healthy adipose tissue". Previously, it was shown that dietary omega-3 fatty acids can be used to reduce inflammation in adipose tissue without influencing level of obesity. Todoric et al., *Diabetologia* (2006), 49(9), 2109-2119. Reduction in adipose tissue inflammation was demonstrated by an increase in circulating levels of adiponectin. Adiponectin is an adipose tissue derived anti-inflammatory hormone. Results on the treatment of obese people with omega-3 fatty acids to alleviate circulating levels of inflammatory markers are inconclusive. Trebble et al., *Br. J. Nutrition* (2003), 90(2), 405-412. However, duration of these studies may not have been sufficient given the slow turnover of adipose tissue in humans. Itoh et al. found that 1.8 g/d of EPA increased adiponectin, a marker of adipose tissue derived inflammation, in a group of overweight subjects with metabolic syndrome. Itoh et al., *Arteriosclerosis, Thrombosis, and Vascular Biology* (2007), 27(9), 1918-1925.

An embodiment of the invention is the use of krill oil to increase serum adiponectin levels. Adiponectin is a protein hormone that modulates a number of metabolic processes, including glucose regulation and fatty acid catabolism. Adiponectin is exclusively secreted from adipose tissue into the bloodstream and is very abundant in plasma relative to many hormones.

Levels of the hormone are inversely correlated with body mass index (BMI). The hormone plays a role in alleviating the metabolic dysregulation that may result in type 2 diabetes, obesity, atherosclerosis and non-alcoholic fatty liver disease (NAFLD). Díez et al., *Eur. J. Endocrinol.* 148 (3): 293-300; Ukkola et al., *J. Mol. Med.* 80 (11): 696-702.

5 Another embodiment of the invention is to use krill oil in an overweight and obese subjects for alleviating diet induced adipose tissue dysfunction and diet induced changes in the lipid metabolism.

In further embodiments, krill oil is effective in reducing risk factors of type 2 diabetes such as hyperinsulinemia and insulin resistance and cardiovascular disease risk factors in
10 overweight subjects. In addition this invention discloses that krill oil is effective in preventing accumulation of fat in muscles and in the liver (liver steatosis).

It is well known in the art that the obese Zucker rat is a useful rat model to study metabolic Syndrome X and non-insulin dependent diabetes mellitus, including glucose tolerance, insulin resistance and hyperinsulinaemia. It has also been shown previously that astaxanthin is a
15 powerful antioxidant, useful for prevention of oxidative stress in vivo and in Zucker rats using vitamin E. See, e.g., Aoi et al., (2003). *Antioxidants & Redox Signaling.* 5(1):139-44; Laight et al., *Eur. J. Pharmacol.* 377 (1999) 89.

In yet another embodiment of the invention is a krill oil composition effective of improving the blood lipid profile by increasing the HDL cholesterol levels, decreasing the LDL
20 cholesterol and triglyceride levels. Hence the novel krill oil composition is effective for treating metabolic syndrome. Metabolic syndrome is defined as the coexistence of 3 or more components selected from the group: abdominal obesity, high serum triglyceride levels, low HDL levels, elevated blood pressure and high fasting plasma glucose levels.

In another embodiment of the invention, the krill oil compositions are found to be
25 effective and safe for the treatment of metabolic syndrome in humans.

In still other embodiments, the krill oil compositions of the present invention find use in increasing or inducing diuresis. In some embodiments, the krill oil compositions of the present invention find use in decreasing protein catabolism and increasing the muscle mass of a subject.

In some embodiments, the kill oil composition of the present invention find use in the
30 treatment of fatty heart disease and non-alcoholic fatty acid liver disease. Thus, the krill oil

compositions are useful for decreasing the lipid content of the heart and/or liver and/or muscle of a subject.

In yet another embodiment of the invention is a method to increase the transfer of DHA to the brain.

5

EXAMPLE 1

Antarctic krill (*Euphausia superba*) was captured and brought on board alive, before it was processed into krill meal, an oil (asta oil) and stickwater. The composition and properties of the krill meal was monitored during the processing and compared to a commercial competitor (Table 1 and 2). Furthermore, the amino acid composition of the krill meal and stickwater was determined (Table 3), showing that krill meal is a suitable feed source for to be used in aquaculture due to the presences of all the essential amino acids teleost fish require. During the krill meal processing a neutral oil (asta oil) is recovered, the chemical composition of the asta oil is shown in Tables 4 and 5.

15

Table 1. Composition of products from the processing line

	Round frozen krill	After decanter	After drier	Konstruktor Koshkin (Ukrainian vessel)
Protein	13,5 g/100 g	20,9 g/100 g	58,5 g/100 g	60,2 g/100 g
Moisture	76,3 g/100 g	65,6 g/100 g	9,1 g/100 g	9,6 g/100 g
Lipid (Folch)	8,6 g/100 g	10 g/100 g	21,8 g/100 g	21,4 g/100 g
Free fatty acids	29,8 g/100 g	25,3 g/100 g	24,8 g/100 g	23,3 g/100 g
Total astaxanthin	53,3 mg/kg	81,3 mg/kg	145 mg/kg	126 mg/kg

Table 2. Lipid class composition in products from the processing line

Crude protein	Round frozen krill (g/100 g)	After decanter (g/100 g)	After drier (g/100 g)	Konstruktor Koshkin (Ukrainian vessel) (g/100 g)
Wax ester/cholesterol ester	2,5	3,0	1,9	3,3
Triglycerides/pigments	30,2	33,7	29,3	32,2
Free fatty acids	15,1	2,5	9,0	5,9
Monoglycerides	3,9	Nd	1,3	Nd
PE	6,6	10,4	7,9	6,3

PS	1,2	1,6	1,4	2,7
PI	1,9	2,0	2,1	3,5
PC	28	35,9	32,0	32,1
Sphingomyeline/lyso PC	2,0	0,5	3,0	3,0

Nd= not detected

Table 3. Amino acids in krill meal and stick water

Amino acid	Total in meal (g/100 g protein)	Free in meal (g/100g protein)	Free in stickwater (g/100 g protein)
Aspartic acid	10,5	0,02	0,22
Glutamic acid	13,5	0,007	0,51
Hydroxiproline	<0,5	<0,001	<0,05
Serine	4,2	0,02	0,13
Glycine	4,4	0,18	3,28
Histidine	2,1	<0,01	<0,05
Arginine	6,7	0,56	4,86
Threonine	4,1	<0,01	0,22
Alanine	5,4	0,08	0,87
Proline	3,8	0,53	2,32
Tyrosine	4,0	0,01	0,2
Valine	5,0	0,02	0,13
Methionine	2,9	<0,01	0,12
Isoleucine	5,0	0,02	0,1
Leucine	7,8	0,14	0,19
Phenylalanine	4,4	0,01	0,1
Lysine	7,8	0,02	0,27
Cysteine/Cystine	1,4	<0,01	<0,05
Thryptophan	1,1	<0,02	<0,05
Creatinine		<0,01	<0,05
Asparagine		<0,01	0,05

Glutamine		<0,01	<0,05
3-aminopropanoic acid		0,5	8,99
Taurine		0,5	8,52
4-aminobutanoic acid		<0,01	<0,05
Citrulline		0,04	0,14
Carnosine		<0,01	<0,05
Anserine		<0,01	<0,05
Ornithine		0,02	1,04

3-aminopropanoic acid is also known as β -alanine

4-aminobutanoic acid is also known as γ -aminobutyric acid or GABA

Table 4. Composition and quality parameters of asta oil.

Moisture	0,14 g/100 g
Insoluble impurities	0,02 g/100 g
Unsaponifiable matter	1,5 g/100 g
Nitrogen	0,5 g/100 g
Free fatty acids	0,3 g/100 g
Peroxide value	<2 meq peroxide/kg oil
Ansidine value	<1
Phosphorous	23 mg/kg
Phospholipids	575 mg/kg
Astaxanthin	1245 mg/kg

5

Table 5. Fatty acid composition of the asta oil

Fatty Acid	Asta oil
File	
C4:0	0,00
C6:0	0,00
C8:0	0,00
C10:0	0,00
C12:0	0,00
C14:0	17,5
C14:1	0,00
C15:0	0,00
C16:0	19,3
C16:1	9,7
C18:0	1,2
C18:1	22,6
C18:2N6	1,4
C18:3N6	0,1

C18:3N3	0,7
C18:4N3	3,0
C20:0	0,1
C20:1	1,3
C20:2N6	<0,1
C20:3N6	0,1
C20:4N6	0,1
C20:3N3	<0,1
C20:4N3	0,2
C20:5N3 (EPA)	5,6
C22:0	0,1
C22:1	0,3
C22:2N6	0,0
C22:4N6	<0,1
C22:5N6	0,00
C22:5N3	0,2
C22:6N3 (DHA)	2,00
C24:1	0,03
Total	88,4
Saturated	38,0
Monounsaturated	33,9
Polyunsaturated	16,4
Total	88,4
Omega-3	11,9
Omega-6	1,6

EXAMPLE 2

The krill meal obtained in example 1 was then ethanol extracted according to the method disclosed in JP02215351. The results showed that around 22% fat from the meal could be extracted, somewhat lower than was extracted using Folch (25%). Table 6 shows the fatty acid composition of the krill meal and the krill oil extracted from the meal using ethanol. Table 7 shows the composition and properties of the krill meal and products before and after extraction, whereas table 8 shows the lipid composition.

10

Table 6. Fatty acid distribution in krill meal (g/100 g lipid) and the ethanol extracted krill oil.

Fatty Acid	Krill meal	EtOH KO
File		
C4:0	0,00	
C6:0	0,00	
C8:0	0,00	
C10:0	0,00	
C12:0	0,00	
C14:0	7,8	6,4
C14:1	0,00	
C15:0	0,00	
C16:0	15,8	14,7
C16:1	5,1	4,2
C18:0	0,9	0,7
C18:1	13,4	11,8
C18:2N6	1,1	1,2
C18:3N6	0,1	0,1
C18:3N3	0,4	0,4
C18:4N3	1,1	0,1
C20:0	0,1	0,1
C20:1	0,8	0,6
C20:2N6	<0,1	<0,1
C20:3N6	0,1	<0,1
C20:4N6	0,2	0,2
C20:3N3	<0,1	<0,1
C20:4N3	0,2	0,2
C20:5N3 (EPA)	10,5	10,4
C22:0	<0,1	<0,1
C22:1	0,5	0,4
C22:2N6	<0,1	<0,1
C22:4N6	<0,1	
C22:5N6	0,00	
C22:5N3	0,2	
C22:6N3 (DHA)	5,4	4,8
C24:1	0,03	
Saturated	24,6	21,9
Monounsaturated	19,9	17,0
Polyunsaturated	21,0	19,4
Total	65,5	58,2

Omega-3	18,2	17,0
Omega-6	1,3	

Table 7. Composition and properties of the krill meal and products after extraction

	Krill meal	Delipidated krill meal	EtOH extracted krill oil
Crude protein	586 g/kg	735 g/kg	
Fat (Folch)	250 g/kg	30 g/kg	
Moisture/ethanol	71 g/kg	134 g/kg	85 g/kg
Astaxanthin esters	144 mg/kg	10 mg/kg	117 mg/kg
Diesters	110 mg/kg	8,5 mg/kg	117 mg/kg
Monoesters	33 mg/kg	1,8 mg/kg	37 mg/kg
Biological digestible protein	854 g/kg protein	870 g/kg protein	
Flow number	4,8	1,9	
NH3	9 mg N/100 g	0	3 mg N/100 g
TMA	2 mg N/100 g	0	70 mg N/100 g
TMAO	125 mg N/100 g	0	456 mg N/100 g

5 **Table 8.** Lipid class distribution

	Krill meal	Delipidated krill meal	EtOH extracted KO
Cholesterol ester	3,5		
TG	32,7	37,4	31,1
FFA	7,8	14,1	16,0
Cholesterol	9,1	8,0	12,6
DG	1,1		3,3
MG	3,7		
Sphingolipid			2,8
PE	6,5	2,5	2,7
Cardiolipin		4,2	
PI	1,1	11,0	
PS	1,4		
PC	28,6	20,2	25,3
LPC	2,9	2,6	6,2
Total polar lipids	40,6	40,5	36,9

Total neutral lipids	54,2	59,5	63,1
----------------------	------	------	------

EXAMPLE 3

The krill meal obtained in example 1 was then subjected to a supercritical fluid extraction method in two stages. During stage 1, 12.1% fat (neutral krill oil) was removed using neat CO₂ only at 300 bars, 60° C and for 30 minutes. In stage 2, the pressure was increased to 400 bar and 20% ethanol was added (v/v) for 90 minutes. This resulted in further extraction of 9% polar fat which hereafter is called polar krill oil. The total fatty acid composition of the polar krill oil, the neutral krill oil and a commercial product obtained from Neptune Biotech (Laval, Quebec, Canada) are listed in Table 9. In addition the fatty acid composition for the phospholipids (Table 10), the neutral lipids (Table 11), the free fatty acids, diglycerides (Table 12), triglycerides, lysophosphatidylcholine (LPC) (Table 13), phosphatidylcholine (PC), phosphatidylethanolamine (PE) (Table 14), phosphatidylinositol (PI) and phosphatidylserine (PS) (Table 15) are shown. Table 16 shows the level of astaxanthin and cholesterol for the different fractions.

Table 9. Total fatty acids compositions of the krill oil products (% (w/w))

Fatty Acid	Total Fatty Acids		
	Neutral KO	Polar KO	NKO
File			
C4:0	0,00	0,00	0,00
C6:0	0,00	0,00	0,00
C8:0	0,00	0,00	0,00
C10:0	0,00	0,00	0,00
C12:0	0,47	0,04	0,24
C14:0	22,08	3,28	12,48
C14:1	0,33	0,01	0,17
C15:0	0,58	0,36	0,52
C16:0	27,03	29,25	23,25
C16:1	0,07	0,01	8,44
C18:0	1,72	1,03	1,42
C18:1	30,29	13,57	18,92
C18:2N6	2,10	1,96	1,71
C18:3N6	0,30	0,21	0,00
C18:3N3	0,69	1,02	1,32
C18:4N3	0,05	1,81	3,50
C20:0	0,06	0,00	0,05
C20:1	1,87	0,80	1,16
C20:2N6	0,05	0,05	0,05

C20:3N6	0,22	0,73	0,04
C20:4N6	0,00	0,00	0,49
C20:3N3	0,09	0,09	0,06
C20:4N3	0,24	0,51	0,33
C20:5N3 (EPA)	7,33	29,88	16,27
C22:0	0,01	0,06	0,05
C22:1	0,64	1,78	0,82
C22:2N6	0,00	0,00	0,00
C22:4N6	0,00	0,00	0,07
C22:5N6	0,00	0,03	0,00
C22:5N3	0,21	0,67	0,36
C22:6N3 (DHA)	3,51	12,61	8,17
C24:0	0,05	0,00	0,01
C24:1	0,03	0,25	0,11
Total	100,00	100,00	100,00
Saturated	52,00	34,01	38,01
Monounsaturated	33,22	16,43	29,61
Polyunsaturated	14,77	49,56	32,37
Total	100,00	100,00	100,00
Omega-3	12,11	46,58	30,02
Omega-6	2,67	2,98	2,35

Table 10. Fatty acid composition of the phospholipid fraction (% (w/w)).

Fatty Acid	Total Phospholipid		
	Neutral KO	Polar KO	Neptune KO
File			
C4:0	0,00	0,00	0,00
C6:0	0,00	0,00	0,00
C8:0	0,00	0,00	0,00
C10:0	0,00	0,00	0,00
C12:0	0,00	0,00	0,00
C14:0	0,01	0,00	0,00
C14:1	0,42	0,01	0,01
C15:0	2,52	0,00	0,00
C16:0	4,73	35,78	32,81
C16:1	0,19	0,17	0,19
C18:0	6,31	1,18	1,55
C18:1	38,40	15,58	13,54
C18:2N6	4,18	2,16	1,90
C18:3N6	0,18	0,22	0,19

C18:3N3	1,02	1,05	1,48
C18:4N3	3,08	1,62	2,15
C20:0	0,27	0,00	0,07
C20:1	2,55	1,02	0,78
C20:2N6	0,19	0,06	0,06
C20:3N6	0,00	0,14	0,10
C20:4N6	0,57	0,62	0,64
C20:3N3	0,43	0,08	0,09
C20:4N3	0,17	0,45	0,42
C20:5N3 (EPA)	20,58	25,53	26,47
C22:0	0,14	0,06	0,00
C22:1	0,00	2,09	1,94
C22:2N6	0,25	0,71	0,85
C22:4N6	0,44	0,00	0,03
C22:5N6	0,11	0,00	0,00
C22:5N3	0,00	0,60	0,63
C22:6N3 (DHA)	10,93	10,30	13,34
C24:0	1,77	0,30	0,37
C24:1	0,59	0,28	0,38
Total	100,00	100,00	100,00
Saturated	15,74	37,32	34,81
Monounsaturated	42,14	19,15	16,84
Polyunsaturated	42,12	43,53	48,34
Total	100,00	100,00	100,00
Omega-3	36,22	39,62	44,56
Omega-6	5,91	3,90	3,78

Table 11. Fatty acid composition of the total neutral lipid fraction (% (w/w)).

Fatty Acid	Total neutral lipid		
	Neutral KO	Polar KO	Neptune KO
File			
C4:0	0,00	0,00	0,00
C6:0	0,00	0,00	0,00
C8:0	0,00	0,00	0,00
C10:0	0,00	0,00	0,00
C12:0	0,00	0,00	0,00
C14:0	20,35	11,31	18,44
C14:1	0,30	0,29	0,25
C15:0	0,53	1,53	0,62

C16:0	23,79	0,49	24,11
C16:1	12,42	5,22	11,86
C18:0	1,54	3,27	1,67
C18:1	26,81	33,09	23,82
C18:2N6	1,68	2,37	1,79
C18:3N6	0,20	0,23	0,25
C18:3N3	0,59	0,62	0,03
C18:4N3	0,03	1,27	0,05
C20:0	0,07	0,00	0,06
C20:1	1,63	1,41	1,39
C20:2N6	0,04	0,00	0,05
C20:3N6	0,18	0,94	0,01
C20:4N6	0,00	0,00	0,00
C20:3N3	0,09	0,00	0,01
C20:4N3	0,18	0,41	0,23
C20:5N3 (EPA)	5,88	19,26	9,68
C22:0	0,02	0,00	0,03
C22:1	0,56	0,60	0,53
C22:2N6	0,00	0,00	0,00
C22:4N6	0,00	0,00	0,04
C22:5N6	0,01	0,00	0,00
C22:5N3	0,17	0,27	0,22
C22:6N3 (DHA)	2,74	17,22	4,64
C24:0	0,15	0,00	0,17
C24:1	0,03	0,21	0,06
Total	100,00	100,00	100,00
Saturated	46,45	16,60	45,10
Monounsaturated	41,75	40,82	37,91
Polyunsaturated	11,80	42,59	16,99
Total	100,00	100,00	100,00
Omega-3	9,68	39,05	14,86
Omega-6	2,11	3,54	2,14

Table 12. Fatty acid composition of the diglyceride and free fatty acids (% (w/w)).

Fatty Acid	Diglycerides			Free fatty acids		
	Neutral KO	Polar KO	Neptune KO	Neutral KO	Polar KO	Neptune KO
File						
C4:0	0,00	0,00	0,00	0,00	0,00	0,00
C6:0	0,00	0,00	0,00	0,00	0,00	0,00
C8:0	0,00	0,00	0,00	0,00	0,00	0,00

C10:0	0,00	0,00	0,00	0,00	0,00	0,00
C12:0	0,00	0,00	0,00	0,00	0,00	0,00
C14:0	13,85	14,35	12,22	5,86	7,19	5,45
C14:1	0,18	0,00	0,17	0,05	0,00	0,08
C15:0	0,49	1,08	0,66	0,46	1,60	0,45
C16:0	23,68	35,24	25,81	28,30	29,37	21,12
C16:1	9,49	6,80	0,09	3,27	3,08	4,91
C18:0	1,56	3,63	1,89	1,13	2,43	0,99
C18:1	23,67	19,85	23,82	14,50	14,77	17,41
C18:2N6	1,79	0,21	1,90	1,69	0,97	1,86
C18:3N6	0,17	0,00	0,01	0,14	0,00	0,22
C18:3N3	0,69	0,00	1,19	0,85	0,00	1,34
C18:4N3	1,92	0,00	2,75	1,30	0,00	2,72
C20:0	0,00	0,00	0,00	0,00	0,00	0,00
C20:1	1,09	0,00	1,01	0,48	0,00	0,57
C20:2N6	0,00	0,00	0,00	0,00	0,00	0,00
C20:3N6	0,13	0,00	0,00	0,08	0,00	0,05
C20:4N6	0,45	0,00	0,64	0,78	0,00	1,43
C20:3N3	0,00	0,00	0,00	0,00	0,00	0,00
C20:4N3	0,35	0,00	0,43	0,39	0,00	0,43
C20:5N3 (EPA)	14,03	9,80	18,00	24,33	23,57	25,36
C22:0	0,18	0,00	0,10	0,00	0,00	0,05
C22:1	0,41	0,00	0,57	0,80	0,69	0,37
C22:2N6	0,28	0,00	0,50	0,46	0,00	0,54
C22:4N6	0,00	0,00	0,00	0,00	0,00	0,00
C22:5N6	0,00	0,00	0,00	0,00	0,00	0,00
C22:5N3	0,20	0,00	0,27	0,34	0,00	0,32
C22:6N3 (DHA)	4,74	9,04	7,53	14,31	16,33	13,95
C24:0	0,64	0,00	0,42	0,49	0,00	0,39
C24:1	0,00	0,00	0,00	0,00	0,00	0,00
Total	100,00	100,00	100,00	100,00	100,00	100,00
Saturated	40,40	54,30	41,10	36,24	40,59	28,45
Monounsaturated	34,84	26,64	25,66	19,09	18,54	23,34
Polyunsaturated	24,77	19,06	33,24	44,67	40,87	48,22
Total	100,00	100,00	100,00	100,00	100,00	100,00
Omega-3	21,95	18,85	30,18	41,51	39,90	44,13
Omega-6	2,82	0,21	3,05	3,15	0,97	4,09

Table 13. Fatty acid composition of the triglyceride and lyso-phosphatidylcholine fractions (% (w/w)).

Fatty Acid	Triglycerides			Lyso PC		
	Neutral KO	Polar KO	Neptune KO	Neutral KO	Polar KO	Neptune KO
File						
C4:0	0,00	0,00	0,00	0,00	0,00	0,00
C6:0	0,00	0,00	0,00	0,00	0,00	0,00
C8:0	0,00	0,00	0,00	0,00	0,00	0,00
C10:0	0,00	0,00	0,00	0,00	0,00	0,00
C12:0	0,00	0,00	0,00	0,00	0,00	0,00
C14:0	23,06	26,65	25,13	19,38	4,27	2,87
C14:1	0,36	0,93	0,36	0,00	0,08	0,00
C15:0	0,56	2,64	0,78	0,00	0,52	0,45
C16:0	23,17	4,93	27,80	41,00	44,14	30,56
C16:1	13,68	11,58	0,04	0,00	1,84	2,24
C18:0	1,52	3,12	1,99	0,76	1,59	1,32
C18:1	27,83	34,39	27,92	6,65	14,24	11,29
C18:2N6	1,64	2,05	1,92	0,00	1,75	2,07
C18:3N6	0,20	0,00	0,30	0,00	0,00	0,06
C18:3N3	0,51	0,00	0,00	7,95	0,67	1,75
C18:4N3	1,99	0,00	4,83	0,00	1,11	2,46
C20:0	0,06	0,00	0,08	0,00	0,00	0,00
C20:1	1,67	0,00	1,76	0,00	0,52	0,00
C20:2N6	0,04	0,00	0,05	0,00	0,00	0,00
C20:3N6	0,05	0,00	0,01	0,00	0,00	0,54
C20:4N6	0,00	0,00	0,00	0,00	0,40	0,00
C20:3N3	0,05	0,00	0,07	0,00	0,00	0,00
C20:4N3	0,11	0,00	0,17	0,00	0,31	0,55
C20:5N3 (EPA)	2,10	7,97	4,44	0,00	18,59	28,48
C22:0	0,02	0,00	0,04	0,00	0,00	0,00
C22:1	0,37	0,00	0,42	0,00	1,46	0,91
C22:2N6	0,00	0,00	0,00	0,00	0,00	0,00
C22:4N6	0,01	0,00	0,01	0,00	0,00	0,00
C22:5N6	0,00	0,00	0,01	0,00	0,00	0,00
C22:5N3	0,10	0,00	0,16	0,00	0,41	0,62
C22:6N3 (DHA)	0,67	3,97	1,42	24,26	7,79	13,82
C24:0	0,26	1,78	0,26	0,00	0,32	0,00
C24:1	0,00	0,00	0,03	0,00	0,00	0,00
Total	100,00	100,00	100,00	100,00	100,00	100,00
Saturated	48,64	39,12	56,08	61,14	50,83	35,21
Monounsaturated	43,90	46,89	30,52	6,65	18,14	14,44
Polyunsaturated	7,45	13,99	13,41	32,20	31,02	50,35
Total	100,00	100,00	100,00	100,00	100,00	100,00

Omega-3	5,51	11,94	11,11	32,20	28,87	47,69
Omega-6	1,94	2,05	2,30	0,00	2,15	2,66

Table 14. Fatty acid composition of the phosphatidylcholine and the phosphatidylserine fractions (% (w/w)).

Fatty Acid	PC			PS		
	Neutral KO	Polar KO	Neptune KO	Neutral KO	Polar KO	Neptune KO
File						
C4:0	0,00	0,00	0,00	0,00	0,00	0,00
C6:0	0,00	0,00	0,00	0,00	0,00	0,00
C8:0	0,00	0,00	0,00	0,00	0,00	0,00
C10:0	0,00	0,00	0,00	0,00	0,00	0,00
C12:0	0,00	0,00	0,00	0,00	0,00	0,00
C14:0	0,75	3,29	2,77	7,60	9,52	2,31
C14:1	2,07	0,04	0,02	0,00	0,00	0,00
C15:0	1,34	0,00	0,00	3,83	0,00	0,00
C16:0	16,65	31,92	29,83	30,44	43,61	19,49
C16:1	0,96	0,01	0,17	9,96	3,47	2,79
C18:0	1,33	1,06	1,33	2,08	3,34	2,24
C18:1	34,34	13,55	11,16	0,00	7,37	11,87
C18:2N6	10,55	2,27	1,90	0,00	0,00	0,00
C18:3N6	1,44	0,25	0,20	0,00	0,00	0,00
C18:3N3	2,49	1,19	1,54	0,00	0,00	0,00
C18:4N3	2,38	1,92	2,41	0,00	0,00	0,00
C20:0	2,79	0,03	0,05	0,00	0,00	0,00
C20:1	2,42	0,82	0,74	0,00	0,00	0,00
C20:2N6	0,56	0,05	0,06	0,00	0,00	0,00
C20:3N6	0,67	0,13	0,09	0,00	0,00	0,00
C20:4N6	1,85	0,61	0,56	0,00	0,00	0,00
C20:3N3	3,94	0,07	0,06	0,00	0,00	0,33
C20:4N3	4,32	0,50	0,46	0,00	0,00	0,00
C20:5N3 (EPA)	1,08	29,85	30,09	25,84	15,81	16,35
C22:0	0,00	0,05	0,02	0,00	0,00	0,00
C22:1	2,77	0,00	1,87	0,00	0,00	0,00
C22:2N6	0,00	0,81	0,97	0,00	0,00	0,00
C22:4N6	0,00	0,01	0,02	0,00	0,00	0,00
C22:5N6	1,49	0,01	0,00	0,00	0,00	0,00
C22:5N3	1,48	0,67	0,68	0,00	0,00	0,00
C22:6N3 (DHA)	0,00	10,53	12,49	20,25	16,89	44,63
C24:0	2,34	0,10	0,18	0,00	0,00	0,00
C24:1	0,00	0,25	0,34	0,00	0,00	0,00
Total	100,00	100,00	100,00	100,00	100,00	100,00

Saturated	25,19	36,46	34,18	43,95	56,47	24,04
Monounsaturated	42,56	14,67	14,29	9,96	10,84	14,65
Polyunsaturated	32,25	48,87	51,53	46,09	32,69	61,31
Total	100,00	100,00	100,00	100,00	100,00	100,00
Omega-3	15,69	44,73	47,73	46,09	32,69	61,31
Omega-6	16,56	4,13	3,81	0,00	0,00	0,00

Table 15. Fatty acid composition of the phosphatidylinositol and phosphatidylethanolamine fractions (% (w/w)).

Fatty Acid	PI			PE		
	Neutral KO	Polar KO	Neptune KO	Neutral KO	Polar KO	Neptune KO
File						
C4:0	0,00	0,00	0,00	0,00	0,00	0,00
C6:0	0,00	0,00	0,00	0,00	0,00	0,00
C8:0	0,00	0,00	0,00	0,00	0,00	0,00
C10:0	0,00	0,00	0,00	0,00	0,00	0,00
C12:0	0,00	0,00	0,00	0,00	0,00	0,00
C14:0	11,15	5,82	5,72	14,42	4,60	0,83
C14:1	3,03	0,66	0,00	0,00	0,00	0,10
C15:0	5,86	1,95	3,18	0,00	1,30	0,23
C16:0	37,02	30,66	31,39	35,91	31,21	18,38
C16:1	18,05	2,24	1,16	0,00	1,51	0,75
C18:0	6,72	2,83	5,56	12,72	16,70	1,84
C18:1	18,15	24,77	14,23	36,96	19,91	18,45
C18:2N6	0,00	2,67	0,00	0,00	2,62	0,85
C18:3N6	0,00	0,00	0,00	0,00	0,00	0,00
C18:3N3	0,00	0,00	0,00	0,00	0,00	0,33
C18:4N3	0,00	0,00	0,00	0,00	0,00	0,00
C20:0	0,00	0,00	0,00	0,00	0,00	0,00
C20:1	0,00	0,00	0,00	0,00	0,00	0,00
C20:2N6	0,00	0,00	0,00	0,00	0,00	0,00
C20:3N6	0,00	0,00	0,00	0,00	0,00	1,15
C20:4N6	0,00	0,00	0,00	0,00	0,00	0,00
C20:3N3	0,00	0,00	0,00	0,00	0,00	0,00
C20:4N3	0,00	0,00	0,00	0,00	0,00	0,00
C20:5N3 (EPA)	0,00	17,60	20,45	0,00	10,76	21,26
C22:0	0,00	0,00	0,00	0,00	0,00	0,00
C22:1	0,00	0,00	0,00	0,00	0,00	0,00

C22:2N6	0,00	0,00	0,00	0,00	0,00	0,00
C22:4N6	0,00	0,00	0,00	0,00	0,00	0,00
C22:5N6	0,00	0,00	0,00	0,00	0,00	0,00
C22:5N3	0,00	0,00	0,00	0,00	0,00	0,67
C22:6N3 (DHA)	0,00	10,79	18,32	0,00	11,39	35,16
C24:0	0,00	0,00	0,00	0,00	0,00	0,00
C24:1	0,00	0,00	0,00	0,00	0,00	0,00
Total	100,00	100,00	100,00	100,00	100,00	100,00
Saturated	60,76	41,26	45,84	63,04	53,81	21,28
Monounsaturated	39,24	27,67	15,39	36,96	21,42	19,30
Polyunsaturated	0,00	31,07	38,77	0,00	24,77	59,42
Total	100,00	100,00	100,00	100,00	100,00	100,00
Omega-3	0,00	28,40	38,77	0,00	22,15	57,43
Omega-6	0,00	2,67	0,00	0,00	2,62	1,99

Table 16. Compositional data for the novel krill oil composition obtained and NKO krill oil.

Compounds	Neptune KO	Ethanol extracted KO	Polar KO	Neutral KO
Astaxanthin esters	472 mg/kg	117 mg/kg	580 mg/kg	98 mg/kg
Astaxanthin free	11 mg/kg	< 1 mg/kg	<1 mg/kg	<1 mg/kg
Total cholesterol	1 g/100g	12 g/100g	< 0,5 g/100g	5,7 g/100g

EXAMPLE 4

5 Neutral lipids were extracted from krill meal (138 kg) using SFE with neat CO₂ (solvent ratio 25 kg/kg) at 500 bar and 75 °C. The neutral lipids were fractionated at 200 bar (75 °C) and at 60 bar (35 °C) at separator S1 and S2, respectively. The extract obtained in S1 (19,6 kg) were characterized and the results can be found in Tables 17A-C. The extract in table S2 (0,4 kg) were rich in water and were not further used. Next, the polar lipids were extracted using CO₂ at 500
10 bar, 20% ethanol and at a temperature of 75 °C. Using a solvent ratio of 32 (kg/kg) and collecting an extract of 18,2 kg using a separator at 60 bars and 35°C. The polar lipids were collected and analyzed (Tables 18A-C). Next, the polar lipids were mixed in a 50/50 ratio with the neutral

lipids collected from S1 before finally the ethanol was removed carefully by evaporation. The product obtained was red and transparent. If the ethanol is removed before the mixing of the fractions a transparent product is not obtained. The composition of the 50/50 red and transparent product can be found in Tables 19A-C.

5

Table 17A Fatty acid composition of the extract collected in S1

Fatty acid	Unit	Amount
14:0	g/100g	18,4
16:0	g/100g	22,2
18:0	g/100g	1,5
16:1 n-7	g/100g	10,9
18:1 (n-9) + (n-7) + (n-5)	g/100g	25,6
20:1 (n-9) + (n-7)	g/100g	1,8
22:1 (n-11) + (n-9) + (n-7)	g/100g	0,5
16:2 (n-4)	g/100g	1,3
16:4 (n-1)	g/100g	1,2
18:2 n-6	g/100g	1,3
18:3 n-3	g/100g	0,8
18:4 n-3	g/100g	2,9
20:5 n-3	g/100g	4,1
22:6 n-4	g/100g	1,7

Table 17B. Lipid class composition of the extract collected in S1

Lipid	Unit	Amount
Triacylglycerol	g/100g	84
Diacylglycerol	g/100g	0,7
Free fatty acids	g/100g	1,5
Cholesterol	g/100g	2,7
Cholesterol esters	g/100g	0,9

10 **Table 17C.** Miscellaneous analysis of the extract in S1.

Compound	Unit	Amount
Free astaxanthin	mg/kg	4,3
Astaxanthin esters	mg/kg	462
Trimethylamin	mg N/100 g	<1
Trimethylamineoxide	mg N/100 g	2

Table 18A Fatty acid composition of the extract collected after CO₂ and 20% ethanol in S1.

Fatty acid	Unit	Amount
14:0	g/100g	1,3
16:0	g/100g	13,8
18:0	g/100g	0,6
16:1 n-7	g/100g	0,9
18:1 (n-9) + (n-7) + (n-5)	g/100g	6,5
20:1 (n-9) + (n-7)	g/100g	0,6
22:1 (n-11) + (n-9) + (n-7)	g/100g	0,1
16:2 (n-4)	g/100g	<0,1
16:4 (n-1)	g/100g	<0,1
18:2 n-6	g/100g	0,8
18:3 n-3	g/100g	0,6
18:4 n-3	g/100g	1,0
20:5 n-3	g/100g	14,7
22:6 n-4	g/100g	6,5

Table 18B. Lipid class composition of the extract collected after CO₂ and 20% ethanol in S1.

Lipid	Unit	Amount
Triacylglycerol	g/100g	<0,5
Cholesterol	g/100g	<0,5
Phosphatidylethanolamine	g/100g	1,6
Phosphatidylcholine	g/100g	67
Lyso-phosphatidylcholine	g/100g	4,4

Table 18C. Miscellaneous analysis of the extract in S1.

Compound	Unit	Amount
Trimethylamin	mg N/100 g	422
Trimethylamineoxide	mg N/100 g	239

Table 19A Fatty acid composition of the final blended product obtained in Example 4 in S1.

Fatty acid	Unit	Amount
14:0	g/100g	9,7
16:0	g/100g	18,5
18:0	g/100g	1,0
16:1 n-7	g/100g	5,8
18:1 (n-9) + (n-7) + (n-5)	g/100g	16,0
20:1 (n-9) + (n-7)	g/100g	1,2
22:1 (n-11) + (n-9) + (n-7)	g/100g	1,0
16:2 (n-4)	g/100g	0,3
16:4 (n-1)	g/100g	<0,1
18:2 n-6	g/100g	1,0
18:3 n-3	g/100g	0,8
18:4 n-3	g/100g	2,1
20:5 n-3	g/100g	10,7
22:6 n-4	g/100g	4,7

5 **Table 19B.** Lipid class composition of the final blended product obtained in Example 4.

Lipid	Unit	Amount
Triacylglycerol	g/100g	53
Diacylglycerol	g/100g	1,3
Free fatty acids	g/100g	0,5
Cholesterol	g/100g	0,6
Cholesterol esters	g/100g	<0,5
Phophatidylethanolamine	g/100g	<1

Phosphatidylcholine	g/100g	42
Lyso-phosphatidylcholine	g/100g	5,9

Table 19C. Miscellaneous analysis of the final blended product obtained in example 4.

Compound	Unit	Amount
Free astaxanthin	mg/kg	1,1
Astaxanthin esters	mg/kg	151
Trimethylamin	mg N/100 g	109
Trimethylamineoxide	mg N/100 g	80

EXAMPLE 5

- 5 The asta oil obtained in example 1 was blended with the polar lipids obtained in example 4 in a ratio of 46:54 (v/v). Next the ethanol was removed by evaporation and a dark red and transparent product was obtained. The product was analyzed and the results can be found in Tables 20A-C. Furthermore, the product was encapsulated into soft gels successfully. During the encapsulation it was observed that any further increase in phospholipids and thereby viscosity
- 10 will make it very difficult to encapsulate the final product.

Table 20A Fatty acid composition of the final blended product obtained in Example 5.

Fatty acid	Unit	Amount
14:0	g/100g	8,2
16:0	g/100g	17,7
18:0	g/100g	1,0
16:1 n-7	g/100g	4,9
18:1 (n-9) + (n-7) + (n-5)	g/100g	14,9
20:1 (n-9) + (n-7)	g/100g	1,1
22:1 (n-11) + (n-9) + (n-7)	g/100g	1,0
16:2 (n-4)	g/100g	0,4
16:4 (n-1)	g/100g	<0,1
18:2 n-6	g/100g	1,2

18:3 n-3	g/100g	0,8
18:4 n-3	g/100g	1,8
20:5 n-3	g/100g	10,6
22:6 n-4	g/100g	4,8

Table 20B. Lipid class composition of the final blended product obtained in Example 5.

Lipid	Unit	Amount
Triacylglycerol	g/100g	41
Diacylglycerol	g/100g	0,8
Free fatty acids	g/100g	1,2
Cholesterol	g/100g	0,4
Cholesterol esters	g/100g	0,3
Phosphatidylethanolamine	g/100g	0,6
Phosphatidylcholine	g/100g	51
Lyso-phosphatidylcholine	g/100g	<0,5
Total polar lipids	g/100g	52,4
Total neutral lipids	g/100g	43,6

Table 20C. Miscellaneous analysis of the final blended product obtained in Example 5

Compound	Unit	Amount
Free astaxanthin	mg/kg	12
Astaxanthin esters	mg/kg	1302
Trimethylamin	mg N/100 g	193
Trimethylamineoxide	mg N/100 g	1,7

5

EXAMPLE 6

10 Fresh krill was pumped from the harvesting trawl directly into an indirect steam cooker, and heated to 90C. Water and a small amount of oil were removed in a screw press before

ethoxyquin (antioxidant) was added and the denatured meal was dried under vacuum at a temperature not exceeding 80C. After 19 months storage in room temperature, a sample of the denatured meal was extracted in two steps with supercritical CO₂ in laboratory scale at a flow rate of 2ml/min at 100C and a pressure of 7500 psi. In the second step 20% ethanol was added to the CO₂. The two fractions collected were combined and analyzed by HPLC using ELS detection. The phosphatidylcholine was measured to 42.22% whereas the partly decomposed phosphatidylcholine was 1.68%. This data strongly contrasts the data obtained by analysis of a krill oil sample in the marketplace that showed a content of 9.05% of phosphatidylcholine and 4.60% of partly decomposed phosphatidylcholine.

10

EXAMPLE 7

Krill lipids were extracted from krill meal (a food grade powder) using supercritical fluid extraction with co-solvent. Initially, 300 bar pressure, 333°K and 5% ethanol (ethanol:CO₂, w/w) were utilized for 60 minutes in order to remove neutral lipids and astaxanthin from the krill meal. Next, the ethanol content was increased to 23% and the extraction was maintained for 3 hours and 40 minutes. The extract was then evaporated using a falling film evaporator and the resulting krill oil was finally filtered. The product obtained was then analyzed and the results can be found in Table 21.

Table 21. Analysis of the krill oil obtained using supercritical fluid extraction.

Parameter	Value
Ethanol	1.11% w/w
Water Content	2.98 % w/w
C20:5 n-3 (EPA)	19.9
C22:6 n-3 (DHA)	11.3
Total Omega 3	35.7
Total Omega 6	3.0
Total Phospholipids	50.55 wt%
Ratio Omega3-PL/Total Omega 3	77.6 % w/w
Ratio EPA- PL/Total EPA	84.4 %w/w
Ratio DHA-PL/Total DHA	74.7 %w/w
Triglycerides	25.9 g/100g
Astaxanthin	2091 mg/kg
Peroxide Value	<0.1

EXAMPLE 8

Krill oil was prepared according to the method described in example 7 extracting from the same krill meal. The oil was subjected to ^{31}P NMR analysis for the identification and quantification of the various forms of phospholipids. The analysis was performed according to the following methods: Samples (20 – 40 mg) were weighed into 1.5 ml centrifuge tubes. Next, NMR detergent (750 μl -10% Na cholate, 1% EDTA, pH 7.0 in $\text{H}_2\text{O}+\text{D}_2\text{O}$, 0.3 g L⁻¹ PMG internal standard) was added. Next, the tube was placed in a oven at 60°C and periodically shaken/sonicated until completely dispersed. The solution was then transferred to a 5 ml NMR tube for analysis. Phosphorus NMR spectra were recorded on the two-channel Bruker Avance300 with the following instrument settings: spectrometer frequency 121.498MHz, sweep width 24,271 Hz, 64,000 data points, 30 degree excitation pulse, 576 transients were normally taken, each with an 8 second delay time and f.i.d. acquisition time of 1.35 sec. Spectra were processed with a standard exponential weighting function with 0.2 Hz line broadening before Fourier transformation.

Peaks were identified using known chemical shifts. Deacylation of samples with monomethylamine was also used on two samples for confirmation of peak identity and to achieve better peak resolution. Example spectra are presented in Figure 1. Peak area integration gave relative molar amounts of each lipid class. Weight percent values were calculated using molecular masses calculated from a krill sample fatty acid profile (average chain length = 18.6). Total PL levels were calculated from the PMG internal standard peak. The quantification of the phospholipids are shown in table 25 for both the raw material, the final product and for a commercially available krill oil (Neptune Krill Oil). The main polar ether lipids of the krill meal are alkylacylphosphatidylcholine (AAPC) at 7-9 % of total polar lipids, lyso-alkylacylphosphatidylcholine (LAAPC) at 1 % of total polar lipids (TPL) and alkylacylphosphatidyl-ethanolamine (AAPE) at < 1 % of TPL.

Table 22: Phospholipid profiles

	<u>Type B krill powder</u>	<u>NKO</u>	<u>Krill Oil obtained in Example 7</u>
PC	66.0	68.6	75.3
AAPC	12.0	7.0	13.0
PI			
1LPC	1.2	1.3	0.4
PS			
2LPC	7.4	13.8	2.9
LAAPC	2.2	1.2	0.9
PE	6.0	3.4	3.4
AAPE			1.5
SM			
GPC		1.3	
DHSM			
NAPE		3.4	
CL	5.3		2.1
LPE			0.5
LCL			
% PL in powder or lipid sample	8.3	30.0	47.9

5

Analysis has been carried out on the fatty acid and ether/alcohol profiles of the AAPC. The following results are presented in Table 23.

Table 23. Fatty acid profile of the alkylacylphosphatidylcholine.

10

AAPC fatty acid composition	AAPC alcohol composition	
	alcohol	%
20:5(n-3) – 46.9%;	16:0	47.6
22:6(n-3) – 36.1%;	18:1	17.8
18:1(n-9) – 4.6%	16:1	14.1
22:5(n-3) – 2.6%	14:0	10
20:4(n-6) – 1.9%	18:0	8.6

21:5(n-3) – 1.5%	18:2	5.1
18:2(n-6) – 0.9%	17:0	4.4
16:1(n-9) – 0.8%	15:0-i	2.1
16:0 – 0.7%	15:0	1.7
phytanic – 0.6%	20:1	1.4
18:3(n-3) – 0.5%	15:0-a	1.3
18:4(n-3) – 0.4%	18:0-i	0.4
18:1(n-7) – 0.4%		
24:1 – 0.4%		
14:0 – 0.3%		

The rest of alcohols (i17:0, etc.), were less than 0.3% each. Only part of 20:1 was confirmed by GC-MS. Alcohol moieties composition of Krill AAPC was determined (identification was performed in the form of 1-alkyl-2,3-diTMS glycerols on GC-MS, % of total fatty alcohols were obtained by GC with FID). Ten other fatty acids were all below 0.3 % by mass.

5

EXAMPLE 9

The purpose of this experiment was to investigate the effect of different omega-3 fatty acid sources on metabolic parameters in the Zucker rat. The Zucker rat is a widely used model of obesity and insulin resistance. Obesity is due to a mutation in the leptin receptor which impairs the regulation of intake. Omega-3 sources compared in this study were fish oil (FO) and two types of krill oil. The krill oil were either from a commercial supplier (Neptune Krill oil) or prepared according to example 7 (Superba™). Four groups of rats (n = 6 per group) were fed *ad lib* either a control diet (CTRL) or a diet supplemented with a source of omega-3 fatty acids (FO, NKO, Superba). All diets supplied same amount of dietary fatty acids, oleic acid, linoleic acid and linolenic acid. Omega-3 diets (FO, NKO and Superba™) were additionally balanced for EPA and DHA content. The Zucker rats were 4 wk old at the start of the study with average initial weight of 250 g. At this stage the Zucker rats can be characterized as being pre-diabetic. Rats were fed the test diets for 4 wk after which they were sacrificed and blood and tissue samples were collected. Data presented in the following figures are means ± SE. This example shows that supplementation of the Zucker rat with krill oil prepared as in example 7 results in an improvement of metabolic parameters characteristic of the obesity induced type two diabetic condition. The effect induced by the novel krill oil is often more pronounced than the effect of

10

15

20

FO an in several cases greater than the effect induced by NKO. Specifically, the effects of the two types of krill oil differentiated with respect to the reduction of blood LDL cholesterol levels as well as lipid accumulation in the liver and muscle (Figure 2-9). Furthermore, the efficacy of transfer of DHA from the diet to the brain tissue was greatest with the krill oil prepared as in example 7 (Figure 10).

10

EXAMPLE 11

This example describes the effect of the supplementation of human diets with krill oil, fish oil (positive control), or a negative control oil (no omega-3 fatty acids) on blood urea nitrogen (BUN).

15

BUN measures the amount of nitrogen in the blood that comes from urea. BUN is used as a measure of renal function. Serum creatinine is, however, considered to be a more specific measure of renal function. In this study, krill oil decreased BUN by 11.8% while creatinine levels were unchanged. Thus, it is likely that the decrease in BUN is due to some other effect than improved renal function. BUN decreases if krill oil induced diuresis i.e. excretion of urine (diuretic effect).

20

BUN also decreases if body protein catabolism is reduced. Protein catabolism is a normal feature of body protein turnover. Many tissues express high protein turnover rates. For example the gastrointestinal system expresses high rates of protein turnover. In growing animals a reduction in GI protein catabolism improves weight gain. Mice supplemented with krill oil grew at a faster rate than mice supplemented with fish oil or control diet (Figure 11).

25

Table 24. The effect on blood urea nitrogen in humans for the different treatment groups.

	Control n = 23	Krill Oil n = 24	Menhaden oil n = 25	p
BUN, mg/dL				
Baseline	11.5 (7.8, 13.8)	11.5 (9.5, 13.5)	11.5 (9.5, 14.0)	0.523
Δ from baseline, %	11.0 (-14.3, 26.1)	-11.8 (-20.0, 1.5)	9.1 (-9.1, 35.7)	0.014r

30

Creatinine, mg/dL				
Baseline	0.9 (0.7, 0.9)	0.9 (0.7, 0.9)	0.8 (0.8, 1.0)	0.952r (r)
Δ from baseline, %	0.0 (-9.6, 2.9)	0.0 (-2.0, 5.9)	0.0 (-5.9, 6.7)	0.416

5

EXAMPLE 12

The purpose of this experiment was to investigate the effect of dietary krill oil on metabolic parameters in high-fat fed mice and to compare the effect of dietary krill oil with that of fish oil containing the same amount of omega-3 fatty acids. Four groups of C57BL/6 mice (n = 10 per group) were fed 1) chow (N), 2) high fat diet comprising 21% butter fat and 0.15% cholesterol (HF), 3) high fat diet + krill oil (HFKO) or 4) high fat diet + fish oil (HFFO). Treatment 3 contained 2.25% (w/w) krill oil as prepared in example 5 (except that the astaxanthin content was 500 ppm) which were equivalent to 0.36% omega-3 fatty acids. Treatment 4 also contained 0.36% omega-3 fatty acids obtained from regular 18-12 fish oil. The diets were fed to the mice for 7 weeks with free access to drinking water. Data represented in this example means ± SE. Columns not sharing a common letter are significantly different ($P < 0.05$) by ANOVA followed by Tukey’s multiple comparison test. N = normal chow diet (n = 10); HF = high-fat diet (n = 10); HFFO = high-fat diet supplemented with fish oil (n = 9); HFKO = high-fat diet supplemented with krill oil (n = 8). The data are presented in Figures 18-25.

This example shows that supplementation of high-fat fed mice with krill oil results in an amelioration of diet-induced hyperinsulinemia, insulin resistance, increase in muscle lipid content (measured as a change in muscle mass), serum adiponectin reduction and hepatic steatosis. These potentially beneficial atheroprotective effects were similar or greater than those achieved with a supplement containing a comparable level of omega-3 fatty acids (Figure 12-19).

CLAIMS

1. A krill oil composition comprising encapsulated *Euphausia superba* krill oil suitable for oral administration, said krill oil comprising from 3% to 15% ether phospholipids w/w of said krill oil, astaxanthin esters in amount of greater than about 100 mg/kg of said krill oil, and trimethyl amine in an amount of less than 1 mg/kg of said krill oil.
2. The krill oil composition of claim 1, wherein said krill oil composition is substantially odorless.
3. The krill oil composition of claim 1, wherein said krill oil contains astaxanthin esters in an amount of greater than about 200 mg/kg of said krill oil.
4. The krill oil composition of claim 1, wherein said krill oil comprises at least 30% total phospholipids w/w of said krill oil.
5. The krill oil composition of claim 1, wherein said krill oil comprises at least 30% phosphatidylcholine w/w of said krill oil.
6. The krill oil composition of claim 1, wherein said capsule contains a phytonutrient derived from a source other than krill.
7. The krill oil composition of claim 1, wherein said krill oil further comprises from about 3% to about 10% w/w ether phospholipids; from about 27% to 50% w/w non-ether phospholipids so that the amount of total phospholipids in the composition is from about 30% to 60% w/w; and from about 20% to 50% w/w triglycerides.
8. The krill oil composition of claim 7, wherein said krill oil further comprises from about 20% to 35% omega-3 fatty acids as a percentage of total fatty acids in said composition.

9. The krill oil composition of claim 1, wherein said krill oil is encapsulated in a soft gel capsule.

5

10. The krill oil composition of claim 1, wherein said krill oil comprises less than about 0.45% w/w arachadonic acid.

11. A composition comprising a soft gel capsule containing *Euphausia superba* krill oil suitable for oral administration, said krill oil comprising from 3% to 15% ether phospholipids w/w of said krill oil, astaxanthin esters in amount of greater than about 100 mg/kg of said krill oil, and trimethyl amine in an amount of less than 1 mg/kg of said krill oil.

15

12. The composition of claim 11, wherein said krill oil composition is substantially odorless.

13. The composition of claim 11, wherein said krill oil contains astaxanthin esters in an amount of greater than about 200 mg/kg of said krill oil.

20

14. The composition of claim 11, wherein said krill oil comprises at least 30% total phospholipids w/w of said krill oil.

15. The composition of claim 11, wherein said krill oil comprises at least 30% phosphatidylcholine w/w of said krill oil.

25

16. The composition of claim 11, wherein said krill oil comprises at least 40% phosphatidylcholine w/w of said krill oil.

17. The composition of claim 11, wherein said capsule contains a phytonutrient derived from a source other than krill.

30

18. The composition of claim 11, wherein said krill oil further comprises from about 3% to about 10% w/w ether phospholipids; from about 27% to 50% w/w non-ether phospholipids so that the amount of total phospholipids in the composition is from about 30% to 60% w/w; and from about 20% to 50% w/w triglycerides.

5

19. The composition of claim 18, wherein said krill oil further comprises from about 20% to 35% omega-3 fatty acids as a percentage of total fatty acids in said composition.

20. The composition of claim 11, wherein said krill oil comprises less than about 0.45% w/w arachadonic acid.

10

ABSTRACT

This invention discloses new krill oil compositions characterized by having high amounts of phospholipids, astaxanthin esters and/or omega-3 contents. The krill oils are obtained from krill meal using supercritical fluid extraction in a two stage process. Stage 1 removes the neutral
5 lipid by extracting with neat supercritical CO₂ or CO₂ plus approximately 5% of a co-solvent. Stage 2 extracts the actual krill oils by using supercritical CO₂ in combination with approximately 20% ethanol. The krill oil materials obtained are compared with commercially available krill oil and found to be more bioeffective in a number of areas such as anti-inflammation, anti-oxidant effects, improving insulin resistances and improving blood lipid profile.

10

FIGURE 1

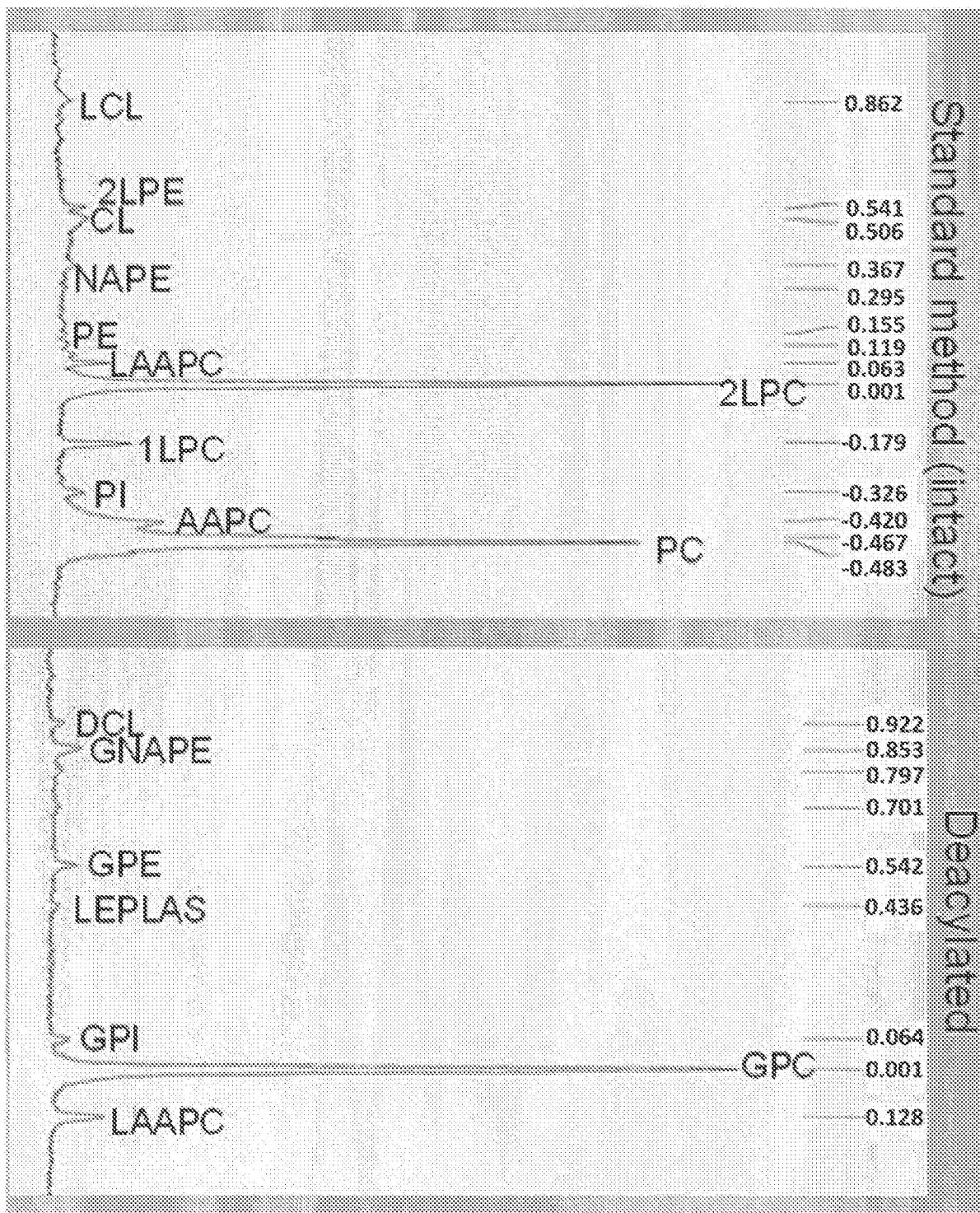

FIGURE 2

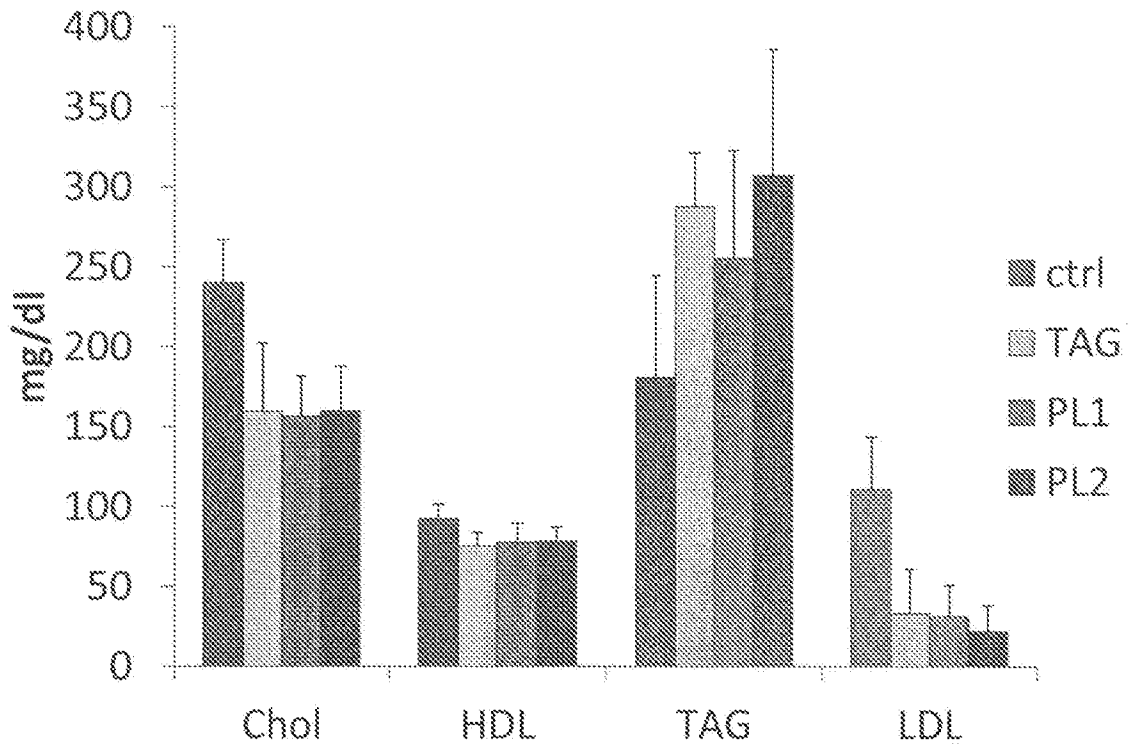

FIGURE 3

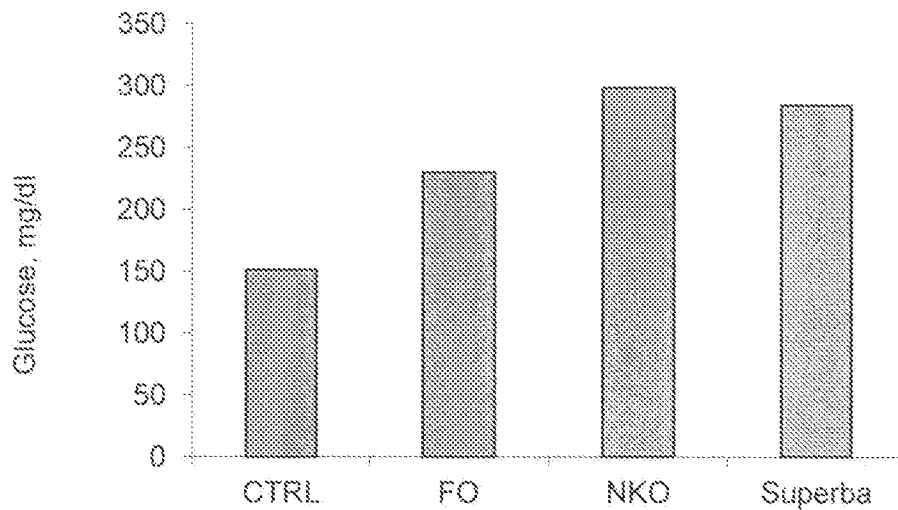

FIGURE 4

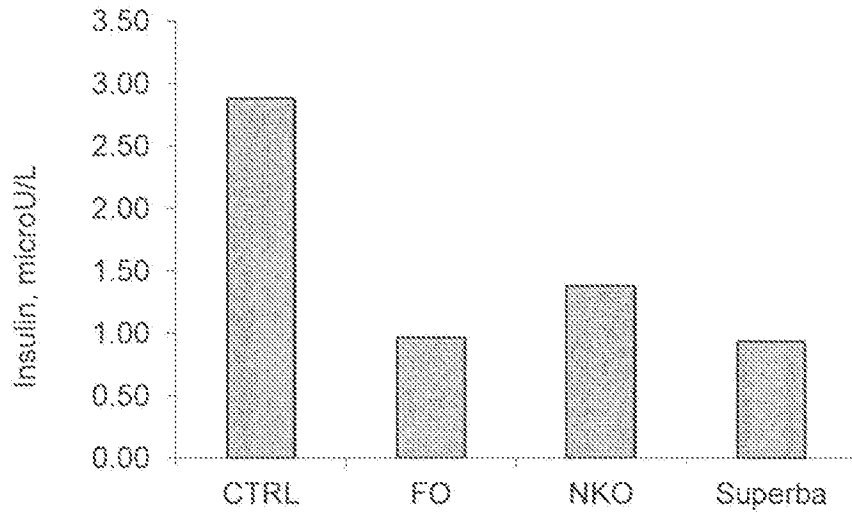

FIGURE 5

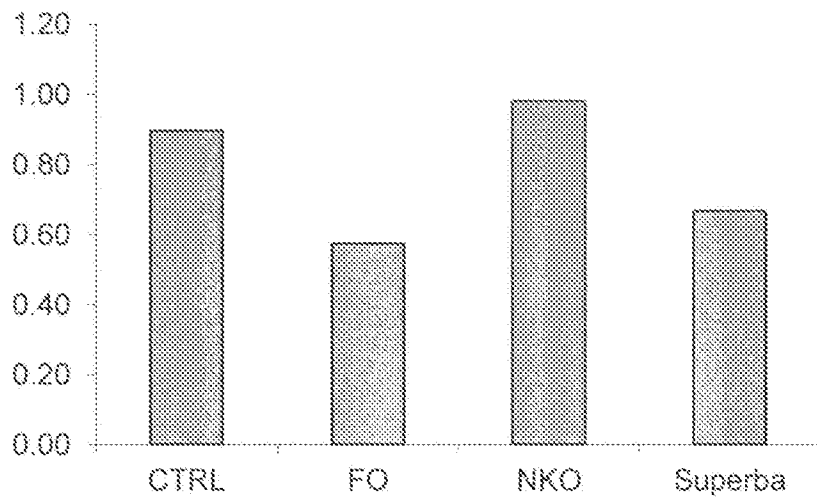

FIGURE 6

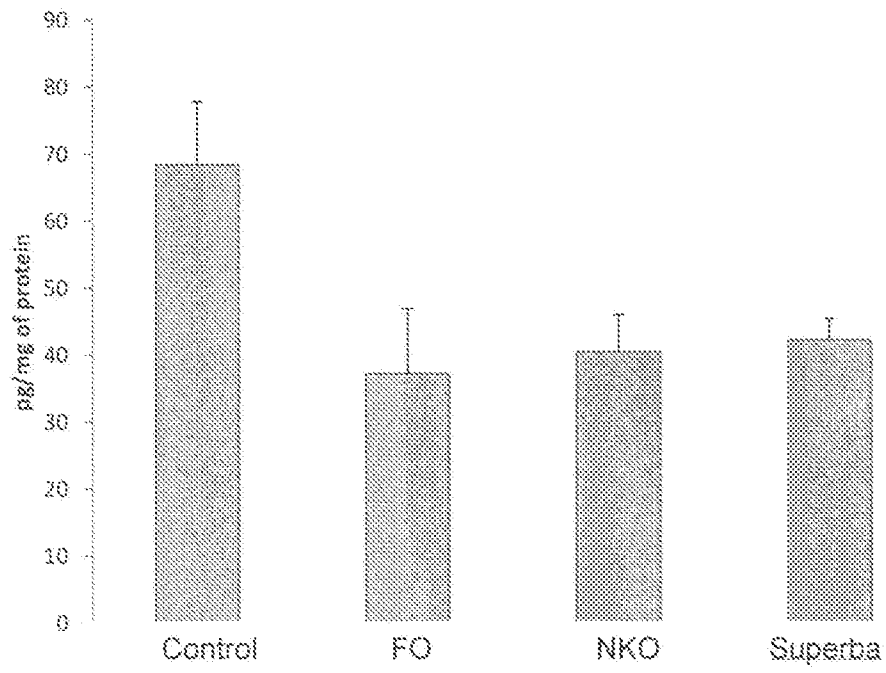

FIGURE 7

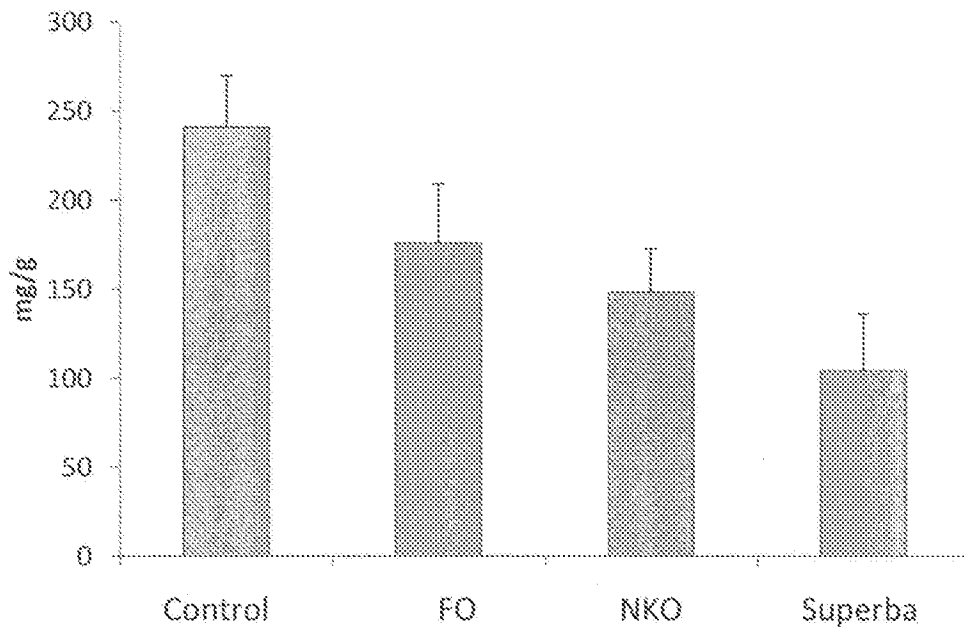

FIGURE 8

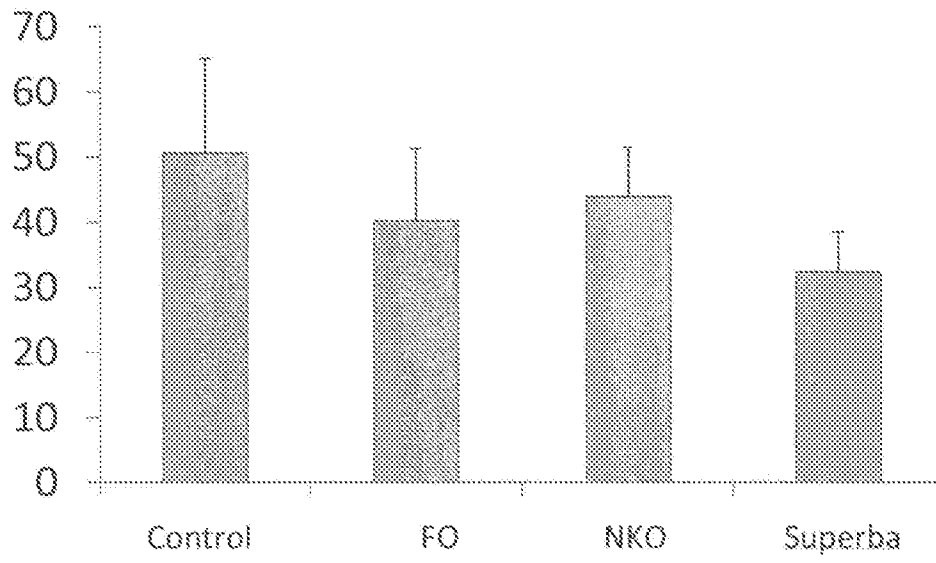

FIGURE 9

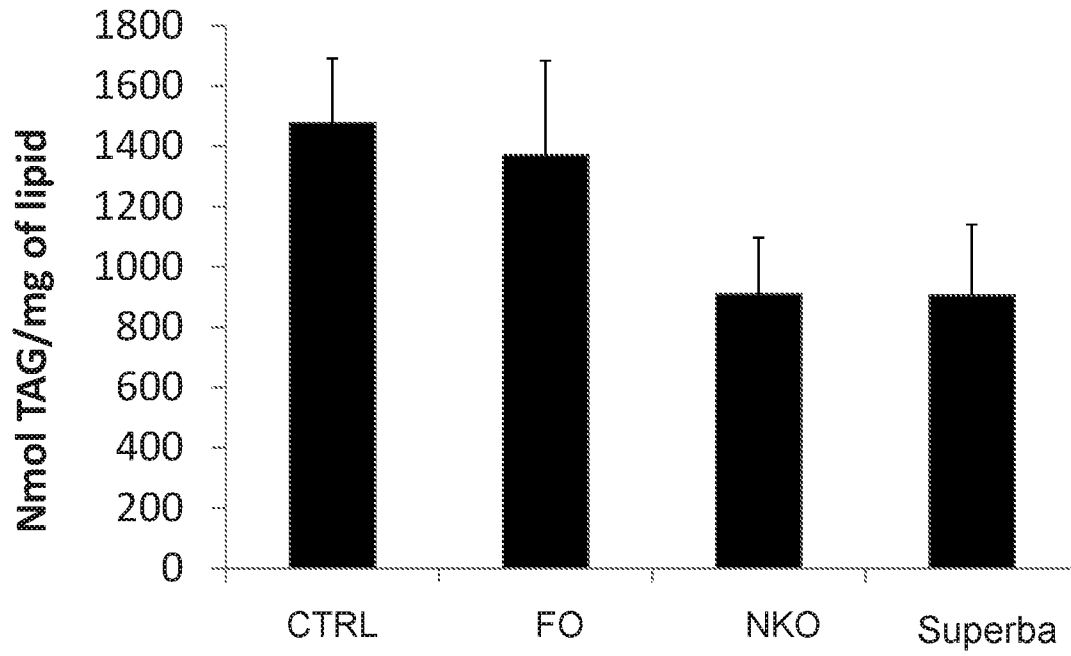

FIGURE 10

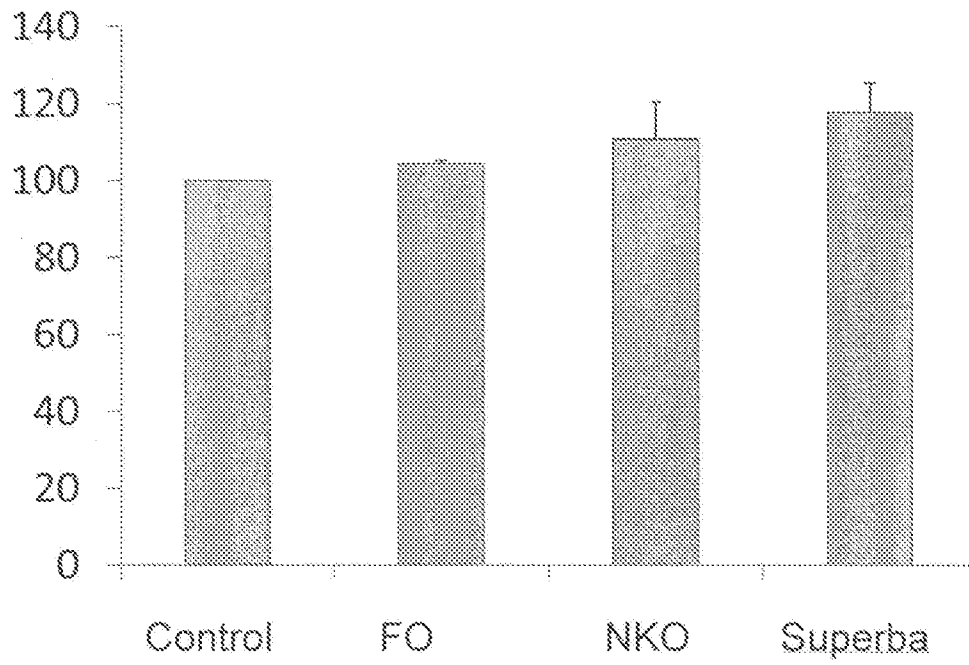

FIGURE 11

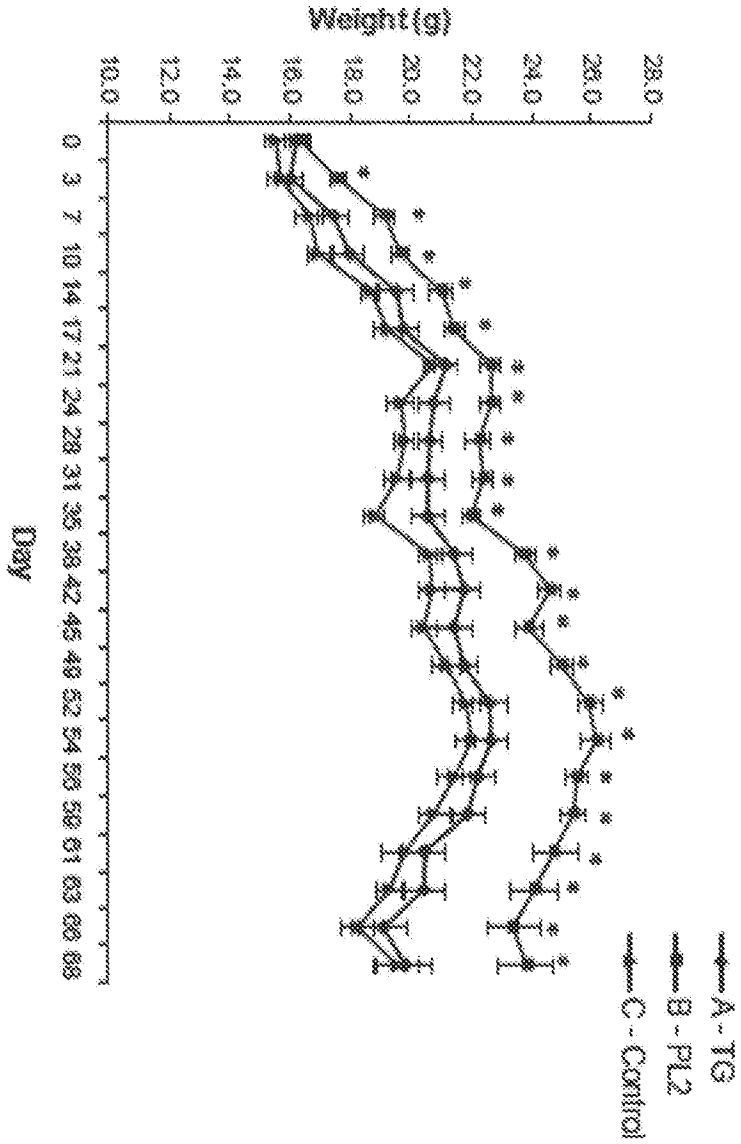

FIGURE 12

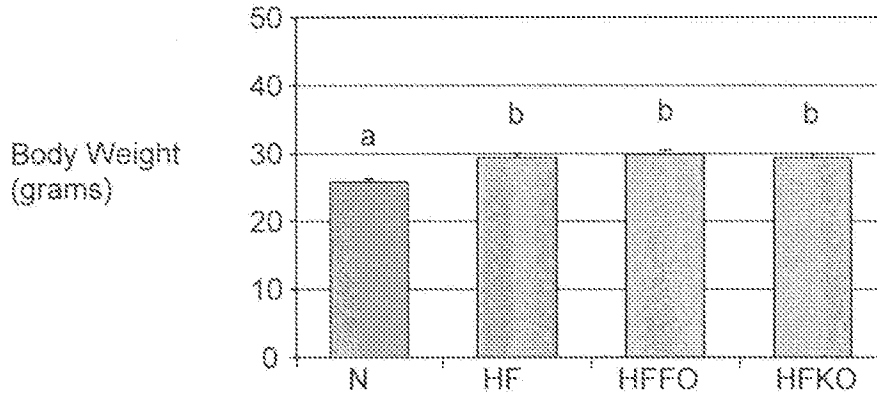

FIGURE 13

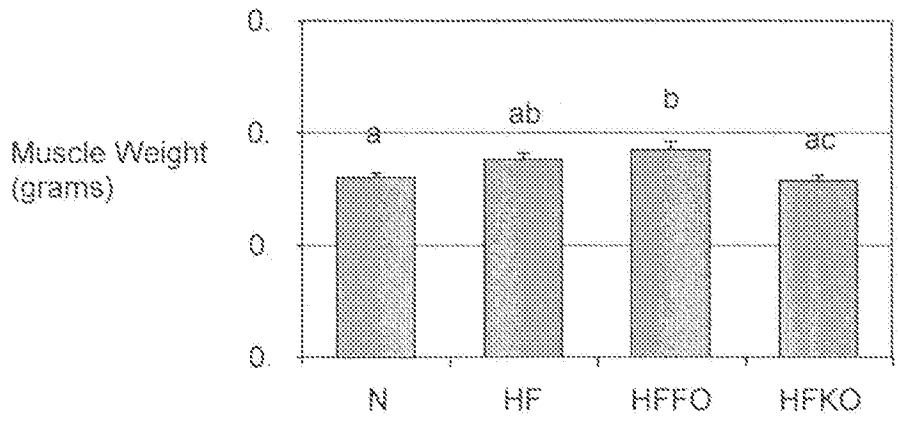

FIGURE 14

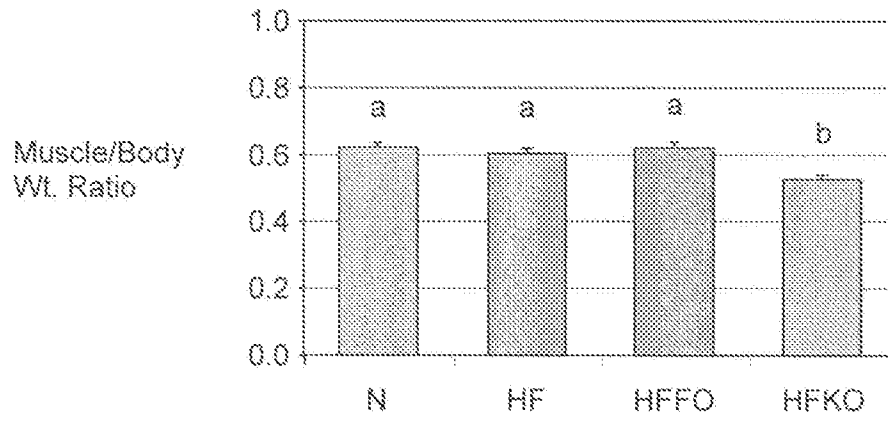

FIGURE 15

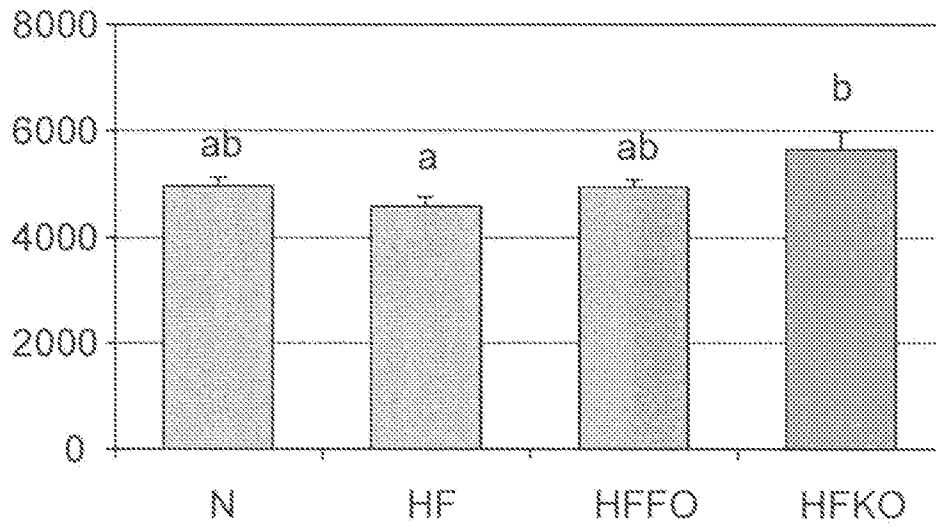

FIGURE 16

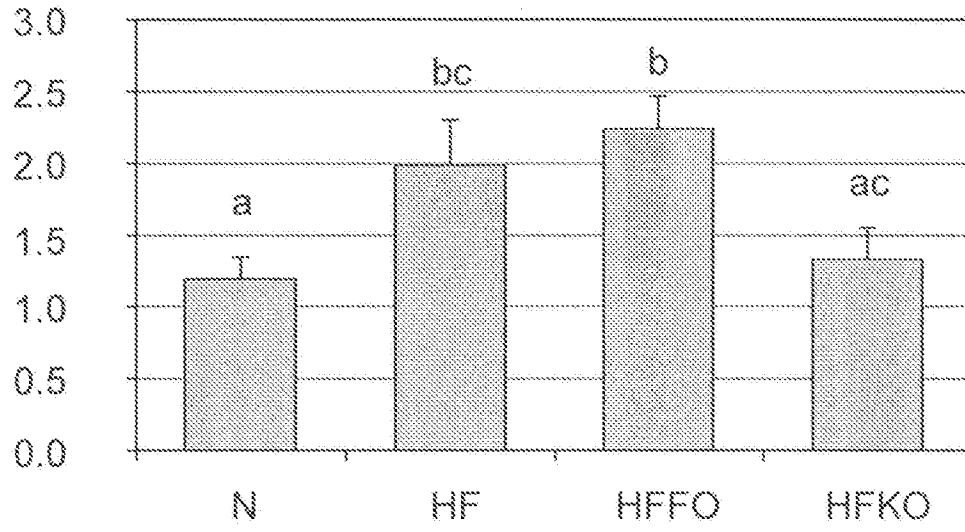

FIGURE 17

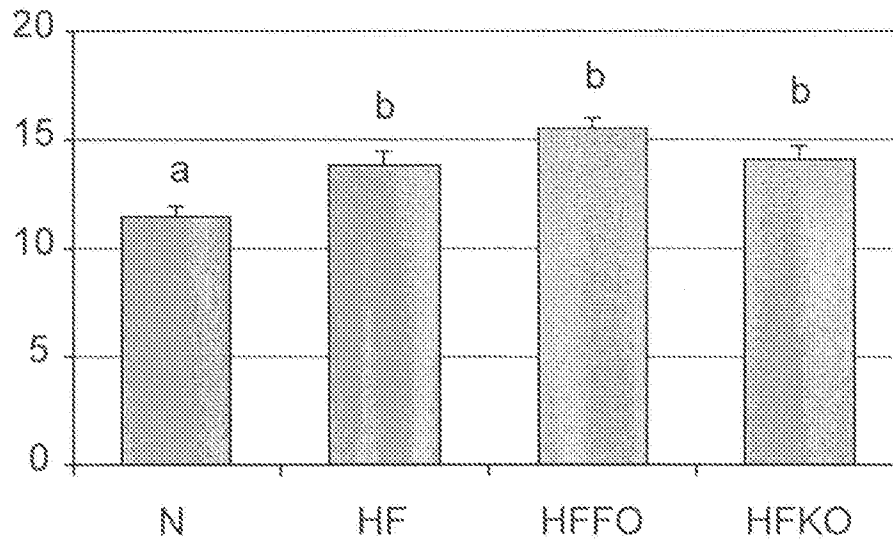

FIGURE 18

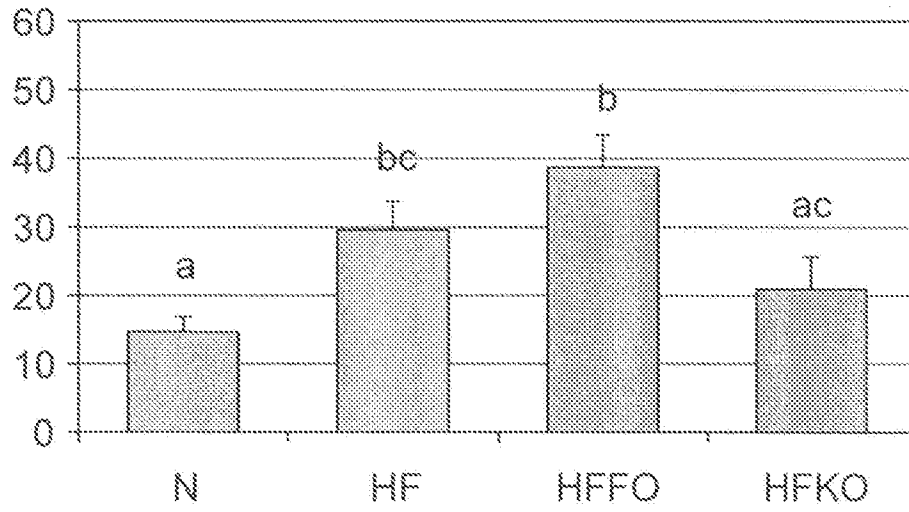
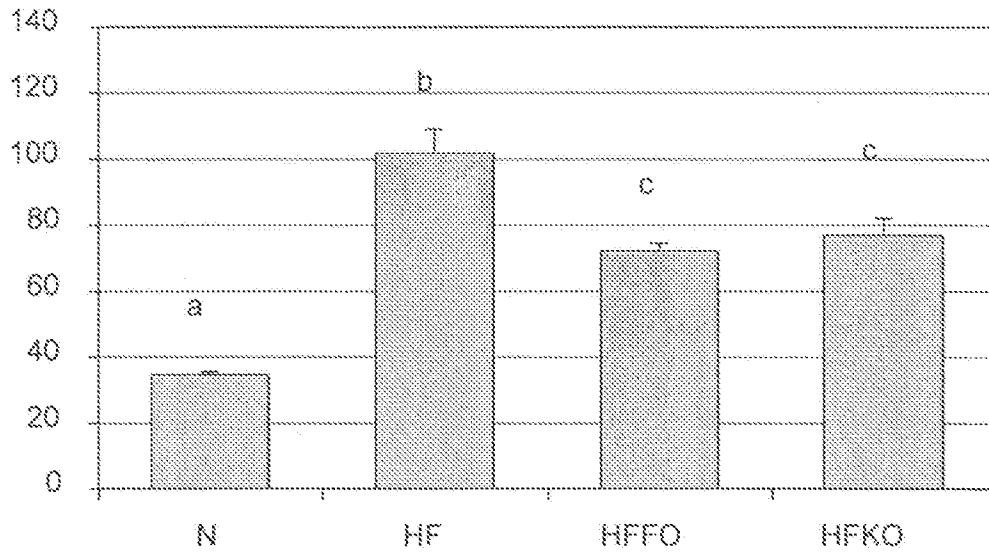

FIGURE 19



IN THE UNITED STATES PATENT AND TRADEMARK OFFICE

In re Application of:	Inge Bruheim et al.	Group No.:	TBD
Serial No.:	____/____,____	Examiner:	TBD
Filed:	Herewith		
Entitled:	BIOEFFECTIVE KRILL OIL COMPOSITIONS		

INFORMATION DISCLOSURE STATEMENT LETTER

EFS WEB FILED
Commissioner for Patents
P.O. Box 1450
Alexandria, VA 22313-1450

Sir or Madam:

The citations listed in the attached IDS Form PTO-SB08 may be material to the examination of the above-identified application, and are therefore submitted in compliance with the duty of disclosure defined in 37 C.F.R. §§ 1.56 and 1.97. The Examiner is requested to make these citations of official record in this application.

Applicants wish to bring to the Examiner’s attention that we are not providing copies of US Patents or published US patent applications as instructed under 37 CFR 1.98(a)(2).

Copies of any patent, publication, pending U.S. application or other information listed in the attached IDS Form PTO-SB08, not provided herewith, have been previously cited in parent U.S. patent application numbers 14/020,162 filed on September 6, 2013, and 12/057,775 filed on March 28, 2008. The documents can be found in the image file wrappers of the parent applications. In compliance with 37 C.F.R. § 1.98(d), Applicants have not included copies of these documents.

This Information Disclosure Statement under 37 C.F.R. §§ 1.56 and 1.97 is not to be construed as a representation that a search has been made, that additional information material to the examination of this application does not exist, or that any one or more of these citations constitutes prior art.

The Commissioner is hereby authorized to charge any required fees or credit any overpayments to Attorney Deposit Account No.: 50-4302, referencing Attorney Docket No.: AKBM-14409/US-13/CON.

Respectfully submitted,

Dated: June 13, 2016

/J. Mitchell Jones/
J. Mitchell Jones
Registration No. 44,174
CASIMIR JONES, S.C.
2275 Deming Way
Suite 310
Middleton, WI 53562
608-662-1277

INFORMATION DISCLOSURE STATEMENT BY APPLICANT (Not for submission under 37 CFR 1.99)	Application Number	
	Filing Date	2016-06-13
	First Named Inventor	Inge Bruheim
	Art Unit	
	Examiner Name	
	Attorney Docket Number	AKBM-14409/US-13/CON

U.S.PATENTS						Remove
Examiner Initial*	Cite No	Patent Number	Kind Code ¹	Issue Date	Name of Patentee or Applicant of cited Document	Pages,Columns,Lines where Relevant Passages or Relevant Figures Appear
	1	4119619		1978-10-10	ROGOZHIN SERGEI VASILIEVICH et al.	
	2	5434183		1997-07-18	LARSSON-BACKSTROM	
	3	6537787		2003-03-25	BRETON	
	4	6800299		2004-10-05	BEAUDOIN & MARTIN	

If you wish to add additional U.S. Patent citation information please click the Add button.

Add

U.S.PATENT APPLICATION PUBLICATIONS						Remove
Examiner Initial*	Cite No	Publication Number	Kind Code ¹	Publication Date	Name of Patentee or Applicant of cited Document	Pages,Columns,Lines where Relevant Passages or Relevant Figures Appear
	1	20030044495		2003-03-06	KAGAN and BRAUN	
	2	20040241249		2004-12-02	SAMPALIS	

If you wish to add additional U.S. Published Application citation information please click the Add button.

Add

FOREIGN PATENT DOCUMENTS						Remove
--------------------------	--	--	--	--	--	--------

**INFORMATION DISCLOSURE
STATEMENT BY APPLICANT**
(Not for submission under 37 CFR 1.99)

Application Number		
Filing Date		2016-06-13
First Named Inventor	Inge Bruheim	
Art Unit		
Examiner Name		
Attorney Docket Number	AKBM-14409/US-13/CON	

Examiner Initial*	Cite No	Foreign Document Number ³	Country Code ^{2j}	Kind Code ⁴	Publication Date	Name of Patentee or Applicant of cited Document	Pages, Columns, Lines where Relevant Passages or Relevant Figures Appear	T ⁵
	1	8701265	BR		1987-03-12	SATO		
	2	1098900	CA		1981-04-07	ROGOZHIN, et al		
	3	0609078	EP		1994-08-03	SCOTIA HOLDINGS PLC		
	4	1127497	EP		2001-08-29	NIPPON SUISAN KAISHA LTD		
	5	1406641	EP		2004-04-14	NEPTUNE TECHNOLOGIES & BIORESSOURCES INC.		
	6	0670306	EP		1995-06-09	NIPPON OIL CO. LTD		
	7	2097014	GB		1982-10-27	BAIKOFF		
	8	921537	GB		1999-06-09	PICKER NORDSTAR INC.		
	9	02049091	JP		1990-02-19	SUNTORY LTD		
	10	2215351	JP		1990-08-28	TAIYO FISHERY CO LTD		

**INFORMATION DISCLOSURE
STATEMENT BY APPLICANT**
(Not for submission under 37 CFR 1.99)

Application Number		
Filing Date		2016-06-13
First Named Inventor	Inge Bruheim	
Art Unit		
Examiner Name		
Attorney Docket Number	AKBM-14409/US-13/CON	

11	2524217	JP		1996-08-14	TAIYO FISHERY CO LTD
12	2963152	JP		1992-02-25	CHLORINE ENG CORP LTD
13	3081692	JP		1994-07-19	CHLORINE ENG CORP LTD
14	3344887	JP		1997-07-08	IKEDA SHOKKEN KK
15	3467794	JP		2003-09-05	NIPPON OIL & FATS CO LTD
16	3486778	JP		2003-10-31	GREEN CROSS CORP
17	3611222	JP		1997-08-05	CHLORINE ENG CORP LTD
18	3678317	JP		2005-05-20	CHLORINE ENG CORP LTD
19	4012665	JP		1992-01-17	MATSUSHITA ELECTRIC IND CO LTD
20	61281159	JP		1986-12-11	SHISEIDO CO LTD; NIPPON SUISAN KAISHA LTD.
21	2001-158736	JP		2001-06-12	SNOW BRAND MILK PROD CO LTD

**INFORMATION DISCLOSURE
STATEMENT BY APPLICANT**
(Not for submission under 37 CFR 1.99)

Application Number		
Filing Date		2016-06-13
First Named Inventor	Inge Bruheim	
Art Unit		
Examiner Name		
Attorney Docket Number		AKBM-14409/US-13/CON

22	2003-003192	JP		2003-01-08	UNITIKA LTD
23	2003-048831	JP		2003-02-21	SUNTORY LTD
24	2003-146883	JP		2003-05-21	SNOW BRAND MILK PROD CO LTD
25	2005-245379	JP		2005-09-15	NIPPON SUISAN KAISHA LTD
26	2006-069948	JP		2006-03-16	HIROSE YUKIHIRO
27	2006-083136	JP		2006-03-30	SUNTORY LTD
28	2006-290784	JP		2006-10-26	HIROSE YUKIHIRO
29	2006-316073	JP		2006-11-24	IBR ISRAELI BIOTECHNOLOGY RESEARCH LTD
30	2006-328014	JP		2006-12-07	HIROSE YUKIHIRO
31	2007-126455	JP		2007-05-24	FUJI CHEM IND CO LTD
32	2007-246404	JP		2007-09-27	SNOW BRAND MILK PROD CO LTD

**INFORMATION DISCLOSURE
STATEMENT BY APPLICANT**
(Not for submission under 37 CFR 1.99)

Application Number		
Filing Date		2016-06-13
First Named Inventor	Inge Bruheim	
Art Unit		
Examiner Name		
Attorney Docket Number	AKBM-14409/US-13/CON	

33	220741	SU	1971-01-06	KRGUCHKOV
34	1986/06082	WO	1986-10-23	MAT-CON RADGIVENDE INGENIØRFIRMA A/S
35	1990/05765	WO	1990-05-31	MIKALSEN
36	1993/24142	WO	1993-12-09	PHAIRSON MEDICAL AB
37	1997/38585	WO	1997-10-23	THE UNIVERSITY OF BRITISH COLUMBIA
38	1997/39759	WO	1997-10-30	BRIGHAM AND WOMEN'S HOSPITAL
39	1998/34498	WO	1998-08-13	BIOZYME SYSTEMS INC.
40	1999/39589	WO	1999-08-12	ALOISE
41	2000/23546	WO	2000-04-27	UNIV SHERBROOKE
42	2000/25608	WO	2000-05-11	NIPPON SUISAN KAISHA, LTD
43	2000/38708	WO	2000-07-06	PHAIRSON MEDICAL INC.

**INFORMATION DISCLOSURE
STATEMENT BY APPLICANT**
(Not for submission under 37 CFR 1.99)

Application Number		
Filing Date		2016-06-13
First Named Inventor	Inge Bruheim	
Art Unit		
Examiner Name		
Attorney Docket Number	AKBM-14409/US-13/CON	

44	2002/102394	WO		2002-12-27	NEPTUNE TECHNOLOGIES & BIORESS
45	2003/011873	WO		2003-02-13	NEPTUNE TECHNOLOGIES & BIORESSOURCES INC.
46	2005/037848	WO		2005-04-28	ENZYMOTEC LTD.
47	2005/038037	WO		2005-04-28	ENZYMOTEC INC.
48	2007/080514	WO		2007-07-19	KRILL A/S
49	2007/080515	WO		2007-07-19	AKER BIOMARINE ASA
50	2007/108702	WO		2007-09-27	AKER SEAFOODS HOLDING AS

If you wish to add additional Foreign Patent Document citation information please click the Add button

NON-PATENT LITERATURE DOCUMENTS

Examiner Initials*	Cite No	Include name of the author (in CAPITAL LETTERS), title of the article (when appropriate), title of the item (book, magazine, journal, serial, symposium, catalog, etc), date, pages(s), volume-issue number(s), publisher, city and/or country where published.	T ⁵
	1	ANDO and HATANO, 1988, "Isolation of apolipoproteins from carotenoid-carrying lipoprotein in the serum of chum salmon, <i>Oncorhynchus keta</i> ", J. Lipid Research, 29: 1264-1271	
	2	AOI et al., 2003, "Astaxanthin limits exercise-induced skeletal and cardiac muscle damage in mice", Antioxidants & Redox Signaling, 5(1): 139-44	

**INFORMATION DISCLOSURE
STATEMENT BY APPLICANT**
(Not for submission under 37 CFR 1.99)

Application Number		
Filing Date		2016-06-13
First Named Inventor	Inge Bruheim	
Art Unit		
Examiner Name		
Attorney Docket Number	AKBM-14409/US-13/CON	

3	BRITTON, 1985, "General Carotenoid Methods", Methods in Enzymology, Vol 111, pp. 113-149
4	CALDER, 2006, "n-3 polyunsaturated fatty acids, inflammation, and inflammatory diseases", Am. J. Clin. Nutr., 83: 1505S
5	CHAREST et al., 2001, "Astaxanthin Extraction from Crawfish Shells by Supercritical CO2 with Ethanol as Cosolvent", J. Aquatic Food Product Technology, 10(3): 79-93
6	CHEN and MEYERS, 1982, "Extraction of Astaxanthin Pigment from Crawfish Waste Using a Soy Oil Process", J. Food Sci., 47: 892-896
7	CLARKE, 1980, "The Biochemical Composition of Krill, Euphausia superba dana, from South Georgia", J. Exp. Mar. Biol. Ecol., 43: 221-236
8	CZECZUGA, 1974, "Comparative Studies of Carotenoids in the Fauna of the Gullmar Fjord (Bohuslan, Sweden). II. Crustacea: Eupagurus bernhardus, Hyas coarctatus and Upogebia deltaura", Marine Biology, 28: 95-98
9	DE RITTER and PURCELL, 1981, "Carotenoid Analytical Methods", Carotenoids as Colorants and Vitamin A Precursors: Technological and Nutritional Applications, pp 815-882
10	DEUTCH, 1995, "Menstrual pain in Danish women correlated with low n-3 polyunsaturated fatty acid intake", Eur. J. Clin. Nutr., 49(7): 508-16
11	DIEZ et al., 2003, "The role of the novel adipocyte-derived hormone adiponectin in human disease", Eur. J. Endocrinol., 148(3): 293-300
12	ELLINGSEN et al., 1987, "Biochemistry of the autolytic processes in Antarctic krill post mortem. Autoproteolysis." Biochem. J. 246, 295-305
13	EMODI, 1978, "Carotenoids: Properties and Applications", Food Technology, 32(5): 38

**INFORMATION DISCLOSURE
STATEMENT BY APPLICANT**
(Not for submission under 37 CFR 1.99)

Application Number		
Filing Date		2016-06-13
First Named Inventor	Inge Bruheim	
Art Unit		
Examiner Name		
Attorney Docket Number	AKBM-14409/US-13/CON	

14	FELIX-VALENZUELA et al., 2001, "Supercritical CO ₂ /Ethanol Extraction of Astaxanthin from Blue Crab (<i>Callinectes Sapidus</i>) Shell Waste", <i>Journal of Food Process Engineering</i> , 24: 101-112
15	FOX and SCHEER, 1941, "Comparative Studies of the Pigments of Some Pacific Coast Echinoderms", <i>The Biological Bulletin</i> , 441-455
16	GEUSENS et al., 1994, "Long-term effect of omega-3 fatty acid supplementation in active rheumatoid arthritis. A 12-month, double-blind, controlled study", <i>Arthritis Rheum.</i> , 37(6): 824-9
17	GILCHRIST and GREEN, 1960, "The Pigments of Artemia", <i>Proceedings of the Royal Society, Series B Biological Sciences</i> , Vol 152 No. 946, pp 118-136
18	GOODWIN and SRISUKH, 1949, "Some Observations on Astaxanthin Distribution in Marine Crustacea", <i>Department of Biochemistry, University of Liverpool</i> , pp. 268-270
19	GULYAEV and BUGROVA, 1976 "Removing fats from the protein paste "Okean". <i>Konservnaya I Ovoshchesushil'naya Promyshlennost</i> , (4), 37-8
20	HARDARDOTTIR and KINSELLA, 1988, "Extraction of Lipid and Cholesterol from Fish Muscle with Supercritical Fluids" <i>Journal of Food Science</i> , 53(6): 1656-1658
21	INTERNATIONAL AQUA FEED, 2006, Vol. 9
22	International Search Report and Written Opinion for PCT/GB2008/002934, Dated 2009-03-11
23	International Search Report and Written Opinion for PCT/IB2010/000512; dated 2010-06-24
24	International Search Report for PCT/IB2007/000098, dated: 2007-06-26

**INFORMATION DISCLOSURE
STATEMENT BY APPLICANT**
(Not for submission under 37 CFR 1.99)

Application Number		
Filing Date		2016-06-13
First Named Inventor	Inge Bruheim	
Art Unit		
Examiner Name		
Attorney Docket Number	AKBM-14409/US-13/CON	

25	TOH et al., 2007; "Increased adiponectin secretion by highly purified eicosapentaenoic acid in rodent models of obesity and human obese subjects", Arteriosclerosis, Thrombosis, and Vascular Biology; 27(9): 1918-1925
26	JOHNSON et al., 1978, "Simple Method for the Isolation of Astaxanthin from the Basidiomycetous Yeast Phaffia rhodozyma", Applied and Environmental Microbiology, 35(6): 1155-1159
27	KOLAKOWSKA, 1989, "Krill lipids after frozen storage of about one year in relation to storage time before freezing", Die Nahrung Food, 33(3): 241-244
28	KRIS-ETHERTON et al., 2002, "Fish Consumption, Fish Oil, Omega-3 Fatty Acids, and Cardiovascular Disease", Circulation, 106:2747-2757
29	KRISTENSEN et al., 1989, "Dietary supplementation with n-3 polyunsaturated fatty acids and human platelet function: a review with particular emphasis on implications for cardiovascular disease", J. Intern. Med. Suppl. 731:141-50
30	KUNESOVA et al., 2006, "The influence of n-3 polyunsaturated fatty acids and very low calorie diet during a short-term weight reducing regimen on weight loss and serum fatty acid composition in severely obese women", Physiol Res.; 55 (1):63-72
31	LAIGHT et al., 1999, "F2-isoprostane evidence of oxidant stress in the insulin resistant, obese Zucker rat: effects of vitamin E", Eur. J. Pharmacol. 377(1): 89-92
32	LAMBERTSON and BRAEKKAN, 1971, "Method of Analysis of Astaxanthin and its Occurrence in some Marine Products," J. Sci. Food. Agr., Vol 22(2): 99-101
33	LIBBY et al., 2006, "Inflammation and Atherothrombosis: From Population Biology and Bench Research to Clinical Practice", J. Amer. Coll. Card., 48 (9, Suppl. A): A33-A46
34	LOPEZ et al., 2004, "Selective extraction of astaxanthin from crustaceans by use of supercritical carbon dioxide", Talanta, 64: 726-731
35	MANDEVILLE, 1991, "Isolation and Identification of Carotenoid Pigments, Lipids and Flavor Active Components from Raw Commercial Shrimp Waste", Food Biotechnology, 5(2): 185-195

**INFORMATION DISCLOSURE
STATEMENT BY APPLICANT**
(Not for submission under 37 CFR 1.99)

Application Number		
Filing Date		2016-06-13
First Named Inventor	Inge Bruheim	
Art Unit		
Examiner Name		
Attorney Docket Number	AKBM-14409/US-13/CON	

36	MEYERS and BLIGH, 1981, "Characterization of Astaxanthin Pigments from Heat-Processed Crawfish Waste", J. Agric. Food Chem., 29: 505-508
37	MEYERS, 1977, "Using Crustacean Meals and Carotenoid-Fortified Diets", Feedstuffs, Vol. 49(19)
38	MEYERS, 1994, "Developments in world aquaculture, feed formulations, and role of carotenoids", Pure & Appl. Chem, Vol. 66(5): 1069-1076
39	MILLS et al., 1989, "Dietary N-6 and N-3 fatty acids and salt-induced hypertension in the borderline hypertensive rat", Lipids, 24(1): 17-24
40	MOATES and VAN BENTEM, 1990, "Separating out the value", Food Science and Technology Today, 4(4): 213-214
41	NIKOLAEVA, 1967 "Amino acid composition of protein-coagulate in krill", VNIRO, 63:161-4
42	
43	PHLEGER, et al. (2002) "Interannual and between species comparison in the lipids, fatty acids, and sterols of Antarctic krill from the US AMLR Elephant Island survey area: 1997 and 1998". Comp Biochem Physiol 131B:733-747
44	POPP-SNIJDERS et al., 1987, "Dietary supplementation of omega-3 polyunsaturated fatty acids improves insulin sensitivity in non-insulin-dependent diabetes", Diabetes Res. 4(3): 141-7
45	SACHINDRA, 2006, "Recovery of carotenoids from shrimp waste in organic solvents", Waste Management, 26: 1092-1098
46	SAETHER et al., 1986, "Lipids of North Atlantic krill", J Lipid Res., 27(3):274-85.

INFORMATION DISCLOSURE STATEMENT BY APPLICANT (Not for submission under 37 CFR 1.99)	Application Number			
	Filing Date		2016-06-13	
	First Named Inventor	Inge Bruheim		
	Art Unit			
	Examiner Name			
	Attorney Docket Number		AKBM-14409/US-13/CON	

47	SHAHIDI et al., 1998, "Carotenoid Pigments in Seafoods and Aquaculture" Critical Reviews in Food Science, 38(1): 1-67
48	SIDEHU et al., 1970, "Biochemical Composition and Nutritive Value of Krill (Euphausia superb dana)", J. Sci Food Agr., Vol 21, 293-296
49	SIMOPOULOS, 1991, "Omega-3 fatty acids in health and disease and in growth and development", Am. Clin. Nutr. 54:438-63
50	SOMIYA, 1982, "Yellow lens' eyes of a stomiatoid deep-sea fish, Malacosteus niger", Proc. R. Soc. Lond., 215: 481-489

If you wish to add additional non-patent literature document citation information please click the Add button

EXAMINER SIGNATURE

Examiner Signature	<input type="text"/>	Date Considered	<input type="text"/>
--------------------	----------------------	-----------------	----------------------

*EXAMINER: Initial if reference considered, whether or not citation is in conformance with MPEP 609. Draw line through a citation if not in conformance and not considered. Include copy of this form with next communication to applicant.

¹ See Kind Codes of USPTO Patent Documents at www.USPTO.GOV or MPEP 901.04. ² Enter office that issued the document, by the two-letter code (WIPO Standard ST.3). ³ For Japanese patent documents, the indication of the year of the reign of the Emperor must precede the serial number of the patent document. ⁴ Kind of document by the appropriate symbols as indicated on the document under WIPO Standard ST.16 if possible. ⁵ Applicant is to place a check mark here if English language translation is attached.

**INFORMATION DISCLOSURE
STATEMENT BY APPLICANT**
(Not for submission under 37 CFR 1.99)

Application Number		
Filing Date		2016-06-13
First Named Inventor	Inge Bruheim	
Art Unit		
Examiner Name		
Attorney Docket Number	AKBM-14409/US-13/CON	

CERTIFICATION STATEMENT

Please see 37 CFR 1.97 and 1.98 to make the appropriate selection(s):

That each item of information contained in the information disclosure statement was first cited in any communication from a foreign patent office in a counterpart foreign application not more than three months prior to the filing of the information disclosure statement. See 37 CFR 1.97(e)(1).

OR

That no item of information contained in the information disclosure statement was cited in a communication from a foreign patent office in a counterpart foreign application, and, to the knowledge of the person signing the certification after making reasonable inquiry, no item of information contained in the information disclosure statement was known to any individual designated in 37 CFR 1.56(c) more than three months prior to the filing of the information disclosure statement. See 37 CFR 1.97(e)(2).

See attached certification statement.

The fee set forth in 37 CFR 1.17 (p) has been submitted herewith.

A certification statement is not submitted herewith.

SIGNATURE

A signature of the applicant or representative is required in accordance with CFR 1.33, 10.18. Please see CFR 1.4(d) for the form of the signature.

Signature	/J. Mitchell Jones/	Date (YYYY-MM-DD)	2016-06-13
Name/Print	J. Mitchell Jones	Registration Number	44174

This collection of information is required by 37 CFR 1.97 and 1.98. The information is required to obtain or retain a benefit by the public which is to file (and by the USPTO to process) an application. Confidentiality is governed by 35 U.S.C. 122 and 37 CFR 1.14. This collection is estimated to take 1 hour to complete, including gathering, preparing and submitting the completed application form to the USPTO. Time will vary depending upon the individual case. Any comments on the amount of time you require to complete this form and/or suggestions for reducing this burden, should be sent to the Chief Information Officer, U.S. Patent and Trademark Office, U.S. Department of Commerce, P.O. Box 1450, Alexandria, VA 22313-1450. **DO NOT SEND FEES OR COMPLETED FORMS TO THIS ADDRESS. SEND TO: Commissioner for Patents, P.O. Box 1450, Alexandria, VA 22313-1450.**

Privacy Act Statement

The Privacy Act of 1974 (P.L. 93-579) requires that you be given certain information in connection with your submission of the attached form related to a patent application or patent. Accordingly, pursuant to the requirements of the Act, please be advised that: (1) the general authority for the collection of this information is 35 U.S.C. 2(b)(2); (2) furnishing of the information solicited is voluntary; and (3) the principal purpose for which the information is used by the U.S. Patent and Trademark Office is to process and/or examine your submission related to a patent application or patent. If you do not furnish the requested information, the U.S. Patent and Trademark Office may not be able to process and/or examine your submission, which may result in termination of proceedings or abandonment of the application or expiration of the patent.

The information provided by you in this form will be subject to the following routine uses:

1. The information on this form will be treated confidentially to the extent allowed under the Freedom of Information Act (5 U.S.C. 552) and the Privacy Act (5 U.S.C. 552a). Records from this system of records may be disclosed to the Department of Justice to determine whether the Freedom of Information Act requires disclosure of these records.
2. A record from this system of records may be disclosed, as a routine use, in the course of presenting evidence to a court, magistrate, or administrative tribunal, including disclosures to opposing counsel in the course of settlement negotiations.
3. A record in this system of records may be disclosed, as a routine use, to a Member of Congress submitting a request involving an individual, to whom the record pertains, when the individual has requested assistance from the Member with respect to the subject matter of the record.
4. A record in this system of records may be disclosed, as a routine use, to a contractor of the Agency having need for the information in order to perform a contract. Recipients of information shall be required to comply with the requirements of the Privacy Act of 1974, as amended, pursuant to 5 U.S.C. 552a(m).
5. A record related to an International Application filed under the Patent Cooperation Treaty in this system of records may be disclosed, as a routine use, to the International Bureau of the World Intellectual Property Organization, pursuant to the Patent Cooperation Treaty.
6. A record in this system of records may be disclosed, as a routine use, to another federal agency for purposes of National Security review (35 U.S.C. 181) and for review pursuant to the Atomic Energy Act (42 U.S.C. 218(c)).
7. A record from this system of records may be disclosed, as a routine use, to the Administrator, General Services, or his/her designee, during an inspection of records conducted by GSA as part of that agency's responsibility to recommend improvements in records management practices and programs, under authority of 44 U.S.C. 2904 and 2906. Such disclosure shall be made in accordance with the GSA regulations governing inspection of records for this purpose, and any other relevant (i.e., GSA or Commerce) directive. Such disclosure shall not be used to make determinations about individuals.
8. A record from this system of records may be disclosed, as a routine use, to the public after either publication of the application pursuant to 35 U.S.C. 122(b) or issuance of a patent pursuant to 35 U.S.C. 151. Further, a record may be disclosed, subject to the limitations of 37 CFR 1.14, as a routine use, to the public if the record was filed in an application which became abandoned or in which the proceedings were terminated and which application is referenced by either a published application, an application open to public inspections or an issued patent.
9. A record from this system of records may be disclosed, as a routine use, to a Federal, State, or local law enforcement agency, if the USPTO becomes aware of a violation or potential violation of law or regulation.

INFORMATION DISCLOSURE STATEMENT BY APPLICANT (Not for submission under 37 CFR 1.99)	Application Number		
	Filing Date		2016-06-13
	First Named Inventor	Inge Bruheim	
	Art Unit		
	Examiner Name		
	Attorney Docket Number		AKBM-14409/US-13/CON

U.S.PATENTS						Remove
Examiner Initial*	Cite No	Patent Number	Kind Code ¹	Issue Date	Name of Patentee or Applicant of cited Document	Pages,Columns,Lines where Relevant Passages or Relevant Figures Appear
	1	5266564		1993-11-30	Modolell	
	2	8030348		2011-10-04	Sampalis, Fotni	
	3	7666447		2010-02-23	Rockway	
	4	4714571		1987-12-22	Kearns et al.	
	5	8278351		2012-10-02	Sampalis	
	6	8383675		2013-02-26	Sampalis	
	7	2652235		1953-09-15	Samuelsen	
	8	5006281		1991-04-09	Rubin et al.	

**INFORMATION DISCLOSURE
STATEMENT BY APPLICANT**
(Not for submission under 37 CFR 1.99)

Application Number		
Filing Date		2016-06-13
First Named Inventor	Inge Bruheim	
Art Unit		
Examiner Name		
Attorney Docket Number	AKBM-14409/US-13/CON	

9	4251557		1981-02-17	Shimose et al.
10	4505936		1985-03-19	Meyers et al.
11	6214396		2001-04-10	Barrier
12	4036993		1977-07-19	Ikeda
13	6346276		2002-02-12	Tanouchi et al.
14	8697138		2014-04-15	Bruheim et al.
15	7488503		2009-02-10	Porzio et al
16	4749522		1988-06-07	Kamarei
17	4814111		1989-03-21	Keams et al.
18	4133077		1979-01-09	Jasniewicz

If you wish to add additional U.S. Patent citation information please click the Add button.

Add

U.S.PATENT APPLICATION PUBLICATIONS

Remove

**INFORMATION DISCLOSURE
STATEMENT BY APPLICANT**
(Not for submission under 37 CFR 1.99)

Application Number		
Filing Date		2016-06-13
First Named Inventor	Inge Bruheim	
Art Unit		
Examiner Name		
Attorney Docket Number	AKBM-14409/US-13/CON	

Examiner Initial*	Cite No	Publication Number	Kind Code ¹	Publication Date	Name of Patentee or Applicant of cited Document	Pages, Columns, Lines where Relevant Passages or Relevant Figures Appear
	1	20060193962		2006-08-31	Kamiya et al.	
	2	20080166419		2008-07-10	Sones	
	3	20110130458		2011-06-02	Harald Breivik	
	4	20080166420		2008-07-10	Scott F. Sones	
	5	20060078625		2006-04-13	Susie Rockway	
	6	20020076468		2002-06-20	Saxby	
	7	20030113432		2003-06-19	Yoshitomi	
	8	20100143571		2010-06-10	Breivik	
	9	20100160659		2010-06-24	Catchpole	
	10	20080166419		2008-07-10	Sones	

**INFORMATION DISCLOSURE
STATEMENT BY APPLICANT**
(Not for submission under 37 CFR 1.99)

Application Number		
Filing Date		2016-06-13
First Named Inventor	Inge Bruheim	
Art Unit		
Examiner Name		
Attorney Docket Number		AKBM-14409/US-13/CON

If you wish to add additional U.S. Published Application citation information please click the Add button.

FOREIGN PATENT DOCUMENTS

Examiner Initial*	Cite No	Foreign Document Number ³	Country Code ² i	Kind Code ⁴	Publication Date	Name of Patentee or Applicant of cited Document	Pages, Columns, Lines where Relevant Passages or Relevant Figures Appear	T ⁵
	1	2008/006607	WO		2008-01-17	NATTOPHARMA ASA		
	2	2008/117062	WO		2008-10-02	AKER BIOMARINE ASA		
	3	2009/027692	WO		2009-03-05	AKER BIOMARINE ASA		
	4	2001/028526	WO		2001-04-26	TRUFFINI & REGGE FARMACEUTICI		
	5	2004/047554	WO		2004-06-10	PHARES PHARM RES NV		
	6	0973532	EP		2005-09-07	I.B.R ISRAELI BIOTECHNOLOGY RESEARCH LTD.		
	7	1123368	EP		2008-04-09	UNIVERSITE DE SHERBROOKE		
	8	1292294	EP		2009-03-18	ACCERA, INC.		
	9	2001/082928	WO		2001-11-08	HENDERSON		

**INFORMATION DISCLOSURE
STATEMENT BY APPLICANT**
(Not for submission under 37 CFR 1.99)

Application Number		
Filing Date		2016-06-13
First Named Inventor	Inge Bruheim	
Art Unit		
Examiner Name		
Attorney Docket Number		AKBM-14409/US-13/CON

10	2003/013497	WO		2003-02-20	SUNTORY LIMITED		
11	1419768	EP		2009-01-07	NEPTUNE TECHNOLOGIES & BIORESOURCES, INC		
12	1385500	EP		2010-07-28	YEDA RESEARCH AND DEVELOPMENT CO. LTD		
13	2002-083122	WO		2002-10-24	YEDA RESEARCH AND DEVELOPMENT CO. LTD		
14	1392623	EP		2004-03-03	MARTEK BIOSCIENCES BOULDER CORPORATION		
15	2002/092540	WO		2002-11-21	MARTEK BIOSCIENCES BOULDER CORPORATION		
16	2005/070411	WO		2005-08-04	BRUZZESE		
17	1542670	EP		2005-06-22	SUNTORY LIMITED		
18	2004/028529	WO		2004-04-08	SUNTORY LIMITED		
19	1743531	EP		2007-01-17	NIPPON SUISAN KAISHA, LTD.		
20	1631280	EP		2004-04-08	BTG INTERNATIONAL LIMITED		

**INFORMATION DISCLOSURE
STATEMENT BY APPLICANT**
(Not for submission under 37 CFR 1.99)

Application Number		
Filing Date		2016-06-13
First Named Inventor	Inge Bruheim	
Art Unit		
Examiner Name		
Attorney Docket Number		AKBM-14409/US-13/CON

21	2004-100943	WO		2006-05-31	BTG INTERNATIONAL LIMITED
22	2005-018632	WO		2005-03-03	BTG INTERNATIONAL LIMITED
23	2006/030552	WO		2006-03-23	SUNTORY LIMITED
24	1706106	EP		2009-07-15	BRUZZESE
25	1689413	EP		2006-08-16	ENZYMOTEC LTD
26	2004-534800	JP		2004-11-18	Kohyo
27	1660071	EP		2007-01-17	NIPPON SUISAN KAISHA, LTD.
28	2002/083122	WO		2002-10-24	YEDA RESEARCH AND DEVELOPMENT CO. LTD
29	05/004593	WO		2005-01-20	Norway Seafoods AS
30	08/117062	WO		2008-10-02	Aker Biomarine ASA
31	02/102394	WO		2002-12-27	Neptune Technologies & Bioress

**INFORMATION DISCLOSURE
STATEMENT BY APPLICANT**
(Not for submission under 37 CFR 1.99)

Application Number		
Filing Date		2016-06-13
First Named Inventor	Inge Bruheim	
Art Unit		
Examiner Name		
Attorney Docket Number		AKBM-14409/US-13/CON

32	07/080515	WO		2007-07-19	Aker Biomarine ASA
33	2003-530448	JP		2003-10-14	Westfalia Separator Industry GmbH
34	S52-114046	JP		1977-09-24	Kokai
35	S51-125774	JP		1976-11-02	Nichiro Gyogyo et al.
36	2002322233	AU		2003-02-17	Neptune Technologies & Bioresources, Inc.
37	04057853	JP		1992-02-25	CHLORINE ENG CORP LTD
38	2004/112767	WO		2004-12-29	Advanced Bionutrition Corp.
39	2251265	CA		2000-04-21	Beaudoin
40	1098900	CA		1981-04-07	Inst. Elementoorganicheskikh So, et al.
41	82/02819	WO		1982-09-02	Baltic Fish Ltd
42	40348	CL		1997-07-08	Tepual S.A.

**INFORMATION DISCLOSURE
STATEMENT BY APPLICANT**
(Not for submission under 37 CFR 1.99)

Application Number		
Filing Date		2016-06-13
First Named Inventor	Inge Bruheim	
Art Unit		
Examiner Name		
Attorney Docket Number	AKBM-14409/US-13/CON	

43	89/01031	WO		1989-02-09	Pharmacia AB
44	89/10960	WO		1989-11-16	Pharmacia AB
45	97/38585	WO		1997-10-23	The University of British Columbia
46	98/34498	WO		1998-08-13	Biozyme Systems, Inc.
47	99/39589	WO		1999-08-12	Biozyme Systems Inc.
48	06/111633	WO		2006-10-26	SC DICOPHAR
49	07/123424	WO		2007-11-01	Catchpole
50	08/072563	WO		2008-06-19	Nippon Suisan Kaisha, Ltd.

If you wish to add additional Foreign Patent Document citation information please click the Add button

NON-PATENT LITERATURE DOCUMENTS

Examiner Initials*	Cite No	Include name of the author (in CAPITAL LETTERS), title of the article (when appropriate), title of the item (book, magazine, journal, serial, symposium, catalog, etc), date, pages(s), volume-issue number(s), publisher, city and/or country where published.	T ⁵
	1	TAKAICHI et al., 2003, "Fatty Acids of astaxanthin esters in krill determined by mild mass spectrometry", Comparative Biochemistry and Physiology Part B, Biochemistry and Molecular Biology, Elsevier, Oxford, Vol. 136, 1 January 2003, p. 317-322	

**INFORMATION DISCLOSURE
STATEMENT BY APPLICANT**
(Not for submission under 37 CFR 1.99)

Application Number		
Filing Date		2016-06-13
First Named Inventor	Inge Bruheim	
Art Unit		
Examiner Name		
Attorney Docket Number	AKBM-14409/US-13/CON	

2	TANAKA et al., 2004, "Extraction of Phospholipids from Salmon Roe with Supercritical Carbon Dioxide and an Entrainer", J. Oleo Sci, 53(9): 417-424
3	TANAKA et al., 2005, "Extraction of Phospholipids from Unused Natrual Resources with Supercritical Carbon Dioxide and an Entrainer", Journal of Oleo Science, Vol. 54(11): 569-576
4	TODORIC et al., 2006, "Adipose tissue inflammation induced by high-fat diet in obese diabetic mice is prevented by n-3 polyunsaturated fatty acids", Diabetologia, 49(9): 2109-2119
5	TOU et al., 2007, "Krill for human consumption: nutritional value and potential health benefits.", Nutrition Rev 65 (2):63-77
6	TRAYHURN et al., 2004, "Adipokines: inflammation and the pleiotropic role of white adipose tissue", Br. J. Nutrition, 92(3): 347-355
7	TREBBLE et al., 2003, "Inhibition of tumour necrosis factor-alpha and interleukin 6 production by mononuclear cells following dietary fish-oil supplementation in healthy men and response to antioxidant co-supplementation", Br. J. Nutrition, 90(2): 405-412
8	JKKOLA et al., 2002, "Adiponectin: a link between excess adiposity and associated comorbidities?", J. Mol. Med., 80 (11): 696-702
9	VAN DER VEEN et al., 1971 "The Lipids of Krill (Euphausia Species) and Red Crab (Pleuroncodes Planipes)", Lipids, 6(7): 481-485
10	VIRTUE, et al. 1996, Reproductive trade-off in male Antarctic krill, Euphausia superba", Marine Biology, Volume 126, Number 3, Pages 521-527
11	YAMAGUCHI et al., 1983, "The Composition of Carotenoid Pigments in the Antarctic Krill Euphausia superba", Bulletin of the Japanese Society of Scientific Fisheries, 49(9): 1411-1415
12	YAMAGUCHI et al., 1986, "Supercritical Carbon Dioxide Extraction Of Oils From Antarctic Krill," Journal Of Agricultural And Food Chemistry, vol. 34, pp. 904-907

**INFORMATION DISCLOSURE
STATEMENT BY APPLICANT**
(Not for submission under 37 CFR 1.99)

Application Number		
Filing Date		2016-06-13
First Named Inventor	Inge Bruheim	
Art Unit		
Examiner Name		
Attorney Docket Number	AKBM-14409/US-13/CON	

13	YANASE M; 1974, "Modification of a Russian method for separation of heat-coagulated protein from Antarctic krill", Database FSTA (online); International Food Information Service (IFIS); FRANKFURT-MAIN, DE
14	YEN et al., 1994, "Effect of dietary omega-3 and omega-6 fatty acid sources on PUVA-induced cutaneous toxicity and tumorigenesis in the hairless mouse", Arch. Dermatol. Res., 286(6): 331-6
15	DATABASE WPI Week 200682, Thomson Scientific, London, GB, 2006
16	YANASE, M., "Modification of Russian Method for Separating Heat Congulated Protein from Antarctic Krill," Bull. Tokai Reg. Fish. Res. Lab, 78: 79-84 (1974)
17	SIKORSKI, E., "The Utilization of Krill For Food," Food Process Eng., 1:845-855 (1980)
18	BUDZINSKI, E., et al., "Possibilities of processing and marketing of products made from Antarctic Krill", FAO Fish. Tech. Pap. (268) 46 pages (1985) (BUDZINSKI)
19	BUNEA R., et al., "Evaluation of the Effects of Neptune Krill Oil on the Clinical Course of Hyperlipidemia," Alternative Medicine Review, Thorne Research Inc., Sandpoint, US, Vol. 9, No. 4, January 1, 2004
20	GORDEEV, K.Y., et al. "Fatty Acid Composition of the Main Phospholipids of the Antarctic Krill, Euphausia superba," Khim. Prirod. Soed. 2 (1990), pp. 181-187
21	December 8, 2011 Office Action, KR Patent Application No. 10-2010-7006897 and its English translation
22	JP Office Action mailed February 23, 2012, JP Patent Application No. 2010-522444 (and English translation)
23	CN Office Action mailed April 27, 2012, JP Patent Application No. 200880112125.6 (and English translation)

**INFORMATION DISCLOSURE
STATEMENT BY APPLICANT**
(Not for submission under 37 CFR 1.99)

Application Number		
Filing Date		2016-06-13
First Named Inventor	Inge Bruheim	
Art Unit		
Examiner Name		
Attorney Docket Number	AKBM-14409/US-13/CON	

24	FRICKE, et al., Lipid, Sterol and Fatty Acid Composition of Antarctic Krill (<i>Euphausia superba</i> Dana), <i>Lipids</i> (1984) 19 (11): 821-827.
25	FRICKE, et al., 1-O-Alkylglycerolipids in Antarctic Krill (<i>Euphausia Superba</i> Dana), <i>Comp. Biochem. Physiol.</i> (1986) 85B(1): 131-134
26	GORDEEV, K.Y., et al. "Fatty Acid Composition of the Main Phospholipids of the Antarctic Krill, <i>Euphausia superba</i> ," <i>Chem. Nat. Cmpds.</i> (1990) 26(2), pp. 143-147
27	GRANTHAM (1977) Southern Ocean Fisheries Survey Programme, FAO Rome, GLO/SO/77/3: 1-61.
28	RAVENTOS et al., Application and Possibilities of Supercritical CO2 Extraction in Food Processing Industry: An Overview, <i>Food Science and Technology International</i> (2002) 8: 269-284
29	TANAKA, T., et al., Platelet-activating Factor (PAF)-like Phospholipids Formed during Peroxidation of Phosphatidylcholines from Different Foodstuffs, <i>Biosci. Biotech. Biochem.</i> (1995) 59 (8), pp. 1389-93
30	WINTHER, et al., Elucidation of Phosphatidylcholine Composition in Krill Oil Extracted from <i>Euphausia superba</i> , <i>Lipids</i> (2011) 46: 25-36
31	"Neptune Technologies & Bioresources Soon to Obtain a Major Patent in Over 30 Countries" ("2001 Press Release,")
32	Action Closing Prosecution, '348 patent
33	April 2, 2012 Response to Office Action, '351 patent
34	Balassa et al., Microencapsulation in the Food Industry, <i>Critical Reviews in Food Technology</i> , 2:2, 245-265 (1971) ("Balassa")

**INFORMATION DISCLOSURE
STATEMENT BY APPLICANT**
(Not for submission under 37 CFR 1.99)

Application Number		
Filing Date		2016-06-13
First Named Inventor	Inge Bruheim	
Art Unit		
Examiner Name		
Attorney Docket Number	AKBM-14409/US-13/CON	

35	BELL and DICK, Molecular Species Composition of the Major Diacyl Glycerophospholipids from Muscle, Liver, Retina and Brain of Cod (<i>Gadus morhua</i>), <i>Lipids</i> , Vol. 26, No. 8, pp. 565-573 (1991) ("Bell and Dick")
36	BELL, Molecular Species Analysis of Phosphoglycerides from the Ripe Roes of Cod, <i>Lipids</i> , Vol. 24, No. 7 (1989)
37	BELL, Molecular Species Composition of Phosphatidylcholine from <i>Crypthecodinium cohnii</i> in Relation to Growth Temperature <i>Lipids</i> 25, 115-118 (1990)
38	BERGELSON (ed.), <i>Lipid Biochemical Preparations</i> , Chapter I.1, pp. 1-13 (1980)
39	BOTTINO N.R., "Lipid Composition of Two Species of Antarctic Krill: <i>Euphausia Superba</i> and <i>E. Crystallorophias</i> ," <i>Comp. Biochem. Physiol.</i> , 1975, Vol. 50B, pp. 479-484
40	Buchi R-220 Rotovapor® Manual
41	BUDA, Structural order of membranes and composition of phospholipids in fish brain cells during thermal acclimatization, <i>Proc. Natl. Acad. Sci. USA</i> Vol. 91, pp. 8234-8238, August 1994
42	Certificate of translation of Ex. 1072: Fisheries Agency, General Report on Research and Development of Techniques in Processing and Utilization of Marine Products, Chapter 6, Development of technology for recovery of valuable substances (astaxanthin) from krill, by Takao Fujita, pp. 273-307 (March 1985); Japanese language document
43	Certificate of translation of Ex. 1074: Japanese Patent No. 60-153779, entitled "Nutritional Supplement"
44	Certificate of translation of Ex. 1076: Japanese Patent Publication No. H08-231391, entitled "Medicine for Improvement of Dementia Symptoms"
45	Certification of translation of Ex. 1070: Japanese Unexamined Patent Application Publication No. 02-215351

**INFORMATION DISCLOSURE
STATEMENT BY APPLICANT**
(Not for submission under 37 CFR 1.99)

Application Number		
Filing Date		2016-06-13
First Named Inventor	Inge Bruheim	
Art Unit		
Examiner Name		
Attorney Docket Number	AKBM-14409/US-13/CON	

46	Certified translation of Ex. 1070: Japanese Unexamined Patent Application Publication No. 02-215351, titled Krill Phospholipids Fractioning Method ("Maruyama,"); Certificate of Translation provided as Ex. 1071.
47	Certified translation of Ex. 1072: Fisheries Agency, General Report on Research and Development of Techniques in Processing and Utilization of Marine Products, Chapter 6, Development of technology for recovery of valuable substances (astaxanthin) from krill, by Takao Fujita, pp. 273-307 (March 1985) ("Fujita") ; Certificate of Translation provided as Ex. 1073.
48	Certified translation of Ex. 1074: Japanese Patent No. 60-153779, entitled "Nutritional Supplement" ("Fukuoka "); Certificate of Translation provided as Ex. 1075
49	Certified translation of Ex. 1076: Japanese Patent Publication No. H08-231391, entitled "Medicine for Improvement of Dementia Symptoms" ("Yasawa"); Certificate of Translation provided as Ex. 1077.
50	Declaration of Bjorn Ole Haugsgjerd in support of Inter Partes Review of U.S. Pat. No. 8,278,351

If you wish to add additional non-patent literature document citation information please click the Add button

EXAMINER SIGNATURE

Examiner Signature		Date Considered	
--------------------	--	-----------------	--

*EXAMINER: Initial if reference considered, whether or not citation is in conformance with MPEP 609. Draw line through a citation if not in conformance and not considered. Include copy of this form with next communication to applicant.

¹ See Kind Codes of USPTO Patent Documents at www.USPTO.GOV or MPEP 901.04. ² Enter office that issued the document, by the two-letter code (WIPO Standard ST.3). ³ For Japanese patent documents, the indication of the year of the reign of the Emperor must precede the serial number of the patent document. ⁴ Kind of document by the appropriate symbols as indicated on the document under WIPO Standard ST.16 if possible. ⁵ Applicant is to place a check mark here if English language translation is attached.

**INFORMATION DISCLOSURE
STATEMENT BY APPLICANT**
(Not for submission under 37 CFR 1.99)

Application Number		
Filing Date		2016-06-13
First Named Inventor	Inge Bruheim	
Art Unit		
Examiner Name		
Attorney Docket Number	AKBM-14409/US-13/CON	

CERTIFICATION STATEMENT

Please see 37 CFR 1.97 and 1.98 to make the appropriate selection(s):

That each item of information contained in the information disclosure statement was first cited in any communication from a foreign patent office in a counterpart foreign application not more than three months prior to the filing of the information disclosure statement. See 37 CFR 1.97(e)(1).

OR

That no item of information contained in the information disclosure statement was cited in a communication from a foreign patent office in a counterpart foreign application, and, to the knowledge of the person signing the certification after making reasonable inquiry, no item of information contained in the information disclosure statement was known to any individual designated in 37 CFR 1.56(c) more than three months prior to the filing of the information disclosure statement. See 37 CFR 1.97(e)(2).

See attached certification statement.

The fee set forth in 37 CFR 1.17 (p) has been submitted herewith.

A certification statement is not submitted herewith.

SIGNATURE

A signature of the applicant or representative is required in accordance with CFR 1.33, 10.18. Please see CFR 1.4(d) for the form of the signature.

Signature	/J. Mitchell Jones/	Date (YYYY-MM-DD)	2016-06-13
Name/Print	J. Mitchell Jones	Registration Number	44174

This collection of information is required by 37 CFR 1.97 and 1.98. The information is required to obtain or retain a benefit by the public which is to file (and by the USPTO to process) an application. Confidentiality is governed by 35 U.S.C. 122 and 37 CFR 1.14. This collection is estimated to take 1 hour to complete, including gathering, preparing and submitting the completed application form to the USPTO. Time will vary depending upon the individual case. Any comments on the amount of time you require to complete this form and/or suggestions for reducing this burden, should be sent to the Chief Information Officer, U.S. Patent and Trademark Office, U.S. Department of Commerce, P.O. Box 1450, Alexandria, VA 22313-1450. **DO NOT SEND FEES OR COMPLETED FORMS TO THIS ADDRESS. SEND TO: Commissioner for Patents, P.O. Box 1450, Alexandria, VA 22313-1450.**

Privacy Act Statement

The Privacy Act of 1974 (P.L. 93-579) requires that you be given certain information in connection with your submission of the attached form related to a patent application or patent. Accordingly, pursuant to the requirements of the Act, please be advised that: (1) the general authority for the collection of this information is 35 U.S.C. 2(b)(2); (2) furnishing of the information solicited is voluntary; and (3) the principal purpose for which the information is used by the U.S. Patent and Trademark Office is to process and/or examine your submission related to a patent application or patent. If you do not furnish the requested information, the U.S. Patent and Trademark Office may not be able to process and/or examine your submission, which may result in termination of proceedings or abandonment of the application or expiration of the patent.

The information provided by you in this form will be subject to the following routine uses:

1. The information on this form will be treated confidentially to the extent allowed under the Freedom of Information Act (5 U.S.C. 552) and the Privacy Act (5 U.S.C. 552a). Records from this system of records may be disclosed to the Department of Justice to determine whether the Freedom of Information Act requires disclosure of these records.
2. A record from this system of records may be disclosed, as a routine use, in the course of presenting evidence to a court, magistrate, or administrative tribunal, including disclosures to opposing counsel in the course of settlement negotiations.
3. A record in this system of records may be disclosed, as a routine use, to a Member of Congress submitting a request involving an individual, to whom the record pertains, when the individual has requested assistance from the Member with respect to the subject matter of the record.
4. A record in this system of records may be disclosed, as a routine use, to a contractor of the Agency having need for the information in order to perform a contract. Recipients of information shall be required to comply with the requirements of the Privacy Act of 1974, as amended, pursuant to 5 U.S.C. 552a(m).
5. A record related to an International Application filed under the Patent Cooperation Treaty in this system of records may be disclosed, as a routine use, to the International Bureau of the World Intellectual Property Organization, pursuant to the Patent Cooperation Treaty.
6. A record in this system of records may be disclosed, as a routine use, to another federal agency for purposes of National Security review (35 U.S.C. 181) and for review pursuant to the Atomic Energy Act (42 U.S.C. 218(c)).
7. A record from this system of records may be disclosed, as a routine use, to the Administrator, General Services, or his/her designee, during an inspection of records conducted by GSA as part of that agency's responsibility to recommend improvements in records management practices and programs, under authority of 44 U.S.C. 2904 and 2906. Such disclosure shall be made in accordance with the GSA regulations governing inspection of records for this purpose, and any other relevant (i.e., GSA or Commerce) directive. Such disclosure shall not be used to make determinations about individuals.
8. A record from this system of records may be disclosed, as a routine use, to the public after either publication of the application pursuant to 35 U.S.C. 122(b) or issuance of a patent pursuant to 35 U.S.C. 151. Further, a record may be disclosed, subject to the limitations of 37 CFR 1.14, as a routine use, to the public if the record was filed in an application which became abandoned or in which the proceedings were terminated and which application is referenced by either a published application, an application open to public inspections or an issued patent.
9. A record from this system of records may be disclosed, as a routine use, to a Federal, State, or local law enforcement agency, if the USPTO becomes aware of a violation or potential violation of law or regulation.

INFORMATION DISCLOSURE STATEMENT BY APPLICANT (Not for submission under 37 CFR 1.99)	Application Number	
	Filing Date	2016-06-13
	First Named Inventor	Inge Bruheim
	Art Unit	
	Examiner Name	
	Attorney Docket Number	AKBM-14409/US-13/CON

U.S.PATENTS							Remove
Examiner Initial*	Cite No	Patent Number	Kind Code ¹	Issue Date	Name of Patentee or Applicant of cited Document	Pages,Columns,Lines where Relevant Passages or Relevant Figures Appear	
	1	4038722		1977-08-02	TERASE et al.		
	2	8057825		2011-11-15	SAMPALIS, TINA		

If you wish to add additional U.S. Patent citation information please click the Add button.

Add

U.S.PATENT APPLICATION PUBLICATIONS							Remove
Examiner Initial*	Cite No	Publication Number	Kind Code ¹	Publication Date	Name of Patentee or Applicant of cited Document	Pages,Columns,Lines where Relevant Passages or Relevant Figures Appear	
	1	20050003073		2005-01-06	PIVOVAROV et al.		

If you wish to add additional U.S. Published Application citation information please click the Add button.

Add

FOREIGN PATENT DOCUMENTS								Remove
Examiner Initial*	Cite No	Foreign Document Number ³	Country Code ² i	Kind Code ⁴	Publication Date	Name of Patentee or Applicant of cited Document	Pages,Columns,Lines where Relevant Passages or Relevant Figures Appear	T ⁵
	1	60-153779	JP		1985-08-13	Honen Seiyu Co. Ltd. Et al.		
	2	H08-231391	JP		1996-08-09	Kanagawa Kagaku Kenkyuujo Co., Ltd. Et al.		

**INFORMATION DISCLOSURE
STATEMENT BY APPLICANT**
(Not for submission under 37 CFR 1.99)

Application Number		
Filing Date		2016-06-13
First Named Inventor	Inge Bruheim	
Art Unit		
Examiner Name		
Attorney Docket Number	AKBM-14409/US-13/CON	

If you wish to add additional Foreign Patent Document citation information please click the Add button

NON-PATENT LITERATURE DOCUMENTS

Examiner Initials*	Cite No	Include name of the author (in CAPITAL LETTERS), title of the article (when appropriate), title of the item (book, magazine, journal, serial, symposium, catalog, etc), date, pages(s), volume-issue number(s), publisher, city and/or country where published.	T ⁵
	1	Declaration of Bjorn Ole Haugsgjerd submitted during inter partes reexamination of parent patent U.S. 8,030,348 ("Haugsgjerd '348 Decl.")	
	2	Declaration of Dr. Albert Lee in Support of Inter Partes Review of U.S. Pat. No. 8,278,351 ("Lee")	
	3	Declaration of Dr. Albert Lee in Support of Inter Partes Review of U.S. Pat. No. 8,383,675 ("Lee")	
	4	Declaration of Dr. Chong Lee submitted during inter partes reexamination of parent patent U.S. 8,030,348 ("Yeboah Reexam Decl.")	
	5	Declaration of Dr. Earl White submitted during prosecution of parent patent U.S. 8,030,348 ("2011 White Decl.")	
	6	Declaration of Dr. Ivar Storrø in support of Inter Partes Review of U.S. Pat. No. 8,278,351 ("Storrø")	
	7	Declaration of Dr. Ivar Storrø in support of Inter Partes Review of U.S. Pat. No. 8,383,675 ("Storrø")	
	8	Declaration of Dr. Jacek Jaczynski from inter partes reexamination of the parent patent U.S. 8,030,348 ("Jaczynski Reexam. Decl.")	
	9	Declaration of Dr. Jaczynski submitted during prosecution of parent patent U.S. 8,278,351 (Jaczynski '351 Decl.")	

**INFORMATION DISCLOSURE
STATEMENT BY APPLICANT**
(Not for submission under 37 CFR 1.99)

Application Number		
Filing Date		2016-06-13
First Named Inventor	Inge Bruheim	
Art Unit		
Examiner Name		
Attorney Docket Number	AKBM-14409/US-13/CON	

10	Declaration of Dr. Jeff Moore in Support of Inter Partes Review of U.S. Pat. No. 8,278,351 ("Moore")
11	Declaration of Dr. Jeff Moore in Support of Inter Partes Review of U.S. Pat. No. 8,383,675 ("Moore")
12	Declaration of Dr. Richard van Breemen in Support of Inter Partes Review of U.S. Pat. No. 8,278,351 ("Van Breemen")
13	Declaration of Dr. Richard van Breemen in Support of Inter Partes Review of U.S. Pat. No. 8,383,675 ("Van Breemen")
14	Declaration of Dr. Shahidi submitted during inter partes reexamination of parent patent U.S. 8,030,348 (Shahidi Reexam. Decl.)
15	Declaration of Dr. Shahidi submitted during prosecution of parent patent U.S. 8,278,351 (Shahidi '351 Decl.)
16	Declaration of Dr. Suzanne Budge in Support of Inter Partes Review of U.S. Pat. No. 8,278,351 ("Budge")
17	Declaration of Dr. Suzanne Budge in Support of Inter Partes Review of U.S. Pat. No. 8,383,675 ("Budge")
18	Declaration of Dr. Thomas Brenna in support of Inter Partes Review of U.S. Pat. No. 8,278,351
19	Declaration of Dr. Thomas Brenna in support of Inter Partes Review of U.S. Pat. No. 8,383,675
20	Declaration of Dr. Thomas Gundersen submitted during inter partes reexamination of parent patent U.S. 8,030,348 ("Gundersen Decl.")

**INFORMATION DISCLOSURE
STATEMENT BY APPLICANT**
(Not for submission under 37 CFR 1.99)

Application Number		
Filing Date		2016-06-13
First Named Inventor	Inge Bruheim	
Art Unit		
Examiner Name		
Attorney Docket Number	AKBM-14409/US-13/CON	

21	Declaration of Dr. Tina Sampalis submitted during inter partes reexamination of parent patent U.S. 8,030,348 (Sampalis")
22	Declaration of Dr. Van Breemen submitted during Ex parte Reexamination of the '351 patent (Van Breemen '351 Reexam. Decl."
23	Declaration of Dr. Van Breemen submitted during Inter partes Reexamination of the '348 patent (Van Breemen '348 Reexam Decl."
24	Declaration of Dr. Yeboah submitted during inter partes reexamination of parent patent U.S. 8,030,348 ("Yeboah Reexam Decl.")
25	Declaration of Dr. Yeboah submitted during prosecution of parent patent U.S. 8,278,351 ("Yeboah '351 Decl.")
26	Eichberg, "Lecithin – It Manufacture and Use in the Fat and Oil Industry," Oils and Soap 51-54, 1939 ("Eichberg")
27	Expert Witness Report of Dr. Theodore Welch submitted in relation to ITC Investigation No. 337-TA-877 ("Welch")
28	Farkas, Composition and Physical State of Phospholipids in Calanoid Copepods from India and Norway, LIPIDS, Vol. 23, No. 6 (1988)
29	Final Prospectus dated May 11, 2001 ("Final Prospectus")
30	
31	Folch, et al., A Simple Method for the Isolation and Purification of Total Lipids from Animal Tissues. J. Biol. Chem., 226, 497-509 (1957)

**INFORMATION DISCLOSURE
STATEMENT BY APPLICANT**
(Not for submission under 37 CFR 1.99)

Application Number		
Filing Date		2016-06-13
First Named Inventor	Inge Bruheim	
Art Unit		
Examiner Name		
Attorney Docket Number	AKBM-14409/US-13/CON	

32	Grant of Request for Ex parte Reexamination of the '351 patent
33	Grit et al., Hydrolysis of phosphatidylcholine in aqueous liposome dispersions, Int. J. Pharmaceutics 50:1-6 (1989)
34	HENDERSON et al., Lipid Composition of the Pineal Organ from Rainbow Trout (<i>Oncorhynchus mykiss</i>), Lipids, Vol. 29, No. 5, pp. 311-317 (1994) ("Henderson ")
35	HERMAN and GROVES, The Influence of Free Fatty Acid Formation on the pH of Phospholipid-Stabilized Triglyceride Emulsions, Pharmaceutical Research 10(5):774-776 (1993)
36	Itano Refrigerated Food Co., Ltd., Bio & High Technology Announcement and Natural Astaxanthin & Krill Lecithin, pp. 1-16 (on or before December 28, 1994) ("Itano")
37	JOHNSON and LUCAS, Comparison of Alternative Solvents for Oils Extraction, JAOCS 60(2):229-242 (1983)
38	LE GRANDOIS et al., Investigation of Natural Phosphatidylcholine Sources: Separation and Identification by Liquid Chromatography -Electrospray Ionization-Tandem Mass Spectrometry (LC-ESI-MS2) of Molecular Species, J. Agric. Food Chem., 57, 6014-20 (2009) ("Le Grandois")
39	LIN et al., Effect of Dietary N-3 Fatty Acids Upon the PhospholipidMolecular Species of the Monkey Retina, Invest Ophthalmol Vis Sci. 1994;35:794-803
40	MEDINA et al., C Nuclear Magnetic Resonance Monitoring of Free Fatty Acid Release After Fish Thermal Processing, J. Amer. Oil Chem. Soc. 71(5):479-82 (1994)
41	October 24, 2012 Office Action, '675 patent
42	Office Action dated January 5, 2012, '351 patent

**INFORMATION DISCLOSURE
STATEMENT BY APPLICANT**
(Not for submission under 37 CFR 1.99)

Application Number		
Filing Date		2016-06-13
First Named Inventor	Inge Bruheim	
Art Unit		
Examiner Name		
Attorney Docket Number	AKBM-14409/US-13/CON	

43	Provisional Application No. 60/307,842 (Priority document for the '351 patent), available in PAIR
44	Supplemental Declaration of Bjorn Ole Haugsgjerd submitted during inter partes reexamination of parent patent U.S. 8,030,348 ("Haugsgjerd '348 Supp. Decl.")
45	Supplemental Declaration of Dr. Earl White submitted during inter partes reexamination of parent patent U.S. 8,030,348 ("White Supp. Reexam. Decl.")
46	Supplemental Declaration of Dr. Earl White submitted during prosecution of parent patent U.S. 8,278,351 ("White Supp. Decl.")
47	Supplemental Declaration of Dr. Thomas Gundersen submitted during inter partes reexamination of parent patent U.S. 8,030,348 ("Gundersen Supp. Decl.")
48	Suzuki, T. and Shibata, N., "The utilization of Antarctic krill for human food," Food Rev. Int'l, 6:1, 119-147 (1990) ("Suzuki")
49	Takahashi et al., Compositional Changes in Molecular Species of Fish Muscle Phosphatidylcholine During Storage, Bull. Fac. Fish. Hokkaido Univ. 37(1), 80-84 1986.
50	Takahashi et al., Molecular Species of Fish Muscle Lecithin, Bulletin of the Japanese Society of Scientific Fisheries 48 (12), 1803-1814 (1982)

If you wish to add additional non-patent literature document citation information please click the Add button

EXAMINER SIGNATURE

Examiner Signature		Date Considered	
--------------------	--	-----------------	--

*EXAMINER: Initial if reference considered, whether or not citation is in conformance with MPEP 609. Draw line through a citation if not in conformance and not considered. Include copy of this form with next communication to applicant.

¹ See Kind Codes of USPTO Patent Documents at www.USPTO.GOV or MPEP 901.04. ² Enter office that issued the document, by the two-letter code (WIPO Standard ST.3). ³ For Japanese patent documents, the indication of the year of the reign of the Emperor must precede the serial number of the patent document. ⁴ Kind of document by the appropriate symbols as indicated on the document under WIPO Standard ST.16 if possible. ⁵ Applicant is to place a check mark here if English language translation is attached.

**INFORMATION DISCLOSURE
STATEMENT BY APPLICANT**
(Not for submission under 37 CFR 1.99)

Application Number		
Filing Date		2016-06-13
First Named Inventor	Inge Bruheim	
Art Unit		
Examiner Name		
Attorney Docket Number	AKBM-14409/US-13/CON	

CERTIFICATION STATEMENT

Please see 37 CFR 1.97 and 1.98 to make the appropriate selection(s):

That each item of information contained in the information disclosure statement was first cited in any communication from a foreign patent office in a counterpart foreign application not more than three months prior to the filing of the information disclosure statement. See 37 CFR 1.97(e)(1).

OR

That no item of information contained in the information disclosure statement was cited in a communication from a foreign patent office in a counterpart foreign application, and, to the knowledge of the person signing the certification after making reasonable inquiry, no item of information contained in the information disclosure statement was known to any individual designated in 37 CFR 1.56(c) more than three months prior to the filing of the information disclosure statement. See 37 CFR 1.97(e)(2).

See attached certification statement.

The fee set forth in 37 CFR 1.17 (p) has been submitted herewith.

A certification statement is not submitted herewith.

SIGNATURE

A signature of the applicant or representative is required in accordance with CFR 1.33, 10.18. Please see CFR 1.4(d) for the form of the signature.

Signature	/J. Mitchell Jones/	Date (YYYY-MM-DD)	2016-06-13
Name/Print	J. Mitchell Jones	Registration Number	44174

This collection of information is required by 37 CFR 1.97 and 1.98. The information is required to obtain or retain a benefit by the public which is to file (and by the USPTO to process) an application. Confidentiality is governed by 35 U.S.C. 122 and 37 CFR 1.14. This collection is estimated to take 1 hour to complete, including gathering, preparing and submitting the completed application form to the USPTO. Time will vary depending upon the individual case. Any comments on the amount of time you require to complete this form and/or suggestions for reducing this burden, should be sent to the Chief Information Officer, U.S. Patent and Trademark Office, U.S. Department of Commerce, P.O. Box 1450, Alexandria, VA 22313-1450. **DO NOT SEND FEES OR COMPLETED FORMS TO THIS ADDRESS. SEND TO: Commissioner for Patents, P.O. Box 1450, Alexandria, VA 22313-1450.**

Privacy Act Statement

The Privacy Act of 1974 (P.L. 93-579) requires that you be given certain information in connection with your submission of the attached form related to a patent application or patent. Accordingly, pursuant to the requirements of the Act, please be advised that: (1) the general authority for the collection of this information is 35 U.S.C. 2(b)(2); (2) furnishing of the information solicited is voluntary; and (3) the principal purpose for which the information is used by the U.S. Patent and Trademark Office is to process and/or examine your submission related to a patent application or patent. If you do not furnish the requested information, the U.S. Patent and Trademark Office may not be able to process and/or examine your submission, which may result in termination of proceedings or abandonment of the application or expiration of the patent.

The information provided by you in this form will be subject to the following routine uses:

1. The information on this form will be treated confidentially to the extent allowed under the Freedom of Information Act (5 U.S.C. 552) and the Privacy Act (5 U.S.C. 552a). Records from this system of records may be disclosed to the Department of Justice to determine whether the Freedom of Information Act requires disclosure of these records.
2. A record from this system of records may be disclosed, as a routine use, in the course of presenting evidence to a court, magistrate, or administrative tribunal, including disclosures to opposing counsel in the course of settlement negotiations.
3. A record in this system of records may be disclosed, as a routine use, to a Member of Congress submitting a request involving an individual, to whom the record pertains, when the individual has requested assistance from the Member with respect to the subject matter of the record.
4. A record in this system of records may be disclosed, as a routine use, to a contractor of the Agency having need for the information in order to perform a contract. Recipients of information shall be required to comply with the requirements of the Privacy Act of 1974, as amended, pursuant to 5 U.S.C. 552a(m).
5. A record related to an International Application filed under the Patent Cooperation Treaty in this system of records may be disclosed, as a routine use, to the International Bureau of the World Intellectual Property Organization, pursuant to the Patent Cooperation Treaty.
6. A record in this system of records may be disclosed, as a routine use, to another federal agency for purposes of National Security review (35 U.S.C. 181) and for review pursuant to the Atomic Energy Act (42 U.S.C. 218(c)).
7. A record from this system of records may be disclosed, as a routine use, to the Administrator, General Services, or his/her designee, during an inspection of records conducted by GSA as part of that agency's responsibility to recommend improvements in records management practices and programs, under authority of 44 U.S.C. 2904 and 2906. Such disclosure shall be made in accordance with the GSA regulations governing inspection of records for this purpose, and any other relevant (i.e., GSA or Commerce) directive. Such disclosure shall not be used to make determinations about individuals.
8. A record from this system of records may be disclosed, as a routine use, to the public after either publication of the application pursuant to 35 U.S.C. 122(b) or issuance of a patent pursuant to 35 U.S.C. 151. Further, a record may be disclosed, subject to the limitations of 37 CFR 1.14, as a routine use, to the public if the record was filed in an application which became abandoned or in which the proceedings were terminated and which application is referenced by either a published application, an application open to public inspections or an issued patent.
9. A record from this system of records may be disclosed, as a routine use, to a Federal, State, or local law enforcement agency, if the USPTO becomes aware of a violation or potential violation of law or regulation.

INFORMATION DISCLOSURE STATEMENT BY APPLICANT (Not for submission under 37 CFR 1.99)	Application Number	
	Filing Date	2016-06-13
	First Named Inventor	Inge Bruheim
	Art Unit	
	Examiner Name	
	Attorney Docket Number	AKBM-14409/US-13/CON

U.S.PATENTS						Remove
Examiner Initial*	Cite No	Patent Number	Kind Code ¹	Issue Date	Name of Patentee or Applicant of cited Document	Pages,Columns,Lines where Relevant Passages or Relevant Figures Appear
	1	9119864		2015-09-01	AKER BIOMARINE ANTARCTIC AS	
	2	9072752		2015-07-07	AKER BIOMARINE ANTARCTIC AS	
	3	9034388		2015-05-19	Inge Bruheim et al.	
	4	9028877		2015-05-12	AKER BIOMARINE ANTARCTIC AS	
	5	9078905		2015-07-14	AKER BIOMARINE ANTARCTIC AS	
	6	8372812		2013-02-12	Snorre Tilseth et al.	
	7	8697138		2014-04-15	Inge Bruheim et al.	
If you wish to add additional U.S. Patent citation information please click the Add button.						Add
U.S.PATENT APPLICATION PUBLICATIONS						Remove

**INFORMATION DISCLOSURE
STATEMENT BY APPLICANT**
(Not for submission under 37 CFR 1.99)

Application Number		
Filing Date		2016-06-13
First Named Inventor	Inge Bruheim	
Art Unit		
Examiner Name		
Attorney Docket Number	AKBM-14409/US-13/CON	

Examiner Initial*	Cite No	Publication Number	Kind Code ¹	Publication Date	Name of Patentee or Applicant of cited Document	Pages, Columns, Lines where Relevant Passages or Relevant Figures Appear
	1	20140274968		2014-09-18	AKER BIOMARINE ANTARCTIC AS	
	2	20150030718		2015-01-29	AKER BIOMARINE ANTARCTIC AS	
	3	20140088043		2014-03-27	AKER BIOMARINE ANTARCTIC AS	
	4	20140088047		2014-03-27	AKER BIOMARINE ANTARCTIC AS	
	5	20140080791		2014-03-20	AKER BIOMARINE ANTARCTIC AS	
	6	20150164841		2015-06-18	AKER BIOMARINE ANTARCTIC AS	
	7	20140363517		2014-12-11	AKER BIOMARINE ANTARCTIC AS	
	8	20100226977		2010-09-09	Snorre Tilseth et al.	
	9	20150050403		2015-02-19	AKER BIOMARINE ANTARCTIC AS	
	10	20140005421		2014-01-02	AKER BIOMARINE ANTARCTIC AS	

**INFORMATION DISCLOSURE
STATEMENT BY APPLICANT**
(Not for submission under 37 CFR 1.99)

Application Number		
Filing Date		2016-06-13
First Named Inventor	Inge Bruheim	
Art Unit		
Examiner Name		
Attorney Docket Number	AKBM-14409/US-13/CON	

11	20140107072	2014-04-17	Snorre Tilseth et al.
12	20090061067	2009-03-05	Snorre Tilseth et al.
13	20140010888	2014-01-09	AKER BIOMARINE ANTARCTIC AS

If you wish to add additional U.S. Published Application citation information please click the Add button.

FOREIGN PATENT DOCUMENTS

Examiner Initial*	Cite No	Foreign Document Number ³	Country Code ² i	Kind Code ⁴	Publication Date	Name of Patentee or Applicant of cited Document	Pages, Columns, Lines where Relevant Passages or Relevant Figures Appear	T ⁵
	1							

If you wish to add additional Foreign Patent Document citation information please click the Add button.

NON-PATENT LITERATURE DOCUMENTS

Examiner Initials*	Cite No	Include name of the author (in CAPITAL LETTERS), title of the article (when appropriate), title of the item (book, magazine, journal, serial, symposium, catalog, etc), date, pages(s), volume-issue number(s), publisher, city and/or country where published.	T ⁵
	1	Takahashi et al., Prediction of Relative Retention Value of the Individual Molecular Species of Diacyl Glycerolipid on High Performance Liquid Chromatography, Bull. Fac. Fish. Hokkaido Univ. 38(4), 398-404. 1987	
	2	Tanaka, Biosynthesis of 1,2-dieicosapentaenoyl-sn-glycero-3-phosphocholine in Caenorhabditis elegans, Eur. J. Biochem. 263, 189±194 (1999)	
	3	Tocher, Chapter 6, Glycerophospholipid metabolism, Biochemistry and molecular biology of fishes, vol. 4, Hochachka and Mommsen (eds.)(1995)	

**INFORMATION DISCLOSURE
STATEMENT BY APPLICANT**
(Not for submission under 37 CFR 1.99)

Application Number		
Filing Date		2016-06-13
First Named Inventor	Inge Bruheim	
Art Unit		
Examiner Name		
Attorney Docket Number	AKBM-14409/US-13/CON	

4	Watanabe et al., Effective Components in Cuttlefish Meal and Raw Krill for Improvement of Quality of Red Seabream Pagrus major Eggs, Nippon Suisan Gakkaishi 57(4):681-694 (1991)("Watanabe")
5	WHO News and Activities, Bulletin of the World Health Organization, 73(4), pp. 547-51 (1995) ("WHO Bulletin")
6	VALERI, D., et al., "Viscosities of Fatty acids, triglycerides and their binary mixtures," JAOCS 74 (1997) pp. 1221-1226
7	CRC 2013-2014, 94th ed., pp. 6-231-6-235
8	EP Opposition filed February 13, 2014 by Olympic Seafood AS, EP Patent Application No. EP0871891016
9	BRZUSTOWICZ, Michael R., et al., "Controlling Membrane Cholesterol Content. A Role for Polyunsaturated (Docosahexaenoate) Phospholipids," Biochemistry (2002), 41, pp. 12509-12519
10	JONG-HO LEE, "A Review: Antioxygenic and Peroxide-decomposing Activities of Antarctic Krill Lipids," J. Korean Soc. Food Nutr. 13(3) pp. 326-333 (1984)
11	KI WOONG CHO, et al., "Lipid and Fatty Acid Composition of the Antarctic Krill Euphausia superba," Ocean Research 21(2): 109-116 (1999)
12	HVATTUM, Erlend, et al., "Effect of soybean oil and fish oil on individual molecular species of Atlantic salmon...", Journal of Chromatography B, 748 (2000) 137-149
13	GARASHI, Daisuke, et al., "Positional Distribution of DHA and EPA in Phosphatidylcholine and Phosphatidylethanolamine from Different Tissues of Squids," J. Oleo Sci. Vol. 50, No. 9 (2001)
14	TOCHIZAWA, Kaoru, et al., "Effects of Phospholipids Containing Docosahexaenoic Acid on Differentiation and Growth of HL-60 Human Promyelocytic Leukemia Cells," J. Jpn. Oil Chem. Soc. Vol. 46, No. 4 (1997)

**INFORMATION DISCLOSURE
STATEMENT BY APPLICANT**
(Not for submission under 37 CFR 1.99)

Application Number		
Filing Date		2016-06-13
First Named Inventor	Inge Bruheim	
Art Unit		
Examiner Name		
Attorney Docket Number	AKBM-14409/US-13/CON	

15	ZEROUGA, Mustapha, et al., "Comparison of phosphatidylcholines containing one or two docosahexaenoic acyl chains on properties of phospholipid monolayers and bilayers," Biochimica et Biophysica Acta 1236 (1995) 266-272
16	EUNG-HO LEE, et al., "Studies on the Processing of Krill Sauce," J. Korean Soc. Food Nutr. 13(1) 97-106 (1984)
17	HYUN-KU KIM, et al., "Effects of Cooking and Drying Methods on the Polar Lipids Composition of Shrimp," Korean J. Food Sci. Technol. Vol. 21, No. 1, pp. 25-30 (1989)
18	SHON, Mi-Yae, et al., "Effects of Krill and Cadmium on Lipid Composition of Plasma in Cholesterol-Fed Rats," J. Korean Soc. Food Nutr. 23(1), 38-43 (1994)
19	Summons Materials downloaded from ESPACE on December 16, 2014 for EP Patent Application No. 08 718 910.6
20	YANASE, M., "Innovations on the russian method for separating heat coagulated protein from antarctic krill, through autolysis," Bulletin of Tokai Regional Fisheries Research Laboratory, 1974, No. 78, p. 79-84
21	KOLAKOWSKI and GAJOWIECKI, "Optimization of autoprotoleolysis to obtain and edible product 'precipitate' from Antarctic krill," Seafood Science and Technology, pp. 331-336
22	EP Opposition filed May 8, 2015 by Olympic Seafood AS, EP Patent No. 2144618, 150 pages
23	ALLAHPICHAY et al., "Extraction of Growth Promoting Fractions from Non-muscle Krill Meal of Euphausia superba and its Effect on Fish Growth," Bulletin of the Japanese Society of Scientific Fisheries, 1984, 50(5): 821-826

If you wish to add additional non-patent literature document citation information please click the Add button

EXAMINER SIGNATURE

Examiner Signature		Date Considered	
--------------------	--	-----------------	--

*EXAMINER: Initial if reference considered, whether or not citation is in conformance with MPEP 609. Draw line through a citation if not in conformance and not considered. Include copy of this form with next communication to applicant.

**INFORMATION DISCLOSURE
STATEMENT BY APPLICANT**
(Not for submission under 37 CFR 1.99)

Application Number		
Filing Date		2016-06-13
First Named Inventor	Inge Bruheim	
Art Unit		
Examiner Name		
Attorney Docket Number		AKBM-14409/US-13/CON

¹ See Kind Codes of USPTO Patent Documents at www.USPTO.GOV or MPEP 901.04. ² Enter office that issued the document, by the two-letter code (WIPO Standard ST.3). ³ For Japanese patent documents, the indication of the year of the reign of the Emperor must precede the serial number of the patent document. ⁴ Kind of document by the appropriate symbols as indicated on the document under WIPO Standard ST.16 if possible. ⁵ Applicant is to place a check mark here if English language translation is attached.

**INFORMATION DISCLOSURE
STATEMENT BY APPLICANT**
(Not for submission under 37 CFR 1.99)

Application Number		
Filing Date		2016-06-13
First Named Inventor	Inge Bruheim	
Art Unit		
Examiner Name		
Attorney Docket Number	AKBM-14409/US-13/CON	

CERTIFICATION STATEMENT

Please see 37 CFR 1.97 and 1.98 to make the appropriate selection(s):

That each item of information contained in the information disclosure statement was first cited in any communication from a foreign patent office in a counterpart foreign application not more than three months prior to the filing of the information disclosure statement. See 37 CFR 1.97(e)(1).

OR

That no item of information contained in the information disclosure statement was cited in a communication from a foreign patent office in a counterpart foreign application, and, to the knowledge of the person signing the certification after making reasonable inquiry, no item of information contained in the information disclosure statement was known to any individual designated in 37 CFR 1.56(c) more than three months prior to the filing of the information disclosure statement. See 37 CFR 1.97(e)(2).

See attached certification statement.

The fee set forth in 37 CFR 1.17 (p) has been submitted herewith.

A certification statement is not submitted herewith.

SIGNATURE

A signature of the applicant or representative is required in accordance with CFR 1.33, 10.18. Please see CFR 1.4(d) for the form of the signature.

Signature	/J. Mitchell Jones/	Date (YYYY-MM-DD)	2016-06-13
Name/Print	J. Mitchell Jones	Registration Number	44174

This collection of information is required by 37 CFR 1.97 and 1.98. The information is required to obtain or retain a benefit by the public which is to file (and by the USPTO to process) an application. Confidentiality is governed by 35 U.S.C. 122 and 37 CFR 1.14. This collection is estimated to take 1 hour to complete, including gathering, preparing and submitting the completed application form to the USPTO. Time will vary depending upon the individual case. Any comments on the amount of time you require to complete this form and/or suggestions for reducing this burden, should be sent to the Chief Information Officer, U.S. Patent and Trademark Office, U.S. Department of Commerce, P.O. Box 1450, Alexandria, VA 22313-1450. **DO NOT SEND FEES OR COMPLETED FORMS TO THIS ADDRESS. SEND TO: Commissioner for Patents, P.O. Box 1450, Alexandria, VA 22313-1450.**

Privacy Act Statement

The Privacy Act of 1974 (P.L. 93-579) requires that you be given certain information in connection with your submission of the attached form related to a patent application or patent. Accordingly, pursuant to the requirements of the Act, please be advised that: (1) the general authority for the collection of this information is 35 U.S.C. 2(b)(2); (2) furnishing of the information solicited is voluntary; and (3) the principal purpose for which the information is used by the U.S. Patent and Trademark Office is to process and/or examine your submission related to a patent application or patent. If you do not furnish the requested information, the U.S. Patent and Trademark Office may not be able to process and/or examine your submission, which may result in termination of proceedings or abandonment of the application or expiration of the patent.

The information provided by you in this form will be subject to the following routine uses:

1. The information on this form will be treated confidentially to the extent allowed under the Freedom of Information Act (5 U.S.C. 552) and the Privacy Act (5 U.S.C. 552a). Records from this system of records may be disclosed to the Department of Justice to determine whether the Freedom of Information Act requires disclosure of these records.
2. A record from this system of records may be disclosed, as a routine use, in the course of presenting evidence to a court, magistrate, or administrative tribunal, including disclosures to opposing counsel in the course of settlement negotiations.
3. A record in this system of records may be disclosed, as a routine use, to a Member of Congress submitting a request involving an individual, to whom the record pertains, when the individual has requested assistance from the Member with respect to the subject matter of the record.
4. A record in this system of records may be disclosed, as a routine use, to a contractor of the Agency having need for the information in order to perform a contract. Recipients of information shall be required to comply with the requirements of the Privacy Act of 1974, as amended, pursuant to 5 U.S.C. 552a(m).
5. A record related to an International Application filed under the Patent Cooperation Treaty in this system of records may be disclosed, as a routine use, to the International Bureau of the World Intellectual Property Organization, pursuant to the Patent Cooperation Treaty.
6. A record in this system of records may be disclosed, as a routine use, to another federal agency for purposes of National Security review (35 U.S.C. 181) and for review pursuant to the Atomic Energy Act (42 U.S.C. 218(c)).
7. A record from this system of records may be disclosed, as a routine use, to the Administrator, General Services, or his/her designee, during an inspection of records conducted by GSA as part of that agency's responsibility to recommend improvements in records management practices and programs, under authority of 44 U.S.C. 2904 and 2906. Such disclosure shall be made in accordance with the GSA regulations governing inspection of records for this purpose, and any other relevant (i.e., GSA or Commerce) directive. Such disclosure shall not be used to make determinations about individuals.
8. A record from this system of records may be disclosed, as a routine use, to the public after either publication of the application pursuant to 35 U.S.C. 122(b) or issuance of a patent pursuant to 35 U.S.C. 151. Further, a record may be disclosed, subject to the limitations of 37 CFR 1.14, as a routine use, to the public if the record was filed in an application which became abandoned or in which the proceedings were terminated and which application is referenced by either a published application, an application open to public inspections or an issued patent.
9. A record from this system of records may be disclosed, as a routine use, to a Federal, State, or local law enforcement agency, if the USPTO becomes aware of a violation or potential violation of law or regulation.

Electronic Patent Application Fee Transmittal

Application Number:				
Filing Date:				
Title of Invention:	BIOEFFECTIVE KRILL OIL COMPOSITIONS			
First Named Inventor/Applicant Name:	Inge Bruheim			
Filer:	John Mitchell Jones/Mallory Checkett			
Attorney Docket Number:	AKBM-14409/US-13/CON			
Filed as Large Entity				
Filing Fees for Track I Prioritized Examination - Nonprovisional Application under 35 USC 111(a)				
Description	Fee Code	Quantity	Amount	Sub-Total in USD(\$)
Basic Filing:				
Utility application filing	1011	1	280	280
Utility Search Fee	1111	1	600	600
Utility Examination Fee	1311	1	720	720
Request for Prioritized Examination	1817	1	4000	4000
Pages:				
Claims:				
Miscellaneous-Filing:				

Description	Fee Code	Quantity	Amount	Sub-Total in USD(\$)
Publ. Fee- Early, Voluntary, or Normal	1504	1	0	0
PROCESSING FEE, EXCEPT PROV. APPLS.	1830	1	140	140
Petition:				
Patent-Appeals-and-Interference:				
Post-Allowance-and-Post-Issuance:				
Extension-of-Time:				
Miscellaneous:				
Total in USD (\$)				5740

Electronic Acknowledgement Receipt

EFS ID:	26042799
Application Number:	15180439
International Application Number:	
Confirmation Number:	4687
Title of Invention:	BIOEFFECTIVE KRILL OIL COMPOSITIONS
First Named Inventor/Applicant Name:	Inge Bruheim
Customer Number:	72960
Filer:	John Mitchell Jones/Mallory Checkett
Filer Authorized By:	John Mitchell Jones
Attorney Docket Number:	AKBM-14409/US-13/CON
Receipt Date:	13-JUN-2016
Filing Date:	
Time Stamp:	14:09:10
Application Type:	Utility under 35 USC 111(a)

Payment information:

Submitted with Payment	yes
Payment Type	Deposit Account
Payment was successfully received in RAM	\$5740
RAM confirmation Number	392
Deposit Account	504302
Authorized User	JONES, J. MITCHELL

The Director of the USPTO is hereby authorized to charge indicated fees and credit any overpayment as follows:

Charge any Additional Fees required under 37 CFR 1.16 (National application filing, search, and examination fees)

Charge any Additional Fees required under 37 CFR 1.17 (Patent application

RIMFROST EXHIBIT 1063 page 0137

Charge any Additional Fees required under 37 CFR 1.19 (Document supply fees)
 Charge any Additional Fees required under 37 CFR 1.20 (Post Issuance fees)
 Charge any Additional Fees required under 37 CFR 1.21 (Miscellaneous fees and charges)

File Listing:

Document Number	Document Description	File Name	File Size(Bytes)/ Message Digest	Multi Part /.zip	Pages (if appl.)
1	TrackOne Request	14409US13CON_Track1Request.pdf	125259	no	2
			8c95938261ba7c120ac3cc413dff1aba80e42269		
Warnings:					
Information:					
2	Application Data Sheet	14409US13CON_ADS.pdf	1823760	no	9
			8fa208eb997be5e274ba1cdc363ae974e2459ae3		
Warnings:					
Information:					
3	Oath or Declaration filed	14409_DeclarationsParent_EXEC.pdf	239051	no	3
			4e654da35fd722f3330d99b1d1ce200d3bb407		
Warnings:					
Information:					
4		14409US13CON_Application.pdf	267350	yes	54
			59e2677b2b7d3284a7743d56c8ebc9fa4e9bf44e		
	Multipart Description/PDF files in .zip description				
	Document Description		Start	End	
	Specification		1	50	
	Claims		51	53	
	Abstract		54	54	
Warnings:					
Information:					
5	Drawings-other than black and white line drawings	14409US13CON_Drawings_uspto.pdf	6756740	no	19
			bc388cb2d3094d2c0d5ba76e9ad0b35461f4846d		
Warnings:					
Information:					
6	Transmittal Letter	14409US13CON_IDS_Letter.pdf	88454	no	1

Warnings:					
Information:					
7	Information Disclosure Statement (IDS) Form (SB08)	14409US13CON_IDS_1.pdf	1041487 5560d21e48710982e22a5bf8aad239233379fc26	no	13
Warnings:					
Information:					
8	Information Disclosure Statement (IDS) Form (SB08)	14409US13CON_IDS_2.pdf	1041711 73ab8b6f6f34d728db21d135d90e6e87d04acdc	no	15
Warnings:					
Information:					
9	Information Disclosure Statement (IDS) Form (SB08)	14409US13CON_IDS_3.pdf	1037964 7943268ef6b2ab8cadac1f4d656d261a7e06145e	no	8
Warnings:					
Information:					
10	Information Disclosure Statement (IDS) Form (SB08)	14409US13CON_IDS_4.pdf	1037936 eee7659c34a3dc8f403ace6d8ecd9af2c43327d2	no	8
Warnings:					
Information:					
11	Fee Worksheet (SB06)	fee-info.pdf	40465 c31bbffc9dfec6e2b9f0f327c0d52d037e05145	no	2
Warnings:					
Information:					
Total Files Size (in bytes):				13500177	

This Acknowledgement Receipt evidences receipt on the noted date by the USPTO of the indicated documents, characterized by the applicant, and including page counts, where applicable. It serves as evidence of receipt similar to a Post Card, as described in MPEP 503.

New Applications Under 35 U.S.C. 111

If a new application is being filed and the application includes the necessary components for a filing date (see 37 CFR 1.53(b)-(d) and MPEP 506), a Filing Receipt (37 CFR 1.54) will be issued in due course and the date shown on this Acknowledgement Receipt will establish the filing date of the application.

National Stage of an International Application under 35 U.S.C. 371

If a timely submission to enter the national stage of an international application is compliant with the conditions of 35 U.S.C. 371 and other applicable requirements a Form PCT/DO/EO/903 indicating acceptance of the application as a national stage submission under 35 U.S.C. 371 will be issued in addition to the Filing Receipt, in due course.

New International Application Filed with the USPTO as a Receiving Office

If a new international application is being filed and the international application includes the necessary components for an international filing date (see PCT Article 11 and MPEP 1810), a Notification of the International Application Number and of the International Filing Date (Form PCT/RO/105) will be issued in due course, subject to prescriptions concerning national security, and the date shown on this Acknowledgement Receipt will establish the international filing date of the application.

Under the Paperwork Reduction Act of 1995, no persons are required to respond to a collection of information unless it displays a valid OMB control number

POWER OF ATTORNEY BY APPLICANT

I hereby revoke all previous powers of attorney given in the application identified in either the attached transmittal letter or the boxes below.

Application Number	Filing Date
15/180,439	13-Jun-2016

(Note: The boxes above may be left blank if information is provided on form PTO/AIA/82A.)

I hereby appoint the Patent Practitioner(s) associated with the following Customer Number as my/our attorney(s) or agent(s), and to transact all business in the United States Patent and Trademark Office connected therewith for the application referenced in the attached transmittal letter (form PTO/AIA/82A) or identified above:

72960

OR

I hereby appoint Practitioner(s) named in the attached list (form PTO/AIA/82C) as my/our attorney(s) or agent(s), and to transact all business in the United States Patent and Trademark Office connected therewith for the patent application referenced in the attached transmittal letter (form PTO/AIA/82A) or identified above. (Note: Complete form PTO/AIA/82C.)

Please recognize or change the correspondence address for the application identified in the attached transmittal letter or the boxes above to:

The address associated with the above-mentioned Customer Number

OR

The address associated with Customer Number:

OR

Firm or Individual Name			
Address			
City	State	Zip	
Country			
Telephone	Email		

I am the Applicant (if the Applicant is a juristic entity, list the Applicant name in the box):

AKER BIOMARINE ANTARCTIC AS

- Inventor or Joint Inventor (title not required below)
- Legal Representative of a Deceased or Legally Incapacitated Inventor (title not required below)
- Assignee or Person to Whom the Inventor is Under an Obligation to Assign (provide signer's title if applicant is a juristic entity)
- Person Who Otherwise Shows Sufficient Proprietary Interest (e.g., a petition under 37 CFR 1.46(b)(2) was granted in the application or is concurrently being filed with this document) (provide signer's title if applicant is a juristic entity)

SIGNATURE of Applicant for Patent

The undersigned (whose title is supplied below) is authorized to act on behalf of the applicant (e.g., where the applicant is a juristic entity).

Signature	Date (Optional)
Name	
Title	

NOTE: Signature - This form must be signed by the applicant in accordance with 37 CFR 1.33. See 37 CFR 1.4 for signature requirements and certifications. If more than one applicant, use multiple forms.

Total of 1 forms are submitted.

This collection of information is required by 37 CFR 1.131, 1.32, and 1.33. The information is required to obtain or retain a benefit by the public which is to file (and by the USPTO to process) an application. Confidentiality is governed by 39 U.S.C. 122 and 37 CFR 1.11 and 1.14. This collection is estimated to take 3 minutes to complete, including gathering, preparing, and submitting the completed application form to the USPTO. Time will vary depending upon the individual case. Any comments on the amount of time you require to complete this form and/or suggestions for reducing this burden, should be sent to the Chief Information Officer, U.S. Patent and Trademark Office, U.S. Department of Commerce, P.O. Box 1450, Alexandria, VA 22313-1450. DO NOT SEND FEES OR COMPLETED FORMS TO THIS ADDRESS. SEND TO: Commissioner for Patents, P.O. Box 1450, Alexandria, VA 22313-1450.

If you need assistance in completing the form, call 1-800-PTO-9199 and select option 2.

Electronic Acknowledgement Receipt

EFS ID:	26047155
Application Number:	15180439
International Application Number:	
Confirmation Number:	4687
Title of Invention:	BIOEFFECTIVE KRILL OIL COMPOSITIONS
First Named Inventor/Applicant Name:	Inge Bruheim
Customer Number:	72960
Filer:	John Mitchell Jones/Mallory Checkett
Filer Authorized By:	John Mitchell Jones
Attorney Docket Number:	AKBM-14409/US-13/CON
Receipt Date:	13-JUN-2016
Filing Date:	
Time Stamp:	15:41:36
Application Type:	Utility under 35 USC 111(a)

Payment information:

Submitted with Payment	no
------------------------	----

File Listing:

Document Number	Document Description	File Name	File Size(Bytes)/ Message Digest	Multi Part /.zip	Pages (if appl.)
1	Power of Attorney	14409US13CON_POA_Exec.pdf	304240 <small>bab30da8209e348e43a8ef5f7835431186645388</small>	no	1

Warnings:

Information:

This Acknowledgement Receipt evidences receipt on the noted date by the USPTO of the indicated documents, characterized by the applicant, and including page counts, where applicable. It serves as evidence of receipt similar to a Post Card, as described in MPEP 503.

New Applications Under 35 U.S.C. 111

If a new application is being filed and the application includes the necessary components for a filing date (see 37 CFR 1.53(b)-(d) and MPEP 506), a Filing Receipt (37 CFR 1.54) will be issued in due course and the date shown on this Acknowledgement Receipt will establish the filing date of the application.

National Stage of an International Application under 35 U.S.C. 371

If a timely submission to enter the national stage of an international application is compliant with the conditions of 35 U.S.C. 371 and other applicable requirements a Form PCT/DO/EO/903 indicating acceptance of the application as a national stage submission under 35 U.S.C. 371 will be issued in addition to the Filing Receipt, in due course.

New International Application Filed with the USPTO as a Receiving Office

If a new international application is being filed and the international application includes the necessary components for an international filing date (see PCT Article 11 and MPEP 1810), a Notification of the International Application Number and of the International Filing Date (Form PCT/RO/105) will be issued in due course, subject to prescriptions concerning national security, and the date shown on this Acknowledgement Receipt will establish the international filing date of the application.

PATENT APPLICATION FEE DETERMINATION RECORD
 Substitute for Form PTO-875

Application or Docket Number
 15/180,439

APPLICATION AS FILED - PART I

		(Column 1)	(Column 2)	SMALL ENTITY		OR	OTHER THAN SMALL ENTITY	
FOR		NUMBER FILED	NUMBER EXTRA	RATE(\$)	FEE(\$)		RATE(\$)	FEE(\$)
BASIC FEE (37 CFR 1.16(a), (b), or (c))		N/A	N/A	N/A			N/A	280
SEARCH FEE (37 CFR 1.16(k), (l), or (m))		N/A	N/A	N/A			N/A	600
EXAMINATION FEE (37 CFR 1.16(o), (p), or (q))		N/A	N/A	N/A			N/A	720
TOTAL CLAIMS (37 CFR 1.16(j))		20	minus 20 = *			OR	x 80 =	0.00
INDEPENDENT CLAIMS (37 CFR 1.16(h))		2	minus 3 = *				x 420 =	0.00
APPLICATION SIZE FEE (37 CFR 1.16(s))	If the specification and drawings exceed 100 sheets of paper, the application size fee due is \$310 (\$155 for small entity) for each additional 50 sheets or fraction thereof. See 35 U.S.C. 41(a)(1)(G) and 37 CFR 1.16(s).							0.00
MULTIPLE DEPENDENT CLAIM PRESENT (37 CFR 1.16(j))								0.00
				TOTAL			TOTAL	1600

* If the difference in column 1 is less than zero, enter "0" in column 2.

APPLICATION AS AMENDED - PART II

						SMALL ENTITY		OR	OTHER THAN SMALL ENTITY			
		(Column 1)	(Column 2)	(Column 3)			RATE(\$)	ADDITIONAL FEE(\$)		RATE(\$)	ADDITIONAL FEE(\$)	
AMENDMENT A	CLAIMS REMAINING AFTER AMENDMENT			HIGHEST NUMBER PREVIOUSLY PAID FOR	PRESENT EXTRA				OR			
	Total (37 CFR 1.16(j))	*	Minus	**	=	x	=		OR	x	=	
	Independent (37 CFR 1.16(h))	*	Minus	***	=	x	=		OR	x	=	
	Application Size Fee (37 CFR 1.16(s))									OR		
	FIRST PRESENTATION OF MULTIPLE DEPENDENT CLAIM (37 CFR 1.16(j))									OR		
						TOTAL ADD'L FEE			OR	TOTAL ADD'L FEE		
AMENDMENT B	CLAIMS REMAINING AFTER AMENDMENT			HIGHEST NUMBER PREVIOUSLY PAID FOR	PRESENT EXTRA				OR			
	Total (37 CFR 1.16(j))	*	Minus	**	=	x	=		OR	x	=	
	Independent (37 CFR 1.16(h))	*	Minus	***	=	x	=		OR	x	=	
	Application Size Fee (37 CFR 1.16(s))									OR		
	FIRST PRESENTATION OF MULTIPLE DEPENDENT CLAIM (37 CFR 1.16(j))									OR		
						TOTAL ADD'L FEE			OR	TOTAL ADD'L FEE		

* If the entry in column 1 is less than the entry in column 2, write "0" in column 3.

** If the "Highest Number Previously Paid For" IN THIS SPACE is less than 20, enter "20".

*** If the "Highest Number Previously Paid For" IN THIS SPACE is less than 3, enter "3".

The "Highest Number Previously Paid For" (Total or Independent) is the highest found in the appropriate box in column 1.



UNITED STATES PATENT AND TRADEMARK OFFICE

UNITED STATES DEPARTMENT OF COMMERCE
United States Patent and Trademark Office
Address: COMMISSIONER FOR PATENTS
P.O. Box 1450
Alexandria, Virginia 22313-1450
www.uspto.gov

Table with 6 columns: APPLICATION NUMBER, FILING or 371(c) DATE, GRP ART UNIT, FIL FEE REC'D, ATTY.DOCKET.NO, TOT CLAIMS, IND CLAIMS. Row 1: 15/180,439, 06/13/2016, 1600, AKBM-14409/US-13/CON, 20, 2

CONFIRMATION NO. 4687

FILING RECEIPT

72960
Casimir Jones, S.C.
2275 DEMING WAY, SUITE 310
MIDDLETON, WI 53562



Date Mailed: 06/24/2016

Receipt is acknowledged of this non-provisional patent application. The application will be taken up for examination in due course. Applicant will be notified as to the results of the examination. Any correspondence concerning the application must include the following identification information: the U.S. APPLICATION NUMBER, FILING DATE, NAME OF APPLICANT, and TITLE OF INVENTION. Fees transmitted by check or draft are subject to collection. Please verify the accuracy of the data presented on this receipt. If an error is noted on this Filing Receipt, please submit a written request for a Filing Receipt Correction. Please provide a copy of this Filing Receipt with the changes noted thereon. If you received a "Notice to File Missing Parts" for this application, please submit any corrections to this Filing Receipt with your reply to the Notice. When the USPTO processes the reply to the Notice, the USPTO will generate another Filing Receipt incorporating the requested corrections

Inventor(s)

Inge Bruheim, Volda, NORWAY;
Snorre Tilseth, Bergen, NORWAY;
Daniele Mancinelli, Orsta, NORWAY;

Applicant(s)

AKER BIOMARINE ANTARCTIC AS, Stamsund, NORWAY;

Power of Attorney: The patent practitioners associated with Customer Number 72960

Domestic Priority data as claimed by applicant

This application is a CON of 14/020,162 09/06/2013 PAT 9375453
which is a CON of 12/057,775 03/28/2008 PAT 9034388
which claims benefit of 60/920,483 03/28/2007
and claims benefit of 60/975,058 09/25/2007
and claims benefit of 60/983,446 10/29/2007
and claims benefit of 61/024,072 01/28/2008

Foreign Applications for which priority is claimed (You may be eligible to benefit from the Patent Prosecution Highway program at the USPTO. Please see http://www.uspto.gov for more information.) - None.

Foreign application information must be provided in an Application Data Sheet in order to constitute a claim to foreign priority. See 37 CFR 1.55 and 1.76.

Permission to Access Application via Priority Document Exchange: Yes

Permission to Access Search Results: Yes

Applicant may provide or rescind an authorization for access using Form PTO/SB/39 or Form PTO/SB/69 as appropriate.

If Required, Foreign Filing License Granted: 06/22/2016

The country code and number of your priority application, to be used for filing abroad under the Paris Convention, is **US 15/180,439**

Projected Publication Date: 09/29/2016

Non-Publication Request: No

Early Publication Request: No

Title

BIOEFFECTIVE KRILL OIL COMPOSITIONS

Preliminary Class

Statement under 37 CFR 1.55 or 1.78 for AIA (First Inventor to File) Transition Applications: No

PROTECTING YOUR INVENTION OUTSIDE THE UNITED STATES

Since the rights granted by a U.S. patent extend only throughout the territory of the United States and have no effect in a foreign country, an inventor who wishes patent protection in another country must apply for a patent in a specific country or in regional patent offices. Applicants may wish to consider the filing of an international application under the Patent Cooperation Treaty (PCT). An international (PCT) application generally has the same effect as a regular national patent application in each PCT-member country. The PCT process **simplifies** the filing of patent applications on the same invention in member countries, but **does not result** in a grant of "an international patent" and does not eliminate the need of applicants to file additional documents and fees in countries where patent protection is desired.

Almost every country has its own patent law, and a person desiring a patent in a particular country must make an application for patent in that country in accordance with its particular laws. Since the laws of many countries differ in various respects from the patent law of the United States, applicants are advised to seek guidance from specific foreign countries to ensure that patent rights are not lost prematurely.

Applicants also are advised that in the case of inventions made in the United States, the Director of the USPTO must issue a license before applicants can apply for a patent in a foreign country. The filing of a U.S. patent application serves as a request for a foreign filing license. The application's filing receipt contains further information and guidance as to the status of applicant's license for foreign filing.

Applicants may wish to consult the USPTO booklet, "General Information Concerning Patents" (specifically, the section entitled "Treaties and Foreign Patents") for more information on timeframes and deadlines for filing foreign patent applications. The guide is available either by contacting the USPTO Contact Center at 800-786-9199, or it can be viewed on the USPTO website at <http://www.uspto.gov/web/offices/pac/doc/general/index.html>.

For information on preventing theft of your intellectual property (patents, trademarks and copyrights), you may wish to consult the U.S. Government website, <http://www.stopfakes.gov>. Part of a Department of Commerce initiative, this website includes self-help "toolkits" giving innovators guidance on how to protect intellectual property in specific countries such as China, Korea and Mexico. For questions regarding patent enforcement issues, applicants may call the U.S. Government hotline at 1-866-999-HALT (1-866-999-4258).

LICENSE FOR FOREIGN FILING UNDER
Title 35, United States Code, Section 184
Title 37, Code of Federal Regulations, 5.11 & 5.15

GRANTED

The applicant has been granted a license under 35 U.S.C. 184, if the phrase "IF REQUIRED, FOREIGN FILING LICENSE GRANTED" followed by a date appears on this form. Such licenses are issued in all applications where the conditions for issuance of a license have been met, regardless of whether or not a license may be required as set forth in 37 CFR 5.15. The scope and limitations of this license are set forth in 37 CFR 5.15(a) unless an earlier license has been issued under 37 CFR 5.15(b). The license is subject to revocation upon written notification. The date indicated is the effective date of the license, unless an earlier license of similar scope has been granted under 37 CFR 5.13 or 5.14.

This license is to be retained by the licensee and may be used at any time on or after the effective date thereof unless it is revoked. This license is automatically transferred to any related applications(s) filed under 37 CFR 1.53(d). This license is not retroactive.

The grant of a license does not in any way lessen the responsibility of a licensee for the security of the subject matter as imposed by any Government contract or the provisions of existing laws relating to espionage and the national security or the export of technical data. Licensees should apprise themselves of current regulations especially with respect to certain countries, of other agencies, particularly the Office of Defense Trade Controls, Department of State (with respect to Arms, Munitions and Implements of War (22 CFR 121-128)); the Bureau of Industry and Security, Department of Commerce (15 CFR parts 730-774); the Office of Foreign Assets Control, Department of Treasury (31 CFR Parts 500+) and the Department of Energy.

NOT GRANTED

No license under 35 U.S.C. 184 has been granted at this time, if the phrase "IF REQUIRED, FOREIGN FILING LICENSE GRANTED" DOES NOT appear on this form. Applicant may still petition for a license under 37 CFR 5.12, if a license is desired before the expiration of 6 months from the filing date of the application. If 6 months has lapsed from the filing date of this application and the licensee has not received any indication of a secrecy order under 35 U.S.C. 181, the licensee may foreign file the application pursuant to 37 CFR 5.15(b).

SelectUSA

The United States represents the largest, most dynamic marketplace in the world and is an unparalleled location for business investment, innovation, and commercialization of new technologies. The U.S. offers tremendous resources and advantages for those who invest and manufacture goods here. Through SelectUSA, our nation works to promote and facilitate business investment. SelectUSA provides information assistance to the international investor community; serves as an ombudsman for existing and potential investors; advocates on behalf of U.S. cities, states, and regions competing for global investment; and counsels U.S. economic development organizations on investment attraction best practices. To learn more about why the United States is the best country in the world to develop technology, manufacture products, deliver services, and grow your business, visit <http://www.SelectUSA.gov> or call +1-202-482-6800.



Casimir Jones, S.C.
2275 DEMING WAY, SUITE 310
MIDDLETON WI 53562

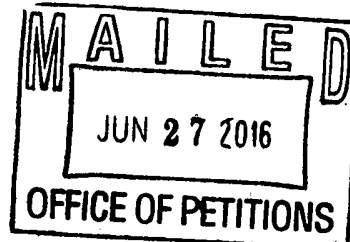

Doc Code: TRACK1.GRANT

Decision Granting Request for Prioritized Examination (Track I or After RCE)	Application No.: 15/180,439
<p>1. THE REQUEST FILED <u>June 13, 2016</u> IS GRANTED.</p> <p>The above-identified application has met the requirements for prioritized examination</p> <p>A. <input checked="" type="checkbox"/> for an original nonprovisional application (Track I). B. <input type="checkbox"/> for an application undergoing continued examination (RCE).</p> <p>2. The above-identified application will undergo prioritized examination. The application will be accorded special status throughout its entire course of prosecution until one of the following occurs:</p> <p>A. filing a <u>petition for extension of time</u> to extend the time period for filing a reply; B. filing an <u>amendment to amend the application to contain more than four independent claims, more than thirty total claims</u>, or a multiple dependent claim; C. filing a <u>request for continued examination</u>; D. filing a notice of appeal; E. filing a request for suspension of action; F. mailing of a notice of allowance; G. mailing of a final Office action; H. completion of examination as defined in 37 CFR 41.102; or I. abandonment of the application.</p> <p>Telephone inquiries with regard to this decision should be directed to Brian W. Brown at 571-272-5338.</p> <p>/Brian W. Brown/ [Signature]</p> <p>Petitions Examiner, Office of Petitions (Title)</p>	

INFORMATION DISCLOSURE STATEMENT BY APPLICANT (Not for submission under 37 CFR 1.99)	Application Number	15180439
	Filing Date	2016-06-13
	First Named Inventor	Inge Bruheim
	Art Unit	1651
	Examiner Name	WARE, DEBORAH K
	Attorney Docket Number	AKBM-14409/US-13/CON

U.S.PATENTS							Remove
Examiner Initial*	Cite No	Patent Number	Kind Code ¹	Issue Date	Name of Patentee or Applicant of cited Document	Pages,Columns,Lines where Relevant Passages or Relevant Figures Appear	
	1						
If you wish to add additional U.S. Patent citation information please click the Add button.							Add

U.S.PATENT APPLICATION PUBLICATIONS							Remove
Examiner Initial*	Cite No	Publication Number	Kind Code ¹	Publication Date	Name of Patentee or Applicant of cited Document	Pages,Columns,Lines where Relevant Passages or Relevant Figures Appear	
	1	20140370115		2014-12-18	HOEM, Nils et al.		
	2	20100226977		2010-09-09	TILSETH SNORRE et al.		
	3	20140274968		2014-09-18	BERGE KJETIL et al.		
If you wish to add additional U.S. Published Application citation information please click the Add button.							Add

FOREIGN PATENT DOCUMENTS								Remove
Examiner Initial*	Cite No	Foreign Document Number ³	Country Code ² i	Kind Code ⁴	Publication Date	Name of Patentee or Applicant of cited Document	Pages,Columns,Lines where Relevant Passages or Relevant Figures Appear	T ⁵
	1	2014/013335	WO		2014-01-23	HOEM, Nils et al.		

**INFORMATION DISCLOSURE
STATEMENT BY APPLICANT**
(Not for submission under 37 CFR 1.99)

Application Number	15180439
Filing Date	2016-06-13
First Named Inventor	Inge Bruheim
Art Unit	1651
Examiner Name	WARE, DEBORAH K
Attorney Docket Number	AKBM-14409/US-13/CON

2	102746941	CN	2014-01-15	UNIV. SHANDONG NORMAL	<input type="checkbox"/>
3	2909508	JP	1999-06-23	TAIYO FISHERY CO LTD.	<input checked="" type="checkbox"/>
4	2010/097701	WO	2010-09-02	AKER BIOMARINE ASA	<input type="checkbox"/>
5	2013/102792	WO	2013-07-11	Olympic Seafood AS	<input type="checkbox"/>

If you wish to add additional Foreign Patent Document citation information please click the Add button

NON-PATENT LITERATURE DOCUMENTS

Examiner Initials*	Cite No	Include name of the author (in CAPITAL LETTERS), title of the article (when appropriate), title of the item (book, magazine, journal, serial, symposium, catalog, etc), date, pages(s), volume-issue number(s), publisher, city and/or country where published.	T ⁵
	1	International Search Report, International Patent Application No. PCT/IB2016/000208, mailed May 13, 2016, five pages	
	2	Partial International Search Report, International Patent Application No. PCT/IB2016/000326, mailed June 15, 2016, six pages	
	3	Database FSTA [Online] International Food Information Service, Frankfurt-Main; SHIBATA N. "Effect of fishing season on lipid content and composition of Antarctic krill (translated)" Database accession no. FS-1985-04-r-0091, abstract only	
	4	Statement of Grounds and Particulars, Rimfrost AS, filed June 10, 2016, Australian Patent Application No. 2014203179, 21 pages	

If you wish to add additional non-patent literature document citation information please click the Add button

**INFORMATION DISCLOSURE
STATEMENT BY APPLICANT**
(Not for submission under 37 CFR 1.99)

Application Number	15180439	
Filing Date	2016-06-13	
First Named Inventor	Inge Bruheim	
Art Unit	1651	
Examiner Name	WARE, DEBORAH K	
Attorney Docket Number	AKBM-14409/US-13/CON	

EXAMINER SIGNATURE

Examiner Signature		Date Considered	
--------------------	--	-----------------	--

*EXAMINER: Initial if reference considered, whether or not citation is in conformance with MPEP 609. Draw line through a citation if not in conformance and not considered. Include copy of this form with next communication to applicant.

¹ See Kind Codes of USPTO Patent Documents at www.USPTO.GOV or MPEP 901.04. ² Enter office that issued the document, by the two-letter code (WIPO Standard ST.3). ³ For Japanese patent documents, the indication of the year of the reign of the Emperor must precede the serial number of the patent document. ⁴ Kind of document by the appropriate symbols as indicated on the document under WIPO Standard ST.16 if possible. ⁵ Applicant is to place a check mark here if English language translation is attached.

INFORMATION DISCLOSURE STATEMENT BY APPLICANT (Not for submission under 37 CFR 1.99)	Application Number	15180439
	Filing Date	2016-06-13
	First Named Inventor	Inge Bruheim
	Art Unit	1651
	Examiner Name	WARE, DEBORAH K
	Attorney Docket Number	AKBM-14409/US-13/CON

CERTIFICATION STATEMENT

Please see 37 CFR 1.97 and 1.98 to make the appropriate selection(s):

That each item of information contained in the information disclosure statement was first cited in any communication from a foreign patent office in a counterpart foreign application not more than three months prior to the filing of the information disclosure statement. See 37 CFR 1.97(e)(1).

OR

That no item of information contained in the information disclosure statement was cited in a communication from a foreign patent office in a counterpart foreign application, and, to the knowledge of the person signing the certification after making reasonable inquiry, no item of information contained in the information disclosure statement was known to any individual designated in 37 CFR 1.56(c) more than three months prior to the filing of the information disclosure statement. See 37 CFR 1.97(e)(2).

See attached certification statement.

The fee set forth in 37 CFR 1.17 (p) has been submitted herewith.

A certification statement is not submitted herewith.

SIGNATURE

A signature of the applicant or representative is required in accordance with CFR 1.33, 10.18. Please see CFR 1.4(d) for the form of the signature.

Signature	/J. Mitchell Jones/	Date (YYYY-MM-DD)	2016-07-13
Name/Print	J. Mitchell Jones	Registration Number	44174

This collection of information is required by 37 CFR 1.97 and 1.98. The information is required to obtain or retain a benefit by the public which is to file (and by the USPTO to process) an application. Confidentiality is governed by 35 U.S.C. 122 and 37 CFR 1.14. This collection is estimated to take 1 hour to complete, including gathering, preparing and submitting the completed application form to the USPTO. Time will vary depending upon the individual case. Any comments on the amount of time you require to complete this form and/or suggestions for reducing this burden, should be sent to the Chief Information Officer, U.S. Patent and Trademark Office, U.S. Department of Commerce, P.O. Box 1450, Alexandria, VA 22313-1450. **DO NOT SEND FEES OR COMPLETED FORMS TO THIS ADDRESS. SEND TO: Commissioner for Patents, P.O. Box 1450, Alexandria, VA 22313-1450.**

Privacy Act Statement

The Privacy Act of 1974 (P.L. 93-579) requires that you be given certain information in connection with your submission of the attached form related to a patent application or patent. Accordingly, pursuant to the requirements of the Act, please be advised that: (1) the general authority for the collection of this information is 35 U.S.C. 2(b)(2); (2) furnishing of the information solicited is voluntary; and (3) the principal purpose for which the information is used by the U.S. Patent and Trademark Office is to process and/or examine your submission related to a patent application or patent. If you do not furnish the requested information, the U.S. Patent and Trademark Office may not be able to process and/or examine your submission, which may result in termination of proceedings or abandonment of the application or expiration of the patent.

The information provided by you in this form will be subject to the following routine uses:

1. The information on this form will be treated confidentially to the extent allowed under the Freedom of Information Act (5 U.S.C. 552) and the Privacy Act (5 U.S.C. 552a). Records from this system of records may be disclosed to the Department of Justice to determine whether the Freedom of Information Act requires disclosure of these records.
2. A record from this system of records may be disclosed, as a routine use, in the course of presenting evidence to a court, magistrate, or administrative tribunal, including disclosures to opposing counsel in the course of settlement negotiations.
3. A record in this system of records may be disclosed, as a routine use, to a Member of Congress submitting a request involving an individual, to whom the record pertains, when the individual has requested assistance from the Member with respect to the subject matter of the record.
4. A record in this system of records may be disclosed, as a routine use, to a contractor of the Agency having need for the information in order to perform a contract. Recipients of information shall be required to comply with the requirements of the Privacy Act of 1974, as amended, pursuant to 5 U.S.C. 552a(m).
5. A record related to an International Application filed under the Patent Cooperation Treaty in this system of records may be disclosed, as a routine use, to the International Bureau of the World Intellectual Property Organization, pursuant to the Patent Cooperation Treaty.
6. A record in this system of records may be disclosed, as a routine use, to another federal agency for purposes of National Security review (35 U.S.C. 181) and for review pursuant to the Atomic Energy Act (42 U.S.C. 218(c)).
7. A record from this system of records may be disclosed, as a routine use, to the Administrator, General Services, or his/her designee, during an inspection of records conducted by GSA as part of that agency's responsibility to recommend improvements in records management practices and programs, under authority of 44 U.S.C. 2904 and 2906. Such disclosure shall be made in accordance with the GSA regulations governing inspection of records for this purpose, and any other relevant (i.e., GSA or Commerce) directive. Such disclosure shall not be used to make determinations about individuals.
8. A record from this system of records may be disclosed, as a routine use, to the public after either publication of the application pursuant to 35 U.S.C. 122(b) or issuance of a patent pursuant to 35 U.S.C. 151. Further, a record may be disclosed, subject to the limitations of 37 CFR 1.14, as a routine use, to the public if the record was filed in an application which became abandoned or in which the proceedings were terminated and which application is referenced by either a published application, an application open to public inspections or an issued patent.
9. A record from this system of records may be disclosed, as a routine use, to a Federal, State, or local law enforcement agency, if the USPTO becomes aware of a violation or potential violation of law or regulation.

(12) INTERNATIONAL APPLICATION PUBLISHED UNDER THE PATENT COOPERATION TREATY (PCT)

(19) World Intellectual Property
Organization
International Bureau



(10) International Publication Number
WO 2014/013335 A2

(43) International Publication Date
23 January 2014 (23.01.2014)

- (51) International Patent Classification:
A23D 9/00 (2006.01)
- (21) International Application Number:
PCT/IB2013/001959
- (22) International Filing Date:
8 July 2013 (08.07.2013)
- (25) Filing Language: English
- (26) Publication Language: English
- (30) Priority Data:
61/672,348 17 July 2012 (17.07.2012) US
- (71) Applicant: AKER BIOMARINE AS [NO/NO]; P.O. Box 1423, Vikja, Fjordalleen 16, N-0115 Oslo (NO).
- (72) Inventors; and
(71) Applicants (for US only): HOEM, Nils [NO/NO]; Skovveien 6a, N-0257 Oslo (NO). TILSETH, Snorre [NO/NO]; Fantoltasen 27A, N-5072 Bergen (NO).
- (81) Designated States (unless otherwise indicated, for every kind of national protection available): AE, AG, AL, AM, AO, AT, AU, AZ, BA, BB, BG, BH, BN, BR, BW, BY,

BZ, CA, CH, CL, CN, CO, CR, CU, CZ, DE, DK, DM, DO, DZ, EC, EE, EG, ES, FI, GB, GD, GE, GH, GM, GT, HN, HR, HU, ID, IL, IN, IS, JP, KE, KG, KN, KP, KR, KZ, LA, LC, LK, LR, LS, LT, LU, LY, MA, MD, ME, MG, MK, MN, MW, MX, MY, MZ, NA, NG, NI, NO, NZ, OM, PA, PE, PG, PH, PL, PT, QA, RO, RS, RU, RW, SC, SD, SE, SG, SK, SL, SM, ST, SV, SY, TH, TJ, TM, TN, TR, TT, TZ, UA, UG, US, UZ, VC, VN, ZA, ZM, ZW.

(84) Designated States (unless otherwise indicated, for every kind of regional protection available): ARIPO (BW, GH, GM, KE, LR, LS, MW, MZ, NA, RW, SD, SL, SZ, TZ, UG, ZM, ZW), Eurasian (AM, AZ, BY, KG, KZ, RU, TJ, TM), European (AL, AT, BE, BG, CH, CY, CZ, DE, DK, EE, ES, FI, FR, GB, GR, HR, HU, IE, IS, IT, LT, LU, LV, MC, MK, MT, NL, NO, PL, PT, RO, RS, SE, SI, SK, SM, TR), OAPI (BF, BJ, CF, CG, CI, CM, GA, GN, GQ, GW, KM, ML, MR, NE, SN, TD, TG).

Published:

— without international search report and to be republished upon receipt of that report (Rule 48.2(g))



WO 2014/013335 A2

(54) Title: CONCENTRATION OF OMEGA-3 POLYUNSATURATED FATTY ACIDS IN KRILL OIL

(57) Abstract: The present invention relates to krill oil, and in particular to krill oil with elevated levels of omega-3 fatty acids and decreased levels of saturated fatty acids.

Concentration of Omega-3 Polyunsaturated Fatty Acids in Krill Oil

Field of the Invention

The present invention relates to krill oil, and in particular to krill oil with elevated
5 levels of omega-3 fatty acids and decreased levels of saturated fatty acids.

Background of the Invention

Fish oils that are abundant in omega-3 polyunsaturated fatty acids (PUFA) have
traditionally been used as the raw material for preparation of omega-3 PUFA concentrate.
10 Since fish oils are complex mixtures of triglycerides containing fatty acids with varying chain
lengths and degrees of unsaturation, separation of individual fatty acids is difficult for
production of concentrated omega-3 components. Therefore, commercial production of
marine oil concentrates with enhanced percentages of EPA and DHA has been a major
challenge for food scientists and biotechnologists engaged in research in this area.

15 Methods for concentration of omega-3 PUFA are numerous, but only few are
suitable for large-scale production. Distillation has been used for partial separation of
mixtures of fatty acid esters. This method takes advantage of differences in the boiling point
and molecular weight of fatty acids under reduced pressure. This technique requires high
temperatures of approximately 250 C. Berger, R. and McPherson, W. (1979) 'Fractional
20 Distillation' in J. Am. Oil Chem. Soc. 56, 743A-746A. Short-path distillation or molecular
distillation uses lower temperatures and short heating intervals. However, fractionation of
fish oil esters is difficult since separation of these components becomes less effective with
increasing molecular weight. Weitkamp, A.W. (1955) 'Distillation' in J. Am. Oil Chem. Soc.
32, 640-646; Brevik, H. (1992) 'N-3 Concentrates: A Scandinavian View-point' in AOCS Short
25 Courses, Modern Application of Marine Oils, 7-8 May, Toronto, ON, Canada.

The most widely used distillation procedure is fractional distillation of methyl esters
under reduced pressure (0.1-1.0 mmHg). Even under these conditions, moderately high
temperatures are required; the more highly unsaturated acids, especially omega-3 PUFA are
more prone to oxidation, polymerization and isomerization of double bonds. Distillation at
30 still lower pressures has been used in the isolation of some highly unsaturated acids, and is
particularly valuable in polymerization studies to separate monomeric, dimeric and

polymeric materials and in the separation of monoacylglycerols from di- and triacylglycerol mixtures.

Another method for making fish oil concentrates is via enzymatic processing, such a lipase catalyzed hydrolysis. The presence of cis carbon-carbon double-bonds in the fatty acids results in bending of the chains. Therefore, the terminal methyl group of the fatty acid lies close to the ester bond which may cause a steric hinderance effect on lipases. The high bending effect of EPA and DHA due to the presence of the 5 and 6 double-bonds, respectively, enhances the steric hinderance effect; therefore, lipases cannot reach the ester-linkage between these fatty acids and glycerol. However, saturated and monounsaturated fatty acids do not present any barriers to lipases and they could be easily hydrolyzed. Therefore, fatty acid selectivity of a lipase for EPA and DHA allows separation and concentration of these fatty acids from others in the remaining portion of marine oils. In addition, lipases have been frequently used to discriminate between EPA and DHA in concentrates containing both of these fatty acids. See, e.g., Bottino, N.R., Vandenberg, G.A. and Reiser, R. (1967) 'Resistance of Certain Long-chain Polyunsaturated Fatty Acids of Marine Oils to Pancreatic Lipase Hydrolysis' in *Lipids* 2, 489-493. In most commercial processes, the hydrolysis is performed on esters produced from fish oils. The end product is accordingly an ester concentrate.

Other methods used in the art for processing fish oils include low temperature crystallization and treatment with solvents (see, e.g., Brown, L.B. and Kolb, D.X. (1955) 'Application of Low Temperature Crystallization in the Separation of the Fatty Acids and their Compounds' in *Prog. Chem. Fats Lipids* 3, 57-94; WO91/13957) and supercritical fluid extraction (see, e.g, Mishra, V.K., Temelli, F. and Ooraikul, B. (1993) 'Extraction and Purification of Omega 3-Fatty Acids with an Emphasis on Supercritical Fluid Extraction, a Review' in *Food Res. Inter.* 26, 217-226).

The concentrated esters produced by these processes can be encapsulated and sold, or the esters can be used to make triglycerides. The TAG form of PUFA is considered to be nutritionally more favorable than methyl or ethyl esters of fatty acids because experimental results have shown impaired intestinal absorption of methyl or ethyl esters of omega-3 PUFA in laboratory animals. Hamazaki, T., Hirai, A., Terano, T., Sajiki, J., Kondo, S., Fujita, T., Tamura, Y. and Kumagai, A. (1982) 'Effect of Orally Administrated Ethyl Ester of Eicosapentaenoic Acid on PGI-like Substance Production by Rat Aorta' in *Prostaglandins* 23,

557-567; El-Boustani, S., Colette, C, Monnier, L., Descomps, B., Paulet, C.A. and Mendey, F. (1987) 'Eternal Absorption in Man of Eicosapentaenoic Acid in Different Chemical Forms' in Lipids 22, 711-714; Lawson, L.D. and Hughes, B.G. (1988) 'Human Absorption of Fish Oil Fatty Acids as Triacylglycerols, Free Fatty Acids or Ethyl Esters' in Biochem. Biophys. Res. Comm. 152, 328±335. Yang et al. have shown that methyl and ethyl esters are hydrolysed slower than their corresponding TAG. Yang, L.Y., Kuksis, A. and Myher, J.J. (1989) 'Luminal Hydrolysis of Menhaden and Rapeseed Oils and their Fatty Acid Methyl and Ethyl Esters in the Rats' in Biochem. Cell Biol. 67, 192-204. From a marketing point of view, triacylglycerols of PUFA are often promoted as being more 'natural' than other fatty acid derivatives. For these reasons, the esters produced by the processes described above are converted into fatty acids and then incorporated into glycerol by direct esterification or incorporated into glycerides by transesterification. See, e.g., Osada, K., Nakamura, M., Nonaka, M. and Hatano, M. (1992) 'Esterification of Glycerol with EPA and DHA by Chromobacterium viscosum and Candida cylindracea Lipases' in J. Jpn. Oil Chem. Soc. 41, 39-43; He, Y. and Shahidi, F. (1997) 'Enzymatic Esterification of Omega-3-fatty Acid Concentrates from Seal Blubber Oil with Glycerol' in J. Am. Oil Chem. Soc. 74, 1133-1136; Akoh, C.C., Jennings, B.H. and Lillard, D.A. (1996) 'Enzymatic Modification of Evening Primrose Oil: Incorporation of n-3 Polyunsaturated Fatty Acids' in J. Am. Oil Chem. Soc. 73, 1059- 1062; Akoh, C.C., Jennings, B.H. and Lillard, D.A. (1995) 'Enzymatic Modification of Triolein: Incorporation of n-3 Polyunsaturated Fatty Acids' in J. Am. Oil Chem. Soc. 72, 1317-1321; Sridar, R. and Lakshminarayana, G. (1992) 'Incorporation of Eicosapentaenoic and Docosahexaenoic Acids into Ground Nut Oil by Lipase-catalyzed Ester Exchange' in J. Am. Oil Chem. Soc. 69, 1041-1042. Basheer, S., Mogi, K. and Nakajuma, M. (1995) 'Interesterification Kinetics of Triacylglycerides and Fatty Acids with Modified Lipase in n-hexane' in J. Am. Oil Chem. Soc. 72, 511-518.

Krill oil differs from fish oil in that krill oil comprises high amounts of phospholipids. See e.g., WO 2008/117062; US PUBL. NO. 20080274203. One of the main advantages of krill oil as compared to fish oil is increased bioavailability of omega-3 PUFA in the form of a phospholipid. However, the enzymatic processes described above are not amenable for use with phospholipids. In particular, conversion of esterified or non-esterified omega-3 PUFA

back to the phospholipid form is not trivial. Thus, the methods that have been developed for production of fish oil concentrates are not easily transferred to krill oil processing.

Oils with increased amounts of EPA and DHA are desirable because a lower dose is needed to provide the same amount of DHA and EPA. Krill oil concentrates containing
5 increased amounts of omega-3 PUFA in the phospholipid form as compared to other fatty acids in the krill oil compositions have not been developed due to the problems described above. This has been a disadvantage in the market because the fish oil concentrates contain higher amounts of omega-3 PUFA, in particular EPA and DHA, than commercial available krill oil.

10 Accordingly, what is needed in the art are krill oil concentrates comprising higher amounts of omega-3 PUFA as compared to commercially available krill oils.

Summary of the Invention

The present invention relates to krill oil, and in particular to krill oil with elevated
15 levels of omega-3 fatty acids and decreased levels of saturated fatty acids.

In some embodiments, the present invention provides a krill oil, such as a krill oil concentrate, comprising greater than about 22% EPA (w/w total fatty acids), greater than about 10% DHA (w/w total fatty acids), from 4% to 8% myristic acid (w/w total fatty acids), from 3% to 9% c9 oleic acid (w/w total fatty acids), and 20 to 4000 ppm astaxanthin. In
20 some embodiments, the krill oil further comprises about 22% to 30% EPA. In some embodiments, the krill oil further comprises about 10% to 15% DHA. In some embodiments, the krill oil is extracted from *Euphausia superba*. In some embodiments, the ratio of DHA and EPA: omega 6 (w/w total fatty acids) is from about 10:1 to 14:1. In some embodiments, the ratio of DHA and EPA: c9 oleic acid (w/w total fatty acids) is from about 4:1 to 8:1. In
25 some embodiments, the ratio of DHA and EPA: myristic acid (w/w total fatty acids) is from about 4:1 to 8:1. In some embodiments, the ratio of DHA and EPA: myristic acid and c9 oleic acid (w/w total fatty acids) is from about 2:1 to 4:1. In some embodiments, the ratio omega 3: omega 6 (w/w total fatty acids) is from about 11:1 to 15:1. In some embodiments, the ratio of omega 3: c9 oleic acid (w/w total fatty acids) is from about 5:1 to 9:1. In some
30 embodiments, the ratio of omega 3: myristic acid (w/w total fatty acids) is from about 5:1 to 9:1. In some embodiments, the ratio of omega 3: myristic acid and c9 oleic acid (w/w total fatty acids) is from about 2.5:1 to 4.5:1.

In some embodiments, the present invention provides a capsule containing a krill oil as described above. In some embodiments, the present invention provides a food product containing a krill oil as described above. In some embodiments, the present invention provides a dietary supplement containing a krill oil as described above. In some

5
embodiments, the present invention provides a oil in water emulsion containing a krill oil as described above.

In some embodiments, the krill oils are used for oil administration to a subject. In some embodiments, the krill oil are used for treatment of a condition for which omega-3 is effective.

10

Definitions

As used herein, "krill oil" refers to an oil extracted from *Euphausia sp.*, for example, *Euphausia superba*.

As used herein, "phospholipid" refers to an organic compound having the following

15
general structure:

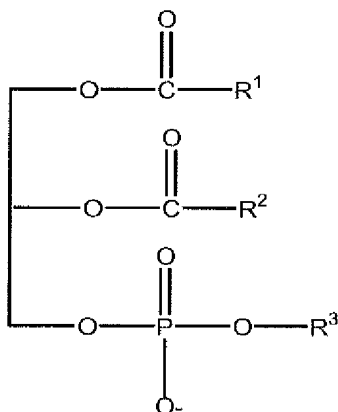

wherein R1 is a fatty acid residue, R2 is a fatty acid residue or -OH, and R3 is a -H or

20
nitrogen containing compound choline ($\text{HOCH}_2\text{CH}_2\text{N}^+(\text{CH}_3)_3\text{OH}^-$), ethanolamine ($\text{HOCH}_2\text{CH}_2\text{NH}_2$), inositol or serine. R1 and R2 cannot simultaneously be OH. When R3 is an -OH, the compound is a diacylglycerophosphate, while when R3 is a nitrogen-containing compound, the compound is a phosphatide such as lecithin, cephalin, phosphatidyl serine or plasmalogen.

As used herein, the term omega-3 fatty acid refers to polyunsaturated fatty acids that have the final double bond in the hydrocarbon chain between the third and fourth carbon atoms from the methyl end of the molecule. Non-limiting examples of omega-3 fatty acids include, 5,8,11,14,17-eicosapentaenoic acid (EPA), 4,7,10,13,16,19-
5 docosahexanoic acid (DHA) and 7,10,13,16,19-docosapentanoic acid (DPA).

As used herein, the term omega-6 fatty acid refers to polyunsaturated fatty acids that have the final double bond in the hydrocarbon chain between the sixth and seventh carbon atoms from the methyl end of the molecule.

As used herein, astaxanthin refers to the following chemical structure:

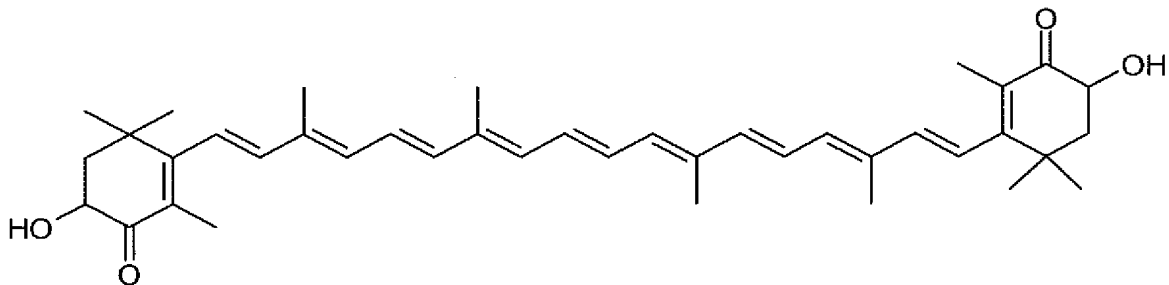

As used herein, astaxanthin esters refer to the fatty acids esterified to OH group in the astaxanthin molecule.

As used herein, the term w/w (weight/weight) refers to the amount of a given
15 substance in a composition on weight basis and can be expressed as a percentage. For example, a composition comprising 50% w/w phospholipids means that the mass of the phospholipids is 50% of the total mass of the composition (i.e., 50 grams of phospholipids in 100 grams of the composition, such as an oil). The w/w may also be used to refer to the amount, on a weight basis, of one member of a class of molecules in a composition as
20 compared to all members of the class of molecules. For example, the amount of a particular fatty acid (or class of fatty acids such as omega 3 fatty acids) may be expressed as a percentage of all other fatty acids in the composition on a weight/weight basis, i.e., the weight of the specific fatty acids as a percentage of the total weight of fatty acids in the composition.

25

Description of the Invention

The present invention relates to krill oil, and in particular to krill oil with elevated levels of omega-3 fatty acids and decreased levels of saturated fatty acids. While it was previously known that krill oil contains both phospholipid and triglyceride fractions, the inventors have discovered that krill oil is a multiphase dispersion of these fractions. This property of krill oil has not been previously described. The present inventors have taken advantage of this novel observation to develop processes for separation of the phases based on solubility of phospholipids in a polar solvent. By these processes, it is possible to separate, at least partially, the triglyceride and phospholipid phases. Unexpectedly, analysis of the phospholipid phase has revealed that the phospholipid phase has a higher content of omega-3 PUFA as compared to the triglyceride phase or to commercially available krill oil. The novel krill oil compositions and processes are described below.

1. Krill oil compositions

In some embodiments, the present invention provides novel krill oil compositions. The novel krill oil compositions are preferably defined by the amount or ratio of total omega-3 PUFA, the amount of EPA and DHA alone or combined, the amount of c9 oleic acid, and/or the amount of myristic acid as compared to previously described krill oils. In some embodiments, the krill oil is produced in whole or in part from *Euphausia superba*.

In some embodiments, the krill oil comprises greater than about 40% total omega-3 PUFA w/w total fatty acids. By this it is meant that the total amount of omega-3 fatty acids in the krill oil is greater than about 40% of the total fatty acid content of the krill oil on a weight basis. In some of the embodiments described herein, the amounts of particular fatty acids in the krill oil are preferably determined by gas chromatography of a fatty acid methyl esters prepared from the krill oil. In some embodiments, the krill oil comprises greater than about 41%, 42% or 43% total omega-3 PUFA w/w total fatty acids. In some embodiments, the krill oil comprises greater than about 35%, 36%, 37%, 38%, 39%, 40%, 41%, 42% or 43% total omega-3 PUFA w/w total fatty acids up to about 45% total omega-3 PUFA w/w total fatty acids. In some embodiments, the krill oil comprises greater than about 35%, 36%, 37%, 38%, 39%, 40%, 41%, 42% or 43% total omega-3 PUFA w/w total fatty acids up to about 46% total omega-3 PUFA w/w total fatty acids. In some embodiments, the krill oil

comprises greater than about 35%, 36%, 37%, 38%, 39%, 40%, 41%, 42% or 43% total omega-3 PUFA w/w total fatty acids up to about 47% total omega-3 PUFA w/w total fatty acids. In some embodiments, the krill oil comprises greater than about 35%, 36%, 37%, 38%, 39%, 40%, 41%, 42% or 43% total omega-3 PUFA w/w total fatty acids up to about 48% total omega-3 PUFA w/w total fatty acids. In some embodiments, the krill oil comprises greater than about 35%, 36%, 37%, 38%, 39%, 40%, 41%, 42% or 43% total omega-3 PUFA w/w total fatty acids up to about 49% total omega-3 PUFA w/w total fatty acids. In some embodiments, the krill oil comprises greater than about 35%, 36%, 37%, 38%, 39%, 40%, 41%, 42% or 43% total omega-3 PUFA w/w total fatty acids up to about 50% total omega-3 PUFA w/w total fatty acids. In some embodiments, the krill oil comprises greater than about 35%, 36%, 37%, 38%, 39%, 40%, 41%, 42% or 43% total omega-3 PUFA w/w total fatty acids up to about 55% total omega-3 PUFA w/w total fatty acids. In some embodiments, the krill oil comprises astaxanthin. In some embodiments, the krill oil comprises from about 10, 20, 30, 40, 50, 60, 70, 80 or 100 ppm astaxanthin up to about 200, 400, 600, 800, 1000, 1500, 2000, or 4000 ppm astaxanthin. In some embodiments, the krill oil comprises from about 4% to about 8% myristic acid (w/w total fatty acids), from 5% to 7% myristic acid (w/w total fatty acids), or from about 6.0% to 6.6% myristic acid. In some embodiments, the krill oil comprises from about 3% to about 9% c9 oleic acid (w/w total fatty acids), from about 4% to about 8% c9 oleic acid (w/w total fatty acids), from about 5% to about 7% c9 oleic acid (w/w total fatty acids), or from about 6.0% to about 6.6% c9 oleic acid (w/w total fatty acids). In some embodiments, the krill oil comprises less than about 5.0%, 4.5%, 4.0%, 3.8% or 3.6% palmitoleic acid (C16:1; w/w total fatty acids). In some embodiment, the krill oil comprises from about 1% to about 5.0%, about 1.5% to about 4.5%, about 2% to about 4.0%, or about 2.5% to about 3.8% palmitoleic acid (C16:1; w/w total fatty acids).

In some embodiments, the krill oil of the present invention comprises greater than about 22% EPA (w/w total fatty acids), greater than about 10% DHA (w/w total fatty acids), or greater than about 32% EPA and DHA (w/w total fatty acids). In some embodiments, the krill oil of the present invention comprises greater than about 23% EPA (w/w total fatty acids), greater than about 11% DHA (w/w total fatty acids), or greater than about 34% EPA and DHA (w/w total fatty acids). In some embodiments, the krill oil of the present invention comprises greater than about 24% EPA (w/w total fatty acids), greater than about 12% DHA (w/w total fatty acids), or greater than about 36% EPA and DHA (w/w total fatty acids). In

some embodiments, the krill oil of the present invention comprises greater than about 25% EPA (w/w total fatty acids), greater than about 12.3% DHA (w/w total fatty acids), or greater than about 37.3% EPA and DHA (w/w total fatty acids). In some embodiments, the krill oil of the present invention comprises greater than about 25.5% EPA (w/w total fatty acids),

5 greater than about 12.5% DHA (w/w total fatty acids), or greater than about 38% EPA and DHA (w/w total fatty acids). In some embodiments, the krill oil comprises an upper limit of 27% EPA and 13% DHA (w/w total fatty acids; total of 40% EPA and DHA), 28% EPA and 14% DHA (w/w total fatty acids; total of 42% EPA and DHA), 30% EPA and 16% DHA (w/w total fatty acids; total of 46% EPA and DHA), 32% EPA and 18% DHA (w/w total fatty acids; total of

10 50% EPA and DHA), or 37% EPA and 23% DHA (w/w total fatty acids; total of 60% EPA and DHA). In some embodiments, the krill oil comprises astaxanthin. In some embodiments, the krill oil comprises from about 10, 20, 30, 40, 50, 60, 70, 80 or 100 ppm astaxanthin up to about 200, 400, 600, 800, 1000, 1500 or 2000 ppm astaxanthin. In some embodiments, the krill oil comprises from about 4% to about 8% myristic acid (w/w total fatty acids), from 5% to 7%

15 myristic acid (w/w total fatty acids), or from about 6.0% to 6.6% myristic acid. In some embodiments, the krill oil comprises from about 3% to about 9% c9 oleic acid (w/w total fatty acids), from about 4% to about 8% c9 oleic acid (w/w total fatty acids), from about 5% to about 7% c9 oleic acid (w/w total fatty acids), or from about 6.0% to about 6.6% c9 oleic acid (w/w total fatty acids).

20 In some embodiments, the krill oil has a ratio of DHA and EPA: omega 6 PUFAs (w/w total fatty acids) of from about 10:1 to 14:1, 11:1 to 13:1, 11.3:1 to 12.1:1, or 11.5:1 to 11.9:1. In some embodiments, the krill oil has a ratio of DHA and EPA: c9 oleic acid (w/w total fatty acids) of from about 4:1 to 8:1, 5:1 to 7:1, 5.7:1 to 6.9:1, or 6.0:1 to 6.6:1. In some embodiments, the krill oil has a ratio of DHA and EPA: myristic acid (w/w total fatty acids) of from about 4:1 to 8:1, 5:1 to 7:1, 5.7:1 to 6.9:1, or 6.0:1 to 6.6:1. In some

25 embodiments, the krill oil has a ratio of DHA and EPA: myristic acid and c9 oleic acid (w/w total fatty acids) of from about 2:1 to 4:1, 2.4:1 to 3.5:1, 2.7:1 to 3.5:1, or 2.9:1 to 3.3:1.

In some embodiments, the krill oil has a ratio omega-3 PUFAs: omega 6 PUFAs (w/w total fatty acids) of from about 11:1 to 15:1, 12:1 to 14:1, 12.5:1 to 13.5:1, or 12.8:1 to

30 13.2:1. In some embodiments, the krill oil has a ratio omega-3 PUFAs: c9 oleic acid (w/w total fatty acids) of from about 5:1 to 9:1, 6:1 to 8:1, 6.2:1 to 7.4:1, or 6.4:1 to 7.2:1. In some embodiments, the krill oil has a ratio omega-3 PUFAs: myristic acid (w/w total fatty

acids) of from about 5:1 to 9:1, 6:1 to 8:1, 6.2:1 to 7.4:1, or 6.4:1 to 7.2:1. In some embodiments, the krill oil has a ratio omega-3 PUFAs: myristic acid and c9 oleic acid (w/w total fatty acids) of from about 2:1 to 5:1, 2.5:1 to 4.5:1, 3:1 to 3.9:1, or 3.2:1 to 3.6:1.

In some embodiments, the krill oil of this invention is formulated with acceptable
5 excipients and/or carriers for oral consumption. The actual form of the carrier, and thus, the composition itself, is not critical. The carrier may be a liquid, gel, gelcap, capsule, powder, solid tablet (coated or non-coated), tea, or the like. The composition is preferably in the form of a tablet or capsule and most preferably in the form of a soft gel capsule. Suitable excipient and/or carriers include maltodextrin, calcium carbonate, dicalcium
10 phosphate, tricalcium phosphate, microcrystalline cellulose, dextrose, rice flour, magnesium stearate, stearic acid, croscarmellose sodium, sodium starch glycolate, crospovidone, sucrose, vegetable gums, lactose, methylcellulose, povidone, carboxymethylcellulose, corn starch, and the like (including mixtures thereof). Preferred carriers include calcium
15 carbonate, magnesium stearate, maltodextrin, and mixtures thereof. The various ingredients and the excipient and/or carrier are mixed and formed into the desired form using conventional techniques. The tablet or capsule of the present invention may be coated with an enteric coating that dissolves at a pH of about 6.0 to 7.0. A suitable enteric coating that dissolves in the small intestine but not in the stomach is cellulose acetate phthalate. Further details on techniques for formulation for and administration may be
20 found in the latest edition of Remington's Pharmaceutical Sciences (Maack Publishing Co., Easton, PA).

In some embodiments, dietary supplements of the present invention comprise krill oil as described above and one or more inert ingredients, especially if it is desirable to limit the number of calories added to the diet by the dietary supplement. The dietary
25 supplement of the present invention may also contain optional ingredients including, for example, herbs, vitamins, minerals, enhancers, colorants, sweeteners, flavorants, inert ingredients, and the like. For example, the dietary supplement of the present invention may contain one or more of the following: ascorbates (ascorbic acid, mineral ascorbate salts, rose hips, acerola, and the like), dehydroepiandrosterone (DHEA), Fo-Ti or Ho Shu Wu (herb
30 common to traditional Asian treatments), Cat's Claw (ancient herbal ingredient), green tea (polyphenols), inositol, kelp, dulse, bioflavonoids, maltodextrin, nettles, niacin, niacinamide, rosemary, selenium, silica (silicon dioxide, silica gel, horsetail, shavegrass, and the like),

spirulina, zinc, and the like. Such optional ingredients may be either naturally occurring or concentrated forms.

In some embodiments, the dietary supplements further comprise vitamins and minerals including, but not limited to, calcium phosphate or acetate, tribasic; potassium phosphate, dibasic; magnesium sulfate or oxide; salt (sodium chloride); potassium chloride or acetate; ascorbic acid; ferric orthophosphate; niacinamide; zinc sulfate or oxide; calcium pantothenate; copper gluconate; riboflavin; beta-carotene; pyridoxine hydrochloride; thiamin mononitrate; folic acid; biotin; chromium chloride or picolonate; potassium iodide; sodium selenate; sodium molybdate; phylloquinone; vitamin D3; cyanocobalamin; sodium selenite; copper sulfate; vitamin A; vitamin C; inositol; potassium iodide. Suitable dosages for vitamins and minerals may be obtained, for example, by consulting the U.S. RDA guidelines.

In further embodiments, the compositions comprise at least one food flavoring such as acetaldehyde (ethanal), acetoin (acetyl methylcarbinol), anethole (parapropenyl anisole), benzaldehyde (benzoic aldehyde), N butyric acid (butanoic acid), d or l carvone (carvol), cinnamaldehyde (cinnamic aldehyde), citral (2,6 dimethyloctadien 2,6 al 8, gera nial, neral), decanal (N decylaldehyde, capraldehyde, capric aldehyde, caprinaldehyde, aldehyde C 10), ethyl acetate, ethyl butyrate, 3 methyl 3 phenyl glycidic acid ethyl ester (ethyl methyl phenyl glycidate, strawberry aldehyde, C 16 aldehyde), ethyl vanillin, geraniol (3,7 dimethyl 2,6 and 3,6 octadien 1 ol), geranyl acetate (geraniol acetate), limonene (d , l , and dl), linalool (linalol, 3,7 dimethyl 1,6 octadien 3 ol), linalyl acetate (bergamol), methyl anthranilate (methyl 2 aminobenzoate), piperonal (3,4 methylenedioxy benzaldehyde, heliotropin), vanillin, alfalfa (*Medicago sativa* L.), allspice (*Pimenta officinalis*), ambrette seed (*Hibiscus abelmoschus*), angelic (*Angelica archangelica*), Angostura (*Galipea officinalis*), anise (*Pimpinella anisum*), star anise (*Illicium verum*), balm (*Melissa officinalis*), basil (*Ocimum basilicum*), bay (*Laurus nobilis*), calendula (*Calendula officinalis*), (*Anthemis nobilis*), capsicum (*Capsicum frutescens*), caraway (*Carum carvi*), cardamom (*Elettaria cardamomum*), cassia, (*Cinnamomum cassia*), cayenne pepper (*Capsicum frutescens*), Celery seed (*Apium graveolens*), chervil (*Anthriscus cerefolium*), chives (*Allium schoenoprasum*), coriander (*Coriandrum sativum*), cumin (*Cuminum cyminum*), elder flowers (*Sambucus canadensis*), fennel (*Foeniculum vulgare*), fenugreek (*Trigonella foenum graecum*), ginger (*Zingiber officinale*), horehound (*Marrubium vulgare*), horseradish (*Armoracia lapathifolia*),

hyssop (*Hyssopus officinalis*), lavender (*Lavandula officinalis*), mace (*Myristica fragrans*), marjoram (*Majorana hortensis*), mustard (*Brassica nigra*, *Brassica juncea*, *Brassica hirta*), nutmeg (*Myristica fragrans*), paprika (*Capsicum annuum*), black pepper (*Piper nigrum*), peppermint (*Mentha piperita*), poppy seed (*Papaver somniferum*), rosemary (*Rosmarinus officinalis*), saffron (*Crocus sativus*), sage (*Salvia officinalis*), savory (*Satureia hortensis*, *Satureia montana*), sesame (*Sesamum indicum*), spearmint (*Mentha spicata*), tarragon (*Artemisia dracunculus*), thyme (*Thymus vulgaris*, *Thymus serpyllum*), turmeric (*Curcuma longa*), vanilla (*Vanilla planifolia*), zedoary (*Curcuma zedoaria*), sucrose, glucose, saccharin, sorbitol, mannitol, aspartame. Other suitable flavoring are disclosed in such references as Remington's Pharmaceutical Sciences, 18th Edition, Mack Publishing, p. 1288-1300 (1990), and Furia and Pellanca, Fenaroli's Handbook of Flavor Ingredients, The Chemical Rubber Company, Cleveland, Ohio, (1971), known to those skilled in the art.

In other embodiments, the compositions comprise at least one synthetic or natural food coloring (e.g., annatto extract, astaxanthin, beet powder, ultramarine blue, canthaxanthin, caramel, carotenal, beta carotene, carmine, toasted cottonseed flour, ferrous gluconate, ferrous lactate, grape color extract, grape skin extract, iron oxide, fruit juice, vegetable juice, dried algae meal, tagetes meal, carrot oil, corn endosperm oil, paprika, paprika oleoresin, riboflavin, saffron, tumeric, tumeric and oleoresin).

In still further embodiments, the compositions comprise at least one phytonutrient (e.g., soy isoflavonoids, oligomeric proanthcyanidins, indol 3 carbinol, sulforaphone, fibrous ligands, plant phytosterols, ferulic acid, anthocyanocides, triterpenes, omega 3/6 fatty acids, conjugated fatty acids such as conjugated linoleic acid and conjugated linolenic acid, polyacetylene, quinones, terpenes, catechins, gallates, and quercitin). Sources of plant phytonutrients include, but are not limited to, soy lecithin, soy isoflavones, brown rice germ, royal jelly, bee propolis, acerola berry juice powder, Japanese green tea, grape seed extract, grape skin extract, carrot juice, bilberry, flaxseed meal, bee pollen, ginkgo biloba, primrose (evening primrose oil), red clover, burdock root, dandelion, parsley, rose hips, milk thistle, ginger, Siberian ginseng, rosemary, curcumin, garlic, lycopene, grapefruit seed extract, spinach, and broccoli.

In still other embodiments, the compositions comprise at least one vitamin (e.g., vitamin A, thiamin (B1), riboflavin (B2), pyridoxine (B6), cyanocobalamin (B12), biotin, ascorbic acid (vitamin C), retinoic acid (vitamin D), vitamin E, folic acid and other folates,

vitamin K, niacin, and pantothenic acid). In some embodiments, the particles comprise at least one mineral (e.g., sodium, potassium, magnesium, calcium, phosphorus, chlorine, iron, zinc, manganese, fluorine, copper, molybdenum, chromium, selenium, and iodine). In some particularly preferred embodiments, a dosage of a plurality of particles includes vitamins or
5 minerals in the range of the recommended daily allowance (RDA) as specified by amino acid supplement formula in which at least one amino acid is included (e.g., L-carnitine or tryptophan).

In some embodiments, the present invention provides functional food products containing krill oil as described above. Examples of functional foods include, but are not
10 limited to dairy products such as yogurt, milk and cheese, cereals, beverages, shakes, powdered supplements, and the like.

2. Processes for making krill oil

The processes of the present invention are useful with krill oil produced by a variety
15 of processes. Suitable processes for producing krill oil include extraction with polar solvents such as ethanol, supercritical fluid extraction, extraction with non-polar organic solvents such as acetone, cold pressing, etc. See, e.g., WO2009/027692, WO2008/117062, WO2003/011873, all of which are incorporated herein by reference. The processes of the present invention may also be performed on commercially available krill oils such as those
20 supplied by Aker Biomarine, Neptune Bioresources, and Enzymotec.

As described above, the present inventors have discovered that krill oil is a multiphase dispersion. The present invention provides processes for separating the multiphase dispersion into two or more phases that can be separated. In some
25 embodiments, krill oil in the multiphase dispersion state is further processed by mixing the krill oil with a polar solvent and incubating the mixture for a period of time (the incubation period) sufficient for the formation of least two phases in the mixture. The upper phase, or phospholipid phase, comprises the krill oil of the present invention.

In preferred embodiments, the phospholipid phase is separated from any other phases formed during the incubation phase, for example, by decanting the phospholipid
30 phase. In some embodiments, the incubation phase is from about 0.5 hours to about 48 hours, 0.5 hours to 24 hours, 0.5 hours to 12 hours, 0.5 hours to 6 hours, 0.5 hours to 4 hours, or 1 hour to 4 hours. In some embodiments, the incubation is conducted at from

about 0 C to about 25 C. In some embodiments, the incubation is conducted at from about 4 C to about 10 C, about 4 C to about 20 C, about 4 C to about 25 C, about 10 C to about 20 C, about 10 C to about 25 C, or about 15 C to 25 C.

In some embodiments, the polar solvent is an alcohol, such as a monohydric
5 alcohol. Suitable monohydric alcohols include, but are not limited to, methanol, ethanol, propanol and isopropanol. Other polar solvents include dimethyl sulfoxide (DMSO), formamide, acetonitrile, N,N-dimethylformamide (DMF) and other solvents with a dielectric constant of higher than 15 or 20. In some embodiments, the krill oil is diluted with the polar solvent at a ratio of krill oil : polar solvent of 1:0.5 to 1:10, 1:1 to 1:5, 1:1 to 1:3, 1:2 to 1:5,
10 1:2 to 1:4, or 1:2 to 1:3. In some embodiments, the polarity of the solvent is adjusted by adding water. In some embodiments, the ratio of polar solvent, for example ethanol, to water is from about 1:1 to 100:1, 2:1 to 100:1, 2:1 to 20:1, 3:1 to 20:1, 4:1 to 20:1, 5:1 to 20:1, or 10:1 to 20:1.

15 3. Uses of krill oil

The krill oil of the present invention is useful for treatment of any disease, disorder or condition in which omega-3 PUFAs have been shown to be effective. Diseases and disorders that may be treated with the omega-3 fatty acid formulations described herein include alopecia, Alzheimer's dementia, angina, anxiety disorders, asthma, attention deficit
20 disorder, attention-deficit hyperactivity disorder, atopic dermatitis, autism, bipolar disorder, borderline personality disorder, cardiovascular disease, chronic fatigue syndrome, chronic pain, chronic polyarthritis, cognitive disorders, communication disorders, colitis, Crohn's disease, cystic fibrosis, dementia, depression, diabetes (of the non-insulin dependent or insulin dependent forms), diabetes-related sequelae, diabetic neuropathy, dry eyes and
25 other inflammatory eye disorders, dry skin, dysmenorrhea, eating disorders (such as anorexia nervosa or bulimia nervosa and obesity), eczema, fibromyalgia, gout, learning disorders (e.g. reading, spelling, mathematics, receptive, and expressive language, and motor skills disorders), lupus, male infertility, metabolic syndrome, melanoma, mild cognitive impairment, migraine, mood disorders, multiple sclerosis, obsessive-compulsive
30 disorder, oppositional-defiant disorder, osteoarthritis, osteoporosis, pervasive developmental disorders, polyarteritis nodosa, psoriasis, psoriatic arthritis, rheumatoid arthritis, schizophrenia, scleroderma, self-injurious behavior, sickle cell anemia, tic

disorders, tinnitus, ulcerative colitis, or vasculitic disorders (such as polyarteritis nodosa and temporal arthritis. Cardiovascular disease and disorders that can be treated with the omega-3 fatty acid formulations described herein include angina, atherosclerosis, hypercholesterolemia, hypertriglyceridemia, low HDL, high blood pressure, Raynaud's disease, and cardiac arrhythmias. Methods of treatment with the omega-3 fatty acid formulations described herein include prophylaxis with Omega-3 formulations to prevent post-cardiotomy (including but not limited to coronary artery bypass graft surgery and valve surgery) complications (including but not limited to depression, neuro-cognitive decline, congestive heart failure and infarction, clotting events, and arrhythmias) as well as for the treatment for such complications.

Experimental

Example 1

Krill oil is extracted from krill meal (Aker Biomarine) by ethanol extraction. Briefly, krill meal is extracted with ethanol for 1 hour at 15-30 C. The liquid fraction is separated by filtration. The liquid fraction is concentrated by evaporating the ethanol under a vacuum at about 50 C until the concentration of ethanol is reduced to about 20%. The concentrated liquid phase is then centrifuged to remove any remaining solids or precipitates and then evaporated under a vacuum to a final concentration of less than 0.5% ethanol. The extracted krill oil is a multiphase dispersion. An exemplary batch of krill oil prepared by this process had the following composition.

	Triacylglycerol	g/100g oil	30
	Diacylglycerol	g/100g oil	0.7
25	Monoacylglycerol	g/100g oil	<1
	Free fatty acids	g/100g oil	4.8
	Cholesterol	g/100g oil	1.2
	Cholesterol esters	g/100g oil	<0.5
	Phosphatidylethanolamine	g/100g oil	1.5
30	Phosphatidylinositol	g/100g oil	<1
	Phosphatidylserine	g/100g oil	<1
	Phosphatidylcholine	g/100g oil	40

Lyso-phosphatidylcholine	g/100g oil	3.3
Total polar lipids	g/100g oil	44.6
Total neutral lipids	g/100g oil	36.9
Total sum lipids	g/100g oil	81.5

5

Example 2

This example describes attempts to concentrate omega-3 PUFA in krill oil by lowering temperature. It was thought that by lowering the temperature, highly saturated fat would turn solid at a faster rate and sediment or in another way form a layer in the column of krill oil. The experiment tested whether triacylglycerol (TAG) and phospholipids (PL) with saturated fatty acyl chains would form a layer or if TAG and PL would form layers independent of the fatty acyl chain type. Krill oil described in Example 1 was diluted with 20 % absolute ethanol and a glass column was filled. The column was placed in a refrigerator overnight. The oil was examined for the formation of layers. The oil turned very viscous, paler but not white. No layers formed. The oil was then taken to room temperature. Again, there was no layer formation. It was not possible to determine if some portion of the fat turns solid faster than other parts. The lack of layer formation can possibly be explained by the fact that the viscosity of the oil is too high to allow vertical movement of fat with higher or lower density. Dilution with 50% absolute ethanol had the same result of no layer formation even though the solution was less viscous.

15
20**Example 3**

This example describes the concentration of omega-3 PUFA in krill oil. Krill oil described in Example 1 was diluted 1:1 with absolute ethanol (B), 1:2 with absolute ethanol (C), 1:3 with absolute ethanol (D), and 1:3 with 95% ethanol (E) in 15 ml polypropylene vials. No phase separation was seen in B, C, or D. E was slightly opaque and after five minutes a layer formed at the bottom. All four vials were then stored at -30 C for two hours. At this time, the oil was solidified and appeared as a white solid. No visible layers were observed in the solid form. After thawing at room temperature, the solid oil melted and drops formed that sedimented in the vials C, D, and E. The volume of the bottom layer increased with increasing ethanol dilution. Vial E had a larger lower phase than vial D. The bottom layer was darker than the top layer in all vials but C.

25
30

The solubility of the lower phase was examined. The lower phase was not soluble in ethanol or water. The lower phase exhibited good solubility in hexane and the color was more brown than the top layer.

The UV spectra of the top and bottom layers was examined. The UV spectra of the lower phase indicated the presence of astaxanthin together with components absorbing at lower wavelengths. The UV spectra of the upper phase indicated a similar pattern with astaxanthin less prominent compared to lower wavelengths.

The upper and lower phases were examined by thin layer chromatography (TLC). The TLC data indicates that after separation of krill oil into two phases is a higher portion of TAG in the lower phase than in the upper phase. It also appears that there is more PL in the upper phase.

The upper and lower phases were next examined by GC-FID. The results are provided below.

Fraction	Upper	Upper	Lower	Lower
ID	1 (D)	2 (E)	3 (D)	4 (E)
C12:0	0.1	0.2	0.4	0.4
C14:0	6.3	6.4	17.4	17.6
C15:0	0.4	0.3	0.5	0.5
C16:0	19.9	20.1	19.6	19.8
C16:1	3.5	3.5	7.8	7.8
C18:0	0.9	0.9	1.3	1.3
C18:1, t6-11	0.3	0.3	0.6	0.6
C18:1, c9	6.3	6.4	13.2	13.2
C18:1, c11	5.7	5.7	6.8	6.7
C18:2, n-6	1.6	1.6	1.8	1.8
C20:0	0.1	0.1	0.1	0.1
C18:3, n-6	0.3	0.2	0.2	0.2
C18:3, n-3	1.0	1.0	0.8	0.8
C20:1, n-9	0.5	0.5	0.8	0.8
C18:4, n-3	2.4	2.4	3.2	3.2
C20:2, n-6	0.1	0.1	0.1	0.1

	C22:0	0.2	0.2	0.2	0.2
	C20:3, n-6	0.1	0.1	0.1	0.1
	C20:3, n-3	0.1	0.1	0.1	0.1
	C20:4, n-6/C22:1, n-9	1.3	1.3	0.5	0.5
5	C20:4, n-3	0.4	0.4	0.2	0.2
	C20:5, n-3	26.0	26.0	7.7	7.7
	C22:5, n-3	0.6	0.6	0.3	0.3
	<u>C22:6, n-3</u>	<u>12.7</u>	<u>12.7</u>	<u>3.8</u>	<u>3.7</u>
	SFA	27.8	28.2	39.6	40.0
10	MUFA	16.3	16.4	29.2	29.2
	PUFA (n-6)	3.3	3.3	2.5	2.6
	PUFA (n-3)	43.1	43.2	16.1	16.0
	Total PUFA	46.4	46.4	18.6	18.6

15 This analysis indicates that there is a higher relative portion of omega-3 PUFA in the upper phase compared to the lower phase. The upper phase has 43 % total omega-3 PUFA. EPA and DHA is equally concentrated. In the lower phase the fatty acids 14:0 (myristic acid) and 18:1 (c9 oleic acid) are concentrated. There are no changes in 16:0.

20 This data describes the separation of a krill oil with approximately 40 % nonpolar lipids (30 % TAG) into two phases by adding ethanol/water and lowering the temperature. The layers form by passive sedimentation. TLC data indicates that PL is high in the upper phase and that TAG is high in the lower phase. GC-FID data shows that omega-3 lipids is high in the upper phase (43 %, 43 g/100 g FAME) and 18 % in the lower phase. An intriguing observation is that the particularly unhealthy fatty acid 14:0 is lowered in the upper phase.

25 The present invention is not limited to any particular mechanism. Nevertheless, the inventors have discovered that krill oil produced by ethanol extraction is a multiphase dispersion. Insoluble components such as triglycerides are entrapped in the soluble phase (polar lipids) and coextracted. The processes describe above take advantage of this fact to provide krill oil compositions with concentrated amounts of desirable omega-3 fatty acids.

30

Claims

What is claimed is:

- 5 1. Krill oil comprising greater than about 22% EPA (w/w total fatty acids), greater than about 10% DHA (w/w total fatty acids), from 4% to 8% myristic acid (w/w total fatty acids), from 3% to 9% c9 oleic acid (w/w total fatty acids), and 20 to 4000 ppm astaxanthin.
2. Krill oil of Claim 1, further comprising about 22% to 30% EPA.
- 10 3. Krill oil of Claim 1, further comprising about 10% to 15% DHA.
4. Krill oil of Claim 1, wherein said krill oil is extracted from *Euphausia superba*.
- 15 5. Krill oil of Claim 1, wherein the ratio of DHA and EPA: omega 6 (w/w total fatty acids) is from about 10:1 to 14:1.
6. Krill oil of Claim 1, wherein the ratio of DHA and EPA: c9 oleic acid (w/w total fatty acids) is from about 4:1 to 8:1.
- 20 7. Krill oil of Claim 1, wherein the ratio of DHA and EPA: myristic acid (w/w total fatty acids) is from about 4:1 to 8:1.
8. Krill oil of Claim 1, wherein the ratio of DHA and EPA: myristic acid and c9 oleic acid
- 25 (w/w total fatty acids) is from about 2:1 to 4:1.
9. Krill oil of Claim 1, wherein the ratio omega 3: omega 6 (w/w total fatty acids) is from about 11:1 to 15:1.
- 30 10. Krill oil of Claim 1, wherein the ratio of omega 3: c9 oleic acid (w/w total fatty acids) is from about 5:1 to 9:1.

11. Krill oil of Claim 1, wherein the ratio of omega 3: myristic acid (w/w total fatty acids) is from about 5:1 to 9:1.

12. Krill oil of Claim 1, wherein the ratio of omega 3: myristic acid and c9 oleic acid (w/w
5 total fatty acids) is from about 2.5:1 to 4.5:1.

13. A capsule containing the krill oil of Claims 1 to 14.

14. A food product containing the krill oil of Claims 1 to 14.

10

15. A dietary supplement containing the krill oil of Claims 1 to 14.

16. An oil in water emulsion containing the krill oil of Claims 1 to 14.

15 17. Use of the krill oil of Claims 1 to 14 for oral administration.

18. Use of the krill oil of Claims 1 to 14 for treatment of a condition for which omega-3 is effective.

20



(43) International Publication Date
23 January 2014 (23.01.2014)

(51) International Patent Classification:

A23D 9/00 (2006.01) A23D 9/04 (2006.01)
A23D 9/013 (2006.01) A61K 35/56 (2006.01)

(21) International Application Number:

PCT/IB2013/001959

(22) International Filing Date:

8 July 2013 (08.07.2013)

(25) Filing Language:

English

(26) Publication Language:

English

(30) Priority Data:

61/672,348 17 July 2012 (17.07.2012) US

(71) Applicant: **AKER BIOMARINE AS** [NO/NO]; P.O. Box 1423, Vika, Fjordalleen 16, N-0115 Oslo (NO).

(72) Inventors; and

(71) Applicants (for US only): **HOEM, Nils** [NO/NO]; Skovveien 6a, N-0257 Oslo (NO). **TILSETH, Snorre** [NO/NO]; Fantoltasen 27A, N-5072 Bergen (NO).

(81) Designated States (unless otherwise indicated, for every kind of national protection available): AE, AG, AL, AM, AO, AT, AU, AZ, BA, BB, BG, BH, BN, BR, BW, BY, BZ, CA, CH, CL, CN, CO, CR, CU, CZ, DE, DK, DM, DO, DZ, EC, EE, EG, ES, FI, GB, GD, GE, GH, GM, GT,

HN, HR, HU, ID, IL, IN, IS, JP, KE, KG, KN, KP, KR, KZ, LA, LC, LK, LR, LS, LT, LU, LY, MA, MD, ME, MG, MK, MN, MW, MX, MY, MZ, NA, NG, NI, NO, NZ, OM, PA, PE, PG, PH, PL, PT, QA, RO, RS, RU, RW, SC, SD, SE, SG, SK, SL, SM, ST, SV, SY, TH, TJ, TM, TN, TR, TT, TZ, UA, UG, US, UZ, VC, VN, ZA, ZM, ZW.

(84) Designated States (unless otherwise indicated, for every kind of regional protection available): ARIPO (BW, GH, GM, KE, LR, LS, MW, MZ, NA, RW, SD, SL, SZ, TZ, UG, ZM, ZW), Eurasian (AM, AZ, BY, KG, KZ, RU, TJ, TM), European (AL, AT, BE, BG, CH, CY, CZ, DE, DK, EE, ES, FI, FR, GB, GR, HR, HU, IE, IS, IT, LT, LU, LV, MC, MK, MT, NL, NO, PL, PT, RO, RS, SE, SI, SK, SM, TR), OAPI (BF, BJ, CF, CG, CI, CM, GA, GN, GQ, GW, KM, ML, MR, NE, SN, TD, TG).

Published:

- with international search report (Art. 21(3))
- before the expiration of the time limit for amending the claims and to be republished in the event of receipt of amendments (Rule 48.2(h))

(88) Date of publication of the international search report:

13 March 2014



WO 2014/013335 A3

(54) Title: CONCENTRATION OF OMEGA-3 POLYUNSATURATED FATTY ACIDS IN KRILL OIL

(57) Abstract: The present invention relates to krill oil, and in particular to krill oil with elevated levels of omega-3 fatty acids and decreased levels of saturated fatty acids.

INTERNATIONAL SEARCH REPORT

International application No
PCT/IB2013/001959

A. CLASSIFICATION OF SUBJECT MATTER
INV. A23D9/00 A23D9/013 A23D9/04 A61K35/56
ADD.

According to International Patent Classification (IPC) or to both national classification and IPC

B. FIELDS SEARCHED

Minimum documentation searched (classification system followed by classification symbols)
A23L A23D A61K

Documentation searched other than minimum documentation to the extent that such documents are included in the fields searched

Electronic data base consulted during the international search (name of data base and, where practicable, search terms used)

EPO-Internal, BIOSIS, FSTA, PAJ, WPI Data

C. DOCUMENTS CONSIDERED TO BE RELEVANT

Category*	Citation of document, with indication, where appropriate, of the relevant passages	Relevant to claim No.
X	US 2008/274203 A1 (BRUHEIM INGE [NO] ET AL) 6 November 2008 (2008-11-06) paragraphs [0002], [0009] - [0017], [0026], [0028], [0031], [0036] tables 9,13,14	1-18
X	US 2011/223246 A1 (OPHEIM JOAR [US]) 15 September 2011 (2011-09-15) paragraphs [0012], [0066], [0067], [0085] - [0091] paragraph [0094]	1-18
X	US 2011/130458 A1 (BREIVIK HARALD [NO] ET AL) 2 June 2011 (2011-06-02) paragraphs [0002], [0009], [0025], [0066] - [0069] tables 1,2,5	1-18
	----- -/--	

Further documents are listed in the continuation of Box C.

See patent family annex.

* Special categories of cited documents :

"A" document defining the general state of the art which is not considered to be of particular relevance

"E" earlier application or patent but published on or after the international filing date

"L" document which may throw doubts on priority claim(s) or which is cited to establish the publication date of another citation or other special reason (as specified)

"O" document referring to an oral disclosure, use, exhibition or other means

"P" document published prior to the international filing date but later than the priority date claimed

"T" later document published after the international filing date or priority date and not in conflict with the application but cited to understand the principle or theory underlying the invention

"X" document of particular relevance; the claimed invention cannot be considered novel or cannot be considered to involve an inventive step when the document is taken alone

"Y" document of particular relevance; the claimed invention cannot be considered to involve an inventive step when the document is combined with one or more other such documents, such combination being obvious to a person skilled in the art

"&" document member of the same patent family

Date of the actual completion of the international search

17 December 2013

Date of mailing of the international search report

07/01/2014

Name and mailing address of the ISA/

European Patent Office, P.B. 5818 Patentlaan 2
NL - 2280 HV Rijswijk
Tel. (+31-70) 340-2040,
Fax: (+31-70) 340-3016

Authorized officer

Couzy, François

INTERNATIONAL SEARCH REPORT

International application No
PCT/IB2013/001959

C(Continuation). DOCUMENTS CONSIDERED TO BE RELEVANT		
Category*	Citation of document, with indication, where appropriate, of the relevant passages	Relevant to claim No.
A	US 2008/268117 A1 (RUBIN DAVID [US] ET AL) 30 October 2008 (2008-10-30) paragraphs [0001], [0003] - [0005], [0018] - [0020], [0027] claims 1-7	1-18
T	----- TOU JANET C ET AL: "Krill for human consumption: nutritional value and potential health benefits", NUTRITION REVIEWS, ALLEN PRESS, LAWRENCE, KS, US, vol. 65, no. 2, 1 February 2007 (2007-02-01), pages 63-77, XP002518830, ISSN: 0029-6643, DOI: 10.1301/NR.2007.FEB.63-77 the whole document	
A,P	----- WO 2012/139588 A2 (TRIPLENINE PHARMA AS [DK]; SOERENSEN HANS OTTO [DK]; JENSEN NILS CHRIS) 18 October 2012 (2012-10-18) page 6, line 21 - page 7, line 8 example 2 claims 1,2,11,16 -----	1-18

INTERNATIONAL SEARCH REPORT

Information on patent family members

International application No PCT/IB2013/001959

Patent document cited in search report	Publication date	Patent family member(s)	Publication date	
US 2008274203	A1	06-11-2008	AU 2008231570 A1	02-10-2008
			CA 2682068 A1	02-10-2008
			DK 2144618 T3	17-06-2013
			EP 2144618 A1	20-01-2010
			EP 2612672 A1	10-07-2013
			ES 2415684 T3	26-07-2013
			HR P20130551 T1	31-07-2013
			PT 2144618 E	08-07-2013
			US 2008274203 A1	06-11-2008
			WO 2008117062 A1	02-10-2008

US 2011223246	A1	15-09-2011	US 2011223246 A1	15-09-2011
			US 2013225533 A1	29-08-2013
			WO 2011112412 A1	15-09-2011

US 2011130458	A1	02-06-2011	CA 2724463 A1	19-11-2009
			CN 102099451 A	15-06-2011
			EP 2291499 A1	09-03-2011
			JP 2011522913 A	04-08-2011
			KR 20110021886 A	04-03-2011
			US 2011130458 A1	02-06-2011
			WO 2009139641 A1	19-11-2009

US 2008268117	A1	30-10-2008	NONE	

WO 2012139588	A2	18-10-2012	AU 2012242355 A1	24-10-2013
			CA 2832913 A1	18-10-2012
			WO 2012139588 A2	18-10-2012

**Espacenet****Bibliographic data: CN102746941 (A) — 2012-10-24****Method for enriching phosphatidyl inositol from antarctic krill****Inventor(s):** DAICHENG LIU; FUCUI MA ± (LIU DAICHENG, ; MA FUCUI)**Applicant(s):** UNIV SHANDONG NORMAL ± (SHANDONG NORMAL UNIVERSITY)**Classification:** - **international:** **C11B1/02; C11B1/10**
- **cooperative:****Application number:** CN20121249120 20120718**Priority number(s):** CN20121249120 20120718**Also published as:** CN102746941 (B)**Abstract of CN102746941 (A)**

The invention discloses a method for enriching phosphatidyl inositol from antarctic krill. The method includes the steps: (1) adding 1 kilogram of frozen antarctic krill to 1-1.3 liters of ethanol solution with the volume fraction of 90-100%, stirring to extract for 4-6 times under natural conditions, keeping extraction each time for 1-3h, and filtering and combining extracting solutions so as to obtain filtrate; (2) concentrating the obtained filtrate under the pressure of negative 0.07-negative 0.09Mpa at the temperature of 60-65 DEG C until 8-10% of the volume of the filtrate remains so as to obtain concentrated extracting solution; (3) adding isometric normal hexane into the obtained concentrated extracting solution, uniformly mixing and statically layering so as to obtain transparent reddish bottom solution; and (4) removing the normal hexane from the obtained bottom solution by vaporizing under the pressure of negative 0.07-negative 0.09Mpa at the temperature of 50-55 DEG C so as to obtain oily solution, namely, a phosphatidyl-inositol-enriched product, wherein the product comprises 2.70-2.76% of phospholipid, and the phosphatidyl inositol accounts for 50.5-51.92% of the phospholipid. Re-extraction, separation, purification and the like can be further performed on the basis so as to obtain the phosphatidyl inositol.



(12) 发明专利

(10) 授权公告号 CN 102746941 B

(45) 授权公告日 2014.01.15

(21) 申请号 201210249120.6

(22) 申请日 2012.07.18

(73) 专利权人 山东师范大学

地址 250014 山东省济南市历下区文化东路
88号

(72) 发明人 刘代成 马夫翠

(74) 专利代理机构 济南圣达知识产权代理有限
公司 37221

代理人 彭成

(51) Int. Cl.

C11B 1/02(2006.01)

C11B 1/10(2006.01)

(56) 对比文件

CN 1727351 A, 2006.02.01, 全文.

CN 1560057 A, 2005.01.05, 全文.

李琳等. 显色底物磷脂酰肌醇的化学法制备及应用. 《精细化工》. 2012, 第29卷(第5期), 453-457.

审查员 费凡

权利要求书1页 说明书3页

(54) 发明名称

一种从南极磷虾中富集磷脂酰肌醇的方法

(57) 摘要

本发明公开了一种从南极磷虾中富集磷脂酰肌醇的方法,步骤如下:(1)取1公斤冰冻的南极磷虾,加入到1~1.3升的体积分数为90~100%的乙醇液中,自然条件下搅拌提取4~6次,每次1~3h,提取液过滤合并,得滤液;(2)将上述得到的滤液于60~65°C和-0.07~-0.09MPa条件下浓缩至滤液体积的8~10%,得浓缩提取液;(3)向上述得到的浓缩提取液中加入等体积的正己烷,混匀,静止分层后,取透明微红的最下层液;(4)将上述得到的最下层液于50~55°C和-0.07~-0.09MPa条件下蒸发除去正己烷,得油状液,即为富集了磷脂酰肌醇的产品,该产品中含磷脂2.70~2.76%,其中PI占磷脂的50.5~51.92%,可以在此基础上对磷脂酰肌醇进行进一步的再提取、分离、纯化等。

CN 102746941 B

1. 一种从南极磷虾中富集磷脂酰肌醇的方法,步骤如下:称冰冻的南极磷虾 500g,加入 95% 乙醇 600mL,在室温下搅拌 3h,倒出上清液并过滤;沉淀再反复提取 4 次,共提取 5 次,提取液过滤合并得滤液;将滤液在 60°C, -0.07MPa 条件下蒸发浓缩至合并滤液体积的 10%,得到浓缩提取液;向浓缩提取液中加入同体积的正己烷,摇匀静置分层,取透明微红色的最下层液,在 52°C, -0.08MPa 条件下蒸发除去正己烷,得含有磷脂酰肌醇的油状液。

2. 一种从南极磷虾中富集磷脂酰肌醇的方法,步骤如下:称冰冻的南极磷虾 500g,加入 90% 乙醇 550mL;在室温下搅拌提取 3h,倒出上清液并过滤;沉淀再重复提取 3 次,共提取 4 次,提取液过滤合并得滤液;将滤液在 65°C, -0.09MPa 条件下浓缩至合并滤液体积的 8%,得到浓缩提取液;向浓缩液中加入同体积的正己烷,摇匀静置分层,取透明微红的最下层液,在 55°C, -0.09MPa 条件下蒸除溶剂,得含有磷脂酰肌醇的油状液。

3. 一种从南极磷虾中富集磷脂酰肌醇的方法,步骤如下:称冰冻的南极磷虾 500g,加入无水乙醇 650mL,在室温下搅拌提取 1h,倒出上清液并过滤;沉淀再重复提取 5 次,共提取 6 次;提取液过滤合并得滤液;将滤液在 60°C, -0.08MPa 条件下浓缩至合并滤液体积的 10%,得到浓缩提取液;向浓缩液中加入同体积的正己烷,摇匀静置分层,取透明微红的最下层液,在 50°C, -0.07MPa 下蒸除溶剂,得含有磷脂酰肌醇的油状液。

4. 一种从南极磷虾中富集磷脂酰肌醇的方法,步骤如下:称冰冻的南极磷虾 500g,加入 95% 乙醇 500mL,在室温条件下搅拌提取 2h,倒出上清液并过滤;沉淀再重复提取 4 次,共提取 5 次,提取液过滤合并得滤液;将滤液在 65°C, -0.09MPa 条件下浓缩至合并滤液体积的 9%,得到浓缩提取液;向该浓缩液中加入同体积的正己烷,摇匀静置分层,取透明微红的最下层液,在 50°C, -0.09MPa 条件下蒸发溶剂,得含有磷脂酰肌醇的油状液。

一种从南极磷虾中富集磷脂酰肌醇的方法

技术领域

[0001] 本发明涉及一种从南极磷虾中富集磷脂酰肌醇的方法。

背景技术

[0002] 南极磷虾是一种生活在南冰洋的南极洲水域的磷虾,以群集方式生活,有时密度高达 1 万-3 万只/ M^3 ,它们可能是地球上最成功的动物物种,据统计大约有 5-50 亿吨(因统计方法不一样有较大差异)。

[0003] 目前南极磷虾渔业每年约 10 万吨,其中 80% 由日本捕获,由于南大洋以磷虾为主食物的须鲸也被歼捕殆尽。有关科学家曾根据旺盛时期鲸类对磷虾类的摄食量估计大约每年有 1.5 亿吨由于鲸类资源的衰退而剩余的磷虾可供捕获。世界上每年的全部的渔业产量为 0.99 亿吨,这标志着南极磷虾有较大的可利用空间。我国正在试探捕南极磷虾以完善南极磷虾的捕捞和相关海上技术。南极磷虾的大量捕捞标志着深加工技术的开始。在日本南极磷虾大多作为料理,而在其他国家则主要作为渔业的饲料和鱼的饵料。南极磷虾高附加价值的研究是其深加工的研究核心。

[0004] 南极磷虾含有较为丰富的油脂,含有不饱和脂肪酸、虾青素和磷脂。磷脂酰肌醇(phosphatidylinositol;PI)是细胞信号的通路成分,称为第三信使,信号通路的研究是当前生命科学研究的热点,也是生物制剂争相开发利用的重大课题。已知的信使如第一信使脂类激素和含氮激素,第二信使 cAMP 等均或为药物,或为保健成分。第三信使 PI 在人体、细胞代谢中起着极为重要的生理生化作用。是细胞快速应答和缓慢应答的启点、交叉点、关键点。PI 就像通信网络中控制着信息传递方向的接线员,控制着人体生理生化、细胞生与死的进展方向。

[0005] PI 的应用开发备受世界各国关注,2001 年美国开发出了世界上第一个以 PI 作为中间体的抗艾滋病药物(US 6316424.B)。科学家在 PI 的肌醇环上接上磺酰基基团($-SO_3$),当这种药物插入细胞膜后,暴露在膜外带有 1-几个磺酰基团的肌醇环有极强的杀病菌、病毒作用,就像细胞全身穿上了盔甲。PI 有望成为抗其他病毒药物的中间体。在流感病毒、SARS、霍乱等菌毒肆虐世界的今天,PI 的应用具有极其广阔的前景。日本等国把 PI 也用于化妆品,作为药物脂质体和日常保健品的原料、食品和药物的乳化剂(JP 05097873 A₂)海产品的保鲜剂;PI 还是心、肝、肾等人体重要器官移植前保存液的主要成分,有抗细胞凋亡(WO 99/47101),也有很好的免疫效果(WO 03/013513 A1)。另外实验证明 PI 有抗动脉粥样硬化的作用,有利尿和治疗便秘的作用等。

[0006] PI 因 sn-1 和 sn-2 位所联接的脂肪酸不一而分子结构和分子量有很大差异。不同动物体 PI 分子群中各种 PI 分子种类及其比例有很大差异,即 PI 是一个分子群。不同的动物体中磷脂中的卵磷脂(PC)、脑磷脂(PE)、PI 和磷脂酸,磷酸酰丝氨酸(PS)等比例也有很大差异。南极磷虾中虾油(磷脂是油的伴随物)的磷脂中 PC 占 80% 以上,而 PS、PE、PA 以及溶血性磷脂的总含量低于 20%,而 PI 量很少,因此制备南极磷虾中的 PI,最重要的第一步是 PI 的富集,然后才能在此基础上进一步再提取,分离,纯化。至今,人们还尚未对南极磷

虾中的 PI 进行过研究报道。

发明内容

[0007] 针对上述现有技术,本发明提供了一种从南极磷虾中富集磷脂酰肌醇的方法,为南极磷虾中磷脂酰肌醇的深入研究奠定了基础。

[0008] 本发明是通过以下技术方案实现的:

[0009] 一种从南极磷虾中富集磷脂酰肌醇的方法,步骤如下:

[0010] (1)取 1 公斤冰冻的南极磷虾,加入到 1~1.3 升的体积分数为 90~100% 的乙醇液中,自然条件下搅拌提取 4~6 次,每次 1~3h,提取液过滤合并,得滤液;

[0011] (2)将上述得到的滤液于 60~65°C 和 -0.07~-0.09MPa 条件下浓缩至滤液体积的 8~10%,得浓缩提取液;

[0012] (3)向上述得到的浓缩提取液中加入等体积的正己烷,混匀,静止分层后,取透明微红的最下层液;

[0013] (4)将上述得到的最下层液于 50~55°C 和 -0.07~-0.09MPa 条件下蒸发除去正己烷,得油状液,即为富集了磷脂酰肌醇的产品,该产品中含磷脂 2.70~2.76% (质量分数),其中 PI 占磷脂的 50.5~51.92% (质量分数)。

[0014] 本发明的从南极磷虾中富集磷脂酰肌醇的方法,在低温下进行,能够保证南极磷虾中的磷脂、DHA、EPA、虾红素、动物类黄酮素、不饱和脂肪酸、维生素 A、维生素 E 和微量元素等成分不受到破坏,且富集过程中的上层溶液可以回收再利用,提取后的南极磷虾可以再用于生产其它产品。经本发明的方法得到的产品,磷脂酰肌醇的富集效率高,产品中含磷脂 2.70~2.76%,其中磷脂酰肌醇占磷脂的 50.5~51.92%,可以在此基础上对磷脂酰肌醇进行进一步的再提取、分离、纯化等。

具体实施方式

[0015] 下面结合实施例对本发明作进一步的说明。

[0016] 实施例 1

[0017] 称冰冻的南极磷虾 500g (含水 80%,虾干物质占 20%,下同),加入 95% 乙醇 600mL,在室温下搅拌 3h,倒出上清液并过滤。沉淀再反复提取 4 次,共提取 5 次,提取液过滤合并得滤液;将滤液在 60°C, -0.07MPa 条件下蒸发浓缩至合并滤液体积的 10%,得到浓缩提取液;向浓缩提取液中加入同体积的正己烷,摇匀静置分层,取透明微红色的最下层液,在 52°C, -0.08MPa 条件下蒸发除去正己烷,得 13g 油状液。该液体中磷脂含量为 2.72%,其中 PI 占磷脂的 51.92%。

[0018] 实施例 2

[0019] 称冰冻的南极磷虾 500g,加入 90% 乙醇 550mL。在室温下搅拌提取 3h,倒出上清液并过滤。沉淀再重复提取 3 次,共提取 4 次,提取液过滤合并得滤液;将滤液在 65°C, -0.09MPa 条件下浓缩至合并滤液体积的 8%,得到浓缩提取液;向浓缩液中加入同体积的正己烷,摇匀静置分层,取透明微红的最下层液,在 55°C, -0.09MPa 条件下蒸除溶剂,得 11g 油状液。该液体中磷脂含量为 2.70%,其中 PI 占磷脂的 50.5%。

[0020] 实施例 3

[0021] 称冰冻的南极磷虾 500g, 加入无水乙醇 650mL, 在室温下搅拌提取 1h, 倒出上清液并过滤。沉淀再重复提取 5 次, 共提取 6 次。提取液过滤合并得滤液; 将滤液在 60° C, -0.08MPa 条件下浓缩至合并滤液体积的 10%, 得到浓缩提取液; 向浓缩液中加入同体积的正己烷, 摇匀静置分层, 取透明微红的最下层液, 在 50° C, -0.07MPa 下蒸除溶剂, 得 12g 油状液。该液体中磷脂含量为 2.76%, 其中 PI 占磷脂的 51.7%。

[0022] 实施例 4

[0023] 称冰冻的南极磷虾 500g, 加入 95% 乙醇 500mL, 在室温条件下搅拌提取 2h, 倒出上清液并过滤。沉淀再重复提取 4 次, 共提取 5 次, 提取液过滤合并得滤液; 将滤液在 65° C, -0.09MPa 条件下浓缩至合并滤液体积的 9%, 得到浓缩提取液; 向该浓缩液中加入同体积的正己烷, 摇匀静置分层, 取透明微红的最下层液, 在 50° C, -0.09MPa 条件下蒸发溶剂, 得 12g 油状液, 该液体中磷脂含量为 2.74%, 其中 PI 占磷脂的 51.9%。



Espacenet

Bibliographic data: JPH02215351 (A) — 1990-08-28

METHOD FOR COLLECTING KRILL PHOSPHOLIPID AND FUNCTIONAL FOOD AND NERVE FUNCTION IMPROVING AGENT HAVING NERVE FUNCTION IMPROVING EFFECT

Inventor(s): MARUYAMA KAZUTERU; NISHIKAWA MASAZUMI; KIMURA SEIJI; NONAKA MICHIO ± (MARUYAMA KAZUTERU, ; NISHIKAWA MASAZUMI, ; KIMURA SEIJI, ; NONAKA MICHIO)

Applicant(s): TAIYO FISHERY CO LTD ± (TAIYO FISHERY CO LTD, ; MARUHA KK)

Classification: - **international:** **A23J7/00; A23L1/30; A23L1/33; A61K31/685; A61K38/00; A61P25/28;** (IPC1-7): A23J7/00; A23L1/30; A23L1/33; A61K31/685; A61K37/22
- **cooperative:**

Application number: JP19890034846 19890214

Priority number (s): JP19890034846 19890214

Also published as: JP2909508 (B2)

Abstract of JPH02215351 (A)

PURPOSE:To obtain an useful phospholipid in high purity by fractionating an ethanol extracted total lipid of fresh krill dehydrated by vacuum freeze drying method to specific two ingredients using an absorption column chromatography and further isolating these ingredients using a fraction collector. **CONSTITUTION:**A fresh krill is dehydrated to <=6% water content using a vacuum freeze drying method. Then the dried krill is homogenized with ethanol to extract total lipid. The ethanol is removed as much as possible from the total lipid and the extracted total lipid is fractionated to soluble fraction and insoluble fraction using an acetone based solvent or hexane based solvent as eluate and then the solvent is cleaned from the insoluble fraction to give a crude phospholipid.; Then the crude phospholipid is fractionated to phosphatidyl choline and phosphatidyl ethanolamine with an absorption column chromatography using ethanol based solvent, acetone based solvent or hexane based solvent as an eluate. Then

each phospholipid ingredient is isolated therefrom in a high purity of about 90-95% by a fraction collector.

(19) 日本国特許庁 (J P)

(12) 特 許 公 報 (B 2)

(11) 特許番号

第2909508号

(45) 発行日 平成11年(1999) 6月23日

(24) 登録日 平成11年(1999) 4月9日

(51) Int.Cl. ⁶	識別記号	F I	
A 2 3 J	7/00	A 2 3 J	7/00
A 2 3 L	1/33	A 2 3 L	1/33
// A 2 3 L	1/30		1/30
A 6 1 K	31/685	A 6 1 K	31/685
	38/00		37/22
			A A M
			B
			A
			A A M

請求項の数1(全 5 頁)

(21) 出願番号 特願平1-34846

(22) 出願日 平成1年(1989) 2月14日

(65) 公開番号 特開平2-215351

(43) 公開日 平成2年(1990) 8月28日

審査請求日 平成8年(1996) 2月14日

(73) 特許権者 999999999
マルハ株式会社
東京都千代田区大手町1丁目1番2号

(72) 発明者 丸山 一輝
東京都中央区月島3丁目2番9号 大洋
漁業株式会社大洋研究所内

(72) 発明者 西川 正純
東京都中央区月島3丁目2番9号 大洋
漁業株式会社大洋研究所内

(72) 発明者 木村 省二
東京都中央区月島3丁目2番9号 大洋
漁業株式会社大洋研究所内

(74) 代理人 弁理士 大津 洋夫

審査官 上條 肇

最終頁に続く

(54) 【発明の名称】 オキアミン脂質の分取方法

(57) 【特許請求の範囲】

【請求項1】 生オキアミを真空凍結乾燥法により脱水し、得られたオキアミをエタノールで総脂質を抽出し、得られた総脂質からエタノールを除去し、アセトンに溶解し、可溶区分と不可溶区分に分画し、不可溶区分を更にアセトンで洗浄し粗リン脂質を得、この粗リン脂質をエタノールを溶離液として、シリカゲルを充填剤として、吸着カラムクロマトグラフィーを用いて90~95%のホスファチジルコリンとホスファチジルエタノールアミンを分画するようにしたことを特徴とするオキアミン脂質の分取方法。

【発明の詳細な説明】

「産業上の利用分野」

本発明は、オキアミからリン脂質を分離抽出する方法、特に、生体内において重要な生理活性を示すホス

ファチジルコリン及びホスファチジルエタノールアミンを高純度に分取する方法であり、こうして分取されたホスファチジルコリン及びホスファチジルエタノールアミン等が記憶力改善剤として利用可能なものである点に特徴を有する技術に関する。

「従来技術」

最近、高齢化社会を迎えて、老人性痴呆症が大きな社会問題になっている。老人性痴呆症は、神経系の障害を原因として起こるアルツハイマー型痴呆症と、脳血管障害を原因として起こる脳血管性痴呆症との二つの型に大別できる。前者のアルツハイマー型痴呆症の場合には、脳内の神経化学的な変化として、神経伝達物質であるアセチルコリンの生産が著しく低下していることが知られており、この病気の予防や治療法として、低下したコリン系の代謝を補給することにより生理機能を回復せんと

することが行なわれている。例えば、PC特許出願公表昭56-500374号「レシチンを投与することにより病気を治療するための方法および組成物」、特開昭59-167514号「脳機能亢進剤組成物」、特開昭60-214734号「神経障害及び走化の治療組成物および治療方法」等がそれぞれある。

即ち、コリン含有リン物質であるホスファチジルコリンを摂取することにより、脳内にアセチルコリンを供給し、これによりアルツハイマー型痴呆症やその他の神経障害の予防と治療が期待されている。

また、リン脂質の一種であるホスファチジルエタノールアミンはS-アデノシルメチオンニンからのメチル基移転反応によりホスファチジルコリンに変換される。従って、当該ホスファチジルエタノールアミンもアルツハイマー型痴呆症やその他の神経障害の予防と治療剤としての利用が期待されている。

本発明者は、特に、グリセロリン脂質である、これらホスファチジルコリン及びホスファチジルエタノールアミンといったリン脂質に注目し、これを記憶力改善剤の原料として利用が可能な状態で工業的に分取する方法を研究開発せんとしたものである。

従来、天然物からリン脂質を工業的に精製する場合の原料といえば大豆が一般的であり、大豆リン脂質は主に健康食品等として、商品化されている。従来大豆リン脂質精製法は、まず原料大豆をクロロホルム・メタノール系の溶媒で総脂質を抽出し、次に当該総脂質をアセトンで分画し、可溶性区分と不溶性区分に分ける。当該アセトン可溶性区分には中性脂質、コレステロール、遊離脂肪酸等が分画されており、またアセトン不溶性区分にはリン脂質が分画されている。そこで、次に、アセトン不溶性区分を90%エタノールで処理して、アルコールに溶けるホスファチジルコリンと不溶性のホスファチジルエタノールアミンとを得る。

また、「Jurnal of Chromatography」, Vol. 365 (1986) p. 229-235には、オキアミから脂質を抽出し、ヘキサンを溶離液としてシリカゲルカラムを用いてカラムクロマトグラフィーを行い、流出時間ごとにフラクション分画をおこない、ホスファチジルコリンとホスファチジルエタノールアミンとを単離するオキアミリン脂質の分取方法が記載されている。

「発明が解決しようとする問題点」

しかし、前記大豆を原料としたリン脂質の精製法の場合には、得られるホスファチジルコリン及びホスファチジルエタノールアミンとも純度が70%~80%程度であり、90%以上の高純度の精製物を得ることはなかなか困難であった。また、上記のように、クロロホルムメタノールを使用する方法は、いかに精製分画しても有害成分が残留する恐れがあるため、食品や薬品には使用しにくいという問題があった。

また後者のオキアミリン脂質の分取方法は、オキアミ

にはホスファチジルコリンが存在していること、シリカゲルカラムを用いてカラムクロマトグラフィーを行いフラクション分画をして単離するオキアミリン脂質の分取方法が記載されている。しかし、当該分取方法でも、オキアミリン脂質を効率的に且つ高純度で取得することができなかった。

本発明者は、オキアミが豊富な蛋白質資源として注目されているが、腐敗しやすく、水分が多過ぎることから保存と運送にコストがかかり過ぎるとして、その有効な利用法が確立していないこと、また、オキアミにはリン脂質が多く含んでいるが、この有効成分であるリン脂質に着目して付加価値が高く経済性のある高額な医薬品等に利用しようとする技術開発が、いまだなされていないことに気が付いた。

そこで本発明者は、未利用の水産資源であるオキアミを原料として、これから有用なリン脂質を高純度で得ることができれば、オキアミの有効利用法として非常に有益であると考え、その精製法の研究開発を進め、完成したのが本発明である。即ち、本発明は、オキアミを原料として、総脂質を分画し、得られた総脂質から高純度のホスファチジルコリン及びホスファチジルエタノールアミンを高純度化して精製単離することを特徴とする分取方法と、そうして得られた生理活性物質を用いて記憶力改善効果を有する記憶力改善剤として利用する技術である。

「問題点を解決する手段」

本発明は、上記問題点を解決するため、次のような手段を採用したものである。

特許を受けようとする第1発明は、生オキアミを真空凍結乾燥法により脱水し、得られたオキアミをエタノールで総脂質を抽出し、得られた総脂質からエタノールを除去し、アセトンに溶解し、可溶区分と不溶区分に分画し、不溶区分を更にアセトンで洗浄し粗リン脂質を得、この粗リン脂質をエタノールを溶離液として、シリカゲルを充填剤として、吸着カラムクロマトグラフィーを用いて90~95%のホスファチジルコリンとホスファチジルエタノールアミンを分画するようにしたことを特徴とするオキアミリン脂質の分取方法である。

第一工程：船内急速凍結生オキアミのブロック中には、90%以上が水分であるため、脱水方法が問題になる。そこで本発明では、吸着カラムクロマトグラフィーを用いた分取の前処理として、真空凍結乾燥装置を用いて脱水し乾燥オキアミとする。このとき水分含量が6%以下になるように脱水乾燥するのが望ましい。すると、水溶性蛋白質のエタノール抽出物への混入が抑制できるので、分別成分の純度を高めることができる。

第二工程：第一工程により得られた乾燥オキアミをエタノールでホモジナイズして総脂質を抽出する。

第三工程：次に総脂質からエタノールを出来るだけ除去したうえ、アセトンを溶媒となし、可溶区分と不溶区分

とに分画する。アセトンを溶媒とした場合には、リン脂質の大部分は不溶区分にあるので、これから溶媒を洗浄すれば、容易に粗リン脂質が得られる。

第四工程：この粗リン脂質をエタノール系溶媒を溶離液となし、吸着カラムクロマトグラフィーを用いてホスファチジルコリンやホスファチジルエタノールアミンに分画し、これからフラクションコレクターにより各リン脂質成分を90%~95%前後の高純度にて単離する。

本発明は、以上のようにして90%~95%前後の高純度のホスファチジルコリンもしくはホスファチジルエタノールアミンなどのオキアミリン脂質を分取する方法である。

この場合、オキアミより単離したホスファチジルコリンもしくはホスファチジルエタノールアミン、またはこれらの誘導体のうち少なくとも一種以上を有効成分として含有して記憶力改善剤を構成するようにしてもよい。この記憶力改善剤は、錠剤、カプセル、顆粒、液状等の形態として、薬品化することができるものである。

「作用」

アルツハイマー型痴呆症の場合には、脳内の神経化学的な変化として、神経伝達物質であるアセチルコリンの生産が著しく低下していることが知られており、この病気の予防や治療法として、低下したコリン系の代謝を補給することにより生理機能を回復せんとすることが行なわれている。

特に、人の場合、コリンまたはコリンに解離する天然産出化合物レシチンを経口投与した場合、脳アセチルコ

リンの合成および放出を増進するのに十分な容量の血液コリン量の増加をもたらすとともに、脳脊髄液のコリン量も増加する生理機能のあること解っている。

従って、オキアミからリン脂質であるホスファチジルコリンをいかに効率良く、しかも安全性を保って抽出するか、それを薬剤として摂取することにより、脳内にアセチルコリンを供給し、これによりアルツハイマー型痴呆症やその他の神経障害の予防と治療を期待するが、特に記憶力改善剤効果を期待しようとするのが本発明である。

「実施例」

以下、本発明を実施例に基づき詳細に説明する。

<実施例1.>

船内急速凍結生オキアミ20kgを真空乾燥装置を用いて水分含量4%前後になるまで乾燥させて乾燥オキアミ2.2kgを得た。この原料である乾燥オキアミの脂質組成をイアトロスキャン法で分析した結果は、表1.の通りであった。

次に、こうして得た乾燥オキアミ2kgをエタノール40kgでホモジナイズして総脂質の抽出を行なった。その後、再抽出はエタノール20kgで同様に行なった。

抽出物である総脂質を濃縮して、できるだけエタノールを除去した後、当該総脂質をアセトンに溶解し、可溶区分と不溶区分に分画する。すると大部分のリン脂質は不溶区分に区画される。そこで、当該不溶区分に分画された物質にアセトン洗浄を数回繰り返して、粗リン脂質408gを得た。

表1. 乾燥オキアミの脂質組成

脂質組成	重量%
ホスファチジルコリン	31.1
ホスファチジルエタノールアミン	7.5
トリグリセリド	43.2
遊離脂肪酸	6.5
その他	5.7

次に、前記粗リン脂質400gをエタノールに2000mlに溶解し、全自動分取型高速液体クロマトグラフィーに装着した分取カラム（カラム長さ×カラム径:50cm×50mm、断面積19.6cm²）に粒径10 μ mの球状シリカゲル（吸着剤）を充填したものに、1バッチ当たり20mlを自動注入した。溶離液はエタノール100%を流速30ml/minで流し、カラム恒温層は40℃で、ピーク検出は紫外吸収検出器（205 μ m）を用いてモニターしたところ、第1図に示したクロマトグラムが得られたので、最初のピークの分画区分をAとなし、2番目の大きなピークの分画区分をBとしてフラクションコレクターを用いて分取した。分画区分Bのホスファチジルコリンの純度はイヤトロスキャン法で分析したところ98%以上であった。1バッチのサイクルタイムは30分で、原料溶液を30分毎に自動充填して100サイクルで約50時間要して、乾燥オキアミ2kgから高純度ホスファチジルコリンを約239g分取した。

また、分画区分Aから同様に純度95%以上の高純度のホスファチジルエタノールアミンを約45g分取した。

<実施例2.>

ウエクスラー方式の記憶ないし知能指数試験をしたところ記憶指数123であった記憶喪失にかかっている患者に、オキアミのから第1実施例にて分取した高純度ホスファチジルコリン（純度98%）を6週間に渡って1日3

回食事毎に10gずつ食品に混入して経口投与した。

試験治療前と高純度ホスファチジルコリン摂取終了の6週間後に、患者からコリン測定用血液資料を採取しておき、血漿資料を分離し、凍結し、そしてそのコリン含量について慣用の放射性酵素法により分析した。その結果は、試験治療前採取した血液中の血漿コリン量が13.4 \pm 1.2ナノモル/mlであったのに対し、高純度ホスファチジルコリン投与から4時間後に得られた血液中の血漿コリン量が31.3 \pm 2.5ナノモル/mlに増加していた（P<0.01）。しかも、高純度ホスファチジルコリン摂取の6週間後には、患者の記憶指数は、142に向上していた。

「効果」

第1請求項に係る保護を受けようとする発明は、未利用の水産資源であるオキアミを原料として、これから有用なホスファチジルコリン及びホスファチジルエタノールアミンを90%以上という高純度で精製単離することができる分取方法である。この分取方法は、精製単離成分が高純度であるというだけでなく、その精製過程において、毒性を持った溶剤などが一切使用されていないので、安全性が高く、薬品などにも安心して利用できる点に特徴がある。

【図面の簡単な説明】

第1図は本発明に係るクロマトグラムが得られた組成成分の分画表である。

【第1図】

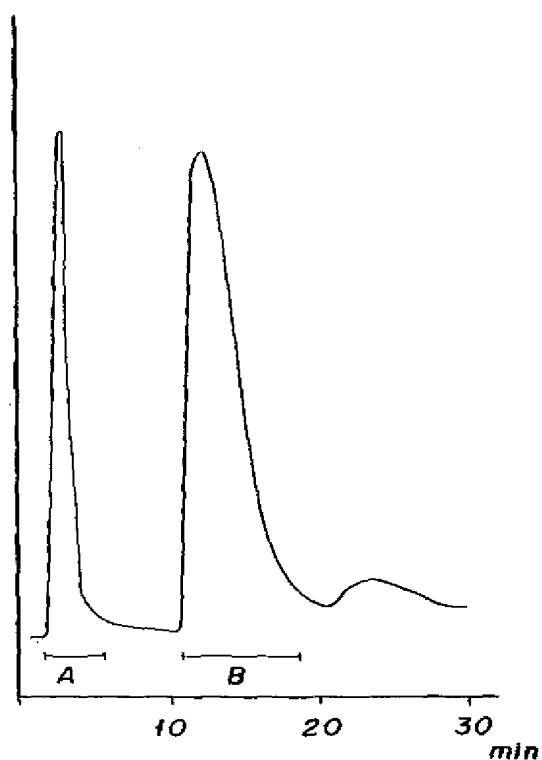

フロントページの続き

(72) 発明者 野中 道夫
 東京都中央区月島3丁目2番9号 大洋
 漁業株式会社大洋研究所内

(56) 参考文献 特開 昭63-23819 (JP, A)
 特開 昭57-123196 (JP, A)
 特開 昭62-228229 (JP, A)
 特公 昭62-3127 (JP, B2)
 米国特許4385053 (US, A)
 Journal of Chroma-
 tography, Vol. 365 (1986)
 p. 229-235

(58) 調査した分野(Int.Cl.⁶, DB名)

A23J 7/00
 A23L 1/33
 A23L 1/30
 A61K 31/685
 WPI (DIALOG)
 JICSTファイル (JOIS)

(19) World Intellectual Property Organization
International Bureau



(43) International Publication Date
2 September 2010 (02.09.2010)

(10) International Publication Number
WO 2010/097701 A1

(51) International Patent Classification:

A23L 1/325 (2006.01) A23L 1/275 (2006.01)
A23D 9/013 (2006.01) A61K 35/56 (2006.01)

(21) International Application Number:

PCT/IB2010/000512

(22) International Filing Date:

25 February 2010 (25.02.2010)

(25) Filing Language:

English

(26) Publication Language:

English

(30) Priority Data:

61/155,767 26 February 2009 (26.02.2009) US

(71) Applicant (for all designated States except US): **AKER BIOMARINE ASA** [NO/NO]; Fjordalleen 16, N-0116 Oslo (NO).

(72) Inventor; and

(75) Inventor/Applicant (for US only): **TILSETH, Snorre** [NO/NO]; Fantoltasen 27 A, N-5072 Bergen (NO).

(81) Designated States (unless otherwise indicated, for every kind of national protection available): AE, AG, AL, AM, AO, AT, AU, AZ, BA, BB, BG, BH, BR, BW, BY, BZ,

CA, CH, CL, CN, CO, CR, CU, CZ, DE, DK, DM, DO, DZ, EC, EE, EG, ES, FI, GB, GD, GE, GH, GM, GT, HN, HR, HU, ID, IL, IN, IS, JP, KE, KG, KM, KN, KP, KR, KZ, LA, LC, LK, LR, LS, LT, LU, LY, MA, MD, ME, MG, MK, MN, MW, MX, MY, MZ, NA, NG, NI, NO, NZ, OM, PE, PG, PH, PL, PT, RO, RS, RU, SC, SD, SE, SG, SK, SL, SM, ST, SV, SY, TH, TJ, TM, TN, TR, TT, TZ, UA, UG, US, UZ, VC, VN, ZA, ZM, ZW.

(84) Designated States (unless otherwise indicated, for every kind of regional protection available): ARIPO (BW, GH, GM, KE, LS, MW, MZ, NA, SD, SL, SZ, TZ, UG, ZM, ZW), Eurasian (AM, AZ, BY, KG, KZ, MD, RU, TJ, TM), European (AT, BE, BG, CH, CY, CZ, DE, DK, EE, ES, FI, FR, GB, GR, HR, HU, IE, IS, IT, LT, LU, LV, MC, MK, MT, NL, NO, PL, PT, RO, SE, SI, SK, SM, TR), OAPI (BF, BJ, CF, CG, CI, CM, GA, GN, GQ, GW, ML, MR, NE, SN, TD, TG).

Published:

- with international search report (Art. 21(3))
- before the expiration of the time limit for amending the claims and to be republished in the event of receipt of amendments (Rule 48.2(h))



WO 2010/097701 A1

(54) Title: LOW VISCOSITY PHOSPHOLIPID COMPOSITIONS

(57) Abstract: The invention relates to processing crustaceans such as krill to oils comprising phospholipids that are Newtonian fluids and/or and have low viscosity, and in particular to the production of oils containing astaxanthin and phospholipids that show Newtonian fluidity and have a low viscosity.

LOW VISCOSITY PHOSPHOLIPID COMPOSITIONS

FIELD OF THE INVENTION

5 The invention relates to processing crustaceans such as krill to oils comprising phospholipids that are Newtonian fluids and/or and have low viscosity, and in particular to the production of oils containing astaxanthin and high levels of phospholipids that show Newtonian fluidity and have a low viscosity.

10 BACKGROUND OF THE INVENTION

 Krill is a small crustacean which lives in all the major oceans world-wide. For example, it can be found in the Pacific Ocean (*Euphausia pacifica*), in the Northern Atlantic (*Meganyctiphanes norvegica*) and in the Southern Ocean off the coast of Antarctica (*Euphausia superba*). Krill is a key species in the ocean as it is the food source for many
15 animals such as fish, birds, sharks and whales. Krill can be found in large quantities in the ocean and the total biomass of Antarctic krill (*E. superba*) is estimated to be in the range of 300-500 million metric tons. Antarctic krill feeds on phytoplankton during the short Antarctic summer. During winter, however, its food supply is limited to ice algae, bacteria, marine detritus as well as depleting body protein for energy. Virtue et al., Mar. Biol. 126, 521-527.
20 For this reason, the nutritional values of krill vary during the season and to some extent annually. Phleger et al., Comp. Biochem. Physiol. 131B (2002) 733. In order to accommodate variations in food supply, krill has developed an efficient enzymatic digestive apparatus resulting in a rapid breakdown of the proteins into amino acids. Ellingsen et al., Biochem. J. (1987) 246, 295-305. This autoproteolysis is highly efficient also post mortem,
25 making it a challenge to catch and store the krill in a way that preserves the nutritional quality of the krill. Therefore, in order to prevent the degradation of krill the enzymatic activity is either reduced by storing the krill at low temperatures or the krill is made into a krill meal.

 During the krill meal process the krill is cooked so that all the active enzymes are denatured in order to eliminate all enzymatic activity. Krill is rich in phospholipids which act
30 as emulsifiers. Thus it is more difficult to separate water, fat and proteins using mechanical separation methods than it is in a regular fish meal production line. In addition, krill becomes solid, gains weight and loose liquid more easily when mixed with hot water. Eventually this may lead to a gradual build up of coagulated krill proteins in the cooker and a non-continuous

operation due to severe clogging problems. In order to alleviate this, hot steam must be added directly into the cooker. This operation is energy demanding and may also result in a degradation of unstable bioactive components in the krill such as omega-3 fatty acids, phospholipids and astaxanthin. The presence of these compounds, make krill oil an attractive
5 source as a food supplement, a functional food products and a pharmaceutical for the animal and human applications.

Omega-3 fatty acids have recently been shown to have potential effect of preventing cardiovascular disease, cognitive disorders, joint disease and inflammation related diseases such as rheumatoid arthritis. Astaxanthin is a strong antioxidant and may therefore assist in
10 promoting optimal health. Hence, there is a need for a method of processing krill into a krill meal at more gentle conditions which prevents the degradation of these valuable bioactive compounds.

SUMMARY OF THE INVENTION

15 The invention relates to processing crustaceans such as krill to oils comprising phospholipids that are Newtonian fluids and/or and have low viscosity, and in particular to the production of oils containing astaxanthin and high levels of phospholipids that show Newtonian fluidity and have a low viscosity.

In some embodiments, the present invention provides compositions comprising less
20 than about 150, 100, 10, 5, 2 or 1 mg/kg astaxanthin or from about 0.1 to about 1, 2, 5, 10 or 200 mg/kg astaxanthin, preferably endogenous, naturally occurring astaxanthin, from about 20% to about 50%, 15% to 45%, or 25% to 35% phospholipids on a w/w basis, and about 15% to 60%, about 20% to 50%, or about 25% to 40% protein on a w/w basis, wherein said phospholipids comprise omega-3 fatty acid residues. In some embodiments, the composition
25 comprises a lipid fraction having an omega-3 fatty acid content of from about 5% to about 30%, from 10% to about 30%, or from about 12% to about 18% on a w/w basis. In some embodiments, the phospholipids comprise greater than about 60%, 65%, 80%, 85% or 90% phosphatidylcholine on a w/w basis. In some embodiments, the phospholipids comprise less than about 15%, 10%, 8% or 5% ethanolamine on a w/w basis. In some embodiments, the
30 compositions comprise from about 1% to 10%, preferably 2% to 8%, and most preferably about 2% to 6% alkylacylphosphatidylcholine. In some embodiments, the compositions comprise from about 40% to about 70% triacylglycerol on a w/w basis. In further embodiments, the compositions comprise less than about 1% cholesterol. In some

embodiments, the protein comprises from about 8% to about 14% leucine on a w/w basis and from about 5% to 11% isoleucine on a w/w basis.

In some embodiments, the present invention comprises an aqueous phase and a solid phase, said solid phase comprising from about 20% to about 40% phospholipids on a w/w basis, and about 20% to 50% protein on a w/w basis, wherein said phospholipids comprise from about 10% to about 20% omega-3 fatty acid residues.

In other embodiments, the present invention provides krill compositions comprising astaxanthin, a protein fraction, and a lipid fraction, wherein said lipid fraction comprises less than about 10%, 5% or 3% phospholipids on a w/w basis. In some embodiments, the phospholipids comprise less than about 15%, 10% or 5% phosphatidylcholine on a w/w basis.

In some embodiments, the present invention provides a krill meal comprising astaxanthin and from about 8 % to about 31 % lipids, preferably from about 8% to about 10 or 18 % lipids, wherein said lipids comprises greater than about 80% neutral lipids on a w/w basis. In some embodiments, the krill meal comprises less than about 15%, 10%, 5%, 3% or 1% phospholipids. In some embodiments, the phospholipids comprise less than about 15%, 10% or 5% phosphatidylcholine on a w/w basis.

In some embodiments, the present invention provides methods of preparing a phospholipid composition from biological material or biomass comprising: mixing said biological material or biomass with water at a suitable temperature to form a solid phase and an aqueous phase comprising phospholipids and proteins; separating said solid phase from said aqueous phase; heating said aqueous phase at a temperature sufficient to form a phospholipid-protein precipitate; and separating said phospholipid-protein precipitate from said aqueous phase. In some embodiments, the present invention provides a phospholipid-protein precipitate obtained by using the foregoing method. In some embodiments, the biological material or biomass is krill. In other embodiments, the biological material or biomass is selected from crabs, shrimp, calanus, plankton, crayfish, eggs or other phospholipid containing biological materials or biomass. In some embodiments, the methods further comprise the step of forming a meal from said solid phase. In some embodiments, the step of forming a meal comprises: heating the solid phase in the presence of water; separating fat and protein in said solid phase; and drying said protein to form a meal. In some embodiments, the processes further comprise the steps of pressing and drying the coagulum to form a coagulum meal. In some embodiments, the drying is by hot air or steam. In some embodiments, the present invention provides a phospholipid-protein precipitate obtained by using the foregoing method. In some embodiments, the present invention provides a

composition comprising a krill solid phase according to the foregoing methods. In some embodiments, the present invention provides a krill meal obtained by the foregoing methods.

In some embodiments, the present invention provides processes comprising: extracting a first lipid fraction from a krill biomass; extracting a second lipid fraction from a krill biomass; and blending said first lipid fraction and said second lipid fraction to provide a krill lipid composition having a desired composition. In some embodiments, the one or more of the extracting steps are performed in the absence of substantial amounts of organic solvents. In some embodiments, the first lipid fraction is extracted by: mixing krill with water at a suitable temperature to form a solid phase and an aqueous phase comprising phospholipids and protein; separating said solid phase from said aqueous phase; heating said aqueous phase at a temperature sufficient to form a phospholipid-protein precipitate; separating said phospholipid-protein precipitate from said aqueous phase; and separating said phospholipids from said protein. In some embodiments, the second lipid fraction is extracted by: heating the solid phase in the presence of water; and separating fat and protein in said solid phase. In some embodiments, the first lipid fraction comprises a phospholipid fraction comprising greater than about 90% phosphatidylcholine on a w/w basis. In some embodiments, the second lipid fraction comprises greater than about 80% neutral lipids on a w/w basis.

In some embodiments, the present invention provides processes of producing a phospholipid composition from biological material or biomass comprising: mixing said biological material or biomass with water to increase the temperature of said biological material to about 25 to 80 °C , preferably to about 50 to 75 °C, and most preferably to about 60 to 75 °C to form a first solid phase and a first aqueous phase comprising phospholipids and proteins; separating said first solid phase from said first aqueous phase; and separating a protein and phospholipid fraction from said first aqueous phase. In some embodiments, the biomass is heated to the first temperature for at least 3 minutes, preferably from about 3 minutes to 60 minutes, more preferably from about 3 minutes to 20 minutes, and most preferably from about 3 minutes to 10 minutes. The present invention is not limited to the use of any particular biological materials or biomass. In some embodiments, the biological material is a marine biomass. In some preferred embodiments, the biological material or biomass comprises krill crabs, shrimp, calanus, plankton, crayfish, eggs or other phospholipid containing biological materials or biomass. The present invention is not limited to the use of any particular type of krill. In some embodiments, the krill is fresh, while in other embodiments, the krill is frozen. In some embodiments, the krill is of the species *Euphausia superba*. In some embodiments, the step of separating a protein and phospholipid fraction

from said first aqueous phase comprises heating said first aqueous phase at a temperature sufficient to form a phospholipid-protein coagulate and separating said phospholipid-protein coagulate from said aqueous phase. In some embodiments, the processes utilize a second heating step. In some embodiments, the first aqueous phase is heated to over 80 °C, preferably 5 to about 80 to 120 °C, and most preferably to about 90 to 100 °C. In some embodiments, the krill milk is held at these temperatures for from about 1 minute to about 60 minutes, preferably about 1 minute to about 10 minutes, and most preferably for about 2 minutes to 8 minutes. In some embodiments, the heating is at atmospheric pressure, while in other embodiments, the pressure is greater than atmospheric pressure. In some embodiments, the 10 processes further comprise the step of pressing said phospholipid-protein coagulate to form a coagulate liquid phase and a coagulate press cake. In some embodiments, the processes further comprise drying said coagulate press cake to form a coagulate meal. In some embodiments, the processes further comprise extracting a coagulate oil from said coagulate meal. In some embodiments, the processes further comprise the steps of pressing and drying 15 the coagulum to form a coagulum meal. In some embodiments, the drying is by hot air or steam.

In some embodiments, the step of separating a protein and phospholipid fraction from said first aqueous phase comprises filtration of said aqueous phase to provide a phospholipid-protein retentate comprising proteins and phospholipids. In some embodiments, filtration is 20 via membrane filtration. In some embodiments, the filtration comprises filtering said aqueous phase through a microfilter with a pore size of from about 50 to 500 nm. In some embodiments, the processes further comprise the step of dewatering said phospholipid-protein retentate to form a retentate liquid phase and a retentate concentrate. In some embodiments, the processes further comprise the step of removing water from said retentate concentrate so 25 that said retentate concentrate is microbially stable. In some embodiments, the processes further comprise the step of extracting a retentate oil from said retentate concentrate. In some embodiments, the processes further comprise the step of heating said first solid phase and then pressing said first solid phase to form a first press cake and a second liquid phase. In some 30 embodiments, the processes further comprise the step of drying said first press cake to provide a first krill meal. In some embodiments, the processes further comprise the steps of heating said second liquid phase and then separating said second liquid phase to provide a first krill oil and stickwater. In some embodiments, the stickwater is evaporated and added to said first press cake, and a meal is formed from said evaporated stickwater and said first press cake to provide a second krill meal. In some embodiments, the second liquid phase is heated to over

80 °C, preferably to about 80 to 120 °C, and most preferably to about 90 to 100 °C prior to said separation. In some embodiments, the processes further comprise the step of combining the previously described coagulate oil or the retentate oil and the first krill oil to provide a blended oil. In other embodiments, the coagulate oil, retentate oil, or oil pressed from the first solid phase are combined with the coagulate meal or retentate. In further embodiments, the processes of the present invention comprise the further step of supplementing the meals or oils produced as described above with additional proteins, phospholipids, triglycerides, fatty acids, and/or astaxanthin to produce an oil or meal with a desired defined composition. As such, a person of skill in the art will readily recognize that the processes described above serve as a starting point for producing compositions that are further supplemented in subsequent process steps to produce a desired composition, such a composition containing elevated levels of proteins, lipids or astaxanthin. In some embodiments, the present invention provides the lipid-protein composition produced by the foregoing processes. In some embodiments, the present invention provides the coagulate meal produced by the foregoing processes. In some embodiments, the present invention provides the coagulate oil produced by the foregoing processes. In some embodiments, the present invention provides the retentate meal produced by the foregoing processes. In some embodiments, the present invention provides the retentate oil produced by the foregoing processes. In some embodiments, the present invention provides the krill meal produced by the foregoing processes. In some embodiments, the present invention provides a krill oil produced by the foregoing processes. In some embodiments, the present invention provides a blended oil produced by the foregoing processes. In some embodiments, the compositions of the present invention are supplemented with additional proteins, phospholipids, triglycerides, fatty acids, and/or astaxanthin to produce an oil or meal with a desired defined composition. As such, a person of skill in the art will readily recognize that the compositions described above serve as a starting point for producing compositions that are further supplemented in subsequent process steps to produce a desired composition, such a composition containing elevated levels of proteins, lipids or astaxanthin.

In some embodiments, the present invention provides processes comprising: heating a krill biomass to about 25 to 80 °C, preferably to about 50 to 75 °C, and most preferably to about 60 to 75 °C; separating said krill biomass into solid and liquid phases; extracting a first lipid fraction from said solid phase; extracting a second lipid fraction from said liquid phases; and blending said first lipid fraction and said second lipid fraction to provide a krill lipid composition having a desired composition. In some embodiments, the extracting steps are

performed in the absence of substantial amounts of organic solvents. In some embodiments, the first lipid fraction comprises a phospholipid fraction comprising greater than about 90% phosphatidylcholine on a w/w basis. In some embodiments, the second lipid fraction comprises greater than about 80% neutral lipids on a w/w basis.

5 In some embodiments, the present invention provides krill compositions comprising from about 0.01 to about 200 mg/kg astaxanthin, from about 45% to about 65% fat w/w, and about 20% to 50% protein w/w, wherein said fat comprises omega-3 fatty acid residues. In some embodiments, the fat has an omega-3 fatty acid content of from about 10% to 30 %, preferably 15% to about 25% on a w/w basis. In some embodiments, the fat comprises from
10 about 20% to about 50% phospholipids w/w, wherein said phospholipids comprise greater than about 65% phosphatidylcholine w/w and from about 1% to about 10% alkylacylphosphatidylcholine. In some embodiments, the phospholipids comprise less than about 10% ethanolamine on a w/w basis. In some embodiments, the fat comprises from about 40% to about 70% triacylglycerol w/w. In some embodiments, the compositions further
15 comprise less than about 1% cholesterol. In some embodiments, the protein comprises from about 8% to about 14% leucine on a w/w basis and from about 5% to 11% isoleucine on a w/w basis.

In some embodiments, the present invention provides krill compositions comprising from about 10% to about 20% protein w/w, about 15% to about 30% fat w/w, and from about
20 0.01 to about 200 mg/kg astaxanthin. In some embodiments, the fat has an omega-3 fatty acid content of from about 10% to about 30% on a w/w basis. In some embodiments, the fat comprises from about 30% to about 50% phospholipids w/w. In some embodiments, the phospholipids comprise greater than about 65% phosphatidylcholine w/w. In some
25 embodiments, the phospholipids comprise less than about 10% ethanolamine on a w/w basis. In some embodiments, the fat comprises from about 40% to about 70% triacylglycerol w/w. In some embodiments, the compositions comprise less than about 1% cholesterol. In some
embodiments, the protein comprises from about 7% to about 13% leucine on a w/w basis and from about 4% to 10% isoleucine on a w/w basis.

In some embodiments, the present invention provides krill meal press cakes
30 comprising from about 65% to about 75% protein w/w (dry matter) , from about 10% to about 25% fat w/w (dry matter), and from about 1 to about 200 mg/kg astaxanthin (wet base). In some embodiments, the fat comprises greater than about 30% neutral lipids and greater than about 30% phospholipids on a w/w basis. In some embodiments, the fat comprises from about 50 to about 60% neutral lipids w/w and from about 40% to about 55% polar lipids w/w.

In some embodiments, the protein comprises from about 5% to about 11% leucine w/w and from about 3% to about 7% isoleucine w/w.

In some embodiments, the present invention provides krill meals comprising from about 65% to about 75% protein w/w (dry matter), from about 10% to about 25% fat w/w
5 (dry matter), and from about 1 to about 200 mg/kg astaxanthin (wet base). In some embodiments, the fat comprises greater than about 30% neutral lipids and greater than about 30% phospholipids on a w/w basis. In some embodiments, the fat comprises from about 50 to about 60% neutral lipids w/w and from about 40% to about 55% polar lipids w/w. In some
10 embodiments, the polar lipids comprise greater than about 90% phosphatidyl choline w/w. In some embodiments, the polar lipids comprise less than about 10% phosphatidyl ethanolamine w/w. In some embodiments, the protein comprises from about 5% to about 11% leucine w/w and from about 3% to about 7% isoleucine w/w.

In some embodiments, the present invention provides krill oil compositions comprising greater than about 1500 mg/kg total esterified astaxanthin, wherein said esterified
15 astaxanthin comprises from about 25 to 35% astaxanthin monoester on a w/w basis and from about 50 to 70% astaxanthin diester on a w/w basis, and greater than about 20 mg/kg free astaxanthin.

In some embodiments, the present invention provides krill compositions comprising from about 3% to about 10% protein w/w, about 8% to about 20% dry matter w/w, and about
20 4% to about 10% fat w/w. In some embodiments, the fat comprises from about 50% to about 70% triacylglycerol w/w. In some embodiments, the fat comprises from about 30% to about 50% phospholipids w/w. In some embodiments, the phospholipids comprise greater than about 90% phosphatidyl choline w/w. In some embodiments, the fat comprises from about 10% to about 25% n-3 fatty acids. In some embodiments, the fat comprises from about 10%
25 to about 20% EPA and DHA.

In some embodiments, the krill compositions of the present invention are supplemented with additional proteins, phospholipids, triglycerides, fatty acids, and/or
astaxanthin to produce an oil or meal with a desired defined composition. As such, a person of skill in the art will readily recognize that the krill compositions described above serve as a
30 starting point for producing compositions that are further supplemented in subsequent process steps to produce a desired composition, such a composition containing elevated levels of proteins, lipids or astaxanthin.

The meal and oil compositions of the present invention described above are characterized in containing low levels, or being substantially free of many volatile compounds

that are commonly found in products derived from marine biomass. In some embodiments, the meals and oils of the present invention are characterized as being substantially free of one or more of the following volatile compounds: acetone, acetic acid, methyl vinyl ketone, 1-penten-3-one, n-heptane, 2-ethyl furan, ethyl propionate, 2-methyl-2-pentenal, pyridine, acetamide, toluene, N,N-dimethyl formamide, ethyl butyrate, butyl acetate, 3-methyl-1,4-heptadiene, isovaleric acid, methyl pyrazine, ethyl isovalerate, N,N-dimethyl acetamide, 2-heptanone, 2-ethyl pyridine, butyrolactone, 2,5-dimethyl pyrazine, ethyl pyrazine, N,N-dimethyl propanamide, benzaldehyde, 2-octanone, β -myrcene, dimethyl trisulfide, trimethyl pyrazine, 1-methyl-2-pyrrolidone. In other embodiments, the meals and oils of the present invention are characterized in containing less than 1000, 100, 10, 1 or 0.1 ppm (alternatively less than 10 mg/100g, preferably less than 1 mg/100 g and most preferably less than 0.1 mg/100 g) of one or more of the following volatile compounds: acetone, acetic acid, methyl vinyl ketone, 1-penten-3-one, n-heptane, 2-ethyl furan, ethyl propionate, 2-methyl-2-pentenal, pyridine, acetamide, toluene, N,N-dimethyl formamide, ethyl butyrate, butyl acetate, 3-methyl-1,4-heptadiene, isovaleric acid, methyl pyrazine, ethyl isovalerate, N,N-dimethyl acetamide, 2-heptanone, 2-ethyl pyridine, butyrolactone, 2,5-dimethyl pyrazine, ethyl pyrazine, N,N-dimethyl propanamide, benzaldehyde, 2-octanone, β -myrcene, dimethyl trisulfide, trimethyl pyrazine, 1-methyl-2-pyrrolidone. In further embodiments, the compositions of the present invention are characterized in comprising less than 10 mg/100g, and preferably less than 1mg/100 g (dry weight) of trimethylamine (TMA), trimethylamine oxide (TMAO) and/or lysophosphatidylcholine.

In some embodiments, the present invention provides systems for processing of marine biomass comprising: a mixer for mixing marine biomass and water to form a mixture having a defined temperature, wherein said mixture has a first solid phase and a first liquid phase. In some embodiments, the water is heated and said defined temperature of said mixture is from about 25 to 80 °C, preferably to about 50 to 75 °C, and most preferably to about 60 to 75 °C. In some embodiments, the systems further comprise a separator in fluid communication with said mixer for separating said first solid phase and said first liquid phase. In some embodiments, the first separator is a filter. In some embodiments, the systems further comprise a first heater unit in fluid communication with said first separator, wherein said first heater unit heats said first liquid phase to a defined temperature. In some embodiments, the defined temperature is about 80°C to about 100°C, preferably 90°C to about 100°C, most preferably 95°C to about 100°C. In some embodiments, the systems further comprise a microfilter in fluid communication with said mixer, wherein said liquid phase is separated into

a retentate phase and a permeate phase by said microfilter. In some embodiments, the systems further comprise a prefilter in line with said microfilter. In some embodiments, the prefilter is a sieve. In some embodiments, the water is heated and said defined temperature of said mixture is from about 25 to 80 °C, preferably to about 50 to 75 °C, and most preferably to about 60 to 75 °C. In some embodiments, the systems further comprise a first separator in fluid communication with said mixer for separating said first solid phase and said first liquid phase. In some embodiments, the first separator is a filter.

In some embodiments, the present invention provides krill compositions comprising from about 10% to about 20% protein w/w, about 15% to about 30% fat w/w, from about 0.01% to about 200 mg/kg astaxanthin, and less than about 1 mg/100g trimethyl amine, trimethyl amine, volatile nitrogen, or 1g/100g lysophosphatidylcholine or combinations thereof. In some embodiments, the fat has an omega-3 fatty acid content of from about 10% to about 25% on a w/w basis. In some embodiments, the fat comprises from about 35% to about 50% phospholipids w/w. In some embodiments, the phospholipids comprise greater than about 90% phosphatidylcholine w/w. In some embodiments, the phospholipids comprise less than about 10% ethanolamine on a w/w basis. In some embodiments, the fat comprises from about 40% to about 60% triacylglycerol w/w. In some embodiments, the compositions further comprise less than about 1% cholesterol. In some embodiments, the protein comprises from about 7% to about 13% leucine on a w/w basis and from about 4% to 10% isoleucine on a w/w basis.

In some embodiments, the present invention provides processes for processing of marine biomass comprising: providing a marine biomass and a mixer for mixing marine biomass and water to form a mixture having a defined temperature, wherein said mixture comprises a first solid phase and a first liquid phase. In some embodiments, the defined temperature of said mixture is from about 25 to 80 °C, preferably to about 50 to 75 °C, and most preferably to about 60 to 75 °C. In some embodiments, the processes further comprise the steps of separating said liquid phase from said solid phase, and heating said liquid phase to about 80°C to about 100°C, preferably 90°C to about 100°C, most preferably 95°C to about 100°C, to produce a coagulate. In some embodiments, the coagulate comprises proteins and lipids. In some embodiments, the coagulate is separated from residual liquid by filtering.

In some embodiments, the present invention provides systems for processing of marine biomass comprising: a ship; a trawl net towable from said ship, said trawl net configured to catch the marine biomass; and a mixer for mixing said marine biomass and water to form a mixture having a defined temperature, wherein said mixture has a first solid

phase and a first liquid phase. In some embodiments, the marine biomass is krill. In some embodiments, the krill is fresh krill and the trawl and ship are configured to deliver the fresh krill to the mixer. In some embodiments, system comprises a pump to transfer the biomass from the krill to the ship. In some embodiments, the system comprises a microfilter in fluid communication with said mixer, wherein said microfilter separates said first solid phase and said first liquid phase. In some embodiments, the marine biomass is krill. In some embodiments, the krill is fresh krill.

In some embodiments, the present invention provides an oil extracted from krill comprising from about 40% to about 60% phospholipids by weight of the oil and about 1 to about 1500 mg/l astaxanthin, said oil having Newtonian fluidity at 25°C. In some embodiments, the oil has a viscosity of about 400 to about 1200 microPascals/sec at 25°C. In some embodiments, the oil comprises about 35% to about 55% w/w triglycerides. In some embodiments, the oil further comprises about 10% to about 35% w/w omega-3 fatty acid residues. In some embodiments, the phospholipids comprise about greater than 90% phosphatidyl choline by weight of the phospholipids. In some embodiments, the oil has a viscosity of about 800 to about 1100 microPascals/sec at 25°C. In some embodiments, the krill is *Euphausia superba*. In some embodiments, the present invention provides a capsule containing the previous oil compositions. In some embodiments, the capsule is a gel capsule.

In some embodiments, the present invention provides an oral dosage form comprising an oil extracted from krill comprising from about 40% to about 60% phospholipids by weight of said oil and about 1 to about 1500 mg/l astaxanthin, the oil having a viscosity of about 700 to about 1200 microPascals/sec at 25°C. In some embodiments, the oral dosage form is a gel capsule. In some embodiments, the oral dosage form is a free flowing oil.

In some embodiments, the present invention provides an oil extracted from krill comprising from about 40% to about 60% phospholipids by weight of the oil and about 1 to about 1500 mg/l astaxanthin, said oil having a viscosity of about 400 to about 1200 microPascals/sec at 25°C. In some embodiments, the oil has Newtonian fluidity at 25°C.

In some embodiments, the present invention provides processes for producing a krill oil having Newtonian fluidity comprising: mixing said krill with water to increase the temperature of the krill to about 25 to 80 °C to form a first solid phase and a first aqueous phase comprising said phospholipids and proteins; separating said first solid phase from said first aqueous phase; heating said first aqueous phase to produce a phospholipid and protein concentrate; and extracting an oil from the phospholipid and protein concentrate. In some embodiments, the oil is extracted with ethanol. In some embodiments, the ethanol is removed

by evaporation under reduced pressure. In some embodiments, the present invention provides krill oils produced by the foregoing processes.

In some embodiments, the present invention provides a pharmaceutical composition comprising one or more of the compositions described above in combination with a
5 pharmaceutically acceptable carrier. In some embodiments, the present invention provides a food product comprising one or of the foregoing compositions. In some embodiments, the present invention provides a dietary supplement comprising one or more of the foregoing compositions. In some embodiments, the present invention provides an animal feed comprising one or more of the foregoing compositions.

10

DESCRIPTION OF THE FIGURES

Figure 1 shows an overview of the process of making krill meal with a two stage cooking process.

15 Figure 2 is a graph of the Permeate flux as function of dry matter of the retentate (% (°Brix).

Figure 3 is a graph of Average Flux as function of dry matter in retentate.

Figure 4 is a GC of the neutral fraction extracted from krill coagulate.

Figure 5 is a GC analysis of the neutral fraction extracted from krill coagulate.

Figure 6 is a GC of the polar fraction extracted from krill coagulate.

20 Figure 7 is a GC analysis of the polar fraction extracted from krill coagulate.

Figures 8a, 8b, and 8c provides graphs depicting Newtonian fluidity at 15°C, 25°C, and 35°C, respectively.

25 DEFINITIONS

As used herein, "phospholipid" refers to an organic compound having the following general structure:

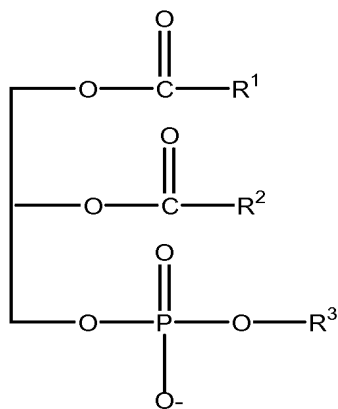

wherein R1 is a fatty acid residue, R2 is a fatty acid residue or $-OH$, and R3 is a $-H$ or nitrogen containing compound choline ($HOCH_2CH_2N^+(CH_3)_3OH^-$), ethanolamine ($HOCH_2CH_2NH_2$), inositol or serine. R1 and R2 cannot simultaneously be OH . When R3 is an $-OH$, the compound is a diacylglycerophosphate, while when R3 is a nitrogen-containing compound, the compound is a phosphatide such as lecithin, cephalin, phosphatidyl serine or plasmalogen.

An “ether phospholipid” as used herein refers to a phospholipid having an ether bond at position 1 the glycerol backbone. Examples of ether phospholipids include, but are not limited to, alkylacylphosphatidylcholine (AAPC), lyso-alkylacylphosphatidylcholine (LAAPC), and alkylacylphosphatidylethanolamine (AAPE). A “non-ether phospholipid” is a phospholipid that does not have an ether bond at position 1 of the glycerol backbone.

As used herein, the term omega-3 fatty acid refers to polyunsaturated fatty acids that have the final double bond in the hydrocarbon chain between the third and fourth carbon atoms from the methyl end of the molecule. Non-limiting examples of omega-3 fatty acids include, 5,8,11,14,17-eicosapentaenoic acid (EPA), 4,7,10,13,16,19-docosahexanoic acid (DHA) and 7,10,13,16,19-docosapentanoic acid (DPA).

As used herein, astaxanthin refers to the following chemical structure:

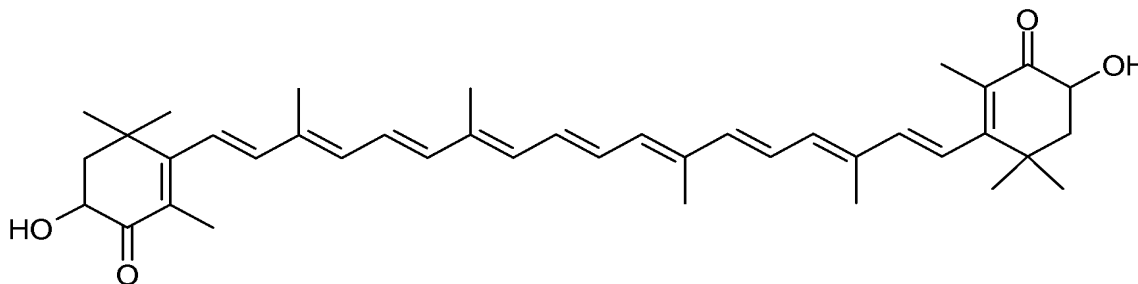

20

As used herein, astaxanthin esters refer to the fatty acids esterified to OH group in the astaxanthin molecule.

As used herein, the term w/w (weight/weight) refers to the amount of a given substance in a composition on weight basis. For example, a composition comprising 50% w/w phospholipids means that the mass of the phospholipids is 50% of the total mass of the composition (i.e., 50 grams of phospholipids in 100 grams of the composition, such as an oil).

As used herein, the term "fresh krill" refers to krill that is has been harvested less than about 12, 6, 4, 2 or preferably 1 hour prior to processing. "Fresh krill" is characterized in that products made from the fresh krill such as coagulum comprise less than 1 mg/100g TMA, volatile nitrogen or Trimethylamine oxide-N, alone or in combination, and less than 1g/100 g lysophosphatidylcholine.

As used herein, the term "Newtonian fluid" refers to a fluid whose stress versus strain rate curve is linear and passes through the origin. The constant of proportionality is known as the "viscosity." The term "having Newtonian fluidity" is used in reference to a fluid, for example an oil containing phospholipids, that exhibits fluidity properties that are substantially Newtonian fluid-like, i.e., the stress versus strain rate curve is substantially linear and passes approximately through the origin.

DETAILED DESCRIPTION OF THE INVENTION

The invention relates to processing crustaceans such as krill to oils comprising phospholipids that are Newtonian fluids and/or and have low viscosity, and in particular to the production of oils containing astaxanthin and high levels of phospholipids that show Newtonian fluidity and have a low viscosity. In some embodiments, the present invention provides systems and methods for the continuous processing of fresh or frozen krill into useful products, including krill oil, krill meal, and a krill protein/phospholipid coagulum.

Previous processes for treating marine biomasses such as krill have utilized a single high temperature treatment to provide a proteinaceous product. Pat No. SU220741; "Removing fats from the protein paste "Okean". Gulyaev and Bugrova, Konservnaya i Ovoshchesushil'naya Promyshlennost (1976), (4), 37-8; Amino acid composition of protein-coagulate in krill. Nikolaeva, VNIRO (1967), 63 161-4. However, these methods result in a product with a relatively low lipid content. The present invention describes a process in which the marine biomass such as krill is first heated at moderate temperatures to provide an aqueous phase which is subsequently heated at a higher temperature. This process provides a novel protein-lipid composition that has a higher lipid content than previously described

compositions produced from marine biomasses. The compositions of the present invention are further distinguished from other krill oil supplements marketed for human use in that the described compositions are, in some embodiments, provided as solids or powders comprising a combination of krill lipids, including krill phospholipids and krill triglycerides, and krill-
5 derived protein. These solids/powders may preferably be provided in capsules, gel capsules, or as tablets or caplets.

In some embodiments, the present invention provides solvent-free methods to produce a phospholipid-containing composition from a biomass such as krill, crabs, Calanus, plankton, eggs, crayfish, shrimp and the like without using organic solvents. In some embodiments, the
10 biomass (preferably krill, freshly harvested or frozen) is heated to a temperature in the range of 25 to 80°C, preferably 40 to 75°C, and most preferably 60 to 75°C in order to dissolve/disperse lipids and proteins from the krill into the water phase, which is called krill milk. In some embodiments, the biomass is heated to and held at this first temperature for at least 3 minutes, preferably from about 3 minutes to 60 minutes, more preferably from about 3
15 minutes to 20 minutes, and most preferably from about 3 minutes to 10 minutes. In some embodiments, the processes then utilize a second heating step. The proteins and phospholipids are precipitated out of the water phase produced from the first heating step by heating the krill milk (after removal of the krill solids) to a temperature of greater than about 80°C, preferably 80 to 120°C, most preferably 95 to 100°C. In some embodiments, the krill
20 milk is held at these temperatures for from about 1 minute to about 60 minutes, preferably about 1 minute to about 10 minutes, and most preferably for about 2 minutes to 8 minutes. The water phase may be heated at atmospheric pressure, or the water phase may be heated in a closed system at an elevated pressure so that the temperature can be increased above 100°C. Accordingly, in some embodiments, the heating is at atmospheric pressure, while in other
25 embodiments, the pressure is greater than atmospheric pressure. The precipitate formed (hereafter called a coagulum) can be isolated and characterized. In some embodiments, the processes further comprise the steps of pressing and drying the coagulum to form a coagulum meal. In some embodiments, the drying is by hot air or steam.

The solid phase (e.g., krill solids) is preferably used to make a krill meal which also
30 has a novel composition. In other embodiments, the krill milk is microfiltrated. The solid phase produced by microfiltration (called the retentate) is similar to that of the coagulum. Data show that the coagulum and retentate are low in cholesterol. In some embodiments, the retentate and coagulum are substantially free of cholesterol. In some embodiments, the retentate and coagulum comprise less than 1% cholesterol, preferably less than 0.1%

cholesterol. This is a novel method to remove at least a portion of the lipids, such as phospholipids, from the krill. Removal of lipids from krill has previously required solvent extraction using liquids such as ethanol or other polar solvents. Solvent extraction is time-consuming and may also result in loss of material and is therefore not wanted. The krill used
5 to separate out the coagulum had been stored frozen for 10 months prior to the experimentation. It is believed that due to the release of proteolytic enzyme activity during a freezing/thawing process, more protein can be expected to be solubilized based on the processing of frozen krill than from fresh krill.

In some embodiments, the present invention provides systems and processes for
10 processing a marine biomass. In preferred embodiments, the marine biomass is krill, preferably the Antarctic krill *Euphausia superba*. Other krill species may also be processed using the systems and processes of the present invention. In some embodiments, the krill is processed in a fresh state as defined herein. In some embodiments, the krill is processed on board a ship as described below within 12, 10, 8, 6, 4, or preferably 2 hours of catching the
15 krill. In some embodiments, the krill is processed on board a ship within 1 or preferably 0.5 hours of catching the krill. In some embodiments, the ship tows a trawl that is configured to catch krill. The krill is then transferred from the trawl to the ship and processed. In some embodiments, the trawl comprises a pump system to pump the freshly caught krill from the trawl to the ship so that the krill can be processed in a fresh state. In preferred embodiments,
20 the pump system comprises a tube that extends below the water the trawl and a pumping action is provided by injecting air into the tube below the waterline so that the krill is continuously drawn or pumped from the trawl, through the tube and on board the ship. Preferred trawling systems with pumps are described in PCT Applications WO 07/108702 and WO 05/004593, incorporated herein by reference.

Some embodiments of the systems and processes of the present invention are shown in
25 Figure 1. As shown in Figure 1, fresh or frozen is krill is mixed in mixer with a sufficient amount of hot water from water heater to increase the temperature of the krill mass to approximately 40 to 75°C, preferably 50 to 75 °C, more preferably 60 to 75 °C, and most preferably about 60 to 70 °C. Many different types of water heaters are useful in the present
30 invention. In some embodiments, the water heater is a steam heated kettle, while in other embodiments, the water heater is a scraped surface heat exchanger. The heated mass is then separated into liquid (krill milk) and krill solid fractions in a filter. In some embodiments, the separation is performed by sieving through a metal sieve. After separation, the krill milk is heated to approximately 90°C to 100°C, preferably to about 95°C to 100°C in a heater. Any

type of suitable water or liquid heater may be used. In preferred embodiments, the heater is a scraped surface heat exchanger. This heating step produced a solid fraction (the coagulum described above) and a liquid fraction. In some preferred embodiments, the separator utilizes a filter as previously described. The present invention is not limited to the use of any particular type of filter. In some embodiments, the filter is a woven filter. In some
5 embodiments, the filter comprises polymeric fibers. The coagulum is introduced into a dewaterer. In some embodiments, the dewaterer is a press such as screw press. Pressing produces a liquid fraction and a press cake. The press cake is dried in a drier to produce coagulum meal.

10 The solid krill fraction is introduced into a dewaterer for dewatering. In some embodiments, the dewaterer is a press such as screw press. Pressing produces a press cake and a liquid fraction. The press cake is dried in a drier, such as an air drier or steam drier, to provide krill meal. The liquid fraction is centrifuged to produce a neutral krill oil containing high levels of astaxanthin and stickwater. In preferred embodiments, the stick water is added
15 back into the krill press cake to make a full meal, including the various components of the stick water such as soluble proteins, amino acids, etc.

In alternative embodiments, the krill milk can be treated by microfiltration instead of by heating to form a coagulum. The krill milk is introduced into a microfilter. Microfiltration produces a fraction called a retentate and a liquid permeate. The retentate is concentrated by
20 evaporation under vacuum to stability, water activity $<0.5 A_w$. Membrane filtration of cooking liquid is preferably performed at about 70 °C with a filter having a pore size of about 10 nm to about 1000nm, more preferably about 50 to about 500 nm, and most preferably about 100 nm. An exemplary filter is the P19-40 100 nm ZrO₂ membrane. In some embodiments, the liquid fraction is prefiltered prior to microfiltration. In preferred
25 embodiments, the prefilter is a roto-fluid sieve (air opening 100 μm).

In yet another embodiment of the invention is a novel and more efficient method of preparing krill meal. By removing the coagulum, the krill meal process is less susceptible to clogging problems and the use of hot steam in the cooker can be avoided. The data disclosed show the coagulum contains a high percentage of phospholipids, hence the separation of the
30 fat in the new krill meal process can be obtained using mechanical methods as in standard fish meal processes. In fact, the separation of fat from the meal is important. Ideally, the krill meal should have a low fat value in order to have satisfactory technical properties. Mechanically separating the fat from the meal will result in a neutral oil rich in astaxanthin. If the neutral oil rich in astaxanthin stays in the meal, the astaxanthin may be degraded during the drying.

In some embodiments, the present invention provides a krill coagulate and retentate compositions. The compositions are characterized in containing a combination of protein and lipids, especially phospholipids. In preferred embodiments, the compositions are solids or powders (also referred to as a meal). In some embodiments, the compositions comprise from 5 about 20% to about 50% protein w/w, preferably about 30% to 40% protein w/w, and about 40% to 70% lipids w/w, preferably about 50% to 65% lipids w/w, so that the total amount of proteins and lipids in the compositions of from 90 to 100%. In some embodiments, the lipid fraction contains from about 10 g to 30 g omega-3 fatty acid residues per 100 g of lipid, preferably about 15 g to 25 g omega-3 fatty acids residues per 100 g lipids (i.e., from 10 to 10 30% or preferably from 15 to 25% omega-3 residues expressed w/w as a percentage of total lipids in the composition). In some embodiments, the lipid fraction of the composition comprises from about 25 to 50 g polar lipids per 100 g lipids (25 to 50% w/w expressed as percentage of total lipids), preferably about 30 to 45 g polar lipids per 100 g total lipids (30 to 45% w/w expressed as percentage of total lipids), and about 50 to 70 g nonpolar lipids per 100 15 g lipids (50 to 70% w/w expressed as percentage of total lipids), so that the total amount of polar and nonpolar lipids is 90 to 100% of the lipid fraction. In some embodiments, the phospholipids comprise greater than about 60% phosphatidylcholine on a w/w basis. In some embodiments, the phospholipids comprise less than about 10% ethanolamine on a w/w basis. In some embodiments, the compositions comprise from about 20% to about 50% 20 triacylglycerol on a w/w basis. In some embodiments, the compositions comprise less than about 1% cholesterol. In some embodiments, the protein fraction comprises from about 8% to about 14% leucine on a w/w basis and from about 5% to 11% isoleucine on a w/w basis. In some embodiments, the compositions comprise less than about 200, 10, 5 or 1 mg/kg naturally occurring or endogenous astaxanthin. In some embodiments, the compositions 25 comprise from about 0.01 to about 200 mg/kg naturally-occurring astaxanthin. It will be recognized that the astaxanthin content of the composition can be increased by adding in astaxanthin from other (exogenous) sources, both natural and non-natural. Likewise, the compositions can be supplemented with exogenous proteins, triglycerides, phospholipids and fatty acids such as omega-3 fatty acids to produce a desired composition.

30 In yet another embodiment of the invention is a pre-heated krill composition. Non-limiting examples of the pre-heated krill composition is a krill composition comprising lipids with less than 10% or 5% phospholipids, and in particular phosphatidylcholine.

In yet another embodiment of the invention is a novel krill meal product produced from the solid phase left after the first heating step (i.e., the heating step at below 80 C). The

krill meal has good nutritional and technical qualities such as a high protein content, low fat content and has a high flow number. Unexpectedly, the ratios of polar lipids to neutral lipids and EPA to DHA is substantially enhanced as compared to normal krill meal. In some embodiments, the krill meals comprise from about 60% to about 80% protein on a w/w basis, preferably from about 70% to 80% protein on a w/w basis, from about 5% to about 20% fat on a w/w basis, and from about 1 to about 200 mg/kg astaxanthin, preferably from about 50 to about 200 mg/kg astaxanthin. In some embodiments, the fat comprises from about 20 to 40% total neutral lipids and from about 50 to 70% total polar lipids on a w/w basis (total lipids). In some embodiments, the ratio of polar to neutral lipids in the meal is from about 1.5:1 to 3:1, preferably about 1.8:1 to 2.5:1, and most preferably from about 1.8:1 to 2.2:1. In some embodiments, the fat comprises from about 20% to 40% omega-3 fatty acids, preferably about 20% to 30% omega-3 fatty acids. In some embodiments, the ratio of EPA:DHA is from about 1.8:1 to 1:0.9, preferably from about 1.4:1 to 1:1.

In still other embodiments, the present invention provides oil produced by the processes described above. In some embodiments, the oils comprise greater than about 1800 mg/kg total esterified astaxanthin, wherein said esterified astaxanthin comprises from about 25 to 35% astaxanthin monoester on a w/w basis and from about 50 to 70% astaxanthin diester on a w/w basis, and less than about 40 mg/kg free astaxanthin.

In still further embodiments, the present invention provides oils extracted from the coagulum powder (meal) described above. In some embodiments, the coagulum powder is extracted with ethanol. For example, the coagulum powder may be extracted with a suitable quantity of 96% ethanol for about one hour at about 15 to 30°C. The mixture of ethanol and coagulum powder is then filtered and the ethanol is removed by evaporation, preferably at reduced pressure. In other embodiments, the coagulum powder is extracted by super critical fluid extraction. In some embodiments, the oils comprise from about 40% to about 60% phospholipids by weight of said oil, about 1 to about 1500 mg/l astaxanthin, and have a viscosity of about 700 to about 1200 microPascals/sec ($\mu\text{P}/\text{sec}$) at 25°C. In some embodiments, the oils have a viscosity of about 800 to about 1100 $\mu\text{P}/\text{sec}$ at 25°C. In some embodiments, the oils comprise about 35% to about 55% w/w triglycerides. In some embodiments, the oils comprise about 10% to about 35% w/w omega-3 fatty acid residues. In some embodiments, the phospholipids comprise about greater than 90% phosphatidyl choline by weight of the phospholipids. In some embodiments, the krill is *Euphausia superba*. In some embodiments, the oil is provided in a capsule, preferably a gel capsule.

The compositions of the present invention are highly palatable humans and other animals. In particular the oil and meal compositions of the present invention are characterized as containing low levels of undesirable volatile compounds or being substantially free of many volatile compounds that are commonly found in products derived from marine biomass.

5 In some embodiments, the meals and oils of the present invention are characterized as being substantially free of one or more of the following volatile compounds: acetone, acetic acid, methyl vinyl ketone, 1-penten-3-one, n-heptane, 2-ethyl furan, ethyl propionate, 2-methyl-2-pentenal, pyridine, acetamide, toluene, N,N-dimethyl formamide, ethyl butyrate, butyl acetate, 3-methyl-1,4-heptadiene, isovaleric acid, methyl pyrazine, ethyl isovalerate, N,N-dimethyl
10 acetamide, 2-heptanone, 2-ethyl pyridine, butyrolactone, 2,5-dimethyl pyrazine, ethyl pyrazine, N,N-dimethyl propanamide, benzaldehyde, 2-octanone, β -myrcene, dimethyl trisulfide, trimethyl pyrazine, 1-methyl-2-pyrrolidone. In other embodiments, the meals and oils of the present invention are characterized in containing less than 1000, 100, 10, 1 or 0.1 ppm (alternatively less than 10 mg/100g, preferably less than 1 mg/100 g and most preferably
15 less than 0.1 mg/100 g) of one or more of the following volatile compounds: acetone, acetic acid, methyl vinyl ketone, 1-penten-3-one, n-heptane, 2-ethyl furan, ethyl propionate, 2-methyl-2-pentenal, pyridine, acetamide, toluene, N,N-dimethyl formamide, ethyl butyrate, butyl acetate, 3-methyl-1,4-heptadiene, isovaleric acid, methyl pyrazine, ethyl isovalerate, N,N-dimethyl acetamide, 2-heptanone, 2-ethyl pyridine, butyrolactone, 2,5-dimethyl pyrazine,
20 ethyl pyrazine, N,N-dimethyl propanamide, benzaldehyde, 2-octanone, β -myrcene, dimethyl trisulfide, trimethyl pyrazine, 1-methyl-2-pyrrolidone. In further embodiments, the compositions of the present invention are characterized in comprising less than 10 mg/100g, and preferably less than 1mg/100 g (dry weight) of trimethylamine (TMA), trimethylamine oxide (TMAO) and/or lysophosphatidylcholine.

25 In some embodiments, the present invention provides an oral dosage form comprising an oil extracted from krill comprising from about 40% to about 60% phospholipids by weight of said oil and about 1 to about 1500 mg/l astaxanthin, wherein the oil has Newtonian fluidity and/or a viscosity of about 700 to about 1200 microPascals/sec at 25°C. In some
30 embodiments, the compositions of this invention (such as those described in the preceding sections) are contained in acceptable excipients and/or carriers for oral consumption. In some embodiments, the present invention provides a pharmaceutical compositions one or more of the foregoing compositions in combination with a pharmaceutically acceptable carrier. The actual form of the carrier, and thus, the composition itself, is not critical. The carrier may be a liquid, gel, gelcap, capsule, powder, solid tablet (coated caplet or non-coated), tea, or the like.

The composition is preferably in the form of a tablet or capsule and most preferably in the form of a soft gel capsule. Suitable excipient and/or carriers include maltodextrin, calcium carbonate, dicalcium phosphate, tricalcium phosphate, microcrystalline cellulose, dextrose, rice flour, magnesium stearate, stearic acid, croscarmellose sodium, sodium starch glycolate, 5 crospovidone, sucrose, vegetable gums, lactose, methylcellulose, povidone, carboxymethylcellulose, corn starch, and the like (including mixtures thereof). Preferred carriers include calcium carbonate, magnesium stearate, maltodextrin, and mixtures thereof. The various ingredients and the excipient and/or carrier are mixed and formed into the desired form using conventional techniques. The tablet or capsule of the present invention may be 10 coated with an enteric coating that dissolves at a pH of about 6.0 to 7.0. A suitable enteric coating that dissolves in the small intestine but not in the stomach is cellulose acetate phthalate. Further details on techniques for formulation for and administration may be found in the latest edition of Remington's Pharmaceutical Sciences (Maack Publishing Co., Easton, PA).

15 The dietary supplement may comprise one or more inert ingredients, especially if it is desirable to limit the number of calories added to the diet by the dietary supplement. For example, the dietary supplement of the present invention may also contain optional ingredients including, for example, herbs, vitamins, minerals, enhancers, colorants, sweeteners, flavorants, inert ingredients, and the like. For example, the dietary supplement of 20 the present invention may contain one or more of the following: ascorbates (ascorbic acid, mineral ascorbate salts, rose hips, acerola, and the like), dehydroepiandrosterone (DHEA), Fo-Ti or Ho Shu Wu (herb common to traditional Asian treatments), Cat's Claw (ancient herbal ingredient), green tea (polyphenols), inositol, kelp, dulse, bioflavonoids, maltodextrin, nettles, niacin, niacinamide, rosemary, selenium, silica (silicon dioxide, silica gel, horsetail, 25 shavegrass, and the like), spirulina, zinc, and the like. Such optional ingredients may be either naturally occurring or concentrated forms.

In some embodiments, the dietary supplements further comprise vitamins and minerals including, but not limited to, calcium phosphate or acetate, tribasic; potassium phosphate, dibasic; magnesium sulfate or oxide; salt (sodium chloride); potassium chloride or acetate; 30 ascorbic acid; ferric orthophosphate; niacinamide; zinc sulfate or oxide; calcium pantothenate; copper gluconate; riboflavin; beta-carotene; pyridoxine hydrochloride; thiamin mononitrate; folic acid; biotin; chromium chloride or picolonate; potassium iodide; sodium selenate; sodium molybdate; phyloquinone; vitamin D3; cyanocobalamin; sodium selenite; copper

sulfate; vitamin A; vitamin C; inositol; potassium iodide. Suitable dosages for vitamins and minerals may be obtained, for example, by consulting the U.S. RDA guidelines.

In further embodiments, the compositions comprise at least one food flavoring such as acetaldehyde (ethanal), acetoin (acetyl methylcarbinol), anethole (parapropenyl anisole),
 5 benzaldehyde (benzoic aldehyde), N butyric acid (butanoic acid), d or l carvone (carvol),
 cinnamaldehyde (cinnamic aldehyde), citral (2,6 dimethyloctadien 2,6 al 8, gera nial, neral),
 decanal (N decylaldehyde, capraldehyde, capric aldehyde, caprinaldehyde, aldehyde C 10),
 ethyl acetate, ethyl butyrate, 3 methyl 3 phenyl glycidic acid ethyl ester (ethyl methyl phenyl
 glycidate, strawberry aldehyde, C 16 aldehyde), ethyl vanillin, geraniol (3,7 dimethyl 2,6 and
 10 3,6 octadien 1 ol), geranyl acetate (geraniol acetate), limonene (d , l , and dl), linalool (linalol,
 3,7 dimethyl 1,6 octadien 3 ol), linalyl acetate (bergamol), methyl anthranilate (methyl 2
 aminobenzoate), piperonal (3,4 methylenedioxy benzaldehyde, heliotropin), vanillin, alfalfa
 (Medicago sativa L.), allspice (Pimenta officinalis), ambrette seed (Hibiscus abelmoschus),
 angelic (Angelica archangelica), Angostura (Galipea officinalis), anise (Pimpinella anisum),
 15 star anise (Illicium verum), balm (Melissa officinalis), basil (Ocimum basilicum), bay (Laurus
 nobilis), calendula (Calendula officinalis), (Anthemis nobilis), capsicum (Capsicum
 frutescens), caraway (Carum carvi), cardamom (Elettaria cardamomum), cassia,
 (Cinnamomum cassia), cayenne pepper (Capsicum frutescens), Celery seed (Apium
 graveolens), chervil (Anthriscus cerefolium), chives (Allium schoenoprasum), coriander
 20 (Coriandrum sativum), cumin (Cuminum cyminum), elder flowers (Sambucus canadensis),
 fennel (Foeniculum vulgare), fenugreek (Trigonella foenum graecum), ginger (Zingiber
 officinale), horehound (Marrubium vulgare), horseradish (Armoracia lapathifolia), hyssop
 (Hyssopus officinalis), lavender (Lavandula officinalis), mace (Myristica fragrans), marjoram
 (Majorana hortensis), mustard (Brassica nigra, Brassica juncea, Brassica hirta), nutmeg
 25 (Myristica fragrans), paprika (Capsicum annum), black pepper (Piper nigrum), peppermint
 (Mentha piperita), poppy seed (Papayer somniferum), rosemary (Rosmarinus officinalis),
 saffron (Crocus sativus), sage (Salvia officinalis), savory (Satureia hortensis, Satureia
 montana), sesame (Sesamum indicum), spearmint (Mentha spicata), tarragon (Artemisia
 dracunculus), thyme (Thymus vulgaris, Thymus serpyllum), turmeric (Curcuma longa),
 30 vanilla (Vanilla planifolia), zedoary (Curcuma zedoaria), sucrose, glucose, saccharin, sorbitol,
 mannitol, aspartame. Other suitable flavoring are disclosed in such references as Remington's
 Pharmaceutical Sciences, 18th Edition, Mack Publishing, p. 1288-1300 (1990), and Furia and
 Pellanca, Fenaroli's Handbook of Flavor Ingredients, The Chemical Rubber Company,
 Cleveland, Ohio, (1971), known to those skilled in the art.

In other embodiments, the compositions comprise at least one synthetic or natural food coloring (e.g., annatto extract, astaxanthin, beet powder, ultramarine blue, canthaxanthin, caramel, carotenal, beta carotene, carmine, toasted cottonseed flour, ferrous gluconate, ferrous lactate, grape color extract, grape skin extract, iron oxide, fruit juice, vegetable juice, dried
5 algae meal, tagetes meal, carrot oil, corn endosperm oil, paprika, paprika oleoresin, riboflavin, saffron, tumeric, tumeric and oleoresin).

In still further embodiments, the compositions comprise at least one phytonutrient (e.g., soy isoflavonoids, oligomeric proanthocyanidins, indol 3 carbinol, sulforaphane, fibrous ligands, plant phytosterols, ferulic acid, anthocyanocides, triterpenes, omega 3/6 fatty acids,
10 conjugated fatty acids such as conjugated linoleic acid and conjugated linolenic acid, polyacetylene, quinones, terpenes, catechins, gallates, and quercetin). Sources of plant phytonutrients include, but are not limited to, soy lecithin, soy isoflavones, brown rice germ, royal jelly, bee propolis, acerola berry juice powder, Japanese green tea, grape seed extract, grape skin extract, carrot juice, bilberry, flaxseed meal, bee pollen, ginkgo biloba, primrose
15 (evening primrose oil), red clover, burdock root, dandelion, parsley, rose hips, milk thistle, ginger, Siberian ginseng, rosemary, curcumin, garlic, lycopene, grapefruit seed extract, spinach, and broccoli.

In still other embodiments, the compositions comprise at least one vitamin (e.g., vitamin A, thiamin (B1), riboflavin (B2), pyridoxine (B6), cyanocobalamin (B12), biotin,
20 ascorbic acid (vitamin C), retinoic acid (vitamin D), vitamin E, folic acid and other folates, vitamin K, niacin, and pantothenic acid). In some embodiments, the particles comprise at least one mineral (e.g., sodium, potassium, magnesium, calcium, phosphorus, chlorine, iron, zinc, manganese, fluorine, copper, molybdenum, chromium, selenium, and iodine). In some particularly preferred embodiments, a dosage of a plurality of particles includes vitamins or
25 minerals in the range of the recommended daily allowance (RDA) as specified by the United States Department of Agriculture. In still other embodiments, the particles comprise an amino acid supplement formula in which at least one amino acid is included (e.g., l-carnitine or tryptophan).

In further embodiments, the present invention provide animal feeds comprising one or
30 more the compositions described in detail above. The animal feeds preferably form a ration for the desired animal and is balanced to meet the animals nutritional needs. The compositions may be used in the formulation of feed or as feed for animals such as fish, including fish fry, poultry, cattle, pigs, sheep, shrimp and the like.

EXAMPLE 1

Four portions of krill were analysed for dry matter, fat, and protein. Most of the variation in the composition can be expected to be due to variation in the sampling. To include the effect of variation in storage time after thawing, raw material samples were also taken at different times during the working day. The observed variation in raw material input is inherent in all calculations of fat, dry matter and protein distributions based on the reported examples.

Table 1. Composition of krill (g/100 g)

	Dry matter	Fat	Fat free dry matter	Protein
Krill 1	21,40	7,80	13,60	11,80
Krill 2	22,13	7,47	14,66	12,96
Krill 3	23,78	7,44	16,34	14,60
Krill 4	23,07	7,55	15,52	13,83
Mean	22,60	7,57	15,03	13,30
SD	1,04	0,16	1,17	1,20
RSD	4,6 %	2,2 %	7,8 %	9,0 %

10

EXAMPLE 2

In this example a novel method for preparing krill meal was investigated. 800 g of preheated water (95-100 °C) and 200g of frozen krill (0 °C) were mixed in a cooker (cooker 1) at a temperature of 75 °C for 6 minutes. Next, the heated krill and the hot water were separated by filtration. The preheated krill was further cooked (cooker 2) by mixing with 300 g hot water (95 °C) in a kitchen pan and kept at 90 °C for 2 minutes before separation over a sieve (1,0 × 1,5 mm opening). The heated krill was separated from the liquid and transferred to a food mixer and cut for 10 seconds. The disintegrated hot krill was added back to the hot water and centrifuged at 8600 × g (RCF average) for 10 minutes. The supernatant corresponding to a decanter liquid (D1) was decanted off. The liquid from cooking step 1 was heated to 95-100 °C to coagulate the extracted protein. The coagulum was separated over a

15
20

sieve (1.0 × 1.5 mm opening) and a weight of 40 g was found. Figure 1 shows an overview of the process of making krill meal with a two stage cooking process.

EXAMPLE 3

5 The total volatile nitrogen (TVN), trimethylamine (TMA) and trimethylamine oxide (TMAO) content were determined in the four products from the cooking test in example 2 (Table 2). The krill was fresh when frozen, so no TMA was detected in the products. The results show that TMAO is evenly distributed in the water phase during cooking of krill.

10 Table 2. Distribution of total volatile nitrogen (TVN), trimethylamine (TMA) and trimethylamine oxide (TMAO) in the products from the cooking procedure.

Products from test no.	10	Krill	Coagulum from cooker	Coagulated cooker liquid	Decanter solids	Decanter liquid	SUM
Weight (wb)	g	200	97,6	711,1	90,3	294,7	
Dry matter	g/100 g	21,4	14,2	1,0	22,2	0,9	
Analytical values							
Total volatile nitrogen	mg N/100 g	8	1,3	1,2	2,3	1	
Trimethylamine-N	mg N/100 g	<1	<1	<1	<1	<1	
Trimethylamine oxid-N	mg N/100 g	107	19,2	13,5	10,4	13,1	
Quantities							
Total volatile nitrogen	mg N	15,0	1,3	8,5	2,1	2,9	14,8
Trimethylamine-N	mg N	-	-	-	-	-	-
Trimethylamine oxid-N	mg N	214	18,7	96,0	9,4	38,6	163
Distribution							
Total volatile nitrogen	% of input	100 %	8 %	57 %	14 %	20 %	99 %
Trimethylamine-N	% of input						
Trimethylamine oxid-N	% of input	100 %	9 %	45 %	4 %	18 %	76 %

In addition, fat, dry matter and astaxanthin were determined in the products (Table 3). It was observed that the major part of the astaxanthin in the krill was found in the press cake (Table 3). Only a minor part is found in the coagulum which contains more than 60 % of the lipid in the krill raw material. The cooking procedure with leaching of a protein-lipid emulsion increases the concentration of astaxanthin in the remaining fat. The results also show that the water free coagulum contains approximately 40% dry matter and 60% fat. The dry matter consist of mostly protein.

Table 3. Distribution of astaxanthin in the products from the cooking procedure.

Products from test no.	10	Krill	Coagulum from cooker	Coagulate d cooker liquid	Decante r solids	Decante r liquid	SUM
Weight (wb)	g	200	97,6	711,1	90,3	294,7	
Fat	g/100 g	7,8	10,3	0,1	5,3	0,2	
Fat free dry matter	g/100 g	13,6	3,9	0,9	16,9	0,8	
Analytical values							
Fri Astaxanthin	mg/kg	3	<1	<1	4,5	<1	
Astaxanthin esters	mg/kg	33	1,2	<0,02	59	0,18	
Conc. in lipid							
Fri Astaxanthin	mg/kg lipid	38	-	-	85	-	
Astaxanthin esters	mg/kg lipid	423	12	-	1111	113	
Quantities							
Free Astaxanthin	mg	0,6	-	-	0,4	-	0,4
Astaxanthin esters	mg	6,6	0,1	-	5,3	0,1	6,2
Distribution							
Free Astaxanthin	% of input	100 %	-	-	68 %	-	68 %
Astaxanthin esters	% of input	100 %	2 %	-	81 %	1 %	83 %

The coagulum from the cooking experiment in Example 2 were analysed for lipid classes. The coagulum lipid was dominated by triacylglycerol and phosphatidyl choline with a small quantity of phosphatidyl ethanolamine (Table 4).

Table 4. Distribution of lipid classes in the coagulum from cooking experiments.

Experiment		Krill	Coagulum F5	Coagulum F6
Fat (Bligh & Dyer)	g/100 g sample	7,8	11,8	9,9
Triacylglycerol	g/100 g fat	47	40	50
Diacylglycerol	g/100 g fat	<0,5	1	0,7
Monocylglycerol	g/100 g fat	<1	<1	<1
Free fatty acids	g/100 g fat	12	0,2	0,4
Cholesterol	g/100 g fat	0,3	<0,3	<0,3
Cholesterol esters	g/100 g fat	0,8	<0,3	<0,3
Phosphatidyl ethanolamine	g/100 g fat	5,3	2,3	2,2
Phosphatidyl inositol	g/100 g fat	<1	<1	<1
Phosphatidyl serine	g/100 g fat	<1	<1	<1
Phosphatidyl choline	g/100 g fat	33	43,1	42,3
Lyso-Phosphatidyl choline	g/100 g fat	2,4	<1	<1
Total polar lipids	g/100 g fat	41,3	45,5	44,5
Total neutral lipids	g/100 g fat	61,0	41,3	51,2
Sum lipids	g/100 g fat	102,3	86,8	95,7

The proportion of phosphatidyl choline increased from 33 % in krill to 42 – 46 % in the coagulum. The other phospholipids quantified, phosphatidyl ethanolamine and lyso-phosphatidyl choline, had lower concentrations in the coagulum than in krill. The free fatty acids were almost absent in the coagulum.

The cooking time in test F5 was 6.75 min, in test F6 it was 4.00 min. The results in Table 4 show no dependence of the distribution of the lipid classes with the cooking time.

The amino acid composition of the coagulum is not much different the amino acid composition in krill. There seems to be a slight increase in the apolar amino acids in the coagulum compared to krill (Table 5). For a protein to have good emulsion properties it is the distribution of amino acids within the protein that is of importance more than the amino acid composition.

Table 5. Amino acids in coagulum from cooking Example 2.

		Coagulum	Coagulum	Krill
		F 10-2	70-100°C	
		mar/apr	24.06.2006	24.06.2006
		2007		
Aspartic acid	g/100 g protein	8,8	10,8	7,8
Glutamic acid	g/100 g protein	10,1	11,6	10,7
Hydroxiprolin	g/100 g protein	<0,10	<0,10	<0,10
Serine	g/100 g protein	4,3	4,6	3,0
Glycine	g/100 g protein	3,7	3,4	4,1
Histidine	g/100 g protein	1,7	1,6	1,6
Arginine	g/100 g protein	4,4	4,4	5,7
Threonine	g/100 g protein	5,2	5,6	3,4
Alanine	g/100 g protein	4,7	4,6	4,7
Proline	g/100 g protein	4,2	4,3	3,9
Tyrosine	g/100 g protein	4,3	4,7	2,7
Valine	g/100 g protein	6,4	6,6	4,2
Methionine	g/100 g protein	2,1	2,1	2,4
Isoleucine	g/100 g protein	8,0	8,5	4,5
Leucine	g/100 g protein	10,8	11,6	6,7
Phenylalanine	g/100 g protein	4,3	4,3	3,6
Lysine	g/100 g protein	7,5	8,2	6,2
Cysteine/Cystine	g/100 g protein	0,75		
Tryptophan	g/100 g protein	0,63		

Sum amino acids	91,9	96,9	75,2
Polar amino acids	47 %	48 %	51 %
Apolar amino acids	53 %	52 %	49 %

The fatty acid profile of the coagulum is presented in Table 6. The content of EPA (20:5) is about 12.4 g/100 g extracted fat and the content of DHA (22:6) is about 5.0 g/100 g extracted fat.

5 Table 6. Fatty acid content of coagulum

Fatty acid	Unit	Amount
14:0	g/100 extracted fat	11,5
16:0	g/100 extracted fat	19,4
18:0	g/100 extracted fat	1,1
20:0	g/100 extracted fat	<0,1
22:0	g/100 extracted fat	<0,1
16:1 n-7	g/100 extracted fat	7,0
18:1 (n-9) + (n-7) + (n-5)	g/100 extracted fat	18,4
20:1 (n-9) + (n-7)	g/100 extracted fat	1,3
22:1 (n-11) + (n-9) + (n-7)	g/100 extracted fat	0,8
24:1 n-9	g/100 extracted fat	0,1
16:2 n-4	g/100 extracted fat	0,6
16:3 n-4	g/100 extracted fat	0,2
16:4 n-4	g/100 extracted fat	<0,1
18:2 n-6	g/100 extracted fat	1,2
18:3 n-6	g/100 extracted fat	0,1
20:2 n-6	g/100 extracted fat	<0,1
20:3 n-6	g/100 extracted fat	<0,1
20:4 n-6	g/100 extracted fat	0,2
22:4 n-6	g/100 extracted fat	<0,1
18:3 n-3	g/100 extracted fat	0,8
18:4 n-3	g/100 extracted fat	2,5
20:3 n-3	g/100 extracted fat	<0,1
20:4 n-3	g/100 extracted fat	0,4
20:5 n-3	g/100 extracted fat	12,4
21:5 n-3	g/100 extracted fat	0,4
22:5 n-3	g/100 extracted fat	0,3
22:6 n-3	g/100 extracted fat	5,0

EXAMPLE 4

To evaluate the two stage cooking process described above, a laboratory scale test was performed. The tests are described below.

Materials and methods

5 **Raw material.** Frozen krill were obtained by Aker Biomarine and 10 tons were stored at Norway Pelagic, Bergen, and retrieved as required. The krill was packed in plastic bags in cardboard boxes with 2×12.5 kg krill. The boxes with krill were placed in a single layer on the floor of the process plant the day before processing. By the time of processing the krill varied from + 3 °C to -3 °C.

10 Analytical methods.

Protein, Kjeldahl's method: Nitrogen in the sample is transformed to ammonium by dissolution in concentrated sulfuric acid with copper as catalyst. The ammonia is liberated in a basic distillation and determined by titration, (ISO 5983:1997(E), Method A 01). Uncertainty: 1 %.

15 **Protein, Combustion:** Liberation of nitrogen by burning the sample at high temperature in pure oxygen. Detection by thermal conductivity. Percent protein in the sample is calculated by a multiplication of analysed percent nitrogen and a given protein factor, (AOAC Official Method 990.03, 16th ed. 1996, Method A 25).

Moisture: Determination of the loss in mass on drying at 103 °C during four hours
20 (ISO 6496 (1999). Method A 04). Uncertainty: 4 %.

Ash: Combustion of organic matter at 550 °C. The residue remaining after combustion is defined as the ash content of the sample. (ISO 5984:2002. Method A 02). Uncertainty: 3 %.

Fat, Ethyl acetate extraction: Absorption of moisture in wet sample by sodium sulphate, followed by extraction of fat by ethyl acetate (NS 9402, 1994 (modified calculation).
25 Method A 29).

Fat, Soxhlet: Extraction of fat by petroleum ether. Mainly the content of triglycerides is determined, (AOCS Official Method Ba 3-38 Reapproved 1993. Method A 03).

Fat, Bligh and Dyer: Extraction of fat by a mixture of chloroform, methanol, and water in the proportion 1:2:0.8 which build a single phase system. Addition of chloroform and
30 water gives a chloroform phase with the lipids and a water/methanol phase. The lipids are determined in an aliquot of the chloroform phase after evaporation and weighing. The extraction includes both triglycerides and phospholipids. (E.G. Bligh & W.J. Dyer: A rapid method of total lipid extraction and purification. Can.J.Biochem.Physiol. Vol 37 (1959). Methode A 56).

Astaxanthin: Extraction with ethanol and di-chloromethane. Polar products are removed by open column chromatography on silica gel. Isomers are separated on normal phase HPLC on Si 60 column and detection at 470 nm. (Schierle J. & Härdi W. 1994. Determination of stabilized astaxanthin in Carophyll® Pink, premixes and fish feeds. Edition 3. Revised Supplement to: Hoffman P, Keller HE, Schierle J., Schuep W. Analytical methods for vitamins and carotenoids in feed. Basel: Department of Vitamin Research and Development, Roche. Method A 23)

Moisture in oil: Determination of actual water content of fats and oils by titration with Karl Fischer reagent, which reacts quantitatively with water, (AOCS Official Method CA 2e-84. Reapproved 1993. Method A 13).

Dry matter in stick water during processing is correlated to refract meter which gives ° Brix. Amino acids were determined as urea derivatives by reversed phase HPLC with fluorescence detection. (Cohen S. A. and Michaud D. P., Synthesis of a Fluorescent Derivatizing Reagent, 6-Aminoquinolyl-N-Hydroxysuccinimidyl Carbamate, and Its Application for the Analysis of Hydrolysate Amino Acids via High-Performance Liquid Chromatography. Analytical Biochemistry **211**, 279-287, 1993. Method A42). TVB-N, TMA-N and TMAO-N were determined in a 6% trichloro-acetic acid extract by micro diffusion and titration. (Conway, E. I., and A. Byrne. An absorption apparatus for the micro determination of certain volatile substances. Biochem. J. 27:419-429, 1933, and Larsen, T, SSF rapport nr. A-152, 1991). Fatty acids were determined by esterifying the fatty acids to methyl esters, separate the esters by GLC, and quantify by use of C23:0 fatty acid methyl ester as internal standard.(AOCS Official Method Ce 1b-89, Method A 68). Lipids were separated by HPLC and detected with a Charged Aerosol Detector. Vitamins A, D and E were analysed at AnalyCen, Kambo.

Results and discussion

Raw material of krill. Table 7 gives the results of analysis of the raw material of the krill that was used in the pilot trials. Besides the first trial, the same shipment of krill was used for all trials. The dry matter was about 21-22 %, fat 6 %, protein 13-14 %, salt 1 % pH, total volatile nitrogen (TVN) 18 mgN/100g, trimethylamine (TMA) 4 mg N/100g and trimethylamineoxide (TMAO) 135 mg N/100g. Compared to fish pH, TMAO and salt (Cl⁻) is high for krill.

Table 7. Analysis of raw krill on wet base (wb)

Sample:	Raw material of krill									
Analysis:	Dry matter	Fat, B&D	Protein	Ash	Salt	pH	TVN	TMA	TMAO	
Date:	g/100 g	g/100 g	g/100 g	g/100 g	g/100 g		mg N/100 g	mg N/100 g	mg N/100 g	
07.08.2007	22,8	7,1	13,5	2,5						Saga Sea 04.07.06 Lot. L1
18.09.2007	21,3	6,0								
04.10.2007	21,6	6,3	13,5							Krillråstoff CO5S
04.10.2007	20,5	5,9	12,8							Krillråstoff AO6S
25.10.2007	22,1	6,0	13,9	2,9	1,1	7,4	20,8	5,8	128,3	Krillråstoff CO5S
25.10.2007	21,3	6,0	13,2	2,7	1,1	7,4	15,0	2,3	140,6	Krillråstoff AO6S
22.11.2007	21,9	5,9				7,8	17,9	3,5	123,7	
Average	21,6	6,2	13,5	2,7	1,1	7,4	17,9	4,0	134,5	

Table 8 gives the analysis of raw krill on dry base. If these figures are multiplied with 0.93 it will give the figures on meal base with 7 % water.

5 Table 8 Analysis of raw krill on dry base (db)

Sample:	Raw material of krill								
Analysis:	Dry matter	Fat, B&D	Protein	Ash	Salt	TVN	TMA	TMAO	
Date:	g/100 g	g/100 g	g/100 g	g/100 g	g/100 g	mg N/100 g	mg N/100 g	mg N/100 g	
07.08.2007	100	31,1	59,2	11,0					
18.09.2007	100	28,2		0,0					
04.10.2007	100	29,2	62,5	0,0					
04.10.2007	100	28,8	62,4	0,0					
25.10.2007	100	27,1	62,9	13,1	5,0	94,1	26,1	580,5	
25.10.2007	100	28,2	62,0	12,7	5,2	70,6	10,9	660,2	
22.11.2007	100	26,9				81,7	16,0	564,8	
Average	100	28,5	62,5	12,3	5,1	82,4	18,5	620,4	

Separation of coagulum and pressing for krill oil. 99 kg krill was processed by adding batches of 20 kg krill to 80 l of water at 95 °C in a steam heated kettle (200 l). The steam on the kettle was closed, and the krill and water were gently mixed manually for 3 minutes, and the mixed temperature became 75 °C (heating step no. 1). The heated krill was separated from the water by sieving. Sieved preheated krill (75°C) was added 20 kg hot water and heated to 85 °C within a minute, (heating step 2). The krill was sieved again and feed into the press. The liquid from step1 (krill milk) was coagulated at 95 °C. All the krill was cooked and the press liquid was separated for oil. From 99 kg krill about 0.5 kg of unpolished krill oil was separated from the press liquid. Tables 9 and 10 provide an analysis of cooked krill after first cooking step on wet base and dry base.

20 Table 9 Analysis of cooked krill on wet base (wb)

Sample:	Cooked krill								
Analysis:	Dry matter	Fat, B&D	Protein	Ash	pH	TVN	TMA	TMAO	
Date:	g/100 g	g/100 g	g/100 g	g/100 g		mg N/100 g	mg N/100 g	mg N/100 g	
07.08.2007	20,2	4,7	13,5	2,2					
18.09.2007	19,8	4,6							
25.10.2007	15,2	3,2	10,3	2,0	8,2	10,5	3,5	75,4	

Table 10 Analysis of cooked krill on dry base (db)

Sample:	Cooked krill						
Analysis:	Dry matter	Fat, B&D	Protein	Ash	TVN	TMA	TMAO
Date:	g/100 g	g/100 g	g/100 g	g/100 g	mg N/100 g	mg N/100 g	mg N/100 g
07.08.2007	100,0	23,3	66,8	10,9			
18.09.2007	100	23,2					
25.10.2007	100	21,1	67,8	13,2	69,3	23,1	496,3

Compared to raw krill (Table 8) there is a reduction in dry matter for cooked krill. The fat content in dry matter is reduced because of the fat in the krill milk which is separated from the cooked krill. The content of protein is increased on dry base, but the ash seems to be at the same level. TMAO in the krill is reduced and is found in the cooking liquid.

Micro filtration. The krill milk (70 °C) from step 1 was coagulated at > 95 °C and separated from the liquid through microfiltration (Soby Miljøfilter). Coagulum was then pressed in a press and dried. Tables 11 and 12 gives analyses of coagulum on wet base and dry base. The dry matter of the coagulum was between 12.8 and 16.7 %. On dry base the fat content about 60 % and TMAO 340 mg N/100 g. The dry matter of the coagulum increased to 34-38 % by pressing. The fat content also increased on dry base (Table 13), but the TMAO was reduced to 145 mg N/100 g. After washing the press cake with 1 part water to 1 part press cake of coagulum and then press again, the TMAO was reduced to 45 mg N/100g on dry base (Table 18).

Table 11 Analysis of coagulum on wet base (wb)

Sample:	Coagulum						
Analysis:	Dry matter	Fat, B&D	Protein	Ash	TVN	TMA	TMAO
Date:	g/100 g	g/100 g	g/100 g	g/100 g	mg N/100 g	mg N/100 g	mg N/100 g
10.10.2007	12,8	7,9					
25.10.2007	14,3	8,3	5,4	1,0	5,9	2,3	48,6
31.10.2007	16,7	9,3	6,2				
Average	14,6	8,5	5,8				

Table 12 Analysis of coagulum on dry base (db)

Sample:	Coagulum						
Analysis:	Dry matter	Fat, B&D	Protein	Ash	TVN	TMA	TMAO
Date:	g/100 g	g/100 g	g/100 g	g/100 g	mg N/100 g	mg N/100 g	mg N/100 g
10.10.2007	100	61,7					
25.10.2007	100	58,0	37,8	7,0	41,0	16,4	340,1
31.10.2007	100	55,7	37,1				
Average	100	58,5	37,4				

Table 13 Analysis of press cake from coagulum on wet base

Sample:	Press cake of coagulum					Raw krill	Coagulum	Coagulum PK
Analysis:	Dry matter	Fat, B&D	TVN	TMA	TMAO	worked up	perss cake	per kg raw krill
Date:	g/100 g	g/100 g	mg N/100 g	mg N/100 g	mg N/100 g	kg	kg	kg/kg
22.11.2007	38,8	23,6	7,9	4,5	56,1	1000	54,2	0,0542
11.12.2007	33,8	22,5	3,4	0	45,3	500	21,92	0,0438
11.12.2007*	33,6	21,3	0	0	15,3	500	15	0,0300

*) After 1 wash (Press cake : water = 1:1)

5 **Membrane filtration.** Another way to collect the lipids from the krill milk is to separate by membrane filtration. For this to be possible the milk must not coagulate, but be brought to the membrane filter from the sieve (heating step no. 1).

Before the krill milk could enter the membrane filter the milk is pre-filtrated, which was done by the sieve (100 µm). The opening of the micro-filter was 100 nm. 80 kg krill was processed by starting by 80 kg water (95 °C) and 20 kg krill into the kettle as described. For the first 2 batches of krill clean water was used (160 kg), but for the last 2 batches permeate from the membrane filter was used instead of water. The membrane filtration was followed with a refract meter calibrated for sugar solution (°Brix). The Brix-value is near the dry matter concentration in the process liquids. The flux value for the filter at about 60 °C was 350 l/m²/h for retentate with 7.8 °Brix (refract meter) and reduced to 290 l/m²/h when the Brix value increased to 9.9 °. The Brix value for the permeate was only 1 ° due to high dilution when the amount to be filtered is small. See Figures 2 and 3. The permeate was golden and transparent.

All permeate was evaporated in a kettle to > 65 ° Brix. Retentate, 2 liter, was evaporated in a laboratory evaporator at 70 °C and 12 mm Hg. At 27.5 °Brix the retentate was still flowing well. As the concentration continued the retentate became more and more viscous, first as a paste and finely to a dry mass. The concentrated retentate (27 °Brix), permeate (> 65 °Brix) and dry retentate were analyzed and the results are given in Table 14 on sample base (% wb) and Table 15 on dry matter base (% db) (sample no 1, 2 and 3). A sample of coagulum was dried as for the retentate (sample no 4).

Table 14 Analysis of concentrate from retentate, permeate and coagulum on wet base (wb)

	Dry matter	Fat (polar+apolar) Bligh & Dyer	Crude Protein	Ash	TVN	TMA	TMAO	Water activity 25 °C
Sample	% wb	% wb	% wb	% wb	mg N/100g wb	mg N/100g wb	mg N/100g wb	aw
No. 1 Concentrate of retentat	26,0	16,3	9,5	1,6	5,7	<1	99	0,978
No. 2 Consentrate of permeat	72,7	1,0	51,1	24,7	138	110	1 157	0,385
No. 3 Vakuüm dried retentate	64,9	39,3	24	4,1	12,8	29,4	196	0,875
No. 4 Vakuüm died coagulum	60,3	37,1	20,9	4,4	52,9	28,1	216	0,912

Table 15 Analysis of concentrate from retentate, permeate and coagulum on dry matter base (db)

	Dry matter	Fat (polar+apolar) Bligh & Dyer	Crude Protein	Ash	TVN	TMA	TMAO
Sample	% db	% db	% db	% db	mg N/100g db	mg N/100g db	mg N/100g db
No. 1 Concentrate of retentat	100,0	62,7	36,5	6,2	21,9	<1	382
No. 2 Consentrate of permeat	100,0	1,4	70,3	34,0	190	152	1 592
No. 3 Vakuüm dried retentate	100,0	60,6	37,0	6,3	19,7	45,3	302
No. 4 Vakuüm died coagulum	100,0	61,5	34,7	7,3	87,7	46,6	358

5 These results indicate that micro filtration of krill milk was promising and is an alternative to coagulate the krill milk. The protein portion was high in taurine. The content of fat, protein, ash and TMAO were almost similar between retentate and coagulum. Permeate can be concentrated to 70 % dry matter and will have a water activity below 0.4 at 25 °C which means that it can be stored at ambient temperature.

10 **Press cake and press liquid.** Tables 16 and 17 provide an analysis of press cake on wet and dry base from the different trials. The average amount of press cake per kg raw krill was found to be 0.23 kg. The dry matter of the press cake was between 44 and 48 %. The fat content in dry matter was reduced from 21 % before to 15-20 % after pressing. This will give a press cake meal from 14 to 18.5 % fat, about 67 % protein and 7 % moisture. TMAO was reduced from about 500 mg N/100g dry matter in cooked krill to 95mg N/100g dry matter in the press cake.

Table 16 Analysis on wet base (wb) of press cake and calculations

Sample:	Press cake						Raw krill	Press cake	Kg press cake
Analysis:	Dry matter	Fat, B&D	Protein	TVN	TMA	TMAO	worked up		per kg raw krill
Date:	g/100 g	g/100 g	g/100 g	mg N/100 g	mg N/100 g	mg N/100 g	kg	kg	kg/kg
18.09.2007	48,1	8,0					327	90	0,28
04.10.2007	47,9	7,0	34,8						
10.10.2007	44,8	9,3					250	55	0,22
31.10.2007	47,4	7,2	33,8				709	143	0,20
22.11.2007	44,4	8,1		8,4	2,1	42,2	1000	226	0,23
11.12.2007	43,8	7,3		5,6	2,2	46,7	500	117	0,23
Average:	46,1	7,8	34,3	7	2,2	44,5			0,23

Table 17 Analysis on dry base (db) of press cake

Press cake					
Dry matter	Fat, B&D	Protein	TVN	TMA	TMAO
g/100 g	g/100 g	g/100 g	mg N/100 g	mg N/100 g	mg N/100 g
100	16,6				
100	14,6	72,7			
100	20,8				
100	15,2	71,3			
100	18,2		18,9	4,7	95,0
100	16,7		12,8	5,0	106,6
100	17,0	72,0	15,9	4,9	100,8

Oil was produced from the krill solids by centrifugation. Table 18. The oil was
5 almost free for water and the content of astaxanthin was quite high (1.8 g/kg).

Table 18 Analysis of krill oil

		Date:	Date:
Tricanter oil (krill oil)		31.10.2007	22.11.2007
Astaxanthin, Free	mg/kg	22	29
Trans	mg/kg	12	14
9-cis	mg/kg	2,3	3,2
13-cis	mg/kg	5,4	7,8
Astaxanthin, Esters	mg/kg	1802	1785
Diester	mg/kg	1142	1116
Monoester	mg/kg	660	669
Astaxanthin - total	mg/kg	1824	1814
Water, Karl F.	g/100 g	0,17	0,04
FFA	g/100 g		0,9
Vitamin A	IE/kg		602730
Vitamin D3	IE/kg		<1000
Vitamin E (alfa-tokoferol)	mg/kg		630

10 Table 19 Analysis of press cake from coagulum on dry base

Sample:	Press cake of coagulum				
Analysis:	Dry matter	Fat, B&D	TVN	TMA	TMAO
Date:	g/100 g	g/100 g	mg N/100 g	mg N/100 g	mg N/100 g
22.11.2007	100	60,8	20,4	11,6	144,6
11.12.2007	100	66,6	10,1	0,0	134,0
11.12.2007*	100	63,4	0,0	0,0	45,5

*) After 1 wash (Press cake : water = 1:1)

The yield of coagulum press cake was about 5 % of raw krill. The compositions of
coagulum and retentate from micro filtration is compared in Table 20. There was hardly any
difference between the products from the two process alternatives. Press cake of coagulum
was dried, and Table 21 gives the analysis of the coagulum and final coagulum meal. The
15 proximate composition based on dry matter did not change during drying, and the amino acid
composition and fatty acid composition is near identical. There was some loss of

phospholipids during drying. This is most probable caused by oxidation of fatty acids, but other chemical modification of the phospholipids may also be of consequence.

5

Table 20 Analysis of Retentate from micro filtration and Coagulum

		Retentat 25.10.07	Coagulum 25.10.07
Protein	g/100 g	5,8	5,4
Dry matter	g/100 g	13,5	14,3
Ash	g/100 g	1,1	1,0
Fat (B&D)	g/100 g	7,3	8,3
pH		8,5	
TFN	mg N/100 g	5,9	5,9
TMA	mg N/100 g	2,3	2,3
TMAO	mg N/100 g	61,0	48,6
Lipid classes:			
Triacylglycerol	g/100 g extracted fat	59,0	51
Diacylglycerol	g/100 g extracted fat	1,3	1
Monocylglycerol	g/100 g extracted fat	<1	<1
Free fatty acids	g/100 g extracted fat	3,8	3,2
Cholesterol	g/100 g extracted fat	<0,5	<0,5
Cholesterol esters	g/100 g extracted fat	1,0	0,8
Phosphatidyl ethanolamine	g/100 g extracted fat	1,8	3
Phosphatidyl inositol	g/100 g extracted fat	<1	<1
Phosphatidyl serine	g/100 g extracted fat	<1	<1
Phosphatidyl choline	g/100 g extracted fat	35,0	40
Lyso-Phosphatidyl choline	g/100 g extracted fat	0,8	1,2
Total polar lipids	g/100 g extracted fat	37,6	44,2
Total neutral lipids	g/100 g extracted fat	67,1	56,0
Sum lipids	g/100 g extracted fat	103,4	100,2
Fatty acid composition:			
14:0	g/100 g extracted fat	10,6	10,4
16:0	g/100 g extracted fat	16,4	16,2
18:0	g/100 g extracted fat	1,1	1,2
20:0	g/100 g extracted fat	0,1	0,1
22:0	g/100 g extracted fat	<0,1	<0,1
16:1 n-7	g/100 g extracted fat	6,3	6,4
18:1 (n-9)+(n-7)+(n-5)	g/100 g extracted fat	15,5	15,4
20:1 (n-9)+(n-7)	g/100 g extracted fat	1,1	1,1
22:1 (n-11)+(n-9)+(n-7)	g/100 g extracted fat	0,6	0,5
24:1 n-9	g/100 g extracted fat	0,1	0,1
16:2 n-4	g/100 g extracted fat	0,5	0,5
16:3 n-4	g/100 g extracted fat	0,2	0,2
18:2 n-6	g/100 g extracted fat	1,4	1,4
18:3 n-6	g/100 g extracted fat	0,2	0,2
20:2 n-6	g/100 g extracted fat	0,1	0,1
20:3 n-6	g/100 g extracted fat	0,1	0,1
20:4 n-6	g/100 g extracted fat	0,3	0,3
22:4 n-6	g/100 g extracted fat	<0,1	<0,1
18:3 n-3	g/100 g extracted fat	0,7	0,7
18:4 n-3	g/100 g extracted fat	1,7	1,7
20:3 n-3	g/100 g extracted fat	<0,1	<0,1
20:4 n-3	g/100 g extracted fat	0,3	0,3
20:5 n-3 (EPA)	g/100 g extracted fat	10,5	10,3
21:5 n-3	g/100 g extracted fat	0,3	0,3
22:5 n-3	g/100 g extracted fat	0,5	0,4
22:6 n-3 (DHA)	g/100 g extracted fat	5,1	5,0
Sum saturated fat acides	g/100 g extracted fat	28,2	27,9
Sum monoene fat acides	g/100 g extracted fat	23,6	23,4
Sum PUFA (n-6) fat acides	g/100 g extracted fat	2,1	2
Sum PUFA (n-3) feat acides	g/100 g extracted fat	19,1	18,7
Sum PUFA fat acides total	g/100 g extracted fat	21,9	21,4
Sum fat acides total	g/100 g extracted fat	73,7	72,7
EPA/DHA		2,1	2,1

Table 21 Analysis of Coagulum press cake and meal dried in a Rotadisc dryer on wet and dry base

		Coagulum press cake	Coagulum meal	Coagulum press cake	Coagulum meal
		22.11.2007	22.11.2007	22.11.2007	22.11.2007
Analysis:		wb	wb	db	db
Protein	g/100 g	14,6	35,3	37,6	37,4
Moisture	g/100 g	61,2	5,7	0,0	0,0
Fat B&D	g/100 g	23,6	55,1	60,8	58,4
Ash	g/100 g		5,9		6,3
TMA	mg N/100 g	4,5	7	11,6	7
TMAO	mg N/100 g	56,1	140	144,6	148
Fatty acid composition:					
14:0	g/100 g extracted fat	10,4	10,4		
16:0	g/100 g extracted fat	17	17		
18:0	g/100 g extracted fat	1,2	1,2		
20:0	g/100 g extracted fat	0,1	0,1		
22:0	g/100 g extracted fat	0,1	0,1		
16:1 n-7	g/100 g extracted fat	6,4	6,4		
18:1 (n-9)+(n-7)+(n-5)	g/100 g extracted fat	15,2	15,3		
20:1 (n-9)+(n-7)	g/100 g extracted fat	1,1	1,1		
22:1 (n-11)+(n-9)+(n-7)	g/100 g extracted fat	0,5	0,6		
24:1 n-9	g/100 g extracted fat	0,1	0,1		
16:2 n-4	g/100 g extracted fat	0,5	0,5		
16:3 n-4	g/100 g extracted fat	0,2	0,2		
18:2 n-6	g/100 g extracted fat	1,5	1,4		
18:3 n-6	g/100 g extracted fat	0,2	0,2		
20:2 n-6	g/100 g extracted fat	0,1	0,1		
20:3 n-6	g/100 g extracted fat	<0,1	<0,1		
20:4 n-6	g/100 g extracted fat	0,3	0,3		
22:4 n-6	g/100 g extracted fat	<0,1	<0,1		
18:3 n-3	g/100 g extracted fat	0,7	0,7		
18:4 n-3	g/100 g extracted fat	1,7	1,7		
20:3 n-3	g/100 g extracted fat	<0,1	<0,1		
20:4 n-3	g/100 g extracted fat	0,4	0,4		
20:5 n-3 (EPA)	g/100 g extracted fat	10,9	10,5		
21:5 n-3	g/100 g extracted fat	0,3	0,3		
22:5 n-3	g/100 g extracted fat	0,3	0,3		
22:6 n-3 (DHA)	g/100 g extracted fat	5,3	5,1		
Sum saturated fat acides	g/100 g extracted fat	28,7	28,7		
Sum monoene fat acides	g/100 g extracted fat	23,3	23,3		
Sum PUFA (n-6) fat acides	g/100 g extracted fat	2	2		
Sum PUFA (n-3) fat acides	g/100 g extracted fat	19,7	19		
Sum PUFA fat acides total	g/100 g extracted fat	22,4	21,7		
Sum fat acides total	g/100 g extracted fat	74,4	73,8		
Amino acids:					
Aspartic acid	g/100 g protein	10,5	10,5		
Glutamic acid	g/100 g protein	11,2	11,6		
Hydroxiprolin	g/100 g protein	<0,10	<0,10		
Serine	g/100 g protein	4,3	4,2		
Glycine	g/100 g protein	4	4		
Histidine	g/100 g protein	2	1,9		
Arginine	g/100 g protein	4,8	4,7		
Threonine	g/100 g protein	4,9	4,9		
Alanine	g/100 g protein	4,8	4,9		
Proline	g/100 g protein	4,2	4,1		
Tyrosine	g/100 g protein	3,7	3,5		
Valine	g/100 g protein	6	5,9		
Methionine	g/100 g protein	2,4	2,4		
Isoleucine	g/100 g protein	6,9	6,7		
Leucine	g/100 g protein	9,6	9,4		
Phenylalanine	g/100 g protein	4,5	4,4		
Lysine	g/100 g protein	7,7	7,6		
Sum AA	g/100 g protein	91,5	90,7		
Lipid classes:					
Triacylglycerol	g/100 g extracted fat	48	63		
Diacylglycerol	g/100 g extracted fat	1,2	1,3		
Monocylglycerol	g/100 g extracted fat	<1	<1		
Free fatty acids	g/100 g extracted fat	3,2	3,1		
Cholesterol	g/100 g extracted fat	1,2	<0,5		
Cholesterol esters	g/100 g extracted fat	0,5	0,9		
Phosphatidyl ethanolamine	g/100 g extracted fat	3,1	1,1		
Phosphatidyl inositol	g/100 g extracted fat	<1	<1		
Phosphatidyl serine	g/100 g extracted fat	<1	<1		
Phosphatidyl choline	g/100 g extracted fat	38	34		
Lyso-Phosphatidyl choline	g/100 g extracted fat	1,2	<1		
Total polar lipids	g/100 g extracted fat	42	34,8		
Total neutral lipids	g/100 g extracted fat	54,6	67,9		
Sum lipids	g/100 g extracted fat	96,7	103,6		

Krill meal. Final krill meal was produced. Press cake and press cake with stick water concentrate were dried in a hot air dryer or steam drier. Table 22.

Table 22 Analysis of krill meal from

		Forberg Air dried	Forberg Air dried	Rota disc. Steam dried
		Press cake	Krill meal	Krill meal
Date: 22.11.2007		meal of krill	with stickwater	with stickwater
Wet base:				
Protein	g/100 g	66,4	63,6	66,3
Moisture	g/100 g	5,9	7,1	3,7
Fat Soxhlet	g/100 g	8,7	10,4	
Fat B&D	g/100 g	15,9	15,6	15,2
Ash	g/100 g	9,8	13,0	13,4
Salt	g/100 g	1,3	4,3	4,4
Water sol. protein	g/100 g prot.	11,1	28,0	27,1
pH		8,6	8,3	
TVN	mg N/100 g	18,8	39,9	38,6
TMA	mg N/100 g	11,1	22,2	29,8
TMAO	mg N/100 g	109,7	442,1	399,5
Dry matter base:				
Protein	g/100 g db	70,6	68,5	
Fat Soxhlet	g/100 g db	9,2	11,2	
Fat B&D	g/100 g db	16,9	16,8	15,8
Ash	g/100 g db	10,4	14,0	
Salt	g/100 g db	1,4	4,6	
TVN	mg N/100 g db	20,0	42,9	40,1
TMA	mg N/100 g db	11,8	23,9	30,9
TMAO	mg N/100 g db	116,6	475,9	414,9
Astaxanthin on wet base:				
Astaxanthin, Free	mg/kg	4,6	3,6	<1
Trans	mg/kg	2,5	1,9	<1
9-cis	mg/kg	0,4	0,4	<1
13-cis	mg/kg	1,3	0,9	<1
Astaxanthin, Esters	mg/kg	112,0	100	58,0
Diester	mg/kg	80,0	72,0	50,0
Monoester	mg/kg	32,0	27,0	8,1
Astaxanthin - total	mg/kg	116,6	103,6	58,0
Astaxanthin on fat base:				
Astaxanthin, Fritt	mg/kg fat	28,9	23,1	<7
Trans	mg/kg fat	15,7	12,2	<7
9-cis	mg/kg fat	2,5	2,6	<7
13-cis	mg/kg fat	8,2	5,8	<7
Astaxanthin, Estere	mg/kg fat	704,4	641,0	381,6
Diester	mg/kg fat	503,1	461,5	328,9
Monoester	mg/kg fat	201,3	173,1	53,3
Astaxanthin - totalt	mg/kg fat	733,3	664,1	381,6
Amino acids:				
Aspartic acid	g/100 g protein	10,6	9,2	9,2
Glutamic acid	g/100 g protein	14,1	12,4	12,3
Hydroxiprolin	g/100 g protein	<0,5	<0,5	0,1
Serine	g/100 g protein	4,2	3,7	3,8
Glycine	g/100 g protein	4,4	4,4	4,5
Histidine	g/100 g protein	2,3	1,9	1,9
Arginine	g/100 g protein	6,6	6,0	6,1
Threonine	g/100 g protein	4,3	3,7	4,1
Alanine	g/100 g protein	5,4	4,9	5,3
Proline	g/100 g protein	3,7	4,1	4
Tyrosine	g/100 g protein	4,4	3,1	4,7
Valine	g/100 g protein	5,1	4,4	4,5
Methionine	g/100 g protein	3,2	2,7	2,7
Isoleucine	g/100 g protein	5,3	4,5	4,5
Leucine	g/100 g protein	8,0	6,9	6,9
Phenylalanine	g/100 g protein	4,6	3,9	4
Lysine	g/100 g protein	8,2	7,0	6,6
Sum AA	g/100 g protein	94,4	82,8	85,2
Lipide classes:				
Triacylglycerol	g/100 g extracted fat		41,0	63
Diacylglycerol	g/100 g extracted fat		1,7	1,3
Monocylglycerol	g/100 g extracted fat		<1	<1
Free fatty acids	g/100 g extracted fat		8,8	3,1
Cholesterol	g/100 g extracted fat		2,4	<0,5
Cholesterol esters	g/100 g extracted fat		<0,5	0,9
Phosphatidyl ethanolamine	g/100 g extracted fat		3,6	1,1
Phosphatidyl inositol	g/100 g extracted fat		<1	<1
Phosphatidyl serine	g/100 g extracted fat		<1	<1
Phosphatidyl choline	g/100 g extracted fat		43,0	34
Lyso-Phosphatidyl choline	g/100 g extracted fat		1,1	<1
Total polar lipids	g/100 g extracted fat		47,2	34,8
Total neutral lipids	g/100 g extracted fat		54,2	67,9
Sum lipids	g/100 g extracted fat		101,4	103,6

EXAMPLE 5

Coagulum meal produced as described in Example 4 was extracted using lab scale SFE. 4,885g of coagulum (freeze dried over night) via a two step extraction: 1) SFE: CO₂,
 5 500 Bar, 60°C, 70min at a medium flow rate of 1,8ml/min of CO₂; 2) SFE: CO₂+15%EtOH, 500 Bar, 60°C, 70min at a medium flow rate of 2,5ml/min of CO₂+EtOH. The first step extracted 1,576g of extracted neutral fraction (NF). As shown in Figures 4 and 5, the analysis at HPLC show lower than the detectable limit content on PL in the NF. It was extracted about 32.25% of the total material. Table 29 provides the peak areas of the components of the
 10 neutral fraction as determined by GC.

Table 29.

Rel.Area %	Peakname	Ret.Time min	Area mV*min	Height mV	Rel.Area %
0,29	n.a.	17,455	0,2864	2,271	0,29
19,49	C14:0	24,073	19,0301	105,696	19,49
21,16	C16:0	32,992	20,6601	88,859	21,16
11,99	C16:1	36,197	11,7032	48,125	11,99
3,5	n.a.	37,28	3,4166	14,344	3,5
1,57	n.a.	43,331	1,5375	6,141	1,57
15,6	n.a.	46,425	15,2285	58,605	15,6
8,81	n.a.	46,873	8,5983	30,65	8,81
0,93	n.a.	50,499	0,9055	3,164	0,93
1,56	n.a.	51,292	1,5216	5,746	1,56
1,67	n.a.	57,312	1,6281	4,78	1,67
2,03	n.a.	60,985	1,98	6,963	2,03
0,02	n.a.	67,761	0,0189	0,116	0,02
0,11	n.a.	68,833	0,1066	0,423	0,11
0,11	n.a.	71,705	0,1028	0,497	0,11
0,08	n.a.	74,053	0,0806	0,398	0,08
3,92	C20:5 EPA	74,489	3,826	12,07	3,92
0,11	n.a.	80,519	0,1095	0,48	0,11
0,08	C22:5 DPA	85,369	0,0785	0,41	0,08
1,3	C22:6 DHA	87,787	1,2719	4,253	1,3

The second step extracted a polar fraction of 1,023g corresponding to 20,95% of the total material. The polar fraction consisted mostly of PL and just less than 1% TG. See Figures 6 and 7. Table 30 provides the peak areas of the components of the polar fraction as determined by GC.

5

Table 30.

Rel.Area %	Peakname	Ret.Time min	Area mV*min	Height mV	Rel.Area %
2,87	C14:0	24,025	4,8099	28,243	2,87
28,5	C16:0	33,084	47,7079	182,756	28,5
1,82	C16:1	36,155	3,0402	13,166	1,82
1,13	n.a.	43,304	1,8848	8,208	1,13
3,89	n.a.	46,336	6,5129	27,429	3,89
5,46	n.a.	46,852	9,1467	35,825	5,46
2,15	n.a.	51,265	3,6015	14,095	2,15
1,6	n.a.	57,121	2,6735	7,213	1,6
1,72	n.a.	60,944	2,8832	10,686	1,72
2,03	n.a.	68,259	3,3913	8,025	2,03
30,09	C20:5 EPA	74,599	50,3768	163,312	30,09
12,11	C22:6 DHA	87,832	20,2774	68,714	12,11

10 The coagulate was dried over night with a weight loss of about 5,53% w/w. The total extracted was about 53,2% of the starting weight of the dried material.

EXAMPLE 6

15 Freshly harvested krill were processed into coagulum on board the ship either 10 minutes or six hours post harvest. The coagulum produced from both the 10 minute post harvest krill and the 6 hour post harvest krill contained less than 1mg/100g volatile nitrogen, less than 1 mg/100 g trimethylamine (TMA), and less than 1g/100g lysophosphatidylcholine. This can be compared to the coagulum produced from frozen krill in Example 4 above, which contained higher levels of volatile nitrogen, and lysophosphatidylcholine. The methods of the
 20 invention which utilize freshly harvested krill provide krill products that are characterized in being essentially free of TMA, volatile nitrogen, and lysophosphatidylcholine.

EXAMPLE 7

Coagulum meal, 250 g, and krill oil were mixed in a kitchen mixer. The aim was to add 300 – 500 mg astaxanthin/kg coagulum meal. If the oil contains 1500 mg astaxanthin/kg krill oil, at least 200 g oil should be added to one kg of coagulum meal. The flow of the meal was markedly reduced by addition of 10 % oil, and the oil came off on the packaging when the addition of oil was increased to 14 and 20 %. 3.5 kg coagulum from was thawed and milled on a Retsch ZM1 with a 2 mm sieve. The quantity of milled powder was 2.96 kg. The 2.96 kg dried coagulum was added 300 g krill oil in three portions. The knives in the mixer (Stephan UM12) were too far from the bottom to give a good mixing, so the mixture was mixed by hand and mixer intermittently. The astaxanthin content in the final mixture was 40 % lower than calculated. New analyses of astaxanthin were performed on the oil and on the fortified meal. The krill oil had been stored in a cold room at 3 °C for 4 months, and the astaxanthin content in the oil did not change during this storage . A new sample were drawn from the fortified meal after 4 weeks frozen storage, and the astaxanthin content was the same in both samples (Table 31).

Table 31. Composition of steam dried coagulum fortified with 10 % krill oil.

		Analysed	Calculated	New analysis	New analysis
		Meal with oil	Meal with oil	Krill oil	Meal with oil
Dry matter	g/100 g	98.0	99.2		
Protein	g/100 g		33.6		
Fat (B&D)	g/100 g	58.9	60.7		
Ash	g/100 g		5.9		
Water soluble protein	g/100 g protein		15.8		
TFN	mg N/100 g		10		
TMA	mg N/100 g		10		
TMAO	mg N/100 g		113		
Astaxanthin, Free	mg/kg	2.5	4.9	27	2.8
Trans	mg/kg	1.4	2.5	14	1.5
9-cis	mg/kg	0.35	0.6	3.1	0.4
13-cis	mg/kg	0.57	1.2	6.2	0.7
Astaxanthin, Esters	mg/kg	193	338	1805	197
Diester	mg/kg	126	216	1128	127
Monoester	mg/kg	67	122	677	70
Astaxanthin - total	mg/kg	196	343	1832	200
Astaxanthin, Free	mg/kg lipid	4.2	8.1		
Trans	mg/kg lipid	2.4	4.2		
9-cis	mg/kg lipid	0.6	1.0		

13-cis	mg/kg lipid	1.0	2.0
Astaxanthin, Esters	mg/kg lipid	328	556
Diester	mg/kg lipid	214	356
Monoester	mg/kg lipid	114	200
Astaxanthin - total	mg/kg lipid	332	564
<hr/>			
Ffa	g/100 g extracted fat		4.4
<hr/>			
Total polar lipids	g/100 g extracted fat		39.7
Total neutral lipids	g/100 g extracted fat		60.1
<hr/>			

The astaxanthin content in fortified coagulum meal is 58 % of the amount in the ingredients. This reduction in astaxanthin takes place during mixing of dried coagulum and krill oil, and indicate that dried coagulum is easily oxidized.

5 **Example 8**

The dried coagulum meal was extracted by supercritical fluid extraction. The extracted oil was analyzed as presented in Tables 32-34.

10 **Table 32. Lipid composition**

Phosphatidylcholine	34 g/100 g lipid
Phosphatidylethanolamine	1,3 g/100 g lipid
Triglycerides	48 g/100 g lipid
Cholesterol	n.d.
Free fatty acids	1,0 g/100 g lipid

Table 33. Fatty acid profile

Total saturated fatty acids	26,3 g/100 g lipid
Total omega-3 fatty acids	18,1 g/100 g lipid
Total fatty acids	67,3 g/100 g lipid

Table 34. Miscellaneous properties

Astaxanthin	130 mg/kg
TMAO	87 mg N/100 g

TMA	<1 mg N/100 g
Viscosity at 25°C	61 mPa s

Example 9

5 Coagulum meal prepared as described above was administered to two human subjects and absorption of the product was determined by measuring omega-3 fatty acids in total lipids and in phospholipids in plasma. Subject 1 consumed 8g of coagulum in combination with yoghurt, whereas subject 2 consumed 8g of krill oil without yoghurt. The data is presented in Tables 35 (Subject 1) and 36 (Subject 2).

10

Table 35

Time (h)	C20:5 W3 (EPA)	C22:5 W3 (DPA)	C22:6 W3(DHA)
0	0.117	0.062	0.267
0.5	0.118	0.063	0.270
1	0.113	0.061	0.260
1.5	0.117	0.064	0.272
2	0.116	0.063	0.271
2.5	0.119	0.063	0.271
3	0.123	0.065	0.281
3.5	0.122	0.063	0.275
4	0.123	0.063	0.275
5	0.141	0.065	0.294
6	0.153	0.064	0.286
7	0.154	0.062	0.277
8	0.165	0.063	0.292
10	0.167	0.063	0.291
12	0.163	0.061	0.275
16	0.169	0.062	0.301
24	0.173	0.074	0.323

Table 36

Time (h)	C20:5 W3 (EPA)	C22:5 W3 (DPA)	C22:6 W3(DHA)
0	0.146	0.052	0.260
0.5	0.142	0.052	0.260
1	0.146	0.054	0.268
1.5	0.142	0.053	0.263
2	0.145	0.054	0.267
2.5	0.140	0.053	0.258

3	0.143	0.054	0.264
3.5	0.155	0.056	0.278
4	0.155	0.055	0.277
5	0.179	0.057	0.295
6	0.217	0.057	0.316
7	0.204	0.057	0.304
8	0.211	0.060	0.320
10	0.187	0.057	0.293
12	0.171	0.054	0.272
16	0.166	0.052	0.272
24	0.169	0.061	0.290

These data show that absorption patterns of the coagulum and krill oil are different for the two subjects. The EPA pattern in subject 1 (coagulum) shows that a high EPA level is maintained over a long time despite the fact that coagulum contains less lipid than the krill oil. The coagulum has also enriched the circulating PL pool which could be an indication of absorption/incorporation of krill oil fatty acids in PL form. We have previously observed that krill oil is more efficient in enriching tissue lipid fatty acid profiles than fish oil. These data indicate that coagulum is even more bioeffective than krill oil.

Example 10.

The phospholipid content of the retentate was further analyzed by NMR. Table 37 provides the results.

Table 37.

Phospholipid	% (w/w)
Phosphatidylcholine	16,5
Alkylacylphosphatidylcholine	1,7
Lyso-alkylacylphosphatidylcholine	0,28
2-lysophosphatidylcholine	0,52
Phosphatidylethanolamine	0,59
N-acylphosphatidylethanolamine	3,6
Total phospholipid	23,23

Example 11

This example provides an analysis of the volatile compounds in oil extracted from krill meal and oil extracted from coagulum meal. Table 38. Briefly, oil was extracted by SFE from regular krill meal or meal prepared from coagulum as described above. The oil prepared from coagulum meal had substantially reduced amounts of volatile compounds as compared to the oil prepared from regular krill meal. In particular, 1-penten-3-one was detected in oil prepared from regular krill meal and was absent in oil prepared from coagulum meal. 1-pentene-3-one have previously been identified has a key marker of fishy and metallic off-flavor in fish oil and fish oil enriched food products (Jacobsen et al., J. Agric Food Chem, 2004, 52, 1635-1641).

Table 38.

15

Compound	TIC peak area (Krill oil extracted from krill meal using SFE)	Description	TIC peak area (Krill oil extracted from coagulum using SFE)	Description
dimethyl amine	180403283		22848535	
trimethyl amine	255213688	old fish, strong bad	49040416	old fish
ethanol	394615326	fresh	1426886614	vodka, ethanol
acetone	875959		0	
acetic acid	36136270	weak smell	0	
methyl vinyl ketone	515892		0	
2-butanone	2807131	sweet	23124362	
ethyl acetate	6231705		404501	
1- [dimethylamino]- 2-propanone	23316404		15380603	
1-penten-3-one	5627101	rubbery	0	weak dishcloth

n-heptane	291386		0	
2-ethyl furan	1640866	weak sweet	0	
ethyl propionate	909959		0	
2-methyl-2-pentenal	6996219		0	
pyridine	2085743		0	
acetamide	6169014	pleasant	0	
toluene	4359806		0	
N,N-dimethyl formamide	177968590	garden hose, mint	0	garden hose
ethyl butyrate	1122805		0	
2-ethyl-5-methyl furan	1550476	good, flower	427805	
butyl acetate	306001		856292	
3-methyl-1,4-heptadiene	1617339		0	weak rubber smell,
isovaleric acid	1528541	foot sweat, weak	0	
methyl pyrazine	1335979	peculiar	0	
ethyl isovalerate	1043918	fruity	0	fruity
N,N-dimethyl acetamide	9895351		0	smell, solvent
2-heptanone	7397187	blue cheese	0	
2-ethyl pyridine	317424		0	
butyrolactone	652076	butter, pleasant	0	
2,5-dimethyl pyrazine	2414087		0	
ethyl pyrazine	1909284	metallic	0	soft
N,N-dimethyl propanamide	1160830	unpleasant	0	
benzaldehyde	3134653		0	
2-octanone	2068169	disgusting	0	
β -myrcene	2618870		0	

dimethyl trisulfide	3279406	sewer	0
n-decane	1851488		331629
trimethyl pyrazine	4186679	unpleasant	0
1-methyl-2-pyrrolidone	9577873		0
eucalyptol	0	peppermint	868411
asetofenoni	1146348	smell, pleasant	350688

Example 12

Krill meal produced by the traditional process (Tables 39-42) was compared with krill meal produced from the solid fraction remaining after removal of krill milk (Tables 43-46).

5

Table 39

14:0	g/100g total fat	8,3
16:0	g/100g total fat	15,4
18:0	g/100g total fat	1,0
20:0	g/100g total fat	<0,1
22:0	g/100g total fat	<0,1
16:1 n-7	g/100g total fat	4,7
18:1 (n-9)+(n-7)+(n-5)	g/100g total fat	13,5
20:1 (n-9)+(n-7)	g/100g total fat	0,9
22:1 (n-11)+(n-9)+(n-7)	g/100g total fat	0,6
24:1 n-9	g/100g total fat	0,1
16:2 n-4	g/100g total fat	0,6
16:3 n-4	g/100g total fat	0,3
18:2 n-6	g/100g total fat	1,1
18:3 n-6	g/100g total fat	0,1
20:2 n-6	g/100g total fat	<0,1
20:3 n-6	g/100g total fat	<0,1
20:4 n-6	g/100g total fat	0,3
22:4 n-6	g/100g total fat	<0,1
18:3 n-3	g/100g total fat	0,8
18:4 n-3	g/100g total fat	1,8
20:3 n-3	g/100g total fat	<0,1
20:4 n-3	g/100g total fat	0,4
20:5 n-3	g/100g total fat	11,3
21:5 n-3	g/100g total fat	0,4
22:5 n-3	g/100g total fat	0,3
22:6 n-3	g/100g total fat	6,5

Table 40

	* Fat Bligh & Dyer	%	22,8
5	Sum saturated fatty acids	g/100g total fat	24,7
	Sum monounsaturated fatty acids	g/100g total fat	19,8
	Sum PUFA (n-6)	g/100g total fat	1,6
	Sum PUFA (n-3)	g/100g total fat	21,5
	Sum PUFA	g/100g total fat	24,0
10	Sum fatty acids total	g/100g total fat	68,5

Table 41

15	Triacylglycerol	g/100g total fat	46
	Diacylglycerol	g/100g total fat	1,0
	Monoacylglycerol	g/100g total fat	<1
	Free fatty acids	g/100g total fat	4,4
20	Cholesterol	g/100g total fat	1,6
	Cholesterol ester	g/100g total fat	0,8
	Phosphatidylethanolamine	g/100g total fat	4,6
	Phosphatidylinositol	g/100g total fat	<1
	Phosphatidylserine	g/100g total fat	<1
25	Phosphatidylcholine	g/100g total fat	37
	Lyso-Phosphatidylcholine	g/100g total fat	2,0
	Total polar lipids	g/100g total fat	36,2
	Totale neutral lipids	g/100g total fat	54,0
30	Total sum lipids	g/100g total fat	96,2

Table 42

35	Protein Kjeldahl (N*6,25)	%	60,9
	Total	%	92,7
	Salt (NaCl)	%	2,9
	Trimethylamine-N	Mg N/100 gram	4
	Trimethylaminoxide-N	Mg N/100 gram	149
	Free Astaxanthin	Mg/kg	<1
	Astaxanthin ester	Mg/kg	122

Table 43

14:0	g/100g total fat	5,0
16:0	g/100g total fat	13,9
18:0	g/100g total fat	0,8
20:0	g/100g total fat	<0,1
22:0	g/100g total fat	<0,1
16:1 n-7	g/100g total fat	3,0
18:1 (n-9)+(n-7)+(n-5)	g/100g total fat	11,4
20:1 (n-9)+(n-7)	g/100g total fat	0,5
22:1 (n-11)+(n-9)+(n-7)	g/100g total fat	0,4
24:1 n-9	g/100g total fat	0,1
16:2 n-4	g/100g total fat	0,4
16:3 n-4	g/100g total fat	0,2
18:2 n-6	g/100g total fat	1,2
18:3 n-6	g/100g total fat	0,1
20:2 n-6	g/100g total fat	0,1
20:3 n-6	g/100g total fat	0,1
20:4 n-6	g/100g total fat	0,4
22:4 n-6	g/100g total fat	<0,1
18:3 n-3	g/100g total fat	0,7
18:4 n-3	g/100g total fat	1,2
20:3 n-3	g/100g total fat	0,1
20:4 n-3	g/100g total fat	0,3
20:5 n-3	g/100g total fat	13,1
21:5 n-3	g/100g total fat	0,3
22:5 n-3	g/100g total fat	0,3
22:6 n-3	g/100g total fat	10,0

Table 44

* Fat Bligh & Dyer	%	10,2
Sum saturated fatty acids	g/100g total fat	19,7
Sum monounsaturated fatty acids	g/100g total fat	15,3
Sum PUFA (n-6)	g/100g total fat	1,8
Sum PUFA (n-3)	g/100g total fat	26,1
Sum PUFA	g/100g total fat	28,5
Sum fatty acids	g/100g total fat	63,5

10

Table 45

Triacylglycerol	g/100g total fat	12,5
Diacylglycerol	g/100g total fat	0,7
Monoacylglycerol	g/100g total fat	<1
Free fatty acids	g/100g total fat	0,9
Cholesterol	g/100g total fat	3,1
Cholesterol ester	g/100g total fat	<0,5
Phosphatidylethanolamine	g/100g total fat	12,8
Phosphatidylinositol	g/100g total fat	<1
Phosphatidylserine	g/100g total fat	<1
Phosphatidylcholine	g/100g total fat	2,9
Lyso-Phosphatidylcholine	g/100g total fat	1,3
Total polar lipid	g/100g total fat	63,2
Total neutral lipid	g/100g total fat	29,7
Total sum lipid	g/100g total fat	92,9

Table 46

Protein Kjeldahl (N*6,25)	%	73,9
Total	%	90,2
Salt (NaCl)	%	1,9
Trimethylamine-N	Mg N/100 gram	7
Trimethylaminoxide-N	Mg N/100 gram	224
Free Astaxanthin	Mg/kg	2,8
Astaxanthin ester	Mg/kg	89

30

Example 13

Dried coagulum meal or powder produced as described above was extracted with ethanol. The results of the extraction are described in Tables 47-50. The total phospholipids content was 48.6 g/100g. The viscosity was analyzed at 15, 25, and 35° C expressed in micro Pascal per second ($\mu\text{P}/\text{sec}$) and the results were 1850, 960 and 535 $\mu\text{P}/\text{sec}$ respectively. This can be compared with oil extracted from conventional krill meal with 46.0 g/100g total phospholipids analyzed at 15, 25, and 35° C, which have viscosities of 9670, 6150 and 2520 $\mu\text{P}/\text{sec}$, respectively.

Table 47

14:0	g/100g oil	8.8
16:0	g/100g oil	16.0
18:0	g/100g oil	1.0
20:0	g/100g oil	<.01
22:0	g/100g oil	<0.1
16:1 n-7	g/100g oil	4.3
18:1 (n-9)+(n-7)+(n-5)	g/100g oil	13.4
20:1 (n-9)+(n-7)	g/100g oil	0.9
22:1 (n-11)+(n-9)+(n-7)	g/100g oil	0.5
24:1 n-9	g/100g oil	0.1
16:2 n-4	g/100g oil	0.6
16:3 n-4	g/100g oil	0.4
18:2 n-6	g/100g oil	1.2
18:3 n-6	g/100g oil	0.2
20:2 n-6	g/100g oil	0.1
20:3 n-6	g/100g oil	<0.1
20:4 n-6	g/100g oil	0.2
22:4 n-6	g/100g oil	<0.1
18:3 n-3	g/100g oil	0.9
18:4 n-3	g/100g oil	2.5
20:3 n-3	g/100g oil	0.1
20:4 n-3	g/100g oil	0.4
20:5 n-3	g/100g oil	11.8
21:5 n-3	g/100g oil	0.4
22:5 n-3	g/100g oil	0.3
22:6 n-3	g/100g oil	5.7

Table 48

Sum saturated fatty acids	g/100g oil	25.9
Sum monounsaturated fatty acids	g/100g oil	19.2
Sum PUFA (n-6)	g/100g oil	1.6
Sum PUFA (n-3)	g/100g oil	22.1
Sum PUFA	g/100g oil	24.7
Sum fatty acids	g/100g oil	69.7

10

Table 49

Triacylglycerol	g/100g oil	14.4
Diacylglycerol	g/100g oil	1.3
Monoacylglycerol	g/100g oil	<1
Free fatty acids	g/100g oil	2.2
Cholesterol	g/100g oil	0.6
Cholesterol ester	g/100g oil	0.7
Phosphatidylethanolamine	g/100g oil	1.4
Phosphatidylinositol	g/100g oil	<1
Phosphatidylserine	g/100g oil	<1
Phosphatidylcholine	g/100g oil	2.5
Lyso-Phosphatidylcholine	g/100g oil	2.1
Total polar lipid	g/100g oil	48.6
Total neutral lipid	g/100g oil	48.3
Total sum lipid	g/100g oil	96.9

Table 50

Trimethylamine-N	Mg N/100 gram	<1
Trimethylaminoxide-N	Mg N/100 gram	2.7
Free Astaxanthin	Mg/kg	1.4
Astaxanthin ester	Mg/kg	120
Water	%	0.62
Volatile comp.	%	1.7
Ash	%	4.0
Acid insoluble ash	%	1.6
Viscosity at 15C	μP/sec	1850
Viscosity at 25C	μP/sec	960
Viscosity at 35C	μP/sec	535

Example 14

Dried coagulum meal or powder produced as described above was extracted with ethanol. Samples were heated to 15°C, 25°C, and 35°C in a Grafnt waterbath. The viscosity
5 was determined in a rotational viscosimeter (Rheomat 30, Contraves AG, Zürich). The viscosity in the sample is measured with cup C. The measuring cup with sample and spindle is placed in a water bath and when the temperature of the sample has reached the required temperature the measurement is started. The rotational velocity of the spindle increases from 0 to 340 min⁻¹ during 1 minute, and then the speed decreases to 0 min⁻¹ during 1 minute. For
10 calculating viscosity the output signal from the sample is compared to the signal from the viscosity standard. The shear rates at 340 min⁻¹ are for cup A: 647 s⁻¹, cup B: 133 s⁻¹, cup C: 74 s⁻¹, and cup D: 36 s⁻¹. For Newtonian liquids the viscosity for the liquid is reported, for non-Newtonian liquids the viscosity at the highest shear rate is reported together with the shear rate. A series of measurements starts with a viscosity standard. For the samples tested,
15 the C cup and 5000 mPa·s standard were used (Brookfield viscosity standards). When the curve is linear, as for this sample, the viscosity is independent of the shear rate, it has a Newtonian flow. The results are shown in Figures 8 a, b, and c.

All publications and patents mentioned in the above specification are herein
20 incorporated by reference. Various modifications and variations of the described method and system of the invention will be apparent to those skilled in the art without departing from the scope and spirit of the invention. Although the invention has been described in connection with specific preferred embodiments, it should be understood that the invention as claimed should not be unduly limited to such specific embodiments. Indeed, various modifications of
25 the described modes for carrying out the invention which are obvious to those skilled in the relevant fields are intended to be within the scope of the following claims.

CLAIMS

- 5 1. An oil extracted from krill comprising from about 40% to about 60% phospholipids by weight of said oil and about 1 to about 1500 mg/l astaxanthin, said oil having Newtonian fluidity at 25°C.
2. The oil of Claim 1, said oil having a viscosity of about 400 to about 1200
10 microPascals/sec at 25°C.
3. The oil of claim 1 or claim 2, further comprising about 35% to about 55% w/w triglycerides.
- 15 4. The oil of any of claims 1 to 3 further comprising about 10% to about 35% w/w omega-3 fatty acid residues.
5. The oil of any of any of claims 1 to 4, wherein said phospholipids comprise about greater than 90% phosphatidyl choline by weight of said phospholipids.
20
6. The oil of any of any of claims 1 to 5, said oil having a viscosity of about 800 to about 1100 microPascals/sec at 25°C.
7. The oil of any of any of claims 1 to 6, wherein said krill is *Euphausia superba*.
25
8. An oil extracted from krill comprising from about 40% to about 60% phospholipids by weight of said oil and about 1 to about 1500 mg/l astaxanthin, said oil having a viscosity of about 400 to about 1200 microPascals/sec at 25°C.
- 30 9. The oil of Claim 8, wherein said oil has Newtonian fluidity at 25°C.
10. A capsule containing the oil of any of claims 1 to 9.
11. The capsule of Claim 10, wherein said capsule is a gel capsule.

12. An oral dosage form comprising an oil as claimed in claims 1 to 9.

13. The oral dosage form of Claim 12, wherein said oral dosage form is a gel capsule.

5

14. The oral dosage form of Claim 12, wherein said oral dosage form is a free flowing oil.

16. A process for producing a krill oil of claims 1 to 9 comprising:

10 mixing krill with water to increase the temperature of said krill to about 25 to 80 °C to form a first solid phase and a first aqueous phase comprising said phospholipids and proteins;

separating said first solid phase from said first aqueous phase;

heating said first aqueous phase to produce a phospholipid and protein concentrate;

and

15 extracting an oil from said phospholipid and protein concentrate.

17. A krill oil produced by the process of Claim 16.

20

FIGURE 1

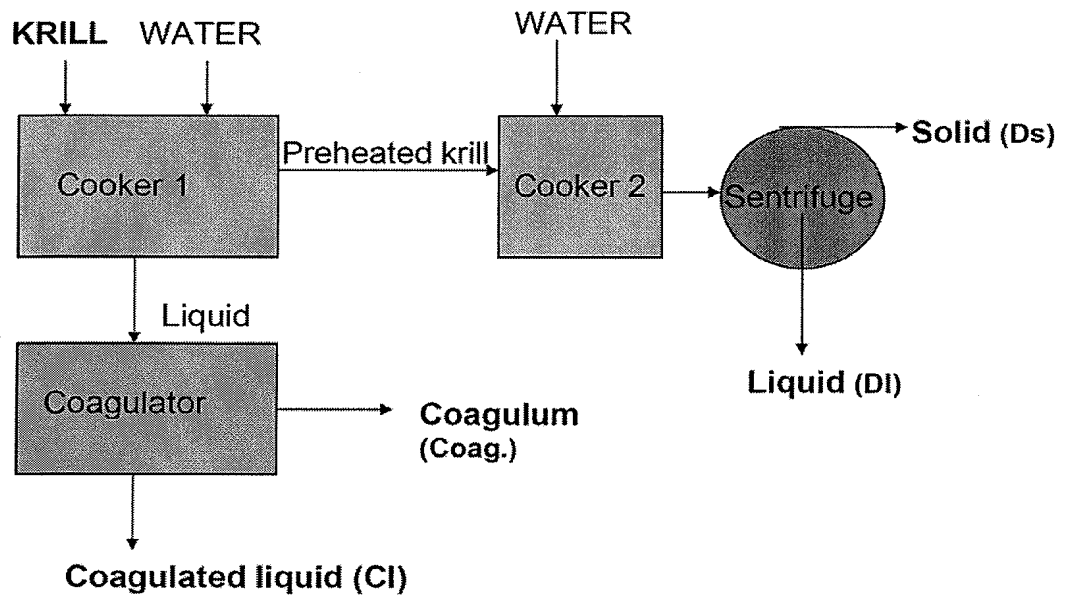

FIGURE 2

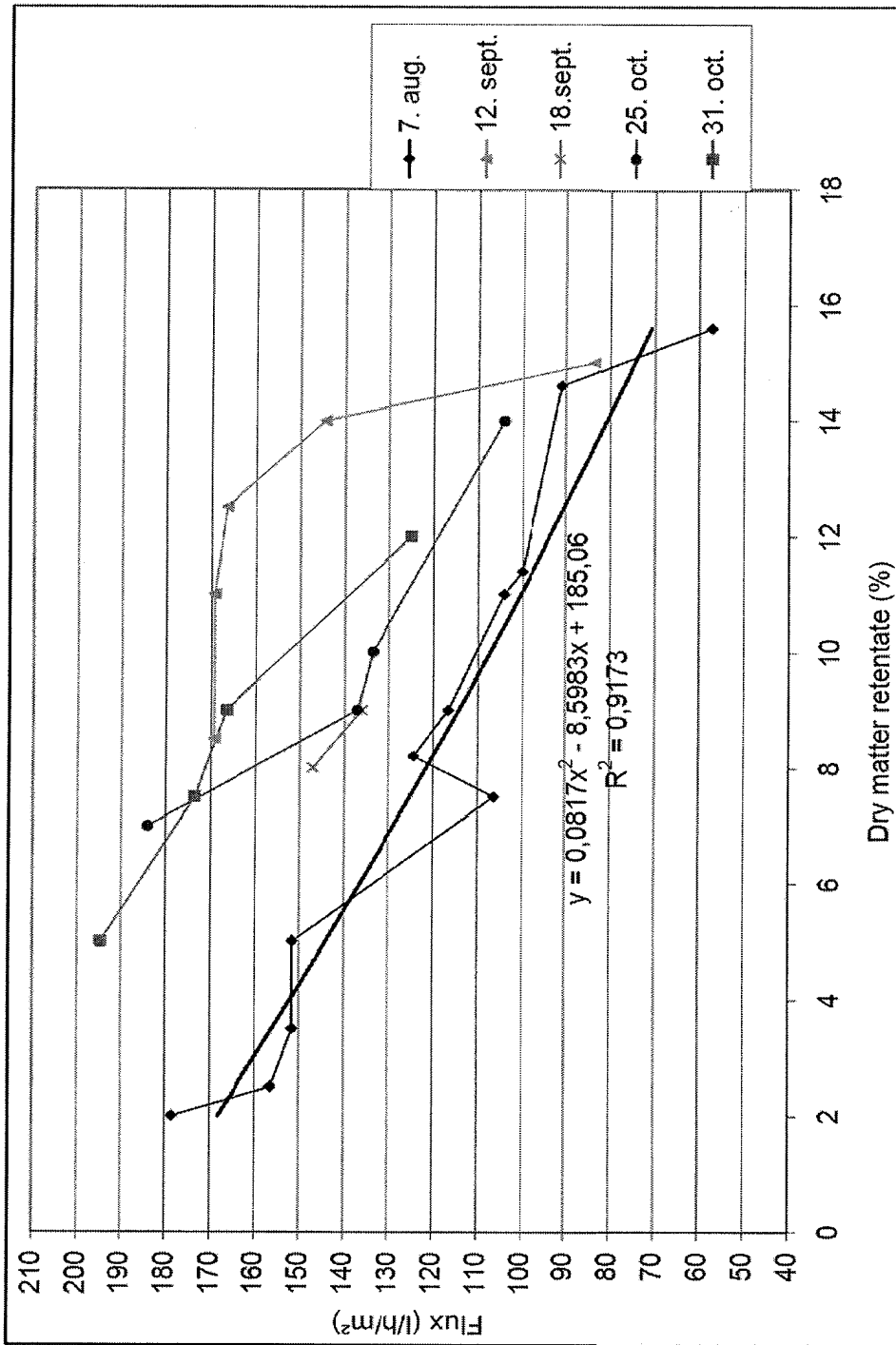

FIGURE 3

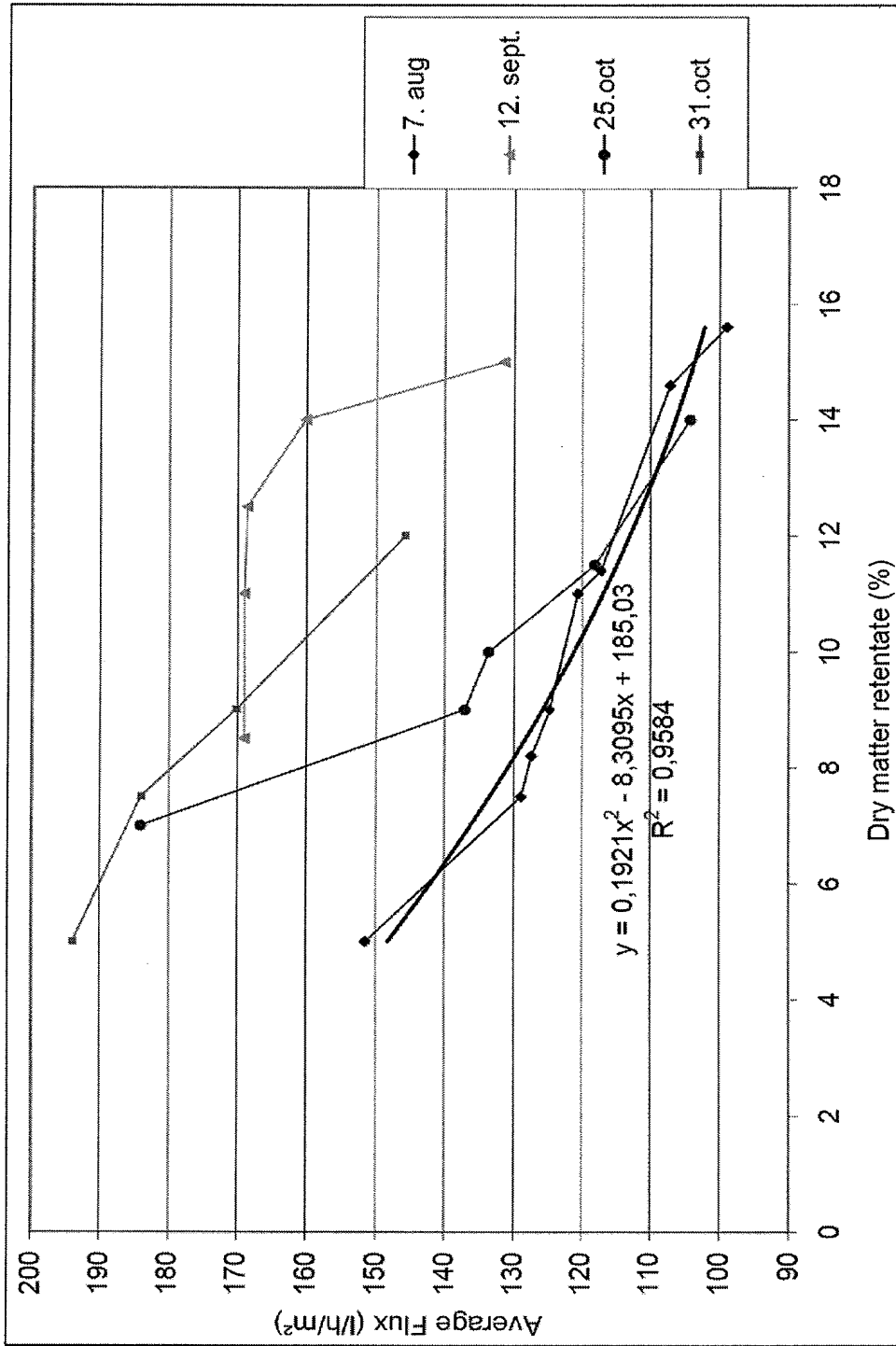

FIGURE 4

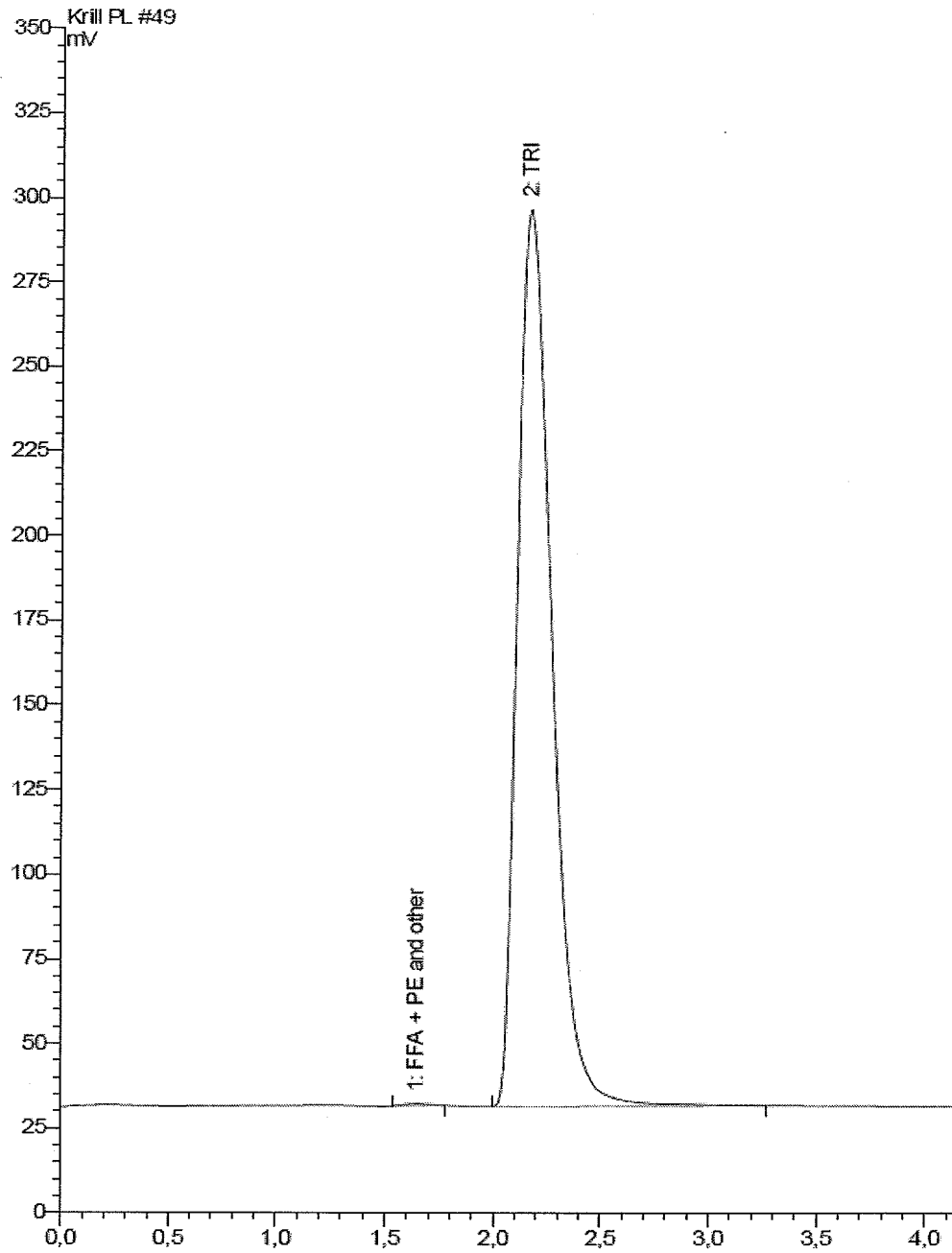

FIGURE 5

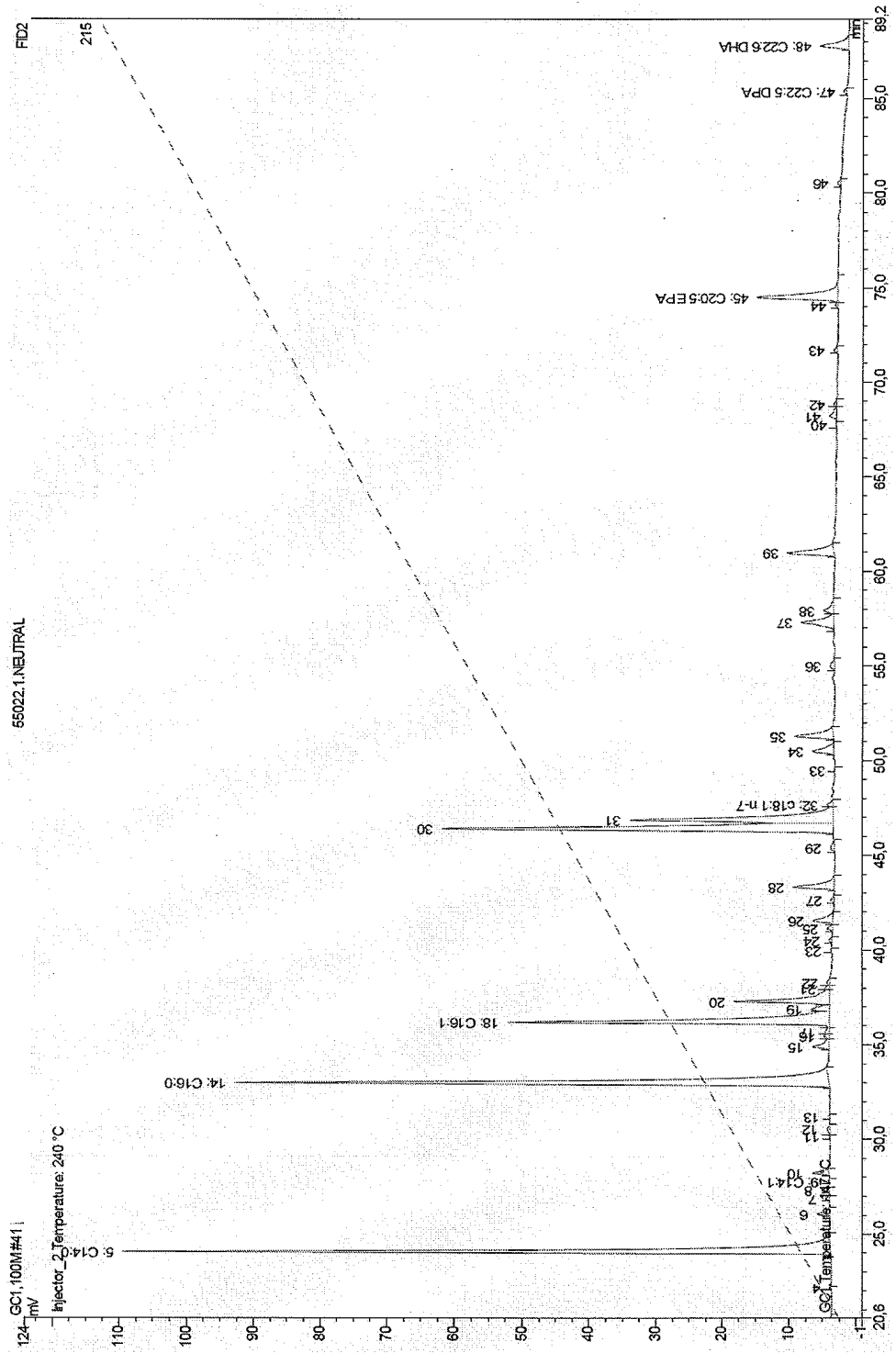

FIGURE 6

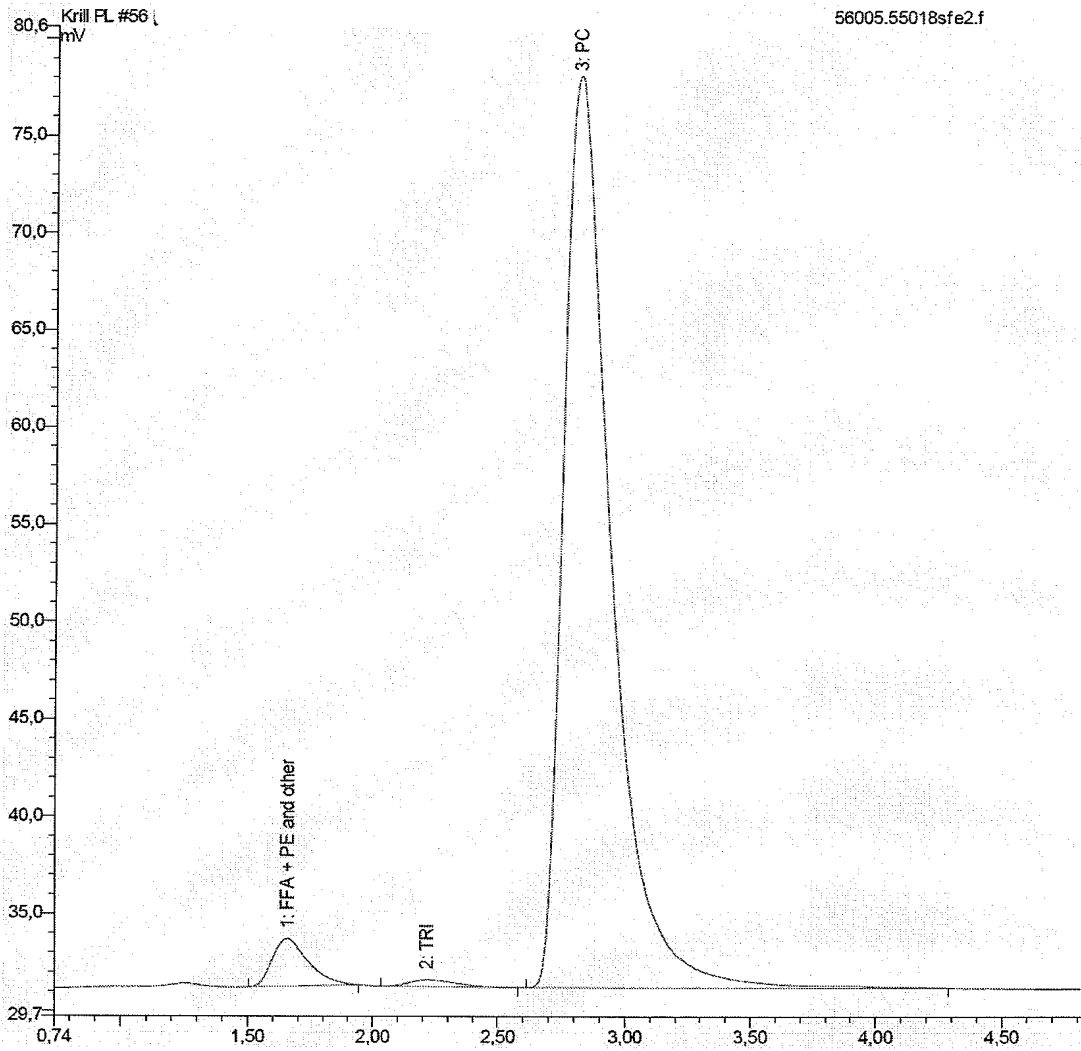

FIGURE 7

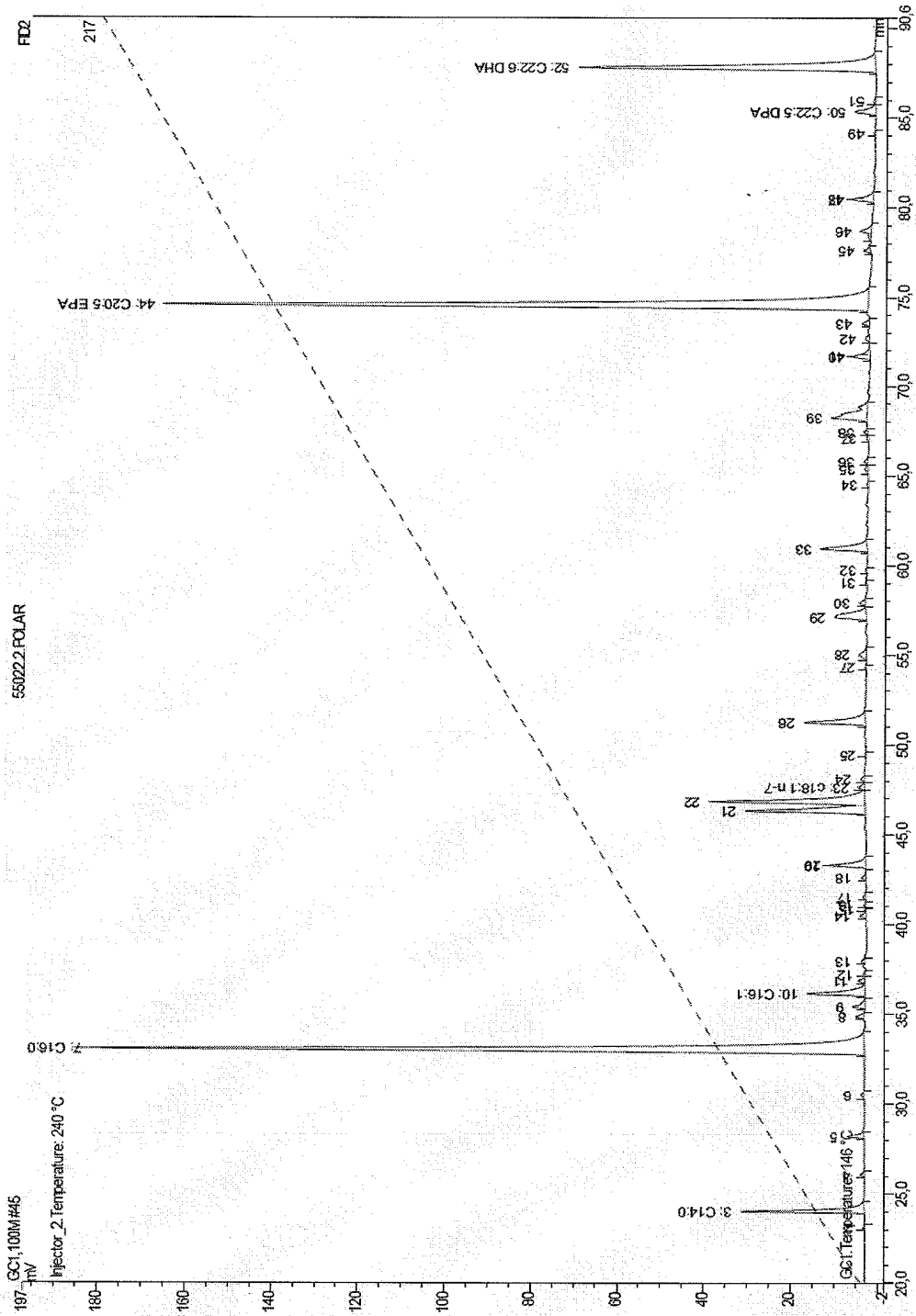

Figure 8a

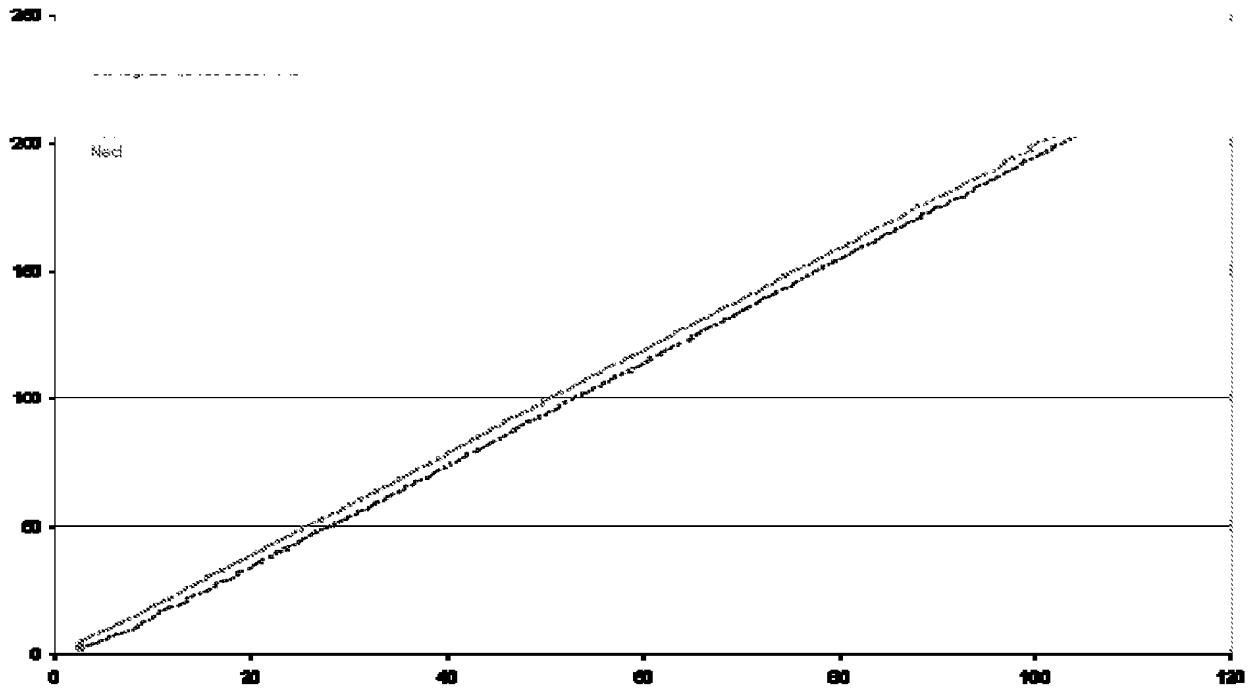

Figure 8b

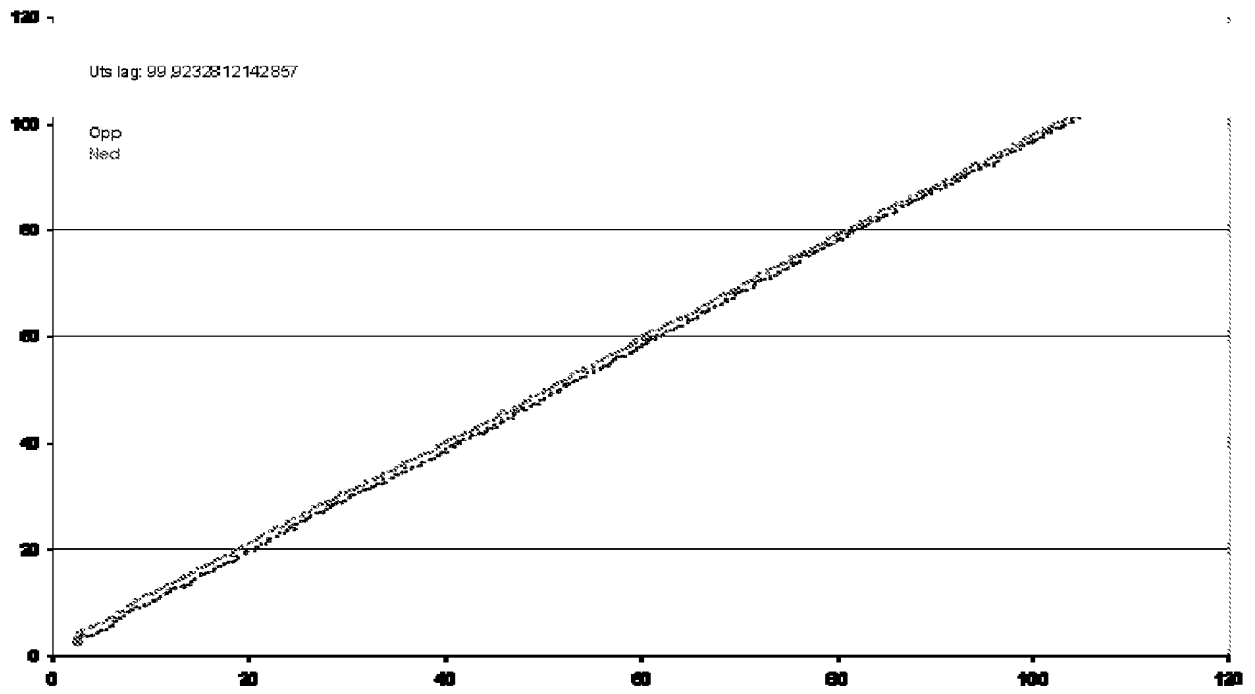
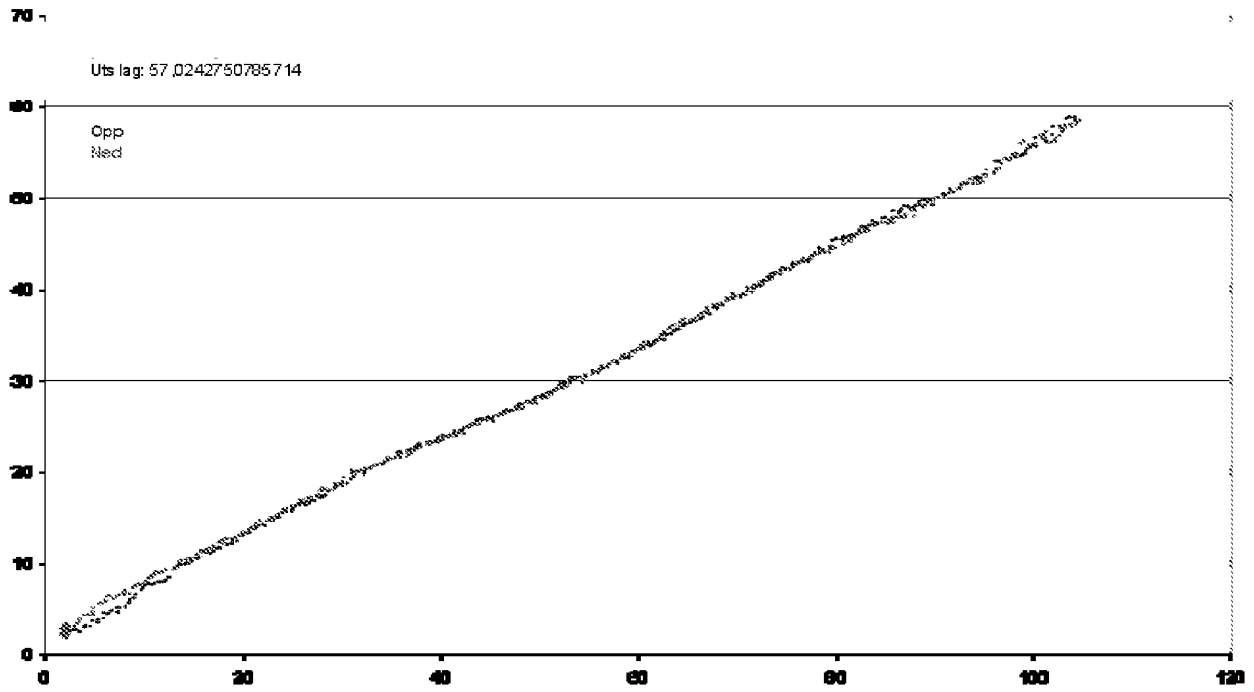

Figure 8c



INTERNATIONAL SEARCH REPORT

International application No
PCT/IB2010/000512

A. CLASSIFICATION OF SUBJECT MATTER
 INV. A23L1/325 A23D9/013 A23L1/275 A61K35/56
 ADD.

According to International Patent Classification (IPC) or to both national classification and IPC

B. FIELDS SEARCHED
 Minimum documentation searched (classification system followed by classification symbols)
 A23L A23D A61K

Documentation searched other than minimum documentation to the extent that such documents are included in the fields searched

Electronic data base consulted during the international search (name of data base and, where practical, search terms used)
 EPO-Internal, WPI Data, FSTA, BIOSIS, EMBASE

C. DOCUMENTS CONSIDERED TO BE RELEVANT

Category*	Citation of document, with indication, where appropriate, of the relevant passages	Relevant to claim No.
X	WO 2008/117062 A1 (AKER BIOMARINE ASA [NO]; GOLDING LOUISE [GB]; BRUHEIM INGE [NO]; GRIIN) 2 October 2008 (2008-10-02) the whole document	1-14, 17
X	WO 2007/080515 A1 (AKER BIOMARINE ASA [NO]; LARSEN PETER MOSE [DK]; FEY STEPHEN JOHN [DK]) 19 July 2007 (2007-07-19) page 3, paragraph 4 - page 5, paragraph 1; claims 1-28; example 1	16
X,P	WO 2009/027692 A2 (AKER BIOMARINE ASA [NO]; GOLDING LOUISE [GB]; OEISTEIN HOESTMARK [NO];) 5 March 2009 (2009-03-05) the whole document	1-17

Further documents are listed in the continuation of Box C.

See patent family annex.

* Special categories of cited documents :

- *A* document defining the general state of the art which is not considered to be of particular relevance
- *E* earlier document but published on or after the international filing date
- *L* document which may throw doubts on priority claim(s) or which is cited to establish the publication date of another citation or other special reason (as specified)
- *O* document referring to an oral disclosure, use, exhibition or other means
- *P* document published prior to the international filing date but later than the priority date claimed
- *T* later document published after the international filing date or priority date and not in conflict with the application but cited to understand the principle or theory underlying the invention
- *X* document of particular relevance; the claimed invention cannot be considered novel or cannot be considered to involve an inventive step when the document is taken alone
- *Y* document of particular relevance; the claimed invention cannot be considered to involve an inventive step when the document is combined with one or more other such documents, such combination being obvious to a person skilled in the art.
- *&* document member of the same patent family

Date of the actual completion of the international search 24 June 2010	Date of mailing of the international search report 13/07/2010
---	--

Name and mailing address of the ISA/ European Patent Office, P.B. 5818 Patentlaan 2 NL - 2280 HV Rijswijk Tel. (+31-70) 340-2040, Fax: (+31-70) 340-3016	Authorized officer Korb, Margit
--	--

INTERNATIONAL SEARCH REPORT

International application No
PCT/IB2010/000512

C(Continuation). DOCUMENTS CONSIDERED TO BE RELEVANT

Category*	Citation of document, with indication, where appropriate, of the relevant passages	Relevant to claim No.
A	<p>YAMAGUCHI K ET AL: "SUPERCRITICAL CARBON DIOXIDE EXTRACTION OF OILS FROM ANTARCTIC KRILL" JOURNAL OF AGRICULTURAL AND FOOD CHEMISTRY, AMERICAN CHEMICAL SOCIETY, US LNKD- DOI:10.1021/JF00071A034, vol. 34, no. 5, 1 January 1986 (1986-01-01), pages 904-907, XP001183110 ISSN: 0021-8561 the whole document</p>	1-17
A	<p>TAKAICHI S ET AL: "Fatty acids of astaxanthin esteres in krill determined by mild mass spectrometry" COMPARATIVE BIOCHEMISTRY AND PHYSIOLOGY. PART B, BIOCHEMISTRYAND MOLECULAR BIOLOGY, ELSEVIER, OXFORD, GB LNKD- DOI:10.1016/S1096-4959(03)00209-4, vol. 136, 1 January 2003 (2003-01-01), pages 317-322, XP008110880 ISSN: 1096-4959 the whole document</p>	1-17

INTERNATIONAL SEARCH REPORT

Information on patent family members

International application No
PCT/IB2010/000512

Patent document cited in search report	Publication date	Patent family member(s)	Publication date
WO 2008117062 A1	02-10-2008	AU 2008231570 A1	02-10-2008
		CA 2682068 A1	02-10-2008
		EP 2144618 A1	20-01-2010
		US 2008274203 A1	06-11-2008
WO 2007080515 A1	19-07-2007	AR 059012 A1	05-03-2008
WO 2009027692 A2	05-03-2009	AU 2008291978 A1	05-03-2009
		CA 2697730 A1	05-03-2009
		EP 2190298 A2	02-06-2010
		US 2009061067 A1	05-03-2009



- (51) International Patent Classification:
A23L 1/30 (2006.01)
- (21) International Application Number:
PCT/IB2012/003004
- (22) International Filing Date:
21 December 2012 (21.12.2012)
- (25) Filing Language: English
- (26) Publication Language: English
- (30) Priority Data:
13/342,664 3 January 2012 (03.01.2012) US
- (71) Applicant: OLYMPIC SEAFOOD AS [NO/NO]; P.O. Box 234, N-6099 Fosnavaag (NO).
- (72) Inventors: BRUHEIM, Inge; Storhagen 24, N-6100 Volda (NO). GRINARI, Mikko; Kultarinnantie 1b, FI-02660 Espoo (FI). ERVIK, Jon, Reidar; Lerstadtoppen 6, N-6014 Aalesund (NO). REMOY, Stig, Rune; Ovre Myklebust 20, N-6092 Fosnavag (NO). REMOY, Even; P.O. Box 234, N-6099 Fosnavaag (NO). CAMERON, John; P.O. Box 234, N-6099 Fosnavaag (NO).

- (81) Designated States (unless otherwise indicated, for every kind of national protection available): AE, AG, AL, AM, AO, AT, AU, AZ, BA, BB, BG, BH, BN, BR, BW, BY, BZ, CA, CH, CL, CN, CO, CR, CU, CZ, DE, DK, DM, DO, DZ, EC, EE, EG, ES, FI, GB, GD, GE, GH, GM, GT, HN, HR, HU, ID, IL, IN, IS, JP, KE, KG, KM, KN, KP, KR, KZ, LA, LC, LK, LR, LS, LT, LU, LY, MA, MD, ME, MG, MK, MN, MW, MX, MY, MZ, NA, NG, NI, NO, NZ, OM, PA, PE, PG, PH, PL, PT, QA, RO, RS, RU, RW, SC, SD, SE, SG, SK, SL, SM, ST, SV, SY, TH, TJ, TM, TN, TR, TT, TZ, UA, UG, US, UZ, VC, VN, ZA, ZM, ZW.
- (84) Designated States (unless otherwise indicated, for every kind of regional protection available): ARIPO (BW, GH, GM, KE, LR, LS, MW, MZ, NA, RW, SD, SL, SZ, TZ, UG, ZM, ZW), Eurasian (AM, AZ, BY, KG, KZ, RU, TJ, TM), European (AL, AT, BE, BG, CH, CY, CZ, DE, DK, EE, ES, FI, FR, GB, GR, HR, HU, IE, IS, IT, LT, LU, LV, MC, MK, MT, NL, NO, PL, PT, RO, RS, SE, SI, SK, SM, TR), OAPI (BF, BJ, CF, CG, CI, CM, GA, GN, GQ, GW, ML, MR, NE, SN, TD, TG).

[Continued on next page]

(54) Title: METHOD FOR PROCESSING CRUSTACEANS TO PRODUCE LOW FLUORIDE/LOW TRIMETHYL AMINE PRODUCTS THEREOF

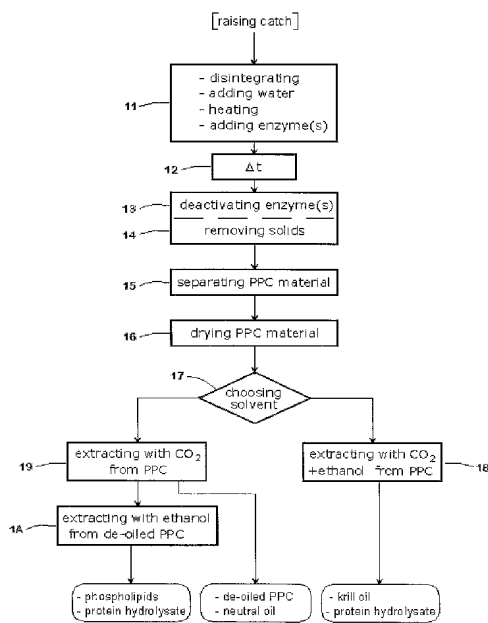

Fig. 1

(57) Abstract: The present invention contemplates the creation of a low fluoride crustacean oil processed from a phospholipid-protein complex (PPC) formed immediately upon a crustacean (i.e., for example, krill) catch. Further, the crustacean oil may also have reduced trimethyl amine and/or trimethyl amino oxide content. The process comprises disintegrating the crustaceans into smaller particles, adding water, heating the result, adding enzyme(s) to hydrolyze the disintegrated material, deactivating the enzyme(s), removing solids from the enzymatically processed material to reduce fluoride content of the material, separating and drying the PPC material. Then, using extraction with supercritical CO₂ or supercritical dimethyl ether, and/or ethanol as solvents, krill oil, inter alia, is separated from the PPC. In the extraction the krill oil can be separated almost wholly from the feed material.

WO 2013/102792 A2

Published:

— *without international search report and to be republished
upon receipt of that report (Rule 48.2(g))*

**Method For Processing Crustaceans To Produce
Low Fluoride/Low Trimethyl Amine Products Thereof**

FIELD OF THE INVENTION

5 The invention relates to a method for processing crustaceans (i.e., for example, krill) rich in lipids to produce compositions low in fluoride, trimethyl amine and trimethyl amine oxide comprising phospholipids, proteinaceous nutrients and oil (i.e., for example, neutral lipids and/or triglycerides).

10 **BACKGROUND OF THE INVENTION**

 The crustaceans, especially krill, represent a vast resource as biological material. The amount of Antarctic krill (*Euphausia superba*), depending on the calculation method and investigation, is roughly 1 to 2×10^9 tons and the possible weight of the annual catch is estimated at 5 to 7×10^6 tons. These small crustaceans, which live in the cold waters around
15 the Antarctic, are interesting as a source for proteins, lipids such as phospholipids, poly-unsaturated fatty acids etc., chitin/chitosan, astaxanthin and other carotenoids, enzymes and other materials.

 Several methods for isolating above-mentioned materials have been developed. One problem is that the products may contain unwanted trace material included in the exoskeleton
20 (also called integument or cuticle) of the crustaceans. For example, krill accumulates fluoride in their exoskeleton, thereby increasing the fluoride amount of any produced material either through the inclusion of parts of the exoskeleton or through extraction processes not taking into account the transfer of fluoride to the final material. In this case free fluoride or loosely bound fluoride may diffuse from the exoskeletal material and into the further
25 processed material, making the end product high in fluoride ions and/or fluorinated compounds.

 Fluoride is a compound that in high concentrations is detrimental for the health of land-dwelling animals as well as all kind of fish and crustaceans and especially fresh-water fish species, since fluoride atoms have the tendency of entering into the bone structure of
30 such organisms and creating fluorosis, or weakening of the bone structure similar in its effect to osteoporosis, but different since it is the bone structure itself, and not the porosity of the bone that is affected. Skeletal fluorosis is a condition characterized by skeletal abnormalities and joint pain. It is caused by pathological bone formation due to the mitogenic action of fluoride on osteoblasts. In its more severe forms, skeletal fluorosis causes kyphosis, crippling

and invalidism. Secondary neurological complications in the form of myelopathy, with or without radiculopathy, may also occur. High fluoride intake has also been shown to be toxic to the male reproductive system in rat experiments, and in humans high fluoride intake and symptoms of skeletal fluorosis have been associated with decreased serum testosterone
5 levels. Consequently, if krill material is used as a starting material for food or feed products, precautions have to be taken for removing fluoride through the processing steps. However, the diffusion of fluoride and the presence of miniscule particles of the exoskeleton represent a problem that is difficult to overcome when processing krill material in an industrial scale.

Polar lipids such as phospholipids are essential for cell membranes and are also called
10 membrane lipids. For most known animal species the content of polar lipids is nearly constant. However, this does not hold for the Antarctic krill. The phospholipids content varies from 2% up to 10% depending on the season. The high content, e.g. more than 5%, of the phospholipids is in principle good, but means also a problem, because it may result in strong emulsions in industrial processes. The emulsions complicate the separation of the lipid and
15 proteinaceous fractions in the processes, such as hydrolysis.

The krill oil is one the valuable products made from krills. It contains *inter alia* phospholipids, triglycerides and carotenoid astaxanthin while being essentially free of protein, carbohydrates and minerals. Different portions of the krill material are separated from each other by, *inter alia*: i) crushing krill mechanically; ii) pressing them, iii) hydrolysis
20 with heat and enzymes; iv) centrifugal force in rotating devices; and v) solvent extraction.

What is needed in the art are significant improvements to these rather conventional approaches and are described within many embodiments of the present invention (*infra*). For example, a disintegrated raw crustacean material may be separated and/or extracted into various enriched low-fluoride, low trimethyl amine and/or low trimethyl amine oxide
25 crustacean meal and/or oil compositions.

SUMMARY

The invention relates to a method for processing crustaceans (i.e., for example, krill) rich in lipids to produce compositions low in fluoride, trimethyl amine and trimethyl amine
30 oxide comprising phospholipids, proteinaceous nutrients and oil (i.e., for example, neutral lipids and/or triglycerides).

In one embodiment, the present invention contemplates a crustacean oil composition comprising phospholipids and less than approximately 0.5 ppm fluoride. In one embodiment, the crustacean oil composition further comprises less than approximately 0.001% (w/w)

trimethyl amine. In one embodiment, the crustacean oil composition further comprises less than approximately 0.02% (w/w) trimethyl amine oxide. In one embodiment, the phospholipids are between approximately 39-52 wt%, wherein said phospholipids comprise at least approximately 65% phosphatidylcholine and at least approximately 2.4 wt%

5 lysophosphatidylcholine. In one embodiment, the crustacean oil further comprises triglycerides, neutral lipids, approximately 20 - 26 wt% Omega-3 (e.g., n-3) fatty acids, and at least approximately 0.8 wt% free fatty acids. In one embodiment, the crustacean oil composition is krill oil.

In one embodiment, the present invention contemplates a crustacean phospholipid-peptide complex (PPC) composition comprising a matrix of hydrolyzed protein,
10 phospholipids and between approximately 200-500 ppm fluoride. In one embodiment, the phospholipids are at least 40 wt%. In one embodiment, the crustacean PPC composition further comprises approximately 0.044% (w/w) trimethyl amine and approximately 0.354% (w/w) trimethyl amine oxide. In one embodiment, the crustacean PPC composition further
15 comprises at least 40% (w/w) triglycerides.

In one embodiment, the present invention contemplates a crustacean de-oiled phospholipid-peptide complex (PPC) composition comprising a matrix of hydrolyzed protein, between approximately 200-500 ppm fluoride, approximately 35% total fat, approximately
20 16.6% eicosapentaenoic acid, approximately 10.0% docosahexaenoic acid and at least 0.1 wt% free fatty acids. In one embodiment, wherein the total fat comprises less than 20% triglycerides, and approximately 69% other lipid components. In one embodiment, total fat comprises approximately 35.2% fatty acids, wherein approximately 30 wt% of said fatty acids are n-3 fatty acids. In one embodiment, the total lipids further comprise at least 68% phospholipids. In one embodiment, the de-oiled PPC further comprises approximately 2.2%
25 lysophosphatidyl choline. In one embodiment, the de-oiled PPC further comprises approximately 115 mg/kg astaxanthin.

In one embodiment, the present invention contemplates a method for creating low fluoride crustacean compositions, comprising: a) disintegrating a crustacean catch into a material having a particle size ranging between approximately 1 – 25 millimeters; and b)
30 separating said disintegrated crustacean material into a phospholipid-peptide complex (PPC) composition subfraction, wherein said subfraction comprises a fluoride content of less than 500 ppm. In one embodiment, the method further comprises extracting said PPC composition subfraction with a fluid comprising a solvent wherein a low fluoride oil is created, said oil having a fluoride content of less than 0.5 ppm. In one embodiment, the

extracting further creates a low trimethyl amine/trimethyl amine oxide oil, wherein said trimethyl amine is less than approximately 0.001% (w/w) and said trimethyl amine oxide is less than approximately 0.02% (w/w). In one embodiment, the separating is performed without emulsification. In one embodiment, the solvent comprises a non-polar solvent. In one embodiment, the solvent comprises at least one polar solvent. In one embodiment, the solvent comprises said non-polar solvent and said at least one polar solvent. In one embodiment, the non-polar solvent includes, but is not limited to, supercritical carbon dioxide and supercritical dimethyl ether. In one embodiment, the polar solvent includes, but is not limited to, ethanol and acetone. In one embodiment, the method further comprises hydrolyzing said crustacean material before said separating. In one embodiment, the extracting further creates a de-oiled PPC composition. In one embodiment, the polar solvent separates a phospholipid composition and a protein hydrolysate composition from said de-oiled PPC composition. In one embodiment, the extracting comprises less than ten hours. In one embodiment, the extracting comprises less than five hours. In one embodiment, the extracting comprises less than two hours. In one embodiment, the crustacean material is krill material. In one embodiment, the separating comprises a centrifugal force of between approximately 1,000 - 1,800 g. In one embodiment, the separating comprises a centrifugal force of between approximately 5,000 - 10,000 g.

In one embodiment, the present invention contemplates a composition comprising a mixture of a low fluoride crustacean PPC and a low fluoride de-oiled PPC, wherein said fluoride level ranges between approximately 200 – 500 ppm. In one embodiment, the crustacean PPC is krill PPC. In one embodiment, the crustacean de-oiled PPC is krill de-oiled PPC. In one embodiment, the crustacean PPC and crustacean de-oiled PPC are in a 1:1 ratio. In one embodiment, the mixture comprises a milled fine powder. In one embodiment, the powder comprises a particle size of approximately 250 μm . In one embodiment, the composition comprises a peroxide level of less than 0.1 %;(mEq/kg). In one embodiment, the composition comprises ananiside level of less than 0.1 % (w/w). In one embodiment, the composition further comprises microencapsulated polyunsaturated Omega-3 fatty acids. In one embodiment, the composition further comprises zinc oxide. In one embodiment, the composition further comprises marine peptides. In one embodiment, the composition further comprises at least one supplemental amino acid.

In one embodiment, the present invention contemplates a method, comprising formulating a composition comprising a low fluoride crustacean PPC and a low fluoride crustacean de-oiled PPC, wherein said fluoride level ranges between approximately 200 –

500 ppm. In one embodiment, the method further comprises milling said composition into a powder. In one embodiment, the method further comprises tableting said composition into a tablet. In one embodiment, the method further comprises encapsulating said composition into a capsule. In one embodiment, the method further comprises mixing said powder with a food product. In one embodiment, the formulating further comprises microencapsulated polyunsaturated Omega-3 fatty acids. In one embodiment, the formulating further comprises zinc oxide. In one embodiment, the formulating further comprises marine peptides. In one embodiment, the formulating further comprises at least one supplemental amino acid.

In one embodiment, the present invention contemplates a composition comprising a mixture of a low fluoride crustacean PPC and a crustacean protein hydrolysate, wherein said fluoride level ranges between approximately 200 – 500 ppm. In one embodiment, the crustacean PPC is krill PPC. In one embodiment, the crustacean protein hydrolysate is a krill protein hydrolysate. In one embodiment, the crustacean PPC and crustacean protein hydrolysate are in a 1:1 ratio. In one embodiment, the mixture comprises a milled fine powder. In one embodiment, the powder comprises a particle size of approximately 250 µm. In one embodiment, the composition comprises a peroxide level of less than 0.1 %;(mEq/kg). In one embodiment, the composition comprises ananiside level of less than 0.1 % (w/w). In one embodiment, the composition further comprises microencapsulated polyunsaturated Omega-3 fatty acids. In one embodiment, the composition further comprises zinc oxide. In one embodiment, the composition further comprises marine peptides. In one embodiment, the composition further comprises at least one supplemental amino acid.

In one embodiment, the present invention contemplates a method, comprising formulating a composition comprising a low fluoride crustacean PPC and a crustacean protein hydrolysate, wherein said fluoride level ranges between approximately 200 – 500 ppm. In one embodiment, the method further comprises milling said composition into a powder. In one embodiment, the method further comprises tableting said composition into a tablet. In one embodiment, the method further comprises encapsulating said composition into a capsule. In one embodiment, the method further comprises mixing said powder with a food product. In one embodiment, the formulating further comprises microencapsulated polyunsaturated Omega-3 fatty acids. In one embodiment, the formulating further comprises zinc oxide. In one embodiment, the formulating further comprises marine peptides. In one embodiment, the formulating further comprises at least one supplemental amino acid.

In one embodiment, the present invention contemplates a phospholipid-peptide complex (PPC) composition comprising a range between approximately 40 - 50% lipids and less than 0.5 mg/kg fluoride. In one embodiment, the lipids comprise phospholipids. In one embodiment, the present invention contemplates an oil composition comprising

5 approximately 400-500 grams/kg phospholipids, approximately 200-260 grams/kg Omega-3 fatty acids, less than 0.5 mg/kg fluoride, approximately 15 grams/kg lysophosphatidic acid, and less than approximately 8 grams/kg free fatty acids. In one embodiment, the present invention contemplates a de-oiled phospholipid-peptide complex (PPC) composition comprising approximately 300-400 grams/kg lipids, wherein approximately 0.1-1.0 % are

10 free fatty acids and a range between approximately 22-27 % (w/w) that are Omega-3 fatty acids. In one embodiment, the lipids comprise phospholipids. In one embodiment, the present invention contemplates a crustacean lipid composition comprising at least 75% phospholipids. In one embodiment, the lipid composition comprises between approximately 75% - 90% phospholipids. In one embodiment, the lipid composition comprises between

15 approximately 75% - 80% phospholipids. In one embodiment, the present invention contemplates a dried protein hydrolysate composition comprising approximately 70 - 80% protein, approximately 1.5 - 3.0% lipids, and approximately 5 -7 % ash.

In one embodiment, the present invention contemplates a method, comprising: a) providing; i) a hydrolyzed and disintegrated crustacean material; ii) at least one horizontal

20 centrifuge capable of separating said hydrolyzed crustacean material; and iii) a fluid comprising a solvent; and b) separating said hydrolyzed crustacean material into a high fluoride solid fraction and a low fluoride hydrolyzed material fraction with a first horizontal centrifuge; c) separating said low fluoride hydrolyzed material fraction into a phospholipid-peptide complex (PPC) composition subfraction and a concentrated hydrolysate subfraction

25 with a second horizontal centrifuge; and d) contacting said PPC composition subfraction with said fluid, wherein a low fluoride oil is extracted. In one embodiment, the disintegrated crustacean material has particle sizes between approximately 1 - 25 millimeters. In one embodiment, the first horizontal centrifuge separates said hydrolyzed crustacean material without emulsification. In one embodiment, the solvent comprises a non-polar solvent. In

30 one embodiment, the non-polar solvent comprises supercritical CO₂. In one embodiment, the solvent comprises a polar solvent. In one embodiment, the polar solvent comprises ethanol. In one embodiment, the second horizontal centrifuge comprises an extended separation pathway. In one embodiment, the contacting is performed at a pressure of less than 300 bar. In one embodiment, the non-polar solvent further extracts a de-oiled PPC composition from

said PPC composition subfraction. In one embodiment, the ethanol separates a phospholipid composition and a protein hydrolysate composition from said de-oiled PPC composition. In one embodiment, the de-oiled PPC is separated from the PPC in less than ten hours. In one embodiment, the de-oiled PPC is separated from the PPC in less than five hours. In one
5 embodiment, the de-oiled PPC is separated from the PPC in less than two hours. In one embodiment, the hydrolyzed crustacean material comprises hydrolyzed krill material. In one embodiment, the separating said hydrolyzed crustacean material is performed at a centrifugal force of between approximately 1,000 - 1,800 g. In one embodiment, the separating said low fluoride hydrolyzed material fraction is performed at a centrifugal force of between
10 approximately 5,000 - 10,000 g. In one embodiment, the method produces a phospholipid-peptide complex (PPC) composition comprising a range between approximately 40%- 50% lipid and less than 0.5 mg/kg fluoride. In one embodiment, the method produces an oil composition comprising approximately 400-500 grams/kg phospholipids, approximately 200-260 grams/kg Omega-3 fatty acids, less than 0.5 mg/kg fluoride, approximately 15 grams/kg
15 lysophosphatidic acid, and less than approximately 8 grams/kg free fatty acids. In one embodiment, the method produces a de-oiled phospholipid-peptide complex (PPC) composition comprising approximately 300-400 grams/kg lipids, wherein approximately 0.1-1.0 % are free fatty acids and a range between approximately 20-28 % (w/w) are Omega-3 fatty acids. In one embodiment, the method produces a crustacean lipid composition
20 comprising at least 75% phospholipids. In one embodiment, the lipid composition comprises a range between approximately 75% - 90% phospholipids. In one embodiment, the lipid composition comprises a range between approximately 75% - 80% phospholipids. In one embodiment, the method produces a dried protein hydrolysate composition comprising approximately 70 - 80% protein, approximately 1.5 - 3.0% lipids, and approximately 5 -7 %
25 ash.

In one embodiment, the present invention contemplates a system comprising: a) a solvent unit comprising at least one non-polar solvent inlet; b) an extraction tank unit in fluidic communication with the solvent unit, wherein the tank comprises an inlet configured to receive a phospholipid-protein complex composition; c) a separator unit comprising an
30 outlet configured to release a low fluoride oil composition and residual co-solvent, wherein the separator is in fluidic communication with the tank; d) an absorbent unit in fluidic communication with the separator unit, wherein the absorbent unit is capable of recycling the non-polar solvent. In one embodiment, the non-polar solvent is a supercritical fluid. In one embodiment, the supercritical fluid comprises carbon dioxide. In one embodiment, the

supercritical fluid comprises dimethyl ether. In one embodiment, the solvent unit further comprises a co-solvent inlet. In one embodiment, the co-solvent is a polar solvent. In one embodiment, the polar solvent is ethanol or acetone. In one embodiment, the at least one non-polar solvent inlet comprises an unused non-polar solvent inlet. In one embodiment, the
5 at least one non-polar solvent inlet comprises a recycled non-polar solvent inlet. In one embodiment, the solvent unit further comprises a fluid pump. In one embodiment, the tank unit is pressurized by the fluid pump. In one embodiment, the solvent unit further comprises a heater. In one embodiment, the phospholipid-protein complex composition in the tank unit is heated by the heater. In one embodiment, the separator outlet is in fluid communication with
10 an evaporator. In one embodiment, the separator further comprises a horizontal centrifuge. In one embodiment, the horizontal centrifuge is a decanter centrifuge having an extended separation pathway. In one embodiment, the phospholipid-protein complex composition is a low fluoride crustacean phospholipid-protein complex composition. In one embodiment, the low fluoride crustacean phospholipid-protein complex composition is a low fluoride krill
15 phospholipid-protein complex composition.

In one embodiment, the present invention contemplates a method for processing crustaceans, especially krills, in which method the crustaceans are disintegrated into smaller particles, fresh water is added to the disintegrated material, the water with the disintegrated material is heated and enzyme(s) are added for hydrolyzing the disintegrated material and
20 said enzyme(s) is/are deactivated, the method further comprising steps: a) removing solids from the hydrolyzed material to reduce fluoride content of the material; b) separating phospholipid-peptide complex material and concentrated hydrolysate fraction from each other; c) drying said phospholipid-peptide complex material; and d) dividing the drying result, or PPC, to components by extraction(s) using at least a supercritical CO₂ as solvent,
25 wherein the processing of crustaceans is started as soon as a crustacean catch has been decked on a ship or boat. In one embodiment, the fluoride content solids are removed from the hydrolyzed material by a decanter. In one embodiment, the phospholipid-peptide complex material and concentrated hydrolysate fraction are separated from each other by a
30 sedicanter with high centrifugal forces and long clarification/separation zones to avoid an emulsification. In one embodiment, the method further comprises using in the extraction ethanol as a co-solvent in addition to the supercritical CO₂ to separate: i) a krill oil consisting of phospholipids and triglycerides, or neutral oil, and ii) a protein hydrolysate from the PPC. In one embodiment, the pressure of the solvent being at most 300 bar. In one embodiment, the extraction includes two steps: i) first using only the supercritical CO₂ as solvent to

separate de-oiled PPC from the PPC; and ii) second using only ethanol as solvent to separate phospholipids and protein hydrolysate from the de-oiled PPC. In one embodiment, the duration of the step when said de-oiled PPC is extracted from the PPC is at most three hours. In one embodiment, the method produces a phospholipid-peptide complex (PPC) composition comprising approximately 40% - 50% lipid and approximately 0.5 mg/kg fluoride. In one embodiment, the lipid comprises phospholipids. In one embodiment, the method produces an oil composition comprising approximately 400-500 grams/kg phospholipids, approximately 200-260 grams/kg Omega-3 fatty acids, approximately 0.5 mg/kg fluoride, approximately 15 grams/kg lysophosphatidic acid, and less than approximately 8 grams/kg free fatty acids. In one embodiment, the method produces a de-oiled phospholipid-peptide complex (PPC) composition comprising approximately 300-400 grams/kg lipids, wherein approximately 0.1-1.0 % are free fatty acids and approximately 22-27 % (w/w) are Omega-3 fatty acids. In one embodiment, the method produces a crustacean phospholipid composition comprising approximately 75% polar lipids. In one embodiment, the method produces a dried protein hydrolysate composition comprising approximately 70 - 80% protein, approximately 1.5 - 3.0% lipids, and approximately 5 -7 % ash.

DEFINITIONS

The term “disintegrated material” as used herein refers to any biological material that has been subjected to a mechanical destruction and/or disruption that results in a composition having particle sizes of between approximately 1 - 25 millimeters, preferably between approximately 3 - 15 millimeters, more preferably between approximately 5 - 10 millimeters and most preferably approximately 8 millimeters.

The term “hydrolyzed material” as used herein refers to any biological material that has been subjected to high heat and/or enzymatic treatment. Such hydrolyzed materials would be expected to have phospholipid/peptide components that are physically separated from the components of the chitinous exoskeleton.

The term “crustacean” as used herein refers to any marine organism have a hard outside shell (e.g., a chitinous exoskeleton combined with a carbonate) encompassing a fleshy interior that is a living organism. More specifically, the crustaceans are usually considered a large class of mostly aquatic arthropods that have a chitinous or calcareous and chitinous exoskeleton, a pair of often much modified appendages on each segment, and two pairs of antennae. For example, a crustacean may include but not limited to, krill, lobsters, shrimps, crabs, wood lice, water fleas, and/or barnacles.

The term “horizontal centrifuge” refers to any device that is capable of rotating a mixture in the Z-plane (as opposed to the X-plane and/or Y-plane as with conventional centrifuges). This rotation is generated by a screw-type conveyor element aligned horizontally within a tube shaped enclosure. The induced centrifugal force then layers the heavier particles to the outside edges of the enclosure, while the lighter particles form layers closer to the center of the enclosure. Some horizontal centrifuges are modified to comprise an extended separation pathway and induce high gravitational forces (e.g., a sedicanter).

The term “polar solvent” as used herein refers to any compound, or compound mixture, that is miscible with water. Such polar solvent compounds include, but are not limited to, ethanol, propanol and/or ethyl acetate.

The term “non-polar solvent” as used herein refers to any compound, or compound mixture, that is not miscible with water. Such non-polar solvent compounds include, but are not limited to, hexane, pentane, dimethyl ether and/or CO₂. Either dimethyl ether or CO₂ may be used in a supercritical phase.

The term “supercritical” refers to any mixture comprising a chemical (e.g., for example, carbon dioxide (CO₂) or dimethyl ether) in a fluid state while held at, or above, its critical temperature and critical pressure where its characteristics expand to fill a container like a gas but with a density like that of a liquid. For example, carbon dioxide becomes a supercritical fluid above 31.1 °C and 72.9 atm/7.39 MPa. Carbon dioxide usually behaves as a gas in air at standard temperature and pressure (STP), or as a solid called dry ice when frozen. If the temperature and pressure are both increased from STP to be at or above the critical point for carbon dioxide, it can adopt properties midway between a gas and a liquid. As contemplated herein, supercritical CO₂ can be used as a commercial and industrial solvent during chemical extractions, in addition to its low toxicity and minimal environmental impact. The relatively low temperature of the process and the stability of CO₂ also allows most compounds (i.e., for example, biological compounds) to be extracted with little damage or denaturing. In addition, because the solubility of many extracted compounds in CO₂ may vary with pressure, supercritical CO₂ is useful in performing selective extractions.

The term “fluoride” as used herein interchangeably and refer to any compound containing an organofluoride and/or an inorganic fluoride.

The term “high fluoride solid fraction” as used herein refers to a composition containing the vast majority of a crustacean’s exoskeleton following a low g-force (e.g., between approximately 1,000 - 1,800 g) horizontal centrifugation separation of a hydrolyzed and disintegrated crustacean material. This fraction contains small particles of exoskeleton of

the crustacean that retains the vast majority of fluoride (i.e., for example, between 50 - 95%) in these organisms.

The term “low fluoride” as used herein may refer to the product of any method and/or process that reduced the fluoride from the original material by approximately 10-fold (i.e., for example, from 5 ppm to 0.5 ppm). For example, ‘a low fluoride crustacean phospholipid-protein complex’ comprises ten-fold less fluoride than ‘a low fluoride hydrolyzed and disintegrated crustacean material’.

The term “low fluoride hydrolyzed material fraction” as used herein refers to a composition containing the vast majority of a crustacean’s fleshy internal material following a low g-force (e.g., between approximately 1,000 - 1,800 g) horizontal centrifugation separation of a hydrolyzed and disintegrated crustacean material. This fraction contains small particles of phospholipids, neutral lipids, proteins and/or peptides that is largely devoid of any fluoride (i.e., for example, between 5% - 50% of the raw hydrolyzed and disintegrated material).

The term “a low fluoride phospholipid-peptide complex composition subfraction” as used herein refers to a low fluoride composition containing the vast majority of lipid material following a high g-force (e.g., between approximately 5,000 - 10,000 g) horizontal centrifugation separation of a low fluoride hydrolyzed material fraction.

The term “concentrated hydrolysate composition subfraction” as used herein refers to a low fluoride composition containing the vast majority of water soluble lean material following a high g-force (e.g., between approximately 5,000 - 10,000 g) horizontal centrifuge separation of a low fluoride hydrolyzed material fraction.

The term “low fluoride oil” as used herein refers to a lipid-rich composition created by the extraction of a phospholipid-peptide complex composition subfraction using a selective extraction process, such as with a supercritical carbon dioxide fluid. Such a process removes approximately ten-fold of the fluoride from the raw hydrolyzed and disintegrated crustacean material.

The term “de-oiled phospholipid-peptide complex” as used herein refers to a low fluoride composition containing the vast majority of dry matter composition created by the extraction of a phospholipid-peptide complex composition subfraction using selective extraction process, such as a supercritical carbon dioxide fluid. A de-oiled PPC generally comprises a reduced triglyceride content in comparison to PPC.

The term “phospholipid composition” as used herein refers to a low fluoride composition comprising a high percentage of polar lipids (e.g., approximately 75%) created

by the extraction of a de-oiled phospholipid-peptide complex using a co-solvent, such as ethanol.

The term “protein hydrolysate” as used herein refers to a low fluoride composition comprising a high percentage of protein (e.g., approximately 70 - 80%) created by the
5 extraction of a de-oiled phospholipid-peptide complex using a co-solvent, such as ethanol.

The term "immediately" as used herein refers to a minimum practical period between decking a crustacean catch in a trawl bag and/or net coupled with a direct transfer to a suitable disintegrator. For example, this minimum practical period should preferably not exceed 60 minutes, more preferred to not exceed 30 minutes, even more preferred to not
10 exceed 15 minutes.

The term “hydrolysis” as used herein refers to any break and/or disruption made in a protein structure of a disintegrated crustacean material, wherein in the naturally occurring protein sequences become shorter (i.e., for example, by breaking peptide bonds of the amino acid sequence primary structure) and/or denatured (i.e., for example, an unfolding of the
15 amino acid sequence secondary, tertiary and/or quaternary structure). This process may be controlled by hydrolytic enzyme(s). For example, one or more exogenous proteolytic enzymes (e.g. alkalase, neutrase, and enzymes derived from microorganisms or plant species) may be used in the process. Co-factors such as specific ions can be added depending on the used enzymes. The selected enzyme(s) can also be chosen for reducing emulsions caused by
20 high content of phospholipids in the raw material. Besides the temperature, the hydrolysis takes place within optimal or near-optimal pH and sufficient time. For example, the exogenous enzyme alkalase the optimum pH is about 8, optimum temperature about 60°C and the hydrolysis time 40-120 minutes.

The term “solvent unit” refers to any enclosed volume configured to heat and pressurize
25 a mixture of supercritical carbon dioxide fluid and/or a co-solvent (e.g., ethanol). Such an enclosed volume may be constructed out of any suitable material including but not limited to metals (e.g., steel, aluminum, iron etc.), plastics (e.g., polycarbonate, polyethylene etc.), fiberglass (etc.).

The term “extraction tank” refers to any enclosed volume configured to withstand heat
30 and pressure sufficient to perform lipid and protein extraction from a raw biomass using a supercritical carbon dioxide fluid. As designed, the extraction tank contemplated herein is configured such that the solvents containing the extracted lipids and proteins rise to the tank top for transfer to a separator unit. Such an enclosed volume may be constructed out of any

suitable material including but not limited to metals (e.g., steel, aluminum, iron etc.), plastics (e.g., polycarbonate, polyethylene etc.), fiberglass (etc.).

5 The term “separator unit” refers to any enclosed volume configured with a centrifuge capable of separating the components of the extracted lipids and proteins received from an extraction tank. The respective extraction components exit the separator unit via outlet ports such that the remaining solvents (i.e., supercritical CO₂) are transferred to an absorbent unit for recycling. Such an enclosed volume may be constructed out of any suitable material including but not limited to metals (e.g., steel, aluminum, iron etc.), plastics (e.g., polycarbonate, polyethylene etc.), fiberglass (etc.).

10 The term “absorbent unit” refers to any enclosed volume configured with materials that will remove contaminants from a supercritical CO₂ fluid. Such materials may include, but are not limited to charchol, coal, purifying gases, plastic polymer resins and/or filtration cartridges comprising single or dual-flat extruded nets (Tenax UK LTD, Wrexham, North Wales LL13 9JT, UK). Such an enclosed volume may be constructed out of any suitable material including but not limited to metals (e.g., steel, aluminum, iron etc.), plastics (e.g., polycarbonate, polyethylene etc.), fiberglass (etc.).

15 The term “in fluidic communication” refers to any means by which a fluid can be transported from one location to another location. Such means may include, but are not limited to pipes, buckets and/or troughs. Such means may be constructed out of any suitable material including but not limited to metals (e.g., steel, aluminum, iron etc.), plastics (e.g., polycarbonate, polyethylene etc.), fiberglass (etc.).

BRIEF DESCRIPTION OF THE FIGURES

25 Figure 1 presents a flow diagram of one embodiment of a method to produce a low fluoride crustacean material.

Figure 2 presents a longitudinal centrifuge with an extended separation path. This specific example is a FLOTTWEG SEDICANTER horizontal decanter centrifuge.

30 Figure 3 depicts one example of an extraction plant suitable for use in the presently disclosed method. For example, the plant comprises a solvent unit (21), an extraction tank (22), separators (23) and adsorbents (24).

Figure 4 present exemplary data showing the extraction efficiencies of two different runs in accordance with one embodiment of the present invention.

DETAILED DESCRIPTION OF THE INVENTION

The invention relates to a method for processing crustaceans (i.e., for example, krill) rich in lipids to produce compositions low in fluoride, trimethyl amine and trimethyl amine oxide comprising phospholipids, proteinaceous nutrients and oil (i.e., for example, neutral lipids and/or triglycerides).

Krill oil comprises lipids extracted with solvents from krill biomass. Krill biomass can be either fresh, whole krill (WO2008/060163A1), frozen whole krill (Neptune Technologies & Bioresources Inc., Canada), lyophilized whole krill (JP2215351) or krill meal (US20080274203). Solvents used in extracting lipids from krill biomass have been reported as acetone + ethanol (WO2000/23546; WO2002/102394), ethanol + hexane (Enzymotec Ltd), ethanol alone (JP2215351; Aker BioMarine ASA, Norway) or supercritical CO₂ + ethanol co-solvent (US2008/0274203; WO2008/060163). Solvent-free technology for obtaining krill oil has also been developed (US20110224450A1). Krill oil comprises a lipid fraction of raw krill biomass that is essentially free of protein, carbohydrates and/or minerals. Krill oil also comprises neutral lipids (e.g., mostly triglycerides), polar lipids (e.g., mostly phospholipids) and carotenoid astaxanthin. Although it is not necessary to understand the mechanism of an invention, it is believed that the lipid and/or fatty acid compositions of krill oil vary depending of the season.

In some embodiments, the present invention contemplates methods of processing crustacean biomass having unexpected findings including, but not limited to: i) removal of most of the exoskeleton from the crustacean biomass that results in low level of fluorides in a PPC composition and very low levels of fluoride in krill oil extracted from the PPC composition by a non-polar solvent (e.g., supercritical CO₂) and, optionally, a polar co-solvent (e.g., ethanol); ii) a level of fluorides in the crustacean oil that is less than 0.5 ppm in contrast to conventional krill oil with fluoride content of approximately 5 - 100 ppm; iii) crustacean oil extracted from PPC by supercritical CO₂ and ethanol co-solvent has a minimal brown color suggesting that minimal degradation of astaxanthin or formation of tertiary oxidation products has occurred; iv) a reduced dark/brown color as measured on a Hunter L* scale; v) a reduced pyrrole content as measured by absorption at 570 nm; v) minimal contents of free fatty acids (i.e., for example, 0.8 g/100 g of oil (~ 0.8% w/w)) and lysophosphatidylcholine (i.e., for example, 1.5 g/100 g of oil (~ 1.5% w/w)). These findings suggest that the lipids of crustacean biomass have undergone minimal hydrolysis during the initial processing steps producing PPC

I. Historical Overview of Crustacean Processing Methods

Publication GB 2240786 discloses a method for processing krill including removing a part of the fluoride content of krill. The removing is based on passing electric current through pulverized krill. However, fluoride-containing solid particles remain in the material.

5 Publication US 2011/0224450 (Sclabos Katevas et al., herein incorporated by reference) discloses a method for obtaining krill oil from whole raw krills using *inter alia* cooking, separating by decanter, and pressing. No solvents and extraction are used.

Publication WO 2008/060163 (Pronova Biopharma AS) discloses a method for obtaining krill oil using supercritical CO₂ and either ethanol, methanol, propanol or
10 isopropanol as co-solvent. Fresh or pre-heated (about 90 °C) whole krills are used as the extraction feed material.

Publication WO 02/102394 (Neptune Technologies & Bioresources) discloses a method for obtaining krill oil using in different phases acetone and ethanol or e.g. ethyl acetate as solvents. Frozen whole krill is used as feed material.

15 Publication JP 2215351 (Taiyo Fishery) discloses a method for obtaining krill oil using ethanol as solvent. Lyophilized whole krills are used as feed material.

Publication US 2008/0274203 (Aker Biomarine ASA, Bruheim et al.)(herein incorporated by reference) discloses a method for obtaining krill oil from krill meal using supercritical fluid extraction in a two-stage process. Stage 1 removes the neutral lipid by
20 extracting with neat supercritical CO₂ or CO₂ plus approximately 5% of a co-solvent. Stage 2 extracts the actual krill oils using supercritical CO₂ in combination with approximately 20% ethanol.

There are a number of problems associated with these conventionally known technologies of extracting krill lipids, including but not limited to: i) whole crustacean
25 biomass contains high fluoride exoskeleton particles that results in the production of fluoride-contaminated crustacean oil; ii) crustacean oil having a brownish hue color may arise from exposing astaxanthin to excessive heat during crustacean biomass processing. Specifically, the brown color can arise from degradation of astaxanthin and/or from accumulation of the end products of non-enzymatic browning (e.g., Strecker degradation products or polymerized
30 pyrroles). Although it is not necessary to understand the mechanism of an invention, it is believed that a brown color resulting from this non-enzymatic process results from oxidative degradation due to a reaction of secondary lipid oxidation products with amino groups from amino acids or proteins creating so-called tertiary oxidation products; iii) freezing the crustacean biomass for transportation to an extraction plant can result in relative stability, but

some changes in the product are known to occur over time, for example, one characteristic change in frozen krill is a partial hydrolysis of the lipids resulting in the accumulation of free fatty acids (FFA) arising from degradation of triglycerides, phospholipids and/or lysophospholipids, specifically lysophosphatidylcholine (LPC), arising from hydrolysis of phosphatidylcholine; and iv) the use of heat and frozen storage can induce oxidation of lipids and proteins in crustacean biomass, where primary oxidation leads into formation of secondary oxidation products that are volatile and can be detected in krill oil as off-flavors or undesirable odor; and v) the separation of the krill oil from the feed material is quite inefficient, wherein only about a half of the oil can be extracted.

II. Production Of Low Fluoride Crustacean Materials

In one embodiment, the present invention contemplates a method comprising forming a phospholipid-peptide complex (PPC) composition from a crustacean (i.e., for example, krill) immediately after the catch has been brought upon on board (e.g., decked) a boat and/or ship (i.e., for example, a fishing vessel). The process of creating the PPC composition comprises disintegrating the crustaceans into a disintegrated material comprising smaller particles (i.e., for example, between approximately 1 - 25 millimeters), adding water, heating the disintegrated material, adding enzyme(s) to hydrolyze the disintegrated material, deactivating the enzyme(s), removing solids (i.e., for example, exoskeleton, shell, and/or carapace) from the enzymatically processed material to reduce the fluoride content of the material, separating and drying the PPC composition. Preferably, the PPC composition is transferred to an on-shore facility (i.e., a fish oil extraction plant) where a low-fluoride crustacean oil is separated from the PPC composition using solvents including, but not limited to, supercritical CO₂ and/or ethanol. Using alternative extractions, de-oiled PPC compositions, phospholipids and/or protein hydrolysate compositions are also separated from the PPC composition.

- An advantage of some embodiments of the invention is that these crustacean products, like krill oil, have a low fluoride content. This is due to the fact that the solid crustacean exoskeletal particles (i.e., for example, shell and/or carapace) are effectively removed from mass to be processed.

- Another advantage of the invention is that crustacean oil can be separated effectively, almost completely, from the disintegrated crustacean material (e.g., feed material) during the extraction. This is due to the fact that, in the extraction process with, for example, a supercritical CO₂ solvent, the feed material comprises a PPC composition. Although it is

not necessary to understand the mechanism of an invention, it is believed that the phospholipids of the feed material are embedded in a matrix of hydrolyzed protein which means that the close association between the phospholipids and hydrophobic/phosphorylated proteins is broken thus facilitating the extraction of the lipids.

5 - An advantage of the invention is that relatively low pressure and temperature can be used in the extraction, which means lower production costs.

 - A further advantage of the invention is that disposal of residual solvents, common when using other more conventional lipid solvents, is avoided when using supercritical CO₂ as a solvent.

10 - A further advantage of the invention is that phosphatidylserine (PS), free fatty acids (FFA) and lysophosphocholine (LPC) contents are very low in the end products.

 - A further advantage of the invention is that a low fluoride crustacean oil product (i.e., for example, a low fluoride krill oil) has very little brown color. It is believed in the art that appearance of a brown color in crustacean oil indicates that unfavorable processes are
15 occurring during the the manufacture of the feed material (e.g., a disintegrated crustacean material).

A. Processing Of Crustaceans

 The present invention provides an industrial method for processing catches of crustaceans comprising a number of steps beginning with a very early and substantially
20 complete removal of the crustacean's exoskeleton (i.e., for example, the crust, carapace and/or shell). Although it is not necessary to understand the mechanism of an invention, it is believed that the crustacean exoskeleton comprises a vast majority of fluoride in the organism. Consequently, this step thereby results in a substantial removal of fluoride from the crustacean material. The method also uses longitudinal centrifugation techniques that
25 prevents separation problems caused by emulsions when processing a raw material with high content of phospholipids.

 The method according to the present invention is initiated immediately after decking a catch of crustacean. It is of importance that the method according to the present invention is initiated as soon as possible after the crustacean catch has been decked since fluoride starts to
30 leak/diffuse immediately from the exoskeleton into the crustacean's flesh and juices.

 When using the term "immediately" in connection with starting the process according to the present invention this relates to the period from decking the crustacean catch and to the initial disintegration of the crustacean. This period of time should be kept to a minimum, and should preferably not exceed 60 minutes, more preferred not exceed 30 minutes, even more

preferred not exceed 15 minutes, and should include a direct transfer of the crustacean catch from the trawl bag and/or net to a suitable disintegrator. A disintegrator of the crustacean material may be a conventional pulping, milling, grinding or shredding machine.

5 The crustacean catch is initially loaded into a disintegration apparatus where the crustacean catch is subjected to pulping, milling, grinding and/or shredding to create a disintegrated crustacean material. The temperature of the disintegration process is around the ambient temperature of the water (i.e., for example, between approximately -2 and +1° C, but more preferably between approximately +0° C to +6° C) and may be performed by any convenient disintegration method. This disintegration process is also conventionally done by
10 the previous known processing methods, and represents one of the obstacles according to the prior art because it produces large amounts of exoskeletal particles from the crustacean mixing in the milled material and producing a disintegrated paste with a high fluoride content. However, this high fluoride content is one of the reasons why the prior art processed crustacean material has limited applications and is less suitable for food, feed or
15 corresponding food or feed additives compared to other marine raw materials e.g. pelagic fish.

According to the present invention the crustacean material is separated into a particle size suitable for a further separation step that does not interfere with the subsequent extraction steps. The disintegrating process is performed continuously and produces particle sizes up to
20 25 mm, a preferred particle size range is between approximately 0.5 - 10 mm and a more preferred size range is between approximately 1.0 - 8 mm.

Although it is not necessary to understand the mechanism of an invention, it is believed that this small particle size distribution represents one of advantages of the present invention because the fluoride has a tendency to leak out of the milled material and mingle
25 with the rest of the raw material. However, this leaking process takes time and is not rapid enough to negatively impact a subsequent enzymatic hydrolysis step, provided the hydrolysis step is performed within specific parameters with respect to time and optimal, or near-optimal conditions, such as pH and temperature and optionally with the addition of co-factors such as specific ions depending on the used enzymes.

30 The temperature of the disintegrated material may, according to the present invention, be elevated to a temperature suitable for the subsequent enzymatic hydrolysis. Preferably, the temperature may be increased within seconds (e.g., 1-300 seconds, more preferred 1-100 seconds, even more preferred 1-60 seconds, most preferred 1-10 seconds) subsequent to the

disintegrating step for reducing the processing time and thereby preventing diffusion of fluoride and for preparing the material for the enzymatic hydrolysis.

According to the present invention enzymes may be added directly to the disintegrated material or through the added water or both, before, during or after the disintegration process.

5 According to the present invention, exogenous proteolytic enzymes (e.g., alkalase, neutrase, enzymes derived from microorganisms including, but not limited to, *Bacillus subtilis* and/or *Aspergillus niger*, and/or or enzymes derived from plant species) may be added before, during or after the disintegration, and before, during or after the heating of the disintegrated material. The added enzyme(s) may be in the form of one single enzyme or a
10 mixture of enzymes. The conditions of the hydrolysis should match the optimal hydrolytic conditions of the added enzyme(s) and the selection of optimal conditions for the selected exogenous hydrolytic enzyme(s) is known to the person skilled in the art. As an example, the exogenous enzyme alkalase having a pH optimum of about 8, a temperature optimum of 60° C and a hydrolysis time of 40-120 minutes. The selected enzymes, or combination of
15 enzymes, should also be chosen for reducing emulsions caused by high content of phospholipids in the raw material.

 An efficient amount of proteolytic enzyme(s) will be set after a process- and product optimization process that depends upon the efficiency of a specific chosen commercial enzyme or mix of enzymes. A typical amount by weight of commercial enzymes, as a ratio
20 of the amount of the weight of the disintegrated raw material, are preferably between 0.5% and 0.05%, more preferably between 0.3% and 0.07% and most preferable between 0.2% and 0.09%. This hydrolysis step is aided by endogenous (natural) enzymes because rapid and uncontrolled autolysis is well known in fresh caught crustaceans.

 In one embodiment, the exogenous enzymes breakdown the proteinaceous material in
25 the disintegrated substance as well as speed up and/or accelerate the hydrolysis of the material to avoid and/or preclude the leaking of fluoride from the shell, carapace and crust. These hydrolytic enzymes, or a combination of hydrolytic enzymes, should also be carefully chosen to reduce emulsion in the separation process. For example, such enzymes may be selected from exo- and/or endopeptidases. If a mixture of enzymes is used, such a mixture
30 may also include one or more chitinases for subsequently making the chitin-containing fraction(s) more amenable to further downstream processing. If chitinases are used, care must be taken for not increasing the leakage of fluoride from the shell/crust/carapace of the crustacean into the other fractions. However, since such fluoride leakage takes time, it is possible to perform such an enzymatic treatment within the preferred time parameters. A

more convenient alternative to including chitinases in the enzyme mix of the initial hydrolysis step will be to process the separated chitin-containing fraction subsequently to the separation step.

5 In one embodiment, the leaking of fluoride from the milled exoskeletal material into the milled fleshy material is avoided by completing the disintegration/hydrolozing steps within a time interval of 100 minutes, preferably within 60 minutes, most preferred within 45 minutes calculated from the addition of the endogenous enzyme(s). The amount of enzyme(s) added is related to the type of enzyme product used. As an example it may be mentioned that the enzyme alkalase may be added in an amount of 0.1-0.5% (w/w) of the raw material. This
10 should be taken into context with the added endogenous enzymes since the addition of more enzymes will reduce the time interval of the hydrolytic step. Although it is not necessary to understand the mechanism of an invention, it is believed that a short hydroloysis duration reduces the diffusion time of fluoride from particles of the exoskeleton into the proteinaceous material.

15 Subsequent to, or together with, the hydrolytic processing step the hydrolyzed and distintegrated crustacean material is passed through a particle removal device operating through a gravitational force such as a longitudinal centrifuge (i.e., for example, a decanter). This first separation step removes the fine particles containing a considerable amount of the fluoride from the hydrolysed or hydrolysing crustacean material to create a solids fraction.
20 The centrifuge is operated with a g force between 1,000 and 1,800 g, more preferably between 1,200 and 1,600 g and most preferably between 1,300 and 1,500 g. Through this particle removal step a substantial amount of fluoride is removed from the proteinaceous crustacean fraction. The reduction of fluoride on a dry weight basis as compared to conventional crustacean meal, with a typical fluoride content of 1,500 ppm, may be up to
25 50%, even more preferred up to 85%, most preferred up to 95%.

The enzymatic hydrolysis may be terminated by heating of the hydrolysing material (incubate) to a temperature over 90° C, preferably between 92-98° C and most preferred between 92-95° C, prior to, during or after the separation step, as long as the hydrolysis duration lies within the above given boundaries. The hydrolysis is terminated before, during,
30 or after the fine particle removal step, most preferred after the fine particle removal step. The temperature of the first centrifugation particle removal step, in one embodiment, depend on the optimal activity temperature of the enzyme (in the case where the enzymatic hydrolysis step is terminated by heating after the fine particle separation step).

The fluoride content in the prior art processed krill protein material (e.g., ~1,500 ppm) has limited applications and are less suitable for food or feed or corresponding food or feed additives. In one embodiment, removal of the fluoride content from the exoskeletal material may be followed by a further separation/purification of materials such as chitin, chitosan and
5 astaxanthin. Such isolation procedures are known within the art. Steps may also be taken to further reduce the fluoride content from the isolated exoskeletal material using techniques including, but not limited to, dialysis, nanofiltration, electrophoresis or other appropriate technologies.

Hydrolytic enzyme(s) deactivation may be performed in different ways, such as
10 adding inhibitors, removing co-factors (e.g., crucial ions through dialysis), through thermal inactivation and/or by any other deactivating means. Among these, thermal inactivation, is preferred by heating the proteinaceous material to a temperature where the hydrolytic enzymes become denatured and deactivated. However, if a product where the relevant native proteins are not denatured is wanted, other means than heating for deactivating the hydrolytic
15 enzymes should be selected.

A first centrifugation forms a de-fluoridated hydrolyzed and disintegrated crustacean material fraction and a solids fraction (e.g., containing high fluoride exoskeleton particles). As described below, the low fluoride hydrolyzed and disintegrated crustacean material fraction may be subsequently separated (e.g., by a second centrifugation) to form a low
20 fluoride phospholipid-peptide complex (PPC) composition fraction and a lean low fluoride concentrated hydrolysate fraction (CHF) fraction that can be used as a food and/or feed additives, and a lipid fraction mainly consisting of neutral lipids. The PPC composition subfraction is rich in lipids, like a smooth cream with no particles, wherein the lipids are well suspended within the peptide components. This suspension results in small density
25 differences between the different PPC composition components thereby making it difficult to further separate the PPC composition with common centrifugal separators and/or decanters. This is especially accentuated with crustacean catches during the second half of the fishing season.

Ordinary disc centrifugal separators (i.e., generating rotational force in the X and Y
30 plane) do not work properly to separate a PPC composition subfraction into its respective components since emptying and necessary cleaning cycles with water will disturb separation zones. Conventional centrifugation separation processes result in the formation of unwanted emulsion products having a high phospholipid (PL) content and low dry matter concentrations. Standard decanters cannot separate the PPC composition subfraction into its

respective components due to a low g force limitation, short separation zone and an intermixing of light and heavy phases at the discharge of heavy phase from the machine.

In one embodiment, the present invention contemplates a method comprising separating a low fluoride PPC material into subfractions using a horizontal decanter centrifuge with an extended separation path. See, Figure 2. Horizontal centrifuges (e.g., generating a rotational force in the Z plane) are useful for the present invention comprise modified convention decanter centrifuges. For example, a PPC composition subfraction would enter an ordinary decanter from a bowl through a central placed feed pipe in the middle of the separation zone. In contrast, when using horizontal centrifuges as contemplated herein, the PPC composition subfraction enters at the end and at the opposite side of the outlet (1). This modification provides a significant improvement in the separation process by providing a considerably longer clarification/separation zone than ordinary decanters and utilizes the total available separation length (2) of the machine. The drive is able to impart high g-forces: 10,000 g for small machines and 5,000 to 6,000 g for high capacity machines, facilitating the separation of very fine, slow-settling PPC composition subfractions without the complications of emulsification. The PPC composition subfraction will be subjected to the highest g-force just before entering under the baffle (3). The different liquid layers separated from PPC composition subfraction are concentrated gradually along the axis of the horizontal centrifuge thereby exiting the machine under baffle (3) by the force pressure generated by the machine (4). The separation of the PPC composition subfraction into a layer comprising about 27-30% dry matter makes the downstream processing efficient in terms of operating/robustness and as well economically considering both yield and costs of preparing the dry matter into a meal composition. The PPC composition subfraction separation also creates a layer comprising a lean hydrolysate that can be evaporated into a concentrated hydrolysate of greater than 60%.

B. Processing Of Krill

One embodiment according to the invention is depicted as a flow diagram for the processing of krill. See, Figure 1. The function according to the method, or the process according to the invention is initiated immediately as a krill catch has been raised to the ship. Although it is not necessary to understand the mechanism of an invention, it is believed that fluoride immediately starts to leak/diffuse from the chitinous exoskeleton into the flesh and juices of the dead krills. "Immediately" means here a period at most 60 minutes, in practice, for example 15 minutes. During this period the krill catch is transferred from the trawl/net to a suitable disintegrator. In the disintegrator the krill material is crushed to relatively small

particles. The disintegrating can be performed by any convenient method: pulping, milling, grinding or shredding. The temperature in the disintegration process is around the ambient temperature of the water, i.e. between -2°C and $+10^{\circ}\text{C}$, preferably between $+0^{\circ}\text{C}$ and $+6^{\circ}\text{C}$. The disintegration produces large amount of chitinous debris among the rest of the krill material, thereby contributing to a high fluoride content.

The particle size distribution of the disintegrated krill material is significant because of the above-mentioned fluoride leak from the chitinous debris and to the rest of the raw material. It is believed that the smaller particle sizes results in a more complete separation of the solids fraction from the disintegrated krill material. For this reason the preferable range of the particle size is 1.0 - 8 mm. However, the leaking process is relatively slow and has not time to be realized during the following process phases.

Next, fresh water is added to the disintegrated krill material (step 11). The volume/L of the water added is, for example, same as the weight/kg of the disintegrated krill material to be processed during the subsequent process phase of enzymatic hydrolysis. The temperature of the disintegrated krill material with the added water is increased such that it is suitable for the hydrolysis and enzyme(s) are added. The heating is carried out fast, within at most five minutes, after the disintegrating step to reduce the processing time and thereby to prevent diffusion of fluoride and to prepare the material for the enzymatic hydrolysis. The enzyme(s) can be added directly to the disintegrated krill material, or through the added water or both, before, during or after the heating step.

The term "hydrolysis" as used herein, means that breaks are made in the protein structure in the disintegrated substance, and the protein chains become shorter. This process is controlled by hydrolytic enzyme(s). For example, one or more exogenous proteolytic enzymes (e.g. alkalase, neutrase, and enzymes derived from microorganisms or plant species) may be used in the process. Co-factors such as specific ions can be added depending on the used enzymes. The selected enzyme(s) can also be chosen for reducing emulsions caused by high content of phospholipids in the raw material. Besides the temperature, the hydrolysis takes place within optimal or near-optimal pH and sufficient time (e.g., for example, the exogenous enzyme alkalase the optimum pH is about 8, optimum temperature about 60°C and the hydrolysis time 40-120 minutes).

The amount of proteolytic enzyme(s) can be set after a process/product optimization, and depends naturally on the efficiency of the chosen enzyme or mix of enzymes. A typical ratio of the weight of added commercial enzymes to the weight of the disintegrated krill material is between 0.05% and 0.5%, preferably between 0.1% and 0.2%. Fresh caught krill

is known for rapid and uncontrolled autolysis, or the destruction of the cells by endogenous (natural) enzymes, for which reason the treatment described here has to be proceeded without delays when the catch is not frozen.

5 The enzymatic hydrolysis also causes removing the bindings between the soft tissue of the krill and the exoskeleton. If a mixture of enzymes is used, the mixture may also include one or more chitinases to facilitate the further processing of the chitin-containing fractions. Chitinases are enzymes that break down glycosidic bonds in chitin.

10 The enzymatic hydrolysis is finished within 100 minutes from the addition of the endogenous enzyme(s). The preferred duration Δt of the hydrolysis is shorter, for example 45 minutes (step 12). Relatively short hydrolysis duration is important, because in that case the diffusion of the fluoride from the exoskeleton particles to the other material is reduced.

15 The hydrolysis is stopped by deactivating the hydrolytic enzyme(s) (step 13). There are many ways to deactivate the enzymes. Here it is used the thermal one: the temperature of the enzymatically processed material is increased over 90°C, preferably between 92-98°C, in which case the hydrolytic enzymes become denatured. In practice the deactivating of the hydrolytic enzyme(s) can be performed also during or after the solid particle removal.

20 The solid particles (e.g., krill exoskeleton) are removed from the enzymatically hydrolyzed and disintegrated krill material by passage through a device based on the centrifugal force such as a conventional horizontal centrifuge and/or decanter (step 14). Although it is not necessary to understand the mechanism of an invention, it is believed that these solid particles, or solids, originate from the exoskeleton of krills and, as mentioned, contain a considerable amount of the fluoride. The decanter is operated with a force between 1,000 and 1,800 g, preferably between 1,300 and 1,500 g. Through this particle removal step a substantial amount of fluoride, more than 90 %, is removed from the krill material. The 25 temperature in the decanter is for example 90°C, and if the deactivation of the enzyme(s) is done after the removal of solids, the temperature in the decanter is then increased to e.g. 93°C.

30 Next, the hydrolyzed and disintegrated krill material with low fluoride content is modified by passage through an extended separation path horizontal centrifuge (i.e., for example, a sedicanter). See, Figure 1 step 15, and Figure 2. In the sedicanter, the hydrolyzed and disintegrated krill material, is separated into the valuable fatty portion, or PPC (phospholipid-peptide complex) material fraction, and a CHF portion (concentrated hydrolysate fraction).

The separation of hydrolyzed and disintegrated krill material into the PPC material is difficult because of the small density differences within the krill material. The sedicanter is a modified horizontal centrifuge including a long horizontal clarification/ separation zone and generating high centrifugal forces (5,000 to 6,000 g). These features facilitate the separation of fine, slow-settling PPC without emulsification. The latter is a problem in the ordinary centrifuges with short separation zone and lower forces, and in which water is used in emptying and cleaning cycles. The dry matter concentration of PPC material, pressured out from the sedicanter, is about 27-30%.

The PPC material may be then dried to a meal to avoid the lipid oxidation. Figure 1, step 16. The drying process is gentle with low temperature (0-15°C, preferably 2-8°C) and inert conditions, which give a reduced oxidative stress on the long-chain poly-unsaturated omega-3 fatty acids. A lyophilisation process would also be suitable since this avoids an over-heating of the product.

The PPC krill meal, or more briefly PPC, is then packed in air tight bags under nitrogen atmosphere for later direct use and continuation process.

A typical mass balance of the processed raw lean Antarctic krill is shown below in Table I:

Table I: Typical Mass Balance Of Antarctic Krill

Matter	From 500kg raw krill + water	Dry weight
Wet PPC material	80 kg	28%
PPC meal	25 kg	97%
Hydrolysate	770 kg	6%
CHF	78 kg	60%
Fluoride-containing particles	45 kg	40%
Neutral oils	<5 kg	

The fluoride content, prior to separation, in hydrolyzed and disintegrated krill material is 1.2 g/kg, whereas, after separation, the PPC is at most 0.5 g/kg and typically 0.3 g/kg. Thus, about two thirds of the fluoride has been removed.

When the PPC is further processed, components may be isolated by an extraction. In this phase, a solvent may be used. Figure 1, step 17. For example, to obtain krill oil from the PPC, supercritical CO₂ and/or ethanol may be utilized, either separately or in combination. The extraction process yields, in addition to the krill oil, a protein hydrolysate (step 18).

Compressing and heating a material (e.g., for example, carbon dioxide or dimethyl ether) to above its critical temperature and pressure results in a supercritical fluid. The

density is intermediate between a liquid and a gas and can be varied as a function of temperature and pressure. Hence, the solubility of supercritical fluids can be tuned so that selective extractions can be obtained. Due to the gas like properties, rapid extractions can be accomplished compared to liquid extractions as the diffusion rates are higher. CO₂ is a
5 commonly utilized supercritical fluid as its critical parameters can easily be reached. For example, one report has demonstrated a low yield of krill phospholipids by using supercritical fluid extraction at a pressure of 500 bar and a temperature of 100°C. Yamaguchi (1986). A second report provides data on specific process conditions, which include pressure and
10 temperature ranges (e.g., 300 to 500 bar and 60 to 75°C). These data are from a pilot scale process wherein an extraction of 84 to 90% of krill total lipids was achieved. Bruheim et al., United States Patent Application Publication Number 2008/0274203 (herein incorporated by reference).

Supercritical CO₂ is also non-flammable, cheap and inert, wherein such factors are relevant when considering industrial applicability. The inertness results in low grade of
15 oxidation of labile compounds during extraction. CO₂ also has a low surface tension which is an advantage so that the extraction medium can penetrate the material efficiently. In order to extract more polar substances, the CO₂ can be mixed with a polar solvent such as ethanol. The level of modifier can be varied to provide extra selectivity as well.

Consequently, currently available industrial scale supercritical fluid extraction
20 processes using high temperatures and pressures has resulted in a low extraction efficiency of conventional krill meal thereby providing an insufficient oil yield to provide a commercially feasible solution for krill extraction. Further, these currently available extraction processes do not solve the problems discussed herein regarding providing improved low fluoride meal and/or oil compositions.

Therefore, the improved solvent extraction methods described herein have been
25 developed. In one embodiment, co-solvents are used with supercritical CO₂ or supercritical dimethyl ether either alone or in various combinations of ethanol, hexane, acetone. For example, if ethanol is used alone as an extraction solvent, it has been observed that krill material is less selective than extraction with supercritical CO₂. Pronova et al., WO
30 2008/060163 A1. As a result, undesirable substances are extracted into the krill oil resulting in a need for additional post-extraction clean-up/processing. Further, ethanol-only extracted krill oil tends to have higher viscosity and darker color which is independent of astaxanthin content of the oil.

In some embodiments, the present invention contemplates methods that have unexpected findings including but not limited to: i) PPC was extracted using low pressures (i.e., for example, between approximately 177 to 300 bar) and low temperatures (i.e., for example, between approximately 33 and 60°C); and ii) high yield of lipid extract was produced (data available). It appears that krill meal comprising hydrolyzed protein allows for easier extraction of the associated lipids in particular the phospholipid rich fraction of krill oil.

The data presented herein demonstrates that supercritical CO₂ was found to be a selective extraction method as it produced high purity extracts containing triglycerides, phospholipids and astaxanthin with minimal brown color and superior organoleptic quality as compared to krill oils produced by ethanol-only extraction and/or acetone + ethanol extraction. Brown color of krill oil is considered to be undesirable. The exact origin of the brown color is unknown but it is believed to be associated with oxidation of krill lipids during the manufacture of krill meal phospholipids and/or degradation of the carotenoid astaxanthin.

The properties of such a supercritical fluid can be altered by varying the pressure and temperature, allowing selective component extraction. Extraction conditions for supercritical CO₂ are above the critical temperature of 31°C and critical pressure of 74 bar. Addition of modifiers may slightly alter these values. For example, neutral lipids and cholesterol can be extracted from egg yolk with CO₂ pressures up to 370 bar and temperature up to 45°C, while using higher temperature, e.g. 55°C, would result in increased rate of phospholipid extraction. CO₂ has a high industrial applicability because it is non-flammable, cheap and inert. The inertness results in low oxidation of labile compounds during extraction.

As mentioned, either supercritical CO₂ or supercritical dimethyl ether is fluid. Its density is intermediate between a liquid and a gas and can be varied as a function of temperature and pressure. Hence, the solubility of supercritical fluids can be tuned so that selective extractions can be obtained. Due to the gas-like properties, rapid extractions can be accomplished compared to liquid-extractions. In the present method the extraction is effective; even 95% of the krill oil existing in the PPC is separated. Although it is not necessary to understand the mechanism of an invention, it is believed that the phospholipids of the feed material are embedded in a matrix of hydrolyzed protein which means that the close association between the phospholipids and hydrophobic/phosphorylated proteins is broken thus facilitating the extraction of the lipids. In addition, a minimal amount of fluoride content is transferred to oil during the CO₂ extraction process. For example, the fluoride

content of PPC is about 0.3 g/kg, but after the CO₂ extraction the fluoride content of the krill oil is less than 0.5 mg/kg.

Alternatively, when using only supercritical CO₂ as solvent, triglycerides and/or neutral oil may be separated from the PPC composition subfraction. Figure 1, step 19. In one embodiment, supercritical CO₂-only extraction also generates a low fluoride 'de-oiled PPC' composition. Although it is not necessary to understand the mechanism of an invention, it is believed that de-oiled PPC is the most valuable portion of the PPC composition subfraction. When thereafter, the de-oiled PPC composition may be extracted using ethanol as a solvent, wherein a phospholipid subfraction and a protein hydrolysate fraction is also generated. See, Figure 1, step 1A.

In one embodiment, the present invention contemplates a system comprising an extraction plant, including but not limited to, a solvent unit 21, vertical tank 22, separators 23 and adsorbents 24. See, Figure 3. Normal CO₂ and possible co-solvent are fed to the solvent unit, which comprises a pump to generate a certain pressure (p) and a heater to generate a certain temperature (T). The supercritical CO₂ with possible co-solvent are then fed to the lower end of the tank 22. The feed material, in this case the PPC, is fed to the tank by means of a pump. Material affected by the solvent flows out of the upper end of the tank. The separators 22 separate the extract result, for example krill oil, to output of the system. If ethanol is used as co-solvent, it follows the extract proper and has to be evaporated away. The CO₂ continues its circulation to adsorbents 23, where it is cleaned, and thereafter back to the solvent unit 21.

In one embodiment, the present invention contemplates low fluoride PPC compositions including, but not limited to, polar lipids (~ 43% w/w) and/or neutral lipids (~ 46% w/w). For example, the PPC neutral lipids may range between approximately 40 – 50% (w/w). In one embodiment, the polar lipids include, but are not limited to, phosphatidylethanoamine (~ 3% w/w), phosphatidylinositol (~ < 1% w/w), phosphatidylserine (~ 1% w/w), phosphatidylcholine (~ 38% w/w) and/or lysophosphatidylcholine (~ 2% w/w). In one embodiment, the neutral lipids include, but are not limited to triacylglycerol (~ 40% w/w), diacylglycerol (~ 1.6% w/w), monoacylglycerol (~ < 1% w/w), cholesterol (~ 2% w/w), cholesterol esters (~ 0.5% w/w), free fatty acids (~ 2% w/w) and fat (~ 48% w/w). In one embodiment, the neutral lipid fat comprises approximately 75% fatty acids. In one embodiment, the neutral lipid fat fatty acids include, but are not limited to, saturated fatty acids (~ 28% w/w), monenoic fatty acids (~ 22% w/w),

n-6 polyunsaturated fatty acids (~ 2% w/w) and/or n-3 polyunsaturated fatty acids (~ 26% w/w). *See, Example XIII.*

Phospholipid profiles have been created to evaluate low fluoride krill oil extracted by the methods described herein. For example, nuclear magnetic resonance technology has
5 determined that phosphatidylcholine is the largest phospholipid component of krill oil and its proportion is relatively stable. Several krill oil samples underwent independent analysis. *See, Example XII.* In one embodiment, the present invention contemplates a low fluoride krill oil comprising approximately 39 – 52% (w/w) phospholipids. In one embodiment, the phospholipids comprise phosphatidylcholine ranging between approximately 65 - 80% (w/w).
10 In one embodiment, the phospholipids comprise alkyl acyl phosphatidylcholine ranging between approximately 6 – 10% (w/w). In one embodiment, the phospholipids comprise phosphatidylinositol ranging between approximately 0.3 – 1.6% (w/w). In one embodiment, the phospholipids comprise phosphatidylserine ranging between approximately 0.0 – 0.7 % (w/w). In one embodiment, the phospholipids comprise lysophosphatidylcholine ranging
15 between approximately 2.4 – 19% (w/w). In one embodiment, the phospholipids comprise lyso acyl alkyl phosphatidylcholine ranging between approximately 0.6 – 1.3% (w/w). In one embodiment, the phospholipids comprise phosphatidylethanolamine ranging between approximately 1.4 – 4.9% (w/w). In one embodiment, the phospholipids comprise alkyl acyl phosphatidylethanolamine ranging between approximately 0.0 – 2.1 % (w/w). In one
20 embodiment, the phospholipids comprise a combination of cardiolipin and N-acylphosphatidylethanolamine ranging between approximately 1 – 3% (w/w). In one embodiment, the phospholipids comprise lysophosphatidylethanolamine ranging between approximately 0.5 – 1.3% (w/w). In one embodiment, the phospholipids comprise lyso alkyl acyl phosphatidylethanolamine ranging between approximately 0.0 and 0.3% (w/w).

25 As described above, the non-polar solvent extraction of a low fluoride crustacean oil results in the production of a low fluoride de-oiled phospholipid-protein complex composition (de-oiled PPC). Although it is not necessary to understand the mechanism of an invention, it is believed that the low fluoride de-oiled phospholipid-protein complex comprises a fluoride content similar to the low fluoride PPC complex (e.g., between
30 approximately 200 – 500 ppm). A component analysis of de-oiled PPC includes, but is not limited to, polar lipids (~ 69% w/w) and/or neutral lipids (~ 20% w/w). In one embodiment, the polar lipids include, but are not limited to, phosphatidylethanoamine (~ 4.2% w/w), phosphatidylinositol (~ < 1% w/w), phosphatidylserine (~ < 1% w/w), phosphatidylcholine (~ 62% w/w) and/or lysophosphatidylcholine (~ 2% w/w). In one embodiment, the neutral

lipids include, but are not limited to triacylglycerol (~ 17% w/w), diacylglycerol (~ 0.6% w/w), monoacylglycerol (~ < 1% w/w), cholesterol (~ 1% w/w), cholesterol esters (~ 0.5% w/w), free fatty acids (~ 1% w/w) and fat (~ 35% w/w). In one embodiment, the neutral lipid fat comprises approximately 69% fatty acids. In one embodiment, the neutral lipid fat fatty acids include, but are not limited to, saturated fatty acids (~ 21% w/w), monenoic fatty acids (~ 13% w/w), n-6 polyunsaturated fatty acids (~ 2% w/w) and/or n-3 polyunsaturated fatty acids (~ 31% w/w). See, *Example IX*.

III. Production Of Low Trimethyl Amine Crustacean Materials

Trimethylamine (TMA) is an organic compound comprising a chemical formula of $N(CH_3)_3$. TMA is a colorless, hygroscopic, and flammable tertiary amine that may have a strong "fishy" odor in low concentrations and an ammonia-like odor at higher concentrations. TMA may be produced commercially and is also a natural by-product of plant and/or animal decomposition. It is the substance mainly responsible for the odor often associated with rotting fish, some infections, and bad breath. It is also associated with taking large doses of choline and carnitine.

Chemically, TMA comprises a nitrogenous base and can be readily protonated to give trimethylammonium cation. Trimethylammonium chloride is a hygroscopic colorless solid prepared from hydrochloric acid. Trimethylamine is a good nucleophile, and this reaction is the basis of most of its applications.

Trimethylamine N-oxide (TMAO) is an organic compound comprising a formula $(CH_3)_3NO$. This colorless solid is usually encountered as the dihydrate. TMAO is an oxidation product of TMA, a common metabolite in animals. TMAO is also an osmolyte found in saltwater fish, sharks and rays, molluscs, and crustaceans. Further, TMAO may function as a protein stabilizer that may serve to counteract urea, the major osmolyte of sharks, skates and rays. TMAO has high concentration in deep-sea fishes and crustaceans, where it may counteract the protein-destabilizing effects of pressure. Yancey, P. "Organic osmolytes as compatible, metabolic, and counteracting cytoprotectants in high osmolarity and other stresses" *J. Exp. Biol.* 208(15):2819–2830 (2005). TMAO decomposes to trimethylamine (TMA), which is the main odorant that is characteristic of degrading seafood.

Removal of TMA/TMAO compounds from crustacean products confers a useful advantage in that these compounds contribute to the strong, unpleasant smell of crustacean oils. Consequently, low TMA/TMAO compounds have an improved industrial applicability as compared to traditionally prepared crustacean oils.

In one embodiment, the present invention contemplates a method comprising extracting a low fluoride protein peptide complex (PPC) is a suitable raw material for krill oil production by extraction with any combination of solvents including, but not limited to, ethanol, acetone, ethyl acetate, carbon dioxide, or dimethyl ether to produce a low fluoride-
5 low trimethyl amine crustacean product. In one embodiment, the low fluoride-low trimethyl amine crustacean product comprises an oil. In one embodiment, the low fluoride-low trimethyl amine crustacean produce comprises a de-oiled PPC.

Dimethyl ether (DME) has been previously reported as an extraction solvent for polyunsaturated fatty, but not for the preparation of low TMA products. Catchpole et al.
10 "Extraction Of Highly Unsaturated Lipids With Liquid Dimethyl Ether" *WO 2007/136281*. When DME is in a supercritical form, the solvent has sufficient solvent power to extract phospholipids resulting in rapid and gentle extractions. DME can be used on wet raw materials and can be operated at low pressures as compared to other supercritical fluids such as CO₂. In one embodiment, the present invention contemplates a crustacean extraction
15 product comprising krill oils with a low TMA/TMAO crustacean oil. In one embodiment, the low TMA/TMAO crustacean oil is a krill oil.

IV. Formulated Compositions

In some embodiments, the present invention contemplates compositions comprising
20 low fluoride crustacean PPC or compositions comprising low fluoride crustacean de-oiled PPC compositions and/or protein hydrolysates as described herein. In one embodiment, the compositions comprises mixtures of the crustacean PPC complex, crustacean de-oiled PPC and the protein hydrolysates in any combination. Although it is not necessary to understand the mechanism of an invention, it is believed that the mixed ratio can be any ratio but is
25 preferably a ratio of approximately 1:1. In one embodiment, the mixture comprises a milled fine powder. In one embodiment, the powder has a particle size of approximately 250 µm. In one embodiment, the compositions have improved stability because of lower peroxide (e.g., < 0.1 %; mEq/kg) and/or aniside levels (< 0.1 %; w/w). In one embodiment, the compositions have improved stability because of lower microbiological contamination. In
30 one embodiment, the composition further comprises microencapsulated polyunsaturated Omega-3 fatty acids. In one embodiment, the composition further comprises zinc oxide. In one embodiment, the composition further comprises marine peptides. In one embodiment, the composition further comprises at least one supplemental amino acid.

In some embodiments, the present invention contemplates a method for formulating a composition comprising a low fluoride crustacean PPC and/or a low fluoride crustacean de-oiled PPC and/or a protein hydrolysate as described herein. In one embodiment, the composition is a powder. In one embodiment, the composition is a tablet. In one
 5 embodiment, the composition is a capsule. In one embodiment, the method further comprises mixing the powder with a food product. In one embodiment, the mixing further comprises a microencapsulated polyunsaturated Omega-3 fatty acids. In one embodiment, the mixing further comprises zinc oxide. In one embodiment, the mixing further comprises marine peptides. In one embodiment the mixing further comprises at least one supplemental amino
 10 acid.

EXPERIMENTAL

Example I

15 Production Of Low Fluoride Krill Oil

The feed material, 'Emerald krill meal' granules (Olymeg[®] or low fluoride PPC prepared as described herein), were supplied in a sealed plastic bag containing approximately 25kg. The feed material was kept frozen until used in extractions. The granules have a size distribution typically in the range 2 to 5mm, but a number of fine fragments were also
 20 present. The granules are greasy to the touch but still break up under compression rather than smear.

5 kg batches of feed material in granular form, as processed using supercritical CO₂ as solvent and azeotropic food grade ethanol as co-solvent, the weight of the ethanol being 23% of the weight of CO₂. The plant was pre-pressurised to operating pressure with CO₂ only, and
 25 ethanol was added when CO₂ circulation started. Solvent to feed material ratio was 25:1 or greater and co-solvent to feed material ratio was 5:1. Runs were carried out under two extraction conditions; 300 bar at 60°C, and 177 bar at 40°C. See, Table II.

30 Table II –Krill Oil Extraction Conditions

	<u>Run 1</u>	<u>Run 2</u>
Feed Mass (g, as received)	5000.5	5000.9
Extraction pressure (bar)	300	177
Extraction temperature (°C)	60	33
35 First separator pressure (bar)	90	90
First separator temperature (°C)	41	41

	Second separator pressure (bar)	48-50	48-50
	Second separator temperature (°C)	39	39
	CO ₂ used with ethanol co-solvent (kg)	132.6	134.9
	Additional CO ₂ at end of run (kg)	33.1	44.5
5	Total ethanol used (kg)	31.65	32.19

The extracted krill oil material was passed through two separation vessels in series, held at 90 bar and 45-50 bar respectively. The final krill oil material collected from both separators was pooled together and the ethanol was evaporated. The residual feed material comprises a de-oiled feed material (e.g., for example, de-oiled PPC) having a reduced lipid content in comparison to the starting feed material. See, Example IX.

After ethanol evaporation, krill oil cumulative extraction curves were generated for both Run 1 and Run 2 by independently analyzing each sample taken during the extraction runs. See, Table III.

15

Table III – Progressive krill oil extraction sample points and yields.

Sample Number	1	2	3	4	5	6	Total	
<u>Run 1</u>								
20	Cumulative CO ₂ (kg/kg feed)	5.5	9.1	13.4	17.8	22.0	33.1	33.1
	Extracted oil (g, dry)	1137	398	282	135	78	86	2115
<u>Run 2</u>								
	Cumulative CO ₂ (kg/kg feed)	5.6	9.1	13.5	17.5	21.5	34.4	34.4
25	Extracted oil (g, dry)	715	496	368	220	149	129	2077

A total yield of 41-42 wt% of the feed material was achieved for all runs. The runs carried out at 300 bar and 60°C had a higher initial rate of extraction. The curves indicate that the extraction is virtually complete at Sample Number 5 after a cumulative CO₂ use ranging between 21.5 - 22.0 kg per kg of feed material. Estimated maximum extraction is achieved at a point where the CO₂:feed ratio is 26.5:1. See, Figure 3 (estimated maximum extraction is marked by an arrow). The ratio of azeotropic ethanol to CO₂ was 0.24:1 for the 300 bar runs, and slightly higher at 0.26:1 for the lower pressure run.

This method of krill oil production resulted in the near complete extraction of total lipids from the krill meal (e.g., for example, approximately 95% of neutral lipids and 90% of phospholipids). The final yield was similar for both the high and low pressure runs, but neutral lipids were more rapidly extracted at higher pressure. The phospholipid extraction rate was similar under both extraction conditions. As detailed below, in this extraction process, the

35

pooled krill oil total lipid had an overall phospholipid level of just over 40 wt% and both phosphatidyl inositol and phosphatidyl serine were poorly extracted.

Phospholipid profiles of the various krill material compositions were then determined using traditional column chromatography techniques. *See, Table IV.*

5

Table IV – Comparative Phospholipid Profiles Of Krill Compositions (run 1)

Sample	Olymeg 10071199	Extract 1	Extract 2	Extract 3	Extract 4	Extract 5	Extract 6	Residue (Top)	Residue (Bottom)
Wt% of total PL									
PC	70.1	80.4	77.1	76.9	75.9	73.5	72.7	40.2	32.5
AAPC	8.5	8.0	9.0	9.8	9.1	10.6	9.0	7.5	7.8
PI	1.8				0.7	0.6	0.6	6.2	10.1
PS	1.0							5.5	8.1
LPC	6.9	4.6	5.6	5.7	6.0	6.8	7.5	13.4	8.9
LAAPC	1.7	1.2	1.2	1.0	1.3	1.2	1.4	3.2	2.6
PE	5.3	3.6	4.0	3.5	3.8	3.5	4.5	9.4	9.4
EPLAS	0.6	0.0	0.5	0.5	0.5	0.5	0.3	1.0	2.2
AAPE	2.0	1.1	1.5	1.3	1.6	1.6	2.0	4.4	4.9
LPS								0.7	1.9
CL/NAPE	1.0	0.9	0.7	0.8	0.8	1.2	1.6	4.2	5.7
LPE	0.8	0.3	0.4	0.4	0.4	0.4	0.4	3.2	4.5
Total PL (wt% of lipid)	40.88							81.46	80.96
Lipid yield (wt%)	44.7							4.9	5.9
Total PL (wt% of sample)	18.3	26.68	46.03	57.94	71.34	76.13	78.50	4.0	4.8

The first column shows the specific phospholipids that were analyzed. The second column show the phospholipid profile of the starting feed material (e.g., a low fluoride PPC prepared as described herein, or 'Olymeg[®]'). Columns three – eight (Extracts 1 – 6) show the phospholipid profile of each krill oil sample taken during the extraction process as described above. The last two columns show the phospholipid profile of the residual extracted feed material sampled from either the top and/or the bottom of the phospholipid extraction column.

The data show that the major phospholipid in the extracted krill oil samples is phosphatidyl choline (PC), ranging approximately from 72.7% to 80.4% of total phospholipids, including contributions from both alkyl acyl phosphatidyl choline (AAPC) and lyso phosphatidyl cholines (e.g., for example, LPC and/or LAAPC). Smaller amounts of phosphatidyl ethanolamine (PE) are present in both the feed material (column 1, ~ 5.3%) and in the krill oil extract samples (columns 3 - 8), ~ 3.5 - 4.5%). Alkyl acyl and lyso forms of PE (AAPE, LPE) are also present in the feed material and krill oil extracts. Phosphatidyl inositol (PI) and phosphatidyl serine (PS) are present in the feed material, but because they are poorly soluble in ethanol, these phospholipids are poorly extracted and are therefore concentrated in the extracted feed material residue (e.g., having a higher level in the residual PPC in comparison to the feed material, see columns 9 and 10).

Further analysis determined the overall relative lipid component proportions of the extracted krill oil. *See, Figure V.*

Table V – Main Lipid Components Of Extracted Krill Oil (%w/w)

	TAG	Polar lipid	Sterols	FFA	Astaxanthin	Total lipid
Run 1	40,3	46,9	1,9	ND	0,05	92,2
Run 2	42,1	50,2	2	ND	0,05	95,3

5

The data show: i) a relative absence of free fatty acids (FFAs); ii) less than 2% of sterols; iii) 40 wt% of triacylglycerides (TAGs); and iv) approximately 50% phospholipids (e.g., polar lipids). While FFA's were not detected (ND) in this particular example, it is believed that extracted krill oils may comprise between approximately 0.01 – 0.1 % FFA of total lipids.

10 As described above, the extraction process results a yield of between approximately 92.2 – 95.3% of the feed material total lipid.

The method and products according to the invention has been described above. The method can naturally vary in its details from those presented. The inventive idea may be applied in different ways within the limits as described herein.

15

Example II

Lipid Extraction Efficiency

This example demonstrates an exemplary analytical lipid extraction with the Soxhlet method comparing conventional krill meal with a low fluoride krill meal (e.g. low fluoride PPC) as described herein. Soxhlet method is a standard method in quantitative determination of fat content of foods and feeds and thus it can be used as a reference method to determine the extractability of various krill meals. For example, the Soxhlet method may be carried out as below using petroleum ether (boiling point 30–60 °C). Conventional krill meal was prepared as described in US 2008/0274203 (Aker Biomarine ASA, Bruheim et al.) and the low fluoride PPC was prepared according to the present invention.

25

The neutral lipids are often part of large aggregates in storage tissues, from which they are relatively easily extracted. The polar lipids, on the other hand, are present as constituents of membranes, where they occur in a close association with proteins and polysaccharides, with which they interact, and therefore are not extracted so readily. Furthermore, the phospholipids are relatively tightly bound with hydrophobic proteins and in particular with the phosphorylated proteins.

30

The data show that partial hydrolysis of the protein matrix in the preparation of a low fluoride PPC composition as described herein improves the extraction efficiency of total lipid by use of non-polar organic solvents (e.g., for example, supercritical CO₂, ethanol, and/or petroleum ether).

5 Briefly, a 10 g sample of either conventional milled krill meal or low fluoride PPC was weighed and placed in a Soxhlet apparatus and then continuously extracted for approximately eight (8) hours using 300 mL petroleum ether. After extraction, the solvent was evaporated at 60 °C under a nitrogen stream. Soxhlet F., “Die gewichtsanalytische bestimmung des milchfettes” *Dingler’s Polytech. J.* 232:461–465 (1879).

10 The results show that the proportion of residual (e.g., un-extracted) lipid was twice as large in the conventional krill meal compared to the low fluoride krill meal. See, Table VI.

Table VI: Lipid Extraction Efficiency Of Low Fluoride Krill Meals

Source material	Extracted krill oil lipid	Source Material Residual lipid (e.g., de-oiled meal)
Conventional krill meal	79.6%	20.4%
Low fluoride krill meal	88.9%	11.1%

15 Consequently, the lipid extraction methods described herein have provided an unpredictable and surprising result that provides a superior product because of a greatly improved extraction efficiency.

Example III

20 Determination Of Fluoride Content

This example presents one method of determining fluoride content of krill products as fluoride by chemical analysis using an ion selective electrode.

A low fluoride PPC krill meal was prepared as described herein and extracted in accordance with Example I to create a low fluoride krill oil were analyzed for fluoride content and compared with conventional preparation processes. Briefly, the method disclosed herein removes, in most part, the krill exoskeleton from the krill meal thereby reducing the fluoride content. In contrast, the krill exoskeleton is included in the conventional krill meal thereby having relatively high levels of fluoride. Conventional processes are, for example, described in WO 2002/102394 (Neptune Technologies & Bioresources) and US 2008/0274203 (Aker Biomarine ASA).

25

30

The krill meals analyzed for fluoride content were produced by: i) a low fluoride method of present invention; and ii) a whole krill material produced by a conventional process. *See, Table VII.*

5 Table VII: Fluoride Content Comparison To Conventional Processes

Analyzed Material	Low Fluoride Preparation	Conventional Preparation
Krill meal	200 - 500 ppm	1300 ppm
Krill oil	< 0.5 ppm	~ 3 - 5 ppm

The data demonstrate that by removing the exoskeleton in the process of producing krill meal (e.g., the low fluoride preparation as disclosed herein), the fluoride content of the krill meal and the krill oil produced from the meal have a markedly reduced fluoride content (e.g., 3 –
 10 10 fold reduction).

Example IV

Krill Oil Color Comparison

Krill oil has typically a strong red colour arising from the carotenoid astaxanthin
 15 present in the oil at levels varying from 50 ppm to 1500 ppm. Color of krill oil can be determined with a LabScan[®] XE spectrophotometer (Hunter Associates Laboratory, INC. Resbon, VA, USA) and reported in CIELAB colour scales (L*, a* and b* values). Deviation from the red colour of astaxanthin can occur when the krill biomass is processed at high temperature and under conditions that induce oxidation. Typical oxidation induced deviation
 20 in krill oil color is an increase in the brownish hue. Brown color in krill oil arises from oxidation of lipids and formation of secondary and tertiary oxidation products with amino residues. This process is also called non-enzymatic browning.

Strecker degradation products and pyrroles are products of non-enzymatic browning that have been characterized in samples of krill oil. For example, polymerization of pyrroles
 25 results in formation of brown, melatonin like macromolecules. Furthermore, pyrrole content of krill oil can be determined spectroscopically with absorbance at 570 nm.

Samples of three krill oils will be examined for color. One produced by the method of the present invention, one produced from frozen krill by a method described in WO
 2002/102394 (Neptune Technologies & Bioresources) and one extracted from dried krill
 30 meal with ethanol alone as described in US 2008/0274203 (Aker Biomarine ASA). It is to be found that krill oil produced by the method of the present invention has the lowest level of

brown color determined spectrophotometrically by using CIELAB colour scales (L^* , a^* and b^* values) and/or the lowest level of pyrroles determined spectroscopically.

Example V

5 Organoleptic Krill Oil Quality Determination

Organoleptic quality of krill oil is conventionally determined by chemical analysis of volatile nitrogenous compounds arising from the decomposition of krill proteins and trimethyl amine oxide (TMAO). Nitrogenous compounds analyzed are total volatile nitrogen (TVN) and trimethylamine (TMA). In simplified terms the level of nitrogenous compounds
10 correlate with the level of spoilage in the raw material i.e. krill biomass used for extraction of the oil.

It has become evident that, in addition to the volatile nitrogenous compounds, a large number of volatile components with distinct odour contribute to the sensory properties of krill oil. Many of the volatile components arise from the oxidation of lipid and proteinaceous
15 compounds of krill biomass. Thus, a method that limits the level of oxidative degradation in the krill biomass, will reduce the amount of volatile components in krill oil.

Assessment of the organoleptic quality of different types of krill oil is to be performed by a panel of trained individuals. The sensory properties to be determined include several pre-defined parameters of smell and taste. It is to be found that the novel krill oil has an
20 improved sensory profile compared to the other oils tested. The other oils to be tested include one extracted from frozen krill by a method described in WO 2002/102394 (Neptune Technologies & Bioresources) and one extracted from dried krill meal with ethanol alone as described in US 2008/0274203 (Aker Biomarine ASA).

25 Example VI

Production Of Low Trimethyl Amine Crustacean Products

This example describes one method to produce low TMA crustacean products using a krill meal material composition. One having ordinary skill in the art, upon reading this
30 specification would understand that this krill meal material composition may have variable fluoride content, including fluoride contents below 0.5 ppm, in addition to the basic components described below. *See, Table VIII.*

35

Table VIII: Unextracted Krill Meal Composition

Eicosapentaenoic Acid (EPA)	11 g/100g (11 % w/w)
Docosahexaenoic acid (DHA)	7 g/100g (7 % w/w)
Omega-3 Fatty Acids	22.7 g/100g (22.7% w/w)
Phospholipids (PLs)	45 g/100g (45% w/w)
Trimethylamine (TMA)	44 mg N/100g (0.044% w/w)
Trimethylamine oxide (TMAO)	354 mg N/100g (0.354% w/w)

5 A krill oil may then be prepared from the krill meal using ethanol extraction as described above that has the basic components described below. See, Table IX.

Table IX. Krill Oil Components After Conventional Ethanol Extraction Of Krill Meal

Parameter	Value
EPA	11.5 g/100g (11.5% w/w)
DHA	6,5 g/100g (6.5% w/w)
Omega-3 Fatty Acides	22,1 g/100g (22.1% w/w)
Phospholipids	44 g/100g (44 % w/w)
Trimethylamine	50 mg N/100g (0.05 % w/w)
Trimethylamineoxide	216 mg N/100g (0.216% w/w)

10 Alternatively, krill oil was prepared by krill meal extraction at 40 bars and 40°C using supercritical dimethyl ether (SC DME). The DME extract composition was dried on a Rotavapor® and then flushed with nitrogen. The components of the resultant dried composition is listed below. See, Table X.

15 Table X: Krill Oil Components After SC DME Extraction Of Krill Meal

Parameter	Value
EPA	10,4 g/100g (10.4% w/w)
DHA	6,8 g/100g (6.8% w/w)
Omega-3 Fatty Acids	21,7 g/100g (21.7% w/w)
Phospholipids	45,7 g/100g (45.7% w/w)
Trimethyl amine	<1 mg N/100 g (< 0.001% w/w)
Trimethylamine oxide	20 mg N/100 g (0.02% w/w)

These data clearly show that supercritical DME extraction of krill meal compositions result in a preferential 10 – 100 fold reduction of TMA and TMAO levels.

20

Example VII

Nuclear Magnetic Resonance Phospholipid Profiles Of Low Fluoride Krill Oil

This example presents representative data of the phospholipid composition of low fluoride krill oils prepared by the methods described herein. See, Table XI.

5

Table XI: Phospholipids in Low fluoride krill oil analyzed using ³¹P NMR.

Sample #1 (color; orange)

Phospholipid (PL)		wt% of total PL g/100g sample	
Phosphatidylcholine	PC	79.7	31.1
Alkyl acyl phosphatidylcholine	AAPC	9.9	3.9
Phosphatidylinositol	PI	0.8	0.3
Phosphatidylserine	PS	0.7	0.3
Lysophosphatidylcholine	LPC	2.4	1.0
Lyso alkyl acyl phosphatidylcholine	LAAPC	0.6	0.2
Phosphatidylethanolamine	PE	3.5	1.4
Alkyl acyl phosphatidylethanolamine	AAPE	0.5	0.2
Cardiolipin + N-acylphosphatidylethanolamine	CL/NAPE	1.1	0.4
Lysophosphatidylethanolamine	LPE	0.6	0.2
Lyso alkyl acyl phosphatidylethanolamine	LAAPE	0.2	0.1
Total phospholipid content*		39.0 g/100g sample	
		39.5 g/100g solids	

n.d. = not detected
* Sum of the identified phospholipid classes

10 Sample #2 (color; orange)

Phospholipid (PL)		wt% of total PL g/100g sample	
Phosphatidylcholine	PC	66.7	27.0
Alkyl acyl phosphatidylcholine	AAPC	6.9	2.8
Phosphatidylinositol	PI	0.9	0.4
Phosphatidylserine	PS		n.d.
Lysophosphatidylcholine	LPC	18.9	7.7
Lyso alkyl acyl phosphatidylcholine	LAAPC	0.8	0.3
Phosphatidylethanolamine	PE	1.4	0.6
Alkyl acyl phosphatidylethanolamine**	AAPE		
Cardiolipin + N-acylphosphatidylethanolamine	CL/NAPE	3.0	1.2
Lysophosphatidylethanolamine	LPE	1.2	0.5
Lyso alkyl acyl phosphatidylethanolamine	LAAPE	0.2	0.1
Total phospholipid content*		40.5 g/100g sample	
		42.2 g/100g solids	

n.d. = not detected
* Sum of the identified phospholipid classes

15

Sample #3 (color; orange)

Phospholipid (PL)		wt% of total PL	g/100g sample
Phosphatidylcholine	PC	72.3	31.1
Alkyl acyl phosphatidylcholine	AAPC	6.1	2.6
Phosphatidylinositol	PI	0.3	0.1
Phosphatidylserine	PS	0.2	0.1
Lysophosphatidylcholine	LPC	16.1	6.9
Lyso alkyl acyl phosphatidylcholine	LAAPC	0.8	0.3
Phosphatidylethanolamine	PE	1.8	0.8
Alkyl acyl phosphatidylethanolamine**	AAPE		
Cardiolipin + N-acylphosphatidylethanolamine	CL/NAPE	1.2	0.5
Lysophosphatidylethanolamine	LPE	1.1	0.5
Lyso alkyl acyl phosphatidylethanolamine	LAAPE		n.d.
		Total phospholipid content*	43.0 g/100g sample
			45.1 g/100g solids

n.d. = not detected
 * Sum of the identified phospholipid classes

5

Sample #4 (color; orange)

Phospholipid (PL)		wt% of total PL	g/100g sample
Phosphatidylcholine	PC	77.4	39.5
Alkyl acyl phosphatidylcholine	AAPC	8.9	4.6
Phosphatidylinositol	PI	0.9	0.5
Phosphatidylserine	PS	0.4	0.2
Lysophosphatidylcholine	LPC	5.5	2.8
Lyso alkyl acyl phosphatidylcholine	LAAPC	0.6	0.3
Phosphatidylethanolamine	PE	2.6	1.3
Alkyl acyl phosphatidylethanolamine**	AAPE	1.3	0.7
Cardiolipin + N-acylphosphatidylethanolamine	CL/NAPE	1.8	0.9
Lysophosphatidylethanolamine	LPE	0.5	0.3
Lyso alkyl acyl phosphatidylethanolamine	LAAPE	0.2	0.1
		Total phospholipid content*	51.1 g/100g sample
			52.8 g/100g solids

n.d. = not detected
 * Sum of the identified phospholipid classes
 ** May contain some glycerophosphocholine (GPC)

10

15

Sample #5 (color; orange)

Phospholipid (PL)		wt% of total PL	g/100g sample
Phosphatidylcholine	PC	65.6	26.8
Alkyl acyl phosphatidylcholine	AAPC	9.4	3.9
Phosphatidylinositol	PI	1.6	0.6
Phosphatidylserine	PS	0.7	0.3
Lysophosphatidylcholine	LPC	10.1	4.2
Lyso alkyl acyl phosphatidylcholine	LAAPC	1.3	0.5
Phosphatidylethanolamine	PE	4.9	2.0
Alkyl acyl phosphatidylethanolamine	AAPE	2.1	0.9
Cardiolipin + N-acylphosphatidylethanolamine	CL/NAPE	2.8	1.2
Lysophosphatidylethanolamine	LPE	1.3	0.5
Lyso alkyl acyl phosphatidylethanolamine	LAAPE	0.3	0.1
		Total phospholipid content*	41.0 g/100g sample
			43.0 g/100g solids

n.d. = not detected
 * Sum of the identified phospholipid classes

5 These data are consistent with those obtained using traditional column chromatography techniques shown in Example I.

Example VIII

Lipid Compositional Analysis Of Low Fluoride PPC Material

10 The example presents data showing the lipid compositional analysis of a low fluoride phospholipid-protein complex composition created by the methods described herein. Consequently, it would be expected that the fluoride content of the compositions described below are less than 500 ppm.

15 The PPC comprises approximately 46.7 g/100 g (e.g., ~ 47%) total fat, 11.8 g/100 g (e.g., ~ 12%) eicosapentaenoic Acid (EPA) and 6.7 g/ 100 g (e.g., ~7%) docosahexaenoic acid (DHA). The total lipid content of the PPC total fat was approximately 87.7 % (w/w) and comprises between approximately 115 - 260 mg/kg astaxanthin and between approximately 35.2% - 46.7% unextracted oil.

20

Table XII: Low Fluoride Krill PPC Fat: Neutral Lipid Content (45.2% w/w of total fat):
Sample Number 1MG

Components	% (w/w) neutral lipid
Triacylglycerol	38
Diacylglycerol	1.7
Monoacylglycerol	< 1
Free fatty acids	2.2
Cholesterol	2.4
Cholesterol Esters	< 0.5

5 Table XIII: Low Fluoride Krill PPC Fat: Neutral Lipid Content (46.6% w/w of total fat):
Sample Number 2MG

Components	% (w/w) neutral lipid
Triacylglycerol	41
Diacylglycerol	1.5
Monoacylglycerol	< 1
Free fatty acids	1.6
Cholesterol	1.8
Cholesterol Esters	0.6

10 Table IXV: Low Fluoride Krill PPC Neutral Lipids: Fatty Acid Content (49.7% w/w of
neutral lipids): Sample Number 1MG

Components	% (w/w) neutral lipid
Saturated	27.4
Monoenoic	21.9
N-6 Polyunsaturated	1.8
N-3 Polyunsaturated	22.7
Total	74.4

Table XV: Low Fluoride Krill PPC Neutral Lipids: Fatty Acid Content (46.7% w/w of
neutral lipid): Sample Number 2MG

Components	% (w/w) neutral lipid
Saturated	29.2
Monoenoic	21.6
N-6 Polyunsaturated	2.1
N-3 Polyunsaturated	23.3
Total	76.9

Table XVI: Low Fluoride Krill PPC Polar Lipid Content (42.6% w/w of total lipids):
Sample Number 1MG

Components	% (w/w) polar lipid
Phosphatidylethanolamine	3.4
Phosphatidylinositol	< 1
Phosphatidylserine	< 1
Phosphatidylcholine	37
Lyso Phosphatidylcholine	2.3

5 Table XVII: Low Fluoride Krill PPC Polar Lipid Content (42.8% w/w of total lipids):
Sample Number 2MG

Components	% (w/w) polar lipid
Phosphatidylethanolamine	2.5
Phosphatidylinositol	< 1
Phosphatidylserine	< 1
Phosphatidylcholine	39
Lyso Phosphatidylcholine	1.8

Example IX

10 Lipid Compositional Analysis Of Low Fluoride De-Oiled PPC Material

The example presents data showing the lipid compositional analysis of a low fluoride de-oiled phospholipid-protein complex composition created by the methods described herein. Consequently, it would be expected that the fluoride content of the compositions described below are less than 500 ppm. The de-oiled PPC comprises approximately 35 g/ 100 g (e.g., ~

15 35%) total fat, 16.6 g/100 g (e.g., ~ 17%) eicosapentaenoic Acid (EPA) and 10.0 g/ 100 g (e.g., ~10%) docosahexaenoic acid (DHA). The total lipid content of the de-oiled PPC total fat was approximately 87.7 % (w/w) and comprises approximately 115 mg/kg astaxanthin and approximately 35.2% unextracted oil.

20

25

Table XVIII: Low Fluoride Krill De-Oiled PPC Fat: Neutral Lipid Content (20.1% w/w of total fat): Sample Number 3MG

Components	% (w/w) Neutral Lipid
Triacylglycerol	17
Diacylglycerol	0.6
Monoacylglycerol	< 1
Free fatty acids	1.1
Cholesterol	1.3
Cholesterol Esters	< 0.5

5 Table IX: Low Fluoride Krill De-Oiled PPC Neutral Lipids: Fatty Acid Content (35.2% w/w of neutral lipids): Sample Number 3MG

Components	% (w/w) Neutral lipid
Saturated	21.3
Monoenoic	13.9
N-6 Polyunsaturated	2.1
N-3 Polyunsaturated	31.2

10 Table XX: Low Fluoride Krill PPC De-Oiled Polar Lipid Content (68.9% w/w of total fat): Sample Number 3MG

Components	% (w/w) polar lipid
Phosphatidylethanolamine	4.2
Phosphatidylinositol	< 1
Phosphatidylserine	< 1
Phosphatidylcholine	62
Lyso Phosphatidylcholine	2.2

Example X

15 Compositional Analysis Of PPC/Protein Hydrolysate Mixtures

The example presents data showing the lipid compositional analysis of a low fluoride phospholipid-protein complex mixed with a protein hydrolysate composition created by the methods described herein in an approximate 60/40 ratio. It would be expected that the fluoride content of the compositions described below are less than 500 ppm. The mixture
 20 comprises between approximately 28-30 g/100 g (e.g., ~ 30%) total fat, approximately 98

mg/kg astaxantine esters, approximately less than 1 mg/kg astaxanthine, a peroxide level of less than 0.1 %;(mEq/kg) and/or an ananise level of less than 0.1 % (w/w).

5

Table XXI: Low Fluoride PPC/Protein Mixture Fat: Neutral Lipid Content (28% w/w of total fat)

Components	% (w/w) Neutral Lipid
Triacylglycerol	34
Diacylglycerol	1.1
Monoacylglycerol	< 1
Free fatty acids	1.0
Cholesterol	1.9
Cholesterol Esters	< 0.5

Table XXII: Low Fluoride PPC/Protein Mixture Neutral Lipids: Fatty Acid Content

Components	% (w/w) Neutral lipid
Saturated	25.1
Monoenoic	19.2
N-6 Polyunsaturated	2.0
N-3 Polyunsaturated	24.9

10

Table XXIII: Low Fluoride PPC/Protein Mixture Polar Lipid Content

Components	% (w/w) polar lipid
Phosphatidylethanolamine	5.0
Phosphatidylinositol	< 1
Phosphatidylserine	< 1
Phosphatidylcholine	41
Lyso Phosphatidylcholine	1.4

CLAIMS

We claim:

- 5 1. A crustacean oil composition comprising phospholipids and less than approximately 0.5 ppm fluoride.
2. The crustacean oil composition of Claim 1, further comprising less than approximately 0.001% (w/w) trimethyl amine.
- 10 3. The crustacean oil composition of Claim 1, further comprising less than approximately 0.02% (w/w) trimethyl amine oxide.
4. The crustacean oil composition of Claim 1, wherein said phospholipids are between
15 approximately 39-52 wt%, wherein said phospholipids comprise at least approximately 65% phosphatidylcholine and at least approximately 2.4 wt% lysophosphatidylcholine.
5. The crustacean oil composition of Claim 1, further comprising triglycerides, neutral lipids,
20 approximately 20 - 26 wt% Omega-3 fatty acids, and at least approximately 0.8 wt% free fatty acids.
6. The crustacean oil composition of Claim 1, wherein said oil is krill oil.
7. A crustacean phospholipid-peptide complex (PPC) composition comprising a matrix of
25 hydrolyzed protein, phospholipids and between approximately 300-500 ppm fluoride.
8. The crustacean PPC composition of Claim 7, wherein said phospholipids are at least 40 wt%.
- 30 9. The crustacean PPC composition of Claim 7, further comprising approximately 0.044% (w/w) trimethyl amine and approximately 0.354% (w/w) trimethyl amine oxide.
10. The crustacean PPC composition of Claim 7, further comprising at least 40% (w/w) triglycerides.

11. A crustacean de-oiled phospholipid-peptide complex (PPC) composition comprising a matrix of hydrolyzed protein, between approximately 200-500 ppm fluoride, approximately 35% total fat, approximately 16.6% eicosapentaenoic acid, approximately 10.0% docosahexaenoic acid and at least 0.1 wt% free fatty acids.
12. The crustacean de-oiled PPC composition of Claim 11, wherein said total fat comprises less than 20% triglycerides and approximately 69% other lipid components.
13. The crustacean de-oiled PPC composition of Claim 12, wherein said total fat comprises approximately 35.2% fatty acids, wherein approximately 30 wt% of said fatty acids are n-3 fatty acids.
14. The crustacean de-oiled PPC composition of Claim 12, wherein said total lipids further comprise at least 68% phospholipids.
15. The crustacean de-oiled PPC composition of Claim 12, further comprising approximately 2.2% lysophosphatidyl choline.
16. The crustacean de-oiled PPC composition of Claim 12, further comprising approximately 115 mg/kg astaxanthin.
17. A dried protein hydrolysate composition comprising approximately 70 - 80% protein, approximately 1.5 - 3.0% lipids, and approximately 5 -7 % ash.
18. A method for creating low fluoride crustacean compositions, comprising:
- a) disintegrating a crustacean catch into a material having a particle size ranging between approximately 1 – 25 millimeters; and
 - b) separating said disintegrated crustacean material into a phospholipid-peptide complex (PPC) composition subfraction, wherein said subfraction comprises a fluoride content of less than 500 ppm.

19. The method according to Claim 18, wherein said method further comprises extracting said PPC composition subfraction with a fluid comprising a solvent wherein a low fluoride oil is created, said oil having a fluoride content of less than 0.5 ppm.
- 5 20. The method according to Claim 19, wherein said extracting further creates a low trimethyl amine/trimethyl amine oxide oil, wherein said trimethyl amine is less than approximately 0.001% (w/w) and said trimethyl amine oxide is less than approximately 0.02% (w/w).
- 10 21. The method according to Claim 18, wherein said separating is performed without emulsification.
22. The method according to Claim 18, wherein said solvent comprises a non-polar solvent.
- 15 23. The method according to Claim 18, wherein said solvent comprises at least one polar solvent.
24. The method according to Claim 18, wherein said solvent comprises said non-polar solvent and said at least one polar solvent.
- 20 25. The method according to Claim 22, wherein said non-polar solvent is selected from at least one of the group consisting of supercritical carbon dioxide and supercritical dimethyl ether.
- 25 26. The method according to Claim 23, wherein said polar solvent is selected from at least one of the group consisting of ethanol and acetone.
27. The method according to Claim 18, wherein said method further comprises hydrolyzing said crustacean material before said separating.
- 30 28. The method according to Claim 22, wherein said extracting further creates a de-oiled PPC composition.

29. The method according to Claim 23, wherein said polar solvent separates a phospholipid composition and a protein hydrolysate composition from said de-oiled PPC composition.
30. The method according to Claim 19, wherein said extracting comprises less than ten
5 hours.
31. The method according to Claim 19, wherein said extracting comprises less than five hours.
- 10 32. The method according to Claim 19, wherein said extracting comprises less than two hours.
33. The method according to Claim 18, wherein said crustacean material is krill material.
- 15 34. The method according to Claim 18, wherein said separating comprises a centrifugal force of between approximately 1,000 - 1,800 g.
35. The method according to Claim 18, wherein said separating comprises a centrifugal force of between approximately 5,000 - 10,000 g.
20
36. A composition comprising a mixture of a low fluoride crustacean PPC and a low fluoride de-oiled PPC, wherein said fluoride level ranges between approximately 200 – 500 ppm.
37. The composition of Claim 36, wherein said crustacean PPC is krill PPC.
25
38. The composition of Claim 36 wherein said crustacean de-oiled PPC is krill de-oiled PPC.
39. The composition of Claim 36, wherein said crustacean PPC and crustacean de-oiled PPC are in a 1:1 ratio.
- 30 40. The composition of Claim 36, wherein said mixture comprises a milled fine powder.
41. The composition of Claim 40, wherein said powder comprises a particle size of approximately 250 µm.

42. The composition of Claim 36, wherein said composition comprises a peroxide level of less than 0.1 % (mEq/kg).
43. The composition of Claim 36, wherein said composition comprises ananiside level of
5 less than 0.1 % (w/w).
44. The composition of Claim 36, wherein said composition further comprises microencapsulated polyunsaturated Omega-3 fatty acids.
- 10 45. The composition of Claim 36, wherein said composition further comprises zinc oxide.
46. The composition of Claim 36, wherein said composition further comprises marine peptides.
- 15 47. The composition of Claim 36, wherein said composition further comprises at least one supplemental amino acid.
48. A method, comprising formulating a composition comprising a low fluoride crustacean PPC and a low fluoride crustacean de-oiled PPC, wherein said fluoride level ranges between
20 approximately 200 – 500 ppm.
49. The method of Claim 48, wherein said method further comprises milling said composition into a powder.
- 25 50. The method of Claim 48, wherein said method further comprises tableting said composition into a tablet.
51. The method of Claim 48, wherein said method further comprises encapsulating said composition into a capsule.
30
52. The method of Claim 48, wherein said method further comprises mixing said powder with a food product.

53. The method of Claim 48, wherein said formulating further comprises microencapsulated polyunsaturated Omega-3 fatty acids.
54. The method of Claim 48, wherein said formulating further comprises zinc oxide.
- 5
55. The method of Claim 48, wherein said formulating further comprises marine peptides.
56. The method of Claim 48, wherein said formulating further comprises at least one supplemental amino acid.
- 10
57. A composition comprising a mixture of a low fluoride crustacean PPC and a crustacean protein hydrolysate, wherein said fluoride level ranges between approximately 200 – 500 ppm.
- 15
58. The composition of Claim 57, wherein said crustacean PPC is krill PPC.
59. The composition of Claim 57, wherein said crustacean protein hydrolysate is a krill protein hydrolysate.
- 20
60. The composition of Claim 57, wherein said crustacean PPC and said crustacean protein hydrolysate are in a 1:1 ratio.
61. The composition of Claim 57, wherein said mixture comprises a milled fine powder.
- 25
62. The composition of Claim 61, wherein said powder comprises a particle size of approximately 250 μm .
63. The composition of Claim 57, wherein said composition comprises a peroxide level of less than 0.1 % (mEq/kg).
- 30
64. The composition of Claim 57, where said composition comprises ananiside level of less than 0.1 wt%.

65. The composition of Claim 57, wherein said composition further comprises microencapsulated polyunsaturated Omega-3 fatty acids.
- 5 66. The composition of Claim 57, wherein said composition further comprises zinc oxide.
67. The composition of Claim 57, wherein said composition further comprises marine peptides.
- 10 68. The composition of Claim 57, wherein said composition further comprises at least one supplemental amino acid.
69. A method, comprising formulating a composition comprising a low fluoride crustacean PPC and a crustacean protein hydrolysate, wherein said fluoride level ranges between approximately 200 – 500 ppm.
- 15 70. The method of Claim 69, wherein said method further comprises milling said composition into a powder.
71. The method of Claim 69, wherein said method further comprises tableting said composition into a tablet.
- 20 72. The method of Claim 69, wherein said method further comprises encapsulating said composition into a capsule.
- 25 73. The method of Claim 69, wherein said method further comprises mixing said powder with a food product.
74. The method of Claim 69, wherein said formulating further comprises microencapsulated polyunsaturated Omega-3 fatty acids.
- 30 75. The method of Claim 69, wherein said formulating further comprises zinc oxide.
76. The method of Claim 69, wherein said formulating further comprises marine peptides.

77. The method of Claim 69, wherein said formulating further comprises at least one supplemental amino acid.

5

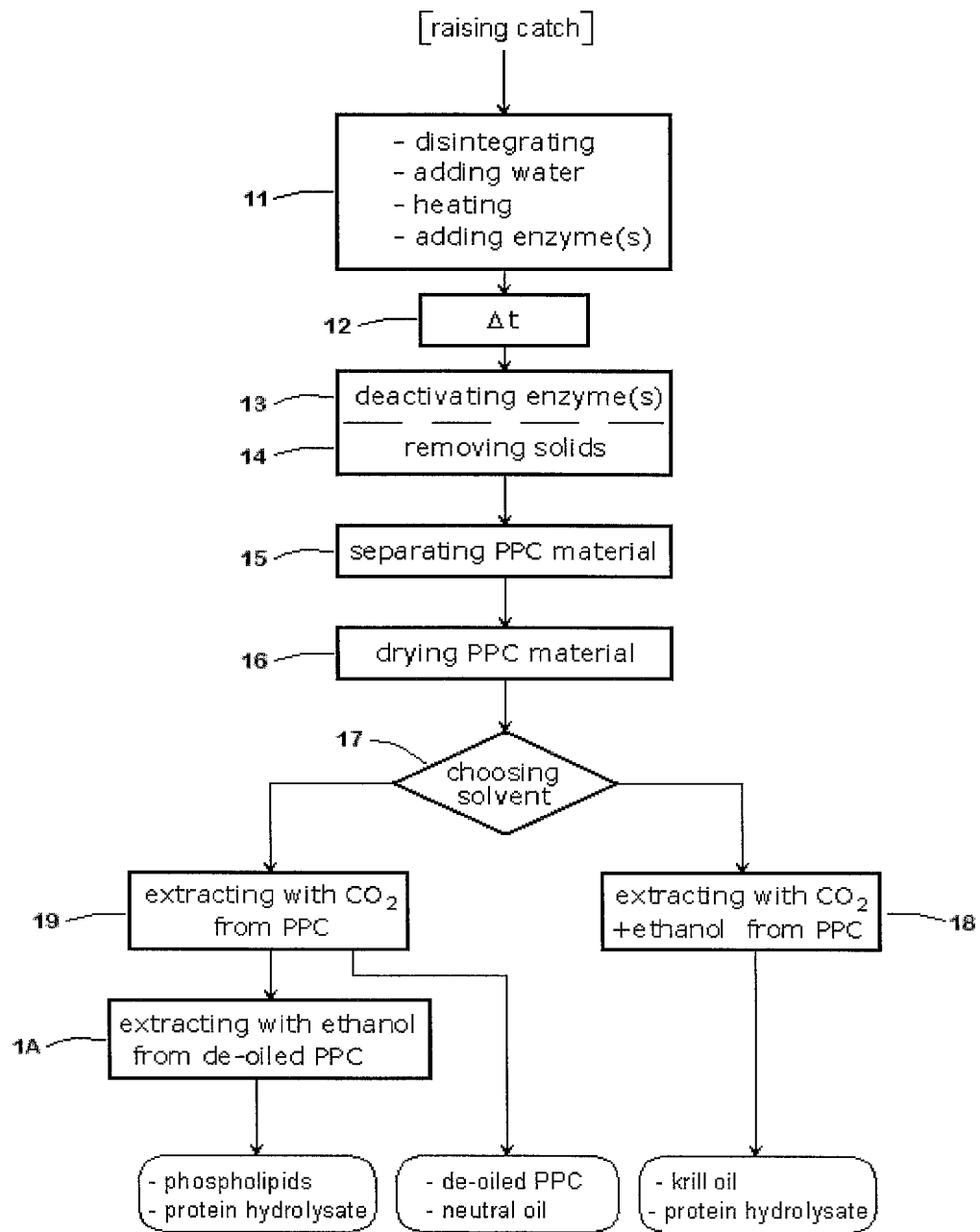

Fig. 1

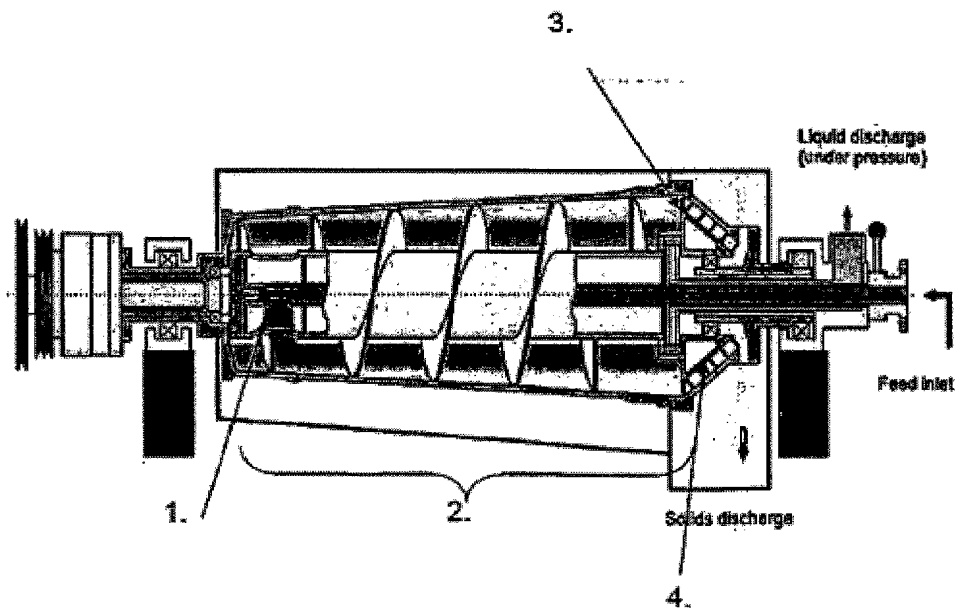

Fig. 2

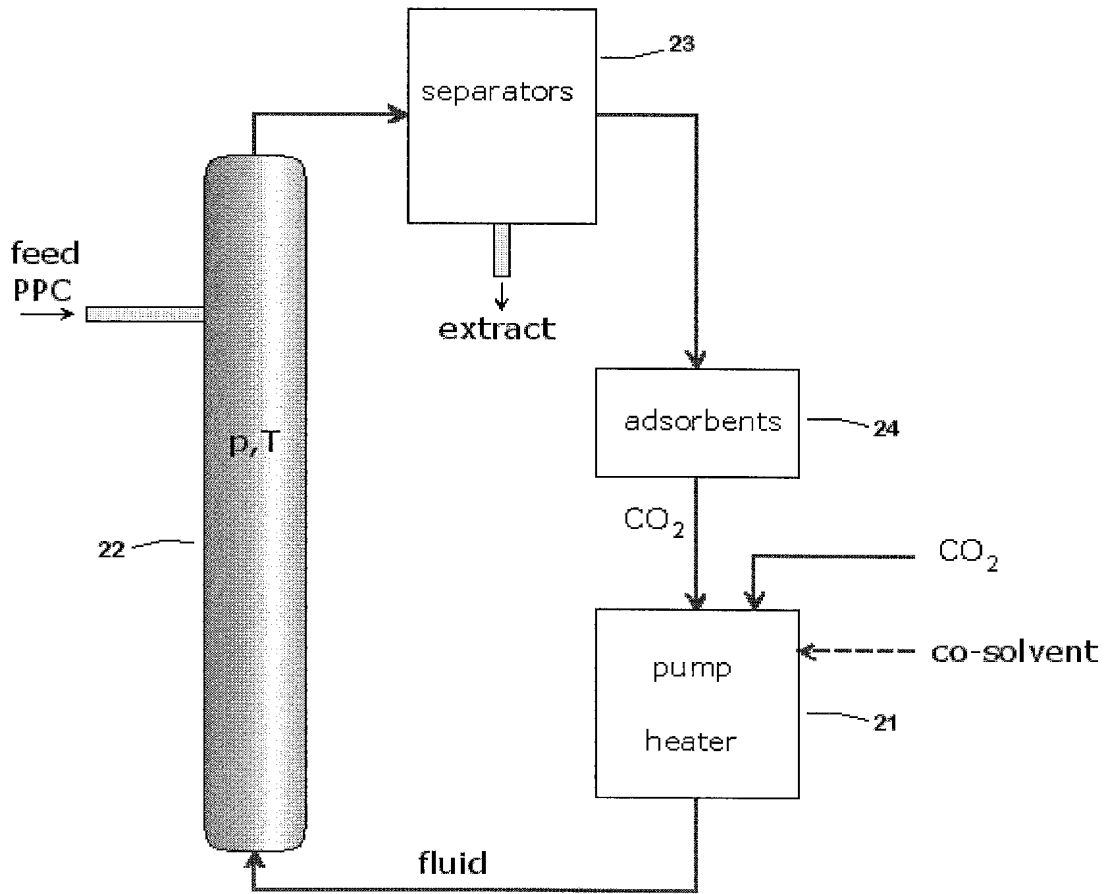

Fig. 3

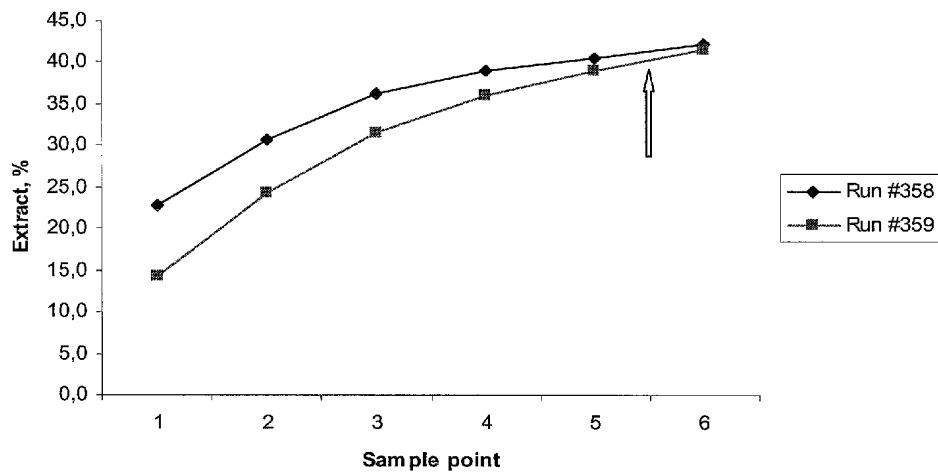

FIG. 4

PATENT COOPERATION TREATY

PCT

INTERNATIONAL SEARCH REPORT

(PCT Article 18 and Rules 43 and 44)

Applicant's or agent's file reference AKBM34345WO	FOR FURTHER ACTION see Form PCT/ISA/220 as well as, where applicable, item 5 below.	
International application No. PCT/IB2016/000208	International filing date (<i>day/month/year</i>) 10 February 2016 (10-02-2016)	(Earliest) Priority Date (<i>day/month/year</i>) 11 February 2015 (11-02-2015)
Applicant AKER BIOMARINE ANTARCTIC AS		

This international search report has been prepared by this International Searching Authority and is transmitted to the applicant according to Article 18. A copy is being transmitted to the International Bureau.

This international search report consists of a total of 4 sheets.

It is also accompanied by a copy of each prior art document cited in this report.

1. **Basis of the report**

a. With regard to the **language**, the international search was carried out on the basis of:

- the international application in the language in which it was filed
- a translation of the international application into _____, which is the language of a translation furnished for the purposes of international search (Rules 12.3(a) and 23.1(b))

b. This international search report has been established taking into account the **rectification of an obvious mistake** authorized by or notified to this Authority under Rule 91 (Rule 43.6*bis*(a)).

c. With regard to any **nucleotide and/or amino acid sequence** disclosed in the international application, see Box No. I.

2. **Certain claims were found unsearchable** (See Box No. II)

3. **Unity of invention is lacking** (see Box No III)

4. With regard to the **title**,

- the text is approved as submitted by the applicant
- the text has been established by this Authority to read as follows:

5. With regard to the **abstract**,

- the text is approved as submitted by the applicant
- the text has been established, according to Rule 38.2, by this Authority as it appears in Box No. IV. The applicant may, within one month from the date of mailing of this international search report, submit comments to this Authority

6. With regard to the **drawings**,

- a. the figure of the **drawings** to be published with the abstract is Figure No. _____
 - as suggested by the applicant
 - as selected by this Authority, because the applicant failed to suggest a figure
 - as selected by this Authority, because this figure better characterizes the invention
- b. none of the figures is to be published with the abstract

INTERNATIONAL SEARCH REPORT

International application No
PCT/IB2016/000208

A. CLASSIFICATION OF SUBJECT MATTER
 INV. A23J7/00 A61K35/612 C11B1/10 C11B3/00 C11C1/00
 C11C1/02 C11C1/08
 ADD.
 According to International Patent Classification (IPC) or to both national classification and IPC

B. FIELDS SEARCHED
 Minimum documentation searched (classification system followed by classification symbols)
 A23L A23J A61K C11B C11C
 Documentation searched other than minimum documentation to the extent that such documents are included in the fields searched

Electronic data base consulted during the international search (name of data base and, where practicable, search terms used)
 EPO-Internal, WPI Data

C. DOCUMENTS CONSIDERED TO BE RELEVANT

Category*	Citation of document, with indication, where appropriate, of the relevant passages	Relevant to claim No.
X	WO 2014/013335 A2 (HOEM NILS [NO]; TILSETH SNORRE [NO]; AKER BIOMARINE AS [NO]) 23 January 2014 (2014-01-23) claims; examples	1-56
X	US 2014/370115 A1 (HOEM NILS [NO] ET AL) 18 December 2014 (2014-12-18) claims; examples 2-4	1-56
X	WO 2012/139588 A2 (TRIPLENINE PHARMA AS [DK]; SOERENSEN HANS OTTO [DK]; JENSEN NILS CHRIS) 18 October 2012 (2012-10-18) claims; example 2	1-56
X	CN 102 746 941 B (UNIV SHANDONG NORMAL) 15 January 2014 (2014-01-15) claims; example 2	1-56
	----- -/--	

Further documents are listed in the continuation of Box C.

See patent family annex.

* Special categories of cited documents :

- "A" document defining the general state of the art which is not considered to be of particular relevance
- "E" earlier application or patent but published on or after the international filing date
- "L" document which may throw doubts on priority claim(s) or which is cited to establish the publication date of another citation or other special reason (as specified)
- "O" document referring to an oral disclosure, use, exhibition or other means
- "P" document published prior to the international filing date but later than the priority date claimed

- "T" later document published after the international filing date or priority date and not in conflict with the application but cited to understand the principle or theory underlying the invention
- "X" document of particular relevance; the claimed invention cannot be considered novel or cannot be considered to involve an inventive step when the document is taken alone
- "Y" document of particular relevance; the claimed invention cannot be considered to involve an inventive step when the document is combined with one or more other such documents, such combination being obvious to a person skilled in the art
- "&" document member of the same patent family

Date of the actual completion of the International search 6 May 2016	Date of mailing of the international search report 13/05/2016
--	---

Name and mailing address of the ISA/ European Patent Office, P.B. 5818 Patentlaan 2 NL - 2280 HV Rijswijk Tel. (+31-70) 340-2040, Fax: (+31-70) 340-3016	Authorized officer Vernier, Frédéric
--	--

INTERNATIONAL SEARCH REPORT

International application No
PCT/IB2016/000208

C(Continuation). DOCUMENTS CONSIDERED TO BE RELEVANT

Category*	Citation of document, with indication, where appropriate, of the relevant passages	Relevant to claim No.
X	JP 2 909508 B2 (TAIYO FISHERY CO LTD) 23 June 1999 (1999-06-23) claims; examples -----	1-56

INTERNATIONAL SEARCH REPORT

Information on patent family members

International application No

PCT/IB2016/000208

Patent document cited in search report	Publication date	Patent family member(s)	Publication date
WO 2014013335 A2	23-01-2014	AU 2013291680 A1 CA 2878786 A1 EP 2874500 A2 US 2015164841 A1 WO 2014013335 A2	05-02-2015 23-01-2014 27-05-2015 18-06-2015 23-01-2014
US 2014370115 A1	18-12-2014	AU 2014203179 A1 AU 2016201168 A1 EP 3008156 A2 US 2014370115 A1 WO 2014207571 A2	22-01-2015 17-03-2016 20-04-2016 18-12-2014 31-12-2014
WO 2012139588 A2	18-10-2012	AU 2012242355 A1 CA 2832913 A1 CN 103635564 A EP 2697345 A2 PE 04962014 A1 US 2014031569 A1 WO 2012139588 A2	24-10-2013 18-10-2012 12-03-2014 19-02-2014 07-05-2014 30-01-2014 18-10-2012
CN 102746941 B	15-01-2014	NONE	
JP 2909508 B2	23-06-1999	JP 2909508 B2 JP H02215351 A	23-06-1999 28-08-1990

TITLE: LIPID EXTRACTION PROCESSES

APPLICANT: AKER BIOMARINE ANTARCTIC AS

IPC CLASSIFICATION: A23J7/00, A61K35/612, C11B1/10, C11B3/00, C11C1/00, C11C1/02, C11C1/08

EXAMINER: Vernier, Frédéric

CONSULTED DATABASES: EPODOC, WPI, INET, DOSYS

CLASSIFICATION SYMBOLS DEFINING EXTENT OF THE SEARCH:

IPC:

CPC: A23L1/3006, A23J7/00, A61K35/612, C11B1/10, C11B3/006, C11C1/007, C11C1/02, C11C1/08

FI/F-TERMS:

KEYWORDS OR OTHER ELEMENTS FEATURING THE INVENTION:

Process for the extraction of lipids from marine biomass, in particular krill, using ethanol. Fractionation into an astaxanthin-rich fraction and a phospholipid-rich fraction.

PATENT COOPERATION TREATY

JM

RECEIVED

From the INTERNATIONAL SEARCHING AUTHORITY

PCT JUN 27 2016

CASIMIR JONES S.C.

To:
 Jones, J. Mitchell
 CASIMIR JONES, S.C.
 2275 Deming Way, Suite 310
 Middleton, WI 53562
 ETATS-UNIS D'AMERIQUE

Add. Search Fees
7.15.16

INVITATION TO PAY ADDITIONAL FEES
 AND, WHERE APPLICABLE, PROTEST FEE
 (PCT Article 17(3)(a) and Rule 40.1 and 40.2(e))

Date of mailing
 (day/month/year) 15 June 2016 (15-06-2016)

Applicant's or agent's file reference
 AKBM34344WO

PAYMENT DUE
 within **ONE MONTH** from
 the above date of mailing

International application No.
 PCT/IB2016/000326

International filing date
 (day/month/year) 10 February 2016 (10-02-2016)

Applicant
 AKER BIOMARINE ANTARCTIC AS

1. This International Searching Authority

- (i) considers that there are 3 (number of) inventions claimed in the international application covered by the claims indicated on an extra sheet:
- (ii) therefore considers that **the international application does not comply with the requirements of unity of invention** (Rules 13.1, 13.2 and 13.3) for the reasons indicated on an extra sheet:
- (iii) has carried out a partial international search (see Annex) will establish the international search report on those parts of the international application which relate to the invention first mentioned in claims Nos.:
see extra sheet
- (iv) will establish the international search report on the other parts of the international application only if, and to the extent to which, additional fees are paid.

2. Consequently, the applicant is hereby invited to pay, within the time limit indicated above, the amount indicated below:

EUR 1.875,00	x	<u>2</u>	=	<u>EUR 3.750,00</u>
Fee per additional invention		number of additional inventions		currency/total amount of additional fees

3. The applicant is informed that, according to Rule 40.2(c), **the payment of any additional fee may be made under protest**, i.e., a reasoned statement to the effect that the international application complies with the requirement of unity of invention or that the amount of the required additional fee is excessive, where applicable, subject to the payment of a protest fee.

Where the applicant pays additional fees under protest, the applicant is hereby invited, within the time limit indicated above, to pay a protest fee (Rule 40.2(e)) in the amount of EUR 875,00 (currency/amount)

Where the applicant has not, within the time limit indicated above, paid the required protest fee, the protest will be considered not to have been made and the International Searching Authority will so declare.

4. Claim(s) Nos. _____ have been found to be unsearchable under Article 17(2)(b) because of defects under Article 17(2)(a) and therefore have not been included with any invention.

Name and mailing address of the International Searching Authority



European Patent Office, P.B. 5818 Patentlaan 2
 NL-2280 HV Rijswijk
 Tel. (+31-70) 340-2040
 Fax: (+31-70) 340-3016

Authorized officer

BENINCA CORDES, Carmelita
 Tel: +49 (0)89 2399-2806

This International Searching Authority found multiple (groups of) inventions in this international application, as follows:

1. claims: 1-30, 46-52(completely); 54-59(partially)

i/ A desalted krill lipid composition, a krill phospholipid concentrate, a krill lipid composition (with a phospholipid content 30-50% or 50-85% and a triglyceride content 32-52%, 5-35% and 26-46% and at least one of the properties mentioned in the respective claims);

and

ii/ an oral delivery vehicle comprising said compositions, a functional food comprising said compositions, a nutritional supplement, dietary supplement or medical food comprising said compositions, a composition comprising said compositions and a second nutraceutical ingredient and a composition comprising said compositions and a pharmaceutically acceptable carrier (as far as as the ii/ refer back to the claims 1-15, 16-30 and 46).

2. claims: 31-45(completely); 54-59(partially)

i/ A krill lipid composition (with a phospholipid content 2-20% and a triglyceride content 70-95%, and at least one of the properties mentioned in the respective claims);

and

ii/ an oral delivery vehicle comprising said compositions, a functional food comprising said compositions, a nutritional supplement, dietary supplement or medical food comprising said compositions, a composition comprising said compositions and a second nutraceutical ingredient and a composition comprising said compositions and a pharmaceutically acceptable carrier (as far as as the ii/ refer back to the claims 31-45).

3. claims: 53(completely); 54-59(partially)

i/ A concentrated krill astaxanthin composition comprising 400-4000 ppm astaxanthin esters and more than 98% krill neutral lipids;

and

ii/ an oral delivery vehicle comprising said composition, a functional food comprising said composition, a nutritional supplement, dietary supplement or medical food comprising said composition, a composition comprising said composition and a second nutraceutical ingredient and a composition comprising said composition and a pharmaceutically acceptable carrier (as far as as the ii/ refer back to the claim 53).

In the first invention, the Special Technical Feature (STF) is the

combination of the concentrations of phospholipids and triglycerides as well as at least one of the properties. This STF solves the technical problem of providing a krill oil composition that has a high quality with respect to purity, smell and taste (see also page 7 of the present invention).

In the second invention, a possible STF is the combination of the (completely different from those of the 1st invention) concentrations of phospholipids and triglycerides as well as at least one of the properties as in the claims of the 2nd invention. This STF does not appear to solve any technical problem.

In the third invention, a possible STF is the combination of the concentration of the astaxanthin esters and krill neutral lipids (no mention of any additional technical features / properties). Again, this STF does not appear to solve any technical problem.

Since the three aforementioned inventions do not have the same STF, the present application lacks unity.

Only the subject-matter of the 1st invention is searched.

**Annex to Form PCT/ISA/206
COMMUNICATION RELATING TO THE RESULTS
OF THE PARTIAL INTERNATIONAL SEARCH**

International Application No
PCT/IB2016/000326

1. The present communication is an Annex to the invitation to pay additional fees (Form PCT/ISA/206). It shows the results of the international search established on the parts of the international application which relate to the invention first mentioned in claims Nos.:
see 'Invitation to pay additional fees'
2. This communication is not the international search report which will be established according to Article 18 and Rule 43.
3. If the applicant does not pay any additional search fees, the information appearing in this communication will be considered as the result of the international search and will be included as such in the international search report.
4. If the applicant pays additional fees, the international search report will contain both the information appearing in this communication and the results of the international search on other parts of the international application for which such fees will have been paid.

C. DOCUMENTS CONSIDERED TO BE RELEVANT

Category °	Citation of document, with indication, where appropriate, of the relevant passages	Relevant to claim No.
X	DATABASE FSTA [Online] INTERNATIONAL FOOD INFORMATION SERVICE (IFIS), FRANKFURT-MAIN, DE; SHIBATA N: "Effect of fishing season on lipid content and composition of Antarctic krill. (translated)", XP002758417, Database accession no. FS-1985-04-R-0091 abstract	1-30, 46-52, 54-59
X	----- WO 2010/097701 A1 (AKER BIOMARINE ASA [NO]; TILSETH SNORRE [NO]) 2 September 2010 (2010-09-02) * page 1, lines 5-8; claims 1-17 *	1-30, 46-52, 54-59
X	----- US 2010/226977 A1 (TILSETH SNORRE [NO]) 9 September 2010 (2010-09-09) * claims 1-15 *	1-30, 46-52, 54-59
X	----- US 2014/274968 A1 (BERGE KJETIL [NO] ET AL) 18 September 2014 (2014-09-18) * claims 1-20 *	1-30, 46-52, 54-59

Further documents are listed in the continuation of box C.

Patent family members are listed in annex.

° Special categories of cited documents :

- *A* document defining the general state of the art which is not considered to be of particular relevance
- *E* earlier document but published on or after the international filing date
- *L* document which may throw doubts on priority claim(s) or which is cited to establish the publication date of another citation or other special reason (as specified)
- *O* document referring to an oral disclosure, use, exhibition or other means
- *P* document published prior to the international filing date but later than the priority date claimed

- *T* later document published after the international filing date or priority date and not in conflict with the application but cited to understand the principle or theory underlying the invention
- *X* document of particular relevance; the claimed invention cannot be considered novel or cannot be considered to involve an inventive step when the document is taken alone
- *Y* document of particular relevance; the claimed invention cannot be considered to involve an inventive step when the document is combined with one or more other such documents, such combination being obvious to a person skilled in the art.
- *Z* document member of the same patent family.

Patent Family Annex

Information on patent family members

International Application No

PCT/IB2016/000326

Patent document cited in search report	Publication date	Patent family member(s)	Publication date
WO 2010097701	A1	02-09-2010	NONE
US 2010226977	A1	09-09-2010	NONE
US 2014274968	A1	18-09-2014	AU 2014229540 A1 08-10-2015
			US 2014274968 A1 18-09-2014
			WO 2014140873 A2 18-09-2014

Information on Search Strategy - Pilot phase (see OJ 2015, A86)

The type of information contained in this sheet may change during the pilot for improving the usefulness of this new service.

Application Number

PCT/IB2016/000326

TITLE: LIPID COMPOSITIONS

APPLICANT: AKER BIOMARINE ANTARCTIC AS

IPC CLASSIFICATION: C11B1/10, A23K10/22, A23K20/158

EXAMINER: Georgopoulos, N

CONSULTED DATABASES: DOSYS, EPODOC, WPI, TXPJPEA, NPL, XPESP, FSTA, BIOSIS, MEDLINE

CLASSIFICATION SYMBOLS DEFINING EXTENT OF THE SEARCH:

IPC:

CPC: A23L1/3008, C11B1/10, A23K10/22, A23K20/158

FI/F-TERMS:

KEYWORDS OR OTHER ELEMENTS FEATURING THE INVENTION:

Krill compositions and products (food products, feed products, nutraceutical products, etc.) containing the same.

XP-002758417

© FSTA / IFIS

AB - Lipids were extracted from krill, *Euphausia superba*, immediately after catching. Lipid content increased (wet wt. basis) from 1.11% at the start of the fishing season (Dec.) to 3.95% at the end (Feb.). Lipid components (%) at the start and end of the season were: phospholipid 63.6, 44.5; triglyceride 5.5, 30.1; free fatty acid 4.2, 0.6. Total cholesterol remained approx. constant at 5.2-7.9%. Some differences in fatty acid composition were noted with season; with the exception of gravid krill, lipid content, lipid composition and fatty acid composition did not differ between krill of different sizes within the same catch. Cephalothorax contained approx. 2 times as much lipid as abdomen, with significantly different contents of phospholipid and triglyceride in the 2 parts. Astaxanthin content was 3-4 mg/100 g wet wt. throughout the fishing season. [From En summ.]

AN - FS-1985-04-R-0091

AU - Shibata N

AUW - Shibata N

DC - 1985-04-01

DT - Journal Article

IRN - ISSN 0021-5392

IW - CAROTENOIDS; CRUSTACEA; KRILL; LIPIDS; SEASON

LA - ja en

NR - 2

PG - 259-264

PUB - Bulletin of the Japanese Society of Scientific Fisheries [Nihon Suisan Gakkai-shi]

- 1983

- Tokai Regional Fisheries Res. Lab., Kachidoki-5, Chuo, Tokyo 104, Japan

TFT - Fish and marine products

TI - Effect of fishing season on lipid content and composition of Antarctic krill. (translated)

VOL - 49

XNPL - 0021-5392-49-2-259



Confidential Communication
Filed Online

The Commissioner of Patents
IP Australia
PO Box 200
Woden ACT 2606

10 June 2016

Our Ref: 91175AUQ00

Attention : Patent Oppositions, Hearings and Legislation

Contact:

Michael Zammit, PhD

Dear Commissioner

Australian Patent Application No. 2014203179
Aker BioMarine Antarctic AS
Title: LIPID EXTRACTION PROCESSES
- and -
Opposition by: Rimfrost AS

We file herewith the Opponent's Statement of Grounds and Particulars, as well as copies of the following documents:

1. Schedule of documents referred to in the Opponent's Statement of Grounds and Particulars; and
2. A copy of each document (D1-D10) mentioned in the Opponent's Statement of Grounds and Particulars.

Yours respectfully
Shelston IP

Katrina Crooks
Legal Practitioner

Email: KatrinaCrooks@Shelstonip.com

Sydney
Level 21
60 Margaret Street
Sydney, NSW 2000
Australia
T +61 2 9777 1111

Brisbane
7 Clunies Ross Court
Brisbane Technology Park
Eight Mile Plains, QLD 4113
Australia
T +61 7 3147 8020

Newcastle
Level 1, IDC House
University Drive
Callaghan, NSW 2308
Australia
T +61 2 4921 7366

Auckland
BDD Tower, Level 22
120 Albert Street
Auckland 1010
New Zealand
T +64 9 638 5300

SCHEDULE OF DOCUMENTS FROM STATEMENT OF GROUNDS AND PARTICULARS

D1	WO 2001/76385 entitled " <i>Method for the fractionation of oil and polar lipid-containing native raw materials using alcohol and centrifugation</i> ", published on 18 October 2001
D2	JP S63 23819 entitled " <i>Medicine for preventing platelet aggregation - comprises organic solvent extracts of euphausia, as active ingredient</i> ", WPI/THOMSON, 16 July 1986 (1986-07-16), XP002430959 published on 16 July 1986
D3	US 2011/256216 entitled " <i>Probiotic confection and lipid compositions</i> ", published on 20 October 2011
D4	WO 2012/139588 entitled " <i>A process for the isolation of a phospholipid</i> ", published on 18 October 2012
D5	WO 2013/102792 entitled " <i>Method for processing crustaceans to produce low fluoride/low trimethyl amine products thereof</i> ", published on 11 July 2013
D6	Winther, B., et al. entitled " <i>Elucidation of Phosphatidylcholine Composition in Krill Oil Extracted from Euphausia superba</i> ", Lipids (2011) 46:25–36
D7	WO 2008/117062 entitled " <i>Bioeffective krill oil compositions</i> ", published on 2 October 2008
D8	US 2004/0234587 entitled " <i>Natural marine source phospholipids comprising flavonoids, polyunsaturated fatty acids and their applications</i> ", published on 25 November 2004
D9	WO 2012/139588 entitled " <i>Extraction and characterisation of lipids from Antarctic krill (Euphausia superba)</i> ", published on 18 October 2012
D10	FOOD CHEMISTRY. ELSEVIER LTD. NL. vol. 125. no. 3. 1 April 2011 (2011-04-01) pages 1028-1036.

AUSTRALIA

PATENTS ACT 1990

IN THE MATTER OF Australian Patent
Acceptance No. 2014203179 in the
name of Aker BioMarine Antarctic AS

AND

Opposition thereto by **Rimfrost AS**

STATEMENT OF GROUNDS AND PARTICULARS

We Rimfrost AS, P.O. Box 234, 6099 Fosnavåg, Norway, provide the following information in support of the Notice of Opposition in relation to Australian Patent Application No. 2014203179 (the **Opposed Application**) in the name of Aker BioMarine Antarctic AS (the **Applicant**)

BACKGROUND

The Opposed Application was filed on 12 June 2014 and claims priority to US provisional application No. 61/925,931 dated 10 January 2014, and US provisional application No. 61/834,965 dated 14 June 2013. The purported earliest priority date of the claims is therefore 14 June 2013.

The Opposed Application was accepted with a total of 58 claims. Claim 1 is a process claim, claim 37 relates to a krill phospholipid composition. Claim 53 is a use-type claim depending on the composition claims. Claim 56 is a further process claim depending on the process/composition claims, and claim 57 is a product by process claim. Claim 58 is a further composition claim depending on the process/composition claims. Claim 1 relates to extraction of a polar lipid-rich extract from a biological material, whereas the composition defined by claim 37 is a krill phospholipid composition.

The inventors of the application are listed as: Nils HOEM and Asgeir SAEBO.

The request for examination of the patent application was filed on 12 June 2014. As a consequence, the substantive amendments of the *Patents Act* brought about by the *Intellectual Property Laws Amendment (Raising the Bar) Act 2012* that came into effect on 15 April 2013 apply to the Opposed Application.

GROUNDS OF OPPOSITION

The grounds and particulars of the opposition relied on by the Opponent are as follows:-

I - Section 59(b)

- Ground 1** The alleged invention, as defined in the claims of the Opposed Application, is not a patentable invention because it does not comply with subsection 18(1)(a) of the *Patents Act 1990* in that, so far as claimed in any claim, it is not a manner of manufacture within the meaning of section 6 of the *Statute of Monopolies*.
- Ground 2** The alleged invention, as defined in the claims of the Opposed Application, is not a patentable invention because it does not comply with subsection 18(1)(b)(i) of the *Patents Act 1990* in that, so far as claimed in any claim, when compared with the prior art base as it existed before the priority date of those claims, it is not novel.
- Ground 3** The alleged invention, as defined in the claims of the Opposed Application, is not a patentable invention because it does not comply with subsection 18(1)(b)(ii) of the *Patents Act 1990* in that, so far as claimed in any claim, when compared with the prior art base as it existed before the priority date of those claims, it does not involve an inventive step.
- Ground 4** The purported invention is not a patentable invention because it does not comply with subsection 18(1)(c) in that it is not useful.

II - Section 59(c)

- Ground 5** The complete specification of the Opposed Application does not comply with subsection 40(2) of the *Patents Act 1990*. Namely, the complete specification of the Opposed Application does not: (a) disclose the invention in a manner which is clear enough and complete enough for the invention to be performed by a person skilled in the relevant art; and/or (aa) disclose the best method known to the applicant of performing the invention.
- Ground 6** The complete specification of the Opposed Application does not comply with subsection 40(3) of the *Patents Act 1990*. Namely, the claims of the Opposed Application are not clear and succinct and supported by matter disclosed in the specification.

PARTICULARS OF OPPOSITION

Each of these particulars is provided in the alternative, and the inclusion of any particular is not to be taken to exclude the application of any other particular merely as a result of any apparent or potential inconsistency between the two. The Opponent reserves the right to rely on further particulars.

Ground 1 - The invention is not a manner of manufacture

1. The alleged invention is not a patentable invention because it does not comply with subsection 18(1)(a) of the *Patents Act 1990* in that, so far as claimed in any claim, it is not a manner of manufacture within the meaning of section 6 of the Statute of Monopolies.
 - 1.1. The alleged invention does not meet the threshold requirement of ingenuity in order to be considered an invention.
 - 1.2. The alleged invention is not a manner of new manufacture.
 - 1.3. The alleged invention was known before the earliest possible priority date of the Opposed Application (14 June 2013).
 - 1.4. The alleged invention defined by claims 1 to 36 (**process claims**) constitutes the use of basic known chemical processing steps and techniques to produce a known material from a known biological starting material. Each step is used for its known purpose and for its known outcome. As such, the alleged invention defined by claim 1 is not a manner of new manufacture.
 - 1.5. The process claims of the Opposed Application represent a mere collocation of known steps, each performing its known function/activity and which have no working interrelationship. Each of the process steps is well-understood, routine and conventional in the field.
 - 1.6. The process claims relate to the use of known method steps in respect of known starting materials to achieve an old result.
 - 1.7. The purported invention defined by the process claims does not relate to the use of any novel processor technique. The claims merely relate to the application of known technologies on known material to produce a known extract.
 - 1.8. The alleged invention defined by claims 37-52 constitutes a known phospholipid composition having certain inherent characteristics which is derived from a known starting/source material, krill. The defined phospholipid structure and characteristics of the composition were known and were not new. As such, the alleged invention defined by claims 37-52 is not a manner of new manufacture.
 - 1.9. The alleged invention defined by claims 53 to 55 constitutes known use of the known composition defined in claims 37 to 51.
 - 1.10. Formulation of lipids (of claims 1-36) or phospholipids (of claims 37-52) into a gummi candy product, or a solid gel matrix, and the products thereof, as claimed in claims 56-58, were well known in the art before the earliest priority date.
 - 1.11. For at least these reasons, the invention defined in claims 1 to 58 does not meet the threshold requirements for a manner of new manufacture.

Ground 2 - The invention is not novel

2. The alleged invention, as defined in the claims of the Opposed Application, is not a patentable invention because it does not comply with subsection 18(1)(b)(i) of the *Patents Act 1990* in that, so far as claimed in any claim, when compared with the prior art base as it existed before the priority date of those claims, it is not novel.

2.1. Prior public use

2.1.1. The alleged invention in so far as claimed in each of claims 1-36 in the Opposed Application is not novel when compared with the prior art base as it existed before the priority date of each claim in light of the information disclosed publicly by commercial sale of a polar lipid-rich extract obtained by the process of claims 1-36.

2.1.2. The alleged invention in so far as claimed in each of claims 37-52 in the Opposed Application is not novel when compared with the prior art base as it existed before the priority date of each claim in light of the information disclosed publicly by commercial sale of a krill phospholipid composition of claims 37-52.

2.1.3. The alleged invention in so far as claimed in each of claims 53-55 in the Opposed Application is not novel when compared with the prior art base as it existed before the priority date of each claim in light of the information disclosed publicly by the use of the composition described at paragraph 2.1.2 above for oral or intravenous administration to treat a subject for reducing serum triglycerides, or to reduce serum cholesterol, or to reduce plaque formation, or to reduce platelet aggregation, or to treat atherosclerosis, or to improve cardiovascular health, or to reduce inflammation, or to reduce coronary heart disease, or to treat depression, or to treat Alzheimer's disease, or to treat attention deficit disorder, or to treat metabolic syndrome.

2.1.4. The alleged invention in so far as claimed in claims 56-57 in the Opposed Application is not novel when compared with the prior art base as it existed before the priority date of each claim in light of the information disclosed publicly by the commercial sale of a gummi candy made using a phospholipid composition as described in the paragraph 2.1.2.

2.1.5. The alleged invention in so far as claimed in claim 58 in the Opposed Application is not novel when compared with the prior art base as it existed before the priority date of the claim in light of the information disclosed publicly by the commercial sale of a composition comprising a washed polar lipid-rich extract based on a phospholipid composition as described in paragraph 2.1.2.

2.2. Prior publication

The alleged invention in so far as claimed in each of claims 1-58 in the Opposed Application is not novel when compared with the information made publicly available in at least each of

the following documents, when read in light of the common general knowledge in the relevant field at the respective publication date of each document:

2.2.1. **Document D1: WO 2001/76385 entitled “*Method for the fractionation of oil and polar lipid-containing native raw materials using alcohol and centrifugation*”, published on 18 October 2001**

2.2.1.1. Document D1 relates to a process for the production of polar lipid-rich materials which are preferably phospholipids. Preferably the polar lipid-rich materials are separated and recovered from native raw materials by extraction with water-soluble organic solvent and by the use of density separation to separate the resulting mixture (Abstract).

2.2.2. **Document D2: JP S63 23819 entitled “*Medicine for preventing platelet aggregation - comprises organic solvent extracts of euphausia, as active ingredient*”, WPI/THOMSON, 16 July 1986 (1986-07-16), XP002430959 published on 16 July 1986**

2.2.2.1. Document D2 discloses a phospholipid composition obtained by extracting a krill product with a mixture of butanol and water and the use of this composition for oral administration to reduce platelet aggregation. The phospholipids of D2 are obtained by an extraction of krill using water and alcohol without additives which could hydrolyse phospholipids (such as acids, peroxides and enzymes).

2.2.3. **Document D3: US 2011/256216 entitled “*Probiotic confection and lipid compositions*”, published on 20 October 2011**

2.2.3.1. Document D3 discloses a gummi candy product and the process for obtaining it, comprising blending krill phospholipids into a gel matrix and forming the final gummi product.

2.2.4. **Document D4: WO 2012/139588 entitled “*A process for the isolation of a phospholipid*”, published on 18 October 2012**

2.2.4.1. Document D4 discloses processes for the isolation of a phospholipid from a fish oil comprising the steps of: providing a fish oil containing lipids and phospholipids; mixing the fish oil with a polar solvent; separating a polar fraction from a lipid fraction; and isolating a phospholipid from the polar fraction. The fish oil may be provided by: extracting a fish material with an extractant solvent; removing the extractant solvent to provide the fish oil, and optionally subjecting the fish oil to a solid-liquid separation. The isolated phospholipids may be used as additives for functional foods, as a dietary supplement and for pharmaceutical application.

2.2.5. **Document D5: WO 2013/102792 entitled “Method for processing crustaceans to produce low fluoride/low trimethyl amine products thereof”, published on 11 July 2013**

2.2.5.1. Document D5 discloses the creation of a low fluoride crustacean oil processed from a phospholipid-protein complex (PPC) formed immediately upon a crustacean (krill) catch. Further, the krill oil may also have reduced trimethyl amine and/or trimethyl amino oxide content. The process comprises disintegrating the krill into smaller particles, adding water, heating the result, adding enzyme(s) to hydrolyze the disintegrated material, deactivating the enzyme(s), removing solids from the enzymatically processed material to reduce fluoride content of the material, separating and drying the PPC material. Then, using extraction with supercritical CO₂ or supercritical dimethyl ether, and/or ethanol as solvents, krill oil is separated from the PPC. In the extraction the krill oil can be separated almost wholly from the feed material.

2.2.6. **Document D6: Winther, B., et al. entitled “Elucidation of Phosphatidylcholine Composition in Krill Oil Extracted from *Euphausia superba*”, *Lipids* (2011) 46:25–36**

2.2.6.1. Document D6 discloses the use of mass spectrometry to elucidate the structure of phospholipids in krill oil.

2.2.7. **Document D7: WO 2008/117062 entitled “Bioeffective krill oil compositions”, published on 2 October 2008**

2.2.7.1. Document D7 discloses krill oil compositions characterized by having high amounts of phospholipids, astaxanthin esters and/or omega-3 contents. The krill oils are obtained from krill meal using supercritical fluid extraction in a two stage process. Stage 1 removes the neutral lipid by extracting with neat supercritical CO₂ or CO₂ plus approximately 5% of a co-solvent. Stage 2 extracts the actual krill oils by using supercritical CO₂ in combination with approximately 20% ethanol. The krill oil materials are bioeffective in a number of areas such as anti-inflammation, anti-oxidant effects, improving insulin resistances and improving blood lipid profile.

2.3. The Opponent reserves the right to rely on further prior art information.

Ground 3 - The invention does not involve an inventive step

3. The alleged invention, as defined in any of the claims of the Opposed Application, is not a patentable invention because it does not comply with subsection 18(1)(b)(ii) of the *Patents Act 1990* in that, so far as claimed in any claim, when compared with the prior art base as it existed

before the priority date of those claims and in light of common general knowledge, it does not involve an inventive step.

- 3.1. The alleged invention would be obvious to a person skilled in the relevant art in light of the common general knowledge (whether in or outside of Australia) before the earliest priority date of the relevant claim.
- 3.2. The common general knowledge of the person skilled in the relevant art at the earliest priority date of the relevant claim included knowledge of at least the following:
 - 3.2.1. A variety of sources of biological material sources suitable to make commercially valuable products for use in pharmaceuticals, nutraceuticals, functional foods, dietary supplements and animal feeds, including algal material, marine animal material, and plant materials. Known sources of marine animal material were fish material, krill material, and marine plankton material. Known krill materials were fresh krill, frozen krill, krill meal, wet krill paste, dried krill paste, and krill oil.
 - 3.2.2. Processes for extracting lipids from a biological material.
 - 3.2.3. Processes for extracting polar lipids from a biological material to produce a polar lipid-rich extract.
 - 3.2.4. Processes for extracting neutral lipids from a biological material to produce a neutral lipid-rich extract.
 - 3.2.5. Polar lipid-rich extracts comprising at least 50% phospholipid w/w.
 - 3.2.6. Use of one or more solvents to extract lipids from a biological material.
 - 3.2.7. Use of one or more solvents to extract polar lipids from a biological material.
 - 3.2.8. Use of one or more solvents to extract neutral lipids from a biological material.
 - 3.2.9. Use of one or more solvents to extract polar and neutral lipids from a biological material.
 - 3.2.10. Balancing or optimizing the ratio between extracted polar lipids and extracted neutral lipids by choice of the solvent(s) (i.e., selection of overall solvent polarity).
 - 3.2.11. Use of protic solvents to extract a polar lipid-rich fraction from a biological material. Known protic solvents used for such purposes are: n-butanol, n-propanol, isopropanol, ethanol, and methanol.
 - 3.2.12. Use of a relatively strong protic solvent to obtain a lipid extract highly enriched for phospholipids from a biological starting material.
 - 3.2.13. Use of concentrated protic solvents in an extraction, for example with concentrations of 70% to about 95% w/w (i.e., weight of protic solvent/total weight of diluted solvent solution).

- 3.2.14. Processes for extracting lipids from a biological material wherein the temperature during the extraction is about -10°C to about 50°C.
- 3.2.15. Processes for preferentially extracting a polar lipid-rich extract from a biological material, resulting in a polar lipid solution and biological residue material. For example, use of a certain solvent in which a target lipid such as a polar lipid is preferentially extracted from the biological material.
- 3.2.16. Processes for separating a solution from an extracted residue material, e.g. filtration. In particular, use of processes for separating a polar lipid-rich solution from an extracted biological residue material.
- 3.2.17. Separating a solution containing polar lipids into 2 phases, one of which is a polar lipid-rich phase and the other a diluted protic solvent phase.
- 3.2.18. Polar lipids have known solubilities in known protic solvents (different solvents have known 'solvating power'). It is known that dilution of a polar lipid-containing solution from a region where the polar lipids have good solubility, to one where there is poor solubility, will inevitably cause the polar lipids to separate from the protic solvent in which they are dissolved. In the case of certain protic solvents, for example, dilution of a polar lipid solution to about 50% to 70% w/w will inevitably cause dissolved polar lipids to 'drop out' of solution as the solvating power of the protic solvent is reduced. Such known processes include dilution of the protic solvent with an aqueous solution (either water or a dilute solution of the protic solvent) in order to separate the solution containing polar lipids into 2 phases. It is also known to take into account the total moisture in the system, for example the moisture in the biological sample/material.
- 3.2.19. Known phase separations which cause a polar lipid-rich phase to migrate/concentrate to a bottom layer, and the diluted solvent phase to migrate/concentrate to an upper layer. Separation into an upper and a lower layer is a function of the differing densities of the solvent and the polar lipids and, depending on relative densities, could be reversed.
- 3.2.20. Known processes to isolate a bottom phase from an upper phase. In particular, if a bottom phase in a phase separation comprises a polar lipid-rich fraction, isolating the bottom phase to provide a polar lipid-rich extract. For example, by decanting the upper layer away, or 'tapping off' the lower layer.
- 3.2.21. Use of a specific protic solvent to preferentially extract polar lipids into that protic solvent.
- 3.2.22. Use of a specific protic solvent to control the preferential extraction of one or more predetermined polar lipids from a polar lipid mixture into that protic solvent.

- 3.2.23. Use of a specific protic solvent to control the preferential extraction of phospholipids into that protic solvent to result in less than about 3% lysophospholipids, or less than about 1%, 0.5%, or 0.1% lysophospholipids.
- 3.2.24. Washing lipid with a solvent in which the lipid has poor solubility (or under conditions in which the lipid has poor solubility), thereby removing impurities from the lipid, wherein the solvent is chosen such that the impurities have relatively good solubility that solvent. In particular, washing a polar lipid-rich extract with a diluted protic solvent in which polar lipids are poorly soluble.
- 3.2.25. Use of a ratio of about 0.5:1 to 5:1 of a polar lipid-rich extract to the diluted protic solvent to undertake a washing step.
- 3.2.26. Use of a diluted protic solvent to undertake a washing step of a polar lipid-rich extract, wherein the diluted protic solvent is an aqueous solution of about 30% to 70% of the protic solvent.
- 3.2.27. Undertaking multiple washing steps, such as 2 to 5 times.
- 3.2.28. Precipitation of polar lipids from an extracted polar lipid solution or a washed and extracted polar lipid solution. Known processes include incorporating a further solvent under such conditions that the polar lipids precipitate from the mixture. For example, wherein the further solvent is a poor solvent for the polar lipids, optionally wherein the further solvent is at a relatively reduced temperature. For example, use of cold acetone to precipitate polar lipids from an aqueous ethanol polar lipid solution.
- 3.2.29. Evaporation (freeze drying) of a solvent or a residual solvent from a lipid solution to result in concentrated lipid. For example, evaporation of a solvent from a phospholipid solution to produce a polar lipid-rich composition comprising at least 90% phospholipids w/w.
- 3.2.30. That if a biological material being extracted includes astaxanthin, at least some of the astaxanthin will be extracted along with the lipid being extracted - chemical compounds such as astaxanthin and its esters have relatively high lipid solubility.
- 3.2.31. For biological materials comprising astaxanthin, the astaxanthin monoester:astaxanthin diester ratio being greater than about 4:1.
- 3.2.32. The majority of the astaxanthin in krill is in the esterified form.
- 3.2.33. Astaxanthin and its esters are coloured pigments.
- 3.2.34. Use of specific protic solvents to undertake a second extraction to extract neutral lipids from a biological residue material (having already been extracted with a protic solvent to extract polar lipids therefrom). Use of ratios of biological residue

material to protic solvent of about 2:1 to 8:1 and at temperatures of from about 15°C to about 40°C in the second extraction step.

- 3.2.35. Separation of a neutral lipid solution from an extracted biological residue material by processes such as decanting.
- 3.2.36. Concentration of a neutral lipid solution to provide a neutral lipid extract by an evaporation step (freeze-drying).
- 3.2.37. Combination of a polar lipid-rich material with a neutral lipid material to provide a blended lipid composition.
- 3.2.38. Providing blended lipid compositions having a predetermined concentration of specific lipids. For example, blending a polar lipid-rich material with a neutral lipid material such that the lysophospholipids are below 1%, 0.5% or 0.1%.
- 3.2.39. Incorporating one or more lipids into an oral delivery vehicle selected from a tablet, a capsule, and gel capsule, a solution, a suspension, an emulsion and a chewable matrix.
- 3.2.40. Compositions comprising phospholipids; compositions derived from the sources mentioned at paragraph 5.2.42 below; phospholipid compositions which are partially or totally derived from krill.
- 3.2.41. Phospholipids have a generalised structure:

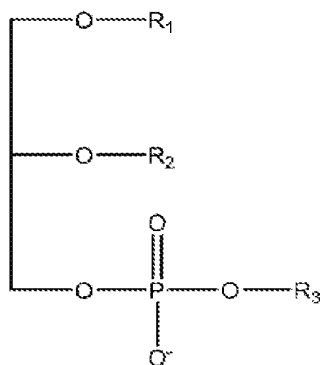

wherein R1 is a fatty acid residue, R2 is a fatty acid residue or -OH, and R3 is a -H or nitrogen containing compound selected from: choline (HOCH₂CH₂N⁺(CH₃)₃OH), ethanolamine (HOCH₂CH₂NH₂), inositol or serine. R1 and R2 cannot simultaneously be OH. When R3 is an -OH, the compound is a diacylglycerophosphate, while when R3 is a nitrogen-containing compound, the compound is a phosphatide such as lecithin, cephalin, phosphatidyl serine or plasmalogen. An "ether phospholipid" refers to a phospholipid having an ether bond at position 1 of the glycerol backbone. Examples of ether phospholipids include, but are not limited to, alkylacylphosphatidylcholine (AAPC), lyso-

alkylacylphosphatidylcholine (LAAPC), and alkylacylphosphatidylethanolamine (AAPE). A "non-ether phospholipid" is a phospholipid that does not have an ether bond at position 1 of the glycerol backbone. Non-ether phospholipids are selected from the group consisting of phosphatidylcholine (PC), phosphatidylserine (PS), phosphatidylethanolamine (PE).

- 3.2.42. Phospholipids produced in nature, such as from algal, marine, animal, and plant material, are a mixture of phospholipids, such as a mixture of PC, PE, and AAPE in different ratios. Each phospholipid has a different solubility in a specific solvent, depending on its chemical structure.
- 3.2.43. Each source of phospholipids has a somewhat characteristic ratio of phospholipids, or a phospholipid profile. By way of example, phospholipids derived from krill are mainly PC, AAPC, with smaller amount of PE and AAPE. Phospholipids derived from krill comprise more than about 85% (mol%) choline moieties at position R3, more than about 30% w/w omega-3 fatty acid moieties, and more than about 90% w/w of the omega-3 fatty acid moieties at position R2.
- 3.2.44. Some phospholipid extracts derived from krill comprise less than about 3% or less than 1% w/w lysophospholipids.
- 3.2.45. The term omega-3 fatty acid refers to polyunsaturated fatty acids that have the final double bond in the hydrocarbon chain between the third and fourth carbon atoms from the methyl end of the molecule. Examples of omega-3 fatty acids include, 5,8,11,14,17-eicosapentaenoic acid (EPA), 4,7,10,13,16,19-docosahexanoic acid (DHA) and 7,10,13,16,19-docosapentanoic acid (DPA).
- 3.2.46. Phospholipid compositions comprising at least 50%, at least 75%, or at least 90% w/w phospholipid compounds.
- 3.2.47. Phospholipid compositions which comprise EPA:DHA ratios of from about 1:1 to about 3:1.
- 3.2.48. Phospholipid compositions which comprise at least 5% ethyl esters comprising omega-3 fatty acid moieties.
- 3.2.49. Phospholipid compositions which comprise at least 10% glyceride compounds comprising said omega-3 fatty acid moieties.
- 3.2.50. Phospholipid compositions which comprise less than about 0.05% w/w fatty acid esters.
- 3.2.51. Phospholipid compositions which comprise at least a second antioxidant (in addition to astaxanthin).
- 3.2.52. Phospholipid compositions which comprise a conductivity of less than about 500, or less than 300, or less than 200 uS/cm measured in a saturated 60% ethanol

solution. Conductivity testing is a standard activity undertaken in the art as a measure of purity and for quality control purposes.

- 3.2.53. Krill phospholipid compositions provided in a form selected from: a capsule, a tablet, a liquid, a powder, an emulsion, a dietary supplement, a nutritional supplement, a beverage and a functional food.
 - 3.2.54. Polar lipid-rich extracts from a biological material, or krill phospholipid compositions are known to be used via oral or intravenous administration to a subject to treat any one or more of the following: to reduce serum triglycerides, reduce serum cholesterol, reduce plaque formation, reduce platelet aggregation, treat atherosclerosis, improve cardiovascular health, reduce inflammation, reduce coronary heart disease, treat depression, treat Alzheimer's disease, treat attention deficit disorder, and treat metabolic syndrome. (see background of the Opposed Application on pages 1-2)
 - 3.2.55. Polar lipid-rich extracts from a biological material, or krill phospholipid compositions administered in a daily dose of from about 0.1 to about 3 grams to a subject selected from the group consisting of humans, non-human primates, domestic raised or farmed animals, and companion animals.
 - 3.2.56. Polar lipid-rich extracts from a biological material, or krill phospholipid compositions formulated into a gummi candy product using a gel matrix.
 - 3.2.57. Krill has a crude protein content of 55 to 75% (depending on species and time of year of harvesting), crude lipid content of around 10 to 25% (approx. 40% phospholipids and 60% neutral lipids), and around 100-400 ppm of astaxanthin and its esters.
 - 3.2.58. Analogous marine biomass extraction methods, such as extraction of phospholipids from salmon roe.
 - 3.2.59. Separation of an oil phase from an aqueous phase and/or a solid phase via methods such as filtration, centrifugation and sedimentation.
 - 3.2.60. It is an inevitable outcome that a biological residue material will contain a relatively high concentration of molecules which have poor solubility in a protic solvent. Protein has a relatively low solubility in typical protic solvents mentioned above. It is an inevitable outcome that a biological residue material will contain a relatively low concentration of molecules which have a high solubility in the protic solvent.
- 3.3. The common general knowledge of the person skilled in the relevant art before the earliest priority date of the relevant claim will be established by the evidence of expert witnesses and includes prior art cited in the Opposed Application.

3.4. In the alternative, the alleged invention, so far as claimed in any claim, would be obvious to a person skilled in the relevant art in light of the common general knowledge (whether in or outside of Australia) considered together with any one of, or combinations of, Documents D1 to D7 listed above or D8 to D10 listed below.

3.5. Relevant details of documents D8 to D10 are provided below:

3.5.1. **Document D8: US 2004/0234587 entitled “Natural marine source phospholipids comprising flavonoids, polyunsaturated fatty acids and their applications”, published on 25 November 2004**

3.5.1.1. Document D8 discloses that phospholipid extracts from a marine or aquatic biomass (krill) possesses therapeutic properties. The phospholipid extract comprises a variety of phospholipids, fatty acids, and a novel flavonoid.

3.5.2. **Document D9: WO 2012/139588 entitled “Extraction and characterisation of lipids from Antarctic krill (*Euphausia superba*)”, published on 18 October 2012**

3.5.2.1. Document D9 discloses processes for the isolation of a phospholipid and for producing a polyunsaturated, long-chain fatty acids (PUFA)-enriched fraction from a fish oil comprising the steps of: -providing a fish oil containing lipids and phospholipids; -mixing the fish oil with a polar solvent; -centrifuging the mixture of the fish oil and the polar solvent to separate a polar fraction from a lipid fraction; -isolating a phospholipid from the polar fraction or isolating a PUFA-enriched fraction from the polar fraction. The fish oil may be provided by -extracting a fish material with an extractant solvent; -removing the extractant solvent to provide the fish oil; - optionally subjecting the fish oil to a solid-liquid separation. The isolated phospholipids and PUFA's may be used as additives for functional foods, as a dietary supplement and for pharmaceutical application.

3.5.3. **Document D10: FOOD CHEMISTRY. ELSEVIER LTD. NL. vol. 125. no. 3. 1 April 2011 (2011-04-01) pages 1028-1036.**

3.6. The Opponent reserves the right to rely on further prior art information.

Ground 4 – Lack of utility

4. The alleged invention in so far as claimed in each of claims 1-58 in the Opposed Application is not a patentable invention because it does not comply with subsection 18(1)(c) in that it is not useful. The Opponent will rely on evidence to demonstrate that the promises for the invention set out in

one or more of the claims have not been met, and/or not everything that falls within the scope of the claims is useful, and/or the claims do not deliver on the multiple promises for the invention set out in the specification.

Ground 5 - Section 40(2)

5. The complete specification of the Opposed Application does not comply with subsection 40(2) of the *Patents Act 1990*.

5.1. Failure to disclose the invention in the specification in a manner which is clear enough and complete enough for the invention to be performed by a person skilled in the relevant art

5.1.1. The specification does not enable the skilled person to readily perform the invention, as claimed in any claim, over the whole area claimed without undue burden and without needing inventive skill.

5.1.2. None of the examples:

- (a) disclose each of the steps in the processes defined in claims 1-36 or 56;
- (b) teach all the features of the composition claims 37-52, 57 or 58;
- (c) teach all the features of the use claims 53 to 55.

Therefore there is no enabling disclosure over the whole area claimed.

5.1.3. The skilled person would need to undertake significant testing and research to work the process of any of claims 1-36 or 56 or produce a composition within claims 37-52.

5.1.4. The specification does not provide any specific guidance to show that any and all oil extracts of krill have the phospholipid constituents of claims 37-52. The person skilled in the art would have to test every potential extraction technique with the virtually limitless number of solvents as well as every species of krill from every specific locale in order to determine if it has the phospholipid compounds claimed. This degree of experimentation clearly places an undue burden on the person skilled in the art.

5.2. Failure to disclose the best method known to the applicant of performing the invention

5.2.1. Information will be adduced during evidence that the best method known to the applicant of performing the invention has not been disclosed in the specification of the Opposed Application.

Ground 6 - Section 40(3)

6. The claims of the Opposed Application do not comply with subsection 40(3) of the *Patents Act 1990*.

6.1. The claims are not clear/succinct

- 6.1.1. Claim 1 defines a process for extracting a polar lipid-rich extract from a biological material. The term 'biological material' is unclear as it covers an extremely large number of compounds and substances. It is also unclear whether the material itself is biological in nature or produced from a 'biological' organism.
- 6.1.2. The term 'concentrated protic solvent' in claim 1 is unclear, in that the term does not define how concentrated the solvent must be, and with what it is diluted. The claim also does not define how or why it has been concentrated.
- 6.1.3. The term 'preferentially extracted' in claim 1 is unclear in that there is no definition of what polar lipids are extracted in preference to.
- 6.1.4. Dilution of the polar lipid solution to dilute the concentration of the protic solvent to about 50% to 70% w/w in claim 1 is unclear, in that it is unclear whether the total weight of the mixture includes the polar lipid-rich extract.
- 6.1.5. The term 'lipid-rich' is unclear in that claim 1 does not define the concentration of lipids with precision.
- 6.1.6. Claim 2 does not add any features to the 'adding' step in claim 1. Claim 2 is redundant on claim 1 and is therefore unclear.
- 6.1.7. Claim 4 is unclear in relation to the 'conditions'. In particular, it is unclear how mixing a biological material with a concentrated protic solvent at a temperature of from about -10°C to about 50°C can cause the solvent concentration (when combined with moisture in the biological material) to be from about 70% to about 95% w/w.
- 6.1.8. Claim 7 defines that the 'diluted protic solvent comprises an aqueous solution of about 30% to 70% of said protic solvent.' It is unclear whether the aqueous component is between 30% to 70%, or whether it is the protic solvent which is 30% to 70%. Further, whether it is a %w/w measure, or some other measure.
- 6.1.9. Claim 10 depends on any one of claims 5 to 9, however claims 8 and 9, in turn, depend on any one of claims 1 to 7. Accordingly, there are antecedent issues when claim 10 depends on claim 8 or 9, and when they in turn depend on any one of claims 1 to 4.
- 6.1.10. Claims 11 to 14 define progressively narrower concentrations of lysophospholipids in the 'washed polar lipid-rich extract', and depend on any of claims 1 to 10. However, the 'washed polar lipid-rich extract' feature only appears in claim 5. Accordingly, there are antecedent issues. It is further unclear how the process of claim 1 could produce an extract characterized in comprising less than, for example, about 3% lysophospholipids. It would appear that the final lysophospholipid concentration is either a function of the starting

material, and/or the extraction/separation/isolation steps in claim 1, and/or the type of protic solvent used, and/or possibly the washing process in claim 5. None of this is defined in the claims, which are unclear on at least this basis. The specification is also silent on how the process claims achieve or control the final lysophospholipid concentration. The specification is also silent on why low lysophospholipid concentrations are beneficial, or why high lysophospholipid concentrations are undesirable. It merely seems that some of the examples may have a lysophospholipid concentration that happen to fall within the claimed range, and this 'characterising' feature was possibly chosen to avoid prior art.

- 6.1.11. Claim 15 depends on 'any of claims 1 to 14' and defines that the 'washed polar lipid-rich extract is characterized in having a conductivity of less than 300 uS/cm measured in a saturated 60% ethanol solution.' However, the 'washed polar lipid-rich extract' feature only appears in claim 5. Accordingly, there are antecedent issues. It is also unclear how the conductivity relates to the purity of the lipid rich extract, what the conductivity of the 'un-washed' extract may be, and how the conductivity changes by the process. The specification is silent on these matters. There is also no information relating conductivity (uS/cm) and the purported "highly improved ... smell and taste" of the extract.
- 6.1.12. Claim 16 depends on 'any of claims 1 to 14' and refers to the 'washed polar lipid-rich extract', which feature only appears in claim 5. Accordingly, there are antecedent issues.
- 6.1.13. Claim 17 defines that the phospholipids are precipitated from the 'washed polar-lipid rich extract' with cold acetone 'under conditions such that phospholipids precipitate to provide a polar lipid-rich precipitate.' Firstly, there are antecedent issues. Secondly, the claim does not define how cold the acetone should be, or whether it is cold compared to another substance. Thirdly, if causing the precipitation is via the 'cold' acetone, it is unclear what the other 'conditions' may be. The specification describes that the acetone may be between -20°C to +20°C (page 13). At least some of this range is at room temperature and is therefore not 'cold'.
- 6.1.14. Claim 18 defines a 'solid polar lipid-rich composition', and depends on any one of claims 1 to 17. However, this is at odds with claims 16 and 17, which define precipitated phospholipids. It is not clear how a precipitated phospholipid is not also a solid.
- 6.1.15. Claims 20 to 21 define progressively narrower concentrations of lysophospholipids in the solid polar lipid-rich composition. It is unclear how precipitation of the polar lipids results in less than about 3% (or 1%) lysophospholipids w/w. It is also unclear how these claims relate to claims 11 to 14.

- 6.1.16. Claim 22 depends on any of claims 1 to 21, and refers to the 'polar lipid-rich composition'. However, the 'composition' only appears in claim 18, and therefore there are antecedent issues. It is also unclear whether the 'less than about 0.05% w/w fatty acid esters' feature applies to a.) the polar lipid-rich extract, and/or b.) the washed polar lipid-rich extract, and/or c.) the polar lipid-rich composition.
- 6.1.17. Claim 23 depends on any of claims 1 to 22, and refers to the 'polar lipid-rich composition'. However, the 'composition' only appears in claim 18, and therefore there are antecedent issues. It is also unclear whether the 'astaxanthin monoester:astaxanthin diester ration [sic] of greater than about 4:1' feature applies to a.) the polar lipid-rich extract, and/or b.) the washed polar lipid-rich extract, and/or c.) the polar lipid-rich composition.
- 6.1.18. Claim 24 depends on any of claims 1 to 24, and defines 'contacting said biological residue material with a protic solvent under conditions such that neutral lipids are extracted'. It is unclear whether it is the same or different protic solvent as per claim 1. If it is the same solvent, it is unclear how the same protic solvent can be used to preferentially extract polar lipids and separately also extract neutral lipids. The term 'neutral lipids' is unclear, in that there is no scale to gauge their 'neutrality'. Presumably the term neutral is meant to convey 'non-polar' lipid. However, if this is the case there is no definition of how the same protic solvent will only extract polar lipids firstly, and then secondly extract a non-polar lipid. Claim 24 is also unclear in that there is no antecedent for a 'concentrated protic solvent'.
- 6.1.19. Claim 26 depends on either of claims 24 or 25, and further comprises combining the 'washed polar lipid-rich extract' with the neutral lipid extract to provide a blended lipid composition. Claim 24 depends on any of claims 1 to 23, however the washed polar lipid-rich extract feature only appears in claim 5, and as such there are antecedent issues. Repeated reference in the claims to the washed polar lipid-rich extract in relation to claim 1 infers that washing the polar lipid-rich extract is an essential feature of the invention.
- 6.1.20. Claims 27 to 30 define progressively narrower concentrations of lysophospholipids in the blended lipid composition. It is unclear how the blending results in less than about 3% (or 1%, or 0.5%, or 0.1%) lysophospholipids. It is also unclear how these claims relate to claims 11 to 14, or claims 20 to 21.
- 6.1.21. Claim 37 defines a krill phospholipid composition. It is unclear whether the entire composition is derived from krill, or just a portion of it. For example, if 1 molecule of a composition has been derived from a krill feedstock, will it be a 'krill phospholipid composition'?

- 6.1.22. Claim 37 defines that the 'mixture of phospholipid compounds comprising more than about 85% (mol%) choline moieties at position R3'. The total basis is not defined in the claim, and therefore the claim is unclear how to measure 'mol%'.
- 6.1.23. Claim 37 also defines that the mixture of phospholipid compounds comprise 'more than about 30% w/w omega-3 fatty acid moieties'. The total basis is not defined in the claim, and therefore the claim is unclear on what basis the percentage of omega-3 fatty acid moieties is being compared to.
- 6.1.24. Claim 37 also defines that the mixture of phospholipid compounds comprise more than about 90% w/w of the omega-3 fatty acid moieties are at position R2. The total basis is not defined in the claim, and therefore it is unclear on what basis the percentage of omega-3 fatty acid moieties is being compared to.
- 6.1.25. Claim 43 defines that the composition further comprises at least 5% ethyl esters comprising omega-3 fatty acid moieties. It is unclear whether this is on a mol or weight basis, and whether the ethyl esters are attached to the structure at the R1, R2 or R3 positions.
- 6.1.26. Claim 44 defines that the composition comprises at least 10% glyceride compounds comprising the omega-3 fatty acid moieties. It is unclear on what basis the 10% is stated.
- 6.1.27. Claim 47 defines that the composition comprises less than about 0.05% w/w fatty acid esters. This seems to contradict claim 43, which defines at least 5% fatty acid ethyl esters.
- 6.1.28. Claim 48 defines "at least a second antioxidant". However, there is no antecedent basis in the claims, because there is no mention of a first antioxidant in claim 37.
- 6.1.29. Claim 49 defines that the composition is partially or totally derived from krill. However, claim 37 defines a krill phospholipid composition, meaning that it must be derived/produced/sourced from krill. Accordingly, the term 'partially' is redundant on claim 37, and claim 49 is therefore unclear.
- 6.2. The claims not supported by matter disclosed in the specification
- 6.2.1. The scope of the claims of the Opposed Application is not justified by the extent of the disclosure and the technical contribution to the art of the description of the Opposed Application.
- 6.2.2. Claim 1 is directed to a principle of general application (solvent extraction of any 'biological material', solvent separation, and isolation techniques) to produce a polar lipid-rich extract. However, the examples only relate to krill (only one of a vast range of biological materials), only a single concentration of solvent is exemplified (60 %w/w in Example 4), only a single extraction solvent is

exemplified (ethanol), and only krill phospholipids are exemplified (the polar lipid-rich extract). Therefore, the breadth of claims 1, 2, 4 to 8, 10 to 14, 17 to 18, 20 to 21, 23 to 25, 27 to 30, and 31 to 36 is not supported by the description.

6.2.3. Claim 37 relates to a krill phospholipid and comprises the generalised form of the phospholipid structure and specific concentrations of choline moieties and omega-3 fatty acids. The composition is characterised in having less than 3% w/w lysophospholipids. However, the only example which may be relevant to claim 37 is Example 4, and in that example the krill phospholipid was produced by a very specific technique. The breadth of claim 37, 42 to 44, and 46 to 52 is not supported by the description.

RELIEF SOUGHT

The Opponent seeks the following relief:

- (i) The refusal to grant a patent on the Opposed Application
- (ii) The cost of these proceedings.

A copy of this statement was filed in Objective Connect on 10 June 2016.

Our address for service is:

SHELSTON IP
60 Margaret Street
SYDNEY NSW 2000
CCN: 3710000352
Attorney Code: KAC

Telephone No.: (02) 9777 1111
Facsimile No.: (02) 9241 4666

DATED this 10th day of June 2016
Rimfrost AS



Michael Zammit, PhD
Fellow Institute of Patent and Trade Mark
Attorneys of Australia of Shelston IP

To: The Commissioner of Patents
WODEN ACT 2606

Our reference: 91175AUQ00

Electronic Acknowledgement Receipt

EFS ID:	26338360
Application Number:	15180439
International Application Number:	
Confirmation Number:	4687
Title of Invention:	BIOEFFECTIVE KRILL OIL COMPOSITIONS
First Named Inventor/Applicant Name:	Inge Bruheim
Customer Number:	72960
Filer:	John Mitchell Jones/Mallory Checkett
Filer Authorized By:	John Mitchell Jones
Attorney Docket Number:	AKBM-14409/US-13/CON
Receipt Date:	13-JUL-2016
Filing Date:	13-JUN-2016
Time Stamp:	17:05:15
Application Type:	Utility under 35 USC 111(a)

Payment information:

Submitted with Payment	no
------------------------	----

File Listing:

Document Number	Document Description	File Name	File Size(Bytes)/ Message Digest	Multi Part /.zip	Pages (if appl.)
1	Transmittal Letter	14409US13CON_IDS_Letter_7-13-2016.pdf	81375 <small>91e20dee8e564309a9ac83c452a3fb9726a51ffb</small>	no	1

Warnings:

Information:					
2	Information Disclosure Statement (IDS) Form (SB08)	14409US13CON_IDS_7-13-2016.pdf	1036092	no	5
			86e708c020e1144634a2d2e8a80ab6209dd66cd7		
Warnings:					
Information:					
3	Foreign Reference	WO2014013335A2.pdf	853239	no	26
			3e490302d63906df9fc52606012318173c35c450		
Warnings:					
Information:					
4	Foreign Reference	CN102746941B.pdf	326292	no	6
			6dc7f0e11f95489f6ce0f024dcde7e92e97ef11c		
Warnings:					
Information:					
5	Foreign Reference	JP2909508.pdf	345403	no	7
			46b28b22bd7163560ec1610f83d98a24369c890f		
Warnings:					
Information:					
6	Foreign Reference	WO2010097701.pdf	2949290	no	71
			78c8095a597e883a8a6045da7cfd3f4cacb7b23d		
Warnings:					
Information:					
7	Foreign Reference	WO2013102792.pdf	3225439	no	60
			0591d9ba8291dcb2418e73f5917754e860706089		
Warnings:					
Information:					
8	Other Reference-Patent/App/Search documents	ISR_34345_PCTIB2016000208.pdf	150964	no	5
			5ef07fa22609ea10dfee4c72980008b61e0cfd52		
Warnings:					
Information:					

9	Other Reference-Patent/App/Search documents	Partial_ISR_34344_PCTIB2016000326.pdf	194408	no	6
			3593f5f7fe5ef309b27fbc9a9fb81acd7c40e07c6		

Warnings:

Information:

10	Non Patent Literature	FSTA_Shibata_abstract.pdf	32615	no	1
			e29068a81bef6233f4d9abe88f6c9299b7764a91		

Warnings:

Information:

11	Other Reference-Patent/App/Search documents	StatemenofGrounds_33382AU_Rimfrost_6-10-2016_USPTO.pdf	477111	no	21
			a4061e996de9c51044fea80ccb522adb0f337134		

Warnings:

Information:

Total Files Size (in bytes):			9672228		
-------------------------------------	--	--	---------	--	--

This Acknowledgement Receipt evidences receipt on the noted date by the USPTO of the indicated documents, characterized by the applicant, and including page counts, where applicable. It serves as evidence of receipt similar to a Post Card, as described in MPEP 503.

New Applications Under 35 U.S.C. 111

If a new application is being filed and the application includes the necessary components for a filing date (see 37 CFR 1.53(b)-(d) and MPEP 506), a Filing Receipt (37 CFR 1.54) will be issued in due course and the date shown on this Acknowledgement Receipt will establish the filing date of the application.

National Stage of an International Application under 35 U.S.C. 371

If a timely submission to enter the national stage of an international application is compliant with the conditions of 35 U.S.C. 371 and other applicable requirements a Form PCT/DO/EO/903 indicating acceptance of the application as a national stage submission under 35 U.S.C. 371 will be issued in addition to the Filing Receipt, in due course.

New International Application Filed with the USPTO as a Receiving Office

If a new international application is being filed and the international application includes the necessary components for an international filing date (see PCT Article 11 and MPEP 1810), a Notification of the International Application Number and of the International Filing Date (Form PCT/RO/105) will be issued in due course, subject to prescriptions concerning national security, and the date shown on this Acknowledgement Receipt will establish the international filing date of the application.

IN THE UNITED STATES PATENT AND TRADEMARK OFFICE

In re Application of:	Inge Bruheim	Confirmation:	4687
Serial No.:	15/180,439	Group No.:	1651
Filing Date:	13-Jun-2016	Examiner:	WARE
Entitled:	BIOEFFECTIVE KRILL OIL COMPOSITIONS		

INFORMATION DISCLOSURE STATEMENT LETTER

EFS Web Filed
Commissioner for Patents
P.O. Box 1450
Alexandria, VA 22313-1450

Examiner Ware:

The citations listed in the attached **IDS Form SB08A** may be material to the examination of the above-identified application, and are therefore submitted in compliance with the duty of disclosure defined in 37 C.F.R. §§ 1.56 and 1.97.

Applicants wish to bring to the Examiner's attention that we are not providing copies of US Patents as instructed under 37 CFR 1.98(a)(2). The Examiner is requested to make these citations of official record in this application.

This Information Disclosure Statement under 37 C.F.R. §§ 1.56 and 1.97 is not to be construed as a representation that a search has been made, that additional information material to the examination of this application does not exist, or that any one or more of these citations constitutes prior art.

This Information Disclosure Statement is being filed under 37 C.F.R. §1.97 (b)(3) before the mailing of a first Office Action on the merits. Therefore, applicant holds that no fee is due.

The Commissioner is hereby authorized to charge any required fees or credit any overpayments to Attorney Deposit Account No.: **50-4302**, referencing Attorney Docket No.: AKBM-14409/US-13/CON.

Dated: July 13, 2016

/J. Mitchell Jones/
J. Mitchell Jones
Registration No. 44174
CASIMIR JONES, S.C.
2275 Deming Way, Suite 310
Middleton, WI 53562
608.662.1277



UNITED STATES PATENT AND TRADEMARK OFFICE

UNITED STATES DEPARTMENT OF COMMERCE
United States Patent and Trademark Office
Address: COMMISSIONER FOR PATENTS
P.O. Box 1450
Alexandria, Virginia 22313-1450
www.uspto.gov

Table with 5 columns: APPLICATION NO., FILING DATE, FIRST NAMED INVENTOR, ATTORNEY DOCKET NO., CONFIRMATION NO. Includes sub-tables for EXAMINER, ART UNIT, PAPER NUMBER, NOTIFICATION DATE, and DELIVERY MODE.

Please find below and/or attached an Office communication concerning this application or proceeding.

The time period for reply, if any, is set in the attached communication.

Notice of the Office communication was sent electronically on above-indicated "Notification Date" to the following e-mail address(es):

docketing@casimirjones.com
pto.correspondence@casimirjones.com

The present application is being examined under the pre-AIA first to invent provisions.

DETAILED ACTION

Claims 1-20 are presented for consideration on the merits.

Information Disclosure Statement

The information disclosure statements (IDSs) submitted on June 13, 2016, were received. The submissions are in compliance with the provisions of 37 CFR 1.97. Accordingly, the information disclosure statements are being considered by the examiner.

Claim Rejections - 35 USC § 112

The following is a quotation of 35 U.S.C. 112(b):

(b) CONCLUSION.—The specification shall conclude with one or more claims particularly pointing out and distinctly claiming the subject matter which the inventor or a joint inventor regards as the invention.

The following is a quotation of 35 U.S.C. 112 (pre-AIA), second paragraph:

The specification shall conclude with one or more claims particularly pointing out and distinctly claiming the subject matter which the applicant regards as his invention.

Claim 6 is rejected under 35 U.S.C. 112(b) or 35 U.S.C. 112 (pre-AIA), second paragraph, as being indefinite for failing to particularly point out and distinctly claim the subject matter which the inventor or a joint inventor, or for pre-AIA the applicant regards as the invention.

Claim 6 recites the limitation "said capsule" in line 1. There is insufficient antecedent basis for this limitation in the claim. Therefore, it is suggested that the claim 1 be amended to insert --in a capsule-- after the second occurrence of term "oil" in line 1 of claim 1.

Claim Rejections - 35 USC § 103

The following is a quotation of pre-AIA 35 U.S.C. 103(a) which forms the basis for all obviousness rejections set forth in this Office action:

(a) A patent may not be obtained though the invention is not identically disclosed or described as set forth in section 102 of this title, if the differences between the subject matter sought to be patented and the prior art are such that the subject matter as a whole would have been obvious at the time the invention was made to a person having ordinary skill in the art to which said subject matter pertains. Patentability shall not be negated by the manner in which the invention was made.

The factual inquiries set forth in *Graham v. John Deere Co.*, 383 U.S. 1, 148 USPQ 459 (1966), that are applied for establishing a background for determining obviousness under pre-AIA 35 U.S.C. 103(a) are summarized as follows:

1. Determining the scope and contents of the prior art.
2. Ascertaining the differences between the prior art and the claims at issue.
3. Resolving the level of ordinary skill in the pertinent art.
4. Considering objective evidence present in the application indicating obviousness or nonobviousness.

This application currently names joint inventors. In considering patentability of the claims under pre-AIA 35 U.S.C. 103(a), the examiner presumes that the subject matter of the various claims was commonly owned at the time any inventions covered therein were made absent any evidence to the contrary. Applicant is advised of the obligation

Art Unit: 1651

under 37 CFR 1.56 to point out the inventor and invention dates of each claim that was not commonly owned at the time a later invention was made in order for the examiner to consider the applicability of pre-AIA 35 U.S.C. 103(c) and potential pre-AIA 35 U.S.C. 102(e), (f) or (g) prior art under pre-AIA 35 U.S.C. 103(a).

Claims 1-20 are rejected under pre-AIA 35 U.S.C. 103(a) as being unpatentable over Sampalis (US 2004/0241249 A1) in view of Joensen (WO 86/06082), cited on enclosed PTO-1449 Forms.

TMA (trimethyl amine) Testing Results is relied upon as evidence of krill products typically contain less than 1 mg and trimethyl amine is a known natural compound present in krill, the reference has no date and is not relied upon as a cited prior art teaching but only as evidence and presented as an attachment and not a cited document against the claims.

Claims are drawn to a composition comprising encapsulated *Euphausia superba* krill oil for oral administration and oil comprising from 3% to 15% ether phospholipids w/w of said krill oil, astaxanthin esters in a amount of greater than about 100 mg/kg of said krill oi, and trimethyl amine in an amount of less than 1 mg/kg of said krill oil.

Sampalis teaches krill oil composition comprising encapsulated (page 3, [0094], lines 1-7) *Euphausia superba* (page 2, [0026], lines 1-4, and [0034]-[0083], and astaxanthin disclosed specifically at [0065], krill oil for oral administration (page 3, [0094], lines 1-7) and oil comprising from 3% to 15% ether phospholipids w/w of said krill oil (page 2, [0048]-[0053], and astaxanthin esters in a amount of greater than about 100 mg/kg of said krill oil (page 2, [0065]).

Art Unit: 1651

Joensen teaches higher yields of astaxanthin are obtained according to the treatment of the source materials, such as shrimp or krill, see page 2, lines 19-25 and page 4, lines 25-31.

Regarding claims 1 and 11, a composition comprising encapsulated *Euphausia superba* krill oil suitable for oral administration is disclosed by Sampalis.

Furthermore, the ingredients of ether phospholipids and astaxanthin esters are disclosed by Sampalis and Joensen. With regard to the presence of TMA, this is well known to be naturally contained in krill and would have been expected to be present in a composition obtained from krill and any resulting product therefrom, see evidence of TMA Testing Results in the Attachment. Hence the presence of TMA is intrinsic to the cited prior art teaches of krill and its resultant products, thereof. The specific amounts of such material in the extracted oil composition would depend on the desired nutritional profile of the composition and the further use and desired degree of supplementation.

Further in regard to the concentration/amounts recitations, it is noted that:

Generally, differences in concentration or temperature will not support the patentability of subject matter encompassed by the prior art unless there is evidence indicating such concentration or temperature is critical. "[W]here the general conditions of a claim are disclosed in the prior art, it is not inventive to discover the optimum or workable ranges by routine experimentation." *In re Aller*, 220 F.2d 454, 456, 105 USPQ 233, 235 (CCPA 1955) (MPEP 2144.05, II A).

Regarding the dependent claims 2 and 12 krill and its products are well known to have some odor because of the presence of TMA, as evidence by the Attachment and

Art Unit: 1651

to be substantially odorless would likewise depend upon how the krill is processed to obtain the oil composition.

Regarding claims 3 and 13, Joensen clearly teaches that astaxanthin is increased as based upon treatments used to process the krill to obtain krill compositions.

Regarding claims 4 and 14, total phospholipids are disclosed and the cited prior art combination clearly reads on about at least 30% based on amounts disclosed by Sampalis at page 2, [0048]-[0053].

Regarding claims 5 and 15-16, phosphatidylcholine is also disclosed by Sampalis at page 2, [0049].

Regarding claim 9, an encapsulated krill oil composition is taught by Sampalis. Soft gel capsules are clearly within the purview of an ordinary skilled artisan.

Regarding claims 6 and 17, since astaxanthin is a phytonutrient, therefore, teaching of compound in the cited prior art clearly distinguishes its functional equivalency as a phytonutrient. Thus, a phytonutrient is disclosed by the cited prior art and can be derived from shrimp or other chitinous containing material, as disclosed by Jonensen, see abstract, all lines.

Regarding claims 7-10 and 18-20, arachidonic acid is disclosed by Sampalis at page 2, [0043]. Also, ether and non-ether phospholipids and total phospholipids are disclosed by Sampalis at page 2, [0035]-[0057]. Omega-3 fatty acids are disclosed by Sampalis at page 2, [0036].

Art Unit: 1651

Regarding all of the claims each are clearly disclosed almost entirely by Sampalis and at least in part by Joensen. Furthermore, the TMA naturally present in krill products is evidenced by the Attachment which is not cited as prior art because it has not date, but merely as evidence and recognition of its inherent presence in the cited prior art against the claimed subject matter.

The claims differ from Sampalis in that the specific concentration amounts are not clearly disclosed.

It would have been obvious to one of ordinary skill in the art at the time the claimed invention was made to combine the teachings of the cited prior art to provide for an encapsulated krill oil composition. Soft gel capsules are clearly well known to those of ordinary skill in the art and the broad teaching of capsules as disclosed by Sampalis clearly encompasses any type of capsule including soft gel capsules. Each of the ingredients of the claimed composition are disclosed or at least suggested by the cited prior art. Hence, krill oil composition as disclosed contains all the claimed lipids, phospholipids, neutral lipids as claimed. In the absence of persuasive evidence to the contrary the claims are rendered prima facie obvious over the cited prior art.

Double Patenting

The nonstatutory double patenting rejection is based on a judicially created doctrine grounded in public policy (a policy reflected in the statute) so as to prevent the unjustified or improper timewise extension of the "right to exclude" granted by a patent and to prevent possible harassment by multiple assignees. A nonstatutory double patenting rejection is appropriate where the conflicting claims are not identical, but at

Art Unit: 1651

least one examined application claim is not patentably distinct from the reference claim(s) because the examined application claim is either anticipated by, or would have been obvious over, the reference claim(s). See, e.g., *In re Berg*, 140 F.3d 1428, 46 USPQ2d 1226 (Fed. Cir. 1998); *In re Goodman*, 11 F.3d 1046, 29 USPQ2d 2010 (Fed. Cir. 1993); *In re Longi*, 759 F.2d 887, 225 USPQ 645 (Fed. Cir. 1985); *In re Van Ornum*, 686 F.2d 937, 214 USPQ 761 (CCPA 1982); *In re Vogel*, 422 F.2d 438, 164 USPQ 619 (CCPA 1970); *In re Thorington*, 418 F.2d 528, 163 USPQ 644 (CCPA 1969).

A timely filed terminal disclaimer in compliance with 37 CFR 1.321(c) or 1.321(d) may be used to overcome an actual or provisional rejection based on nonstatutory double patenting provided the reference application or patent either is shown to be commonly owned with the examined application, or claims an invention made as a result of activities undertaken within the scope of a joint research agreement. See MPEP § 717.02 for applications subject to examination under the first inventor to file provisions of the AIA as explained in MPEP § 2159. See MPEP §§ 706.02(l)(1) - 706.02(l)(3) for applications not subject to examination under the first inventor to file provisions of the AIA. A terminal disclaimer must be signed in compliance with 37 CFR 1.321(b).

The USPTO Internet website contains terminal disclaimer forms which may be used. Please visit www.uspto.gov/patent/patents-forms. The filing date of the application in which the form is filed determines what form (e.g., PTO/SB/25, PTO/SB/26, PTO/AIA/25, or PTO/AIA/26) should be used. A web-based eTerminal Disclaimer may be filled out completely online using web-screens. An eTerminal Disclaimer that meets

Art Unit: 1651

all requirements is auto-processed and approved immediately upon submission. For more information about eTerminal Disclaimers, refer to www.uspto.gov/patents/process/file/efs/guidance/eTD-info-I.jsp.

Claims 1-20 are provisionally rejected on the ground of nonstatutory double patenting as being unpatentable over over claims 1-15 of copending Application No. 14/136848 and claims 78-99 of copending Application No. 14/370324 (reference application), both in view of Sampalis, cited and discussed above. Although the claims at issue are not identical, they are not patentably distinct from each other because the only difference between the compositions is a matter of scope and that the instantly claimed invention is required to be in a capsule form.

This is a provisional nonstatutory double patenting rejection because the patentably indistinct claims have not in fact been patented.

Claims are discussed above.

Copending claims disclose krill compositions comprising the same or similar ingredients as claimed and discussed above.

The difference between instant claims and copending claims is that no capsule is required by the copending claims and other variations of scope as well provide for some differences between the claims.

It would have been obvious to one of ordinary skill in the art at the time the claimed invention was made to encapsulate the krill compositions of the copending claims as disclosed by Sampalis to provide for the instant claimed composition. One of skill would have been motivated by the teachings of the copending claims and Sampalis

Art Unit: 1651

to provide for the composition in a capsule as disclosed. One of skill would have expected successful results because Sampalis clearly shows the good results are obtained in patients orally administered these compositions in capsule form. In the absence of persuasive evidence to the contrary the claims are prima facie obvious over the cited prior art.

All claims fail to be patentably distinguishable over the state of the art discussed above and cited on the enclosed PTO-892 and/or PTO-1449. Therefore, the claims are properly rejected.

The remaining references listed on the enclosed PTO-892 and/or PTO-1449 are cited to further show the state of the art.

No claims are allowed.

Any inquiry concerning this communication or earlier communications from the examiner should be directed to DEBBIE K. WARE whose telephone number is (571)272-0924. The examiner can normally be reached on 9:30-6:00.

If attempts to reach the examiner by telephone are unsuccessful, the examiner's supervisor, Renee Claytor can be reached on 571-272-8394. The fax phone number for the organization where this application or proceeding is assigned is 571-273-8300.

Art Unit: 1651

Information regarding the status of an application may be obtained from the Patent Application Information Retrieval (PAIR) system. Status information for published applications may be obtained from either Private PAIR or Public PAIR. Status information for unpublished applications is available through Private PAIR only. For more information about the PAIR system, see <http://pair-direct.uspto.gov>. Should you have questions on access to the Private PAIR system, contact the Electronic Business Center (EBC) at 866-217-9197 (toll-free). If you would like assistance from a USPTO Customer Service Representative or access to the automated information system, call 800-786-9199 (IN USA OR CANADA) or 571-272-1000.

Deborah K. Ware
Primary Examiner
Art Unit 1651

/DEBBIE K. WARE/
Primary Examiner, Art Unit 1651

ATTACHMENT

Low TMA in A*** Krill Products**

Third party analysis of A***** krill products typically detect TMA values of <1mgN/100g. Such levels are considered to be an indication that:

- 1) Natural TMA levels found in our krill were initially low and have been efficiently removed during our processing steps
- 2) The PC is stable, since the breakdown product of choline (TMA) is nearly below detection limits.

These attributes are considered to be key components of why A***** krill products have high acceptability related to smell.

As part of A***** competitive market analysis, we submitted other krill products being sold in the marketplace to an independent lab for analysis of TMA. In these cases, TMA levels have been found to be as high as 451 mgN/100g

<u>Company</u>	<u>TMA Value</u>
A*****	1mgN/100g
Competitor	451mgN/100g

For obvious reasons, A***** is unable to identify the company(ies) whose products were submitted for analysis. However, A***** recommends that any company interested in selecting a provider of krill oil for their customers, submit blind samples from the various krill providers for independent laboratory analysis of trimethylamine. This will allow for a fair comparison of the content of this tiny molecule that is known to have a considerable impact on product smell and acceptability.

Trimethylamine

Trimethylamine (TMA) is a small nitrogenous molecule. There are two key attributes of TMA that are important to understand, as they relate to finished krill oil products. These are:

- 1) TMAO as an Osmolyte
- 2) TMA as a Breakdown Product of Choline

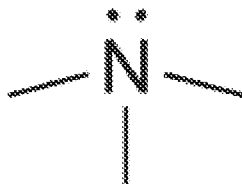

Figure 1. Trimethylamine Structure

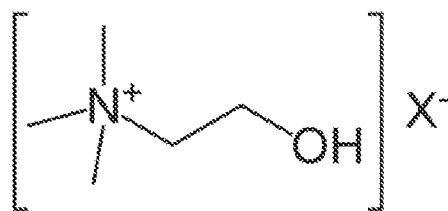

Figure 2. Choline Structure

TMA as an Osmolyte

In order for small crustaceans like krill and shrimp to survive the high salt environment of the ocean, they must possess certain charged molecules within their bodies. This ensures that the krill do not shrivel up from water rushing out of their bodies or swell up and burst because of water rushing into their bodies.

One of the key osmolytes (molecules that control the osmotic pressure) in krill is called trimethylamine oxide (TMAO). Krill produce this in response to the varying salt conditions of seawater, so that they maintain the proper cellular water balance. For the krill, TMAO is not a problem, but a solution.

TMA as a Breakdown Product of Choline

Choline forms the key head group of the phosphatidylcholine molecule (PC). In krill products, EPA- and DHA-enriched PC are what give krill its unique attributes as a supplement or medical therapeutic.

In a well-described biochemical reaction, choline is known to easily degrade to TMA. This is one reason why ingesting high levels of free choline can lead to “fishy” breath, “fishy” bowel gas, or “fishy” stools. As excess choline is broken down in the gut, TMA is formed, with its attendant fishy odor.

Trimethylamine can also form when the choline portion of PC breaks down in storage or processing. Thus, the presence of TMA in a finished product may indicate degradation (of the choline portion) of PC.

Why is TMA a Problem in Finished Krill Products

First, TMA is not a health problem (except for those with a rare disorder called trimethylaminuria). When you eat a shrimp cocktail at dinner, you get a fair amount of TMA. However, TMA has a very strong “fishy” smell. Thus, any finished krill product with high levels of TMA is going to have a “fishy” smell that is related to the amount of TMA in the product. This has certainly been shown to be a problem with encapsulators who must work with krill oil in their facilities. But it has also proven to be an issue for consumers, wherein the finished capsules they take daily can have a very strong fish smell. In short, keeping TMA levels as low as possible is the best way to keep encapsulators and consumers happy.

Why TMA May be Found in Finished Krill Products

The presence of residual TMA in a finished krill product may generally indicate one of two things. First, it may signal an incomplete extraction or purification (during processing) of the normal TMAO found in krill that must live in the high salinity of the ocean. In other words, the naturally-occurring TMA in live krill is not removed and carries over into the finished krill oil product. Second, the presence of TMA may indicate that the choline portion of the phospholipids (specifically PC) may be breaking down in storage. This would be a potential indication of product instability.

Thus, when TMA appears in a finished krill oil product, it may represent inefficiencies in either the raw materials or processing, or instability in storage that leads to the breakdown of the krill phospholipids. Our third party analysis of other krill products does not make it clear which of these conditions may be at work. It may be one or a combination of the above.

Search Notes 	Application/Control No. 15180439	Applicant(s)/Patent Under Reexamination BRUHEIM ET AL.
	Examiner DEBBIE K WARE	Art Unit 1651

CPC- SEARCHED		
Symbol	Date	Examiner
A61K2300/00 A61K35/612 A61K31/122 A61K31/685 A61K31/133 A61K31/198 A61K31/202 A61K31/575 A61K38/1767 A61K9/2009 A61K9/2054 A61K9/2866 A23L1/3006 A23L1/33 A23L1/305 A23L1/	7/2016	dkw

CPC COMBINATION SETS - SEARCHED		
Symbol	Date	Examiner

US CLASSIFICATION SEARCHED			
Class	Subclass	Date	Examiner

SEARCH NOTES		
Search Notes	Date	Examiner
WEST_CPC_Inventor_Searches and NPL Searches: see search history print out	7/2016	dkw

INTERFERENCE SEARCH			
US Class/ CPC Symbol	US Subclass / CPC Group	Date	Examiner

--	--

Doc code: IDS

Doc description: Information Disclosure Statement (IDS) Filed

PTO/SB/08a (03-15)

Approved for use through 07/31/2016. OMB 0651-0031

U.S. Patent and Trademark Office; U.S. DEPARTMENT OF COMMERCE

Under the Paperwork Reduction Act of 1995, no persons are required to respond to a collection of information unless it contains a valid OMB control number.

INFORMATION DISCLOSURE STATEMENT BY APPLICANT (Not for submission under 37 CFR 1.99)	Application Number	
	Filing Date	2016-06-13
	First Named Inventor	Inge Bruheim
	Art Unit	
	Examiner Name	
	Attorney Docket Number	AKBM-14409/US-13/CON

U.S.PATENTS							Remove
Examiner Initial*	Cite No	Patent Number	Kind Code ¹	Issue Date	Name of Patentee or Applicant of cited Document	Pages,Columns,Lines where Relevant Passages or Relevant Figures Appear	
	1	4038722		1977-08-02	TERASE et al.		
	2	8057825		2011-11-15	SAMPALIS, TINA		
If you wish to add additional U.S. Patent citation information please click the Add button.							Add

U.S.PATENT APPLICATION PUBLICATIONS							Remove
Examiner Initial*	Cite No	Publication Number	Kind Code ¹	Publication Date	Name of Patentee or Applicant of cited Document	Pages,Columns,Lines where Relevant Passages or Relevant Figures Appear	
	1	20050003073		2005-01-06	PIVOVAROV et al.		
If you wish to add additional U.S. Published Application citation information please click the Add button.							Add

FOREIGN PATENT DOCUMENTS								Remove
Examiner Initial*	Cite No	Foreign Document Number ³	Country Code ²ⁱ	Kind Code ⁴	Publication Date	Name of Patentee or Applicant of cited Document	Pages,Columns,Lines where Relevant Passages or Relevant Figures Appear	T ⁵
	1	60-153779	JP		1985-08-13	Honen Seiyu Co. Ltd. Et al.		
	2	H08-231391	JP		1996-08-09	Kanagawa Kagaku Kenkyujo Co., Ltd. Et al.		

**INFORMATION DISCLOSURE
STATEMENT BY APPLICANT**
(Not for submission under 37 CFR 1.99)

Application Number		
Filing Date		2016-06-13
First Named Inventor	Inge Bruheim	
Art Unit		
Examiner Name		
Attorney Docket Number	AKBM-14409/US-13/CON	

If you wish to add additional Foreign Patent Document citation information please click the Add button

NON-PATENT LITERATURE DOCUMENTS

Examiner Initials*	Cite No	Include name of the author (in CAPITAL LETTERS), title of the article (when appropriate), title of the item (book, magazine, journal, serial, symposium, catalog, etc), date, pages(s), volume-issue number(s), publisher, city and/or country where published.	T ⁵
	1	Declaration of Bjorn Ole Haugsgjerd submitted during inter partes reexamination of parent patent U.S. 8,030,348 ("Haugsgjerd '348 Decl.")	
	2	Declaration of Dr. Albert Lee in Support of Inter Partes Review of U.S. Pat. No. 8,278,351 ("Lee")	
	3	Declaration of Dr. Albert Lee in Support of Inter Partes Review of U.S. Pat. No. 8,383,675 ("Lee")	
	4	Declaration of Dr. Chong Lee submitted during inter partes reexamination of parent patent U.S. 8,030,348 ("Yeboah Reexam Decl.")	
	5	Declaration of Dr. Earl White submitted during prosecution of parent patent U.S. 8,030,348 ("2011 White Decl.")	
	6	Declaration of Dr. Ivar Storrø in support of Inter Partes Review of U.S. Pat. No. 8,278,351 ("Storrø")	
	7	Declaration of Dr. Ivar Storrø in support of Inter Partes Review of U.S. Pat. No. 8,383,675 ("Storrø")	
	8	Declaration of Dr. Jacek Jaczynski from inter partes reexamination of the parent patent U.S. 8,030,348 ("Jaczynski Reexam. Decl.")	
	9	Declaration of Dr. Jaczynski submitted during prosecution of parent patent U.S. 8,278,351 (Jaczynski '351 Decl.)	

**INFORMATION DISCLOSURE
STATEMENT BY APPLICANT**
(Not for submission under 37 CFR 1.99)

Application Number		
Filing Date		2016-06-13
First Named Inventor	Inge Bruheim	
Art Unit		
Examiner Name		
Attorney Docket Number	AKBM-14409/US-13/CON	

10	Declaration of Dr. Jeff Moore in Support of Inter Partes Review of U.S. Pat. No. 8,278,351 ("Moore")
11	Declaration of Dr. Jeff Moore in Support of Inter Partes Review of U.S. Pat. No. 8,383,675 ("Moore")
12	Declaration of Dr. Richard van Breemen in Support of Inter Partes Review of U.S. Pat. No. 8,278,351 ("Van Breemen")
13	Declaration of Dr. Richard van Breemen in Support of Inter Partes Review of U.S. Pat. No. 8,383,675 ("Van Breemen")
14	Declaration of Dr. Shahidi submitted during inter partes reexamination of parent patent U.S. 8,030,348 (Shahidi Reexam. Decl.)
15	Declaration of Dr. Shahidi submitted during prosecution of parent patent U.S. 8,278,351 (Shahidi '351 Decl.)
16	Declaration of Dr. Suzanne Budge in Support of Inter Partes Review of U.S. Pat. No. 8,278,351 ("Budge")
17	Declaration of Dr. Suzanne Budge in Support of Inter Partes Review of U.S. Pat. No. 8,383,675 ("Budge")
18	Declaration of Dr. Thomas Brenna in support of Inter Partes Review of U.S. Pat. No. 8,278,351
19	Declaration of Dr. Thomas Brenna in support of Inter Partes Review of U.S. Pat. No. 8,383,675
20	Declaration of Dr. Thomas Gundersen submitted during inter partes reexamination of parent patent U.S. 8,030,348 ("Gundersen Decl.")

**INFORMATION DISCLOSURE
STATEMENT BY APPLICANT**
(Not for submission under 37 CFR 1.99)

Application Number		
Filing Date		2016-06-13
First Named Inventor	Inge Bruheim	
Art Unit		
Examiner Name		
Attorney Docket Number	AKBM-14409/US-13/CON	

21	Declaration of Dr. Tina Sampalis submitted during inter partes reexamination of parent patent U.S. 8,030,348 (Sampalis")
22	Declaration of Dr. Van Breemen submitted during Ex parte Reexamination of the '351 patent (Van Breemen '351 Reexam. Decl."
23	Declaration of Dr. Van Breemen submitted during Inter partes Reexamination of the '348 patent (Van Breemen '348 Reexam Decl."
24	Declaration of Dr. Yeboah submitted during inter partes reexamination of parent patent U.S. 8,030,348 ("Yeboah Reexam Decl.")
25	Declaration of Dr. Yeboah submitted during prosecution of parent patent U.S. 8,278,351 ("Yeboah '351 Decl.")
26	Eichberg, "Lecithin - It Manufacture and Use in the Fat and Oil Industry," Oils and Soap 51-54, 1939 ("Eichberg")
27	Expert Witness Report of Dr. Theodore Welch submitted in relation to ITC Investigation No. 337-TA-877 ("Welch")
28	Farkas, Composition and Physical State of Phospholipids in Calanoid Copepods from India and Norway, LIPIDS, Vol. 23, No. 6 (1988)
29	Final Prospectus dated May 11, 2001 ("Final Prospectus")
30	
31	Folch, et al., A Simple Method for the Isolation and Purification of Total Lipids from Animal Tissues. J. Biol. Chem., 226, 497-509 (1957)

**INFORMATION DISCLOSURE
STATEMENT BY APPLICANT**
(Not for submission under 37 CFR 1.99)

Application Number		
Filing Date		2016-06-13
First Named Inventor	Inge Bruheim	
Art Unit		
Examiner Name		
Attorney Docket Number	AKBM-14409/US-13/CON	

32	Grant of Request for Ex parte Reexamination of the '351 patent
33	Grit et al., Hydrolysis of phosphatidylcholine in aqueous liposome dispersions, Int. J. Pharmaceutics 50:1-6 (1989)
34	HENDERSON et al., Lipid Composition of the Pineal Organ from Rainbow Trout (<i>Oncorhynchus mykiss</i>), Lipids, Vol. 29, No. 5, pp. 311-317 (1994) ("Henderson")
35	HERMAN and GROVES, The Influence of Free Fatty Acid Formation on the pH of Phospholipid-Stabilized Triglyceride Emulsions, Pharmaceutical Research 10(5):774-776 (1993)
36	Itano Refrigerated Food Co., Ltd., Bio & High Technology Announcement and Natural Astaxanthin & Krill Lecithin, pp. 1-16 (on or before December 28, 1994) ("Itano")
37	JOHNSON and LUCAS, Comparison of Alternative Solvents for Oils Extraction, JAOCS 60(2):229-242 (1983)
38	LE GRANDOIS et al., Investigation of Natural Phosphatidylcholine Sources: Separation and Identification by Liquid Chromatography -Electrospray Ionization-Tandem Mass Spectrometry (LC-ESI-MS2) of Molecular Species, J. Agric. Food Chem., 57, 6014-20 (2009) ("Le Grandois")
39	LIN et al., Effect of Dietary N-3 Fatty Acids Upon the PhospholipidMolecular Species of the Monkey Retina, Invest Ophthalmol Vis Sci. 1994;35:794-803
40	MEDINA et al., C Nuclear Magnetic Resonance Monitoring of Free Fatty Acid Release After Fish Thermal Processing, J. Amer. Oil Chem. Soc. 71(5):479-82 (1994)
41	October 24, 2012 Office Action, '675 patent
42	Office Action dated January 5, 2012, '351 patent

**INFORMATION DISCLOSURE
STATEMENT BY APPLICANT**
(Not for submission under 37 CFR 1.99)

Application Number		
Filing Date		2016-06-13
First Named Inventor	Inge Bruheim	
Art Unit		
Examiner Name		
Attorney Docket Number	AKBM-14409/US-13/CON	

43	Provisional Application No. 60/307,842 (Priority document for the '351 patent), available in PAIR
44	Supplemental Declaration of Bjorn Ole Haugsgjerd submitted during inter partes reexamination of parent patent U.S. 8,030,348 ("Haugsgjerd '348 Supp. Decl.")
45	Supplemental Declaration of Dr. Earl White submitted during inter partes reexamination of parent patent U.S. 8,030,348 ("White Supp. Reexam. Decl.")
46	Supplemental Declaration of Dr. Earl White submitted during prosecution of parent patent U.S. 8,278,351 ("White Supp. Decl.")
47	Supplemental Declaration of Dr. Thomas Gundersen submitted during inter partes reexamination of parent patent U.S. 8,030,348 ("Gundersen Supp. Decl.")
48	Suzuki, T. and Shibata, N., "The utilization of Antarctic krill for human food," Food Rev. Int'l, 6:1, 119-147 (1990) ("Suzuki")
49	Takahashi et al., Compositional Changes in Molecular Species of Fish Muscle Phosphatidylcholine During Storage, Bull. Fac. Fish. Hokkaido Univ. 37(1), 80-84 1986.
50	Takahashi et al., Molecular Species of Fish Muscle Lecithin, Bulletin of the Japanese Society of Scientific Fisheries 48 (12), 1803-1814 (1982)

If you wish to add additional non-patent literature document citation information please click the Add button

EXAMINER SIGNATURE

Examiner Signature	/Deborah Ware/	Date Considered	07/11/2016
--------------------	----------------	-----------------	------------

*EXAMINER: Initial if reference considered, whether or not citation is in conformance with MPEP 609. Draw line through a citation if not in conformance and not considered. Include copy of this form with next communication to applicant.

¹ See Kind Codes of USPTO Patent Documents at www.USPTO.GOV or MPEP 901.04. ² Enter office that issued the document, by the two-letter code (WIPO Standard ST.3). ³ For Japanese patent documents, the indication of the year of the reign of the Emperor must precede the serial number of the patent document. ⁴ Kind of document by the appropriate symbols as indicated on the document under WIPO Standard ST.16 if possible. ⁵ Applicant is to place a check mark here if English language translation is attached.

**INFORMATION DISCLOSURE
STATEMENT BY APPLICANT**
(Not for submission under 37 CFR 1.99)

Application Number			
Filing Date		2016-06-13	
First Named Inventor	Inge Bruheim		
Art Unit			
Examiner Name			
Attorney Docket Number		AKBM-14409/US-13/CON	

CERTIFICATION STATEMENT

Please see 37 CFR 1.97 and 1.98 to make the appropriate selection(s):

That each item of information contained in the information disclosure statement was first cited in any communication from a foreign patent office in a counterpart foreign application not more than three months prior to the filing of the information disclosure statement. See 37 CFR 1.97(e)(1).

OR

That no item of information contained in the information disclosure statement was cited in a communication from a foreign patent office in a counterpart foreign application, and, to the knowledge of the person signing the certification after making reasonable inquiry, no item of information contained in the information disclosure statement was known to any individual designated in 37 CFR 1.56(c) more than three months prior to the filing of the information disclosure statement. See 37 CFR 1.97(e)(2).

See attached certification statement.

The fee set forth in 37 CFR 1.17 (p) has been submitted herewith.

A certification statement is not submitted herewith.

SIGNATURE

A signature of the applicant or representative is required in accordance with CFR 1.33, 10.18. Please see CFR 1.4(d) for the form of the signature.

Signature	/J. Mitchell Jones/	Date (YYYY-MM-DD)	2016-06-13
Name/Print	J. Mitchell Jones	Registration Number	44174

This collection of information is required by 37 CFR 1.97 and 1.98. The information is required to obtain or retain a benefit by the public which is to file (and by the USPTO to process) an application. Confidentiality is governed by 35 U.S.C. 122 and 37 CFR 1.14. This collection is estimated to take 1 hour to complete, including gathering, preparing and submitting the completed application form to the USPTO. Time will vary depending upon the individual case. Any comments on the amount of time you require to complete this form and/or suggestions for reducing this burden, should be sent to the Chief Information Officer, U.S. Patent and Trademark Office, U.S. Department of Commerce, P.O. Box 1450, Alexandria, VA 22313-1450. **DO NOT SEND FEES OR COMPLETED FORMS TO THIS ADDRESS. SEND TO: Commissioner for Patents, P.O. Box 1450, Alexandria, VA 22313-1450.**

Privacy Act Statement

The Privacy Act of 1974 (P.L. 93-579) requires that you be given certain information in connection with your submission of the attached form related to a patent application or patent. Accordingly, pursuant to the requirements of the Act, please be advised that: (1) the general authority for the collection of this information is 35 U.S.C. 2(b)(2); (2) furnishing of the information solicited is voluntary; and (3) the principal purpose for which the information is used by the U.S. Patent and Trademark Office is to process and/or examine your submission related to a patent application or patent. If you do not furnish the requested information, the U.S. Patent and Trademark Office may not be able to process and/or examine your submission, which may result in termination of proceedings or abandonment of the application or expiration of the patent.

The information provided by you in this form will be subject to the following routine uses:

1. The information on this form will be treated confidentially to the extent allowed under the Freedom of Information Act (5 U.S.C. 552) and the Privacy Act (5 U.S.C. 552a). Records from this system of records may be disclosed to the Department of Justice to determine whether the Freedom of Information Act requires disclosure of these records.
2. A record from this system of records may be disclosed, as a routine use, in the course of presenting evidence to a court, magistrate, or administrative tribunal, including disclosures to opposing counsel in the course of settlement negotiations.
3. A record in this system of records may be disclosed, as a routine use, to a Member of Congress submitting a request involving an individual, to whom the record pertains, when the individual has requested assistance from the Member with respect to the subject matter of the record.
4. A record in this system of records may be disclosed, as a routine use, to a contractor of the Agency having need for the information in order to perform a contract. Recipients of information shall be required to comply with the requirements of the Privacy Act of 1974, as amended, pursuant to 5 U.S.C. 552a(m).
5. A record related to an International Application filed under the Patent Cooperation Treaty in this system of records may be disclosed, as a routine use, to the International Bureau of the World Intellectual Property Organization, pursuant to the Patent Cooperation Treaty.
6. A record in this system of records may be disclosed, as a routine use, to another federal agency for purposes of National Security review (35 U.S.C. 181) and for review pursuant to the Atomic Energy Act (42 U.S.C. 218(c)).
7. A record from this system of records may be disclosed, as a routine use, to the Administrator, General Services, or his/her designee, during an inspection of records conducted by GSA as part of that agency's responsibility to recommend improvements in records management practices and programs, under authority of 44 U.S.C. 2904 and 2906. Such disclosure shall be made in accordance with the GSA regulations governing inspection of records for this purpose, and any other relevant (i.e., GSA or Commerce) directive. Such disclosure shall not be used to make determinations about individuals.
8. A record from this system of records may be disclosed, as a routine use, to the public after either publication of the application pursuant to 35 U.S.C. 122(b) or issuance of a patent pursuant to 35 U.S.C. 151. Further, a record may be disclosed, subject to the limitations of 37 CFR 1.14, as a routine use, to the public if the record was filed in an application which became abandoned or in which the proceedings were terminated and which application is referenced by either a published application, an application open to public inspections or an issued patent.
9. A record from this system of records may be disclosed, as a routine use, to a Federal, State, or local law enforcement agency, if the USPTO becomes aware of a violation or potential violation of law or regulation.

ALL REFERENCES CONSIDERED EXCEPT WHERE LINED THROUGH. /D.W./

Doc code: IDS

PTO/SB/08a (03-15)

Doc description: Information Disclosure Statement (IDS) Filed

Approved for use through 07/31/2016. OMB 0651-0031

U.S. Patent and Trademark Office; U.S. DEPARTMENT OF COMMERCE

Under the Paperwork Reduction Act of 1995, no persons are required to respond to a collection of information unless it contains a valid OMB control number.

INFORMATION DISCLOSURE STATEMENT BY APPLICANT (Not for submission under 37 CFR 1.99)	Application Number	
	Filing Date	2016-06-13
	First Named Inventor	Inge Bruheim
	Art Unit	
	Examiner Name	
	Attorney Docket Number	AKBM-14409/US-13/CON

U.S.PATENTS						Remove
Examiner Initial*	Cite No	Patent Number	Kind Code ¹	Issue Date	Name of Patentee or Applicant of cited Document	Pages,Columns,Lines where Relevant Passages or Relevant Figures Appear
	1	5266564		1993-11-30	Modolell	
	2	8030348		2011-10-04	Sampalis, Fotni	
	3	7666447		2010-02-23	Rockway	
	4	4714571		1987-12-22	Kearns et al.	
	5	8278351		2012-10-02	Sampalis	
	6	8383675		2013-02-26	Sampalis	
	7	2652235		1953-09-15	Samuelsen	
	8	5006281		1991-04-09	Rubin et al.	

ALL REFERENCES CONSIDERED EXCEPT WHERE LINED THROUGH. /D.W./

**INFORMATION DISCLOSURE
STATEMENT BY APPLICANT**
(Not for submission under 37 CFR 1.99)

Application Number	
Filing Date	2016-06-13
First Named Inventor	Inge Bruheim
Art Unit	
Examiner Name	
Attorney Docket Number	AKBM-14409/US-13/CON

9	4251557	1981-02-17	Shimose et al.
10	4505936	1985-03-19	Meyers et al.
11	6214396	2001-04-10	Barrier
12	4036993	1977-07-19	Ikeda
13	6346276	2002-02-12	Tanouchi et al.
14	8697138	2014-04-15	Bruheim et al.
15	7488503	2009-02-10	Porzio et al
16	4749522	1988-06-07	Kamarei
17	4814111	1989-03-21	Keams et al.
18	4133077	1979-01-09	Jasniewicz

If you wish to add additional U.S. Patent citation information please click the Add button.

U.S.PATENT APPLICATION PUBLICATIONS

ALL REFERENCES CONSIDERED EXCEPT WHERE LINED THROUGH. /D.W./

**INFORMATION DISCLOSURE
STATEMENT BY APPLICANT**
(Not for submission under 37 CFR 1.99)

Application Number	
Filing Date	2016-06-13
First Named Inventor	Inge Bruheim
Art Unit	
Examiner Name	
Attorney Docket Number	AKBM-14409/US-13/CON

Examiner Initial*	Cite No	Publication Number	Kind Code ¹	Publication Date	Name of Patentee or Applicant of cited Document	Pages, Columns, Lines where Relevant Passages or Relevant Figures Appear
	1	20060193962		2006-08-31	Kamiya et al.	
	2	20080166419		2008-07-10	Sones	
	3	20110130458		2011-06-02	Harald Breivik	
	4	20080166420		2008-07-10	Scott F. Sones	
	5	20060078625		2006-04-13	Susie Rockway	
	6	20020076468		2002-06-20	Saxby	
	7	20030113432		2003-06-19	Yoshitomi	
	8	20100143571		2010-06-10	Breivik	
	9	20100160659		2010-06-24	Catchpole	
	10	20080166419		2008-07-10	Sones	

ALL REFERENCES CONSIDERED EXCEPT WHERE LINED THROUGH. /D.W./

**INFORMATION DISCLOSURE
STATEMENT BY APPLICANT**
(Not for submission under 37 CFR 1.99)

Application Number	
Filing Date	2016-06-13
First Named Inventor	Inge Bruheim
Art Unit	
Examiner Name	
Attorney Docket Number	AKBM-14409/US-13/CON

If you wish to add additional U.S. Published Application citation information please click the Add button.

FOREIGN PATENT DOCUMENTS

Examiner Initial*	Cite No	Foreign Document Number ³	Country Code ^{2j}	Kind Code ⁴	Publication Date	Name of Patentee or Applicant of cited Document	Pages, Columns, Lines where Relevant Passages or Relevant Figures Appear	T ⁵
	1	2008/006607	WO		2008-01-17	NATTOPHARMA ASA		
	2	2008/117062	WO		2008-10-02	AKER BIOMARINE ASA		
	3	2009/027692	WO		2009-03-05	AKER BIOMARINE ASA		
	4	2001/028526	WO		2001-04-26	TRUFFINI & REGGE FARMACEUTICI		
	5	2004/047554	WO		2004-06-10	PHARES PHARM RES NV		
	6	0973532	EP		2005-09-07	I.B.R ISRAELI BIOTECHNOLOGY RESEARCH LTD.		
	7	1123368	EP		2008-04-09	UNIVERSITE DE SHERBROOKE		
	8	1292294	EP		2009-03-18	ACCERA, INC.		
	9	2001/082928	WO		2001-11-08	HENDERSON		

ALL REFERENCES CONSIDERED EXCEPT WHERE LINED THROUGH. /D.W./

**INFORMATION DISCLOSURE
STATEMENT BY APPLICANT**
(Not for submission under 37 CFR 1.99)

Application Number	
Filing Date	2016-06-13
First Named Inventor	Inge Bruheim
Art Unit	
Examiner Name	
Attorney Docket Number	AKBM-14409/US-13/CON

10	2003/013497	WO		2003-02-20	SUNTORY LIMITED
11	1419768	EP		2009-01-07	NEPTUNE TECHNOLOGIES & BIORESOURCES, INC
12	1385500	EP		2010-07-28	YEDA RESEARCH AND DEVELOPMENT CO. LTD
13	2002-083122	WO		2002-10-24	YEDA RESEARCH AND DEVELOPMENT CO. LTD
14	1392623	EP		2004-03-03	MARTEK BIOSCIENCES BOULDER CORPORATION
15	2002/092540	WO		2002-11-21	MARTEK BIOSCIENCES BOULDER CORPORATION
16	2005/070411	WO		2005-08-04	BRUZZESE
17	1542670	EP		2005-06-22	SUNTORY LIMITED
18	2004/028529	WO		2004-04-08	SUNTORY LIMITED
19	1743531	EP		2007-01-17	NIPPON SUISAN KAISHA, LTD.
20	1631280	EP		2004-04-08	BTG INTERNATIONAL LIMITED

ALL REFERENCES CONSIDERED EXCEPT WHERE LINED THROUGH. /D.W./

**INFORMATION DISCLOSURE
STATEMENT BY APPLICANT**
(Not for submission under 37 CFR 1.99)

Application Number	
Filing Date	2016-06-13
First Named Inventor	Inge Bruheim
Art Unit	
Examiner Name	
Attorney Docket Number	AKBM-14409/US-13/CON

21	2004-100943	WO		2006-05-31	BTG INTERNATIONAL LIMITED
22	2005-018632	WO		2005-03-03	BTG INTERNATIONAL LIMITED
23	2006/030552	WO		2006-03-23	SUNTORY LIMITED
24	1706106	EP		2009-07-15	BRUZZESE
25	1689413	EP		2006-08-16	ENZYMOTEC LTD
26	2004-534800	JP		2004-11-18	Kohyo
27	1660071	EP		2007-01-17	NIPPON SUISAN KAISHA, LTD.
28	2002/083122	WO		2002-10-24	YEDA RESEARCH AND DEVELOPMENT CO. LTD
29	05/004593	WO		2005-01-20	Norway Seafoods AS
30	08/117062	WO		2008-10-02	Aker Biomarine ASA
31	02/102394	WO		2002-12-27	Neptune Technologies & Bioress

ALL REFERENCES CONSIDERED EXCEPT WHERE LINED THROUGH. /D.W./

**INFORMATION DISCLOSURE
STATEMENT BY APPLICANT**
(Not for submission under 37 CFR 1.99)

Application Number	
Filing Date	2016-06-13
First Named Inventor	Inge Bruheim
Art Unit	
Examiner Name	
Attorney Docket Number	AKBM-14409/US-13/CON

32	07/080515	WO		2007-07-19	Aker Biomarine ASA
33	2003-530448	JP		2003-10-14	Westfalia Separator Industry GmbH
34	852-114046	JP		1977-09-24	Kokai
35	851-125774	JP		1976-11-02	Nichiro Gyogyo et al.
36	2002322233	AU		2003-02-17	Neptune Technologies & Bioresources, Inc.
37	04057853	JP		1992-02-25	CHLORINE ENG CORP LTD
38	2004/112767	WO		2004-12-29	Advanced Bionutrition Corp.
39	2251265	CA		2000-04-21	Beaudoin
40	1098900	CA		1981-04-07	Inst. Elementoorganicheskikh So, et al.
41	82/02819	WO		1982-09-02	Baltic Fish Ltd
42	40348	CL		1997-07-08	Tepual S.A.

ALL REFERENCES CONSIDERED EXCEPT WHERE LINED THROUGH. /D.W./

**INFORMATION DISCLOSURE
STATEMENT BY APPLICANT**
(Not for submission under 37 CFR 1.99)

Application Number	
Filing Date	2016-06-13
First Named Inventor	Inge Bruheim
Art Unit	
Examiner Name	
Attorney Docket Number	AKBM-14409/US-13/CON

43	89/01031	WO		1989-02-09	Pharmacia AB
44	89/10960	WO		1989-11-16	Pharmacia AB
45	97/38585	WO		1997-10-23	The University of British Columbia
46	98/34498	WO		1998-08-13	Biozyme Systems, Inc.
47	99/39589	WO		1999-08-12	Biozyme Systems Inc.
48	06/111633	WO		2006-10-26	SC DICOPHAR
49	07/123424	WO		2007-11-01	Catchpole
50	08/072563	WO		2008-06-19	Nippon Suisan Kaisha, Ltd.

If you wish to add additional Foreign Patent Document citation information please click the Add button

NON-PATENT LITERATURE DOCUMENTS

Examiner Initials*	Cite No	Include name of the author (in CAPITAL LETTERS), title of the article (when appropriate), title of the item (book, magazine, journal, serial, symposium, catalog, etc), date, pages(s), volume-issue number(s), publisher, city and/or country where published.	T ⁵
	1	TAKAICHI et al., 2003, "Fatty Acids of astaxanthin esters in krill determined by mild mass spectrometry", Comparative Biochemistry and Physiology Part B, Biochemistry and Molecular Biology, Elsevier, Oxford, Vol. 136, 1 January 2003, p. 317-322	

ALL REFERENCES CONSIDERED EXCEPT WHERE LINED THROUGH. /D.W./

**INFORMATION DISCLOSURE
STATEMENT BY APPLICANT**
(Not for submission under 37 CFR 1.99)

Application Number	
Filing Date	2016-06-13
First Named Inventor	Inge Bruheim
Art Unit	
Examiner Name	
Attorney Docket Number	AKBM-14409/US-13/CON

2	TANAKA et al., 2004, "Extraction of Phospholipids from Salmon Roe with Supercritical Carbon Dioxide and an Entrainer", J. Oleo Sci, 53(9): 417-424
3	TANAKA et al., 2005, "Extraction of Phospholipids from Unused Natrual Resources with Supercritical Carbon Dioxide and an Entrainer", Journal of Oleo Science, Vol. 54(11): 569-576
4	TODORIC et al., 2006, "Adipose tissue inflammation induced by high-fat diet in obese diabetic mice is prevented by n-3 polyunsaturated fatty acids", Diabetologia, 49(9): 2109-2119
5	TOU et al., 2007, "Krill for human consumption: nutritional value and potential health benefits.", Nutrition Rev 65 (2):63-77
6	TRAYHURN et al., 2004, "Adipokines: inflammation and the pleiotropic role of white adipose tissue", Br. J. Nutrition, 92(3): 347-355
7	TREBBLE et al., 2003, "Inhibition of tumour necrosis factor-alpha and interleukin 6 production by mononuclear cells following dietary fish-oil supplementation in healthy men and response to antioxidant co-supplementation", Br. J. Nutrition, 90(2): 405-412
8	JKKOLA et al., 2002, "Adiponectin: a link between excess adiposity and associated comorbidities?", J. Mol. Med., 80 (11): 696-702
9	VAN DER VEEN et al., 1971 "The Lipids of Krill (Euphausia Species) and Red Crab (Pleuroncodes Planipes)", Lipids, 6(7): 481-485
10	VIRTUE, et al. 1996, Reproductive trade-off in male Antarctic krill, Euphausia superba", Marine Biology, Volume 126, Number 3, Pages 521-527
11	YAMAGUCHI et al., 1983, "The Composition of Carotenoid Pigments in the Antarctic Krill Euphausia superba", Bulletin of the Japanese Society of Scientific Fisheries, 49(9): 1411-1415
12	YAMAGUCHI et al., 1986, "Supercritical Carbon Dioxide Extraction Of Oils From Antarctic Krill," Journal Of Agricultural And Food Chemistry, vol. 34, pp. 904-907

ALL REFERENCES CONSIDERED EXCEPT WHERE LINED THROUGH. /D.W./

**INFORMATION DISCLOSURE
STATEMENT BY APPLICANT**
(Not for submission under 37 CFR 1.99)

Application Number		
Filing Date		2016-06-13
First Named Inventor	Inge Bruheim	
Art Unit		
Examiner Name		
Attorney Docket Number	AKBM-14409/US-13/CON	

13	YANASE M; 1974, "Modification of a Russian method for separation of heat-coagulated protein from Antarctic krill", Database FSTA (online); International Food Information Service (IFIS); FRANKFURT-MAIN, DE
14	YEN et al., 1994, "Effect of dietary omega-3 and omega-6 fatty acid sources on PUVA-induced cutaneous toxicity and tumorigenesis in the hairless mouse", Arch. Dermatol. Res., 286(6): 331-6
15	DATABASE WPI Week 200682, Thomson Scientific, London, GB, 2006
16	YANASE, M., "Modification of Russian Method for Separating Heat Congulated Protein from Antarctic Krill," Bull. Tokai Reg. Fish. Res. Lab, 78: 79-84 (1974)
17	SIKORSKI, E., "The Utilization of Krill For Food," Food Process Eng., 1:845-855 (1980)
18	BUDZINSKI, E., et al., "Possibilities of processing and marketing of products made from Antarctic Krill", FAO Fish. Tech. Pap. (268) 46 pages (1985) (BUDZINSKI)
19	BUNEA R., et al., "Evaluation of the Effects of Neptune Krill Oil on the Clinical Course of Hyperlipidemia," Alternative Medicine Review, Thorne Research Inc., Sandpoint, US, Vol. 9, No. 4, January 1, 2004
20	GORDEEV, K.Y., et al. "Fatty Acid Composition of the Main Phospholipids of the Antarctic Krill, Euphausia superba," Khim. Prirod. Soed. 2 (1990), pp. 181-187
21	December 8, 2011 Office Action, KR Patent Application No. 10-2010-7006897 and its English translation
22	JP Office Action mailed February 23, 2012, JP Patent Application No. 2010-522444 (and English translation)
23	CN Office Action mailed April 27, 2012, JP Patent Application No. 200880112125.6 (and English translation)

ALL REFERENCES CONSIDERED EXCEPT WHERE LINED THROUGH. /D.W./

**INFORMATION DISCLOSURE
STATEMENT BY APPLICANT**
(Not for submission under 37 CFR 1.99)

Application Number	
Filing Date	2016-06-13
First Named Inventor	Inge Bruheim
Art Unit	
Examiner Name	
Attorney Docket Number	AKBM-14409/US-13/CON

24	FRICKE, et al., Lipid, Sterol and Fatty Acid Composition of Antarctic Krill (<i>Euphausia superba</i> Dana), <i>Lipids</i> (1984) 19 (11): 821-827.
25	FRICKE, et al., 1-O-Alkylglycerolipids in Antarctic Krill (<i>Euphausia Superba</i> Dana), <i>Comp. Biochem. Physiol.</i> (1986) 85B(1): 131-134
26	GORDEEV, K.Y., et al. "Fatty Acid Composition of the Main Phospholipids of the Antarctic Krill, <i>Euphausia superba</i> ," <i>Chem. Nat. Compds.</i> (1990) 26(2), pp. 143-147
27	GRANTHAM (1977) Southern Ocean Fisheries Survey Programme, FAO Rome, GLO/SO/77/3: 1-61.
28	RAVENTOS et al., Application and Possibilities of Supercritical CO2 Extraction in Food Processing Industry: An Overview, <i>Food Science and Technology International</i> (2002) 8: 269-284
29	TANAKA, T., et al., Platelet-activating Factor (PAF)-like Phospholipids Formed during Peroxidation of Phosphatidylcholines from Different Foodstuffs, <i>Biosci. Biotech. Biochem.</i> (1995) 59 (8), pp. 1389-93
30	WINTHER, et al., Elucidation of Phosphatidylcholine Composition in Krill Oil Extracted from <i>Euphausia superba</i> , <i>Lipids</i> (2011) 46: 25-36
31	"Neptune Technologies & Bioresources Soon to Obtain a Major Patent in Over 30 Countries" ("2001 Press Release,")
32	Action Closing Prosecution, '348 patent
33	April 2, 2012 Response to Office Action, '351 patent
34	Balassa et al., Microencapsulation in the Food Industry, <i>Critical Reviews in Food Technology</i> , 2:2, 245-265 (1971) ("Balassa")

ALL REFERENCES CONSIDERED EXCEPT WHERE LINED THROUGH. /D.W./

**INFORMATION DISCLOSURE
STATEMENT BY APPLICANT**
(Not for submission under 37 CFR 1.99)

Application Number		
Filing Date		2016-06-13
First Named Inventor	Inge Bruheim	
Art Unit		
Examiner Name		
Attorney Docket Number	AKBM-14409/US-13/CON	

35	BELL and DICK, Molecular Species Composition of the Major Diacyl Glycerophospholipids from Muscle, Liver, Retina and Brain of Cod (<i>Gadus morhua</i>), <i>Lipids</i> , Vol. 26, No. 8, pp. 565-573 (1991) ("Bell and Dick")
36	BELL, Molecular Species Analysis of Phosphoglycerides from the Ripe Roes of Cod, <i>Lipids</i> , Vol. 24, No. 7 (1989)
37	BELL, Molecular Species Composition of Phosphatidylcholine from <i>Crypthecodinium cohnii</i> in Relation to Growth Temperature <i>Lipids</i> 25, 115-118 (1990)
38	BERGELSON (ed.), <i>Lipid Biochemical Preparations</i> , Chapter I.1, pp. 1-13 (1980)
39	BOTTINO N.R., "Lipid Composition of Two Species of Antarctic Krill: <i>Euphausia Superba</i> and <i>E. Crystallorophias</i> ," <i>Comp. Biochem. Physiol.</i> , 1975, Vol. 50B, pp. 479-484
40	Buchi R-220 Rotovapor® Manual
41	BUDA, Structural order of membranes and composition of phospholipids in fish brain cells during thermal acclimatization, <i>Proc. Natl. Acad. Sci. USA</i> Vol. 91, pp. 8234-8238, August 1994
42	Certificate of translation of Ex. 1072: Fisheries Agency, General Report on Research and Development of Techniques in Processing and Utilization of Marine Products, Chapter 6, Development of technology for recovery of valuable substances (astaxanthin) from krill, by Takao Fujita, pp. 273-307 (March 1985); Japanese language document
43	Certificate of translation of Ex. 1074: Japanese Patent No. 60-153779, entitled "Nutritional Supplement"
44	Certificate of translation of Ex. 1076: Japanese Patent Publication No. H08-231391, entitled "Medicine for Improvement of Dementia Symptoms"
45	Certification of translation of Ex. 1070: Japanese Unexamined Patent Application Publication No. 02-215351

ALL REFERENCES CONSIDERED EXCEPT WHERE LINED THROUGH. /D.W./

**INFORMATION DISCLOSURE
STATEMENT BY APPLICANT**
(Not for submission under 37 CFR 1.99)

Application Number	
Filing Date	2016-06-13
First Named Inventor	Inge Bruheim
Art Unit	
Examiner Name	
Attorney Docket Number	AKBM-14409/US-13/CON

46	Certified translation of Ex. 1070: Japanese Unexamined Patent Application Publication No. 02-215351, titled Krill Phospholipids Fractioning Method ("Maruyama,"); Certificate of Translation provided as Ex. 1071.
47	Certified translation of Ex. 1072: Fisheries Agency, General Report on Research and Development of Techniques in Processing and Utilization of Marine Products, Chapter 6, Development of technology for recovery of valuable substances (astaxanthin) from krill, by Takao Fujita, pp. 273-307 (March 1985) ("Fujita") ; Certificate of Translation provided as Ex. 1073.
48	Certified translation of Ex. 1074: Japanese Patent No. 60-153779, entitled "Nutritional Supplement" ("Fukuoka "); Certificate of Translation provided as Ex. 1075
49	Certified translation of Ex. 1076: Japanese Patent Publication No. H08-231391, entitled "Medicine for Improvement of Dementia Symptoms" ("Yasawa"); Certificate of Translation provided as Ex. 1077.
50	Declaration of Bjorn Ole Haugsgjerd in support of Inter Partes Review of U.S. Pat. No. 8,278,351

If you wish to add additional non-patent literature document citation information please click the Add button

EXAMINER SIGNATURE

Examiner Signature	/Deborah Ware/	Date Considered	07/11/2016
--------------------	----------------	-----------------	------------

*EXAMINER: Initial if reference considered, whether or not citation is in conformance with MPEP 609. Draw line through a citation if not in conformance and not considered. Include copy of this form with next communication to applicant.

¹ See Kind Codes of USPTO Patent Documents at www.USPTO.GOV or MPEP 901.04. ² Enter office that issued the document, by the two-letter code (WIPO Standard ST.3). ³ For Japanese patent documents, the indication of the year of the reign of the Emperor must precede the serial number of the patent document. ⁴ Kind of document by the appropriate symbols as indicated on the document under WIPO Standard ST.16 if possible. ⁵ Applicant is to place a check mark here if English language translation is attached.

ALL REFERENCES CONSIDERED EXCEPT WHERE LINED THROUGH. /D.W./

**INFORMATION DISCLOSURE
STATEMENT BY APPLICANT**
(Not for submission under 37 CFR 1.99)

Application Number			
Filing Date		2016-06-13	
First Named Inventor	Inge Bruheim		
Art Unit			
Examiner Name			
Attorney Docket Number		AKBM-14409/US-13/CON	

CERTIFICATION STATEMENT

Please see 37 CFR 1.97 and 1.98 to make the appropriate selection(s):

That each item of information contained in the information disclosure statement was first cited in any communication from a foreign patent office in a counterpart foreign application not more than three months prior to the filing of the information disclosure statement. See 37 CFR 1.97(e)(1).

OR

That no item of information contained in the information disclosure statement was cited in a communication from a foreign patent office in a counterpart foreign application, and, to the knowledge of the person signing the certification after making reasonable inquiry, no item of information contained in the information disclosure statement was known to any individual designated in 37 CFR 1.56(c) more than three months prior to the filing of the information disclosure statement. See 37 CFR 1.97(e)(2).

See attached certification statement.

The fee set forth in 37 CFR 1.17 (p) has been submitted herewith.

A certification statement is not submitted herewith.

SIGNATURE

A signature of the applicant or representative is required in accordance with CFR 1.33, 10.18. Please see CFR 1.4(d) for the form of the signature.

Signature	/J. Mitchell Jones/	Date (YYYY-MM-DD)	2016-06-13
Name/Print	J. Mitchell Jones	Registration Number	44174

This collection of information is required by 37 CFR 1.97 and 1.98. The information is required to obtain or retain a benefit by the public which is to file (and by the USPTO to process) an application. Confidentiality is governed by 35 U.S.C. 122 and 37 CFR 1.14. This collection is estimated to take 1 hour to complete, including gathering, preparing and submitting the completed application form to the USPTO. Time will vary depending upon the individual case. Any comments on the amount of time you require to complete this form and/or suggestions for reducing this burden, should be sent to the Chief Information Officer, U.S. Patent and Trademark Office, U.S. Department of Commerce, P.O. Box 1450, Alexandria, VA 22313-1450. **DO NOT SEND FEES OR COMPLETED FORMS TO THIS ADDRESS. SEND TO: Commissioner for Patents, P.O. Box 1450, Alexandria, VA 22313-1450.**

Privacy Act Statement

The Privacy Act of 1974 (P.L. 93-579) requires that you be given certain information in connection with your submission of the attached form related to a patent application or patent. Accordingly, pursuant to the requirements of the Act, please be advised that: (1) the general authority for the collection of this information is 35 U.S.C. 2(b)(2); (2) furnishing of the information solicited is voluntary; and (3) the principal purpose for which the information is used by the U.S. Patent and Trademark Office is to process and/or examine your submission related to a patent application or patent. If you do not furnish the requested information, the U.S. Patent and Trademark Office may not be able to process and/or examine your submission, which may result in termination of proceedings or abandonment of the application or expiration of the patent.

The information provided by you in this form will be subject to the following routine uses:

1. The information on this form will be treated confidentially to the extent allowed under the Freedom of Information Act (5 U.S.C. 552) and the Privacy Act (5 U.S.C. 552a). Records from this system of records may be disclosed to the Department of Justice to determine whether the Freedom of Information Act requires disclosure of these records.
2. A record from this system of records may be disclosed, as a routine use, in the course of presenting evidence to a court, magistrate, or administrative tribunal, including disclosures to opposing counsel in the course of settlement negotiations.
3. A record in this system of records may be disclosed, as a routine use, to a Member of Congress submitting a request involving an individual, to whom the record pertains, when the individual has requested assistance from the Member with respect to the subject matter of the record.
4. A record in this system of records may be disclosed, as a routine use, to a contractor of the Agency having need for the information in order to perform a contract. Recipients of information shall be required to comply with the requirements of the Privacy Act of 1974, as amended, pursuant to 5 U.S.C. 552a(m).
5. A record related to an International Application filed under the Patent Cooperation Treaty in this system of records may be disclosed, as a routine use, to the International Bureau of the World Intellectual Property Organization, pursuant to the Patent Cooperation Treaty.
6. A record in this system of records may be disclosed, as a routine use, to another federal agency for purposes of National Security review (35 U.S.C. 181) and for review pursuant to the Atomic Energy Act (42 U.S.C. 218(c)).
7. A record from this system of records may be disclosed, as a routine use, to the Administrator, General Services, or his/her designee, during an inspection of records conducted by GSA as part of that agency's responsibility to recommend improvements in records management practices and programs, under authority of 44 U.S.C. 2904 and 2906. Such disclosure shall be made in accordance with the GSA regulations governing inspection of records for this purpose, and any other relevant (i.e., GSA or Commerce) directive. Such disclosure shall not be used to make determinations about individuals.
8. A record from this system of records may be disclosed, as a routine use, to the public after either publication of the application pursuant to 35 U.S.C. 122(b) or issuance of a patent pursuant to 35 U.S.C. 151. Further, a record may be disclosed, subject to the limitations of 37 CFR 1.14, as a routine use, to the public if the record was filed in an application which became abandoned or in which the proceedings were terminated and which application is referenced by either a published application, an application open to public inspections or an issued patent.
9. A record from this system of records may be disclosed, as a routine use, to a Federal, State, or local law enforcement agency, if the USPTO becomes aware of a violation or potential violation of law or regulation.

Doc code: IDS
 Doc description: Information Disclosure Statement (IDS) Filed

PTO/SB/08a (03-15)
 Approved for use through 07/31/2016. OMB 0651-0031
 U.S. Patent and Trademark Office; U.S. DEPARTMENT OF COMMERCE
 Under the Paperwork Reduction Act of 1995, no persons are required to respond to a collection of information unless it contains a valid OMB control number.

INFORMATION DISCLOSURE STATEMENT BY APPLICANT (Not for submission under 37 CFR 1.99)	Application Number	
	Filing Date	2016-06-13
	First Named Inventor	Inge Bruheim
	Art Unit	
	Examiner Name	
	Attorney Docket Number	AKBM-14409/US-13/CON

U.S.PATENTS						Remove
Examiner Initial*	Cite No	Patent Number	Kind Code ¹	Issue Date	Name of Patentee or Applicant of cited Document	Pages,Columns,Lines where Relevant Passages or Relevant Figures Appear
	1	4119619		1978-10-10	ROGOZHIN SERGEI VASILIEVICH et al.	
	2	5434183		1997-07-18	LARSSON-BACKSTROM	
	3	6537787		2003-03-25	BRETON	
	4	6800299		2004-10-05	BEAUDOIN & MARTIN	

If you wish to add additional U.S. Patent citation information please click the Add button.

Add

U.S.PATENT APPLICATION PUBLICATIONS						Remove
Examiner Initial*	Cite No	Publication Number	Kind Code ¹	Publication Date	Name of Patentee or Applicant of cited Document	Pages,Columns,Lines where Relevant Passages or Relevant Figures Appear
	1	20030044495		2003-03-06	KAGAN and BRAUN	
	2	20040241249		2004-12-02	SAMPALIS	

If you wish to add additional U.S. Published Application citation information please click the Add button.

Add

FOREIGN PATENT DOCUMENTS						Remove
--------------------------	--	--	--	--	--	--------

**INFORMATION DISCLOSURE
STATEMENT BY APPLICANT**
(Not for submission under 37 CFR 1.99)

Application Number		
Filing Date		2016-06-13
First Named Inventor	Inge Bruheim	
Art Unit		
Examiner Name		
Attorney Docket Number	AKBM-14409/US-13/CON	

Examiner Initial*	Cite No	Foreign Document Number ³	Country Code ^{2j}	Kind Code ⁴	Publication Date	Name of Patentee or Applicant of cited Document	Pages, Columns, Lines where Relevant Passages or Relevant Figures Appear	T ⁵
	1	8701265	BR		1987-03-12	SATO		
	2	1098900	CA		1981-04-07	ROGOZHIN, et al		
	3	0609078	EP		1994-08-03	SCOTIA HOLDINGS PLC		
	4	1127497	EP		2001-08-29	NIPPON SUISAN KAISHA LTD		
	5	1406641	EP		2004-04-14	NEPTUNE TECHNOLOGIES & BIORESSOURCES INC.		
	6	0670306	EP		1995-06-09	NIPPON OIL CO. LTD		
	7	2097014	GB		1982-10-27	BAIKOFF		
	8	921537	GB		1999-06-09	PICKER NORDSTAR INC.		
	9	02049091	JP		1990-02-19	SUNTORY LTD		
	10	2215351	JP		1990-08-28	TAIYO FISHERY CO LTD		