

DECLARATION OF JINSUNG CHOI, PH.D.
CONCERNING THE PUBLICATION OF A PAPER AUTHORED BY DR. CHOI

I, Jinsung Choi, declare as follows:

1. I am currently employed by Qorvo, Inc., which is an American semiconductor company that designs, manufactures, and supplies radio-frequency (RF) systems and solutions for wireless and broadband communications. I have worked at Qorvo for approximately six years. At Qorvo, I am a member of the technical staff. In that role, I contribute to the design of RF components such as switches and low noise amplifiers. A copy of my curriculum vitae is attached hereto as Exhibit A.

2. I earned my Bachelor of Science degree in electrical engineering from Pohang University of Science and Technology in South Korea in 2003. I earned my Doctor of Philosophy degree in electrical engineering from Pohang University of Science and Technology in 2009.

3. I am the co-author of a paper entitled “Envelope Tracking Power Amplifier Robust to Battery Depletion” (the “Choi 2010 paper”), submitted as Exhibit B to this declaration. The paper was published by the Institute of Electrical and Electronics Engineers (IEEE) in 2010. According to the IEEE website (<https://ieeexplore.ieee.org/document/5517825/>), the paper was added to IEEE’s digital library—IEEE *Xplore*—on July 23, 2010.

4. Earlier in 2010, I attended the IEEE International Microwave Symposium (“IMS”) 2010 conference, held in Anaheim, California from May 23 to 28, 2010. The IMS is an annual technical conference for professionals specializing in RF/microwave theory and applications. The conference is well publicized in the field, and is open to any member of the public interested in the topic. On information and belief, the IMS is the largest gathering of RF/microwave professionals in the world.

5. The IMS 2010 conference was attended by hundreds of people. These attendees included many engineers specializing in RF circuit and power supply design for RF. The

conference included, for example, leading engineers in these areas from academia and industry, including many electrical engineers with multiple years' experience designing RF circuits and/or power supplies. At the time of the IMS 2010 conference, I had earned my doctorate in electrical engineering and had over five years' experience designing RF circuits and power supplies.

6. I presented the Choi 2010 paper at the IMS 2010 conference during the Power Amplifier Circuits technical session on Wednesday, May 26, 2010. About a hundred people attended the session where I presented my paper, and there were also other parallel sessions.

7. Before the IMS 2010 conference, a program book was made available to attendees and potential attendees. A copy of that program book is attached as Exhibit C. My presentation is listed on page 40 of the program book, in the middle column, near the bottom, at the WEPF-5 session. The program book confirms my memory that I presented the Choi 2010 paper on Wednesday, May 26, 2010.

8. People registering for IMS 2010 could pay a small extra fee to receive a USB drive. The fees for registration and the USB drive are shown at page 9 of the program book (Exhibit C). My understanding is that each USB drive contained PDF copies of the presented papers, including a copy of my Choi 2010 paper.

9. I also recall that IMS 2010 had printing stations set up at the conference venue. Attendees could use any of these printing stations to print a copy of any paper being presented at the conference, including my own paper. These printing stations are mentioned on page 5 of the program book (Exhibit C), which states that "Print on Demand (PoD) is back again and will be available at a centralized station located in the Registration area at the Anaheim Convention Center. This will allow all registered attendees to print out any paper FREE!" This is what I recall seeing at IMS 2010.

10. No confidentiality restrictions were imposed on attendees at IMS 2010, and no confidentiality restrictions were placed on any of the papers contained on the USB drives. Attendees were free to disseminate and discuss the technical material presented during the conference.

11. I am not receiving any compensation for my declaration or testimony in this matter, aside from my standard Qorvo salary, which does not depend on my submission of this declaration or its contents.

12. I declare that all statements made herein of my own knowledge are true and that all statements made on information and belief are believed to be true; and further that these statements were made with the knowledge that willful false statements and the like are punishable by fine or imprisonment, or both, under Section 1101 of Title 18 of the United States Code.

Signed: JINSUNG CHOI

Dated: May, 20, 2018

EXHIBIT A

JINSUNG, CHOI

3401 Iron Point Drive APT520, San Jose, CA 95134

Tel: 336-338-0168

E-mail: jinsungc@gmail.com

Highlights

- 7 years of industry RFIC design experience with multi-million parts in production
- Self-motivated, proactive and dedicated team player
- 36 registered patents in United States & 13 research publications (cited more than 1000 times)
- Ph. D. in Electrical Engineering (thesis: Envelope tracking PAs)
- IEEE Senior Member
- Multiple awards from Employer and Conferences

Experience

June 2012 – Present Qorvo, San Jose, CA

Member of Technical Staff in Advanced Development Team

- ✓ Lead analog/RF IC design engineer (2015-)
 - Sub-6GHz 5G NR module (2017-)
 - ◆ Lead SOI LNA and switch
 - +90dBm IIP3 high linearity antenna switch module in 0.13um SOI technology (2016)
 - ◆ Developed RF SOI switch design optimization tool
 - ◆ Achieved record-high switch linearity
 - Mid/high-bands switchable diplexer in 0.13um SOI technology (2015)
 - ◆ In mass production for multiple customers
- ✓ Analog/RF IC design engineer (2012-2014)
 - Mid/high-bands antenna switch modules in 0.24um SOI technology (2014)
 - ◆ In mass production for a top customer
 - 802.11g/n/ac RF power amplifiers in 0.35um SiGe BiCMOS technology (2012-2013)
 - ◆ Invented a dynamic biasing technique for pulsed PA operations

Jan. 2010 – Apr. 2012 Samsung Advanced Institute of Technology, Yongin, South Korea

Member of Research Staff in Signal and Systems Lab.

- ✓ Designed power amplifiers and transmitters for highly efficient and adaptive wireless power transmission system based on a magnetic resonant coupling

Mar. 2004 – Dec. 2009 POSTECH, Pohang, South Korea

Research Assistant in MMIC Lab.

- ✓ Designed RF power amplifiers, transmitters, and power management ICs for high linearity and high efficiency
 - Delta-sigma modulator (DSM) based polar transmitter for CDMA application
 - Multi-mode envelope tracking power amplifier for EDGE/WCDMA/Mobile-WiMax
 - Envelope tracking Doherty power amplifier
 - Boosted PA supply modulator for 4.5V PA operation

Aug. 2005 – Dec. 2005 University of Waterloo, Ontario, Canada

- ✓ Visiting Scholar, Electrical and Computer Engineering

Education

- ✓ Pohang University of Science and Technology (POSTECH), Korea
 - Ph. D., Electrical Engineering (Feb. 2010)
 - Advisor: Prof. Bumman Kim, IEEE Fellow
 - Thesis: A study on polar modulated power transmitters for wireless communication
- ✓ Pohang University of Science and Technology (POSTECH), Korea
 - B. Sc., Electrical Engineering (Feb. 2004)

Specialization, Accomplishments, and Strengths

- ✓ RF front-ends circuits
- ✓ Power management IC for RF power amplifiers
- ✓ Digitally assisted analog/RF circuit design in CMOS technology

Technical Skills

1. Analog/RF circuit design and system synthesis: Cadence Design System, Advanced Design System, Momentum/FEM, and MATLAB/Simulink
2. RF and Microwave Measurements

Membership, Activities & Awards

1. Senior Member of IEEE
2. Member of Technical Program Committee for IEEE Tropical Conference on RF Power Amplifiers for Radio and Wireless Applications (PAWR) since 2013
3. Reviewer of IEEE Transactions on Circuits and Systems II (TCAS-II) *since 2009*
4. Reviewer of IEEE Microwave Theory and Techniques (TMTT) *since 2009*
5. Reviewer of IEEE Microwave and Wireless Components Letters (MWCL) *since 2009*
6. Reviewer of Journal of Electromagnetic Waves and Applications (JEMWA) *since 2009*
7. Bronze Prize Winner in 15th Samsung Human-Tech Thesis Prize, Feb. 2009.
8. Samsung outstanding paper in the 16th Korean Conference on Semiconductors, Feb. 2009.

9. Proud Samsung Employee Award, Dec. 2010.

Publications and Presentations

Journal Papers (cited more than 1000 times)

1. Nam Yoon Kim, Ki Young Kim, **Jinsung Choi**, and Chang-Woo Kim, "Adaptive frequency with power-level tracking system for efficient magnetic resonance wireless power transfer," *Electronics Letters*, vol. 48, no. 8, pp. 452-454, April 2012.
2. **Jinsung Choi**, Dongsu Kim, Daehyun Kang, and Bumman Kim, "A new power management IC architecture for envelope tracking power amplifier," *IEEE Trans. Microw. Theory Tech.*, vol. 59, no. 7, pp. 1796-1802, July 2011.
3. Dongsu Kim, Daehyun Kang, **Jinsung Choi**, Jooseung Kim, Yunsung Cho, and Bumman Kim, "Optimization for envelope shaped operation of envelope tracking power amplifier" *IEEE Trans. Microw. Theory Tech.*, vol. 59, no. 7, pp. 1787-1795, July 2011.
4. Daehyun Kang, Dongsu Kim, **Jinsung Choi**, Jooseung Kim, Yunsung Cho, and Bumman Kim, "A multimode/multiband power amplifier with a boosted supply modulator," *IEEE Trans. Microw. Theory Tech.*, vol. 58, no. 10, pp. 2598-2608, Oct. 2010.
5. Daehyun Kang, **Jinsung Choi**, Dongsu Kim, and Bumman Kim, "Design of Doherty power amplifiers for handset applications," *IEEE Trans. Microw. Theory Tech.*, vol. 58, no. 8, pp. 2134-2142, Aug. 2010.
6. **Jinsung Choi**, Daehyun Kang, Dongsu Kim, Jungmin Park, Boshi Jin, and Bumman Kim, "Power amplifiers and transmitters for next generation mobile handset," *invited paper* in Journal of Semiconductor Technology and Science, Dec. 2009.
7. **Jinsung Choi**, Dongsu Kim, Daehyun Kang, and Bumman Kim, "A polar transmitter with CMOS programmable hysteretic-controlled hybrid switching supply modulator for multi-standard applications," *IEEE Trans. Microw. Theory Tech.*, vol. 57, no. 7, pp. 1675-1686, July 2009.
8. **Jinsung Choi**, Daehyun Kang, Dongsu Kim, and Bumman Kim, "Optimized envelope tracking operation of Doherty power amplifier for high efficiency over an extended dynamic range," *IEEE Trans. Microw. Theory Tech.*, vol. 57, no. 6, pp. 1508-1515, June 2009.
9. Boshi Jin, Kichon Han, **Jinsung Choi**, Daehyun Kang, and Bumman Kim, "The fully-integrated CMOS RF power amplifier using the semi-lumped transformer," *Microwave and Optical Technology Letters*, vol. 50, no. 11, pp. 2857-2860, Nov. 2008.
10. Hyejeong Song, Huijung Kim, Kichon Han, **Jinsung Choi**, Changjoon Park, and Bumman Kim, "A Sub-2 dB NF dual-band CMOS LNA for CDMA/WCDMA applications," *IEEE Microw. Wireless Compon. Lett.*, vol. 18, no. 1, pp. 49-51, Jan. 2008.
11. Daehyun Kang, Daekyu Yu, Kyoungjoon Min, Kichon Han, **Jinsung Choi**, Dongsu Kim, Boshi Jin, Myongsu Jun and Bumman Kim, "A highly efficient and linear class-AB/F power amplifier for multi-mode operation," *IEEE Trans. Microw. Theory Tech.*, vol. 56, no. 1, pp. 77-87, Jan. 2008.

12. **Jinsung Choi**, Jeonghyun Yim, Jinho Yang, Jinguook Kim, Jeonghyun Cha, Daehyun Kang, Dongsu Kim, and Bumman Kim, "A delta-sigma-digitized polar RF transmitter," *IEEE Trans. Microw. Theory Tech.*, vol. 55, no. 12, pp. 2679-2690, Dec. 2007.
13. Huijung Kim, Seonghan Ryu, Yujin Chung, **Jinsung Choi**, and Bumman Kim, "A Low Phase Noise CMOS VCO with Harmonic Tuned LC Tank," *IEEE Trans. Microw. Theory Tech.*, vol. 54, no. 7, pp. 2917-2924, Jul. 2006.

Conference Papers

1. Ki Young Kim, Changwook Yoon, Nam Yoon Kim, **Jinsung Choi**, Young-Ho Ryu, Dong-Zo Kim, Keum-Su Song, Chi-Hyung Ahn, Eunseok Park, Yun-Kwon Park, and Sangwook Kwon, "Magnetic resonance wireless power transfer system for practical mid-range distance powering scenario references," *Consumer Electronics (ICCE), 2013 IEEE International Conference on*, vol., no., pp.175,176, 11-14 Jan. 2013
2. Dong-zo Kim, Ki Young Kim, **Jinsung Choi**, Young-ho Ryu, Yoon-kwon Park, Sangwook Kwon, Youngjin Moon, and Changsik Yoo, "High Efficient Power Receiver IC with Load Modulator for Wireless Resonant Power Transfer," in *Proc. 42nd Eur. Microw. Conf.*, Oct 2012.
3. Nam Yoon Kim, Ki Young Kim, **Jinsung Choi**, Young-ho Ryu, Dong-zo Kim, Changwook Yoon, Sangwook Kwon, and Yoon-kwon Park, "Automated Adaptive Frequency Tracking System for Efficient Mid-Range Wireless Power Transfer via Magnetic Resonance Coupling," in *Proc. 42nd Eur. Microw. Conf.*, Oct 2012.
4. Ki Young Kim, Young-Ho Ryu, Eunseok Park, Nam Yoon Kim, **Jinsung Choi**, Dong-zo Kim, Changwook Yoon, Keum-su Song, Chi-hyung Ahn, Yoon-kwon Park, and Sangwook Kwon, "Power Transfer Efficiency in Magnetic Resonance Wireless Power Link Including Relay Resonator with Non-Coaxially Aligned," in *Proc. 42nd Eur. Microw. Conf.*, Oct 2012.
5. **Jinsung Choi**, Young-Ho Ryu, Dong-zo Kim, Nam Yoon Kim, Changwook Yoon, Ki Young Kim, Yoon-kwon Park, Sangwook Kwon, and Youngoo Yang, "Design of Wireless Power Charging Pad based on Magnetic Resonance Coupling," in *Proc. 42nd Eur. Microw. Conf.*, Oct 2012.
6. Changwook Yoon, Nam Yoon Kim, Ki Young Kim, **Jinsung Choi**, Dong-Zo Kim, Young-Ho Ryu, Yun-Kwon Park, and Sangwook Kwon, "Analysis of power/ground resonance frequency in printed circuit board inside strong magnetic field for wireless power transmission (WPT) system," in *32nd Progress in Electromagnetics Research Symposium in Moscow (PIERS 2012)*, Moscow, Russia, August 19-23, 2012.
7. Nam Yoon Kim, Ki Young Kim, **Jinsung Choi**, Changwook Yoon, Dong-Zo Kim, Young-Ho Ryu, Keum-Su Song, Chi-Hyung Ahn, Yun-Kwon Park, and Sangwook Kwon, "Automated adaptive frequency and power-level tracking system for near-to mid-range wireless power transfer via magnetic resonance coupling," in *32nd Progress in Electromagnetics Research Symposium in Moscow (PIERS 2012)*, Moscow, Russia, August 19-23, 2012.

8. Daehyun Kang, **Jinsung Choi**, Dongsu Kim, Bumman Kim, "LTE power amplifier for envelope tracking polar transmitters," in *Proc. 40th Eur. Microw. Conf.*, Paris, France, Sep. 2010.
9. Bumman Kim, Daehyun Kang, **Jinsung Choi**, and Dongsu Kim, "Doherty power amplifiers for handset applications", *invited paper in 18th Int. Conf. on Microw., Radar., Wireless Commun. MIKON-2010*, Lithuania, June, 2010.
10. Dongsu Kim, **Jinsung Choi**, Daehyun Kang, and Bumman Kim, "High Efficiency and Wideband Envelope Tracking Power Amplifier with Sweet Spot Tracking," in *IEEE Radio Frequency Integrated Circuits (RFIC) Symp.*, Anaheim, CA, USA, 23~25 May, 2010.
11. **Jinsung Choi**, Dongsu Kim, Daehyun Kang, Jungmin Park, Boshi Jin, and Bumman Kim, "Envelope Tracking Power Amplifier Robust to Battery Depletion," in *IEEE MTT-S Int. Microw. Sympo. Dig.*, Anaheim, CA, USA, 23~28 May, 2010.
12. Daehyun Kang, **Jinsung Choi**, Dongsu Kim, Daekyu Yu, Kyoungjoon Min, and Bumman Kim, "30.3% PAE HBT Doherty power amplifier for 2.5~2.7 GHz Mobile WiMAX," in *IEEE MTT-S Int. Microw. Symp. Dig.* Anaheim, USA, May, 2010.
13. Bumman Kim, **Jinsung Choi**, Daehyun Kang, and Dongsu Kim, "A Multi-mode envelope tracking power amplifier for software defined radio transmitters," *invited paper in IEEE Int. Microw. Workshop Series on RF Front-ends for Software Defined and Cognitive Radio Solutions*, Feb. 2010.
14. **Jinsung Choi**, Dongsu Kim, Daehyun Kang, Jungmin Park, Boshi Jin, and Bumman Kim, "A CMOS PA supply modulator robust to battery depletion," in *17th Korean Conference on Semiconductors*, Daegu, Korea, Feb. 2010.
15. Bumman Kim, **Jinsung Choi**, Daehyun Kang, and Dongsu Kim, "Optimized Envelope Tracking Operation of Doherty PA," *invited paper in 3rd Int. Conf. on Signals, Circuits, and Systems*, Nov. 2009.
16. Bumman Kim, **Jinsung Choi**, Daehyun Kang, and Dongsu Kim, "Envelope tracking technique for multimode PA operation," *invited paper in Proc. 39th Eur. Microw. Conf.*, Oct. 2009.
17. Daehyun Kang, **Jinsung Choi**, Myoungsu Jun, Dongsu Kim, Jungmin Park, Boshi Jin, Daekyu Yu, Kyungjun Min, and Bumman Kim, "Broadband class-F power amplifiers for handset applications," in *Proc. 39th Eur. Microw. Conf.*, Oct. 2009.
18. Dongsu Kim, **Jinsung Choi**, Daehyun Kang and Bumman Kim, "A wideband CMOS hybrid switching supply modulator for polar transmitter," *best paper awards in 9th RF Integrated Circuit Tech. Workshop*, Jeju, Korea, Sep. 2009.
19. Bumman Kim, **Jinsung Choi**, Daehyun Kang and Dongsu Kim, "Multi-mode power amplifier based on the mode-dependent power supply modulator," *invited talk in 9th RF Integrated Circuit Tech. Workshop*, Jeju, Korea, Sep. 2009.
20. **Jinsung Choi**, Dongsu Kim, Daehyun Kang, Myoungsu Jun, Boshi Jin, Jungmin Park, and Bumman Kim, "A 45/46/34% PAE linear polar transmitter for EDGE/WCDMA/Mobile-WiMax," in *IEEE MTT-S Int. Microw. Sympo. Dig.*, Boston, MA, June 2009, vol. 1, pp. 413-416.

21. Daehyun Kang, **Jinsung Choi**, Daekyu Yu, Kyungjun Min, Dongsu Kim, Myoungsu Jun, Jungmin Park, Boshi Jin, and Bumman Kim, "Input power dividing of Doherty power amplifiers for handset applications," in *IEEE MTT-S Int. Microw. Sympo. Dig.*, Boston, MA, June 2009, vol. 1, pp. 421-424.
22. Bumman Kim and **Jinsung Choi**, "A new emerging technology of digitally assisted RF circuits," *invited talk in IEEE Mini-Colloquium on Nano-Scale Devices and Circuits*, Seoul, Korea, Apr. 2009.
23. **Jinsung Choi**, Dongsu Kim, Daehyun Kang, Myoungsu Jun, Boshi Jin, Jungmin Park, and Bumman Kim, "A PA supply modulator for multi-standard polar transmitter in 0.13um CMOS technology," *Samsung Awards in 16th Korean Conference on Semiconductors*, Daejeon, Korea, Feb. 2009.
24. **Jinsung Choi**, "A linear polar transmitter with CMOS programmable hysteretic-controlled supply modulator for multi-standard applications," *Bronze Prize Winner in 15th Samsung Human-Tech Thesis Prize*, Feb. 2009.
25. Boshi Jin, **Jinsung Choi**, Daehyun Kang, Myoungsu Jun, and Bumman Kim, "Optimized design of wideband transformer for handset CMOS power amplifier application," in *Asia-Pacific Microwave Conference (APMC) 2008*, Hongkong, China.
26. Daehyun Kang, Daekyu Yu, Kyoungjoon Min, **Jinsung Choi**, Myoungsu Jun, Dongsu Kim, and Bumman Kim, "Class-AB/F Doherty amplifier," *Proc. 38th Eur. Microw. Conf.*, Amsterdam, Netherlands, Oct. 2008, pp. 230-233.
27. Bumman Kim and **Jinsung Choi**, "Delta-sigma modulator (DSM) based polar transmitter," *presented in IEEE MTT-S Int. Microw. Sympo. Dig.*, Atlanta, Georgia, USA, WMA: Highly efficient linear power transmitters for wireless applications based on switching mode amplifiers, Jun. 2008.
28. Bumman Kim, Jangheon Kim, **Jinsung Choi**, and Ildu Kim, "Performance enhancement of linear power amplifier employing digital technique," *invited paper in Proc. IEEE Int. Symp. Circuits Systems*, Seattle, WA (USA), May 2008.
29. Bumman Kim, Jangheon Kim, **Jinsung Choi**, and Ildu Kim, "Power amplifiers for next generation transmitters," *invited talk in 2008 International Conference on Microwave and Millimeter Wave (ICMMT2008)*, Nanjing, China, Apr. 2008.
30. Bumman Kim, **Jinsung Choi**, and Ildu Kim, "High efficiency RF transmitter modulating power supply," *invited paper in 8th Int. Conf. on Telecommunication in Modern Satellite, Cable and Broadcasting Services (TELSIKS)*, Nis, Serbia, Sep. 2007.
31. Bumman Kim and **Jinsung Choi**, "Delta-Sigma based polar transmitter," *invited talk in 7th RF Integrated Circuit Tech. Workshop*, Jeju, Korea, Sep. 2007.
32. Bumman Kim, Jangheon Kim, Ildu Kim, and **Jinsung Choi**, "Recent works on power amplifiers and transmitters," *invited talk in 2007 RF Power Amplifier Workshop*, Seoul, Korea, Aug. 2007, vol. 1, pp. 5-35.

33. **Jinsung Choi**, Jounghyun Yim, Jinho Yang, Jinguook Kim, Jeonghyun Cha, and Bumman Kim, "A delta-sigma-digitized RF transmitter," in *IEEE MTT-S Int. Microw. Sympo. Dig.*, Honolulu, Hawaii, June 2007, vol. 1, pp. 81-84.
34. Bumman Kim, Youngyoon Woo, Huijung Kim, **Jinsung Choi**, and Jinho Yang, "3G & 4G handset transmitter based on switching power amplifiers," in *IEEE MTT-S Int. Microw. Sympo. Dig.*, San Francisco, USA, WMB: Switching mode amplifiers with applications to wireless transmitter design, Jun. 2006, pp. 115-132.
35. Jinho Yang, Huijung Kim, Changjoon Park, **Jinsung Choi**, Jehyung Yoon, and Bumman Kim, "Improving the linearity of CMOS low noise amplifier using multiple gated transistors," 2006 Korea Society of Electrical Eng. Summer Workshop, vol. 29, no. 1, Jun. 2006, pp. 505-506.
36. **Jinsung Choi**, Seonghan Ryu, Huijung Kim, and Bumman Kim, "A low phase noise 2 GHz VCO using 0.13 um CMOS process," *Asia-Pacific Microwave Conference (APMC) 2005*, Suzhou, China, Dec., 2005, pp. 2270-2272.
37. Seonghan Ryu, Yujin Chung, Huijung Kim, **Jinsung Choi** and Bumman Kim, "Phase noise optimization of CMOS VCO through harmonic tuning," in *IEEE Radio Frequency Integrated Circuit (RFIC) Sympo.*, Long Beach, CA (USA), Jun. 2005, pp. 403-406.

Registered Patents

1. 9,520,837, "Pulse Shaping Biasing Circuitry"
2. 9,160,283, "Integrated Pulse Shaping Biasing Circuitry"
3. 9,160,421, "Method and Apparatus for Controlling Wireless Power Transmission and Reception, And Wireless Power Transmission System"
4. 9,431,707, "Apparatus and Method for Wireless Power Transmission Including a Source Resonator Having a Substantially Uniform Magnetic Field"
5. 9,543,766, "Resonance Power Transmission System and Method to Control Resonance Power Transmitting and Receiving"
6. 9,502,174, "Wireless Power Transmission Apparatus and Wireless Power Reception Apparatus"
7. 9,437,362, "Method and Apparatus for Wireless Power Reception"
8. 9,130,515, "Apparatus and Method for Balanced Power Amplifying"
9. 9,287,735, "Wireless Power Transmission System and Multi-Mode Resonator in Wireless Power Transmission System"
10. 9,413,429, "Wireless Power Transmission System Based on Cell Division"
11. 9,418,785, "Wireless Power Transmission System with Enhanced Magnetic Field Strength"
12. 9,493,084, "Source Device and Method for Controlling Magnetic Field Using Two Source Resonators in Wireless Power Transmission System"
13. 9,065,488, "Method and Apparatus for Data Communication in Wireless Power Transfer"
14. 9,369,007, "Apparatus and Method for Wireless Power Transmission"

15. 9,350,193, "Method and Apparatus for Detecting Load Fluctuation of Wireless Power Transmission"
16. 9,178,568, "Apparatus and Method for Communication Using Wireless Power"
17. 9,484,985, "Apparatus and Method for Communication Using Wireless Power"
18. 9,391,461, "Wireless Power Transmission and Charging System, And Power Control Method of Wireless Power Transmission and Charging System"
19. 8,971,399, "Apparatus and Method for High Efficiency Variable Power Transmission"
20. 9,083,178, "Apparatus for and Method of Protecting Wireless-Coupled Power Devices from Overvoltage, Overcurrent, And Overtemperature Using Hysteresis"
21. 9,444,247, "Apparatus and Method of Protecting Power Receiver of Wireless Power Transmission System"
22. 8,730,697, "Method and Apparatus for Wireless Power Transmission Using Power Receiver"
23. 9,030,052, "Apparatus and Method for Using Near Field Communication and Wireless Power Transmission"
24. 9,509,166, "Apparatus and Method for Wireless Power Transmission"
25. 9,272,630, "Electronic Device and Method for Transmitting and Receiving Wireless Power"
26. 9,000,620, "Apparatus and Method That Divide Wireless Power in Wireless Resonant Power Transmission System"
27. 9,431,830, "Apparatus and Method for Wireless Power Transmission"
28. 9,225,176, "Apparatus and Method for High Efficiency Variable Power Transmission"
29. 9,124,115, "High Efficiency Rectifier, Wireless Power Receiver Including the Rectifier"
30. 9,484,737, "Protector of Rectifier and Wireless Power Receiver Including Protector"
31. 9,214,818, "Wireless Power Transmission System, And Method of Controlling Transmission and Reception of Resonance Power"
32. 9,553,456, "Power Converter in Resonance Power Transmission System, And Resonance Power Transmission Apparatus"
33. 9,431,889, "Active Rectifier with Delay Locked Loop, Wireless Power Receiving Apparatus Including Active Rectifier"
34. 8,987,942, "Wireless Power Transmitter and Method That Transmits Resonance Power Using Multiple Bands"
35. 8829849, "Roof Type Charging Apparatus Using Resonant Power Transmission"
36. 9,337,691, "Wireless Charging Set"

Pending Patents

1. 15/400,348, "Resonance Power Transmission System and Method to Control Resonance Power Transmitting and Receiving"
2. 15/351,078, "Source Apparatus and Method That Control Magnetic Field Using Two Source Resonators in Wireless Resonant Power Transfer System"
3. 15/218,142, "Wireless Power Transmission System Based On Cell Division"

4. 15/177,732, "Apparatus and Method for Wireless Power Transmission"
5. 15/054,824, "Electronic Device and Method for Transmitting and Receiving Wireless Power"
6. 14/929,811, "Apparatus and Method for Communication Using Wireless Power"
7. 14/142,571, "Apparatus and Method for Resonance in Wireless Power Transmission System"
8. 13/675,055, "Wireless Power Transmission System, And Method of Controlling Power in Wireless Power Transmission System Based On Detection Parameter"
9. 13/938,671, "Wireless Power Transmitter, Wireless Power Relay Apparatus, And Wireless Power Receiver"
10. 13/742,992, "Wireless Power Transmission System and Method for Increasing Coupling Efficiency by Adjusting Resonant Frequency"
11. 13/671,027, "Wireless Power Transmission System and Method Based On Impedance Matching Condition"
12. 14/980,886, "Apparatus and Method for High Efficiency Variable Power Transmission"
13. 14/089,112, "Apparatus and Method for Charge Control in Wireless Charging System"
14. 13/211,687, "Resonance Power Transmission System Based On Power Transmission Efficiency"
15. 14/708,844, "Apparatus and Method for Using Near Field Communication and Wireless Power Transmission"
16. 14/023,758, "Apparatus and Method for Controlling Resonator of Wireless Power Transfer System"
17. 13/614,098, "Wireless Power Transmission System, Resonator in Wireless Power Transmission System, And Resonator Design Method for Optimum Power Division"
18. 13/602,524, "Sound System Using Wireless Power Transmission"

Written in Aug. 30, 2017

By Jinsung Choi

EXHIBIT B

Envelope Tracking Power Amplifier Robust to Battery Depletion

Jinsung Choi, Dongsu Kim, Daehyun Kang, Jungmin Park, Boshi Jin, and Bumman Kim

Department of Electrical Engineering, Pohang University of Science and Technology,
Gyeongbuk, Republic of Korea
jinsungc@ieee.org

Abstract—A wideband envelope tracking power amplifier, which is robust to battery depletion, is introduced. An integrated boost converter keeps a stable operation of the PA supply modulator. Even at the battery depletion from 4.2V to 2.8V, there is no significant degradation of output power and linearity in the power amplifier. Moreover, the efficiency degradation by the additional regulator is minimized for the novel supply modulator architecture proposed in this work. The fabricated 2.535GHz envelope tracking power amplifier presents max/min power-added efficiencies of 32.3/26.2% for 10MHz BW 3GPP LTE standard along the battery voltage from 4.2V to 2.8V.

I. INTRODUCTION

As the wireless communication systems evolve, the peak-to-average power ratio (PAPR) of the signal increases. For 2G and 3G systems such as CDMA, EDGE, and WCDMA, the PAPRs of the signals are around 3.5dB as depicted in Fig. 1. For the next generation communication systems such as 3GPP LTE and Mobile-WiMAX, however, an orthogonal frequency-division multiplexing (OFDM) is employed for a wideband communication, which results in higher PAPR around 8–10dB. In the case, an efficiency of a radio frequency (RF) power amplifier (PA) is so low that the efficiency improvement technique is required. The envelope tracking (ET) technique is one of the best way achieving a high efficiency. Because the supply of the RF PA is modulated according to the instantaneously transmitted power level, the power dissipated as a heat is minimized. Ideally, it is the optimum PA architecture with assumption of high efficiency supply modulator. In [1], the low drop-out (LDO) regulator is employed as a supply modulator. It operates over a wide bandwidth, but efficiency of the LDO is not high enough for high PAPR signals. The switching mode power supply such as a buck converter shows a high efficiency, but the switching frequency is limited by the switching loss so that wide bandwidth capability can not be fulfilled [2].

At the same time, due to battery depletion, the performances of PAs such as output power and efficiency are degraded as shown in Fig. 2-a and Fig. 3. In the envelope tracking power amplifier, the battery is directly coupled to the PA supply modulator as illustrated in Fig. 2-b. Therefore, the supply voltage of the PA depends on the topology of the supply modulator. For the step-down converter such as the LDO and the buck converter, the output voltage swings are limited by the minimum battery voltage, as there is always a voltage drop across the transistor between the battery and the load. To prevent the degradation of the output power, a boost converter,

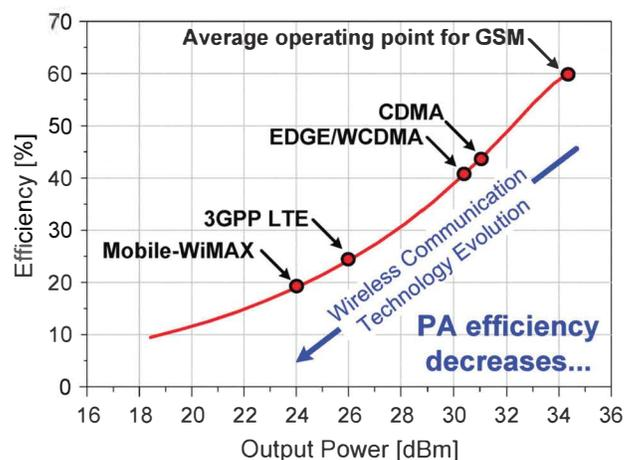

Fig. 1. Efficiencies of PA for various applications

whose output voltage is always higher than the input voltage, can be utilized [3]. However, drawback of employing the boost converter is that it is not possible to deliver the load voltage lower than the battery voltage. As the efficiency improvement at a low power region becomes very important, a good low voltage operation of the PA should be achieved. Therefore, the buck-boost converter taking advantage of the buck and boost converters is suitable for the application [4].

Still, the power converters mentioned above are not the best solution for the modern PA applications. It works well for average power tracking of the PA, but the instantaneous bias modulation is impossible due to the bandwidth limitation of the switching mode power supply. As the PAPR increases, the efficiency at the specific average power level is so low that the instantaneous bias modulation is essential.

In this paper, a new supply modulator architecture employing a hybrid switching amplifier and a boost converter is proposed. The hybrid switching amplifier (HSA) combines the advantage of the LDO and buck converter and simultaneously achieves high efficiency and linearity [5]-[8]. By boosting up the supply voltage of the linear amplifier to 5V regardless of the battery voltage variation, while that of the buck converter is still coupled to the battery in the HSA, the supply modulator dynamically regulates the PA with the peak voltage of 4.5V. The implemented 2.535GHz ET PA delivers the output power of 25.8dBm with the maximum PAE of 32.3% for 10MHz

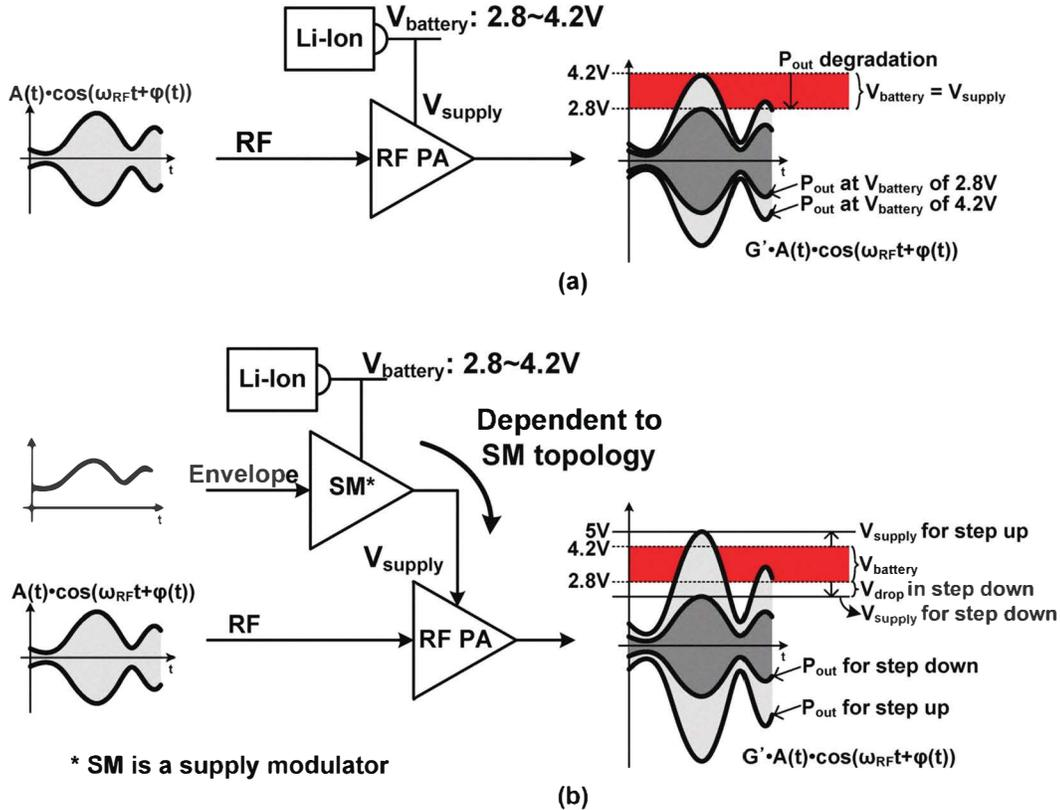

Fig. 2. Battery depletion in (a) general power amplifiers and (b) envelope tracking power amplifiers. In the general PA, the output power is degraded according to the battery depletion. In the ET PA, however, the supply voltage of the PA is coupled to the supply modulator so that it depends on the topology of the supply modulator. With the step-down supply modulator, the regulated supply voltage of RF PA is always lower than the minimum battery voltage, while it is always higher than the maximum battery voltage with the step-up supply modulator.

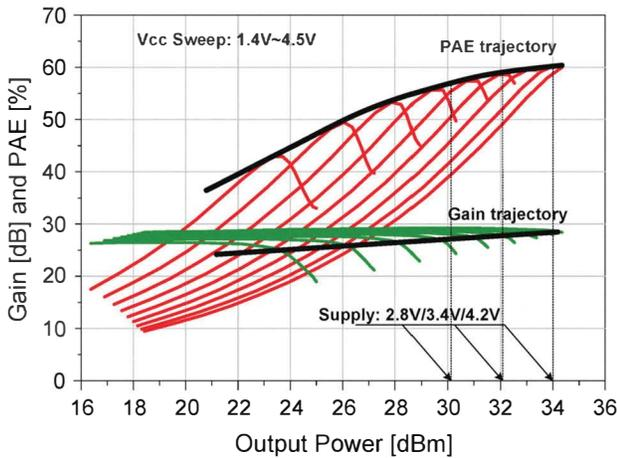

Fig. 3. Simulation results of RF PA: PAE and gain with the supply voltage from 1.4V to 4.5V.

BW 3GPP LTE standard. Thanks to the robust performance of the proposed architecture, there is no degradation of the output power, gain, and linearity with only a slight decrease in efficiency [9].

II. DESIGN OF ET PA ROBUST TO BATTERY DEPLETION

In the HSA, as shown in Fig. 4, the LDO operates as an independent voltage source with a low output impedance, while the switching buck converter roles as a dependent current source with a high output impedance and supplies most of the current needed at the output. The current sensing unit detects the current flowing from the linear amplifier to the output and it changes the state of the switching amplifier according to the magnitude and polarity of the sensed current. For the control of the switching buck converter, the self-oscillating architecture through the hysteretic operation is employed. Compared with pulse-width modulation, it shows the reduced switching frequency resulting in low switching loss. This is advantageous in the wideband application such as WiMAX and 3GPP LTE.

As the load voltage is regulated by the linear amplifier, boosting up the supply voltage of the linear amplifier results in a stable supply voltage to the RF PA regardless of the battery depletion. Thus, the additional 5V boost converter, whose input range is from 2.8V to 4.2V, is coupled to the supply of the linear amplifier, while that of the switching amplifier is directly connected to the battery as illustrated in Fig. 5. Even though the V_{Load} in Fig. 5 is instantaneously higher than the battery voltage, the current through the inductor does not flow

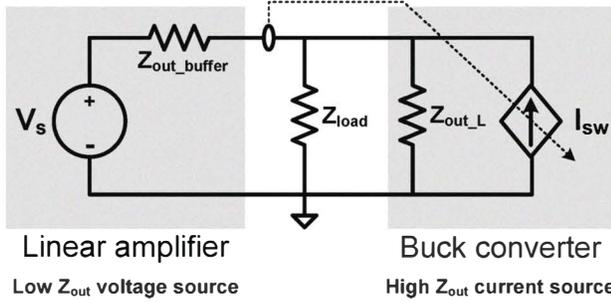

Fig. 4. Simplified block diagram of a hybrid switching amplifier.

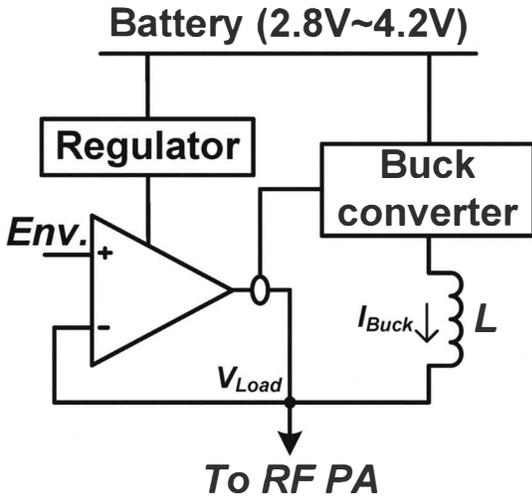

Fig. 5. Battery-to-5V boosting PA supply modulator.

in an opposite direction because the output impedance of the switching buck converter is high enough.

In the proposed architecture, the efficiency degradation by the additional boost converter is not serious because the load current provided by the linear amplifier is about 30% of the overall load current. Assuming that $\eta_{linear}/\eta_{boost}/\eta_{switch}$ of each block are 50%, 90% and 90%, respectively, the efficiency of the proposed supply modulator is 76.5%, while that of the conventional HSA without the boost converter is 78%. When the boost converter regulates the whole HSA, the supplies of linear amplifier and switching amplifier together, the efficiency drops to 70.2%. There is a 6.3% efficiency improvement of the supply modulator while achieving the robust operation against the battery depletion.

As the supply voltage of the modulator is boosted up to the 5V, considering the 0.5V drop across the modulator, the PA now operates with 4.5V supply voltage. In this case, to meet the 2W output power level, the maximum current of the power cell is 1A while it is 1.6A for the PA with the supply voltage of 3V. It stands for the 1.6 times smaller cell size, and directly results in smaller die size and routing loss, which means the lower cost and higher efficiency. To cover the 3GPP LTE band VII, the PA is designed to operate at 2.535GHz with 70MHz channel bandwidth. With the class-AB bias condition,

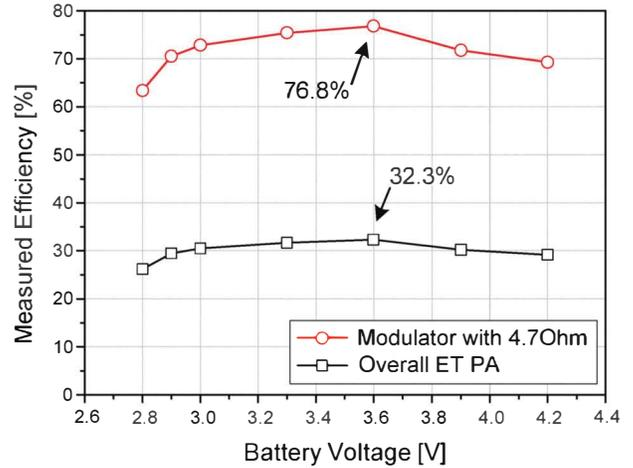

Fig. 6. Measured efficiencies of the 5V boosting envelope tracking PA for 3GPP LTE application.

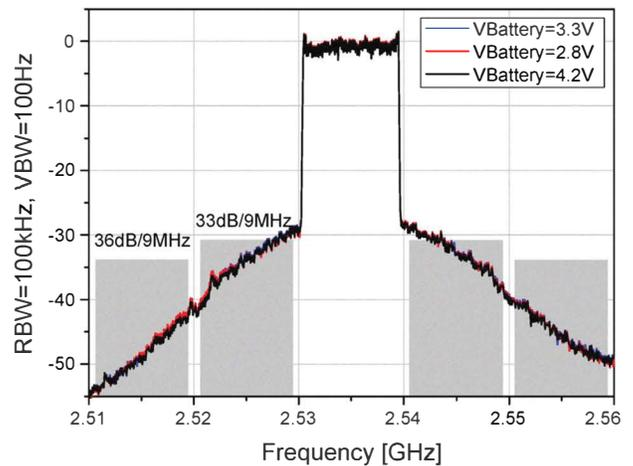

Fig. 7. Measured spectra of the 5V boosting envelope tracking PA for 3GPP LTE application.

the designed two-stage PA delivers 34dBm output power with the 60% PAE.

III. MEASUREMENT RESULTS

The fabricated supply modulator delivers 4.5V peak voltage 10MHz 3GPP LTE envelope signal to the 4.7Ohm load with the maximum efficiency of 76.8%. The LTE envelope signal is shaped for the linear operation of the RF PA [8]. With 2.535GHz class-AB HBT PA, the ET PA presents the maximum PAE of 32.3% at the average output power of 25.8dBm for 3GPP LTE. The worst-case efficiency of 26.2% is obtained at the supply voltage of 2.8V. The efficiencies over the battery voltage from 4.2V to 2.8V are presented in Fig. 6. The output spectra of the ET PA with various battery voltages are shown in Fig. 7. They satisfy the spectrum emission mask, and there is no degradation of the output power and the linearity according to the battery voltage variation from 4.2V to 2.8V. The proposed supply modulator is fabricated in 0.18um CMOS process with 3.3V compatible I/O devices. The die micrograph

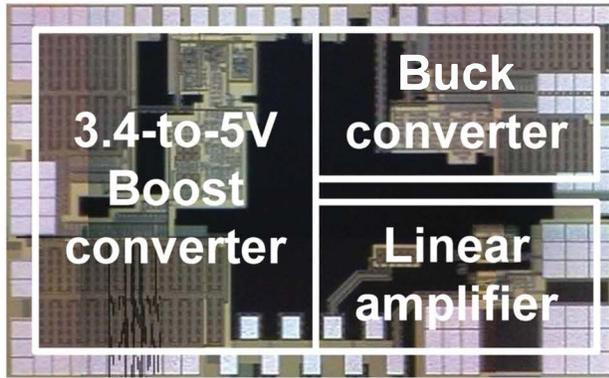

Fig. 8. Microphotograph of the fabricated boosting supply modulator.

of the chip is shown in Fig. 4. The area including all pads is $2.6 \times 1.7 \text{ mm}^2$.

IV. CONCLUSIONS

The voltage-boosting hybrid switching supply modulator is proposed and designed using the TSMC 0.18 μm CMOS technology. It enables the high voltage operation of the RF PA resulting in the overall performance enhancement over the broad operating frequency range. The fabricated chip is composed of the battery-to-5V boost converter, the linear class-AB amplifier and the highly efficient buck converter. The supply voltage of the linear amplifier is boosted to 5V, and it enables the RF PA operating with the maximum 4.5V supply voltage regardless of the battery depletion. For 10MHz BW 3GPP LTE shaped envelope signal, it provides the maximum output voltage of 4.5V to the 4.7 Ω resistive load with 76.8% efficiency. With the 2.535GHz class-AB PA, it shows the overall PAE of 32.3% at the output power of 25.8dBm. For the additional boost converter, the proposed supply modulator presents the robust performance over the battery voltage variation while the efficiency degradation is minimized.

V. ACKNOWLEDGEMENT

This work was supported by ETRI SoC Industry Promotion Center, Human Resource Development Project for IT SoC Architect, by WCU (World Class University) program through the Korea Science and Engineering Foundation funded by the Ministry of Education, Science and Technology (Project No. R31-2008-000-10100-0), and supported by the Ministry of Knowledge Economy, Korea, under the ITRC (Information Technology Research Center) support program supervised by the IITA (Institute of Information Technology Advancement) (IITA-2009-C1090-0902-0037).

REFERENCES

[1] P. Raynaert and S. Steyaert, "A 1.75-GHz polar modulated CMOS RF power amplifier for GSM-EDGE," *IEEE J. Solid-State Circuits*, vol. 40, no. 12, pp. 2598–2608, Dec. 2005.

- [2] J. Staudinger, B. Gilsdorf, D. Newman, G. Norris, G. Sadowiczak, R. Sherman, and T. Quach, "High efficiency CDMA power amplifier using dynamic envelope tracking technique," in *IEEE MTT-S Int. Microw. Symp. Dig.*, June. 2000, pp. 873–976.
- [3] G. Hanington, P. Chen, P. M. Ashbeck, and L. E. Larson, "High-efficiency power amplifier using dynamic power-supply voltage for CDMA applications," *IEEE Trans. Microw. Theory Tech.*, vol. 47, no. 8, pp. 1471.1476, Aug. 1999.
- [4] B. Sahu, and G. A. Rincon-mora, "A high efficiency WCDMA RF power amplifier with adaptive, dual-mode buck-boost supply and bias-current control," *IEEE Microw. Compon. Lett.*, vol. 17, no. 3, pp. 238–240, Mar. 2007.
- [5] T. Kwak, M. Lee, B. Choi, H. Le, and G. Cho, "A 2W CMOS hybrid switching amplitude modulator for EDGE polar transmitter," *IEEE Int'l Solid State Circ. Conf. Dig. Tech. Papers*, Feb. 2007, pp. 518–519.
- [6] F. Wang, D. F. Kimball, D. Y. Lie, P. M. Asbeck, and L. E. Larson, "A monolithic high-efficiency 2.4-GHz 20-dBm SiGe BiCMOS envelope-tracking OFDM power amplifier," *IEEE J. Solid-State Circuits*, vol. 42, no. 6, pp. 1271–1281, June 2007.
- [7] W. Chu, B. Bakaloglu, and S. Kiaei, "A 10MHz-bandwidth 2mV-ripple PA-supply regulator for CDMA transmitters," *IEEE Int'l Solid State Circ. Conf. Dig. Tech. Papers*, Feb. 2008, pp. 448–449.
- [8] J. Choi, D. Kim, D. Kang, and B. Kim, "A polar transmitter with CMOS programmable hysteretic-controlled hybrid switching supply modulator for multistandard applications," *IEEE Trans. Microw. Theory Tech.*, vol. 57, no. 7, pp. 1675–1686, July 2009.
- [9] J. Choi, D. Kim, D. Kang, and B. Kim, "Envelope tracking power amplifier with CMOS supply modulator robust to battery depletion," unpublished.

EXHIBIT C



2010

IEEE MTT-S
INTERNATIONAL



MICROWAVE SYMPOSIUM

MAY 23-28, 2010 • ANAHEIM, CALIFORNIA

THE GOLDEN STATE OF MICROWAVES



ANAHEIM

CALIFORNIA

Sunday

07:00-08:00 – Workshop and Short Course Breakfast RFIC Attendee Breakfast 07:00-08:00	08:00 Full-Day and Morning Workshops and Short Courses	13:00 Afternoon Workshops
	WSA: Software Defined Radio for Microwave Applications	WSB: Advances in Filtering and Sampling for Integrated Transceivers
	WSC: Interference, Noise and Coupling Effects in Modern SoC and SiP Products: Issues, Problems and Solutions	
	WSD: Ultra-Wideband (UWB) Technology: The State-of-the-Art and Applications	
	WSE: High Speed Signal Integrity Workshop	
	WSF: GaN for High Power, High Bandwidth Applications, Finally Fulfilling the Promise	
	WSG: MOSFET Modeling for RFIC Design Based On the Industry-Standard PSP Model	
	WSH: Power Management for Integrated RF Circuits: Challenges and Solutions	
	WSI: Substrate Integrated Circuits (SICs)	
	WSJ: Re-configurable Multi-Radios at the Nanoscale	
	WSK: Multi-Mode Front End Design Challenges and Techniques	
	WSL: Silicon-Based Technologies for Millimeter-Wave Applications	
WSM: RF Packaging Solutions for Wireless Communication Platforms		
WSN: The State of Art of Microwave Filter Synthesis, Optimization and Realization		
Registration 07:00-18:00 • RFIC Plenary Session 17:30-19:00 (ACC Room 210)		

Monday

07:00-08:00 – Workshop and Short Course Breakfast RFIC Attendee Breakfast 07:00-08:00	08:00 Full-Day and Morning Workshops and Short Courses	12:00-13:10 Panel	13:00 Afternoon Workshops
	WMA: SiGe HBTs towards THz Operation	Hubbert's Peak, The Coal Question, and Climate Change (ACC Room 210AB)	WMF: High Efficiency High Power Microwave Amplifiers for High Data Rate Space Communications
	WMB: Advances in Photovoltaic Solar Cell Technology and its Possible Applications in Microwave Communications Systems as an Energy Source		
	WMC: Recent Advancements and Challenges in mm-Wave Applications and Systems		
	WMD: New Microwave Devices and Materials Based on Nanotechnology		
	WME: High-Power-Density Packaging of Gallium Nitride		
	WMG: Ultra-high Speed Microwave and Photonic Devices and Systems: How will they be tested?		
	WMH: 3D Microwave and Millimeter-Wave Packaging	The Challenges, Competitions and Future Prospect of 60 GHz (ACC Room 210CD)	
	WMI: Making Reliable Measurements at Millimeter and Submillimeter Wavelengths		
	WMJ: Recent Advances in Reconfigurable Filters		
	WMK: RF MEMS for Antennas and Integrated RF Front End		
	SC-1: Theory and Design of Phased Locked Loop		
SC-2: Low Phase Noise Oscillators: Lecture (theory and design) and Laboratory			
SC-2A: Low Noise Oscillators: Lecture Only			
SC-3: Microwave Packaging and Manufacturing 101			
Registration 07:00-18:00 • RFIC Symposium 08:00-17:10			

Tuesday

07:00-08:00 Attendee Breakfast	08:00-09:40 TU1 Oral Sessions	10:10-11:50 Plenary Session	12:00-13:10 Panel	13:20-15:00 TU3 Oral Sessions	15:30-17:10 TU4 Oral Sessions	
	TU1A: Novel Guiding and Radiating Structure (ACC Room 203B)	Plenary Session (ACC Third Level Ballroom A-C)	Silicon at THz Frequencies: A Reality or a Dream? (ACC Room 210AB)	TU3A: Time-Domain Techniques and Applications (ACC Room 203B)	TU4A: Advances in Space Mapping Technologies (ACC Room 203B)	
	TU1B: Metamaterial Structures, Phenomena, and Applications (ACC Room 205AB)			TU3B: Advances in Power Divider/Combiner Technology (ACC Room 205AB)	TU4B: Ultra Wide Band Planar Filters and Devices (ACC Room 205AB)	
	TU1C: Submillimeter-Wave Amplifiers and Enabling Components (ACC Room 206AB)			TU3C: III-V Compound Semiconductor Based Microwave Circuit Technology (ACC Room 206AB)	TU4C: Millimeter-Wave Power Amplifiers and Power-Combining Techniques (ACC Room 206AB)	
	TU1D: Beamforming and Retrodirective Arrays (ACC 202AB)			Future of High-Speed I/O: Electrical, Optical or Wireless? (ACC Room 210CD)	TU3D: Advances in Radar Systems for Detection in Detection, Imaging, Mapping and Localization (ACC Room 202AB)	TU4D: Novel Circuit and System Technologies for Wireless Communication (ACC Room 202AB)
					TU3E: Novel Structures, Effects and Techniques (ACC Room 207C)	TU4E: Microwave and Millimeter Wave VCO's (ACC Room 207C)
	Registration 07:00-18:00 • IMS Exhibition 09:00-17:00 • Micro Apps 09:10-16:50 • IMS Interactive Forum 15:00-17:00 (ACC Room 204 ABC) • RFIC Symposium 08:00-17:10 • RFIC Interactive Forum 14:00-17:00					

Wednesday

07:00-08:00 Attendee Breakfast	08:00-09:40 WE1 Oral Sessions	10:10-11:50 WE2 Oral Sessions	12:00-13:10 Panel	13:20-15:00 WE3 Oral Sessions	15:30-17:10 WE4 Oral Sessions	
	WE1A: Modeling and Characterization of Devices (ACC Room 205AB)	WE2A: Nonlinear circuit analysis and system modeling (ACC Room 205AB)	Semiconductor Technology Impact on Microwave and Millimeter Wave Markets (ACC Room 210AB)	WE3A: Frequency-domain based modeling of microwave components (ACC Room 205AB)	WE4A: RFID and power harvesting technologies (ACC Room 205AB)	
	WE1B: New Synthesis Techniques for Filter and Multiplexers (ACC Room 206AB)	WE2B: Novel Techniques for Planar Filter Design (ACC Room 206AB)		WE3B: Novel 3-dB Coupler Structures (ACC Room 206AB)	WE4B: Novel Transmission Structures and Characterization (ACC Room 206AB)	
	WE1C: Advanced Millimeter-Wave Packaging (ACC Room 207AB)	WE2C: Advances in Measurement: Microwaves Through Sub-Millimeter-Waves (ACC Room 207AB)		WE3C: Microwave Photonic Technologies (ACC Room 207AB)	WE4C: Novel Technological Realizations of Filters and Multiplexers (ACC Room 207AB)	
	WE1D: Advances in microwave sensors and objects detection systems (ACC Room 207C)	WE2D: RF and Microwave in Medicine: Medical Sensors and Devices (ACC Room 207C)		WE3D: RF and Microwave in Medicine: Imaging and Monitoring (ACC Room 207C)	WE4D: High-speed Signal Processing Circuits for Wireless and Optical Communication Systems (ACC Room 207C)	
	WE1E: Advances in Low Noise Technologies (ACC Room 207D)	WE2E: Emerging Technologies for mm to Submm systems (ACC Room 207D)		Standardizing Attributes for RF and Microwave Components and Assemblies - The Time is Now? (ACC Room 210CD)	WE3E: Frequency Conversion and Control Component IC's (ACC Room 207D)	WE4E: Power-Amplifier and Combiner Techniques for HF, VHF, and UHF (ACC Room 207D)
	WE1F: High Efficiency Power Devices in Various Technologies (ACC Room 208AB)	WE2F: Power Amplifiers Systems Concepts (ACC Room 208AB)			WE3F: Techniques to Enhance Power Amplifier Linearity and Efficiency (ACC Room 208AB)	WE4F: Novel Si-based devices and Circuits (ACC Room 208AB)
	WE1G: Status and Trends in E-scan Radar for Air- and Spaceborne Applications (ACC Room 209AB)	WE2G: Trends in Future Systems with Low Cost Phased Array (ACC Room 209AB)	WE3G: Microwave Space Sensors (ACC Room 209AB)		WE4G: CAD Techniques and Methodologies: Future Directions (ACC Room 209AB)	
					SPECIAL SESSION IN HONOR OF DR. KIYO TOMIYASU (ACC Room 210AB)	
	Registration 07:00-18:00 • IMS Exhibition 09:00-18:00 • Micro Apps 09:10-17:50 • IMS Interactive Forum 15:00-17:00 (ACC Room 204 ABC)					

Thursday

07:00-08:00 Attendee Breakfast	08:00-09:40 TH1 Oral Sessions	10:10-11:50 TH2 Oral Sessions	12:00-13:10 Panel	13:20-15:00 TH3 Oral Sessions	15:30-17:10 TH4 Oral Sessions	
	TH1A: Filter Terahertz Electronics (ACC Room 205AB)	TH2A: Wide Bandgap Semiconductor Applications (ACC Room 205 AB)	On-Die Synthesized Inductors: Boon or Bane? (ACC Room 210AB)	TH3A: Advances in Silicon-based Millimeter-Wave Integrated Circuits (ACC Room 205AB)	TH4A: Microwave High Power Processes: Modeling and Applications (ACC Room 205AB)	
	TH1B: RF-MEMS Circuits (ACC Room 206AB)	TH2B: RF MEMS Switches and Switched Capacitors (ACC Room 206AB)		TH3B: Ferrite Materials and Devices (ACC Room 206AB)	TH4B: Ferro-Electric and Acoustic Devised and Components (ACC Room 206AB)	
	TH1C: Large Signal Measurements (ACC Room 207AB)	TH2C: Phased Array Systems and Integration (ACC Room 207AB)		TH3C: Tunable, active and integrated filter technologies (ACC Room 207AB)	TH4C: Compact reconfigurable filter technology (ACC Room 207AB)	
	TH1D: Developments in Microwave Signal Generation (ACC Room 207C)	TH2D: Novel Concepts for Advanced Packaging and Interconnect Technologies (ACC Room 207C)		TH3D: High Power and Broad Band Amplifiers (ACC Room 207C)	TH4D: Advances in Doherty Power Amplifier Technology (ACC Room 207C)	
	TH1E: Advances in Active Device Modeling (ACC Room 207D)	TH2E: Advances in MMIC Packaging (ACC Room 207D)		RF GaN Reliability: Where does the Technology Stand? (ACC Room 210CD)	TH3E: The Impact of Nanoelectronics on Radio Frequency Technology (ACC Room 207D)	TH4E: Advances in RFID Circuits and Systems (ACC Room 207D)
		GOLD PANEL SESSION: WE WANT YOU! BUT, WHAT'S IN IT FOR ME? 10:20-11:40 (ACC Room 208AB)				
	Registration 07:00-16:00 • IMS Exhibition 09:00-15:00 • Micro Apps 09:10-13:10 • IMS Interactive Forum 09:40-11:40, 15:00-17:00 (ACC Room 204 ABC)					

Friday

07:00-08:00 – Workshop and Short Course Breakfast	08:00 Full-Day and Morning Workshops and Short Courses
	WFA: The Expanding Role of GaN in RF Systems
	WFB: Wireless Power Transmission
	WFC: Millimeter-Wave SiGe/CMOS and III-V Chips and Imaging Systems
	WFF: New Theories, Applications and Practices of Electromagnetic Field Simulators
	WFG: Emerging Optical Modulator Technologies for RF Photonics
	WFI: Practical Metamaterial RF and Antennas for Commercial Application
ARFTG Conference and Interactive Forum 08:00-17:00 • ARFTG Late Registration 07:00-09:00	

TABLE OF CONTENTS

<p>RFIC Reception 19:00-21:00 ACC Room 213</p>	<p>Los Angeles County Museum of Art, Petersen Automotive Museum & La Brea Tar Pits 10:00-17:30</p>	23 May 2010
	<p>Newport Harbor Cruise 13:30-16:30</p>	
<p>IMS 2010 Welcome Reception 18:00-20:00 Hilton Hotel, Sunset Deck</p>	<p>Quiet on the Set! 09:00-14:30</p>	24 May 2010
	<p>A Presidential Peek 13:00-17:00</p>	
<p>Special Luncheon for Chuck Swift 12:00-14:00 ACC Rooms AR1&2</p> <p>Women In Engineering Reception 17:30-19:30 Uva Bar Downtown Disney</p> <p>Ham Radio Social 18:00-21:00 Hilton Hotel Room California A</p> <p>Student Reception 19:00-21:00 Hilton Hotel Room California B</p>	<p>In Vino Veritas- Wine Country of Temecula 8:15-16:30</p> <p>Brushstrokes of Laguna 10:30-14:30</p>	25 May 2010
<p>Industry Hosted Cocktail Reception 17:00-18:00 ACC Exhibition Floor</p> <p>MTT-S Awards Banquet 19:00-22:00 Hilton Hotel, California Room</p>	<p>The Glitz and Glamour... An Inside Look 10:00-16:30</p> <p>Windows of Discovery at Bowers Museum 11:15-13:45</p>	26 May 2010
<p>MTT-S Student Awards Luncheon 12:00-14:00 Hilton Hotel, California B</p> <p>MTT-S Graduates of the Last Decade (GOLD) Reception 17:30-19:00 300 Anaheim</p>	<p>Landmarks of Long Beach 08:45-14:45</p> <p>Secrets of the Sea 09:00-12:00</p>	27 May 2010
	<p>The Getty Center 09:30-14:30</p>	28 May 2010

MICROWAVE WEEK	
IMS Chair's Message	4
Things to Note for Your Ultimate Microwave Week Experience!	5
IEEE and MTT-S Membership	6
Advance and On-site Registration	7-10
US Visa Advisory	11
Accommodations	12-13
About Anaheim and Transportation	14-15
IMS TECHNICAL PROGRAM	
Technical Program Chair's Message	16
Monday Panel Session	17
Tuesday	18-29
Technical Sessions	
Panel, Special, and Focused Sessions	
Student Paper Competition	
Interactive Forum	
Wednesday	30-42
Technical Sessions	
Interactive Forum	
Panel, Special, and Focused Sessions	
Special Session in Honor of Dr. Kiyo Tomiyasu	
Thursday	43-57
Technical Sessions	
Interactive Forum	
Panel, Special, and Focused Sessions	
Steering Committee	58-59
Technical Program Committee	60
MTT-S Administrative Committee	61
Future IMS Locations	61
MTT-S Awards and IEEE Fellows	62-63
RFIC TECHNICAL PROGRAM	
Chair's Message	64
Plenary and Panel Sessions	65-67
Technical Program	68-72
Committees	73
ARFTG TECHNICAL PROGRAM	
Chair's Message and Committees	74
Technical Program	75
WORKSHOPS AND SHORT COURSES	
Sunday	76-81
Monday	82-88
Friday	89-91
EXHIBITION	
Commercial Exhibit	92-95
MicroApps	96-97
SOCIAL EVENTS AND GUEST PROGRAM	
Social Events	98
Hospitality Suite, Recreational Activities, and Golf Course Descriptions	99-106
Convention Center Maps	107



WELCOME FROM THE IMS CHAIR

On behalf of the entire 2010 International Microwave Symposium Steering Committee, it is an honor and pleasure to both invite, and welcome, you to Anaheim for Microwave Week. The Steering Committee has endeavored to attract the best workshops, technical papers, sessions, short courses, and microwave exhibition possible from around the world.

During Microwave Week, May 23rd through May 28th, you will be able to participate in the Radio-Frequency Integrated Circuit Symposium (www.rfic2010.org), International Microwave Symposium (www.ims2010.org), and the 75th Automatic Radio-Frequency Test Group Conference (www.arftg.org). In conjunction with the IMS, you will have the opportunity to attend the world's largest microwave industry exhibition featuring over 808 booths from more than 484 exhibitors. Microwave week offers an unmatched opportunity for networking and interacting with leading researchers and professionals from all aspects of radio-frequency and microwave fields.

All registered attendees are encouraged, and welcome, to attend the Plenary Session. This year's Keynote Address is being provided by the Honorable Zachary Lemnios, whose talk is entitled "A Strategic View of Defense Research and Engineering".

An extensive guest program allowing all ages to experience many of the wonderful aspects Anaheim and Southern California has been arranged. A children friendly hospitality suite will be available to assist and provide additional individual options to all guests as needed.

Anaheim has significantly expanded dining and social opportunities since we were last here in 1999. Downtown Disney and the newly completed Garden Walk along with top name restaurants are now available. Local transportation may not be required as these are within easy walking distance. Anaheim Resort Transit is available should one desire.

Please have a wonderful time attending IMS2010 in Anaheim!

Best regards,

JK





THINGS TO NOTE FOR YOUR ULTIMATE MICROWAVE WEEK EXPERIENCE!

Plenary Session

The Plenary Session will be held on Tuesday Morning, starting at 10:10 AM. All registered attendees are encouraged to come and hear Honorable Zachary Lemnois, Director of the Defense Research and Engineering Office of the Secretary of Defense. See page 19 for more details.

Student Paper Competition

The Student Paper Competition posters will be available all day in Room 213AB on Tuesday along with the Student Design Competitions organized by the various Technical Coordinating Committees (TCC's) of the IEEE MTT Society. See pages 21–23 for a complete listing of the Student Paper Finalists and information on the various design competitions.

Panel Sessions

Panel Sessions present current opinions on hot topics. Order optional and convenient box lunches with your registration so you can keep up to date on the latest topics without skipping lunch!

Interactive Forum

The IMS Interactive Forum will include demonstrations, hardware, and simulations presented by authors. Authors will be available to discuss their work from 15:00 to 17:00 each afternoon of the IMS, including Tuesday, Wednesday, and Thursday, and in addition, in the morning at 9:40 to 11:40 a.m. on Thursday. All IMS Interactive Forum Sessions will be located in Room 204 ABC. Please review the IMS Technical program section for specifics on the posters.

MicroApps

Informative MicroApps seminars from vendors of products and services in the microwave industry will be presented daily in the updated MicroApps Theater. Do not miss the “key-note” talks by David Root of Agilent (Nonlinear Analog Behavioral Modeling of Microwave Devices and Circuits) on Wednesday at 9:50 AM and Jim Rautio of Sonnet (Title: A Tutorial on Silicon Spiral Inductor Ground Return Effects on RFIC Design) on Wednesday at 5:20 PM. Please see pages 96 – 97 for the detailed schedule of topics and speakers.

Exhibition

Free Exhibit Only registration for Wednesday has returned. Come experience the many vendors and learn about recent advances within the Microwave industry. Be sure to be on the exhibit floor on Wednesday afternoon from 5:00 PM to 6:00 PM for the Industry Hosted Reception. Please come and visit as drinks and refreshments will be provided throughout the show floor. A complete list of participating companies is available on pages 92 – 97.

Hospitality Suite and Guest Program

Families and guests will enjoy the hospitality suite located in the Sheraton Park next door to the Hilton. A children friendly hospitality suite will be available to come and relax in a comfortable, welcoming environment. Please visit pages 99 – 106 to plan your tours and activities while in Anaheim!

Print on Demand

Print on Demand (PoD) is back again and will be available at a centralized station located in the Registration area at the Anaheim Convention Center. This will allow all registered attendees to print out any paper FREE!



IEEE AND MTT-S MEMBERSHIPS

IEEE

The IEEE is a nonprofit, professional association with more than 375,000 members (including 80,00 students) in over 160 countries. This global organization helps support the development and application of technology and science around the world for the benefit of humanity, the individual, and the profession.

MTT-S

The IEEE Microwave Theory and Techniques Society (MTT-S) is a transnational society with more than 11,000 members and 125 chapters worldwide. Our society promotes the advancement of microwave theory and its applications, at frequencies from 200 MHz to 1 THZ and beyond. As we enter into an exciting future, our mission is to continue to understand and influence microwave technology.

Benefits of Membership

The benefits of IEEE membership include:

- Discounted conference registration rates
- Subscriptions to the award-winning IEEE Spectrum and online access to IEEE Potentials magazines
- Online access to the tables of contents and expanded abstract from over million IEEE documents with full text-searching capability
- Free IEEE e-mail alias including virus scanning and optional spam filtering
- The IEEE Financial Advantage- negotiated exclusively for IEEE member

Join the IEEE and MTT-S

Web: <http://www.ieee.org/web/membership/join/join.htm>

Phone:

- (US and Canada): + 1.800.678.4333
- (Worldwide): + 1.732.981.0060

Attendees who join the IEEE for \$84.50 and MTT-S for \$7.00 before the Symposium will save \$195 on their registration fee. The price of an IEEE/MTT-S membership more than pays for itself!

Half-year rates apply to new members only. New applications received between 1 March 2010 and 15 August 2010

will automatically be processed for half-year membership. An exception is if the application specifically requests their application be processed for the full year.

IEEE and MTT-S Membership Dues

Residence	IEEE Half Year Dues		MTT-S Half Year Dues	
	Member	Student	Member	Student
United States	\$84.50	\$15.00	\$7.00	\$3.50
Canada (Including GST)	\$77.23	\$15.90	\$7.00	\$3.50
Canada (Including HST)	\$82.39	\$17.10	\$7.00	\$3.50
Africa, Europe, Middle East	\$71.00	\$12.50	\$7.00	\$3.50
Latin America	\$66.50	\$12.50	\$7.00	\$3.50
Asia, Pacific	\$67.00	\$12.50	\$7.00	\$3.50

The optional MTT-S dues include a subscription to IEEE Microwave Magazine. MTT-S members can also purchase electronic and print subscriptions to the IEEE Transactions on Microwave Theory and Techniques, IEEE Microwave and Wireless Components Letter, IEEE/OSA Journal of Lightwave Technology, and IEEE MTT CD-Rom Collection. See IEEE Membership website for pricing.

ADVANCE REGISTRATION

Registration Categories

The Registration process is split into three tiers in order to better serve membership needs. The 1st tier is the **Early Bird Registration** period. It begins Tuesday, January 19th and will last through Friday, May 7th. This period provides an opportunity to register for the Symposium at the lowest possible cost. Immediately following the Early Bird period is the 2nd tier or **Advance Registration** period. It extends from Saturday May 8th through Friday, May 21st, just prior to the start of **Microwave Week**. The 3rd and final tier is the **On-Site Registration** period that will remain the same as in past Symposia, starting on Saturday May 22nd, the first day of Microwave Week, and ending on Friday, May 28th.

Early Bird Period	January 19th	May 7th (thru midnight PST)
Advance Period	May 8th	May 21st (thru midnight PST)
On-Site Period	May 22nd	May 28th (throughout Microwave Week)

Symposium SUPERPASS

The Symposium **SUPERPASS**. For one low price, registrants can attend as many technical sessions as they can from any of the three contributing organizations, MTT, RFIC, and ARFTG, as well as attend one full-day workshop (or two half-day workshops, if desired). In addition, the **SUPERPASS** will allow you to attend the Awards Banquet on Wednesday and the Symposium Reception on Thursday.

The **SUPERPASS** is a **SUPER DEAL** offering a **15% discount** over the combined ala-carte pricing.

Early Bird Registration

Please follow these instructions for completing the Early Bird Registration Form on the facing page. Early Bird Registration rates provide significant savings from the on-site fees shown on page 10 of this Program Book and are available through midnight May 7th. Registration is required for all attendees including SESSION CHAIRS and PRESENTERS. Only paid attendees will be admitted to the breakfasts, workshops, technical sessions, and Exhibition Hall. This form is not used for guest tour registration, which is described elsewhere in this Program Book. Each registrant must submit a separate form with payment.

1) Methods of Registration

Individuals can register online, by fax or by mail. All registrations must be accompanied with a payment; we accept Visa, MasterCard, American Express, and checks drawn from a U.S. bank. Registration forms received without a form of payment will be discarded. We do NOT accept phone registrations.

2) Personal Information

If you would like to receive information by email from the IEEE, MTT-S, or microwave companies, simply select the appropriate boxes. An optional complimentary badge for one guest allows access to the Hospitality Suite, Plenary Session, and Exhibition Hall, but does not allow access to Technical Sessions and Workshops.

3) Membership

Check boxes of all organizations of which you are a member. To receive IEEE member rates, enter your member number and present your IEEE card upon check in at the conference. Registrants who do not have a current IEEE membership card at check in will be charged non-member rates. If you are not a member and would like to learn about the advantages of being a member and receiving the conference member rate, please visit www.ieee.org/services/ join or call 1-800-678-IEEE. Please note that you must be a member at the time of registration to receive the member rate.

4) Symposia

Microwave Week includes the IMS Technical program (www.ims2010.org), and Exhibition, as well as the RFIC Symposium (www.rfic2010.org), and ARFTG Conference (www.arftg.org).

Select the conference(s) you wish to attend. Students, Retiree's, and IEEE Life Members receive a discount on some registration fees. To qualify as a student, a registrant must be either an IEEE Student Member or a full time student carrying a course load of at least nine credit hours.

- IMS Technical Sessions are held on Tuesdays, Wednesday, and Thursday. Registration includes continental breakfast, admission to the exhibits, abstract books, and a CD ROM.
- RFIC Technical Sessions are held on Monday and Tuesday. Registration includes continental breakfast, admission to the RFIC, Reception, and Exhibition
- ARFTG Technical Sessions are held on Friday. Registration includes breakfast, lunch, a CD-ROM, and admission the ARFTG Exhibition. ARFTG Conference member rates are available to both ARFTG and IEEE Members.
- Microwave Week hosts the largest exhibition of its kind with over 400 companies. Exhibit only registration is available.

5) Extra CD-ROMs and Digests

Additional CD ROMS (IMS, RFIC, and ARFTG) and digests (RFIC only) are available for purchase and pickup at the conference. After the Symposium, these digests and CD ROMS will be available for purchase from IEEE.

6) Awards Banquet

The MTT Awards Banquet will be held on Wednesday, May 26 from 6:30 to 10:00pm at the Hilton Anaheim. The evening will include fine dining, an awards presentation, and excellent entertainment. Major Society Awards will be presented.

7) Boxed Lunches

Optional boxed lunches are available for purchase by all attendees but are especially convenient for those attending the panel sessions or exhibition hall during lunchtime. Please purchase boxed lunches before Microwave Week. Boxed lunches are NOT available for purchase on-site. Refunds for lunches will not be available since they are ordered in advance.

8) Workshops

The workshop fee includes a CD ROM and speaker's notes for that workshop. Full-day workshops include a continental breakfast, a morning refreshment break, a boxed lunch, and an afternoon refreshment break. Morning workshops include a continental breakfast, a morning refreshment break, and a boxed lunch. Afternoon workshops include a boxed lunch and an afternoon refreshment break. The All-Workshop DVD-ROM includes material for all RFIC and IMS workshops on one DVD-ROM, but the DVD-ROM price alone does not include admission to any workshops. Note: Registrants can save by selecting a combined Workshop (one full-day or two half-day workshops) and All-Workshop DVD-ROM.

9) Payment

Individual payment must accompany the registration form and is payable in U.S. dollars only, using a personal check drawn on US bank or credit card (VISA, MasterCard, or American Express only). Bank drafts, wire transfers, cash, international money order, and purchase orders are unacceptable and will be returned. Personal checks must be encoded at the bottom with the bank, bank account number, and check number. Bank drafts, wire transfers, cash, and purchase orders are UNACCEPTABLE and will be returned. Please make checks payable to "2010 IEEE IMS". Written requests for refunds will be honored if received by May 7, 2010. Refer to the Refund Policy for complete details.



2010

IEEE MTT-S
INTERNATIONAL
MICROWAVE SYMPOSIUM

MAY 23-28, 2010 • ANAHEIM, CALIFORNIA
THE GOLDEN STATE OF MICROWAVES

IMS - RFIC - ARFTG Registration Form
Anaheim Convention Center
May 23-28, 2010



1 All Early Bird and Advance registration must be received by **online:** www.mpassociates.com/IMS2010/IMS_registration.html **by mail:** IMS 2010 Registration, MP Associates, Inc.
May 7 and May 21, respectively, for appropriate costs to apply. **1721 Boxelder St. Suite 107**
by fax: +1 (303) 530-4334 **Louisville, CO 80027 USA**

2 Attendee Information

First Name [] Last Name []
Company [] Mail Stop []
Address:
Street [] City []
State [] Postal Code [] Country [] Email []
Telephone [] IEEE Membership # [] Member of: MTT-S ARFTG

Guest Information:

First Name [] Last Name []
Email [] I would you like to receive emails from: IEEE and MTT-S Industry

3 Attendee Survey

1) What is your principal job function?

- 101 Executive/Senior Management
- 102 Engineering Management
- 103 Design Engineering
- 104 Engineering Services
- 105 Manufacturing/Production Engineering
- 106 Application Engineer
- 107 Procurement/Purchasing
- 108 Professor/Research - Academic
- 109 Research & Development - Government
- 110 Research & Development - Industry
- 111 Student
- 112 Financial or Industry Analyst
- 113 Editor/Publisher
- 114 Marketing/Sales
- 115 Consultant
- 116 Other _____

2) What primary end product or service do you work on?

- 201 Communication systems, equipment
- 202 Wireless (WiFi, WiMAX, UWB)
- 203 Government - Military
- 204 Government - Other
- 205 Defense Electronics
- 206 Medical Electronics
- 207 Navigation/telemetry/GPS systems
- 208 Industrial automation/control systems
- 209 Transportation (Automotive/Aviation)
- 210 Consumer Electronics
- 211 Computers or peripherals
- 212 Test & Measurement

- 213 Components/Hardware
- 214 Data Transmission
- 215 Semiconductors & Ics
- 216 Materials
- 217 Services
- 218 Software
- 219 Other _____

3) Which products and/or services in the following areas do you recommend, purchase or influence the purchase of? (Answer all that apply)

- 301 Active Components
- 302 Antennas
- 303 Control Components
- 304 Materials
- 305 Manufacturing Equipment
- 306 Optoelectronics & Fiber-Optics
- 307 Passive Components
- 308 Semiconductors/Integrated Circuits
- 309 Services
- 310 Signal Processing Components
- 311 Software & CAD
- 312 Subsystems & Systems
- 313 Test Equipment and Instruments
- 314 Transmission-Line Components

4) At what frequency is your primary work?

- 401 RF
- 402 Microwave
- 403 Both
- 404 Other _____

5) Number of engineers in your

organization

- 501 10 or fewer
- 502 11 to 40
- 503 41 to 100
- 504 More than 100

6) Which hotel will you be using while in Anaheim?

- 601 Hilton Anaheim Headquarter Hotel
- 602 Anabella Hotel
- 603 Best Western Stovall's Inn
- 604 Clarion Hotel Anaheim Resort
- 605 Crowne Plaza
- 606 Hyatt Regency Orange County
- 607 Portofino Inn & Suites
- 608 Red Lion Anaheim Maingate Hotel
- 609 Sheraton Park Hotel at the Anaheim Resort
- 610 Desert Palms Hotel & Suites
- 611 Other Hotel
- 612 Other Accomadations
- 613 Local - no accommodations

7) Is this the first time you have attended International Microwave Week?

- 701 Yes
- 702 No

8) Are you an MTT member?

- 801 Yes
- 802 No

IMS provides an email list of attendees to exhibitors. If you do NOT want to receive this correspondence, check here:

4 Registration Pricing

Superpass

All IMS, RFIC, & ARFTG Sessions, Awards Banquet, & All Workshop DVD (RFIC/IMS) plus Full Day (or 2 Half Day) Workshop Attendance

IMS

All IMS Sessions
All IMS Sessions (No CD-ROM)
Single Day Registration

RFIC Symposium

All RFIC Sessions
RFIC Reception Only

ARFTG Conference

All ARFTG Sessions

Exhibition

Exhibition Only Pass x \$20
Wednesday Exhibition Only Pass x FREE

Early Bird (1/19 - 5/7)

IEEE or ARFTG Membership Member Student, Retiree, Life Member Non-Member

Advance (5/8 - 5/21)

IEEE or ARFTG Membership Member Student, Retiree, Life Member Non-Member

Cost

<input type="radio"/> \$995	<input type="radio"/> \$595	<input type="radio"/> \$1,495	<input type="radio"/> \$1,195	<input type="radio"/> \$695	<input type="radio"/> \$1,745	\$ <input type="text"/>
<input type="radio"/> \$405	<input type="radio"/> \$70	<input type="radio"/> \$600	<input type="radio"/> \$485	<input type="radio"/> \$80	<input type="radio"/> \$720	\$ <input type="text"/>
<input type="radio"/> \$350		<input type="radio"/> \$540	<input type="radio"/> \$415		<input type="radio"/> \$610	\$ <input type="text"/>
<input type="radio"/> \$205		<input type="radio"/> \$300	<input type="radio"/> \$255		<input type="radio"/> \$355	\$ <input type="text"/>
<input type="radio"/> \$220		<input type="radio"/> \$320	<input type="radio"/> \$250		<input type="radio"/> \$370	\$ <input type="text"/>
<input type="radio"/> \$55		<input type="radio"/> \$75	<input type="radio"/> \$60		<input type="radio"/> \$80	\$ <input type="text"/>
<input type="radio"/> \$210	<input type="radio"/> \$130	<input type="radio"/> \$310	<input type="radio"/> \$240	<input type="radio"/> \$145	<input type="radio"/> \$360	\$ <input type="text"/>
						\$ <input type="text"/>
						\$ <input type="text"/>

5 Extra CDs & Digests

IMS CD-ROM	<input type="text"/> x \$60	<input type="text"/> x \$110	<input type="text"/> x \$75	<input type="text"/> x \$140	\$ <input type="text"/>
RFIC Digest	<input type="text"/> x \$60	<input type="text"/> x \$110	<input type="text"/> x \$75	<input type="text"/> x \$140	\$ <input type="text"/>
RFIC CD-ROM	<input type="text"/> x \$60	<input type="text"/> x \$110	<input type="text"/> x \$75	<input type="text"/> x \$140	\$ <input type="text"/>
ARFTG CD-ROM	<input type="text"/> x \$60	<input type="text"/> x \$110	<input type="text"/> x \$75	<input type="text"/> x \$140	\$ <input type="text"/>
ARFTG Conf. Compendium CD-ROM 1982-2006	<input type="text"/> x \$65	<input type="text"/> x \$90	<input type="text"/> x \$65	<input type="text"/> x \$90	\$ <input type="text"/>

6 Events

Special Luncheon for Chuck Swift (Tuesday)	<input type="text"/> x \$35	<input type="text"/> x \$35	<input type="text"/> x \$35	<input type="text"/> x \$35	\$ <input type="text"/>
Awards Banquet (Wed. Night)	<input type="text"/> x \$50	<input type="text"/> x \$50	<input type="text"/> x \$60	<input type="text"/> x \$60	\$ <input type="text"/>

7 Lunch

Boxed Lunches	Mon <input type="radio"/> Tues <input type="radio"/> Wed <input type="radio"/> Thur <input type="radio"/>	<input type="text"/> x \$20	<input type="text"/> x \$20	<input type="text"/> x \$20	<input type="text"/> x \$20	\$ <input type="text"/>
---------------	---	-----------------------------	-----------------------------	-----------------------------	-----------------------------	-------------------------

8 Workshops and Short Courses

Full Day Workshops: WSC WSD WSE WSF WSH WSI WSJ WSK WSL WSM WSN
WMA WMB WMC WMD WMH WMI WMJ WMK WFC WFF WFG

Half Day Workshops: WSA WSB WSG WME WMF WMG WFA WFB WFH WFI

Full Day Short Course: SC1 SC2

Half Day Short Course: SC2A SC3

Full Day Workshops	<input type="text"/> x \$160	<input type="text"/> x \$110	<input type="text"/> x \$230	<input type="text"/> x \$190	<input type="text"/> x \$130	<input type="text"/> x \$280	\$ <input type="text"/>
Half Day Workshops	<input type="text"/> x \$110	<input type="text"/> x \$80	<input type="text"/> x \$180	<input type="text"/> x \$145	<input type="text"/> x \$95	<input type="text"/> x \$210	\$ <input type="text"/>
Full Day Short Course SC1	<input type="text"/> x \$285	<input type="text"/> x \$200	<input type="text"/> x \$410	<input type="text"/> x \$340	<input type="text"/> x \$230	<input type="text"/> x \$500	\$ <input type="text"/>
Full Day Short Course SC2 (class and lab)	<input type="text"/> x \$335	<input type="text"/> x \$250	<input type="text"/> x \$460	<input type="text"/> x \$390	<input type="text"/> x \$280	<input type="text"/> x \$550	\$ <input type="text"/>
Half Day Short Courses	<input type="text"/> x \$200	<input type="text"/> x \$140	<input type="text"/> x \$320	<input type="text"/> x \$260	<input type="text"/> x \$170	<input type="text"/> x \$375	\$ <input type="text"/>
All Workshop DVD (RFIC/IMS)	<input type="text"/> x \$240	<input type="text"/> x \$165	<input type="text"/> x \$345	<input type="text"/> x \$285	<input type="text"/> x \$195	<input type="text"/> x \$420	\$ <input type="text"/>
All Workshop DVD (RFIC/IMS) with attendance*	<input type="text"/> x \$315	<input type="text"/> x \$220	<input type="text"/> x \$460	<input type="text"/> x \$375	<input type="text"/> x \$260	<input type="text"/> x \$545	\$ <input type="text"/>

*Includes One Full Day Workshop or Two Half Day Workshops

9 Card Number Expiration Date / Total Remittance: \$

MasterCard Visa American Express Security Code Signature: _____

10 Submit via Fax or Mail to:

Make checks payable to: **IMS2010**

IMS2010 Fax registrations accepted with credit card payment only!
Attn: Registration Desk Phone Number: (303) 530-4562
1721 Bolxelder St., Ste 107 Louisville, CO 80027 USA Fax Number: (303) 530-4334

Refund Policy: Written requests for cancellations received on or before May 7, 2010, will be honored. Cancellations received after May 7, 2010 will NOT be honored and all registration fees will be forfeited. **After May 14, 2010, faxed registrations will not be accepted in office - You MUST register on-site.** **TELEPHONE REGISTRATIONS WILL NOT BE ACCEPTED! ANY REGISTRATION WITHOUT PAYMENT WILL BE DISCARDED!** If payment is received from a non-US bank, attendees will be charged a collection fee of \$45.00.



ON SITE REGISTRATION

On Site Registration

On Site registration for all Microwave Week events will be available in the Anaheim Convention Center Lobby C. Registration hours are:

Day	Time
Saturday, May 22	14:00 – 17:00
Sunday, May 23	07:00 – 18:00
Monday, May 24	07:00 – 18:00
Tuesday, May 25	07:00 – 18:00
Wednesday, May 26	07:00 – 18:00
Thursday, May 27	07:00 – 16:00
Friday, May 28	07:00 – 09:00

Exhibit Only Registration

Exhibit only registration is available.

Guest Tour Registration

Registration for guest tours will be available in the hospitality suite in the Garden Terrace Room at the Sheraton Park Hotel. Please refer to the Guest Tour Program section of this program book for further details and tour descriptions.

Press Registration

Credentialed press representatives are welcome to register without cost, receiving access to technical sessions and exhibits. Digests are not included. The Press Room will be available from Tuesday thru Friday of Microwave Week.

ARFTG Registration

Late on-site registration will be available at the Anaheim Convention Center Lobby C on Friday from 7:00 to 9:00am. If at all possible, please pre-register earlier in the week to reduce the on-site workload.

Refund Policy

Written requests received by May 7, 2010 will be honored. Refund requests postmarked after this date and on-site refunds will be generated only if an event is cancelled. This policy applies to the registration for the symposium sessions, workshops, digests, extra CD-ROM's, awards banquet and boxed lunches. Please state the pre-registrants name and provide an email address for the refund check. If registration was paid for by credit card, the refund will be made through an account credit. An account number must be provided if the initial registration was completed on-line. Address your requests to:

MTT-S Registration

Nannette Jordan
 MP Associates
 1721Boxelder St. Ste. 107
 Louisville, CO 80027
 nannette@mpassociates.com

Registration Fees

On-site registration fees are as follows:

	Member	Non-Member
SuperPass		
All IMS, RFIC, and ARFTG Sessions, Awards Banquet, and All Workshop CD (RFIC/IMS) + Full Day (or 2 Half Day) Attendance	1295	1895
Student, Retiree, Life Member SuperPass	745	
IMS		
All IMS Sessions	525	785
All IMS Sessions (No CD ROM)	450	665
Single Day Registration	275	385
Student, Retiree, Life Member All IMS Sessions	85	
RFIC Symposium		
All RFIC Sessions	270	400
RFIC Reception Only	65	85
ARFTG Conference		
All ARFTG Sessions	260	390
Student, Retiree, Life Member All ARFTG Sessions	160	
Exhibition Only		
Exhibition Only Pass	25	25
Wednesday Exhibition Only Pass	FREE	FREE
Extra CD's and Digests		
IMS CD-ROM	80	150
RFIC Digest	80	150
RFIC CD ROM	80	150
ARFTG CD-ROM	80	150
ARFTG Conference Compendium CD-ROM 1982 - 2006	65	90
Events		
Special Luncheon for Chuck Swift (Tuesday)	35	35
Awards Banquet (Wed. Night)	75	75
Workshops		
Full Day	205	305
Half Day	155	230
Full Day Short Courses	365	540
Full Day Short Course w/Lab	415	590
Half Day Short Course	275	410
All Workshop CD (RFIC/IMS)	308	458
All Workshop CD (RFIC/IMS) plus Full Day (or 2 Half Day) Attendance	405	595

UNITED STATES VISA ADVISORY

The United States has updated its visa policy for increased security. As a result, it now takes longer to obtain a visa. Advance planning by travelers is essential to avoid frustration and disappointment.

- Review your visa status to find out if you need a U.S. visa or a visa renewal.
- Plan to submit your visa application well in advance of your intended departure date.
- Contact your nearest U.S. embassy or consulate for current time estimates and recommendations.
- Visit the embassy or consular section website to find important information on how to schedule an interview appointment and pay fees. An interview is required as a standard part of processing for most visa applicants.
- Plan on having finger scans as part of the visa application process. Two index-finger scans are normally collected by the consular officer at the visa interview window. However; in some countries, they may be collected prior to the actual visa interview.

Visa Waiver Program (VWP)

Citizens of the following countries can travel to the U.S. without a visa for tourism or business for 90 days or less under the Visa Waiver Program (VWP) if they meet other travel requirements. As of June 26, 2005, all VWP travelers must have a machine-readable passport to enter the United States without a visa.

Andorra	France	Lithuania	Singapore
Australia	Germany	Luxembourg	Slovakia
Austria	Hungary	Malta	Slovenia
Belgium	Iceland	Monaco	South Korea
Brunei	Ireland	the Netherlands	Spain
Czech Republic	Italy	New Zealand	Sweden
Denmark	Japan	Norway	Switzerland
Estonia	Latvia	Portugal	United Kingdom
Finland	Liechtenstein	San Marino	

Some citizens of Canada and Bermuda do not need a visa to visit the United States. Contact your nearest U.S. embassy or consulate for guidance. Travelers should be aware that by requesting admission under the Visa Waiver Program, they are generally waiving their right to review or appeal a CBP (Customs and Border Protection) officer's decision as to their application for admission at the port of entry

Effective January 20, 2010, the Department of Homeland Security is transitioning to enforced compliance of the Electronic System for Travel Authorization (ESTA) requirement for VWP travelers. Therefore, VWP travelers who have not obtained approval through ESTA should expect to be denied boarding on any air carrier bound for the United States. ESTA applications may be completed FREE online at the official DHS website, which is: <https://esta.cbp.dhs.gov>

Passports

A passport with a validity date of at least six months beyond the applicant's intended period of stay in the U.S. is required. If more than one person is included in the passport, each person desiring a visa must make a separate application. Please check with the website, <https://www.cbp.gov>, to confirm that your passport is compliant. Temporary Passports will likely merit special scrutiny. To avoid complications, check with your local US consular offices, well ahead of your intended departure dates.

Visa Letters

A visa support letter can be provided for authors and registered attendees upon request. Please submit your requests for letters of support well in advance of your interview dates to allow sufficient time for processing. Spouses requiring visa assistance must be registered for an IMS Guest Program Event. Check the IMS 2010 website (www.ims2010.org) for Guest Program details. For additional assistance, please contact Dr. Zaher Bardai at zb@ieee.org

Disclaimer

This information is provided in good faith but travel regulations do change. The only authoritative sources of information are the U.S. Government websites at www.unitedstatesvisas.gov and http://travel.state.gov/visa/visa_1750.html.



Accommodations:

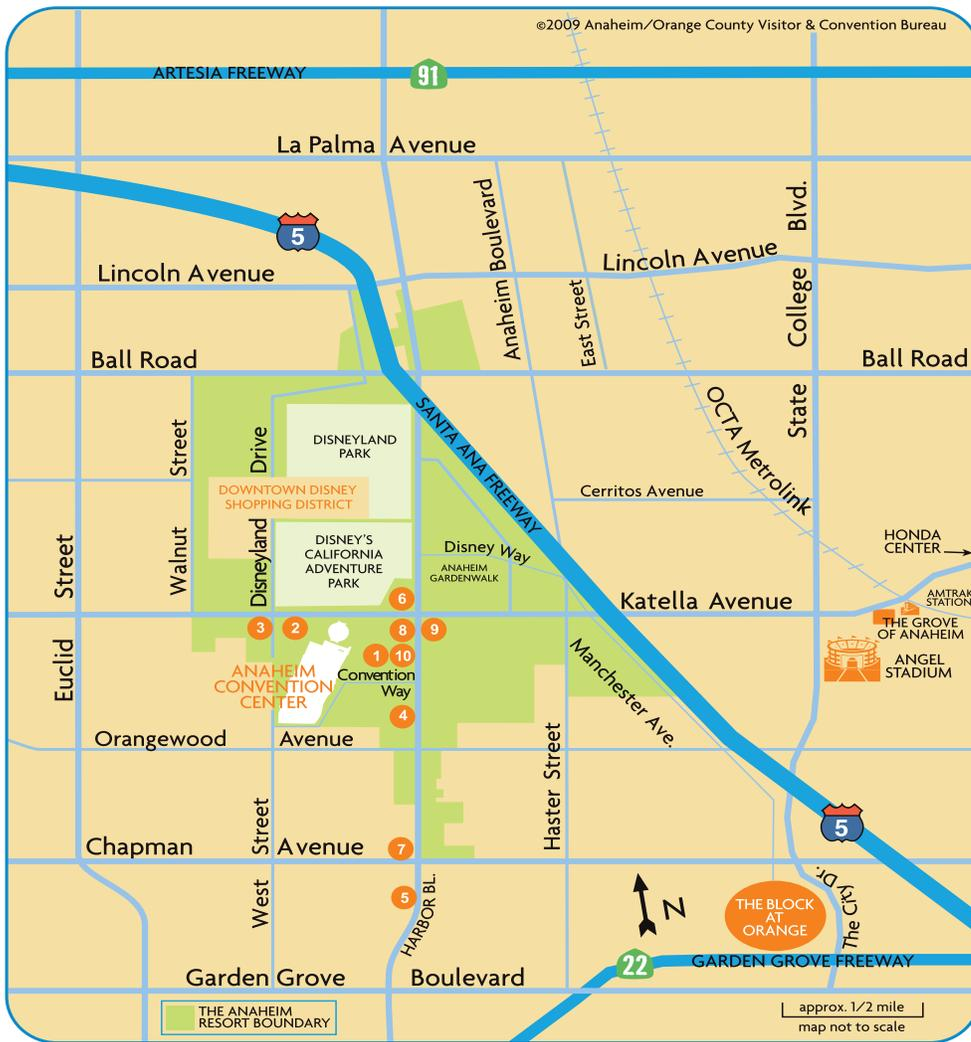

The IMS2010 has secured special rates for Attendees at the official IMS2010 hotels in Anaheim. The map below shows the location and rates of these hotels.

For advanced hotel reservations, visit www.ims2010.org for online reservations, or submit the Attendee Housing Form by fax or postal mail before 16 April 2010.

ANAHEIM hotel locator map

IMS 2010

- 1 Hilton Anaheim Headquarter Hotel
- 2 Anabella Hotel
- 3 Best Western Stovall's Inn
- 4 Clarion Hotel Anaheim Resort
- 5 Crowne Plaza
- 6 Desert Palms
- 7 Hyatt Regency Orange County
- 8 Portofino Inn & Suites
- 9 Red Lion Anaheim Maingate Hotel
- 10 Sheraton Park Hotel at the Anaheim Resort

Number on Map	Hotel Name	Rate
1	Hilton Anaheim- Headquarter Hotel	\$215 Standard Guest Rooms \$235 Lanai Guest Rooms \$255 Executive Guest rooms
2	Anabella Hotel	\$149 Single/Double Room
3	Best Western Stovall's Inn	\$129 Single/Double Room
4	Clarion Hotel Anaheim Resort	\$129 Single/Double Room
5	Crowne Plaza	\$159 Single/Double
6	Desert Palms	\$140 Standard Deluxe \$159 Tanami Suites \$159 Mohave Suites \$179 Borrego Suites \$199 Sahara Kitchen Suites
7	Hyatt Regency Orange County	\$199 Single/Double
8	Portofino Inn & Suites	\$135 Deluxe Room \$159 Suite
9	Red Lion Anaheim Maingate Hotel	\$149 Single/Double Room
10	Sheraton Park Hotel at the Anaheim Resort	\$199 Single/Double Room

All reservation requests must be received by 16 April 2010.

Changes to existing reservations may be made through the housing bureau until 16 April 2010. Listed convention rates available until 16 April 2010 based on availability.

Online:

www.ims2010.org

Fax:

1-732-465-6447

Mail:

IMS 2010 Housing Bureau
IEEE Meetings & Conference Management
445 Hoes Lane, Piscataway, NJ 08854

Instructions and Housing Bureau Policies:

1. Acknowledgements will be sent after each reservation booking, modification and/or cancellation. If you do not receive a confirmation via e-mail within 24 hours after any transaction, contact the Housing Bureau by phone or e-mail. You will not receive a confirmation from the hotel.
2. All rates are per room, per night and are subject to 15% tax (subject to change).
3. Request room and bedding and please indicate special requests in the section provided on the form. Specific room types will be assigned at check-in. Please be advised that requests are not guaranteed.
4. A credit card is needed to guarantee a room reservation. Credit cards must be valid through June 2010 to be used for deposits.
5. Changes, modifications and cancellations prior to 16 April 2010 must be made in writing through the Housing Bureau. Reservations guaranteed by a credit card may be cancelled without penalty until 16 April 2010 after which a \$15.00 fee will be charged for each cancellation.
6. Any hotel reservation changes or cancellations after 16 April 2010 must be made with the hotel directly.
7. You will receive your hotel confirmation number three weeks before the start of the 2010 IMS Conference.

Housing Reservation Information:

Full Name: _____

E-mail Address: _____

Company: _____

Address: _____

City: _____ State: _____ Zip: _____

Country: _____ Daytime Phone: _____ Fax: _____

Frequent Hotel Stay Number: _____

Credit Card Type (Circle): MasterCard Visa Amex Discover

Cardholder Name (As it appears on card) _____

Cardholder Signature (REQUIRED) _____

Card Number: _____ Exp. Date _____

Hotel names, locations and rates are on the facing page. Please list a minimum of three choices.

First Choice: _____ Second Choice: _____ Third Choice: _____

First Choice Rate: _____ Second Choice Rate: _____ Third Choice Rate: _____

Arrival Date _____ Departure Date _____

If hotel choice is not available, which is most important: Rate: _____ or Location _____ (Please select one)

Special Requests

Government Rate King Bed Two Beds Wheelchair Accessible

Other Requests _____

If more than one room is required, attach a list of occupants names and the above information for each additional room.



WELCOME TO ANAHEIM AND ORANGE COUNTY!

Popularly recognized as The OC, this world-class visitor destination is the center of Southern California fun located between Los Angeles and San Diego. OC's second largest city is Anaheim - the perfect starting point for your OC adventures. You'll find plenty of things to see and do: inviting beaches, unparalleled shopping and entertainment, trendy restaurants, abundant nightlife, championship golf, lively art districts, beautiful historic landmarks and the ultimate family attractions. Warm sunshine, swaying palm trees and breathtaking ocean views create a relaxed lifestyle where shorts, sandals and sunglasses are always in style.



THE HISTORY OF ANAHEIM:

More than 150 years ago, German colonists came to the land that is now Anaheim to grow grapes and produce wine. The original purchase price? A humble \$2.00 an acre!

The city's name was originally spelled "Annaheim." "Anna" was taken from the nearby Santa Ana River, a vital part of the early settlers and farmers life and named for Saint Anne by Spanish explorers. The word "Heim" is the German word for home, so the name meant "home by the Santa Ana River." Today, the second "n" is dropped, blending Spanish (Ana) with German (heim)

Anaheim was the wine capital of California for many years, but in the late 1880s a blight completely wiped out the vineyards, thus ending the thriving industry.

Then, the orange industry developed and grew, as did the prosperous new city of Anaheim. The area remained a booming agricultural community until post World War II.

On July 17, 1955, an enterprising visionary named Walt Disney opened the doors of his fabled "magic kingdom" - Disneyland.

Only 11 years later, in 1966, Anaheim Stadium was built. It is currently the home field of Major League Baseball's Angels. Just across the street from the baseball stadium is the Honda Center, a 19,200-seat state-of-the-art entertainment facility and home ice for National Hockey League's Anaheim Ducks - 2006/07 Stanley Cup Champion.

The Anaheim Convention Center was built in 1967 directly across from Disneyland and received five major expansions since its opening. The fifth expansion, which was completed in December 2000, gave the center a total 1.6 million gross square feet, making it the largest convention center on the West Coast. The latest expansion of the Anaheim Convention Center was part of a \$5 billion renovation now called The Anaheim Resort™ district. The 1,100-acre garden district encompasses the Anaheim Convention Center and the Disneyland® Resort, which features Disneyland® Park, Disney's California Adventure™ Park and Downtown Disney District. Today, the Resort is also home of the Anaheim Arsenal NBA D-League team and the USA Men's National Volleyball team. Anaheim is now the second largest city in Orange County and is the center of Orange County's visitor industry, which attracts nearly 45 million people annually.

IMS 2010 is pleased to offer a complete Guest tour program which can be found on pages 99 – 106 of this program book! You can also view the Guest tour program online at <http://www.pra-tours.com/IEEE>.

For more information on all that Anaheim and the O.C. has to offer please visit www.anaheimoc.org.

TRANSPORTATION

Flying to Anaheim/Orange County:

Anaheim/Orange County has four nearby airports to choose from:

JOHN WAYNE ORANGE COUNTY AIRPORT (SNA)

18601 Airport Way, Santa Ana, CA 92707 (949) 252-5200

Drive time: 20 minutes (13 miles/20.92km) to Anaheim

Approximate rates to & from Anaheim:

Shuttle Services: starting at \$10 per person/one way

Disneyland Express Bus: \$15 per person/one way.

Taxi: metered rates, ranging from \$45-\$75 per car or van load/one way.

Rental Car, Van or SUV: \$50-\$95 per car/daily.

Limousine Service: approx. \$115.00.

Town car or SUV: approx. \$85

LOS ANGELES INTERNATIONAL AIRPORT (LAX)

1 World Way, Los Angeles, CA 90045 (310)646-5252

Drive time: 50 minutes (35 miles/56.33km) to Anaheim

Approximate rates to & from Anaheim:

Shuttle Services: starting at \$16 per person/one way

Disneyland Express Bus: \$20 per person/one way

Taxi: metered rates, ranging from \$90-\$130 per car or van load/one way

Rental Car, Van or SUV: \$50-\$130 per car or van/daily

Limousine Service: approx. \$160

Town car or SUV: approx. \$100

LONG BEACH AIRPORT (LGB)

4100 Donald Douglas Dr., Long Beach, CA 90808 (562)570-2619

Drive time: 30 minutes (18 miles/28.97km) to Anaheim

Approximate rates to & from Anaheim:

Shuttle Services: starting at \$35 for the first person + \$9-10 each additional person/one way

Taxi: metered rates, ranging from \$50-\$80 per car or van/one way

Rental Car, Van or SUV: \$75-\$100 per car or van/daily

Limousine Service: approx. \$110, per car/one way

Town car or SUV: approx. \$90

ONTARIO INTERNATIONAL AIRPORT (ONT)

2500 Airport Dr., Ontario, CA 91761 (909)937-2700

Drive time: 45 minutes (36 miles/57.94km) to Anaheim

Approximate rates to & from Anaheim:

Shuttle Services: starting at \$43 for the first person + \$9-10 each additional person/one way

Taxi: metered rates, ranging from \$95-\$135 per car or van/one way.

Rental Car, Van or SUV: \$45-\$95 per car or van/daily.

Limousine Service: approx. \$170.

Town car or SUV: approx. \$110.

For more information on these airports and ground transportation please visit:

www.anaheimoc.org

Driving Directions to the Anaheim Convention Center:

FROM POINTS NORTH

Take I-5 South. Take the HARBOR BLVD. exit. Keep RIGHT at the fork in the ramp. Merge onto S. HARBOR BLVD. Cross W. Katella Ave. Turn RIGHT onto CONVENTION WAY. Anaheim Convention Center is straight ahead.

FROM POINTS SOUTH

Take I-5 North. Take the KATELLA AVE. exit toward DISNEY WAY. Turn SLIGHT LEFT onto ANAHEIM WAY. Turn LEFT (west) onto E. KATELLA AVE. (becomes W. Katella Ave.) Turn LEFT onto S. HARBOR BLVD. Turn RIGHT onto CONVENTION WAY. Anaheim Convention Center is straight ahead.

FROM POINTS EAST

Take CA-91 West. Merge onto CA-57 South toward SANTA ANA. Take the KATELLA AVE. exit. Turn RIGHT (west) onto E. KATELLA AVE. (becomes W. Katella Ave.) Turn LEFT onto S. HARBOR BLVD. Turn RIGHT onto CONVENTION WAY. Anaheim Convention Center is straight ahead.

Bus and Rail Information Routes:

Local bus service is provided by Orange County Transportation Authority. OCTA can be reached at (714) 636-RIDE (7433) or www.octa.net/busrail. The following bus routes have stops near the Anaheim Convention Center (ACC):

Route 50 Long Beach – Anaheim via Katella Ave.: stops on W. Katella Ave. between S. Harbor Blvd. & West St., short walk South to Anaheim Convention Center entrance.

Route 205 Laguna Hills – Anaheim: stops on W. Katella Ave. between S. Harbor Blvd. & West St., short walk South to Anaheim Convention Center entrance.

Route 430 Anaheim Metrolink/Amtrak Station – Anaheim Resort: stops at S. Harbor & W. Katella Ave., and also stops at West St. & W. Katella Ave., short walk South to ACC.

Air Travel and Rental Car Discounts

For your convenience, airline tickets and car rentals may be booked through IEEE's corporate travel agency, World Travel Inc. Hours of operation are 08:00 to 17:30 EDT, Monday through Friday.

For more information please visit the IEEE Travel Program Website at www.ieee.org/web/aboutus/travel/index.htm

Email: ieeeworldtravelinc.com

Phone: +1 800.TRY.IEEE (+1 800.879.4333) in the US and Canada;
+1 717.556.1100 elsewhere

PLEASE REFERENCE IEEE's account 1iV9



WELCOME FROM TECHNICAL PROGRAM COMMITTEE CHAIR



Welcome to The Technical Program of IEEE MTT-S International Microwave Symposium 2010 Anaheim, CA, May 25-27, 2010.

From: Madhu S. Gupta, Chair, IMS2010 Technical Program Committee

A warm welcome to the International Microwave Symposium (IMS), which has been the premier annual event of the IEEE Microwave Theory & Techniques Society (MTT-S) for over half a century, and is the world's largest and most prestigious conference in the technology of RF, microwave, millimeter- and sub-millimeter wave components, devices, circuits, modules and systems. We have organized a vast and varied technical program for IMS2010, to meet the expectations of all the attendees, each with their own needs and preferences, and we are confident that the technical program of IMS2010 will measure up to your expectations in every respect. No matter what your field of work or specialization, and whether you are a newcomer or an old-timer, there is something here that will interest you.

Please sample some the following parts of the technical program:

<p>We have over 250 technical papers, being presented orally in some five dozen sessions, that describe original research, development, and application work on radio-frequency and microwave theory and techniques, within the four major areas of this discipline: (1) Microwave Field and Circuit Techniques; (2) Passive RF and Microwave Components; (3) Active RF and Microwave Components; and (4) RF and Microwave Systems and Applications.</p>	<p>There are close to four dozen workshops this year that provide an opportunity to hob knob with the experts in some of the newly emerging fields as well as those experiencing an intense activity.</p>
<p>There are 122 papers being presented as interactive forum papers that permit a one-on-one discussion with presenters, as well as an opportunity to observe prototypes and simulations being demonstrated by them.</p>	<p>There are short courses during the Microwave Week, if you are looking for a refresher, or retreading, in a new field or specialization.</p>
<p>There is a student paper contest, presented in the interactive forum format, where you can find out how well the new entrants to your profession are currently being prepared, and renew your confidence that the future of the microwave discipline is in good hands.</p>	<p>There is a historical exhibit that displays hardware, books, and photographs from the bygone eras, that will bring back memories if you go back as long as those artifacts, or satisfy your curiosity about the past if you are younger than the displayed artifacts.</p>
<p>Carry out a technical exchange with the presenters of oral and interactive forum papers to help them in refining their ideas by asking questions, engaging them in discussion, and bringing up ignored considerations.</p>	<p>There are Microapps seminars, from the vendors of products and services in the microwave industry, that can help in learning the latest techniques, skills, and methods.</p>
<p>Get exposed to new technical sessions in areas that are appearing for the first time in IMS this year: in the fields of high-power microwaves for industrial and material processing, and RFID and power scavenging technologies</p>	<p>Attend and join the various technical committee meetings dealing with specialized technical and professional issues, being organized by the MTT Society Technical Committees.</p>
<p>At the plenary session, learn from a national leader of advanced research and innovation in the defense sector how the current technological advances are likely to influence the future evolution of the microwave field.</p>	<p>Participate in the student design competitions organized by the various technical committees (TCs) of the IEEE MTT Society.</p>
<p>If controversy and debate attract you, we have panel sessions each day, with panelists, who are recognized experts of the field, presenting their opinions and rationales on each side of the issue.</p>	<p>Enjoy the hallway discussions with old friends and new acquaintances, and network with the shakers and movers of the field from all around the world.</p>
<p>Sample some of the special sessions dedicated to significant research areas and themes that are currently drawing a lot of attention.</p>	<p>Catch up on the latest advances in the industry by taking a stroll through the industry exhibits area where hundreds of exhibitors display their latest products and services for a period of three days.</p>

IMS is the centerpiece of the "microwave week" which comprises still other technical activities, including the RFIC Symposium, and the ARFTG conference, co-located with IMS2010 in Anaheim during the week of Sunday, May 23 through Friday, May 29, 2010.

Please enjoy the International Microwave Symposium in Anaheim during May 2010, and give us the benefit of your opinion about the success of our efforts at developing a conference with an outstanding technical program. We are confident you will agree that IMS2010 offers everything that we have come to expect from IMS.



MONDAY PANEL SESSIONS

Monday 12:00 – 13:10 Room 210AB

Hubbert's Peak, The Coal Question, and Climate Change

**David Rutledge, Tomiyasu Professor of Electrical Engineering,
*California Institute of Technology***

Panel Session Abstract:

An accurate estimate of the ultimate production of oil, gas, and coal would be helpful for the ongoing policy discussion on alternatives to fossil fuels and climate change. By ultimate production, we mean total production, past and future. It takes a long time to develop energy infrastructure, and this means it matters whether we have burned 20% of our oil, gas, and coal, or 40%. In modeling future temperature and sea-level rise, the carbon dioxide from burning fossil fuels is the most important factor. The time frame for the climate response is much longer than the time frame for burning fossil fuels, and this means that the total amount burned is more important than the burn rate. Oil, gas, and coal ultimates are traditionally estimated by government geological surveys from measurements of oil and gas reservoirs and coal seams, together with an allowance for future discoveries of oil and gas. We will see that where these estimates can be tested, they tend to be too high, and that more accurate estimates can be made by curve fits to the production history. Professor Rutledge will discuss the implications of this analysis for climate, and comment on the Climategate episode.



TUESDAY TECHNICAL SESSIONS

8:00-9:40

TU1A: Novel Guiding and Radiating Structures
David Jackson, *University of Houston*
Jan Machac, *Czech Technical University in Prague*
Room: 203B

TU1B: Metamaterial Structures, Phenomena and Applications
Guoan Wang, *IBM*
Francisco Mesa, *University of Seville*
Room: 205AB

TU1C: Submillimeter-Wave Amplifiers and Enabling Components
Goutam Chattopadhyay, *NASA JPL*
Vesna Radisic, *Northrop Grumman*
Room: 206AB

TU1D: Beamforming and Retrodirective Arrays
Wayne Shiroma, *University of Hawaii*
Joseph Modelski, *Warsaw University of Technology*
Room: 202AB

8:00 - 8:20

TU1A-1: Dispersion Characteristics of Metamaterial Slow-Wave Coupled Lines
H. Ma, H. Yang, *University of Illinois, Chicago, United States*

TU1B-1: Fully planar implementation of generalized composite right/left handed transmission lines for quad-band applications
M. Durán-Sindreu, G. Sisó, J. Bonache, F. Martín, *Universitat Autònoma de Barcelona, Bellaterra, Spain*

TU1C-1: A 50 mW 220 GHz Power Amplifier Module
V. Radisic, K. M. Leong, X. Mei, S. Sarkozy, W. Yoshida, P. Liu, J. Uyeda, R. Lai, W. R. Deal, *Northrop Grumman Corporation, Redondo Beach, United States*

TU1D-1: CMOS 4x4 and 8x8 Butler Matrices
B. Cetinoneri¹, Y. A. Atesal¹, J. Kim², G. M. Rebeiz¹, ¹University of California, San Diego, La Jolla, United States, ²Kwangwoon University, Seoul, Republic of Korea

8:20 - 8:40

TU1A-2: A Substrate Integrated Waveguide Leaky Wave Antenna Radiating from a Slot in the Broad Wall
J. Machac¹, P. Lorenz², M. Saglam², C. Bui³, W. Kraemer^{2,1} *Czech Technical University in Prague, Prague, Czech Republic, ²Rohde & Schwarz GmbH & Co. KG, Muenchen, Germany, ³RWTH Aachen, Aachen, Germany*

TU1B-2: Dispersion characterization of CRLH transmission lines by electro-optic visions of forward/backward waves
M. Tsuchiya¹, T. Shiozawa², ¹National Institute of Information and Communications Technology, Koganei, Japan, ²Kagawa National College of Technology, Takuma, Japan

TU1C-2: 300 GHz Six-Stage Differential-Mode Amplifier
H. J. Park¹, J. S. Rieh¹, M. Kim¹, J. B. Hacker², ¹Korea University, Seoul, Republic of Korea, ²Teledyne Scientific, Thousand Oaks, United States

TU1D-2: A V-band Switched Beam-Forming Network Using Absorptive SP4T Switch Integrated with 4x4 Butler Matrix in 0.13- μ m CMOS
K. Park, W. Choi, Y. Kim, K. Kim, Y. Kwon, *Seoul National University, Seoul, Republic of Korea*

8:40 - 9:00

TU1A-3: Dual-Mode Leaky-Wave Excitation in Symmetric Composite Right/Left-Handed Structure with Center Vias
M. M. Hashemi, T. Itoh, *University of California, Los Angeles, Los Angeles, United States*

TU1B-3: 2D Transformation Optics using Anisotropic Transmission-Line Metamaterials
M. Zedler, G. V. Eleftheriades, *U of Toronto, Toronto, Canada*

TU1C-3: High-Gain Submillimeter-Wave mHEMT Amplifier MMICs
A. Tessmann, A. Leuther, V. Hurm, H. Massler, M. Zink, M. Riessle, R. Loesch, *Fraunhofer IAF, Freiburg, Germany*

TU1D-3: Polar Phase-Conjugating Active Arrays for Spectrally-Efficient Linear Wireless Links
L. Cabria¹, J. A. Garcia¹, T. Aballo¹, Z. Popovic², ¹Universidad de Cantabria, Santander, Spain, ²University of Colorado at Boulder, Boulder, United States

9:00 - 9:10

TU1A-4: Tunable Composite Right/Left-Handed Leaky Wave Antenna Based on a Rectangular Waveguide Using Liquid Crystals
C. Damm, *TU-Darmstadt, Darmstadt, Germany*

TU1B-4: Negative and Zero Group Velocity in Microstrip/Negative-refractive-index Transmission-line Couplers
H. Mirzaei, G. V. Eleftheriades, *University of Toronto, Toronto, Canada*

TU1C-4: A 210-280GHz 3-Stage Amplifier in 35nm InP mHEMT, Using a Thin-film Microstrip Environment
Z. Griffith, W. Ha, P. Chen, D. Kim, B. Brar, *Teledyne Scientific Company, Thousand Oaks, United States*

TU1D-4: A Retrodirective Null-Scanning Array
R. T. Iwami, A. Zamora, T. F. Chun, M. K. Watanabe, W. A. Shiroma, *University of Hawaii at Manoa, Honolulu, United States*

9:10 - 9:20

TU1A-5: The Geometric Characteristics and Mechanism Analysis of Quasi-TEM Waveguides with Dipole-FSS Walls
D. Li¹, K. Wu², ¹Anhui University of Science & Technology, Huainan, China, ²École Polytechnique de Montréal, Montréal, Canada

TU1B-5: Pseudo-Traveling-Wave Resonator Based on Nonreciprocal Phase-Shift Composite Right/Left Handed Transmission Lines
T. Ueda, H. Kishimoto, *Kyoto Institute of Technology, Kyoto, Japan*

TU1C-5: Analog Type Millimeter Wave Phase Shifters Based on MEMS Tunable High-Impedance Surface
D. Chicherin¹, M. Sterner², J. Oberhammer², S. Dudorov¹, J. Aberg³, A. V. Räisänen¹, ¹Aalto University (formerly TKK), Espoo, Finland, ²KTH - Royal Institute of Technology, Stockholm, Sweden, ³MicroComp Nordic AB, Tullinge, Sweden

TU1D-5: Development of Robust Safety-of-Life Navigation Receivers at the German Aerospace Center (DLR)
M. V. Heckler, M. Cuntz, A. Konovaltsev, L. A. Greda, A. Dreher, M. Meurer, *German Aerospace Center, Wessling, Germany*

9:20 - 9:30

TU1A-6: Analysis of Periodic Structures by Means of a Generalized Transverse Resonance Approach
J. E. Varela, J. Esteban, *Universidad Politécnica de Madrid, Madrid, Spain*

TU1C-6: Micromachined On-wafer Probes
T. J. Reck¹, L. Chen¹, C. Zhang¹, C. Groppi², H. Xu¹, A. Arsenovic¹, N. S. Barker¹, A. Lichtenberger¹, R. M. Weikle¹, ¹University of Virginia, Charlottesville, United States, ²Arizona, Tempe, United States

9:30 - 9:40

PLENARY PRESENTATION

A Strategic View of Defense Research and Engineering

Tuesday, 10:10-11:50

Anaheim Convention Center, Third level Ballroom A-C



Plenary Speaker: Honorable Zachary J. Lemnios

Abstract: In this presentation, Mr. Lemnios will give an overview of a number of defense related technology opportunities and challenges facing the electronic industry. From defense research and engineering perspective, the first major challenge is to preserve the technological edge of the forces, by extending the capabilities of the defense systems – through better intelligence, greater speed, longer range, higher precision, and more effectiveness. The second major challenge is to identify breakthrough capabilities. Finally, the third major challenge is to provide a hedge against an uncertain future via a set of scientific and engineering options to deter against strategic surprise. To enhance defense capabilities, development programs shall balance near and long term activities and balance incremental change with revolutionary technologies. We should understand where the state-of-the-art is in science, and understand how to apply these technologies, and create opportunities through investment.

Biography of the speaker:

The Honorable Zachary J. Lemnios currently serves as the Chief Technology Officer (CTO) for the Department of Defense.

Prior to acceptance of his current role, Mr. Lemnios was the MIT Lincoln Laboratory Chief Technology Officer (CTO) responsible for coordinating technology strategy across the Laboratory and for establishing and growing strategic relationships outside the Laboratory to support current and future Laboratory missions. He also served as Assistant Division Head of the MIT Lincoln Laboratory Solid State Division, as a member of the Laboratory's Senior Management Council and as the Co-Chair of the Laboratory's New Technology Initiative (NTI) Board.

Mr. Lemnios was also the Director of the Defense Advanced Research Projects Agency (DARPA) Microsystems Technology Office (MTO) as well as the Deputy Director of Information Processing Technology Office (IPTO). In these positions, he oversaw the development of research thrusts, analyzed and evaluated program proposals and engagements with commercial, academic organizations and represented DARPA on various national committees.

He has been in close contact with industry - he held various positions within industry at Hughes Aircraft Company, Westinghouse Electric Corporation and Ford Microelectronics, Inc. that led to the development and demonstration of advanced microelectronic components.

Mr. Lemnios has served on numerous DoD, industry and academic committees. Mr. Lemnios has authored over 40 papers, holds 4 patents in advanced GaAs device and MMIC technology and is a Senior Member of the IEEE.



TUESDAY PANEL SESSIONS

Tuesday 12:00 – 13:10 Room 210AB

Silicon at THz Frequencies: A Reality or a Dream?

Chair/Moderator: Prof. Gabriel M. Rebeiz, University of California, San Diego

Panelists:

- Bill Deal, Northrop Grumman
- Jonathan Lynch, HRL Laboratories
- K.K. O, University of Florida/University of Dallas
- Ullrich Pfeifer, University of Wuppertal
- Sorin Voinigescu, University of Toronto

Panel Session Abstract:

InP MMICs are the only technology used at Terahertz frequencies. This technology has demonstrated low-noise amplifiers and oscillators up to 300 GHz, and recently state of the art amplifiers up to 500 GHz. Also, GaAs Schottky-diodes are the technology of choice for low-noise room-temperature mixers and multipliers up to 1 THz. However, both the InP and GaAs technologies are developed in few research labs world-wide and are quite expensive. These technologies are therefore used nowadays for radio-astronomy and in laboratory set-ups such as biological detection systems, and test and instrumentation, and there is minimal adoption of THz systems for general use (imaging, portable medical diagnostics, high-data rate communications, etc.).

Recently, silicon circuits have demonstrated acceptable performance up to 650 GHz using standard CMOS and SiGe technologies and with no additional processing. The NF (or NEP), output power and phase noise does not compare to InP and GaAs MMICs, but still, they are being developed as an alternative low-cost solution. Will we have high performance CMOS/SiGe circuits at THz frequencies in the next few years? Can we build low-cost THz silicon RFICs for large volume commercial applications? There are many different challenges such as available output power vs. frequency, integrated high efficiency THz antennas on low-resistivity silicon substrates, and $1/f$ phase noise in oscillators, to name a few. Several of the panel members believe that these challenges are currently being solved, paving the way to low cost THz silicon RFICs.

This panel will present an honest discussion of silicon and InP/GaAs circuits at THz frequencies with distinguished scientists in the field.

STUDENT PAPER COMPETITION

Tuesday, May 25, 2010

14:00-16:00

213CD, Anaheim Convention Center

The student paper competition had become one of the largest technical events at IMS. The purpose of the competition is to determine and acknowledge the best student work of the year in the MTT-S. This year we received 218 student papers approximately 26% of all submitted papers. Each student paper went through the regular review process by the Technical Program Committee. Approximately 49% of the student submitted papers were accepted for presentations. Based on the review scores, only 27 of the accepted student papers were selected as finalists. The finalists are given complimentary registration for IMS 2010, complimentary tickets to the MTT-S awards banquet and travel subsidies. The student finalists will present their papers at their appropriate regular sessions and make special presentations at the Interactive Forum on Tuesday from 14:00-16:00pm. Six top papers and four honorable mentions will be selected to receive cash awards, certificates, and gifts. These will be announced and presented during the Students Awards Luncheon on Thursday. We are very pleased to announce the finalists for the IMS 2010 Student Paper Competition:

<p>Dispersion Characteristics of Metamaterial Slow-Wave Coupled Lines H. Ma, H. Yang, University of Illinois, Chicago, United States</p>	<p>Dual-Mode Leaky-Wave Excitation in Symmetric Composite Right/Left-Handed Structure with Center Vias M. M. Hashemi, T. Itoh, University of California, Los Angeles, Los Angeles, United States</p>
<p>Exploiting the Relativistic Formulation of Maxwell's Equations to Introduce Moving Grids into Finite Difference Time Domain Solvers R. B. Armenta, C. D. Sarris, University of Toronto, Toronto, Canada</p>	<p>Single Section Wilkinson Type UWB Power Divider with Bandpass Filter and DC Block Characteristics in LTCC Technology T. Duong, I. Kim, Kyung Hee University, Yongin-si, Republic of Korea</p>
<p>A 20-90 MHz 26-Channel Cochlear-Based Channelizer Y. C. Ou, G. M. Rebeiz, University of California, San Diego, La Jolla, United States</p>	<p>Oscillator Phase-Noise Reduction Using Low-Noise High-Q Active Resonators M. Nick, A. Mortazawi, University of Michigan, Ann Arbor, United States</p>
<p>Sub-nanosecond Pulse Characteristics of InGaP/GaAs HBTs R. Jin, C. Chen, S. Halder, W. R. Curtice, J. C. Hwang, Lehigh University, Bethlehem, United States</p>	<p>Third-Order Intermodulation Distortion due to Self-heating in Gold Coplanar Waveguides E. Rocas¹, C. Collado¹, N. Orloff², J. C. Booth², ¹ Universitat Politècnica de Catalunya, Barcelona, Spain, ²National Institute of Standards and Technology, Boulder, United States</p>
<p>A New Mixed Time-Frequency Simulation Method for Nonlinear Heterogeneous Multirate RF Circuits J. S. Oliveira¹, J. C. Pedro², ¹Polytechnic Institute of Leiria, Leiria, Portugal, ²University of Aveiro, Aveiro, Portugal</p>	<p>Lumped Isolation Circuits for Improvement of Matching and Isolation in Three-Port Balun Band-Pass Filter T. Yang¹, P. Chi¹, T. Itoh¹, ¹University of California, Los Angeles, Los Angeles, United States, ²University of Electronic and Science Technology of China, Chengdu, China</p>
<p>A novel methodology for fast harmonic-load control with a passive tuner and an active loop S. Bonino, V. Teppati, A. Ferrero, Politecnico di Torino, Torino, Italy</p>	<p>Wideband High Efficiency Digitally-Assisted Envelope Amplifier with Dual Switching Stages for Radio Base-Station Envelope Tracking Power Amplifiers C. Hsia¹, D. F. Klmball¹, S. Lanfranco², P. M. Asbeck¹, ¹University of California, San Diego, La Jolla, United States, ²Nokia Siemens Networks, Mountain View, United States</p>
<p>Application of Composite Right/Left-Handed Half-Mode Substrate Integrated Waveguide to the Design of a Dual-Band Rat-Race Coupler Y. Dong, T. Itoh, UCLA Microwave Electronics Lab., Los Angeles, United States</p>	<p>A Method to Control Non-uniformity RF H_{θ} Field for High Field Magnetic Resonance Imaging H. Yoo, A. Gopinath, T. Vaughan, University of Minnesota, Minneapolis, United States</p>



STUDENT PAPER COMPETITION

<p>An 85-95.2 GHz Transformer-Based Injection-Locked Frequency Tripler in 65nm CMOS Z. Chen, P. Heydari, University of California, Irvine, Irvine, United States</p>	<p>TM Dual-Mode Pseudoelliptic Filters using Nonresonating Modes S. Bastioli¹, C. Tomassoni¹, R. Sorrentino¹, ¹University of Perugia, Perugia, Italy, ²RF Microtech srl, Perugia, Italy</p>
<p>Switch-Controlled Multi-Octave Bandwidth Radial Power Divider/Combiner Y. Hong¹, D. F. Kimball², J. Yook¹, P. M. Asbeck², L. E. Larson², ¹Yonsei University, Seoul, Republic of Korea, ²University of California, San Diego, La Jolla, United States</p>	<p>A Ka-Band High-Pass Distributed Amplifier in 120nm SiGe BiCMOS T. D. Gathman, J. F. Buckwalter, University of California, San Diego, La Jolla, United States</p>
<p>Low-Power Low-Noise 0.13 μm CMOS X-Band Phased Array Receivers D. Shin, G. M. Rebeiz, UCSD, La Jolla, United States</p>	<p>An RF-MEMS Switch with mN Contact Forces C. D. Patel, G. M. Rebeiz, University of California, San Diego, La Jolla, United States</p>
<p>X/Ku-Band 8-Element Phased Arrays Based on Single Silicon Chips Y. A. Atesal¹, B. Cetinoneri¹, K. Koh², G. M. Rebeiz¹, ¹University of California, San Diego, La Jolla, United States, ²Intel Corp., Hillsboro, United States</p>	<p>Adjustable Dielectric Using Magnetically Aligned Conductive Particles for Microwave Applications S. Moon, W. J. Chappell, Purdue University, West Lafayette, United States</p>
<p>Concurrent Enhancement of Q and Power Handling in Multi-Tether High-Order Extensional Resonators M. Shahmohammadi, B. P. Harrington, R. Abdolvand, Oklahoma State University, Tulsa, United States</p>	<p>Dual-Band Integrated Self-biased Edge-Mode Isolator based on the Double Ferromagnetic Resonance of a Bistable Nanowire Substrate L. Carignan¹, C. Caloz², D. Ménard¹, ¹Polytechnique School of Montreal, Montreal, Canada, ²Ecole Polytechnique of Montreal, Montreal, Canada</p>
<p>Tunable, Substrate Integrated, High Q Filter Cascade for High Isolation E. J. Naglich, J. Lee, D. Peroulis, W. J. Chappell, Purdue University, West Lafayette, United States</p>	<p>Highly Directive Package-Integrated Dipole Arrays for Low-Cost 60-GHz Front End Modules A. L. Amadjikpè¹, D. Choudhury², G. E. Ponchak³, J. Papapolymerou¹, ¹Georgia Institute of Technology, Atlanta, United States, ²Intel Corporation, Hillsboro, United States, ³NASA Glenn Research Center, Cleveland, United States</p>
<p>Implementation and Analysis of a 30 GHz Wireless Communication System with a Novel Receiver Front-end tZ. Zhang, Y. Wei, K. Wu, Ecole Polytechnique Montreal, Montreal, Canada</p>	



STUDENT DESIGN COMPETITIONS

The Technical Committees of MTT-S are sponsoring four Student Design Competitions at IMS. This year the student competition topics are low noise amplifier, packaged ultra-wide-band filter, and high efficiency power amplifier. These topics are geared toward the practical applications that working engineers face every day and therefore represent an excellent opportunity for students to show off how well prepared they are for a professional career. These competitions are open to all students registered at an educational institution. The winners will receive cash awards and participants will be recognized at the Student Awards Luncheon on Thursday.

High Efficiency Power Amplifier

Tuesday May 25, 2010

9:00-11:00

Anaheim Convention Center, Room 213AB

This competition is the fifth sponsored by High Power Amplifiers (MTT-5) and is open to students enrolled at a university. Competitors are required to design, construct, and measure a high efficiency power amplifier, at a frequency of their choice above 1 GHz but less than 20 GHz, and having an output power level of at least 5 Watts. The winner will be judged on the design which demonstrates the highest Power Added Efficiency (PAE) weighted for frequency.

ASH Receiver Design Competition

Tuesday May 25, 2010

9:00-11:00

Anaheim Convention Center, Room 213AB

This competition is sponsored by the Microwaves Systems (MTT-16) and Microwave Acoustics (MTT-2) sub-committees. This Competition is open to all students and graduate students registered at an educational establishment. The competitors are required to design, construct, and measure an Amplifier-Sequenced Hybrid Receiver (ASH receiver) at a frequency of 433.92 MHz.

Packaged Diplexer Design Competition

Tuesday May 25, 2010

12:00-14:00

Anaheim Convention Center, Room 213AB

This competition is sponsored by Microwave Filters, Multiplexers, and Passive Components (MTT-8) and Interconnects, Packaging, and Manufacturing (MTT-12) and is open to IEE IMS students enrolled at a university. Competitors are required to design, construct, and measure a packaged diplexer. The designs will be judged using criteria that include filter performance, robustness and weight.

Optical-to-Microwave Converter Design Competition

Tuesday May 25, 2010

12:00-14:00

Anaheim Convention Center, Room 213AB

This competition is sponsored by the Microwave photonics (MTT-3) and is open to all IEEE MTT-S members who are enrolled as students at a university. The objective of the contest is to demonstrate new and effective photodiode power combining and power extraction techniques. The designs will be judged by members of MTT-3 using pre-defined criteria that include converter efficiency, maximum power output, and linearity.

MTT-S Student Awards Luncheon

Thursday May 27, 2010

12:00-14:00

Hilton Hotel, Room California B

All students are invited to attend this luncheon which recognizes recipients of the MTT-S Undergraduate Scholarships, MTT-S Graduate Fellowships, IMS2010 Student Volunteers, IMS2010 Student Paper Awards, and the winners and participants of the IMS2010 Student Design Competitions.



TUESDAY TECHNICAL SESSIONS

13:20-15:00

TU3A: Time-Domain Techniques and Applications
 Costas Sarris, *University of Toronto*
 Nathan Bushyager, *Northrop Grumman*
Room: 203B

TU3B: Advances in Power Divider/Combiner Technology
 Victor Fouad Hanna, *University of Paris*
 Rashaunda Henderson, *University of Texas at Dallas*
Room: 205AB

TU3C: III-V Compound Semiconductor Based Microwave Circuit Technology
 Cheng P. Wen, *Peking University*
 Ho C. Huang, *AMCOM Communications, Inc.*
Room: 206AB

13:20 - 13:40

TU3A-1: Time Domain Study of Electromagnetic Cloaks for Wideband Invisibility under Transient Illumination
 W. J. Hoefler, G. H. Park, E. P. Li, Institute of High Performance Computing, Singapore, Singapore

TU3B-1: Design of a Compact Balun With Three Octant-Wavelength Coupled Lines
 C. Tang¹, W. Cheng¹, J. Wu¹, Y. Lin², ¹National Chung Cheng University, Chia-Yi, Taiwan, ²Cheng Shiu University, Kaohsiung, Taiwan

TU3C-1: A Complete Transmit, Receive, and LO Buffer Chip Set in Low Cost SMT Package Covering 38 & 42 GHz Applications
 H. Morkner, K. Fujii, S. Kumar, K. Phan, T. Niedzwiecki, B. Ostermann, Avago Technologies INC, San Jose, United States

13:40 - 14:00

TU3A-2: Exploiting the Relativistic Formulation of Maxwell's Equations to Introduce Moving Grids into Finite Difference Time Domain Solvers
 R. B. Armenta, C. D. Sarris, University of Toronto, Toronto, Canada

TU3B-2: Isolation Circuit of Impedance-Transforming 3-dB Compact Baluns for Perfect Output Matching and Isolation
 H. Ahn, T. Itoh, UCLA, Los Angeles, United States

TU3C-2: Design of a 0.5-30 GHz Darlington Amplifier for Microwave Broadband Applications
 S. Weng¹, H. Chang¹, C. Chiong², ¹National Central University, Jhongli, Taiwan, ²Institute of Astronomy and Astrophysics, Taipei, Taiwan

14:00 - 14:20

TU3A-3: Meshless RPIM Modeling of Open-Structures Using PMLs
 Y. Yu¹, Z. Chen², ¹Dalhousie University, Halifax, Canada, ²Dalhousie University, Halifax, Canada

TU3B-3: Single Section Wilkinson Type UWB Power Divider with Bandpass Filter and DC Block Characteristics in LTCC Technology
 T. Duong, I. Kim, Kyung Hee University, Yongin-si, Republic of Korea

TU3C-3: Multi-octave GaN MMIC Amplifier
 A. Darwish¹, A. Hung¹, E. Viveiros¹, M. Kao², ¹Army Research Laboratory, Adelphi, United States, ²TriQuint Semiconductor, Richardson, United States

14:20 - 14:40

TU3A-4: Microstrip-Based Nanosecond Pulse Generators: Numerical and Circuital Modeling
 C. Merla¹, S. El-Amari¹, F. Danei², M. Liberti², F. Apollonio², D. Arnaud-Cormos¹, V. Couderc¹, P. Leveque¹, ¹XLIM, CNR-University of Limoges, Limoges, France, ²CEMBA at "Sapienza" University of Rome, Rome, Italy

TU3B-4: A Miniaturized Power Combiner for Compact Design of CMOS Phase Shifter at K-band
 C. Wang, H. Wu, C. C. Tzuang, National Taiwan University, Taipei, Taiwan

TU3C-4: Wideband High Power GaN on SiC SPDT Switch MMICs
 C. F. Campbell, D. C. Dumka, TriQuint Semiconductor, Richardson, United States

14:40 - 14:50

TU3A-5: Transient Thermal Analysis of Active device (FETs) for High-Power Applications
 L. Zhou¹, Z. Wang¹, W. Yin², J. Mao¹, ¹Center for Microwave and RF Technology, Shanghai, China, ²Center for Optics and EM Research, State Key Lab of MOI, Hangzhou, China

TU3B-5: A Novel Power Divider Design with Enhanced Harmonic Suppression and Simple Layout
 W. IP, K. M. Cheng, The Chinese University of Hong Kong, Hong Kong, Hong Kong

TU3C-5: Current Collapse, Memory Effect Free GaN HEMT
 C. P. Wen, J. Wang, Y. Hao, Peking University, Beijing, China

14:50 - 15:00

TU3B-6: A Novel Power Divider with Enhanced Physical and Electrical Port Isolation.
 C. J. Trantanella, Custom MMIC Design Services, Westford, United States

TUESDAY

TECHNICAL SESSIONS

13:20-15:00

TU3D: Advances in Radar Systems for Detection in Detection, Imaging, Mapping and Localization
 Gregory Lyons, *MIT Lincoln Laboratory*
 Mohamed Abouzahra, *MIT Lincoln Laboratory*
Room: 202AB

TU3E: Novel structures, Effects, and Techniques
 Tapan K. Sarkar, *Syracuse University*
 Silvio E. Barbin, *University of Sao Paulo*
Room: 207C

TU3D-1: Fast Response Retrodirective Radar
 V. Fusco, N. B. Buchanan, P. Sundaralingam, Queens University Belfast, Belfast, United Kingdom

TU3E-1: Broadband Negative Refraction at Microwaves with a Multilayered Mushroom-Type Metamaterial
 A. B. Yakovlev¹, M. G. Silveirinha², C. S. Kaipa¹, ¹University of Mississippi, University, United States, ²University of Coimbra - Instituto de Telecomunicações, Coimbra, Portugal

13:20 - 13:40

TU3D-2: Development of a Multi-Frequency Airborne Radar Instrumentation Package for Ice Sheet Mapping and Imaging
 F. Rodriguez-Morales, P. Gogineni, C. Leuschen, C. T. Allen, S. Seguin, J. Ledford, C. Lewis, A. Patel, L. Shi, W. Blake, B. Panzer, K. Byers, R. Crowe, L. Smith, C. Gifford, University of Kansas, Lawrence, United States

TU3E-2: Photonic Choke-Joints for Dual-Polarization Waveguides
 E. J. Wollack, K. U-yen, D. T. Chuss, NASA Goddard Space Flight Center, Greenbelt, United States

13:40 - 14:00

TU3D-3: Calibration of a Digital Phased Array for Polarimetric Radar
 C. J. Fulton, W. J. Chappell, Purdue University, West Lafayette, United States

TU3E-3: High-Frequency Scattering by a Narrow Gap on a Microstrip Line
 R. R. Berral¹, F. Mesa¹, D. R. Jackson², ¹University of Seville, Seville, Spain, ²University of Houston, Houston, United States

14:00 - 14:20

TU3D-4: Advanced System Level Simulation of UWB Three-Dimensional Through-Wall Imaging Radar for Performance Limitation Prediction
 Y. Wang¹, M. J. Kuhn², A. E. Fathy¹, ¹The University of Tennessee, Knoxville, United States, ²The University of Tennessee, Knoxville, United States

TU3E-4: Heat Distribution Pattern of Double Brillouin Pulse Inside Water
 B. Montazeri Najafabadi, R. Safian, Isfahan university of technology, Isfahan, Iran

14:20 - 14:40

TU3D-5: A 3-5 GHz impulse radio UWB transceiver IC optimized for precision localization at longer ranges
 J. J. Xia, C. L. Law, K. S. Koh, Y. Zhou, C. Fang, Nanyang Technological University, Singapore, Singapore

TU3E-5: Detection at Microwave Frequencies Based on Self-Adjoint Sensitivity Analysis
 L. Liu, A. Trehan, N. K. Nikolova, McMaster University, Hamilton, Canada

14:40 - 15:00



TUESDAY

INTERACTIVE FORUM

15:00 - 17:00

TUPA: MEMS Switches
Jim Hwang, *Lehigh University*

TUPB: Advanced Devices and Circuits in III-V and Silicon Technologies
James Buckwalter, *University of California San Diego*

TUPC: Power-Amplifiers at HF, VHF, and UHF, and GHz Signal Processing
Frederick Raab, *Green Mountain Radio Research*
John Heaton, *BAE Systems*

TUPA-1: Performance of Temperature-Stable RF MEMS Switched Capacitors under High RF Power Conditions

I. C. Reines¹, G. Rebeiz¹, B. Pillans², ¹University of California San Diego, La Jolla, United States, ²Raytheon Systems, Dallas, United States

TUPB-1: Fabrication of AlGaIn/GaN HEMT with the improved ohmic contact by encapsulation of silicon dioxide thin film

J. G. Heo¹, H. K. Sung¹, J. W. Lim², S. K. Kim¹, W. K. Park¹, C. G. Ko¹, ¹Device dev., Suwon, Republic of Korea, ²CC & MR Lab., Daejeon, Republic of Korea

TUPC-1: Lumped-element Output Networks for High-efficiency Power Amplifiers

R. A. Beltran¹, F. H. Raab², ¹Tijuana, Mexico, ²Green Mountain Radio Research Company, Colchester, United States

TUPA-2: Magnetically-Actuated Dielectric Cantilever RF MEMS Switches

A. A. Fomani, S. Fouladi, R. R. Mansour, University of Waterloo, Waterloo, Canada

TUPB-2: A novel active variable gain X-Band amplifier in SiGe technology

R. Corbier¹, B. Louis¹, J. Tartarin², ¹Thales Airborne Systems, Elancourt, France, ²LAAS, Toulouse, France

TUPC-2: Second harmonic reduction in broadband HF/VHF/UHF class E RF power amplifiers

K. Narendra¹, A. Mediano², L. Anand³, C. Prakash¹, ¹Motorola Technology, Pulau Pinang, Malaysia, ²University of Zaragoza, Zaragoza, Spain, ³University Science Malaysia, Pulau Pinang, Malaysia

TUPA-3: CMOS-based Monitoring of Contact Events up to 4 MHz in Ohmic RF MEMS Switches

A. J. Fruehling, M. Abu Khater, B. Jung, D. Peroulis, Purdue University - Birck Nanotechnology Center, West Lafayette, United States

TUPB-3: The Impact of Uniaxial Strain on Low Frequency Noise of Nanoscale PMOSFETs with e-SiGe and i-SiGe Source/Drain

K. Yeh, W. Hong, J. Guo, National Chiao-Tung University, Hsinchu, Taiwan

TUPC-3: A Novel Inverse Class-D Output Matching Network and its Application to Dynamic Load Modulation

M. Gamal El Din, B. Geck, I. Rolfs, H. Eul, Leibniz Universität Hannover, Hannover, Germany

TUPA-4: Variable Spring Constant, High Contact Force RF MEMS Switch

H. Sedaghat-Pisheh, G. M. Rebeiz, University of California, San Diego (UCSD), San Diego, United States

TUPB-4: Channel Temperature Estimation in GaAs FET Devices

A. P. Fattorini¹, J. Tarazi², S. J. Mahon¹, ¹Mimix Broadband, North Sydney, Australia, ²Macquarie University, Sydney, Australia

TUPC-4: DSP Assisted Low Cost IQ Mismatch Measurement and Compensation Using Built in Power Detector

S. Sen, S. K. Devarakond, A. Chatterjee, Georgia Institute of Technology, Atlanta, United States

TUESDAY

ROOM 204ABC

15:00 - 17:00

TUPE: mm-Wave and THz Signal Generation, Detection and TransmissionJae-Sung Rieh, *Korea University*
Tsuneo Tokumitsu, *Sumitomo Electric Ind.***TUPF: Microwave Photonics and Low Noise Receivers**Bill Jemison, *Lafayette College***TUPH: Packaging, Interconnect, MCMs, and Integration**Rudy Emrick, *General Dynamics***TUPE-1:Optically Generated Sub-THz Continuous Wave Using Feedbacked 3rd Order Double Sideband-Suppressed Carriers (DSB-SCs)**

S. Kim, K. Kang, Electronics and Telecommunications Research Institute, Daejeon, Republic of Korea

TUPF-1: Microwave Photonic Instantaneous Frequency Measurement with Simultaneous Parallel Operation within a Single Optical Fiber

N. Sarkhosh, H. Emami, L. Bui, A. Mitchell, School of Electrical and Computer Engineering, GPO Box 2476, Australia

TUPH-1: Analytical Approaches to Calculating the Parasitic Coupling between Packages and Microwave CircuitsA. Beyer¹, T. Bolz², ¹Duisburg-Essen University, Campus Duisburg, Duisburg, Germany, ²IMST GmbH, Kamp-Lintfort, Germany**TUPE-2: A Broadband Heterostructure Barrier Varactor Tripler Source**T. Bryllert², J. Vukusic², A. Olsen¹, J. Stake², ¹Wasa Millimeter Wave, Torshanda, Sweden, ²Chalmers University of Technology, Goteborg, Sweden**TUPF-2: Optimization of Phase Noise in an All-optical Frequency Upconverter Utilizing an Optical Interleaver and a Semiconductor Optical Amplifier for Radio-over-Fiber Applications**

H. Kim, J. Song, Gwangju Institute of Science and Technology (GIST), Gwangju, Republic of Korea

TUPH-2: Dual-band CRLH branch-line coupler in LTCC by lump elements with parasite control

H. Lu, Y. Kuo, P. Huang, Y. Chang, National Taiwan University, Taipei, Taiwan

TUPE-3: Highly Directive Package-Integrated Dipole Arrays for Low-Cost 60-GHz Front End ModulesA. L. Amadjikpè¹, D. Choudhury², G. E. Ponchak³, J. Papapolymerou¹, ¹Georgia Institute of Technology, Atlanta, United States, ²Intel Corporation, Hillsboro, United States, ³NASA Glenn Research Center, Cleveland, United States**TUPF-3: Dynamics of the Optical Frequency Locked Loop using tunable Nd: YVO4 microchip lasers**M. Alemohammad¹, Y. Li², P. R. Herzfeld¹, ¹Drexel University, Philadelphia, United States, ²UMass Dartmouth, North Dartmouth, United States**TUPH-3: Cost-Effective High-Yield Manufacturing Process of Integrated Passive Devices (IPDs) for RF and Microwave Application**C. Wang¹, W. Lee², N. Kim¹, ¹Kwangwoon University, Seoul, Republic of Korea, ²Nano ENS Inc., Suwon, Republic of Korea**TUPE-4: SIP-based 60GHz 4x4 Antenna Array with 90nm CMOS OOK Modulator in LTCC**M. F. Karim¹, M. Sun¹, M. L. Ong¹, Y. Guo², J. Brinkhoff³, K. Kang³, F. Lin³, ¹Institute for Infocomm Research, Singapore, Singapore, ²National University of Singapore, Singapore, Singapore, ³Institute of Microelectronics, Singapore, United States**TUPF-4: A 18.85 mW 20-29 GHz Wideband CMOS LNA with 3.85±0.25 dB NF and 18.1±1.9 dB Gain**

Y. Chiu, Y. Lin, J. Chang, National Chi Nan University, Puli, Taiwan

TUPH-4: Miniaturised Low Cost Solid State 4W TXRX Common leg for 6÷18 GHz Phased Array

D. Baccello, M. D'Antoni, B. Orobello, E. Sperduti, Elettronica S.p.A., Roma, Italy

TUPE-5: Analysis of Plasmon Excited by Metal-Insulator-Metal Structure with Insulator Thickness of Hundreds of Nanometers

M. Tamura, H. Kagata, Panasonic Electronic Devices Co., Ltd., Kadoma, Japan

TUPF-5: Differential Noise Figure Measurement: A Matrix Based Approach

M. Robens, R. Wunderlich, S. Heinen, RWTH Aachen University, Aachen, Germany

TUPH-5: Packaging of Microstrip Circuits Using Spring Mattress to Suppress Cavity Modes - a Replacement for Bed of NailsE. Rajo-Iglesias¹, P. Kildal², A. A. Kishk³, ¹University Carlos III of Madrid, Leganes, Spain, ²Chalmers University of Technology, Gothenburg, Sweden, ³University of Mississippi, Mississippi, United States**TUPE-6: Energy Detection and Radiation by Metallic Rings Embedded into a Self-Rolled InGaAs/GaAs Micro-Tube**G. Monti¹, R. De Paolis¹, L. Tarricone¹, M. T. Todaro², M. De Vittorio², A. Passaseo², ¹University of Salento, Lecce, Italy, ²Consiglio Nazionale delle Ricerche INFM, Lecce, Italy**TUPE-7: Experimental Characterization of EC-CPW Transmission Lines and Passive Components for 60-GHz CMOS Radios**I. Haroun², J. Wight¹, C. Plett¹, A. Fathy³, ¹Calreton University, Ottawa, Canada, ²Communications Research Centre Canada, Nepean, Canada, ³The University of Tennessee, Knoxville, United States



TUESDAY TECHNICAL SESSIONS

15:30-17:10

TU4A: Advances in Space Mapping Technologies for Design Optimization

Paul Draxler, *Qualcomm, Inc. and UCSD*
Jose E. Rayas-Sanchez, *ITESO*
Room: 203B

TU4B: Ultra Wide Band Planar Filters and Devices

Magdalena Salazar-Palma, *Universidad Carlos III de Madrid*
Roberto Gomez-Garcia, *Universidad de Alcala*
Room: 205AB

TU4C: Millimeter-Wave Power Amplifiers and Power-Combining Techniques

Debasis Dawn, *Georgia Institute of Technology*
Chang-Ho Lee, *Samsung Electro-Mechanics*
Room: 206AB

15:30 - 15:50

TU4A-1: Response Corrected Tuning Space Mapping for Yield Estimation and Design Centering
Q. S. Cheng¹, J. W. Bandler¹, S. Koziel², ¹McMaster University, Hamilton, Canada, ²Reykjavik University, Reykjavik, Iceland

TU4B-1: A 20-90 MHz 26-Channel Cochlear-Based Channelizer
Y. C. Ou, G. M. Rebeiz, University of California, San Diego, La Jolla, United States

TU4C-1: W-Band GaN MMIC with 842 mW Output Power at 88 GHz
M. Micovic¹, A. Kurdoghlian¹, K. Shinohara¹, I. Milosavljevic¹, S. D. Burnham¹, M. Hu¹, A. L. Corrion¹, W. S. Wong¹, A. Schmitz¹, P. B. Hashimoto¹, P. J. Willadsen¹, D. H. Chow¹, A. Fung², R. H. Lin², L. Samoska², P. P. Kangaslahti², B. H. Lambriqtsen², P. F. Goldsmith², ¹HRL Laboratories LLC, Malibu, United States, ²JPL, Pasadena, United States

15:50 - 16:10

TU4A-2: Surrogate Modeling of Microwave Circuits Using Polynomial Functional Interpolants
J. E. Rayas-Sanchez, J. Aguilar-Torrentera, J. A. Jasso-Urzuza, *ITESO, Tlaquepaque, Mexico*

TU4B-2: Two Novel Classes of Band-Reject Filters Realizing Broad Upper Pass Bandwidth
W. M. Fathelbab, H. M. Jaradat, D. Reynolds, South Dakota School of Mines and Technology, Rapid City, United States

TU4C-2: W-Band, 5W Solid-State Power Amplifier/Combiner
J. Schellenberg¹, E. Watkins¹, M. Micovic², B. Kim¹, K. Han¹, ¹QuinStar Technology, Torrance, United States, ²HRL Laboratories, Malibu, United States

16:10 - 16:30

TU4A-3: Robust Multi-Fidelity Simulation-Driven Design Optimization of Microwave Structures
S. Koziel, S. Ogurtsov, Reykjavik University, Reykjavik, Iceland

TU4B-3: A Compact UWB Bandpass Filter with Ultra Narrow Notched Band and Competitive Attenuation Slope
X. Luo¹, H. Qian¹, J. Ma², K. Ma³, K. S. Yeo⁴, ¹University of Electronic Science and Technology of China, Chengdu, China, ²Tianjin University, Tianjin, China, ³ST Electronics, Singapore, Singapore, ⁴Nanyang Technological University, Singapore, Singapore

TU4C-3: A Compact Self-similar Power Combining Topology
K. Sengupta, A. Hajimiri, California Institute of Technology, Pasadena, United States

16:30 - 16:50

TU4A-4: Adaptively Constrained Parameter Extraction for Robust Space Mapping Optimization of Microwave Circuits
S. Koziel¹, J. W. Bandler², Q. S. Cheng², ¹Reykjavik University, Reykjavik, Iceland, ²McMaster University, Hamilton, Canada

TU4B-4: New Bandstop Filter Based on Capacitively Coupled Lambda/4 Short-Circuited Lines Embedded into U.S. UWB BPF
T. Duong, I. Kim, Kyung Hee University, Yongin-si, Republic of Korea

TU4C-4: A 22-dBm 24-GHz power amplifier using 0.18-µm CMOS technology
P. Huang, J. Juo, Z. Tsai, K. Lin, H. Wang, Department of Electrical Engineering, Taipei, Taiwan

16:50 - 17:10

TU4A-5: Automated Synthesis of Resonant-type Metamaterial Transmission Lines using Aggressive Space Mapping
A. Rodriguez¹, J. Selga², M. Gil², J. Carbonell³, V. E. Boria¹, F. Martin², ¹Universidad Politécnic de Valencia, Valencia, Spain, ²Universitat Autònoma de Barcelona, Bellaterra, Spain, ³Universidad Politécnic de Valencia, Valencia, Spain

TU4B-5: Wideband Ring Resonator Bandpass Filter With Dual Stepped Impedance Stubs
C. H. Kim, K. Chang, Texas A&M University, College Station, United States

17:00 - 17:10

TU4B-6: Novel Low Cost Compact Size Planar Low Pass Filters with Deep Skirt Selectivity and Wide Stopband Rejection
K. Ma¹, K. Yeo², ¹ST Electronics, Singapore, Singapore, ²Nanyang Technological University, Singapore, Singapore

TUESDAY

TECHNICAL SESSIONS

15:30-17:10

TU4D: Novel Circuit and System Technologies for Wireless Communications
 Kyutae Lim, *Georgia Institute of Technology*
 Shoichi Narahashi, *NTT DOCOMO, INC.*
Room: 202AB

TU4E: Microwave and Millimeter Wave VCOs
 John Papapolymerou, *Georgia Institute of Technology*
 Yi-Jan Emery Chen, *National Taiwan University*
Room: 207C

TU4D-1: ISO-less, SAW-less Open-loop Polar Modulation Transceiver for 3G/GSM/EDGE Multi-mode/Multi-band Handset
 T. Tsukizawa¹, M. Nakamura¹, G. L. Do², M. Igarashi³, K. Ishida¹, ¹Panasonic Corporation, Yokohama, Japan, ²Panasonic Corporation, San Jose, United States, ³Panasonic Corporation, Nagaokakyo, Japan

TU4E-1: 300GHz Fixed-Frequency and Voltage-Controlled Fundamental Oscillators in an InP DHBT Process
 M. Seo¹, M. Urteaga¹, A. Young¹, V. Jain², Z. Griffith¹, J. Hacker¹, P. Rowell¹, R. Pierson¹, M. Rodwell², ¹Teledyne Scientific & Imaging, Thousand Oaks, United States, ²University of California, Santa Barbara, Santa Barbara, United States

15:30 - 15:50

TU4D-2: A Highly Integrated Dual Band SiGe BiCMOS Power Amplifier that Simplifies Dual-band WLAN and MIMO Front-End Circuit Designs
 Chun-Wen Paul Huang, Mark Doherty, Philip Antognetti, Lui (Ray) Lam, and William Vaillancourt
 SiGe Semiconductor, Andover, MA 01810, USA
 C. P. Huang, M. Doherty, P. Antognetti, L. Lam, W. Vaillancourt, SiGe Semiconductor, Andover, United States

TU4E-2: Oscillator Phase-Noise Reduction Using Low-Noise High-Q Active Resonators
 M. Nick, A. Mortazawi, University of Michigan, Ann Arbor, United States

15:50 - 16:10

TU4D-3: A Technique for Wireless LAN Connection through Building Concrete Wall at 2.4GHz.
 S. Mizushima, A. Adachi, Enegene Co. Ltd., Hamamatsu, Japan

TU4E-3: Low Phase Noise Load Independent Switched LC VCO
 P. Liu¹, P. Upadhyaya², J. Jung¹, T. Luo³, Y. Chen², D. Heo¹, ¹Washington State University, Pullman, United States, ²Xilinx Inc., San Jose, United States, ³National Taiwan University, Taipei, Taiwan

16:10 - 16:30

TU4D-4: Asymmetric multilevel outphasing transmitter using Class-E PAs with discrete pulse width modulation
 S. Chung, P. A. Godoy, T. W. Barton, J. L. Dawson, D. J. Perreault, Massachusetts Institute of Technology, Cambridge, United States

TU4E-4: A C-Band GaAs-pHEMT MMIC Low Phase Noise VCO for Space Applications Using a New Cyclostationary Nonlinear Noise Model
 C. Florian¹, P. A. Traverso¹, M. Feudale², F. Filicori¹, ¹University of Bologna, Bologna, Italy, ²Thales Alenia Space Italia, Roma, Italy

16:30 - 16:50

TU4D-5: Experimental Performance Evaluation of IQ Imbalance and DC Offset Estimation and Compensation Technique for 3GPP LTE Base Station
 A. Yamaoka, K. Yamaguchi, T. Kato, Y. Tanabe, TOSHIBA Corporation, Kawasaki, Japan

TU4E-5: A Millimeter-Wave Reflection-Type Dual-Frequency VCO MMIC with a Coupled Line
 H. Mizutani, K. Nishida, M. Tsuru, K. Kawakami, M. Hieda, E. Taniguchi, M. Shimozawa, Y. Hirano, Mitsubishi Electric Corporation, Kamakura, Japan

16:50 - 17:10



WEDNESDAY TECHNICAL SESSIONS

8:00-9:40

WE1A: Modeling and Characterization of Devices
 John Atherton, *Win Semiconductor*
 Jim Hwang, *Lehigh University*
Room: 205AB

WE1B: New Synthesis Techniques for Filter and Multiplexers
 Ming Yu, *COM DEV*
 Giuseppe Macchiarella, *Politecnico di Milano*
Room: 206AB

WE1C: Advanced Millimeter-Wave Packaging
 Kavita Goverdhanam, *US Army CERDEC*
 C.K. Clive Tzuang, *National Taiwan University*
Room: 207AB

WE1D: Advances in microwave sensors and object detection systems.
 Lora Schulwitz, *General Dynamics*
 Manos Tentzeris, *GEDC, Georgia Tech*
Room: 207C

8:00 - 8:20

WE1A-1: Sub-nanosecond Pulse Characteristics of InGaP/GaAs HBTs
 R. Jin, C. Chen, S. Halder, W. R. Curtice, J. C. Hwang,
 Lehigh University, Bethlehem, United States

WE1B-1: Design of Triplexer Combiners for Base Stations of Mobile Communications
 G. Macchiarella¹, S. Tamiazzo², ¹Politecnico di Milano, Milano, Italy, ²Andrew Telecommunication Products, Agrate Brianza, Italy

WE1C-1: Cost-Effective 60-GHz Antenna-Packaging with End-Fire Radiation from Open-Ended Post-Wall Waveguide for Wireless File-Transfer System
 R. Suga¹, H. Nakano², Y. Hirachi², J. Hirokawa¹, M. Ando¹, ¹Tokyo Institute of Technology, Tokyo, Japan, ²AMMSYS Inc., Tokyo, Japan

WE1D-1: A Microwave-Based Gamma-Ray Detector
 B. Cetinoneri¹, Y. A. Atesal¹, R. A. Kroeger², G. Tepper³, J. Losee², C. Hicks¹, M. Rasmussen², G. M. Rebeiz¹, ¹University of California, San Diego, La Jolla, United States, ²Space and Naval Warfare Systems Center, San Diego, United States, ³Virginia Commonwealth University, Richmond, United States

8:20 - 8:40

WE1A-2: Characterization of Trapping and Thermal Dispersion in GaN HEMTs
 S. A. Albahrani, A. E. Parker, Macquarie University, Sydney, Australia

WE1B-2: Direct Synthesis of General Chebyshev Bandpass Filters with A Frequency Variant Complex Load
 M. Meng, K. L. Wu, The Chinese University of Hong Kong, Hong Kong, Hong Kong

WE1C-2: A 77 GHz Broadband Flip-Chip Transition on LTCC Submount
 F. J. Schmueckle¹, U. Pursche¹, W. Heinrich¹, J. Purden², ¹Ferdinand-Braun-Institut für Höchstfrequenztechnik (FBH), Berlin, Germany, ²Delphi, Malibu, United States

WE1D-2: A Novel Passive Wireless Ultra-sensitive Temperature RF Transducer for Remote Sensing
 T. T. Thai², M. Jatlaoui¹, P. Pons¹, H. Aubert⁴, M. Tentzeris², G. DeJean³, R. Plana¹, ¹LAAS, Toulouse, France, ²Georgia Institute of Technology, Atlanta, United States, ³Microsoft Research, One Microsoft Way, Redmond, United States, ⁴Université de Toulouse, Toulouse, France

8:40 - 9:00

WE1A-3: Large-signal FET Models with Multiple Time Scale Dynamics from Nonlinear Vector Network Analyzer Data
 J. Xu, J. Horn, M. Iwamoto, D. E. Root, Agilent Technologies, Inc., Santa Rosa, United States

WE1B-3: New Distributed Model for Synthesis of Classical Dual Mode Filters
 S. Cogollos¹, M. Brumos¹, V. E. Boria¹, C. Vicente², B. Gimeno³, M. Guglielmi⁴, ¹Universidad Politécnica de Valencia, Valencia, Spain, ²Aurorasat, s.l., Valencia, Spain, ³Universidad de Valencia, Burjasot, Spain, ⁴European Space Research and Technology Centre (ESTEC), Noordwijk, Netherlands

WE1C-3: Broadband, Quad Flat No-Lead (QFN) Package Developed using Standard Overmold Leadframe Technology
 M. J. Chen, S. A. Tabatabaei, Endwave Corporation, San Jose, United States

WE1D-3: Novel Image Reconstruction Algorithm for a UWB Cylindrical Microwave Imaging System
 M. E. Bialkowski, Y. Wang, A. Abu Bakar, W. Khor, University of Queensland, Brisbane, Australia

9:00 - 9:20

WE1A-4: Compact RF Large-Signal Model for MEMS Capacitive Switches
 S. Halder¹, C. Palego¹, J. C. Hwang¹, C. L. Goldsmith², ¹Lehigh University, Bethlehem, United States, ²Memtronics Corporation, Plano, United States

WE1B-4: Wide-Band Bandpass Filters Simulation, Design and Diagnosis
 H. Lee¹, K. Zaki¹, A. Atia², ¹College Park, United States, ²Orbital Sciences Corporation, Dulles, United States

WE1C-4: A Highly Integrated Heterogeneous Micro- and mm-wave Platform
 P. Alleaume¹, L. Aspemyr², S. Gevorgian³, J. Houbert⁴, H. Jacobsson², L. Pettersson⁵, D. Platt⁶, M. Salter², A. Vorobiev³, ¹United Monolithic Semiconductors, Orsay Cedex, France, ²Ericsson AB, Mölndal, Sweden, ³Chalmers University of Technology, Gothenburg, Sweden, ⁴STMicroelectronics, Tours Cedex 2, France, ⁵Acree, Norrköping, Sweden

WE1D-4: Multi-Resonant Perturbation Method for Capacitive Sensing with Composite Right/Left-Handed Transmission Lines
 M. Schüßler, M. Puentes, C. Mandel, R. Jakoby, TU Darmstadt, Darmstadt, Germany

9:20 - 9:40

WE1A-5: Third-Order Intermodulation Distortion due to Self-heating in Gold Coplanar Waveguides
 E. Rocas¹, C. Collado¹, N. Orloff², J. C. Booth², ¹Universitat Politècnica de Catalunya, Barcelona, Spain, ²National Institute of Standards and Technology, Boulder, United States

WE1B-5: Tri-band Filter Design using Substrate Integrated Waveguide Resonators in LTCC.
 W. Tsai¹, R. Wu², ¹Graduate Institute of Communication Engineering, Taipei, Taiwan, ²Graduate Institute of Communication Engineering, Taipei, Taiwan

WE1C-5: W-band Flip-Chip Assembled CMOS Amplifier with Transition Compensation Network for SiP Integration
 C. Kuo¹, P. Lin², H. Lu¹, Y. Jiang¹, C. Liu¹, Y. Hsin², H. Wang¹, ¹National Taiwan University, Taipei, Taiwan, ²National Central University, Zhongli, Taiwan

WEDNESDAY TECHNICAL SESSIONS

8:00-9:40

WE1E: Advances in Low Noise Technologies
James Whelehan, *JJW Consulting, Inc*,
Matthias Rudolph, *Brandenburg Univ. of
Technology*
Room: 207D

**WE1F: High Efficiency Power Devices in
Various Technologies**
Aryeh Platzker, *Raytheon Company*
Douglas Teeter, *RFMD*
Room: 208AB

**WE1G: Status and Trends in E-scan Radar for
Air- and Spaceborne Applications.**
Hans van Bezouwen, *EADS Deutschland*
Wolfgang Holpp, *EADS Deutschland*
Room: 209AB

<p>WE1E-1: A 6.5kV ESD-Protected Low Noise Amplifier in 65-nm CMOS M. H. Tsai¹, F. L. Hsueh¹, C. P. Jou¹, M. H. Song¹, J. C. Tseng¹, S. S. Hsu², S. Chen¹, ¹Taiwan Semiconductor Manufacturing Company, Hsinchu, Taiwan, ²National Tsing Hua University, Hsinchu, Taiwan</p>	<p>WE1F-1: 43W, 52% PAE X-Band AlGaIn/GaN HEMTs MMIC Amplifiers S. Piotrowicz², Z. Ouarch², E. Chartier¹, R. Aubry¹, G. Callet¹, D. Floriot², J. Jacquet¹, O. Jardel¹, E. Morvan¹, T. Reveyrand³, N. Sarazin¹, S. Delage¹, ¹ALCATEL-THALES III-V Lab, Marcoussis, France, ²United Monolithic Semiconductors, Orsay, France, ³XLIM, Limoges, France</p>	<p>WE1G-1: Status and Trends in AESA-based Radar H. van Bezouwen, H. Feldle, EADS Deutschland GmbH, Ulm, Germany</p>	<p>8:00 - 8:20</p>
<p>WE1E-2: A 4.9-dB NF 53.5-62-GHz Micro-machined CMOS Wideband LNA with Small Group-Delay-Variation Y. Lin¹, C. Chen¹, P. Huang², S. Lu², ¹National Chi Nan University, Puli, Taiwan, ²National Taiwan University, Taipei, Taiwan</p>	<p>WE1F-2: Evaluation of a GaN HEMT Transistor for Load- and Supply-Modulation Applications Using Intrinsic Waveform Measurements H. Mashad Nemati¹, A. L. Clarke², S. C. Cripps², J. Benedikt², P. J. Tasker², C. Fager¹, J. Grahn¹, H. Zirath¹, ¹Chalmers University of Technology, Gothenburg, Sweden, ²Cardiff School of Engineering, Cardiff University, Cardiff, United Kingdom</p>	<p>WE1G-2: The New Generation of European E-Scan Fighter Radars W. Holpp, EADS Deutschland GmbH, Ulm, Germany</p>	<p>8:20 - 8:40</p>
<p>WE1E-3: An Ultra-Broadband Robust LNA for Defence Applications in AlGaIn/GaN Technology E. Limiti¹, W. Ciccognani¹, P. E. Longhi², C. Mitrano², A. Nanni³, M. Peroni³, ¹Università di Roma Tor Vergata, Roma, Italy, ²Elettronica S.p.A., Roma, Italy, ³Selex Sistemi Integrati S.p.A., Roma, Italy</p>	<p>WE1F-3: High-efficiency class E MMIC power amplifiers at 4.0 GHz using AlGaIn/GaN HEMT technology V. Zomorrodian, Y. Pei, U. K. Mishra, R. A. York, University of California Santa Barbara, Santa Barbara, United States</p>	<p>WE1G-3: The SAR/GMTI Airborne Radar PAMIR: Technology and Performance H. Wilden², A. Brenner², ¹Fraunhofer FHR, Wachtberg, Germany, ²Fraunhofer FHR, Wachtberg, Germany</p>	<p>8:40 - 9:00</p>
<p>WE1E-4: Miniature Low Noise G-band I-Q Receiver P. Kangaslahti¹, D. Pukala¹, A. Tanner¹, I. O'Dwyer¹, B. Lambrigtsen¹, T. Gaier¹, X. Mei², R. Lai², ¹Jet Propulsion Laboratory, California Institute of Technology, Pasadena, United States, ²Northrop Grumman Corporation, Redondo Beach, United States</p>	<p>WE1F-4: A 1 W Si-LDMOS Power Amplifier with 40 % Drain Efficiency for 6 GHz WLAN Applications D. Gruner¹, R. Sorge², O. Bengtsson¹, A. Z. Markos¹, G. Boeck¹, ¹Berlin Institute of Technology, Berlin, Germany, ²IHP GmbH, Frankfurt (Oder), Germany</p>	<p>WE1G-4: Spaceborne SAR Systems and Technologies C. Heer, C. Fischer, Astrium, Friedrichshafen, Germany</p>	<p>9:00 - 9:20</p>
<p>WE1E-5: A Versatile and Cryogenic mHEMT-Model Including Noise M. Seelmann-Eggebert¹, F. Schäfer², A. Leuther¹, H. Massler¹, ¹Fraunhofer IAF, Freiburg, Germany, ²MPIFR, Bonn, Germany</p>	<p>WE1F-5: High Efficiency Push-Pull Inverse Class F Power Amplifier Using a Balun and Harmonic Trap Waveform Shaping Network A. N. Stameroff¹, A. V. Pham¹, R. E. Leoni III², ¹University of California Davis, Davis, United States, ²Raytheon Company, Andover, United States</p>	<p>WE1G-5: Earth Observation Instruments with E-Scan Antennas State-of-the-Art and Outlook M. Ludwig¹, C. H. Buck¹, S. D'Addio¹, R. Torres¹, F. Rostan², C. Schaefer², R. Croci³, ¹Esa/Estec, Noordwijk, Netherlands, ²Astrium GmbH, Friedrichshafen, Germany, ³Thales Alenia Space, Roma, Italy</p>	<p>9:20 - 9:40</p>



WEDNESDAY FOCUSED AND PANEL SESSIONS

Wednesday 08:00 – 09:40 Room 209AB

Status and Trends in E-Scan Radar for Air- and Spaceborne Applications

Chair: Hans van Bezouwen
EADS Deutschland

Co-Chair: Wolfgang Holpp,
EADS Deutschland

Sponsor: IMS 2010 TPC

Abstract: Active Electronically Steered Array (AESA) antennas provide today's and future radar systems with an enormous degree of operational flexibility. These arrays constitute the very foundation kernels of E-Scan radars with highly enhanced capabilities, and opening up a wide spectrum of new air- and spaceborne applications. This Focused Session will give an overview of the current status and trends in E-Scan Radar, with emphasis on air- and spaceborne applications, and will illustrate actual European advances in the area of fighter radar, air- and spaceborne SAR/GMTI radar as well as spaceborne radar for Global Monitoring for Environment and Security.

Wednesday 10:10 – 11:50 Room 209AB

Trends in Future Systems with Low Cost Phased Arrays

Chair: Jeffery Herd
MIT Lincoln Laboratory

Co-Chair: John Horton
J. B. Horton Group

Sponsor: IMS 2010 TPC, MTT-12

Abstract: Electronically steered phased array antennas will provide a large degree of operational flexibility in future systems. These arrays, with the new capabilities, open a wide spectrum of new applications. The applications covered here rely on low cost arrays. This session will provide an overview of the developments required for wide spread use of low cost arrays in future systems.

Wednesday 12:00 – 13:10 Room 210AB

Semiconductor Technology Impact on Microwave and Millimeter Wave Markets

Chair/Moderator: Doug Lockie, *Gigabeam*

Panelists:

Mike Peters, *TriQuint Semiconductor*
Miroslav Micovic, *HRL Laboratories*
Earl Lum, *EJL Wireless*
Paul Blount, *Custom MMIC Design Services*

Abstract: Continuing progress in Silicon (Standard CMOS and SiGe) and GaN technologies is setting the stage for rewriting the application rules in microwave and millimeter wave market spaces. At the same time, GaAs performance and cost improvements are holding their own against silicon incursions at lower frequencies for cellular phone and WiFi/Wimax radios.

This panel will review recent progress in semiconductor technologies, emerging microwave and millimeter wave markets, and the give and take between silicon, SiGe, GaAs, InP and GaN semiconductor platforms. Projections on the future markets and semiconductor market shares will be made by industry experts.

Wednesday 12:00 – 13:10 Room 210CD

Standardizing Attributes for RF and Microwave Components and Assemblies – The Time Is Now?

Chairs/Moderators:

Dr. Chandra Gupta, *Aeroflex-KDI*
Dr. Paul Khanna, *Phase Matrix*

Panelists:

Douglas Bajgot Cobham *DES*
Thomas Eichenberger, *Northrop Grumman*
Joe Graycar, *Teledyne Microwave*
Peter Pupalakakis, *LeCroy Corporation*
Steve Schwerdtfeger, *Telephonics Corporation*

Abstract: At this panel we will explore on the need for standards for RF and Microwave Components and Sub-Assemblies. We will discuss electrical and mechanical parameters and characteristics such as connector interfaces, biases, EMI, mechanical dimensions as well as the pros and cons of developing standards. The potential advantages are immense: standardization will lead to lower manufacturing costs, economy of scale, faster development cycles and will eliminate repetitive analyses by different manufacturers for the same part. In this forum, we bring together key representatives from the user and manufacturing community to discuss this timely topic as this industry reaches maturity and applications proliferate. One session will naturally not be enough for this broad topic; however, this panel session will allow us to share opinions on the topic, and a course of action may be determined from the outcome of this session.



WEDNESDAY FOCUSED AND PANEL SESSIONS

Wednesday **13:20 – 15:00** **Room 209AB**

Microwave Space Sensors

Chair: J Frank Maiwald,
JPL/Caltech

Co-Chair: Alain Maestrini,
Observatoire de Paris

Sponsor: MTT 4, IMS 2010 TPC

Abstract: This focused session includes progress made in development of microwave space Sensors for past and future space missions. Along with a review of space missions and their impact on the science community, two recent projects will be presented in detail: 1) JUNO, a polar orbiter around Jupiter (currently under development), and 2) the Herschel space telescope (launched in 2009). New hardware including digital radiometers and frontend hardware using HEMT MMIC devices, operating at frequencies beyond 100 GHz, will be presented.

Wednesday **15:30 – 17:10** **Room 209AB**

CAD Techniques and Methodologies: Future Directions

Chair: Q.J. Zhang
Department of Electronics, Carleton University

Co-Chair: Arvind Sharma
Northrop Grumman Aerospace Systems

Sponsor: IMS 2010 Steering Committee

Abstract: CAD techniques and methodologies are essential in helping microwave designers to achieve improved designs in a shorter time. Also, accurate modeling has become more challenging as the industry moves towards higher frequencies, from RF/microwave to millimeter-wave and beyond. This focused session will present a review of the state of the art, and describe future trends of Microwave CAD.

SPECIAL SESSION IN HONOR OF DR. KIYO TOMIYASU

Wednesday, May 26, 2010

15:30 - 17:10

Convention Center, Room 210 AB

Chair: John Horton

Co-Chair: Josef Modelski

Plenary Session: Dr. Tomiyasu will receive the Thomas Alva Edison Medal at the IMS 2010 Plenary Session, and he will be inducted into the IEEE Heritage Circle, which is the IEEE Foundation's donor recognition program. Dr. Tomiyasu has helped established two IEEE Foundation Funds that support students: the Harold Sobol Student Grant, administered by the MTT Society; and the Mike Takagi Student Prize, Administered by the IEEE Geoscience and Remote Sensing Society (GRSS).. Also, he set up and funded the IEEE Kiyo Tomiyasu Award, the technical field award that recognizes early-to-mid-career contributions to technologies that show promise of innovative applications.



Special Session (WE4S)

This Special Session will include invited speakers to recall activities associated with Dr. Tomiyasu, and his contributions to the MTTs, GRSS and the IEEE. Three speakers have been invited, but additional speakers can be heard, as time permits.

Session Abstract: This session is dedicated to the career of Dr. Kiyo Tomiyasu. His career includes technical accomplishments in Microwaves, Lasers, and remote sensing of the earth using satellite-borne radiometers, scatterometers and synthetic radars. He has contributed much to MTT-S, and to the IEEE, including creating awards and providing contributions to guarantee perpetuation of the awards.

Biography: Kiyo Tomiyasu received his B. S. degree in electrical engineering from the California Institute of Technology, Pasadena, CA, in 1940; the M. S. degree in communication engineering from Columbia University, New York, NY, in 1941; and his Ph.D degree in engineering science and applied physics from Harvard University in 1948. In 1949, he joined the Sperry Gyroscope Company (in Seymour Cohn's group), Great Neck, NY in 1941 as a Project Engineer. In 1955 he joined the General Electric Microwave Laboratory, Palo Alto, CA, as a Consulting Engineer, and five years later he transferred to the General Electric Research and Development Center, Schenectady, NY, where he was involved with lasers and microwave projects. In 1969 he became a Consulting Engineer in the General Electric Valley Forge Space Center, Philadelphia, PA. He was involved with microwave remote sensing of the earth using satellite-borne radiometers, scatterometers, and synthetic aperture radars.

IEEE Activities: Dr. Tomiyasu is a Life Fellow of IEEE, with over 60 years membership. He was President of the IEEE MTT Society during 1960-1961, and served on its Nomination Committee and Awards Committee. He was Editor of the Transactions of MTT in 1958 and 1959, and Guest Editor of the of the May 1978 Special Issue of the Transactions of MTT on High Power Microwaves. In 1973, he was elected Honorary Life Member of the MTT Society and its Administration Committee (AdCom). He was named recipient of the Microwave Career Award in 1980, and the Distinguished Service Award in 1987. He was recipient of the IEEE Centennial Medal in 1984 and the Third Millennium Medal in 2000. He is an Honorary Lifetime Member of the IEEE GRSS and its AdCom, and he received its Outstanding Service Award in 1986.



WEDNESDAY TECHNICAL SESSIONS

10:10-11:50

WE2A: Nonlinear circuit analysis and system modeling

J Stevenson Kenney, *Georgia Institute of Technology*
Jose Carlos Pedro, *University of Aveiro*
Room: 205AB

WE2B: Novel Techniques for Planar Filter Design

Christopher Galbraith, *MIT Lincoln Laboratory*
Chi Wang, *Orbital Sciences Corp.*
Room: 206AB

WE2C: Advances in Measurement: Microwaves Through Sub-Millimeter-Waves

Ken Wong, *Agilent Technologies*
Leonard Hayden, *Cascade Microtech, Inc.*
Room: 207AB

WE2D: RF and Microwave in Medicine: Medical Sensors and Devices

Mohammad-Reza Tofighi, *Penn State University*
Natalia K. Nikolava, *McMaster University*
Room: 207C

10:10 - 10:30

WE2A-1: A New Mixed Time-Frequency Simulation Method for Nonlinear Heterogeneous Multirate RF Circuits

J. S. Oliveira¹, J. C. Pedro², ¹Polytechnic Institute of Leiria, Leiria, Portugal, ²University of Aveiro, Aveiro, Portugal

WE2B-1: Synthesis of 4th order lossy filters with uniform Q distribution

J. Mateu¹, A. Padilla¹, C. Collado¹, M. Martinez-Mendoza², E. Rocas¹, C. Ernst², J. M. O'Callaghan¹, ¹Universitat Politècnica de Catalunya, Castelldefels, Spain, ²ESA, Noordwijk, Netherlands

WE2C-1: Understanding the Effect of Uncorrelated Phase Noise on the Phase Coherency of Multi-Channel RF Vector Signal Analyzers

D. A. Hall, A. Hinde, National Instruments, Austin, United States

WE2D-1: An Implantable Batteryless Wireless Impedance Sensor for Gastroesophageal Reflux Diagnosis

T. Ativanichayaphong¹, S. Tang², L. Hsu¹, W. Huang¹, Y. Seo¹, H. F. Tibbals⁴, S. J. Spechler³, J. C. Chiao¹, ¹University of Texas at Arlington, Arlington, United States, ²Trinity Mother Frances Hospitals and Clinics, Tyler, United States, ³University of Texas Southwestern Medical Center, Dallas, United States, ⁴University of Texas Southwestern Medical Center, Dallas, United States

10:30 - 10:50

WE2A-2: Discrete-Time Representation of Band-pass Frequency-Domain Data for Envelope Transient Simulation

Z. Su, T. Brazil, University College Dublin, Dublin, Ireland

WE2B-2: Design of Dual-Band Net-Type Bandpass Filter

C. Tseng, H. Shao, National Taiwan University of Science and Technology, Taipei, Taiwan

WE2C-2: The Impact of Long-term Memory Effects on Diode Power Probes

H. Gomes¹, A. R. Testera², N. B. Carvalho¹, M. F. Barciela², K. A. Remley³, ¹Instituto de Telecomunicações, Aveiro, Portugal, ²Universidad de Vigo, Vigo, Spain, ³NIST, Boulder, United States

WE2D-2: 3D Packaging Technique on Liquid Crystal Polymer (LCP) for Miniature Wireless Biomedical Sensor

D. Ha, B. Kim, T. Lin, Y. Ouyang, P. Irazoqui, W. Chappell, Purdue University, West Lafayette, United States

10:50 - 11:30

WE2A-3: A Polar-oriented Volterra Model for Power Amplifier Characterization

T. R. Cunha, E. G. Lima, J. C. Pedro, Instituto de Telecomunicações - Universidade de Aveiro, Aveiro, Portugal

WE2B-3: New Dual-Mode Dual-Band Bandpass Filter With Quasi-Elliptic Function Passbands and Controllable Bandwidths

T. Lin, U. Lok, J. Kuo, National Chiao Tung University, Hsinchu, Taiwan

WE2C-3: On-Wafer S-Parameter De-embedding of Silicon Active and Passive Devices up to 170 GHz

K. Yau¹, I. Sarkas¹, A. Tomkins¹, P. Chevalier², S. Voinigescu¹, ¹University of Toronto, Toronto, Canada, ²STMicroelectronics, Crolles, France

WE2D-3: An Ultrasensitive CMOS Magnetic Biosensor Array with Correlated Double Counting Noise Suppression

H. Wang, S. Kosai, C. Sideris, A. Hajimiri, California Institute of Technology, Pasadena, United States

11:00 - 11:10

WE2A-4: Design of pulsed waveform oscillators with a short nonlinear transmission line

M. Ponton, F. Ramirez, A. Suarez, University of Cantabria, Santander, Spain

WE2B-4: Application of Generalized Bagley-Polygon Four-Port Power Dividers to Designing Microwave Dual-Band Bandpass Planar Filters

R. Gomez-Garcia, M. Sanchez-Renedo, University of Alcalá, Alcalá de Henares, Spain

WE2C-4: A Ring-Centered Waveguide Flange for Millimeter- and Submillimeter-Wave Applications

H. Li¹, A. R. Kerr², J. L. Hesler³, H. Xu¹, R. M. Weikle¹, ¹University of Virginia, Charlottesville, United States, ²National Radio Astronomy Observatory, Charlottesville, United States, ³Virginia Diodes, Inc., Charlottesville, United States

WE2D-4: Microwave Sensors for Stem Cell Identification and Discrimination

C. Dalmay¹, A. Pothier¹, M. Cheray², F. Lalloué², M. Jauberteau², P. Blondy¹, ¹XLIM – UMR 6172 Université de Limoges/CNRS, Limoges, France, ²Homéostasie Cellulaire et Pathologies – EA 3842 Université de Limoges, Limoges, France

11:30 - 11:40

WE2A-5: Stochastic characterization of the phase noise spectrum of coupled-oscillator circuits

A. Suarez, S. Sancho, F. Ramirez, University of Cantabria, Santander, Spain

WE2B-5: Lumped Isolation Circuits for Improvement of Matching and Isolation in Three-Port Balun Band-Pass Filter

T. Yang¹, P. Chi¹, T. Itoh¹, ¹University of California, Los Angeles, Los Angeles, United States, ²University of Electronic and Science Technology of China, Chengdu, China

WE2D-5: A Novel Zigbee-based Low-cost, Low-Power Wireless EKG system

V. Mukala, V. Lakafosis, A. Traille, M. M. Tentzeris, GEDC, Atlanta, United States

11:40 - 11:50

WE2B-6: Reconfigurable 4 Pole Bandstop Filter based on RF-MEMS-loaded Split Ring Resonators

D. Bouyge¹, A. Crunteanu², A. Pothier², P. Martin², P. Blondy², A. Velez¹, J. Bonache¹, J. Orlianges³, F. Martin¹, ¹Cimitec, Bellaterra (Cerdanyola del Vallès), Spain, ²XLIM Research Institute - CNRS, Limoges, France, ³SPCTS Research Insitute - CNRS, Limoges, France

WE2D-6: Substrate Integrated Resonant Near-Field Sensor for Material Characterization

M. Ambrozkiwicz, A. F. Jacob, Hamburg University of Technology, Hamburg, Germany

WEDNESDAY TECHNICAL SESSIONS

10:10-11:50

WE2E: Emerging Technologies for mm to Submm systems
 Imran Mehdi, *NASA JPL*
 H. Alfred Hung, *Army Research Lab*
Room: 207D

WE2F: Power Amplifier System Concepts.
 John Wood, *Freescale Semiconductor, Inc.*
 Fadhel Ghannouchi, *University of Calgary*
Room: 208AB

WE2G: Trends in Future Systems with Low Cost Phased Arrays
 Jeffery Herd, *MIT Lincoln Laboratory*
 John Horton, *J.B. Horton Group*
Room: 209AB

WE2E-1: 10-Gbit/s QPSK Modulator and Demodulator for a 120-GHz-band Wireless Link
 H. Takahashi¹, T. Kosugi², A. Hirata¹, K. Murata², N. Kukutsu¹, ¹Nippon Telegraph and Telephone Corporation, Atsugi, Japan, ²Nippon Telegraph and Telephone Corporation, Atsugi, Japan

WE2F-1: Behavioral Modeling and Digital Predistortion of Power Amplifiers with Memory using Two Hidden Layers Artificial Neural Networks
 F. Mkadem¹, M. Ben Ayed¹, S. Boumaiza¹, J. Wood², P. Aaen², ¹University of Waterloo, Waterloo, Canada, ²Freescale Semiconductor, Inc., Tempe, United States

WE2G-1: Advanced Architecture for a Low Cost Multifunction Phased Array Radar
 J. Herd¹, S. Duffy¹, M. Weber¹, G. Brigham¹, C. Weigand², D. Curcio², ¹MIT Lincoln Laboratory, Lexington, United States, ²M/A-COM Technology Solutions, Lowell, United States

10:10 - 10:30

WE2E-2: High-phase-resolution 77-GHz-band radar module for near-field millimeter-wave imaging
 S. Mochizuki¹, S. Oka², H. Togo¹, N. Kukutsu¹, ¹NTT Microsystem Integration Laboratories, Atsugi, Japan, ²NTT Access Network Service Systems Laboratories, Tsukuba, Japan

WE2F-2: High Accuracy Wide Band Analog Predistortion Linearizer for Telecom Satellite Transmit Section
 J. Villemazet, H. Yahi, D. Lopez, M. Perrel, J. Maynard, J. Cazaux, Thales Alenia Space France, Toulouse, France

WE2G-2: Commercial Manufacturing Practices Applied to Phased Array Radars
 D. J. Carlson, C. Weigand, D. Curcio, T. Boles, M/A-COM Technology Solutions Inc., Lowell, United States

10:30 - 10:50

WE2E-3: Waveguide Transition to Feed a Fully PCB Integrated Dielectric Rod Antenna
 F. Poprawa¹, A. Zanati¹, A. Ziroff¹, F. Ellinger², ¹Siemens AG, Munich, Germany, ²Dresden University of Technology, Dresden, Germany

WE2F-3: Novel Wide Band High-Efficiency Active Harmonic Injection Power Amplifier Concept
 A. Al-Muhaisen, P. Wright, J. Lees, P. Tasker, S. Cripps, J. Benedikt, Cardiff University, Cardiff, United Kingdom

WE2G-3: Leveraging Commercial Wireless Communications Industry Advances to Lower the Cost of Phased Arrays
 M. B. Davis, Ball Aerospace and Technology Corporation, Westminster, United States

10:50 - 11:00

WE2E-4: Hollow-core Electromagnetic Band Gap (EBG) Waveguide Fabricated by Rapid Prototyping for Low-loss Terahertz Guiding
 Z. Wu, W. Ng, M. Gehm, H. Xin, University of Arizona, Tucson, United States

WE2F-4: High Efficiency Envelope Tracking Supply Voltage Modulator for High Power Base Station Amplifier Applications
 T. M. Aitto-oja, Nokia Siemens Networks, Oulu, Finland

WE2G-4: Low Cost Electronically Scanned Arrays Based on Surface Mount Active Antennas
 M. Sanchez-Barberty, R. W. Jackson, University of Massachusetts, Amherst, United States

11:00 - 11:10

11:10 - 11:30

WE2E-5: Monolithic 28.3 THz Thermal Image Sensor Incorporating 0.18-um CMOS Foundry
 S. Yang, L. Su, I. Huang, C. C. Tzuang, National Taiwan University, Taipei, Taiwan

WE2F-5: Wideband High Efficiency Digitally-Assisted Envelope Amplifier with Dual Switching Stages for Radio Base-Station Envelope Tracking Power Amplifiers
 C. Hsia¹, D. F. Klmball¹, S. Lanfranco², P. M. Asbeck¹, ¹University of California, San Diego, La Jolla, United States, ²Nokia Siemens Networks, Mountain View, United States

WE2G-5: Technology Trends for Future Low Cost Phased Arrays
 M. Sarcone, Raytheon Company, Sudbury, United States

11:30 - 11:50



WEDNESDAY TECHNICAL SESSIONS

13:20-15:00

	<p>WE3A: Frequency-domain based modeling of microwave components Abbas Omar, <i>University of Magdeburg</i> Luca Perregrini, <i>University of Pavia</i> Room: 205AB</p>	<p>WE3B: Novel 3-dB Coupler Structures Roberto Vincenti Gatti, <i>University of Perugia</i> Jesse Taub, <i>Consultant</i> Room: 206AB</p>	<p>WE3C: Microwave Photonic Technologies Adil Karim, <i>JHU/APL</i> Ron Reano, <i>Ohio State University</i> Room: 207AB</p>	<p>WE3D: RF and Microwave in Medicine: Imaging and Monitoring J-C. Chiao, <i>University of Texas at Arlington</i> Arye Rosen, <i>Drexel University</i> Room: 207C</p>
13:20 - 13:40	<p>WE3A-1: Modeling of Printed Periodic Structures with Thick Metal Patches by the MoM/BI-RME Method M. Bozzi, M. Montagna, L. Perregrini, <i>University of Pavia, Pavia, Italy</i></p>	<p>WE3B-1: Novel uniplanar synthesized coplanar waveguide and the application to miniaturized rat-race coupler C. Wang, C. Lai, T. Ma, <i>National Taiwan University of Science and Technology, Taipei, Taiwan</i></p>	<p>WE3C-1: Highly Linear InP Phase Modulator for High Dynamic Range RF/Photonic Links R. Wang¹, A. Bhardwaj², S. Ristic², P. Herczfeld³, Y. Li¹, ¹University of Massachusetts Dartmouth, North Dartmouth, United States, ²University of California, Santa Barbara, Santa Barbara, United States, ³Drexel University, Philadelphia, United States</p>	<p>WE3D-1: A Method to Control Non-uniformity RF S_{B}^{-1} Field for High Field Magnetic Resonance Imaging H. Yoo, A. Gopinath, T. Vaughan, <i>University of Minnesota, Minneapolis, United States</i></p>
13:40 - 13:50	<p>WE3A-2: Use of Ground Planes within the Spatial Images Technique: Application to the Analysis of Rectangular Multilayered Shielded Enclosures J. S. Gomez-Diaz, M. Garcia-Viguera, D. Cañete-Rebenaque, F. D. Quesada-Pereira, A. Alvarez-Melcon, <i>Technical University of Cartagena, Cartagena, Spain</i></p>	<p>WE3B-2: Application of Composite Right/Left-Handed Half-Mode Substrate Integrated Waveguide to the Design of a Dual-Band Rat-Race Coupler Y. Dong, T. Itoh, <i>UCLA Microwave Electronics Lab., Los Angeles, United States</i></p>	<p>WE3C-2: A New Optoelectronic Oscillator Topology Based on a Class E Analog Fiber Optic Link W. D. Jemison¹, T. A. Wey¹, A. Paolella², ¹Lafayette College, Easton, United States, ²Artisan Laboratories, Inc., Jamison, United States</p>	<p>WE3D-2: Alternating Impedance Multi-Channel Transmission Line Resonators for High Field Magnetic Resonance Imaging C. E. Akgun¹, L. DelaBarre¹, C. J. Snyder¹, S. Sohn², G. Adriany¹, K. Ugurbil¹, A. Gopinath², J. T. Vaughan¹, ¹University of Minnesota, Minneapolis, United States, ²University of Minnesota, Minneapolis, United States</p>
13:50 - 14:00				<p>WE3D-3: Near-Field Microwave Imaging Based on Planar Aperture Scanning R. Khalaj Amineh, M. Ravan, A. Trehan, N. K. Nikolova, <i>McMaster University, Hamilton, Canada</i></p>
14:00 - 14:10	<p>WE3A-3: A Novel Skin-Effect Based Surface Impedance Model for Accurate Broadband Characterization of Interconnects with Method of Moments M. A. Al-Qedra, V. I. Okhmatovski, <i>University of Manitoba, Winnipeg, Canada</i></p>	<p>WE3B-3: Quasi-Optical Cruciform Substrate Integrated Waveguide (SIW) Coupler for Millimeter-Wave Systems T. Djerafi, J. Gauthier, K. Wu, <i>Ecole Polytechnique de Montreal, Montreal, Canada</i></p>	<p>WE3C-3: Front-End Design of W-band Integrated Photonic Transmitter with Wide Optical-to-Electrical Bandwidth for Wireless-Over-Fiber Applications H. Tsai, N. Chen, F. Kuo, J. Shi, <i>National Central University, Jhongli, Taiwan</i></p>	
14:10 - 14:20				<p>WE3D-4: A Fast Clutter Cancellation Method in Quadrature Doppler Radar for Noncontact Vital Signal Detection T. Chin, K. Lin, S. Chang, C. Chang, <i>National Chung Cheng Univ., Ming-Hsiung Chia-Yi, Taiwan</i></p>
14:20 - 14:30	<p>WE3A-4: Design Equations for Tapered Microstrip-to-Substrate Integrated Waveguide Transitions D. Deslandes, <i>UQAM, Montreal, Canada</i></p>	<p>WE3B-4: A Planar Magic-T Structure Using Substrate Integrated Circuits Concept F. He¹, K. Wu¹, X. Chen¹, L. Han¹, W. Hong², ¹Poly-Grames Research Center, Montreal, Canada, ²State Key Laboratory of Millimeter Waves, Nanjing, China</p>	<p>WE3C-4: Whispering-gallery mode based photonic RF receiver V. Ilchenko, J. Byrd, A. Savchenkov, P. Koonath, A. Matsko, D. Seidel, L. Maleki, <i>DEwaves Inc., Pasadena, United States</i></p>	
14:30 - 14:40				<p>WE3D-5: An Injection-Locked Detector for Concurrent Spectrum and Vital Sign Sensing F. Wang¹, C. Li¹, C. Hsiao¹, T. Horng¹, J. Lin², K. Peng³, J. Jau⁴, J. Li⁴, C. Chen⁴, ¹National Sun Yat-Sen University, Kaohsiung, Taiwan, ²University of Florida, Gainesville, United States, ³National Kaohsiung First University of Science and Technology, Kaohsiung, Taiwan, ⁴Industrial Technology Research Institute, Hsinchu, Taiwan</p>
14:40 - 14:50		<p>WE3B-5: Advanced Characterization and Design of Compensated High Directivity Quadrature Coupler J. Müller, A. F. Jacob, <i>Technische Universität Hamburg Harburg, Hamburg, Germany</i></p>	<p>WE3C-5: Experimental Demonstration of a Downlink Multi-Channel Hybrid Fiber-Radio using Digitized RF-over-Fiber Technique Y. Yang, C. Lim, A. Nirmalathas, <i>the University of Melbourne, Melbourne, Australia</i></p>	<p>WE3D-6: A Wire Patch Cell for "in vitro" Exposure at the Wi-Fi Frequencies A. Paffi¹, F. Apollonio¹, M. Liberti¹, G. A. Lovisolo², R. Lodato², S. Mancini², S. Chicarella¹, G. d'Inzeo¹, ¹ICeMB at "Sapienza" University of Rome, Rome, Italy, ²ICeMB at RC Casaccia ENEA, Rome, Italy</p>
14:50 - 15:00		<p>WE3B-6: Broadband and Compact 3-dB MMIC Directional Coupler with Lumped Element K. Nishikawa¹, M. Kawashima², T. Seki¹, K. Hiraga¹, ¹NTT Corporation, Yokosuka, Japan, ²NTT Advanced Technology, Yokosuka, Japan</p>		

WEDNESDAY TECHNICAL SESSIONS

13:20-15:00

WE3E: Frequency Conversion and Control Component IC's
 Brad Nelson, *RFMD*
 Bert Henderson, *Cobham Sensor Systems*
Room: 207D

WE3F: Techniques to Enhance Power Amplifier Linearity and Efficiency
 Wayne Kennan, *ACCO Semiconductor, Inc*
 Raghu Mallavarpu, *Raytheon Company*
Room: 208AB

WE3G: Microwave Space Sensors
 Frank Maiwald, *JPL/CALTECH*
 Alain Maestrini, *Observatoire de Paris*
Room: 209AB

WE3E-1: An 85-95.2 GHz Transformer-Based Injection-Locked Frequency Tripler in 65nm CMOS
 Z. Chen, P. Heydari, University of California, Irvine, Irvine, United States

WE3F-1: 30.3% PAE HBT Doherty Power Amplifier for 2.5~2.7 GHz Mobile WiMAX
 D. Kang¹, J. Choi¹, D. Kim¹, D. Yu², K. Min², B. Kim¹,
¹Postech, Pohang, Republic of Korea, ²WIPAM, Seongnam, Republic of Korea

WE3G-1: THz for Space: The Golden Age
 P. H. Siegel, California Institute of Technology, Pasadena, United States

13:20-13:40

WE3E-2: A Dual-Mode mm-Wave Injection-Locked Frequency Divider with Greater than 18% Locking Range in 65nm CMOS
 H. M. Cheema¹, X. Yu², R. Mahmoudi¹, P. T. van Zeijl³, A. van Roermund¹, ¹Eindhoven University of Technology, Eindhoven, Netherlands, ²Zhejiang University, Hangzhou, China, ³Philips Research, Eindhoven, Netherlands

WE3F-2: A Fully Integrated CMOS RF Power Amplifier with Tunable Matching Network for GSM/EDGE Dual-Mode Application
 H. Kim¹, Y. Yoon¹, O. Lee¹, K. An¹, D. Lee², W. Kim³, C. Lee³, J. Laskar¹, ¹Georgia Electronic Design Center, Georgia Institute of Technology, Atlanta, United States, ²Skyworks, Cedar Rapids, United States, ³Samsung Design Center, Atlanta, United States

WE3G-2: The Juno Microwave Experiment
 S. J. Bolton, Southwest Research Institute, Dallas, United States

13:40-14:00

WE3E-3: A 15-50 GHz Broadband Resistive FET Ring Mixer Using 0.18- μ m CMOS Technology
 H. Wang¹, Y. Hsin², J. Chen¹, C. Kuo¹, ¹National Taiwan University, Taipei, Taiwan, ²National Central University, Jhongli, Taiwan

WE3F-3: Efficiency Improvement of a Handset WCDMA PA Module Using Adaptive Digital Predistortion
 C. D. Presti¹, A. G. Metzger², H. M. Banbrook², P. J. Zampardi², P. M. Asbeck¹, ¹University of California, San Diego, La Jolla, United States, ²Skyworks Solutions Inc., Newbury Park, United States

WE3G-3: Sub-millimeter and Far-Infrared Technology in the Herschel Space Observatory and Beyond
 J. C. Pearson, Jet Propulsion Laboratory, California Institute of Technology, Pasadena, United States

14:00-14:20

WE3E-4: A linear 70-95 GHz differential IQ modulator for E-band Wireless Communication
 M. Gavelli¹, H. Zirath¹, M. Ferndahl², S. E. Gunnarsson², ¹Chalmers University of Technology, Göteborg, Sweden, ²Gotmic AB, Göteborg, Sweden

WE3F-4: A Pulse Modulated Polar Transmitter for CDMA Handsets
 H. Yang¹, H. Shih¹, J. Chen², Y. E. Chen¹, ¹National Taiwan University, Taipei, Taiwan, ²National Taiwan University, Taipei, Taiwan

WE3G-4: Digital Radiometers for Earth Science
 C. Ruf, S. Gross, University of Michigan, Ann Arbor, United States

14:20-14:40

WE3E-5: A 6-18 GHz 5-Bit Active Phase Shifter
 K. Koh¹, G. Rebeiz², ¹University of California San Diego, La Jolla, United States, ²University of California San Diego, La Jolla, United States

WE3F-5: RF Class-S Power Amplifiers: State-of-the-Art Results and Potential
 A. Wentzel, C. Meliani, W. Heinrich, Ferdinand-Braun-Institut für Hochfrequenztechnik, Berlin, Germany

WE3G-5: HEMT MMW MMICS for Radiometer Sensor Applications
 R. Lai, Northrop Grumman, Redondo Beach, United States

14:40-15:00



WEDNESDAY INTERACTIVE FORUM

15:00 - 17:00

WEPA: Development in Signal Generation
Scott Wetenkamp, *SCEAN*

WEPB: Frequency Conversion and Control
Hiroshi Okazaki, *NTT DOCOMO, INC.*

WEPD: Advanced Fabrication Techniques in Phased Arrays
Julio Navarro, *Boeing Research & Technology*
Constantine Balanis, *Arizona State University*

WEPA-1: Impact of Radiated EMI in High Frequency Crystal Oscillator
U. L. Rohde², A. K. Poddar¹, ¹Synergy Microwave Corp., Paterson, United States, ²University of Cottbus, Cottbus, Germany

WEPB-1: A 90 nm CMOS 14.5 GHz Injection Locked LO Generator with Digital Phase Control
A. Axholt, H. Sjöland, Lund University, Lund, Sweden

WEPD-1: Compact Tunable Ka-Band Phase Shifter based on Liquid Crystals
A. Moessinger, C. Fritsch, S. Bildik, R. Jakoby, Technische Universität Darmstadt, Darmstadt, Germany

WEPA-2: Time-Filtered Squarewave Output from Direct Digital Synthesis
E. W. McCune, RF Communications Consulting, Santa Clara, United States

WEPB-2: High Power, High Conversion Gain Frequency Doublers using SiC MESFETs and AlGaN/GaN HEMTs
K. S. Yuk, G. R. Branner, C. Wong, University of California, Davis, United States

WEPD-2: A Light Weight 8-Element Broadband Phased Array Receiver on Liquid Crystal Polymer
J. S. Chieh¹, A. Pham¹, T. W. Dalrymple², D. G. Kuhl², B. Garber², K. Aihara², ¹University of California Davis, Davis, United States, ²Air Force Research Laboratory, Wright Patterson Air Force Base, United States

WEPA-3: Frequency-tunable High-Efficiency Power Oscillator using GaN HEMT
S. Shin, G. Choi, H. Kim, S. Lee, S. Kim, J. Choi, Kwangwoon University, Seoul, Republic of Korea

WEPB-3: A 22-39 GHz Passive Mixer in SiGe:C Bipolar Technology
V. Issakov¹, H. Knapp², M. Wojnowski², A. Thiede¹, W. Simbuerger², ¹University Paderborn, Paderborn, Germany, ²Infinion Technologies AG, Neuburg, Germany

WEPD-3: 3D System-in-Package Integration of 60 GHz Aperture-Coupled Micromachined Microstrip Antennas
S. Brebels¹, K. Mohammadpour-Aghdam², W. De Raedt¹, G. Vandenbosch², ¹IMEC, Heverlee, Belgium, ²Katholieke Universiteit Leuven, Heverlee, Belgium

WEPB-4: Dynamic Range Reduction Due to RF and Image Signal Co-Existence in a Highly-Merged 2.4/5.7-GHz Dual-Band Low-IF Downconverter
J. Syu¹, C. Meng¹, G. Huang², ¹National Chiao Tung University, Hsinchu, Taiwan, ²National Nano Device Laboratories, Hsinchu, Taiwan

WEDNESDAY

ROOM 204ABC

15:00 - 17:00

WEPE: Microwave High Power Processes: Modeling and Applications

Yoshio Nikawa, *Kokushikan University*
Monika Willert-Porada, *University of Bayreuth*

WEFP: Power Amplifier Circuits

Franco Sechi, *Microwave Power*

WEPG: Power Amplifier Devices

Leo de Vreede, *Delft University of Technology*
Peter Asbeck, *University of California San Diego*

WEPE-1:2.45 GHz Waveguide Plasma Generation in Cylindrical Structures

G. Cerri, R. De Leo, V. Mariani Primiani, P. Russo, E. Vecchioni, *Università Politecnica delle Marche, Ancona, Italy*

WEFP-1:Signal Pre-Distortion and Bandwidth Requirements for Sequential Power Amplifiers.

T. Lehmann, R. Knoechel, *University of Kiel, Kiel, Germany*

WEPG-1:A Compact Flip Chip Single Die WiFi FEM for Smart Phone Application

C. Yuen¹, K. Laursen¹, D. Chu¹, Y. Pao¹, A. Chernyakov², P. Heide², ¹Epic Communications, Inc., Sunnyvale, United States, ²Epos AG, Munich, Germany

WEPE-2:2.45 GHz Perfluorator Heating Module for Industrial Infiltration Processes

S. Stanculovic¹, L. E. Feher², ¹Karlsruhe Institute of Technology, Karlsruhe, Germany, ²Karlsruhe Institute of Technology, Karlsruhe, Germany

WEFP-2:A 29dBm Linear Output Power Amplifier with 21.3% Efficiency for 700MHz-band 3GPP LTE OFDMA applications

Y. H. Chow, H. H. Nyeo, W. C. Chan, K. L. Lau, S. H. Khoo, *Avago Technologies, Bayan Lepas, Malaysia*

WEPG-2:A Highly Efficient 1-GHz, 15-W Power Amplifier Design Based on a 50-V LDMOS Transistor

P. Singer¹, C. Fager², Z. Wang¹, C. Schuberth³, ¹Infineon Technologies Austria AG, Villach, Austria, ²Chalmers University of Technology, Gothenburg, Sweden, ³Vienna University of Technology, Vienna, Austria

WEPE-3:Wood Timber Disinfestation by Microwave Power Application

A. T. Zona-Ortiz, O. Calderón-Luna, J. V. Balbastre-Tejedor, E. de los Reyes, *ITACA Research Institute, Valencia, Spain*

WEFP-3:A Novel Broadband Power Amplifier Architecture for High Efficiency and High Linearity Applications

R. I. Alidio, W. Lee, A. Gummalla, M. Achour, *Rayspan Corporation, San Diego, United States*

WEPG-3:High-Efficiency Broadband Power Amplifier Design Technique Based on a Measured-Load-Line Approach

S. Di Falco¹, A. Raffo¹, F. Scappaviva², D. Resca², M. Pagani³, G. Vannini¹, ¹University of Ferrara, Ferrara, Italy, ²MEC s.r.l., Bologna, Italy, ³Ericsson R&D Italy, Vimodrone (MI), Italy

WEPE-4:Measurement of dielectric properties at high-temperatures in real-time with cylindrical cavity

A. J. Canos-Marin, F. L. Penaranda-Foix, J. M. Catala-Civera, B. Garcia-Banos, *UPV, Valencia, Spain*

WEFP-4:A measurement Set-up and methodology combining dynamic biasing and baseband predistorsion for high efficiency and linear amplifier design

M. Saad El Dine¹, T. Reveyard¹, G. Neveux¹, P. Bouysse¹, D. Barataud¹, J. Nebus¹, W. Rebernak², ¹University of Limoges, Limoges, France, ²THALES Communications, Colombes, France

WEPG-4:Laser Driver Switching 20 A with 2 ns Pulse Width Using GaN

A. Liero, A. Klehr, S. Schwertfeger, T. Hoffmann, W. Heinrich, *Ferdinand-Braun-Institut für Hoehstfrequenz-technik, Berlin, Germany*

WEPE-5:High-Q Applicators for Microwave Processes in Material Science

P. Kopyt, W. K. Gwarek, *Warsaw Univ. of Technology, Warsaw, Poland*

WEFP-5:Envelope Tracking Power Amplifier Robust to Battery Depletion

J. Choi, D. Kim, D. Kang, J. Park, B. Jin, B. Kim, *Pohang University of Science and Technology, Pohang, Republic of Korea*

WEPG-5:Investigation and Analysis into Device Optimization for Attaining Efficiencies In-Excess of 90% When Accounting for Higher Harmonics

A. L. Clarke, M. Akmal, J. Lees, P. J. Tasker, J. Benedikt, *Cardiff University, Cardiff, United Kingdom*

WEPE-6:Dielectric Relaxation Study of Binary Mixtures of 2-Methoxyethanol in Nitrobenzene and Chlorobenzene Using Time Domain Reflectometry

R. H. Fattapur¹, S. B. Sayyad², N. H. Ayachit³, P. W. Khirade⁴, S. C. Mehrotra³, ¹Basaveshwar Science College, Bagalkot, India, ²Milliya Arts Science and Management Science College, Beed, India, ³BVB College of Engineering and Technology, Hubli, India, ⁴Dr B A M University, Aurangabad, India, ⁵Dr B A M University, Aurangabad, India

WEFP-6:Quad-Band Inverse Class-F Power Amplifier using Novel Composite Right/Left-Handed Transmission Line

J. Choi, C. Seo, *Soongsil Univ., Seoul, Republic of Korea*

WEFP-7:High Performance Wideband Digital Predistortion Platform for 3G+ Applications with Better than 55dBc over 40 MHz Bandwidth

A. Kwan¹, O. Hammi¹, M. Helaoui², F. M. Ghannouchi², ¹Green Radio Technologies Inc., Calgary, Canada, ²University of Calgary, Calgary, Canada

WEFP-8:Doherty Amplifier with Envelope Tracking for High Efficiency

J. Moon¹, J. Son¹, J. Kim¹, I. Kim¹, S. Jee¹, Y. Y. Woo², B. Kim¹, ¹Pohang University of Science and Technology, Pohang, Republic of Korea, ²Samsung Electronics co., LTD, Suwon, Republic of Korea

WEFP-9:Design of a Broadband and Highly Efficient 45W GaN Power Amplifier via Simplified Real Frequency Technique

D. Wu, F. Mkaem, S. Boumaiza, *University of Waterloo, Waterloo, Canada*

WEFP-10:Adaptive digital pre-distortions based on affine projection algorithm for WCDMA power amplifier applications

Y. Kim¹, S. Chun¹, J. Kim¹, D. Kim², C. Hahn², J. Kim¹, ¹Kwangwoon University, Seoul, Republic of Korea, ²Korea Electronics Technology Institute, Seongnam, Republic of Korea



WEDNESDAY TECHNICAL SESSIONS

15:30-17:10

WE4A: RFID and power harvesting technologies

Apostolos Georgiadis, *Centre Tecnologic de Telecomunicacions de Catalunya (CTTC)*
Luca Roselli, *University of Perugia*
Room: 205AB

WE4B: Novel Transmission Structures and Characterization

George Eleftheriades, *U. Toronto*
Michael Zedler, *U. Toronto*
Room: 206AB

WE4C: Novel Technological Realizations of Filters and Multiplexers

Vicente Boria, *Technical University of Valencia*
Huiwen Yao, *Orbital Sciences Corp.*
Room: 207AB

WE4D: High-speed Signal Processing Circuits for Wireless and Optical Communication Systems

Koichi Murata, *NTT Photonics Labs.*
Edward Gebara, *Georgia Institute of Technology*
Room: 207C

15:30 - 15:40

WE4A-1: Long range, low power UHF RFID analog front-end suitable for batteryless wireless sensors

A. Vaz¹, H. Solar¹, I. Rebollo², I. Gutiérrez¹, R. Berenguer¹,
¹CEIT and Tecnun, San Sebastián, Spain, ²Farsens, San Sebastián, Spain

WE4B-1: Compact Artificial Line Phase Shifter on Ferroelectric Thick-Film Ceramics

M. Sazegar¹, Y. Zheng¹, H. Maune¹, X. Zhou², C. Damm¹,
R. Jakoby¹, ¹TU-Darmstadt, Darmstadt, Germany,
²Karlsruhe Institute of Technology, Karlsruhe, Germany

WE4C-1: TM Dual-Mode Pseudoelliptic Filters using Nonresonating Modes

S. Bastioli¹, C. Tomassoni¹, R. Sorrentino¹, ¹University of Perugia, Perugia, Italy, ²RF Microtech srl, Perugia, Italy

WE4D-1: A 50-GS/s 5-b ADC in 0.18-um SiGe BiCMOS

J. Lee, Y. Chen, Alcatel-Lucent, Murray Hill, United States

15:40 - 15:50

WE4A-2: An RFID System with Enhanced Hardware-Enabled Authentication and Anti-counterfeiting Capabilities

V. Lakafofis¹, A. Traille¹, H. Lee¹, G. Orecchini², E. Gebara¹, M. M. Tentzeris¹, J. Laskar¹, G. DeJean², D. Kirovski², ¹Georgia Institute of Technology, Atlanta, United States, ²Microsoft Research, Redmond, United States, ³University of Perugia, Perugia, Italy

WE4B-2: Accurate Analysis of Irregular Periodic Substrate Integrated Waveguide Structures and Its Applications

L. Han, K. Wu, X. Chen, F. He, Poly-Grames Research Center, Montreal, Canada

WE4C-2: Coupling Topologies for Realizing Compact Microwave Diplexers with Dual-mode Cavities

H. Ezzeddine¹, S. Bila¹, S. Verdeyme¹, F. Seyfert², D. Pacaud³, ¹XLIM, Limoges, France, ²INRIA, Sophia Antipolis, France, ³Thalès Alenia space, Toulouse, France

WE4D-2: A 17pJ/bit Broadband Mixed-Signal Demodulator in 90nm CMOS

K. S. Chuang, D. Yeh, F. Barale, B. Perumana, S. Sarkar, P. Sen, S. Pinel, J. Laskar, Georgia Electronic Design Center, Atlanta, United States

16:00 - 16:10

WE4A-3: Crossed dipole frequency doubling RFID TAG based on paper substrate and ink-jet printing technology

F. Alimenti¹, V. Palazzari¹, G. Orecchini¹, G. Pinca², P. Mezzanotte¹, M. M. Tentzeris³, L. Roselli¹, ¹University of Perugia, Perugia, Italy, ²Wireless Solutions S.r.l., Passignano sul Trasimeno, Italy, ³Georgia Institute of Technology, Atlanta, United States

WE4B-3: Conductor Profile Effects on the Propagation Constant of Microstrip Transmission Lines

A. F. Horn, III¹, J. W. Reynolds¹, J. C. Rautio², ¹Rogers Corporation, Rogers, United States, ²Sonnet Software, Inc., North Syracuse, United States

WE4C-3: A Novel Ku-Band Dielectric Resonator Triplexer based on Generalized Multiplexer Theory

F. Loras-Gonzalez¹, I. Hidalgo-Carpintero¹, S. Sobrino-Arias¹, A. Garcia-Lampérez², M. Salazar-Palma², ¹Thales Alenia Space, Tres Cantos, Spain, ²Universidad Carlos III de Madrid, Leganés, Spain

WE4D-3: Pulse Shaping and Clock Data Recovery for Multi-Gigabit Standard Compliant 60 GHz Digital Radio

F. Barale, G. B. Iyer, B. G. Perumana, P. Sen, S. Sarkar, A. Rachamadugu, N. Dubeout, S. Pinel, J. Laskar, Georgia Institute of Technology, Atlanta, United States

16:10 - 16:20

WE4A-4: Harmonic Generation from Integrated Nonlinear Transmission Lines for RFID Applications

F. Yu, K. G. Lyon, E. C. Kan, Cornell University, Ithaca, United States

WE4B-3: Conductor Profile Effects on the Propagation Constant of Microstrip Transmission Lines

A. F. Horn, III¹, J. W. Reynolds¹, J. C. Rautio², ¹Rogers Corporation, Rogers, United States, ²Sonnet Software, Inc., North Syracuse, United States

WE4C-3: A Novel Ku-Band Dielectric Resonator Triplexer based on Generalized Multiplexer Theory

F. Loras-Gonzalez¹, I. Hidalgo-Carpintero¹, S. Sobrino-Arias¹, A. Garcia-Lampérez², M. Salazar-Palma², ¹Thales Alenia Space, Tres Cantos, Spain, ²Universidad Carlos III de Madrid, Leganés, Spain

WE4D-4: A 1 V 6-bit 2.4 GS/s Nyquist CMOS DAC for UWB Systems

B. Kim, M. Cho, Y. Kim, J. Kwon, Electronics and Telecommunications Research Institute, Daejeon, Republic of Korea

16:20 - 16:30

WE4A-5: A device-level analog and digital subsystem SPICE library for the design of low-cost pentacene OFET RFIDs

R. Tinivella, S. Shen, M. Pirola, G. Ghione, V. Camarchia, Politecnico di Torino, Torino, Italy

WE4B-4: Bandwidth Enhancement of Substrate Integrated Waveguide Tunnels by Longitudinal Resonances

A. Corona-Chavez¹, T. Itoh¹, ¹University of California at Los Angeles, Los Angeles, United States, ²INAOE, Puebla, Mexico

WE4C-4: Compact Wide-Band Ridge Waveguide Dual-Band Filters

M. M. Fahmi¹, J. A. Ruiz-Cruz², R. R. Mansour¹, K. A. Zaki³, ¹University of Waterloo, Waterloo, Canada, ²Universidad Autónoma de Madrid, Madrid, Spain, ³University of Maryland, College Park, College Park, United States

WE4D-5: A 6 Bit Linear Binary RF DAC in 0.25um SiGe BiCMOS for Communication Systems

M. Khafaji, H. Gustat, J. Scheytt, IHP Microelectronics, Frankfurt Oder, Germany

16:30 - 16:40

WE4A-6: Temporally Resolved Impedance Measurement of Differential, RF-Powered Devices using the Example of a μ Wave RFID Front-End

C. Bansleben¹, S. Kühn², N. Gay¹, W. J. Fischer¹, ¹Fraunhofer IPMS, Dresden, Germany, ²Ferdinand-Braun-Institut, Berlin, Germany

WE4B-5: Micromachined High Aspect Ratio Coplanar Waveguide with High Impedance and Low Loss on Low Resistivity Silicon

S. T. Todd¹, J. E. Bowers¹, N. C. MacDonald², ¹University of California, Santa Barbara, Santa Barbara, United States, ²University of California, Santa Barbara, Santa Barbara, United States

WE4C-5: A New Class of 3-D Filter/Antenna Integration with High Quality Factor and High Efficiency

Y. Yusuf, X. Gong, University of Central Florida, Orlando, United States

WE4D-6: Distributed Amplifiers in InP DHBT for 100-Gbit/s Operation

J. Dupuy, A. Konczykowska, F. Jorge, M. Riet, J. Godin, Alcatel-Lucent, Marcoussis, France

16:50 - 17:00

WE4A-7: Co-design of Ultra Low Power RF/Microwave Receivers and Converters for RFID and Energy Harvesting Applications

A. Costanzo¹, M. Fabiani¹, A. Romani¹, D. Masotti², V. Rizzoli², ¹University of Bologna, Cesena, Italy, ²University of Bologna, Bologna, Italy

WE4B-5: Micromachined High Aspect Ratio Coplanar Waveguide with High Impedance and Low Loss on Low Resistivity Silicon

S. T. Todd¹, J. E. Bowers¹, N. C. MacDonald², ¹University of California, Santa Barbara, Santa Barbara, United States, ²University of California, Santa Barbara, Santa Barbara, United States

WE4C-6: Quasi-elliptic 150 GHz Highly Selective LTCC Filter

A. Khalil¹, D. Passerieux¹, D. Baillargeat¹, N. Delhote¹, S. Verdeyme¹, L. Rigauddau², J. Puech², ¹Xlim Laboratory CNRS 6172, Limoges, France, ²French National Space Agency, Toulouse, France

WEDNESDAY TECHNICAL SESSIONS

15:30-17:10

WE4E: Power-Amplifier and Combiner Techniques for HF, VHF, and UHF
Richard Campbell, *Portland State University*
Robert Caverly, *Villanova University*
Room: 207D

WE4F: Novel Si-based devices and circuits
Zaher Bardai, *IMN Epiphany*
Kenjiro Nishikawa, *NTT Corporation*
Room: 208AB

WE4G: CAD Techniques and Methodologies: Future Directions
Q.J. Zhang, *Carleton University*
Arvind Sharma, *Northrop Grumman*
Room: 209AB

<p>WE4E-1: Class-D Power Amplifier with RF Pulse-Width Modulation F. H. Raab, <i>Green Mountain Radio Research Company, Colchester, United States</i></p>	<p>WE4F-1: A Novel Small Capacitance RF-MOSFET with small-resistance Long-finger Gate Electrode H. Nagase, A. Tanabe, Y. Hayashi, <i>NEC Electronics Corporation, Sagamihara, Japan</i></p>	<p>WE4G-1: Techniques for Nonlinear High-Frequency Circuit-Level Simulation T. Brazil, <i>University College Dublin, Dublin, Ireland</i></p>	15:30-15:50
<p>WE4E-2: An Efficient, 35 dBm, Inverse Class-F, UHF RF Power Amplifier Module on a 10 mm² Footprint Designed in First Pass through Accurate Modeling and Simulation M. J. Franco, <i>RFMD, Greensboro, United States</i></p>	<p>WE4F-2: Silicon-Based PIN SPST RF Switches for Improved Linearity P. Sun¹, G. Wang¹, P. Liu², P. Upadhyaya², D. Jeong³, D. Heo², ¹IBM, <i>Essex Junction, United States</i>, ²Washington State University, <i>Pullman, United States</i>, ³Handong Global University, <i>Pohang, United States</i></p>	<p>WE4G-2: Historical Trends and Evolution of Circuit-Simulation Technology S. Maas, <i>AWR Corp., El Segundo, United States</i></p>	15:50-16:10
<p>WE4E-3: Switch-Controlled Multi-Octave Bandwidth Radial Power Divider/Combiner Y. Hong¹, D. F. Kimball², J. Yook¹, P. M. Asbeck², L. E. Larson², ¹Yonsei University, <i>Seoul, Republic of Korea</i>, ²University of California, <i>San Diego, La Jolla, United States</i></p>	<p>WE4F-3: A Ka-Band High-Pass Distributed Amplifier in 120nm SiGe BiCMOS T. D. Gathman, J. F. Buckwalter, <i>University of California, San Diego, La Jolla, United States</i></p>	<p>WE4G-3: Multi-PC FDTD: Solving Large Scale EM Problems A. Wien, A. Lauer, I. Wolff, <i>IMST GmbH, Kamp-Lintfort, Germany</i></p>	16:10-16:30
<p>WE4E-4: High-Efficiency 400-W Power Amplifier with Dynamic Drain Voltage Control for 6-MHz OFDM Signal S. Hiura, H. Sumi, H. Takahashi, <i>Toshiba Corporation, Corporate Manufacturing Engineering Center, Yokohama, Japan</i></p>	<p>WE4F-4: Low-Power Low-Noise 0.13 μm CMOS X-Band Phased Array Receivers D. Shin, G. M. Rebeiz, <i>UCSD, La Jolla, United States</i></p>	<p>WE4G-4: ANN and Space Mapping for Microwave Modeling and Optimization Q. Zhang¹, J. W. Bandler², S. Koziel³, H. Kabir¹, L. Zhang¹, ¹Carleton University, <i>Ottawa, Canada</i>, ²McMaster University, <i>Hamilton, Canada</i>, ³Reykjavik University, <i>Reykjavik, Iceland</i></p>	16:30-16:50
<p>WE4E-5: 100 W GaN HEMT Power Amplifier Module with 60% Efficiency over 100–1000 MHz Bandwidth K. Krishnamurthy, T. Driver, R. Vetry, J. Martin, <i>RF Micro Devices, Charlotte, United States</i></p>	<p>WE4F-5: An L-Band Gain and Bandwidth Tunable Low-Noise Differential Amplifier Using Varactor-Tuned Bias Circuits and Active Loads Y. Itoh, W. Cao, T. Murata, K. Sakurai, <i>Shonan Institute of Technology, Fujisawa, Japan</i></p>	<p>WE4G-5: State-of-the-Art, Challenges, and Future Directions of Nonlinear Behavioral Modeling D. E. Root, <i>Agilent Technologies, Santa Rosa, United States</i></p>	16:50-17:10



THURSDAY TECHNICAL SESSIONS

8:00-9:40

TH1A: Terahertz Electronics
 Reynold Kagiwada, Northrop Grumman
 Aaron Oki, Northrop Grumman
Room: 205AB

TH1B: RF-MEMS Circuits
 Joachim Oberhammer, Royal Institute of Technology
 Jing Wang, University of South Florida
Room: 206AB

TH1C: Large Signal Measurements
 Nuno Borges Carvalho, Universidade de Aveiro
 Kate A. Remley, NIST
Room: 207AB

8:00 - 8:20

TH1A-1: THz Electronics Projects at DARPA: Transistors, TMICs, and Amplifiers
 J. D. Albrecht¹, M. J. Rosker¹, H. B. Wallace², T. Chang³,
¹Defense Advanced Research Projects Agency, Arlington, United States, ²MMW Concepts LLC, Havre de Grace, United States, ³Booz Allen Hamilton Inc., Arlington, United States

TH1B-1: A High Power-Handling RF MEMS Tunable Capacitor Using Quadruple Series Capacitor Structure
 H. Yamazaki¹, T. Ikehashi¹, T. Saito¹, E. Ogawa¹, T. Masunaga², T. Ohguro¹, Y. Sugizaki¹, H. Shibata¹,
¹Toshiba Corporation, Yokohama, Japan, ²Toshiba Corporation, Yokohama, Japan

TH1C-1: A novel methodology for fast harmonic-load control with a passive tuner and an active loop
 S. Bonino, V. Teppati, A. Ferrero, Politecnico di Torino, Torino, Italy

8:20 - 8:40

TH1A-2: Solid-State Amplifiers for Terahertz Electronics
 W. R. Deal, X. B. Mei, D. Scott, V. Radisic, M. K. Leong, S. Sarkozy, B. Gorospe, J. Lee, P. H. Liu, W. Yoshida, J. Zhou, R. Elmadjian, S. Wang, M. Lange, J. Uyeda, R. Lai, A. Gutierrez, R. Kagiwada, Northrop Grumman, Redondo Beach, United States

TH1B-2: Anti-Biased RF MEMS Varactor Topology for 20-25 dB Linearity Enhancement
 K. Chen, A. Kovacs, D. Peroulis, Purdue University, West Lafayette, United States

TH1C-2: A Low-Cost and Accurate Technique for the Prediction of Load-Pull Contours
 V. Vadalà, A. Raffo, S. Di Falco, G. Vannini, University of Ferrara, Ferrara, Italy

8:40 - 9:00

TH1A-3: THz MMICs based on InP HBT Technology
 J. Hacker¹, M. Seo¹, A. C. Young¹, Z. Griffith¹, M. Urteaga¹, T. Reed², M. Rodwell²,
¹Teledyne Scientific & Imaging, Thousand Oaks, United States, ²University of California, Santa Barbara, Santa Barbara, United States

TH1B-3: A Tunable Asymmetric Notch Filter using RFMEMS
 J. R. De Luis², A. S. Morris III¹, Q. Gu¹, F. De Flaviis²,
¹Wispry Inc, Irvine, United States, ²University of California Irvine, Irvine, United States

TH1C-3: Active Simultaneous Harmonic Source and Load Pull Assisted by Local Polyharmonic Distortion Models
 R. E. Leoni III, S. A. Harris, D. G. Ries Jr., Raytheon Company, Andover, United States

9:00 - 9:20

TH1A-4: N-polar GaN-based MIS-HEMTs for Mixed Signal Applications
 U. K. Mishra¹, M. Wong¹, N. Nidhi¹, S. Dasgupta¹, D. F. Brown¹, B. L. Swenson¹, S. Kellera¹, J. S. Speck²,
¹University of California, Santa Barbara, Santa Barbara, United States, ²University of California, Santa Barbara, Santa Barbara, United States

TH1B-4: An Experimental Investigation on Viscoelastic Behavior in Tunable Planar RF-MEMS Resonators
 H. Hsu, D. Peroulis, Purdue University, West Lafayette, United States

TH1C-4: A Method to Select Correct Stimuli Levels for S-functions Behavioral Model Extraction
 M. Myslinski¹, F. Verbeyst², M. Vanden Bossche², D. Schreurs¹,
¹K.U.Leuven, Leuven, Belgium, ²NMDG n.v., Bornem, Belgium

9:20 - 9:40

TH1A-5: Toward practical applications over 100 GHz
 N. Kukutsu¹, A. Hirata¹, M. Yaita¹, K. Ajito¹, H. Takahashi¹, T. Kosugi², H. Song¹, A. Wakatsuki², Y. Muramoto², T. Nagatsuma³, Y. Kado¹,
¹NTT Microsystem Integration Laboratories, Atsugi-shi, Japan, ²NTT Photonics Laboratories, Atsugi-shi, Japan, ³Osaka University, Toyonaka, Japan

TH1B-5: A MEMS Variable Capacitor with Piezoresistive Position Sensing Fabricated in a Standard 0.35um CMOS Process
 N. Zahirovic¹, R. R. Mansour¹, M. Yu²,
¹University of Waterloo, Waterloo, Canada, ²COM DEV International, Cambridge, Canada

THURSDAY

TECHNICAL SESSIONS

8:00-9:40

TH1D: Developments in Microwave Signal Generation
 Scott Wetenkamp, *SCEAN*
 Bhaskar Banerjee, *University of Texas at Dallas*
Room: 207C

TH1E: Advances in Active Device Modeling
 Arvind Sharma, *Northrop Grumman*
 Q.J. Zhang, *Carleton University*
Room: 207D

TH1D-1: Study of Direct-Conversion Transmitter Pulling Effects in Constant Envelope Modulation Systems
 C. Hsiao¹, C. Li¹, F. Wang¹, T. Horng¹, K. Peng²,
¹National Sun Yat-Sen University, Kaohsiung, Taiwan, ²National Kaohsiung First University of Science and Technology, Kaohsiung, Taiwan

TH1E-1: Nonlinear Modeling of Compound Semiconductor HEMTs, State of the Art
 W. R. Curtice, W. R. Curtice Consulting, Washington Crossing, United States

8:00 - 8:20

TH1D-2: Low-Phase-Noise Wide-Frequency-Range Ring-VCO-Based Scalable PLL with Subharmonic Injection Locking in 0.18 μm CMOS
 S. Lee, S. Amakawa, N. Ishihara, K. Masu, Integrated Research Institute, Yokohama, Japan

TH1E-2: Empirical Modeling of GaN FETs for Nonlinear Microwave Circuit Applications
 A. Santarelli, V. Di Giacomo, Univ. of Bologna, Bologna, Italy

8:20 - 8:40

TH1D-3: Ku Band Second Harmonic N-Coupled Push-Push Oscillator Array using Microstrip Resonator
 K. Kawasaki, T. Tanaka, M. Aikawa, Saga University, Saga, Japan

TH1E-3: Strategies for addressing linearity Issues in Active Device Modeling
 A. Mediavilla, J. A. Garcia, L. Cabria, F. R. Marante, Univ. of Cantabria, Santander, Spain

8:40 - 9:00

TH1D-4: Low Phase Noise K-Band Oscillator on Organic Liquid Crystal Polymer (LCP) Substrate
 W. T. Khan, S. K. Bhattacharya, S. Horst, J. D. Cressler, J. Papapolymerou, Georgia Institute of Technology, Atlanta, United States

TH1E-4: Compact HBT modeling: status and challenges
 M. Rudolph, Brandenburg University of Technology, Cottbus, Germany

9:00 - 9:20

TH1D-5: A Sub-Resonant 40GHz Clock Distribution Network with Near Zero Skew
 F. Aryanfar¹, T. Wu¹, M. Koochakzadeh², C. Werner¹, K. Chang¹, ¹Rambus Inc, Los Altos, United States, ²Arizona State University, Tempe, United States

TH1E-5: State-of-Art, Challenges and Future Directions in Large Signal Measurements for Active Device Modeling
 D. Schreurs, K.U.Leuven, Leuven, Belgium

9:20 - 9:40



THURSDAY

INTERACTIVE FORUM

9:40 - 11:40

THPA: Transmission Line Circuits

Dominic Deslandes, *University of Quebec, Montreal*

THPB: Recent Advancements in Passive Circuitry

Nickolas Kingsley, *Auriga Measurement Systems*
Peter Russer, *Munich University of Technology*

THPD: Biological Effects and Medical Applications of RF and Microwave

Mohammad Reza Tofighi, *Pennsylvania State University*

THPA-1: Metamaterial Transmission Line Transformers/Baluns
H. Yang, V. Chekka, H. Ma, *University of Illinois, Chicago, United States*

THPB-1: A Modified Wilkinson Divider using Zero-Degree Phase Shifting Composite Right/Left-Handed Transmission Line
S. Kim¹, J. Yoon¹, Y. Kim¹, Y. Yoon², ¹Kumoh National Institute of Technology, Gumi, Republic of Korea, ²Kwandong University, Gangneung-shi, Republic of Korea

THPD-1: The response of electric field probes to realistic RF environments
D. Adamson, D. Bownds, A. Fernández, E. Goodall, *National Physical Laboratory, Teddington, United Kingdom*

THPA-2: Novel Synthesized Microstrip Line with Quasi-Elliptic Response for Harmonic Suppressions
C. Lai, T. Ma, *National Taiwan University of Science and Technology, Taipei, Taiwan*

THPB-2: High CMRR in Reduced-Coupling Monolithic Baluns
R. C. Frye¹, K. Liu², P. Hlaing³, ¹RF Design Consulting, LLC, Piscataway, United States, ²STATS ChipPAC, Tempe, United States, ³STATS ChipPAC, Ltd., Singapore, Singapore

THPD-2: Multiplicative Regularized Gauss-Newton Approach for Three-Dimensional Microwave Imaging
A. Abubakar, T. M. Habashy, *Schlumberger-Doll Research, Cambridge, United States*

THPA-3: Design of Microwave Circuits in Ridge-Gap Waveguide Technology
E. Alfonso¹, M. Baquero¹, P. Kildal², A. Valero-Nogueira¹, E. Rajo-Iglesias³, J. I. Herranz¹, ¹Universidad Politecnica de Valencia, Valencia, Spain, ²Chalmers University of Technology, Gothenburg, Sweden, ³Universidad Carlos III, Leganes, Spain

THPB-3: A Novel TE10-TE20 Mode Transducer Utilizing Vertical Cross-Excitation
H. Ikeuchi¹, S. Matsumoto², T. Kawai¹, I. Ohta¹, ¹University of Hyogo, Himeji, Japan, ²Furuno Electric Co., Ltd., Nishinomiya, Japan

THPD-3: A Heterodyne Receiver for Harmonic Doppler Radar Cardio-pulmonary Monitoring with Body-worn Passive RF Tags
A. Singh, V. M. Lubecke, *University of Hawaii at Manoa, Honolulu, United States*

THPA-4: A Novel Multi-Octave Differential Power Divider
C. F. Marki, V. D. Kodwani, F. A. Marki, *Marki Microwave, Morgan Hill, United States*

THPB-4: Wireless Power Transmission Based on Directional Coupler or Directional Filter
I. Awai, K. Hori, S. Yakuno, K. Namikoshi, *Ryukoku University, Otsu, Japan*

THPD-4: Energy Efficient 136 Mb/s OOK Implantable Transmitter for Wireless Brain Computer Interface
J. Jung, S. Zhu, P. Liu, D. Heo, *Washington State University, Pullman, United States*

THPA-5: A Reconfigurable Impedance Matching Network Using Dual-Beam MEMS Switches for an Extended Operating Frequency Range
F. Domingue¹, S. Fouladi², R. R. Mansour², ¹Universite du Quebec à Trois-rivières, Trois-Rivières, Canada, ²University of Waterloo, Waterloo, Canada

THPB-5: A New UWB Coupled Transmission Line Power Divider
R. Kravchenko¹, M. Stadler¹, E. Leitgeb², ¹EPCOS, Deutschlandsberg, Austria, ²TU Graz, Graz, Austria

THPD-5: A Planar Covered Multi-Slot-Array Heat Applicator with Beam Scanning Capability for Interstitial Microwave Hyperthermia
D. Kim¹, N. Kim¹, C. Cheon², Y. Kwon¹, ¹Seoul National University, Seoul, Republic of Korea, ²University of Seoul, Seoul, Republic of Korea

THPB-6: Dual-Band Hybrid Balun Structure using Transmission-lines and Lumped Component Resonators
P. Aflaki¹, R. Negra², F. Ghannouchi¹, ¹University of Calgary, Calgary, Canada, ²RWTH Aachen University, Aachen, Germany

THPB-7: A Novel Compact Three-Dimensional CMOS Branch-Line Coupler using the Meandering ECPW/TFMS and Buried Micro Coaxial Technologies at 60 GHz
K. Hettak, *Communications Research Center, Ottawa, Canada*

THPB-8: A Novel Volumetric Folded Ring Resonator Metamaterial Structure
N. R. Labadie, S. K. Sharma, *San Diego State University, San Diego, United States*

THPB-9: Design and Characterization of Periodically-Loaded Substrate Integrated Waveguide Phase Shifters
A. Suntives, K. Payandehjoo, R. Abhari, *McGill University, Montreal, Canada*

THPB-10: Compact Wilkinson Power Divider with Simultaneous Bandpass Response and Harmonic Suppression
P. Cheong, K. Lai, K. Tam, *University of Macau, Macau, Macau*

THURSDAY

ROOM 204ABC

9:40 - 11:40

THPF: Advances in Communication, Radar, Sensor and Measurement Systems

Shoichi Narahashi, *NTT DOCOMO, Inc*

THPH: RFID and Power Harvesting Technologies

Luca Roselli, *University of Perugia*
Apostolos Geprgoados, *CTTC, Barcelona*

THPF-1: Implementation and Analysis of a 30 GHz Wireless Communication System with a Novel Receiver Front-end

Z. Zhang, Y. Wei, K. Wu, *Ecole Polytechnique Montreal, Montreal, Canada*

THPH-1: CAD of Wireless Resonant Energy Links (WREL) Realized by Coils

M. Dionigi, M. Mongiardo, *Università di Perugia, Perugia, Italy*

THPF-2: A 3.1-10.6 GHz RF Receiver Front-end in 0.18 um CMOS for Ultra-Wideband Applications

B. Park¹, K. Lee¹, S. Choi¹, S. Hong², ¹ETRI, Daejeon, Republic of Korea, ²KAIST, Daejeon, Republic of Korea

THPH-2: Wireless Remote Localization System utilizing Ambient RF/Solar Power Scavenging RFID Tags

R. J. Vyas, V. Lakafosis, M. Tentzeris, *Georgia Institute of Technology, Atlanta, United States*

THPF-3: Cable imaging with an active W-band millimeter-wave sensor

D. Goshi, Y. Liu, K. Mai, L. Bui, Y. Shih, *Honeywell International, Torrance, United States*

THPH-3: CAD Procedure for Predicting the Energy Received by Wireless Scavenging Systems in the Near- and Far-field Region

V. Rizzoli¹, D. Masotti¹, N. Arbizzani¹, A. Costanzo², ¹University of Bologna, Bologna, Italy, ²Il School of Engineering-University of Bologna, Cesena, Italy

THPF-4: Time-Domain Calibration Technique for Ultra-Wide Instantaneous-Bandwidth Vector Waveform Generation Using Parallel I/Q Channels

J. X. Qiu, *Army Research Laboratory, Adelphi, United States*

THPH-4: Sensor Data Transmission Through Passive RFID Tags to Feed Wireless Sensor Networks

L. Catarinucci, R. Colella, L. Tarricone, *University of Salento, Lecce, Italy*

THPF-5: Interferometric Detection of the Angular Velocity of Moving Objects

J. A. Nanzer, *Johns Hopkins University, Laurel, United States*

THPH-5: Piggyback Modulation for UHF RFID Sensors

H. Chen, A. Bhadkamkar, D. W. van der Weide, *University of Wisconsin - Madison, Madison, United States*

THPF-6: Design and Implementation of a Wireless Link Coupled Channel Emulator for DSRC Wireless Systems

T. Faseth, M. Winkler, C. Schubert, H. Arthaber, G. Magnerl, *Vienna University of Technology, Vienna, Austria*

THPF-7: Miniature Radio Frequency Ion Trap Mass Spectrometry

J. D. Maas, W. Xu, W. J. Chappell, *Purdue University, West Lafayette, United States*



THURSDAY TECHNICAL SESSIONS

10:10-11:50

TH2A: Wide Bandgap Semiconductor Applications

Aaron Oki, *Northrop Grumman*
Reynold Kagiwada, *Northrop Grumman*
Room: 205AB

TH2B: RF MEMS Switches and Switched Capacitors

Dimtri Peroulis, *Purdue University*
Art Morris, *Wispry Inc.*
Room: 206AB

TH2C: Phased Array Systems and Integration

Zoya Popovic, *University of Colorado*
Glenn Hopkins, *GTRI*
Room: 207AB

10:10 - 10:30

TH2A-1: DARPA's GaN Technology Thrust

M. J. Rosker¹, J. D. Albrecht¹, E. Cohen², J. Hodiak³, T. Chang³, ¹Defense Advanced Research Projects Agency, Arlington, United States, ²EBCO Technology Advising, Inc., North Potomac, United States, ³Booz Allen Hamilton Inc., Arlington, United States

TH2B-1: Sub-Hundred Nanosecond Reconfiguration Capabilities of Nanogap RF MEMS Switched Capacitor

A. Verger¹, A. Pothier¹, C. Guines¹, A. Crunteanu¹, P. Blondy¹, J. Orlianges², J. Dhennin³, F. Courtade⁴, O. Vendier⁵, ¹XLIM UMR 6172 – Université de Limoges/CNRS, Limoges, France, ²spcts CNRS UMR 6638, Limoges, France, ³NovaMEMS, Ramonville, France, ⁴CNES, Toulouse Cedex9, France, ⁵Thales Alenia Space, Toulouse, France

TH2C-1: X/Ku-Band 8-Element Phased Arrays Based on Single Silicon Chips

Y. A. Atesal¹, B. Cetinoneri¹, K. Koh², G. M. Rebeiz¹, ¹University of California, San Diego, La Jolla, United States, ²Intel Corp., Hillsboro, United States

10:30 - 10:50

TH2A-2: Reliable GaN HEMTs for High Frequency Applications

B. Heying¹, W. Luo¹, I. Smorchkova¹, Y. Chen¹, P. Huang¹, S. Din¹, M. Siddiqui¹, W. Sutton¹, V. Gambin¹, M. Wojtowicz², A. Oki¹, ¹Northrop Grumman Corporation, Redondo Beach, United States, ²Northrop Grumman Corporation, Redondo Beach, United States

TH2B-2: An RF-MEMS Switch with mN Contact Forces

C. D. Patel, G. M. Rebeiz, University of California, San Diego, La Jolla, United States

TH2C-2: UWB Array Antenna Utilizing Novel Electrical Scanning System with Tapped Delay Lines

F. Sakai, K. Ohta, Sakuratech Corporation, Kawasaki-city, Japan

10:50 - 11:10

TH2A-3: GaN Technology for Microwave and Millimeter Wave Applications

N. J. Kolas, T. E. Kazior, C. S. Whelan, S. K. Brierley, K. V. Smith, E. M. Chumbes, S. D. Bernstein, J. A. Smolko, Raytheon Company, Andover, United States

TH2B-3: Charging Characteristics of Ultra-nano-crystalline Diamond in RF MEMS Capacitive Switches

C. L. Goldsmith¹, A. V. Sumant², O. Auciello², J. A. Carlisle³, J. C. Hwang⁶, C. Palego⁶, W. Wang⁶, R. W. Carpick⁵, V. Adiga⁵, A. Datta⁴, C. Gudeman⁴, S. O'Brien¹, S. Sampath⁴, H. Zeng³, ¹MEMTronics Corporation, Plano, United States, ²Argonne National Laboratory, Argonne, United States, ³Advanced Diamond Technologies, Inc., Romeoville, United States, ⁴Innovative Micro Technology, Santa Barbara, United States, ⁵University of Pennsylvania, Philadelphia, United States, ⁶Lehigh University, Bethlehem, United States

TH2C-3: Narrowband Frequency Scanning Array Antenna at 5.8 GHz for Short Range Imaging

A. Fackelmeier, E. Biebl, Technische Universität München, Munich, Germany

11:10 - 11:20

TH2A-4: 100 mm GaN-on-SiC RF MMIC Technology

J. W. Palmour, C. Hallin, A. Burk, F. Radulescu, D. Namishia, H. Hagleitner, J. Duc, B. Pribble, S. T. Sheppard, J. B. Barner, J. Milligan, Cree, Inc., Durham, United States

TH2B-4: Effect of Surface Conduction on Dielectric Charging in RF MEMS Capacitive Switches

Z. Peng¹, D. Molinero¹, C. Palego¹, J. Hwang¹, C. Moody², A. Malczewski², B. W. Pillans², ¹Lehigh University, Bethlehem, United States, ²Raytheon Systems Co., Dallas, United States

TH2C-4: A New Approach to Design Low Cost, Low Complexity Phased Arrays

D. Ehyae, A. Mortazawi, University of Michigan, Ann Arbor, United States

11:20 - 11:30

TH2A-5: Wideband Power Amplifier MMICs Utilizing GaN on SiC

E. Reese, D. Allen, C. Lee, T. Nguyen, TriQuint Semiconductor, Richardson, United States

TH2B-5: Electrostatic RF MEMS Tunable Capacitors with Analog Tunability and Low Temperature Sensitivity

R. Mahameed, G. M. Rebeiz, University of California, San Diego, La Jolla, United States

TH2C-5: Sidelobe Level Reduction in Wide-Angle Scanning Array System Using Pattern-Reconfigurable Antennas

J. Wu, C. Chang, T. Chin, S. Huang, S. Chang, National Chung Cheng University, Ming-Hsiung Chia-Yi, Taiwan

11:30 - 11:40

TH2A-6: Gallium Nitride RF-Devices: An Overview on the Development Activities in Europe

R. Quay, M. Mikulla, Fraunhofer IAF, Freiburg, Germany

TH2C-6: Active 30 GHz Antenna Array for Digital Beam Forming and Polarization Multiplexing

K. Kuhlmann¹, A. F. Jacob², ¹Physikalisch-Technische Bundesanstalt, Braunschweig, Germany, ²Tech. Univ. Hamburg-Harburg, Hamburg, Germany

11:40 - 11:50

THURSDAY

TECHNICAL SESSIONS

10:10-11:50

TH2D: Novel Concepts for Advanced Packaging and Interconnect Technologies
 Rhonda Franklin, *University of Minnesota*
 Eric Strid, *Cascade Microtech*
Room: 207C

TH2E: Advances in MMIC Packaging
 Arvind Sharma, *Northrop Grumman*
 Debabani Choudhury, *Intel*
Room: 207D

TH2D-1: K-band Near-Hermetic Surface Mount Package using Liquid Crystal Polymer for High Power Applications.
 C. Chen, A. Pham, *University of California, Davis, Davis, United States*

TH2E-1: 3D Integration Technologies for Emerging Microsystems (Invited)
 D. Choudhury, *Intel, Hillsboro, United States*

10:10 - 10:30

TH2D-2: Heterogeneous Flip-Chip Assembly of a GaAs C-band Power Amplifier MMIC Using Liquid Metal Vertical Interconnects
 P. E. Ralston¹, J. Wood², K. Vummidi¹, J. M. Oliver¹, S. Raman¹, ¹Virginia Tech, Blacksburg, United States, ²BAE Systems, Nashua, United States

TH2E-2: A wafer-level interposer based microwave circuit and system integration technology
 C. Hillman, J. B. Hacker, W. Ha, P. Stupar, *Teledyne Scientific Company, Thousand Oaks, United States*

10:30 - 10:50

TH2D-3: Adjustable Dielectric Using Magnetically Aligned Conductive Particles for Microwave Applications
 S. Moon, W. J. Chappell, *Purdue University, West Lafayette, United States*

TH2E-3: Ultra Compact RFICs Using Three-dimensional MMIC technology
 T. Kaho, Y. Yamaguchi, K. Nishikawa, I. Toyoda, K. Uehara, *NTT Corporation, Yokosuka, Japan*

10:50 - 11:10

TH2D-4: Modeling and Metrology of Metallic Nanowires with Application to Microwave Interconnects
 K. Kim¹, M. Wallis², P. Rise³, C. Chiang⁴, A. Imtiaz², P. Kabos², D. S. Filipovic¹, ¹University of Colorado, Boulder, United States, ²National Institute of Science and Technology, Boulder, United States, ³University of Colorado, Boulder, United States, ⁴National Changhua University of Education, Changhua City, Taiwan

TH2E-4: Ultra Compact & Light Weight T/R Module Constructed by Hermetic Wafer-Scale Assembly Technology
 P. Chang-Chien, *Northrop Grumman Aerospace Systems, Redondo Beach, United States*

11:10 - 11:30

11:30 - 11:50



THURSDAY FOCUSED AND PANEL SESSIONS

Thursday **08:00 – 09:40** **Room 207D**

Advances in Active Device Modeling

Chair: Arvind Sharma, *Northrop Grumman Aerospace Systems*

Co-Chair: Q.J. Zhang, *Department of Electronics, Carlton University*

Sponsor: IMS 2010 Steering Committee

Abstract: First-pass design of microwave and millimeter-wave circuits require that device models accurately describe the device under various operating environments. There has been considerable progress in the test equipment and measurement procedures, as well as in characterization and modeling techniques. Several new compound semiconductor technologies have also emerged to address demanding system application requirements. Modeling complex device behavior requires innovative approaches. In this focused session, presenters will report on the status of linear models, noise, and nonlinear models, and address future directions in measurement approaches and modeling techniques.

Thursday **08:00 – 09:40** **Room 205AB**

Terahertz Electronics:

Chair: Reynold S. Kagiwada, *Northrop Grumman Aerospace Systems*

Co-Chair: Aaron Oki, *Northrop Grumman Aerospace Systems*

Sponsor: IMS 2010 Steering Committee

Abstract: Recent advances in device technology are making the dream of terahertz electronics a reality. Rapid progress is being made in solid state devices, amplifiers, and MMICs. Recently InP HEMT amplifiers have been produced with gain above 500 GHz. This session will cover the state-of-the-art in Terahertz Electronics.

Thursday **10:10 – 11:30** **Room 207D**

Advances in MMIC Packaging

Chair: Arvind Sharma, *Northrop Grumman Aerospace Systems*

Co-Chair: Debabani Choudhury, *Intel*

Sponsor: IMS 2010 Steering Committee

Abstract: Higher performance requirements of millimeter and sub-millimeter systems are driving the development of various packaging technologies such as 3D-on-wafer integration, 3D-IC stacking including wafer-level packaging (3D-WLP), and stacked IC (3D-SIC). This focused session will present an overview of 3D packaging technologies, and will provide state-of-the-art performance of components and systems utilizing these technologies.

Thursday **10:10 – 11:50** **Room 205AB**

Wide Bandgap Semiconductor Applications

Chair: Aaron Oki, *Northrop Grumman Aerospace Systems*

Co-Chair: Reynold S. Kagiwada, *Northrop Grumman Aerospace Systems*,

Sponsor: MTT-2, MTT-15, MTT-16, MTT-20, RFIC; IMS 2010

Abstract: Wide bandgap technologies continue to make significant advances with improvements in gain, bandwidth, power added efficiency, and reliability. Microwave power applications are moving up to millimeter wave frequencies. Industry leaders will present the state-of-the-art in wide bandgap devices, MMICs, and applications.

Thursday **12:00 – 13:10** **Room 210AB**

On-Die Synthesized Inductors: Boon or Bane?

Chair/Moderator: Jim Wight, *Carleton University*

Panelists:

John Long, *Delft University of Technology*

Rick Carley, *Carnegie Mellon University*

Tom Riley, *Kaben Wireless Silicon*

Abstract: Since the introduction of full transceivers on-silicon, inductor design has presented a problem. Inductors are necessary in the design of VCOs for frequency synthesizers, as well as in reconstruction filters following transmitter DACs. However, inductors are costly in terms of die area, and can attain only a modest Q in performance.

Alternative approaches have been developed to render the on-die inductor unnecessary. In particular, synthesized inductors can be achieved using active elements. Further, since most inductors in a transceiver are needed to form part of a resonator section for an oscillator or filter, approaches that realize the complete resonator could be useful. Such techniques include microelectromechanical systems (MEMS) and sampled analog finite impulse response (FIR) techniques.

While these approaches avoid the disadvantages of the on-die inductor, they have their

THURSDAY FOCUSED AND PANEL SESSIONS

own disadvantages. The competing strengths and inherent limitations of different realizations of on-die inductors will be discussed in this panel session. Whether the industry would adopt Synthesized (Active) Inductors, or other alternatives such as MEMS or Sampled Analog (FIR) techniques, is an open question.

Thursday **12:00 – 13:10** **Room 210CD**

RF GaN Reliability: Where Does the Technology Stand?

Chair/Moderator:

Frank Sullivan, *Raytheon*
Bernie Geller, *Vadum, Inc.*

Sponsor: MTT-6 & MTT-7

Panelists:

Steve Binari, *Naval Research Laboratory*
Toshihiro Ohki, *Fujitsu*
Ruediger Quay, *Fraunhofer Institute*
Robert Trew, *North Carolina State University*
David Via, *Air Force Research Laboratory, Wright Patterson*
Roger Wallace, *BAE Systems*
Colin Whelan, *Raytheon*

Abstract: This panel session will address the reliability issues associated with GaN discrete devices and MMICs in RF applications. The technology has made very large advances in the past few years and is starting to be vigorously deployed in a variety of applications, both commercial and military. At this point reliability becomes a major concern. Degradation mechanisms related to traps, hot carriers, passivation, material defects and metallization will be covered. The panel will address where the technology stands today, both in terms of intrinsic device properties and implementation issues. Data will be presented to substantiate the current reliability status.

Thursday **13:20 – 15:40** **Room 207D**

Advances in Silicon-based Millimeter-Wave Integrated Circuits

Chair: Dietmar Kissinger, *University of Erlangen-Nuermberg*

Co-Chair: Robert Weigel, *University of Erlangen-Nuermberg*

Sponsor: MTT-2, MTT-15, MTT-16, MTT-20, RFIC, IMS 2010

Abstract: The advancement of silicon-based technologies like CMOS and SiGe has enabled the low-cost fabrication of fully integrated millimeter-wave transceivers for consumer applications in communication and sensor technologies. Current research in silicon technology is targeting transition frequencies of 500GHz, which will enable the integration of systems with operational frequencies well above 100GHz, paving the way towards monolithic electronic THz solutions. This session focuses on recent advancements in millimeter-wave circuits based on silicon technologies for emerging applications around 100GHz and beyond.

Thursday **13:20 – 15:00** **Room 207D**

The Impact of Nanoelectronics on Radiofrequency Technology

Chair: Peter Russer, *Technische Universitaet Muenchen*

Co-Chair: Lucia Pierantoni, *Universita Ploitecnica delle Marche Ancona*

Sponsor: MTT-15, IMS 2010 TPC

Abstract: For future electronic devices, circuits and systems using information and communication technologies, nanotechnology will provide EXCELLENT POTENTIALITIES. The future development of systems using information and communications technologies, will be characterized by substantially increasing the amounts of data to be stored, processed and transmitted. The evolution of devices following Moores law will be possible only on the basis of nanoelectronic concepts. The goal of this Focused Session is to present an overview of recent developments of new microwave materials, devices and systems based on nanotechnology.

Thursday **15:30 – 17:10** **Room 207D**

Advances in RFID Circuits and Systems

Chair: Jürgen Heidrich, *University of Erlangen-Nuermberg*

Co-Chair: Robert Weigel, *University of Erlangen-Nuermberg*

Sponsor: MMT-2, MMT-16, MTT-24, RFIC, IMS 2010 TPC

Abstract: Contactless technologies, especially RFID systems operating in the HF region, have become very popular in commercial and industrial application areas. They are well-known for article surveillance, access control and near field communications. Lately, higher frequency ranges have become a growing interest. Also, greater demands on the circuit and antenna design are being made. This focused session will show the different requirements for antenna and circuit design, and the performance required by the RFID systems and the devices used in the systems.



GOLD PANEL SESSION

Thursday 10:20-11:40
Room 208 AB

We Want YOU!
But
What's In It For ME?

Chair: Sergio Pacheco, Freescale Semiconductor

Co-Chair: Rashaunda Henderson, University of Texas at Dallas

Sponsor: IEEE MTT-S GOLD Committee

This panel is comprised of leaders of the Microwave Theory and Techniques Society (MTT-S). They share their vast experience of the society and good reasons for becoming a committed member through technical and voluntary contributions. Speakers from industry, academia, US and International regions will be available to explain how they were "retained" in MTT-S.

IEEE Graduates of the Last Decade (GOLD) was created in 1996 as a membership program to help students transition to young professionals within the larger IEEE community. MTT-S GOLD activities began at the IMS2007 meeting in Honolulu, HI. GOLD makes up approximately 10% of the MTT-S population and are a valuable part of the community.



THURSDAY TECHNICAL SESSIONS

13:20-15:00

TH3A: Advances in Silicon-based Millimeter-Wave Integrated Circuits
 Dietmar Kissinger, *University of Erlangen-Nuernberg*
 Robert Weigel, *University of Erlangen-Nuernberg*
Room: 205AB

TH3B: Ferrite Materials and Devices
 Steven N. Stitzer, *Northrop Grumman ES*
 Spartak Gevorgian, *Chalmers University*
Room: 206AB

TH3C: Tunable, Active and Integrated Filter Technologies
 Har Dayal, *BAE SYSTEMS -EWS*
 Atsushi Sanada, *Yamaguchi University*
Room: 207AB

13:20 - 13:30

TH3A-1: On the Development of CMOS Sub-THz Phased Array Technology for Communication/Sensing Nodes
 J. Laskar, S. Pinel, S. Sarkar, P. Sen, B. Perunama, D. Dawn, M. Leung, F. Barale, D. Yeh, J. Shin, S. W. Hsiao, K. Chuang, E. Juntunen, G. Iyer, A. Muppalla, P. Melet, Georgia Tech, Atlanta, United States

TH3B-1: Dual-Band Integrated Self-biased Edge-Mode Isolator based on the Double Ferromagnetic Resonance of a Bistable Nanowire Substrate
 L. Carignan¹, C. Caloz², D. Ménard¹, ¹Polytechnique School of Montreal, Montreal, Canada, ²Ecole Polytechnique of Montreal, Montreal, Canada

TH3C-1: Novel MMIC Architectures for Tunable Microwave Wideband Active Filters
 F. Bergeras¹, P. Duème², J. Plaze², L. Darcel³, B. Jarry¹, M. Campovecchio¹, ¹XLIM Research Institute, Limoges, France, ²Thales Airborne Systems, Elancourt, France, ³Thales Air Systems, Elancourt, France

13:30 - 13:40

TH3A-2: A 76GHz PLL for mm-Wave Imaging Applications
 K. M. Nguyen¹, H. Kim², C. G. Sodini¹, ¹Massachusetts Institute of Technology, Cambridge, United States, ²Lincoln Laboratory, Lexington, United States

TH3B-2: Magnetically Tunable Nanocomposites for Microwave Applications
 C. Morales¹, J. Dewdney¹, S. Pal², K. Stojak², H. Srikanth², J. Wang¹, T. Weller¹, ¹Center for Wireless and Microwave Information Systems (WAMI), Tampa, United States, ²Functional Materials Lab (FML), Tampa, United States

TH3C-2: Three Approaches for the realization of a Chebyshev Cross-Coupled UWB Filter
 W. Galal El Dine¹, H. Ezzeddine¹, S. Bila², S. Verdeyme², ¹STMicroelectronics, Tours, France, ²XLIM - UMR CNRS n°6172, Limoges, France

13:40 - 13:50

TH3A-3: Towards High-Performance 100 GHz SiGe and CMOS Circuits
 G. M. Rebeiz¹, J. W. May¹, M. Uzunkol¹, W. Shin¹, O. Inac¹, M. Chang², ¹University of California, San Diego, La Jolla, United States, ²University of Michigan, Ann Arbor, Ann Arbor, United States

TH3C-3: High Rejection BPF for WiMAX Applications from Silicon Integrated Passive Device Technology
 K. Liu¹, R. C. Frye², B. Ahn¹, ¹STATS ChipPAC, Tempe, United States, ²RF Design Consulting, LLC, Piscataway, United States

13:50 - 14:00

TH3A-4: Highly Integrated 79, 94, and 120-GHz SiGe Radar Frontends
 M. Jahn, A. Stelzer, A. Hamidipour, Johannes Kepler University of Linz, Linz, Austria

TH3B-3: L-Band High Power Electronically Rotatable Ferrite Half-Wave Plate
 C. R. Boyd, Jr., W. E. Hord, S. T. Van Dyke, S. J. McKechnie, Microwave Applications Group, Santa Maria, United States

TH3C-4: Single-Chip Integration of Electronically Switchable Bandpass Filter for 3.5GHz WiMAX Application
 W. Liao, C. Chen, Y. Lin, National Central University, Jhongli City, Taoyuan County, Taiwan

14:00 - 14:10

TH3C-5: Very Compact Transformer-Coupled Balun-Integrated Bandpass Filter Using Integrated Passive Device Technology on Glass Substrate
 C. Chen¹, C. Huang¹, T. Horng¹, S. Wu², C. Chiu³, C. Hung³, J. Li⁴, C. Chen⁴, ¹National Sun Yat-Sen University, Kaohsiung, Taiwan, ²National University of Kaohsiung, Kaohsiung, Taiwan, ³Advanced Semiconductor Engineering Inc., Kaohsiung, Taiwan, ⁴Industrial Technology and Research Institute, Hsinchu, Taiwan

14:10 - 14:20

TH3A-5: Second Generation Transceivers for D-Band Radar and Data Communication Applications
 I. Sarkas¹, E. Laskin¹, J. Hasch², P. Chevalier³, S. P. Voinigescu¹, ¹University of Toronto, Toronto, Canada, ²Robert Bosch GmbH, Stuttgart, Germany, ³STMicroelectronics, Crolles, France

TH3B-4: Toroid Microinductors Using Segmented Magnetic Cores
 F. Hettstedt, U. Schürmann, R. Knöchel, E. Quandt, Christian-Albrechts-University, Kiel, Germany

TH3C-6: Low Temperature Superconductive Tunable Band-Stop Resonators and Filters
 S. S. Attar, S. Setoodeh, R. R. Mansour, University of Waterloo, Waterloo, Canada

14:20 - 14:30

14:30 - 14:40

TH3A-6: 122 GHz ISM-Band Transceiver Concept and Silicon ICs for Low-Cost Receiver in SiGe BiCMOS
 K. Schmalz¹, W. Winkler², J. Borngräber¹, W. Debski², B. Heinemann³, J. C. Scheytt¹, ¹IHP GmbH, Frankfurt (Oder), Germany, ²Silicon Radar GmbH, Frankfurt (Oder), Germany

TH3B-5: High Isolation Lange-Ferrite Circulators with NF Suppression for Simultaneous Transmit and Receive
 S. K. Cheung, W. H. Weedon, C. C. Caldwell, Applied Radar, Inc., North Kingstown, United States

TH3C-7: A Vertically Integrated Tunable UHF Filter
 E. E. Hoppenjans, W. J. Chappell, Purdue University, West Lafayette, United States

THURSDAY

TECHNICAL SESSIONS

13:20-15:00

TH3D: High Power and Broad Band Amplifiers.
 Bumman Kim, *POSTECH*
 Kiki Ikossi, *DTRA*
Room: 207C

TH3E: The Impact of Nanoelectronics on Radio Frequency Technology
 Peter Russer, *Technische Universitaet Munchen*
 Lucia Pierantoni, *Universita Ploitecnica delle Marche*
Room: 207D

TH3D-1: A 68% Efficiency, C-Band 100W GaN Power Amplifier for Space Applications
 T. Yamasaki¹, Y. Kittaka³, H. Minamide¹, K. Yamauchi², S. Miwa¹, S. Goto¹, M. Nakayama¹, M. Kono¹, N. Yoshida¹, ¹Mitsubishi Electric Corporation, Itami, Japan, ²Mitsubishi Electric Corporation, Kamakura, Japan, ³Wave Technology Inc, Kawanishi, Japan

TH3E-1: Semiconductor Nanomaterials For Radio Frequency Devices and Systems
 J. A. Rogers, University of Illinois, Champaign-Urbana, Champaign-Urbana, United States

13:20 - 13:40

TH3D-2: Over 10W C-Ku Band GaN MMIC Non-uniform Distributed Power Amplifier with Broadband Couplers
 S. Masuda, A. Akasegawa, T. Ohki, K. Makiyama, N. Okamoto, K. Imanishi, T. Kikkawa, H. Shigematsu, Fujitsu Laboratories Ltd., Atsugi, Japan

TH3E-2: Molecular electronics on its way to RF
 E. Albert, C. Erlen, S. Locci, P. Lugli, Technische Universitaet Muenchen, Munich, Germany

13:40 - 14:00

TH3D-3: Three Stage 6-18 GHz High Gain and High Power Amplifier based on GaN Technology
 Z. Ouarch¹, G. Mougnot¹, B. Lefebvre¹, S. Heckmann¹, J. Lhortolary¹, D. Baglieri¹, D. Floriot¹, M. Camiade¹, H. Blanck², M. Le Pipec³, D. Meslager³, P. Le Helleye³, ¹UMS, Orsay, France, ²UMS GmbH, Ulm, Germany, ³Dga/Celar, Bruz Cedex, France

TH3E-3: Nanostructure Antennas for the LW-IR Regime
 W. Porod, J. A. Bean, Z. Sun, B. Tiwari, G. Szakmany, G. H. Bernstein, P. Fay, University of Notre Dame, Notre Dame, United States

14:00 - 14:20

TH3D-4: High Efficiency 80W X-Band Power Amplifier using Coaxial Waveguide Spatial Power Combining Technique
 P. G. Courtney, T. Tran, C. Bartak, S. Behan, P. Jia, CAP Wireless Inc., Newbury Park, United States

TH3E-4: Recent Advances in Micro-structured Electric and Nano-structured Magnetic Microwave Metamaterials
 C. Caloz, L. Carignan, V. Boucher, T. Kodera, S. Couture, A. Parsa, D. Ménard, A. Yelon, École Polytechnique de Montréal, Montréal, Canada

14:20 - 14:40

TH3D-5: High-Efficiency K-Band Space Traveling-Wave Tube Amplifier for Near-Earth High Data Rate Communications
 R. N. Simons¹, D. A. Force¹, P. C. Spitsen², W. L. Menninger², N. R. Robbins², D. R. Dibb², P. C. Todd², ¹NASA Glenn Research Center, Cleveland, United States, ²L-3 Communications Electron Technologies, Inc., Torrance, United States

TH3E-5: All-semiconducting nanotube devices for RF and microwave applications
 N. Rouhi, D. Jain, K. Zand, P. Burke, UC Irvine, Irvine, United States

14:40 - 15:00



THURSDAY

INTERACTIVE FORUM

15:00 - 17:00

THPJ: Advances in Metamaterial, EM Analysis and Circuit Modeling

Tapan K. Sarkar, *Syracuse University*
Peter Aaen, *Freescale Semiconductor Inc*

THPM: Device Modeling and Characterization

Peter Asbeck, *University of California, San Diego*

THPN: Nonlinear Circuit and System Simulation

Almudena Suarez, *University of Cantabria*

THPJ-1: The Quantum Effects on the Transmission Properties of Periodic Rod Array

S. Li¹, Q. Zhu¹, X. Yu¹, N. Zhou¹, R. Mo¹, W. Liu², H. Xin³, L. Qiu⁴, ¹University of Sci. &Tech. of China, Hefei, China, ²University of Sci. &Tech. of China, Hefei, China, ³Univ. of Arizona, Tucson, United States, ⁴Stanford University, Stanford, United States

THPM-1: Improved Parameter Extraction Method for GaN HEMT on Si Substrate

A. Jarndal¹, A. Z. Markos², G. Kompa³, ¹Hodeidah University, Hodeidah, Yemen, ²Berlin University of Technology, Berlin, Germany, ³University of Kassel, Kassel, Germany

THPN-1: Modeling Band-Pass Sampling Receivers Nonlinear Behavior in Different Nyquist Zones

P. M. Cruz, N. B. Carvalho, *IT Universidade de Aveiro, Aveiro, Portugal*

THPJ-2: Experimental Dielectric Sensing of materials using Epsilon-Near-Zero tunnel in SIW technology

H. Lobato-Morales¹, A. Corona-Chavez¹, D. V. Murthy¹, J. Martinez-Brito², L. G. Guerrero-Ojeda², ¹INAOE, Tonanzintla, Mexico, ²UDLA-P, Cholula, Mexico

THPM-2: Thermal Resistance Modeling for the Electrothermal Layout of High-Power RF Transistors

P. H. Aaen, J. Wood, Q. Li, E. Mares, *Freescale Semiconductor Inc., Tempe, United States*

THPN-2: Behavioral Model Analysis of Active Harmonic Load-pull Measurements

S. P. Woodington¹, R. S. Saini¹, D. Williams², J. Lees¹, J. Benedikt¹, P. J. Tasker¹, ¹Cardiff University, Cardiff, United Kingdom, ²Mimix Broadband, Belfast, United Kingdom

THPJ-3: A Concentrically Corrugated Near-Field Plate

M. F. Imani, A. Grbic, *University of Michigan, Ann Arbor, United States*

THPM-3: Nonlinear HEMT Model Direct Formulated From the Second-Order Derivative of the I-V/ Q-V Characteristics

L. Liu¹, J. Ma², H. Wu¹, G. Ng³, Q. Zhang⁴, ¹University of Electronic Science and Technology of China, Chengdu, China, ²Tianjin University, Tianjin, China, ³Nanyang Technological University, Singapore, ⁴Carleton University, Ottawa, Canada

THPN-3: A Dual Branch Hammerstein-Wiener Architecture for Behavior Modeling of Wideband RF Transmitters

F. Taringou, O. Hammi, F. M. Ghannouchi, *University of Calgary, Calgary, Canada*

THPJ-4: A Sparse Grid based Collocation Method for Model Order Reduction of Finite Element Approximations of Passive Electromagnetic Devices under Uncertainty

P. S. Sumant¹, H. Wu², A. C. Cangelaris¹, N. R. Aluru³, ¹University of Illinois at Urbana-Champaign, Urbana, United States, ²Extreme-DA Corporation, Santa Clara, United States, ³University of Illinois at Urbana-Champaign, Urbana, United States

THPM-4: Nonlinear Characterization Techniques for Improving Accuracy of GaN HEMT Model Predictions in RF Power Amplifiers

R. Marante¹, J. A. Garcia¹, L. Cabria¹, T. Aballo¹, P. Cabral², J. C. Pedro², ¹Universidad de Cantabria, Santander, Spain, ²Universidade de Aveiro, Aveiro, Portugal

THPJ-5: A General 2D-FDFD based Eigen-Dielectric Formulation of the Maxwell Equations for Arbitrary Waveguide Structures

A. Gaebler, F. Goelden, O. H. Karabey, R. Jakoby, *Technische Universitaet Darmstadt, Darmstadt, Germany*

THPJ-6: Shape-Preserving Response Prediction for Microwave Circuit Modeling

S. Koziel, *Reykjavik University, Reykjavik, Iceland*

THPJ-7: A Simplified Methodology for Matched Filter Design with constraints - Filter-Antenna Subsystem for Space Application

U. Naeem¹, S. Bila¹, S. Verdyme¹, H. Chreim¹, R. Chantalat¹, M. Thevenot¹, T. Monediere¹, B. Palacin², Y. Cailloce³, ¹XLIM-University of Limoges, Limoges, France, ²CNES, Toulouse, France, ³Thales Alenia Space, Toulouse, France

THURSDAY

ROOM 204ABC

15:00 - 17:00

THPP: Advances in Planar Filter Designs
Chi Wang, *Orbital Sciences Corp*

THPQ: Non-Planar Passive Filters and Multiplexers
Raafat Mansour, *University of Waterloo*
Kawthar Zaki, *University of Maryland*

THPR: Frequency Agile, Reconfigurable, Tunable and Active Filters
Ian Hunter, *University of Leeds*

THPP-1: Sharp-Rejection Broadband Microstrip Bandpass Filters Using Loaded Open-Loop Resonator
W. Tu, National Central University, Taoyuan, Taiwan

THPQ-1: Synthesis of Multi-Coupled Resonator Filters with Frequency-Dependent Couplings
W. Meng¹, H. Lee¹, K. A. Zaki¹, A. E. Atia², ¹University of Maryland, College Park, United States, ²Orbital Science Corporation, Dulles, United States

THPR-1: 26 GHz on Chip Cascaded Filter Using Low Q Inductors
B. K. Kormanyos¹, T. K. Quach², P. L. Orlando², A. G. Mattamana², K. S. Groves², ¹Boeing Research and Technology, Seattle, United States, ²Air Force Research Laboratory, Dayton, United States

THPP-2: Design of Wide Single-/Dual-Passband Microstrip Bandpass Filters With Comb-Loaded Resonators
C. Tang, Y. Hsu, J. Wu, National Chung Cheng University, Chia-Yi, Taiwan

THPQ-2: Comparison of lossy filters and predistorted filters using novel software
A. Padilla¹, J. Mateu¹, C. Collado¹, C. Ernst², J. M. Rius¹, J. M. Tamayo¹, J. M. O'Callaghan¹, ¹Universitat Politècnica de Catalunya, Castelldefels, Spain, ²ESA, Noordwijk, Netherlands

THPR-2: A New Floating Active Inductor Using Resistive Feedback Technique
Q. Lai, J. Mao, Center for Microwave and RF Technologies, Shanghai, China

THPP-3: Design of A Microstrip Bandpass Filter With a Wide Stopband
H. Lai¹, C. Tang¹, J. Wu¹, Y. Lin², ¹National Chung Cheng University, Chia-Yi, Taiwan, ²Cheng Shiu University, Kaohsiung, Taiwan

THPQ-3: Fabrication of PTFE-Filled Waveguide Bandpass Filter Using SR Direct Etching
M. Kishihara¹, M. Kato², H. Ikeuchi³, K. Murai³, Y. Ukita², Y. Utsumi², T. Kawai³, I. Ohta³, ¹Okayama Prefectural University, Soja, Japan, ²University of Hyogo, Kamigori, Japan, ³University of Hyogo, Himeji, Japan

THPR-3: A Tunable Bandpass Patch Filter with Varactors
A. L. Serrano¹, T. P. Vuong¹, F. S. Correr², P. Ferrari¹, ¹Grenoble INP, Grenoble, France, ²University of São Paulo (USP), São Paulo, Brazil

THPP-4: RF System Integration and Miniaturization using Advanced Polymers
M. Swaminathan, S. Hwang, N. Altunyurt, S. Min, Georgia Institute of Technology, Atlanta, United States

THPQ-4: Dual Bandpass Ladder-type Filter
J. Verdú, O. Menéndez, P. de Paco, E. Corrales, Universitat Autònoma de Barcelona, Cerdanyola del Vallés, Spain

THPR-4: Reconfigurable-Order Bandpass Filter for Frequency Agile Systems
H. H. Sigmarsson, J. Lee, D. Peroulis, W. J. Chappell, Purdue University, West Lafayette, United States

THPP-5: Design of 60 GHz CMOS Bandpass Filters Using Complementary-Conducting Strip Transmission Lines
Y. Hsiao, C. Tseng, National Taiwan University of Science and Technology, Taipei, Taiwan

THPQ-5: X-Band Microwave Power Divider Based on Bow-Tie Shaped Dielectric Resonator High-Order Modes
L. K. Hadry¹, A. A. Kishk², D. Kajfez², L. Talbi¹, ¹Université du Québec en Outaouais, Gatineau (Hull), Canada, ²The University of Mississippi, University, United States

THPQ-6: A Novel Integrated Tx-Rx Diplexer for Dual-band WiMAX System
D. H. Kim², D. S. Kim¹, J. I. Ryu¹, J. C. Kim¹, J. C. Park¹, C. D. Park², ¹Korea Electronics Technology Institute, Gyeonggi-do, Republic of Korea, ²Myongji University, Gyeonggi-do, Republic of Korea

THPQ-7: High Q SAW Resonator Using upper-electrodes on Grooved-electrodes in LiTaO3
T. Kimura, M. Kadota, Y. Ida, Murata mfg.,co.ltd., Yasu, Japan



THURSDAY TECHNICAL SESSIONS 15:30-17:10

TH4A: Microwave High Power Processes: Modeling and Applications
 Malgorzata Celuch, *Warsaw University of Technology*
 Vadim Yakovlev, *Worcester Polytechnic Institute*
Room: 205AB

TH4B: Ferro-Electric and Acoustic Devised and Components
 Clemens Ruppel, *TDK-EPC*
 Amir Mortazawi, *University of Michigan*
Room: 206AB

TH4C: Compact reconfigurable filter technology
 Doug Jachowski, *Naval Research Laboratory*
 Sanghoon Shin, *RS Microwave*
Room: 207AB

15:30 - 15:50

TH4A-1: Microwave Antenna Array for High Temperature Materials Processing
 T. Gerdes¹, H. Park², A. Rosin³, A. Schmidt³, M. A. Willert-Porada¹, ¹University of Bayreuth, Bayreuth, Germany, ²Centre of New Materials, Bayreuth, Germany, ³InVerTec eV., Bayreuth, Germany

TH4B-1: Tunable BaSr1-xTiO3 FBARs Based on SiO2/W Bragg Reflectors
 A. Vorobiev¹, S. Gevorgian², ¹Chalmers University, Gothenburg, Sweden, ²Ericsson AB, Moelndal, Sweden

TH4C-1: Tunable, Substrate Integrated, High Q Filter Cascade for High Isolation
 E. J. Naglich, J. Lee, D. Peroulis, W. J. Chappell, Purdue University, West Lafayette, United States

15:50 - 16:00

TH4A-2: A Modeling-Based Technique for Non-destructive Evaluation of Metal Powders Undergoing Microwave Sintering
 A. V. Brovko¹, E. K. Murphy², V. V. Yakovlev³, ¹Saratov State Technical University, Saratov, Russian Federation, ²Rensselaer Polytechnic Institute, Troy, United States, ³Worcester Polytechnic Institute, Worcester, United States

TH4B-2: Interdigitated Contour Mode Resonators Based on Barium Titanate Thin Films
 V. C. Lee, S. A. Sis, X. A. Zhu, A. Mortazawi, University of Michigan, Ann Arbor, United States

TH4C-2: Electronically Tunable Diplexer for Frequency-Agile Transceiver Front-End
 E. E. Djoumessi, K. Wu, Ecole polytechnique de Montreal, Montreal, Canada

16:00 - 16:10

TH4C-3: Combine Filter with Tunable Bandwidth and Centre Frequency
 A. I. Abunjaileh, I. C. Hunter, Institute of Microwaves and Photonics, Leeds, United Kingdom

16:10 - 16:20

TH4A-3: Latest Developments in the Microwave Processing of Oil Contaminated Drill Cuttings
 S. Kingman, J. Robinson, C. Antonio, I. Pereira, University of Nottingham, Nottingham, United Kingdom

TH4B-3: Concurrent Enhancement of Q and Power Handling in Multi-Tether High-Order Extensional Resonators
 M. Shahmohammadi, B. P. Harrington, R. Abdolvand, Oklahoma State University, Tulsa, United States

TH4C-4: Compact 2-pole and 4-Pole 2.4-2.8GHz Dual-Mode Tunable Filters
 R. Stefanini¹, M. Chatras¹, P. Blondy¹, G. M. Rebeiz², ¹XLIM, Limoges, France, ²UCSD, La Jolla, United States

16:20 - 16:30

TH4C-5: Widely Tunable High-Q Filter using Plasma Material
 A. Djermoun², G. Prigent², N. Raveu², T. Callegari¹, ¹INPT, France, France, ²INPT, France, France, ³CNRS, France, France

16:30 - 16:40

TH4A-4: Influence of the magnetron operating frequency on the results of microwave heating
 M. Soltysiak¹, U. Erle², M. Celuch³, ¹QWED, Warsaw, Poland, ²Nestle, Solon, United States, ³Warsaw University of Technology, Warsaw, Poland

TH4B-4: Electromagnetic Modeling, Simulation and Design of Balanced Ceramic IF SAW Filters
 G. Moreno-Granado¹, J. E. Kiwitt², F. M. Pitschi², M. Mayer², W. Menzel¹, ¹University of Ulm, Ulm, Germany, ²Epcos AG, Munich, Germany

TH4C-6: Switchable Microstrip Bandpass Filters With Reconfigurable Frequency Responses
 W. Tu, National Central University, Taoyuan, Taiwan

16:40 - 16:50

TH4C-7: BaSrTiO3-Based 30-88MHz Tunable Filter
 K. Zhang, T. Watson, A. Cardona, M. Fink, Agile RF, Inc., Santa Barbara, United States

16:50 - 17:10

TH4A-5: Microwave-induced electromigration in multicomponent metallic alloys
 S. Vaucher¹, L. Bernau³, M. Stir¹, K. Ishizaki¹, J. Catala-Civera², R. Nicula¹, ¹Empa- Swiss Federal Laboratories for Materials Testing and Research, Thun, Switzerland, ²Polytechnic University of Valencia, Valencia, Spain, ³Empa- Swiss Federal Laboratories for Materials Testing and Research, Thun, Switzerland

TH4B-5: Small-sized SAW Duplexer on Non-flat SiO2/Al/LiNbO3 Structure for UMTS Band I System
 H. Nakamura, H. Nakanishi, T. Tsurunari, J. Fujiwara, Y. Hamaoka, R. Goto, Panasonic Electronic Devices Co., Ltd., Kadoma City, Japan

THURSDAY

TECHNICAL SESSIONS

15:30-17:10

TH4D: Advances in Doherty Power Amplifier Technology.

Allen Katz, *TCNJ/Linearizer Technology, Inc.*
Paul Tasker, *Cardiff University*
Room: 207C

TH4E: Advances in RFID Circuits and Systems

Jurgen Heidrich, *University of Erlangen-Nuernberg*
Robert Weigel, *University of Erlangen-Nuernberg*
Room: 207D

TH4D-1: A 2.655 GHz 3-stage Doherty Power Amplifier using Envelope Tracking Technique

I. Kim, B. Kim, Pohang university of Science and Technology (POSTECH), Pohang, Republic of Korea

TH4E-1: Design of a Low-voltage Reference circuit with reconfigurable Temperature Range for RFID applications

J. Heidrich¹, D. Brenk¹, J. Essel¹, M. Heinrich¹, G. Hofer², G. Holweg², G. Fischer¹, R. Weigel¹, ¹University of Erlangen-Nuremberg, Erlangen, Germany, ²Infineon Technologies AG, Graz, Austria

15:30 - 15:40

TH4E-2: Multiresonator Based Chipless RFID Tag and Dedicated RFID Reader

S. Preradovic, N. C. Karmakar, Monash University, Melbourne, Australia

15:40 - 15:50

TH4D-2: Advanced Design of Double Doherty Power Amplifier with a Flat Efficiency Range

Y. Lee, M. Lee, S. Kam, Y. Jeong, Pohang University of Science and Technology, Pohang, Republic of Korea

TH4E-3: Parameter Analysis and Reader Architectures for Broadband 13.56 MHz RFID Systems

M. Gossar¹, H. Witschnig², H. Enzinger³, ¹Graz University of Technology, Graz, Austria, ²IXP Semiconductors Austria, Gratkorn, Austria, ³University of Applied Science, Kapfenberg, Austria

15:50 - 16:10

TH4D-3: A Wide-Band 20W LDMOS Doherty Power Amplifier

J. H. Qureshi¹, L. Nan¹, E. Neo², F. V. Rijs², I. Blednov², L. de Vreede¹, ¹Tudelft, Delft, Netherlands, ²IXP, Nijmegen, Netherlands

TH4E-4: Battery-free RFID-enabled Wireless Sensors

L. Yang¹, G. Orecchini², G. Shaker³, H. Lee², M. Tentzeris², ¹Texas Instruments, Dallas, United States, ²Georgia Institute of Technology, Atlanta, United States, ³University of Waterloo, Waterloo, Canada

16:10 - 16:30

TH4D-4: Generation 2 High Voltage Heterojunction Bipolar Transistor Technology for High Efficiency Base Station Power Amplifiers

T. R. Landon, J. Delaney, C. F. Steinbeiser, O. B. Krutko, R. Branson, R. Hajji, P. Page, S. Wey, C. Hall, L. Witkowski, TriQuint Semiconductor, Richardson, United States

TH4E-5: Low-Cost Assembly of UHF RFID Chips and Flexible Substrate Antennas by Magnetic Coupling Approach

F. Alimenti¹, M. Virili¹, P. Mezzanotte¹, V. Palazzari¹, L. Roselli¹, M. M. Tentzeris², ¹University of Perugia, Perugia, Italy, ²Georgia Institute of Technology, Atlanta, United States

16:30 - 16:50

TH4D-5: A Doherty Amplifier for TD-SCDMA Base Station Applications Based on a Single Packaged Dual-path Integrated LDMOS Power Transistor

G. Wang, L. Zhao, M. Szymanowski, Freescale Semiconductor, Inc., Tempe, United States

TH4E-6: Active Carrier Compensation for a Multi-Antenna RFID Reader Frontend

R. Langwieser, G. Lasser, C. Angerer, M. Fischer, A. L. Scholtz, Vienna University of Technology, Vienna, Austria

16:50 - 17:10



IMS STEERING COMMITTEE



General Chairman

JK McKinney
Gina Lucas, Conference Administrator
Aaron Stys, Conference Administrator

Vice Chairman

Paul Yu

Technical Program

Madhu Gupta, Chairman
James Buckwalter, TPC Membership and Database
Tastsuo Itoh, TPC Advisory Council
John Kuno, TPC Advisory Council
David Rutledge, TPC Advisory Council
Kiyoy Tomiyasu, TPC Advisory Council
S. Jerry Fiedziuszko, Emerging Technologies
Gabriel Rebeiz, Emerging Technologies
Paul Draxler, TPRC Reviewer
Lawrence Larson, TPRC Reviewer
Richard Snyder, TPRC Reviewer

Workshops/Short Courses

James Schellenberg, Chairman
Peter Asbeck
Kai Hui Lin
Anne Lee
Shayan Mookherjea
Ethan Wang

Panel Sessions

Michael DeLisio, Chairman
Behnam Analui
Michael Aust
Upkar Dahliwal

Interactive Forum

John Kuno, Chairman
Jitendra Goel
Cynthia Hang
Lance Kuo
Kai Hui Lin
Bo Pan

MicroApps

Jim Weiler, Chair
Phil Arnold
Gary Hawisher
Sherry Hess
Mircea Metes
Robert Welstand

Focused and Special Sessions

John Horton, Chairman
Arvind Sharma, Co-Chair

Plenary Sessions

Paul Yu, Chairman
Jeurgen Flamm
Gary Guo

Student Competitions

William Deal, Chairman
Satish Sharma

RFIC Liaison

David Ngo

ARFTG Liaison

Rusty Myers
Ken Wong

Publications and Publicity

Freddie Chavez, Chairman
Bill Baumann
Amanda Scacchitti
Carl Sheffres

IEEE Microwave Magazine Special Issue Editor

Arvind Sharma

Electronic Paper Management

Jon Hacker
Jeff Pond
Roger Pollard

Proceedings USB

Debabani Choudhury, Chairman
Weiheng Chang

Gifts

Dustin Hoekstra, Chairman

Public Relations

Emily Taylor, Weber Shandwick

Photography

Matt Swass, Chairman
Jim Lyle
Tammy Lyle

Website

Steve Maas

Wireless Access

Chad Deckman

PDA Program

Tim Lee

Microwave Insider

Anne Lee
Tim Lee

Local Arrangements

Steve Swift, Chairman
Jodi Braverman
Sarah Siemianowski
Sacha Tani

Finance

Upkar Dhaliwal
Bob Alongi

Registration

Chic Shishido, Chairman
John Kuno

Banquets

Manorama (Mona) Gupta

Entertainment

Cindy Machingo

Guest Programs

Mary Jacobs

Hospitality Suite

Julie Maas

Ham Radio

Jeffery Pawlan
Steve Vaughn

Historical Exhibits

Steve Vaughn

MTT GOLD

Sergio Pacheco

Women in Engineering

Sherry Hess

University Liaison/Student Volunteers

Katie Allen
Kevin Leong
Younkyu Chung

VIP Protocol

Charlie Jackson

International Liaison

Zaher Bardai

Conference Management

Keisha Carr, Meeting Planner IEEE MCM
Elsie Cabrera, IEEE MCM

Exhibition Management

Kevin Lepine, MP Associates
Lee Wood, MP Associates

Senior Members

Chuck Krumm
John Wood

Special Advisors to Chairman

Terry Cisco
Reynold Kagiwada
Edward Rezek
Chuck Swift



IMS TECHNICAL PROGRAM REVIEW COMMITTEES

Field Analysis and Guided Waves

Tapan Sarkar, Chair
David Jackson
Jan Machac
Paolo Lampariello

Frequency Domain EM Analysis Techniques

Abbas Omar, Chair
Luca Perregrini, Co-Chair
Atef Elsherbeni

Time-Domain EM Analysis Techniques

Costas Sarris, Chair
Zhizhang (David) Chen, Co-Chair
Wolfgang Hoefler
Poman So
Nathan Bushyager
Ingo Wolff

CAD Algorithms and Techniques

Paul Draxler, Chair
Jose Rayas-Sanchez, Co-Chair
Q.J. Zhang
Arvind Sharma
John Bandler
Michel Nakhla
Peter Aaen

Nonlinear Device Modeling

Yusuke Tajima, Chair
John Atherton, Co-Chair
David Root
Christopher Snowden
Robert Leoni
James Hwang
Thomas Brazil

Nonlinear Circuit and System Simulation

Dominique Schreurs, Chair
Jose-Carlos Pedro, Co-Chair
Almudena Suarez
Vittorio Rizzoli
Kevin Gard
J. Stevenson Kenney

Transmission Line Elements

Tatsuo Itoh, Chair
George Eleftheriades, Co-Chair
George Ponchak
Branka Jokanovic
Ke Wu
Barry Spielman
Francisco Mesa
Guoan Wang

Passive Circuit Elements

Nickolas Kingsley, Chair
Victor Fouad Hanna
Linda Katehi
Rashaunda Henderson
Allen Podell

Roberto Vincenti Gatti
Inder Bahl
Peter Russer
Jesse Taub

Planar Passive Filters and Multiplexers

Chi Wang, Chair
James Rautio, Co-Chair
Roberto Sorrentino
Magdalena Salazar-Palma
Christopher Galbraith
Roberto Gomez-Garcia
Jason Hong

Non-planar Passive Filters and Multiplexers

Vicente E. Boria, Chair
Giuseppe Macchiarella, Co-Chair
Ming Yu
Huiwen Yao
Richard Snyder
Kawthar Zaki
H Clark Bell
Raafat Mansour

Active, Tunable, and Integrated Filters

Har Dayal, Chair
Atsushi Sanada, Co-Chair
Sanghoon Shin
Ian Hunter
Douglas Jachowski

Ferroelectric, Ferrite, and Acoustic Wave Components

Spartak Gevorgian, Chair
Amir Mortazawi, Co-Chair
Steven Stitzer
Robert Weigel
Clemens Ruppel
John Owens

MEMS Components and Technologies

Scott Barker, Chair
John Ebel, Co-Chair
Tom Weller
Youngwoo Kwon
Gabriel Rebeiz
Chuck Goldsmith
Pierre Blondy
Joachim Oberhammer

Semiconductor Devices and Monolithic IC's

Ho Huang, Chair
Timothy Lee, Co-Chair
Zaher Bardai
Paul Watson
Cheng (CP) Wen
Bernard Geller
Jonathan Comeau
Kenjiro Nishikawa
Nicholas Kolias

Thomas Ussmueller
James Buckwalter

Signal Generation

Amarpal Khanna, Chair
John Papapolymerou
Yi-Jan (Emery) Chen
Danny Elad
Bhaskar Banerjee
Scott Wetenkamp
Hossein Hashemi

Frequency Conversion and Control

Huei Wang, Chair
Deukhyoun Heo, Co-Chair
Brad Nelson
Hiroshi Okazaki
Kenji Itoh
Mohammad Madihian
Stephen Maas
Bert Henderson

HF/VHF/UHF Technologies and Applications

Frederick Raab, Chair
Richard Campbell, Co-Chair
Robert Caverly
John Heaton
Frank Sullivan

Power Amplifier Circuits

Anh-Vu Pham, Chair
Wayne Kennan, Co-Chair
Raghu Mallavarpu
Wolfgang Heinrich
Debasis Dawn
Chang-Ho Lee
Franco Sechi

Power Amplifier Devices

Douglas Teeter, Chair
Aryeh Platzker, Co-Chair
Leo de Vreede
Peter Asbeck
Charles Weitzel
Rudiger Quay

High-Power Amplifiers

Steve Cripps, Chair
Paul Tasker, Co-Chair
Kiki Ikossi
James Schellenberg
Allen Katz
Bumman Kim
John Wood
Fadhel Ghannouchi
James Komiak

Low-Noise Components and Receivers

Terry Cisco, Chair
Phillip Smith
James Whelehan
Marian Pospieszalski

Francois Danneville
William Deal
Alfred Riddle
Matthias Rudolph

Millimeter-Wave and THz Components and Technologies

Edward Niehenke, Chair
Debabani Choudhury, Co-Chair
Kenichi Maruhashi
Goutam Chattopadhyay
John Cunningham
Asher Madjar
Reynold Kagiwada
H. Alfred Hung
H. John Kuno
Tsuneo Tokumitsu
Jae-Sung Rieh
Imran Mehdi
Vesna Radisic

Microwave Photonics

Bill Jemison, Chair
Edward Rezek
Dalma Novak
Ronald Reano
Tibor Berceci
Dieter Jaeger
Yifei Li
Young-Kai Chen
Adil Karim

Signal Processing Circuits at GHz Speeds

Keh-Chung Wang, Chair
Agnieszka Konczykowska, Co-Chair
Edward Gebara
Hermann Boss
Andreas Weisshaar
Koichi Murata
Johann Luy

Packaging, Interconnects, MCMs and Integration

Kavita Goverdhanam, Chair
Eric Strid
Rudy Emrick
C-K (Clive) Tzuang
Bruce Kopp
Shamsur Mazumder
Daniela Staiculescu
Rhonda Franklin

Instrumentation and Measurement Techniques

Andrea Ferrero, Chair
Michael Janezic, Co-Chair
Kate Remley
John Barr
Jon Martens
Nuno Borges Carvalho
Ken Wong
Leonard Hayden

Biological Effects and Medical Applications

Mohammad-Reza Tofighi, Chair
Arye Rosen, Co-Chair
Guglielmo d'Inzeo
Claude Weil
Anand Gopinath
Natalilia Nikolova
J-C. Chiao

RF Arrays as Antennas and Power Combiners

Julio Navarro, Chair
Constantine Balanis, Co-Chair
Wayne Shiroma
Ronglin Li
Chris Rodenbeck
Jozef Modelski
Glenn Hopkins
Zoya Popovic
Darren Goshi

Radar and Broadband Communication Systems

Reinhard Knoechel, Chair
Arne Jacob, Co-Chair
Ryan Miyamoto
Mohamed Abouzahra
Roger Kaul
Ramesh Gupta
Gregory Lyons

Wireless and Cellular Communication Systems

Vijay Nair, Chair
Shoichi Narahashi, Co-Chair
Ethan Wang
Richard Ranson
Mohamed Megahed
Kyutae Lim

Sensors and Sensor Systems

Alan Jenkins, Chair
George Heiter, Co-Chair
Ian Gresham
Lora Schulwitz
Manos Tentzeris
Hiroshi Kondoh
Peter Staecker

Microwave Processing

Malgorzata Celuch, Chair
Yoshio Nikawa
Vadim Yakovlev
John Osepchuck
Monika Willert-Porada

RFID

Luca Roselli, Chair
Daniel van der Weide
Marrocco Gaetano
Alexandros Margomenos
Apostolos Georgiadis

IEEE MTT-S Administrative Committee

President Samir El-Ghazaly	President Elect Richard Snyder	Treasurer Nick Kolas	Secretary Mohammad Madihian
--------------------------------------	--	--------------------------------	---------------------------------------

Elected Adcom Members

Term Expires in 2010:

Jonathan Hacker	Tim Lee	Amir Mortazawi	Vijay Nair
Barry Perlman	Wayne Shiroma	Richard Snyder	

Term Expires in 2011:

Madhu Gupta	Joy Laskar	Jenshan Lin	Yoshio Nikawa
Dominique Schreurs	Bela Szendreyi	Ke Wu	

Term Expires in 2012:

Luciano Boglione	William Chappell	Mark Gouker	Nick Kolas
Shiban Koul	George Ponchak	Robert Weigel	

Immediate Past Presidents:

2009 Barry Perlman	2008 Jozef Modelski	2007 Steve Kenney
------------------------------	-------------------------------	-----------------------------

Honorary Life Members:

Tatsuo Itoh	Arthur Oliner	Theodore Saad	Peter Staecker	Kiyo Tomiyasu
-------------	---------------	---------------	----------------	---------------

Future IEEE MTT-S International Microwave Symposia Sites

2011: Baltimore, MD Jeff Pond, Chairman Naval Research Laboratory j.m.pond@ieee.org	2012: Montreal, Can Ke Wu, Chairman Ecole Polytechnique Ke.wu@ieee.org	2013: Seattle, WA Tom Raschko Sea-Port Technical Sales Tom.Raschko@ieee.org	2014: Tampa, FL Larry Dunleavy, Chairman University of South Florida Dunleavy@eng.usf.edu
2015: Phoenix, AZ Vijay Nair, Chairman Intel Corporation v.nair@ieee.org	2016: San Francisco, CA Paul Khanna, Chairman Phase Matrix, Inc. apkhanna@ieee.org	2017: Honolulu, HI Kevin Miyashiro, Chairman TeraSys kmiyashi@ieee.org	



IEEE MTT-S AWARDS

Microwave Career Award

This award recognizes an individual for a career of meritorious achievement and outstanding technical contribution in the field of microwave theory and techniques. This year's recipient is **Arye Rosen**.

"For a Career of Leadership, Meritorious Achievement, Creativity and Outstanding Contributions in the Field of Microwave Theory and Techniques"

Distinguished Service Award

This award recognizes significant contributions and outstanding service to the MTT-S and the microwave profession over a sustained period of time. This year's recipient is **Roger Sudbury**.

"For his Outstanding and Dedicated Service to the Society"

Distinguished Educator Award

This award was inspired by the untimely death of Prof. F.J. Rosenbaum (1937-1992), an outstanding teacher of microwave science and a dedicated AdCom Member and contributor. The award recognizes a distinguished educator in the field of microwave engineering and science who best exemplifies the special human qualities of Fred Rosenbaum who considered teaching a high calling and demonstrated his dedication to the Society through tireless service. This year's recipient is **Gabriel Rebeiz**.

"For Outstanding Achievements as an Educator, Mentor and Role Model of Microwave Engineers and Engineering Students"

N. Walter Cox Award

This award was established in recognition of the qualities of N. Walter Cox and his service to the MTT-S prior to his untimely death in 1988. It is given to a Society volunteer whose efforts on behalf of MTT-S best exemplify Walter's spirit and dedication. This year's recipient is **Herbert (Mike) Harris**.

"For Exemplary Service, Given in a Spirit of Selfless Dedication and Cooperation"

Microwave Application Award

This award recognizes an individual or team for outstanding application of microwave theory and techniques. This year's recipients are **Tom Hyltin** and **Britton Vincent**.

Outstanding Young Engineer Award

This award recognizes MTT-S members, who have distinguished themselves through technical achievements, service to the MTT-S, or a combination of both. Nominees must not have reached their 39th birthday and must be an MTT-S member at the time of nomination. This year's recipients are **Frank Ellinger**, **Telesphor Kamgaing**, **Linus Maurer** and **Fernando Teixeira**.

IEEE FELLOWS

The member grade of Fellow is conferred in recognition of unusual and outstanding professional distinction. It is awarded at the initiative of the IEEE Board of Directors following a rigorous nomination and evaluation process. Individuals receiving this distinction have demonstrated extraordinary contributions to one or more fields of electrical engineering, or related sciences. The total number of Fellows selected in any one year does not exceed one tenth of one percent of the total voting Institute membership. Fifteen MTT-S members who were evaluated by our Society were elevated to the grade of Fellow, effective 1 January 2010. The new IEEE Fellows are:

Christophe Caloz	for contributions to the development and application of electromagnetic metamaterial structures
Zhizhang Chen	for contributions to time-domain electromagnetic modeling and simulation
Charles Goldsmith	for development of micro-electromechanical capacitive switches
Ganesh Gopalakrishnan	for leadership in microwave photonics and high-speed optical lithium niobate modulator development
Ching-Wen Hsue	for contribution to discrete-time signal processing in microwave engineering
Rhee Jin Koo	for contributions to Gallium Arsenide, Microwave and Millimeter-wave Monolithic Integrated Circuits
Shiban Koul	for contributions to analysis and design of microwave and millimeter wave components and circuits
Richard Lai	for development and space-qualified insertion of millimeter-wave transistor and integrated-circuit technologies
Jenshan Lin	for contributions to integrated microwave circuits and systems for wireless sensors
Imran Mehdi	for contributions to submillimeter-wave device technology
Francisco Mena	for contributions to the analysis and physical understanding of planar structures, anisotropic media, and metamaterials
Ahmadreza Rofougaran	for contributions to single chip system integration of radio frequency complementary metal-oxide semiconductor technology
Emmanouil Tentzeris	for contributions to three dimensional conformal integrated devices for wireless communications and sensing
Charles Weitzel	for contributions to compound semiconductor technology and microwave devices
Ruey-Beei Wu	for contributions to coplanar waveguide passive components
MTT-S members who were evaluated by another IEEE Society are shown below; the other Society is shown in parentheses.	
Shanker Blasubramaniam (AP)	for contributions to time and frequency domain in computational electromagnetics
Jennifer Bernhard (AP)	for development of multifunctional, reconfigurable, and integrated antennas
Jose Encinar Garcinuno (AP)	for contributions to analysis and design of reflectarray antennas
Powen Hsu (AP)	for leadership in electrical engineering education
Douglas Riley (AP)	for contributions to time-domain techniques in computational electromagnetics
Abdel Sebak (AP)	for contributions to electromagnetics scattering, and design and modeling of antennas
Guiseppe Vecchi (AP)	for the application of multi-resolution algorithms to computational electromagnetics
Kiyotoshi Yasumoto (AP)	for contributions to electromagnetic wave scattering and wave guiding
Takamaro Kikkawa (ED)	for contributions to interconnect technologies for integrated circuits
Christopher Holloway (EMC)	for application of new material in the field of electromagnetic compatibility
Maria Sabrina Sarto (EMC)	for contributions to advanced materials in electromagnetic compatibility applications
Motoyuki Sato (GRS)	for contributions to radar remote sensing technologies in environmental and humanitarian applications
Paul Dodd (NPS)	for contributions to the understanding and simulation of single-event effects in microelectronics
Norman Chapman (OE)	for contributions to geoacoustic characterization of ocean bottom environments
Katherine Ferrara (UFFC)	for contributions to ultrasound and its applications in molecular imaging and drug delivery
Pooi Kam (VT)	for contributions to receiver design and performance analysis for wireless communications



WELCOME TO THE 2010 RFIC SYMPOSIUM

On behalf of the Steering Committee, we would like to welcome you to the RFIC Symposium!

The 2010 RFIC Symposium maintains its reputation as one of the foremost IEEE technical conferences dedicated to the latest innovations in RFIC development for wireless and wireline communication IC's. Running in conjunction with the International Microwave Symposium and Exhibition, the RFIC Symposium adds to the excitement of Microwave Week with three days focused exclusively on RFIC technology and innovation. The RFIC symposium will be held at the Anaheim Convention Center, May 23-25, 2010.

The RFIC Symposium will start on Sunday with half-day and full-day workshops, covering a large breadth of topics. Some of the topics include: SiGe HBTs towards THz operation, power management for integrated RF circuits, challenges and techniques for 3G/4G multi-mode front end designs and silicon-based design techniques for millimeter-wave applications. Don't miss out on this great opportunity to expand your horizons!

Sunday evening activities continue at 5:30pm with RFIC Plenary Session. Two renowned speakers will share their views on the direction and challenges that the RF IC industry will be facing. The first speaker is Professor David Allstot from the University of Washington, and the second speaker is Gregory Waters, Executive Vice President of Skyworks Inc. In addition to the keynote addresses, the best student paper awards are presented in the Plenary Session. The highly anticipated RFIC Reception will follow immediately after the Plenary Session, providing a relaxing time for all to mingle with old friends and catch up on the latest news.

The technical program includes oral sessions, an Interactive Forum (poster session), and two exciting lunch panel sessions. The oral presentation sessions start on Monday, May 24th with four parallel sessions throughout the morning and the afternoon. The oral sessions continue on Tuesday, May 25th synchronized with the IMS technical Program. The Interactive Forum will be held on Tuesday afternoon. This forum is the perfect place to have an opportunity to have more detailed technical discussions with the authors. Panel Sessions are also planned at lunch time on Monday and Tuesday, the topics being respectively "The Challenges, Competitions and Future Prospects of 60 GHz" and "Future of High-Speed I/O: Electrical, Optical or Wireless?".

The RFIC Symposium concludes on Tuesday allowing participants to attend the IMS and ARFTG as well as plenty of time to visit the exhibit hall.

The RFIC organization is thankful to the IMS2010 team, without whom we could not make this conference successful. Most of all, we are particularly thankful to all the technical contributors to the RFIC Symposium. We look forward to your participation. Please continue to make this conference so vibrant within the wireless industry!

We look forward to seeing you in Anaheim!



Yann Deval
General Chair
2010 RFIC Symposium



David Ngo
TPC Chair
2010 RFIC Symposium

RFIC PLENARY SESSION

Sunday, May 23, 2010, 17:30-19:00, ACC Room 210 ABCD



RF Power Amplification: Can CMOS Deliver?

David J. Allstot — Dept. of Electrical Engineering, *Univ. of Washington*

The total energy consumed by cellular telephones in the United States is currently estimated at about 750,000 times the energy used by an average home in one year. Moreover, about 7,500 tons of CO₂ are emitted into the atmosphere.

The RF power amplifier dissipates a large fraction of the total power because of its low efficiency. Despite more than two decades of intensive research, the challenge of on-chip RF PAs with high efficiency in digital-friendly CMOS technologies has not been met.

Switching PA topologies with relatively high efficiency have gained momentum for use in CMOS RF transceivers, and relatively high output power is being delivered using power combining techniques with several PA cells. Supply regulation techniques have enabled higher efficiency when amplifying non-constant envelope modulated signals.

This talk will cite leading-edge designs and on-going research to assess the remaining challenges for CMOS RF power amplifiers.

David J. Allstot received the B.S. from the Univ. of Portland in 1969, the M.S. from Oregon State Univ. in 1974 and the Ph.D. from the Univ. of California, Berkeley in 1979.

He has held several industrial and academic positions and has been the Boeing-Egtvedt Chair Professor of Engineering at the Univ. of Washington since 1999. He was Chair of the Dept. of Electrical Engineering from 2004 to 2007.

Dr. Allstot has advised approximately 100 M.S. and Ph.D. graduates, published about 275 papers, and received several awards for outstanding teaching and graduate advising. Awards include the 1980 IEEE W.R.G. Baker Award, 1995 IEEE Circuits and Systems Society (CASS) Darlington Award, 1998 IEEE International Solid-State Circuits Conference (ISSCC) Beatrice Winner Award, 1999 IEEE CASS Golden Jubilee Medal, 2004 IEEE CASS Technical Achievement Award, 2005 Semiconductor Research Corp. Aristotle Award, and 2008 Semiconductor Industries Assoc. University Research Award. His service includes: 1990-93 Assoc. Editor and 1993-95 Editor of IEEE TCAS II, 1990-93 Member of Technical Program Committee of the IEEE CICC Conference, 1992-95 Member, Board of Governors of IEEE CASS, 1994-2004, Member, Technical Program Committee, IEEE ISSCC, 1995-97, 2001, 2003-04, Member, Executive Committee of IEEE ISSCC, 1996-2000 Short Course Chair of IEEE ISSCC, 2000-2001 Distinguished Lecturer, IEEE CASS, 2001 and 2008 Co-General Chair of IEEE ISCAS, 2006-2007 Distinguished Lecturer, IEEE Solid-State Circuits Society and 2009 President of IEEE CASS.



The Universal Connector: RF Application Trends over the next decade

Gregory L. Waters — Executive Vice President and General Manager, *Skyworks Solutions Inc.*

RF technology has enjoyed a significant expansion in consumer electronics and everyday appliances over the past two decades. This presentation will outline key new opportunities and requirements for the RF industry to assume a much greater application reach. This talk will outline why RF growth will accelerate in non-traditional markets, and the key technical and commercial problems that must be solved to enable this. We will conclude with examples of how this growth will affect industry R&D practices, and result in a different business model for leading RF firms.

Gregory L. Waters, 49, is executive vice president and general manager, front-end solutions for Skyworks Solutions, Inc. He joined the company in April 2003. Prior to joining Skyworks, he served as senior vice president of Strategy and Business development at Agere Systems, and previously held positions there as Vice president of the Wireless Communications business, and Vice president of the Broadband Communications business. Prior to this, he held a variety of senior management positions within Texas Instruments, including director of Network Access Products and Director of North American sales.

Waters received a bachelor's of science in engineering from the University of Vermont, and a master's in computer science from Northeastern University.



RFIC PANEL SESSIONS

Monday May 24th, 2010

12:00 – 13:10

Room Number: 210CD

The Challenges, Competitions and Future Prospect of 60 GHz

Chair/Moderator:

1. SK Yong, *Samsung Electronics*,
2. Myron Hattig, *Intel Corporation*

Panelists:

1. Mr. Jason Trachewsky, *Senior Technical Director and Broadcom Fellow, Broadcom Corporation*
2. Dr. Scott Reynolds, *Manager, IBM TJ Watson*
3. Mr. Myron Hattig, *Director of WLAN Standards, Intel Corporation*
4. Mr. Raja Banerjee, *Principal Architect, Marvell Semiconductor, Inc.*
5. Mr. Michiaki Matsuo, *Senior Manager/Chief Engineer, Panasonic Corporation*
6. Dr. Jisung Oh, *Principle Engineer/Director, Samsung Electronics*

Sponsors: RFIC

Panel Session Abstract:

The ever growing demand for multi-gigabit data rates to support variety of new applications has pushed to the emergence of 60 GHz radio technology. Significant R&D work in the past decade have demonstrated the viability of wideband 60 GHz CMOS RFIC circuit and transceiver, which were difficult if not impossible to realize in the past, have now become a reality for commercialization. The momentum is further intensified by the heavily harmonized regulations and frequency allocation globally that allow higher EIRP limit and operation of huge unlicensed (i.e. 7 GHz) bandwidth in the 60 GHz band.

As a result, various standards (IEEE 802.11ad and IEEE 802.15.3c) and industry alliances (WirelessHD™ and WiGig Alliance) have emerged to deliver the promise of gigabit wireless solution. Multiple standard solutions could lead to two contradictory effects: On one hand, competition could lead to better 60 GHz products and drives the cost down towards commoditization. On the other hand, competition could create market confusion and co-existence issues among different products if not handled correctly. To date, among the various different standards, only 60 GHz products based on WirelessHD™ solution that supports wireless transmission of full HD contents has reported to hit the high end TV market in Jan 2009. Other 60 GHz products are under rigorous development and in the pipeline for productization. However, the question remains on their timeline in delivering the promise of gigabit experience to the customers.

In addition, Wi-Fi based IEEE 802.11n solution has started to enter the market for audio/video distribution on top of the widespread used of wireless Ethernet. Built strongly upon a broad ecosystem and interoperability among billions of Wi-Fi devices, Wi-Fi centric solution is set to evolve into gigabit data rate range with the recent development in IEEE 802.11ac. This could potentially yet another solution that serves the similar applications and thus creates competition in market place with 60 GHz. However, the distinct characteristics of Wi-Fi (2.4/5 GHz) and 60 GHz provide a different deployment perspective in which both technologies could be complementary rather than competing to each other. Such complementary technology requires multi-band radios that allow fast and seamless session transfer between them whenever the performance of the current radio deteriorates or an enhanced performance could be achieved.

In this panel, industry leaders and experts will discuss the challenges ahead of full scale commercialization of 60 GHz technology including implementation, tug-of-war among competitive standards, co-existence issues and future direction of 60 GHz.



RFIC PANEL SESSIONS

Tuesday May 25th, 2010

12:00 – 13:10

Room Number: 210CD

Future of High-Speed I/O: Electrical, Optical, or Wireless?

Chair/ Moderator: Jacques C. Rudell, *University of Washington*

Co-Organizer: Sam Palermo, *Texas A&M*

Panelists:

1. Ali Hajimiri, *Caltech*
2. Byunghoo Jung, *Purdue University*
3. Jared Zerbe, *Rambus*
4. Sam Palermo, *Texas A&M*
5. Ronald Ho, *Sun Microsystems*

Sponsors: RFIC

Panel Session Abstract:

The rising power consumption associated with microprocessors realized in nanometer length silicon processes, has placed a fundamental limit on core clock rates. This has lead to new advanced microprocessor architectures which seek to increase computational power by replicating the number of cores on a single die. Processors currently under development are estimated to use as many as 128 cores integrated on the same IC, leaving the routing of data via high-speed signaling from core-to-core, core-to-cache, or core-to-off-chip memory as a critical aspect of modern microprocessor performance. What is the future of high-speed I/O? Will the future demand for higher data rate I/Os come through incremental advances of all-electrical integrated transceivers, or will a new breed of high-speed I/O come to life in the form of either integrated optical (nanophotonics) transceivers, or perhaps mmWave wireless transceivers. Come hear a panel of experts debate what the future holds for high-speed signaling.



MONDAY

TECHNICAL SESSIONS

08:00-11:50

<p>RM01A: Cellular Transceivers Room: 208AB Chair: Fazal Ali, <i>Qualcomm</i> Co-Chair: Didier Belot, <i>ST Microelectronics</i></p>	<p>RM01B: RF CMOS Modulators & Receivers Room: 209AB Chair: Sayfe Kiaei, <i>Arizona State University, Tempe, Arizona</i> Co-Chair: Noriharu Suematsu, <i>Tohoku University, Japan</i></p>	<p>RM01C: Frequency Generation and Synthesis Room: 211AB Chair: Lawrence Kushner, <i>Intersil Co.</i> Co-Chair: Bertan Bakkaloglu, <i>Arizona State University</i></p>	<p>RM01D: W-band and Above Room: 212AB Chair: Jenshan Lin, <i>University of Florida</i> Co-Chair: Georg Boeck, <i>Berlin Institute of Technology</i></p>
<p>RM01A-1: A 28mW WCDMA/GSM/GPRS/EDGE Transformer-Based Receiver in 45nm CMOS D. L. Griffith, V. Srinivasan, S. Pennisi, V. Rentala, Y. Su, S. Sankaran, I. Elahi, S. Samala, H. Kiper, B. Patel, S. Akhtar, D. Edmondson <i>Texas Instruments</i></p>	<p>RM01B-1: A Quadrature Charge-Domain Filter with an Extra In-Band Filtering for RF Receivers Ming-Feng Huang <i>SoC Technology Center, Industrial Technology Research Institute, Taiwan</i></p>	<p>RM01C-1: A D-Band PLL Covering the 81-82 GHz, 86-92 GHz and 162-164 GHz Bands S. Shahrman*, A. Hart*, A. C. Carusone*, P. Garcia**, P. Chevalier**, S.P. Voinigescu* *University of Toronto, Canada, **STMicroelectronics, France</p>	<p>8:00:00 AM: RM01D-1: Transmitter Chipset for 24/77-GHz Automotive Radar Sensors V. Giammello, E. Ragonese, G. Palmisano <i>Università di Catania, Facoltà di Ingegneria, DICEES, Catania, Italy</i></p>
<p>RM01A-2: An EDGE Transmitter with Mitigation of Oscillator Pulling I. Bashir, R. B. Staszewski, O. Eliezer, K. Waheed, W. Zocias, N. Tal, J. Mehta, P. T. Balsara, B. Banerjee <i>University of Texas at Dallas, Texas Instruments Inc., USA, Delft University of Technology, Netherlands</i></p>	<p>RM01B-2: A Low-Power Receiver Down-Converter with High Dynamic Range Performance D. Ghosh, R. Gharpurey <i>University of Texas, Austin, USA</i></p>	<p>RM01C-2: An Integrated Frequency Synthesizer for 81-86GHz Satellite Communications in 65nm CMOS Zhiwei Xu, Qun Jane Gu, Yi-Cheng Wu, Heng-Yu Jian, Frank Wang, Mau-Chung Frank Chang <i>University of California, Los Angeles, CA 90095, USA</i></p>	<p>RM01D-2: A 94-GHz Passive Imaging Receiver using a Balanced LNA with Embedded Dicke Switch L. Gilreath, V. Jain*, H.C. Yao, L. Zheng, and P. Heydari <i>University of California, Irvine, **SaberTek, Irvine CA</i></p>
<p>RM01A-3: An All-Digital Offset PLL Architecture R. B. Staszewski, S. Vemulapalli* <i>Texas Instruments, *Delft University of Technology</i></p>	<p>RM01B-3: A Multiphase PWM RF Modulator Using a VCO-Based Opamp in 45nm CMOS M. Park, M. H. Perrot* <i>Massachusetts Institute of Technology (now at Maxim Integrated Products), **SilTime Corporation</i></p>	<p>8:40:00 AM: RM01C-3: Low-Noise Fractional-N PLL Design with Mixed-Mode Triple-Input LC VCO in 65nm CMOS Yuanfen Sun*, Xueyi Yu*, Woogeun Rhee*, Sangsoo Ko**, Wooseung Choo**, Byeong-Ha Park**, and Zhihua Wang* *Tsinghua University, Beijing, China, **MSC Development Team, Samsung Electronics, Yongin-City, Gyeonggi-Do, Korea</p>	<p>RM01D-3: 3.94 GHz silicon co-integrated LNA and antenna in a mm-wave dedicated BiCMOS technology R. Pilard (1,2), D. Gloria (1), F. Giancesello (1), F. Le Pennec (2), C. Person (2) (1) STMicroelectronics, (2) Lab-STICC/MOM, FRANCE</p>
<p>RM01A-4: An Interstage Filter-Free Mobile Radio Receiver with Integrated TX Leakage Filtering R. Vazny, W. Schelmbauer, H. Pretl, S. Herzinger*, R. Weigel** <i>Danube Integrated Circuit Engineering GmbH, Austria, *Infineon Technologies AG, Germany, **Institute for Electronics Engineering Friedrich-Alexander-University Erlangen-Nuremberg, Germany</i></p>	<p>RM01B-4: Spurious Noise Reduction by Modulating Switching Frequency in DC-to-DC Converter for RF Power Amplifier E. J. Kim, C. Cho*, W. Kim*, C.-H. Lee*, J. Laskar <i>Georgia Institute of Technology at Atlanta, **Samsung Design Center at Atlanta</i></p>	<p>RM01C-4: A Wideband Millimeter-Wave Frequency Doubler-Tripler in 0.13-μm CMOS S. Saberi Ghouchani, J. Paramesh <i>Carnegie Mellon University</i></p>	<p>RM01D-4: A 3-Gbit/s W-Band SiGe ASK Receiver with a High-Efficiency On-Chip Electromagnetically-Coupled Antenna Jason W. May, Ramadan A. Alhalabi, Gabriel M. Rebeiz <i>University of California at San Diego</i></p>
<p>RM01A-5: A SAW-less CMOS TX for EGPRS and WCDMA K. Hausmann, J. Ganger, M. Kirschenmann, G. B. Norris, W. Shepherd, V. Bhan., and D. B. Schwartz. <i>Fujitsu Microelectronics of America</i></p>	<p>RM01B-5: A Rail-To-Rail Input Receiver Employing Successive Regeneration and Adaptive Cancellation of Intermodulation Products Edward A. Keehr, Ali Hajimiri <i>California Institute of Technology</i></p>	<p>RM01C-5: 200GHz CMOS Prescalers with Extended Dividing Range via Time-Interleaved Dual Injection Locking Qun Jane Gu*, Heng-Yu Jian*, Zhiwei Xu*, Yi-Cheng Wu*, Mau-Chung Frank Chang*, Yves Baeyens** and Young-Kai Chen** *University of California, Los Angeles, CA, USA, **Alcatel-Lucent/Bell-Labs, Murray Hills, NJ, USA</p>	<p>RM01D-5: A 325 GHz Frequency Multiplier Chain in a SiGe HBT Technology E. Öjefors, B. Heinemann*, U. R. Pfeiffer <i>University of Wuppertal, *HP GmbH, Germany</i></p>
<p>RM02A: RFID Circuits Room: 208AB Chair: Glenn Chang, <i>MaxLinear</i> Co-Chair: Natalino Camilleri, <i>Alien Technology</i></p>	<p>RM02B: Wideband LNAs Room: 209AB Chair: Jean-Baptiste Begueret, <i>IMS Lab, University of Bordeaux, France</i> Co-Chair: Danilo Manstretta, <i>University of Pavia, Italy</i></p>	<p>RM02C: Millimeter-Wave VCOs Room: 211AB Chair: Jing-Hong Chen, <i>Analog Devices</i> Co-Chair: Tian-Wei Huang, <i>National Taiwan University</i></p>	<p>RM02D: Reconfigurable PA Concepts Room: 212AB Chair: Joseph Staudinger, <i>Freescale</i> Co-Chair: Jyoti P. Mondal, <i>Northrop Grumman</i></p>
<p>RM02A-1: Semi-Active High-Efficient CMOS Rectifier for Wireless Power Transmission S. T. Kim, T. Song, J. Choi, F. Bien*, K. Lim, J. Laskar <i>Georgia Institute of Technology, *Ulsan National Institute of Science and Technology</i></p>	<p>RM02B-1: A 2-1100 MHz Wideband Low Noise Amplifier with 1.43 dB minimum Noise Figure M. El-Nozahi, A. A. Helmy, E. Sanchez-Sinencio, K. Entesari <i>Department of Electrical and Computer Engineering, Texas A&M University, College station, TX, 77843</i></p>	<p>RM02C-1: A mm-Wave Arbitrary 2**N Band Oscillator Based on Even-Odd Mode Technique A. H.T. Yu, S.-W. Tam, D. Murphy, T. Itoh, F. Chang <i>University of California at Los Angeles</i></p>	<p>RM02D-1: Multi-Mode WCDMA Power Amplifier Module with Improved Low-Power Efficiency using Stage-Bypass G. Hau, M. Singh <i>ANADIGICS, Inc., USA.</i></p>
<p>RM02A-2: A Single-Chip CMOS UHF RFID Reader Transceiver Runxi Zhang, Chunqi Shi, Yihao Chen, Wei He, Ping Xu, Shuai Xu and Zongshen Lai <i>Dept. of Electronic Engineering, Suzhou Vocational University, IMCS, East China Normal University, Shanghai, China</i></p>	<p>RM02B-2: An 0.045mm² 0.1-6GHz reconfigurable multi-band, multi-gain LNA for SDR A. Geis***, Y. Rolain*, G. Vandersteen*, J. Craninckx** *Vrije Universiteit Brussel, Belgium, **IMEC, Belgium</p>	<p>RM02C-2: A 24-GHz and 60-GHz Dual-Band Standing-Wave VCO in 0.13μm CMOS L. Wu*, A. W. L. Ng*, L. L. K. Leung** and H. C. Luong* *Hong Kong University of Science and Technology, Clear Water Bay, Hong Kong, **Qualcomm, San Diego, USA</p>	<p>RM02D-2: A 3.4 GHz to 4.3 GHz Frequency-Reconfigurable Class E Power Amplifier with an Integrated CMOS-MEMS LC Balun L. Wang, T. Mukherjee <i>Department of ECE, Carnegie Mellon University, Pittsburgh, PA, 15213</i></p>
<p>RM02A-3: Near Zero Turn-on Voltage High-Efficiency UHF RFID Rectifier in Silicon-on-Sapphire CMOS P. T. Theilmann, C. D. Presti, *D. Kelly, P. M. Asbeck <i>University of California at San Diego, **Peregrine Semiconductor Corp., USA</i></p>	<p>RM02B-3: A Linearity-Enhanced Wideband Low-Noise Amplifier K. Choi, T. Mukherjee*, J. Paramesh* <i>Samsung Electronics, *Carnegie Mellon University</i></p>	<p>RM02C-3: Multi-band Local Oscillator Generation for Direct up/down Conversion Transceiver Architectures Supporting WiFi and WiMax Standards Ram Sadhwani, Assaf Ben Bassat, Adil A. Kidwai, Shahar Rivet*, Jonathan C. Jensen <i>Intel Corporation, Hillsboro, OR; *Intel Corporation, Petah Tikva, Israel</i></p>	<p>RM02D-3: A Q-band 6W MMIC Power Amplifier with 3-way Power Combination Circuit Hiroshi Otsuka, Kazuhisa Yamauchi, Koji Yamanaka, Shin Chaki, Kazuhiko Nakahara, Kunihiko Endo, Akira Inoue and Yoshihito Hirano <i>Mitsubishi Electric Corp., Japan</i></p>
<p>RM02A-4: A Low Power Low Cost Fully Integrated UHF RFID Reader with 17.6dBm Output P1dB in 0.18 μm CMOS Process J.C. Wang, C. Zhang, Z.H. Wang <i>Institute of Microelectronics, Tsinghua University</i></p>	<p>RM02B-4: Power Efficient Distributed Low-Noise Amplifier in 90nm CMOS B. Machiels, P. Reynaert, M. Steyaert <i>ESAT-MICAS</i></p>	<p>RM02C-4: A 0.13-μm CMOS Local Oscillator for 60-GHz Applications Based on Push-Push Characteristic of Capacitive Degeneration Tino Copani, Hyungseok Kim, Bertan Bakkaloglu, Sayfe Kiaei <i>Electrical, Energy and Computer Engineering, Arizona State University, Tempe, AZ, 85287, USA</i></p>	<p>RM02D-4: A Multi-Band Reconfigurable Power Amplifier for UMTS Handset Applications U. Kim, K. Kim, J. Kim*, and Y. Kwon <i>Seoul National University, *Hanyang University, Korea</i></p>
<p>RM02A-5: Far-field RF Powering System for RFID and Implantable Devices with Monolithically Integrated On-Chip Antenna Sohel Radiomi, Majid Baghaei-Nejad*, Guy Vandenbosch, Li-Rong Zheng*, Georges Gielen <i>MICAS-ESAT, Katholieke Universiteit Leuven Belgium, *Royal Institute of Technology Stockholm Sweden</i></p>	<p>RM02B-5: A Wide-Band RF Front-End with Linear Active Notch Filter for Mobile TV Applications Seung Hwan Jung, Kang Hyuk Lee, Young Jae Lee*, Hyun Yoo Yu* Yun Seong Eo <i>University of Kwangju in Seoul Korea, **Electronic and Telecommunications Research Institute in Daegu Korea</i></p>	<p>RM02C-5: A Switched-Capacitor mm-Wave VCO in 65 nm Digital CMOS M. Nariman, F. De Flaviis <i>University of California at Irvine, Broadcom Corporation, USA</i></p>	<p>RM02D-5: High-efficiency Reconfigurable RF transmitter for Wireless Sensor Network Applications F. Carrara and G. Palmisano <i>University of Catania - DICEES, Italy</i></p>

MONDAY

TECHNICAL SESSIONS

13:20-17:10

RM03A: CMOS Wideband Transceiver ICs Room: 208AB Chair: Domine Leenaerts, <i>NXP Semiconductor</i> Co-Chair: Haolu Xie, <i>Fujitsu Microelectronics</i>	RM03B: Advanced Characterization of mm-Wave Components Room: 209AB Chair: Kevin McCarthy, <i>University of College Cork</i> Co-Chair: Herbert Zirath, <i>Chalmers University of Technology</i>	RM03C: Advanced Device Technologies & Design Techniques Room: 211AB Chair: Aditya Gupta, <i>Northrup Grumman</i> Co-Chair: Eli Reese, <i>TriQuint Semiconductor</i>	RM03D: Switch & Switch-mode Technologies Room: 212AB Chair: Nick Cheng, <i>Skyworks Solutions</i> Co-Chair: Youngwoo Kwon, <i>Seoul National University</i>	13:20 - 13:40
RM03A-1: A Tri-band 65nm CMOS Tuner for ATSC Mobile DTV SoC Sanghoon Kang, Huijung Kim, Jeong-Hyun Choi, Jae-Hong Chang, Jong-Dae Bae, Wooseung Choo, Byeong-ha Park <i>Samsung Electronics System LSI MSC team, Korea</i>	RM03B-1: The "Load-Thru" (LT) De-embedding Technique for the Measurements of mm-Wave Balanced 4-Port Devices Z. Deng, A. M. Niknejad <i>Berkeley Wireless Research Center</i>	RM03C-1: Integration of multi-standard Front End Modules SOCs on High Resistivity SOI RF CMOS Technology F. Giansello*, S. Boret*, B. Martineau*, C. Durand*, R. Pilard*, D. Gloria*, B. Rauber* and C. Raynaud** <i>*STMicroelectronics, TR&D, Crolles, France, **CEA Leti, Grenoble, France</i>	RM03D-1: High Efficiency and Wideband Envelope Tracking Power Amplifier with Sweet Spot Tracking D. Kim, J. Choi, D. Kang, B. Kim <i>University of Science and Technology, Korea</i>	13:40 - 14:00
RM03A-2: A Multi-standard Multi-band Tuner for Mobile TV SoC with GSM Interoperability H. Kim, S. Kang, J. Chang, J. Choi, H. Chung, J. Heo, J. Bae, W. Choo, and B. Park <i>Samsung Electronics Co. Ltd.</i>	RM03B-2: RF-pad, Transmission Lines and Balun Optimization for 60GHz 65nm CMOS Power Amplifier S. Aloui, E. Kerherve, R. Plana*, D. Belot** <i>Université de Bordeaux 1, IMS Laboratory, 351 Cours de la Liberation, Talence, France, *LAAS-CNRS, 7 avenue du tonel Roche, Toulouse, France, **STMicroelectronics, Central R&D - Colles, France.</i>	RM03C-2: Low-Parasitic Ultra-Low-Triggering ULTDCSR ESD Protection for RF ICs in CMOS Jian Liu, Lin Lin, Xin Wang, Hui Zhao, He Tang, Qiang Fang, Albert Wang, Hongyi Chen, Haolu Xie, Siqiang Fan and Gary Zhang <i>Dept. of Electrical Engineering, University of California, Riverside, CA</i>	RM03D-2: A 150MHz, 84% efficiency, Two Phase Interleaved DC-DC Converter in AlGaAs/GaAs P-HEMT Technology for Integrated Power Amplifier M H. Peng, V. Pala, T. P. Chow, and M. Hella <i>Rensselaer Polytechnic Institute, ECSE Department</i>	14:00 - 14:20
RM03A-3: A 2.2 mW Regenerative FM-UWB Receiver in 65 nm CMOS N. Saputra, J. R. Long, and J. J. Pekarik* <i>Delft University of Technology, the Netherlands, *IBM Microelectronics, USA</i>	RM03B-3: 200GHz ft SiGe HBT Load Pull Characterization at mm-Wave Frequencies Luciano Bagnione, Richard T. Webster* <i>University of Massachusetts, Lowell, *Air Force Research Laboratories, Hanscom AFB, MA</i>	RM03C-3: A Cost-Competitive High Performance Junction-FET (JFET) in CMOS Process for RF Front-End-Module Applications Y. Shi, R. M. Rassel, R. A. Phelps, P. Candra, D. B. Hershberger, X. Tian, S. L. Sweeney, J. Rascoe, B. Rainey, J. Dunn, and D. Haramie <i>IBM Microelectronics, Essex Junction, Vermont, USA</i>	RM03D-3: A 0dBm 10Mbps 2.4GHz Ultra-Low Power ASK/OOK Transmitter with Digital Pulse-Shaping Xiongchuan Huang, Pieter Harpe, Xiaoyan Wang, Guido Dolmans, Harmke de Groot <i>Holst Centre - IMEC, Eindhoven, The Netherlands</i>	14:20 - 14:40
RM03A-4: A 75 pJ/bit All-Digital Quadrature Coherent IR-UWB Transceiver in 0.18 μm CMOS D. Gómez, D. Mateo, J.L. González <i>Universitat Politècnica Catalunya, SPAIN</i>	RM03B-4: A Miniature 26-/77-GHz Dual-band Branch-line Coupler Using Standard 0.18-μm CMOS Technology Y. S. Lin*, C. Y. Hsu*, H. R. Chuang*, C. Y. Chen** <i>*National Cheng Kung University, Tainan, Taiwan, R.O.C, **National University of Tainan, Tainan, Taiwan, R.O.C.</i>	RM03C-4: Reconfiguration of Bulk Acoustic Wave Filters Using CMOS Transistors: Concept, Design and Implementation M. El Hassan, E. Kerherve*, Y. Deval*, J.B. David**, D. Belot*** <i>University of Balamand - Alkoura Lebanon; IMS Laboratory - UMR 5218 CNRS - ENSEIRB - University of Bordeaux, **CEA-Leti - Minatex - Grenoble, ***STMicroelectronics Crolles.</i>	RM03D-4: A Linear-in-dB SiGe HBT Wideband High Dynamic Range RF Envelope Detector Hsuan-yu Marcus Pan and Lawrence E. Larson <i>University of California, San Diego, 9500 Gilman Drive, La Jolla, CA, 92093, USA</i>	14:40 - 15:00
RM03A-5: A 90nm-CMOS, 500Mbps, Fully-Integrated IR-UWB Transceiver Using Pulse Injection-Locking for Receiver Phase Synchronization C.H.Hu, P.Y. Chiang, K.M.Hu, R.Khanna*, J.Nejedlo* <i>Oregon State University, *Intel</i>	RM03B-5: Compact Transformer Power Combiners for Millimeter-wave Wireless Applications Y. Zhao, J.R. Long, M. Spirito <i>Delft University of Technology, The Netherlands</i>	RM03C-5: A Layout Efficient, Vertically Stacked, Resonator-Coupled Bandpass Filter in LTCC for 60 GHz SOP Transceivers R. E. Amaya <i>Communications Research Centre</i>	RM03D-4: Cellular Antenna Switches for Multimode Applications Based on a Silicon-on-Insulator Technology A. Tombak, C. Iversen*, J.-B. Pierres**, D. Kerr, M. Carroll, P. Mason, E. Spears and T. Gillenwater <i>RFMD Inc., USA, *RFMD Denmark Design Center, DENMARK, **RFMD Toulouse Design Center, FRANCE</i>	15:00 - 15:30
RM04A: Ultra Low Power Receivers and Transmitters Room: 208AB Chair: Julian Tham, <i>Arda Technologies</i> Co-Chair: Bill Redman-White, <i>NXP</i>	RM04B: Optimized Design Techniques for RF Front-end Building Blocks Room: 209AB Chair: Osama Shana'a, <i>Mediatek Corp.</i> Co-Chair: Ali Afshahi, <i>Broadcom</i>	RM04C: Temperature Compensated Oscillators Room: 211AB Chair: Timothy Hancock, <i>MIT Lincoln Laboratory</i> Co-Chair: Donald Y.C. Lie, <i>Texas Tech University</i>	RM04D: Silicon Millimeter-Wave Amplifiers Room: 212AB Chair: Kevin Kobayashi, <i>RF Micro Devices</i> Co-Chair: Paul Blount, <i>Custom MMIC Design</i>	15:30 - 15:50
RM04A-1: A 120μW Fully-Integrated BPSK Receiver in 90nm CMOS H. Yan, J. G. Macias-Montero, A. Akhnouk, L. C. N. de Vreede, J. R. Long, J. J. Pekarik*, J. N. Burghartz <i>ERL/DIMES, Delft University of Technology, Netherlands, *IBM Microelectronics, Essex Junction VT, USA</i>	RM04B-1: A Differential 4-Path Highly Linear Widely Tunable On-Chip Band-Pass Filter A. Ghaifari, E.A.M. Klumpernik, B. Nauta <i>University of Twente, CTIT Institute, IC Design group, Enschede, The Netherlands</i>	RM04C-1: A 65nm CMOS DCXO System for Generating 38.4MHz and a Real Time Clock from a Single Crystal in 0.09mm² D. L. Griffith, F. Dulger, G. S. Feygin, A. N. Mohieldin, P. Vallur <i>Texas Instruments</i>	RM04D-1: A 60GHz Transformer Coupled Amplifier in 65 nm Digital CMOS Michael Boers <i>Broadcom Corp., Irvine, CA, 92617, USA</i>	15:50 - 16:10
RM04A-2: A Fully Integrated 2.4-GHz CMOS Diversity Receiver with a Novel Antenna Selection Yong-H. Kwon*, Sang-Ku Park*, T.J.Park*, and Hai-Young Lee** <i>*UC solution team, SAMSUNG Electro-Mechanics, Suwon, 443-743, Korea, **Department of Electronics Engineering, Ajou University, Suwon, 443-749, Korea</i>	RM04B-2: A CMOS Wide-Bandwidth High-Power Linear-in-dB Variable Attenuator Using Body Voltage Distribution Method Yan-Yu Huang, Wangmyong Woo, Chang-Ho Lee, Joy Laskar <i>Georgia Electronic Design Center, Georgia Institute of Technology, Samsung Design Center, USA</i>	RM04C-2: A 50ppm 600MHz Frequency Reference Utilizing the Series Resonance of an FBAR Julie Hu, Lori Callaghan*, Richard Ruby*, Brian Otis <i>University of Washington, **Avago Technologies, Inc.</i>	RM04D-2: A Stage-Scaled Distributed Power Amplifier Achieving 110GHz Bandwidth and 17.5dBm Peak Output Power J. Chen, A. M. Niknejad <i>University of California at Berkeley</i>	16:10 - 16:30
RM04A-3: A 90μW MICS/ISM Band Transmitter with 22% Global Efficiency J. Pandey, B. Otis <i>University of Washington, Seattle, WA, USA</i>	RM04B-3: A 17 GHz Transformer-neutralized Current Re-use LNA and Its Application to a Low-power RF Front-end S. Kundu, J. Parameesh <i>Carnegie Mellon University, USA</i>	RM04C-3: An Electronically Temperature-Compensated 427MHz Low Phase-Noise AIN-on-Si Micromechanical Reference Oscillator H. M. Lavasani, W. Pan, F. Ayazi <i>Georgia Institute of Technology</i>	RM04D-3: DC Hot Carrier Stress Effect on CMOS 65nm 60 GHz Power Amplifiers T. Quémerais**, L. Moquillon**, V. Huard**, J.-M. Fournier*, P. Benech*, N. Corrao* <i>*IMEP-LHAC, UMR INPG/UFV/US/CNRS, 3 parvis Louis Néel, BP 257, 38016 Grenoble Cedex, France, **STMicroelectronics, 850 rue Jean Monnet 38920 Crolles, France</i>	16:30 - 16:50
RM04A-4: A 2mW CMOS MICS-Band BFSK Transceiver with Reconfigurable Antenna Interface S. Min, S. Shashidharan, M. Stevens, T. Copani, S. Kiaei, B. Bakkaloglu, S. Chakraborty* <i>Arizona State University, *Texas Instruments, USA</i>	RM04B-4: A Self-Healing 2.4GHz LNA with On-Chip S11/S21 Measurement/Calibration for In-Situ PVT Compensation Karthik Jayaraman, Qadeer Khan, *Baoyong Chi, William Beattie, *Zhishua Wang, and Patrick Chiang <i>School Of Electrical Engineering and Computer Science, Oregon State University, Corvallis, OR, USA, *Institute of Microelectronics, Tsinghua University, China</i>	RM04C-4: A Wide Tuning 1.3 GHz LC VCO with Fast Settling Noise Filtering Voltage Regulator in 0.18 μm CMOS Process Hiroshi Akima, Aleksander Dec, and Ken Suyama <i>Epoch Microelectronics, Inc., Tarrytown, NY, USA</i>	RM04D-4: A Layout-Based Optimal Neutralization Technique for mm-Wave Differential Amplifiers Z. Deng, A. M. Niknejad <i>Berkeley Wireless Research Center</i>	16:50 - 17:10
RM04A-5: A 1.8 to 2.4-GHz 20mW Digital-Intensive RF Sampling Receiver with a Noise-Canceling Bandpass Low-Noise Amplifier in 90nm CMOS Joonhee Lee, Jaewook Kim and Seonghwan Cho <i>Department of Electrical Engineering, KAIST, Daejeon, Republic of Korea</i>	RM04B-5: A Low Power LNA using Miniature 3D Inductor without Area Penalty of Passive Components Akira Tanabe, Ken'ichiro Hijioka, Hirokazu Nagase, Yoshihiro Hayashi <i>NEC Electronics Corporation</i>	RM04C-5: A Wide-Range VCO with Optimum Temperature Adaptive Tuning Behzad Saeidi*, Joshua Cho** <i>*Marvell Semiconductor, Aliso Viejo, CA 92656; **Skyworks Solutions, Inc, Irvine, CA 92618</i>	RM04D-5: A 100 GHz Transformer-Coupled Fully Differential Amplifier in 90 nm CMOS N. Deferm, P. Reynaert <i>K. U. Leuven, ESAT/MICAS, Heverlee, Belgium</i>	



TUESDAY

TECHNICAL SESSIONS

08:00-11:50

RTU1B: CMOS Millimeter-Wave 60/24 GHz Radio**Room: 207AB**Chair: Frank Henkel, *IMST GmbH, Kamp-Lintfort, Germany*
Co-Chair: Mark Ruberto, *Intel Corp.***RTU1C: CMOS PAs****Room: 211AB**Chair: Eddie Spears, *RFMD*
Co-Chair: Freek van Straten, *NXP Semiconductors***RTU1D: Emerging Architectures in Digital Frequency Synthesis****Room: 212AB**Chair: Stefano Pellerano, *Intel Corporation*
Co-Chair: Sanjay Raman, *Virginia Tech*

08:00-08:20

RTU1B-1: A 68-82 GHz integrated wideband linear receiver using 0.18 μ m SiGe BiCMOS Technology

A. Y.-K. Chen**, Y. Baeyens*, Y.-K. Chen*, and J. Lin**

*Alcatel-Lucent/Bell Laboratories, 600 Mountain Ave. Murray Hill, NJ 07974 USA, **Department of ECE, University of Florida, Gainesville, FL 32611 USA

RTU1C-1: A Discrete Resizing and Concurrent Power Combining Structure for Linear CMOS Power Amplifier

J. Kim*, H. Kim*, Y. Yoon*, K. H. An*, W. Kim*, C.-H. Lee**, K. T. Kornegay*, and J. Laskar*

Georgia Electronic Design Center, Georgia Institute of Technology, Atlanta, GA 30308, USA*, Samsung Design Center, Atlanta, GA 30308, USA**

RTU1D-1: A 700uA, 405MHz Fractional-N All Digital Frequency-Locked Loop for MICS Band Applications

S. Shashidharan, W. Khalil*, S. Chakraborty**, S. Kiaei, T. Copani and B. Bakaloglu

Arizona State University, Tempe, AZ., **Ohio State University, Columbus, OH., ***Texas Instruments Inc., Dallas, TX, USA

08:20-08:40

RTU1B-2: A 24-GHz Low-Power Fully Integrated Receiver with Image-Rejection using Rich-Transformer Direct-Stacked/Coupled TechniqueN. Shiramizu, T. Nakamura, T. Masuda, K. Washio
*Hitachi, Ltd.***RTU1C-2: A Single-Chip 2.4GHz Double Cascode Power Amplifier under Multiple Supply Voltages in 65nm CMOS for WLAN Application**Mingyuan Li, Ali Afsahi, Arya Behzad
*Broadcom Corporation, San Diego***RTU1D-2: A 2-MHz Bandwidth Δ - Σ Fractional-N Synthesizer Based On a Frequency Divider with Digital Spur Suppression**

P.-E. Su and S. Pamarti

Department of Electrical Engineering, University of California at Los Angeles, U.S.A.

08:40-09:00

RTU1B-3: A 60 GHz CMOS Receiver Front-End with Integrated 180-degree Out-of-Phase Wilkinson Power Divider

C. C. Chen, J. H. Lee, Y. S. Lin

*National Chi Nan University, Taiwan***RTU1C-3: A 31-dBm, High Ruggedness Power Amplifier in 65-nm Standard CMOS with High-Efficiency Stacked-Cascode Stages**

S. Leuschner*, S. Pinarello***, U. Hodel***, J.-E. Mueller***, H. Klar*

*Technical University of Berlin, **Friedrich-Alexander-Universitaet Erlangen-Nuernberg, ***Infineon Technologies AG

RTU1D-3: A 6fj/step, 5.5ps Time-to-Digital Converter for a Digital PLL in 40nm Digital LP CMOS

J. Borremans, K. Vengattarmane*, J. Craninckx

*IMEC, Leuven, Belgium, *KUL, Leuven, Belgium*

9:00-9:20

RTU1B-4: Coherent Parametric RF Downconversion in CMOS

Z. Zhao, J.F. Boudquet*, S. Magierowski**

*University of Calgary, Canada***RTU1C-4: Analysis and Design of a Wideband High Efficiency CMOS Outphasing Amplifier**

M.C.A. van Schie, M.P. van der Heijden*, M. Acar*, A.J.M. de

Grauw*, L.C.N. de Vreeede

*Delft University of Technology, *NXP Semiconductors, The Netherlands***RTU1D-4: A 6GHz Direct Digital Synthesizer MMIC with Nonlinear DAC and Wave Correction ROM**

D. Y. Wu, G. P. Chen, J. W. Chen, X. Y. Liu, L. X. Zhao, Z. Jin

Institute of Microelectronics of Chinese Academy of Sciences, China

9:20-9:40

RTU1B-5: 60 GHz Broadband Image Rejection Receiver using Varactor Tuning

J. Kim, W. Choi, Y. Park, and Y. Kwon

*Seoul National University, Korea***RTU1C-5: A Highly Efficient 5.8 GHz CMOS Transmitter IC with Robustness over PVT Variations**

Eun-Hee Kim, Jeong-Ki Choi*, Seok-Oh Yun*, Jinho Ko*, Kwiro Lee

*Korea Advanced Institute of Science and Technology, *PHYCHIPS Inc.***RTU1D-5: A 10GHz 8-bit Direct Digital Synthesizer Implemented in GaAs HBT Technology**

G. P. Chen, D. Y. Wu, Z. Jin, X. Y. Liu

Institute of Microelectronics, Chinese Academy of Sciences, Beijing, China

TUESDAY

TECHNICAL SESSIONS

13:20-17:10

RTU2A: WLAN Transceivers and Components**Room: 207AB**Chair: Albert Jerng, *Ralink Technology*Co-Chair: Srenik Mehta, *Atheros Communications***RTU2A-1: Dual-Band CMOS Transceiver with Highly Integrated Front-End for 450Mb/s 802.11n systems**S. Gross, T. Maimon, F. Cossoy, M. Ruberto, G. Normatov, A. Rivkind, N. Telzhensky, R. Banin, O. Ashckenazi, A. Ben-Bassat, S. Zaguri, G. Hara, M. Zajac, N. Shahar, S. Shahaf, A. Fridman, O. Degani
*Intel Corporation, Mobile Wireless Group, Haifa, Israel***RTU2A-2: A CMOS Transceiver with internal PA and Digital Pre-distortion For WLAN 802.11a/b/g/n Applications**Chia-Jun Chang, Po-Chih Wang, Chih-Yu Tsai, Chin-Lung Li, Chiao-Ling Chang, Han-Jung Shih, Meng-Hsun Tsai, Wen-Shan Wang, Ka-Un Chan, and Ying-Hsi Lin
*Realtek Semiconductor Corp., Hsinchu, 300, Taiwan***RTU2A-3: Highly Linear SOI Single-Pole 4-Throw Switch with an Integrated Dual-band LNA and Bypass Attenuators**Chun-Wen Paul Huang, Lui (Ray) Lam, Mark Doherty, and William Vaillancourt
*SiGe Semiconductor, Andover, MA 01810, USA***RTU2A-4: A 6.1GS/s 52.8mW 43dB DR 80MHz Bandwidth 2.4GHz RF Bandpass $\Delta\Sigma$ ADC in 40nm CMOS**J. Ryckaert, A. Geis*, L. Bos*, G. Van der Plas, J. Craninckx
*IMEC, *also at VUB***RTU2A-5: Single-chip WiFi bgn 1x2 SoC with Fully integrated Front end & PMU in 90nm digital CMOS technology**J.C. Jensen, R. Sathwani, A.A. Kidwai, B. Jann, A. Oster*, M. Sharkansky*, I. Ben-Bassat*, O. Degani*, S. Porat*, A. Fridman*, H. Shang, C. Chu, A. Ly, M. Smith
*Intel Corporation, Hillsboro OR, *Intel Corporation, Haifa Israel***RTU2C: Millimeter-Wave Arrays****Room: 211AB**Chair: Brian Floyd, *North Carolina State University*Co-Chair: C. Patrick Yue, *UC Santa Barbara***RTU2C-1: A 44-GHz 8-Element Phased-Array SiGe HBT Transmitter RFIC with an Injection-locked Quadrature Frequency Multiplier**Sung-hwan Kim*, Prasad S. Gudem**, and Lawrence E. Larson*
Center for Wireless Communication, University of California San Diego, CA, USA, **Qualcomm Inc., San Diego, CA, USA*RTU2C-2: A thirty two element phased-array transceiver at 60GHz with RF-IF conversion block in 90nm flip chip CMOS process**Emanuel Cohen**/*, Claudio Jakobson*, Shmuel Ravid*, and Dan Ritter**
Mobile Wireless Group, Intel Haifa, Israel, **Electrical Engineering Technion, Haifa, Israel*RTU2C-3: A 16-Element Phased-Array Receiver IC for 60-GHz Communications in SiGe BiCMOS**S. Reynolds, A. Natarajan, M.-D. Tsai*, S. Nicolson**, J.-H. Zhan*, D. Liu, D. Kam, O. Huang*, A. Valdes-Garcia, B. Floyd
*IBM T. J. Watson Research Center (Yorktown Heights, NY), *MediaTek (HsinChu, Taiwan), **MediaTek Inc. (San Jose, CA)***RTU2C-4: A 24-GHz Phased-Array Receiver in 0.13- μ m CMOS using an 8-GHz LO**S. Patnaik, R. Harjani
*Department of Electrical and Computer Engineering, University of Minnesota, Minneapolis, MN 55455***RTU2C-5: Wafer-Scale W-Band Power Amplifiers Using on-chip Antennas**Y. A. Atesal, B. Cetinoneri, R. A. Alhalabi, G. M. Rebez
*University of California at San Diego***RTU2D: RF Modeling for Switch and PA Applications****Room: 212AB**Chair: Francis Rotella, *Peregrine Semiconductor*Co-Chair: Yuhua Cheng, *Peking University***RTU2D-1: Application of BSIMSOI MOSFET Model to SOS**Technology: J. W. Roach, L.-W. Chen, P. G. Clarke, F. M. Rotella
*Peregrine Semiconductor, San Diego, USA***RTU2D-2: Modeling of SOI FET for RF Switch Applications**T.-Y. Lee, S. Lee
*Skyworks Solutions, Inc.***RTU2D-3: A High Power CMOS Differential T/R Switch using Multi-section Impedance Transformation Technique**H.-W. Kim, M. Ahn*, O. Lee, C.-H. Lee*, and J. Laskar
*Georgia Institute of Technology, *Samsung Design Center***RTU2D-4: Exploitation of Active Load-pull and DLUT Models in MMIC DesignA**D. M. FitzPatrick, T. Williams*, J. Lees, J. Benedikt, S.C. Cripps and P.J. Tasker
*Cardiff University, *Selex-Galileo SAS Ltd.***RTU2D-5: A Mixed-signal Load-Pull System for Base-station Applications**Mauro Marchetti*, Rob Heeres**, Michele Squillante*, Marco Pelk*, Marco Spirito*, and Leo C. N. de Vreede*
**Delft University of Technology, Mekelweg 4, 2628 CD, Delft, The Netherlands, **NXP Semiconductors, Gerstweg 2, 6534 AE, Nijmegen, The Netherlands*

13:20 - 13:40

13:40 - 14:00

14:00 - 14:20

14:20 - 14:40

14:40 - 15:00



TUESDAY

INTERACTIVE FORUM

14:00-16:00

RTUIF: RFIC Interactive Forum

Room: 208AB & 209AB

Chair: David Ngo, RFMD

Co-Chair: Chris Rudell, University of Washington

RTUIF-01: A 228 μ W Injection Locked Ring Oscillator based BPSK Demodulator in 65nm CMOS

Q. Zhu, Y. Xu

Illinois Institute of Technology

RTUIF-02: A 0.13- μ m CMOS Wireless Reflector for Phase Sweep Cooperative Diversity

J.-F. Bousquet, S.C. Magierowski, G.G. Messier, Z. Zhao

Schulich School of Engineering, University of Calgary

RTUIF-03: Design methodology and comparison of rectifiers for UHF-band RFID

Francesco Mazzilli*, Prakash E. Thoppay*, Norbert Jöhl+, and Catherine Dehollain*

*Swiss Federal Institutes of Technology, Lausanne, 1015, Switzerland, +Advanced Silicon, Lausanne, 1004, Switzerland

RTUIF-04: A CMOS Ultra-wideband Radar Transmitter with Pulsed Oscillator

Sungeun Lee, Sanghoon Sim, Songcheol Hong

School of Electrical Engineering and Computer Science at KAIST, Korea

RTUIF-05: 900MHz/1800MHz GSM Base Station LNA with Sub-1dB Noise Figure and +36dBm OIP3

D. Leenaerts, J. Bergervoet, J.-W. Lobeek, M. Schmidt-Szalowski

NXP Semiconductors, Eindhoven, 5656AE, the Netherlands

RTUIF-06: A 4.35-mW +22-dBm IIP3 Continuously Tunable Channel Select Filter for WLAN/WiMax Receivers in 90-nm CMOS

Mostafa Savadi Oskooei**, Nasser Masoumi**, Mahmud Kamareh**, and Henrik Sjöland*

*Department of Electrical and Information Technology, Lund University, Lund, Sweden, **School of Electrical and Computer engineering, University of Tehran, Tehran, Iran

RTUIF-07: Wideband Trans-Impedance Filter Low Noise Amplifier

M. Kallio*, A. Pärssinen**, J. Rynnänen*

*Aalto University, Finland, **Nokia Research Center, Finland

RTUIF-08: A Wideband High-Linearity Mixer in 0.5 μ m InP DHBT Technology

M. Stuenkel, M. Feng

University of Illinois

RTUIF-09: A High Gain Wideband 77GHz SiGe Power Amplifier

IBM Haifa Research Lab

Roei Ben Yishay, Roi Carmon, Oded Katz and Danny Elad

RTUIF-10: A Broadband Differential Cascode Power Amplifier in 45 nm CMOS for High-Speed 60 GHz System-on-Chip

M. Abbasi*, T. Kjellberg**, A. de Grauw***, E. V. Heijden***, R. Roovers***, H. Zirath*

*Chalmers University of Technology, **Chalmers Industrial Technologies, Sweden, ***NXP Semiconductors, The Netherlands

RTUIF-11: A CMOS LC VCO with Novel Negative Impedance Design for Wide-Band Operation

Chang-Hsi Wu and Guan-Xiu Jian

Department of Electronic Engineering, Linghua University of Science and Technology, *RF Integrated Circuits, Wireless Communication Systems Nonlinear System Theory*, R.O.C.

RTUIF-12: An 80GHz range Synchronized Push-push Oscillator For Automotive Radar Application

C. Ameziane, T. Taris, Y. Deval, D. Belot*, R. Plana** and J.-B. Bégueret

IMS-Bordeaux, *STMicroelectronics, **LAAS, FRANCE

RTUIF-13: Millimeter Wave CMOS VCO with a High Impedance LC tank

S. Chai, J. Yang, B. Ku, S. Hong

Korea Advanced Institute of Science and Technology

RTUIF-14: Controlled dither for effective fractional delay in 90 nm digital to time conversion based DDS for spur mitigation

S. A. Talwalkar, T. Gradishar, B. Stengel, G. Cafaro and G. Nagaraj

Motorola, Inc., Plantation, FL

RTUIF-15: 2-4 and 9-12 Gb/s CMOS Fully Integrated ILO-based CDR

Q. Mazouffre*, R. Toupet*, M. Pignol**, Y. Deval and J.B. Bégueret*

*IMS Laboratory, University of Bordeaux, Talence, France, **CNES (Centre National d'Etudes Spatiales), Toulouse, France

RTUIF-16: A 22.5-dB Gain, 20.1-dBm Output Power K-band Power Amplifier in 0.18- μ m CMOS

Chi-Cheng Hung, Jing-Lin Kuo, Kun-You Lin, and Hwei Wang

Dept. of Electrical Engineering and Graduate Institute of Communication Engineering, National Taiwan University

RTUIF-17: A 40% PAE Linear CMOS Power Amplifier with Feedback Bias Technique for WCDMA Applications

H. Jeon, K.-S. Lee, O. Lee, K. H. An, Y. Yoon, H. Kim, D. H. Lee*, J. Lee**, C.-H. Lee***, J. Laskar

Georgia Electronic Design Center, USA, *Skyworks, USA, **Gwangju Institute of Science and Technology, Korea, ***Samsung Design Center, USA

RTUIF-18: A Switching-Mode Amplifier for Class-S Transmitters for Clock Frequencies up to 7.5 GHz in 0.25 μ m SiGe-BiCMOS

S. Heck, M. Schmidt, A. Bräckle, F. Schuller, M. Grözing, M. Berroth, H. Gustat*, C. Scheyt**

University of Stuttgart (Institute of Electrical and Optical Communications Engineering), *IHP GmbH, Germany

RTUIF-19: SiGe Power Amplifier ICs for 4G (WIMAX and LTE) Mobile and Nomadic Applications

V. Krishnamurthy, K. Hershberger, J. Dekosky, H. Zhao, D. Poulin, R. Rood, E. Prince

VT Silicon, Inc., USA

RTUIF-20: Self-Matched ESD Cell in CMOS Technology for 60-GHz Broadband RF Applications

Chun-Yu Lin 1, Li-Wei Chu 1, Ming-Dou Ker 1,2, Tse-Hua Lu 3, Ping-Fang Hung 3, and Hsiao-Chun Li 3

1. National Chiao-Tung University, Hsinchu, Taiwan; 2. I-Shou University, Kaohsiung, Taiwan; 3. Taiwan Semiconductor Manufacturing Company

RTUIF-21: The Impact of MOSFET Layout Dependent Stress on High Frequency Characteristics and Flicker Noise

Kuo-Liang Yeh, Chih-You Ku, and Jyh-Chyurn Guo

Institute of Electronics Engineering, National Chiao Tung University, Hsinchu, Taiwan

RTUIF-22: A Novel Low-Profile Low-Parasitic RF Package Using High-Density Build-Up Technology

Chien-Cheng Wei, Ming-Chien Lin, Chin-Ta Fan, Ta-Hsiang Chiang, Ming-Kuen Chiu, Shao-Pin Ru, and Albert Cardona*

Tong Hsing Electronic Industries, LTD., 5S, Lane 365, Yingtao Road, Yinko, Taipei Hsien, Taiwan 239, Agile RF*, Inc. 93 Castilian Drive, Santa Barbara, CA 93117

RTUIF-23: A High Quality Factor Varactor Technology Evaluation

R. DEBROUCKE*, S. JAN*, J.-F. LARCHANCHE*, C. GAQUIERE

*STMicroelectronics Crolles, FRANCE; IEMN University of Lille, FRANCE

RTUIF-24: Power Improvement for 65nm nMOSFET with High-Tensile CESL and Fast Nonlinear Behavior Modeling

C.S.Chiu, K.M.Chen, G.W.Huang, K.H.Liao, S.Y.Lin, C.C.Hung*, S.Y.Huang*, C.W.Fan*, C.Y.Tzeng*, S.Chou*

National Nano Device Lab., United Microelectronics Corporation*, National Chiao Tung University**, Taiwan

RTUIF-25: RF Benchmark Tests for Compact MOS Models

G.D.J Smit, A.J Scholten, D.B.M Klaassen

NXP Semiconductors, The Netherlands

RTUIF-26: A 1.8V 74mW UHF RFID Reader Receiver with 18.5dBm IIP3 and -77dBm Sensitivity in 0.18 μ m CMOS

X. Sun, B. Chi, C. Zhang, Z. Wang,

Z. Wang Beijing, 100084, P.R. China

Steering Committee

General Chair	Yann Deval, IMS Lab	Panel Sessions Chair	Bertan Bakkaloglu, Arizona State Univ.
TPC Chair	David Ngo, RFMD	Transactions/Guest Editor	Yuhua Cheng, SHRIME Peking Univ.
TPC Co-Chair	Jacques C. Rudell, Univ. of Washington	Student Papers Chair	Brian Floyd, North Carolina State Univ.
Finance Chair	Albert Jerng, Ralink	Secretary	Albert Wang, UC Riverside
Workshops Chair	Kevin McCarthy, Univ. College Cork	Asia Pacific Liaisons	Noriharu Suematsu, Mitsubishi Electric
Digest & CD ROM Chair	Georg Boeck, Berlin Institute of Technology	Webmaster	Takao Inoue, Univ. of Texas, Austin
Publicity Chair	Kevin Kobayashi, RFMD	Conference Coordinator	Larry Whicker, LRW Associates

Advisory Board

Natalino Camilleri	Fazal Ali	Reynold Kagiwada	Sayfe Kiaei
Louis Liu	David Lovelace	Vijay Nair	Joseph Staudinger

Executive Committee

Tina Quach	Stefan Heinen	Luciano Boglione	Jenshan Lin	Yann Deval
------------	---------------	------------------	-------------	------------

RFIC 2010 Technical Program Committee

Ali Afsahi, <i>Broadcom Corp.</i>	Aditya Gupta, <i>Northrop Grumman</i>	Fujiang Lin, <i>IME Singapore</i>	Carlos Saavedra, <i>Queen's University, Canada</i>
Fazal Ali, <i>Qualcomm</i>	Timothy Hancock, <i>MIT Lincoln Lab</i>	Jenshan Lin, <i>University of Florida</i>	Derek Shaeffer, <i>InvenSense, Inc.</i>
Walid Ali-Ahmad, <i>MediaTek Inc.</i>	Andre Hanke, <i>Infineon Technologies AG</i>	Louis Liu, <i>CT Communication Technologies</i>	Osama Shana'a, <i>MediaTek Corporation</i>
Bertan Bakkaloglu, <i>Arizona State University</i>	Stefan Heinen, <i>RWTH Aachen University</i>	Ting-Ping Liu, <i>Nuvoton Technology</i>	Eddie Spears, <i>RFMD, Inc.</i>
Jean-Baptiste Begueret, <i>University of Bordeaux, IMS Lab</i>	Frank Henkel, <i>IMST GmbH</i>	David Lovelace, <i>ON Semiconductor</i>	Robert Staszewski, <i>Delft University of Technology</i>
Didier Belot, <i>ST Microelectronics</i>	Tian-Wei Huang, <i>National Taiwan University</i>	Danilo Manstretta, <i>University of Pavia</i>	Joseph Staudinger, <i>Freescale Semiconductor Inc.</i>
Paul Blount, <i>Custom MMIC Design</i>	Lars Jansson, <i>Tumbledown Technical Inc.</i>	Kevin McCarthy, <i>University College Cork</i>	Bob Stengel, <i>Motorola</i>
Georg Boeck, <i>Berlin Institute of Technology</i>	Albert Jerng, <i>Ralink</i>	Srenik Mehta, <i>Atheros Communications</i>	Freek van Straten, <i>NXP Semiconductor</i>
Luciano Boglione, <i>University of Massachusetts Lowell</i>	Waleed Khalil, <i>Ohio State University</i>	Jyoti Mondal, <i>Northrop Grumman</i>	Noriharu Suematsu, <i>Mitsubishi Electric</i>
Pierre Busson, <i>ST Microelectronics</i>	Jaber Khoja, <i>Microtune, Inc.</i>	Sule Ozev, <i>Arizona State University</i>	Julian Tham, <i>Arda Technologies</i>
Natalino Camilleri, <i>Alien Technology</i>	Sayfe Kiaei, <i>Arizona State University, Connection One</i>	Stefano Pellerano, <i>Intel Corporation</i>	Bruce Thompson, <i>Motorola Labs</i>
Sudipto Chakraborty, <i>Texas Instruments</i>	Bumman Kim, <i>Pohang University of Science and Technology</i>	Tina Quach, <i>Consultant</i>	Albert Wang, <i>University of California, Riverside</i>
Glenn Chang, <i>MaxLinear</i>	Kevin Kobayashi, <i>RFMD, Inc.</i>	Sanjay Raman, <i>Virginia Tech</i>	Haolu Xie, <i>Fujitsu Microelectronic, Tempe/Fudan University, Shanghai</i>
Jing-Hong Chen, <i>Analog Devices</i>	Larry Kushner, <i>Intersil Corp.</i>	Madhukar Reddy, <i>MaxLinear</i>	Li-Wu Yang, <i>SMIC</i>
Nick Cheng, <i>Skyworks Solutions</i>	Youngwoo Kwon, <i>Seoul National University</i>	Bill Redman-White, <i>NXP Semiconductor</i>	Patrick Yue, <i>University of California, Santa Barbara</i>
Yuhua Cheng, <i>Shrime Peking University</i>	Chang-Ho Lee, <i>Samsung</i>	Eli Reese, <i>TriQuint Semiconductor</i>	Gary Zhang, <i>Skyworks Solutions</i>
Brian Floyd, <i>North Carolina State University</i>	Domine Leenaerts, <i>NXP Semiconductor</i>	Mark Ruberto, <i>Intel Corporation</i>	Herbert Zirath, <i>Chalmers University</i>
Ranjit Gharpurey, <i>University of Texas, Austin</i>	Donald Y.C. Lie, <i>Texas Tech. University</i>	Francis Rotella, <i>Peregrine Semiconductor</i>	



75TH ARFTG MICROWAVE MEASUREMENT CONFERENCE



Welcome to the 75th Automatic RF Techniques Group (ARFTG) Microwave Measurement Conference Hilton Anaheim on Friday, 28 May 2010.

From: Ken Wong, General Chair, 75th ARFTG Conference
John Wood, Technical Program Chair, 75th ARFTG Conference



The conference will include technical presentations, an interactive forum, and an exhibition; all to give you ample opportunity to interact with your colleagues in the automated RF and microwave measurement and test community. The conference theme is "Measurement of Modulated Signals for Communications" with papers focusing on vector signal measurements and complex waveform analysis, nonlinear measurement techniques in time domain and envelope domain, application of digital signal processing to communications signal measurements, on wafer measurements, measure-

ments in fixtures for high power applications, nonlinear modeling, linearization and predistortion techniques, and other areas of RF, microwave and millimeter wave measurements. Also, be sure to check out the joint ARFTG/IMS workshops on mm-wave waveguide measurements and signal integrity. An important part of any ARFTG Conference is the opportunity to interact one-on-one with colleagues, experts and vendors in the RF and microwave test and measurement community. Whether your interests include high-throughput production or one-of-a-kind metrology measurement, complex systems or simple circuit modeling, small to large signal measurements, phase noise or noise figure, dc to lightwave, you will find a kindred spirit or maybe even an expert. Starting with the continental breakfast in the exhibition area, continuing through the two exhibition/interactive forum sessions and the luncheon, there will be ample opportunity for discussion with others facing similar challenges. Attendees find that these interactions are often the best source of ideas and information for their current projects. So come and join us. You'll find that the atmosphere is informal and friendly.

ARFTG STEERING COMMITTEE

EXECUTIVE COMMITTEE			
Conference Chair Ken Wong Agilent Technologies	President Ronald Ginley NIST	Nominations & Awards John Wood Freescale Semiconductor	Sponsorship Rusty Myers Maury Microwave
Technical Program Chair John Wood Freescale Semiconductor	Vice President & Publicity Nick Ridler National Physical Lab	Technical Mohamed Sayed MMS	Electronic Communications Mitch Wallis NIST
Local Host Rusty Myers Maury Microwave	Secretary Jon Martens Anritsu	Education Dominique Schreurs K.U. Leuven	MTT-S Liaison Leonard Hayden Cascade Microtech
Publication Chair David Blackham Agilent Technologies	Treasurer Ken Wong Agilent Technologies	Workshops Jean-Pierre Teyssier University of Limoges XLIM	Exhibits Brett Grossman Intel
Treasurer Ken Wong Agilent Technologies	Publications David Blackham Agilent Technologies	Standards Uwe Arz PTB	Technical Patrick Roblin Ohio State University
Exhibits Brett Grossman Intel			
Administrative Assistant Jim L. Taylor			

ARFTG TECHNICAL PROGRAM COMMITTEE

Peter Aaen Freescale Semiconductor	John Barr Retired	Loren Betts Agilent Technologies	Dave Blackham Agilent Technologies
Slim Boumaiza University of Waterloo	Neil Braithwaite Powerwave	Juan Mari Collantes University of the Basque	Gayle Collins Freescale Semiconductor
Steve Kenney Georgia Tech	Jon Martens Anritsu	Basim Noori Freescale Semiconductor	Nick Ridler National Physical Lab
Patrick Roblin The Ohio State University	Yves Rolain Vrije Universiteit Brussel	Mohamed Sayed MMS	Dominique Schreurs K. U. Leuven
Roland Sperlich Texas Instruments	Bela Szendrenyi Verigy	John Wood (Chair) Freescale Semiconductor	

Find out more about ARFTG and the latest conference updates at www.arftg.org

ARFTG TECHNICAL SESSIONS

PACIFIC A

08:00 – 09:20

Session 1: Modulated Signals for Wireless Communications

Chair: John Wood, Freescale Semiconductor Inc

10:20 – 12:00

Session 2: Nonlinear Measurements

Chair: Dominique Schreurs, KU Leuven

13:20 – 15:00

Session 3: Calibration Techniques

Chair: Dave Blackham, Agilent Technologies, Inc

15:40 – 16:40

Session 4: Other Areas of Microwave and Millimetre-wave Measurements

Chair: Jean-Pierre Teyssier, University of Limoges

Session 1-1: Modern Cellular Wireless Signals (Invited) 8:00 AM-8:40 AM E. McCune, RF Communications Consulting, Santa Clara, United States	Session 2-1: A Simplified Extension of X-parameters to Describe Memory Effects for Wideband Modulated Signals 10:20 AM-10:40 AM J. Verspecht1, D. E. Root2, J. Horn2, 1Jan Verspecht B.V.B.A., Opwijk, Belgium, 2Agilent Technologies, Santa Rosa, United States	Session 3-1: A multi-step phase calibration procedure for closely spaced multi-tone signals 1:20 PM-1:40 PM M. Mirra1, M. Marchetti1, F. Tessitore1, M. Spirito1, L. C. de Vreede1, L. Betts2, 1TU Delft, Delft, Netherlands, 2Agilent technology, Santa Rosa, United States	Session 4-1: Impact of the Pulse-amplifier Slew-rate on the Pulsed-IV measurement of GaN HEMTs 3:40 PM-4:00 PM S. A. Albahrani, A. E. Parker, Macquarie University, Sydney, Australia
Session 1-2: Measurement and Correction of Residual Nonlinearities in a Digitally Predistorted Power Amplifier 8:40 AM-9:00 AM R. N. Braithwaite, Powerwave Technologies, Santa Ana, United States	Session 2-2: Multi-Harmonic Broadband Measurements using a Large Signal Network Analyzer 10:40 AM-11:00 AM Y. Kot1, P. Roblin2, S. Myoung3, J. Strahler4, F. D. Groote5, J. P. Teyssier6, 1The Ohio State University, Columbus, United States, 2The Ohio State University, Columbus, United States, 3Samsung Corporation, Suwon, Republic of Korea, 4Andrew Corporation, Westerville, United States, 5Verspecht-Teysier-DeGroot s.a.s., Brive-la-Gaillarde, France, 6XLIM Limoges University, Brive, France	Session 3-2: Traceable calibration of Vector Signal Analyzers 1:40 PM-2:00 PM D. A. Humphreys, M. R. Harper, M. Salter, National Physical Laboratory, Teddington, United Kingdom	Session 4-2: A Novel Method for Direct Impedance Measurement in Microwave and mm-Wave Bands 4:00 PM-4:20 PM M. Randus, K. Hoffmann, Czech Technical University in Prague, Prague, Czech Republic
Session 1-3: Experimental Sensitivity Analysis of Multi-Standard Power Amplifiers Nonlinear Characterization under Modulated Signals 9:00 AM-9:20 AM M. Ben Ayed, S. Boumaiza, University of Waterloo, Waterloo, Canada	Session 2-3: A VNA based broadband loadpull for non-parametric 2-port Best Linear Approximation Modelling 11:00 AM-11:20 AM Y. Rolain, J. Schoukens, R. Pintelon, L. Delocht, G. Vandersteen, Vrije Universiteit Brussel (VUB), Brussel, Belgium	Session 3-3: A Novel Method for Measuring Phase and Group Delay of Mixers Without a Reference Mixer 2:00 PM-2:20 PM J. P. Dunsmore, J. Ericsson, Agilent Technologies, Santa Rosa, United States	Session 4-3: Inter-laboratory Comparison of Reflection and Transmission Measurements in WR-06 waveguide (110 GHz to 170 GHz) 4:20 PM-4:40 PM M. Salter1, N. Ridler1, P. Goy2, S. Caropen2, J. Watts3, R. Clarke4, Y. Lau5, D. Linton6, R. Dickie6, P. Huggard7, M. Henry7, J. Hesler8, S. Barker9, J. Stanec9, 1NPL, Teddington, United Kingdom, 2AB Millimetre, Paris, France, 3Flann Microwave Ltd, Bodmin, United Kingdom, 4University of Leeds, Leeds, United Kingdom, 5OML Inc, Morgan Hill, United States, 6Queens University Belfast, Belfast, United Kingdom, 7Rutherford Appleton Laboratory, Didcot, United Kingdom, 8Virginia Diodes Inc, Charlottesville, United States, 9University of Virginia, Charlottesville, United States
	Session 2-4: An Intelligence Driven Active Loadpull System 11:20 AM-11:40 AM R. S. Saini, S. P. Woodington, J. Lees, J. Benedikt, P. J. Tasker, Cardiff University, Cardiff, United Kingdom	Session 3-4: A new 75-110 GHz primary power standard with reduced thermal mass 2:20 PM-2:40 PM D. Adamson, J. Miall, J. Howes, M. Harper, R. Thompson, National Physical Laboratory, Teddington, United Kingdom	
	Session 2-5: Investigation of X-Parameters Measurements on a 100 W Doherty Power Amplifier 11:40 AM-12:00 AM J. Wood, G. Collins, Freescale Semiconductor, Inc., Tempe, United States	Session 3-5: Some effects of error term interpolation on network analyzer uncertainties 2:40 PM-3:00 PM J. Martens, Anritsu Company, Morgan Hill, United States	

ARFTG INTERACTIVE FORUM

PACIFIC B

Poster-1: Metrology standards for digital modulation error Based on CW combination 9:30 AM-10:30 AM R. Zhang, F. Zhong, L.Q. Guo, China Academy of telecommunication Research of MIT, Beijing, China	Poster-2: Harmonic Load Pull of High-Power Microwave Devices using Fundamental-Only Load Pull Tuners 9:30 AM-10:30 AM J. Hoversten, M. Robert, Z. Popovic, University of Colorado at Boulder, Boulder, United States	Poster-3: S-functions behavioral model order reduction based on narrow-band modulated large-signal network analyzer measurements 9:30 AM-10:30 AM M. Myslinski1, F. Verbeyst2, M. Vanden Bossche2, D. Schreurs1, 1K.U.Leuven, Leuven, Belgium, 2NMDG n.v., Bornem, Belgium	Poster-4: X-Parameter Measurement Challenges for Unmatched Device Characterization 9:30 AM-10:30 AM D. T. Bespalko, S. Boumaiza, University of Waterloo, Waterloo, Canada
Poster-5: Time reference for measurements of arbitrarily shaped pulses. 9:30 AM-10:30 AM M. Odyniec, NSTec, Livermore, , United States	Poster-6: Analysis of Phase Noise Effect On Microwave Attenuation Precision Measurement Using A Heterodyne Receiver 9:30 AM-10:30 AM T. Y. Wu1, S. W. Chua1, Y. L. Lu2, 1A*STAR, Singapore, Singapore, 2Nanyang Technological University, Singapore, Singapore	Poster-7: Automation of Absolute Phase/Power Calibrations Applied to Real Time Large Signal Systems 9:30 AM-10:30 AM I. Volokhine, NXP Semiconductors, Nijmegen, Netherlands	Poster-8: Uncertainties in Coplanar Waveguide and Microstrip Line Standards for On-Wafer Thru-Reflect-Line Calibrations 9:30 AM-10:30 AM U. Arz, K. Kuhlmann, PTB, Braunschweig, Germany
Poster-9: Multimode TRL Technique for De-embedding of Differential Devices 9:30 AM-10:30 AM M. Wojnowski1, V. Issakov2, G. Sommer1, R. Weigel3, 1Infineon Technologies AG, Neubiberg, Germany, 2University of Paderborn, Paderborn, Germany, 3University of Erlangen-Nuremberg, Erlangen, Germany	Poster-10: Comparison of noise figure calibration and measurement techniques using noise figure verification techniques 9:30 AM-10:30 AM B. Shoulders, K. H. Wong, Agilent Technologies, Santa Rosa, United States	Poster-11: An Improved Method to Extract the Parasitic Capacitances Cpg and Cpd of AlGaIn/GaN FETs 9:30 AM-10:30 AM J. R. Loo-Yau1, J. A. Reynoso-Hernández2, 1Centro de Investigacion y Estudios Avanzados del I. P. N., Guadalajara, Mexico, 2Centro de Investigacion Cientifica y Educacion Superior de Ensenada, Ensenada, Mexico	



WORKSHOPS AND SHORT COURSES

Workshops and Short courses are offered on Sunday, Monday and Friday of Microwave week. Please see daily handout on Sunday, Monday, and Friday in the registration area and from volunteers through out the meeting floors to confirm room location.

SUNDAY WORKSHOPS

WSA (IMS)

Sunday, 08:00 - 12:00

Software Defined Radio for Microwave Applications

Reviewed by: MTT-9, MTT-20

Organizers:

Jeffrey Pawlan, *Pawlan Communications*
Hermann Boss, *Rohde & Schwarz*

Abstract: Software Defined Radio (SDR) is the most significant innovation and change to radio communications since 1990. From HF to microwave frequencies, it allows the use of a fixed hardware platform to change bands, frequencies, and modulation types without any change in the hardware at all. This synergistic combination of analog and digital microwave hardware combined with software has significantly improved performance, allowed for great flexibility to ever-changing modulations and standards, shortened development time, and reduced cost. This workshop will make SDR understandable and applicable to microwave engineers. It will begin with a clear explanation of how SDR works and its evolution through several generations of refinements. You will see and hear SDR in action with several live demonstrations of operating hardware and software along with test equipment. Your future work as a microwave engineer will be put in perspective with the current and future radio requirements. Actual space communications SDR hardware and software will be demonstrated by the second speaker who is from JPL / NASA. Cognitive Radio, a new related field, will be presented by a third speaker. SDR makes it possible to dynamically assess spectrum activity and change the modulation format to allow multiple signals to co-exist on the same frequency without interference or jamming. This workshop will be practical and emphasize weak signal communications and commercial applications.

Speakers:

1. Jeffrey Pawlan, *Pawlan Communications*
"Software Defined Radio for Weaksignal and Commercial Applications"
2. James Lux, *JPL*
"The Adoption of SDR by NASA for Space Communications"
3. Vasu Chakravarthy, *Air Force Research Laboratory/Sensors Directorate*
"An Introduction to Cognitive Radio and its Implementation"

WSB (RFIC)

Sunday, 13:00 - 17:00

Advances in Filtering and Sampling for Integrated Transceivers

Reviewed by: RFIC, MTT-9, MTT-20

Organizer:

Tom Riley, *Kaben Wireless Silicon Inc.*

Abstract: Blocker and interference filtering is a key issue in highly integrated Software Defined Radio (SDR) Receivers. If blockers can be removed prior to the ADC and

conversion to the digital domain, power and area in the ADC can be greatly reduced. This workshop will show how Analog, sampled-time signal processing can be used to implement highly selective FIR, IIR and spatial FIR filters. N-path filtering can be used to design high bandwidth filters using low bandwidth analog components. Component mismatch, timing jitter and other sources of error that can affect receiver performance will be discussed. Linearity enhancement techniques for filters will be presented, as well as wideband RF front-end circuit techniques. For added blocker rejection, notched Delta-Sigma data converters are presented. Following each speaker's presentation, the floor will be opened for interactive discussion with the audience.

Speakers:

1. Tom Riley, *Kaben Wireless Silicon Inc.*
"Advances in Discrete-Time Analog Filtering"
2. Bogdan Staszewski, *Technical University of Delft*
"Discrete-Time Receiver"
3. Asad Abidi, *University of California, Los Angeles*
"A Discrete-Time Wideband Receiver for Software-Defined Radio"
4. Martin Snelgrove, *Kapik Integration Inc.*
"Interference Mitigation in Receivers"

WSC (RFIC)

Sunday, 8:00 - 17:00

Interference, Noise and Coupling Effects in Modern SoC and SiP Products: Issues, Problems and Solutions

Reviewed by: RFIC, MTT-6, MTT-12

Organizers:

Jan Niehof, *NXP Semiconductors*
Matthias Locher, *ST-Ericsson; Oren Eliezer, Xtendwave*

Abstract: The focus of this interactive workshop will be on resolving noise and self-interference problems: on-chip coupling effects, chip-package co-design, substrate issues, noise (inherent and external), coupling-aware RFIC floor planning, digitally assisted solutions for interference problems, EMC (chip and board level), design practices, and CAD/EDA modeling capabilities to effectively analyze and address these effects. Recognized companies and partnerships active in the semiconductor industry will present actual issues encountered in their designs and the solutions/design-practices used to address them, including key lessons learned. Interactive discussions will be facilitated to exchange valuable ideas for the benefit of participants and the industry at large.

Speakers:

1. Nikos Haralabidis, *Broadcom*
"Self-Interference in Multi-Standard RF SoC Transceivers"
2. Dietolf Seippel, *Infineon*
"Floor planning of complex Baseband-Radio SoCs in consideration of cross talk prevention"
3. Matthias Locher, *ST-Ericsson*

"A Bottom-Up Design and Verification Approach for Coexistence in Multi-System SoCs"

4. Ayman Fayed, *Iowa State University, Oren Eliezer, Xtendwave*
"System-level methodology for the power management system design in complex SoCs: minimize the impact of interference through the supply"
5. Jonathan Jensen, *Intel*
"Isolation and coexistence challenges – a single-chip Bluetooth/WiFi combo example"
6. Jan Niehof, *NXP Semiconductors*
"Interference issues and coupling effects in RF products"
7. Ravi Subramanian, *Berkeley Design Automation*
"Advances in CAD: Simulation & Analysis of RF SoCs"

WSD (IMS)

Sunday, 8:00 - 17:00

Ultra-Wideband (UWB) Technology: The State-of-the-Art and Applications

Reviewed by: MTT-15, MTT-16

Organizers:

Zhizhang (David) Chen, *Dalhousie University*
Hong (Jeffery) Nie, *University of Northern Iowa*

Abstract: Since the FCC issued a Report and Order allowing license-free use of 0-960 MHz and 3.1-10.6GHz frequency bands in 2002, extensive research and development efforts have been made worldwide in utilizing these ultra-wide-band (UWB) frequency allocations for applications such as microwave imaging, high-speed short-range wireless communications, and wireless sensor networks. Despite a couple of setbacks in its commercialization, UWB technology and application continue to advance. More UWB algorithms and hardware design approaches are emerging. This workshop presents the latest developments of various UWB technologies, paving the way for ultimate realization of practical UWB systems. The workshop provides insight into (a) the operating principles and limitations of UWB systems, (b) design and test of UWB antennas, components, RF front-ends and transceivers, (c) the state-of-the-art in UWB signal processing algorithms, and (d) future trends in the UWB systems and their applications. This workshop will be beneficial to students, engineers and researchers who want to learn about the current status of UWB and related designs, tests and applications, and who want to follow and understand the recent developments and advanced applications of UWB.

Speakers:

1. Dave Michelson, *University of British Columbia*
"Deployment of UWB Wireless Systems in Industrial Environments"
2. Zhining Chen, *Institute for Infocomm Research*
"Miniaturization of Ultra-Wideband Antennas"
3. Ke Wu, Serge O. Tatu and Renato G. Bosisio, *École Polytechnique de Montréal*
"Multi-Port Interferometers for UWB Transceiver Systems and Applications"
4. Natalia Nikolova, *McMaster University*
"Direct Methods for Detection and Imaging with Microwave Measurements in the Ultra-wide Band"
5. Aly Fathy and Mohamed R. Mahfouz, et. al., *University of Tennessee*
"Recent Trends and Advances in UWB Positioning"
6. Hong Nie, *University of Northern Iowa*
"Code Shifted Reference UWB transceiver and Its Applications for Intra-Vehicle Control and Communication"
7. Zhizhang (David) Chen, *Dalhousie University*
"UWB Reference-based Impulse Radio Systems and Hardware Design Issues"

WSE (IMS)

Sunday, 8:00 - 17:00

High Speed Signal Integrity Workshop

Reviewed by: MTT-11, MTT-12

Organizers:

Brett Grossman, *Intel Corporation*
Mike Resso, *Agilent Technologies*

Abstract: The triple play of voice, video, and data continues to demand ever greater bandwidths from devices and interconnects. This requirement is driving the challenges faced by the signal integrity engineer into a realm which may seem somewhat familiar to the microwave engineer. However, the challenges associated with frequency content, coupled with the density of signals, and the need to fit into relatively low cost consumer products, are a unique set of constraints which drive these solutions. This signal integrity workshop will feature presentations which discuss practical case studies, as well as more fundamental and theoretical signal integrity research. You are welcome to attend and listen to industry and academic experts describe several of the latest developments in the field of high speed signal and power integrity.

Speakers:

1. Paul Huray, *University of South Carolina*
"Bridging the Gap"
2. Michael Hill, *Intel Corporation*
"Microprocessor Power Integrity – Metrologies and Future Challenges"
3. Heidi Barnes, *Verigy*
"The Art of VNA Calibrations for Measuring Low Loss PCB Components"
4. Matthew Claudius, *Intel Corporation*
"End Use Model Correlation"
5. Bob Schaefer, *Agilent Technologies*
"Comparison of Fixture Removal Techniques for Connector and Cable Measurements"
6. Jim Rautio, *Sonnet Software*
"Measurement and Analysis of Substrate Dielectric Constant Anisotropy"
7. Evan Fledell, *Intel Corporation*
"Passive Interconnect Frequency Domain Characterization for Mixed-Medium and Vertical Interconnect Systems"
8. Leung Tsang, *University of Washington*
"Electromagnetic Modeling of High Speed Vertical Interconnect on Chip-Package-Board"



WSF (IMS)

Sunday, 8:00 - 17:00

**GaN for High Power, High Bandwidth Applications:
Finally Fulfilling the Promise**

Reviewed by: MTT-5, MTT-6, MTT-7

Organizers:

Bill Vassilakis, *Empower RF Systems*
David W. Runton, *RF Micro Devices*

Abstract: GaN circuits have, for a long time, promised to enable amplifier applications that have not been possible with GaAs or LDMOS such as higher temperatures of operation, large operating bandwidths, and higher operating power. Material quality problems have slowed the progress on the delivery of such applications leaving many wondering when GaN would displace incumbent technologies. GaN has also defied declining cost trends of semiconductors, due to higher processing costs, smaller wafers, and lower yields. In the commercial market, dollars per watt delivered has long dominated in the selection of technology. Other factors such as efficiency, the ability to pre-distort, and linearity have been secondary. GaN is at last emerging as a serious contender for both commercial and military applications, as we see more demand for power, efficiency and larger bandwidths of operation. As other technologies are reaching inherent limits, GaN is finally ready for prime time.

Speakers:

1. Norihiko Ui, *Sumitomo Electric Device Innovations*
"Power and High Efficiency GaN-HEMTs for Cellular Base Station Applications"
2. Oualid Hammi and Fadhel M. Ghannouchi, *iRadio Lab, Department of Electrical and Computer Engineering, University of Calgary*
"Power Amplifiers for Wireless Communication Infrastructure"
3. Dr. James J. Komiak, *BAE Systems Electronic Solutions*
"Progress in High Power GaN HEMT Power Amplifiers for Wideband Applications"
4. Simon Wood, *Cree Inc.*
"Trends in high power GaN transistors and MMICs"
5. Bumman Kim, *Pohang University of Science and Technology*
"Highly Efficient Saturated Power Amplifier based on GaN – A class P amplifier"
6. David W. Runton, *RF Micro Devices*
"Defining Application Spaces for High Power GaN"
7. Rik Jos, *NXP Semiconductors*
"GaN HEMT and their commercial RF power applications"

WSG (RFIC)

Sunday, 8:00 - 12:00

MOSFET Modeling for RFIC Design Based On the Industry-Standard PSP Model

Reviewed by: RFIC, MTT-6

Organizers:

Kevin McCarthy, *University College Cork*
Weiman Wu, *Arizona State University*

Abstract: This workshop will present an overview of the state-of-the art in MOSFET modeling for the design of CMOS Radio Frequency ICs using modern nanometer-scale

CMOS. It focuses on the industry-standard PSP (MOSFET) and MOSVAR (varactor) models. The workshop will review the fundamentals of both models and demonstrate the highly-accurate RF simulation capabilities they provide for RFIC designs. The workshop will also show how the PSP model can be extended to SOI and Multi-Gate devices, which will become of increasing importance to RFIC design.

Speakers:

1. Gert-Jan Smit, *NXP Semiconductors*
"The PSP Compact MOSFET Model: Physical Background and Benefits for RFIC Design"
2. Brandt Braswell, *Freescale Semiconductor*
"Deployment of an Advanced MOSFET Model in an Industrial Context"
3. James Victory, *Sentinel IC Technologies*
"MOSVAR – A PSP-Derived MOS Varactor Model"
4. Weimin Wu, *Arizona State University*
"PSP-Based Modeling of SOI and Multi-Gate MOS Devices"

WSH (RFIC) Sunday, 8:00 - 17:00

Power Management for Integrated RF Circuits: Challenges and Solutions

Reviewed by: RFIC, MTT-6

Organizers:

Ayman Fayed, *Iowa State University*
Waleed Khalil, *Ohio State University*; Oren Eliezer: *Xtendwave*

Abstract: The recent expansion in the use of mobile communications and multi-media devices has fueled the demand for various wireless/RF transceivers to be integrated in a single SoC with the digital processing circuitry and power management functions. As battery life in mobile devices is critical, and with these transceivers typically not operating directly from the battery, regulating and delivering power to them in an efficient manner is becoming a bottleneck. Since power delivery efficiency and implementation cost on one hand, and noise and regulation quality on the other hand are two contradictory factors in traditional power management circuits, RF loads present a great challenge due to their high sensitivity to their power supply quality. This workshop will discuss the challenges and tradeoffs that power management designers have to make when designing for RF loads while maintaining high efficiency and cost-effectiveness.

Speakers:

1. Ayman Fayed, *Iowa State University*
"Challenges in Integrated Power Management for Analog, RF, and mixed-signal SoCs"
2. Keith Kunz, *Texas Instruments*
"Integrated DC-DC converters in nanometer CMOS RF SOCs"
3. Bertan Bakkaloglu, *Arizona State University*
"Low-noise switched-mode and low-dropout linear regulators for RF applications"
4. Siamak Abedinpour, *Freescale*
"An overview of Integrated Power Management Circuits for Portable RF applications"
5. Sam Palermo, *Texas A&M University*
"Supply Regulation Techniques for Frequency Synthesizers"

6. David Allstot, Jeffery Walling, *University of Washington*
"Supply Regulators in Class-E/G/H CMOS Power Amplifiers"
7. Ram Sathwani, *Intel*
"Direct powering of RF and analog circuits from DC-DC converters"
8. Ahmed Emira, *Newport Media*
"DC-DC converters noise considerations in RF SoCs"

WSI (IMS)

Sunday, 8:00 - 17:00

Substrate Integrated Circuits (SICs)

Reviewed by: MTT-8, MTT-12

Organizers:

Maurizio Bozzi, *University of Pavia*
Ke Wu, *Ecole Polytechnique (Université de Montréal)*

Abstract: Substrate integrated circuits (SICs) are probably the most promising candidate for the design and implementation of low-cost and high-density millimeter-wave integrated circuits and systems in the next decades. SICs, which integrate planar and non-planar structures together, are able to offer a compact, low-loss, flexible, high integration density, and cost-effective solution for integrating active circuits, passive components and radiating elements on the same substrates including multilayered geometries regardless of technological platforms such as PCB, LTCC, MHMICs, MMICs and even CMOS processes. In this way, the concept of System-in-Package (SiP), widely adopted in the design of RF/microwave circuits, can be extended to System-on-Substrate (SoS) for up-higher frequency ranges. This technological concept can be extended to terahertz and optoelectronic domains. The aim of this workshop is to provide an overview of the current trends of research and development in the field of SICs, including modeling methods, innovative structures, design techniques and technological issues.

Speakers:

1. Ke Wu, *Ecole Polytechnique (Université de Montréal)*
"State-of-the-art and Future Perspective of Substrate Integrated Circuits"
2. Tatsuo Itoh, *University of California*
"Progress in Composite Right/Left Handed Structures based on Substrate Integrated Waveguide"
3. Vicente E. Boria-Esbert, *Polytechnic University of Valencia*
"Computer-Aided Design Tools of Passive Circuits in Substrate Integrated Waveguide Technology"
4. Jens Bornemann, *University of Victoria*
"Multilayered Substrate-Integrated Waveguide Couplers"
5. Maurizio Bozzi, *University of Pavia*
"Full-Wave Analysis and Equivalent-Circuit Modeling of SIW Components"
6. Ruey-Beei Wu, *National Taiwan University*
"Development of LTCC mm-wave Passive Components for SoP Wireless Applications"
7. Apostolos Georgiadis, *Centre Tecnològic de Telecomunicacions de Catalunya*
"Oscillator and active antenna design in SIW technology"
8. Roberto Vincenti Gatti, *University of Perugia*
"SIW components and solutions for large electronic beam steering arrays"
9. Stepan Lucyszyn, *Imperial College*
"Substrate Integrated Metal-Pipe Rectangular Waveguides"

WSJ (RFIC)

Sunday, 8:00 - 17:00

Re-configurable Multi-Radios at the Nanoscale

Reviewed by: RFIC, MTT-6, MTT-20

Organizers:

Gernot Hueber, *DICE*
Robert Bogdan Staszewski, *Delft University of Technology*
Stefan Heinen, *RWTH Aachen University*

Abstract: Advances in CMOS fabrication technology have enabled the use of CMOS in today's RF transceivers for wireless communications. Multi-band and multi-mode radios covering the diversity of communication standards from 2G GSM, 3G UMTS, to 4G LTE impose unique challenges on the RF-transceiver design due to limitations of reconfigurable RF components that meet the demanding cellular performance criteria at costs that are attractive for mass market applications. Nanoscale CMOS on one hand features the possibility for implementing a significant computational power and complex functionality directly on a single IC, on the other hand it shows poor raw performance or RF circuits compared to other technologies. The focus of this workshop is on the challenges the cellular standards pose on future multi-radio integration in nanoscale CMOS, along with a thorough discussion of advanced techniques for receivers and transmitters towards integration in a multi-radio SoC or SiP. Approaches include novel architectures, highly configurable analog circuitry, digitally assisted and enhanced analog/RF modules and the integration of digital signal processing into the traditionally purely analog front-ends.

Speakers:

1. Gernot Hueber, *DICE*
"Flexible RF Transceivers for 4G Systems"
2. Ali M. Niknejad, *UC Berkeley*
"High Dynamic Range Wide Bandwidth Building Blocks for Multi-Mode CMOS"
3. Vito Giannini, *IMEC*
"The Green-Scalable Revolution of Nanoscale Software-Defined Radios"
4. Jaques C. Rudell, *University of Washington*
"Nanometer CMOS Transceiver Design Enters the Era of "Co-Existence" and the SDR"
5. Hooman Darabi, *Broadcom*
"Radio architectures for 2/3/4G highly integrated cellular applications"
6. Francois Rivet, *IMS Lab, University of Bordeaux & Atlantic Innovation ES, France*
"Towards Software Radio Receiver"
7. Ali Hajimiri, *Caltech*
"Electromagnetically Reconfigurable Radios: Antenna Meets Digital"
8. Frank Op 't Eynde, *Audax-Technologies Ltd.*
"Unsolved Issues in SDR RF Frontends"
9. Larry Larson, *University of California*
"Low-Power Transmitters in Nanoscale CMOS"
10. Robert Bogdan Staszewski, *TU Delft*
"Advances in Digital RF Architectures"



WSK (RFIC)

Sunday, 8:00 - 17:00

Multi-Mode Front End Design Challenges and Techniques

Reviewed by: RFIC, MTT-6, MTT-20

Organizers:

Edward Spears, *RFMD*
 Nick Chang, *Skyworks Solutions*

Abstract: With the proliferation of data services, mobile device original equipment manufacturers (OEMs) are presented with new, unprecedented challenges and demands from both mobile operators and consumers. Mobile operators require customized handsets and mobile devices to meet various consumer roaming needs, and the issue of rapid customization has fallen to OEMs who must configure these complex 3G devices to function in multiple frequency bands and operating modes (GSM, EDGE, WCDMA, HSPA+, with LTE on the horizon). As the number of bands and band combinations grow, frequency flexibility and signal routing at the platform level have increased in importance as critical parameters for 3G mobile device development. This sets up an unprecedented challenge for front end suppliers, who are challenged to design a broad portfolio of high-performance, multi-band, multimode front ends and components that offer frequency flexibility, ease of implementation, size reduction, and low current consumption. Presentations in this workshop will focus on the design challenges to meet these multi-mode front end requirements along with the required advancements in device technology and design techniques to meet the overall bandwidth and efficiency requirements. Design techniques of linearization, efficiency enhancement, power detection and controls will be covered in design examples utilizing various technologies such as GaAs HBT, CMOS, Silicon-on-Insulator and Silicon Germanium.

Speakers:

1. Ville Vintola, *Nokia*
"OEM prospective for Multi-mode solutions"
2. Ray Arkiszewski, *RFMD*
"GaAs HBT Multi Mode Amplifiers"
3. David Ripley, *Skyworks Solutions*
"Multi-mode, Multiband Power Amplifiers and Serial Bus Interface Standards"
4. Larry Larson, *University of California at San Diego*
"Design Techniques for Broadband Efficient Linear Power Amplifiers for Multi-Mode Wireless Applications"
5. Dan Nobbe, *Peregrine*
"Multimode Antenna Switch Modules"
6. Nadim Khat, *RFMD*
"Tunable Front Ends Performance Benefits"
7. Pasi Tikka, *Epcos*
"Multimode Filter and Switch Modules"

WSL (IMS/RFIC)

Sunday, 8:00 - 17:00

Silicon-Based Technologies for Millimeter-Wave Applications

Reviewed by: MTT-6, MTT-16, RFIC

Organizers:

Jitendra Goel, *Raytheon Company*;
 Lance Wei-Min Kuo, *Raytheon Company*
 Didier Belot, *STMicroelectronics*
 Eric Kerhervé, *IMS Lab*
 Georg Boeck, *TU Berlin*

Abstract: Traditionally, millimeter-wave (MMW) circuits utilizing only III-V technologies have been employed in low-volume, high-performance products. With the recent progress of highly scaled Si-based (SiGe and CMOS) technologies achieving f_t and f_{max} beyond 200 GHz, the application space of Si-based technologies has broadened from digital, analog, RF, and microwave domains to include MMW applications. The workshop will focus on MMW applications such as imaging (94 GHz and 140 GHz), automotive radar (LRR at 77 GHz and SRR at 79 GHz), and wireless high data rate communications (W-HDMI at 60 GHz). It gives an overview of recently developed architectures, circuit design techniques, and antenna configurations to meet the demanding performance specifications of MMW applications.

Speakers:

1. Ali Hajimiri, *California Institute of Technology*
"Si Millimeter-Wave Systems"
2. Gabriel M. Rebeiz, *University of California at San Diego*
"Ultra-Low Power Millimeter-Wave Phased Arrays and Gbps Communications Systems Using On-Chip Antennas"
3. M. C. Frank Chang, *University of California, Los Angeles*
"60-1300 GHz Circuit/System Developments Based on Super-Scaled CMOS"
4. Tian-Wei Huang and Huei Wang, *National Taiwan University*
"Millimeter Wave Broadband Multi-Gigabit CMOS Transceiver Design"
5. Scott K. Reynolds, *IBM T. J. Watson Research Center*
"Millimeter-Wave Circuits and Systems Work at IBM Research"
6. Piet Wambacq, *IMEC*
"CMOS Radio Integration for High-Datarate 60 GHz Applications"
7. Ali Niknejad, *UC Berkeley*
"mm-Wave Medical Imaging Using a 94 GHz Time-Domain Ultrawide-band Synthetic Imager (TUSI)"
8. Ullrich Pfeiffer, *University of Wuppertal*
"Silicon Process Technologies for Emerging Terahertz Applications"
9. Pierre Busson, *STMicroelectronics*
"60 GHz W-HDMI Transceiver"
10. Joy Laskar, *Georgia Tech*
"mmW Digital CMOS Radio Solutions for Ultra-Low Power, High Resolution Sensing and High Bandwidth Connectivity"
11. Katya Laskin, *University of Toronto*
"140 GHz Imaging"

WSM (IMS/RFIC)**Sunday, 8:00 - 17:00****RF Packaging Solutions for Wireless Communication Platforms**

Reviewed by: MTT-12, MTT-20, RFIC

Organizers:Telesphor Kamgaing, *Intel Corporation*Vijay Nair, *Intel Corporation*Clemens Ruppel, *TDK-EPC*

Abstract: In order to satisfy the decreasing form factor and increasing functionality demand from novel devices such as netbooks and smartphones, it is imperative to create a platform, where different radios and digital logic have to co-exist. This ultimate goal can only be achieved by overcoming various significant challenges at the silicon, packaging and testing levels. This full day workshop will focus on recent research and development work that will enable future ultra-small form factor computing and communication devices that incorporate one or multiple radios on the same platform. Various technology ingredients and packaging solutions for 60GHz, WiFi, WiMAX, Bluetooth, GPS and 3G/4G radios among others will be addressed by leading industrial and academic experts in the field.

Speakers:

1. Vijay Nair, *Intel Corporation*
"Multi-protocol Multi-radio Wireless Platform Integration Challenges"
2. Joy Laskar, *Georgia Institute of Technology*
"Development of Millimeter-Wave QFN: CMOS, PCB and Phased Array"
3. Anh-Vu Pham, *University of California, Davis*
"Development of Ultra-small Wireless Passive Modules Using 3-D Organic Metamaterials"
4. Telesphor Kamgaing, *Intel Corporation*
"Package Level Realization of Passives for Multiradio Wireless Modules"
5. Clemens Ruppel, *TDK-EPC*
"Front-End Integration for Multi-Band, Multi-Standard Mobile Phones Based on LTCC"
6. William Chappell, *Purdue University*
"Silicon on Silicon Packaging Using Self-aligned Interconnects"
7. Walter De Raedt, *IMEC*
"3D Heterogeneous Integration Techniques for Wireless Devices"
8. Kevin Slattery, *Intel Corporation*
"RF Interference in Small Form Factor Devices"

WSN (IMS)**Sunday, 8:00 - 17:00****The State of Art of Microwave Filter Synthesis, Optimization and Realization**

Reviewed by: MTT-8, MTT-16

Organizers:Ming Yu, *COM DEV, Canada*John Bandler, *McMaster University*

Abstract: Today systems require increasingly sophisticated microwave filters and multiplexers. The designer often faces the challenges of compromising between several contrasting requirements. This workshop will present a comprehensive overview of the state of the art of microwave filter synthesis, optimization and realization. Recent advances in some of the most promising application areas of microwave filters; innovative solutions concerning both design approaches and technological achievements will also be presented.

Speakers:

1. Dick Snyder, *RS Microwave*
"Phase Shift, Delay, Anomalous Dispersion, and Meta-Materials: Implications for Future Filter Designs"
2. John W. Bandler, *McMaster University*
"Advanced Optimization Techniques for Modern Filter Design—From Newton to Space Mapping"
3. Smain Amari, *RMC, France*
"New Development in the Synthesis and Design of Microwave Filters of Arbitrary Bandwidth"
4. K. Zaki, *University of Maryland*
"Dielectric Resonator and LTCC Filters"
5. Jen-Tsai Kuo, *National Chiao Tung University*
"Microwave Planar Filter Technologies"
6. G. Macchiarella, *Politecnico di Milano*
"Advanced Filter Technologies for Wireless Base Stations"
7. Ming Yu, *COM DEV*
"Advanced Filter/Multiplexer Technologies for Satellite Transponders"
8. Ian Hunter, *University of Leeds*
"Advanced Tunable and Reconfigurable Filters"
9. Vicente E. Boria-Esbert, *University of Valencia*
"Prediction Models of RF Breakdown Effects in Passive Components for Satellite Payloads"



MONDAY WORKSHOPS AND SHORT COURSES

WMA (IMS)

Monday, 08:00 - 17:00

SiGe HBTs towards THz Operation

Reviewed by: MTT-4, MTT-7, MTT-11

Organizers:

Paulius Sakalas, *TU Dresden and FPL Semiconductor Physics Institute*
Michael Schroter, *RFnano Corporation and UC San Diego, USA*

Abstract: This workshop will overview state-of-the-art SiGe HBT technology and its perspectives, aiming at operation towards TeraHertz frequencies: (1) the technology aspects, (2) the most relevant physical effects and the concepts of analytical formulations for compact modeling and the (3) physical limits, explored by device simulation in the framework of semi-classical transport theory (doping profiles, dimensions, lattice stress effects), (4) high frequency noise trends and practical noise modeling, (5) cryogenic operation as a mean to assess the basic physical properties and transport physics of SiGe HBTs, (6) circuits for wireless applications with mm-wave front-end for short and long-range radar, phased-array transceivers, imaging and (7) circuits for fiber optical applications such as next generation data transport in 100 Gigabit Ethernet networks a range of components from 112 Gb/s for simple on-off-keying (OOK) to 30 or even 60 GS/s A/D and D/A converters for sophisticated modulation schemes like OFDM or CPDQPSK as well as (8) calibration, de-embedding techniques at mm-frequencies and beyond.

Speakers:

1. H. Rucker, *Innovations for High Performance (IHP)*
"Technology aspects of high-speed SiGe HBTs"
2. M. Schroter, *RFnano Corporation*
"Compact modeling of high speed SiGe HBTs"
3. C. Jungemann, *Bundeswehr Universität München*
"Exploring high speed SiGe HBTs and their limits by physics based simulation"
4. P. Sakalas, *TU Dresden and FPL Semiconductor Physics Institute*
"High frequency noise in SiGe HBTs, practical modeling, challenges"
5. J. Cressler, *Georgia Institute of Technology*
"Using cryogenic temperatures to probe physics and scaling limits of SiGe HBTs"
6. J. Long, *Delft University*
"SiGe HBTs in Wireless Applications"
7. M. Moeller, *Saarland University and Micram GmbH*
"Circuit design with SiGe HBTs for future 100 Gb/s data transport network"
8. A. Rumiantsev, *Suss Microtec*
"Measurement accuracy at mm-frequencies and beyond: on-wafer calibration vs. de-embedding techniques. Who wins for THz SiGe HBTs"

WMB (IMS)

Monday, 08:00 - 17:00

Advances in Photovoltaic Solar Cell Technology and its Possible Applications in Microwave Communications Systems as an Energy Source

Reviewed by: MTT-4, MTT-10, MTT-16

Organizers:

Aly E Fathy, *University of Tennessee*
Samir El-Ghazaly, *National Science Foundation*
Fuad Abulfotuh, *University of Alexandria*

Abstract: This workshop will address the need to: create a revolution in existing PV systems, develop new technologies, increase efficiency, significantly reduce associated costs, and discuss ways to extend the limits of various enabling technologies such as: single-crystal solar, thin films, organic semiconductors, dye sensitization, and quantum dots. Recent advances in the fabrication of nanoscale architectures to develop low-cost material and device technologies will be presented with emphasis on developing THz components, nanotennas, and demonstrating various possible applications in microwave communications systems.

Speakers:

1. Samir El-Ghazaly, *NSF*
"Novel Devices for capturing solar energy spectrum"
2. Steven Novack, *Idaho National Lab (INL)*
"The Nanoantenna Prospect for Harvesting Energy"
3. Nathan Lewis, *Caltech*
"Advances in Photovoltaics Enabled by Nanotechnology"
4. Hameed Naseem, *University of Arkansas*
"Low Cost Plasmon Enhanced Thin Silicon Solar Cells using Aluminum Induced Crystallization of Amorphous Silicon at Low Temperatures"
5. Arthur Nozik, *NREL*
"Third Generation Solar Photon Conversion to Electricity: Multiple Exciton Generation in Silicon and Group IV-VI Quantum Dots; Quantum Dot Arrays and Solar Cells"
6. Aimin Song, *University of Manchester*
"Terahertz nano-Diodes for Energy"
7. Sandra Rosenthal, *Vanderbilt University*
"CdSe Nanocrystal Sensitized TiO₂ Nanotube Arrays Incorporated in Solid-State, Ordered-heterojunction Solar Cells"
8. Tim Anderson, *University of Florida*
"Synthesis Routes for CuInxGa1-xSe2 Thin Film Absorbers"
9. Fuad Abulfotuh, *University of Alexandria*
"Concentrated Photovoltaics: Advanced Technology with economic Performance"

WMC (IMS) Monday, 08:00 - 17:00

Recent Advancements and Challenges in mm-Wave Applications and Systems

Reviewed by: MTT-6, MTT-12, MTT-16

Organizers:

Amin Rida, *Georgia Institute of Technology*
 Manos Tentzeris, *Georgia Institute of Technology*
 Seung Lee, *Toyota Research Institute North America*

Abstract: MM-Wave technology has been rapidly evolving and is characterized with a plethora of benefits for several applications such as: broadband communication, automotive radars, imaging, and radio astronomy systems. This workshop highlights recent advancements and discusses the challenges in mm-Wave applications and systems. Active as well as passive mm-wave systems will be covered. Topics include: mm-wave imaging arrays (from 30 to 94 GHz) with designs approaching RF-VLSI status, architectures of several recently produced highly integrated MMICs for military and space applications using GaAs and SiGe as well as CMOS sub-mm oscillators. Integration examples such as FMCW System on Chip will be demonstrated. The second part of the workshop will focus on the passive RF-Front Ends (packaging considerations, interconnections, antenna arrays, and scanning arrays employing phase shifters) as well as on some radio architectures that realize beamforming. In addition, a talk on mm-wave imaging system for radio astronomy will be given. A panel session with speakers and attendees will be held as a conclusion of this workshop.

Speakers:

1. S. Nicolson, *MediaTek USA*
"Recent Advancements and Challenges in mm-Wave Applications and Systems"
2. Dave Saunders, *ViaSat Advanced Microwave Products*
"Highly Integrated MMIC Design – Advantages and Pitfalls"
3. G. Rebeiz, *University of California San Diego*
"Large Scale Phased Arrays for Millimeter-Wave Applications"
4. Q. Jane Gu, *University of California Los Angeles*
"Terahertz Circuits in CMOS"
5. P. Wambacq, *IMEC*
"Riding the mm-Waves, Destination Many Gbit/s"
6. L. Roselli, *University of Perugia*
"MIOS: 90 GHz Space Based Radiometer for Observation of Sun Flares"
7. J. Volakis, *Ohio State University*
"mm-Wave Front-end Modules for 60 GHz Wireless Systems"
8. A. Rida, *Georgia Institute of Technology*
"Low Cost Integrated mm-Wave Automotive Systems"

WMD (IMS) Monday, 08:00 - 17:00

New Microwave Devices and Materials Based on Nanotechnology

Reviewed by: MTT-15, IMS2010

Organizers:

Luca Pierantoni, *Università Politecnica delle Marche*
 Fabio Coccetti, *LAAS-CNRS*
 Christophe Caloz, *École Polytechnique de Montréal*
 George W. Hanson, *University of Wisconsin-Milwaukee*

Abstract: Nano-materials and nano-devices often exhibit their most interesting properties at microwave and millimeterwave frequencies. Therefore, the area of nanoelectronics is an enormous opportunity for the microwave community, which can utilize its established body of modelling, design and measurement techniques with the aim to bridge the gap between nano-science and a new generation of extremely integrated circuits. Our goal is to present a meaningful overview of new microwave materials and devices based on recent achievements of nanotechnology. We introduce nanoscale metamaterials, discuss the electromagnetic heating of nanoparticles and explore superconducting nanodevices. We show how the transport properties of carbon-based materials (graphene, GNR, CNT) lead to new device concepts, as ambipolar transistors and mixers, CNT-arrayed devices (antennas, resonators), nano-interconnects, nano-electro-mechanical switches. We compare the RF performances between graphene-based and conventional semiconductor materials (e.g. Si) FETs. A novel CNT-nanoradio transistor is introduced. We focus on the metrology of heterostructured nanodevices. We introduce a unified model for the electromagnetic/transport problem in nanodevices.

Speakers:

1. Christophe Caloz, *École Polytechnique de Montréal, Montréal, Canada*
"Ferromagnetic Nanowire Metamaterial Structures for Microwave Applications"
2. George W. Hanson, *University of Wisconsin-Milwaukee, WI, USA*
"RF dissipation and electromagnetic heating of nanoparticles for thermal therapies and thermoacoustic imaging"
3. Peter Russer, *Technische Universität München, Munich, Germany*
"Superconducting Nanoelectronic Devices"
4. Mitch Wallis, *National Institute of Standards and Technology, Boulder, CO, USA*
"Metrology of heterostructured nano-devices for microwave applications"
5. Tomas Palacios, *Massachusetts Institute of Technology, Cambridge, MA USA*, "Ambipolar Graphene Electronics for RF Applications"
6. Yu-Ming Lin, *IBM T.J. Watson Research Center, Yorktown Heights, NY, USA*
"High Performance Graphene FETs for RF Applications"
7. Azad Naeemi, *Georgia Institute of Technology, GA, USA*
"High-frequency circuit models for carbon nanotube and graphene nanoribbon interconnects"
8. Peter Burke, *University of California, Irvine CA, USA*
"Arrays of SWNT devices for analog RF: overview of the field"
9. Stephen Purcell, *Laboratoire de Physique de la Matière Condensée et Nanostructures, Villeurbanne, Cedex, France*
"Towards RF applications in Nanotubes and Nanowires: the Nanoradio and Self Oscillations"
10. Stephen M. Goodnick, *Arizona State University, AZ, USA*
"Terahertz Nanoelectronics"
11. Luca Pierantoni, *Università Politecnica delle Marche, Ancona, Italy*
"Advanced Frequency- and Time-Domain Multiphysics Techniques for the Electromagnetic/ Coherent-Transport Problem in Nanodevices"
12. Fabio Coccetti, *LAAS-CNRS Toulouse & National Institute for Research and Development in Micro and Nanotechnologies (IMT), Bucharest, Romania*
"Exploring nanostructured materials for sensing and communication applications"



WME (IMS)

Monday, 08:00 - 12:00

High-Power-Density Packaging of Gallium Nitride

Reviewed by: MTT-5, MTT-6, MTT-12

Organizers:

Rüdiger Quay, *Fraunhofer Institute Applied Solid-State Physics, Freiburg*
Bernie Geller, *Vadum Inc, North Carolina*
Frank Sullivan, *Raytheon Company*

Abstract: GaN has long been praised to be -THE- solution on the high-power side of RF-electronics. Next to reliability, packaging technology is the prime bottleneck for efficient heat extraction; high-power transfer and combining; and bandwidth: The intention of this workshop is to give an overview on recent advances in the packaging technology suitable for III-N electronics based both on performance and cost issues. We have five speakers covering the following topics: cost-effective diamond as high-density-wafer substrate, packaging for space in the European project AGAPAC, and packaging aspects with focus on traditional packaging to keep the integration cost-effective. Further, the thermal modeling of GaN with liquid microchannel coolers and advanced amplifier modules including high-density switching, filters, broadband board design, and modulator integration are addressed.

Speakers:

1. Ed Piner, *Nitronex Corp.*
"GaN/Diamond AlGaIn/GaN/AlGaIn HEMT – The Next Frontier"
2. O. Vendier, *Thales Alenia Space, Toulouse*
"AGAPAC: A European View for Advanced High Power Amplifier Packaging"
3. Paul Garland, *Koycera America, San Diego*
"Packaging Materials and Processes to Optimize Performance for GaN Devices"
4. Morag Garven, *Science Applications International Corporation (SAIC)/Naval Research Laboratory*
"High Heat Flux Thermal Management and Packaging Techniques for GaN on-SiC Semiconductor Devices"
5. Martin Oppermann, *EADS Defense Electronics, Ulm*
"Application-specific Packaging Solutions for GaN Based Amplifier Modules"

WMF (IMS)

Monday, 13:00 - 17:00

High Efficiency, High Power Microwave Amplifiers for High Data Rate Space Communications

Reviewed by: MTT-5, MTT-7, MTT-16

Organizers:

Kavita Goverdhanam, *U.S. Army – CERDEC*
Rainee N. Simons, *NASA Glenn Research Center*

Abstract: In space and terrestrial communication systems, high power amplifiers are needed to boost signal amplitude for propagation over long distances. Hence, the high power amplifier determines the overall efficiency and linearity of the system. In this workshop state-of-the-art MMICs and TWTAs for Ka-Band and above will be reviewed. Failure rates of both types of amplifiers will be discussed. As the satellite ages to account for losses, the RF output power may need adjustment.

Therefore, on-orbit re-configurability of amplifiers will be discussed. Future space platforms, which have size, weight and power constraints may require amplifiers for dual-functions such as, communications and radar. Hence dual-band operation will be discussed. The non-linearity of the amplifier may affect the performance of the link depending on the type of modulation and these aspects will be discussed. Finally, the relationships between higher order modulation formats, higher-speed data rates, amplifier bandwidth and linearity parameters will be discussed.

Speakers:

1. Mansoor Siddiqui, *Northrop Grumman Aerospace Systems*
"High Efficiency MMIC Power Amplifiers for Space and Satellite Communications Applications"
2. William L. Menninger, *L-3 Communications, Electronics Technologies Inc*
"Recent Advances in High-Efficiency and High-Power Space Traveling-Wave Tube Amplifiers"
3. Eric Nicol, *The Boeing Company*
"On-Orbit Reliability Data for Solid State Power Amplifiers (SSPAs) and Traveling-Wave Tube Amplifiers (TWTAs)"
4. Christopher P. Silva, *The Aerospace Corporation*
"Characterization, Impact, and Mitigation of Distortion Effects in Solid-State and Traveling-Wave Tube Power Amplifiers"
5. Ramesh K. Gupta, *SkyTerra LP*
"Efficient Modulation Schemes for High Data Rate Satellite Communications"

WMG (IMS)

Monday, 08:00 - 12:00

Ultra-high Speed Microwave and Photonic Devices and Systems: How Will They be Tested?

Reviewed by: MTT-3, MTT-11

Organizers:

Stavros Iezekiel, *University of Cyprus*
Ron Reano, *Ohio State University*

Abstract: Despite the bursting of telecoms bubble in 2000/2001, bit rates have continued to rise inexorably in both wireless and optical communications. This is manifested by the development of multi-Gb/s 60 GHz systems and the interest in 100 GbE technology. This workshop addresses a number of state-of-the-art approaches to the time- and frequency-domain measurement and diagnostic testing of critical components in present and emerging broadband optical, mm-wave and THz systems.

Speakers:

1. Paul D. Hale and Dylan Williams, *NIST*
"Electro-optic sampling for traceability of high-speed electrical measurements"
2. John Whitaker, *University of Michigan*
"Electro-Optic Sensing of Microwave Fields via Photonic Heterodyne Down Mixing"
3. Miguel Drummond, *Instituto de Telecomunicações*
"Photonic RF instantaneous frequency measurement system by means of a polarization domain interferometer"
4. Robert E. Miles, *University of Leeds*
"Terahertz Electronics"

WMH (IMS)

Monday, 08:00 - 17:00S

3D Microwave and Millimeter-Wave Packaging

Reviewed by: MTT-6, MTT-12

Organizers:

John A. Pierro, *Telephonics Corporation*
Debabani Choudhury, *Intel Corporation*

Abstract System applications ranging from highly complex commercial wireless handsets to the most sophisticated active electronically steered arrays for radar, remote sensing, and communications are demanding more and more functionality in ever smaller footprints. Wireless devices must continually make room for circuitry to support the latest emerging wireless standards without any changes to the size of the device. The trend toward “tile” packaging in modern AESA’S to achieve the affordability needed to make active arrays practical is forcing packaging innovations to solve very difficult PA thermal management problems and solve the problems of integrating and interconnecting very heterogeneous technologies. An element (typically one of thousands!) in an AESA typically comprises the printed antenna, the T/R module electronics and the controller. All of this functionality must be packaged in a very size-constrained area “behind” the radiating element. The T/R module and controller may employ as many as five distinct semiconductor technologies to perform the required functions. The workshop will assemble experts from around the world who are working to find practical, relevant solutions to these problems. Experts knowledgeable in AESA, RFID tags and wireless sensor networks, hand-sets, and high speed wireless access systems will present their latest thinking on the perennial challenge of providing more and more capability to both the commercial and defense industries at ever lower cost.

Speakers:

1. Takana Kaho, *NTT*
“Ultra Compact RFICs Using Three-dimensional MMIC Technology from Microwave to Millimeter Wave Band”
2. Katherine J. Herrick, *Raytheon USA*
“Wafer Level 3D Integration and Packaging for T/R Modules”
3. Douglas J. Carlson, *M/A-COM Technology Solutions Inc.*
“Low Cost Panel Based Phased Array Technology: Creating a Three Dimensional RF System in Low Cost PCB Technology”
4. Manos M. Tentzeris, *Georgia Tech*
“Flexible 3D Organic, Ceramic and Paper-based Modules for Communication and Sensing Applications”
5. Tauno Vähä-Heikkilä, *VTT Technical Research Center*
“LTCC - 3D Integration Platform from Handset to Millimeter Wave Modules”
6. Tzzy-Sheng Jason Horng, *National Sun Yat-Sen University, Taiwan*
“Integrated/Embedded Passive Substrate Design Technology for Wireless System-in-Package Applications”
7. Jean-Marc Rollin, *Nuvotronics*
“Poly-Strata Technology for 3D System Integration”
8. Yves Mancuso, *Thales Systèmes Aéroportés*
“Microwave Developments for AESA Tile Antennas with 3D Modules”

WMI (IMS)

Monday, 08:00 - 17:00

Making Reliable Measurements at Millimeter and Submillimeter Wavelengths

Reviewed by: MTT-4, MTT-11

Organizers:

Nick Ridler, *National Physical Laboratory (NPL)*
Andrej Rumiantsev, *SUSS MicroTec Test Systems GmbH*

Abstract: At the present time, there is a great deal of support available for making reliable measurements at frequencies up to 110 GHz. However, above 110 GHz this situation changes dramatically: there are only a few suppliers of test equipment and virtually no traceability for these measurements. In recent years, there has been a dramatic increase in interest in using frequencies in the millimeter- and submillimeter-wave bands (30 GHz to 3 THz) and this is challenging the current state of play regarding available test equipment and measurement assurance mechanisms. This workshop will provide a review of the current state-of-the-art for making reliable measurements at frequencies above 110 GHz. This will concentrate on the various transmission media that are being used at these frequencies – metallic waveguide, on-wafer and alternative wave-guiding structures (e.g. dielectric-based waveguides). The workshop will conclude with a panel session aimed at identifying priority areas where reliable measurements are needed now, and in the coming few years.

Speakers:

1. Dylan Williams and Erich Grossman, *NIST*
“Overview of Rectangular Metal Waveguide, Power, and On-Wafer Measurements at Millimeter and Submillimeter Wavelengths”
2. Nick Ridler, *NPL, UK*
“Methods for Verifying VNA Measurements Above 100 GHz”
3. Bobby Weikle, *University of Virginia*
“Waveguide-Based Measurements at Terahertz Frequencies”
4. Jon Hacker, *Teledyne*
“Silicon Waveguide Design Above 300 GHz”
5. Shelley Begley, *Agilent Technologies*
“Characterizing Electromagnetic Properties of Materials at 110 GHz and Beyond”
6. Martin Salter, *NPL*
“Realizing Dielectric Waveguide Network Analyzers for Millimeter-Wave Frequencies”
7. Richard Wylde, *Thomas Keating Ltd*
“Quasi-Optical Measurement Systems”
8. Francisco Falcone, *Public University of Navarra*
“Measurement of Metamaterial Devices and Structures in Millimeter Wave and Sub-Terahertz Frequency Range”



WMJ (IMS)

Monday, 08:00 - 17:00

Recent Advances in Reconfigurable Filters”

Reviewed by: MTT-8, MTT-21

Organizers:

Dimitrios Peroulis, *Purdue University*
Raafat Mansour, *University of Waterloo*

Abstract: Tunable RF and microwave filters are critical components in reconfigurable radios, radars and sensors. Over the past several years, a number of different technologies have been proposed to address this challenge with distinct advantages, drawbacks, maturity levels and market potentials. This workshop will review the state of the art in several of these technologies. The first few talks will focus on system-level aspects. The workshop will address challenges and opportunities for employing tunable filters in wireless communication systems. Non-linearity and distortion issues will also be covered in detail. The remaining ones will discuss a variety of tuning approaches such as ferroelectric, BST, BAW devices and MEMS with an emphasis on 3-D architectures and power handling. In addition, the performance, requirements and market opportunities for very high-Q superconducting tunable filters will also be discussed. Techniques for temperature compensation and frequency tracking/control will be presented. Overall, there is approximately equal split among all technologies and a fair comparison is expected.

Speakers:

1. Kristi Pance, *M/A COM*
“The benefits that reconfigurable filters will bring to base stations”
2. Christoph Ernst, *European Space Agency*
“Tunable filters for flexible satellite payloads”
3. Gabriel Rebeiz, *University of California*
“Distortion mitigation in tunable high-Q filters”
4. Balam Willemsen, *Superconductor Technologies Inc.*
“Reconfigurable high temperature superconductor filters”
5. Robert York, *University of California*
“Voltage-activated BAW devices”
6. John Papapolymerou, *Georgia Institute of Technology*
“Electronically Tunable ferroelectric filters”
7. Pierre Blondy, *Université de Limoges*
“High-Q tunable filters using RF-MEMS”
8. Dimitrios Peroulis, *Purdue University*
“Power handling and monitoring issues in high-Q RF MEMS tunable filters”

WMK (IMS)

Monday, 08:00 - 17:00

RF MEMS for Antennas and Integrated RF Front End

Reviewed by: MTT-14, MTT-16, MTT-21

Organizers:

John Papapolymerou, *Georgia Institute of Technology*
Art Morris, *WiSpry*
Hector De Los Santos, *NanoMEMS Research*
James C. Hwang, *Lehigh University*

Abstract: RF MEMS technology has been under development for the last 15 years with primary emphasis on individual RF devices and circuits such as SPMT switches, tunable filters and phase shifters, as well as reliability and RF power handling issues. As the technology has matured and has started to be inserted in more complex and integrated RF systems, such as antenna arrays and RF front ends, there is increased interest in investigating new challenges that arise from MEMS integration into RF systems and antennas, including design, simulation and modeling. This workshop will highlight some of these issues to create awareness among circuit and system designers of the maturity and level of technology readiness of RF MEMS, as well as bridge the gap with a very important RF MEMS application area (antennas) that has never been presented as a stand-alone workshop at IMS.

Speakers:

1. J.C.M. Hwang, *Lehigh University*
“Compact RF model for transient characteristics of MEMS capacitive switches”
2. Kartikeya Mayaram, *Oregon State University*
“Accurate simulation of RF MEMS VCO performance including phase noise”
3. Raphael Mzyk, *University of Erlangen*
“Modeling mechanical dynamics of MEMS self actuation and its application”
4. Andre van Bezooijen, *EPCOS*
“Adaptively controlled RF-MEMS antenna tuners for hand-held applications”
5. John Maciel, *Radant MEMS*
“RF MEMS Switches for Electronically Steerable Antenna Applications”
6. Aly Fathy, *The University of Tennessee*
“Reconfigurable Antennas for Wireless Applications-examples, implementations, challenges”
7. Volker Ziegler, *EADS*
“Reconfigurable antennas and RF-front ends on aeronautic and space platforms”
8. Nickolas Kingsley, *Auriga*
“RF MEMS Antennas and Systems on Light Weight Organic Substrates”
9. Dimitri Peroulis, *Purdue University*
“Real-time Reconfigurable Matching Networks for Miniaturized Antennas in Pulse-based Systems”
10. Art Morris, *WiSpry*
“Integrated Tuning Technology for Antennas and Radio Front Ends”

SC-1 Monday**08:00–17:00****Theory and Design of Phase Locked Loops****Instructors:**

L. Dayaratna, Lockheed Martin; Dean Banerjee, National Semiconductor; Cicero S. Vaucher, NXP Semiconductors; P. White, Applied Radio Labs; Ron Reedy, Peregrine Semiconductor

Topics and Speakers:

- Theory and Design of Phase Locked Loops, Lama Dayaratna, Ph.D., Lockheed Martin Commercial Space Systems, United States
- Phase locked loop Performance and Simulation, Dean Banerjee, Ph.D., National Semiconductor corporation, United States
- PLL System and Circuit Design for Microwave and mmWave Applications Cicero S. Vaucher, Ph.D., Edwin van der Heijden, and Juan Osorio, NXP Semiconductors, The Netherlands
- Modelling and Analysis of PLL Frequency Synthesizers, Peter White, Ph.D., Applied, Applied Radio Labs., Australia
- Recent Development in PLL Technologies, Ron Reedy, Ph.D., Peregrine Semiconductors corporations, United States

This one day design course, deals with the theory and design of phase locked loops for RF and microwave applications. The course provides an in-depth coverage of the design, analysis, simulation, and measurements of phase lock loop circuits. It is taught by several leading experts from industry

The course is developed as a laboratory hands-on course with live hardware and software demonstrations. The objective is to provide a state of the art review of phase locked loop design with special reference to low noise techniques. This PLL workshop is an intensive short course where the fundamentals of design, analysis, and modeling of phase lock loops will be covered. The following topics will be addressed in detail: Phase Locked loop design, Phase lock loop components, Voltage controlled Oscillators, Phase detector Circuits, Loop filter design, Loop characterization, Fractional- N synthesis, DDS, Multi Loop synthesis, Composite DDS/PLL solutions, Noise in Phase Locked loop circuits.

The phase locked loops have found widespread use in RF and Microwave applications. The dynamics of its operation, however, are quite complex and not surprisingly, the loops are too often incorrectly optimized. A badly designed loop can lock on wrong frequencies, not sufficiently reduce injected noise, can drop out of lock too easily. This workshop provides information on the design, simulation, applications, and product development of phase locked loops by several leading experts from industry. Many of the lectures rely on the use of live demonstrations involving test equipment and computer-based simulation tools to illustrate concepts. Attendees will have access to live 'hands-on' hardware and software demonstrations 'set-ups' during this one day session.

This course is an engineer's guide to planning, designing, and implementing phase locked loops for RF and microwave applications.

SC-2 Monday**08:00–17:00****Low Phase Noise Oscillators: Lecture (theory and design) and Laboratory****Instructor:**

Jeremy K.A. Everard, BAE Systems/Royal Academy of Engineering Research Professor in Low Phase Noise Signal Generation, Department of Electronics, University of York, UK.

Topics:

- Oscillator phase noise theory
- Optimum operating conditions
- Flicker noise measurement and reduction
- Oscillator tuning and the effect on phase noise
- Generic design rules for low noise oscillators
- Oscillator designs: LC, Crystal, SAW, CRO, DRO
- Phase noise measurements: Phase detector and direct digital measurements
- Lab Class
 - Non contact measurement of Q0 and design of the resonator for correct QL/Q0
 - Simulate and measure the open loop resonator on PCB
 - Close Oscillator loop, measure phase noise and compare with theory

This full day course will present theory and design lectures in the morning and a lab class in the afternoon. The lectures will present the theory and design rules required to design low noise oscillators operating within 0 to 1dB of the theory. The course will include the latest state of the art techniques and results as well as the material required for a clear understanding of the underlying principles. Detailed design discussions will cover oscillators operating from 10MHz to 10GHz using, LC, Crystal, SAW, Ceramic (CR) and Dielectric (DR) resonators. A battery powered laboratory pack will be provided to enable the delegates to design, simulate, build and measure a 100MHz low noise oscillator. This pack will enable both fixed frequency and tuneable oscillators to be built. The delegates will be provided with a copy of the PowerPoint slides and a disk containing the specific Java Runtime software required for simulation of the resonator and the phase noise. Delegates should bring a laptop to the laboratory class. The latest test equipment will be provided by Agilent, Rohde & Schwarz and Symmetricom. Delegates can either attend this full day class including lab or just the morning theory/design class (see separate listing SC-2A); however, the number of delegates attending the full day class is limited.

Latest results using these techniques demonstrate -123dBc/Hz at 1Hz offset for a 10MHz SC cut crystal oscillator, -173dBc/Hz at 10kHz offset for a 1.25GHz DRO and -153dBc/Hz at 10kHz offset for a 4GHz DRO. This course was run at IMS 2009 for the first time last year and was very successful.

**SC-2A Monday****08:00–12:00****Low Phase Noise Oscillators: Lecture Only****Instructor:**

Jeremy K.A. Everard, BAE Systems/Royal Academy of Engineering Research Professor in Low Phase Noise Signal Generation, Department of Electronics, University of York, UK.

Topics:

- Oscillator phase noise theory
- Optimum operating conditions
- Flicker noise measurement and reduction
- Oscillator tuning and the effect on phase noise
- Generic design rules for low noise oscillators
- Oscillator designs: LC, Crystal, SAW, CRO, DRO
- Phase noise measurements: Phase detector and direct digital measurements

Abstract:

This half day course will present the theory and design rules required to design low noise oscillators operating within 0 to 1dB of the theory. The course will include the latest state of the art techniques and results as well as the material required for a clear understanding of the underlying principles. Detailed design discussions will cover oscillators operating from 10MHz to 10GHz using, LC, Crystal, SAW, Ceramic (CR) and Dielectric (DR) resonators. The delegates will be provided with a copy of the PowerPoint slides.

Dr. Jeremy K. A. Everard obtained his PhD from the University of Cambridge in 1983 and currently holds the BAE Systems/Royal Academy of Engineering Research Professorship in Low Phase Noise Signal Generation at the University of York, UK. He has been designing low noise oscillators for over 30 year at Marconi Research Laboratories, Philips Research, MA-COM, the Universities of London and York. A brief CV and recent publications are given on his Departmental web pages at: <http://www.elec.york.ac.uk/staff/jke1.html> . His personal web page is at: <http://www-users.york.ac.uk/~jke1/> . His group has now developed a number of designs offering the best performance available in the world. For example our: 10MHz SC cut crystal oscillators demonstrate -123dBc/Hz at 1Hz and -149dBc/Hz at 10Hz and our L band (1.25GHz) DR oscillators demonstrate -173dBc/Hz at 10kHz and -180dbc/Hz at 50kHz offset.

SC-3 Monday**13:00–17:00****Microwave Packaging and Manufacturing 101****Organizer:**

Alan Lindner, L-3 Communications, Narda Microwave - West

MTT Affiliation: MTT-12**Topics and Speakers:**

- Accuracy of Package and Interconnect Simulation Models, HeeSoo Lee, Agilent
 - For microwave and millimeter-wave packaging and interconnects, there are many instances where distances are electrically short and that there are discontinuities. How to know when to rely on a linear model or when to perform a complete electromagnetic simulation will be discussed. The tradeoffs with speed and accuracy with such analysis will be explained.
- LTCC Substrates & Packaging Solutions, Paul Garland, Kyocera
 - Low temperature co-fired ceramic (LTCC) technology provides a unique solution for high interconnect density, compact networks and high frequency applications. Design guidelines will be presented on how to incorporate embedded passive components, route high density interconnects, define the thermal management requirements and assemble active devices.
- Multilayer High Frequency Laminates, Art Aguayo, Rogers Corporation
 - Use of high frequency laminates to construct microwave single and multilayer assemblies. The process in fabricating such material will be discussed explaining tradeoffs for electrical performance and assembly techniques.
- Materials and Metallization Schemes used in Thin Film Processing, David Adams, Applied Thin-Film Products
 - Thin Film technology provides a robust and highly accurate topology used in microwave products. The process steps will be discussed to help the design engineer better understand the construction. Design guidelines including materials and metallizations will be presented on how to have assemblies built to meet the electrical performance requirements and the cost objects.
- Accurate Testing and Calibration Techniques, Alan Lindner, L-3 Communications, Narda Microwave – West
 - An overview of the use of launches, probes and feedthrus. Also, how to choose the appropriate calibration and what accuracies can be achieved.

Packaging, assembly and test of most microwave and millimeter-wave devices are a challenging task. Issues arise with the material selection, modeling accuracy, assembly and testing. Most engineers are only aware of what techniques are implemented in their facility or rely on what the process engineer recommends. With a good understanding of the options, proper design choices can be made. This half day course will give the attendee an understanding of the construction processes and tradeoffs, and how best to model and test.

FRIDAY WORKSHOPS

WFA (IMS)

Friday, 08:00 - 12:00

The Expanding Role of GaN in RF Systems

Reviewed by: MTT-5, MTT-6, MTT-16

Organizers:

Jim Sowers, *Space Systems/Loral*
Jay Banwait, *Northrop Grumman*

Abstract: Because of its unique properties, GaN is expanding into many different areas of an RF System. GaN's significant benefits of power density, efficiency, and bandwidth are well known with respect to power amplifier performance. A lesser known fact is the properties that enable these performance benefits for power amplifiers also provide advantages for other types of devices. As an example, control devices which manage signal flow or signal level in an RF system such as switches and limiters, as well as high dynamic range LNA's and oscillators, can benefit greatly from the high voltage breakdown property of GaN. The objective of this workshop is to help device, circuit, and system designers understand these benefits, the tradeoffs that come with them, and the status of these types of component developments. The workshop will conclude with a panel discussion in which the attendees will be asked to submit their questions and comments to the speakers.

Speakers:

1. James J. Komiak, *BAE Systems Electronic Solutions*
"GaN HEMT Control, Termination, and LNA/Gain Block Components for Wideband Applications"
2. Shyh-Chiang Shen, *School of Electrical and Computer Engineering, Georgia Tech*
"High-Voltage III-V Power Transistor Switches"
3. J.W. Milligan, *Cree, Inc.*
"Commercial GaN Devices for Switching and Low Noise Applications"
4. Eli Reese, *TriQuint Semiconductor*
"GaN MMICs for Control Components in RF Systems"
5. Rama Vetury, *RFMD*
"GaN Applications Beyond the PA for RF Systems"

WFB (IMS)

Friday, 08:00 - 12:00

Wireless Power Transmission

Reviewed by: MTT-5, MTT-16, IMS2010

Organizers:

Debabani Choudhury, *Intel Corporation*
John A. Pierro, *Telephonics Corporation*

Abstract: While energy has become a hot topic nationally and internationally, wireless delivery of energy has also come into the spotlight in RF and wireless engineering. The dream of collecting a tiny percentage of the limitless energy emitted by the sun, converting it to electric power via low earth orbit collection/conversion stations and transmitting this energy to earth via very narrow high power microwave beams emanating from electrically large antenna arrays is something we all can appreciate and give credence to. In the consumer products market, several

academic and industrial organizations are investing in R&D of various wireless power technologies for fixed as well as portable devices in recent years. Examples include high-power resonant wireless energy link, wireless charging technologies and wireless powering of tiny sensors allowing remote battery-free powering and sensing. This workshop will bring together experts in the field who are exploring and refining techniques to transmit power without the use of wires.

Speakers:

1. Richard M. Dickinson, *Off Earth-WPT*
"Wireless Power Transmission Retrospective of World's Record: Usefully Recovered Electric Power"
2. Shigeo Kawasaki, *Japan Aerospace Exploration Agency (JAXA)*
"High Power Active Integrated Phased Array Antenna for Wireless Communication and Power Transmission"
3. Joshua Smith, *Intel Corporation*
"Mapping the Space of Wirelessly Powered Systems"
4. Brian Otis, *Univ. of Washington*
"Miniaturized Sensors Enabled by Wireless Power Transfer"
5. Jenshan Lin, *Univ. of Florida*
"From Far-Field Wireless Power Transmission to Near-Field Wireless Charging"

WFC (IMS)

Friday, 08:00 - 17:00

Millimeter-Wave SiGe/CMOS and III-V Chips for Imaging Systems

Reviewed by: MTT-4, MTT-6, MTT-16

Organizers:

Gabriel M. Rebeiz, *University of California, San Diego*
Sorin Voinigescu, *University of Toronto; Vipul Jain, Sabertek*

Abstract: The workshop will present the latest advances in III-V, SiGe and CMOS chips for passive and active imaging systems. Recent advances in SiGe and CMOS designs have shown that it is possible to use silicon for millimeter-wave passive radiometers and active imaging systems. Several questions remain un-answered: what about the $1/f$ noise in CMOS chips? Can SiGe and CMOS result in as low a NF as InP at 94 GHz? What about 45nm or 32nm CMOS? Does advanced digital functions placed on the same chip as the active imaging systems or passive radiometers result in improved performance? What is III-V doing to compete with this technology? The workshop will show the state of the art in Silicon and III-V passive and active chips and related imaging systems, and present an honest discussion on the pros and cons of silicon vs. III-V.

Speakers:

1. Erich Grossman, *NIST*
"Imaging Systems at 100 GHz and Above for Security Applications"
2. Larry Yujiri, *Northrop Grumman Aerospace Systems*
"An Introduction to Passive Millimeter-Wave Imaging"
3. Jonathan Lynch, *HRL Laboratories*
"W-Band Sensors for Passive Millimeter-Wave Imaging"
4. Roger Appleby, *QinetiQ*
"Passive Millimeter Wave Imaging Systems"



5. Michael Schlechtweg, *Fraunhofer Institute IAF*
"Multifunctional ICs up to 350 GHz for Active and Passive Imaging Systems"
6. Gabriel Rebeiz, *University of California*
"Millimeter-Wave SiGe ICs for Passive Imaging Systems"
7. Alexander Tomkins, *University of Toronto*
"W and D-Band Passive Imagers in 65nm CMOS and SiGe HBT technology"
8. Toshihide Suzuki, *Fujitsu Laboratories*
"W-band transceivers in InP HEMT and CMOS for Active/Passive Imaging Systems"
9. Payam Heydari, *University of California*
"W-band passive imaging receiver ICs in (Bi)CMOS Technologies"
10. Ullrich Pfeiffer, *University of Wuppertal*
"Terahertz Imaging with SiGe and CMOS Focal-Plane Arrays"
11. Koji Mizuno, *Tohoku University*
"Millimeter-Wave Imaging through a Flame"

3. Zhizhang (David) Chen, *Dalhousie University*
"Unification of Numerical Methods: Grid-based and Meshless"
4. Wolfgang J. R. Hoefer, *Institute of High Performance Computing*
"Transient Wide-Band Modeling of Metamaterials and Cloaking Devices"
5. Wojciech Gwarek/Malgorzata Celuch, *Warsaw University of Technology*
"Modeling and Simulation in Multi-physics Environments and Optics"
6. Natalia Nikolova, *McMaster University*
"Electromagnetic Simulations Aiding Imaging and Detection with Microwaves"
7. Peter Thoma, *CST - Computer Simulation Technology AG*
"Advanced Modeling of EM Problems by Using Coupled Simulations"
8. Poman So, *University of Victoria*
"Computational Electromagnetics on Graphics Processors"

WFF (IMS)

Friday, 08:00 - 17:00

New Theories, Applications and Practices of Electromagnetic Field Simulators

Reviewed by: MTT-1, MTT-15

Organizers:

Zhizhang (David) Chen, *Dalhousie University, Canada*
Poman So, *University of Victoria, Canada*

Abstract: Proliferation of electromagnetic simulators is having a profound effect on the way microwave engineers and researchers operate, as evidenced by the growing numbers of commercially available electromagnetic simulators and applications to a wide range of R&D areas such as microwave imaging and cloaking devices. Such new developments also create challenges for users and developers of electromagnetic simulators as well as researchers in computational electromagnetics in understanding and utilizing these developments. In this workshop, we will (a) provide insight into the operating principles and limitations of electromagnetic field simulators, (b) show how these principles are related to or translated into simulator parameters for practical applications, and (c) present recently developed theories, applications and practices pertaining to electromagnetic simulations: examples include the analysis of large complex problems using a combination of different approaches and techniques. This workshop be beneficial to (a) microwave engineers and researchers with circuit simulation experience who would also like to learn more about field-solvers, (b) students and beginners who would want to see what is involved in electromagnetic modeling and simulation, (c) users of electromagnetic simulators who seek a better understanding of theoretical and computational foundation, and (d) researchers and engineers who want to have more detailed knowledge of the recent developments and advanced applications of electromagnetic simulations. A discussion session is planned at the end of the workshop for interactions among all the participants.

Speakers:

1. Peter Russer, *Munich University of Technology*
"Time-Domain Network Methods for Electromagnetic Field Modeling"
2. Costas Sarris, *University of Toronto*
"Transformation Optics inspired Advances in Time-Domain Numerical Electromagnetics"

WFG (IMS)

Friday, 08:00 - 17:00

Emerging Optical Modulator Technologies for RF Photonics

Reviewed by: MTT-3, MTT-16, IMS2010

Organizers:

Ronald M. Reano, *Ohio State University*
Dieter Jäger, *Universität Duisburg-Essen*

Abstract: The optical modulator is a central component for coupling RF signals with optical signals. A widely employed configuration involves coplanar waveguide RF electrodes proximity coupled to a guided wave Mach Zehnder optical interferometer incorporated on a substrate exhibiting 2nd order susceptibility (linear electro-optic effect). But what are emerging alternative methods to modulate an optical beam with a high-frequency signal? Specifically, what are alternatives to the linear electro-optic effect? Or, if linear electro-optic effect is used, what are alternative approaches to couple the RF signal to the optical signal. What performance metrics are enhanced, and which are degraded? Do these alternative approaches spawn ideas for new applications? This workshop will address these questions, focusing on novel concepts for optical modulators and the resulting application areas that emerge.

Speakers:

1. Ebrahim Mortazy and Ke Wu, *Ecole Polytechnique*
"Substrate Integrated Waveguide Traveling-Wave Electro-Optical Modulators"
2. Lute Maleki, *OEwaves, Inc*
"New directions in whispering gallery mode modulators"
3. Mani Hossein-Zadeh, *University of New Mexico*
"Optical modulation using optomechanical interaction in high-Q microcavities"
4. Rod Waterhouse and Dalma Novak, *Pharad, LLC*
"Photonically Integrated Antennas"
5. Hiroshi Murata, *Osaka University*
"Electro-Optic Modulators Using Antenna-Coupled Electrodes and Polarization Reversed Structures"
6. Raluca Dinu, *GigOptix*
"100 Gbps Electro-Optic Polymer Modulators"
7. Jaesang Oh and Anand Gopinath, *University of Minnesota*
"Linearized Optical Directional Coupler Modulators"
8. Yifei Li, *University of Massachusetts*
"Quadratic electro-optic phase modulator for frequency mixing"
9. Ronald M. Reano, *Ohio State University*
"Dispersion engineering for RF-optical devices"

WFH (IMS)

Friday, 08:00 - 12:00

How to Start a Microwave Business

Reviewed by: MTT-19, IMS2010

Organizers:

Fred Schindler, *RF Micro Devices*
Mike Golio, *Golio Pubs*

Abstract: Much of the world is facing tough economic times producing turmoil in the ranks of microwave engineering professionals. This climate causes many engineers to consider taking on business risk that will be somewhat in their control as opposed to employment risk entirely in the hands of their employer. This workshop will examine the challenges several entrepreneurial working engineers have experienced in starting their own successful businesses and provide valuable advice to those just starting out or considering making that step. The workshop will also provide viewpoints from a venture capitalist describing requirements for a good business from their perspective.

Speakers:

1. Lamberto Raffaelli, *LNX Corp*
"When you start a business it is all about cash flow: it is really true?"
2. Geoff Dawe, *BitWave*
"The Venture Capital Path to Starting a RF/Microwave Company – An Entrepreneurs' Prospective"
3. Nitin Jain, *Anokiwave*
"Anokiwave"
4. Wayne Boulais, *Apex Venture Partners*
"Microwave Business – a VC perspective"

WFI (IMS)

Friday, 08:00 - 12:00

Practical Metamaterial RF and Antennas for Commercial Application

Reviewed by: MTT-15, MTT-16, MTT-20

Organizer:

Maha Achour, *RAYSPAN Corporation*

Abstract: The air interface is an essential part of every radio and includes the antenna and the associated passive and active RF front-end components between the RFIC chip and air wireless access. But as standards have proliferated to include 3/4G cellular, WiFi MIMO, GPS, Bluetooth, WiMax and UWB, the air interface now presents some of the most challenging RF system integration problems facing the wireless industry. Because these standards require support of multiple radio bands, multiple signal modulation and multiple channels within bands, the size and spacing requirements make it challenging to meet specifications while maintaining adequate system performance. In the past two years, metamaterial-based solutions have been successfully adopted by the wireless industry and deployed in the market to meet stringent performance and size reduction requirements. This workshop will focus on practical passive and active metamaterial-based RF designs that address these emerging challenges facing the wireless industry.

Speakers:

1. George V. Eleftheriades, *University of Toronto*
"The Transmission-Line Paradigm for Realizing Metamaterials: Fundamentals & Applications"
2. Tatsuo Itoh, *UCLA*
"Applications of CRLH Structures for Active Microwave Circuits"
3. Christophe Caloz, *Polytechnique Montréal*
"Recent Advances in Metamaterial Smart Antenna Concepts and Applications"
4. Richard W. Ziolkowski, *University of Arizona*
"Multi-band Linear and Circular Polarized, Electrically Small, Metamaterial-inspired, Near Field Resonant Parasitic Antennas"
5. Carlos Camacho-Peñalosa, *Universidad de Málaga, Spain*
"Active microwave distributed circuits inspired by Metamaterials"



Exhibit hours have been scheduled to provide maximum interaction between conference attendees and exhibitor personnel:

Tuesday, 25 May	09:00 to 17:00
Wednesday, 26 May	09:00 to 18:00
Thursday, 27 May	09:00 to 15:00

IMS2010 Exhibition companies as of February 22, 2010:

denotes a first-time exhibitor

2COMU	Assemblies Inc.	COMSOL Inc.	EMCO Elektronik GmbH
A-Alpha Waveguide Co.	Astrolab, Inc.	Connecticut Microwave Corp.	Emerson & Cuming
A.J. Tuck Co.	ATK	Connectronics, Inc.	Microwave Products
A.T. Wall Company	Auriga Measurement Systems, LLC.	Constant Wave, Inc.	Emerson Connectivity Solutions
Actipass R&M Co., Ltd.	Aurora Software & Testing SL	Coming Gilbert, Inc.	Empower RF Systems
AdTech Ceramics	Avago Technologies	CORWIL Technology Corp.	Endwave Corp.
Advanced Control Components, Inc.	Aviel Electronics	Crane Aerospace & Electronics	Epoch Microelectronics, Inc.
Advanced Test Equipment Rentals	AWR Corp.	Crane Polyflon	Epoxy Technology, Inc.
Aegis Technology Inc.	AWT	Cree, Inc.	Equipment Management Technology
AEM, Inc.	Axiom Test Equipment, Inc.	Cristek Interconnects, Inc.	ET Industries
Aeroflex Inc.	B&Z Technologies	Crystek Corp.	ETL Systems
Aethercomm Inc.	Bary Industries, Inc.	CST of America, Inc.	ETS-Lindgren
AFM Microelectronics Inc.	BEEcube, Inc.	CTT Inc.	EuMW2010
Agilent Technologies	Beijing Corelogic	Cuming Microwave Corp.	Euvis Inc.
AI Technology, Inc.	Communication Co., Ltd.	Custom Cable Assemblies, Inc.	Excelics Semiconductor Inc.
Airpoint Co., Ltd.	Besser Associates, Inc.	Custom Interconnects	EZ Form Cable Corp.
AKON, Inc.	Bliley Technologies, Inc.	Custom Microwave Components, Inc.	F&K Delvotec, Inc.
Aldetec, Inc.	Bowei Integrated Circuits Co., Ltd.	Custom MMIC Design Services, Inc.	Ferraz Shawmut, Inc.
Allrizon-TG	Brush Ceramic Products	Daa-Sheen Technology Co., Ltd.	Ferrite Co., The
Communications Equipment	C W Swift & Associates, Inc.	dBm	Ferro-Ceramic Grinding
Allstron Corp.	C-Tech	Delta Electronics Mfg. Corp.	Filtel Microwave Inc.
AMCAD Engineering	C.E. Precision Assemblies, Inc.	Delta Microwave	Flann Microwave
American Microwave Corp.	CAD Design Software	Design Workshop Technologies Inc.	Flexco Microwave Inc.
American Standard Circuits, Inc.	Cadence Design Systems, Inc.	Diablo Industries Thin Film	Florida RF Labs/EMC Technology
American Technical Ceramics	Cambridge University Press	Diamond Antenna & Microwave Corp.	Focus Microwaves Inc.
Ametek HCC Industries	CAP Wireless Inc.	Dielectric Laboratories, Inc.	Fotofab
AML Communications Inc.	CapeSym, Inc.	Diemat, Inc.	Freescale Semiconductor
Amplifier Solutions Corp.	Carlisle Interconnect Technologies	DiTom Microwave Inc.	FTG Corp.
AmpliTech Inc.	Cascade Microtech, Inc.	Doo Sung Industrial Co., Ltd.	FujiFilm Dimatix, Inc.
Analog Devices, Inc.	Centellax, Inc.	Dorado International Corp.	FutureComm Co., Ltd.
AnaPico AG	Cemex Inc.	Dow Key Microwave Corp.	General Dynamics Satcom Technology
Anaren, Inc.	Channel Microwave Corp.	Ducommun Technologies Inc.	Gerotron Communication GmbH
Anatech Electronics, Inc.	Charter Engineering, Inc.	Dyconex AG	GGB Industries Inc.
Anoison Electronics	Chin Nan Precision Electronics Co., Ltd.	Dynawave Inc.	GigaLane Co., Ltd.
Anritsu Co.	Ciao Wireless, Inc.	E2v	Gigatronics Inc.
Ansoft, LLC	Cirexx International, Inc.	EADS North America	Global Communication Semiconductors
Antenna Research Associates-ARA Inc.	Coastline Metal Finishing Corp.	Eagle Comtronics, Inc.	GNI Microwave Co., Ltd.
Antenna Systems/Webcom	Cobham	Eastern - Optx / Noisext	Gowanda Electronics
Communications	Coilcraft, Inc.	Eclipse Microwave, Inc.	Greenray Industries Inc.
APA Wireless Technologies	Coining, Inc.	EE-Evaluation Engineering	GuangShun Electronic
Applied Thin-Film Products	Coleman Cable, Inc.	Electro Rent Corp.	Tech. Research Inst.
AR RF/Microwave Instrumentation	Coleman Microwave Co.	ElectroMagneticWorks Inc.	Hantech Inc.
ARC Technologies, Inc.	COM DEV Ltd.	Elisra Electronic Systems Ltd.	Harbour Industries, Inc.
Arlon Tech. Enabling Innovation	Communications & Power Industries	EM Research Inc.	Herley Industries
Artech House	Compex Corp.	EM Software & Systems - FEKO	Herotek Inc.
ASB Inc.	Component Distributors Inc.	EMAG Technologies Inc.	Hesse & Knipps Inc.

- High Frequency Electronics
 Historical Booth
 Hittite Microwave Corp.
 Holzworth Instrumentation Inc.
 Huada Intl. Electronics & Technology
 HVVI Semiconductors Inc.
 HXI, LLC
 IBM Corp.
 IEEE Microwave Magazine
 IHP GmbH
 IMST GmbH
 In-Phase Technologies
INGUN Pruefmittelbau GmbH
 Innertron, Inc.
 Innovative Micro Technology
 Instek America Corp.
 Instruments For Industry (IFI)
 Integra Technologies Inc.
 Integrand Software, Inc.
 International Manufacturing Services
 Ion Beam Milling, Inc.
Ironwood Electronics
 Isola
 ISOTEC Corp.
 ITF Co., Ltd.
 ITT Microwave Systems Corp.
 IW Inc.
 J MicroTechnology, Inc.
 Jersey Microwave, LLC.
 JFW Industries, Inc.
 Johanson Manufacturing Corp.
 Johanson Technology Inc.
 John Wiley & Sons
 JQL Electronics Inc.
 Junper Interconnection Inc.
 Jye Bao Co., Ltd.
 K&L Microwave Inc.
 Kemac Technology, Inc.
 Keragis Corp.
 Krytar Inc.
**KVG Quartz Crystal
 Technology GmbH**
 Kyocera America, Inc.
 L-3 Communications
 LA Techniques Ltd.
 LadyBug Technologies LLC
 Lake Shore Cryotronics Inc.
 Lanjian Electronics
 Lansdale Semiconductor Inc.
 Lark Engineering Co.
 Laser Process Mfg. Inc.
 Laser Processing Technology, Inc.
 Laser Services Inc.
 Linearizer Technology, Inc.
- Lintek Pty Ltd.
 Litron Inc.
 LNX Corp.
 Logus Microwave Corp.
 Lorch Microwave
 LPKF Laser & Electronics
 M/A-COM Technology Solutions
 M2 Global Technology Ltd.
 Marcel Electronics International
MathWorks
 Maury Microwave Corp.
 McGraw-Hill Professional
 MECA Electronics, Inc.
 Mega Circuit Inc.
 MegaPhase
 Meggitt Safety Systems, Inc.
 Merrimac Industries Inc.
 MESL Microwave Ltd.
 Metropole Products Inc.
 Mlcable Inc.
 Mician GmbH
 Micro Limited
Micro Communications, Inc.
 Micro Lambda Wireless, Inc.
 Micro-Coax Inc.
 Micro-Mode Products Inc.
 MicroApps
 MicroFab Inc.
 Micronetics Inc.
 Microphase Corp.
 Microsemi Corp.
 Microsorb Technologies Inc.
 Microtech, Inc.
 Microwave Applications Group
 Microwave Circuits
 Microwave Communications Labs, Inc.
 Microwave Development Labs Inc.
 Microwave Dynamics
 Microwave Engineering Corp.
 Microwave Engineering Europe
 Microwave Filter Co., Inc.
 Microwave Journal
Microwave Marketing.com Ltd.
Microwave Packaging Technology
 Microwave Product Digest
 Microwave Technology, Inc.
 Microwavefilters S.R.L
 MIG-Microwave Innovation Group
 Millitech Inc.
 Mimix Broadband
 Mini-Circuits
 Mini-Systems Inc.
 MITEQ, Inc.
 Mitsubishi Electric & Electronics
- Modelithics, Inc.
 Modular Components National Inc.
 Molex
 Momentive Performance Materials
 Mosis
 MPDevice Co., Ltd.
 MtronPTI
 Murata Electronics
 Nanjing Jiexi Technologies Co., Ltd.
 National Instruments
 National Reconnaissance Office
 NAVICP
 NDK
 Nearfield Systems Inc.
 Netcom Inc.
 Networks International Corp. (NIC)
 Nitronex Corp.
 NoiseWave Corp.
 Norden Millimeter Inc.
 Northrop Grumman
 NTK Technologies Inc.
 Nuhertz Technologies, LLC
 Nuvotronics
 NuWaves Engineering
 NXP Semiconductors
 OEwaves Inc.
 OMMIC
 OPHIR RF Inc.
 Orient Microwave Corp.
 P1dB, Inc.
 PA&E
 Pascall Electronics Ltd.
 Passive Microwave Technology, Inc.
 Passive Plus Inc.
 PedaSoft LLC.
 Penn Engineering Components, Inc.
 Penton Media/ Microwaves & RF
 Peregrine Semiconductor Corp.
 Phase Matrix Inc.
 Phoenix Company Of Chicago, The
 Piconics Inc.
Pivotone Communication Tech., Inc.
 Planar Monolithics Industries, Inc.
 Plextek Ltd.
 Pole/Zero Corp.
 Polyfet RF Devices
 Precision Connector, Inc.
 Precision Ferrites & Ceramic Inc.
 Precision Photo-Fab, Inc.
 Presidio Components Inc.
 Prewell Corp.
Procast/John List Corp.
 Q Microwave, Inc.
 Quest Microwave Inc.
- Questech Services Corp.
 Quik-Pak/Gel-Pak
 QuinStar Technology Inc.
 R&D Microwaves LLC
 R&K Company Ltd.
 Radant MEMS, Inc.
Rayspan Corp.
 Reactel Inc.
 Reinhardt Microtech AG
 RelComm Technologies Inc.
 Remcom Inc.
 Remtec, Inc.
 Renaissance Electronics Corp.
 Resin Systems Corp.
RF Connections, LLC
 RF Depot Inc.
 RF Industries RF Connectors Div.
 RF Logic
 RF Morecom
 RFcore Co., Ltd.
 RFHIC Corp.
 RFMD
 RFMW, Ltd.
 RFS/Ferocom Ferrite Division
 RH Laboratories Inc.
 RHe Microsystems GmbH
 Richardson Electronics
 RIV Inc.
 RJR Polymers Inc.
 RLC Electronics Inc.
Rockwell Collins
 Rogers Corp.
 Rohde & Schwarz Inc.
 Rosenberger North America LLC
 Roswin, Inc.
Rsoft Design Group
 Sage Laboratories Inc.
 Sainty-Tech Communications Ltd.
 Samtec, Inc.
 San-tron Inc.
 Sangshin Elecom Co., Ltd.
 Sawncis Inc.
 Schmid & Partner Engineering AG
 Scientific Microwave Corp.
Scintera
 SEI
 Semi Dice Inc.
 SGMC Microwave
**Shanghai Huaxiang
 Computer Comm. Eng.**
**Shenzhen Yulongtong
 Electron Co.,Ltd.**
 Signatone (Lucas/Signatone)
 Sinclair Manufacturing Co.



denotes a first-time exhibitor

SIPAT Co.
 Skyworks Solutions, Inc.
 Solid Sealing Technology
 Sonnet Software Inc.
 Soshin Electric Co., Ltd.
 Southwest Microwave Inc.
 Spectracom
 Spectrum Elektrotechnik GmbH
 Spectrum Microwave, Inc.
 Spinner Atlanta
 SRI Connector Gage Company
 SRI Hermetics
 SSI Cable Corp.
 State Of The Art Inc.
 Statek Corp.
 Stellar Industries Corp.
 Stellar Microelectronics
 StratEdge Corp.
 Sumitomo Devices
 Innovations U.S.A., Inc.
 Summitek Instruments Inc.
 Sunwave Communication Co., Ltd.
 Superior Technical Ceramics Corp.
 SUSS Microtec Inc.
 SV Microwave Inc.
 Synergy Microwave Corp.
 Synopsys, Inc.
 SynQor, Inc.
 T-Tech Inc.
 Taconic
 Tactron Elektronik oHG
 Tahoe RF Semiconductor, Inc.
 TDI International, Inc.
 TDK-Lambda Americas
 Tecdia Inc.
 Tech-X Corp.
 Tektronix Inc.
 Teledyne Coax Switches
 Teledyne Cougar
 Teledyne Defence Limited
 Teledyne MEC
 Teledyne Microelectronics
 Teledyne Microwave
 Teledyne Relays
 Teledyne Scientific Company
 Teledyne Storm Products
 Teledyne Technologies, Inc.
 Telegartner, Inc.
 Telnova Technology Co., Ltd.
 Telogy LLC
 Temp-Flex Cable Inc.
 Temwell Corp.
 TestEquity LLC
 Thales Components Corp.
 THINFILMS Inc.
 Times Microwave Systems
 TLC Precision Wafer Technology
 Inc.
 TMD Technologies Ltd.
 Toshiba America Electronic Cmpts.
 TowerJazz
 TRAK Microwave Corp.
 Trak Microwave Ltd./Farran Tech.
 Transcom, Inc.
 Trilithic Inc.
 TriQuint Semiconductor
 TRM Microwave
 Tronser Inc.
 TRU Corporation Inc.
 TTE Inc.
 Tyco Electronics Relay Products
 Group
 UltraSource Inc.
 UMS (United Monolithic
 Semiconductors)
 University Booth
 UTE Microwave Inc.
 VACCO Industries
 Valpey Fisher Corp.
 Vectron International
 Verspecht-Teyssier-Degroote
 VIDA Products, Inc.
 VidaRF
 Virginia Diodes Inc.
 Vishay Intertechnology
 Voltronics Corp.
 VTI Instruments Corp.
 W.L. Gore & Associates
 Wavenics, Inc.
 Weinschel Associates
 Wenzel Associates Inc.
 Werlatone Inc.
 West Bond Inc.
 WEVERCOMM Co., Ltd.
 Williams Advanced Materials
 WIN Semiconductor Corp.
 WIPL-D D.O.O.
 Wireless Telecom Group
 X5 Systems, Inc.
 XMA Corp.
 Ya Guang Electronics Co., Ltd.
 Yantel Corp.
 Ying Chuang
 Microwave Electronics Co.,Ltd.
 Z-Communications, Inc.
 Zeeteq Electronics Ltd.
 Zeland Software, Inc.
 ZIFOR Enterprise Co. Ltd.

PLATINUM/GOLD/SILVER SPONSORS

PLATINUM

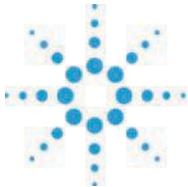

Agilent Technologies

GOLD



SILVER



MEDIA PARTNER



OFFICIAL MEDIA SOURCE OF THE MTT-SOCIETY



MEDIA SPONSOR





MICROAPPS

The MicroApps program features practical Application papers describing state-of-the-art products and processes of interest to the microwave community. This year's highlights include a keynote presentation by Dr. David Root of Agilent Technologies on nonlinear behavioral modeling Wednesday morning. There are also two tutorials on Wednesday evening, prior to the industry-hosted reception. MicroApps attendees will receive a free DVD of presentations sponsored by Agilent.

	Tuesday	Wednesday	Thursday
9:10	Design-Stage Thermal Analysis using Templates Shariar Motakef, Cape Sym, Inc.	High-Power Measurements using the Agilent Nonlinear Vector Network Analyzer Keith Anderson, Agilent Technologies	Practical Considerations in the Design and Implementation of RF and Microwave Signal Switching Solutions for ATE Walt Strickler, Giga-tronics Incorporated
9:30	Multi-chip Module Design Challenges Josh Moore, Dustin Hoekstra, AWR Corp.	An Introduction to Gallium Nitride (GaN) Device Characterization Steve Dudkiewicz, Maury Microwave Corp.	Test & Measurement Migration to Integrated Simulation, Test & Measurement for M&RF Design Christina Gessner, Sherry Hess, Rohde & Schwarz; AWR Corp.
9:50	How to Prevent MMIC/RFIC Packaging Integration Failures Hee-Soo Lee, Agilent Technologies	KEYNOTE: X-parameters: The Emerging Paradigm for Interoperable Characterization, Modeling, and Design of Nonlinear Microwave and RF Components and Systems David Root, Agilent Technologies	Fundamentals of Phase-Coherent RF Measurements David A. Hall, National Instruments
10:10	Nonlinear co-simulation with real-time channel measurements for PCB Signal Integrity Mike Heimlich, Khaled Nikro, Harry Momjian, Macquire University; AWR Corp.; Anritsu Corp.		Mobile Phone Testing using Impedance Tuner Roman Meierer, Steve Dudkiewicz, Maury Microwave Corp.
10:30	Causality Considerations for Multi-Gigabit StatEye Analysis Michael Heimlich, Scott Wedge, Ted Mido, AWR Corp.; Synopsys, Inc.		Improved Amplifier Testing Using Statistics BoB Muro, Wireless Telecom Group
10:50	Do Something Really Useful with VNA Time Domain Processing Don Metzger, Constant Wave		Redefine How You Measure & Simulate Nonlinear Devices Using X-Parameters™, Jack Sifri Agilent Technologies
11:10	Unexpected Effects of Conductor Profile on the Propagation Constant in Rogers RO4000® LoPro™ High Frequency Laminates Allen F. Horn, III, Rogers Corp.	S-functions, the "S-parameters" for nonlinear devices Guillaume PAILLONCY, NMDG nv	Ultra-Fast Noise Parameter Measurements – 100x Faster and More Accurate Gary Simpson, Maury Microwave Corp.
11:30	Microwias for Microwave Applications in Cofired Ceramics Iris Labadie, Kyocera America, Inc.	A New Approach for Nonlinear Behavioral Modeling Darren McCarthy, Johannes Benedikt, Tektronix Inc.; Mesuro Limited	WinCal the Microwave Tool Leonard Hayden, Cascade Microtech, Inc.
11:50	Drop-on-demand Inkjet Printing of Functional Materials using the Dimatix Materials Printer DMP-3000 Jan Sumerel, FUJIFILM Dimatix, Inc.	Accurate Mixer Measurements Using Multi-tone X-parameter™ Models Mihai Marcu, Radek Biernacki, Agilent Technologies	Coaxial Measurements – Common Mistakes and Simple Solutions Sathya Padmanabhan, Rocky Teresa, Maury Microwave Corp.
12:10	Characterization Of Adhesive Films From kHz to GHz Dietmar Koether, Uwe Gollor, Joerg Berben, IMST GmbH		Application of second-tier VNA calibration with Cascade Microtech WinCal XE Craig Kirkpatrick, Cascade Microtech, Inc.
12:30	Advances in High Frequency Printed Circuit Board (PCB) materials used in Power Amplifier Applications John Coonrod, Rogers Corp.	A methodical approach to analyzing and understanding the performance of a LTE system Joel Kirshman, AWR Corp.	The challenges of the Nanoscale material and device characterization Hassan Tanbakuchi, Pavel Kabos, Agilent Technologies; NIST

Color Coding Key:

- High Power
- SW/signal processing
- Comp Modeling
- Materials CZ
- Phase Noise
- Wide bandwidth
- Test equipment/meas

MICROAPPS

	Tuesday	Wednesday	Thursday
12:50	How to Save Money by Using Custom Designed GaAs MMICs Liam Devlin, Plextek Limited	Practical Digital Pre-Distortion Techniques for Linearization in 3GPP LTE Systems Jin-Biao Xu, Agilent Technologies	60 GHz Power Amplifier Design for Wireless HDMI (WPAN) Michael Thompson, Ken Mays, Agilent Technologies; TriQuint Semiconductor
13:10	System-Level Component Models for RF EDA Jiang Liu, Lawrence Dunleavy, Modelithics, Inc.	Wideband Linearization Allen Katz, Linearizer Technology, Inc	
13:30	Multi-Rate Harmonic Balance for Non-Linear Simulation Josh Moore, AWR Corp.	EMPIRE XCcel – Efficient solving of large scale EM problems Winfried Simon, A. Wien, IMST GmbH	
13:50	A Survey of Load-Pull Simulation Capabilities -- How Do They Help You Design Power Amplifiers? Andy Howard, Agilent Technologies	XFddt 7 and Wireless InSite: Remcom's Multi-Physics Toolset Joseph J. Rokita, Remcom, Inc.	
14:10	PA Design Inclusive of Load-Pull Analysis Josh Moore, Dustin Hoekstra, AWR Corp.	When Should You Apply Planar EM Simulation? Andy Howard, Agilent Technologies	
14:30	Online Design Environment provide Interactive Datasheets for Small Signal RF Transistors – Allows Users to Generate Custom Datasheets for a Variety of Operating Conditions Sherry Hess, Uwe Knorr, Ronald Thissen, "AWR Corp.; Transim Technology Corp NXP Semiconductors"	Rapid 3-D Analysis of Multiple Design Configurations with HFWorks Hussam Maleh, Kousseil Ben Ahmed, ElectroMagnetic Works	
14:50	Using AWR's iFilter™ Mark Saffian, AWR Corp.	The Use of Computer Clusters and Spectral and Domain Decomposition in 3D FEM Analysis John DeFord, AWR Corp.	
15:10	Synthesis, design and high-power analysis of dual-mode filters with FEST3D Jordi Gil Raga, Carlos Vicente, Vicente Esbert Boria, Benito Gimeno, Aurora Software and Testing S. L.	Low Phase Noise Signal Generation and Measurement John S. Hansen, Agilent Technologies	
15:30	Creating and Tuning a Conformal Antenna with Remcom's XF 7 Software James F. Stack, Jr., Remcom, Inc.	Miniature low phase noise microwave opto-electronic oscillator (OEO) Danny Fung, Oewaves, Inc.	
15:50	Ultraminiature High Power RF Switch Werner Johler, Tyco Electronics	Pulse Generation and Analysis John S. Hansen, Agilent Technologies	
16:10	Silicon Technology Solutions for Wireless Front End Modules Alvin Joseph, Randy Wolf, Peter Rabbeni, Alan Botula, Dawn Wang, David Hame, Jim Dunn, IBM Microelectronics	"Modern Methods for Fast And Accurate Frequency Converter Characterization" David Ballo, Agilent Technologies	
16:30	Single Chip LNA using high Q inductors on a Silicon-on-Sapphire process Duncan Widman, Andrew Greatbatch, AWR Corp.; Sapphicon Semiconductor	Down-Converting Ultra Wideband Track and Hold Circuits Mehran Mokhtari, Teledyne Scientific	
16:50		High Power Load Pull with X-Parameters – A New Paradigm for Modeling and Design Gary Simpson, Maury Microwave Corp.	
17:20		A Tutorial on Silicon Spiral Inductor Ground Return Effects on RFIC Design James Rautio, Sonnet Software, Inc.	

Color Coding Key:

High Power
SW/signal processing
Comp Modeling
Materials CZ
Phase Noise
Wide bandwidth
Test equipment/meas

Historical Exhibit

While enjoying the latest technology and products in the exhibitor's hall, take a leisurely break and visit the Historical Exhibit in booth 3530. Here you will find some of the early groundbreaking inventions and microwave related items from the National Electronics Museum as well as contributions from companies in the Southern California area. As you reflect on the history of the items contained in this exhibit, you will be amazed how far technology has evolved from its humble beginnings and has revolutionized the microwave and communications industry into that which we know and enjoy today.



SOCIAL EVENTS

Sunday, May 23, 2010

RFIC Reception — 19:00-21:00 **Anaheim Convention Center, Room 213BCD**

Immediately following the RFIC Plenary Session is the RFIC Reception to be held in adjacent ROOM 213BCD at the Anaheim Convention Center. This social event is a key component of the RFIC Symposium, providing an opportunity to connect with old friends, make new acquaintances, and catch up on the wireless industry. Admission is included with RFIC Symposium registration. Additional tickets can also be purchased separately at registration.

Monday, May 24, 2010

IMS 2010 Welcome Reception — 18:00-20:00 **Hilton Hotel, Sunset Deck**

All Microwave Week attendees and exhibitors are invited to attend a reception hosted by IMS 2010.

Tuesday, May 25, 2010

Special Luncheon for Chuck Swift — 12:00-14:00 **Anaheim Convention Center, Rooms AR1 & 2**

The IMS 2010 will hold a Special Luncheon on May 25, 2010, to celebrate Chuck Swift's 52 years of service in support of the Los Angeles Chapter of the Microwave Theory and Techniques Society. The chapter has sponsored monthly technical meetings since 1952 and periodic national/international 3-5 day meetings since 1970, such as the IMS meeting being held in Anaheim on May 23-28, 2010. Chuck formed his business, C. W. Swift & Associates, in July 1958. Since 1958, Chuck, his business and his family have supported 450 meetings and 7 IMS symposia. IMS 1989 stands out as the best performance, where Chuck put on a show of shows. The Luncheon will be held on Tuesday May 25 from 12:00 (noon) to 2:00 pm, in the Convention Center, in Rooms AR1 & 2 (near the Arena). The Luncheon is a full sit-down lunch. Admission is \$35.00 per person; sign-up is through the IMS 2010 Registration.

Women in Microwave Engineering (WIM) Reception — 17:30-19:30 **Uva Bar, 1580 Disneyland Drive, Downtown Disney**

Meet with old friends as well as make new connections to the growing community of women who make a career in the field of high-technology. Enjoy good food, cool beverages and warm conversation at the WIM Social Event. Join us at the outside patio area of the Uva Bar in the center of the Downtown Disney entertainment district.

Student Reception — 19:00-21:00 **Hilton Hotel, Room California B**

Mix and mingle with fellow students from across the globe!

Ham Radio Social — 18:00-21:00 **Hilton Hotel, California A**

While enjoying a buffet and open bar, the attendees will have the opportunity to see the accomplishments of amateur radio operators who have skillfully designed and built transceivers for use from VHF to high millimeter wave bands. Some of these transceivers were made from surplus and commercially available components and some are state-of-the-art new designs including SDR. Several will be on display and their builders will be there to answer questions.

All conference attendees are welcome. You will find that amateur radio operators are utilizing their allocated frequency spectrum for very important uses and you may be interested in obtaining your license so you too can test your new designs and microwave propagation.

Wednesday, 26 May 2010

Industry Hosted Cocktail Reception — 17:00-18:00 **Anaheim Convention Center Exhibition Floor**

Symposium Exhibitors will host a cocktail reception.

MTT-S Awards Banquet — 19:00-22:00 **Hilton Hotel, California Room**

The MTT-S Awards Banquet includes a fine dinner, major society awards presentation, and entertainment. This year's entertainment will be provided by String Theory. String Theory is an exceptional music performance drawing on the very space of the performance by transforming architecture into musical instruments and then playing the building. The result is a visually stunning landscape in which the performance unfolds. Tickets can be purchased at the time of registration.

Thursday, 19 June 2010

MTT-S Student Awards Luncheon — 12:00-14:00 **Hilton Hotel, California B**

All students are invited to attend this luncheon which recognizes recipients of the MTT-S Undergraduate Scholarships, MTT-S Graduate Fellowships, IMS2010 Student Volunteers, IMS2010 Student Paper Awards, and the winners and participants of the IMS2010 Student Design Competitions.

MTT-S Graduates of the Last Decade (GOLD) Reception — 17:30-19:00 **300 Anaheim**

The IEEE MTT Graduates of Last Decade (GOLD) Committee invites all MTT GOLD members to a complimentary reception at 300 Anaheim. This will be an excellent opportunity not only to relax and entertain, but also to interact and network with other GOLD members.

HOSPITALITY SUITE

Enjoy Southern California hospitality by joining us in the Hospitality Suite in the Garden Room of the Sheraton Hotel. Grab your guest badge and come have breakfast in the morning or snacks later in the day. Meet friends, make friends, kick back and relax. There will be a special area for children with toys and games. Guest Tours will depart from the Hospitality Suite. Don't forget to bring your swim gear, as guests will have access to the pool at the Sheraton Park during the hours the Hospitality Suite is open.

Open Sunday, May 23 through Thursday, May 27 7:30am to 3:30pm

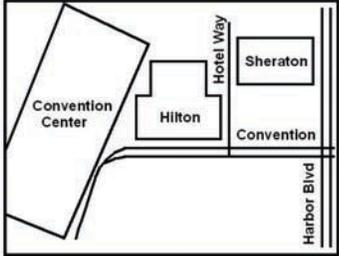

RECREATIONAL ACTIVITIES

Registration for all the guest tours will be available on line at <http://www.pra-tours.com/IEEE> and in the Hospitality Suite at the Sheraton Park.

LOS ANGELES COUNTY MUSEUM OF ART, PETERSEN AUTOMOTIVE MUSEUM & LA BREA TAR PITS Sunday, May 23, 2010



Suggested Itinerary:

- 10:00 AM Depart Sheraton Park Hotel
- 11:30 AM Arrive LACMA and Petersen – Free time to explore both museums
- 1:30 PM Lunch at LACMA
- 2:30 PM Arrive Page Museum and La Brea Tar Pits- guided tour
- 4:00 PM Depart Museum
- 5:30 PM Return to Sheraton Park Hotel

Time: 10:00 AM – 5:30 PM
Price: \$125.00 per person

Explore a collection with more than 100,000 works of art at LA CMA, the largest encyclopedic museum west of Chicago. Through its far-reaching collections, the museum is both a resource to and a reflection of the many cultural communities and heritages

in Southern California. Highlights include European masterpieces, cutting-edge contemporary art, an extensive collection of American art from the United States and Latin America, a major Islamic art collection, one of the most comprehensive Korean art collections outside of Korea, and the stunning Pavilion for Japanese art.

Across the street is the Petersen Automotive Museum, where imagination drives guests from memory lane to the fast lane, and destinations beyond. The Petersen Automotive Museum is dedicated to collecting, preserving and interpreting the role of the automobile and its technology in shaping American culture. It is the largest and most innovative automotive museum in the world.

Concluding the tour guests are treated to views of one of the world's most famous Fossil sites found in the heart of Los Angeles, The La Brea Tar Pits. The tar pits were formed about 12,000 years ago by layers of soil that built up into sedimentary formations. Eventually, heat and pressure sent oil oozing through cracks in this sediment. As the water began to dry up, the oil turned into sticky asphalt, imprisoning animals which had come to drink or prey on those already stuck. The bones of all these animals were eventually covered by asphalt. Water brought more sediment, causing a buildup. All this was bad for the animals, but good for scientists who have dug up more than one-million fossils representing 4,000 mammals and 126 types of birds. Among the fossils discovered were the bones of a twenty-five to thirty-year-old woman, dubbed "La Brea Woman." Carbon-dating indicated the woman died about 9,000 years ago.

A visit to the George C. Page Museum of La Brea Discoveries gives a picture of the diversity of Ice Age life in Southern California. The Rancho La Brea fossils that are exhibited and stored in the museum are a unique natural resource . . . a window into the life of the past.





RECREATIONAL ACTIVITIES

NEWPORT HARBOR CRUISE Sunday, May 23, 2010



Suggested Itinerary:

- 1:30 PM Depart Sheraton Park Hotel
- 2:00 PM Newport Harbor Cruise
- 2:45 PM Free time to explore Balboa Island
- 4:00 PM Board coach and depart for hotel
- 4:30 PM Return to Sheraton Park Hotel

Time: 1:30 PM – 4:30 PM
Price: \$64.00 per person

Welcome to the Newport Beach, one of Southern California’s most vibrant recreation and entertainment centers. Famous worldwide for its picturesque sandy beaches, majestic coastline, infinite recreational activities, award-winning dining and world-class shopping, Newport Beach is more than a sophisticated beach town - it’s a way of life.

Guests are treated to a cruise along Newport Harbor. Newport Harbor is home for yacht clubs, beachfront mansions, and sportfishing fleets. Film crews in the silent screen era used its beautiful coastline to double as a Caribbean pirate’s hidden cove. Today, Newport is one of California’s busiest harbors, filled with dozens of colorful sailboats and majestic yachts.

As an added enhancement, following the harbor cruise, free time has been allotted for guests to explore quaint Balboa Island with its one of a kind boutique shops, beautiful homes, and their infamous frozen banana!

QUIET ON THE SET! Monday, May 24, 2010

Suggested Itinerary:

- 9:00 AM Depart Sheraton Park Hotel
- 9:45 AM Arrive Warner Bros. Studio
- 10:00 AM Watch film on the Studio’s history
- 10:30 AM Docent guided tram tour
- 12:45 PM Lunch at Warner Brothers cafeteria Commissary
- 1:45 PM Depart Warner Bros. Studio
- 2:30 PM Return to Sheraton Park Hotel

Time: 9:00 AM – 2:30 PM
Price: \$138.00 per person

Built in 1919, Warner Bros. Studio was the first Hollywood studio to introduce sound. This event occurred in 1927 with its production of “The Jazz Singer,” starring Al Jolson.

The tour begins with a short film showcasing the movies and television shows created by Warner Bros. talent over the years. Guests are then escorted via tour carts to the Warner Bros. Museum - a true archive of filmed entertainment history. Exhibits include costumes, props, awards and actual scripts from some of their most renowned productions. From the Museum, guests will visit our backlot sets, sound stages and craft/production shops - routes change from day to day to accommodate production on the lot, so no two tours are exactly alike.

As guests tour the studio on the VIP tour cart, anything can happen - perhaps a celebrity sighting, or a shoot just wrapping on an exterior set! They may pull into New York Street - location for such television hits as ER, but originally constructed in the 1930s for the film noir classics. Or visit Midwest Street - Warner Bros.’ answer to “Any Town USA” - made famous in the musical A Music Man. If the timing is right, guides will take guests onto a sound stage to see the set of a current Warner Bros. show! Guests may also visit “The Mill”, home to craft shops since the 1930’s; the costume or prop warehouses; or maybe enter the Foley stage for a demonstration of how sounds are recreated for film.



RECREATIONAL ACTIVITIES

A PRESIDENTIAL PEEK Monday, May 24, 2010



Suggested Itinerary:

1:00 PM	Depart Sheraton Park Hotel
1:30 PM	Docent guided tour of the Nixon Library, based on (2) hours
3:30 PM	Free time on own at the Nixon Library
4:30 PM	Depart the Nixon Library
5:00 PM	Return to Sheraton Park Hotel

Time: 1:00 PM – 5:00 PM

Price: \$60.00 per person

The story of our times is told in unforgettable fashion at the Richard Nixon Library & Birthplace. The library opened its doors on July 19, 1990. This privately supported, non-profit institution is dedicated to educating the public about the life and times of the 37th President and encouraging interest in history, government and public affairs.

The nine acre Library & Birthplace is a three-dimensional walk-through memoir featuring a 52,000 square foot museum. Exhibits include the "Structure of Peace" exhibit, which highlights President Nixon's foreign policy breakthroughs and a piece of the Berlin Wall that serves as a stark reminder of the danger of totalitarianism. Another featured gallery is the "Hall of World Leaders", where 10 life-sized bronze figures of postwar titans, from Churchill to Mao are on display, with priceless gifts presented to President and Mrs. Nixon by heads of state and governments from around the world. The Watergate Gallery is the largest exhibit dedicated to a single subject. It describes Watergate as a political struggle between Nixon and a Democratic Congress which adamantly opposed the Administration's policies in Vietnam during his first term. Visitors can listen to key portions of the so-called "smoking gun" conversation from June 23, 1972, in which the President is first given John Dean's idea for covering up Watergate.

In addition to the Library site is the faithfully preserved boyhood home of the 37th President, built by President Nixon's father in 1912, decorated with original furniture, including the bed, in a closet-sized room, where Richard M. Nixon was born. Rounding out the Library & Birthplace site are nine flower-drenched acres including Orange County's largest public rose garden. The President and Mrs. Nixon's memorial is also located at the library. President Nixon's gravestone reads: "Even when people can't speak your language, they can tell if you have love in your heart."

IN VINO VERITAS - WINE COUNTRY OF TEMECULA Date: Tuesday, May 25, 2010

Suggested Itinerary:

8:15 AM	Depart Sheraton Park Hotel
9:45 AM	Ponte Winery
11:45 AM	Free time in the Visitor's Center
12:15 PM	Depart Ponte Winery
12:30 PM	Lunch and tasting at Wilson Creek Winery & Vineyards
2:30 PM	Free time in Visitor's Center
3:00 PM	Depart Temecula
4:30 PM	Return to Sheraton Park Hotel

Time: 8:15 AM – 4:30 PM

Price: \$140.00 per person

The magic ingredients of soil, climate, and skill combined in an effort to make great wines are hard to find or duplicate. Just east of Orange County is one of America's most beautiful and bountiful wine countries . . . Temecula.

Guests sample this grand panorama and learn the history and legends that truly make California the Golden State while touring two of the most popular wineries and tasting the products of their labors.

The Ponte Family Estate Winery is one of Temecula's most appealing wineries. The Ponte family, who has been growing grapes in Temecula since 1984 opened the winery in May of 2003 right in the heart of Temecula Valley Wine Country. The journey began back in 1984 when the Ponte Family purchased over 500 acres of Cabernet, Merlot, Chardonnay, Zinfandel and Sauvignon Blanc vineyards. At first the Ponte Family sold the fruit to other California wineries but now they are proud to offer a full array of wines under the Ponte label. Guests will make their first stop here at Ponte Winery and will enjoy a private tour and have the chance to experience wine right from the barrel in the Barrel Room.





RECREATIONAL ACTIVITIES

Wilson Creek Winery – Three generations of the Wilson family participate in running the winery, making it truly a family endeavor. Gerry and Rosie got their start in winemaking thirty years ago, making rhubarb and dandelion wines in tubs beside the sauna in their Minnesota basement. What was once a hobby is now their full-time passion. After retiring, the Wilson’s purchased the twenty-acre vineyard on winery row in Temecula in 1996. It truly was a diamond in the rough. A seasonal creek fronting the property was dubbed “Wilson Creek”. Today, visitors benefit from all their hard work by enjoying picnics surrounded by Rosie’s elegant flower gardens. Work on the winery building itself was completed in 1999. Gerry can usually be found behind the tasting bar, pouring wines, sharing stories, and making people feel welcome. If not behind the tasting bar herself, Rosie is usually hard at work in her beautiful flower gardens, which adorn the property.

The serenity and beauty of the Temecula region combined with a visit to these wineries make this a relaxing, informative and tasty day.

Today, acquire a very special insight into the world of art as guests explore some of the city’s premier galleries where they find art for sale to suit every taste, décor and budget.

One of Laguna’s foremost artists accompanies guests on their “art walk” giving them an insight into the world of art, which is the very heart of Laguna.

Following a gallery tour, guests have free time to explore the quaint specialty shops and seaside boutiques that offer bargain shopping with an ocean view, explaining why many feel Laguna Beach is a shopper’s paradise. Shopping is concentrated in a charming area along Pacific Coast Highway near Main Beach and Forest Avenue. Quaint shops, antique galleries, art studios and boutiques offering the latest in designer fashions abound. Browse and shop at your own pace, then take a few minutes to kick off your shoes and enjoy a leisurely stroll along the shore!

BRUSHSTROKES OF LAGUNA Tuesday, May 25, 2010



Itinerary:

- 10:30 AM Depart Sheraton Park Hotel
- 11:00 AM Art walk with local artist, based on (1½) hours
- 12:30 PM Free time for browsing and shopping in Laguna Beach
- 2:00 PM Depart Laguna Beach
- 2:30 PM Return to Sheraton Park Hotel

Time: 10:30 AM – 2:30 PM
Price: \$96.00 per person

THE GLITZ AND GLAMOUR...AN INSIDE LOOK Wednesday, May 26, 2010



Suggested Itinerary:

- 10:00 AM Depart Sheraton Park Hotel
- 11:00 AM Arrive Hollywood, begin Historic Hollywood tour
- 12:15 PM Tour ends – free time in Hollywood
- 1:00 PM Depart Hollywood
- 1:15 PM Lunch at uWink
- 2:15 PM Free time on Rodeo Drive
- 3:30 PM Depart for Hotel
- 4:30 PM Return to Sheraton Park Hotel

Time: 10:00 AM – 4:30 PM
Price: \$108.00 per person

The tour begins on the motorcoach ride into Hollywood, where a guide gives guests a brief history of Hollywood and an overview of the tour. Once in Hollywood, the one-hour walking tour includes inside looks at some of Hollywood’s most well known movie palaces, including Disney’s El Capitan Theater, Grauman’s Egyptian Theatre,

RECREATIONAL ACTIVITIES

and Grauman's Chinese Theatre, as well as some lesser-known but equally important landmarks. Additionally, the "live audio" system allows guests to hear the tour over extreme city noise. Each guest wears an audio headset and the tour guide speaks into a microphone, so guests don't miss any information while looking around.

Lunch at uWink - Guests will enjoy lunch at the hippest and newest dining experience, uWink! This interactive restaurant will truly give your guests the ultimate unique diner is all about the latest in technology. Order from a touch screen, play games with those sitting around you and see your group feel special and welcomed with custom signage and screen boards.

Following lunch, guests have free time on Rodeo Drive in Beverly Hills. Few areas in the world can compete with Beverly Hills for luxurious, exclusive, and expensive shopping. Window displays drip with diamonds, evoke scenes of extravagant elegance, hint at lifestyles most people can only dream about. Rolls-Royces, Bentleys, Mercedes Benzes, and other luxury cars arrive at roadside valet-parking stations. The rich and famous, clad in attention-getting attire, stroll casually along. Even if you can't afford one thing that's on display in the fabulous shops (and that's unlikely, because even the most pricey boutiques carry reasonably priced gift items), a visit to Rodeo Drive is a must!

WINDOWS OF DISCOVERY AT BOWERS MUSEUM Wednesday, May 26, 2010

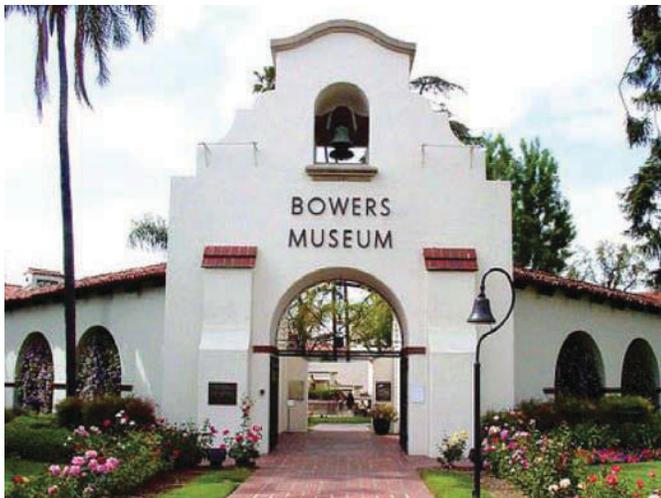

Suggested Itinerary:

11:15 AM	Depart Sheraton Park Hotel
11:30 AM	Free time at Bowers Museum
1:30 PM	Depart the Bowers Museum
1:45 PM	Return to Sheraton Park Hotel

Time: 11:15 AM – 1:45 PM
Price: \$60.00 per person

Step into a world of mystery, adventure, power, and magic. It's a world where Africans transform the harshest surroundings into the most graceful art, ancient mariners settle the wild islands of the Pacific with the aid of spirits and dreams, and the native peoples of our vast continent commune with nature to forbear the rise and fall of powerful empires. Discover the Bowers Museum of Cultural Art . . . a place where art can communicate both the diversity and the unity of human experience.



Temporary Exhibitions

Where Masks Still Dance
December 26, 2009 - June 6, 2010

Masters of Adornment: The Miao People of China
November 15, 2008 – ongoing

Permanent Collections at Bowers Museum

ART OF ADORNMENT: TRIBAL BEAUTY

Tribal art represents the art of the world's indigenous people. In many of these indigenous cultures, there isn't a word for "art." Instead, there is an inherent aesthetic incorporated into the people's daily life. This can be seen in all aspects of their life from preparation of food, hunting and warfare, ceremony and religion, and in the way they enhance their appearance in body adornment. "Art of Adornment: Tribal Beauty" will feature 70 rare and spectacular treasures and will focus on the tribal aesthetic of body adornment from indigenous peoples around the world.

Relive the adventures, hardships, and triumphs of early California settlers from the days when Native Americans lived in harmony with the land, to the fierce Spanish conquest and the frenzy of the great California Gold Rush. As part of the permanent collections, California Legacies takes a fascinating look at the people and events that helped shape today's Orange County and the Southwest.



RECREATIONAL ACTIVITIES

Following on the heels of Treasures From Shanghai: 5000 Years of Chinese Art and Culture, the Bowers is drawing on its own collections, and the curatorial expertise of the world renowned Shanghai Museum, to maintain the Shanghai theme in this now permanent exhibition called, Arts of Ancient China.

LANDMARKS OF LONG BEACH Thursday, May 27, 2010



Suggested Itinerary:

8:45 AM Depart from Sheraton Park Hotel
 9:15 AM Arrive Aquarium of the Pacific Self Guided Tour
 10:45 AM Depart for Queen Mary
 11:00 AM Arrive Queen Mary Self Guided Tour
 12:00 PM Lunch at Promenade Cafe
 1:30 PM Ghost and Legends Show
 2:15 PM Board coach and depart for hotel
 2:45 PM Return to Sheraton Park Hotel

Time: 8:45 AM – 2:45 PM

Price: \$135.00 per person

The Aquarium of the Pacific tells the story of the Pacific Rim and the vast and populous sea that covers nearly half of the planet. Over 17 major exhibit tanks, 30 smaller focus tanks, one million gallons of sea water, and more than 10,000 denizens of the Pacific Ocean, representing over 550 different species are showcased.

The endless wonders of the world’s largest, deepest and most astonishing ocean come to life at the Aquarium of the Pacific.

Come aboard the legendary Queen Mary, the most elegant ocean liner afloat. Built with all the pride of Great Britain’s seafaring tradition and presented to the world as

a standard of luxury and craftsmanship unequalled in shipbuilding history, she is as beautiful today as when she first set sail in 1936.

Guests have the opportunity to explore this majestic ship and discover her rich past from engine room to wheelhouse. A tour of the R.M.S Queen Mary includes newly restored areas that have been under wraps since the final voyage in 1967 and examines her life as both a World War II troopship and luxury liner. They also experience “Ghosts and Legends of the Queen Mary”, an interactive, state of the art, special effects attraction that blurs the line between what’s real and what isn’t.

SECRETS OF THE SEA Thursday, May 27, 2010

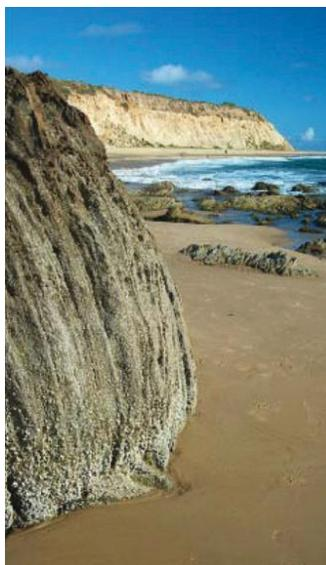

Itinerary:

9:00 AM Depart Sheraton Park Hotel
 9:30 AM Arrive at Crystal Cove

Beach Walk
 11:30 AM Board coach and depart for hotel
 12:00 PM Return to Sheraton Park Hotel

Time: 9:00 AM – 12:00 PM

Price: \$97.00 per person

Crystal Cove State Park offers three and a half miles of unobstructed pristine beach and remains the most natural beach in Orange County. Miles of beautiful coastal bluffs support healthy strands of coastal sage scrub habitat along with blooming seasonal native flowers and shrubs. Trails meander along the bluffs and lead down to the beach. A strong wildlife population includes coyotes, squirrels, raccoons, rabbits, deer, bobcats, opossum, hawks and a variety of inland and coastal birds.

Walking along coastal bluffs through a mosaic of native plants, guests enjoy a panoramic overview of the sparkling Pacific Ocean. As guests descend the trails onto the beach, they are amazed to learn about the sophistication of dolphin societies, whose members are often seen playing in the waves. Guests learn how dolphin schools operate, how they call each other by name, the elaborate games they play and the advanced echolocation system that allows dolphins to picture their world in virtual reality even in the dark. Guests also learn about the birth and death of a wave, whose “life” may have begun continents away.

On the beach, guests explore what a forty-ton gray whale has in common with a two-ounce hummingbird and what the difference is about their annual 2,000 to 10,000 mile migrations.

A unique Southern California experience!

THE GETTY CENTER Friday, May 28, 2010

Suggested Itinerary:



9:30 AM	Depart Sheraton Park Hotel
10:30 AM	Self-guided tour at the Getty Center, based on (3) hours Lunch on Getty Center lawn
1:30 PM	Depart the Getty Center
2:30 PM	Return to Sheraton Park Hotel

Time: 9:30 AM – 2:30 PM

Price: \$81.00 per person

As the crowning jewel of the J. Paul Getty Trust, the original museum was created entirely for the benefit of the public, and is devoted to the visual arts. The Getty Museum began as a Romanesque villa in the secluded mountains of Malibu, displaying its permanent, ornate collection of Greek and Roman antiquities, pre-twentieth century European paintings, drawings and sculpture, as well as decorative arts.

The Getty Museum was transformed into the much-anticipated J. Paul Getty Center, a 110-acre, six-building comprehensive art complex situated in the Santa Monica Mountains. The exhibits have expanded from its European roots to reflect the creative and cultural dynamics of art around the world, incorporating ancient and modern works of Latin America, Africa and the Far East in captivating, constantly changing exhibits. The Getty Center has also become an interactive, state-of-the-art research and educational facility for art students and enthusiasts of all ages. The grounds consist of elaborate gardens and sweeping

views, such as the Central Garden, which is an ever-changing work of art filled with the color, sound and light of nature.





GOLF COURSE DESCRIPTIONS

To those who wish to enjoy the links of Southern California, the Anaheim / Orange County area offers something to fit any golfer's skill. While a formal golf outing is not part of the official recreation schedule, we can certainly assist those interested in finding a course to suit their needs. There are plenty of choices within a ten mile radius; Anaheim Hills, Dad Miller, Tustin Ranch, Coyote Hills, and Black Gold just to name a few.

If you have the time & inclination to test your swing while attending IMS2010 please let us know. Contact Philip Arnold, philip_arnold@ieee.org, cell 818-808-8315. He will be delighted to assist in getting you headed in the right direction. If there's enough interest in heading out early morning (before 9:00 a.m.) on Monday the 24th it might be possible he can set up a group outing to one of the local courses. Each individual would be on their own for green fees, clubs, transportation, etc. but he can assist in making the logistics less cumbersome. For a complete listing of the local courses check out the URL <http://www.playogolf.com/>

Enjoy IMS2010 and your stay in So Cal.

Anaheim Hills

Anaheim Hills is located just 20 minutes from Disneyland and rests in enchanting, old California terrain, featuring incredible vistas and cool valleys, with a natural stream flowing past stands of oaks and sycamores. Richard Bigler designed the 6200 yard par 71 layout. Combine all this with very affordable green fees and you have the best golf value in Orange County.

Call the golf shop up to seven days in advance for reservations 714-998-3041.

Well maintained and price friendly, Dad Miller Golf Course in Anaheim has become a popular destination for players of all ages and abilities. The par 71, 5900 yard course features a lake, with lovely trees surrounding the fairways, and can be easily walked. Tiger Woods used to play the course while he was in high-school.

Reservations can be made up to seven days in advance by calling 714-765-3481.

Tustin Ranch Golf Club

Tustin Ranch Golf Club is a championship course designed by famed architect Ted Robinson. The par 72, 6800 yard layout offers breathtaking scenery, sparkling lakes and cascading falls. It was recently voted the "Best Orange County Golf Course 2009" by the readers of the Orange County Register. In addition, Tustin Ranch is a multiple-year, 4-Star recipient of Golf Digest Magazine's "Places To Play".

For reservations up to seven days in advance call 714-730-1611.

Mile Square Golf Course

Mile Square Golf Course in Fountain Valley has been one of the top rated public courses in Orange County since it opened in 1969. Both the Players and Classic Courses, designed by David Rainville, have the reputation for outstanding greens that are consistently ranked among the best in the county and have become a "must play" for anyone in the area.

For reservations up to seven days in advance call 714-968-4556 or 714-545-7106.

Coyote Hills

Coyote Hills in Fullerton was designed by Cal Olsen and golf legend Payne Stewart. The par 70, 6500 yard layout is tucked away in the foothills of Orange County amongst 250 acres filled with streams and gnatcatchers and coyotes. The scenic terrain will challenge even the most experienced players.

For reservations up to seven days in advance call 714-672-6800.

Black Gold Golf Club

Black Gold Golf Club in Yorba Linda is a favorite of Orange County Golfers. Arthur Hills designed this par 72 layout which stretches up to 6756 challenging yards. Incorporating several design features which include a stunning waterfall off the 18th green, slight elevation changes, rolling hills, strategic bunkering and the incredible vistas overlooking coastal Orange & Los Angeles Counties. Recently rated 4.5 stars by Golf Digest.

Call 714-961-0060 to reserve a tee time up to seven days in advance.

CONVENTION CENTER MAPS

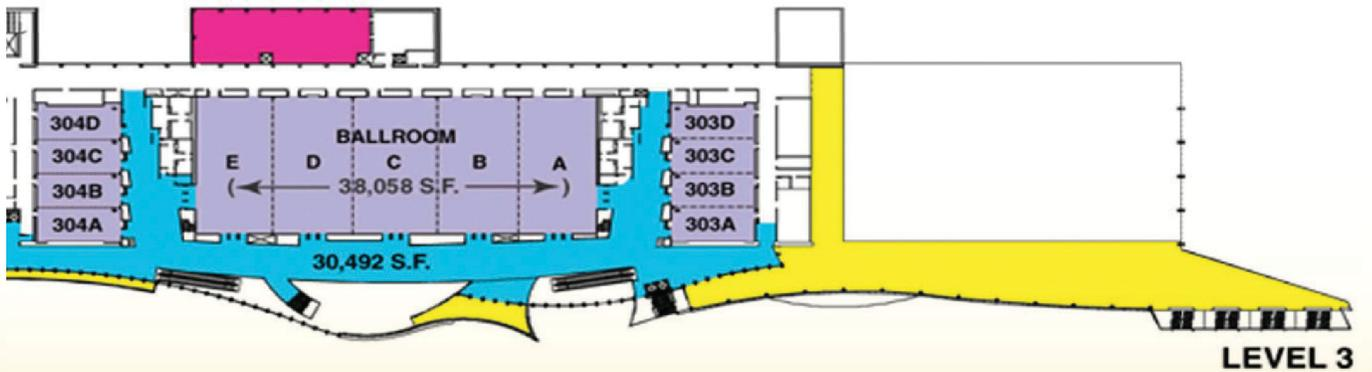
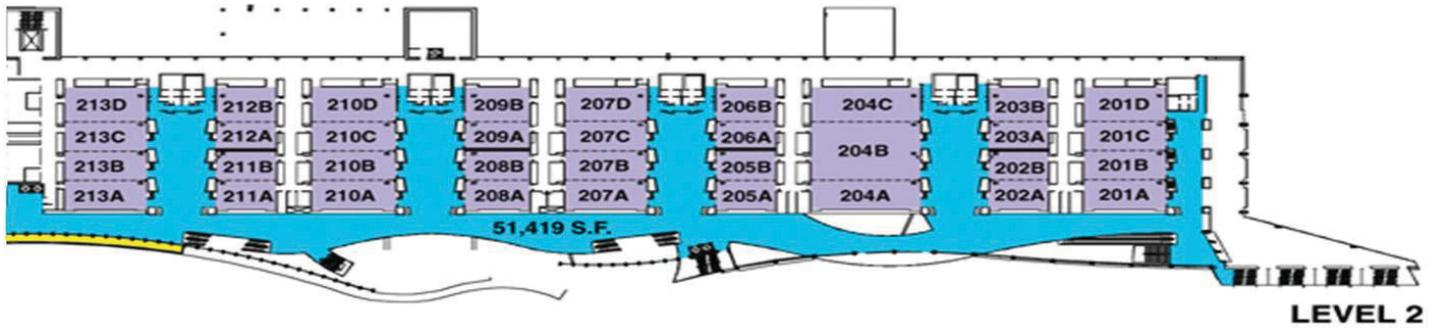
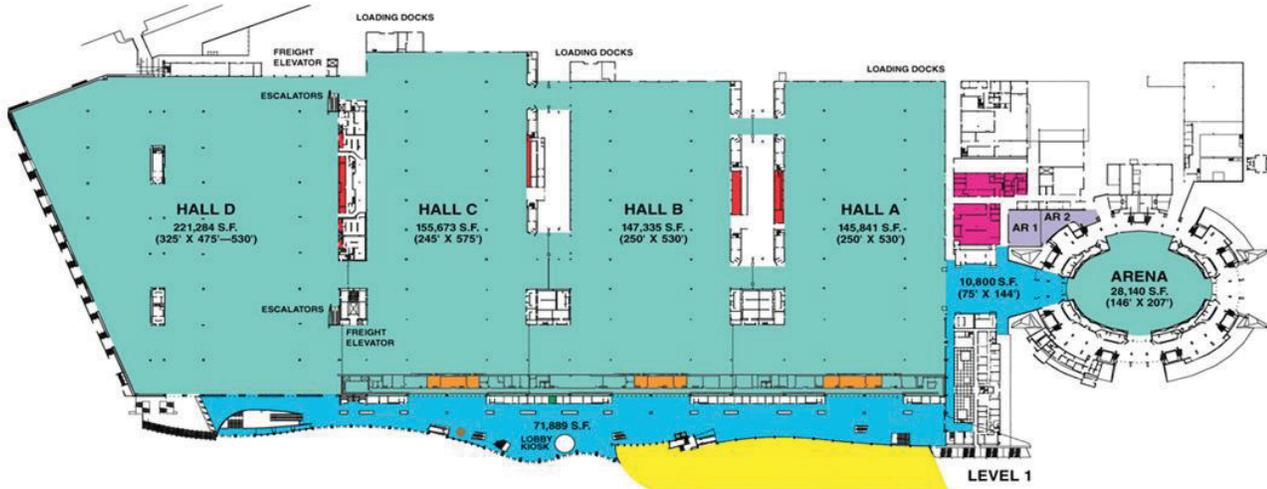



ANAHEIM
 ORANGE COUNTY
 VISITOR & CONVENTION BUREAU

Restaurants

- 1 18 Fifty Bar and Grill
- 2 Agio Ristorante
- 3 Baja Fresh/Mix Restaurant
- 4 Sbarro/Frozen Assets Yogurt
- 5 Café Del Sol
- 6 Coco's Bakery Restaurant
- 7 Disney's PCH Grill
- 8 Garden Court Bistro
- 9 Goofy's Kitchen
- 10 Hook's Pointe & Wine Cellar
- 11 IHOP
- 12 JW's Steakhouse
- 13 K'ya Anaheim
- 14 McDonald's
- 15 Mimi's Cafe
- 16 Molly's Kitchen
- 17 Morton's The Steakhouse
- 18 Napa Rose
- 19 Overland Stage Southwestern Grill & BBQ Company
- 20 Ruth's Chris Steak House
- 21 Steakhouse 55
- 22 Storyteller's Cafe
- 23 Tangerine Grill & Patio
- 24 The Mexicana Cafe & Cantina
- 25 The Sandbox Bar & Grille
- 26 Tivoli Gardens Café
- 27 Tony Roma's

Downtown Disney

- 22 AMC Theatre
- 23 Catal Restaurant & Uva Bar
- 24 ESPN Zone
- 25 House of Blues
- 26 Naples Ristorante e Pizzeria
- 27 Rainforest Cafe
- 28 Ralph Brennan's Jazz Kitchen
- 29 Tortilla Jo's

THE SHOPS AT ANAHEIM GARDENWALK

30 Bar Louie	37 P.F. Chang's China Bistro
31 Bubba Gump Shrimp Co.	38 Pop the Cork Wine Bar
32 California Pizza Kitchen	39 Roy's Hawaiian Fusion Cuisine
33 FIRE + ICE Grill + Bar	40 The Cheesecake Factory
34 Heat Ultra Lounge	41 Cinemafusion 14/IMAX
35 Johnny Rockets	42 24 Hour Fitness
36 McCormick & Schmick's Grille	43 300 Anaheim Bowling & Entertainment Center

GardenWalk Retail Stores

Harley-Davidson of Anaheim • LuxAveda Salon & Spa
 O'Neill • White House/Black Market
 ...and more!