



# 16V<sub>P-P</sub> Class G Amplifier with Inverting Boost Converter

MAX9738

## General Description

The MAX9738 features a mono Class G power amplifier with an integrated inverting boost converter. The Class G amplifier is specifically designed to drive the high capacitance of a ceramic/piezoelectric loudspeaker. The inverting boost converter can typically supply up to 400mA of peak output current, allowing for a constant output of 16V<sub>P-P</sub> over the 2.7V to 5.5V supply voltage range.

The MAX9738 maximizes battery life by offering high-performance efficiency. Maxim's proprietary output stage provides efficiency levels greater than Class AB devices without the EMI penalties commonly associated with Class D amplifiers.

The MAX9738 is ideally suited to deliver the high output voltage swing required to drive ceramic/piezoelectric speakers.

The device utilizes fully differential inputs and outputs, comprehensive click-and-pop suppression, shutdown control, and soft-start circuitry. The MAX9738 is fully specified over the -40°C to +85°C extended temperature range and is available in an ultra-small, lead-free 5x4 WLP (2.5mm x 2mm) package.

**Typical Application Circuit/Functional Diagram and Pin Configuration appear at end of data sheet.**

## Features

- ◆ Integrated Inverting Boost Converter
- ◆ 2.7V to 5.5V Single-Supply Operation
- ◆ 16V<sub>P-P</sub> Output Voltage Swing, Ideal for Driving a Ceramic Speaker
- ◆ Maintains Output Voltage Swing as the Battery Decays
- ◆ Clickless/Popless Operation
- ◆ Small, Thermally Efficient 5x4 WLP Package (2.5mm x 2mm)

## Applications

Cellular Phones  
Smartphones  
MP3 Players  
Personal Media  
Players

Handheld Gaming  
Consoles  
Notebook Computers

## Ordering Information

PART	TEMP RANGE	PIN-PACKAGE
MAX9738EWP+TG45	-40°C to +85°C	5x4 WLP

+ Denotes a lead-free package.

T = Tape and reel.

G45 indicates protective die coating.

## Simplified Block Diagram

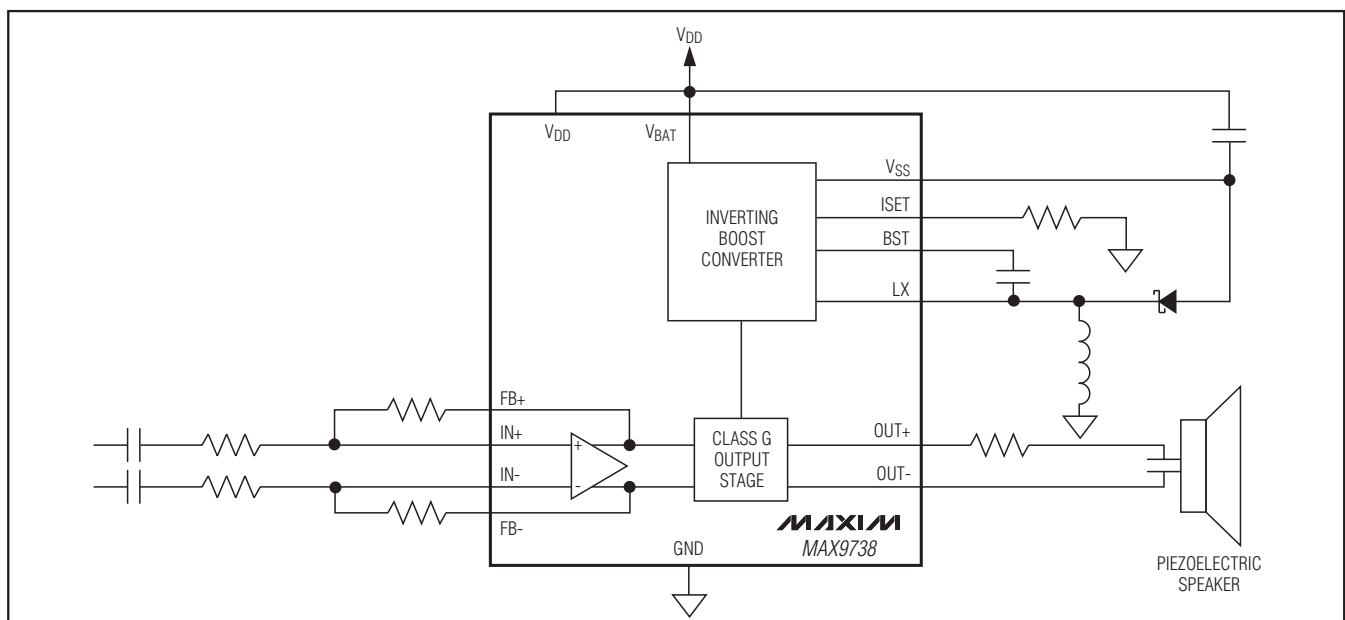

MAXIM

Maxim Integrated Products 1

# 16V<sub>p-p</sub> Class G Amplifier with Inverting Boost Converter

## ABSOLUTE MAXIMUM RATINGS

(Voltages with respect to GND.)

V <sub>DD</sub> , V <sub>BAT</sub> .....	-0.3V to +6V	
V <sub>DD</sub> to V <sub>BAT</sub> .....	-0.1V to +0.1V	
V <sub>SS</sub> .....	Capacitor Connection Only, (V <sub>BAT</sub> - 10V) to +0.3V	
OUT+, OUT- .....	-6V to (V <sub>DD</sub> + 0.3V) (OUT+ to OUT-) .....	-8.7V to +8.7V
IN+, IN-, FB+, FB-, ISET .....	-0.3V to (V <sub>DD</sub> + 0.3V)	
LX .....	(V <sub>DD</sub> - 11.5V) to (V <sub>DD</sub> + 0.3V)	
BST .....	(LX - 0.3V) to (LX + 6V)	
SHDN .....	-0.3V to +6V	

Continuous Current into/out of	
OUT+, OUT-, V <sub>BAT</sub> , V <sub>SS</sub> , V <sub>DD</sub> .....	400mA
Any Other Pin .....	20mA
Duration of OUT+, OUT- Short Circuit to	
V <sub>DD</sub> , GND, V <sub>SS</sub> (V <sub>SS</sub> > -6V) .....	Continuous
RMS Current per Bump	
V <sub>BAT</sub> , LX .....	800mA
Continuous Power Dissipation (T <sub>A</sub> = +70°C)	
20-Bump UCSP (derate 10mW/°C above +70°C) .....	800mW
Operating Temperature Range .....	-40°C to +85°C
Junction Temperature .....	+150°C
Storage Temperature Range .....	-65°C to +150°C
Bump Temperature (soldering) Reflow .....	+235°C

Stresses beyond those listed under "Absolute Maximum Ratings" may cause permanent damage to the device. These are stress ratings only, and functional operation of the device at these or any other conditions beyond those indicated in the operational sections of the specifications is not implied. Exposure to absolute maximum rating conditions for extended periods may affect device reliability.

## ELECTRICAL CHARACTERISTICS

(V<sub>DD</sub> = V<sub>BAT</sub> =  $\overline{\text{SHDN}}$  = 3.6V, GND = 0V, V<sub>DD</sub> - V<sub>SS</sub> = 9V, R<sub>ISET</sub> = 100k $\Omega$ , R<sub>IN+</sub> = R<sub>IN-</sub> = 10k $\Omega$ , R<sub>FB+</sub> = R<sub>FB-</sub> = 10k $\Omega$ , C<sub>L</sub> = open, R<sub>L</sub> =  $\infty$ , C<sub>1</sub> = 10 $\mu$ F, C<sub>2</sub> = 10 $\mu$ F, C<sub>3</sub> = 0.1 $\mu$ F, C<sub>4</sub> = 0.1 $\mu$ F, T<sub>A</sub> = T<sub>MIN</sub> to T<sub>MAX</sub>, unless otherwise noted. Typical values are at T<sub>A</sub> = +25°C.) (Note 1)

PARAMETER	SYMBOL	CONDITIONS	MIN	TYP	MAX	UNITS
<b>GENERAL</b>						
Supply Voltage Range	V <sub>DD</sub>	Inferred from PSRR test	2.7		5.5	V
Total Quiescent Current	I <sub>DD_TOT</sub>	V <sub>DD</sub> +  V <sub>BAT</sub> (boost converter disabled)		7	12.5	mA
Maximum Total Quiescent Current	I <sub>DD_TOT_MAX</sub>	Typical application circuit (Note 2)		16.5		mA
Shutdown Supply Current	I <sub>SHDN</sub>	$\overline{\text{SHDN}}$ = GND		0.6	2	$\mu$ A
Turn-On Time	t <sub>ON</sub>	Time from shutdown or power-on to full operation (C <sub>IN</sub> = 0.1 $\mu$ F)		10		ms
ISET Bias Voltage	V <sub>ISET</sub>		0.9	1.0	1.1	V
Thermal Shutdown Threshold				150		°C
Thermal Shutdown Hysteresis				15		°C

# 16V<sub>p-p</sub> Class G Amplifier with Inverting Boost Converter

MAX9738

## ELECTRICAL CHARACTERISTICS (continued)

( $V_{DD} = V_{BAT} = \overline{SHDN} = 3.6V$ ,  $GND = 0V$ ,  $V_{DD} - V_{SS} = 9V$ ,  $R_{ISET} = 100k\Omega$ ,  $R_{IN+} = R_{IN-} = 10k\Omega$ ,  $R_{FB+} = R_{FB-} = 10k\Omega$ ,  $C_L = \text{open}$ ,  $R_L = \infty$ ,  $C1 = 10\mu F$ ,  $C2 = 10\mu F$ ,  $C3 = 0.1\mu F$ ,  $C4 = 0.1\mu F$ ,  $T_A = T_{MIN}$  to  $T_{MAX}$ , unless otherwise noted. Typical values are at  $T_A = +25^\circ C$ .) (Note 1)

PARAMETER	SYMBOL	CONDITIONS	MIN	TYP	MAX	UNITS	
<b>SPEAKER AMPLIFIER</b>							
Output Offset Voltage	$V_{OS}$	$V_{DD} = 2.7V$ or $5.5V$	$T_A = +25^\circ C$		$\pm 3.7$	$\pm 15$	mV
			$T_{MIN} \leq T_A \leq T_{MAX}$			$\pm 30$	
Input DC Bias Voltage	$V_{BIAS}$	(Note 3)	1.0	1.23	1.5	V	
Common-Mode Output Level	$V_{CM}$	$V_{DD} = 2.7V$	0.75	1.17	1.60	V	
		$V_{DD} = 5.5V$	2.40	3	3.45		
Click-and-Pop Level	$K_{CP}$	Peak voltage into/out of shutdown, A-weighted, 32 samples per second (Note 4)		-60		dBV	
Voltage Gain	$A_V$	$V_{DD} = 2.7V$ (Note 5)	11.5	12	12.5	dB	
Continuous Output Power	$P_{OUT}$	$V_{BAT} = V_{DD} = 2.7V$ or $5.5V$ , $R_{LOAD} = 8\Omega$ , $THD+N = 1\%$		0.25		W	
Output Voltage	$V_{OUT}$	$THD+N < 1\%$ , $C_{IN-} = 0.1\mu F$ , $C_L = 1.6\mu F$ , $R_L = 20\Omega$ , $T_A = +25^\circ C$ (Note 6)	$V_{BAT} = V_{DD} = 2.7V$ , $f = 1kHz$		5.5	$V_{RMS}$	
			$V_{BAT} = V_{DD} = 2.7V$ , $f = 10kHz$		5.0		
			$V_{BAT} = V_{DD} = 3.6V$ , $f = 1kHz$	5.65	6.3		
			$V_{BAT} = V_{DD} = 3.6V$ , $f = 10kHz$	5.37	6.0		
Common-Mode Rejection Ratio	$CMRR$	$f_{IN} = 1kHz$ (Note 7)		60		dB	
Power-Supply Rejection Ratio	$PSRR$	$V_{DD} = 2.7V$ to $5.5V$	54	60		dB	
		$f = 217Hz$ , 100mV <sub>p-p</sub> ripple		80			
		$f = 1kHz$ , 100mV <sub>p-p</sub> ripple		70			
		$f = 20kHz$ , 100mV <sub>p-p</sub> ripple		60			
Total Harmonic Distortion Plus Noise	$THD+N$	$f = 1kHz$ , $V_{OUT} = 16V_{p-p}$ , $C_L = 1.6\mu F$ , $R_L = 20\Omega$		0.2	0.5	%	
		$f = 10kHz$ , $V_{OUT} = 15.2V_{p-p}$ , $C_L = 1.6\mu F$ , $R_L = 20\Omega$		0.4			
Peak Load Current				355		mA	
Signal-to-Noise Ratio	$SNR$	$V_{OUT} = 5V_{RMS}$ , A-weighted (Note 6)		95		dB	
Dynamic Range	$DR$	A-weighted (Note 8)		110		dB	
$\overline{SHDN}$ Input Threshold	$V_{IH}$		1.4			V	
	$V_{IL}$				0.4		
$\overline{SHDN}$ Input Leakage Current	$I_{IH}$ , $I_{IL}$		-3		+3	$\mu A$	

# 16V<sub>p-p</sub> Class G Amplifier with Inverting Boost Converter

## ELECTRICAL CHARACTERISTICS (continued)

( $V_{DD} = V_{BAT} = \overline{SHDN} = 3.6V$ ,  $GND = 0V$ ,  $V_{DD} - V_{SS} = 9V$ ,  $R_{ISET} = 100k\Omega$ ,  $R_{IN+} = R_{IN-} = 10k\Omega$ ,  $R_{FB+} = R_{FB-} = 10k\Omega$ ,  $C_L = \text{open}$ ,  $R_L = \infty$ ,  $C1 = 10\mu F$ ,  $C2 = 10\mu F$ ,  $C3 = 0.1\mu F$ ,  $C4 = 0.1\mu F$ ,  $T_A = T_{MIN}$  to  $T_{MAX}$ , unless otherwise noted. Typical values are at  $T_A = +25^\circ C$ .) (Note 1)

PARAMETER	SYMBOL	CONDITIONS	MIN	TYP	MAX	UNITS
<b>INVERTING BOOST CONVERTER (<math>V_{DD} - V_{SS} = -8.75V</math>)</b>						
Switching Frequency					1.5	MHz
FET On-Time	$t_{FON}$		550	750	950	ns
Minimum FET Off-Time			100	220	350	ns
Peak Output Current		$V_{DD} > 3V$ , typical application circuit (Note 9)		400		mA
FET Current Limit (DC)		$T_A = +25^\circ C$ (Note 10)	0.77	1.1	1.35	A
FET Current Limit (Transient)		Typical application circuit, inductor $I_{SAT}$ rating $> 1.7A$		1.6		A
FET On-Resistance	$R_{DSON}$	$I_{LX} = 100mA$ , $T_A = +25^\circ C$		0.2	0.26	$\Omega$
Regulated Output Voltage		$V_{BAT} - V_{SS}$	8.15	8.9	9.60	V
Transient Load Regulation		0 to 400mA load step, typical application circuit		300		mV
Maximum Output Ripple		$I_{LOAD} = 20mA$ , typical application circuit		200		mV <sub>p-p</sub>
BST Shutdown Leakage		$\overline{SHDN} = 0V$ , $LX = 0V$ , $BST = 5V$		0.01	1	$\mu A$
$V_{BAT}$ Shutdown Current		$V_{BAT} = V_{DD}$ , $\overline{SHDN} = 0V$ , $LX = 0V$ , $BST = 5V$		0.01	3	$\mu A$
LX Shutdown Leakage		$LX = 0V$ , $\overline{SHDN} = 0V$ , $BST = 5V$		0.01	3	$\mu A$

- Note 1:** All devices are 100% production tested at  $T_A = +25^\circ C$ . Specifications over temperature limits are guaranteed by design.
- Note 2:** Total quiescent current depends on overall efficiency and varies with the LX inductor value and ESR, diode turn-on voltage, and the parasitic losses in all external components.
- Note 3:** Input DC bias voltage determines the maximum voltage swing of the input signal. An input signal with an amplitude greater than the input DC bias voltage results in clipping.
- Note 4:** Amplifier inputs AC-coupled to GND.
- Note 5:** Voltage gain is defined as  $[V_{OUT+} - V_{OUT-}]/[V_{IN+} - V_{IN-}]$ .
- Note 6:**  $V_{OUT}$  is defined as  $[V_{OUT+} - V_{OUT-}]$ .
- Note 7:** Matching of external AC-coupling input capacitors and gain resistors is critical to achieving good CMRR.
- Note 8:** Dynamic range calculated by measuring the RMS voltage difference between a -60dBFS output signal and the noise floor, then adding 60dB. Full scale is defined as the output signal needed to achieve 1% THD+N.
- Note 9:** Peak output current depends on external power-supply components and the signal frequency.
- Note 10:** Boost converter current limit is tested with a DC sweep. Actual current-limit values under transient conditions may be higher. At high input supply,  $V_{BAT}$ , and low inductance, L, transient current limit might be higher than 1.7A.

# 16Vp-p Class G Amplifier with Inverting Boost Converter

## Typical Operating Characteristics

( $V_{DD} = V_{BAT} = \text{SHDN} = +3.6\text{V}$ ,  $GND = 0\text{V}$ ,  $R_{\text{ISET}} = 100\text{k}\Omega$ ,  $R_{\text{IN}+} = R_{\text{IN}-} = 10\text{k}\Omega$ ,  $R_{\text{FB}+} = R_{\text{FB}-} = 10\text{k}\Omega$ ,  $C_L = 1.6\mu\text{F}$ ,  $R_L = 20\Omega$ ,  $C_1 = 10\mu\text{F}$ ,  $C_2 = 10\mu\text{F}$ ,  $C_3 = 0.1\mu\text{F}$ ,  $C_4 = 0.1\mu\text{F}$ ,  $T_A = +25^\circ\text{C}$ , Typical Application Circuit.)

**TOTAL HARMONIC DISTORTION PLUS NOISE vs. FREQUENCY**

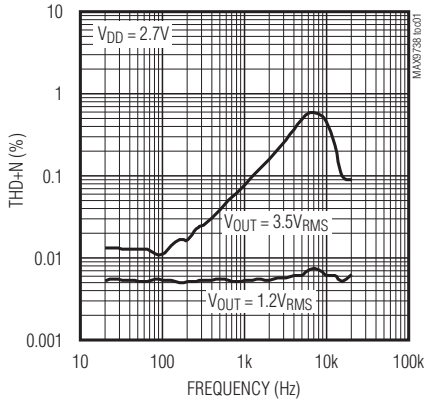

**TOTAL HARMONIC DISTORTION PLUS NOISE vs. FREQUENCY**

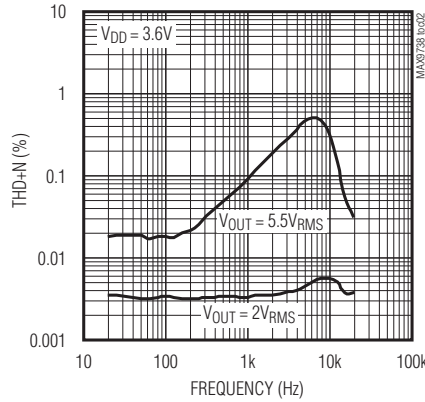

**TOTAL HARMONIC DISTORTION PLUS NOISE vs. FREQUENCY**

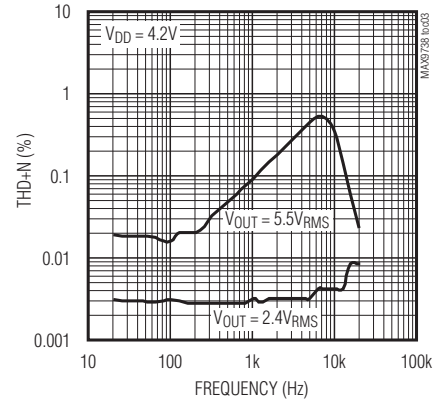

**TOTAL HARMONIC DISTORTION PLUS NOISE vs. OUTPUT VOLTAGE**

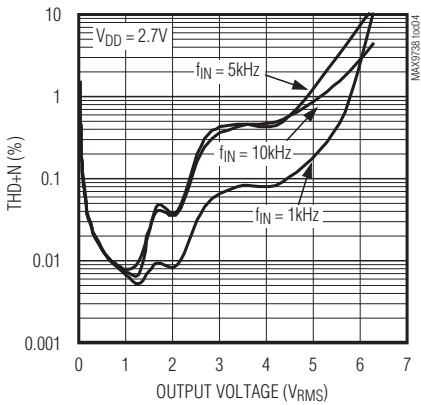

**TOTAL HARMONIC DISTORTION PLUS NOISE vs. OUTPUT VOLTAGE**

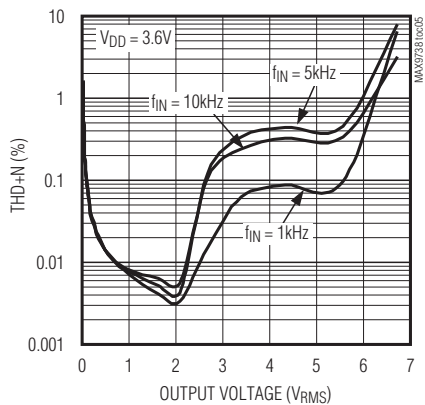

**TOTAL HARMONIC DISTORTION PLUS NOISE vs. OUTPUT VOLTAGE**

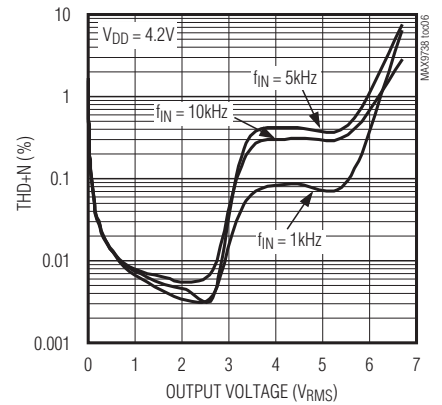

**TOTAL QUIESCENT CURRENT vs. SUPPLY VOLTAGE**

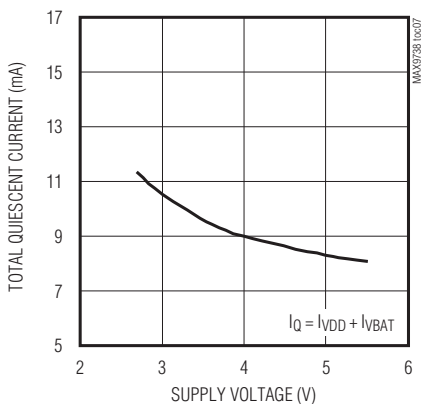

**SHUTDOWN CURRENT vs. SUPPLY VOLTAGE**

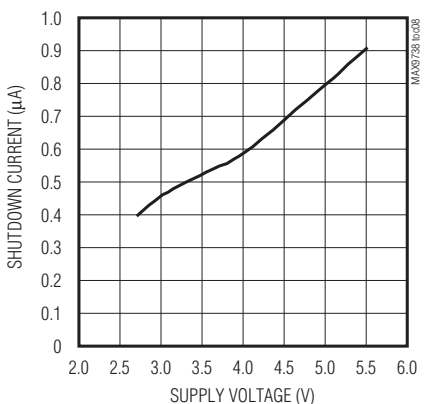

**POWER-SUPPLY REJECTION RATIO**

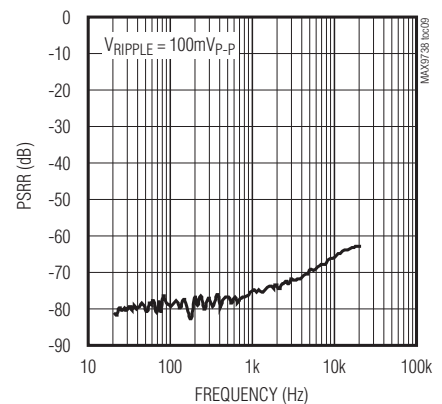

# Explore Litigation Insights

Docket Alarm provides insights to develop a more informed litigation strategy and the peace of mind of knowing you're on top of things.

## Real-Time Litigation Alerts



Keep your litigation team up-to-date with **real-time alerts** and advanced team management tools built for the enterprise, all while greatly reducing PACER spend.

Our comprehensive service means we can handle Federal, State, and Administrative courts across the country.

## Advanced Docket Research



With over 230 million records, Docket Alarm's cloud-native docket research platform finds what other services can't. Coverage includes Federal, State, plus PTAB, TTAB, ITC and NLRB decisions, all in one place.

Identify arguments that have been successful in the past with full text, pinpoint searching. Link to case law cited within any court document via Fastcase.

## Analytics At Your Fingertips



Learn what happened the last time a particular judge, opposing counsel or company faced cases similar to yours.

Advanced out-of-the-box PTAB and TTAB analytics are always at your fingertips.

## API

Docket Alarm offers a powerful API (application programming interface) to developers that want to integrate case filings into their apps.

## LAW FIRMS

Build custom dashboards for your attorneys and clients with live data direct from the court.

Automate many repetitive legal tasks like conflict checks, document management, and marketing.

## FINANCIAL INSTITUTIONS

Litigation and bankruptcy checks for companies and debtors.

## E-DISCOVERY AND LEGAL VENDORS

Sync your system to PACER to automate legal marketing.