



LIQUID CRYSTAL FLAT PANEL DISPLAYS
O'MARA

994/
02093

LOWES 1017, Page 2

BRITISH
LIBRARY



Our Order Line Ref: 01631766-001

Your Order Ref: 51-3335YING

LOAN ITEM DUE BACK BY:11/01/2017

The British Library, On Demand, Boston Spa,
Wetherby, United Kingdom, LS23 7BQ
OnDemand.bl.uk

9

LIQUID CRYSTAL FLAT PANEL DISPLAYS

MANUFACTURING
SCIENCE &
TECHNOLOGY

BRITISH LIBRARY
DOCUMENT SUPPLY CENTRE

- 7 FEB 1984

994 102093

WILLIAM C. O'MARA

 VAN NOSTRAND REINHOLD
New York

Copyright © 1993 by Van Nostrand Reinhold

Library of Congress Catalog Card Number 92-43119
ISBN 0-442-01428-7

All rights reserved. No part of this work covered by the copyright hereon may be reproduced or used in any form or by any means—graphic, electronic, or mechanical, including photocopying, recording, taping, or information storage and retrieval systems—without the written permission of the publisher.

ITP Van Nostrand Reinhold is a division of International Thomson Publishing. ITP logo is a trademark under license.

Printed in the United States of America

Van Nostrand Reinhold
115 Fifth Avenue
New York, NY 10003

International Thomson Publishing
Berkshire House
168-173 High Holborn
London WC1V 7AA, England

Thomas Nelson Australia
102 Dodds Street
South Melbourne 3205
Victoria, Australia

Nelson Canada
1120 Birchmount Road
Scarborough, Ontario
M1K 5G4, Canada

16 15 14 13 12 11 10 9 8 7 6 5 4 3 2 1

Library of Congress Cataloging in Publication Data

O'Mara, William C.

Liquid crystal flat panel displays: manufacturing science & technology / William C. O'Mara.

p. cm.

Includes index

ISBN 0-442-01428-7

1. Liquid crystal display. I. Title
TK7872.L56046 1993
621.38—dc20

92-43119
CIP

Table of Contents

INTRODUCTION

CHAPTER ONE

LARGE AREA LIQUID CRYSTAL DISPLAYS	1
1.1 Computer Displays	3
1.1.1 Desktop Computers	3
1.1.2 Portable Computers	3
1.1.3 Engineering Workstations	7
1.1.4 Computer Display Summary	7
1.2 Television Displays	9
1.2.1 Portable TVs	9
1.2.2 Projection Displays	10
1.2.3 High Definition TV	11
1.2.4 Video Camera Viewfinders	11
1.3 Automotive Applications	11
1.4 Other Applications	12
1.5 Liquid Crystal Display Technology	13
1.5.1 Types of Liquid Crystal Display	16
1.5.2 Passive vs Active Addressing	21
1.5.3 Workstation B/W Display	23
1.5.4 Polymer Dispersed Displays	24
1.5.5 Automotive Display	26
1.6 Active Matrix Devices	27
1.6.1 Two Terminal Devices	28
1.6.2 Amorphous Silicon Transistors	31
1.6.3 Polysilicon Transistors	35
1.6.4 Comparison of Device Performance	39
1.6.5 Ferroelectric Polymer	43
1.6.6 Printed Transistors	45
1.7 Display Manufacturers	47
1.7.1 Japan	47
Current Suppliers	48
1.7.2 USA	48
Xerox	48
Department of Defense Initiatives	48

TABLE OF CONTENTS

LIQUID CRYSTAL FLAT PANEL DISPLAYS

IBM	48
Advanced Display Manufacturers	50
Others	51
1.7.3 Rest Of World	51
Europe	51
Korea	53
Other Asian Firms	53
References	54

FIGURES

1-1 Portable and laptop computers	3
1-2 Active matrix liquid crystal display screen size in recent years	5
1-3 Pixel count versus display diagonal size for flat panels	6
1-4 No. of pixels & display diagonal for high information content displays	7
1-5 Basic liquid crystal polymer molecule	14
1-6 Principle of operation of a twisted nematic liquid crystal display	15
1-7 Transmission versus voltage curves for TN and STN materials	18
1-8 Schematic representation of passive and active matrix color LCD's.	22
1-9 Polymer dispersed liquid crystal projection TV system	24
1-10 Structure of the dispersed liquid crystal droplets	25
1-11 Projection display using polysilicon thin film transistors	28
1-12 Amorphous silicon PIN diode	29
1-13 MIM diode structure	30
1-14 Double pixel design for MIM diode.	30
1-15 Cross-section view of three TFT configurations	32
1-16 Aluminum gate a-Si TFT	33
1-17 Light leakage in TFT structure	33
1-18 Plan view of TFT structure with light shield.	33
1-19 Hitachi TFT array equivalent circuit	34
1-20 Relative cost of silicon TFT processes	42
1-21 Data rate of driver circuits for complex TFT displays	43
1-22 Construction of ferroelectric matrix active device	44
1-23 LCD panel structure with ferroelectric matrix device	44
1-24 Comparison of photolithography and printing for imaging on FPD's.	46
1-25 Photoresist application by offset printing	46
1-26 Polysilicon transistors made by offset printing and photolithography ...	47

TABLES

1-1 Classification of Portable Computers	4
1-2 Japanese Large Flat Panel Displays	8

TABLE OF CONTENTS

LIQUID CRYSTAL FLAT PANEL DISPLAYS

1-3 Japanese LCD TV and VCR Displays	10
1-4 Calculation of S for various values of Nmax	17
1-5 Requirements for Vertical TN LCD Display	19
1-6 Types of Liquid Crystal Displays	20
1-7 Processing and Relative Cost of Active and Passive Displays	31
1-8 TFT Array Process and Specifications	31
1-9 Resistivity of Metals	35
1-10 Comparison of a-Si and poly-Si TFTs	37
1-11 Polysilicon Fabrication Methods and TFT Properties	38
1-12 Comparison of TFT, PIN Diode, and MIM Diode Displays	40
1-13 CMOS poly-Si TFT and a-Si:H TFT Comparison	41
1-14 AMLCD Drive Circuit Types	42
1-15 Characteristics of Ferroelectric Liquid Crystal Display	45
1-16 Liquid Crystal Display Status in Japan	49
1-17 Advanced Display Manufacturers Association Members	50
1-18 US Liquid Crystal Display Activity	51
1-19 European LCD Activity	52
1-20 Liquid Crystal Display Status in Korea	53
1-21 LCD Manufacturing in Asia	53

CHAPTER TWO

DISPLAY MANUFACTURING PROCESS	57
2.1 Color Filter Manufacturing	58
2.1.1 Glass Substrate Preparation	58
Glass Fabrication	58
Cutting, Beveling, Polishing	59
Annealing	61
Cleaning	63
ITO Deposition	66
2.1.2 Color Filter Process	70
Black Matrix Definition	71
Dye Method	71
Pigment Method	71
Electrodeposition	72
Printing	73
Overcoating	73
ITO Deposition	73
2.2 Active Matrix Display Manufacturing	74

TABLE OF CONTENTS

LIQUID CRYSTAL FLAT PANEL DISPLAYS

2.2.1 Thin Film Transistor Manufacturing	74
Plasma CVD & Sputtering	75
Photolithography	77
Etching	78
Transistor Processes	79
2.2.2 In Process Testing	84
Optical Inspection	84
Electrical Inspection	85
Functional Inspection	85
2.2.3 Defect Repair	85
2.3 Display Assembly	86
2.3.1 Orientation Film Deposition and Rubbing	86
2.3.2 Seal Printing	87
2.3.3 Spacer Placement and Sealing	90
2.3.4 Liquid Crystal Injection	90
2.3.5 Inspection and Test	91
2.3.6 Polarizer Attach	91
2.3.7 Die Attach	94
2.3.8 Backlight	97
2.4 DISPLAY MANUFACTURING	98
2.4.1 STN Display Manufacturing	98
2.4.2 Color Filter Manufacturing	100
2.4.3 Equipment for Color Filter Manufacturing	101
2.5 AMLCD Factory	101
2.5.1 Throughput and Productivity	101
2.5.2 Manufacturing Cost and Yield	103
Yield vs ASP	103
Manufacturing Cost Model	105
Manufacturing Yield Model	106
AMLCD Factory	108

FIGURES

2-1 Schematic outline of the display manufacturing process	57
2-2 Fusion process for glass sheet formation	58
2-3 Thermal expansion of Corning 7059 glass	62
2-4 Thermal shrinkage of NA 35 glass: heat treatment time & temperature	62
2-5 Cleaning methods evaluated by contact angle measurement	66
2-6 Sputtering voltage, deposition temperature, and ITO film resistivity	69
2-7 Plasma-assisted electron beam evaporation equipment	70
2-8 Color Filter Formation	72

TABLE OF CONTENTS

LIQUID CRYSTAL FLAT PANEL DISPLAYS

2-9 Active Device Formation	76
2-10 Photoresist adhesion by side etch for various precoating processes.	78
2-11 Cross-section view of three TFT configurations	79
2-12 Assembly, Packaging & Test	88
2-13 Automated flat panel assembly line	89
2-14 Variations in external pressure & spacer size lead to cell gap variations. ...	91
2-15 Active matrix liquid crystal display cross section.	93
2-16 Packaging configurations in flat panel displays.	94
2-17 Number and pitch of leads for flat panel displays.	95
2-18 Connection of TAB tape to flat panel leads w/ anisotropic conductive paste. .	96
2-19 Schematic of backlight arrangement with light pipe.	97
2-20 Factory layout for passive matrix LCD manufacturing	98
2-21 Simulated yield curves: defect densities in TFT manufacturing	104
2-22 Cost components of flat panel display production.	106
2-23 NEC two story AMLCD fabrication facility layout	109

TABLES

2-1 Glass Substrates for Flat Panel Display Manufacturing	60
2-2 Glass Substrate Specification for Active Matrix Display	63
2-3 Proposed Substrate Standard Sizes for Flat Panel Displays	64
2-4 Cleaning Processes for Flat Panel Displays	65
2-5 DI Water Quality and Substrate Particle Count	66
2-6 Types of Color Filters for LCDs	71
2-7 Color Filter Process Comparison	74
2-8 Process Flow Chart for Inverted-Staggered Back Channel Etched TFT ..	80
2-9 Inverted-Staggered Trilayered TFT Process	81
2-10 Process Flow for Normal Staggered TFT	82
2-11 TFT Array Process and Specifications	83
2-12 Defects in LCD TFT Array Manufacturing	84
2-13 Causes of Defects in Assembled Flat Panel Displays	92
2-14 Clean room Conditions for STN Process Line	99
2-15 Production Lines for Large Liquid Crystal Displays in Japan	99
2-16 AMLCD Equipment Productivity and Price	102
2-17 AMLCD Production Equipment Categories	102
2-18 In-Process Inspection and Repair Equipment List	103
2-19 Assembly and Die Attach Equipment	104
2-20 TFT Array Yield Summary (No Repair)	107

TABLE OF CONTENTS

LIQUID CRYSTAL FLAT PANEL DISPLAYS

CHAPTER THREE

MATERIALS FOR FLAT PANEL DISPLAYS	113
3.1 Glass Substrates	113
3.2 ITO Sputtering	114
3.2.1 ITO Powder and Thin Film Properties	116
3.3 Other Sputtering Materials	117
3.4 Color Filters	118
3.4.1 Dye Method	119
3.4.2 Pigment Dispersion	121
3.4.3 Electrodeposition	124
3.4.4 Electromist	125
3.4.5 Overcoat	126
3.4.6 Two Color Approach	126
3.5 Process Chemicals & Gases	126
3.6 Photoresists	129
3.7 Photomasks	129
3.8 Orientation Films	130
3.8.1 Polyimide Orientation Films	131
3.9 Spacers	135
3.10 Sealing Materials	137
3.11 Liquid Crystals	138
3.11.1 Other Liquid Crystal Materials	142
3.11.2 Polymer Dispersed Displays	144
3.11.3 Polymer Network Displays	146
3.12 Polarizers/Compensation Films	146
3.13 Die Attach/Connector Materials	149
3.14 Display Backlighting	152
References	157

FIGURES

3-1 CIE Chromaticity Diagram for color filters	121
3-2 Resistance to fading of dyed and printed color filters	121
3-3 Comparison of spin-coated and printed filter element	122
3-4 Transmittance of green pigment material / function of particle size	123
3-5 Schematic of electrodeposition process for color filters	125
3-6 Synthesis and structure of aliphatic soluble polyimide	132
3-7 Glass fiber spacer size distribution.	137
3-8 Typical liquid Crystal	138

TABLE OF CONTENTS

LIQUID CRYSTAL FLAT PANEL DISPLAYS

3-9 Nematic phase	139
3-10 Cholesteric phase	139
3-11 Smectic phase	139
3-12 Structure & properties of difluorobenzene derivatives.	143
3-13 Trans-4-n-pentylcyclohexyl (PCH-5) derivatives.	143
3-14 Structure of polarizer film for LCD	147
3-15 Polarizer film structures	147
3-16 Transmittance vs polarization efficiency	148
3-17 Heat seal connector construction	151
3-18 Usage ratio of TAB ICs	151
3-19 IC bonding methods in chip on glass packaging	153
3-20 Construction of WedgeLight™ backlight	154
3-21 Spatial brightness uniformity of Wedgelight™	155
3-22 Flat fluorescent lamp structure	156

TABLES

3-1 LCD Glass Supplier Matrix in Japan	114
3-2 ITO Film Properties	115
3-3 Characteristics of ITO Targets	115
3-4 Glass Substrates for Liquid Crystal Displays	117
3-5 Specifications for High Density ITO Target	118
3-6 Properties of Color Filters	119
3-7 Test Conditions for Color Filters	119
3-8 Alternative Methods of Color Filter Formation	123
3-9 Solubility of Cleaning Chemicals	127
3-10 Particles in Electronic Chemicals	127
3-11 DI Water Quality	128
3-12 Measurement of Cleaning Efficiency	128
3-13 Alignment Film Material Requirements	131
3-14 Comparison of Polyimides for Orientation Film Applications	134
3-15 Plastic Spacer Size Variation	136
3-16 Plastic Spacer Thermal Expansion Coefficient	137
3-17 Parameters Specified in Liquid Crystal Formulations	140
3-18 Relation Between UV Exposure and Turn On Voltage	145
3-19 Polarizing Film Structures	148
3-20 STN Display Cost	155
3-21 Comparison of Backlight Technologies	156

TABLE OF CONTENTS

LIQUID CRYSTAL FLAT PANEL DISPLAYS

CHAPTER FOUR

MANUFACTURING EQUIPMENT	159
4.1 Substrate Cleaning	159
4.2 Photoresist Application/Baking	160
4.2.1 Spin Coating	160
4.2.2 Roll Coating	160
4.2.3 Conveyor Ovens	160
4.3 Photolithography	160
4.3.1 Steppers	161
4.3.2 Mirror Projection	162
4.4 Etching/Stripping	164
4.4.1 Wet Etch Equipment	164
4.4.2 Plasma Etching/Ashing	164
4.5 Thin Film Deposition	165
4.5.1 Sputtering	165
4.5.2 Chemical Vapor Deposition	167
4.5.3 Plasma CVD	170
4.5.4 LPCVD and APCVD	173
4.5.5 Thermal Processing	174
4.5.6 Ion Implant/Doping	175
Phased Linear Scanner	176
Ion Flux Doping	177
4.6 Test Equipment	179
4.6.1 Visual and Functional Test	179
4.6.2 Optical Imaging	180
Optical Image Processing Equipment	182
Digital Image Processing Equipment	184
4.6.3 Electrical Evaluation	184
Transfer Admittance	185
IBM Test Set	186
4.6.4 Voltage Imaging	189
4.7 TFT Repair	189
4.7.1 Laser Cutting	190
4.7.2 Laser-Assisted Deposition	191
4.8 Assembly	192
4.8.1 Polymer Printing	192
4.8.2 Assembly/Final Test	194
4.8.3 Die/PCB Attach	198
References	199

TABLE OF CONTENTS

LIQUID CRYSTAL FLAT PANEL DISPLAYS

FIGURES

4-1 Mirror projection schematic diagram	163
4-2 Example of PECVD system for thin film deposition	170
4-3 Deposition chamber cutaway schematic	171
4-4 Cross section of PEVD electrode	171
4-5 Plan view of phased linear scanner showing two substrates	177
4-6 Cross-section view of linear scanner end station	177
4-7 Ion bucket source and deposition chamber schematic	179
4-8 Optical pattern filtering for defect imaging	182
4-9 Transfer admittance testing	186
4-10 Schematic diagram of voltage imaging of a TFT array	189
4-11 Laser connect and disconnect alternatives	190
4-12 Laser connect and disconnect using polysilicon	190
4-13 Polymer printing schematic	193

TABLES

4-1 Canon MPA-2000 Specifications	163
4-2 Nextral NE550 RIE System Specifications	165
4-3 Dry Etch Systems	166
4-4 Ulvac SDT-VT In-line Sputtering Systems	167
4-5 CVD Systems and Suppliers	168
4-6 Anelva In-Line Plasma CVD Systems	171
4-7 Amorphous Silicon Deposition	172
4-8 Nextral ND 400 PECVD System Specifications	173
4-9 LPCVD Silicon Films (Leybold LC350 Reactor)	174
4-10 Watkins-Johnson SiO ₂ Deposition System	174
4-11 KLA Acrotec 6000 Parameters	185
4-12 Spin Coating vs Print Coating	194
4-13 L-400 Rubbing Machine	194
4-14 Villa Precision GS 110 16 L Scriber Specifications	195

CHAPTER FIVE

5.1 Materials Suppliers	201
5.2 Materials Supplier Listing	205
5.3 Equipment Suppliers	208
5.4 Test, Inspection & Repair Equipment Suppliers	213
5.5 Equipment Supplier Listing	215
INDEX	221

INTRODUCTION

We live in the silicon age, and the quintessential item that defines our world is the computer. Silicon chips power the computer as well as many other products for work and leisure, such as calculators, radios, and televisions. In the forty years since the transistor was invented, the solid state revolution has affected the lives of almost everyone in the world. Based on silicon, solid state devices and integrated circuits have revolutionized electronics, data processing, communications, and the like. The computer, especially the personal computer, would be impossible without silicon devices. Only one computer was ever built using vacuum tubes, and the tubes had to be constantly replaced because they generated too much heat and burned out. Silicon devices allowed for reliable switching operations in arrays of hundreds and thousands of discrete devices. As a result, the very substantial industrial base that existed for producing vacuum tubes disappeared - with one exception. That exception is, of course, the CRT, which is evident in televisions, computer displays, and a host of other information display terminals. Until recently, there was nothing that could take its place, and it seemed that the CRT would remain as the electronic medium for all except the simplest displays.

The CRT is about to go the way of the other vacuum tubes. It's dead, but doesn't know it yet. Just like the transistor revolution, it will be a few decades before you need to go to a museum to see this other kind of vacuum tube, but the end is coming. The instrument of the CRT's demise is again the silicon transistor, in a new, thin film form. In this form, thousands of transistors can act as a switch array for liquid crystal displays, LCDs, providing picture quality equal to that of the CRT. Liquid crystal displays have been with us for more than 20 years, for watches, calculators, and other small displays. But the technology for large displays with high information content is quite recent. There are various kinds of display technologies besides LCDs, and various kinds of switching schemes besides the silicon transistor. However, this combination of liquid crystal and thin film transistor, termed active matrix liquid crystal display, AMLCD, technology, appears to be the path to complex, colorful displays for computer and other applications.

The silicon materials technology for the AMLCD thin film transistor actually had its beginnings in the solar cell investigations of 1975-1980. While the US and

INTRODUCTION

LIQUID CRYSTAL FLAT PANEL DISPLAYS

Europe poured millions of dollars into crystalline silicon for solar cells, the Japanese developed amorphous silicon deposited by chemical vapor deposition. While the US sponsors of solar research thought about paving Arizona with solar cells for power generation, the Japanese made small cells, put them in calculators, and threw away the wet-cell battery. That same silicon technology is now used for thin film silicon transistors, hundreds of thousands on a glass plate, that replace the scanning electron beam of the CRT.

This book describes the construction, operation, and manufacturing of flat panel displays, emphasizing the AMLCD type. Many of the manufacturing processes are akin to integrated circuit processes, and will be familiar to IC process engineers. These are described in some detail as well as the other operations for display manufacturing. Emphasis is on current manufacturing practice and trends in manufacturing that will impact the equipment and materials. Separate chapters are devoted to the manufacturing equipment and to the materials.

This book concentrates on large liquid crystal displays to the exclusion of other types. These other types include electroluminescent displays, plasma displays, vacuum fluorescent displays and electrochromic displays. Their manufacturing technologies and applications are certainly interesting, but someone else will have to do them justice. In terms of their applications, these latter displays are mainly for niche applications. The LCD display is the mainstream.

The emerging AMLCD industry has the look of inevitability about it, something that is going to happen sooner or later. Of course, lots of people are going to speed lots of time, money and brainpower making it happen. Some of us worry that the engineering and manufacturing won't happen in the US, and therefore won't provide jobs for those of us who are looking for work. Unfortunately, it isn't clear how to correct this situation, or even that things would be much better if it could be corrected. Hopefully, motivated people and organizations will find useful information here if they do decide to build a factory.

What is striking about the new technology is how nicely it fits the bill for the next advance in computing, the portable, and assists in the proliferation of that device. Probably we need more computers and other electronic devices, and we do love our gadgets. But, in the end, what we seem to be pointed towards is just more and different and better kinds of television. Is this progress?

INTRODUCTION

LIQUID CRYSTAL FLAT PANEL DISPLAYS

It is a pleasure to acknowledge the assistance of many of the people at the Semiconductor Equipment and Materials International (SEMI) trade organization in gathering the data for this book. In particular, the people who assisted in every way during my three month stay in the SEMI office in Tokyo, Japan, were very helpful. These include George Moore, Steve Nakayama, Yoshi Kohuo and many others. It was a pleasure to work in their company.

Palo Alto, California

LARGE AREA LIQUID CRYSTAL DISPLAYS

1.0

Liquid crystal displays (LCDs) have been commercially available for more than 20 years, but until recently have been restricted to relatively small size. Such displays are ubiquitous in watches, calculators, radios, and other products requiring indicators and three or four alphanumeric characters. Recently, improvements in the liquid crystal materials have occurred, allowing large displays to be manufactured. These have achieved widespread acceptance in portable computers, very light laptop computers, and dedicated word processors. Other products include flat screen and projection television systems. Additional improvements in the technology have led to full color displays, now entering production. These improvements include the addition of an active switch to control the action of the liquid crystal at each picture element or pixel. The active switch can be a thin film diode or a thin film transistor, and, for large displays, the number of active elements approaches the number of transistors in a dynamic memory.

This chapter describes some of the new display products, and provides a description of the basic technology involved. Computer displays seem to be the most important single product category at the moment, in terms of projected manufacturing volume. The portability of laptop and notebook computers has created what is in effect a new tool. The true power of computing is just beginning to be realized, now that it is portable. Initially a highly legible portable display was possible only with plasma discharge, which glowed a characteristic orange color. In addition, yellow electroluminescent displays can be built with adequately low power consumption. However, a true black and white display, not to mention full color, is unavailable with these technologies. NEC, one of the pioneers of plasma discharge technology, has closed its manufacturing line. In Japan, only Sharp maintains a small electroluminescent display manufacturing capability. Liquid crystal displays satisfy both the technical and economic requirements for this new era of computing.

This is not to imply that liquid crystal displays are without their problems. The low power black and white displays must be made to exacting tolerances. Adding a color filter array and an active matrix of hundreds of thousands of pixels creates a manufacturing nightmare. The complexity of such displays negates the low power consumption inherent in the technology. For example, the transmission

CHAPTER ONE: PRODUCT APPLICATIONS

LIQUID CRYSTAL FLAT PANEL DISPLAYS

of light by a full color display may be less than 5%. The bright backlight required for illumination and the power required to operate the active matrix switches limit battery life in a portable computer to less than 30 minutes.

In spite of this, the technology brings computing power to the point of use. Especially combined with the pen or stylus computer for filling in forms, the display becomes a natural and essential component of "computerless computing". This comes close to freeing the user from the complexities of the computer, making it almost as easy to use as a telephone or other artifact of modern life. The computing power of portable instruments is great enough that almost any "desktop" task can be accomplished, including, for example, the writing of this document.

In the end, the full color active matrix liquid crystal display spells the end of the cathode ray tube, known affectionately as the CRT. For the laptop is only the beginning. A true laptop was really impossible with a CRT display in the first place. The analogy between the LCD display and the transistor is interesting here. The first "shirt-pocket" portable radio was introduced in the mid 1950s using germanium transistors instead of vacuum tubes. A true "shirt-pocket" radio would have been impossible with tubes. At the time, a table model tube radio sold for about \$15, but the transistor radio sold for \$65, quite a premium. Although pundits may have predicted a peaceful coexistence of transistor and tube, within thirty years, vacuum tubes had become a curiosity - except for the display.

Just like the transistor, the liquid crystal display is going to move onto the table top. It is going to take thirty years, but it is going to happen. All the reasons given for the continued peaceful coexistence of CRTs and LCDs ignore the history of solid state devices, especially if the active device is made of silicon. Germanium transistors are almost as hard to find today as vacuum tubes. They were quickly displaced by those made of silicon, with superior performance. Until silicon devices were available, the high reliability we associate with solid state components was unknown. Today, the liquid crystal display is in the "germanium" phase of development. The first silicon-based displays are just emerging from prototype manufacturing lines. Once these reach high volume, competitive cost with CRTs is inevitable. Whether the devices turn out to be thin film amorphous silicon or polysilicon remains to be seen. However, the outcome is no longer in doubt, the CRT is finished. Just like the rest of electronics, a law of Nature is at work here. *IF IT CAN BE DONE IN SILICON, IT WILL BE DONE IN SILICON.*

Computer Displays**1.1****1.1.1 DESKTOP COMPUTERS**

Computers have become more commonplace than typewriters, it seems. This has happened in less than 10 years, since the introduction of the Apple, then the IBM personal computer. Before this, computers were mysterious monsters tended by men in white coats, the men constantly spooling huge rolls of magnetic tape onto tape drives, the only visible parts of the monster. Since then, we have come to terms with the idea of a computer on our desk, and have even learned to make use of it. For many, this has spelled the demise of the secretary, as they learned to prepare their own memos. Progress is never easy. The quality of the display lagged behind the capability of the computer for a long time. IBM's decision to provide us with either green or amber-colored monitors made the box uglier and more forbidding than it had to be. For all the talk about the Macintosh computer's "intuitive" interface, it may be simply that the screen showed black letters on a white background, more or less like a piece of paper. It was only with the advent of a full color EGA display for the IBM three or four years ago that the same black and white display was possible for the more common IBM PC and clones.

The representation of things more or less the way we are used to seeing them is very important to ready acceptance of a new technology. Liquid crystal displays, with the new black on white representation of the last few years, have achieved the status of the ordinary, thereby guaranteeing their acceptance.

1.1.2 PORTABLE COMPUTERS

Figure 1-1 shows the portable and laptop style computers familiar to most of us. The attraction of the portable computer is its battery operation, which means that it is available at any place, at any time. Technical developments have allowed the computing power of portables to increase dramatically. These include the low power 386 microprocessor chip, small hard disk drives, and the LCD VGA screen. Many lightweight portables are available at a weight of 7 pounds or less.

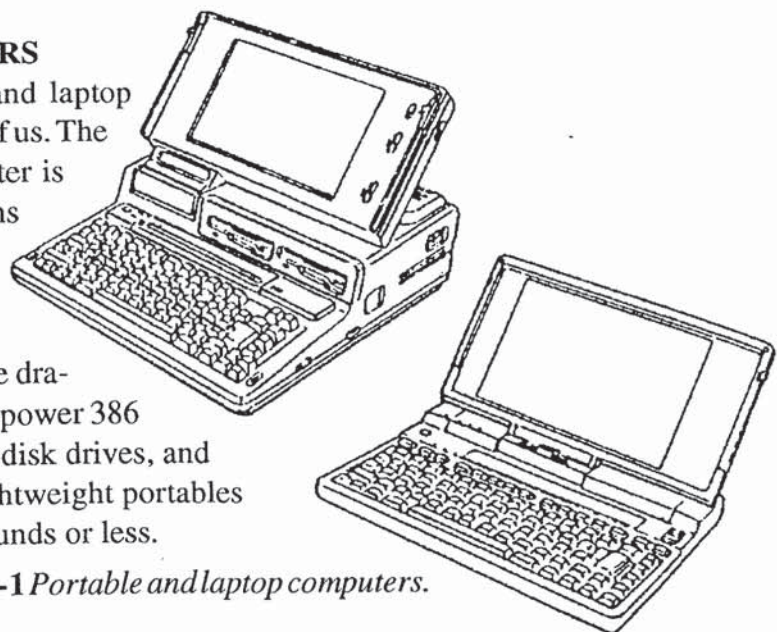

Figure 1-1 *Portable and laptop computers.*

CHAPTER ONE: PRODUCT APPLICATIONS

LIQUID CRYSTAL FLAT PANEL DISPLAYS

Approximately 650 types of portable computers are available, divided into desktops, laptops, and ultralight, specialized portables. Table 1-1 shows some of the features of these computers.

Table 1-1 *Classification of Portable Computers*

	Transportable	Laptop	Specialized
Weight	20-30 lbs	5-12 lbs	<5 lbs
CPU	386	80286/386SX	8088
Hard Disk	120MB	40MB	RAM Disk
Application	Full PC applications	Selected PC applications	Resident software, RAM disk resident
Display	Plasma, Color LCD	B/W LCD backlit	B/W LCD
% w/ LCD Display	50%	80%	100%

The “transportable” computers are heavy enough that moving them is not an easy task. However, they constitute a desktop system that has all the capabilities of the heavier fixed computing systems. They may allow battery operation, but are more typically used in satellite offices where power is available. Still, these computers typically have some kind of flat screen display, to make transporting them possible at all.

The laptop variety has many of the capabilities of the desktop, but some compromises have been made to minimize weight. The compromises are growing smaller in number each year, as high speed microprocessors, high capacity hard disks, and high information content displays become available.

The specialized computer is the truly innovative class of computer, and represents a revolution all by itself. Rather than try to do everything, this computer does only one thing well. It keeps schedules, it does simple word processing, it acts as a dictionary or translator. Computing has become cheap enough to allow single purpose machines. Now display technology is beginning to match the price of the integrated circuit chips.

Figure 1-2 shows the trends in active matrix liquid crystal display screen size during the last few years. A five year forecast of these trends is also shown on the

chart. The active matrix is the array of transistors or other switches used to make the displays perform to their true capabilities. The details of the technology are explained further on.

Figure 1-2 Active matrix liquid crystal display screen size in recent years

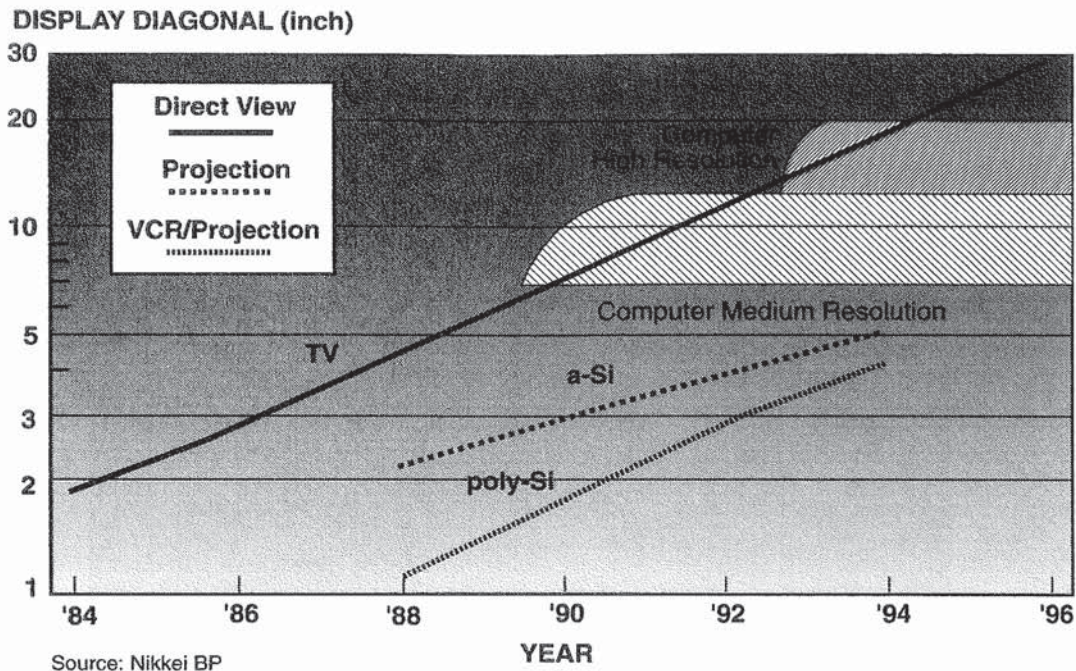

The figure shows that it is only in the last year or two that active matrix displays have reached a size suitable for computer use. Prior to 1990, the screen size was limited to portable TVs of 3-inch, 4-inch, and so on. The active matrix display size is increasing, at least to 14-15-inch diagonal size. Beyond this lie barriers that can be crossed only with very new and different technology. But for now, the way to 10-inch diagonal, full color, medium resolution computer displays is clear. The next step will be the higher resolution appropriate to engineering workstations.

Notice that the dotted curves on this figure refer to the projection displays coming into production in Japan. The display is actually a light valve that controls the projected image, and is much smaller in dimensions than direct-view displays.

As the size of the display increases, so often does the complexity. Figure 1-3

shows the relation between the number of pixels (picture elements) as a function of display diagonal size for different kinds of displays. Trend lines are indicated for projection devices, computer displays, and TVs. A pixel or picture element is an individual point on the display that can be turned on and off. The information content that can be represented by the display is a function of the number of pixels. The corresponding term for integrated circuits is the number of bits of information processed or stored. Just as we are leaving the 1 megabit memory chip era, on our way to the 4 megabit era, we are entering the 1 megabit display era, in terms of the number of pixels on a flat panel display. It may be that the learning experience of making a million devices at a time on a silicon wafer was necessary before it could be done for displays.

Figure 1-3 Pixel count versus display diagonal size for flat panels

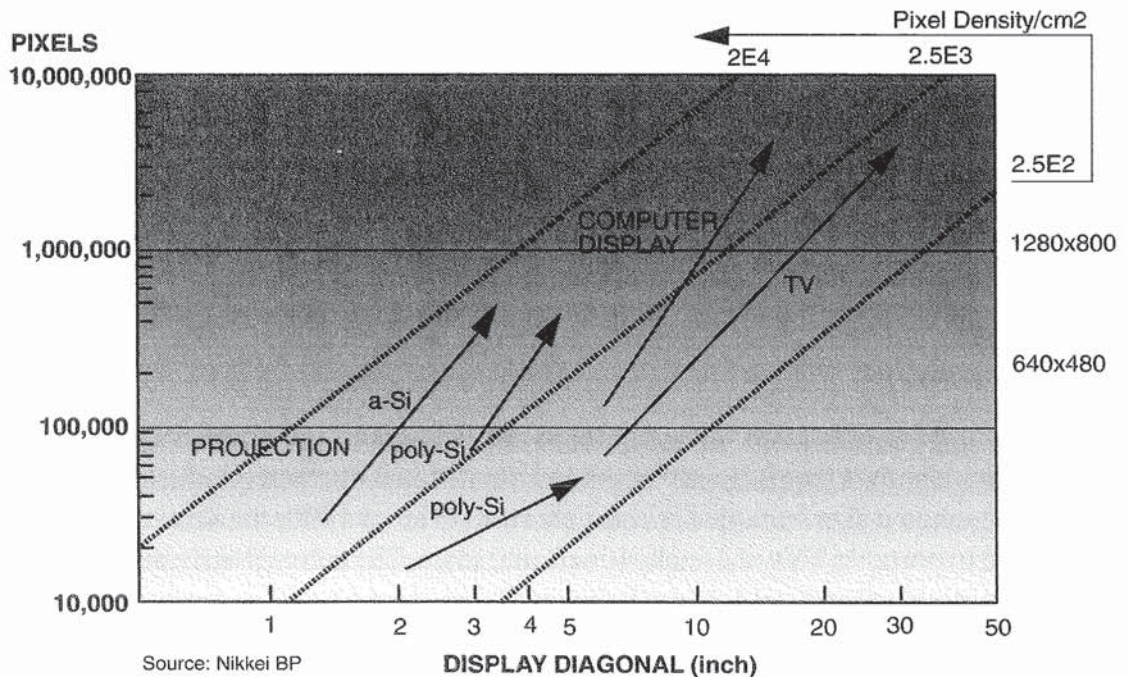

One million pixels is just the threshold for high information content displays. Figure 1-4 shows that one million buys a full color VGA computer display, with 640 horizontal lines, 480 vertical lines, and three colors. Each dot is 0.3-0.36mm on a side, and has three color elements. The display is 10-inch diagonal size. If they were available, they would cost about \$5000-7000 each. The manufacturing of these displays, with all the relevant information about yields, costs, equipment and so forth, is the subject of this report.

1.1.3 ENGINEERING WORKSTATIONS

The more complex displays of the future are also shown in the illustration. These include the XGA display, and engineering workstations of increasing complexity. The dot pitch decreases to 0.21-0.27mm at the same time that diagonal size is increasing to 16-18 inches. Pixel count grows to 4 million for the most complex displays. It is only a matter of time. However, the timing, also discussed in detail here, is a matter of intense speculation in the display community.

Figure 1-4 *Number of pixels and display diagonal for high information content displays*

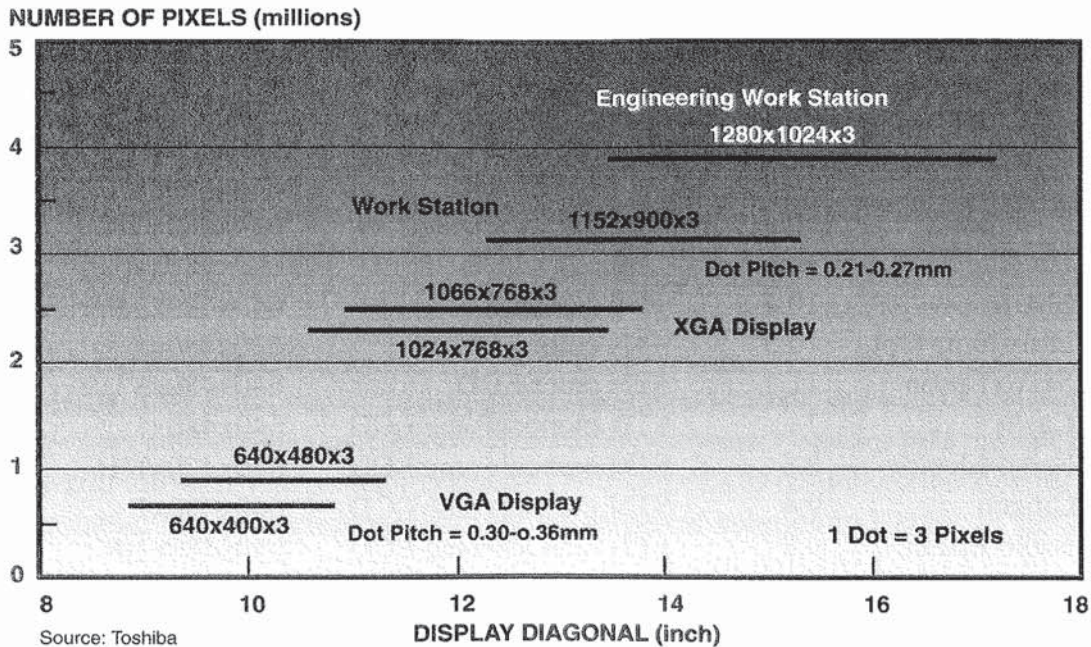

1.1.4 COMPUTER DISPLAY SUMMARY

Japanese suppliers are introducing many new full color displays each year. The actual volume of the displays is somewhat limited, as suppliers learn the ropes of high volume, high yield manufacturing. The complexity and display capabilities of these new products is impressive, and with improvements in manufacturing, the cost will soon be acceptable for standard computer products.

Table 1-2 shows examples of large size flat panel displays from various suppliers

CHAPTER ONE: PRODUCT APPLICATIONS

LIQUID CRYSTAL FLAT PANEL DISPLAYS

Table 1-2 Japanese Large Flat Panel Displays

Firm	Size (inches)	Display Type	rows x columns x colors / grey scale
NEC	9.3	TFT color LCD	640x400x8
Matsushita	9.8	STN color LCD	640x400x16
Seiko Epson	9.8	MIM color LCD	640x480x4096
Sharp	9.8	TFT color LCD	640x400x4096
Mitsubishi	10	TFT color LCD	640x480x4096
Kyocera	10.1	STN color LCD	640x480x16
Stanley	10.3	VTN color LCD	640x400x8
Hoshiden	10.4	TFT color LCD	640x808
Toshiba	10.4	STN color LCD	640x480x16
Seiko	10.4	STN color LCD	640x480x64
Sanyo	10.4	STN color LCD	640x480x64
Sanyo	10.4	TFT color LCD	640x480xfull color
Toshiba	10.4	TFT color LCD	640x480x512
Hitachi	10.4	TFT color LCD	640x480x4096
Sharp	10.4	TFT color LCD	640x480x16million
Hiroshima Opto	10.5	STN color LCD	640x480x8
Seiko Epson	11	STN color LCD	640x480x8
Casio	7	STN monochrome LCD	640x480x1
Seiko Electric	8.8	STN monochrome LCD	640x480x1/16
Citizen	9.4	STN monochrome LCD	640x480x1
Seiko Epson	9.8	STN monochrome LCD	640x480x1/8
Toshiba	10	STN monochrome LCD	640x400x1/16
Alps	10.1	STN monochrome LCD	640x400x1
Hitachi	10.3	TFT color LCD	1120x780x4096
Seiko Epson	13	MIM monochrome LCD	1280x800x1/16
Hoshiden	15	TFT color LCD	1280x800x4096

A lot of personal computers are sold each year. In 1988, total sales of 20 million units were valued at \$50 billion. This increased to 22 million units in 1989, and the share of portables increased from 10% to 14%. For 1990, the share of portables is estimated at 16%, growing to at least 25% in 1995. This represents a market of 8 to 9 million laptops. At least 75% of these will have LCD screens, or 8 million LCD laptops. It's going to be a big market.

Other kinds of office equipment already incorporate liquid crystal displays, but the information content of these displays is much lower than for computers. Examples include facsimile machines, typewriters, copiers, telephones and telephone answering machines. One exception to the rule is overhead projector devices which are attached to a computer to provide sequential displays for presentations. Overall growth of displays amount to doubling in units every three or four years.

12**Television Displays**

Small screen active matrix displays have been available in Japan for the last four or five years. They are not generally available in the rest of the world. The manufacture of these displays has provided some of the necessary experience for moving upward to the more complex displays for computers. New equipment has been developed to allow the processing of larger substrates. Small displays with high information content have been developed for the video camera display market, almost entirely a Japanese industry. Projection TV displays of impressive quality and screen dimensions are in initial production. Table 1-3 lists some of the current display products for home entertainment.

1.2.1 PORTABLE TVS

Portable TVs amounted to 2 million units produced in 1989, and some Japanese forecasts predict a stagnant market for the next five years. Costs for TFT modules are still too high, and projection systems with three LCD modules are becoming available. The projection systems are the technical solution to HDTV as well. Japanese experts are predicting a total production of portable LCD-TVs of 2 million units, and a further 1.5-2 million VCR/LCD-TV systems (e.g., the Sony Watchman). LCD projection TV could reach 1 million units in 1995. Traditional TN units will more or less disappear, replaced by TFT displays. However, some manufacturers expect the simple matrix display to continue be used, at least for small displays.

An increase in screen size is predicted, from 3-4" diagonal in 1989, to 7" diagonal in 1995. Therefore, a doubling of the diagonal size over the five year period is expected, resulting in a market for displays amounting to 60,000m². It remains to be seen whether large size (7-14" diagonal) TVs can be sold at an acceptable price. It is unclear what an acceptable price for such a TV would be. A potential competitor is the projection LCD TV.

CHAPTER ONE: PRODUCT APPLICATIONS

LIQUID CRYSTAL FLAT PANEL DISPLAYS

Table 1-3 Japanese LCD TV and VCR Displays

Firm	Size (inch)	Display Type	Comment
Seiko Epson	0.9	VCR color viewfinder	
Matsushita	1.06	VCR color viewfinder	90,000 pixels
NEC	2.6	Direct view TFT color LCD	Game
Pioneer	4	Direct view TFT color LCD	Car navigation
Hitachi	5	Direct view TFT color LCD	Car TV
Sharp	5.6	Direct view TFT color LCD	Car TV
Toshiba	43	Rear projection color LCD	230,000 pixels
Mitsubishi	48	Rear projection color LCD	345,000 pixels
Sharp	60	Projection TFT color LCD	1.2 million pixels
Sharp	110	Projection TFT color LCD	
Sanyo	110	Projection TFT color LCD	1.5 million pixels

1.2.2 PROJECTION DISPLAYS

Projection displays, which make use of three liquid crystal shutters to control each primary color, have been introduced in Japan. These shutters are up to 3-inch in size, and allow resolution of up to 1 million pixels per primary color. Limits on light transmission through the shutter limit image brightness, and the screen must be viewed in a partially darkened room. Images of up to 110 inch diagonal can be projected, and the picture quality far exceeds that of projection CRT devices. However, the home theater concept promoted by Sharp and other manufacturers of projection TVs has yet to be widely accepted. The price for projection LCD TVs in Japan is in the \$2,000-3,000 range and higher, which is too expensive for widespread replacement of traditional CRT models.

1.2.3 HIGH DEFINITION TV

High definition TV, with up to twice the picture elements of a standard broadcast screen, is available now with CRT technology and screen sizes up to 40 inches. Several broadcast systems have been proposed for HDTV in different parts of the world, and more than one will be adopted. The highly political issues for such systems aside, HDTV is likely to become the last hurrah for the CRT. The resolution required by the HDTV systems is already available on projection LCD-TVs, and the only requirement for large screen HDTV is higher brightness than is currently available. At 40 inch diagonal, the LCD projection system should be cost competitive with the CRT unit. There is research in Japan on manufacturing 40 inch direct view LCD panels. This research may eventually allow even larger direct view screen sizes. It is unlikely that CRT displays will exceed the 40 inch size.

1.2.4 VIDEO CAMERA VIEWFINDERS

Video cameras have been limited to black and white viewfinders until the recent introduction of the full color, LCD viewfinder display. These displays will be required by the millions, replacing older style displays, but their small physical dimensions mean relatively small volume of substrate processed. These displays are usually built on quartz substrates, and can be made using semiconductor manufacturing equipment and processes.

Automotive Applications**1.3**

Automotive applications for displays include the radio, dashboard, and new product areas like on-board navigation systems and car-mounted TVs. Displays for car radios are moving to color LCDs. Although some increase in the size of the display allows for additional information about the type of program, these will remain relatively small.

The complexity of hardware and software is still a big obstacle for on-board navigation systems for cars. These systems allow constant reference to computerized maps and provide information about the car's location and destination. The first prototypes are now 10 years old, although many more modern systems are under development in Europe, in Japan (a government project with 50 manufacturers started in 1987), and in the USA. All leading manufacturers of car electronics have projects, but the market will be slow to emerge.

Only a small number of car makers are presenting modern electronic dashboard versions at car exhibitions in Tokyo, Frankfurt, Geneva, etc. On the other hand, a partial LCD instrumentation type is beginning to establish itself, and it is possible that 50% of the higher priced models have some LCD displays. Full LCD dashboards are something else. Attractive models have recently been introduced by Fiat and Lancia, and development is underway in Norway, Germany, and France. Concept cars such as the Toyota FXV II, Ford HFX Aerostar, and VW Futura include modern versions of LCD displays.

The proportion of vehicles with a digital dashboard is much higher in the US than in Europe, which is again much higher than in Japan. A large percentage of American digital dashboards are based on vacuum florescent display (VFD) technology. There may be a large untapped market potential for automotive LCD applications, but the Japanese and German manufacturers already in the business seem placed to profit from this growth. These include Optrex, VDO, and Borg Instruments. In Japan, there are highly developed prototypes in all the major Japanese vehicle manufacturers, although actual sales are limited. A combination analog/digital dashboard may find a higher degree of consumer acceptance.

Another trend for automotive is away from TN towards more sophisticated STN technology for higher information content displays. TFT technology is waiting in the wings for highly complex navigation systems. Heads-up displays, in which information is projected onto the windshield, are not very advanced at the moment.

1.4**Other Applications**

Information boards are used in banking applications and for score boards in sports arenas. These command a relatively high price at the moment.

Polymer dispersed liquid crystal displays were first investigated by Ferguson.[1] These are termed PDLC or NCAP films. The films are highly translucent and scattering in the off state, and transparent when an electric field is applied. They are the basis of light valves and displays up to 3mx1m in size. Drzaic and coworkers at Taliq described such displays on plastic substrates for curved, flexible displays[2]. Addition of a dichroic dye confers the property of electrically controlled absorbance as well as scattering. The response time of a few milliseconds makes possible displays that maintain slowly changing information such as

CHAPTER ONE: PRODUCT APPLICATIONS

LIQUID CRYSTAL FLAT PANEL DISPLAYS

timetables, scoreboards and so forth, but is currently too slow for multiplexing high frame rate information. Droplet size is about $1.6\mu\text{m}$, and film thickness is $16\mu\text{m}$. Voltages of 40-60V are required to operate the displays. To achieve high levels of multiplexing, improvements are needed in the uniformity of droplet size and shape, which would increase the sharpness of the electro-optic response curves.

Nippon Sheet Glass encapsulated small nematic liquid crystals in a polymer matrix, and sandwiched the film between a pair of glass plates for architectural glazing purposes[3]. A combined rear projection screen and light controlled window have been developed. Total transmission of light is $>70\%$. High brightness is achieved for low birefringence, $\Delta n=0.143$. Droplet diameter affects projection screen brightness and viewing angle, Brightness decreases as diameter decreases from $4\mu\text{m}$ to $1\mu\text{m}$, then increases again for diameter $d=0.87\mu\text{m}$. The small diameter droplet produced the largest viewing angle.

Other markets include military and avionics displays. LCD is preferred for cockpit applications, and military aircraft applications for electronic displays are forecast to reach \$3 billion per year by the late 1990s. This does not include several billion dollars of expenditures prior to this to update current US military aircraft with displays. The military/avionics display business is dominated by Bendix/King, Rockwell Avionics, and Honeywell, with participation by Tompson CSF.

One attractive niche market is in-flight video for passenger aircraft [4]. In 1989, British Airways introduced 8-millimeter LCD video monitors for their first class passengers, and are also testing the new Airvision system, a Warner Brothers/Philips joint venture display system. If the (3" LCD) screens are mounted in the seat backs, the viewing angle might be a problem.

Liquid Crystal Display Technology

1.5

Liquid crystal materials are rod-like molecules typified by the cyanobiphenyl compound shown in Figure 1-5. These molecules possess the property of rotating the direction of polarized light passing through. Although the molecules are transparent to visible light, a container of the liquid material appears milky or translucent instead of transparent. The reason for this is because the long axis of the molecules are aligned at random angles, so the light is scattered randomly. A

liquid crystal display cell is arranged so that the molecules follow a specific alignment. This alignment can be changed with an external electric field, allowing the polarization of incoming light to be changed.

Figure 1-5 Basic liquid crystal polymer molecule

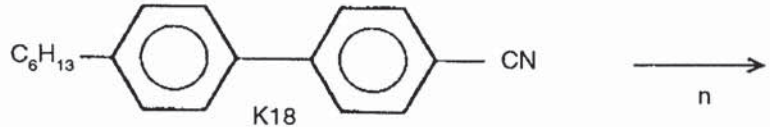

The director, n , of a liquid crystal is a unit vector parallel with the long axis of the molecule. If liquid crystal molecules are parallel, their directors are also parallel. Furthermore, it is possible to arrange the molecules in a cell so that the liquid crystal director gradually changes direction, or “twists” from one side of the cell to the other. The angle of twist depends on a number of factors which will be discussed in this section.

Since the liquid crystal molecules respond to an external applied voltage, liquid crystals can be used as an optical switch, or light valve. A common arrangement is shown in Figure 1-6. The illustration shows two parallel glass plates, each with a polarizing film on its outer side. The space between the plates is filled with the liquid crystal polymer. The technical designation for the most commonly used liquid crystal type is twisted nematic (TN), and the twist refers to the tendency of the polymers to form chains that rotate from one side of the gap between the plates to the other side. The degree of rotation can be controlled during cell fabrication.

Light passing through one of the polarizers, then through the cell, has its polarization direction rotated, following the physical rotation of the liquid crystal. In the illustration here, the polarizer on the exit side of the cell has been positioned to allow the rotated light to pass through. Viewed from this side, this pixel is clear, or transmitting. Other arrangements are possible; this is only one example.

A transparent electrical conductor (not shown) is deposited on the inner surfaces of the glass plates, and patterned into a series of mutually perpendicular lines. If a voltage is placed across the cell gap by addressing the appropriate line on each side of the cell, the liquid crystal reorients to follow the applied electric field, and the material is “untwisted” as shown in the figure. As long as the voltage is present, the passage of light will be blocked by the exit polarizer. When the voltage is turned off, the liquid crystal returns to its original state, and the pixel

CHAPTER ONE: PRODUCT APPLICATIONS

LIQUID CRYSTAL FLAT PANEL DISPLAYS

Figure 1-6 *Principle of operation of a twisted nematic liquid crystal display*

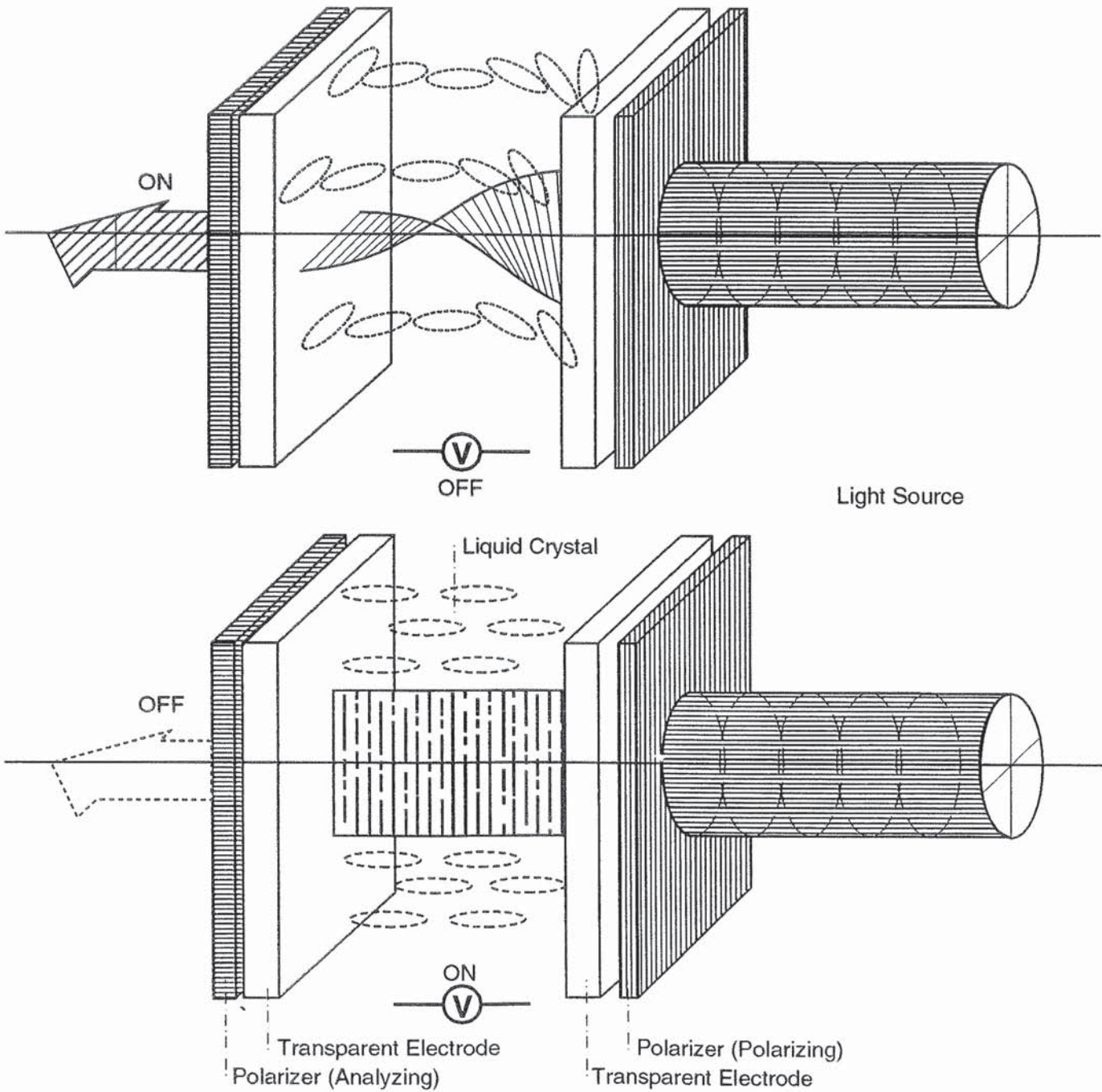

becomes clear again. Typical voltages and currents are quite low, which is why liquid crystal displays have been incorporated in battery-operated equipment, and in other applications where power consumption is an issue.

Liquid crystal materials for small displays have a twist angle of 90°. A “supertwisted” nematic material, developed in the mid-1980’s forms a twist angle of up to 270°, and allows much higher contrast, faster response, and the ability to multiplex many pixel elements in a single display. The supertwisted nematic (STN) technology has continued to improve, and forms the mainstream of current display technology. Many other types of materials with very different properties have been developed for specialized applications.

1.5.1 TYPES OF LIQUID CRYSTAL DISPLAY

A great variety of liquid crystal materials have been developed. These include the common twisted nematic materials, and exotic compounds which show very different response to an external field. The most important commercial ones are discussed here, based on a recent summary of the field[5].

Nematic liquid crystals show a root mean square (RMS) response to an applied voltage. This means a relatively slow response to the signal. As long as the information content is limited, TN-LCDs allow high contrast, since the ON voltage can be set to several times the threshold voltage to counteract the RMS response. Threshold voltage might be as low as 0.6V for TN materials.

Multiplexing addressing makes use of time sequential voltage changes to address individual pixels. The ratio of voltages in the select and non-select state has been derived by Alt and Plesho [6] and is given by

$$\frac{V_s}{V_{NS}} = \left(\frac{\sqrt{N} + 1}{\sqrt{N} - 1} \right)^{\frac{1}{2}}$$

where

V_s = Select voltage V_{NS} = Non-select voltage N =Maximum number of rows.

Then N_{max} , the maximum number of addressable lines is a function of the ratio of select and non-select voltages, S

$$N_{max} = \left(\frac{s^2 + 1}{s^2 - 1} \right)^2 \quad \text{where} \quad S = \frac{V_s}{V_{NS}}$$

Table 1-4 shows the calculation of S for various values of N_{max} .

$$\frac{V_s}{V_{NS}} = \left(\frac{\sqrt{N} + 1}{\sqrt{N} - 1} \right)^{\frac{1}{2}}$$

N	S=V _s /V _{NS}	N	S=V _s /V _{NS}
2	2.41	32	1.20
3	1.93	64	1.13
4	1.73	100	1.11
8	1.45	128	1.09
16	1.29	200	1.07

The table shows how small the voltage difference becomes when more than a few lines are multiplexed. Therefore, for multiplexing, the steepness of the electro-optic curve of the liquid crystal should be very high, close to infinite. The slope depends on the elastic properties of the material, although the dielectric properties and optical path difference also play a role. Three elastic constants for a long liquid crystal molecule can be defined. These are “splay”, “twist”, and “bend”. In a “splay” deformation, the molecular directors diverge from one another. Twisting and bending refer to uniform changes in director direction. The ratio of bend/splay constants, K_3/K_1 determines the steepness of the electro-optic response curve. Advanced TN materials have a K_3/K_1 ratio of 0.6 to 0.8, allowing a multiplexing of about 100 lines. For supertwisted nematic (STN) molecules, the twist angle is 240-270°, and a large K_3/K_1 value is preferable. In practice, a K_3/K_1 value of 2.5 is the largest for commercially available liquid crystal materials. Figure 1-7 is a schematic representation of the transmission characteristics versus applied voltage of a TN and STN material. The STN response curve is much sharper, allowing switching with just a small difference in ON and OFF voltages.

Supertwist LCD material was developed about 1982 when it was realized that very steep electro-optic response curve could be obtained for nematic liquid crystals with a twist angle >180°. At about 270°, an infinite slope occurs. This means that the slight voltage differences for multiplexing could be tolerated, and the “supertwisted” display was introduced. Some of the first displays were based on the supertwisted birefringence effect (SBE), which produced displays with distinctly colored backgrounds. Adjusting the polarizers to 60° and 30° with respect to the rubbing directions produced black figures on a yellow background.

Figure 1-7 Transmission versus voltage curves for TN and STN materials.

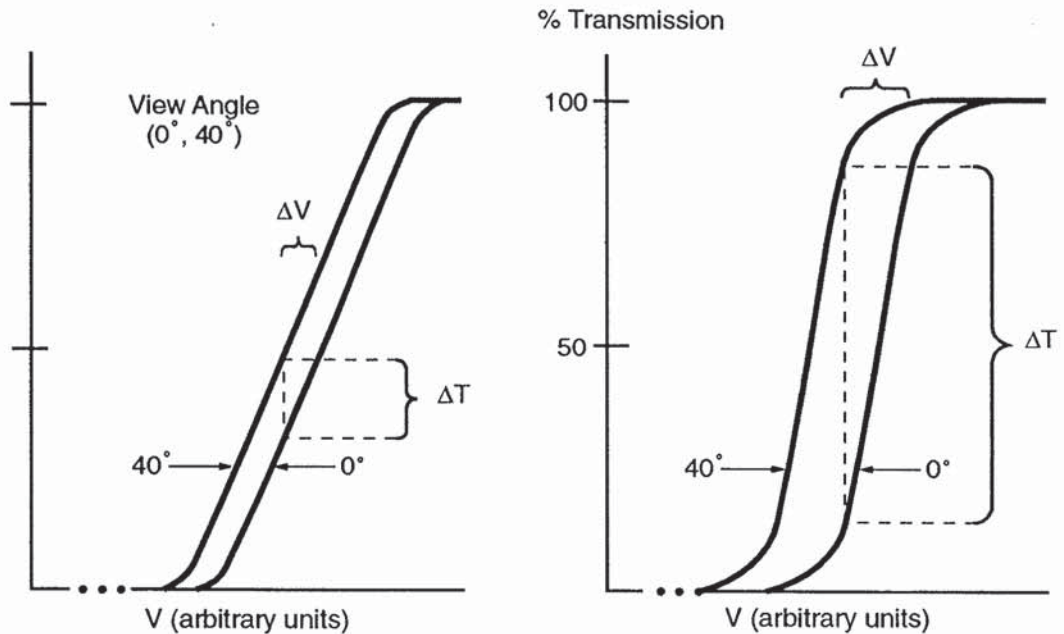

With both polarizers at 45° to the rubbing directions, white figures on a blue background are produced. High surface tilt angles are required to avoid “striped domains” in STN displays.

To avoid the interference colors of the SBE display, several options have been explored to produce a true black and white display. One example is the optical mode interference (OMI) display, for which $\Delta n \cdot d$ is reduced to 0.4-0.6 μm from the previous standard STN value of 0.8-1.0 μm . The quantity Δn refers to the optical anisotropy of the liquid crystal material. The control of this property is an important element in the synthesis of liquid crystal materials. The product $\Delta n \cdot d$ is a design parameter of the liquid crystal cell. For a constant response, it should be maintained at a high value. Consequently, the OMI display suffers from low overall brightness.

Double layer STN LCDs produce a true black and white display with high brightness. The interference color of a standard STN-LCD can be compensated by a second STN-LCD with opposite helical twist sense but otherwise identical properties. Using a second STN-LCD with opposite twist sense instead of a compensation film guarantees the same temperature dependence of the birefrin-

gence and the same dispersion, assuming the LCD material is identical in both cells. Combined with color filters, a high information content full color display can be produced.

A new development in TN technology makes use of vertical alignment of the molecules, termed homeotropic. The director, n , is perpendicular to the glass surface instead of parallel to it, as in the case of STN displays. A very slight tilt may be introduced, perhaps $0.5-1^\circ$. The advantages of vertical TN technology include high display contrast, wide viewing angle, and a more stable grey scale. Summary of requirements for vertical TN cell are shown in Table 1-5. In this table, the requirement for a small value of γ' is equivalent to a high contrast value. High information content displays of the vertical TN type are currently available from Stanley Electric.

Table 1-5 *Requirements for Vertical TN LCD Display*

Requirement	Ideal Values
Thin cell	$d < 5\mu\text{m} \pm 0.3\mu\text{m}$
Small pretilt angle	$0.5-1.0^\circ$
Large $\Delta n \cdot d$	$\Delta n \cdot d = 0.8-1.0\mu\text{m}$
Large ratio of K_3/K_1	$K_3/K_1 > 1.5$
Small $\gamma' = \frac{ \Delta\epsilon }{\epsilon_1}$	$\gamma' < 0.5$

Ferroelectric displays employ liquid crystals that maintain their orientation in the absence of an applied voltage. The display can be switched between the OFF and ON state, and will maintain the selected state without refreshing. In contrast, other display modes discussed here require that the voltage be ON for the state to be selected. Ferroelectric displays are therefore more easily multiplexed, and can serve as memory devices. Problems with these displays include the very thin cells ($<2\mu\text{m}$) required for their operation, and the lack of a suitable grey scale.

For active matrix displays, TN materials are suitable. However, the requirements are very different than for simple matrix displays. One requirement is extremely high resistivity, on the order of $10^{13} \Omega\text{-cm}$. New fluorinated materials are available for TN-AMLCD displays.

Table 1-6 shows the currently available displays, either R&D or production, and some critical parameters for each of them.

Table 1-6 Types of Liquid Crystal Displays

Properties	Status	STN			STN		V/TN	FLC	AM/TN	AM Proj.
		STN	OMI	FSTN	DSTN					
Display Area	R&D	12"	12"	14"	20"	10"	14"	15"	110"	
	Production	12"	12"	12"	12"	-	-	10"	100"	
Resolution	R&D	640x480	640x480	1120x780	1120x780	640x480	1120x1280	1280x800	960x1422	
	Production	640x480	640x480	1120x780	640x480	-	-	640x480	440x480	
Duty Ratio	R&D	1/240	1/240	1/480	1/390	1/480	1/2000	-	-	
	Production	1/240	1/240	1/390	1/240	-	-	-	-	
$\Delta n \cdot d(\mu\text{m})$		0.8-1.0	0.4-0.6	0.4-1.0	0.8-0.9	0.8-1.0	0.25	0.5	0.5	
							(1. min.)	(1. min.)	(1. min.)	
d(μm)		7-8	4-7	4-7	4-7	4-6	1-2	4-7	4-7	
$\Delta d(\mu\text{m})$		± 0.1	$\pm 0.1-0.2$	$\pm 0.05-0.1$	± 0.05	$\pm 0.1-0.2$	± 0.05	$\pm 0.1-0.3$	$\pm 0.1-0.3$	

Definitions: OMI=optical mode interference, FSTN=film-compensated STN, DSTN=double layer STN, V/TN=vertical TN, FLC=ferroelectric, AM/TN=active matrix addressed TN, AM/Proj.=projection active matrix display

1.5.2 PASSIVE VS ACTIVE ADDRESSING

The information content of a computer display or television is much higher than for calculators or watches. The number of rows and columns of a VGA computer display is 640x480, or about 300,000 pixels. Full color displays require three color "dots" at each pixel, bringing the total number of discrete picture elements to nearly 1 million. There are two approaches to addressing so many pixels: using a passive addressing matrix or an active one. The difference is shown schematically in Figure 1-8. For the passive (STN) display, the transparent electrodes are patterned on both facing glass plates in perpendicular arrays. The pitch, or repeating distance, of the electrodes corresponds to the pixel dimension, about 100x300 μ m. Red, green, and blue (RGB) color filters on the outer glass plate provide the full color display. The figure also shows the corresponding active matrix construction. The active switch is shown as a shaded area on the rear panel at the corner of each pixel. This transistor or diode is connected electrically to the edge of the display, and is switched with an external electrical signal. The conducting electrode is patterned to follow the pixel shape on the rear glass panel, but is a continuous film on the front plate.

In principle, passive displays are much easier to fabricate, but in practice, are more difficult to operate. There are conducting lines on both sides of the display, and the drive circuits are much more complicated. This has produced an effort to develop thin film deposition technology that allows the manufacture of a million or more transistors on a glass plate, with a repeatability exceeding that for an integrated circuit.

Passive matrix displays are currently the most common, and have been used in simple watch and calculator applications for some time. Recently, improvements in liquid crystal materials have extended applications of passive matrix displays to large area, backlit computer and word processing products. These displays employ supertwisted nematic liquid crystals for very high contrast, and double cell or film compensation layer construction for a true black and white display. 10 inch displays are employed in portable and laptop computers, and power consumption is low enough for several hours of battery operation, even with a backlight.

Passive matrix displays depend on multiplexing signals on the upper and lower glass substrates. Multiplexing means that voltage pulses are repetitively intermixed and transmitted along row and column electrodes, combining at the

Figure 1-8 Schematic representation of passive and active matrix color liquid crystal displays.

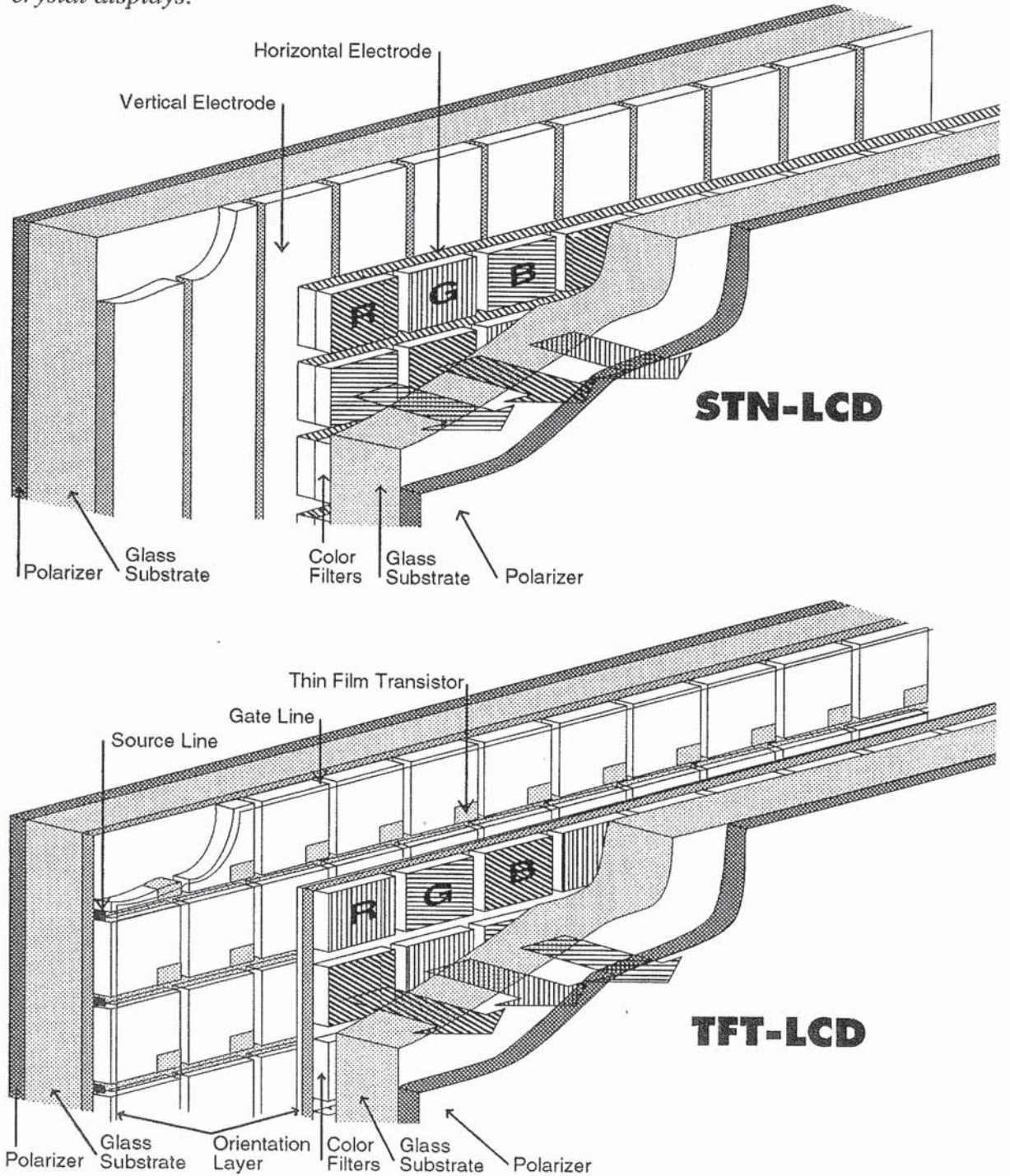

appropriate cross point, i.e., at the pixel being addressed. A pixel or picture element is turned "on" when a voltage is present at both sides of the liquid crystal, and is "off" in the absence of such a voltage. It is possible to manufacture displays with high information content, up to 640x480 pixels and greater. Color display manufacturing is being planned, and displays suitable for engineering work stations are under development. In some sense, these passive displays are competing for the same market as active matrix displays. Ultimately, the problems associated with passive display operation may limit their size and complexity. Very complex schemes are required in order to address each pixel separately from the outside. The transparent conductor for both the upper and lower panel must be patterned, and hundreds of connections are required. For large displays, the liquid crystal material properties, including response time, limit display performance. However, for the next year or two at least, most large displays will be of the passive matrix type.

1.5.3 WORKSTATION B/W DISPLAY

One example of the excellent performance which can be achieved by STN technology is a fast response black and white display that has been reported by Toshiba[7]. For this display, response characteristic is fast enough to allow the use of a mouse in a graphical display environment. This means that the response time of the display has to be faster than 80ms.

The value of $\Delta n \cdot d = 0.67\mu\text{m}$ was maintained in developing cell thickness, d , and other cell parameters. This value is optimum for supertwist displays with retardation films. A threshold sharpness function is defined as

$$\gamma = \frac{(V_{40} - V_{90})}{V_{90}} \times 100(\%)$$

where V_{90} is the voltage for which 90% transmission occurs, and V_{40} is the voltage for which 40% transmission is observed. A small value of γ gives a large contrast.

γ varies with cell thickness. The more desirable low values of γ are obtained at large cell thickness, $6\mu\text{m}$ or greater. This requirement conflicts with the fast response speed which is obtained by cell thickness of $5\mu\text{m}$ or less. A compromise value of $5\mu\text{m}$ was chosen for the cell thickness.

Display development employed two retardation films to provide true black/white response and wide viewing angle. For the liquid crystal material the birefrin-

gence, Δn , has to increase as d , the cell gap, decreases. The product $\Delta n \cdot d$ must remain constant for best response. However, as the birefringence increases, so also does its wavelength dependence. This has a strong affect on the contrast ratio of the display.

Display specifications are shown below.

Panel size: 235mm (H) x 175mm (V)
 Display area: 211mm (H) x 132mm (V)
 Pixel density: 640 (H) x 400 (V)
 Pixel pitch: 0.33mm
 Duty cycle: 1/200
 Bias ratio: 1/15
 Frame frequency: 140Hz
 Response time: 75ms ($\tau_{on} = \tau_{off}$)
 Contrast ratio: 14:1

1.5.4 POLYMER DISPERSED DISPLAYS

Polymer dispersed liquid crystal (PDLC) displays make use of liquid crystal droplets to control the passage of light without the use of polarizers. This technology has been used by Asahi Glass to construct light valves for a full color projection TV system[8]. In this system, three light valves are combined with a metal halide lamp and dichroic mirrors as shown in Figure 1-10. Incident white light is divided into blue, green, and red light beams by two dichroic mirrors and one metal coated mirror. Three light valves modulate each primary color to produce the TV image. The light valves are poly-Si thin film transistor active matrix arrays which control the PDLC material. The light valves scatter light in the OFF state, and this scattered light does not reach the lens of the projection system. In the ON, state, light passes through the valve, is collected by the lens and projected as an image on the screen. The switching is accomplished without the use of polarizers.

Figure 1-9 *Polymer dispersed liquid crystal projection TV system*

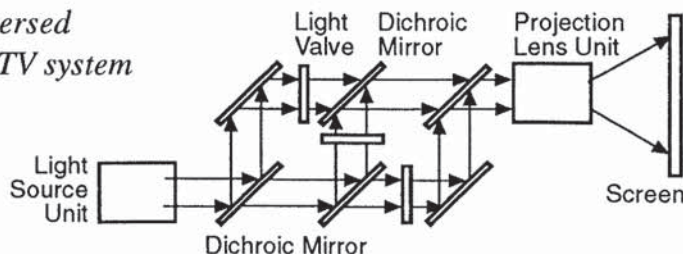

CHAPTER ONE: PRODUCT APPLICATIONS

LIQUID CRYSTAL FLAT PANEL DISPLAYS

The light valve material is a dispersion of liquid crystal droplets in a vinyl acrylate prepolymer. Ultraviolet light-induced polymerization creates a solid polymer film containing the dispersed droplets as shown in Figure 1-10. The droplets contain a twisted nematic liquid crystal, and the small droplet size of a few microns or less causes the liquid crystal directors to adopt a uniform alignment within each droplet. However, the alignment direction of each droplet is random, and light passing through the cell in the off state is scattered. An electric field orients the molecules within the droplets so that the directors are parallel to the field, and light passes through the cell. Rise time of 35ms and fall time of 25ms are fast enough for TV use.

Figure 1-10 Structure of the dispersed liquid crystal droplets

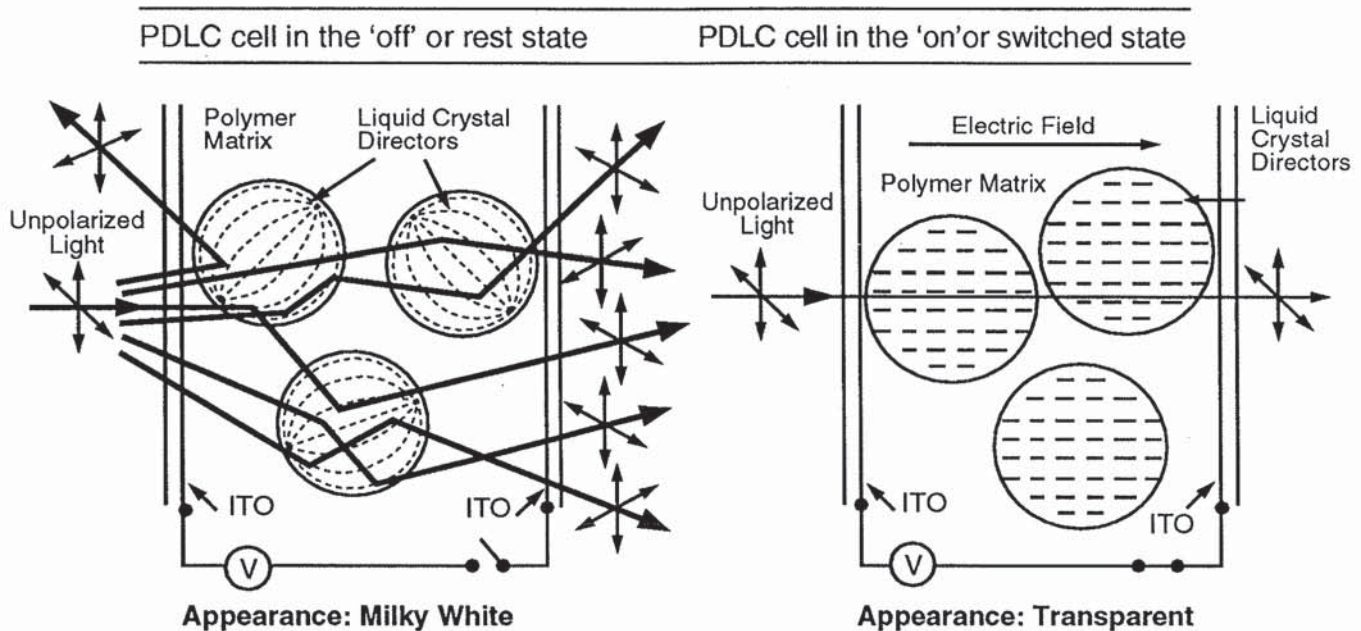

Because the threshold voltage characteristics of the material are not sharp, an active matrix drive scheme is employed. Polysilicon TFTs are used because they are less sensitive to light than a-Si devices. TFT structure is the inverted staggered type, and polysilicon is obtained by laser recrystallization of amorphous silicon. This means that a glass substrate can be employed rather than quartz. The array includes a storage capacitor at each pixel to maintain pixel voltage since the PDLC has relatively low resistivity ($<10^{12}\Omega\text{-cm}$). Transistor characteristics include a mobility of $10\text{cm}^2/\text{Vs}$, and On/Off current ratio of about 10^6 . Array size is 3.4-in. diagonal, 240x360 pixel resolution, and aperture ratio of 60%.

A full color TV image is achieved with contrast ratio of 100:1, 540 ft-L brightness, and 50 inch diagonal projected image. Screen gain is 5. Chromaticity coordinates of the display are comparable to those of a CRT. Compared with standard light valves employing polarizers, a factor of four gain in luminance is achieved. Since the light valve is not heated by the incident light, cooling is not required, and even higher screen brightness could be achieved with a more intense source of illumination.

1.5.5 AUTOMOTIVE DISPLAY

Matsumoto and coworkers at Asahi Glass, a leader in automotive displays, with its manufacturing subsidiary Optrex, recently discussed some of the requirements for highly legible displays[9]. Advantages of these displays include good legibility under bright ambient light conditions and reduced restrictions on design and color of the display. However, the background transmission of the display, called bleedthrough, reduces legibility.

One solution to bleedthrough is very high contrast (VHC) display technology developed at Asahi Glass and Optrex. A light shielding black mask, positive mode TN-LCD and a reversed driving method are combined to produce contrast in excess of 1000:1. LCD panels for automobile dashboards have to be set in at an oblique angle to prevent display wash-out caused by surface reflection. Because of this oblique mounting angle, the optical anisotropy of the polarizers must be taken into account.

It is possible to obtain high contrast when the display is viewed perpendicularly, but the contrast ratio declines at shallower angles. The angular dependence is a function of the product of birefringence and cell thickness, $\Delta n \cdot d$, and must have a value of 0.45-0.5nm.

Polarizers used in this application must have a high degree of polarization, >99.9% to achieve 1000:1 contrast ratio, and the deviation of the cross-angle of the two polarizers must be maintained within $\pm 1.0^\circ$.

For the low angle viewing appropriate for dashboard installation, the twist angle of the liquid crystal layer should be reduced to about 70° , and the cross-angle of the polarizers shifted from 90° by about 2.6° . In this investigation, the unexpected retardation from the triacetyl cellulose film (which supports the polarizer) complicated the response of the display, and had to be corrected for.

Active Matrix Devices**1.6**

The limitations of liquid crystal switching by a multiplexing scheme can be overcome by placing an active device behind each pixel. The high information content displays for computers benefit from increased response speed, higher contrast, and higher overall brightness. The cost of these improvements is the added fabrication sequence for thin film devices behind each pixel, a total of hundreds of thousands of individual devices for each display.

Having a switch at each pixel greatly simplifies the electronics of the flat panel display. The front panel transparent electrode is not patterned at all, and acts simply as a ground electrode. Problems due to voltage nonuniformity along the display are reduced or eliminated. Twisted nematic liquid crystal material can be used instead of the more demanding supertwisted variety. Various kinds of switches have been investigated for this application, including diodes and transistors. All of these devices are deposited as thin films, and are patterned using technology similar to semiconductor integrated circuit methods. Current production displays employ either a metal-insulator-metal (MIM) diode made from tantalum and tantalum oxide layers, or a MOS thin film transistor (TFT) made in either an amorphous silicon (a-Si) or polysilicon thin film.

Polysilicon transistors have some performance advantages over a-Si devices, and transistor performance is good enough to allow simple integrated circuits to be fabricated at the outside edges of the display. These circuits act as on-board drivers, and greatly reduce the number of external connections. Processing requirements for polysilicon transistors currently require quartz substrates rather than glass. Since quartz is a much more expensive substrate, applications for polysilicon/quartz displays are currently limited to small displays used as viewfinders or projection units. One example is shown in Figure 1-11 below.

Most of the development effort for flat panel displays is devoted to amorphous silicon transistor switches. The technology for depositing thin film amorphous silicon with stable electrical properties has been known for some time, and is used commercially to make thin film "solar batteries" for pocket calculators[11]. Many of these calculators have no other battery, and operate with light from room illumination rather than sunlight. The additional complications of transistor fabrication have so far limited production to small displays, but the difficulties are being overcome, and 10 inch displays are in pilot production in Japan. Full color

10 inch displays incorporating TFTs for computer displays are backlit, but they suffer from low overall transmission of light, less than 5% or so. The bright backlight required for adequate visibility limits their application; for portable computers, battery recharging is required after thirty minutes of operation.

The manufacturing process for active matrix liquid crystal displays (AMLCD) which employ a-Si transistors is described in the following section of the report. This complex process sequence employs specialized equipment, some of which is "home-made" by the display manufacturer. In some cases, advanced equipment is supplied by outside suppliers, but in almost no instance has a perfect solution to high volume manufacturing been achieved. This means there are many opportunities for equipment suppliers to develop improved products for this fast growing industry. However, in order to succeed as a supplier, a significant presence in Japan is essential, since almost all active matrix flat panel displays are currently made in Japan.

1.6.1 TWO TERMINAL DEVICES

Two terminal devices are simpler to make than TFTs, and have the potential for higher yield for large active matrix displays[12]. Several kinds of devices have been investigated, including SiN_x thin film diode, Ta_2O_5 metal-insulator-metal (MIM) diode, and a-Si PIN diode. It is essential for all of these devices to eliminate polarity-asymmetry to prevent a DC bias from occurring.

The amorphous silicon PIN diode structure is shown in Figure 1-12. Bottom and top metals are chromium, which also forms the address line. The bottom Cr layer is also used to form a light shield for the amorphous silicon. a-Si films are formed by PECVD, and p^+ , i , and n^+ layers are deposited sequentially. The ON/OFF current ratio is about 8 orders of magnitude, much larger than the MIM devices, and PIN diodes should be able to be used for high resolution AMLCDs.

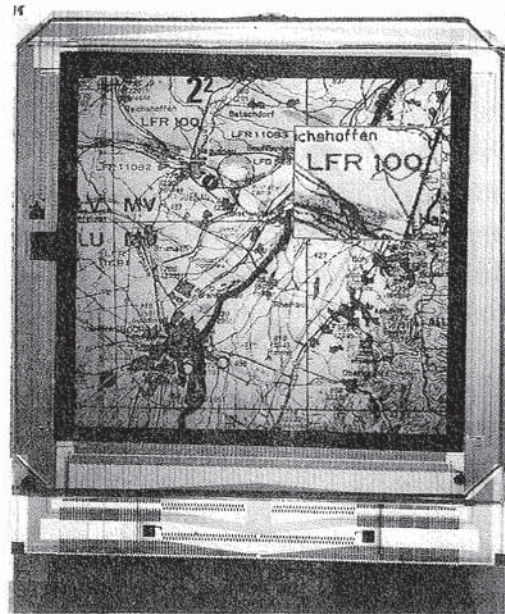
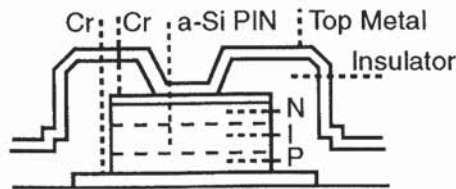

Figure 1-11 Projection display using polysilicon thin film transistors [10]

Figure 1-12 *Amorphous silicon PIN diode*



Ta₂O₅ devices are simple and device characteristics are stable, so high yield should be possible for large area arrays. Figure 1-13 shows the fabrication sequence of the Ta₂O₅ MIM. A 600Å Ta₂O₅ layer is deposited on non-alkali glass and 3000Å of Ta metal is sputter deposited. Photolithography and etching form a tapered Ta metal structure. Anodic oxidation in citric acid solution forms a 600Å Ta₂O₅ coating over the metal line, and chromium is deposited and patterned. For the chromium patterning, four quadrants are needed to create the active areas, and four photomasks are used to expose this layer. ITO deposition and patterning completes the process. Sheet resistivity of the ITO layer is 20 Ω/square. The state of the Ta metal in the as-deposited form affects the stability and performance of the device, and nitrogen doping during deposition has been used to create an a-Ta+TaN₂ structure.

The Ta₂O₅ MIM device has been used to produce a high resolution black and white workstation display, 13" diagonal size[13]. The counter substrate ITO layer is covered with a protective organic film, 4000Å thick, to prevent short circuits through the cell. Reduced resistivity of bus lines was achieved using a double layer structure of Ta and Cr. The width of the Ta line is 24µm, and Cr 18µm, to include a margin for error in alignment in masking. Bus line resistivity is 17.6Ω/cm. The cell gap is maintained at 6.0±0.3µm, and twisted nematic liquid crystal is used.

Redundancy is obtained using a double pixel design, as shown in Figure 1-14. Each subpixel is 86x189µm, and overall pixel pitch is 0.22x0.22mm. Two cold cathode backlights were employed for illumination. Display characteristics include 1280x800 pixels, pulse width modulated addressing, 16 levels of gray, device size of 4x4µm, and aperture ratio of 85%. Contrast ratio is maintained through a wide viewing angle. Right/Left viewing angle is about ±30°, and Up/Down viewing angle is about ±15°.

Color filter arrays for full color operation presented a problem when using this device when the color filter is formed over the ITO layer on the front substrate. This increases the voltage drop across the cell, making it difficult to apply

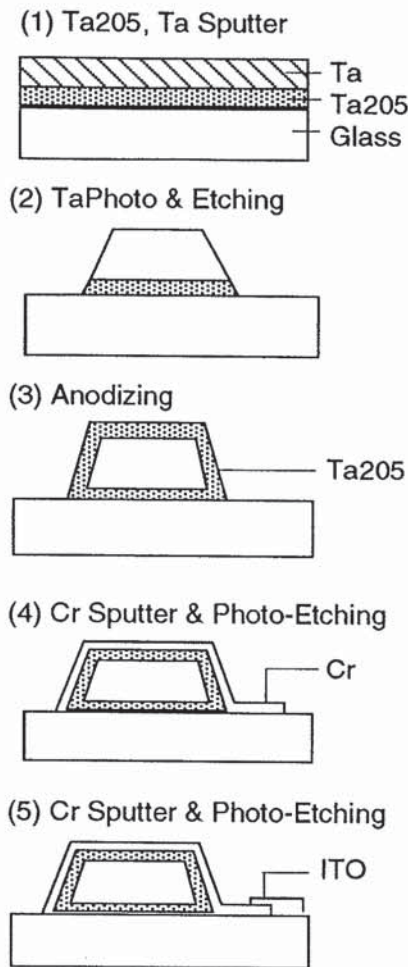

Fabrication Process of MIM diode

Figure 1-13 (left) MIM diode structure

Figure 1-14 (below) Double pixel design for MIM diode.

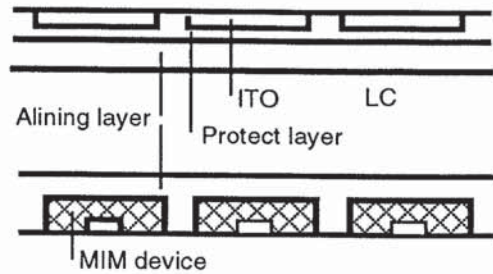

Structure of B/W MIM LCD

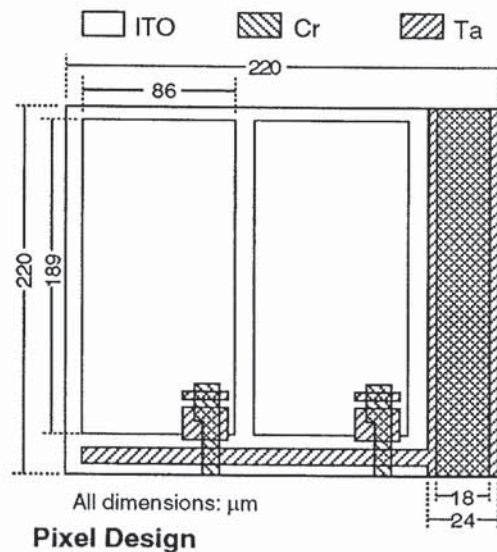

Pixel Design

sufficient voltage to the liquid crystal. For this reason, the color filter must be formed first, then covered with ITO. This adds to the difficulty of patterning the ITO, and open circuits sometimes occur.

Given the same yield, a thin film diode (TFD) costs only 75% as much to manufacture as a TFT array, since the number of process steps are fewer[14]. For comparison, an STN panel is only 15% the cost of a TFT panel. Table 1-7 shows the comparison. However, full color with 16 gray scale, near CRT equivalent display type cannot be easily achieved by TFD.

CHAPTER ONE: PRODUCT APPLICATIONS

LIQUID CRYSTAL FLAT PANEL DISPLAYS

Table 1-7 Processing and Relative Cost of Active and Passive Displays

Display Type	Masking Operations	Thin Film Depositions	Relative Array Cost	Relative Total Cost
Thin film transistor	7-8	8-9	100	100
Thin film diode (MIM, PIN)	3-4	3-4	50	75
STN	1	1	-	15

1.6.2 AMORPHOUS SILICON TRANSISTORS

Two types of TFT structures are used for amorphous silicon (a-Si) devices. One is the inverted staggered (IS) type, which can be either back channel etched (IS-BCE) or tri-layered (IS-TL). The other is called a normal staggered (NS) device. These three transistors (IS-BCE, IS-TL, and NS) are shown in cross-section in Figure 1-15. They are currently being used for LCD TVs or other products in Japan as shown in Table 1-8.

Table 1-8 TFT Array Process and Specifications

Manufacturer	Toshiba	Hitachi	Sharp	Matsushita	Hoshiden
Screen size	4-inch	5-inch	3-inch	3-inch	10-inch
TFT type	IS-BCE	IS-BCE	IS-TL	IS-TL	NS
Number of masks	6	9	8	9	8
a-Si thickness	3000Å	2000Å	500Å	500Å	300Å
Gate insulator	SiN/SiO	SiN	SiN/TaO	SiN	SiN
Gate line	Mo-Ta	Al/Cr	Ta	MoSi/Cr	Al
Signal line	Al/Mo	Al	ITO/Ti	Al	ITO/Cr
Storage capacitor	Yes	Yes	Yes	Yes	Yes

The performance of a TFT as well as the manufacturing yield and throughput depend on the transistor's construction. The inverted staggered back channel etched transistor, (IS-BCE), can be fabricated with the minimum number of six masks, whereas the inverted staggered tri-layered transistor, (IS-TL) requires nine. On the other hand, the IS-TL type has only a 500Å a-Si layer, minimizing

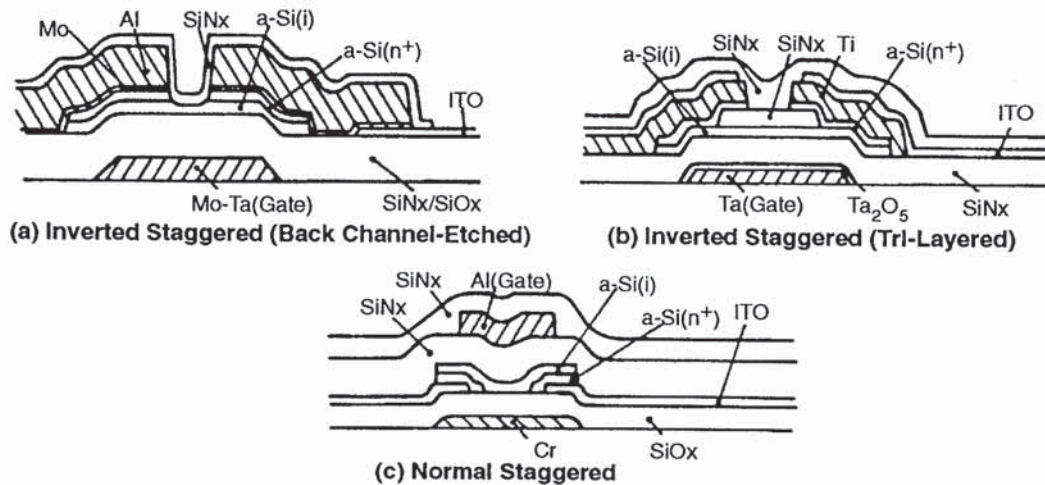

Figure 1-15 Cross-section view of three TFT configurations[15]

the deposition time for this layer. This is important because amorphous silicon deposition is very slow, and can constitute a manufacturing bottleneck when thick layers are required.

Double layer gate insulator structures such as $\text{SiN}_x/\text{SiO}_x$ or $\text{SiN}_x/\text{TaO}_x$ are commonly used to minimize yield loss due to line or point defects which cause crossover shorts. These kinds of shorts are difficult or impossible to repair.

Specific resistivities of tantalum (Ta), chromium (Cr) or molybdenum-tantalum alloy (Mo-Ta) films used for gate lines and gate electrodes in some of these structures ranges from 20 to 40 $\mu\Omega\text{-cm}$. These values are too high for large screen TFT-LCDs, since the high resistance and capacitance of the gate line leads to gate pulse delay. For a 12 inch TFT-LCD with 1024x768 pixels and a 16 level grey scale, the resistivity of the gate line should be less than 10 $\mu\Omega\text{-cm}$. Aluminum is the only appropriate material for such high density displays.

One of the difficulties in transistor design and manufacturing is the need for a storage capacitor to improve the image quality. The storage capacitor adjoins the TFT and has an ITO top plate. Charging this capacitor requires that the TFT be relatively large, and the increased area at each pixel devoted to the transistor reduces the amount of light which can be transmitted (aperture ratio). If a second transistor is added at each pixel for redundancy, transmitted light can drop to less than 5% in a finished display.

Tsumura and coworkers at Hitachi described a 10.3" full color display using a TFT with an aluminum gate, which is shown in Figure 1-16[16]. This gate design uses aluminum for low resistivity, and an anodized aluminum material forms the gate oxide of the device. Aluminum has about one tenth the electrical resistance of chromium. Aluminum is also used for the common electrode of the storage capacitor, as shown in the figure. The TFT is of the inverted stagger type. The storage capacitor is added to improve the uniformity of the displayed image.

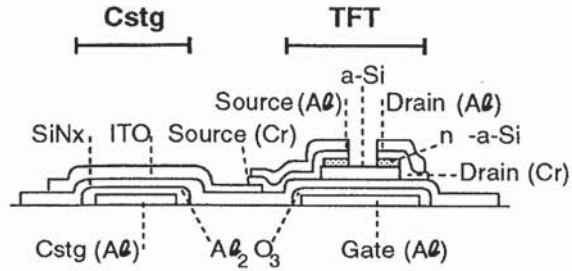

Figure 1-16 Aluminum gate a-Si TFT

Figure 1-17 shows that stray light passing through the display structure can leak through, reducing display contrast. In order to eliminate this stray light, a second light shield was added to the structure, as shown in the lower part of the figure. Figure 1-18 shows the plane view of the active matrix device. The pixel size is 64x192µm. Aperture ratio of more than 25% and contrast of 100:1 were measured. Using 8 level signal drivers, 512 colors were obtained for a full color display.

Figure 1-17 Light leakage in TFT structure

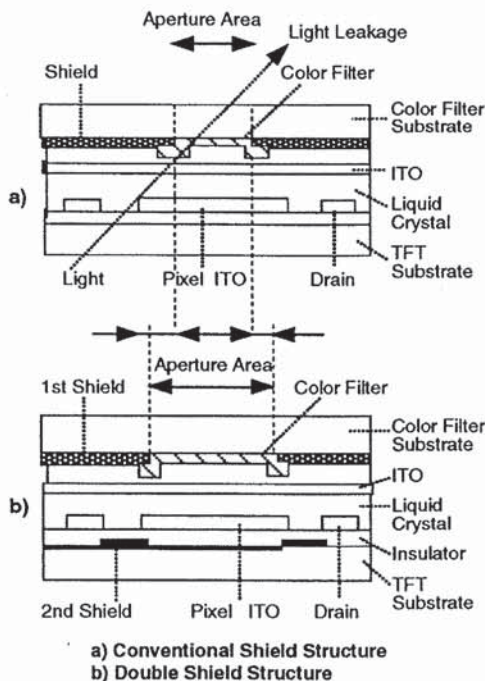
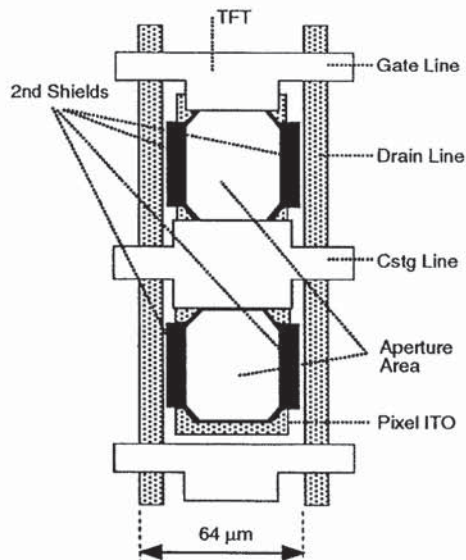

Figure 1-18 Plan view of TFT structure with light shield.



CHAPTER ONE: PRODUCT APPLICATIONS

LIQUID CRYSTAL FLAT PANEL DISPLAYS

Hitachi's investigation of TFT technology was summarized by Tsukada[17]. The effect of the data or drain address line on the delay time is relatively small. Therefore, the choice of metallization and metal thickness for this line is not critical. However, the situation for the gate line is different. The gate line is deposited at the beginning of the process for inverted structures. This places some limits on the metal and its thickness. Metals investigated for the gate address line application include Cr, Ta, Mo-Ta, and Ta-Cu-Ta. The resistivity of these metals is relatively high, as shown in Table 1-9. For large displays, these materials cannot be used by themselves; ultimately, the choice of metals is limited to Al and Cu. Gold, the only other candidate, is not cost effective. Copper has low resistivity and low cost, but adherence to the substrate is a problem. Therefore, a three layer metal system like Ta-Cu-Ta has been proposed. Hitachi, however, is using aluminum.

The equivalent circuit of the TFT array used by Hitachi is shown in Figure 1-19. The resistivity of the gate line is more than one order of magnitude lower than for the other metal, with reduced gate delay. For computer applications, the display is driven in the non-interlaced mode. In this case, the time allotted to the gate line

Figure 1-19 Hitachi TFT array equivalent circuit

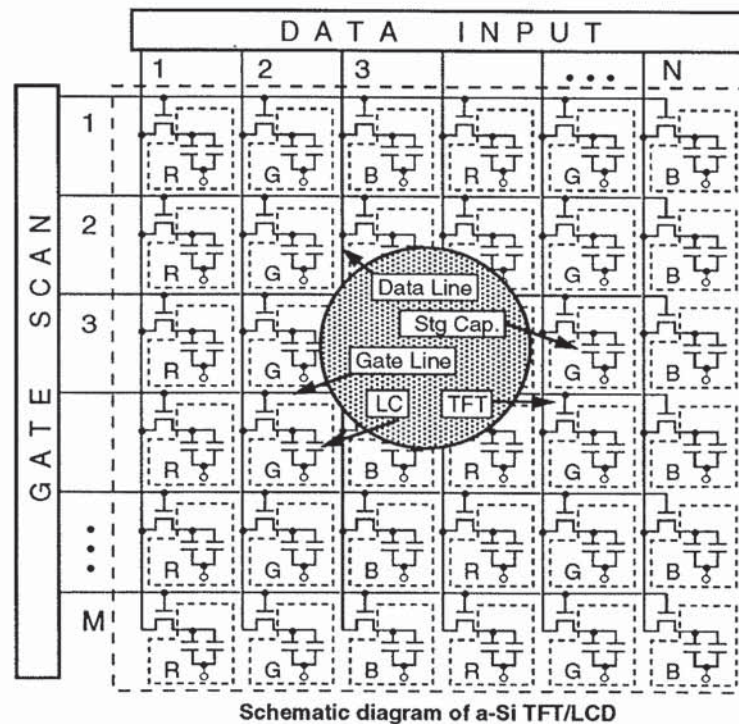

CHAPTER ONE: PRODUCT APPLICATIONS

LIQUID CRYSTAL FLAT PANEL DISPLAYS

address is about 20-30 μ s. Assuming 10% of the gate address time is allowed for gate delay, the gate delay time should be 2-3 μ s. It is possible to achieve this value using aluminum.

Another important benefit from aluminum gate metallization is the capability of anodic oxidation. This initial step in gate oxide formation provides a defect free structure which resists the shorting effects of foreign particles which might deposit in subsequent processes. This provides a more robust gate insulator structure, and a reduced incidence of crossover shorts. For larger panels and smaller pixels, such shorts between conductors become a more serious problem.

Table 1-9 Resistivity of Metals

Metal	Resistivity ($\mu\Omega$ -cm)	Anodic Oxidation Possible
Al	3	Yes
Cr	55	No
Ta	180	Yes
Ta-Mo	40	Yes
Ti	84	Difficult

Usually in processing aluminum lines, heating causes hillock formation. However, if the surface is anodized, hillock formation is suppressed, and a strong, etch resistant oxide film covers the surface. Leakage current is only 3×10^{-12} A at 20V for a 200nm, 1mm² layer. Breakdown field is 7MV/cm, which is less than for other oxides. Metallization shorts are reduced to a low value. For TFT production, a double gate insulator structure of Al₂O₃ and SiN is used. The ON current of the Al-gate TFT is higher compared with a TFT with only SiN single layer insulation. The dielectric constant of aluminum oxide is higher than silicon nitride, but its mobility is also higher. The transconductance of the Al gate structure can be increased by using a thinner SiN layer.

1.6.3 POLYSILICON TRANSISTORS

Current applications for polysilicon TFT displays include projection and video camera displays which are physically very small, about 1 inch diagonal or smaller for video cameras, and up to 3 inch diagonal for projection devices. It is economical to fabricate such displays on quartz substrates. However, the large

CHAPTER ONE: PRODUCT APPLICATIONS

LIQUID CRYSTAL FLAT PANEL DISPLAYS

area displays needed for direct view can't be made on quartz substrates, and the high performance of polysilicon will be available only if a low temperature process can be developed.

Such a process was recently described by Morozumi of Seiko Epson[18]. Manufacturing of large area polysilicon TFTs requires processing temperatures of $<600^{\circ}\text{C}$. At the same time, the carrier mobility must be increased to achieve higher operating speed. Self-aligned transistors are made by depositing poly-Si, then gate oxide followed by source/drain regions which are self-aligned with respect to the gate electrode. The device is completed with a thick oxide, ITO, and Al contacts.

Non-self-aligned devices are made using doped poly-Si for the source/drain layer, then intrinsic poly-Si for the channel region. After the gate oxide is formed, contact metallization is made using some overlap between the gate and source/drain electrodes. .

Five photomasks are used for both processes. Special equipment is required for self-aligned structures for B or P diffusion. Otherwise, "standard" equipment is used for both processes.

Poly-Si material allows the formation of CMOS circuits, which is not possible using amorphous material. Carrier mobility is about $6\text{ cm}^2/\text{Vs}$ for n-channel devices. This is suitable for up to 240×320 pixel displays. For larger displays, higher mobility is required. One way to increase the mobility is to reduce the trap density around the grain boundary by hydrogenation. Doing this increases the mobility of n-channel devices to $30\text{ cm}^2/\text{Vs}$, and p-channel devices to $20\text{ cm}^2/\text{Vs}$. A second approach is to increase the grain size by laser annealing. The mobility increases to about $120\text{ cm}^2/\text{Vs}$.

Driver circuits made from polysilicon transistors have to be fast enough to drive at least 640 horizontal rows. Recrystallized polysilicon shift registers show 30MHz operation, which is fast enough for this requirement.

Process and performance comparisons of amorphous and polysilicon TFTs is shown in Table 1-10.

CHAPTER ONE: PRODUCT APPLICATIONS

LIQUID CRYSTAL FLAT PANEL DISPLAYS

Table 1-10 Comparison of a-Si and poly-Si TFTs

	a-Si TFT	poly-Si TFT
Substrate	Hard Glass	Hard Glass
Fabrication		
Mask Steps	6	6
Deposition	Plasma CVD (2 steps)	LPCVD (3 steps)
Sputtering	3 steps	3 steps
Substrate Area	1m square	1ft square
Throughput	3 substrates/hr	30 substrates/hr
Temperature	350°C	550-600°C
Source/Drain	Doped n ⁺ a-Si	Ion doping/Diffusion (self-aligned), Doped n ⁺ poly-Si (non-self-aligned)
Transistor Properties		
Mobility	0.5 cm ² /Vs	5-100 cm ² /Vs
Threshold Voltage	1-2 volts	1-5 volts
On/Off	10 ⁶⁻⁸	10 ⁶⁻⁸
Current Ratio		

Substrate cost is <10% of the fabrication cost of the device, so the cost difference of the glass for a-Si and poly-Si, if any, may be negligible. Facility operating cost is determined by the number of processing steps and throughput at each step. The difference is mainly in the CVD processes. Two CVD steps are used for a-Si TFTs, and three steps are required for CMOS poly-Si. In addition, two ion doping steps are used for poly-Si devices. However, throughput of a-Si depositions is very low. In the end, the competing factors result in a fabrication cost which is almost equal for the two transistor types.

Cost advantage of having the drivers on-board is difficult to calculate. There is some yield degradation due to having the drivers. However, since they occupy a very small area, it may be possible to achieve a high yield, making the cost difference of fabrication very slight. In considering a relatively low yield process, polysilicon on-board drivers make sense only for very small area displays. For

CHAPTER ONE: PRODUCT APPLICATIONS

LIQUID CRYSTAL FLAT PANEL DISPLAYS

large area displays, outside drivers make more sense. In the future, for very high yield manufacturing processes, it may be cost effective to place the drivers on-board.

In a recent survey of polysilicon, a summary of conditions for deposition, annealing, transistor type and characteristics was presented. Table 1-11 shows the survey results, with emphasis on sputtering as the deposition method of the future for polysilicon [19].

Table 1-11 *Polysilicon Fabrication Methods and TFT Properties*

Precursor (Deposition Method)	Annealing Method	TFT Structure	Mobility (cm ² /Vs)	Grain Size (nm)
a-Si (LPCVD)	Thermal	coplanar	37	20
	Ar laser	coplanar	-	<100
	XeCl laser	coplanar	120	60-100
	ArF laser	inverted staggered	90	-
	KrF laser	coplanar	60-120	-
a-Si (PECVD)	Thermal	coplanar	(158)	2000
	XeCl laser	staggered	102	200
	XeCl laser	coplanar	60	80
	Ar laser	coplanar	40	30
	Ar laser	inverted staggered	50	10-100
a-Si (Sputtered)	Ar laser	coplanar	383	40

Problems with the LPCVD material include the high temperature deposition required, above the strain temperature of 7059 glass or equivalent. This means that quartz must be used as the substrate. For PECVD a-Si precursor material, converting to polysilicon by laser annealing causes the eruption of hydrogen; some method of dehydrogenation must be found for this to become practical. The

Hitachi researcher says that sputtered a-Si gives high quality polysilicon after laser annealing, and thinks that this is the future direction for the technology.

1.6.4 COMPARISON OF DEVICE PERFORMANCE

There are advantages and disadvantages for each of the active devices used for liquid crystal switching. For two-terminal and transistor devices, the considerations are shown below[20].

a-Si diodes

- Advantages, $I_{on}/I_{off} > 10^8$, simple process and simple device
- Disadvantages: non-reproducible breakdown, voltage not optimized to liquid crystal threshold. Low threshold with one diode, complex structure with multiple diodes

MIM devices

- Advantages: 2-3 masks, tantalum oxide MIM is light insensitive, hi resolution, no crossovers
- Disadvantages: cross talk, tight tolerances on voltage and temperature, insulator thickness, device area, materials, complex cover plate. For the tantalum oxide MIM, tapered edge is required for Ta line. Spread of taper angles is too large for gray scale.

PIN diodes

- Advantages: charge storage possible, small diodes, redundancy, series/parallel, $I_{on}/I_{off} \sim 10^8$
- Disadvantages: twice the row interconnects required, poor storage capacitors, complicated color filter with column lines and ITO on top of filters, non-uniform diode threshold.

a-Si Transistors

- Advantages: charge storage, fewer interconnects, storage capacitor
- Disadvantages: complex process, $I_{on}/I_{off} \sim 10^6$, light sensitive

The leakage current requirement is $I = C\Delta V/t_{frame} \sim 10^{-12}A$, where $C=0.3pF$, $\Delta V=50mV$, $t_{frame}=16ms$. For a single transistor, the leakage current is higher than

CHAPTER ONE: PRODUCT APPLICATIONS

LIQUID CRYSTAL FLAT PANEL DISPLAYS

desirable. A more complex two gate transistor structure can reduce the leakage considerably.

These devices are compared in Table 1-12.

Table 1-12 Comparison of TFT, PIN Diode, and MIM Diode Displays

Property	a-Si TFT	a-Si PIN	Ta ₂ O ₅ MIM	SiN _x MIM
On/Off current ratio	10 ⁶ -10 ⁷	10 ⁸	10 ³ -10 ⁴	10 ⁴ -10 ⁵
Number of masks (active substrate)	6-8	6-7	3	2-3
Number of film depositions (active substrate)	6-8	7-8	3	3
Number of leads required for M x N matrix	M+N	2M+N	M+N*	M+N*

*no crossovers

Poly-Si TFT

- Advantages: higher mobility, transistor performance. CMOS circuit capability for on-board drivers.

- Disadvantages: higher process temperature, ion implantation requirement.

Table 1-13 compares the CMOS poly-Si TFT with a-Si:H TFT. There are two types of poly-Si processes; HT CMOS describes the process for high temperature CVD of polysilicon, while LT CMOS employs a 600°C maximum deposition temperature.

The advantage of developing a CMOS poly Si process is the fact that on-board drivers can be fabricated, cutting down on the number of interconnects to the outside world. However, the LT CMOS process shown above, while it produces transistors with much higher mobility than a-Si devices, cannot operate at a speed high enough for on-board shift registers for high information content displays, at least not yet.

The relative cost of the three processes, amorphous silicon, high temperature polysilicon, and low temperature polysilicon, is shown as a function of display

CHAPTER ONE: PRODUCT APPLICATIONS

LIQUID CRYSTAL FLAT PANEL DISPLAYS

Table 1-13 CMOS poly-Si TFT and a-Si:H TFT Comparison

	Poly-Si TFT HT CMOS	Poly-Si TFT LT CMOS	a-Si:H TFT NMOS
Substrate	fused quartz	hard glass	hard glass
Maximum process temperature	~1000°C	600°C	300°C
Number of mask steps	6*-8	5*-7	5-6#
Dielectric depositions (LPCVD or PECVD)	3	4	2
a-Si Deposition (LPCVD or PECVD)	1	1	2
Metal sputtering	3	3	3
Ion Implantation	3	2	N/A
Hydrogenation	Yes	Yes	N/A
Threshold Voltage (Volts, n-channel)	2.0	2.0	1.5
Mobility (cm ² /V·s, n-channel)	100	40	0.75
Shift register @ 15V; L=10μm	20MHz	5MHz	0.1MHz

*=NMOS #=light shield

size in Figure 1-20. The cost is estimated in arbitrary units. For small displays, high temperature polysilicon is low in cost, even when the cost of a quartz substrate is included. This indicates that small displays such as video cameras and projection TVs will be built with this technology, to display sizes of 2-3-inch diagonal. Amorphous silicon is much lower in cost for large displays. The future of low temperature polysilicon lies in this large display area. As mentioned above, low cost relative to amorphous silicon requires a very high yield process, and integration of driver circuits onto the glass substrate. New manufacturing processes and equipment for CVD, implantation, and recrystallization will be required.

A brief discussion of some of the circuit types is shown in Table 1-14. The basic types of integrated circuits that can be considered for driving the active matrix devices include D/A converters, sampled ramp, and 1-of-n selector for digital input. On the other hand, for video input, multiplexer, sample and hold, and double sample and hold are available. The table shows the comparison.

CHAPTER ONE: PRODUCT APPLICATIONS

LIQUID CRYSTAL FLAT PANEL DISPLAYS

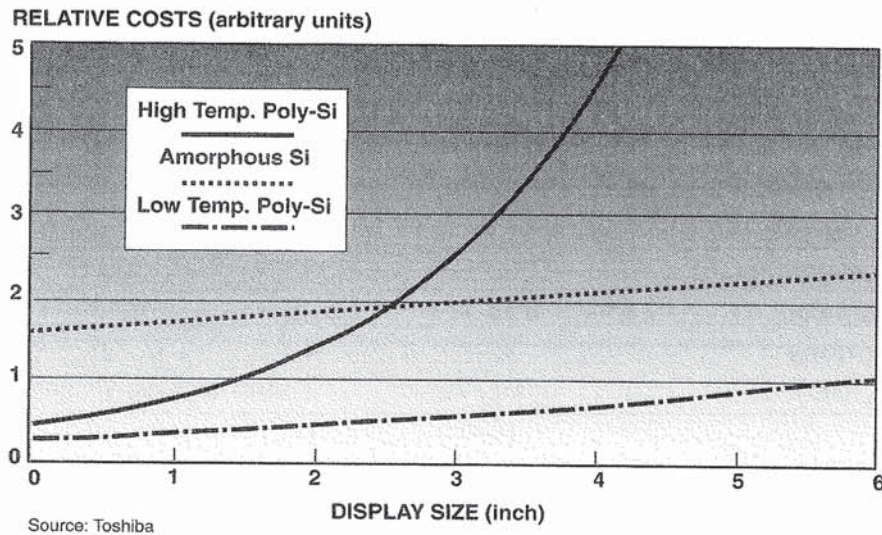

Figure 1-20
Relative cost of silicon TFT processes

Table 1-14 AMLCD Drive Circuit Types

Driver Type	Advantages	Disadvantages
Digital Input		
D/A Converters	digital input	complex requires precise correction for LC response variation
Sampled Ramp	digital input programmable ramp	complex high speed, reduced pixel charging time
1-of-n Selector	digital input programmable external voltages	complex high speed, many pass gates per data line
Video Input		
Multiplexer	simple fewer external connections	many analog inputs reduced pixel charging time
Sample and Hold	video input	fast data line charging needed, reduced pixel charging time
Double Sample and Hold	video input, small load, full line time to charge pixel	complex analog circuit large size

The demands on driver circuits increase as the complexity of the display increases. Figure 1-21 shows the data rate in megahertz (MHz) needed to address displays of differing complexity, expressed as pixel count. Above 1 million pixels, the data rate exceeds 10MHz, and approaches 50MHz for workstations.

Figure 1-21 Data rate of driver circuits for complex TFT displays

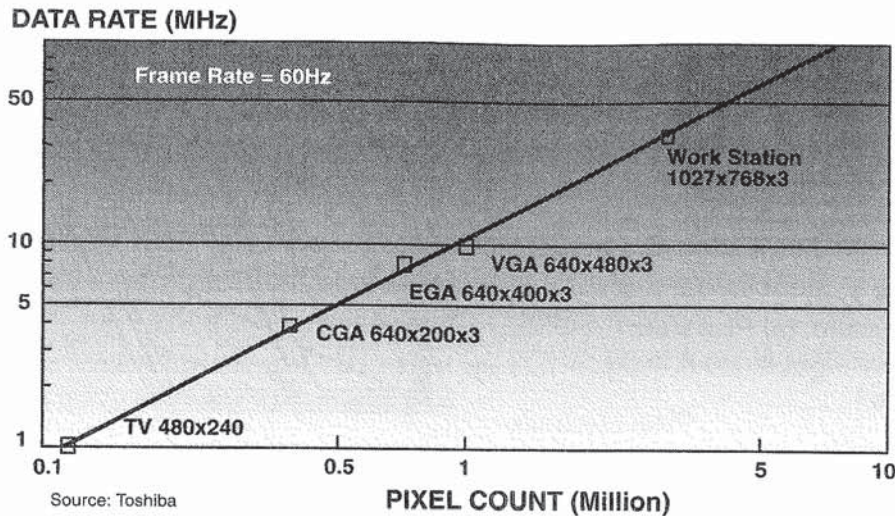

1.6.5 FERROELECTRIC POLYMER

There is a new two terminal device which is termed a FEMT, Ferroelectric Matrix device[21]. Figure 1-22 shows the construction of the device. A ferroelectric layer, composed of vinyliden fluoride, VDF, and trifluoroethylene, TrFE copolymer is deposited over an ITO pixel electrode. Thickness of the copolymer is 180 nm. A 400nm thick aluminum common electrode is formed on the ferroelectric layer. Only two photolithography processes are required. The active layer is formed by spin coating after dissolving in a solvent. Coating is followed by annealing at 145°C and slow cooling which induces recrystallization and the ferroelectric transition. The polymer layer is transparent and colorless, with a dielectric constant of approximately 9.

Figure 1-23 shows the LCD panel structure, which is the same as a conventional MIM-LCD structure. The Al common electrodes are connected in the horizontal direction. The ITO segments on the counter glass substrate are perpendicularly arranged with respect to the common electrodes.

Ferroelectric material has a spontaneous polarization which can maintain a

Figure 1-22 Construction of ferroelectric matrix active device

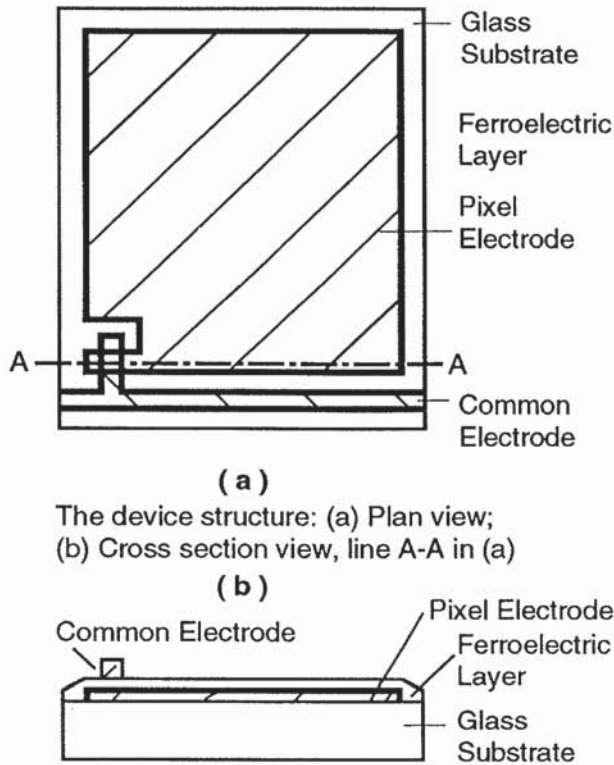
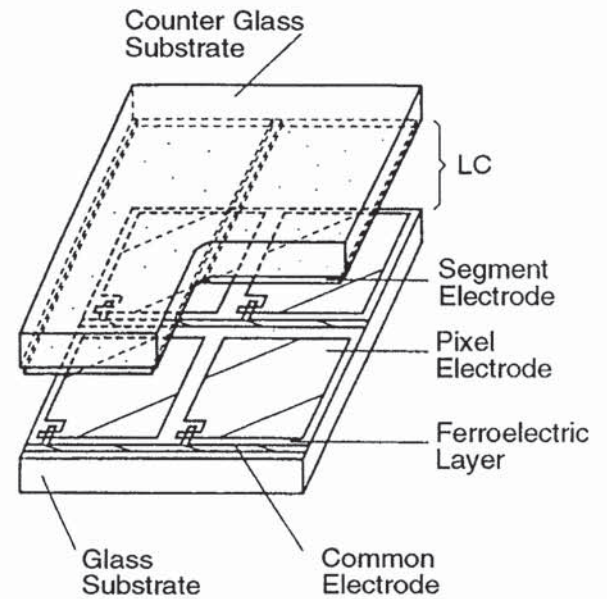

Figure 1-23 LCD panel structure with ferroelectric matrix device



surface charge. This spontaneous polarization is inverted or reversed by an applied electric field greater than the coercive field, E_c , of the material. The inversion of spontaneous polarization causes a change in surface charge, which results in a current flow. The change in surface charge of the FEMT is used to control the voltage on the liquid crystal.

When a negative voltage is applied, spontaneous polarization is inverted over parts of the polymer. An amount of charge $-S_f \cdot P_r$ is induced on the active layer surface connected to the liquid crystal. S_f is the area polarization and P_r is the remnant polarization (surface charge density) of the active layer. In the non-selected period, the voltage applied to the terminal is opposite in sign to the select voltage. A charge amounting to $-S_f P_r$ is maintained by capacitances due to the liquid crystal, C_{lc} , and the device, C_f . Therefore, $V_{lc} = -S_f P_r / (C_{lc} + C_f)$

In the next field, a positive voltage is applied to terminal T in the select period. The spontaneous polarizations are repeatedly inverted, and $+P_r$ is induced instead

CHAPTER ONE: PRODUCT APPLICATIONS

LIQUID CRYSTAL FLAT PANEL DISPLAYS

of -Pr. The polarity of V_{lc} is changed, meaning that ac driving of the liquid crystal is achieved. The symmetry of V_{lc} results from the symmetry of the ferroelectric material itself. The value of V_{lc} can be controlled by changing the value of Pr, which is in turn controlled by the pulse height and width of the applied voltage when the active layer is composed of multidomain structure.

V_{lc} is maintained without decay during the non-selected period because of the memory effect of the Pr. This means that the leakage current of the device is eliminated. This promises high contrast ratio and reduction of cross talk.

The surface charge of the active layer is able to apply ac voltage with good symmetry. Voltage is maintained during non-select periods. V_{lc} decays with time constant R_{lc}(C_{lc}+C_f) when R_{lc} is connected in parallel with C_{lc}. V_{lc} is continuously controlled by pulse height and pulse width modulation.

The characteristics of the experimental display built using this ferroelectric device are shown in Table 1-15.

Table 1-15 *Characteristics of Ferroelectric Liquid Crystal Display*

Display Size	2 inch diagonal
Pixels	220x320
Active Area	4x4 μ m
Capacitance Ratio, C _{lc} /C _f	18
Display Operation	Normally White TN
Contrast Ratio	>80
Gray Scale	>10

1.6.6 PRINTED TRANSISTORS

GTC Corporation in Japan is conducting fundamental research in manufacturing methods to produce 40-in. diagonal HDTV liquid crystal displays. The research focuses on ways to substitute processes such as printing for photolithography in TFT fabrication. The objective is to provide a low-cost, high speed fabrication process that can produce a 40-in. panel. Such a large substrate size is likely to be outside the practical limit of conventional photolithography. Figure 1-24 compares the standard optical lithography approach to the printing method of the GTC investigators.

Figure 1-24
Schematic comparison of (a) photolithography and (b) printing for imaging transistor features on that panels displays.

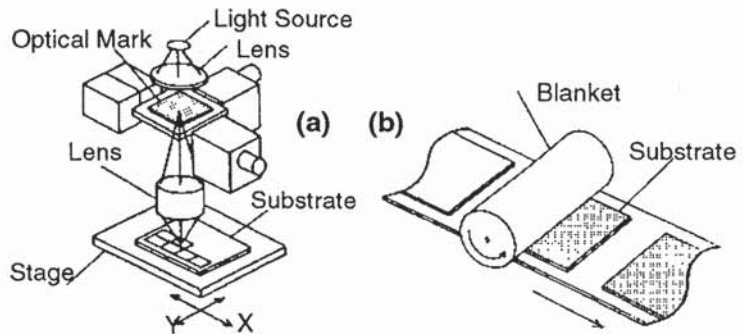

Results of offset printing of photoresist patterns have been reported[22]. The technique is shown in Figure 1-25. A glass substrate is patterned by etching and a UV curable ink is applied, filling the etched grooves, referred to as intaglio. A cylinder covered by a silicone blanket is rotated on the intaglio at constant pressure to transfer the ink to the cylinder. The ink is then rolled onto the TFT substrate as shown. Since semiconductor ink is not yet available, a double resist process is used.

Figure 1-25 Photoresist application by offset printing

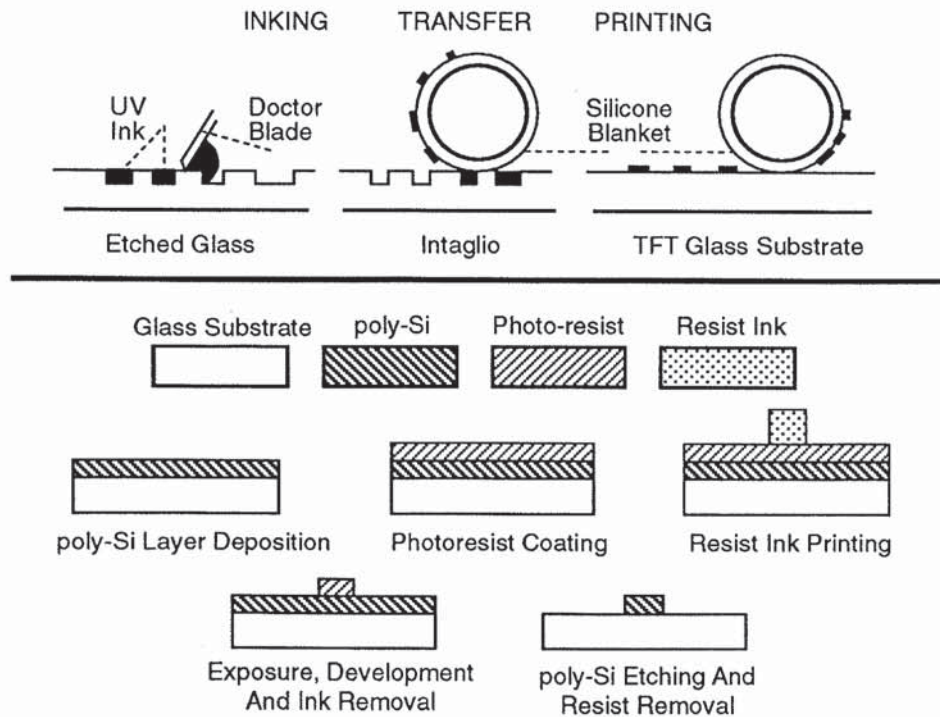

The devices are self-aligned n-channel MOS transistors. Polysilicon is used as the semiconducting material. The substrate is Asahi AN glass, and the processing temperature was limited to 600°C maximum, which is compatible with the glass properties. After the first polysilicon deposition, solid-phase recrystallization is performed to increase the mobility. Doping of source and drain is performed by ion implantation, and all patterning is done by the offset printing method. The transistor fabrication process using printed resists produces working devices with reasonable electrical properties. Threshold voltage is 9V, on/off current ratio is more than 5 orders of magnitude, and electron mobility is 40 cm²/Vs. Figure 1-26 shows a TFT made by the printing process compared to a similar one made by photolithography.

Figure 1-26 Polysilicon transistor made by offset printing (a), compared to a similar device made using photolithography (b)

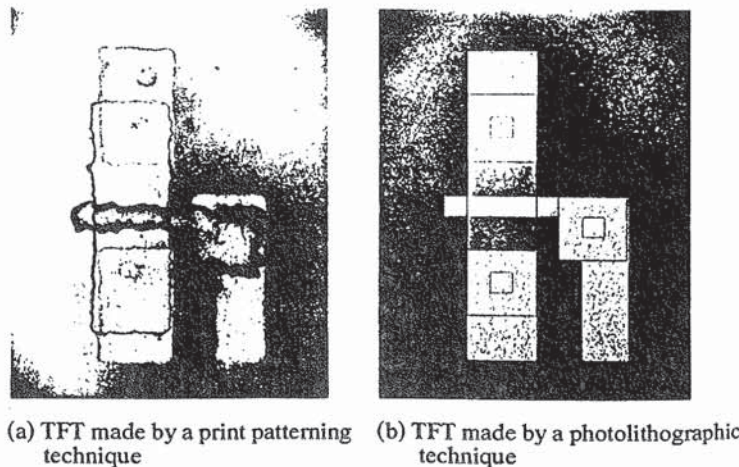

Display Manufacturers

1.7

This section provides a summary of liquid crystal display manufacturers around the world.

1.7.1 JAPAN

Japan is most active in the LCD industry, and estimates of Japan's portion of worldwide production, including simple TN displays, range from 65-75% of the total number of displays manufactured. The portion of the large display market that belongs to Japan is nearly 100%.

Current Suppliers

A summary of Japanese display manufacturers' current activity is presented in Table 1-16. The table indicates the technology for large area displays, and the status of production, development, and research in different technologies. Production status is indicated as either major, indicating that the firm in question is a major supplier of the product specified, or minor, a minor supplier status. Abbreviated designations for the technologies are listed at the bottom of the table. In subsequent sections, research and production efforts for liquid crystal displays are summarized.

1.7.2 USA**Xerox**

For several years, Xerox has been actively researching amorphous silicon material, and makes use of it in page scanners and other kinds of sensors used in Xerox products. The amorphous silicon devices are manufactured by Fuji-Xerox, a joint venture company in Japan. Recently, Xerox extended R&D activity to include displays of various kinds, and also to include polysilicon materials and devices. Complete display prototyping facilities were built at the Palo Alto Research Center, and an example of a Xerox display was shown in an earlier chapter. The firm has formed a joint venture with Hamlin/Standish, the liquid crystal display maker, to make large active matrix displays. Currently, the firm is seeking to form a separate company supported by a consortium of display users.

Department of Defense Initiatives

The US Department of Defense supports research activities to produce various kinds of displays, including AMLCD displays for avionics applications. Through the Defense Advanced Research Projects Agency, DARPA, a number of other programs are being funded at firms such as Xerox, Sarnoff Labs, and other locations. Research activity at Sarnoff labs includes polysilicon TFT development, and contracts to investigate drive circuit IC design. DARPA has initiated discussions to form a research consortium for pilot display manufacturing with a number of firms.

IBM

As the largest manufacturer of computers, IBM deserves separate mention whether or not it is manufacturing displays. The joint venture with Toshiba to form Display Technology Incorporated, DTI, has been delayed. The factory has started to manufacture displays. The potential demand for flat panels combined

CHAPTER ONE: PRODUCT APPLICATIONS

LIQUID CRYSTAL FLAT PANEL DISPLAYS

Table 1-16 *Liquid Crystal Display Status in Japan*

Firm	Production	Development	Research
Sharp	a-Si, STN major, TN, minor	p-Si	FLC
Epson	MIM, p-Si major	a-Si	
Hitachi	a-Si, STN, TN, major		p-Si, MIM, FLC
Toshiba	a-Si, STN, major TN, minor	TFD, p-Si	FLC
DTI	a-Si startup		
Sanyo	STN, major	MIM, a-Si	FLC
Matsushita	STN, major a-Si, TN, minor	p-Si	FLC
Hoshiden	a-Si, major TN, STN, minor	p-Si	
Optrex	TN, STN, major	MIM	
Asahi Glass			a-Si, p-Si, STN, FLC, PLCD
Mitsubishi/Asahi Glass (Advanced Display)		a-Si in '92 p-Si	TN, FLC
Seiko Denshi	TN, major STN, minor	MIS in '92	FLC
Casio	TN, major STN, minor		FLC
Citizen	TN, STN, minor		TFD, FLC
Alps	TN, STN, minor	a-Si in '92	
Stanley	TN, STN, minor		a-Si, FLC
Kyocera	STN, minor	a-Si in '92	
NEC	a-Si, major	p-Si, TFD	STN, FLC
Rohm	TN, minor	TFD, p-Si	
Sony		p-Si	
TDK		a-Si, p-Si	
Oki		a-Si	
NTT			a-Si, p-Si, TN, FLC

FLC = ferroelectric liquid crystal, MIM = metal/insulator/metal device, TFD = thin film diode

CHAPTER ONE: PRODUCT APPLICATIONS

LIQUID CRYSTAL FLAT PANEL DISPLAYS

with IBM's ability to manufacture any of the components of its products lend credibility to speculation that it is considering high volume production in the US, perhaps at its Manassas, VA plant

Advanced Display Manufacturers

The US Commerce Department and more recently the International Trade Commission has agreed to impose levies on imported active matrix displays. The duties amount to a substantial 62.67% on displays which are now imported in small volumes by Sharp and Hoshiden. For passive matrix displays, no duties were imposed since there is no equivalent domestic industry. For electroluminescent displays made by Sharp, duties of 7.02% were imposed. No duties will be collected on gas plasma displays.

This decision was prompted by the petition of a newly formed association, the Advanced Display Manufacturers Association. Composed of seven small display manufacturers, the ADMA represents only one actual supplier of AMLCDs. Table 1-17 lists the companies and their principal products.

Table 1-17 *Advanced Display Manufacturers Association Members*

Firm	Principal Product
Planar Systems <i>Beaverton, OR</i>	Thin-film electroluminescent displays
Plasmaco <i>Highland, NY</i>	AC plasma displays (IBM technology)
OIS <i>Troy, MI</i>	AMLCDs for military/avionics applications
Magnascreen <i>Pittsburgh, PA</i>	CdSe TFT technology
Cherry <i>Waukegan, IL</i>	Thick-film electroluminescent displays
Electroplasma <i>Milbury, OH</i>	AC plasma displays
Photonics Systems <i>Northwood, OH</i>	AC plasma, large displays

The action of the Commerce Department was objected to by the major computer

CHAPTER ONE: PRODUCT APPLICATIONS

LIQUID CRYSTAL FLAT PANEL DISPLAYS

suppliers, especially IBM, Apple, and Compaq. Apple is buying black and white AMLCD displays for its portable computers from Hoshiden, and had been importing them for assembly in the US. At the request of Apple, Hoshiden will now send the screens to Apple's plants in Asia or Europe. There is no duty on imported, fully assembled computers, so Apple and other manufacturers will avoid the duties that way.

There is some place for duties used to protect native industries during periods of early growth. But the action of the Commerce Department and the ITC benefited no one. Not the petitioners, not the Japanese screen makers, not the computer makers, not the user. The action reduces the level of computer manufacturing in the US, since the assembly of laptops will have to be done overseas. Arbitrary rulings of this sort are to be expected in the absence of a US trade policy or industrial policy.

The Commerce Department also provided a \$7.5 million research grant to the ADMA. The funds will be administered by MCC, the Microelectronic and Computer Research Corporation in Austin, TX.

Others

US suppliers of TN liquid crystal displays are shown in Table 1-18.

Table 1-18 *US Liquid Crystal Display Activity*

Firm	Display Type
Hamlin	TN production, STN and AM R&D
Crystalloid	TN, GH (guest-host)
LXD	TN
Tektronix	TN, STN
Polytronix	TN
OIS	AM

1.7.3 REST OF WORLD

Europe

Philips is constructing an AMLCD plant in Eindhoven, Netherlands, based on a-Si diode arrays. In addition, a collaborative venture is being discussed by Philips, Thomson (France), and AEG-Telefunken (Germany) in development

CHAPTER ONE: PRODUCT APPLICATIONS

LIQUID CRYSTAL FLAT PANEL DISPLAYS

and manufacture of large LCD displays. Thomson has acquired a-Si TFT capability from GE (USA). GEC in Britain will also possibly join the group. GEC performs research on liquid crystal display technology at its Hirst Research Laboratory near London. GEC Plessey Semiconductors has the high volume manufacturing experience. English Electric Valve, EEV is another GEC company that has worked on LCDs for many years.

Table 1-19 shows the liquid crystal display activity at European firms. Research on active matrix display technology is led by Philips and Thompson CSF. Of the firms shown in the table, AEG currently has the largest manufacturing activity, based on coated glass purchases.

Table 1-19 *European LCD Activity*

Country/Firm	Display Type
<hr/>	
UK	
EEV	TN
GEC	STN, FLC R&D
Racal	TN
Thorne EMI	FLC R&D
Germany	
Optrex Europe	TN, STN
AEG/Hitachi	TN, STN
Hoerner	TN
Univ. Stuttgart	AM R&D
Netherlands, Philips	AM diode array
Italy, Tecdis	TN, STN
Switzerland	
EM Micro, Asulab, ETA	TN
Norway, Autodisplay	STN
Finland, Nokia	STN
France	
Thomson LCD, CNET	AM R&D
Belgium, Univ. Ghent	AM R&D
Czechoslovakia, Tesla	TN
Poland, Polo Color	TN

CHAPTER ONE: PRODUCT APPLICATIONS

LIQUID CRYSTAL FLAT PANEL DISPLAYS

Korea

The major Korean electronics equipment manufacturers have taken a recent interest in the liquid crystal display technology developments, and have undertaken production and development activities as indicated in Table 1-20.

Table 1-20 *Liquid Crystal Display Status in Korea*

Firm	Production	Research & Development
Goldstar	-	a-Si
Samsung	TN, STN	a-Si
Daiwo	-	TN
Hyundai	TN	STN
Zuitsu	-	TN
Kankoku	TN major producer	

Other Asian Firms

South East Asia accounts for 20-25% of liquid crystal display manufacturing, primarily small, low cost TN displays. Table 1-21 shows the companies involved.

Table 1-21 *LCD Manufacturing in Asia*

Country/Firm	Display Type
Taiwan	
Epson, Hitachi, Mesostate, Excel, Goldentek, URT, Wintek, Isotek	TN
Picvue	TN, STN R&D
Hong Kong	
Philips, Epson, Conic, Yeebo, SII, Jic, Truly RCL, DTL, Clover, Hosiden, Adamant	TN
Varitronix	TN, STN
China	
Vikay, Jinghua, Hebei, Shantow, Shanghai, Beijing, Quirtao, Kwan Tong	TN
Tianma	TN, STN R&D
Singapore	
Vicay	TN, STN
PCI	TN
India	
Bharat, Coventry	TN

CHAPTER ONE: PRODUCT APPLICATIONS

LIQUID CRYSTAL FLAT PANEL DISPLAYS

REFERENCES

1. J. L. Fergason, "Polymer Encapsulated Nematic Liquid Crystals for Display and Light Control Applications", Society for Information Display Technical Digest 1985, p 68
2. P. S. Drzaic, R. Wiley, J. McCoy, and A. Guillaume, "High Brightness Reflective Displays Using Nematic Droplet/Polymer Films", Society for Information Display Technical Digest 1990, p 210.
3. N. Kinugasa et al., "NCAP Liquid Crystals for Large-Area Projection Screen", Society for Information Display Technical Digest 1991, p598
4. see the Hoffman-La Roche "Green Book 1990"
5. B. S. Scheuble, "Liquid Crystal Displays With High Information Content", Society for Information Display Lecture Notes, May 10, 1991
6. P. M. Alt and P. Pleshko, IEEE Trans. Elec. Dev. **ED-21**, 146 (1974)
7. S. Kondo et al., "A Fast Response Black and White ST-LCD with a Retardation Film", Society for Information Display Technical Digest 1991, p 747
8. M. Kunigita et al., "A Full-Color Projection TV using LC/Polymer Composite Light Valves", Society for Information Display Technical Digest 1990, p 227
9. T. Matsumoto et al., "Very High Contrast (VHC) LCD for Automotive Applications: Important Role of Polarizers", Japan Display '89 Technical Digest, p 682
10. Figure courtesy of Xerox Corporation.
11. D. E. Carlson and C. R. Wronski, "Amorphous Silicon Solar Cell", Applied Physics Lett., **28**, 671 (1976). D. E. Carlson, US patent 4,064,521.
12. K. Oguchi and H. Aruga, "Two-Terminal Devices for AMLCDs", Technical Proceedings, SEMICON/Kansai 1991, Semi Japan, 1991, p186.
13. K. Nagashima et al., "A 13-in.-Diagonal B/W MIM-LCD for Workstation", Society for Information Display Technical Digest 1991, p223.
14. from "Flat Panel Display 1991" Nikkei BP, 1990, p 80
15. Y. Oana, "Technical Developments and Trends in A-Si TFT-LCDs" Flat Panel Display Process Tutorial, Semicon West, May 23, 1991.
16. M. Tsumura et al., "High Resolution 10.3-in.-Diagonal Multicolor TFT-LCD", Society for Information Display Technical Digest 1991, p 215.
17. T. Tsukada, "Large Display-Size TFT/LCD Technology", Technical Proceedings, SEMICON/Kansai 1990, Semi Japan, 1990, p344.
18. S. Morozumi, "Poly-Si TFTs for Large-Area Applications", Japan Display '89, p 148

CHAPTER ONE: PRODUCT APPLICATIONS

LIQUID CRYSTAL FLAT PANEL DISPLAYS

19. N. Konishi, "Polycrystalline-Silicon Thin Film Transistors for Liquid Crystal Display", Technical Proceedings, SEMICON Kansai 1991, Semi Japan, 1991, p181.
20. R. Bruce, "Active Matrix Liquid Crystal Displays", Society for Information Display Seminar Notes, May 10, 1991, pF-3/1.
21. T. Sato, A. Hatta, and H. Komatsu, "A New Two-Terminal Device Using Ferroelectric Polymeric Thin Film for Large-Area LCDs", Society for Information Display Technical Digest 1991, p18.
22. Y. Mori et al., "A New Process Concept for Large Area Patterning-A Large Area Transistor Circuit Fabrication without Using Optical Mask Aligner, Society for Information Display Technical Digest 1991, p561.

DISPLAY MANUFACTURING PROCESS

2.0

The manufacturing flow for flat panel displays is shown conceptually in Figure 2-1. This figure indicates that two glass substrates are processed separately, then joined together. One substrate is patterned to create a color filter array, and the other is patterned to form thin film transistors. These plates are mated in the assembly process. In the case where several displays have been patterned on the substrate, they are sliced and separated into individual displays. Liquid crystal material is injected into a gap between the two glass plates, and the finished display is ready for incorporation into a computer or other product. Not shown in the figure are operations to attach integrated circuits to address the display, nor the backlight to illuminate it. These are discussed later on.

The individual processes required to pattern each glass plate, to assemble and test each unit, and to create a finished display, are numerous, and require specialized equipment, materials, and processes. These are discussed in some detail in subsequent sections of this book.

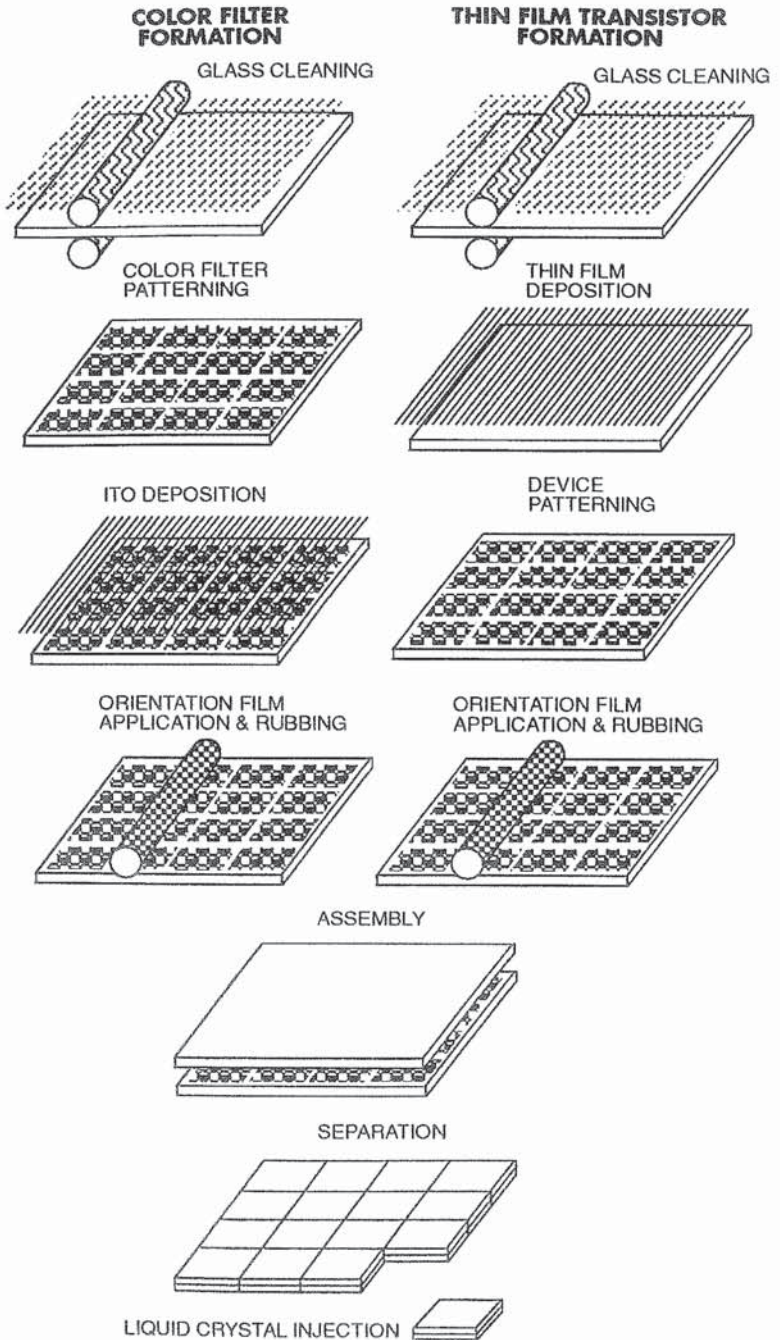

Figure 2-1 Schematic outline of the display manufacturing process.

2.1

Color Filter Manufacturing

This section includes a discussion of glass substrate manufacturing and finishing, which precedes both color filter and TFT manufacturing.

2.1.1 GLASS SUBSTRATE PREPARATION

The glass substrate is an essential component of the display, and a rather expensive one at that. Very tight control of the optical and mechanical properties of the material are required at every stage of the process, especially when heating is involved. The glass, ordinarily 1.1mm thick, ranges in size from 300x300mm to 450x550mm for the fabrication of large displays. Even larger sizes will be used in the future. This section outlines the glass manufacturing process.

Glass Fabrication

Very thin glass with very precise dimensions and reproducible mechanical properties can be made by two processes. The so-called fusion process, developed by Corning, is shown in Figure 2-2. Glass fusion employs a feed rod of glass which melts in a wedge-shaped trough and flows up and over the sides of the trough. Flowing down both sides of the trough, the molten glass joins into a single sheet at the bottom of the trough, and can be drawn downward as a uniform sheet. Thickness of the sheet is controlled by the speed of drawing down the glass. Widths of up to 36" can be obtained.

Figure 2-2 Fusion process for glass sheet formation

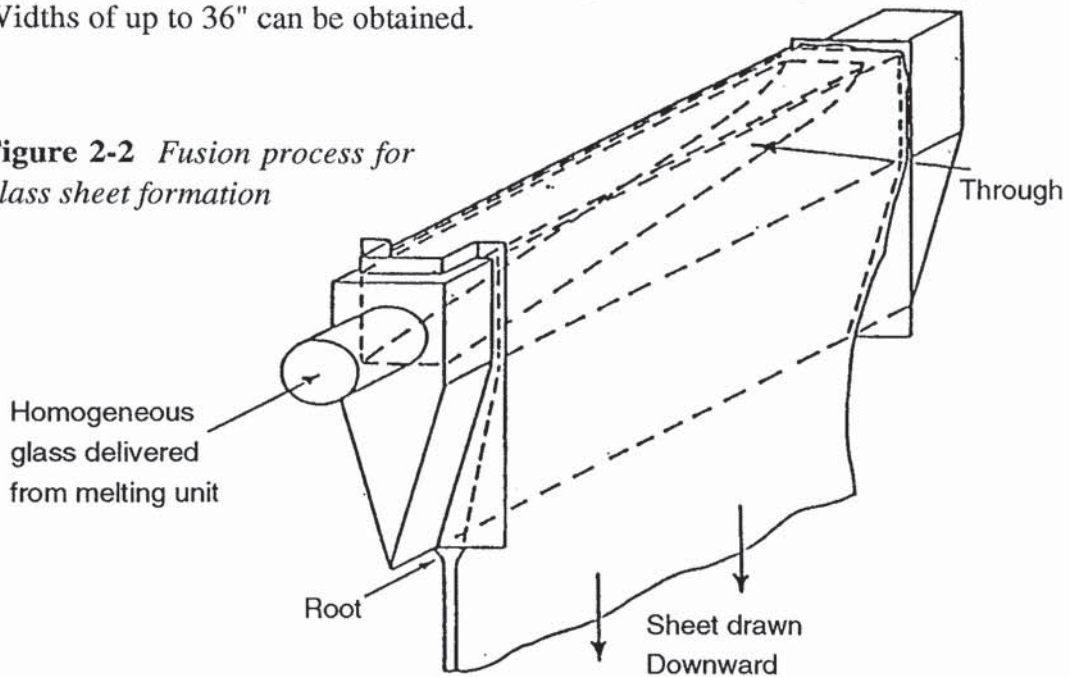

CHAPTER TWO: DISPLAY MANUFACTURING

LIQUID CRYSTAL FLAT PANEL DISPLAYS

Other manufacturers of glass with the appropriate dimensions for LCD substrates use the float method of manufacturing. In this method, the molten glass is allowed to flow out onto a bed of molten tin. The glass does not dissolve or react with the metallic tin, but floats on the surface. This allows gravity to smooth the surface and allow both sides to become parallel.

Sodium free glass is used for active matrix displays, because the presence of sodium is considered harmful to the reliability of displays where thin film devices such as diodes or transistors are employed. Glass can be supplied to users in three surface finish conditions; as drawn, polished, and annealed. Each material has a specific application in display technology.

Table 2-1 shows the variety of glasses available for display manufacturing. The glasses are ranked in order of increasing strain point. The strain point is indicative of the maximum processing temperature of the glass. Low temperature glasses are restricted to simple TN applications, and medium temperature strain point materials, such as Corning 7059, Hoya NA45, and Asahi AN substrates are used for STN and active matrix displays. These are borosilicate glasses, which offer low levels of alkali metals as well as higher strain point. The silica glasses (quartz) shown in this table are used for very small displays used as viewfinders in videocameras. These displays require the performance of polysilicon transistor switches, and this can only be obtained using high temperature LPCVD deposition of silicon at 600-900°C, far above the practical working temperature of the glasses.

A variety of substrate sizes are available, up to a current substrate of typical 300x350mm dimensions, but extending to 450x550mm and larger. Typical glass thickness is 1.1mm, also referred to as 1.1t. Thinner glass is available, and is used for some smaller displays, such as pagers, telephones, games, and so forth.

Cutting, Beveling, Polishing

Glass substrates are trimmed to size after the fusion or float process, typically to about 1 meter on a side. Various mechanical operations follow the forming process, depending on the ultimate application of the material.

Since glass is brittle and easily chipped or cracked at the edges, these are typically beveled, chamfered or otherwise treated to reduce chipping during handling. Thermal stresses at edge cracks accumulate during substrate processing, and lead

Table 2-1 Glass Substrates for Flat Panel Display Manufacturing

Glass	Code	Type	Reference Temperatures			Thermal Expansion x 10 ⁻⁷ /°C (0-300°C)	Density g/cm ³
			Strain point °C	Annealing point °C	Softening point °C		
Corning	0211	Alkali-zinc Borosilicate (Microsheet)	508	550	720	74	2.57
Corning	7740	Borosilicate (Pyrex)	510	560	821	32.5	2.23
Asahi	AS	Soda lime	511	554	740	81	2.49
Asahi	AX	Borosilicate	527	571	790	49	2.41
NEG	BLC	Sodium borosilicate	535	575	775	51	2.36
Corning	7059	Barium aluminoborosilicate	593	639	844	46	2.76
Hoya	NA45	Borosilicate	610	658	859	46	2.78
Asahi	AN	Alkaline-earth aluminoborosilicate	616	661	862	43	2.72
NEG	OA2	Alkaline-earth-zinc aluminoborosilicate	635	685	895	47	2.76
Corning	1733	Alkaline-earth Boroaluminosilicate	640	689	928	36.5	2.49
Hoya	NA40	Alkaline-earth-zinc-lead aluminosilicate	656	708	895	43	2.87
Corning	1724	Alkaline-earth boroaluminosilicate	674	721	926	44	2.64
Corning	1729	Alkaline-earth aluminosilicate	799	855	1107	35	2.56
Corning	7913	96% silica (Vycor)	890	1020	1530	7.5	2.18
Corning	7940	Fused silica	990	1094	1580	5.5	2.20
Asahi	AQ	Synthesized silica	1000	1120	1600	6	2.20
		Silicon				38	2.3
		Stainless SUS 304				175	8.0
		Stainless SUS 410				105	7.7

CHAPTER TWO: DISPLAY MANUFACTURING

LIQUID CRYSTAL FLAT PANEL DISPLAYS

to breakage. Glass breakage is a major problem in flat panel production. First of all, the broken plate is itself a yield loss, but fragments of glass may remain behind in carriers or equipment to cause particulate contamination or scratching of other substrates.

Surface flatness is an important parameter of the substrate, and is a function of the glass forming process. A certain level of waviness occurs in fusion glass. Such slight thickness variations as well as other "nonflat" conditions are either difficult or impossible to remove in a polishing operation. Instead, a grinding step must be performed, which greatly adds to the manufacturing cost, and makes it uneconomical as a finishing step for display substrates. Glass manufacturers concentrate on improving the forming process to reduce surface irregularities in manufacturing.

Glass polishing is more and more difficult as substrate size increases. Large substrates must be mounted to carriers using wax or other adhesive, and polished using a slurry of abrasive material. This polishing process must be followed by a thorough chemical cleaning to remove any remaining wax or other organic residue, as well as the metallic contaminants which are part of any abrasive or polishing medium.

For glass prepared by the fusion or float processes, the surface of the as-produced glass is smoother than a polished surface. However, some scratches are found on the as-grown surface. If glass can be formed without scratches, the polishing process may well be eliminated.

Annealing

Figure 2-3 shows the thermal expansion of Corning 7059 glass as a function of temperature. For substrates used in thin film transistor fabrication, process temperatures of 350-450°C are common, and are repeated several times. At these temperatures, thermal expansion of several parts per million is observed. Near the strain point, thermal expansion increases in a nonlinear fashion. This makes it difficult to control the properties of the thin films deposited on the surface. For this reason, thin film deposition is performed at temperatures considerably lower than the strain point of the glass.

Heat treatments to control thermal processing during display manufacturing include annealing processes to produce compaction or shrinkage of the glass, so

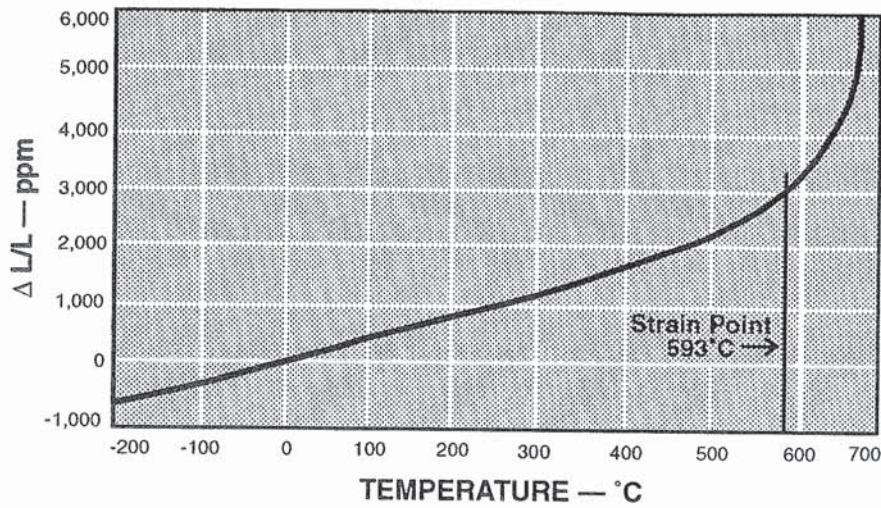
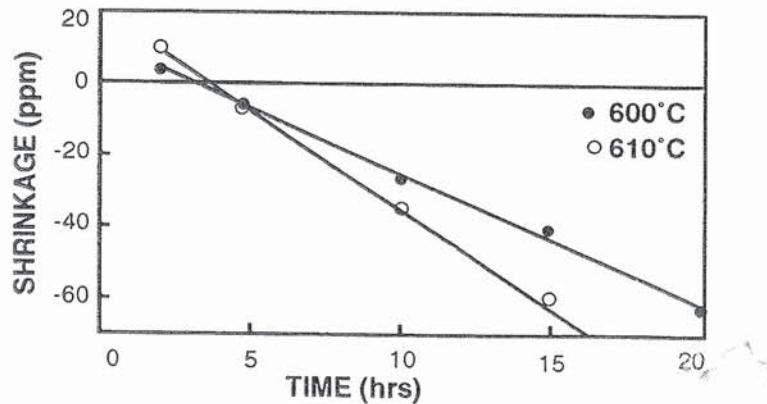

Figure 2-3 Thermal expansion of Corning 7059 glass

that further shrinkage during use is minimized. Hoya has developed a new glass, NA35, suitable for polysilicon TFT fabrication. This material has a strain point of 610°C, and Hoya suggests processing temperatures as high as 600°C. Abrupt heating and cooling occur in the TFT process. When glass is subsequently heated at a lower temperature, the glass may transform from a high temperature structure to a low temperature one, leading to shrinkage of several parts per million. Figure 2-4 shows the shrinkage observed for NA 35 annealed at 600°C and 610°C. Shrinkage increases linearly with time at a constant temperature. However, there is some limit to how much shrinkage will occur. Annealing treatments by the glass manufacturer can bring the glass near to this limit and stabilize its properties for reproducible overlay of photolithography patterns.

Figure 2-4 Thermal shrinkage of NA 35 glass as a function of heat treatment time and temperature



CHAPTER TWO: DISPLAY MANUFACTURING

LIQUID CRYSTAL FLAT PANEL DISPLAYS

Specifications and standards for glass substrate properties are being developed by suppliers and users, with the cooperation of standards committees at SEMI Japan. (SEMI is the name of the Trade organization, Semiconductor Equipment and Materials International.) A typical specification for an active matrix display substrate is shown in Table 2-2. This specification includes surface properties and thermal shrinkage requirements appropriate for TFT array fabrication. When displays are manufactured, the front panel containing the color filter array experiences very little high temperature treatment, so preannealing is not required.

Table 2-2 *Glass Substrate Specification for Active Matrix Display*

Parameter	Value
Size (mm)	300 x 350 \pm 0.2
Thickness (mm)	1.1 \pm 0.1
Chamfer (mm)	0.1 to 0.4
Corner Cut (mm)	1.5 \pm 0.1
Orientation Corner (mm)	(2.0 \pm 0.1) x (5.0 \pm 1.5)
Warp (mm/mm)	0.45/300
Inclusion (mm)	Not allowed over 0.1
Streak (μ m)	Under 0.1
Shrinkage (ppm)	<10 for 1 hr. at 350°C
Surface Quality (scratch, stain)	No visible defect under 10K Lux

It has proven difficult to establish standard substrate sizes for flat panel displays, which makes substrate and process equipment manufacturing difficult as well. Literally dozens of sizes of substrates are in use, with more than ten size specifications for active matrix substrates alone. The SEMI organization is the focus for standardization efforts for substrates, and a set of sizes is under consideration before the substrate standards committee at SEMI Japan. This set of proposed standard sizes is shown in Table 2-3.

Cleaning

Cleaning processes are used for bare glass substrates, and for substrates covered with organic films, such as color filters, polyimide orientation films and so forth. In addition, substrates with semiconductor, insulator and metal films require cleaning

CHAPTER TWO: DISPLAY MANUFACTURING

LIQUID CRYSTAL FLAT PANEL DISPLAYS

Table 2-3 *Proposed Substrate Standard Sizes for Flat Panel Displays (dimensions in millimeters)*

300 x 300	300 x 350	300 x 400	300 x 450	300 x 500
	350 x 350	350 x 400	350 x 450	350 x 500
		400 x 400	400 x 450	400 x 500
			450 x 450	450 x 500
				500 x 500

as the fabrication process progresses. As a minimum, cleaning is required prior to each masking step in color filter or thin film transistor fabrication. An overview of the cleaning steps used in the entire process will be presented here.

The types of cleaning used in flat panel display manufacturing include physical, chemical, and dry cleaning. Physical cleaning is currently most important, and includes brush scrubbing, ultrasonic, and megasonic assisted cleaning. Megasonic cleaning is effective in eliminating submicron particles[3]. Table 2-4 summarizes the cleaning methods currently employed, with comments on their efficacy. Most panel cleaning employs a combination of physical and chemical methods, with selective use of dry methods. After chemical etching or cleaning, substrates are usually dried using isopropyl alcohol.

One way of evaluating the performance of a cleaning sequence is to measure the contact angle of a water drop on the surface of a bare substrate. The test indicates whether organic contaminants remain on the substrate surface. If organic molecules are present, the water droplet will not wet the surface, since “oil” and water don’t mix. This causes the water to form a bead with a contact angle that is relatively large, up to 45°. On the other hand, a clean surface will be wetted by the droplet, which will spread out over the surface, resulting in a contact angle of zero. Figure 2-5 shows the results of an investigation of substrate cleaning methods where a combination of methods was employed [4].

The illustration shows a sequence of steps. Step 1 is a wet cleaning with the appropriate chemical and water rinse, each with brush scrubbing followed by ultrasonic (US) rinse and water spray. After step 1, two different final treatments were used. In the sequence step 2 and step 3, an air knife plus an infrared/ultraviolet (IR/UV) heating were applied. An alternative consisted of isopropyl alcohol (IPA) dip, freon vapor dry, and IR/UV treatment. The illustration shows

CHAPTER TWO: DISPLAY MANUFACTURING

LIQUID CRYSTAL FLAT PANEL DISPLAYS

Table 2-4 *Cleaning Processes for Flat Panel Displays*

CLEANING METHOD	COMMENTS
Physical Cleaning	
Brush scrubbing	Removes adhering particles, not necessarily smaller ones; effect proportional to brush pressure
Jet spray	Suitable for patterned, hydrophilic, and soft surfaces; substrate may acquire static charge
Ultrasonic	Accelerates chemical cleaning, but particles remain; standing wave formation in bath limits uniformity
Chemical Cleaning	
Organic solvent	Contaminant specific, removes organic films
Neutral detergent	Suitable for organic films and particles, little or no substrate damage, but residual film may remain
Chemical cleaning	Process specific for etching, cleaning, and stripping; suitable for all contaminants and particles
Pure water	Suitable for chemical removal, not for particles and organic films
Dry Cleaning	
Ultraviolet ozone	Can eliminate adsorbed organic films, improves photoresist adhesion
Plasma (oxide)	Photoresist ashing; not suitable for particle removal, low throughput
Plasma (non-oxide)	Eliminates low level organic and inorganic contamination; limited application
Laser	Localized cleaning; not suitable for full surface cleaning

that effective removal of residual contaminants requires more than just a wet cleaning step. The method of drying is an essential component of cleaning the substrate.

Organic contamination is one limit to high yield flat panel display production. Another, more serious limitation is due to particles. Although typical linewidths

Figure 2-5 Cleaning methods evaluated by contact angle measurement

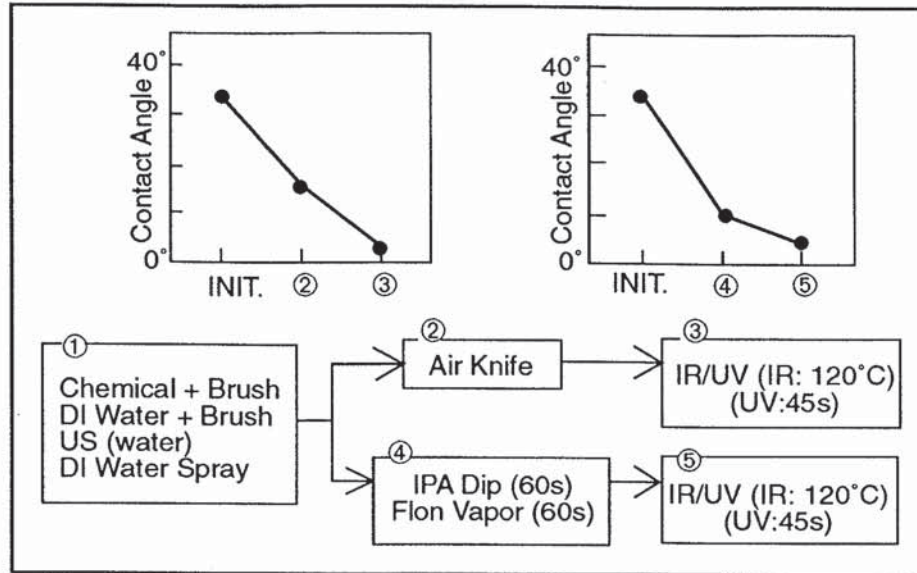

for thin film transistors are $5\mu\text{m}$, and the lower limit appears to be $3\mu\text{m}$ for the near future, particles of $0.5\mu\text{m}$ size and greater are extremely detrimental to yield. One major contributor to particles on the substrate surface is the rinse water itself, in the case of low purity water. Table 2-5 shows measurements reported by Tamada comparing water resistivity and surface particle count before and after rinsing the substrate. Clearly, a relatively high purity water source is essential.

Table 2-5 DI Water Quality and Substrate Particle Count (particles $>0.5\mu\text{m}$ on 4 inch Si substrate)

Water Specific Resistance $\text{M}\Omega$	Initial Particle Count	Post-Rinse Particle Count	Increase in Particles
7.5	7	10	3
1.0	2	5	3
0.15	5	328	323
0.01	14	6356	6342

ITO Deposition

ITO is indium tin oxide, actually a mixture of the oxides, In_2O_3 and SnO_2 . This material is the only one suitable for the transparent conductor application for

liquid crystal displays; a thin film of ITO is required on both sides of the display, either as a continuous film or patterned to form stripes, lines, or rectangular plates.

When sodalime glass is used, just prior to ITO deposition, the glass is covered with a SiO_2 coating, to prevent ion migration from the glass during further processing. The coating can be performed by dipping the substrate into a liquid colloidal source or coating by chemical vapor deposition.

Today, ITO thin films are mostly made using vacuum evaporation and sputtering. ITO films with a small amount of added SnO_2 show low electrical resistance, $\sim 2 \times 10^{-4}$ ohm-cm, depending on the quantity added, and transmittance in the visible spectral region of 75-90% or more. Film thickness is ordinarily in the 1000-2000Å range.

Usually, for vacuum evaporation, in a chamber evacuated to less than 1×10^{-5} Torr, oxygen gas at a pressure of $\sim 1 \times 10^{-4}$ Torr is introduced, and a pellet of indium is evaporated from a e-beam gun. At a temperature of 400°C, quantity of oxygen, and control of evaporation rate are important parameters. Heated In_2O_3 decomposes and evaporates, and, on the way to the substrate, recombines.

For ITO films made by sputtering, two methods are used. In-Sn alloy targets are used in one method, and, for the second, reactive sputtering, in which about (5-10) weight % SnO_2 is added to In_2O_3 to form an ITO target. The cost is relatively low for the first method, but it is difficult to control the conditions for good film production, and reproducibility is inferior. Reactive sputtering using In_2O_3 - SnO_2 targets, compared to using metal targets, shows reduced cycle time, and stable reproducible properties. 400°C substrate temperature is necessary for evaporation, and it is hard to evaporate high quality films at lower temperatures, but for sputtering, low temperature formation can be used, with resistance values somewhat higher than for evaporation. Temperatures as low as 200°C are necessary when the ITO film must be deposited over the color filter array, discussed later in the report. There is no great difference in the transparency of sputtered films compared to evaporated films.

The resistivity of ITO films is a complicated function of oxygen and tin content, as well as deposition conditions. Increasing oxygen content during sputtering or evaporation may increase the crystallinity of the ITO film, leading to a higher carrier mobility. On the other hand, increasing the oxygen content reduces the

carrier concentration, supposedly due to chemical combination with the Sn^{+4} species. An optimum oxygen concentration must be determined for each process.

The glass substrate with thin film coating is patterned by etching, either wet or dry. For large area high information content displays, this results in a large number of very small features. Since the pattern size is small, and at the same time, low surface electrical resistance is required, inevitably, the transparent electrode film thickness tends to increase. Typical sheet resistance for ITO films are $100 \Omega/\text{square}$ down to $50 \Omega/\text{square}$. However, addressing high density displays requires much lower values, either 20 or $10 \Omega/\text{square}$. Achieving low sheet resistance by increasing the film thickness produces lower light transmission and panel contrast is degraded. In addition, etching is more difficult. Etch materials and etch rate are adjusted so that etching time is reasonable and so that overetching does not occur. The etch rate for sputtered films is generally lower than for evaporated films.

Thin films of ITO are easy to etch with wet chemicals such as hydrochloric acid, but, as the pitch of the electrodes become smaller and features become finer, dry etching may be necessary to prevent undercutting of the lines due to overetching. Plasma etching can be employed with good results. Researchers at General Electric have discovered that a two step plasma etching process is most efficient.[6]. They used HCl as the reactive gas in the first step, followed by acetone and other hydrocarbons in the second; HCl provided etching speed, while the hydrocarbon mixture gave good control over the endpoint.

Where ITO films are deposited over a color filter pattern, special processing must be employed to ensure that low resistivity films are obtained at the low deposition temperatures that are required when depositing onto organic thin films. Two approaches to solving this problem have been reported recently.

The first approach modifies the parameters of a sputtering system to obtain low resistivity films at temperatures of $200\text{-}250^\circ\text{C}$. This system employs DC magnetron sputtering for which the sputtering voltage is adjusted (reduced) to obtain improved results. Figure 2-6 shows the relation between sputtering voltage and film resistivity for voltages of -400V , (the normal bias voltage used in the system), -250V , and -110V . The figure also shows the change of resistivity as a function of temperature. At temperatures of 250°C and below, it is difficult to obtain a low enough resistivity with high sputtering voltage without making the

film very thick. The reduced bias voltage allows lower resistivity while increasing light transmission through the film.

The investigators studied the reason for lower resistivity with lower sputtering voltage. They determined that at -400V bias, oxygen atoms were sputtered from the target with high energy, and these oxygen atoms impacted the substrate with energy 400eV. One result was the formation of a sub-oxide, InO, rather than the expected In₂O₃ compound. This InO material is high resistivity, and is also black (absorbing). Lowering the sputter bias voltage eliminates this black particle formation, lowering the resistivity and improving the optical transmittance at the same time.

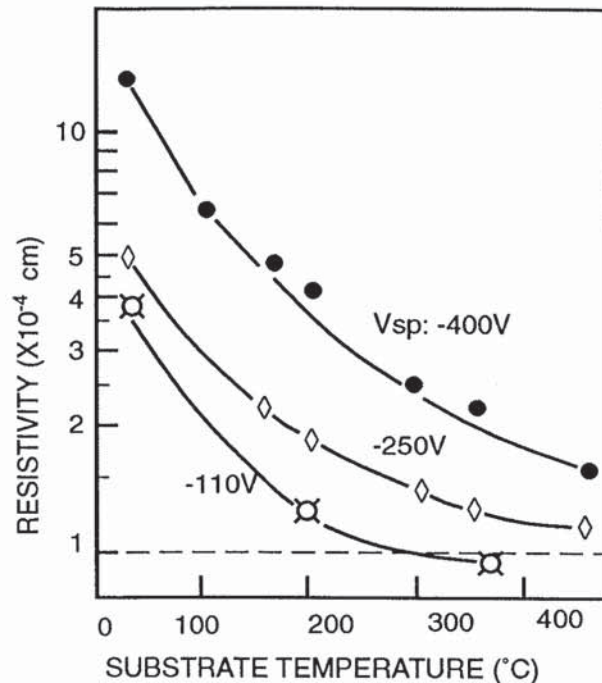

Figure 2-6 Relation between sputtering voltage, deposition temperature, and ITO film resistivity

A second method for depositing ITO over color filters has been reported, using plasma-assisted electron beam evaporation [8]. Figure 2-7 shows a schematic diagram of the apparatus. Substrates of 300x300mm size are heated prior to deposition in a separate chamber. The deposition chamber contains a crucible containing ITO pellets and a set of arc plasma generators. Argon and oxygen gases are mixed in controlled volume ratios of 0-50% and introduced into the chamber at a pressure of 2×10^{-4} - 1×10^{-3} Torr. ITO deposition rate is 50Å/sec, and film thickness is 1000-2000Å.

Film stress is an important property, since highly stressed films can cause substrate bow, which makes control of the cell gap difficult. Also, where color filters are present under the ITO film, high stress can cause peeling and lifting of the filters. Compressive stress was minimized by employing higher total gas pressure, near 1×10^{-3} Torr. Film resistivity for 200°C deposition was $1.8 \times 10^{-4} \Omega\text{-cm}$,

and 10 Ω /square films were patterned for color STN displays using 100 μ m ITO stripes with 10 μ m spaces between them. The displays were driven at 1/400 duty ratio without additional metal electrodes to reduce the sheet resistance of the conducting lines.

Figure 2-7 Schematic diagram of plasma-assisted electron beam evaporation equipment

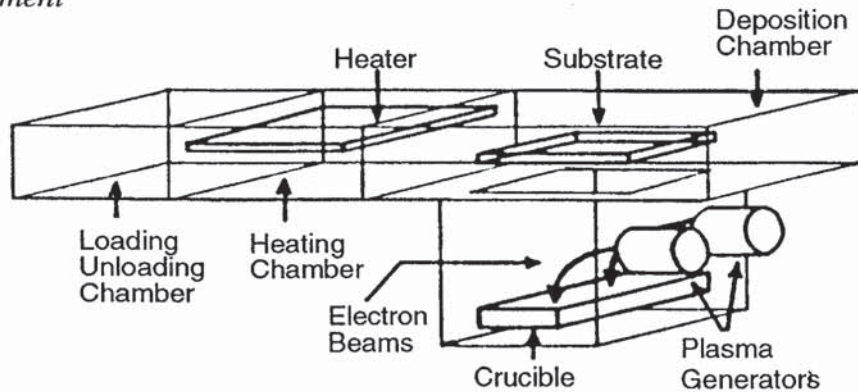

2.1.2 COLOR FILTER PROCESS

Color filter processing involves a number of steps besides color filter application. These include CVD or spin coating of insulators and metals, as well as planarization and orientation film coatings. Currently there are at least ten firms in Japan involved in color filter manufacturing, either as merchant or captive suppliers. These firms perform the entire process, with the exception of orientation film deposition and rubbing. For the most part, display manufacturers purchase completed panels from outside suppliers.

The first step, color filter formation on the front glass substrate, is shown schematically in Figure 2-8. The illustration indicates the equipment used in each step of the process. This figure includes some of the glass finishing and preparation steps common to both the front and rear panels, including the beveling and lapping processes. Operations such as substrate washing and cleaning, coating, curing and other steps are performed repetitively on the substrate. Many points of similarity with silicon wafer processing exist. Glass substrates are typically handled in track systems for cleaning and coating.

Table 2-6 summarizes the various materials, application methods, and suitability for various flat panel display types. The most important methods for color filter preparation are discussed in this section.

Table 2-6 *Types of Color Filters for LCDs*

Material	Application Method	Element Definition	TFT Compatible	MIM Compatible	STN Compatible
Dyestuff	dye	photolithography	Yes	No	No
Dyestuff	dispersed	etching	Yes	No	No
Pigment	dispersed	photolithography	Yes	Yes	Yes
Pigment	dispersed	printing	No	Yes	Yes
Pigment	electro-deposited		No	Yes	Yes

Source: Nikkei Microdevices

Black Matrix Definition

The figure indicates that color filter formation is a repetitive process, occurring either three or four times in succession. Three primary color elements are formed, each one about 100x300µm in size. A black border area is needed around each color element for contrast. If the black border is deposited and patterned using photolithography, a total of four steps will be required for red, green, blue, and black color deposition. The black border is very important for definition and contrast, and can be deposited in two ways. The first method is to deposit a thin layer of chrome metal, the back surface of which is either oxidized or coated with CrO light absorbing film. The second way is to mix all three color pigments to form a black organic border around the filters. Typically the chrome matrix is applied before the filters while the pigment mixture black border is applied afterwards.

Dye Method

Table 2-7 shows the primary types of organic materials which are suitable as light absorbing color filter materials. Basically, either a dyestuff or a pigment can be used, and either one can be deposited and patterned in several ways. Currently gelatin is deposited and dyed in successive photolithographic operations, using proximity printing equipment and standard photoresists.

Pigment Method

In addition, pigments dispersed in photoresist are being employed. The pigment dispersion method has the advantage of eliminating the gelatin layer, and higher

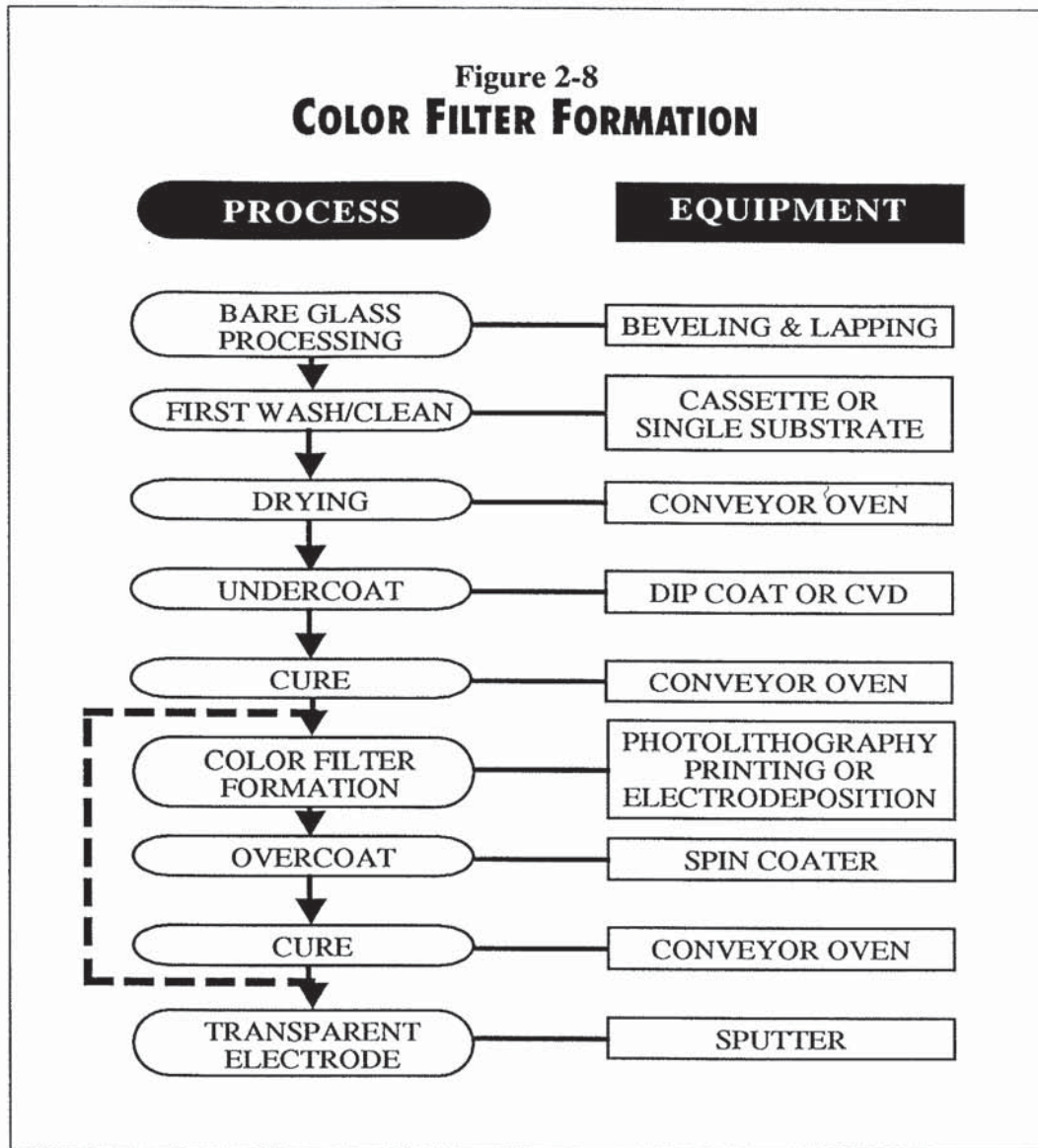

temperature capability is one result of its use. Both of these methods produce uniform color elements with the spectral purity required for full color displays. Color filters formed from pigments dispersed in polyimide give the highest temperature capability and some simplification in processing [9].

Electrodeposition

Other methods for forming color filters are being investigated. These include

electrodeposition and printing. One new electrodeposition process employs only one photoresist deposition, and can include the black matrix deposition as a final step [10]. Another process uses a charged mist of dye molecules which deposit to uniform final thickness over the substrate in a self-limiting electrodeposition scheme [11]. Although these have the potential for low cost, technical problems prevent them from being employed for the TFT active matrix display, since they allow only the deposition of color stripes.

Printing

Screen printing is already in use for some passive displays, but the minimum thickness is 10 μ m. Other kinds of printing processes, such as offset printing, with 1-2 μ m film thickness capability, are being investigated for high density displays. The table summarizes the properties of color filters made by the various processes.

Overcoating

Both dyeing and pigmented photoresist methods leave a non-planar surface after color filter definition. Since an ITO common electrode thin film as well as a liquid crystal alignment polymer layer must be deposited over the filters, at least one intermediate planarizing layer must be added over the color filter array, thus adding to its cost. In addition, some sort of definition of the outer edges of the planarizing layer must be performed, so that the ITO conductor makes good contact with the underlying glass substrate. This is a particular problem for simple matrix color displays, for which the ITO is patterned in stripes rather than as a continuous layer. Each stripe must form an electrically continuous line.

ITO Deposition

After color filter preparation, the final step is the sputter deposition of a transparent electrode material. This is indium-tin oxide (ITO), which is ordinarily not patterned when active matrix thin film transistors are used to switch the color elements. On the other hand, STN color displays have patterned ITO stripes as mentioned previously. One limit on the performance of the color filter material is the compatibility with the ITO sputter deposition conditions. Ideally, a substrate temperature of >200°C is preferred for sputtering in order to achieve the lowest possible resistivity for the ITO film. However, not all color filter materials can withstand such a temperature. This consideration, as well as other requirements for color filters, has led to investigation of the various approaches to color filter manufacturing mentioned here.

CHAPTER TWO: DISPLAY MANUFACTURING

LIQUID CRYSTAL FLAT PANEL DISPLAYS

Table 2-7 *Color Filter Process Comparison*

Properties	Dye	Dye Dispersion	Printing	Pigment Dispersion	Electro-deposition
Film Thickness	1.0-2.5 μ m	1.0-2.5 μ m	2.0-3.5 μ m	0.8-2.0 μ m	1.5-2.5 μ m
Spectral Properties	Superior	Good	Good	Good	Good
Resolution	10-20 μ m	10-20 μ m	70-100 μ m	20-30 μ m	10-20 μ m
Planarity	Good	Good	Inferior	Good	Superior
Heat Resistance	180°C/1 hr	200°C/1 hr	250°C/1 hr	<250°C/1 hr	250°C/1 hr
Chemical Resistance	Inferior	Good	Good	Good	Good
Resin Material	acrylic	polyimide	epoxy	acrylic, Sbq-PVA	acrylic
Color Element	dyestuff	dyestuff	pigment	pigment	pigment
Advantages	spectral properties	detail	light & heat resistance	light & heat resistance	light & heat resistance, planarity
Disadvantages	stability	stability	planarity		pattern restriction

Source: Toppan Printing

2.2

Active Matrix Display Manufacturing

The fabrication of an active matrix flat panel display is performed in three distinct operations. In the first step, the (front) glass substrate is prepared, including the deposition and patterning of the color filter elements. A separate (rear) glass substrate is used for the formation of thin film transistors, as well as for metal interconnect lines. The third and final step is the assembly of the two panels, injection of the liquid crystal material between them, and final inspection of the finished device.

2.2.1 THIN FILM TRANSISTOR MANUFACTURING

Thin film transistor fabrication is shown in Figure 2-9. The illustration shows

both processes and equipment for thin film transistor formation. This process is very similar to the fabrication of an integrated circuit. With the extra transistors often used for redundancy, a total of one million transistors may be fabricated on a single 10 inch panel, meaning that the complexity of the process is similar to that of a dynamic memory chip. Substrates begin the fabrication process with a thin film application step. Then, a photoresist is applied and imaged to allow etching of the thin film to the appropriate dimensions. A sequence of thin films is deposited and etched, as with integrated circuit fabrication.

Plasma CVD & Sputtering

The number and sequence of thin films depend on the transistor design being used. Thin films are deposited by chemical vapor deposition, (CVD), or physical vapor deposition (PVD). Plasma enhanced CVD, also known as glow discharge, is used for amorphous silicon, silicon nitride, and silicon dioxide. Amorphous silicon is used in all active matrix TFT devices. PVD, usually sputtering, is used primarily for metal films. Thin film deposition typically occurs in in-line deposition chambers which incorporate vacuum load locks, and, in some cases, chambers for sequential deposition of several thin films in a single operation. The combination of large substrate size, up to 400x400mm, sequential handling of multiple substrates in succession, and precise and repeatable deposition requirements makes in-line CVD equipment especially complicated and expensive.

For plasma-assisted CVD (PECVD), glass substrates are moved sequentially through in-line, load-locked chambers that are tens of meters long. Substrates are preheated and maintained at temperatures of 300-400°C during deposition. Source gases are introduced for one thin film, deposition occurs, and the panel is moved to the next chamber. In the case of sequential deposition, another film is deposited while low pressure conditions are maintained. The plasma is generated by RF power, typically 13.5 MHz, and 60-70 mW/cm² power density. Gases include silane and hydrogen for a-Si films, silane, hydrogen and phosphine for n⁺ doped a-Si, and silane/ammonia mixtures for SiN_x films. Amorphous silicon film properties depend on the incorporation of a controlled amount of hydrogen during the deposition process of 5-15%. Hydrogen atoms tie up dangling silicon bonds, rendering the film stable. Control of hydrogen content is thus an essential element of the deposition process.

Deposition rates are low, typically less than 100Å per minute. Problems include control of film thickness and uniformity over the dimensions of a large substrate,

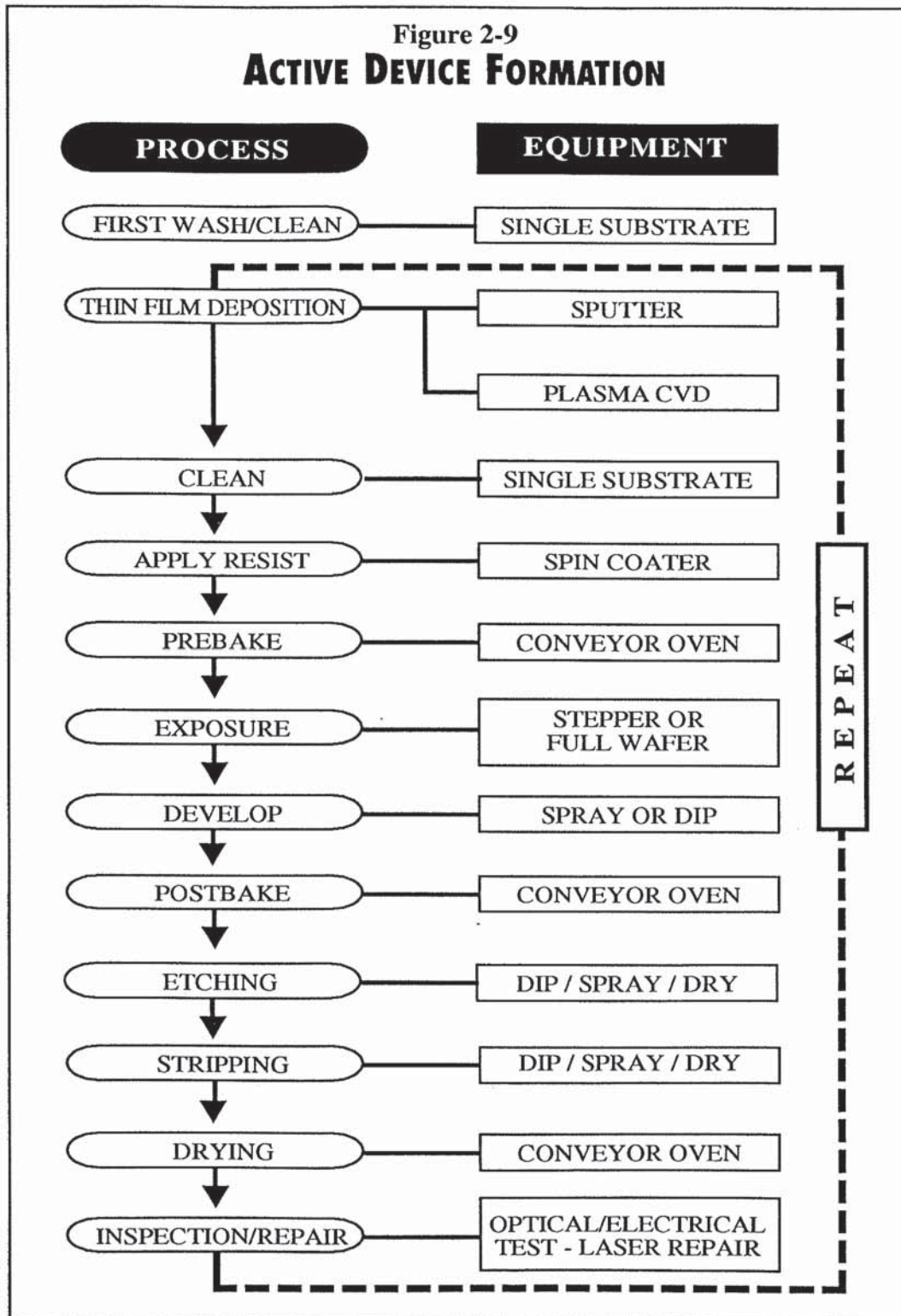

particle formation during deposition, and control of sequential formation of undoped, doped, and insulating films in a single deposition step. Equipment up-time and throughput is especially problematic for amorphous silicon deposition.

Sputtering for the deposition of metals is performed using in-line equipment, although batch sputtering and electron beam deposition is still used for ITO, as mentioned previously. Magnetron sputtering technology is well developed compared to PECVD. Metal deposition for aluminum, chromium, tantalum, molybdenum and the other metals used for gate electrode and source/drain lines is possible using the semi-automatic in-line equipment, with either vertical or horizontal transport of substrates. Control of pumpdown conditions is employed to minimize particle generation in this step. Elevated substrate temperature is also employed. In the case of ITO, pass-through sputtering processes, in which the substrate travels continuously past the sputtering target, can be used. Typically, throughput of in-line sputtering equipment is two to three times greater than for PECVD.

Photolithography

Typically, 6-9 thin film layers are used, with photolithography required at each step. Typical dimensions for the active layer (channel) in a thin film transistor are 3-5 μ m, and images are obtained with steppers or mirror projection units that can image the large substrate used. Currently, very long photoresist application and etching lines, up to 30 meters in length, are used to process TFT substrates. Standard IC photoresists are employed. Photoresist adhesion is a strong function of the substrate surface preparation prior to coating. Figure 2-10 shows the amount of side etching of photoresist features as a function of etching time[12]. Strong adhesion of photoresist results in a very small amount of side etching. Best results are indicated with a brush scrubbing followed by ultrasonic rinse and baking prior to photoresist application

Although the technology developed for integrated circuit photolithography is applicable to forming thin film transistor arrays, the problems to be solved are somewhat different, and the equipment is tailored to solving these problems. TFT substrates are very large compared to silicon wafers, and full field imaging of a large display is not possible. Instead, the lithography is usually performed in steps which are stitched together to form the array. Specialized steppers have been developed which allow imaging of 10 inch and larger displays.

One major difference between these steppers and those used for IC's is that the

Figure 2-10 Photoresist adhesion evaluated by side etch for various precoating processes.

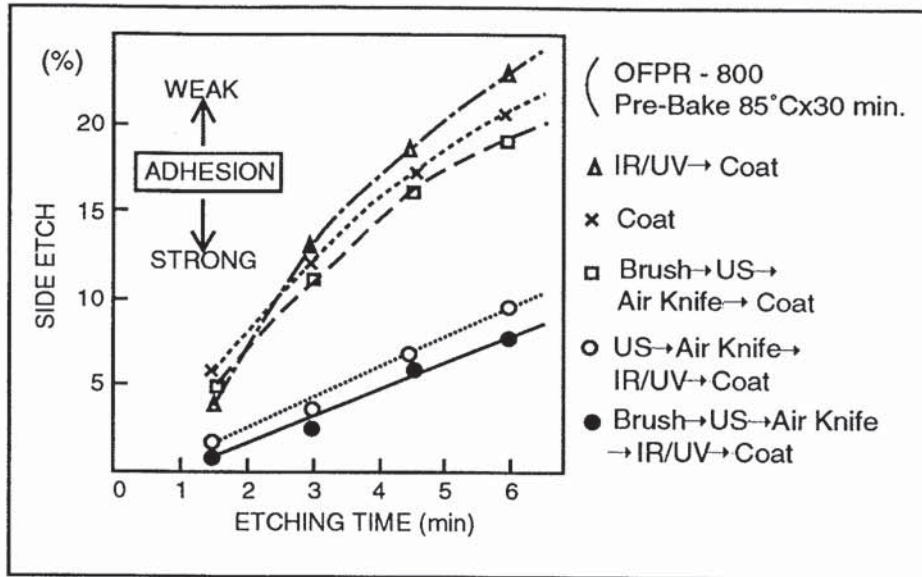

TFT array is continuous, whereas discrete chips are imaged on a silicon wafer. This means that there are no “streets” between images for TFT production, and the images must be stitched or butted together precisely across the display. Another major difference is the thermal compaction or shrinkage of the glass substrate during TFT fabrication. This change in substrate dimension is a function of the masking step, and the amount of correction required is a function of the distance from the center of the substrate. Controlling the stitching accuracy and accounting for substrate shrinkage require advanced metrology and control hardware and software.

An alternative to steppers for TFT manufacturing is mirror projection, in which an image is scanned across the substrate in continuous fashion. It is necessary to scan the substrate and the photomask as a unit, and the photomask is the same size as the substrate (1:1 projection). The details of stepper and projection equipment are provided in the section on manufacturing equipment.

Etching

Etching of amorphous silicon, silicon nitride, silicon oxide, and metal films is usually performed by wet etching. Although it is possible to use a batch process, continuous, single substrate process systems are more commonly employed. Dry

processing is under evaluation for some steps, as mentioned previously for ITO etching. Reactive etching many offer advantages of linewidth control and reproducible end point detection. However, for the time being, throughput considerations ensure that most etching steps will be performed in wet systems.

Transistor Processes

Two types of TFT structures are used for amorphous silicon (a-Si) devices. One is the inverted staggered (IS) type, which can be either back channel etched (IS-BCE) or tri-layered (IS-TL). The other is called a normal staggered (NS) device. These three transistors (IS-BCE, IS-TL, and NS) are shown in cross-section in Figure 2-11.

Figure 2-11 Cross-section view of three TFT configurations [13]

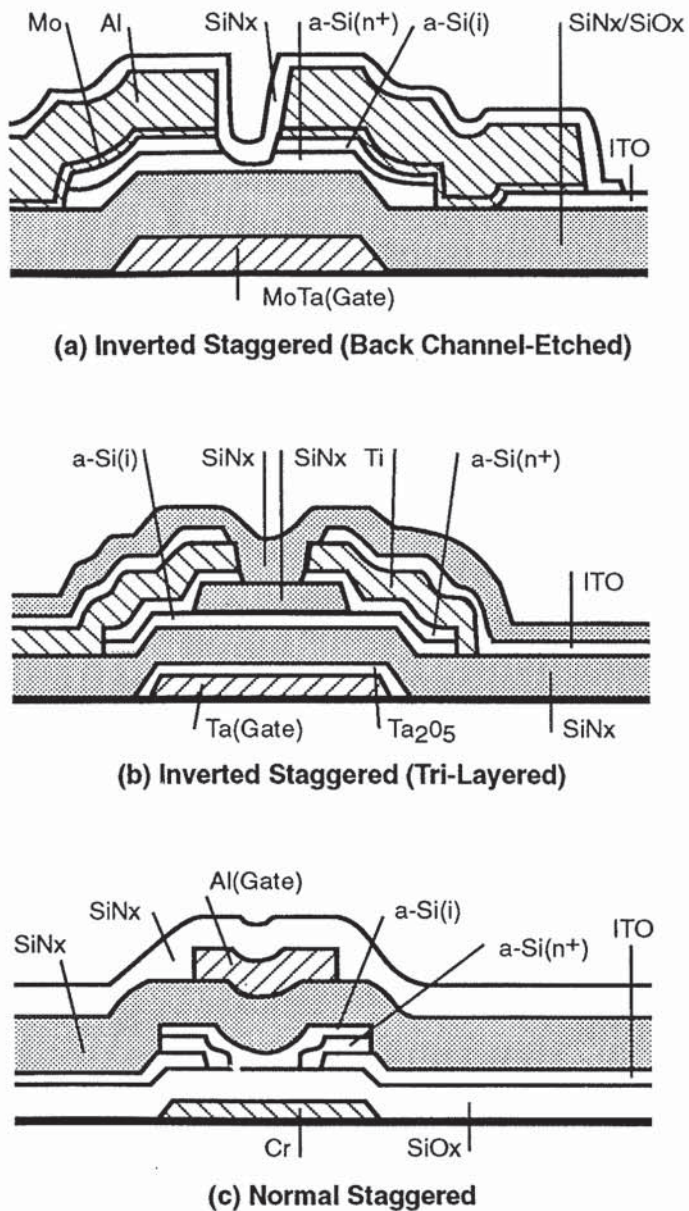

CHAPTER TWO: DISPLAY MANUFACTURING

LIQUID CRYSTAL FLAT PANEL DISPLAYS

The process flow for each of these transistors is shown here, with indications of photolithography and other processing operations. The first flow chart, shown in Table 2-8, is for the inverted-staggered back channel etched (IS-BCE) device.

Table 2-8 *Process Flow Chart for Inverted-Staggered Back Channel Etched TFT*

Material/Feature	Process
Gate definition	
Mo-Ta	Sputter
1st masking step	Photolithography, etching
a-Si island definition	
SiO/SiN/a-Si(i)/a-Si(n ⁺)	Plasma CVD
2nd masking step	Photolithography, etching
Display electrode formation	
ITO deposition	Sputter
3rd masking step	Photolithography, etching
Thru-hole formation	
4th masking step	Photolithography, etching
Source/Drain/Signal Line definition	
Mo-Al deposition	Sputter
5th masking step	Photolithography, etching
Back Channel definition	
n ⁺ a-Si etching	Wet, dry etching
Passivation	
SiN deposition	Plasma CVD
6th masking step	Photolithography, etching
Array Completed	

The process for an inverted staggered trilayered (IS-TL) device is shown in Table 2-9.

CHAPTER TWO: DISPLAY MANUFACTURING

LIQUID CRYSTAL FLAT PANEL DISPLAYS

Table 2-9 *Inverted-Staggered Trilayered TFT Process*

Material/Feature	Process
Gate definition	
Ta deposition	Sputter
1st mask step	Photolithography, etching
Gate oxide formation	
oxidation	anodization with mask
a-Si TFT deposition	
SiN/a-Si(i)/SiN deposition	Plasma CVD
2nd mask step	Photolithography, etching
a-Si island definition	
3rd mask step	Photolithography, etching
Source/drain definition	
a-Si(n ⁺) deposition	Plasma CVD
4th mask step	Photolithography, etching
(source/drain)	
5th mask step	Photolithography, etching
(thru hole)	
Ti deposition	Sputter
6th mask step (metal)	Photolithography, etching
Display electrode formation	
ITO deposition	Sputter
7th mask step	Photolithography, etching
Passivation	
SiN deposition	Plasma CVD
8th mask step	Photolithography, etching
Array Completed	

The process flow chart for the normal staggered (NS) device is shown in Table 2-10.

CHAPTER TWO: DISPLAY MANUFACTURING

LIQUID CRYSTAL FLAT PANEL DISPLAYS

Table 2-10 *Process Flow for Normal Staggered TFT*

Material/Feature	Process
Light shield and signal line formation	
Cr deposition	Sputter
1st mask step	Photolithography, etching
Insulator Deposition	
SiO _x deposition	Plasma CVD or Sputter
2nd mask step (thru hole)	
Display electrode, signal line formation	
ITO deposition	Sputter
3rd mask step	Photolithography, etching
TFT formation	
a-Si (n ⁺) deposition	Plasma CVD
Source/Drain formation	
4th masking step	Photolithography, etching
a-Si (i) deposition	Plasma CVD
5th masking step (island)	Photolithography, etching
Gate dielectric formation	
SiN deposition	Plasma CVD
6th mask step	Photolithography, etching
Gate electrode definition	
Al deposition	Sputter
7th mask step	Photolithography, etching
Passivation	
SiN deposition	Plasma CVD
8th mask step	Photolithography, etching
Array Completed	

The transistors whose process sequence has been described above are currently being used for LCD TVs or other products in Japan as shown in Table 2-11.

CHAPTER TWO: DISPLAY MANUFACTURING

LIQUID CRYSTAL FLAT PANEL DISPLAYS

Table 2-11 *TFT Array Process and Specifications*

Manufacturer	Toshiba	Hitachi	Sharp	Matsushita	Hoshiden
Screen size	4-inch	5-inch	3-inch	3-inch	10-inch
TFT type	IS-BCE	IS-BCE	IS-TL	IS-TL	NS
Number of masks	6	9	8	9	8
a-Si thickness	3000Å	2000Å	500Å	500Å	300Å
Gate insulator	SiN/SiO	SiN	SiN/TaO	SiN	SiN
Gate line	Mo-Ta	Al/Cr	Ta	MoSi/Cr	Al
Signal line	Al/Mo	Al	ITO/Ti	Al	ITO/Cr
Storage capacitor	Yes	Yes	Yes	Yes	Yes

Some previous comments about TFT manufacturing are repeated here for reference. The performance of a TFT as well as the manufacturing yield and throughput depend on the transistor's construction. The inverted staggered back channel etched transistor, (IS-BCE), can be fabricated with the minimum number of six masks, whereas the inverted staggered tri-layered transistor, (IS-TL) requires nine. On the other hand, the IS-TL type has only a 500Å a-Si layer, minimizing the deposition time for this layer. This is important because amorphous silicon deposition is very slow, and can constitute a manufacturing bottleneck when thick layers are required.

Double layer gate insulator structures such as $\text{SiN}_x/\text{SiO}_x$ or $\text{SiN}_x/\text{TaO}_x$ are commonly used to minimize yield loss due to line or point defects which cause crossover shorts. These kinds of shorts are difficult or impossible to repair.

Specific resistivities of tantalum (Ta), chromium (Cr) or molybdenum-tantalum alloy (Mo-Ta) films used for gate lines and gate electrodes in some of these structures ranges from 20 to 40 $\mu\Omega\text{-cm}$. These values are too high for large screen TFT-LCDs, since the high resistance and capacitance of the gate line leads to gate pulse delay. For a 12 inch TFT-LCD with 1024x768 pixels and a 16 level grey scale, the resistivity of the gate line should be less than 10 $\mu\Omega\text{-cm}$. Aluminum is the only appropriate material for such high density displays.

One of the difficulties in transistor design and manufacturing is the need for a storage capacitor to improve the image quality. The storage capacitor adjoins the

TFT and has an ITO top plate. Charging this capacitor requires that the TFT be relatively large, and the increased area at each pixel devoted to the transistor reduces the amount of light which can be transmitted (aperture ratio). If a second transistor is added at each pixel for redundancy, transmitted light can drop to less than 5% in a finished display.

2.2.2 IN PROCESS TESTING

Inspection and repair are common at each step of the transistor fabrication process, and commercial equipment is just beginning to be developed for this application. Table 2-12 shows the cause of defects in TFT array processing. About half of the defects, including severed signal lines and gate line etching defects, might be repaired if they could be located. Current inspection technology focuses on optical microscopy, although electrical testing and non-contact imaging of transistor arrays are under development. Accurate and rapid inspection must be accompanied by information allowing automatic or semi-automatic repair, based on inspection results. Typically, a substrate is moved to a separate repair station, which uses a laser to cut away shorts. Decomposition of organo-metallic vapors allows the laser to form conducting metal paths around open circuit areas as well.

Table 2-12 *Defects in LCD TFT Array Manufacturing*

Defect	Occurrence (% of total)
Severed signal line	26.1
Substrate breakage	24.8
Gate line etching defect	23.0
Faulty transistor characteristics	11.2
Other	14.9

Source: Toshiba

Optical Inspection

Optical inspection consists of automatic inspection of images after each photolithography step to identify defects in lithography or etching. The equipment used for the process is adapted from automatic or semi-automatic equipment used for semiconductor device or mask inspection. Similar software routines can be used for rapid inspection and defect classification. Generally, the repair or rework of defective sites is performed on another piece of equipment. The information

needed to locate a defect may be transferred from the inspection equipment's computer to that of the repair device.

Because the patterns consist of small transistors of $10 \times 10 \mu\text{m}$ or so in a pixel of $100 \times 200 \mu\text{m}$ size, not every defect is automatically a fatal one. This means that sophisticated software routines are needed which allow classification of defects automatically.

Electrical Inspection

Optical inspection is the most common form of inspection during manufacturing. Other types of equipment are under development, including electrical testing during the fabrication process. In silicon circuit manufacturing, the electrical properties of a thin film or implanted region can be tested using test patterns on the wafer, often at several sites across the substrate. These can be probed and electrical evaluation performed. In addition, test wafers specifically evaluate each deposition and doping process.

It is more difficult to perform electrical evaluation on TFT work in process. Test sites are not possible on large area display substrates, and "test wafers" are expensive. In order to perform electrical continuity tests on signal lines and transistor layers, special connectors around the outside of the display pattern must be designed in. These electrical connectors must be separated prior to final assembly. Because of the difficulties involved in electrical inspection, most display manufacturers use redundant transistors at each pixel. After the TFT process is completed, each pixel is addressed. If one transistor is not working, the second one can be "turned on" using a laser to cut a metal trace between the two.

Functional Inspection

Non-contact testing of transistor arrays has recently become possible using an electro-optic modulator which transform voltages on the individual transistors into optical impulses [14]. The modulator forms an optical image of a transistor array which is fed to electronic processing equipment for defect detection. The modulator is indexed across an array and the computer files information on defective sites to be fed to a repair station.

2.2.3 DEFECT REPAIR

Redundancy and repair are two important measures to obtain high yield in TFT manufacturing. The second of these, repair of defects, makes use of a laser to cut

or deposit metal lines on the display. Simple shorts may be adjacent lines with residual metal between them. These are repaired by laser cutting, using information from the visual inspection equipment which locates the defect. The more serious kinds of shorts occur where one line crosses another. If a short occurs through the insulation separating these lines, there is currently no good way to repair the defect. For this reason, redundant transistors are often built into the array, and if a crossover short renders a transistor inoperative, the second one can be activated by cutting metal lines around the first one.

Open circuit defects are more difficult to repair than simple shorts, and the strategy is to use laser-assisted CVD to deposit metal in selected areas, building a conducting path around the open circuit. Metal-organic vapors are the precursors for deposition, and laser power breaks the molecules apart, causing metal to deposit on the substrate.

2.3

Display Assembly

The assembly process for active matrix displays is presented here. The color filter array and thin film transistor substrate are joined together and liquid crystal material is injected into the gap between them. Polarizers are applied to both sides, integrated circuits for driving the display are mounted, and a backlight is installed to complete the operation.

2.3.1 ORIENTATION FILM DEPOSITION AND RUBBING

The assembly process is shown in Figure 12. For each substrate, a thin polymer film is deposited for orientation of the liquid crystal molecules at the glass surface. This orientation film, perhaps only $0.1\mu\text{m}$ thick, may be a polyimide or other "hard" polymer material. After deposition and baking, it is rubbed with fabric in a chosen direction, leaving barely detectable grooves in the surface. There is more art than science in choosing the rubbing material and process. The grooves serve to aid the liquid crystal molecules to align at the substrate surface, and also to assume the proper tilt angle. The latter feature of tilt angle is especially important for supertwist passive matrix displays, for which a high tilt angle provides the high twist of up to 270° .

The orientation film can be deposited by spin coating or by printing. The printing method is more efficient in material usage; 70-80% of the polyimide is transferred from the printing roll to the substrate surface.

Rubbing can be done with a once through cloth on a belt, fed from a roller on one side, passing under roller which contacts the substrate, onto roller on the other side. The substrate moves underneath the cloth in same direction as the cloth. Other methods include a traveling brush that moves across the substrate. The nap of the rubbing material is important.

The mechanism of alignment of liquid crystals by rubbed films isn't well understood. Depending on materials and process conditions, tilt angles of from 1° for low tilt liquid crystals to the 5-10° range are obtained. Using an SEM, researchers can't detect the changes in the surface that are produced by rubbing, but a slight optical anisotropy occurs, which can be detected by polarizing microscope.

The tilt angle is controlled by rubbing pressure and speed. Display manufacturers would like to have greater than 10° for wider viewing angle. The know-how of polyimide selection and rubbing process details constitutes the key to successful LCD manufacturing. STN displays need high twist angle, and aligning the material is difficult. Some polyimide will work in one process and not another. Curing temperature for high tilt polyimide is 250°C, but is 200°C for low tilt. For color STN displays, lower curing temperature is needed.

The cleaning processes prior to and after the orientation film deposition step are perhaps the most critical cleaning operations in the entire panel manufacturing process. At this point, the color filter array on one substrate and the TFT array on the other substrate are completed; any failure to clean the surface thoroughly at this point is even more critical to yield than earlier processes.

2.3.2 SEAL PRINTING

After the orientation film has been applied, the substrates are ready for seal printing and lamination. Depending on the size of the substrate and final display size, a substrate may constitute several displays, and a seal is needed around each display. Seal material can be applied more than one way. Typically, silkscreening is used. Finally front and rear substrates are laminated together. Just prior to lamination, spacers are deposited on one substrate to allow a precise gap between the front and rear surfaces. Spacers may be fibers or spheres of a uniform dimension, made either from glass or plastic. Typical large area flat panel displays have a cell gap of 5-10µm.

Figure 2-12

ASSEMBLY, PACKAGING & TEST

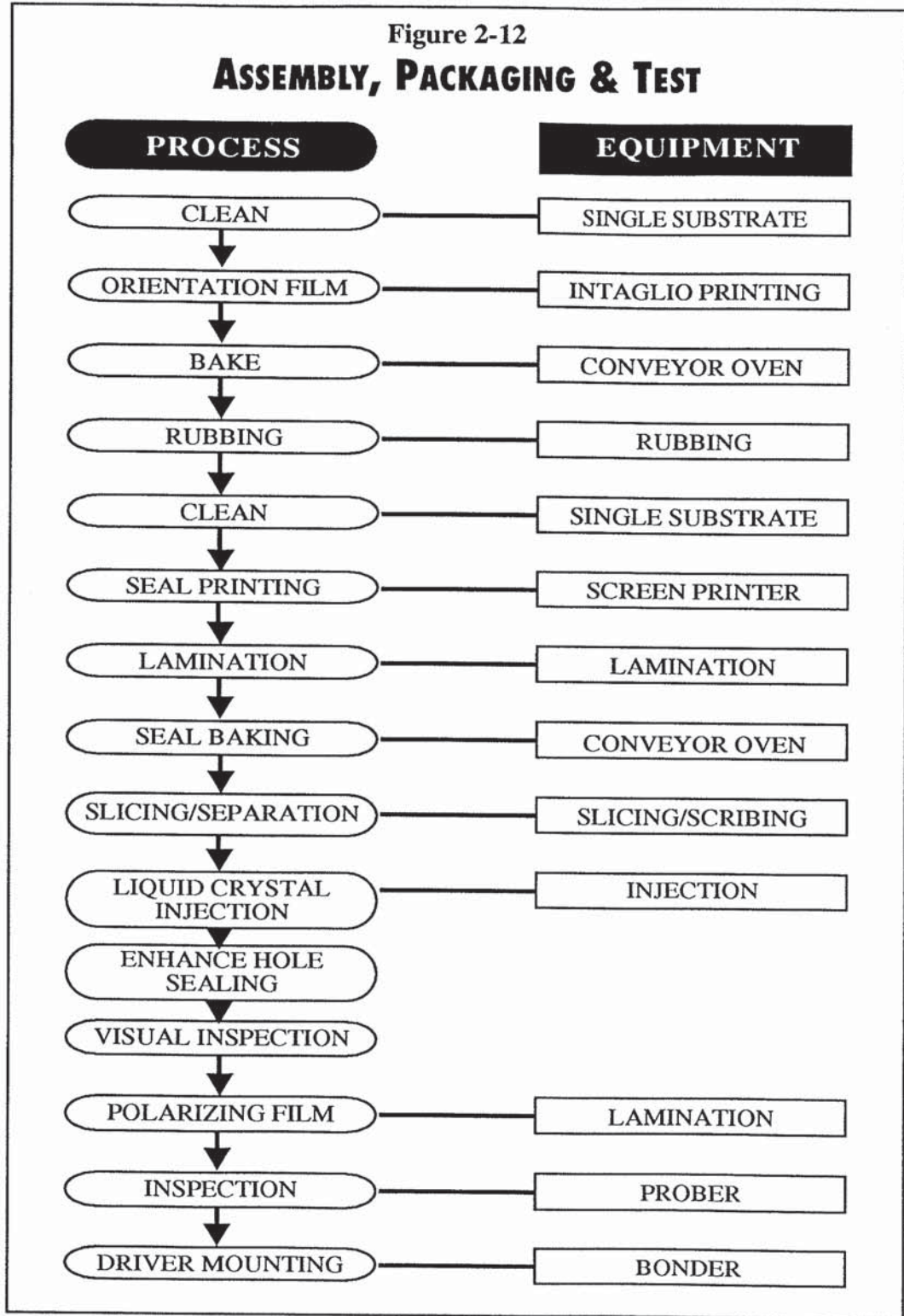

Figure 2-13 shows the flow of work through an automated assembly line [15]. The illustration shows an assembly sequence consisting of adhesive dispense, required for sealing the panels, spacer application, location and optical alignment of one plate with respect to the other, exposure to cure the adhesive and bond the two glass plates together, which ends the assembly process. Automated transport of both top and bottom plates through the line is indicated; one plate receives the adhesive, and the second plate is introduced at the spacer applicator station.

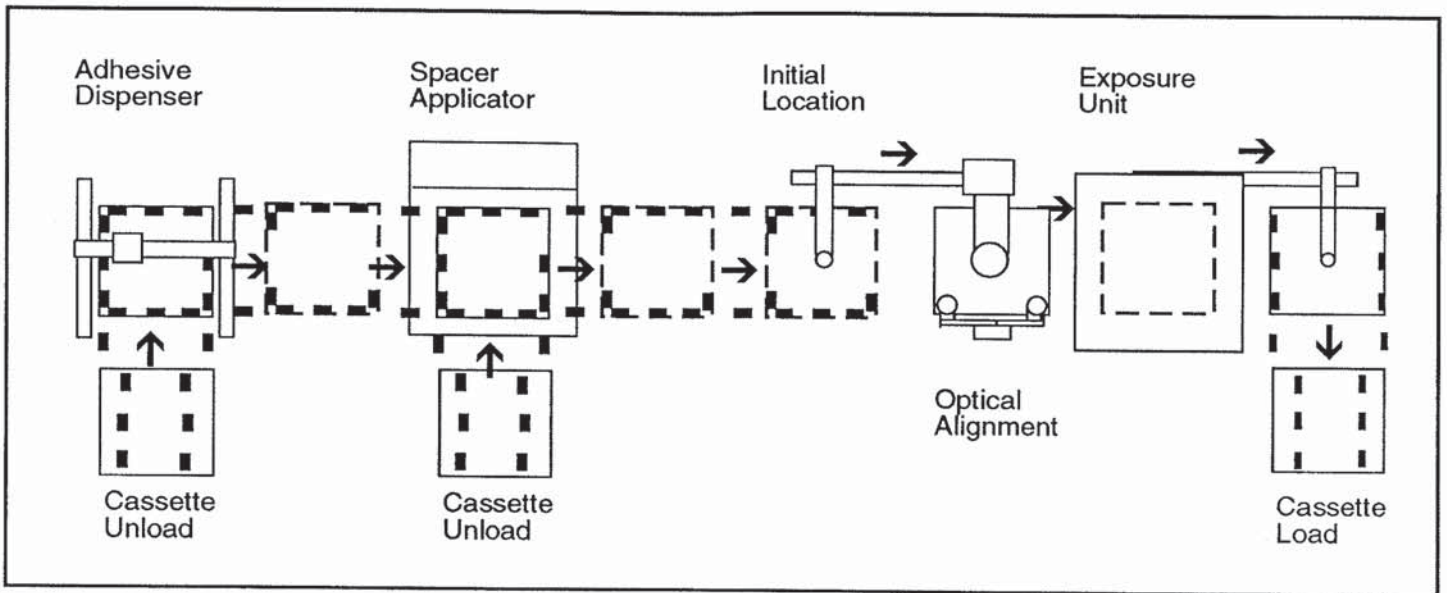

Figure 2-13 Automated flat panel assembly line

Screen printing is often used for LCD seal application, but here a programmable X-Y dispenser is employed. In this case, the dispense time can be matched to other process times and multiple heads and sequential machines allow automation of the entire process. A further advantage of dispensing the adhesive, rather than screen printing it, is that contact with the inner surface of the display is avoided, and contamination and degradation of the aligning surface is greatly reduced.

Traditional edge seal adhesives, usually epoxies, have been heat cured after screen printing. The curing removes the solvent, and the resultant β -stage material is dry to the touch, allowing plate-to-plate alignment even when plates are in contact. After alignment, heat and pressure are applied to cross-link the seal polymer. Pressure must be maintained during the cross-linking process so that the proper spacing is achieved. Problems with this process include incomplete

solvent removal, non-uniform pressure during curing, and movement of plates away from alignment as the seal deforms under pressure.

UV-cure epoxies have some advantages in an automated process, including the low viscosity needed for dispenser application. However, the adhesive must remain wet until the final UV curing step, which introduces some complications into the assembly process. The entire assembly equipment line must be kept in a controlled environment chamber, and plate-to-plate alignment must be accomplished without allowing the plates to touch.

2.3.3 SPACER PLACEMENT AND SEALING

In the next assembly step, the second plate is introduced into the spacer application station, and spacers are applied by air scattering. This plate is moved to the initial locator station, which orients it for transport to the optical alignment station. The first plate, with the adhesive, is then inverted, moved to the locator stage, and then to the optical alignment station above the second plate.

Alignment of the two plates is performed using marks etched into one of the conducting layers on each side. Optical pattern recognition and computer control can assure precise alignment. After alignment, the plates are brought into contact, a sealing membrane is lowered, and the space between the plates is evacuated. Clamped together by the outside air pressure, the plates are moved to the curing station for UV exposure. After curing, the assembled plates are off-loaded into a cassette for liquid crystal injection.

Obtaining uniform performance of large area displays requires that the gap between the two plates be very closely controlled. This is especially true for STN displays, where the cell gap may be only $5\mu\text{m}$, and gap tolerance is $\pm 0.1\mu\text{m}$ or even less. This introduces extreme requirements for uniformity of spacer size and for reproducibility of positioning the plates prior to curing. Figure 2-14 shows the schematic relation between variations in spacer size, pressure, and final spacing of the plates. It indicates that a broad range of sizes in spacers will translate to final spacing non-uniformities; the variation of pressure is held to a minimum by employing an evacuated cell and air pressure exerted against the plates and through them to the spacers.

2.3.4 LIQUID CRYSTAL INJECTION

In the case where more than one display has been constructed on the substrate, the

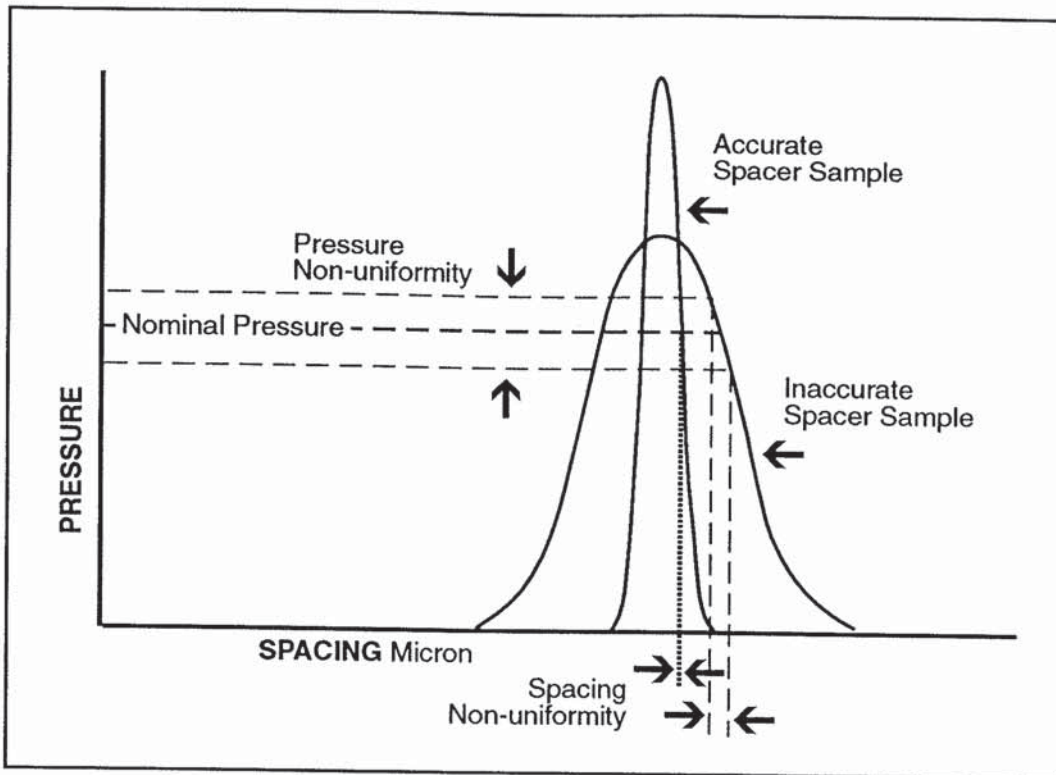

Figure 2-14 Variations in external pressure and spacer size lead to variations in cell gap.

displays are now separated by slicing. At this point, the liquid crystal material can be introduced into the gap between the substrates, making use of a hole left in the seal material. This entrance hole is then sealed, and prepared for final inspection. Liquid crystal materials are often delivered as two or three component systems which are mixed at injection. Injection systems provide mixing and purging of the cell to avoid trapping bubbles during the filling process.

2.3.5 INSPECTION AND TEST

Inspection and functional testing are performed after assembly and liquid crystal injection. The causes of rejected cells are shown in Table 2-13. Most defects are related to particles, including point and line defects, and cell gap problems.

2.3.6 POLARIZER ATTACH

The final manufacturing step for the liquid crystal display itself is the application of the polarizer to the outside of each glass plate. In some cases, a compensation film is applied prior to the polarizer.

CHAPTER TWO: DISPLAY MANUFACTURING

LIQUID CRYSTAL FLAT PANEL DISPLAYS

Table 2-13 *Causes of Defects in Assembled Flat Panel Displays*

Defect	Occurrence (% of total)
Point defect	32.6
Particles, scratches, dirt	24.7
Breakage	4.9
Line defects	7.7
Faulty cell gap	6.1
Other	20.4

Compensation films are polymer films that are stretched in one direction. This stretching changes the optical properties of the film. By combining several films of two or more materials and with different orientations of the stretched direction, many improvements in LCD display characteristics are achieved. This is especially true for STN displays, which have a distinct yellow or blue color unless corrected by a means such as compensation films. True black and white displays can be obtained, and viewing angle is also increased using compensation films. Film materials include polycarbonate and polymethyl methacrylate. The films are usually attached to the polarizer material according to customer specifications about the number of layers, angle of the stretch direction with respect to the polarizer and so forth. The compensator/polarizer is delivered as a unit to the display manufacturer for attachment.

Polarizer films are composite films which contain the pressure sensitive adhesive layer needed to attach the polarizer to the glass. The direction of polarization is selected for each side of the glass. Usually, if the liquid crystal material has a twist of 90°, then the polarizers will be set at this angle with respect to one another. This allows light passing from one side and rotated by the liquid crystal to pass through the other side, a “normally white” condition. Polarizers are often trimmed to size for delivery to the display manufacturer. They are applied by automated machines which dispense the material from rolls or precut sheets. The machines are variants of labeling machines developed for other industries. The polarizing film is attached to both sides of the display.

The completed display is shown in cross-section in Figure 2-15. The illustration indicates the many materials needed to form the final product.

A completed display will ordinarily have driver integrated circuits mounted on or near one of the glass substrates, usually the TFT side. A variety of mounting

Figure 2-15 Active matrix liquid crystal display cross section.

From, "Solving the AMLCD Puzzle", copyright SEMI 1991

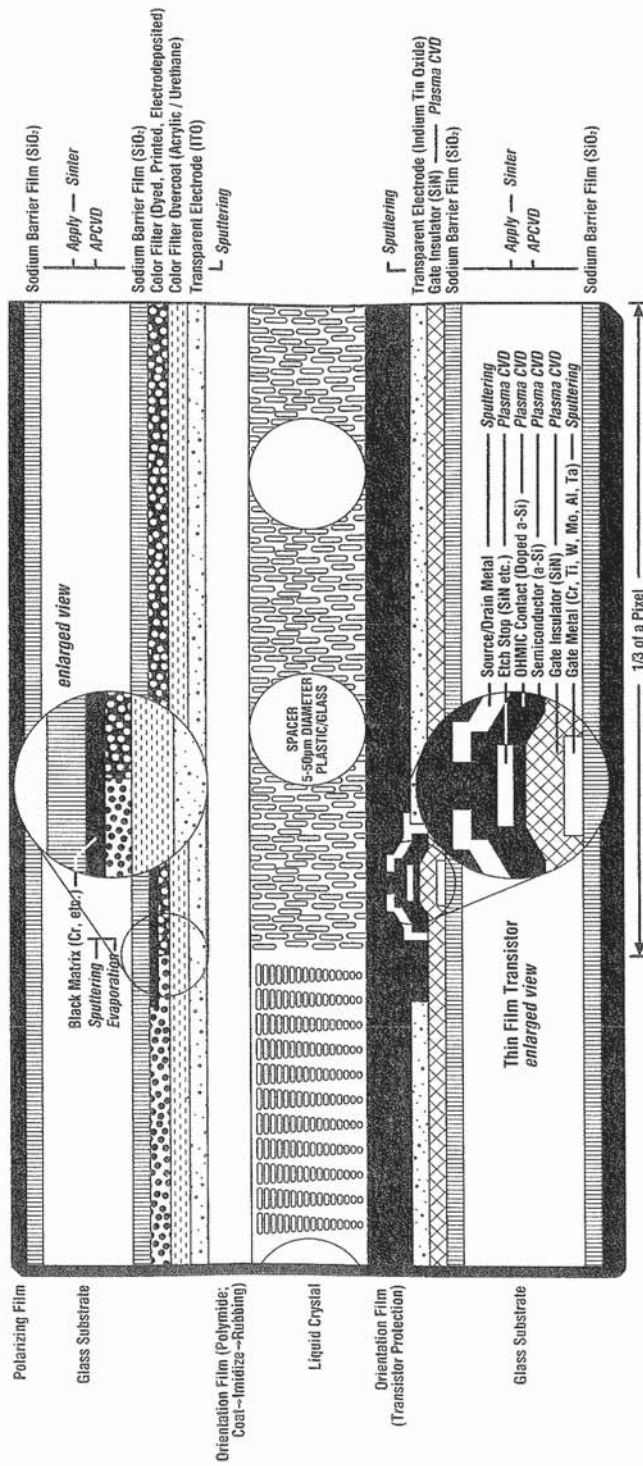

methods are employed, with TAB bonding especially suited for the space and weight saving requirements of flat panels.

2.3.7 DIE ATTACH

Integrated circuit drivers are an important part of a flat panel display, and several dozen circuits may be required to drive the display. Packing these circuits around the display requires special techniques to minimize the space and weight of

Figure 2-16 *Packaging configurations in flat panel displays.*

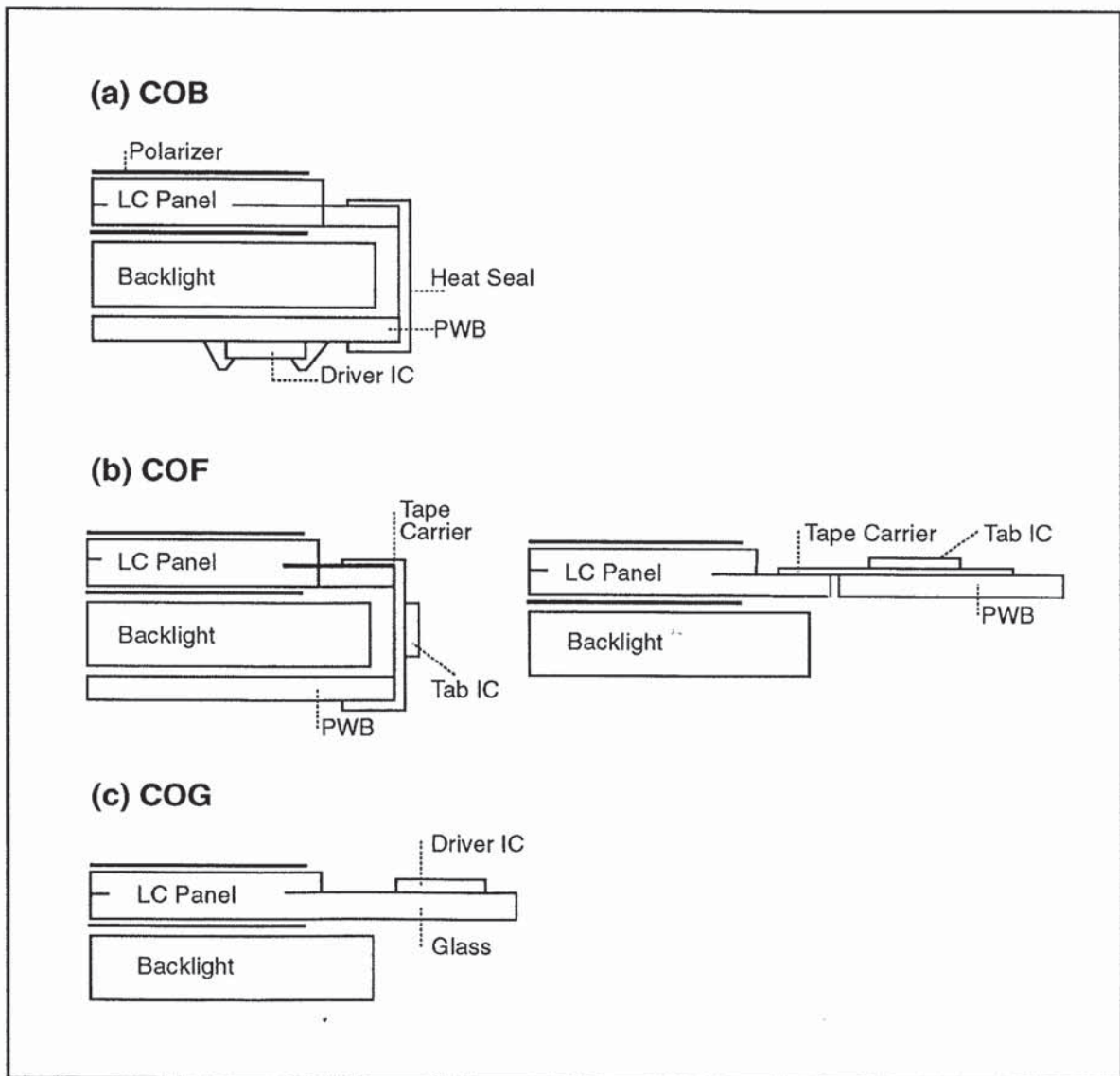

CHAPTER TWO: DISPLAY MANUFACTURING

LIQUID CRYSTAL FLAT PANEL DISPLAYS

circuits and connectors. A variety of packaging and die attach methods are employed in flat panel display production, depending on the location of the circuits. Figure 2-16 shows three types of chip packaging methods, termed chip on board, (COB), chip on film, (COF), and chip on glass, (COG), respectively. For each of these packages, a different attachment method is used. This illustration and others in this section are taken from a recent presentation by Adachi [16].

The density of pin-outs possible with these three packaging methods is shown in Figure 2-17. Monochrome displays for computer (OA) applications have a pixel pitch of 300-500 μm and 500-700 leads per panel side. Personal TVs have a similar number of leads, but a much reduced pixel pitch of 50-200 μm . In the monochrome display situation, chip on board packaging is satisfactory, but chip on film must be used for the TV. Similarly, even finer pitch and higher lead count for projection TV for example, will require chip on glass bonding.

Figure 2-17 Number and pitch of leads for flat panel displays.

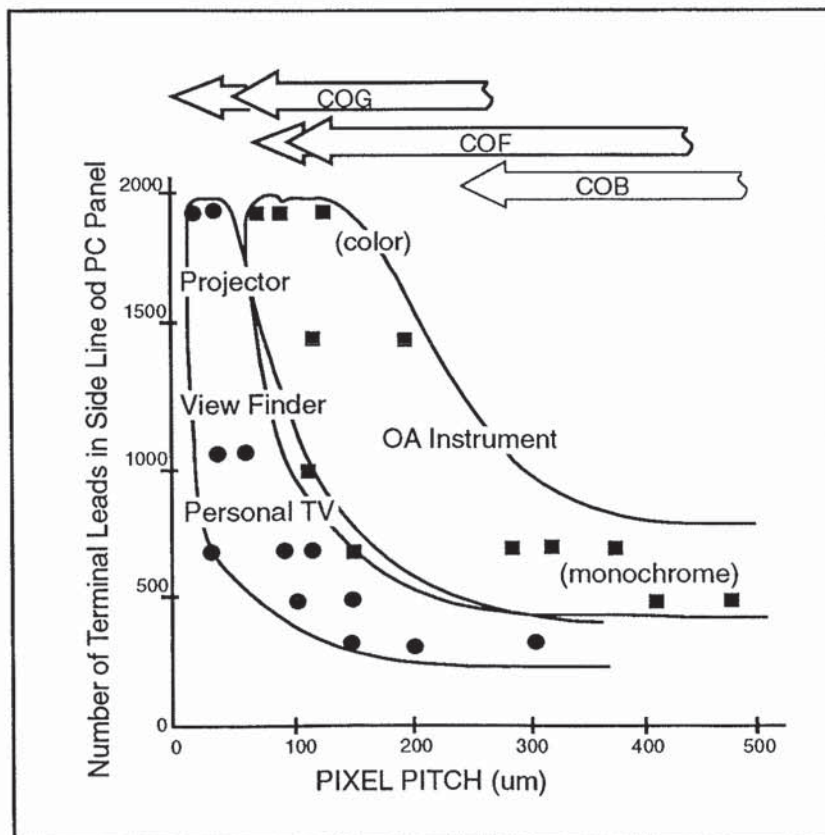

For chip on board assembly, ICs are wire bonded directly to the printed wiring board. Bare chips reduce the area required by the package assembly. The heat seal connector between the printed wiring board and the panel has a pitch limited to about 260 μm , but advanced patterns of 100 μm pitch have been achieved with etched copper foil and anisotropic paste connecting the foil to the panel ITO lines.

Currently, chip on film configurations are the most widely used, and TAB bonding is employed to attach devices to the flexible polyimide film. Source driver and gate driver ICs having up to 200 pinouts can be mounted and tested prior to bonding using the TAB approach. Anisotropic conductive adhesive is used to connect the tape carrier directly to the ITO conductor leads. This conductor is resin containing conductive particles dispersed evenly throughout. When heat and pressure bond the TAB tape carrier to the glass substrate, electrical connection is made via the conductive particles only between the copper foil on the tape and the ITO on the glass, as shown in Figure 2-18.

Figure 2-18 Connection of TAB tape to flat panel leads using anisotropic conductive paste.

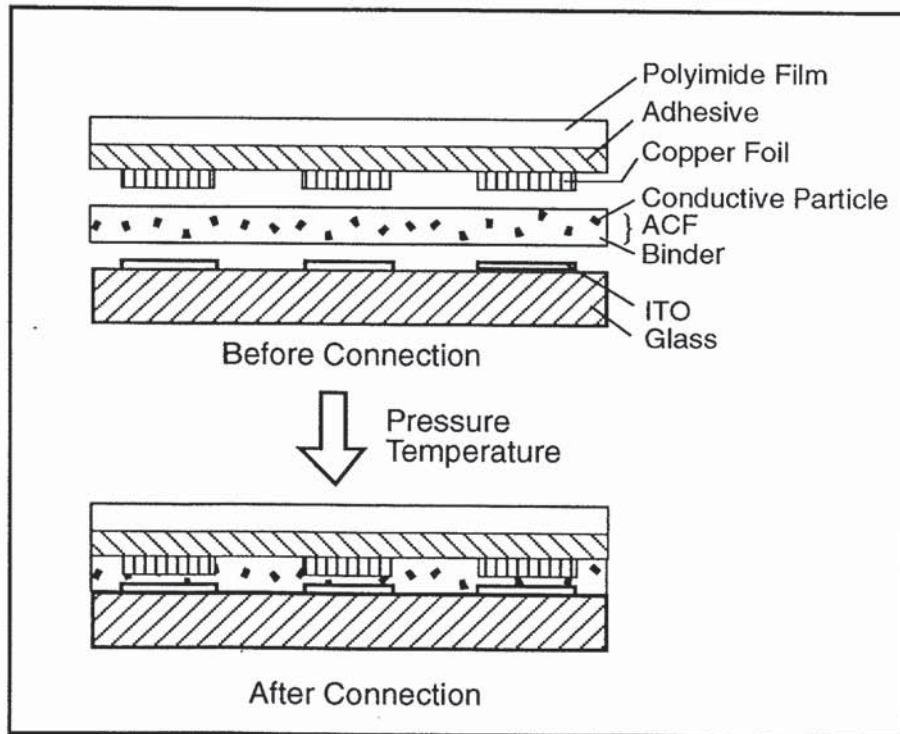

CHAPTER TWO: DISPLAY MANUFACTURING

LIQUID CRYSTAL FLAT PANEL DISPLAYS

Chip on glass mounts drivers directly on the glass substrate using some kind of flip chip assembly. This method should allow for the highest possible packing density, as well as minimum weight and volume for the display. However, mounting and repair technology have to be developed to make this assembly method possible. In addition, the method will require more area on the glass substrate itself to allow for chip mounting. Ultimately, the chip on glass mounting method may compete with polysilicon circuit manufacture at the edge of the display. Polysilicon, deposited during display fabrication or formed by annealing the a-Si film in selected areas, can be used for circuits in thin film form. For viewfinders and projection displays, polysilicon circuits on glass offer the ultimate match to fine pitch displays.

2.3.8 BACKLIGHT

Backlighting for flat panel displays typically makes use of cold cathode fluorescent lamps that possess the characteristics needed to illuminate the display. These include high luminous efficiency, long life, light weight, and ruggedness. These factors make battery operation possible in portable computers. These lamps are used in pairs along the sides of the display, and a light pipe arrangement is used to create uniform light across a diffuser screen as shown in Figure 2-19. Other arrangements are possible, including the use of a variable transmission curtain [17]. Improvements in backlighting described by Hathaway and coworkers include a flat fluorescent backlight and a wedge-shaped light pipe which distributes the light from a single bulb evenly over the entire display surface.

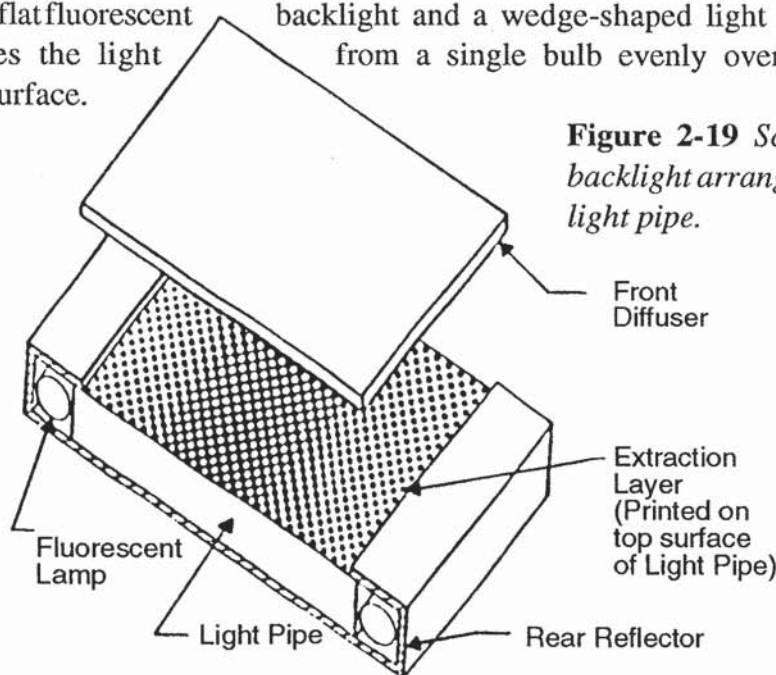

Figure 2-19 Schematic of backlight arrangement with light pipe.

2.4

Display Manufacturing

2.4.1 STN DISPLAY MANUFACTURING

The current “state of the art” production display is the STN, black and white model. Improved versions of this display will include a response speed fast enough for mouse operation, higher resolution, and full color displays. In some ways, improvements in STN technology divert resources and attention from active matrix development and production. However, as liquid crystal displays, STN cells are much harder to make than AMLCDs. If only we can learn how to make the TFTs, everything else is easier.

An STN display manufacturing facility processes displays at a very rapid pace of 120 panels per hour. It is unlikely that AMLCD panel throughput will ever approach this figure. Although STN manufacturing processes are relatively “straightforward”, there are many distinct steps. Figure 2-20 shows a schematic representation of an STN line. This figure is adapted from one in a recent book entitled “Liquid Crystals - Fundamentals and Applications” published by Kogyochosakai in 1991 (in Japanese). The process flow is shown beginning with substrate preparation and first cleaning on the upper right. Process areas are numbered sequentially. The details of each process step have been described in previous sections, but actual ambient conditions for processing are shown in Table 2-14. The table lists the temperature, humidity, and cleanliness of the process areas shown in the diagram. ITO deposition, photolithography, orienta-

Figure 2-20 Factory layout for passive matrix LCD manufacturing

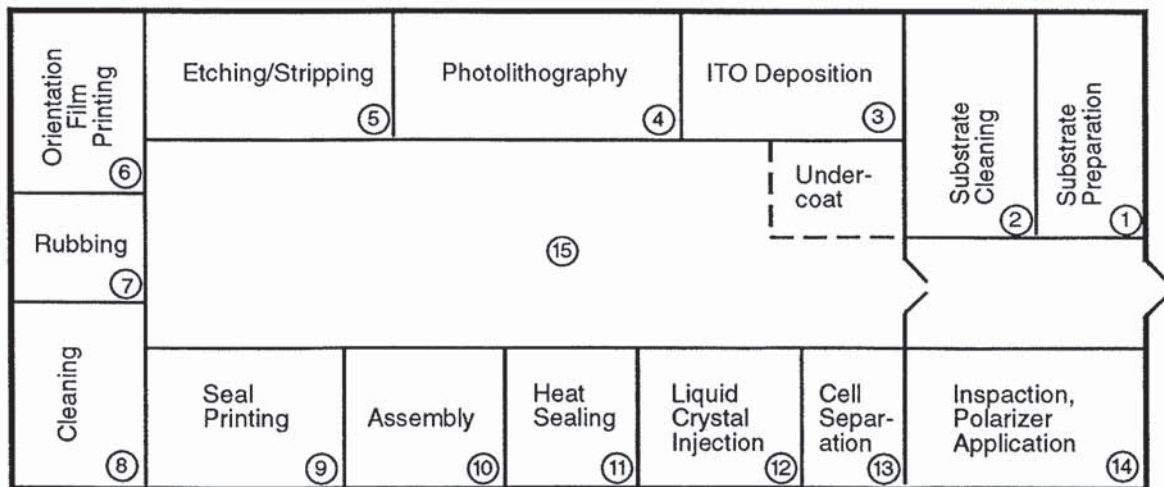

CHAPTER TWO: DISPLAY MANUFACTURING

LIQUID CRYSTAL FLAT PANEL DISPLAYS

tion film printing and seal printing areas have a particle class requirement approaching that of an IC factory. In other areas, the surface of the glass is not exposed directly to room ambient and a lesser grade of clean room is required.

Table 2-14 *Clean room Conditions for STN Process Line*

Process Areas	Temperature (°C)	Relative Humidity (%)	Particle Count (Class)
(4), (6), (10)	23±1.5	30±5	10-100
(3), (9)	23±1.5	40±5	10-100
(7), (11), (12)	23±1.5	30±5	500
(2), (5), (8)	23±1.5	40±5	500
(1), (13), (14), (15)	23±1.5	40±5	1000

Manufacturing yields for STN displays vary from 60% to 80%, with the industry average for large displays near the lower figure. Overall yields are not expected to improve since more complex displays are being introduced into manufacture. Cell thicknesses are going down for improved response speed. ITO linewidth is going down for higher resolution. Color filters and retardation films are being added. The added performance is welcome, but manufacturing is more difficult. Therefore, industry average yields will be static even though yields on more mature products will improve.

STN manufacturing uses proximity printers for imaging the relatively wide ITO patterns for STN displays. These printers are used in lines as shown in Table 2-15. The table also lists some active matrix lines, such as those of DTI.

The reasonable cost and quality of STN displays will make these the displays of choice for the next few years for low cost laptop computers and dedicated word processors. The dedicated word processor is a product that is peculiar to Japan. Until very recently, it was impossible to produce typed or printed documents using the Chinese character set except with extremely complicated mechanical equipment that only typesetters could master. Development of the micro-processor-based word processor including a one or two line LCD display and thermal print head that could produce the characters revolutionized the Japanese office. Further improvements have included the half-page backlit STN display capable of displaying black characters on a white background.

CHAPTER TWO: DISPLAY MANUFACTURING

LIQUID CRYSTAL FLAT PANEL DISPLAYS

Table 2-15 *Production Lines for Large Liquid Crystal Displays in Japan*

Firm	No. of Production Lines	Firm	No. of Production Lines
Sharp	8	Futaba Denshi	4
Toshiba	6	Rohm	3
Hitachi	4	Mitsubishi	2
Hoshiden	4	Optrex	2
Seiko/Epson	4	Matsushita	1
Casio	4	Akita Seimitsu	1
NEC	4	DTI (Toshiba/IBM)	2

The CRT was never a candidate display for this type of office equipment. Japanese word processors are still rather complicated, but can be used by ordinary office workers. However, like software for word processing on computers, most people know how to use only one product. Each brand expands and improves its products, and the display is a prominent candidate for further improvement.

Expansion of the word processor, laptop computer, and notebook computer markets will be assisted by improved STN displays. These displays will include very high resolution, response speeds suitable for the use of a mouse, and full color display. Low cost will extend their use to other products such as games and pocket TVs. In most of these categories, they are real competition for AMLCD's.

2.4.2 COLOR FILTER MANUFACTURING

The attention of display manufacturers is concentrated on the active thin film transistor formation, while the color filter panel is built on the outside by firms such as DaiNippon Printing and Toppan printing. The color filter matrix consists of 100x300 μ m rectangles of the three primary colors, formed a single color at a time by standard photolithographic processes. Each color is imaged at 300,000 picture elements across the display. DaiNippon Printing forms the color elements by using a photoresist with colored pigment dispersed throughout, while Toppan Printing deposits a gelatin base that is subsequently dyed the appropriate hue. Neither of these processes is a high volume production process, in the terms required by flat panel display manufacturers. The completed color filter panels are quite expensive, nearly \$200 per display at present, and production for AMLCDs is limited due to relatively low yields.

The display manufacturers' goal for mid-1990's color filter cost is \$40 per panel, a five-fold decrease from the current price. The pigmented photoresist and dyeing processes will probably be unable to meet this pricing goal. Color filter manufacturers are investigating alternative methods, such as offset printing, to increase the volume and reduce the manufacturing cost, but it may be very difficult to do. In the printing process, for example, alignment of panels from one color to the next is a problem. Also, printed filters don't yet possess the required uniformity of transmission across each pixel. A technical breakthrough is required to provide the registration, color uniformity, low price, and high volume required for flat panel displays. If this doesn't occur, the laborious photolithography technique may limit the number of displays available, and make them high ticket items for the next five years.

2.4.3 EQUIPMENT FOR COLOR FILTER MANUFACTURING

The manufacture of color filters makes use of only some of the equipment described in the previous section. Primarily a photoresist operation at present, color filter manufacturing employs proximity photolithography tools and associated photoprocessing lines for coating, developing, etching and stripping. A typical process employs sputtered chrome and four masking steps to produce the three colors plus black matrix. A transparent overcoat protects the filter array after completion. Spin coating is used for applying the materials.

AMLCD Factory

2.5

2.5.1 THROUGHPUT AND PRODUCTIVITY

Throughput of major equipment is shown in Table 2-16. For the most part, productivity is similar to IC manufacturing equipment. Productivity is a problem especially in PECVD, where amorphous silicon deposition is a bottleneck. However, overall yield problems are more serious, and productivity limitations could be accepted if improvement in material quality and yield could be achieved.

Productivity considerations determine the number of units of each item required in a factory. The current equipment list and number of units is shown in Table 2-17. The table shows that the least productive equipment is for PECVD deposition, and, in this hypothetical factory, 5 units are required for a balanced manufacturing line. For inspection and repair equipment and for assembly equipment, the equipment is listed as 1 item here, and the detailed equipment list is shown separately.

CHAPTER TWO: DISPLAY MANUFACTURING

LIQUID CRYSTAL FLAT PANEL DISPLAYS

Table 2-16 AMLCD Equipment Productivity and Price

Equipment	Throughput (panels/hr)	Concerns	Price (\$M)
PECVD	20-25	particles	2.50-3.20
Sputtering	45-50	particles	2.2-2.6
Coater/Developer	50-60	photoresist consumption	0.2-0.3
Cleaning	60	-	0.2-0.4
Lithography	35-40	stitching accuracy	1.6-1.9
Wet Etch	60	particles	0.25-0.35
Dry Etch	20-25	particles	0.5-1.5
Asher	60	particles	0.3

Table 2-17 AMLCD Production Equipment Categories

Equipment	Number of Units per Fab
Photolithography (stepper or projection)	4
Photoresist Process Lines	6
Wet Etching/Stripping Lines	3
Dry Etching/Ashing Systems	3
Physical Deposition Systems (metal & ITO sputtering)	3
Plasma-enhanced CVD (amorphous Si, silicon nitride)	5
Panel Cleaning Lines	3
In-Process Inspection and Repair	1 - equipment list shown separately
Assembly	1 - equipment list shown separately
Final Test	1

Table 2-18 shows the kinds of test and repair equipment required for TFT panel manufacturing. Some of the items are similar or identical to those used for IC manufacture while others are specifically designed for TFTs. Where equipment is specifically designed for TFTs, it is generally not available at the moment, and