

known by those of ordinary skill in the art for use in preserved formulations, or a combination thereof.

As used herein, the term “alkalizing agent” is intended to mean a compound used to provide alkaline medium, such as for product stability. Such compounds include, by way of example and without limitation, ammonia solution, ammonium carbonate, diethanolamine, monoethanolamine, potassium hydroxide, sodium borate, sodium carbonate, sodium bicarbonate, sodium hydroxide, triethanolamine, diethanolamine, organic amine base, alkaline amino acids and trolamine and others known to those of ordinary skill in the art.

As used herein, the term “acidifying agent” is intended to mean a compound used to provide an acidic medium for product stability. Such compounds include, by way of example and without limitation, acetic acid, acidic amino acids, citric acid, fumaric acid and other alpha hydroxy acids, hydrochloric acid, ascorbic acid, phosphoric acid, sulfuric acid, tartaric acid and nitric acid and others known to those of ordinary skill in the art.

Inclusion of a preservative in the solution is optional, since the formulation is self-preserved by SAE-CD depending upon its concentration in solution. If a conventional preservative is included in the composition, the corticosteroid, such as budesonide, can have a greater binding with the SAE-CD than does a conventional preservative. Nonetheless, a preservative can be further included in the formulation if desired. Preservatives can be used to inhibit microbial growth in the compositions. The amount of preservative is generally that which is necessary to prevent microbial growth in the composition for a storage period of at least six months. As used herein, a preservative is a compound used to at least reduce the rate at which bioburden increases, but preferably maintains bioburden steady or reduces bioburden after contamination has occurred. Such compounds include, by way of example and without limitation, 3-(trimethoxysilyl)propyldimethyloctadecylammonium chloride, stearyldimethylbenzylammonium chloride, 6-acetoxy-2,4-dimethylmetadioxane, alkali metal sorbates and mixtures, ammonium sorbate, BAC, benzalkonium chloride, benzethonium chloride, benzoic acid (and salts), benzyl alcohol, boric acid, bronopol, butyl parabens, C.sub.16 benzalkonium halide compounds, cetrimide, cetyldimethylbenzylammonium chloride, cetylpyridinium bromide, cetylpyridinium chloride, chlorbutanol, chlorhexidine, chlorine dioxide, chlorite components, Chlorobutanol, chlorocresol, chlorohexidine gluconate, chlorohexidine hydrochloride, cresol, distearyldimethylammonium chloride,

dodecylguanidine, dodecylguanidine hydrochloride, domiphen bromide, ethanol, ethyl parabens, guanidines, lauroylisoquinolium bromide, metacresol, Methylparaben, myristylgamma picolinium chloride, paraben mixtures, phenol, phenol derivative, phenoxyethanol, phenylethanol, phenylmercuric acetate, phenylmercuric nitrate, 5 phenylmercuric salts, polyhexmethylenebiguanidine hydrochloride, polymeric quaternary ammonium compounds, potassium sorbate, propylparaben, quaternary ammonium alkylene glycol phospholipid derivatives, quaternary ammonium salts, propyl parabens, sodium sorbate, sorbic acid (and salts), stearyl pentaethoxyammonium chloride, stearyl tolylmethyl-ammonium chloride, sulfites inorganic, thiomersal, thymol, and others 10 known to those of ordinary skill in the art.

As used herein, the term “antioxidant” is intended to mean an agent that inhibits oxidation and thus is used to prevent the deterioration of preparations by the oxidative process. Such compounds include, by way of example and without limitation, acetone, potassium metabisulfite, potassium sulfite, ascorbic acid, ascorbyl palmitate, citric acid, 15 butylated hydroxyanisole, butylated hydroxytoluene, hypophosphorous acid, monothioglycerol, propyl gallate, sodium ascorbate, sodium citrate, sodium sulfide, sodium sulfite, sodium bisulfite, sodium formaldehyde sulfoxylate, thioglycolic acid, EDTA, pentetate, sodium metabisulfite, and others known to those of ordinary skill in the art.

As used herein, the term “buffering agent” is intended to mean a compound used to resist change in pH upon dilution or addition of acid or alkali. Buffers are used in the present compositions to adjust the pH to a range of between about 2 and about 8, about 3 to about 7, or about 4 to about 5. Such compounds include, by way of example and without limitation, acetic acid, sodium acetate, adipic acid, benzoic acid, sodium benzoate, 25 boric acid, sodium borate, citric acid, glycine, maleic acid, monobasic sodium phosphate, dibasic sodium phosphate, HEPES, lactic acid, tartaric acid, potassium metaphosphate, potassium phosphate, monobasic sodium acetate, sodium bicarbonate, tris, sodium tartrate and sodium citrate anhydrous and dihydrate and others known to those of ordinary skill in the art. Other buffers include citric acid/phosphate mixture, acetate, barbital, borate, 30 Britton-Robinson, cacodylate, citrate, collidine, formate, maleate, McIlvaine, phosphate, Prideaux-Ward, succinate, citrate-phosphate-borate (Teorell-Stanhagen), veronal acetate, MES (2-(N-morpholino)ethanesulfonic acid), BIS-TRIS (bis(2-hydroxyethyl)imino-tris(hydroxymethyl)methane), ADA (N-(2-acetamido)-2-iminodiacetic acid), ACES (N-

(carbamoylmethyl)-2-aminoethanesulfonic acid), PIPES (piperazine-N,N'-bis(2-ethanesulfonic acid)), MOPSO (3-(N-morpholino)-2-hydroxypropanesulfonic acid), BIS-TRIS PROPANE (1,3-bis(tris(hydroxymethyl)methylamino)propane), BES (N,N-bis(2-hydroxyethyl)-2-aminoethanesulfonic acid), MOPS (3-(N-morpholino)propanesulfonic acid), TES (N-tris(hydroxymethyl)methyl-2-aminoethanesulfonic acid), HEPES (N-(2-hydroxyethyl)piperazine-N'-(2-ethanesulfonic acid), DIPSO (3-(N,N-bis(2-hydroxyethyl)amino)-2-hydroxypropanesulfonic acid), MOBS (4-(N-morpholino)-butanesulfonic acid), TAPSO (3-(N-tris(hydroxymethyl)methylamino)-2-hydroxypropanesulfonic acid), TRIZMA™ (tris(hydroxymethylaminomethane), HEPPSO (N-(2-hydroxyethyl)piperazine-N'-(2-hydroxypropanesulfonic acid), POPSO (piperazine-N,N'-bis(2-hydroxypropanesulfonic acid)), TEA (triethanolamine), EPPS (N-(2-hydroxyethyl)piperazine-N'-(3-propanesulfonic acid), TRICINE (N-tris(hydroxymethyl)methylglycine), GLY-GLY (glycylglycine), BICINE (N,N-bis(2-hydroxyethyl)glycine), HEPBS (N-(2-hydroxyethyl)piperazine-N'-(4-butanesulfonic acid)), TAPS (N-tris(hydroxymethyl)methyl-3-aminopropanesulfonic acid), AMPD (2-amino-2-methyl-1,3-propanediol), and/or any other buffers known to those of skill in the art.

A complexation-enhancing agent can be added to the compositions of the invention. When such an agent is present, the ratio of cyclodextrin /active agent can be changed. A complexation-enhancing agent is a compound, or compounds, that enhance(s) the complexation of the active agent with the cyclodextrin. Suitable complexation enhancing agents include one or more pharmacologically inert water soluble polymers, hydroxy acids, and other organic compounds typically used in liquid formulations to enhance the complexation of a particular agent with cyclodextrins.

Hydrophilic polymers can be used as complexation-enhancing, solubility-enhancing and/or water activity reducing agents to improve the performance of formulations containing a cyclodextrin. Suitable polymers are disclosed in *Pharmazie* (2001), 56(9), 746-747; *International Journal of Pharmaceutics* (2001), 212(1), 29-40; *Cyclodextrin: From Basic Research to Market*, International Cyclodextrin Symposium, 10th, Ann Arbor, MI, United States, May 21-24, 2000 (2000), 10-15 (Wacker Biochem Corp.: Adrian, Mich.); PCT International Publication No. WO 9942111; *Pharmazie*, 53(11), 733-740 (1998); *Pharm. Technol. Eur.*, 9(5), 26-34 (1997); *J. Pharm. Sci.* 85(10), 1017-1025 (1996); European Patent Application EP0579435; Proceedings of the

International Symposium on Cyclodextrins, 9th, Santiago de Comostela, Spain, May 31-June 3, 1998 (1999), 261-264 (Editor(s): Labandeira, J. J. Torres; Vila-Jato, J. L. Kluwer Academic Publishers, Dordrecht, Neth); *S.T.P. Pharma Sciences* (1999), 9(3), 237-242; ACS Symposium Series (1999), 737(Polysaccharide Applications), 24-45; *Pharmaceutical Research* (1998), 15(11), 1696-1701; *Drug Development and Industrial Pharmacy* (1998), 24(4), 365-370; *International Journal of Pharmaceutics* (1998), 163(1-2), 115-121; Book of Abstracts, 216th ACS National Meeting, Boston, August 23-27 (1998), CELL-016, American Chemical Society; *Journal of Controlled Release*, (1997), 44/1 (95-99); *Pharm.Res.* (1997) 14(11), S203; *Investigative Ophthalmology & Visual Science*, (1996), 37(6), 1199-1203; Proceedings of the International Symposium on Controlled Release of Bioactive Materials (1996), 23rd, 453-454; *Drug Development and Industrial Pharmacy* (1996), 22(5), 401-405; Proceedings of the International Symposium on Cyclodextrins, 8th, Budapest, Mar. 31-Apr. 2, (1996), 373-376. (Editor(s): Szejtli, J.; Szente, L. Kluwer: Dordrecht, Neth.); *Pharmaceutical Sciences* (1996), 2(6), 277-279; *European Journal of Pharmaceutical Sciences*, (1996) 4(SUPPL.), S144; Third European Congress of Pharmaceutical Sciences Edinburgh, Scotland, UK September 15-17, 1996; *Pharmazie*, (1996), 51(1), 39-42; *Eur. J. Pharm. Sci.* (1996), 4(Suppl.), S143; U.S. Patents No. 5,472,954 and No. 5,324,718; *International Journal of Pharmaceutics* (Netherlands), (Dec. 29, 1995) 126, 73-78; Abstracts of Papers of the American Chemical Society, (02 APR 1995) 209(1), 33-CELL; *European Journal of Pharmaceutical Sciences*, (1994) 2, 297-301; *Pharmaceutical Research* (New York), (1994) 11(10), S225; *International Journal of Pharmaceutics* (Netherlands), (Apr 11, 1994) 104, 181-184; and *International Journal of Pharmaceutics* (1994), 110(2), 169-77, the entire disclosures of which are hereby incorporated by reference.

Other suitable polymers are well-known excipients commonly used in the field of pharmaceutical formulations and are included in, for example, *Remington's Pharmaceutical Sciences, 18th Edition*, Alfonso R. Gennaro (editor), Mack Publishing Company, Easton, PA, 1990, pp. 291-294; Alfred Martin, James Swarbrick and Arthur Commarata, *Physical Pharmacy. Physical Chemical Principles in Pharmaceutical Sciences, 3rd edition* (Lea & Febinger, Philadelphia, PA, 1983, pp. 592-638); A.T. Florence and D. Altwood, (*Physicochemical Principles of Pharmacy, 2nd Edition*, MacMillan Press, London, 1988, pp. 281-334. The entire disclosures of the references cited herein are hereby incorporated by references. Still other suitable polymers include

water-soluble natural polymers, water-soluble semi-synthetic polymers (such as the water-soluble derivatives of cellulose) and water-soluble synthetic polymers. The natural polymers include polysaccharides such as inulin, pectin, algin derivatives (e.g. sodium alginate) and agar, and polypeptides such as casein and gelatin. The semi-synthetic polymers include cellulose derivatives such as methylcellulose, hydroxyethylcellulose, hydroxypropyl cellulose, their mixed ethers such as hydroxypropyl methylcellulose and other mixed ethers such as hydroxyethyl ethylcellulose and hydroxypropyl ethylcellulose, hydroxypropyl methylcellulose phthalate and carboxymethylcellulose and its salts, especially sodium carboxymethylcellulose. The synthetic polymers include polyoxyethylene derivatives (polyethylene glycols) and polyvinyl derivatives (polyvinyl alcohol, polyvinylpyrrolidone and polystyrene sulfonate) and various copolymers of acrylic acid (e.g. carbomer). Other natural, semi-synthetic and synthetic polymers not named here which meet the criteria of water solubility, pharmaceutical acceptability and pharmacological inactivity are likewise considered to be within the ambit of the present invention.

An emulsifying agent is intended to mean a compound that aids the formation of an emulsion. An emulsifier can be used to wet the corticosteroid and make it more amenable to dissolution. Emulsifiers for use herein include, but are not limited to, polyoxyethylene sorbitan fatty esters or polysorbates, including, but not limited to, polyethylene sorbitan monooleate (Polysorbate 80), polysorbate 20 (polyoxyethylene (20) sorbitan monolaurate), polysorbate 65 (polyoxyethylene (20) sorbitan tristearate), polyoxyethylene (20) sorbitan mono-oleate, polyoxyethylene (20) sorbitan monopalmitate, polyoxyethylene (20) sorbitan monostearate; lecithins; alginic acid; sodium alginate; potassium alginate; ammonium alginate; calcium alginate; propane-1,2-diol alginate; agar; carrageenan; locust bean gum; guar gum; tragacanth; acacia; xanthan gum; karaya gum; pectin; amidated pectin; ammonium phosphatides; microcrystalline cellulose; methylcellulose; hydroxypropylcellulose; hydroxypropylmethylcellulose; ethylmethylcellulose; carboxymethylcellulose; sodium, potassium and calcium salts of fatty acids; mono-and di-glycerides of fatty acids; acetic acid esters of mono- and di-glycerides of fatty acids; lactic acid esters of mono-and di-glycerides of fatty acids; citric acid esters of mono-and di-glycerides of fatty acids; tartaric acid esters of mono-and di-glycerides of fatty acids; mono-and diacetyltartaric acid esters of mono-and di-glycerides of fatty acids; mixed acetic and tartaric acid esters of mono-and di-glycerides of fatty

acids; sucrose esters of fatty acids; sucroglycerides; polyglycerol esters of fatty acids; polyglycerol esters of polycondensed fatty acids of castor oil; propane-1,2-diol esters of fatty acids; sodium stearyl-2-lactylate; calcium stearyl-2-lactylate; stearyl tartrate; sorbitan monostearate; sorbitan tristearate; sorbitan monolaurate; sorbitan monooleate; 5 sorbitan monopalmitate; extract of quillaia; polyglycerol esters of dimerised fatty acids of soya bean oil; oxidatively polymerised soya bean oil; and pectin extract.

As used herein, the term “stabilizer” is intended to mean a compound used to stabilize the therapeutic agent against physical, chemical, or biochemical process that would reduce the therapeutic activity of the agent. Suitable stabilizers include, by way of 10 example and without limitation, albumin, sialic acid, creatinine, glycine and other amino acids, niacinamide, sodium acetyltryptophonate, zinc oxide, sucrose, glucose, lactose, sorbitol, mannitol, glycerol, polyethylene glycols, sodium caprylate, sodium saccharin and other known to those of ordinary skill in the art.

As used herein, the term “viscosity modifier” is intended to mean a compound or 15 mixture of compounds that can be used to adjust the viscosity of an aqueous liquid composition of the invention. The viscosity modifier can increase or decrease the viscosity. Suitable viscosity modifiers include HPMC, CMC (sodium carboxymethylcellulose), glycerin, PEG and others recognized by artisans in the field. In some embodiments, the composition excludes HPMC.

As used herein, the term “tonicity modifier” is intended to mean a compound or 20 compounds that can be used to adjust the tonicity of the liquid formulation. Suitable tonicity modifiers include glycerin, lactose, mannitol, dextrose, sodium chloride, sodium sulfate, sorbitol, trehalose and others known to those of ordinary skill in the art. Other tonicity modifiers include both inorganic and organic tonicity adjusting agents. Tonicity 25 modifiers include, but are not limited to, ammonium carbonate, ammonium chloride, ammonium lactate, ammonium nitrate, ammonium phosphate, ammonium sulfate, ascorbic acid, bismuth sodium tartrate, boric acid, calcium chloride, calcium disodium edetate, calcium gluconate, calcium lactate, citric acid, dextrose, diethanolamine, dimethylsulfoxide, edetate disodium, edetate trisodium monohydrate, fluorescein sodium, 30 fructose, galactose, glycerin, lactic acid, lactose, magnesium chloride, magnesium sulfate, mannitol, polyethylene glycol, potassium acetate, potassium chlorate, potassium chloride, potassium iodide, potassium nitrate, potassium phosphate, potassium sulfate, propylene glycol, silver nitrate, sodium acetate, sodium bicarbonate, sodium biphosphate, sodium

bisulfite, sodium borate, sodium bromide, sodium cacodylate, sodium carbonate, sodium chloride, sodium citrate, sodium iodide, sodium lactate, sodium metabisulfite, sodium nitrate, sodium nitrite, sodium phosphate, sodium propionate, sodium succinate, sodium sulfate, sodium sulfite, sodium tartrate, sodium thiosulfate, sorbitol, sucrose, tartaric acid, triethanolamine, urea, urethan, uridine and zinc sulfate. In some embodiments, the tonicity of the liquid formulation approximates the tonicity of the tissues in the respiratory tract.

An osmotic agent can be used in the compositions to enhance the overall comfort to the patient upon delivery of the corticosteroid composition. Osmotic agents can be added to adjust the tonicity of SAE-CD containing solutions. Osmolality is related to concentration of SAE-CD in water. At SBE7- β -CD concentrations below about 11-13% w/v, the solutions are hypotonic or hypoosmotic with respect to blood and at SBE7- β -CD concentrations above about 11-13% w/v the SBE7- β -CD containing solutions are hypertonic or hyperosmotic with respect to blood. When red blood cells are exposed to solutions that are hypo- or hypertonic, they can shrink or swell in size, which can lead to hemolysis. SBE-CD is less prone to induce hemolysis than other derivatized cyclodextrins. Suitable osmotic agents include any low molecular weight water-soluble species pharmaceutically approved for nasal delivery such as sodium chloride, lactose and glucose. The formulation of the invention can also include biological salt(s), potassium chloride, or other electrolyte(s).

As used herein, the term “antifoaming agent” is intended to mean a compound or compounds that prevents or reduces the amount of foaming that forms on the surface of the liquid formulation. Suitable antifoaming agents include dimethicone, simethicone, octoxynol, ethanol and others known to those of ordinary skill in the art.

As used herein, the term “bulking agent” is intended to mean a compound used to add bulk to the lyophilized product and/or assist in the control of the properties of the formulation during lyophilization. Such compounds include, by way of example and without limitation, dextran, trehalose, sucrose, polyvinylpyrrolidone, lactose, inositol, sorbitol, dimethylsulfoxide, glycerol, albumin, calcium lactobionate, and others known to those of ordinary skill in the art.

A solubility-enhancing agent or solubility enhancer can be added to the formulation of the invention. A solubility-enhancing agent is a compound, or compounds, that enhance(s) the solubility of the corticosteroid when in an aqueous liquid carrier.

When another solubility enhancing agent is present, the ratio of SAE-CD to corticosteroid can be changed, thereby reducing the amount of SAE-CD required to dissolve the corticosteroid. Suitable solubility enhancing agents include one or more cyclodextrins, cyclodextrin derivatives, SAE-CD, organic solvents, detergents, soaps, surfactant and other organic compounds typically used in parenteral formulations to enhance the solubility of a particular agent. Exemplary solubility enhancers are disclosed in U.S. Patent No. 6,451,339; however, other surfactants used in the pharmaceutical industry can be used in the formulation of the invention. Some suitable cyclodextrin include underivatized cyclodextrins and cyclodextrin derivatives, such as SAE-CD, SAE-CD derivatives, hydroxyalkyl ether cyclodextrin and derivatives, alkyl ether cyclodextrin and derivatives, sulfated cyclodextrin and derivatives, hydroxypropyl- β -cyclodextrin, 2-HP- β -CD, methyl- β -cyclodextrin, carboxyalkyl thioether derivatives, succinyl cyclodextrin and derivatives, and other cyclodextrin suitable for pharmaceutical use. SAE-CD cyclodextrins are particularly advantageous.

Suitable surfactants include phospholipids, among other compounds, which include for example phosphocholines or phosphatidylcholines, in which the phosphate group is additionally esterified with choline, furthermore phosphatidyl ethanolamines, phosphatidyl inositols, lecithins. Other ionic surfactants which can serve as solubility-enhancing agents are, for example, sodium lauryl sulfate, sodium cetylstearyl sulfate, sodium (or calcium or potassium) docusate, medium and long chain fatty acids.

SAE-CD can serve as a taste-masking agent by complexation with poor-tasting molecule. For example, SAE-CD can complex with a bitter or sour tasting active agent in a composition of the invention to reduce the bitterness or sourness of the agent as compared to the uncomplexed active agent. Accordingly, "improved taste" or "taste-masking" is taken to mean a reduction in the bitterness or sourness of a composition or active agent. Active agents can differ in the native bitterness or sourness. For example, olopatadine is known to have reduced bitterness as compared to azelastine. The invention includes taste-masked embodiments, wherein the SAE-CD is complexed with an active agent having reduced bitterness or reduced sourness as compared to another active agent.

In some embodiments, the methods, systems, devices, and compositions of the invention are associated with improved taste of a therapeutic agent as compared to the therapeutic agent alone or in existing formulations. In some embodiments, the improved taste is associated with administration of an antihistamine. In some embodiments, the

improved taste is associated with administration of azelastine. The effectiveness of SAE-CD at masking the taste of a drug can be determined, for example, according to Example 31, which details the procedure used to conduct an electronic tongue study on a composition comprising SBE- β -CD and azelastine.

5 If desired, the composition further comprises an aqueous liquid carrier other than water. Suitable organic solvents that can be used in the formulation include, for example, ethanol, glycerin, poly(ethylene glycol), propylene glycol, poloxamer, aqueous forms thereof, others known to those of ordinary skill in the art and combinations thereof.

10 It should be understood that compounds used in the art of pharmaceutical formulations generally serve a variety of functions or purposes. Thus, if a compound named herein is mentioned only once or is used to define more than one term herein, its purpose or function should not be construed as being limited solely to that named purpose(s) or function(s).

15 A composition can be purged with an inert gas prior to storage to remove substantially all of the oxygen contained in the formulation. In general, the formulation or composition of the invention has a shelf-life of at least 6 months depending upon the intended use.

20 If needed, the SAE-CD-containing formulation can be prepared as a clear aqueous solution that can be sterile filtered through a filter having a pore size of 0.45 μm or less and that is stable and preserved under a variety of storage conditions. The invention thus provides a filtration-sterilized liquid formulation comprising a solution of the invention and a method of sterilizing a solution of the invention by sterile filtration through a filter. Sterile filtration can be done without substantial mass loss of solubilized corticosteroid, meaning less than 5% mass loss.

25 The formulation can be prepared at a temperature at or above 5°C, at or above 25°C, at or above 35°C, at or above 45°C or at or above 50°C. Specific embodiments of the methods of preparing a liquid formulation include those wherein: 1) the method further comprises sterile filtering the formulation through a filtration medium having a pore size of 0.1 microns or larger; 2) the liquid formulation is sterilized by irradiation or autoclaving; and/or 3) the nebulization solution is purged with nitrogen or argon or other
30 inert pharmaceutically acceptable gas prior to storage such that a substantial portion of the oxygen dissolved in, and/or in surface contact with the solution is removed.

An active agent contained within the present formulation can be present as its pharmaceutically acceptable salt. As used herein, “pharmaceutically acceptable salt” refers to derivatives of the disclosed compounds wherein the active agent is modified by reacting it with an acid or base as needed to form an ionically bound pair. Examples of pharmaceutically acceptable salts include conventional non-toxic salts or the quaternary ammonium salts of the parent compound formed, for example, from non-toxic inorganic or organic acids. Suitable non-toxic salts include those derived from inorganic acids such as hydrochloric, hydrobromic, sulfuric, sulfonic, sulfamic, phosphoric, nitric and others known to those of ordinary skill in the art. The salts prepared from organic acids such as amino acids, acetic, propionic, succinic, glycolic, stearic, lactic, malic, tartaric, citric, ascorbic, pamoic, maleic, hydroxymaleic, phenylacetic, glutamic, benzoic, salicylic, sulfanilic, 2-acetoxybenzoic, fumaric, toluenesulfonic, methanesulfonic, ethane disulfonic, oxalic, isethionic, and others known to those of ordinary skill in the art. The pharmaceutically acceptable salts of the present invention can be synthesized from the parent active agent which contains a basic or acidic moiety by conventional chemical methods. Lists of other suitable salts are found in *Remington’s Pharmaceutical Sciences*, 17th. ed., Mack Publishing Company, Easton, PA, 2005, the relevant disclosure of which is hereby incorporated by reference.

The phrase “pharmaceutically acceptable” is employed herein to refer to those compounds, materials, compositions, and/or dosage forms which are, within the scope of sound medical judgment, suitable for use in contact with the tissues of human beings and animals without excessive toxicity, irritation, allergic response, or other problem or complication, commensurate with a reasonable benefit/risk ratio.

As used herein, the term “patient” or “subject” are taken to mean humans and non-humans, such as mammals, for example, cats, dogs, mice, guinea pigs, horses, bovine cows, and sheep.

The utility and therapeutic efficacy of a nasal aqueous liquid composition according to the invention for the treatment of seasonal allergic rhinitis (SAR)/conjunctivitis (SARC) was demonstrated in a clinical trial conducted according to Example 33.

The time to target or peak therapeutic effect is the period of time after administration of a dose that it takes for the active agent to achieve the target or peak therapeutic effect, respectively, in a subject. The onset of a target or desired therapeutic

effect is the point in time that the beginning of the target or desired therapeutic effect is first observed in the subject after administration of a composition.

In some embodiments, the compositions, methods, and systems of the invention relieve non-nasal symptoms sooner and to a greater degree than an aqueous suspension-based formulation comprising the same unit dose of corticosteroid and administered under substantially the same conditions but excluding SAE-CD. In some embodiments, the compositions and systems provide more rapid relief of nasal symptoms than the aqueous suspension based formulation. The compositions and systems of the invention also provide simplified manufacture, improved administered-dose uniformity, and improved taste-masking and odor-masking as compared to the aqueous suspension-based formulation. In some embodiments, the compositions, methods, and systems of the invention provide an enhanced and/or more rapid onset of a target or desired therapeutic effect and/or a more rapid time to target, desired or peak therapeutic effect as compared to the aqueous suspension-based compositions, methods, or systems excluding SAE-CD.

A therapeutic effect will be observed following administration of a composition. The onset of a target or desired therapeutic effect is the point in time that the beginning of the target or desired therapeutic effect is first observed in the subject after administration of a composition. In some embodiments, the onset of a target or desired therapeutic effect generally occurs within 0.1 min to 120 min, 1 min to 90 min, 1 min to 60 min, 1 min to 30 min, 1 min to 20 min, 1 min to 15 min, or 1 min to 10 min after nasal or ophthalmic administration of the composition.

In some embodiments, the time to a target or peak therapeutic effect can occur from minutes to hours after administration. In some embodiments, the time to can occur from 8 to 10 hours, within 1 to 2 days, or within 1 to 2 weeks after nasal or ophthalmic administration of the composition, said administration being conducted according to a dosing regimen as detailed herein.

In some embodiments, the methods, systems, devices, and compositions of the invention comprise a combination of corticosteroid and azelastine with SAE-CD in a solution that is useful for treating nasal, non-nasal, and ocular symptoms. In some embodiments, the symptoms are allergic symptoms resulting from exposure of a subject to an airborne allergen.

A clinical study according to Example 34 was conducted to demonstrate the therapeutic efficacy of a nasal composition comprising budesonide, azelastine

hydrochloride, CAPTISOL and buffer as compared to the sequential administration of RHINOCORT AQUA (RA) and ASTELIN (AST).

In some embodiments, the nasal compositions, systems, and methods of the invention comprising a corticosteroid, SAE-CD and an antihistamine provides a therapeutic effect (clinical benefit) that approximates or is enhanced over the therapeutic effect provided by the separate and sequential nasal administration of: a) an aqueous suspension composition comprising the same unit dose of corticosteroid; and b) an aqueous composition comprising the same unit dose of antihistamine. In some embodiments, the therapeutic effect is relief of nasal, non-nasal and ocular allergic symptoms. In some embodiments, the nasal composition, system and method of the invention provide an improved quality of life in subjects suffering from an allergic disorder, such as SAR and/or SARC.

The compositions, methods, and systems of the invention can provide an enhanced therapeutic effect as compared to a suspension-based aqueous formulation of corticosteroid. The enhanced therapeutic effect can be: 1) enhanced or better relief of non-nasal symptoms (especially ocular symptoms); 2) a more rapid onset of therapeutic effect; 3) a more rapid time to peak or target therapeutic effect; 4) more rapid relief of nasal symptoms; 5) enhanced or better relief of nasal symptoms; 6) more rapid relief of non-nasal symptoms; 7) enhanced quality of life, especially emotional status or practical problems; and/or 8) reduced corticosteroid-related side effects, such as epistaxis, dryness, or burning.

In some embodiments, the corticosteroid solutions of the invention provide more rapid relief of a symptom or disorder, such as an allergic symptom or disorder, when compared with a corticosteroid suspension at the same unit dose and under substantially similar conditions. In some embodiments, the corticosteroid solutions of the invention provide a rate of relief that is about 25%, about 35%, about 45%, about 50%, about 60%, or about 75% more rapid when compared with a corticosteroid suspension at the same unit dose and under substantially similar conditions. In some embodiments, the corticosteroid solutions of the invention provide a rate of relief that is about 1.2-fold greater, about 1.5-fold greater, about 2-fold greater, about 2.5-fold greater, about 3-fold greater, about 4-fold greater, or about 5-fold greater than a corticosteroid suspension suspension at the same unit dose and under substantially similar conditions.

An in vivo study according to Example 41 was conducted in rabbits to compare the ability of budesonide to provide an anti-inflammatory therapeutic effect or other clinical benefit.

5 In some embodiments, the corticosteroid solutions of the methods, systems, devices, and compositions of the present inventions are administered ophthalmically for the treatment of ocular symptoms. In some embodiments, the corticosteroid solutions of the inventions are administered for the treatment of nasal symptoms when administered ophthalmically.

10 In some embodiments, the corticosteroid solutions of the invention provide more rapid relief in the treatment of ocular and nasal symptoms compared to other corticosteroid solutions or suspensions at the same unit dose when administered ophthalmically. In some embodiments, the ocular symptom is inflammation. In some embodiments, the corticosteroid solutions of the invention allow for a more rapid reduction in ocular inflammation compared to other corticosteroid solutions or suspensions when
15 administered ophthalmically. In some embodiments, the corticosteroid solutions of the invention provide more rapid relief of total ocular symptoms based on a Total Ocular Symptom Score (TOSS) using a visual analogue scale (TOSS-VAS) of subjects or a five point scale (0-4) of subjects with allergic conjunctivitis exposed to controlled ragweed pollen using an EEC model compared with other corticosteroid solutions or suspensions at
20 the same unit dose when administered ophthalmically. In some embodiments, the corticosteroid solutions of the invention provide a greater relief of TNSS compared with other corticosteroid solutions or suspensions at the same unit dose when administered ophthalmically. In some embodiments, the corticosteroid solutions of the invention provide more rapid onset of action in the treatment of allergic rhinitis compared with other
25 corticosteroid solutions or suspensions at the same unit dose when administered ophthalmically. In some embodiments, the corticosteroid solutions of the invention provide a reduced dose of corticosteroid to elicit an equivalent or greater therapeutic effect as provided by other corticosteroid solutions or suspensions at higher unit doses when administered ophthalmically. In some embodiments, the corticosteroid solutions of the
30 invention provide improved dose uniformity among separate unit doses compared to unit doses provided by other corticosteroid solutions or suspensions when administered ophthalmically. In some embodiments, the corticosteroid solutions of the invention are more easily manufactured than other corticosteroid solutions or suspensions for

ophthalmic administration. In some embodiments the corticosteroid solution for ophthalmic administration comprises one or more additional therapeutic agents, such as an antihistamine. In some embodiments, the corticosteroid solution additionally comprises azelastine.

5 When comparing the performance of a liquid composition of the invention to the performance of a suspension-based composition, it is assumed that administration of the two compositions will be conducted using the same administration device, the same unit dose or total dose, substantially the same dosing regimen, and/or substantially the same administration procedure.

10 All the various embodiments or options described herein can be combined in any and all variations. The following examples should not be considered exhaustive, but merely illustrative of only a few of the many embodiments contemplated by the present invention.

15

EXAMPLE 1

Exemplary formulations according to the invention were made according to the following general procedures.

Method A

20 Cyclodextrin is dissolved in water (or buffer) to form a solution containing a known concentration of cyclodextrin. This solution is mixed with an active agent in solid, suspension, gel, liquid, paste, powder or other form while mixing, optionally while heating to form a solution.

Method B

25 A known amount of substantially dry cyclodextrin is mixed with a known amount of substantially dry active agent. A liquid is added to the mixture to form a suspension, gel, solution, syrup or paste while mixing, optionally while heating and optionally in the presence of one or more other excipients, to form a solution.

Method C

30 A known amount of substantially dry cyclodextrin is added to a suspension, gel, solution, syrup or paste comprising a known amount of active agent while mixing,

optionally while heating and optionally in the presence of one or more other excipients, to form a solution.

The methods of this example can be modified by the inclusion of a wetting agent in the composition in order to facilitate dissolution and subsequent inclusion complexation of the corticosteroid. A surfactant, soap, detergent or emulsifying agent can be used as a wetting agent.

Method D

To a solution comprising a known concentration or amount of SAE-CD, aqueous liquid carrier, and optionally one or more other excipients, is added a molar excess of the corticosteroid based upon the molar ratio of SAE-CD to corticosteroid at the point of saturated solubility of the corticosteroid, in the presence of the SAE-CD, as determined herein. For example, corticosteroid would be added at a 5%, 10%, 15%, 20%, 25%, 30% or greater molar excess. The components are mixed until equilibration, the point at which there is only a minor change in the concentration of budesonide over a one-hour period of time. Then, the excess corticosteroid is removed leaving behind the target solution of the invention.

The budesonide is added to the SAE-CD-containing solution as either a solid or suspension in an aqueous liquid carrier, which can be water, buffer, aqueous alcohol, aqueous organic solvent or a combination thereof. The alcohol and organic solvent are of a pharmaceutically acceptable grade, such as ethanol, propylene glycol, and others as described herein.

Method E

The SAE-CD and corticosteroid are triturated to form a mixture. Then, an aqueous liquid carrier is added to the mixture form the target solution of the invention.

The trituration can be conducted dry or in the presence of moisture, water, buffer, alcohol, surfactant, organic solvent, glycerin, poly(ethylene glycol), poloxamer, or a combination thereof.

Method F

Any of the methods herein are conducted in the presence of heat, e.g. at a temperature of least 40 °C.

- 87 -

Method G

Any of the methods herein are conducted with cooling, e.g. at a temperature of less than 20 °C or less than 10 °C or less than 5 °C.

Method H

- 5 Any of the methods herein are conducted in the presence of high shear mixing such as with a sonicator, narrow gauge syringe(s), mixer/homogenizer (POLYTRON from KINEMATICA, Europe; FLUKO, Shanghai, China; ULTIMAGRAL from GEA Niro, Inc., Columbia, MD), rotor-stator mixer, or saw tooth mixer.

Method I

- 10 Any of the methods herein are conducted under reduced pressure.

Method J

The aqueous corticosteroid solution can be prepared by diluting a concentrated corticosteroid solution with water, buffer, or other aqueous liquid carrier.

EXAMPLE 2

- 15 The MMD of nebulized solutions containing SBE7- β -CD and budesonide was determined as follows.

Placebo solutions of three different cyclodextrins were prepared at different concentrations. Two mL of the solutions were added to the cup of a Pari LC Plus nebulizer supplied with air from a Pari Proneb Ultra compressor. The particle size of the
20 emitted droplets was determined using a Malvern Mastersizer S laser light scattering instrument.

EXAMPLE 3

- The content of corticosteroid in aqueous solutions containing SAE-CD was determined by HPLC chromatography of aliquots periodically drawn from the liquid in
25 storage.

Citrate-phosphate (McIlvaines) buffer solutions at a pH of 4, 5, 6, 7, or 8 were prepared by mixing various portions of 0.01M citric acid with 0.02 M Na₂HPO₄. These stock solutions contained 5% w/w CAPTISOL. Approximately 250 μ g /mL of budesonide was dissolved in each buffer solution. Aliquots of the solutions were stored at 40 °C, 50

°C and 60 °C. Control samples were stored at 5 °C but are not reported here. HPLC analysis of the samples was performed initially and after 1, 2, and 3 months storage.

The HPLC conditions included:

Instrument:	PE Series 200
Column:	Phenomenex Luna C18(2) 4.6x150 mm 3um
Mobile Phase:	58% Phosphate Buffer pH 3.4/ 39.5% ACN / 2.5% MeOH
Mobile Phase Program:	100% A (isocratic)
Wavelength	240
Flow Rate:	0.6 mL/min
Standard Range:	Seven standards - 1 to 500 µg/mL

5

EXAMPLE 4

The viscosity of aqueous solutions containing SAE-CD was measured using a cone and plate viscometer.

A Brookfield Programmable DV-III+ Rheometer, CPE-40 cone and CPE 40Y plate (Brookfield Engineering Laboratories, Middleboro, MA) was used to make measurements on 0.5mL samples at 1, 2, 3, 5 and 10 rpm. Samples were sheared for approximately 5 revolutions prior to each measurement. This allowed accurate rheological characterization of the samples. The temperature of all samples was equilibrated to 25+/-1 degree centigrade using a double wall viscometer cone supplied with water from an electronically controlled thermostatic circulating water bath (Model, 8001, Fisher Scientific, Pittsburgh, PA). The viscometer was calibrated using 5 and 50 centipoise using silicon oil calibration standards. Viscosity measurements were made at 5 or more rotation speeds to look for shear thinning behavior (viscosities that decrease as the rate of shear increases). Higher rotation speeds result in increased rates of shear.

20

EXAMPLE 5

Nebulizer output rate as a function of SAE-CD concentration was measured according to the following general procedure.

Nebulizer Output was tested using Pari LC Plus Nebulizer with a Pari ProNeb Ultra Air Compressor (Minimum Nebulizer Volume = 2mL, Maximum Nebulizer Volume = 8mL) for solutions containing 43%, 21.5%, 10.75% and 5.15%w/w SBE7-β-CD. Percentage of sample emitted was estimated gravimetrically. The nebulizer cup was weighed before and after nebulization was complete. Nebulization Time was defined as

the duration of time when nebulizer run was started until the time of first sputter. Nebulizer Output Rate was calculated by dividing % Emitted with Nebulization Time.

EXAMPLE 6

Preparation of a solution containing budesonide.

5 A buffer solution containing 3mM Citrate Buffer and 82mM NaCl at pH 4.45 is prepared. ~12.5 grams of CAPTISOL was placed into a 250 mL volumetric flask. ~62.5 mg of budesonide was placed into the same flask. Flask was made to volume with the 3mM citrate buffer/82mM NaCl solution. The flask was well-mixed on a vortexer for 10 minutes and sonicated for 10 minutes. The flask was stirred over weekend with magnetic
10 stirrer. Stirring was stopped after ~62 hours and flask was revortexed and resonicated again for 10 minutes each. The solution was filtered through a 0.22 µm Durapore Millex-GV Millipore syringe filter unit. The first few drops were discarded before filter rest of solution into an amber glass jar with a Teflon-lined screw cap. Sample concentration was ~237 µg/mL.

EXAMPLE 7

Preparation of a solution containing budesonide.

Approximately 5 grams of CAPTISOL was placed into a 100 mL volumetric flask. ~26.3 mg of budesonide was placed into the same flask. The flask was made to volume with the 3mM citrate buffer/82mM NaCl solution. The mixture was well-mixed on a
20 vortexer for 10 minutes and sonicated for 10 minutes. The mixture was stirred overnight with a magnetic stirrer. Stirring was stopped after ~16 hours and flask was revortexed and resonicated again for 10 minutes each. The solution was filtered through 0.22 µm Durapore Millex-GV Millipore syringe filter unit. The first 5 drops were discarded before
25 filter rest of solution into an amber glass jar with a Teflon-lined screw cap. Sample was analyzed to be 233 µg budesonide/mL.

EXAMPLE 8

Preparation of a solution containing budesonide.

The procedure of Example 7 was followed except that 12.5 g of CAPTISOL, 62.5 mg of budesonide and about 250 mL of buffer were used. Sufficient disodium EDTA was

added to prepare a solution having an EDTA concentration of about 0.01 or 0.05 % wt/v EDTA.

EXAMPLE 9

Preparation of a solution containing SAE-CD and budesonide as prepared from a
 5 PULMICORT RESPULES suspension.

Method A.

To the contents of one or more containers of the Pulmicort Respules (nominally 2
 mL of the suspension), about 50 mg (corrected for water content) of CAPTISOL was
 added per mL of Respule and mixed or shaken well for several minutes. After standing
 10 from about 30 minutes to several hours, the solution was used as is for in vitro
 characterization. In addition to budesonide and water, the PULMICORT RESPULE
 (suspension) also contains the following inactive ingredients per the label: citric acid,
 sodium citrate, sodium chloride, disodium EDTA and polysorbate 80.

Method B.

15 Weigh approximately 200 mg amounts of CAPTISOL (corrected for water
 content) into 2-dram amber vials. Into each vial containing the weighed amount of
 CAPTISOL empty the contents of two Pulmicort Respules containers (0.5 mg/2 mL, Lot #
 308016 Feb05) by gently squeezing the deformable plastic container to the last possible
 drop. The Respules were previously swirled to re-suspend the budesonide particles. The
 20 vials are screw capped, mixed vigorously by vortex and then foil wrapped. The material
 can be kept refrigerated until use.

The liquid composition prepared according to any of these methods can be used in
 any known administration device. By converting the suspension to a liquid, an
 improvement in delivery of budesonide (a corticosteroid) is observed.

25

EXAMPLE 10

Other solutions according to the invention can be prepared as detailed below.

Component	Mg per mL (as prepared)		Mg per mL (per target)
	Concentrate A	Concentrate B	Final Solution
Budesonide EP	1	~1.6 (sat'd)	0.250
CAPTISOL	200	200	50

Sodium Citrate tribasic dihydrate	0	0	0.44
Citric Acid	0	0	0.32
Sodium Chloride	0	0	4.8
Disodium EDTA	0	0	0-0.5
Polysorbate 80 (Tween 80)	0	0	0-1
Water	Qs	Qs	QS with buffer containing CAPTISOL or budesonide

- 5 Dilute Concentrate A at a ratio of 1 to 4 with pH 4.5 salinated citrate buffer (4 mM containing 109 mM sodium chloride) to contain 5% w/v CAPTISOL on an anhydrous basis. Filter the diluted concentrate through a 0.22 μ m Millipore Durapore Millex-GV syringe filter unit. Assay the filtered solution by HPLC then add supplemental budesonide as needed to give a solution final concentration of about 250 μ g/mL ($\pm < 5\%$).
- 10 Dilute Concentrate B at a ratio of 1 to 4 with pH 4.5 salinated citrate buffer (4 mM containing 109 mM sodium chloride) to contain 5% w/v CAPTISOL on an anhydrous basis. Filter the diluted concentrate through a 0.22 μ m Millipore Durapore Millex-GV syringe filter unit. Assay the filtered solution by HPLC then dilute further with pH 4.5 salinated citrate buffer (3 mM containing 82 mM sodium chloride containing 5% w/v CAPTISOL) as required to give a final solution concentration of about 250 μ g/mL ($\pm < 5\%$). This technique takes advantage of the excess solid budesonide used to saturate the solution.

15

EXAMPLE 11

Clarity of solutions was determined by visual inspection or instrumentally. A clear solution is at least clear by visual inspection with the unaided eye.

20

EXAMPLE 12

The following method was used to determine the performance of nebulization compositions emitted from a nebulizer.

Two mL of the test CD solution or Pulmicort suspension was accurately pipetted by volumetric pipettes into a clean nebulizer cup prior to starting each experiment. The test nebulizer was assembled and charged with the test solution or suspension according to

25

the manufacturer instructions. The end of the mouthpiece was placed at a height of approximately 18 cm from the platform of the MALVERN MASTERSIZER to the middle point of tip of the nebulizer mouthpiece. A vacuum source was positioned opposite the mouthpiece approximately 6 cm away to scavenge aerosol after sizing. The distance
5 between the mouthpiece and the detector was approximately 8 cm. The center of the mouthpiece was level with the laser beam (or adjusted as appropriate, depending on the individual design of each nebulizer). The laser passed through the center of the emitted cloud when the nebulizer was running. Measurements were manually started 15 seconds into nebulization. Data collection started when beam obscuration reached 10% and was
10 averaged over 15,000 sweeps (30 seconds). Scattered light intensity data on the detector rings was modeled using the "Standard-Wet" model. Channels 1 and 2 were killed due to low relative humidity during measurement to prevent beam steering. The volume diameter of droplets defining 10, 50 (volume median), and 90% of the cumulative volume undersize was determined. (Dv10 is the size below which 10% of the volume of material exists,
15 Dv50 is the size below which 50% of the volume of material exists and Dv90 is the size below which 90% of the volume of material exists.

The procedure above can be practiced with slight modification on a MALVERN SPRAYTEC to determine the particle size of droplets emitted by a nebulizer.

EXAMPLE 13

20 Solutions of budesonide with and without SBE7- β -CD were prepared at two different pHs (4 and 6) and stored at 2 different temperatures (60 °C and 80 °C). Citrate buffers (50mM) at each pH value were prepared by mixing differing portions of 50mM citric acid and 50mM sodium citrate (tribasic, dihydrate) solutions. To achieve a concentration of budesonide in the buffers without SBE7- β -CD sufficient for accurate
25 measurement, the budesonide was dissolved first in 100% ethyl alcohol. An aliquot of the ethanol/budesonide solution was then added drop-wise with stirring to each buffer solution. The theoretical budesonide concentration was 100 μ g/mL with a final ethanolic content of 5% in each buffer. All solution preps and procedures involving budesonide were done in a darkened room under red light. After shaking solutions for 24 hours, both
30 buffer solutions were filtered through Millipore Millex-GV 0.22 μ m syringe filters to remove any solid that had precipitated (no significant amounts observed) from the solutions. The final budesonide concentration was about 50 μ g/mL. Both the pH 4 and 6

solutions were split in two, and solid SBE7- β -CD was added to one of the portions to create solutions with and without 1% w/v SBE7- β -CD at each pH. Each solution was aliquoted into individual amber vials. They were then placed in ovens at 60 °C and 80 °C. Sample vials were removed from the ovens and analyzed by HPLC at 0, 96, 164, and 288 hours. The HPLC assay conditions are summarized below.

Chromatographic Conditions

(Adapted from Hou, S., Hindle, M., and Byron, P. R. A. **Stability-Indicating HPLC Assay Method for Budesonide**. *Journal of Pharmaceutical and Biomedical Analysis*, 2001; 24: 371-380.)

Instrument:	PE Series 200
Column:	Phenomenex Luna C18(2) 4.6x150 mm 3 μ m
Mobile Phase:	58% Phosphate Buffer pH 3.4/ 39.5% ACN / 2.5% MeOH
Mobile Phase Program:	100% A (isocratic)
Wavelength	240 nm
Flow Rate:	0.6 mL/min
Standard Range:	Seven standards - 1 to 500 μ g/mL

EXAMPLE 14

Preparation of solution comprising SAE-CD (10% wt.), budesonide (500 μ g/mL), and azelastine hydrochloride (0.2% wt.).

CAPTISOL (2.37g) was weight into an amber vial. Azelastine hydrochloride (43.8 mg) was weighed into the same vial. PULMICORT NEBUAMPs (10) were mixed vigorously for 1 min. The contents of each NEBUAMP were dispensed into the amber vial containing CAPTISOL and azelastine and mixed by vortexing, shaking, sonication and overnight mixing on a roller mixer to permit equilibration. The resulting solution was clear.

EXAMPLE 15

The temperature stability of the composition of Example 14 was determined as follows.

The solution of Example 14 was divided into vials and grouped and stored at 25°C, 40°C, or 60°C. A control sample was stored at 5°C. The samples were stored for 10 days and two vials were removed for analysis at 0, 3, and 10 days. Assay samples were prepared by drawing one aliquot from each vial, diluting 200 μ L with 800 μ L of mobile phase (see below), and assaying the samples by HPLC according to the European

Pharmacopeia, Monograph 1633E for “azelastine hydrochloride” (version 5.0 corrected 01/2005).

EXAMPLE 16

The pH and temperature stability of an aqueous liquid composition comprising SAE-CD, azelastine, and buffer were determined as follows.

Aqueous solutions comprising azelastine HCl (0.5mg/mL) with and without CAPTISOL (1.75% wt.) were prepared. Stock citrate solutions (sodium citrate (3mM) and citric acid solution (3mM); 500 mL each) were prepared. The citrate solutions were combined and titrated to prepare stock buffered solutions (at least 150 mL each) having a pH of 4, 5, or 6. A stock solution of azelastine hydrochloride (5 mg/mL) in water was prepared. Assay solutions comprising CAPTISOL, azelastine and buffer were prepared by mixing CAPTISOL (1.4 g) and stock solution of azelastine (7.5mL) in stock buffered solution (QS to final volume of 75 mL for each different pH). Assay solutions comprising azelastine and buffer were prepared by mixing stock solution of azelastine (7.5 mL) and stock buffered solution (67.5 mL, or QS to final volume of 75 mL). Six assay solutions were prepared as follows: 1) pH 4--azelastine only; 2) pH 4--azelastine + CAPTISOL; 3) pH 5--azelastine only; 4) pH 5--azelastine + CAPTISOL; 5) pH 6--azelastine only; 6) pH 6--azelastine + CAPTISOL. Portions of each assay solution were stored at 25°C, 40°C, and 60°C for a period of sixteen weeks. Aliquots of the assay solutions were taken at 0, 1, 2, 4, 8, 12, and 16 weeks. The aliquots were assayed by HPLC as described herein. Control samples for each assay solution were stored at 5°C to provide reference points.

EXAMPLE 17

Exemplary compositions of the invention packaged in various multi-dose volume metered dose pump spray devices are made to include the following ingredients in the amounts specified according to the procedure below.

Ingredient	Function	50 μ L Spray	70 μ L Spray	100 μ L Spray	137 μ L Spray
		(mg/mL)	(mg/mL)	(mg/mL)	(mg/mL)
Budesonide	Active Substance	0.64	0.46	0.32	0.234
Captisol	Solubilizer/Stabilizer	96	68	48	36
Disodium edetate,	Antioxidant	0.1	0.1	0.1	0.1
Sodium chloride,	Tonicity modifier	0	27	45	56
Citric acid,	Buffer	0.3	0.3	0.3	0.3
Sodium citrate dihydrate	Buffer	0.5	0.5	0.5	0.5
Polysorbate 80 0.05 mg/mL	Surfactant	optional	optional	optional	optional
Potassium Sorbate 1 mg/mL	Antimicrobial	optional	optional	optional	optional
Sterile water for injection,	Solvent	q.s. to 1.0 mL	q.s. to 1.0 mL	q.s. to 1.0 mL	q.s. to 1.0 mL

Ingredient	Function	50 μ L Spray	70 μ L Spray	100 μ L Spray	137 μ L Spray
		(mg/mL)	(mg/mL)	(mg/mL)	(mg/mL)
Budesonide	Active Substance	0.64	0.46	0.32	0.234
Azelastine HCl	Active Substance	2.74	1.96	1.37	1.00
Captisol	Solubilizer/Stabilizer	128	91	64	48
Disodium edetate,	Antioxidant	0.1	0.1	0.1	0.1
Sodium chloride,	Tonicity modifier	0	27	45	56
Citric acid,	Buffer	0.3	0.3	0.3	0.3
Sodium citrate dihydrate	Buffer	0.5	0.5	0.5	0.5
Polysorbate 80 0.05 mg/mL	Surfactant	optional	optional	optional	optional
Potassium Sorbate 1 mg/mL	Antimicrobial	optional	optional	optional	optional
Sterile water for injection,	Solvent	q.s. to 1.0 mL	q.s. to 1.0 mL	q.s. to 1.0 mL	q.s. to 1.0 mL

- Compositions comprising the specified concentrations of ingredients are prepared and packaged into multi-dose metered volume pump spray devices. The compositions optionally comprise potassium sorbate at a concentration of about 1 mg/mL and/or polysorbate 80 at a concentration of about 0.005%. Each package contains approximately 120 doses plus an overfill of the composition. Suitable packages for the specified spray volumes include:
1. 50 μ L Spray volume: 9 mL of composition in a 10 mL bottle; for example 20242 02 001 diagnostic 6/8 amber glass type 1 400 20 neck finish bottle fitted with Nasal Spray Pump having a 50 μ L dose volume, 20/400 screw closure, and 42.0mm dip tube length;
 2. 70 μ L Spray volume: 13 mL of composition in a 15 mL amber glass bottle;

3. 100 μ L Spray volume: 17 mL of composition in a 20 mL amber glass vial;
4. 137 μ L Spray volume: 24 mL of composition in a 24 mL amber glass vial.

EXAMPLE 18

Comparative evaluation of various forms of SAE-CD in the solubilization of corticosteroid derivatives.

The solubility of beclomethasone dipropionate (BDP), beclomethasone 17-monopropionate (B17P), beclomethasone 21-monopropionate (B21P) and beclomethasone (unesterified) in solutions containing CAPTISOL and various SBE_n γ -CD was evaluated. BDP, B17P and B21P were obtained from Hovione. Beclomethasone was obtained from Spectrum Chemicals. CAPTISOL, SBE(3.4) γ -CD, SBE(5.23) γ -CD and SBE(6.1) γ -CD were provided by CyDex, Inc. (Lenexa, KS). γ -CD was obtained from Wacker Chemical Co. SBE(5.24) γ -CD and SBE(7.5) γ -CD were provided by the University of Kansas.

A 0.04M solution of each selected CD was prepared. Each form of beclomethasone required 2mL of CD solution, therefore the 0.04M solutions were prepared in 20 or 25 mL volumetric flasks in duplicate (N=2). The following table indicates the amount of each CD used after accounting for the content of water in each CD.

CD	MW (g/mole)	mg of CD (volume)
SBE(6.7) β -CD	2194.6	2297.0 (25mL)
γ -CD	1297	1433.0 (25mL)
SBE(3.4) γ -CD	1834.9	1891.6 (25mL)
SBE(5.24) γ -CD	2119.5	1745.7 (20mL)
SBE(6.1) γ -CD	2261.9	1866.8 (20mL)
SBE(7.5) γ -CD	2483.3	2560.0 (25mL)

Beclomethasone forms were weighed in amounts in excess of the anticipated solubilities directly into 2-dram Teflon-lined screw-capped vials. These amounts typically provided approximately 6 mg/mL of solids. Each vial then received 2 mL of the appropriate CD solution. The vials were vortexed and sonicated for about 10 minutes to aid in wetting the solids with the fluid. The vials were then wrapped in aluminum foil to protect from light and placed on a lab quake for equilibration. The vials were visually inspected periodically to assure that the solids were adequately being wetted and in contact

with the fluid. The time points for sampling were at 24 hrs for all samples and 72 hours for BDP only.

Solutions of SBE(6.1) γ -CD were prepared at 0.04, 0.08, and 0.1M and solutions of SBE (5.23) γ -CD were prepared at only 0.04 and 0.08M. Beclomethasone dipropionate was weighed in amounts in excess of the anticipated solubilities directly into 2-dram teflon-lined screw-capped vials. These amounts typically provided approximately 2 mg/mL of solids. Each vial then received 2 mL of the appropriate CD solution (N = 1). The vials were vortexed and sonicated for about 10 minutes to aid in wetting the solids with the fluid. The vials were then wrapped in aluminum foil to protect from light and placed on a lab quake for a five-day equilibration.

Solutions of γ -CD were prepared at 0.01 and 0.02M. Beclomethasone dipropionate was weighed in amounts in excess of the anticipated solubilities directly into 2-dram teflon-lined screw-capped vials. These amounts typically provided approximately 2 mg/mL of solids. Each vial then received 2 mLs of the γ -CD solution (N = 2). A solution was also prepared to measure the intrinsic solubility of BDP using HPLC grade water in place of the CD. The samples were wrapped in foil and placed on a lab quake for five days.

At the end of the equilibration time for each stage, the vials were centrifuged and 1 mL of the supernatant removed. The removed supernatant was then filtered using the Durapore PVDF 0.22 μ m syringe filter (discarded first few drops), and diluted with the mobile phase to an appropriate concentration within the standard curve. The samples were then analyzed by HPLC to determine concentration of solubilized corticosteroid. The data are detailed below.

CD	Beclomethasone dipropionate (µg/mL)	Beclomethasone 17-mono-propionate (µg/mL)	Beclomethasone 21-mono-propionate (µg/mL)	Beclomethasone (unesterified) (µg/mL)
SBE _{3,4} γ-CD	0.04M →336.8	0.04M →10621.6	0.04M →172.6	0.04M →11360.2
SBE _{5,24} γ-CD	0.04M → 267.0	0.04M →9500.8	0.04M →139.8	0.04M →10949.9
SBE _{6,1} γ-CD	0.04M →243.8	0.04M →11666.9	0.04M →153.8	0.04M →11007.0
SBE _{7,5} γ-CD	0.04M → 168.5	0.04M →8539.1	0.04M →122.4	0.04M →9635.2
SBE _{6,7} β-CD	0.04M →60.4	0.04M → 6799.6	0.04M → 50.6	0.04M → 6927.0
γ-CD	0.04M →105.8	0.04M →136.9	0.04M →9.4	0.04M →114.8

The survey study shows that in the presence of SBE(3.4) γ-CD (0.04M), all of the forms of beclomethasone were at or near their highest solubilities. B17P, the active metabolite of BDP, has the highest solubility of the esterified beclomethasone forms in any of the derivatized CDs. The results indicate that SBE-γ-CD complexes with beclomethasone dipropionate better than CAPTISOL or γ-CD alone. Of the SAE-CD derivatives evaluated, the optimal degree of substitution of the SBE γ-CD that provides the greatest enhancement in solubility of BDP is DS = 3.4, and solubility decreases almost linearly as the degree of substitution increases. This is true for both the 24 hr and 5 day equilibration times. In terms of BDP solubilization with SAE-CD: SBE(3.4)γ-CD > SBE(5.2)γ-CD > SBE(6.1)γ-CD > SBE(7.5)γ-CD > γ-CD > CAPTISOL (SBE7-β-CD). The data is summarized in FIG. 5. Therefore, it has been determined that SAE-γ-CD cyclodextrin derivatives are unexpectedly better at solubilizing corticosteroids than are SAE-β-CD derivatives. Formulations based upon SAE-γ-CD are suitable for use in the compositions of the invention.

EXAMPLE 19

Determination of the phase solubility of budesonide in the presence of SAE-CD and azelastine hydrochloride.

A stock solution of citrate buffer (3 mM, pH 4.5) was prepared. Stock solutions of CAPTISOL in buffer having CAPTISOL present in the varying concentrations (10mM, 20mM, 30mM, and 40mM) were prepared by mixing appropriate amounts of CAPTISOL and the buffer stock solution. The stock solutions of CAPTISOL in buffer were used to
 5 prepare stock solutions of azelastine HCl/CAPTISOL/buffer having 1mg/mL, 1.37mg/mL, 1.96mg/mL, or 2.74mg/mL azelastine HCl. Budesonide (at a concentration of 2 mg/mL) was added to the various stock solutions of azelastine HCl/ CAPTISOL/ buffer and mixed and allowed to equilibrate at ambient temperature for a period of four days. Any budesonide remaining suspended in the solutions was removed by filtration and the
 10 concentration of budesonide in each solution measured by HPLC as described herein. The results are depicted in FIG. 11A.

The above procedure was repeated with 10 mM, 15 mM and 20 mM solutions of SBE- γ -CD and only one concentration of azelastine HCl (2.74 mg/mL). The data are summarized in FIG. 11B.

15

EXAMPLE 20

Exemplary compositions of the invention packaged in various multi-dose volume metered dose pump spray devices and nebulizers are made to include the following ingredients in the amounts specified according to the procedure below.

Ingredient ¹	Function	For a 50	For a 70	For a 100	200 μ L	5000 μ L
		μ L Spray	μ L Spray	μ L Spray	Ampoule	Ampoule
		(mg/mL)	(mg/mL)	(mg/mL)	(mg/mL)	(mg/mL)
Mometasone Furoate	Active Substance	1.0	0.71	0.50	1.00	0.1
Olopatadine HCl	Active Substance	13.3	9.5	6.65	26.6	1.3
SBE γ -CD	Solubilizer-Stabilizer Nominal/Practical amts	452/500	323/429	226/300	452/500	45.2/60
Disodium edetate, dihydrate	Antioxidant	0.1	0.1	0.1	0.1	0.1
Citric acid,	Buffer	0.3	0.3	0.3	0.3	0.3
Sodium citrate dihydrate	Buffer	0.5	0.5	0.5	0.5	0.5
Sterile water for injection,	Solvent	q.s. to 1.0 mL	q.s. to 1.0 mL	q.s. to 1.0 mL	q.s. to 1.0 mL	q.s. to 1.0 mL

To prepare the above formulation, the mometasone furoate and olopatadine HCl are dissolved using SBE(6.1) γ -CD and citrate buffer at about pH 4.5. Vigorous mixing and sonication may be required for a day or more under an inert atmosphere to effect total dissolution. If after assaying the solution it is determined to be below the desired target
5 for the active ingredients, additional active ingredient can be added to the solution and stirring continued. Once both drugs have dissolved completely in the CD solution, confirmed by assay, the product is filtered using a 0.22 μ m PVDF filter. The solution is then dispensed under an inert atmosphere into a preservative free multidose container fitted with a suitable pump spray or filled into blow-fill-seal LDPE containers for use in a
10 suitable nebulizer or as a drop. Optionally, compositions could contain potassium sorbate present at a concentration of about 1 mg/mL and or polysorbate 80 present at a concentration of about 0.005% and be filled in suitable multi dose containers and fitted with a suitable metering pump spray device.

Each package contains approximately 120 doses plus an overfill as defined herein.
15 Suitable packages for the specified spray volumes include:

1. 50 μ L Spray volume: 9 mL of composition in a 10 mL bottle; for example 20242 02 001 diagnostic 6/8 amber glass type 1 400 20 neck finish bottle fitted with Nasal Spray Pump having a 50 μ L dose volume, 20/400 screw closure, and 42.0mm dip tube length;
- 20 2. 70 μ L Spray volume: 13 mL of composition in a 15 mL amber glass bottle;
3. 100 μ L Spray volume: 17 mL of composition in a 20 mL amber glass vial;
4. 200 μ L ampoule: a single blow-fill-seal LDPE (or comparable substance ampoule used for nebulization);
- 25 5. 5000 μ L ampoule: a single blow-fill-seal LDPE (or comparable substance ampoule used for nebulization).

EXAMPLE 21

Evaluation of the AERONEB GO nebulizer versus a RAINDROP nebulizer with a solution comprising budesonide, aqueous liquid carrier and SAE-CD.

The AERONEB GO nebulizer (AEROGEN Inc., Mountainview, California) is
30 detailed in U.S. Pregrant Publication No. 2005-011514 to Power et al. (Application USSN 10/833,932 filed April 27, 2004), PCT International Publication No. WO 2005/009323 to Aerogen, Inc. et al. (PCT Application No. PCT/US2004/021268 filed July 6, 2004), and

European Application No. EP 16426276, the entire disclosures of which are hereby incorporated by reference.

The RAINDROP nebulizer is available from Nellcor (Tyco Healthcare).

The solution of the invention used for this study was prepared according to
5 Example 28.

Characterization of droplet size distribution of an aerosolized solution using a cascade impactor was determined according to Example 26.

Determination of total drug output and drug output rate from a nebulizer containing a liquid of the invention was determined according to Example 27.

10

EXAMPLE 22

Evaluation of the pulsating membrane nebulizer of U.S. Patent No. 6,962,151 with a solution comprising budesonide, aqueous liquid carrier and SAE-CD. Inertial Impaction Characterization of Tc^{99m}-DTPA Labelled CAPTISOL-ENABLED Budesonide Aerosols Generated via a Pari Electronic Nebulizer

15

The nebulizer detailed in U.S. Patent No. 6,962,151, is also described in PCT International Application No. PCT/US00/29541 filed October 27, 2000, and U.S. Application Serial No. 11/269,783 filed November 7, 2005.

20

Aerosol characterization was conducted by standard *in vitro* inertial impaction tests using an Andersen Cascade Impactor (ACI). Technetium-99m (^{99m}Tc), in the form of diethylenetriaminepenta-acetic acid (DTPA, GE Healthcare), was added to the CAPTISOL-ENABLED Budesonide Nasal Solution (CEBUD). The suitability of ^{99m}Tc-DTPA to function as a surrogate for budesonide in CEBUD preparations was validated in the course of an earlier clinical trial. Preparation of the budesonide solution formulation for testing was conducted as per the description below. It was calculated that
25 approximately 10MBq of ^{99m}Tc should be added to the budesonide formulation (11.05g) on the day of testing, in order to provide sufficient activity for *in vitro* imaging.

30

Two Pari electronic vibrating membrane nebulizers were used. At the core of this electronic nebulizer is a stainless steel membrane with thousands of laser drilled holes. Laser drilling allows flexibility to customize particle size, ensure reproducibility, and maintain a high output rate with smaller particles. The perforated membrane is vibrated at high frequencies in a resonant "bending" mode which yields high particle output rates. The nebulizer provides rapid drug delivery, efficiency, ideal particle sizing, low residual

volume, and optimal performance matched to the drug formulation (See Rajiv Dhand, *Respiratory Care* 2002;(12): 1406 – 1416). Approximately 0.5 mL of drug solution was loaded and subsequently delivered via each nebulizer on 3 separate occasions. Runs 1, 3 and 5 were conducted with Device 1 and runs 2, 4 and 6 were conducted with Device 2.

5 *Pre-dose*

On each occasion, prior to dose delivery, the filled nebulizer was imaged for 60 seconds on Head I of the dual head gamma camera (Axis, Philips Medical Systems). Also, the nebulizers were weighed before and after addition of the budesonide formulation.

10 *Inertial impaction testing*

The nebulizer was positioned at the USP (United States Pharmacopoeia) inlet of the ACI and a flow rate of 28.3 L/min was drawn through the impactor using a vacuum pump. Flow through the impactor was started prior to activation of the electronic nebulizer. A stopwatch was used in order to measure the duration of dose delivery.

15 The ACI test conditions were the same as those used for Pari LC Plus air-jet nebulizer evaluation in the course of the earlier clinical study.

Following deposition the USP throat was removed from the ACI and imaged for 120 seconds. The collection plates were removed from the impactor and placed on Head I of the gamma camera and imaged for 120 seconds. The plates were subsequently washed and dried before conduct of further impaction tests.

20

Post-dose

On each occasion, the nebulizer weight was recorded after delivery of the dose. The nebulizer was imaged as described below.

25 *Image Processing*

A rectangular ROI was applied to image to the nebulizer pre-dose. This ROI was then re-applied to image the nebulizer after dose delivery.

A rectangular ROI was also applied to the USP Inlet image.

30 A circular ROI was drawn around collection plate 0, copied and placed around plate 1. This was repeated for plates 2-7 and the filter. A rectangular ROI was also drawn to assess the background counts. Raw counts were corrected for background activity and adjusted to counts per minute (cpm).

Aerosol performance is characterized in the table, in terms of the fine particle fraction (FPF) i.e. % emitted dose with a particle size $< 5.8\mu\text{m}$, mass median aerodynamic diameter (MMAD), geometric standard deviation (GSD) and the nebulization delivery time.

5 *CEBUD Preparation*

The expelled contents of five Pulmicort Respules (1mg/mL) were combined together. CAPTISOL (165 mg) on a dried basis was added per Respule used to the combined contents of the commercial suspension to provide a CAPTISOL concentration of about 7.5 %w/v.

10 The mixture was vortexed briefly to disperse and dissolve the CAPTISOL. Then placed on a roller-bed mixer and allowed to mix for two-four or several hours. Aliquots of the equilibrated mixture were used to recover any budesonide retained in the original Respule container, and the recombined together. The mixture was the further equilibrated overnight (~20 hours) on the roller-bed mixer. After visually checking that all the
15 suspended solids had dissolved, the required volume of 99m Tc-D5PA / saline solution (provided by Medical Physical Department, UHW) was added. So about 180 μl of the Radiolabel solution was added to the CAPTISOL-ENABLED Budesonide Nasal Solution and vortexed briefly.

EXAMPLE 23

20 Determination of the phase solubility curve for corticosteroid dissolution with SAE-CD.

The solubility of corticosteroid solutions containing SAECD was determined by HPLC chromatography of aliquots from equilibrated filtered or centrifuged corticosteroid solutions as follows.

25 SAE-CD/steroid solutions were prepared by weighing dry solids of SAE-CD (to provide 0.04 molar) and excess steroid drug (6 mg/mL) together into a screw-capped vial. A volume of water was aliquoted to each vial (separate vial for each steroid). Intrinsic solubility was determined by weighing excess steroid (6 mg/mL) and adding a volume of water in the absence of CD. Vials were capped, initially vortexed and sonicated.
30 were then placed on a roller-mixer (model: SRT2; Manufacturer: Stuart Scientific; Serial number: R000100052) or rocker/mixer (Model: LabQuake; Manufacturer: Barnstead/ThermoLyne; Serial number: 1104010438202). Higher excesses of solid steroid

(up to 10 mg/mL) were then added to any vial where the liquid contents clarified overnight (e.g. prednisolone, hydrocortisone, and prednisone). Samples were rolled and mixed on the roller or rocker for 72 hours. At various times during the equilibration, samples were additionally vortexed or sonicated briefly (up to 30 minutes). After the designated equilibration time, samples were filtered (0.22 μm, 25 mm, Duropore – PVDF, manufacturer: Millipore) into clean vials except for the intrinsic solubility sample for Beclomethasone Dipropionate which was centrifuged and the supernatant transferred to a clean vial. Samples were analyzed by conventional HPLC methods. The results are detailed below.

10

-CD	[CD] M	[Fluticasone] x10 ⁵ M		[Mometasone] x10 ⁵ M		[Budesonide] x10 ⁵ M	[Triamcinolone acetonide] x10 ⁵ M
		as propionate	non esterified	As furoate	non esterified		
H ₂ O	NA	0.39	0.16	1.82	0.00	6.59	3.56
β	0.015M			1.36	12.9	81.3	
(SBE) _{6,7} β	0.0465	5.41	126.4	16.4	121.7	254.8	457.0
	0.0950	7.99	215.9	31.1	226.1	428.1	1023.3
(SBE) _{2,4} β	0.04	1.70	12.8				
	0.08	2.46					
(SPE) ₇ β	0.04	1.05	93.9	7.23	122.4		
	0.08	2.12	151.2	10.8	223.3	241.6	

Solubility of selected steroids enhanced by alpha-cyclodextrins

-CD	[CD] M	[Fluticasone] x10 ⁵ M		[Mometasone] x10 ⁵ M		[Budesonide] x10 ⁵ M	[Triamcinolone acetonide] x10 ⁵ M
		as propionate	non esterified	as furoate	non esterified		
H ₂ O	NA	0.39	0.16	1.82	0.00	6.59	3.56
A	0.04			0.00	8.4		
	0.08			0.27	28.5		
(SBE) ₇ α	0.04	8.37		30.1	55.0	348.1	
	0.08	11.4		35.5	116.9	597.9	

15

Solubility of selected steroids enhanced by gamma-cyclodextrins

-CD	[CD] M	[Fluticasone] x10 ⁵ M		[Mometasone] x10 ⁵ M		[Budesonide] x10 ⁵ M	[Triamcinolone acetonide] x10 ⁵ M
		as propionate	non esterified	as furoate	non esterified		
H ₂ O	NA	0.39	0.16	1.82	0.00	6.59	3.56

-CD	[CD] M	[Fluticasone] x10 ⁵ M		[Mometasone] x10 ⁵ M		[Budesonide] x10 ⁵ M	[Triamcin- olone acetoneide] x10 ⁵ M
		as propionate	non esterified	as furoate	non esterified		
Γ	0.035	73.5		14.1	2.71	10.1	197.8
	0.1	22.1	82.2	65.8	0.09	4.1	138.6
(SBE) _{5.2}	0.04	79.12				375.8	
γ	0.1	215.3	1440.4	93.9	889.2	861.6	
(SBE) _{6.1}	0.04	51.82	575.6	41.5	841.1	306.6	1059.5
	0.08	120.8	949.0	92.9	1423.1	698.8	2386.1
(SBE) _{9.7}	0.04	54.5					
	0.075	103.1	895.0	94.0	889.6	453.4	
(SPE) _{5.4}	0.04	71.7	759.5	28.7		400.9	
	0.08	140.1	1387.8	51.3	1467.1	774.2	

The phase solubility data, determined according to this example or Example 18, can be used to determine the molar ratio of SAE-CD to corticosteroid necessary to dissolve the corticosteroid in an aqueous medium. The table below details relevant molar ratio data.

5

Corticosteroid	SAE-CD	Approximate Molar Ratio at Saturated Solubility of Corticosteroid* (SAE-CD : corticosteroid)
Beclomethasone dipropionate	SAE-β-CD	358
Beclomethasone dipropionate	SAE-γ-CD	86
Budesonide	SAE-β-CD	16
Budesonide	SAE-γ-CD	13 (SBE6.1), 10.8 (SBE5.2), 10.1 (SPE5.4)
Budesonide	SAE-α-CD	12
X-1 corticosteroid	SAE-β-CD	190
X-1 corticosteroid	SAE-γ-CD	1390
Flunisolide	SAE-β-CD	16
Flunisolide	SAE-γ-CD	9
Fluticasone	SAE-β-CD	32
Fluticasone Propionate	SAE-β-CD	797
Fluticasone Propionate	SAE-γ-CD	78
Fluticasone Propionate	SAE-α-CD	501
Hydrocortisone	SAE-β-CD	1.6
Hydrocortisone	SAE-γ-CD	1.8
Methylprednisolone	SAE-β-CD	5.7
Methylprednisolone	SAE-γ-CD	3.4
Mometasone	SAE-α-CD	73
Mometasone	SAE-β-CD	33

Corticosteroid	SAE-CD	Approximate Molar Ratio at Saturated Solubility of Corticosteroid* (SAE-CD : corticosteroid)
Mometasone furoate	SAE- α -CD	141
Mometasone furoate	SAE- β -CD	274
Mometasone furoate	SAE- γ -CD	101
Prednisolone	SAE- β -CD	2.2
Prednisolone	SAE- γ -CD	2
Prednisone	SAE- β -CD	2.2
Prednisone	SAE- γ -CD	3.2
Triamcinolone acetonide	SAE- β -CD	8.8
Triamcinolone acetonide	SAE- γ -CD	3.8

*This value was determined in the presence of SAE-CD under the conditions detailed in Example 18 or this example.

EXAMPLE 24

Exemplary compositions of the invention packaged in various multi-dose volume metered dose pump spray devices are made to include the following ingredients in the amounts specified according to the procedure below.

Ingredient ¹	Function	50 μ L Spray	70 μ L Spray	100 μ L Spray	200 μ L Ampule	5000 μ L Ampule
		(mg/mL)	(mg/mL)	(mg/mL)	(mg/mL)	(mg/mL)
Fluticasone Propionate	Active Substance	1.0	0.71	0.50	1.00	0.1
Cetirizine HCl	Active Substance	22	15.7	11	11	0.22
SBE γ -CD	Solubilizer-Stabilizer nominal/practical	452/500	323/429	226/300	452/500	45.2/60.0
Disodium edetate, dihydrate	Antioxidant	0.1	0.1	0.1	0.1	0.1
Citric acid,	Buffer	0.3	0.3	0.3	0.3	0.3
Sodium citrate dihydrate	Buffer	0.5	0.5	0.5	0.5	0.5
Sterile water for injection,	Solvent	q.s. to 1.0 mL	q.s. to 1.0 mL	q.s. to 1.0 mL	q.s. to 1.0 mL	q.s. to 1.0 mL

To prepare the above formulation, the fluticasone propionate and cetirizine HCl are dissolved using SBE γ -CD and citrate buffer at about pH 4.5 to 5. Vigorous mixing and sonication may be required for a day or more under an inert atmosphere to effect total dissolution. If after assaying the solution it is determined to be below the desired target for the active ingredients, additional active ingredient can be added to the solution and stirring continued. Once both drugs have dissolved completely in the CD solution,

confirmed by assay, the product is filtered using a 0.22 μ m PVDF filter. The solution is then dispensed under an inert atmosphere into a preservative free multidose container fitted with a suitable pump spray or filled into blow-fill-seal LDPE containers for use in a suitable nebulizer or as drops. Optionally, compositions can contain potassium sorbate present at a concentration of about 1 mg/mL and or polysorbate 80 present at a concentration of about 0.005% and be filled in suitable multi dose containers and fitted with a suitable metering pump spray device.

Suitable packaging is detailed in Example 20. The packaging can be in a preservative free pump spray system such as the Advanced Preservative Free system from Pfeiffer, or the Freepod from Valois, or in a single use pump spray device such as the Pfeiffer Bidose System or Unitdose System. For the nebulized solutions the Kurve ViaNase™ or another comparable nasal nebulizer device could be used.

EXAMPLE 25

A composition comprising a corticosteroid and antifungal agent is prepared as follows.

The following ingredients are combined in the amounts indicated.

Ingredient	Function	1 mL vial	2 mL vial	5 mL vial
		(mg/mL)	(mg/ 2 mL)	(mg/ 5 mL)
Budesonide	Active Substance	0.05	0.1	0.25
Voriconazole	Active Substance	10	20	50
Captisol	Solubilizer/Stabilizer	165	330	825
Disodium edetate dehydrate	Antioxidant	0.1	0.2	0.5
Citric acid,	Buffer	0.3	0.6	1.5
Sodium citrate dihydrate	Buffer	0.5	1.0	2.5
Sterile water for injection*	Solvent	q.s. to 1.0 mL	q.s. to 2.0 mL	q.s. to 5.0 mL

* The water is removed during processing by lyophilization or spray drying or other suitable drying technique to form a powdered composition. Hence the contents are reconstituted just prior to use.

EXAMPLE 26

A composition comprising a corticosteroid and antimicrobial agent is prepared as follows.

Method A.

Ingredient	Function	For 50 μ L	For 70 μ L	For 100	200 μ L	5000 μ L
		Spray	Spray	μ L Spray	Ampoule	Ampoule
		(mg/mL)	(mg/mL)	(mg/mL)	(mg/mL)	(mg/mL)
Budesonide	Active Substance	0.64	0.46	0.32	0.16	0.0064
Azithromycin	Active Substance	0.4	0.29	0.2	0.1	0.004
Captisol	Solubilizer/ Stabilizer	64	46	32	16	0.64
Disodium edetate dehydrate	Antioxidant	0.1	0.1	0.1	0.1	0.1
Citric acid,	Buffer	0.3	0.3	0.3	0.3	0.3
Sodium citrate dehydrate	Buffer	0.5	0.5	0.5	0.5	0.5
Sterile water for injection	Solvent	q.s. to 1.0 mL	q.s. to 1.0 mL	q.s. to 1.0 mL	q.s. to 1.0 mL	q.s. to 1.0 mL

To prepare the above formulation the budesonide and azithromycin is dissolved using Captisol and citrate buffer at about pH 4.5. Vigorous mixing and sonication may be required for a day or more under an inert atmosphere to effect total dissolution. If after assaying the solution it is determined to be below the desired target for the active ingredients, additional active ingredient can be added to the solution and stirring continued. Once both drugs have dissolved completely in the CD solution, confirmed by assay, the product is filtered using a 0.22 μ m PVDF filter. The solution can then be dispensed under an inert atmosphere into a preservative free multidose container fitted with a suitable pump spray or filled into blow-fill-seal LDPE containers for use in a suitable nebulizer or as a drop. Optionally, compositions can contain potassium sorbate present at a concentration of about 1 mg/mL and or polysorbate 80 present at a concentration of about 0.005% and be filled in suitable multi dose containers and fitted with a suitable metering pump spray device. Suitable packaging is detailed in Example 24.

Method B.

Ingredient	Function	1 mL vial	2 mL vial	5 mL vial
		(mg/mL)	(mg/mL)	(mg/mL)
Budesonide	Active Substance	0.05	0.1	0.25
Azithromycin	Active Substance	10	20	100
Captisol	Solubilizer/Stabilizer	7.5	15	37.5
Disodium edetate dihydrate	Antioxidant	0.1	0.2	0.5
Citric acid,	Buffer	0.3	0.6	1.5
Sodium citrate dihydrate	Buffer	0.5	1.0	2.5
Sterile water for injection*	Solvent	q.s. to 1.0 mL	q.s. to 2.0 mL	q.s. to 5.0 mL

5 *The water is removed during processing by lyophilization or spray drying or other suitable drying technique to prepare a powdered composition. Hence the contents are reconstituted just prior to use.

EXAMPLE 27

A powdered composition of budesonide and azelastine can be prepared as follows.

The following ingredients are combined in the amounts indicated to prepare an active composition.

Ingredient	Function	Amount needed
		(mg/mL)
Budesonide	Active Substance	0.457
Azelastine HCL	Active Substance	1.96
Captisol	Solubilizer/Stabilizer	100
Disodium edetate, dihydrate	Antioxidant	0.1 (0.05 to 0.15)
Citric acid	Buffer	0.3
Sodium citrate dihydrate	Buffer	0.5 (0.45 to 0.55)
Sterile water for injection,*	Solvent	q.s. to 1 mL

10 * Water is removed during processing by lyophilization or spray drying or other suitable technique. If necessary, the concentration used for the processing method can be adjusted to assist in achieving the desired particle size.

The budesonide and azelastine HCL are dissolved in the Captisol and citrate buffer (about pH 4.5) using a vigorous stirring method. During processing and packaging the liquid product is further protected using an inert atmosphere. In addition the water used for the process may be sparged with nitrogen to reduce oxygen. Once both drugs are dissolved, the solution is lyophilized using a suitable method that will produce a stable, uniform cake. The lyophilized product is then sized to obtain an average particle size of $D_v(50)$ between 10 – 100 μm or about 65 μm as the active composition.

The active composition can be mixed with a bulking agent to prepare a powder formulation for administration with an administration device capable of emitting and nasally delivering the powder. The powder formulation can be prepared according to the table below.

Ingredient	Function	20 mg Powder Nasal Aerosol	50 mg Powder Nasal Aerosol
Actives Composition (see below)	Active Substances (Includes: budesonide, azelastine)	7.225 mg (0.032 mg, 0.137 mg)	7.225 mg (0.032 mg, 0.137 mg)
Lactose	Diluent/Bulking Agent	12.775 mg	42.775 mg

The following procedure can be used. A bulking agent, such as lactose suitable for inhalation (Lactohale®), is dry mixed with the sized lyophilized product to provide a total administered amount of 20 to 50 mg as needed for a unit dose powder nasal spray such as the Monopowder (Valois) or DirectHaler™ (DirectHaler).

EXAMPLE 28

Preparation of a liquid formulation comprising SAE-CD and budesonide, optionally containing Tween.

A 3mM citrate buffer at pH 4.5 was added to 2 grams of CAPTISOL and 25 mg of budesonide in a serum vial to make the final volume 10 mL. The suspension was well mixed by vortexing and sonication. A 20% stock solution of CAPTISOL without budesonide was also prepared in 3mM citrate buffer. These mixtures, along with the buffer were sealed in separate vials and autoclaved using the 20-minute hold at 121 °C cycle. HPLC analysis of the clear budesonide solution showed the concentration was 2100 $\mu\text{g/mL}$. The 20% CAPTISOL stock solution was used to dilute the sample to 2000

µg/mL. A portion of the above resulting solution was optionally diluted with an equal volume of the 3mM citrate buffer. HPLC analysis showed the final concentration was 990 µg of budesonide/mL.

The Tween could be added to the above solution as follows. A solution of 0.02% Tween was prepared with the autoclaved buffer only solution to form a Tween stock solution for use as a diluent for the above solutions. The dilutions for the 10% CAPTISOL/1 mg/mL budesonide were done by weight. Approximately 9 grams of the 20% captisol/2000 µg/mL was mixed with ~9 grams of either the autoclaved buffer only solution or the autoclaved buffer/0.02% Tween solution. These solutions were well-mixed, filtered and reassayed by HPLC.

The budesonide concentrations of the above formulations were found to be 986 µg/mL for the solution without Tween and 962 µg/mL for the solution with Tween.

The solutions can be nebulized with any nebulizer; however, with an AERx nebulizer, an initial sample volume of 50 µl can be used. Administration of this solution with the nebulizer makes it feasible for a therapeutic dose to be administered to a subject in a single puff (a single full inspiration by a subject) via nebulization.

EXAMPLE 29

Preparation and dissolution of a lyophilized formulation comprising SAE-CD and budesonide.

An excess of budesonide, 3.5 mg/mL, was added to 3L of 30% CAPTISOL in 3 mM citrate buffer containing 0.1 mg/mL EDTA. After mixing for 2 days, an additional 1 mg/mL budesonide was added and equilibrated an additional 4 days. The preparation was filtered through a 0.22 µ Durapore filter and placed in three stainless steel trays in a freeze dryer. The solution was frozen at -30 °C for one hour and lyophilized over 30 hours to remove essentially all the water. The lyophile was powdered, screened and the powder transferred to a plastic bottle. The final composition contained 8.2 mg budesonide per gram of powder.

When approximately 65 mg of powder was added to 2 mL of water, an essentially clear solution containing the same amount of budesonide as in the reference suspension product was rapidly obtained.

EXAMPLE 30

Preparation of an aqueous liquid formulation comprising SAE-CD, ethanol and budesonide.

CAPTISOL/Ethanol solutions were prepared by making a stock CAPTISOL solution at 22.2% (~0.1 M) w/v which was diluted with either ethanol or water in varying amounts to create four solutions of 0, 1, 2, 5 % ethanol and about 20% w/v CAPTISOL. CAPTISOL/Ethanol/Budesonide solutions were prepared by adding dry Budesonide (2.5 mg/mL) to a volume of the prepared CAPTISOL/ethanol solutions and then these were equilibrated on a Labquake for 72 hours. These solutions were filtered (Duro pore syringe filters) and analyzed by HPLC to determine the concentration ($\mu\text{g/mL}$) of budesonide dissolved in the formulation.

EXAMPLE 31

An electronic tongue study can be conducted as follows to determine the effectiveness of SAE-CD at masking the bitter taste of an active agent, such as azelastine.

The e-tongue (Astree II, Alpha M.O.S., Toulouse, France) has been used to demonstrate an increasing change in the taste of azelastine HCl solution upon the addition of increasing amounts of captisol. Solutions containing 2 mg/mL azelastine HCL in 3 mM, pH=4 citrate buffer, with different amounts of captisol were prepared. The e-tongue uses a seven-sensor probe assembly to detect dissolved organic and inorganic compounds. The probes consist of a silicon transistor with proprietary organic coatings, which govern the probe's sensitivity and selectivity. Measurement is potentiometric, with readings taken against an Ag/AgCl reference electrode. Samples are placed in an autosampler carousel where the electrodes are introduced into each sample. Each probe is cross-selective to allow coverage of full taste profile. The system samples, quantifies, digitizes, and records potentiometer readings. Taste cognition happens not in the probe, but in the computer, where the e-tongue's statistical software interprets the sensor data into taste patterns. The distance from the azelastine HCL in buffer to the solutions containing 5%, 10% or 15% captisol were 334.03, 418.96, and 491.76 respectively indicating a large change in taste.

EXAMPLE 32

To investigate how the incorporation of CAPTISOL at 5% w/v into Pulmicort Respules impact performance of different types of nebulizers.

The emitted dose of budesonide from four different nebulizers (PARI LC PLUS (air jet), OMRON MICROAIR NE-U22, AIRSEP MYSTIQUE(ultrasonic), AEROGEN AERONEB) was determined. The package insert-approved Pari air jet system was used as the benchmark to judge performance of the other nebulizers. The emitted dose was from 1.25 to 3.7 times higher when CAPTISOL was added to the budesonide suspension. The Emitted dose (ED) was determined by:

- 1) Drawing the nebulized formulations through a 300 mL glass filter apparatus at 15 l/min, and collecting drug on double or triple layers of glass fiber depth filter and the interior walls. Collection was stopped every two minutes, the budesonide quantitatively recovered, and filters were changed to prevent filter saturation or alterations in airflow. Budesonide recovery was quantified by HPLC; and/or
- 2) Summing the amount of budesonide on the cascade impactor stages after nebulization.

The results are detailed below. (ND means “not determined.”)

Formulation	Total Delivered (ED) (µg, mean & SD), Filter ¹	Total Delivered (ED) (µg, mean & SD), Impactor ²
Pari LC Plus (Air Jet) Listed in the Pulmicort package insert		
Pulmicort	171.5 ± 6.3	137.8 ±14.9
Pulmicort + 5% CAPTISOL	247.4 ± 11.3	172.4 ± 6.6
Omron MicroAir NE-U22		
Pulmicort	179.9 ± 17.2	168.8 ±30.1
Pulmicort + 5% CAPTISOL	380.1 ± 8.5	349.6 ±10.0
AirSep Mystique (Ultrasonic)		
Pulmicort	32.9 ± 6.4	ND*
Pulmicort + 5% CAPTISOL	120.8 ± 19.6	ND*
Aerogen AeroNeb		
Pulmicort	90.7 ± 4.5	ND*
Pulmicort + 5% CAPTISOL	301.2 ± 19.5	ND*

EXAMPLE 33

A clinical trial was conducted to evaluate the performance of a formulation of the invention in the treatment of nasal symptoms and non-nasal symptoms caused by exposure of subjects to an allergen.

5 Three aqueous based formulations were made: Solution A- comprising CAPTISOL, budesonide and aqueous liquid carrier; Suspension B- comprising RHINOCORT AQUA suspension of budesonide in aqueous liquid carrier; and Solution C (placebo)- comprising buffered saline. Solution A was made by mixing two NEBUAMPS (500 µg/mL nominal) to a bottle containing 348 mg CAPTISOL, followed by mixing
10 overnight to form a solution containing 424 µg/mL of budesonide and 75 mg/mL of CAPTISOL in a total volume of 4.4 mL. Solution B was purchased and used as is (32 µg of budesonide per spray) using a spray volume of 50 µl with the supplied valve. Bottles containing Solutions A and C were equipped with a 70 µl Pfeiffer spray valve. Bottles were masked prior to use. Solutions A and B were administered at a dose of 32 µg per
15 spray.

The bulk solution concentration of budesonide in Solution A ranged from 418 - 439 µg/mL with an average of 432 ± 6 µg/mL. Based upon HPLC analysis, each spray of Solution A contained about 31. µg of budesonide.

Clinical protocol.

20 A randomized, double-blind, placebo-controlled, single-center, three-way cross-over study was conducted to compare the relative efficacy of budesonide, administered via nasal spray using Solution A and Solution B, with Solution C as the placebo control, in the treatment of SAR in an environmental exposure chamber. Sixty five subjects were enrolled in the study and exposed to ragweed pollen using an EEC model. The total nasal
25 symptom score (TNSS) and total non-nasal symptom score (TNNSS) for each subject was determined. A graphical summary of the study protocol is depicted in FIG. 7. Patients were exposed to 3000 to 4000 particles per cubic meter of ragweed pollen using an Environmental Exposure Chamber model of the disease. After the initial exposure to pollen, patients were then treated with Solution A (CAPTISOL, budesonide, aqueous
30 carrier solution), Suspension B (RHINOCORT AQUA: budesonide, aqueous carrier suspension), or Solution C (saline placebo) in a crossover design. Each patient remained

in the chamber exposed to pollen and rated their nasal symptom and their non-nasal symptoms over a period of 10 hours.

Objectives of the study were to: 1) assess the onset of action of Solution A and Solution B as compared to placebo; 2) compare the tolerance of each as determined by patient questionnaire and adverse events recorded; and 3) compare the effect of the three solutions on the EEC-specific Quality of Life Questionnaire (EEC-QOLQ).

This was a randomized, double-blind, placebo-controlled, single-center, 3- way cross-over study with three periods of two-four 3h priming visits followed by a 12h treatment visit. Following an initial 30-minute exposure to ragweed pollen in the EEC, the patients evaluated four nasal symptoms (itchy nose, runny nose, congestion and sneezing) and four non-nasal symptoms (itchy/gritty eyes, tearing/watery eyes, red/burning eyes, and itchy ears/palate) every 30 minutes for 1.5 hours to determine adequate baseline symptoms. Each symptom was rated on a scale of 0 to 3 (none, mild, moderate, and severe). Patients who met the predetermined minimum TNSS score of 6 out of a maximum of 12, including a minimum score of 2 out of 3 for runny nose on the last two diary cards prior to treatment, were randomized to receive one of three treatments in a double-blind manner. Patients who did not meet the predetermined TNSS were not dosed and were withdrawn from the study.

Following administration of the study drug, the patients were asked to assess their NSS (nasal symptom score), OSS (ocular symptom score), and NNSS (non-nasal symptom score) at 15, 30, 45, 60, 90 and 120 minutes post dosing; then every hour up to 10 hours post-dose. During the entire time the patients were in the EEC, they were exposed to ragweed pollen at a concentration of 3500 ± 500 particles per m^3 .

Patients rated nasal symptoms (rhinorrhea, nasal congestion, nasal itchiness, and sneezing) and non-nasal symptoms (itchy/gritty eyes, tearing/watery eyes, red/burning eyes, itchy ears and palate). Area under the curve (AUC) was calculated based on the mean change from baseline TNSS and TNNSS and was compared using analysis of covariance. Secondary efficacy assessed the onset of action of CAPTISOL-ENABLED Budesonide compared to RHINOCORT AQUA and placebo. The TNSS and TNNSS scores were then totaled. This data was evaluated to determine efficacy and speed of action.

The effect of CAPTISOL-ENABLED Budesonide compared to placebo on ocular symptoms was determined. The mean AUC for itchy/gritty eyes demonstrated significant

efficacy of CAPTISOL-ENABLED budesonide (-4.21 ± 7.00) over placebo (-2.10 ± 6.62) ($p=0.042$). The mean AUC for tearing/watery eyes also demonstrated significant efficacy of CAPTISOL-ENABLED budesonide (-3.05 ± 7.08) over placebo (-1.67 ± 6.66) ($p=0.047$). Unlike CAPTISOL-ENABLED budesonide, micronized suspension (RHINOCORT AQUA) did not demonstrate significant efficacy compared to placebo in ocular symptoms. The effect of CAPTISOL-ENABLED budesonide compared to placebo on itchy/gritty eyes was greatest at timepoints 1.5, 2 and 3 hr post-dose with changes from baseline of -0.70 ± 0.84 ($p=0.031$), -0.67 ± 0.83 ($p=0.020$) and -0.58 ± 0.83 ($p=0.044$), respectively. Similarly, the effect on tearing/watery eyes was greatest at 3 hr with changes from baseline of -0.55 ± 0.89 ($p=0.004$) and the effect on red/burning eyes was greatest at 0.5, 1 and 2 hr with changes from baseline of -0.47 ± 0.74 ($p=0.010$), -0.58 ± 0.88 ($p=0.030$) and -0.55 ± 0.97 ($p=0.022$), respectively. Based on the mean change from baseline, the onset of action for CAPTISOL-ENABLED budesonide for improvement in itchy/gritty eyes was 1.5 hr. CAPTISOL-ENABLED budesonide also demonstrated significance on itchy/gritty eyes over RHINOCORT AQUA at 0.5 hr ($p=0.008$) and 0.75 hr ($p=0.014$). The data for these symptoms is summarized in FIGS. 6E-6G.

The mean AUC TNSS was significant for CAPTISOL-ENABLED Budesonide (-18.02 ± 22.7) versus placebo (-11.12 ± 23.1) ($p=0.036$). At 0.25h, 0.5h and 0.75h, the mean change from baseline TNSS was greater for CAPTISOL-ENABLED Budesonide (-1.22 , -2.11 , -2.27 respectively) than for RHINOCORT AQUA (-0.87 , -1.44 , -1.73 , respectively) with an onset of action for ocular symptoms at 0.5h. RHINOCORT AQUA had no onset of action for ocular symptoms. Overall TNNSS AUC was significant ($p=0.012$) for CAPTISOL-ENABLED Budesonide (mean decrease of -16.61 ± 27.3) compared to placebo (-7.62 ± 24.0) (p values <0.05). Of note, at 0.5h, 0.75h and 1h, the changes from baseline for the CAPTISOL-ENABLED Budesonide were -1.90 ± 2.41 , -2.03 ± 2.92 and -2.41 ± 3.11 , respectively (all p values <0.05 compared to RHINOCORT AQUA and placebo). The onset of action of CAPTISOL-ENABLED Budesonide versus RHINOCORT AQUA and placebo was significantly different at 0.5h-1h (p values <0.05). No deaths or clinically significant adverse events were reported in this study. The CAPTISOL-ENABLED Budesonide reduced TOSS versus placebo (-11.40 ± 20.5 vs -5.38 ± 19.0 $p<0.05$) while RHINOCORT AQUA did not (-8.57 ± 23.1). Further, each ocular symptom of itchy/gritty eyes and tearing/watery eyes demonstrated significant efficacy of CAPTISOL-ENABLED budesonide over placebo while RHINOCORT AQUA did not for

any ocular symptom. The onset of action for CAPTISOL-ENABLED budesonide on TOSS was 1.5 hr. The average TOSS is shown as a function of time in FIG. 6D.

The data are depicted in FIGS. 6A-6G and summarized in the table below.

Time Point (hour)	CE-Budesonide Nasal Solution (N=65)		RHINOCORT AQUA (N=65)		Placebo (N=65)	
	Mean	SE	Mean	SE	Mean	SE
0	0		0		0	
0.25	-1.22	0.32	-0.87	0.26	-0.85	0.25
0.5	-2.11	0.32	-1.44	0.32	-1.33	0.32
0.75	-2.27	0.35	-1.73	0.33	-1.72	0.36
1	-2.16	0.36	-2	0.36	-1.84	0.36
1.5	-2.37	0.34	-2.25	0.39	-1.78	0.34
2	-2.48	0.34	-2.32	0.41	-1.79	0.39
3	-2.14	0.35	-2.43	0.42	-1.67	0.36
4	-2.3	0.37	-2.1	0.4	-1.21	0.36
5	-1.81	0.35	-1.94	0.43	-1.22	0.37
6	-1.56	0.34	-1.63	0.41	-0.98	0.33
7	-1.65	0.33	-1.73	0.44	-0.93	0.33
8	-1.76	0.35	-1.9	0.45	-0.65	0.3
9	-1.59	0.34	-1.62	0.44	-0.62	0.34
10	-1.3	0.35	-1.43	0.41	-0.61	0.32

5

The table below includes a summary of the TNNSS data for the study.

Time Point (hour)	CE-Budesonide Nasal Solution (N=65)		RHINOCORT AQUA (N=65)		Placebo (N=65)	
	Mean	SE	Mean	SE	Mean	SE
0	0		0		0	
0.25	-1.11	0.31	-0.63	0.28	-0.48	0.24
0.5	-1.9	0.3	-0.9	0.33	-1.02	0.3
0.75	-2.03	0.37	-1.22	0.36	-1.16	0.33
1	-2.41	0.39	-1.43	0.38	-1.55	0.37
1.5	-2.4	0.38	-1.78	0.42	-1.48	0.36
2	-2.38	0.39	-1.59	0.41	-1.19	0.35
3	-2.11	0.37	-1.89	0.44	-1.04	0.35
4	-1.76	0.39	-1.41	0.42	-0.92	0.35
5	-1.73	0.37	-1.38	0.45	-0.73	0.36
6	-1.51	0.41	-1.14	0.42	-0.65	0.35

7	-1.38	0.44	-1.14	0.44	-0.58	0.34
8	-1.43	0.44	-1.13	0.43	-0.68	0.36
9	-1.3	0.41	-0.84	0.45	-0.36	0.34
10	-1.13	0.4	-0.68	0.44	-0.38	0.34

The efficacy, as determined from the area under the TNSS rating-time curve (AUC), for Solution A and Suspension B was better than placebo. There was little difference in efficacy between Solution A and Suspension B although the median score for Solution A was better. Also, nasal itchiness trended better for Solution A than for Suspension B or Solution C.

The efficacy, based on TNNSS AUC, shows that Solution A was better than Solution C, while Suspension B was equivalent to Solution C. Overall, Solution A was substantially better than Solution C in three out of the four non-nasal categories and trended better than Solution C in the fourth non-nasal category.

The initial reduction in TNSS was greatest for Solution A. This shows that the speed of action of Solution A was faster than either Suspension B or Solution C. Even though it was faster, the reduction in TNSS lasted as long as Suspension B.

The Onset of Action in reducing TNNSS was determined to be 0.5 hours for Solution A. Suspension B never met the previously established criterion.

Captisol-Enabled Budesonide reduced non-nasal symptom scores at 30 minutes. This effect was not observed with Rhinocort Aqua. There was no significant difference in the efficacy of Captisol-Enabled Budesonide and Rhinocort Aqua for the primary efficacy variable of TNSS. The mean AUC TNSS illustrates a significant treatment effect for both Captisol-Enabled Budesonide versus placebo and Rhinocort Aqua versus placebo. Captisol-Enabled Budesonide is a well tolerated, effective treatment for SAR.

EEC-QOLQ

The EEC-QOLQ consisted of the following questions by way of which subjects rated their overall symptoms before and after administration of the three solutions.

EEC-RQOL Questionnaire

How bothered by each of the following symptoms have you been during your stay in the EEC?
(Circle one number per question)

	Not troubled	Hardly troubled	Somewhat troubled	Moderately troubled	Quite a bit troubled	Very troubled	Extremely troubled
Non-nose/eye symptoms							
1. Lethargy, fatigue, exhaustion	0	1	2	3	4	5	6
2. Headaches	0	1	2	3	4	5	6
3. Nausea	0	1	2	3	4	5	6
4. Coughing	0	1	2	3	4	5	6
5. Thirst or dryness	0	1	2	3	4	5	6
6. Difficulties swallowing	0	1	2	3	4	5	6
7. Reduced productivity	0	1	2	3	4	5	6
8. General Body Aching	0	1	2	3	4	5	6
9. Plugged and/or popping ears	0	1	2	3	4	5	6
10. Feeling worn out (physically)	0	1	2	3	4	5	6
Practical problems							
11. Need to rub nose/eyes	0	1	2	3	4	5	6
12. Need to blow nose repeatedly	0	1	2	3	4	5	6
Emotional							
13. Restlessness	0	1	2	3	4	5	6
14. Irritability	0	1	2	3	4	5	6
15. Lack of concentration	0	1	2	3	4	5	6

The EEC-RQOLQ consists of Non-nose/Eye Symptoms, Practical Problems, and Emotional domains to assess the QOL experienced by patients in the EEC. The higher the score, the worse patients feel. The Practical Problems domain is important in the EEC-

RQOLQ as it assesses the need to rub nose/eyes and to blow nose repeatedly, thus having an impact on daily activity.

Baseline was defined as the QOL questionnaire administered prior to EEC entry, after exposure in the EEC and after treatment. Comparisons between treatments were completed using ANCOVA. The EEC-RQOLQ was administered at -0.75 hours pre-dose, and at 2, 6 and 10 hours post-dose. Quality of life was improved in patients treated with CAPTISOL-ENABLED Budesonide compared to placebo in all domains. The mean change from baseline in EEC-RQOLQ scores for CAPTISOL-ENABLED Budesonide versus placebo were, for each domain, respectively: Emotional: 2h: -0.3; -0.1; 6h: 0.1; 0.3; 10h: 0.4; 0.4. Non-nose/Eye symptoms 2h:-0.1; 0.1; 6h: 0.1; 0.3; 10h: 0.3; 0.5. Practical Problems: 2h: -0.9; -0.2 (p=0.008); 6h: -0.5; 0.1 (p=0.016), 10h: -0.3; 0.3 (p=0.019). The effects of the three solutions on the EEC-QOLQ are summarized in FIGS. 9A to 9C. Subjects receiving CAPTISOL-ENABLED budesonide demonstrated improved QOL in the Emotional Domain and Practical Problems Domain.

This study demonstrates that this EEC-RQOLQ is a good indicator of QOL in the EEC. Practical Problems is an important domain in the EEC-RQOLQ as it assesses the need to rub nose/eyes and to blow nose repeatedly, thus having an impact on daily activity. QOL scores in this domain were significantly improved in patients treated with CAPTISOL-ENABLED Budesonide compared to placebo.

EXAMPLE 34

A clinical trial was conducted to evaluate the performance of a combination composition of the invention in the treatment of nasal symptoms and non-nasal symptoms caused by exposure of subjects to an allergen.

Four aqueous based formulations were made: Solution A- comprising CAPTISOL, budesonide, azelastine hydrochloride, and aqueous liquid carrier; Suspension B- comprising RHINOCORT AQUA suspension of budesonide in aqueous liquid carrier; Solution C- comprising ASTELIN solution of azelastine hydrochloride in aqueous liquid carrier, and Solution D (placebo)- comprising buffered saline. Solution A was made by mixing twenty NEBUAMPS (500 µg/mL nominal) to a bottle containing 4.71 mg CAPTISOL and 87.6 mg azelastine hydrochloride followed by mixing overnight to form a solution containing 424 µg/mL of budesonide and 100 mg/mL of CAPTISOL. A 4 mL portion of the solution was placed in a smaller bottle fitted with a spray valve. Solution B

was purchased and used as is (32 µg of budesonide per spray) using a spray volume of 50 µl with the supplied valve. Solution C was purchased, poured into a smaller bottle and used with the supplied valve. Bottles containing Solutions A and D were equipped with a 70 µl Pfeiffer spray valve. Bottles were masked prior to use.

5 Clinical protocol.

A Randomized, Double-Blind, Placebo-Controlled, Three-Way Cross-Over Study to Compare the Relative Efficacy of CAPTISOL-ENABLED Budesonide + Azelastine Nasal Spray (Single Solution) and RHINOCORT AQUA + ASTELIN Nasal Spray (Two Separate Solutions) against Placebo Nasal Spray Solution in the Treatment of Allergic
10 Rhinitis in an Environmental Exposure Chamber (EEC) Model

All study drugs were administered as one spray in each nostril. The test treatment (CAPTISOL-ENABLED Budesonide + Azelastine Nasal Solution) were administered along with a placebo in a blinded fashion ensuring that the CAPTISOL-ENABLED formulation is administered first. The reference treatment (RHINOCORT AQUA Nasal
15 Spray + ASTELIN Nasal Spray) were administered in a blinded fashion ensuring that the ASTELIN Nasal Spray formulation is administered first. Two bottles were used for Treatment C (the placebo treatment). All study medications were administered intranasally using metered-dose nasal spray pumps. In this particular study, the allergic symptoms were due to allergic rhinitis and rhinoconjunctivitis.

20 Subjects enrolled in the study were exposed to ragweed pollen using an EEC model. The nasal symptoms, non-nasal symptoms, and quality of life for each subject were determined.

After passing the initial Screening Visit (Visit 1), which will occur within 30 days prior to randomization (Visit 3), patients attended two 3-hour Priming Visits (Visits 2a and
25 2b) in the EEC. During the Priming Visits, patients will be exposed to ragweed pollen at an average session concentration of approximately 3500 ± 500 particles per m^3 for a total duration of approximately 3 hours. Following an initial 30-minute exposure, patients were asked to record their instantaneous nasal symptom scores (NSS) and non-nasal symptom scores (NNSS) every 30 minutes for 2.5 hours. Patients were required to meet a minimum
30 threshold response on one Priming Visit to be eligible to be randomized on Treatment Day 1 (Visit 3). The minimum threshold is a TNSS of 6 units, including a score of at least 2 for congestion on at least one diary card on at least one priming visit.

Patients were not permitted to use rescue medications throughout the study. Use of rescue medications would result in removal from the study at the discretion of the investigator. Patients were monitored for adverse events throughout the exposure sessions.

On Treatment Day 1 (Visit 3), patients reported to the clinic approximately 1 hour
5 prior to entry into the EEC. The patients were questioned regarding changes in their health and concomitant medications. All patients entered the EEC within an approximate 10-minute window and were exposed to ragweed pollen in the EEC for a period of 12 hours.

Over the first 1.5 hours in the EEC, the patients evaluated their nasal and non-nasal
10 symptoms every 30 minutes to determine adequate baseline symptoms. Patients who met the predetermined minimum TNSS of 6 units, including a minimum score of 2 for congestion on at least one diary card prior to treatment, were randomized to receive one of three treatments in a double-blind manner. Patients who did not meet the predetermined TNSS were not dosed and were withdrawn from the study.

Following administration of the study drug, patients were asked to assess their
15 nasal and ocular symptoms (TSS, TNSS and TOSS) at 10, 20, 40, 60, 90 and 120 minutes post dose, then every hour up to 10 hours post-dose. During the entire time (a total of about 12 hours) patients were in the EEC, they will be exposed to ragweed pollen controlled at an average session concentration of approximately 3500 ± 500 particles per m^3 . An EEC-RQLQ was administered prior to entering the EEC, at -0.75 hours pre-dose,
20 and post-dose at 2, 6 and 10 hours. At the end of the session, patients were asked to globally assess the study drug efficacy compared to how they felt prior to its administration (using a 7-point scale).

Patients were asked to return to the EEC for two priming visits prior to each of
25 Treatment Days 2 and 3. However, patients were not required to achieve a minimum threshold response on these follow-up priming visits (Visits 4a and 4b and Visits 6a and 6b).

The procedures for Treatment Days 2 and 3 (Visits 5 and 7) was the same as for
30 Treatment Day 1 described above, except that patients did not need to meet the predetermined minimum TNSS to proceed in the study. There was a washout period of at least 10 days between treatment periods.

The total duration of a patient's participation in this study did not exceed 75 days.

The primary objective of this study was to evaluate the relative efficacy of
CAPTISOL-ENABLED Budesonide + Azelastine Nasal Spray Solution and

RHINOCORT AQUA + ASTELIN Nasal Spray compared to Placebo using Total Nasal Symptom Score (TNSS) in patients with SAR exposed to controlled ragweed pollen using an EEC model.

The secondary objectives were to evaluate the relative efficacy of:

- 5 • CAPTISOL-ENABLED Budesonide + Azelastine Nasal Spray (Single Solution) and Budesonide + Azelastine Nasal Spray (Two Separate Solutions) compared to Placebo by evaluating Total Symptom Score (TSS) and Total Ocular Symptom Score (TOSS)

- 10 • The three study treatments on an EEC - Rhinoconjunctivitis Quality of Life Questionnaire (EEC-RQLQ).

- The three study treatments on the global rating score.

The questions included in the Rhinoconjunctivitis Quality of Life Questionnaire for use in the Environmental Exposure Chamber (RQLQ-EEC) were developed using focus groups and are used in the current study as a secondary efficacy measurement.

- 15 Patients will be asked to complete the RQLQ-EEC 5 times at each treatment visit, once before entering the EEC, 3 times while in the EEC, and once following the completion of the final Symptom Diary Card in the EEC. The RQLQ-EEC is administered before entering the EEC and during the EEC is divided into 3 domains: non-nose/eye symptoms (10 questions), practical problems (2 questions), and emotions (3 questions). The non-
20 nose/eye symptoms and practical problems domains will be scored between 0 (not troubled) and 6 (extremely troubled), and the emotions domain will be scored between 0 (none of the time) and 6 (all of the time). The mean score of the 3 domains will yield an overall quality-of-life score. The RQLQ-EEC administered at the end of the EEC session
25 assessment will be scored between 0 (very much better) and 6 (very much worse).

Patients rated nasal symptoms (rhinorrhea, nasal congestion, nasal itchiness, and sneezing) and non-nasal symptoms (itchy/gritty eyes, tearing/watery eyes, red/burning eyes, itchy ears and palate).

- 30 The severity of the nasal and non-nasal symptoms of allergic rhinitis was recorded on a diary card using the severity rating scale shown below. The nasal and non-nasal symptoms are as follows: 1) nasal: runny nose (anterior rhinorrhea/postnasal drainage), itchy nose, nasal congestion (stuffy nose) and sneezing; 2) non-nasal: itchy/gritty eyes,

red/burning eyes, tearing/watery eyes, itchy ear/palate; and 3) ocular: itchy/gritty eyes, red/burning eyes, tearing/watery eyes.

Severity Rating Scale for Allergy Symptoms

<u>Score</u>	<u>Definition</u>
0 = none	Symptom is not present
1 = mild	Sign/symptom is clearly present but minimal awareness; easily tolerated
2 = moderate	Definite awareness of sign/symptom that is bothersome but tolerable
3 = severe	Sign/symptom is hard to tolerate; causes interference with activities of daily living and/or sleep

5

The TNSS, TOSS and TSS scores were then totaled. The data are detailed in the following tables and corresponding FIGS. 12A-12C.

TNSS: (FIG. 12A)

Time Point	Treatment Group		
	CE-Bud + Az	Rhin. Aqua + As.	Placebo
0.17	-0.78	-1.1	-0.82
0.33	-1.34	-1.89	-1.49
0.66	-1.7	-2.09	-1.75
1	-2.2	-2.35	-2.15
1.5	-2.41	-2.62	-2.2
2	-2.38	-2.22	-2.06
3	-2.51	-2.28	-2.03
4	-2.33	-2.33	-1.81
5	-2.26	-2.13	-1.75
6	-2.11	-1.76	-1.4
7	-1.79	-1.46	-1.31
8	-1.58	-1.41	-1.45
9	-1.26	-1.16	-1.01
10	-1.44	-0.97	-1.16

TOSS: (FIG. 12B)

Time Point	Treatment Group		
	CE-Bud + Az	Rhin. Aqua + As.	Placeb o
0.17	-0.08	-0.36	-0.48
0.33	-0.67	-0.74	-0.83
0.66	-1.08	-1.17	-1.26
1	-1.37	-1.34	-1.46
1.5	-1.49	-1.65	-1.37
2	-1.43	-1.35	-1.42
3	-1.59	-1.6	-1.25
4	-1.48	-1.57	-1.17
5	-1.38	-1.05	-0.97
6	-1.17	-0.99	-0.68
7	-0.9	-0.98	-0.63
8	-0.68	-0.75	-0.56
9	-0.46	-0.62	-0.32
10	-0.57	-0.37	-0.32

TSS: (FIG. 12C)

Time Point	Treatment Group		
	CE-Bud + Az	Rhin. Aqua + As.	Placeb o
0.17	-0.91	-1.67	-1.52
0.33	-2.19	-2.9	-2.65
0.66	-3.15	-3.61	-3.46
1	-3.97	-4.19	-4.07
1.5	-4.39	-4.85	-4.11
2	-4.32	-4	-4.01
3	-4.63	-4.33	-3.77
4	-4.34	-4.37	-3.45
5	-4.09	-3.61	-3.15
6	-3.68	-3.12	-2.45
7	-3	-2.74	-2.27
8	-2.56	-2.46	-2.35
9	-1.99	-2.01	-1.65
10	-2.24	-1.56	-1.72

5 The data demonstrate that the composition of the invention is at least as good as (provides at least the same overall relief of nasal, ocular and total symptoms as does the) combined sequential administration of the two commercial products RA and AST.

The data demonstrated the following trends as regards the performance of the CAPTISOL ENABLED budesonide nasal solution (the combination solution) compared to

placebo and the separate and sequential administration of RHINOCORT AQUA and ASTELIN:

Total symptom scores:	Better than placebo Combination comparable to drugs administered separately
Total nasal symptom scores	Better than placebo Combination comparable to drugs administered separately
Total ocular symptom scores	Better than placebo Combination comparable to drugs administered separately
Duration of action	Longer duration of action than placebo for relief of nasal symptoms Longer duration of action than drugs administered separately for relief of nasal symptoms

EXAMPLE 35

5 Performance of an aqueous liquid composition of the invention in a multi-dose pump nasal spray was evaluated to determine the spray content uniformity (SCU), pump delivery, spray pattern, droplet size distribution. The spray content of a delivered dose or emitted dose is the quantity of drug outside of the device that is available to a subject on a unit dose basis, i.e. after a single actuation of the pump nasal spray.

10 The composition comprised a corticosteroid and antihistamine, e.g., combination of budesonide (425 µg/mL), azelastine HCl (0.2%), Captisol (10%). The pump nasal spray was adapted to provide a target pump delivery (the weight of composition emitted by the device) of 70 mg of composition upon each actuation.

15 Results from evaluation of performance of an aqueous liquid composition (budesonide (425 µg/mL), azelastine HCl (0.2%), CAPTISOL (10%) in buffer) in a pump nasal spray.

Droplet distribution data:

Dv10 (µm)	Dv50 (µm)	Dv90 (µm)	Span	<10 µm (%)
16.73±0.28	32.78±0.14	67.48±0.31	1.55±0.03	2.66±0.13
17.11±0.82	33.45±1.63	69.55±5.82	1.57±0.07	2.47±0.36
19.68±0.05	39.18±0.88	88.33±2.04	1.75±0.01	1.68±0.08
19.30±0.17	38.10±0.34	88.36±1.54	1.81±0.04	1.9±0.05
17.31±0.5	36.74±0.63	80.74±3.26	1.73±0.08	2.51±0.21
17.39±0.43	35.95±1.25	77.57±4.88	1.67±0.08	2.48±0.21
17.33±0.31	35.74±2.52	76.99±8.21	1.66±0.12	2.5±0.21

Spray pattern data:

3 cm Distance to the Laser Beam			
Unit #	Dmin (mm)	Dmax (mm)	Ovality Ratio
SP3-COMBO1	20.0	24.5	1.225
SP3-COMBO2	23.3	33.0	1.416
SP3-COMBO3	34.7	25.9	1.211
Mean	22.7	29.1	1.284
SD	2.41	4.30	0.11
%CV	10.65	14.77	8.92

6 cm Distance to the Laser Beam			
Unit #	Dmin (mm)	Dmax (mm)	Ovality Ratio
SP6-COMBO1	32.8	57.3	1.747
SP6-COMBO2	38.6	60.1	1.634
SP6-COMBO3	33.4	47.7	1.428
Mean	34.3	55.0	1.603
SD	2.16	6.50	0.16
%CV	6.28	11.82	10.09

3 cm Distance to Laser Beam	
Unit #	Spray Weight (mg)
SP3-COMBO1	66.5
SP3-COMBO2	73.0
SP3-COMBO3	70.9
Mean	66.3
SD	9.44
%CV	14.24

6 cm Distance to Laser Beam	
Unit #	Spray Weight (mg)
SP6-COMBO1	71.7
SP6-COMBO2	75.1
SP6-COMBO3	70.8
Mean	72.5
SD	2.27
%CV	3.13

Unit #	Spray Weight (mg)
COMBO1-DSD3	66.5
COMBO2-DSD3	72.8
COMBO3-DSD3	68.0
Mean	70.1
SD	2.44
%CV	3.48

5

10

15

The results indicate that the mean pump delivery ranged from 72.5 to 74.5 mg per actuation with a standard deviation ranging from ± 0.54 to ± 1.6 . The plume emitted by the nasal spray was characterized by laser diffraction to determine the droplet size distribution (Dv10, Dv50, Dv90), span and percentage of droplets having a droplet size of $<10 \mu\text{m}$. The mean Dv10 ranged from 16.73 to 19.68 μm with a standard deviation ranging from ± 0.05 to $\pm 0.82 \mu\text{m}$. The mean Dv50 ranged from 32.78 to 39.18 μm with a standard deviation ranging from ± 0.14 to $\pm 1.63 \mu\text{m}$. The mean Dv90 ranged from 67.48 to 88.36 μm with a standard deviation ranging from ± 0.31 to $\pm 5.82 \mu\text{m}$. The mean span ranged from 1.55 to 1.81 with a standard deviation ranging from ± 0.01 to $\pm 0.08 \mu\text{m}$. The percentage of droplets $<10 \mu\text{m}$ in size ranged from 1.68 to 2.66% with a standard deviation ranging from ± 0.05 to $\pm 0.36\%$.

EXAMPLE 36

An ophthalmic solution comprising a corticosteroid and SAE-CD is prepared as follows.

Method A. fluticasone propionate

5 A citrate buffer solution at a pH of 4.5 was prepared by mixing various portions of 0.003M citric acid with 0.003M of trisodium citrate. A phosphate buffer solution at a pH of 6.0 was prepared by mixing various portions of 0.003M monobasic sodium phosphate with 0.003M of dibasic sodium phosphate. These stock solutions contained 10% w/v SBE-Gamma (D.S.= 6.1) and 0.01% Tween. An excess of fluticasone propionate was added to the vials and equilibrated on a rocker for three days. The samples were then filtered using a PVDF 0.22 μ m syringe filter. Aliquots of the solutions were placed into clear glass 2mL serum vials with aluminum crimp caps and Daikyo Flurotec septums. The concentration of the pH 4.5 solution was 232 μ g/mL. The concentration of the pH 6.0 solution was 238 μ g/mL.

15 Method B. mometasone furoate

A 50 mL solution of 0.08M CAPTISOL with 80 μ g/mL of mometasone furoate was prepared by weighing approximately 9.6 grams of CAPTISOL into a 50 mL volumetric flask and qs with a 3 mM citrate buffer pH 4.5. The approximately 4 mg of mometasone furoate was weighed into a media bottle and the CAPTISOL/buffer solution was added to the drug and the bottles were vortexed and sonicated for approximately 5 minutes. The bottles were then placed on a roller mixer (Stuart Scientific SRT2 33 rpm rise/fall 16 mm) protected from light and mixed overnight. After the overnight mixing on the roller mixer the bottles were transferred to a magnetic stirrer, set at 330 RPM, for three days. The solutions were filtered using a PVDF 0.22 μ m filter and a sample was assayed from each bottle. The results from the assay were about 6% low from target so additional mometasone furoate anhydrous was added to each bottle and were placed back onto the roller mixer for another 3 days. The solutions were aseptically filtered again and 2 mLs were transferred to the 2 mL clear vials with Teflon stoppers.

Method C. mometasone furoate and SBE- γ -CD

30 A 50 mL solution of 0.08M SBE γ -CD with 400 μ g/mL of mometasone furoate was prepared by weighing approximately 9.1 grams of SBE γ -CD into a 50 mL volumetric flask and qs with a 3 mM citrate buffer pH 4.5. The approximately 20 mg of mometasone

- 129 -

furoate was weighed into a media bottle and the SBE γ -CD /buffer solution was added to the drug and the bottles were vortexed and sonicated for approximately 5 minutes. The bottles were then placed on a roller mixer (Stuart Scientific SRT2 33 rpm rise/fall 16 mm) protected from light and mixed overnight. After the overnight mixing on the roller mixer the bottles were transferred to a magnetic stirrer, set at 330 RPM, for three days. The solutions were filtered using a PVDF 0.22 μ m filter and a sample was assayed from each bottle. The results from the assay were about 6% low from target so additional mometasone furoate anhydrous was added to each bottle and were placed back onto the roller mixer for another 3 days. The solutions were aseptically filtered again and 2 mLs were transferred to the 2 mL clear vials with Teflon stoppers.

EXAMPLE 37

Preparation of ophthalmic budesonide solution and its placebo for in *vivo*-testing.

Method A.

15

A buffered, isotonic CAPTISOL solution was prepared. 100mL water was placed in a suitable vessel. Approximately 4.2 grams of CAPTISOL, approximately 32.3 milligrams of citric acid monohydrate, Approximately 43.3 milligrams of sodium citrate dihydrate, and Approximately 580 milligrams of sodium chloride were added to the vessel. The solution was mixed with a magnetic stir-bar until all solids were dissolved. The measured pH was 4.5 and the tonicity was 300mOs.

20

Method B.

The same procedure was followed as was in Method A, with the addition of budesonide and polysorbate-80 after the CAPTISOL, citric acid monohydrate, sodium citrate dihydrate, and sodium chloride were dissolved. Approximately 26.2 milligrams of budesonide was added to the vessel and allowed to mix for approximately 2.5 hours. Approximately 5.0 microliters of polysorbate-80 was added to the vessel and allowed to mix for an additional approximately 2.5 hours. This solution was filtered to remove undissolved excess budesonide, then assayed by HPLC to determine the final budesonide concentration, which was 251 micrograms per milliliter. The measured pH was 4.5 and the tonicity was 300mOs.

25

30

EXAMPLE 38

Preparation and use of a combination solution containing SAE-CD, budesonide, and azelastine. A solution can be made according to Example 37, except that 500 mg of azelastine is added to the vessel with the budesonide.

5

EXAMPLE 39

Preparation and use of a combination solution containing SAE-CD, budesonide, and diclofenac.

A citrate buffer (3 mM pH 4.5) is prepared as follows. Approximately 62.5 mg of citric acid is dissolved in and brought to volume with water in one 100 mL volumetric flask. Approximately 87.7 mg of sodium citrate is dissolved in and brought to volume with water in another 100 mL volumetric flask. In a beaker the sodium citrate solution is added to the citric acid solution until the pH is approximately 4.5.

Approximately 10.4 mg of budesonide, 100 mg of diclofenac and 1247.4 mg of CAPTISOL are ground together with a mortar and pestle and transferred to a 10 mL flask. Buffer solution is added, and the mixture is vortexed, sonicated and an additional 1.4 mg budesonide added. After shaking overnight, the solution is filtered through a 0.22 μ m Durapore Millex-GV Millipore syringe filter unit. The resulting budesonide concentration will be approximately 1 mg/mL and the concentration of diclofenac will be approximately 10 mg/mL.

20

EXAMPLE 40

Preparation and use of a combination ophthalmic solution comprising CAPTISOL, ofloxacin, and mometasone furoate.

A 50 mL solution of 0.08M CAPTISOL with 80 μ g/mL of mometasone furoate and 3 mg/mL ofloxacin can be prepared by weighing approximately 9.6 grams of CAPTISOL into a 50 mL volumetric flask and qs with a 3 mM citrate buffer pH 4.5. The approximately 4 mg of mometasone furoate and 150 mg ofloxacin are weighed into a media bottle and the CAPTISOL/buffer solution was added to the drug and the bottles vortexed and sonicated for approximately 5 minutes. The bottles are then placed on a roller mixer (Stuart Scientific SRT2 33 rpm rise/fall 16 mm) protected from light and mixed overnight. After the overnight mixing on the roller mixer the bottles are transferred

30

to a magnetic stirrer, set at 330 RPM, for three days. The solutions are filtered using a PVDF 0.22µm filter and a sample assayed from each bottle.

EXAMPLE 41

In vivo evaluation of a dosage form according to the invention was conducted in 5 rabbits as follows.

A pilot study to test the effectiveness of CE-Budesonide on ocular wound healing was conducted in rabbits. The effectiveness of CE-Budesonide (250 mcg/mL) from Example 37 was compared with commercial products-- Pulmicort Respules (a suspension of Budesonide, 250 mcg/mL) and prednisolone acetate (Pred Forte suspension, 1%) and a 10 CAPTISOL placebo.

Treatment protocol:

The animals were administered 40 microliter (10 µg) of test material each to both eyes of animals four times a day (6 hours apart) for 3 days prior to induction of eye injury by laser energy on Day 0 (the day of induction of eye injury). Each animal was placed in 15 the left lateral position and thermal injury was made to the right eye with a semiconductor, diode laser. Laser energy was directed through the peripheral clear cornea to the iris surface using a hand-held fiberoptic laser probe injuring three separate sites measuring 2 mm in diameter. Laser energy treatment of the eyes resulted in inflammatory responses of the iris along with proteinaceous and cellular inflammation in the anterior chamber of the 20 eye on Day 0. The injury was graded for inflammation based on the study Ophthalmologist’s routine criteria (0: no inflammation, 1: trace flare or cells (very faint), 2: flare/cell mild but clearly visible in anterior chamber, 3: flare/cell turbidity moderate in anterior chamber, 4: flare/cell severe in anterior chamber). Ocular pressure was determined using an applanation tonometer.

Group	Treatment	Concentration	Number Of Animals	Eye drop volume	Anterior chamber flare ¹		Anterior chamber cell ¹	
					score		Score	
					D0	D1	D0	D1 ²
			M	microliter				
1	Vehicle Control (~4% CAPTISOL)	0 mcg/mL	4	40	1.75	1	1.25	0
2	Pulmicort Respules (a suspension of Budesonide)	250 mcg/mL	4	40	1.75	1	1.25	0.25
3	prednisolone acetate (Pred Forte suspension)	1%	4	40	1.75	0.75	1.25	0.25

4	CAPTISOL-ENABLED Budesonide	250 mcg/mL	4	40	2	0	1.25	0
---	-----------------------------	------------	---	----	---	---	------	---

1. Average score of 4 animals. Day 0: the day injury was induced.
- 2 Group 2 and 3 each had one animal scored as 1+, all others were 0.

Slit lamp examinations revealed aqueous flare, conjunctivitis, iritis, and/or superficial keratitis of the right eye following the laser injury in all animals. Aqueous flare had resolved by Day 3 in all animals but one in the Pulmicort Respules group.

Decreased eye pressure in the right eye was observed in all animals following laser injury on Day 0. Eye pressure returned to normal values in the CAPTISOL-ENABLED budesonide solution group by Day 1, and in CAPTISOL vehicle controls, Pulmicort Respules, and PRED FORTE by Day 3, 7, and 3, respectively. The results are summarized in the table below and in FIGS. 9a and 9b.

Eye Pressure (Mean±SD)

Left Eye				
Surgical day	CAPTISOL	Pulmicort Respules	Pred Forte	CAPTISOL-ENABLED Budesonide
D-1	17.00±2.71	20.00±1.83	21.25±0.96	17.25±5.12
D0	19.25±2.22	18.75±2.22	19.25±1.50	19.50±1.91
D1	21.75±2.50	21.00±3.37	20.75±2.75	19.75±2.50
D3	20.75±1.26	18.75±2.22	20.50±2.08	21.75±1.50
D7	19.25±2.50	21.25±2.36	20.00±1.41	19.50±1.73

15

Right Eye				
Surgical day	CAPTISOL	Pulmicort Respules	Pred Forte	CAPTISOL-ENABLED Budesonide
D-1	16.75±3.69	18.25±2.06	20.25±2.22	17.75±4.35
D0	17.00±2.71	20.00±1.83	21.25±0.96	17.25±5.12
D1	13.75±5.62	16.00±3.92	13.25±2.50	20.25±0.96
D3	15.75±3.10	11.25±4.43	18.50±3.00	20.75±2.50
D7	21.00±2.16	19.75±2.06	18.25±3.40	19.25±1.71

The results showed that CE-Budesonide solution effectively reduced inflammatory reactions following laser injury to the iris of rabbits. The resolution of laser-induced eye injury by CAPTISOL-ENABLED Budesonide occurs more rapidly than by either
 5 PULMICORT RESPULES, or PRED FORTE. Intraocular pressure returned to normal values more quickly in the CE-Budesonide solution treatment group than in all other treatment groups and the vehicle control.

EXAMPLE 42

Preparation and use of a combination ophthalmic solution containing SAE-CD,
 10 budesonide and tobramycin.

An ophthalmic solution of the invention can be made to contain the following ingredients in the approximate amounts indicated per mL of solution.

Ingredient	Amount in 1 mL of solution
Tobramycin	0.3% (3 mg)
Budesonide	0.025% (250 µg)
Benzalkonium chloride	0.01%
SBE-γ-CD	2%
Edentate disodium	0.1%
Sodium chloride	0.01%
Sulfuric acid and/or sodium hydroxide	To adjust pH to physiologic pH
Water	Qs. to 1 mL

EXAMPLE 43

15 Preparation and use of a combination ophthalmic solution containing SAE-CD, budesonide and azithromycin.

Ingredient	Amount in 1 mL of solution
Azithromycin	0.5% (5 mg)
Budesonide	0.025% (250 µg)
Benzalkonium chloride	0.01%
SBE-γ-CD	2%
Edentate disodium	0.1%
Sodium chloride	0.01%
Sodium sulfate, sulfuric acid and/or sodium hydroxide	To adjust pH to physiologic pH
Water	Qs. to 1 mL

EXAMPLE 44

Preparation of ophthalmic solution of SBE γ -CD, Mometasone Furoate, and Timolol

A 50 mL solution of 0.08M SBE γ -CD with 400 μ g/mL of mometasone furoate and 2.5 mg/mL of timolol can be prepared by weighing approximately 9.1 grams of SBE γ -CD into a 50 mL volumetric flask and qs with a 3 mM citrate buffer pH 4.5. The approximately 20 mg of mometasone furoate and 125 mg of timolol are weighed into a media bottle and the SBE γ -CD /buffer solution is added to the drugs. The bottles are vortexed and sonicated for approximately 5 minutes. The bottles are then placed on a roller mixer (Stuart Scientific SRT2 33 rpm rise/fall 16 mm) protected from light and mixed overnight. After the overnight mixing on the roller mixer the bottles are transferred to a magnetic stirrer, set at 330 RPM, for three days. The solutions are filtered using a PVDF 0.22 μ m filter.

EXAMPLE 45

The table below summarizes some solubility data for the listed corticosteroids in the absence (intrinsic solubility of corticosteroid in the aqueous test medium) and in the presence of two different SAE-CD's as determined herein.

Steroid ID	[Steroid] x10 ⁵ M		
	Intrinsic Solubility (H ₂ O)	0.04 M Captisol	0.04 M (SBE) _{6.1} γ
Hydrocortisone	92.4	2656.3	2369.3
Methylprednisolone	43.6	743.1	1215.3
Prednisolone	62.5	1995.3	2095
Prednisone	50.5	1832.7	1313.7
Flunisolide	11.3	261.5	455.1
Beclomethasone Dipropionate	0.41	11.6	46.8
Budesonide	6.6	254.8	306.6
Fluticasone Propionate	0.39	5.41	51.8
Mometasone Fuorate	1.82	16.4	41.5
Triamcinolone Acetonide	3.56	457	1059.5

- 135 -

EXAMPLE 46

The table below summarizes the equilibrium binding constants (K) for some corticosteroids in the presence of Captisol[®] or SBE6.1- γ -CD (0.04 M).

Steroid ID	Binding Constant- K	
	Captisol	(SBE) _{6.1} γ
Hydrocortisone	1932	1430
Methylprednisolone	486	950
Prednisolone	1496	1653
Prednisone	1591	914
Flunisolide	590	1104
Beclomethasone Dipropionate	684	2862
Budesonide	1002	1229
Fluticasone Propionate	322	3338
Mometasone Fuorate	201	551
Triamcinolone Acetonide	3591	10075

5

All documents cited herein are each incorporated by reference herein in its entirety. The above is a detailed description of particular embodiments of the invention. It will be appreciated that, although specific embodiments of the invention have been described
 10 herein for purposes of illustration, various modifications may be made without departing from the spirit and scope of the invention. Accordingly, the invention is not limited except as by the appended claims.

CLAIMS

1. A method for treating an allergic symptom or disorder in a subject in need thereof, comprising:

nasally administering to the subject a corticosteroid solution comprising a therapeutically effective amount of a corticosteroid, SAE-CD, and a pharmaceutically acceptable aqueous liquid carrier,

wherein the corticosteroid solution provides more rapid relief from an allergic symptom or disorder compared to a corticosteroid suspension at the same unit dose.

2. A method for treating an allergic symptom or disorder in a subject in need thereof, comprising:

nasally administering to the subject a corticosteroid solution comprising a therapeutically effective amount of a corticosteroid, SAE-CD, and a pharmaceutically acceptable aqueous liquid carrier,

wherein the allergic symptom or disorder includes a non-nasal symptom selected from the group consisting of itchy/gritty eyes, tearing/watery eyes, red/burning eyes, itchy eyes and palate, and combinations thereof.

3. A method for treating an ocular symptom or disorder in a subject in need thereof, comprising:

nasally administering to the subject a corticosteroid solution comprising a therapeutically effective amount of a corticosteroid, SAE-CD, and a pharmaceutically acceptable aqueous liquid carrier,

wherein the ocular symptom or disorder is itchy/gritty eyes, tearing/watery eyes, red/burning eyes, or a combination thereof.

4. A system for treating an allergic symptom or disorder in a subject in need thereof, comprising:

a corticosteroid solution comprising a therapeutically effective amount of a corticosteroid, a therapeutically effective amount of an antihistamine, SAE-CD, and a pharmaceutically acceptable aqueous liquid carrier, and

a metered dose device for nasal administration of the corticosteroid solution to the subject, wherein the corticosteroid solution is provided in the device.

5. A system for treating an ocular symptom or disorder in a subject in need thereof, comprising:

a corticosteroid solution comprising a therapeutically effective amount of a corticosteroid, a therapeutically effective amount of an antihistamine, SAE-CD, and a pharmaceutically acceptable aqueous liquid carrier, and

a metered dose device for nasal administration of the corticosteroid solution to the subject, wherein the corticosteroid solution is provided in the device.

6. A metered dose device for nasal administration comprising a corticosteroid solution comprising a therapeutically effective amount of a corticosteroid, a therapeutically effective amount of an antihistamine, SAE-CD, and a pharmaceutically acceptable aqueous liquid carrier.

7. A method for treating a nasal symptom or disorder in a subject in need thereof, comprising:

nasally administering to the subject a corticosteroid solution comprising a therapeutically effective amount of a corticosteroid, SAE-CD, and a pharmaceutically acceptable aqueous liquid carrier,

wherein the symptom or disorder is selected from the group consisting of: acute or chronic rhinitis, nasal polyps, post surgical nasal polyps, snoring, cluster headache, and combinations thereof.

8. A method for treating a nasal symptom or disorder in a subject in need thereof, comprising:

nasally administering to the subject a corticosteroid solution comprising a therapeutically effective amount of a corticosteroid, SAE-CD, and a pharmaceutically acceptable aqueous liquid carrier,

wherein the symptom or disorder is selected from the group consisting of: obstructive sleep apnea, eustachian tube dysfunction, serous otitis media, sleep disturbances, daytime somnolence, nasal furuncles, epistaxis, wounds of the nasal or sinusal mucosa, dry nose syndrome, nasal bleeding, and combinations thereof.

9. A method for treating an allergic symptom or disorder in a subject in need thereof, comprising:

ophthalmically administering to the subject a corticosteroid solution comprising a therapeutically effective amount of a corticosteroid, SAE-CD, and a pharmaceutically acceptable aqueous liquid carrier,

5 wherein the corticosteroid solution provides more rapid relief from an allergic symptom or disorder compared to a corticosteroid suspension at the same unit dose.

10. A method for treating ocular inflammation in a subject in need thereof, comprising:

10 ophthalmically administering to the subject a corticosteroid solution comprising a therapeutically effective amount of a corticosteroid, SAE-CD, and a pharmaceutically acceptable aqueous liquid carrier,

wherein the corticosteroid solution provides a more rapid reduction in ocular inflammation compared with a corticosteroid suspension at the same unit dose.

11. A system for treating an allergic symptom or disorder in a subject in need thereof, comprising:

15 a corticosteroid solution comprising a therapeutically effective amount of a corticosteroid, a therapeutically effective amount of an antihistamine, SAE-CD, and a pharmaceutically acceptable aqueous liquid carrier, and

a device for ophthalmic administration of the corticosteroid solution to the subject, wherein the corticosteroid solution is provided in the device.

20 12. A device for ophthalmic administration comprising a corticosteroid solution comprising a therapeutically effective amount of a corticosteroid, a therapeutically effective amount of an antihistamine, SAE-CD, and a pharmaceutically acceptable aqueous liquid carrier.

25 13. The invention of any one of claims 1 to 3 and 7 to 10, further comprising administering a therapeutically effective amount of an antihistamine.

14. The invention of any one of claims 4 to 6, wherein the metered dose device is a atomizer, sprayer, pump spray, dropper, squeeze tube, squeeze bottle, pipette, ampule, nasal cannula, metered dose device, nasal spray inhaler, nasal continuous positive air pressure device, or breath actuated bi-directional delivery device.

30 15. The invention of claim 11 or claim 12, wherein the device for ophthalmic administration is selected from the group consisting of a dropper, drop dispensing package, tube, eye spray device, and eye wash unit.

16. The invention of claim 13 or claim 14, wherein the device emits 10 μ l to 500 μ l of the corticosteroid solution per unit dose.

17. The invention of any one of claims 4 to 6 or 11 to 12, wherein the device comprises a nozzle,

5 wherein the nozzle comprises a valve, and

wherein the valve provides a release of a volume of 25 μ l to 260 μ l per unit dose through the nozzle upon operation of the device.

18. The invention of any one of claims 1 to 17, wherein the corticosteroid is selected from the group consisting of beclomethasone dipropionate, beclomethasone
10 monopropionate, betamethasone, budesonide, ciclesonide, desisobutyryl-ciclesonide, dexamethasone, flunisolide, fluticasone propionate, fluticasone furoate, mometasone furoate, triamcinolone acetonide, and combinations thereof.

19. The invention of any one of the above claims, wherein the corticosteroid solution further comprises an additional therapeutically effective agent selected from the
15 group consisting of a anti-IgE antibody, antibiotic agent, anticholinergic agent, antifungal agent, anti-inflammatory agent, anti-infective agent, antihistamine agent, analgesic agent, decongestant, expectorant, antitussive agent, antimicrobial agent, leukotriene receptor antagonist, and combinations thereof.

20. The invention of any one of claims 4 to 6 and 11 to 13, wherein the antihistamine is selected from the group consisting of diphenhydramine, clemastine,
20 chlorpheniramine, brompheniramine, dexchlorpheniramine, dexbrompheniramine, triprolidine, doxylamine, tripelemnamine, heptadine, carbinoaxime, bromdiphenhydramine, hydroxyzine, pyrillamine, acrivastine, AHR-11325, phenindamine, astemizole, azatadine, azelastine, cetirizine, ebastine, fexofenadine, ketotifen, lodoxine, loratadine,
25 descarboethoxyloratadine, levocabastine, mequitazine, oxatomide, setastine, taziflyline, temelastine, terfenadine, tripelemnamine, terfenadine carboxylate, phenyltoloxamine, pheniramine, and combinations thereof.

21. The invention of any one of claims 4 to 6 and 11 to 13, wherein the antihistamine is selected from the group consisting of carebastine, eflerizine,
30 mapinastine, antazoline, bilastine, bepotastine besilate, rupatadine, emedastine,

- 140 -

tecastemizole, epinastine, levocetirizine, mizolastine, noberastine, norastemizole, olopatadine, and combinations thereof.

22. The invention according to any one of the above claims, wherein the molar ratio of the SAE-CD to the corticosteroid is 1:1 or greater.

5 23. The invention of any one of claims 4 to 6 and 11 to 22, wherein the molar ratio of the SAE-CD to the antihistamine is greater than 2:1.

24. The invention of any one of claims 4 to 6, 11 to 20, and 22 to 23, wherein the antihistamine is azelastine.

10 25. The invention of claim 24, wherein the azelastine is present at an amount of about 30 μg to about 275 μg per unit dose.

26. The invention of claim 24 or 25, wherein the azelastine is present at a concentration of 0.5 to 10 mg/mL.

27. The invention of any one of claims 4 to 6, 11 to 19, and 21 to 23, wherein the antihistamine is olopatadine.

15 28. The invention of claim 27, wherein the olopatadine is present at an amount of about 330 μg to about 2660 μg per unit dose.

29. The invention of claim 27 or 28, wherein the olopatadine is present at a concentration of 1 to 15 mg/mL.

20 30. The invention of any one of claims 4 to 6, 11 to 20, and 22 to 23, wherein the antihistamine is cetirizine.

31. The invention of claim 30, wherein the cetirizine is present at an amount of about 0.25 mg to about 4.4 mg per unit dose.

32. The invention of claim 30 or 31, wherein the cetirizine is present at a concentration of 0.25 to 4.4 mg/mL.

25 33. The invention of any one of claims 1 to 32, wherein the administering is performed once or twice daily.

34. The invention of any of claims 1, 2, 4, 9, or 11, wherein the allergic symptom or disorder is or further includes a nasal symptom, non-nasal symptom, allergic

rhinitis, seasonal allergic rhinitis, perennial allergic rhinitis, perennial non-allergic rhinitis, grass pollen rhinitis, have fever, nasal polyps, or a combination thereof.

35. The invention of any of claims 1, 2, 4, 9, or 11, wherein the allergic symptom or disorder is or further includes ocular symptom, bacterial rhinitis, fungal rhinitis, viral rhinitis, atrophic rhinitis, vasomotor rhinitis, blocked nose, nasal congestion, or a combination thereof.

36. The invention of claim 34, wherein the nasal symptom is rhinorrhea, nasal congestion, nasal itchiness, sneezing, nasal obstruction, or a combination thereof.

37. The invention of claim 34, wherein the non-nasal symptom is itchy/gritty eyes, tearing/watery eyes, red/burning eyes, itchy ears and palate, or a combination thereof.

38. The invention of any one of the above claims, wherein the corticosteroid is budesonide.

39. The invention of claim 38, wherein the budesonide is present at an amount of about 5 μg to about 500 μg per unit dose.

40. The invention of claim 38 or 39, wherein the budesonide is present at a concentration of 40 to 2000 $\mu\text{g}/\text{mL}$.

41. The invention of any one of claims 1-37, wherein the corticosteroid is fluticasone propionate.

42. The invention of any one of claims 1-37, wherein the corticosteroid is fluticasone furoate.

43. The invention of any one of claims 1-37, wherein the corticosteroid is mometasone furoate.

44. The invention of any one of claims 1-37, wherein the corticosteroid solution comprises:

a corticosteroid selected from the group consisting of budesonide, fluticasone propionate, fluticasone furoate, and mometasone furoate; and

an additional therapeutically effective agent selected from the group consisting of azelastine, olopatadine, cetirizine, loratadine, desloratadine, azithromycin, voriconazole, and a combination thereof.

- 142 -

45. The invention of any one of the above claims, wherein the aqueous liquid carrier comprises water, buffer, alcohol, organic solvent, glycerin, propylene glycol, poly(ethylene glycol), poloxamer, surfactant or a combination thereof.

46. The invention of any one of the above claims, wherein the aqueous liquid carrier comprises povidone, polyol or a combination thereof.

47. The invention according to any one of the above claims, wherein the SAE-CD is a compound, or mixture of compounds, of the Formula 1:

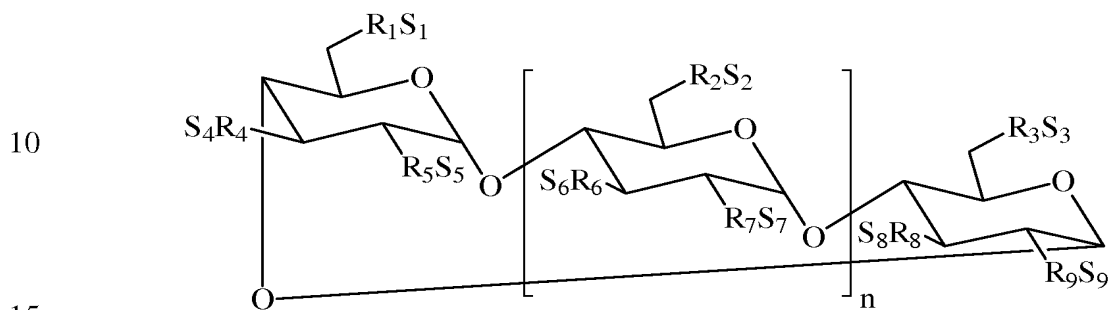

Formula 1

wherein:

n is 4, 5 or 6;

R₁, R₂, R₃, R₄, R₅, R₆, R₇, R₈ and R₉ are each, independently, -O- or a-O-(C₂ - C₆

alkylene)-SO₃⁻ group, wherein at least one of R₁ - R₉ is independently a -O-(C₂ - C₆ alkylene)-SO₃⁻ group, a -O-(CH₂)_mSO₃⁻ group wherein m is 2 to 6, -OCH₂CH₂CH₂SO₃⁻, or -OCH₂CH₂CH₂CH₂SO₃⁻); and

S₁, S₂, S₃, S₄, S₅, S₆, S₇, S₈ and S₉ are each, independently, a pharmaceutically acceptable cation.

48. The invention of any of the above claims, wherein the corticosteroid solution further comprises one or more pharmaceutically acceptable excipients selected from the group consisting of a preservative, an antioxidant, a buffering agent, an acidifying agent, an alkalizing agent, a solubility-enhancing agent, a complexation-enhancing agent, a diluent, an electrolyte, glucose, a stabilizer, a bulking agent, an antifoaming agent, an oil, an emulsifying agent, flavor, sweetener, a taste-masking agent, a tonicity modifier, a surface tension modifier, a viscosity modifier, a density modifier, and combinations thereof.

- 143 -

49. The invention of any one of the above claims, wherein the SAE-CD is present at a concentration of about 10 mg to about 500 mg of SAE-CD per mL of the corticosteroid solution.

50. The invention of any one of the above claims, wherein the SAE-CD is
5 present in an amount of 100 μ g to 1000 mg per unit dose.

FIG. 1A

Phase Solubility of Budesonide

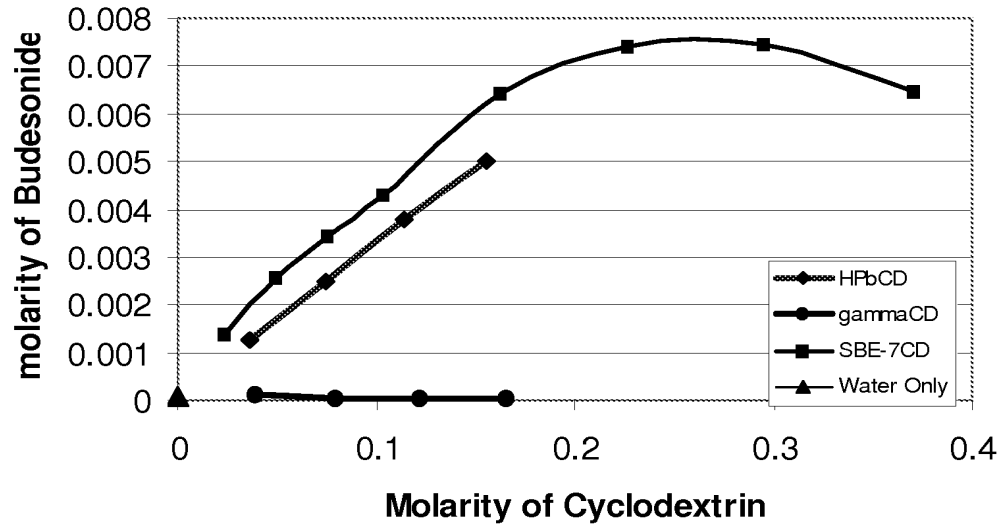

FIG. 1B

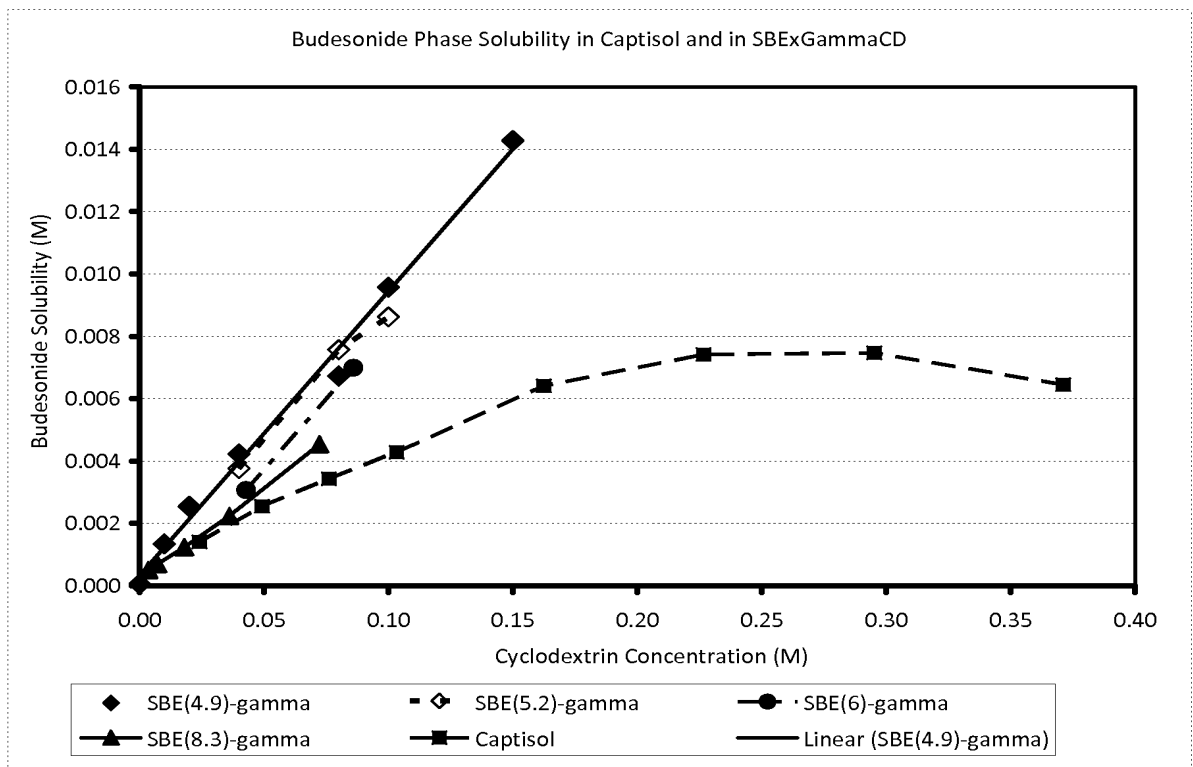

FIG. 2

Effect of CD Ring Size and DS on Solubility of Fluticasone Propionate

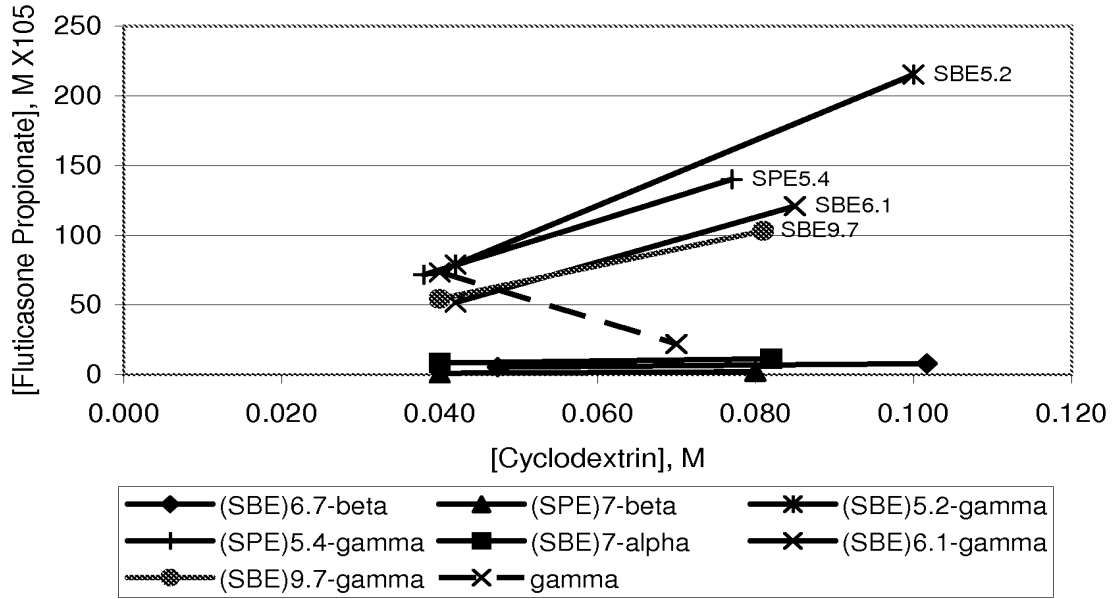

FIG. 3

Effect of CD Ring Size and DS on Solubility of Mometasone Furoate

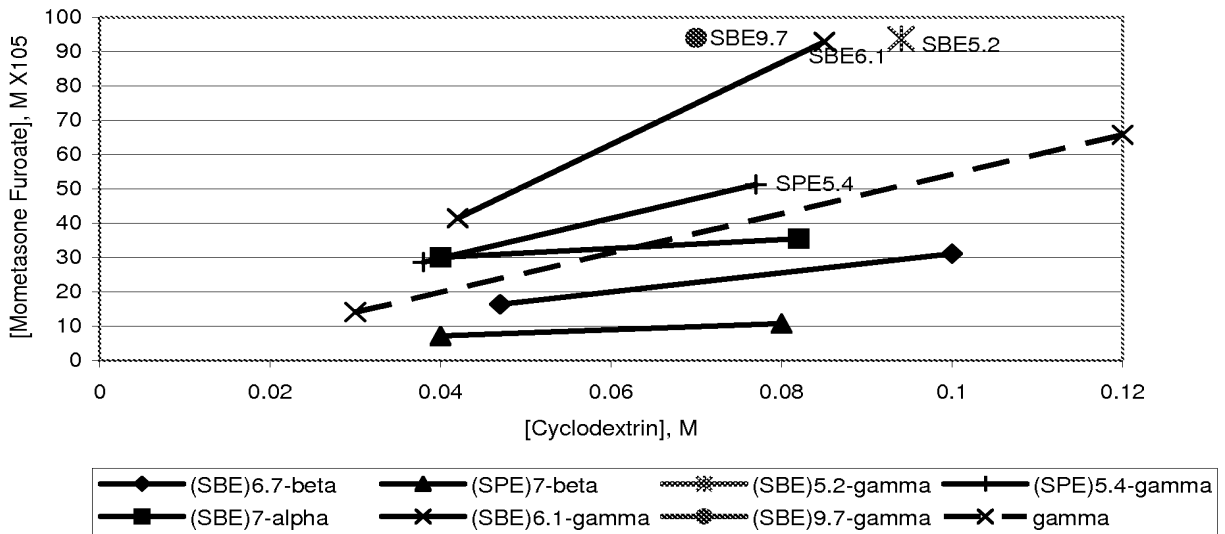

FIG. 4

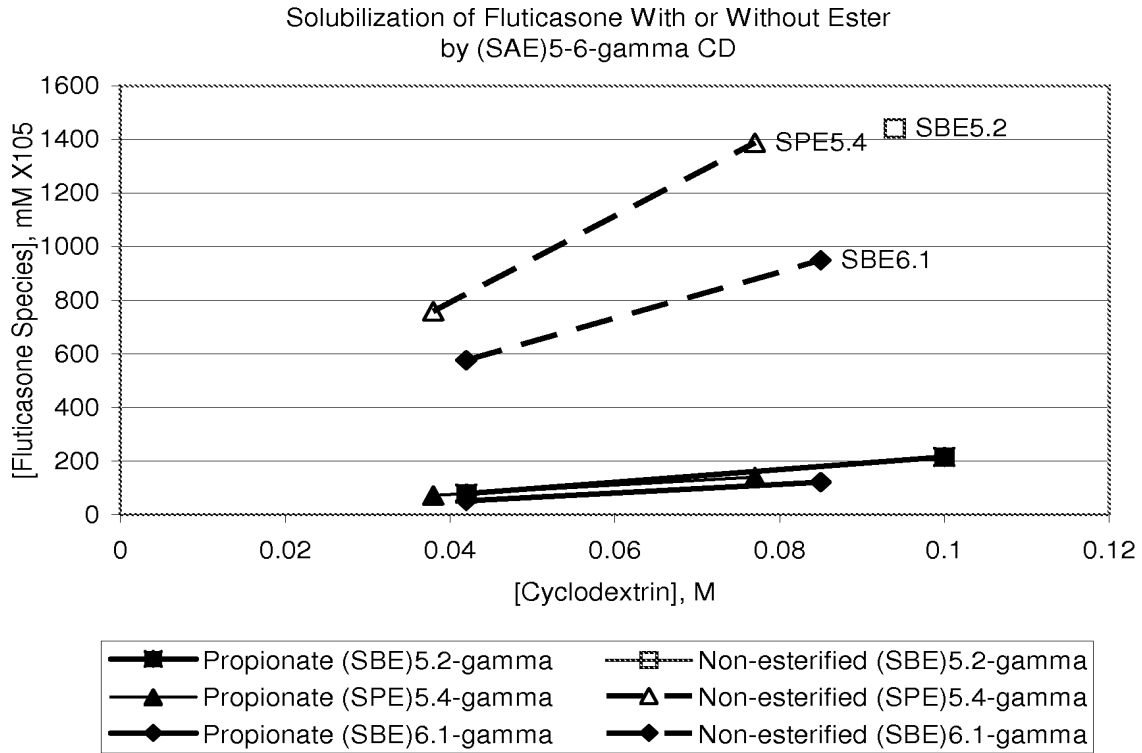

FIG. 5

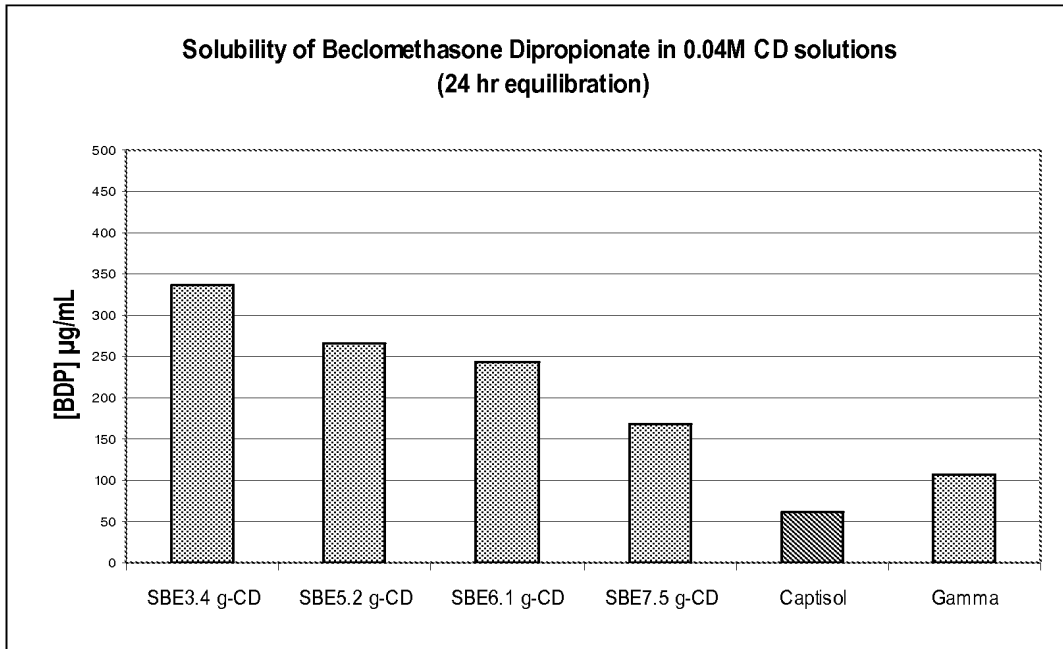

FIG. 6A

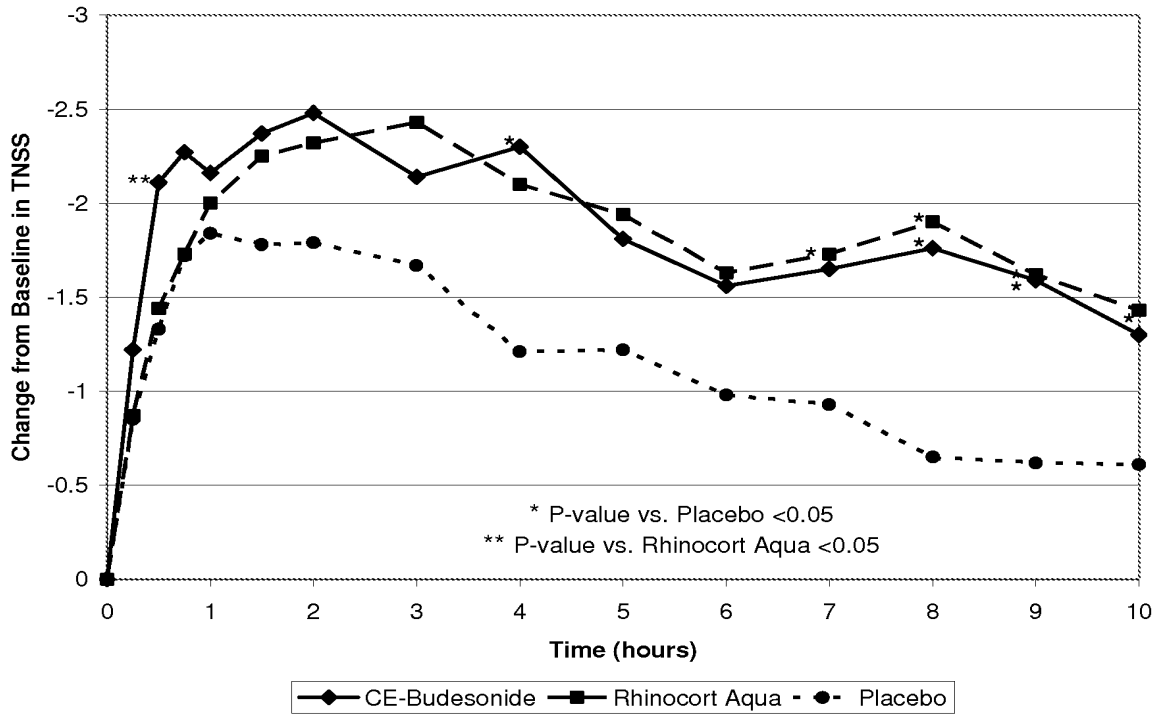

FIG. 6B

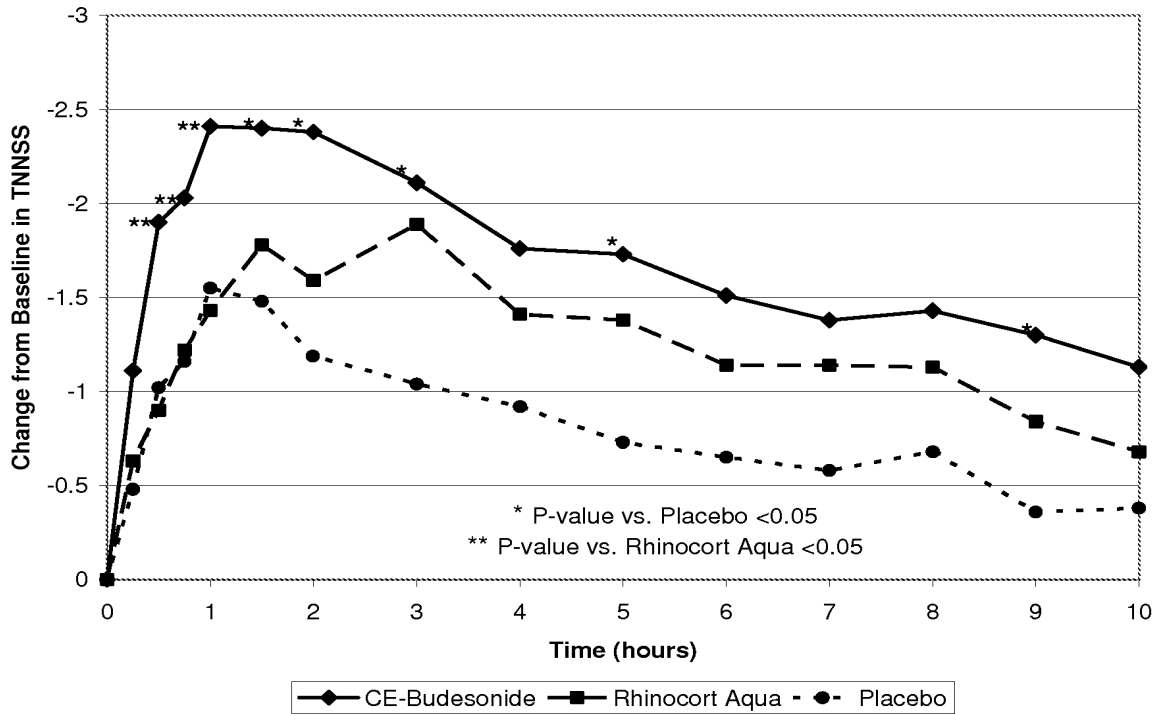

FIG. 6C

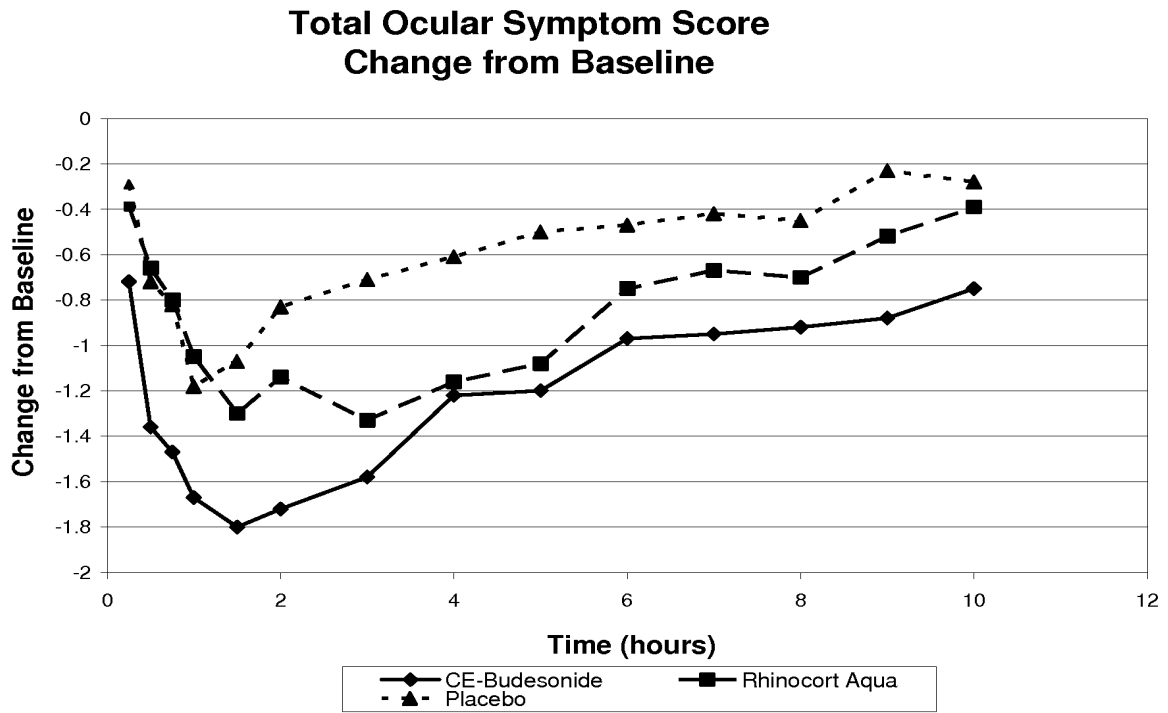

FIG. 6D

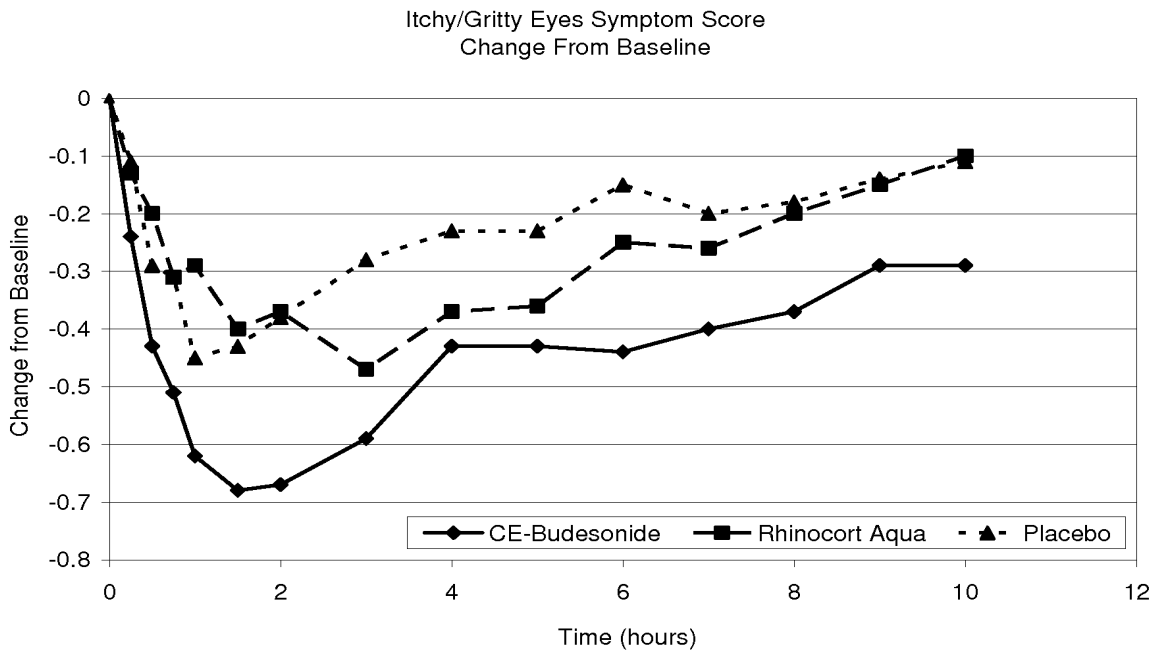

FIG. 6E

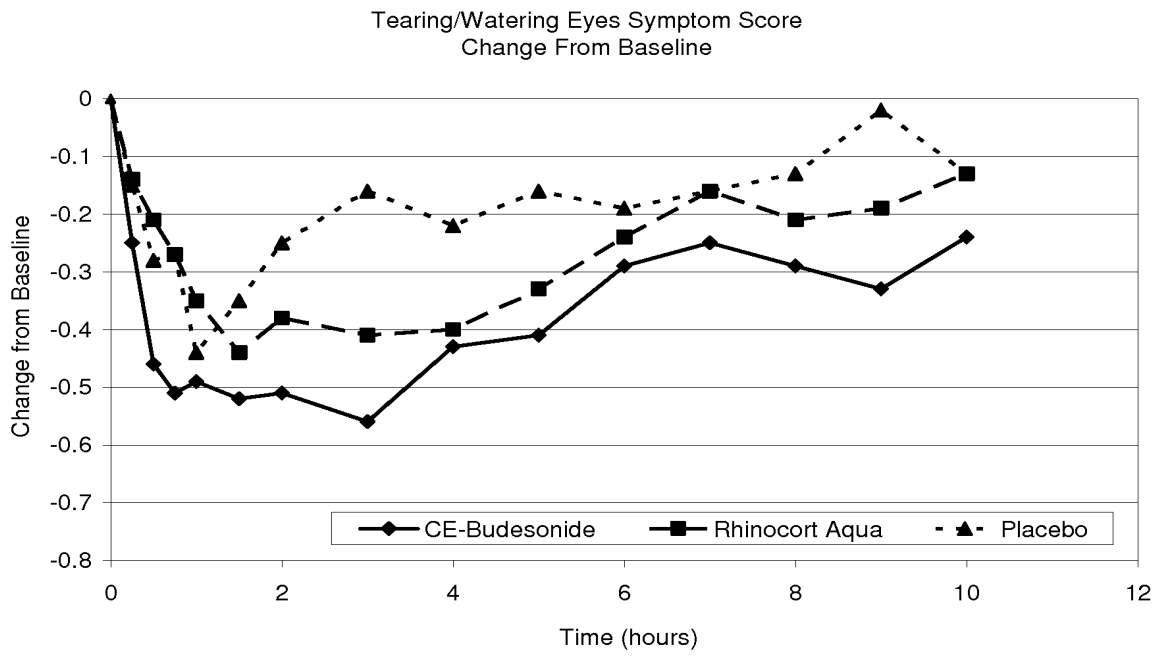

FIG. 6F

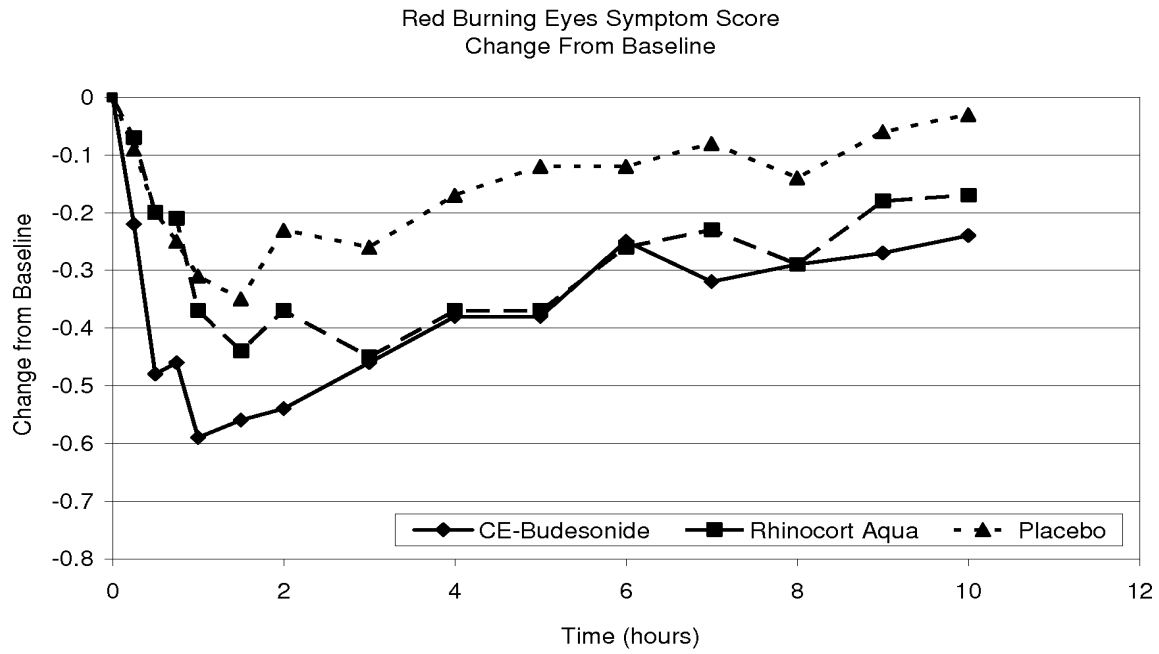

FIG. 7

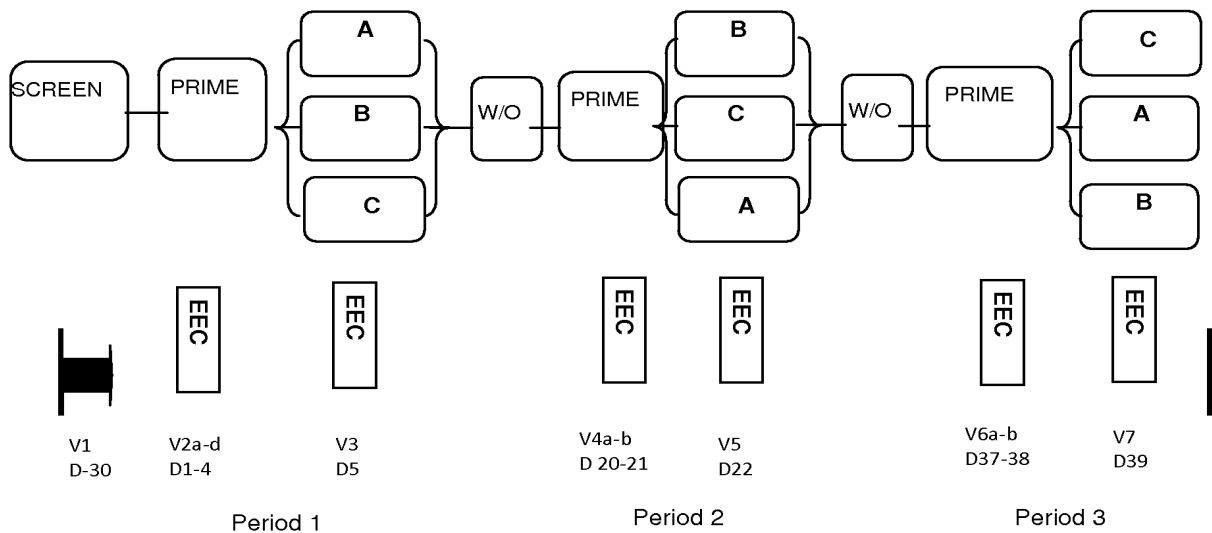

FIG. 8A

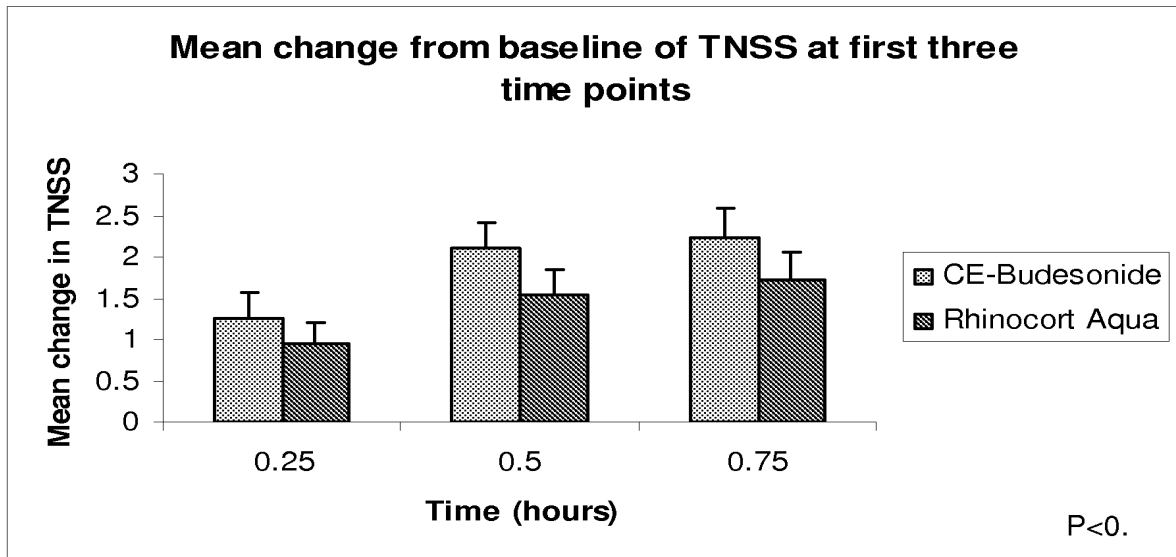

FIG. 8B

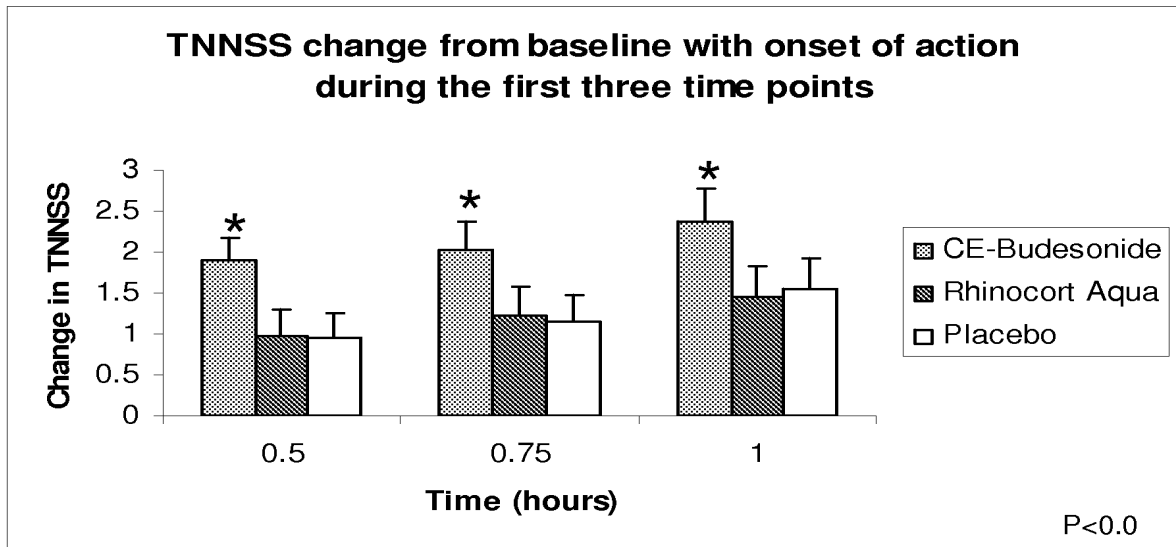

FIG. 9A

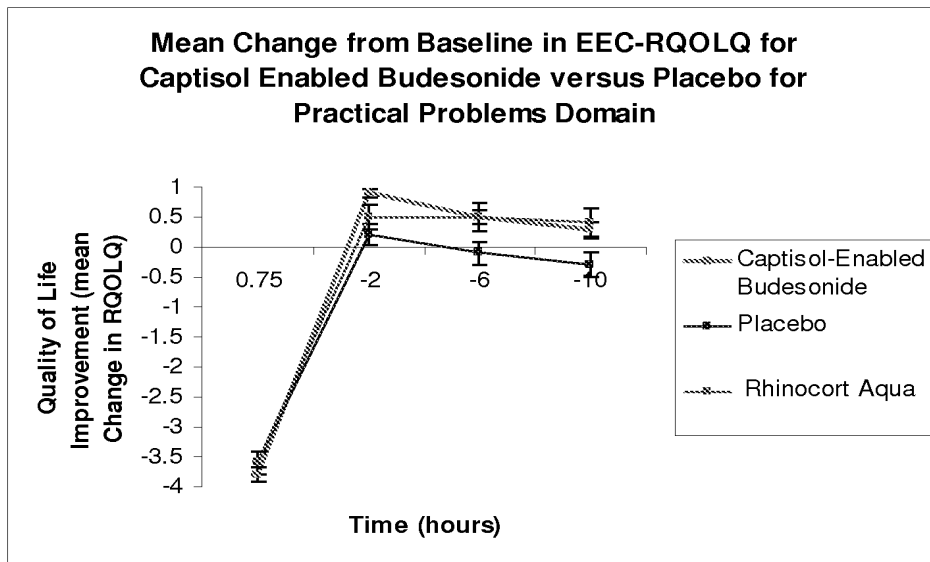

FIG. 9B

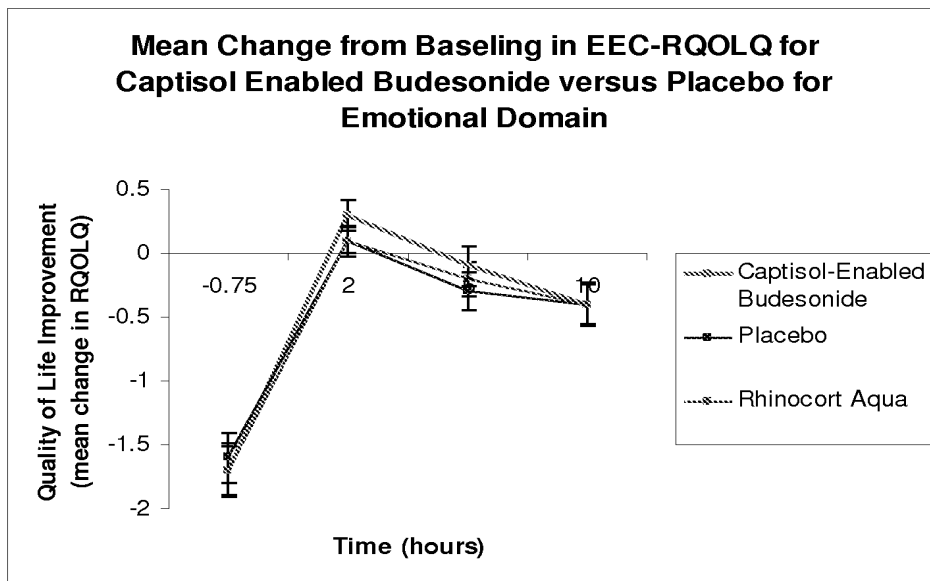

FIG. 9C

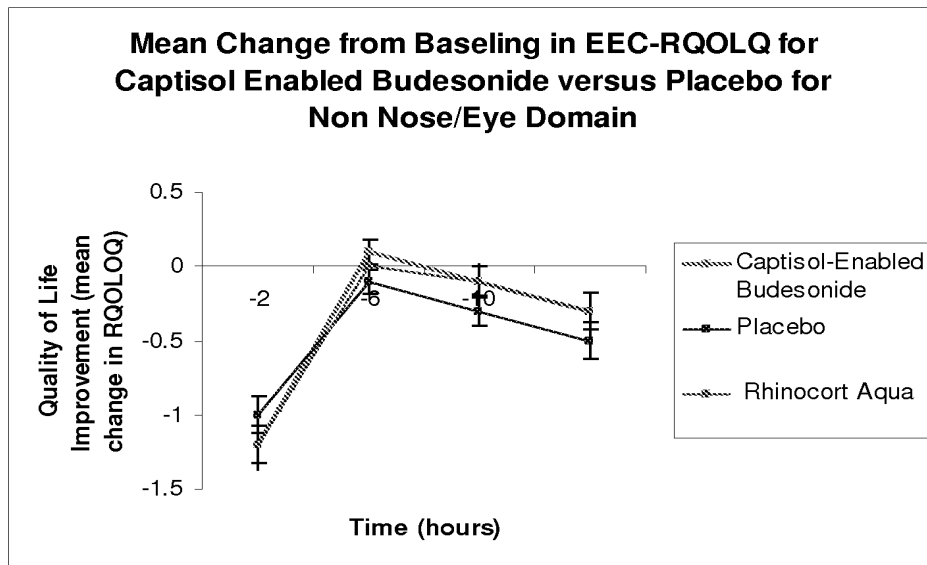

FIG. 10A

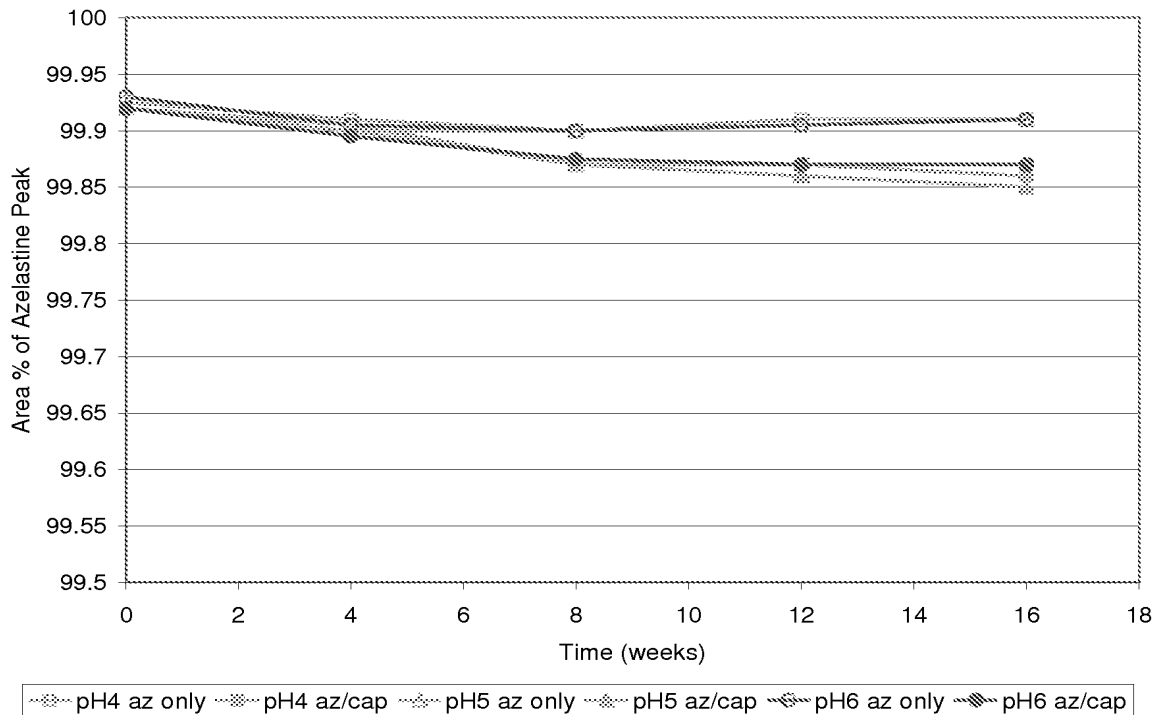

FIG. 10B

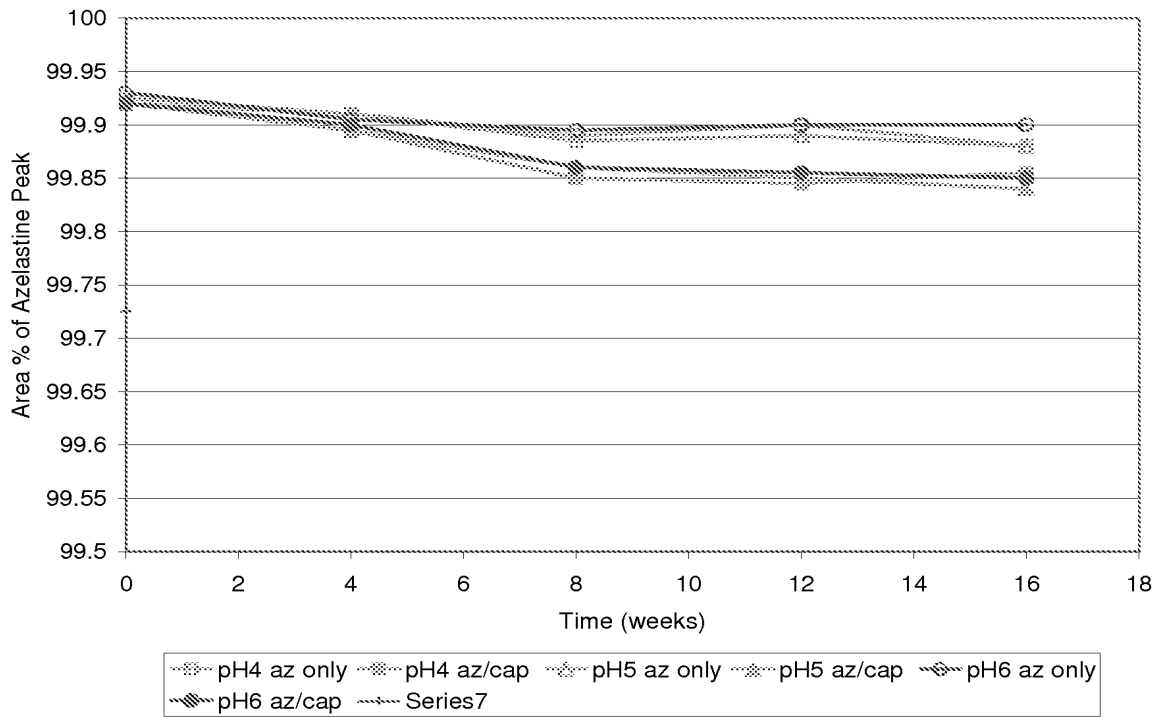

FIG. 10C

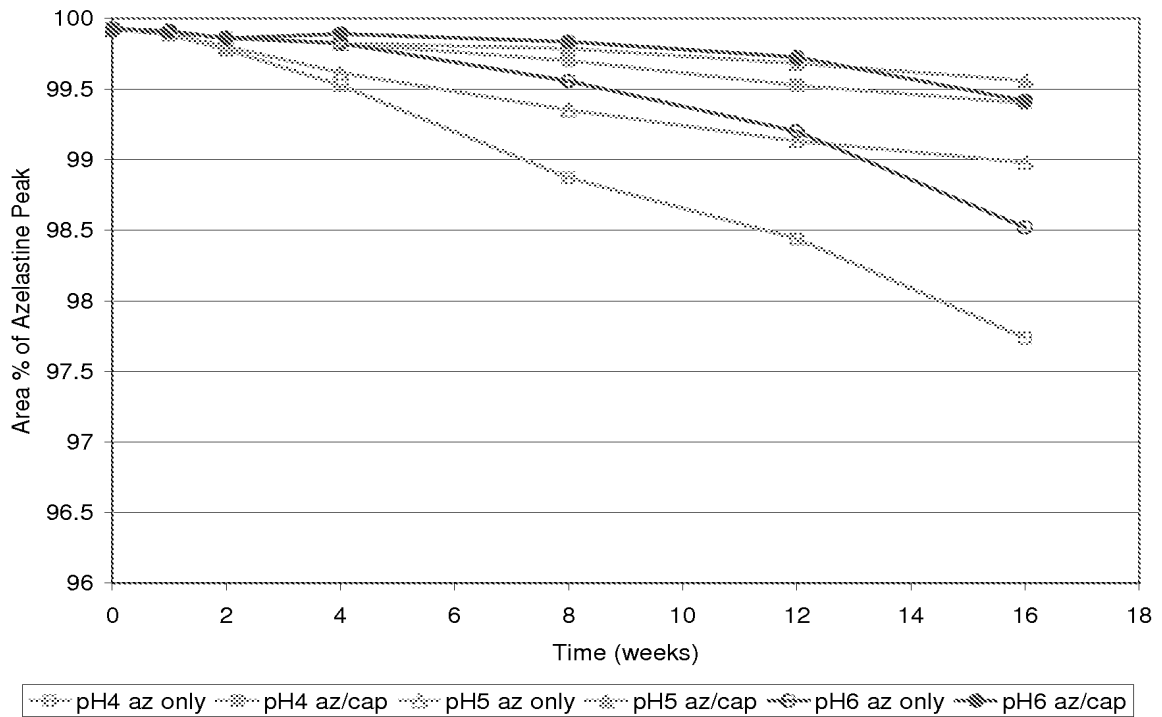

FIG. 11A

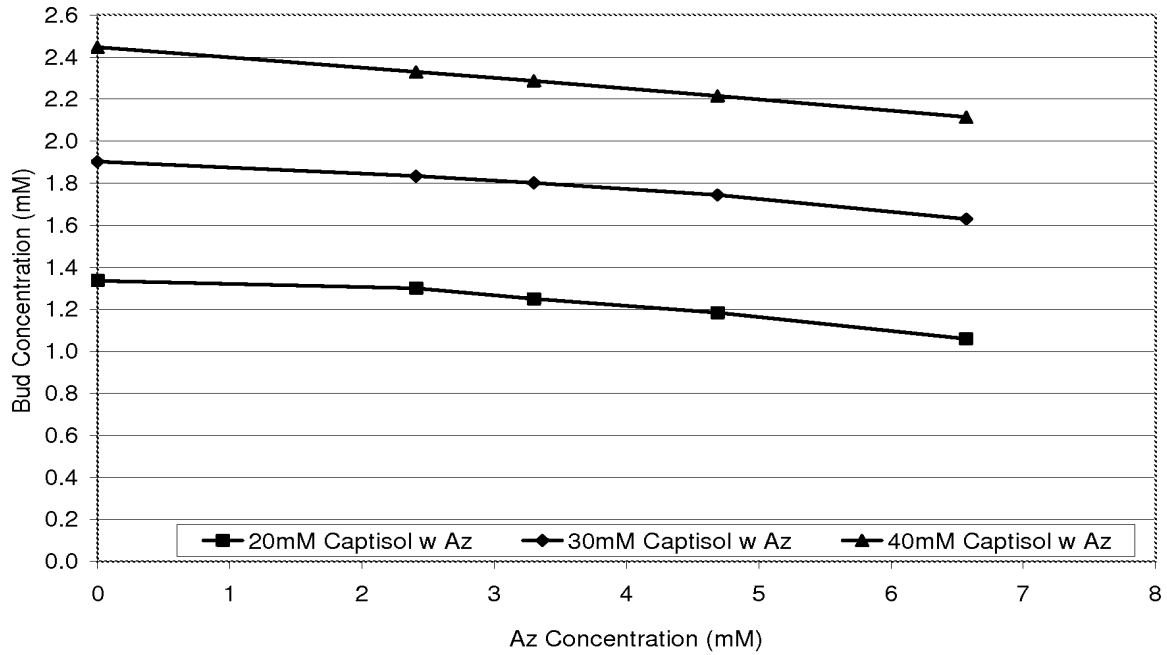

FIG. 11B

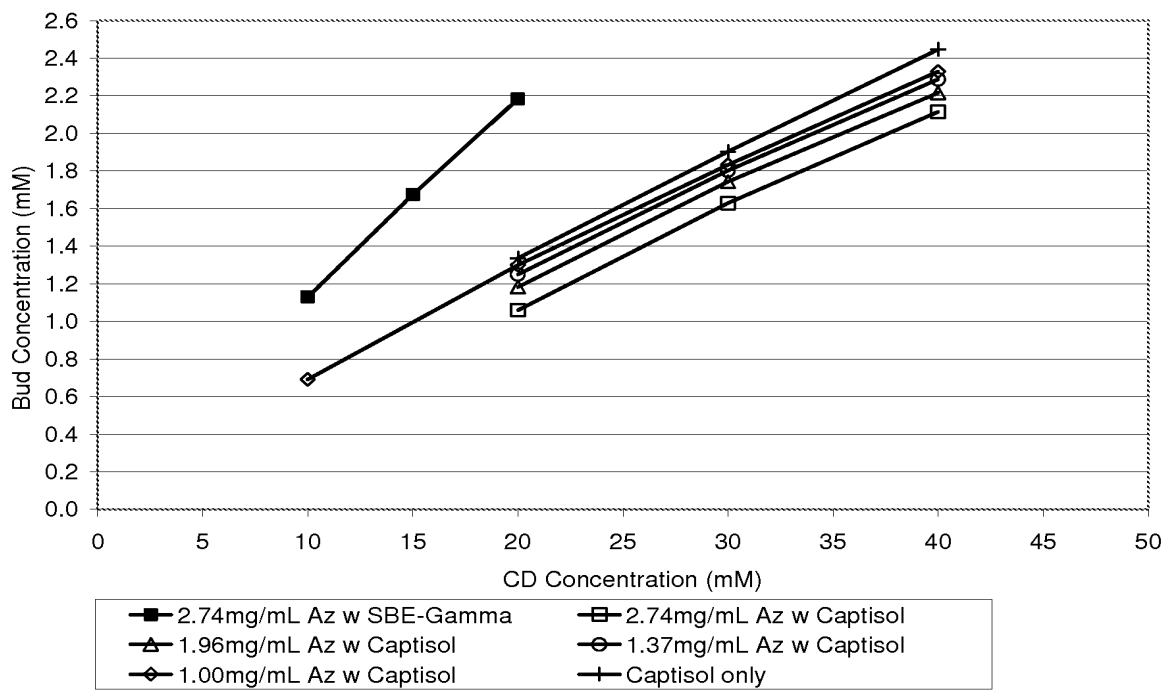

FIG. 12A

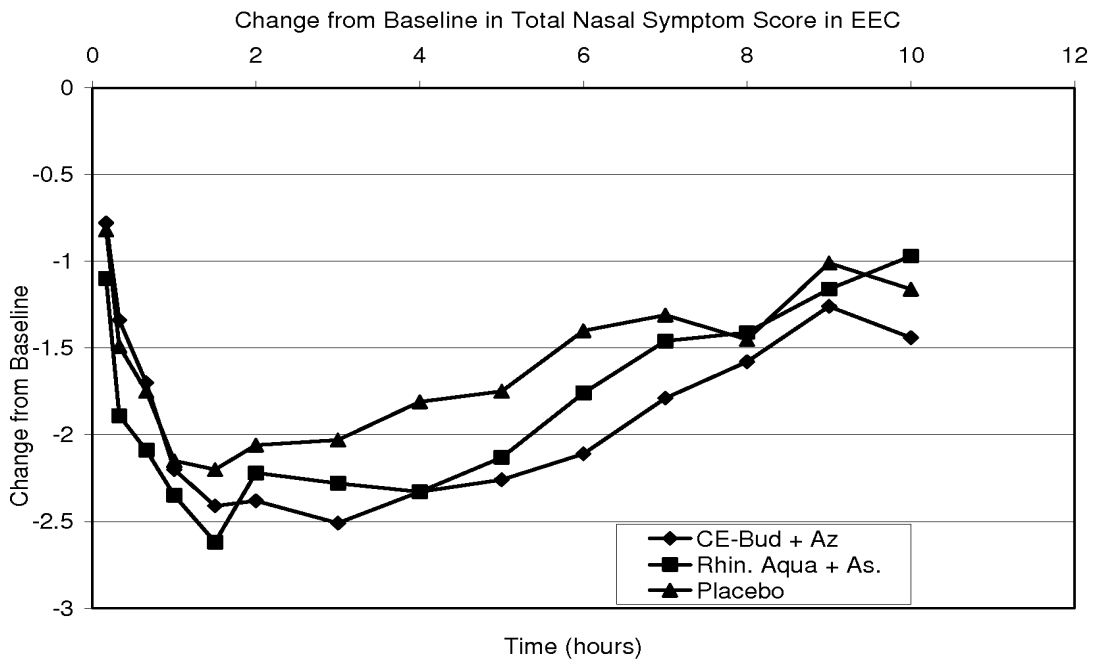

FIG. 12B

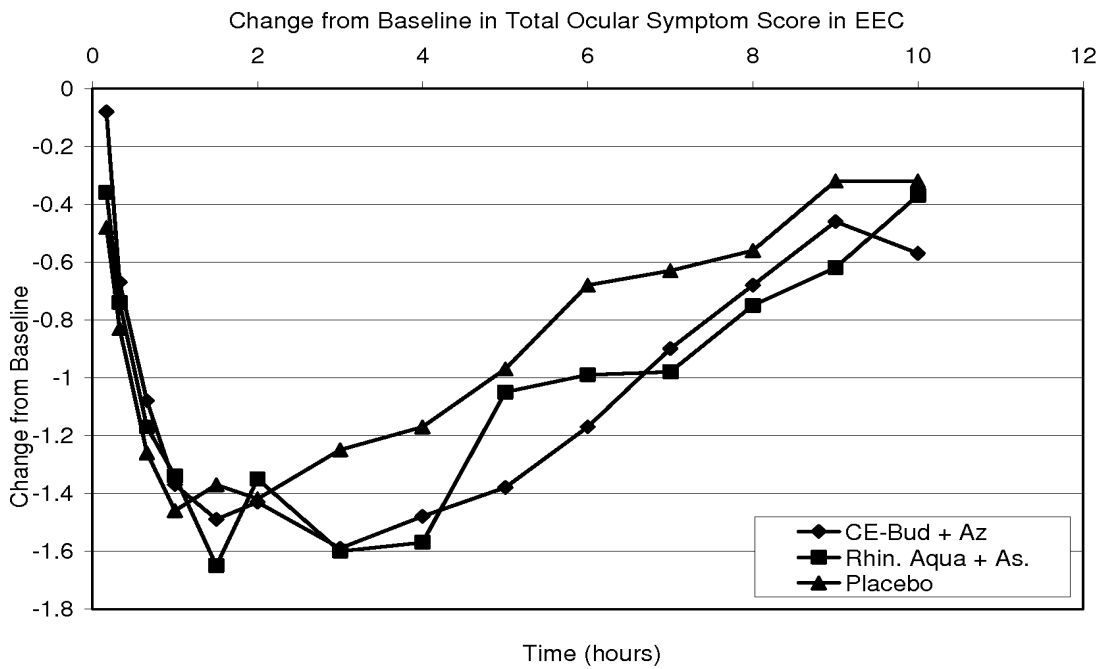

FIG. 12C

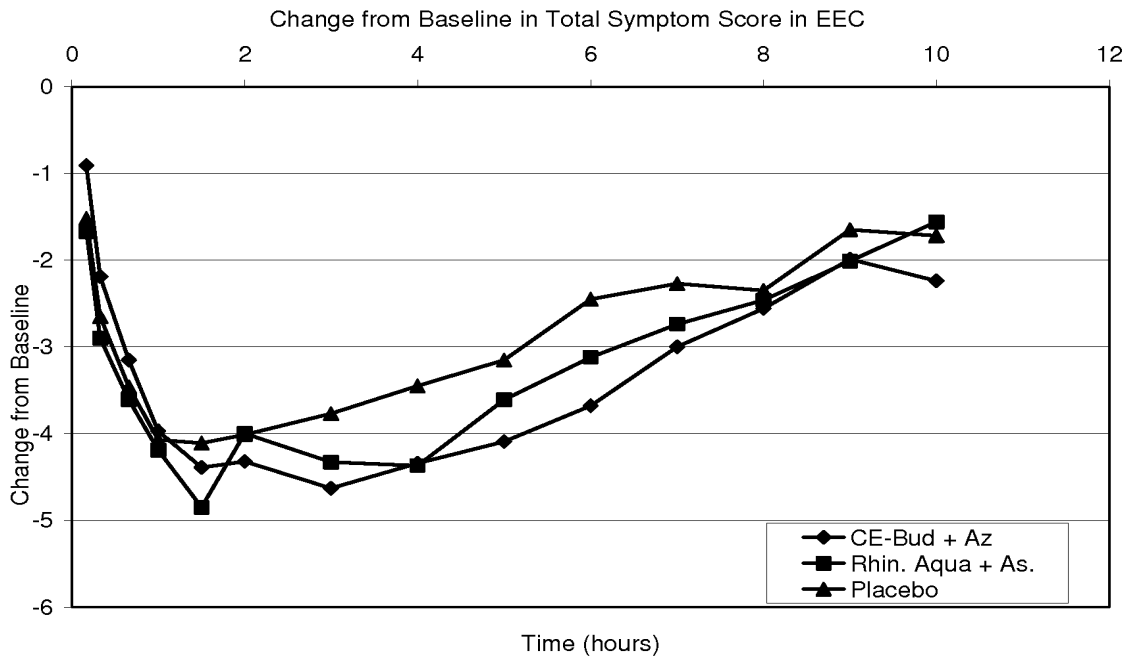

FIG. 13A

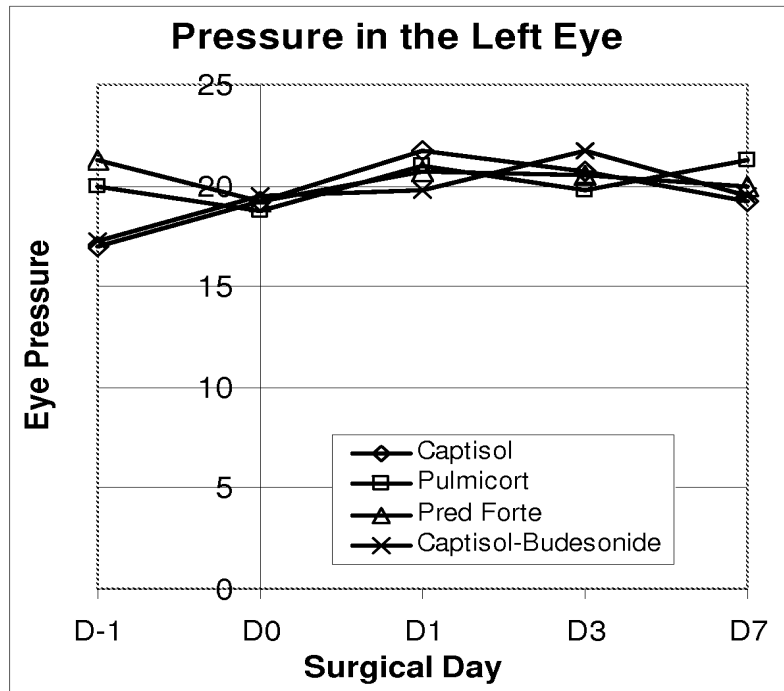
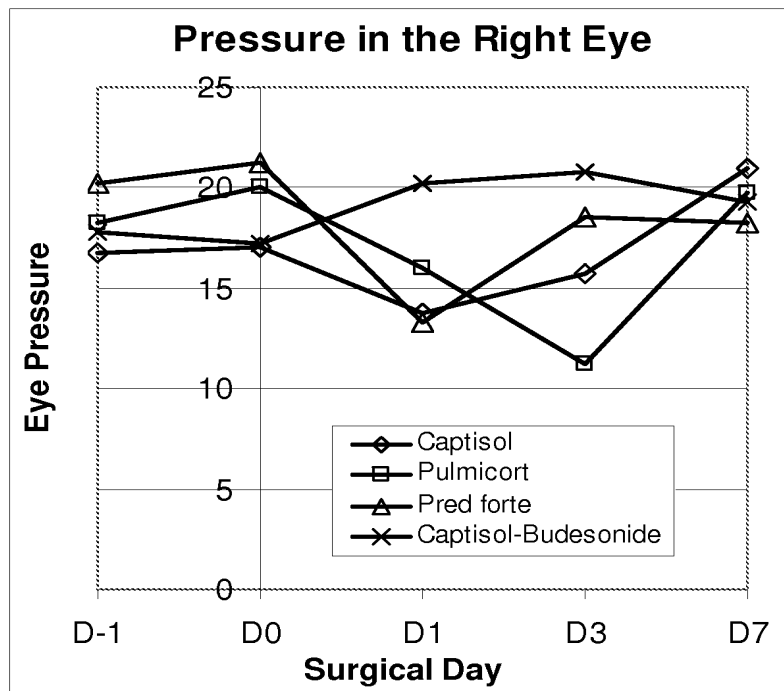

FIG. 13B



INTERNATIONAL SEARCH REPORT

International application No.

PCT/US 08/68872

A. CLASSIFICATION OF SUBJECT MATTER
 IPC(8) - A01N 43/04; A61K 31/715 (2008.04)
 USPC - 514/58

According to International Patent Classification (IPC) or to both national classification and IPC

B. FIELDS SEARCHED

Minimum documentation searched (classification system followed by classification symbols)
 USPC: 514/58

Documentation searched other than minimum documentation to the extent that such documents are included in the fields searched
 USPC: 514/171, 424/400, 424/434, 424/810 (text search)

Electronic data base consulted during the international search (name of data base and, where practicable, search terms used)
 US WEST (PGPB, USPT, EPAB, JPAB), Google Scholar, Dialog PRO (Engineering)
 corticosteroid, SAE-CD, sulfoalkylether cyclodextrin, composition, formulation, nasal, ophthalmic administration, allergy, ophthalmic inflammation, metered dose, itchy, watery, tearing, gritty eyes, antihistamine

C. DOCUMENTS CONSIDERED TO BE RELEVANT

Category*	Citation of document, with indication, where appropriate, of the relevant passages	Relevant to claim No.
Y	US 2007/0020330 A1 (DANG et al.) 25 January 2007 (25.01.2007) para [0010], [0014], [0016], [0022], [0023], [1179], [1184], [1185], [1187], [1283]	1-7, 9-15, 17, 34-37
Y	US 2007/0020299 A1 (PIPKIN et al.) 25 January 2007 (25.01.2007) para [0068], [0082], [0243]	1-15, 17, 34-37
Y	US 2006/0194840 A1 (GOZAL) 31 August 2006 (31.08.2006) par [0018], [0160]	8

Further documents are listed in the continuation of Box C.

* Special categories of cited documents:

"A" document defining the general state of the art which is not considered to be of particular relevance

"E" earlier application or patent but published on or after the international filing date

"L" document which may throw doubts on priority claim(s) or which is cited to establish the publication date of another citation or other special reason (as specified)

"O" document referring to an oral disclosure, use, exhibition or other means

"P" document published prior to the international filing date but later than the priority date claimed

"T" later document published after the international filing date or priority date and not in conflict with the application but cited to understand the principle or theory underlying the invention

"X" document of particular relevance; the claimed invention cannot be considered novel or cannot be considered to involve an inventive step when the document is taken alone

"Y" document of particular relevance; the claimed invention cannot be considered to involve an inventive step when the document is combined with one or more other such documents, such combination being obvious to a person skilled in the art

"&" document member of the same patent family

Date of the actual completion of the international search

03 October 2008 (03.10.2008)

Date of mailing of the international search report

09 OCT 2008

Name and mailing address of the ISA/US

Mail Stop PCT, Attn: ISA/US, Commissioner for Patents
 P.O. Box 1450, Alexandria, Virginia 22313-1450
 Facsimile No. 571-273-3201

Authorized officer:

Lee W. Young

PCT Helpdesk: 571-272-4300
 PCT OSP: 571-272-7774

INTERNATIONAL SEARCH REPORT

International application No.

PCT/US 08/68872

Box No. II Observations where certain claims were found unsearchable (Continuation of item 2 of first sheet)

This international search report has not been established in respect of certain claims under Article 17(2)(a) for the following reasons:

- 1. Claims Nos.:
because they relate to subject matter not required to be searched by this Authority, namely:

- 2. Claims Nos.:
because they relate to parts of the international application that do not comply with the prescribed requirements to such an extent that no meaningful international search can be carried out, specifically:

- 3. Claims Nos.: 16, 18, 19-33, 38-50
because they are dependent claims and are not drafted in accordance with the second and third sentences of Rule 6.4(a).

Box No. III Observations where unity of invention is lacking (Continuation of item 3 of first sheet)

This International Searching Authority found multiple inventions in this international application, as follows:

- 1. As all required additional search fees were timely paid by the applicant, this international search report covers all searchable claims.
- 2. As all searchable claims could be searched without effort justifying additional fees, this Authority did not invite payment of additional fees.
- 3. As only some of the required additional search fees were timely paid by the applicant, this international search report covers only those claims for which fees were paid, specifically claims Nos.:

- 4. No required additional search fees were timely paid by the applicant. Consequently, this international search report is restricted to the invention first mentioned in the claims; it is covered by claims Nos.:

Remark on Protest

- The additional search fees were accompanied by the applicant's protest and, where applicable, the payment of a protest fee.
- The additional search fees were accompanied by the applicant's protest but the applicable protest fee was not paid within the time limit specified in the invitation.
- No protest accompanied the payment of additional search fees.

(19) World Intellectual Property Organization
International Bureau



(43) International Publication Date
23 September 2010 (23.09.2010)

(10) International Publication Number
WO 2010/107689 A1

(51) International Patent Classification:
A61K 31/4965 (2006.01)

Gate Circle, Suwanee, GA 30024 (US). NICE, Jackie [US/US]; 75 Hume Avenue, Medford, MA 02155 (US).

(21) International Application Number:
PCT/US20 10/027295

(74) Agents: ELRIFI, Ivor R. et al; Mintz Levin Cohn Ferris Glovsky And Popeo, P.C., One Financial Center, Boston, MA 02111 (US).

(22) International Filing Date:
15 March 2010 (15.03.2010)

(81) Designated States (unless otherwise indicated, for every kind of national protection available): AE, AG, AL, AM, AO, AT, AU, AZ, BA, BB, BG, BH, BR, BW, BY, BZ, CA, CH, CL, CN, CO, CR, CU, CZ, DE, DK, DM, DO, DZ, EC, EE, EG, ES, FI, GB, GD, GE, GH, GM, GT, HN, HR, HU, ID, IL, IN, IS, JP, KE, KG, KM, KN, KP, KR, KZ, LA, LC, LK, LR, LS, LT, LU, LY, MA, MD, ME, MG, MK, MN, MW, MX, MY, MZ, NA, NG, NI, NO, NZ, OM, PE, PG, PH, PL, PT, RO, RS, RU, SC, SD, SE, SG, SK, SL, SM, ST, SV, SY, TH, TJ, TM, TN, TR, TT, TZ, UA, UG, US, UZ, VC, VN, ZA, ZM, ZW.

(25) Filing Language: English

(26) Publication Language: English

(30) Priority Data:
61/161,006 17 March 2009 (17.03.2009) US
61/174,850 1 May 2009 (01.05.2009) US

(63) Related by continuation (CON) or continuation-in-part (CIP) to earlier applications:
US 61/161,006 (CIP)
Filed on 17 March 2009 (17.03.2009)
US 61/174,850 (CIP)
Filed on 1 May 2009 (01.05.2009)

(84) Designated States (unless otherwise indicated, for every kind of regional protection available): ARIPO (BW, GH, GM, KE, LS, MW, MZ, NA, SD, SL, SZ, TZ, UG, ZM, ZW), Eurasian (AM, AZ, BY, KG, KZ, MD, RU, TJ, TM), European (AT, BE, BG, CH, CY, CZ, DE, DK, EE, ES, FI, FR, GB, GR, HR, HU, IE, IS, IT, LT, LU, LV, MC, MK, MT, NL, NO, PL, PT, RO, SE, SI, SK, SM, TR), OAPI (BF, BJ, CF, CG, CI, CM, GA, GN, GQ, GW, ML, MR, NE, SN, TD, TG).

(71) Applicant (for all designated States except US): ACIEX THERAPEUTICS, INC. [US/US]; 82 Flanders Road, Suite 102, Westborough, MA 01581 (US).

(72) Inventors; and

(75) Inventors/Applicants (for US only): ABELSON, Mark, Barry [CA/US]; 26 Phillips Street, Andover, MA 01810 (US). CHAPIN, Mathew, Jonathan [US/US]; 54 Pleasant Valley Road, Amesbury, MA 01913 (US). GOMES, Paul [US/US]; 33 Brickett Hill Circle, Haverhill, MA 01830 (US). MINNO, George [US/US]; 355 Highland

Published:

— with international search report (Art. 21(3))



WO 2010/107689 A1

(54) Title: OPHTHALMIC FORMULATIONS OF CETIRIZINE AND METHODS OF USE

(57) Abstract: The present invention provides stable topical formulations of cetirizine that provide a comfortable formulation when instilled in the eye and is effective in the treatment of allergic conjunctivitis and/or allergic conjunctivitis. The invention further provides methods of treating allergic conjunctivitis and/or allergic rhinoconjunctivitis in a subject in need of such treatment by topical application of the cetirizine formulations of the invention directly to the eye.

**OPHTHALMIC FORMULATIONS OF CETIRIZINE
AND METHODS OF USE**

REFERENCE TO RELATED APPLICATIONS

5 This application claims priority to U.S. Provisional Application No. 61/161006, filed March 17, 2009 and U.S. Provisional Application No. 61/174850, filed May 1, 2009, the contents of which are each hereby incorporated by reference in their entireties.

FIELD OF THE INVENTION

10 The invention relates to compositions comprising cetirizine, alone or in combination with one or more additional active agents such as a steroid and/or a vasoconstrictor, and methods for using the same for treating allergic conjunctivitis and allergic rhinoconjunctivitis.

BACKGROUND OF THE INVENTION

15 There exists a need for topical ophthalmic pharmaceutical products to effectively treat allergic conjunctivitis, a disorder that presents with both acute allergic symptoms (i.e., seasonal allergy) and late phase inflammatory reactions (i.e., chronic, refractory or persistent allergy), as well as allergic rhinoconjunctivitis. It has been estimated that 46% (~ 70 million) of the adult allergy patients in the United States suffer from both the acute and late phase conditions of allergic conjunctivitis, whereas only 19% suffer from only acute or late phase allergy,
20 respectively. It is estimated that allergic rhinoconjunctivitis (a combination of ocular and nasal symptoms) may occur in up to 90% of patients with allergies. The average age of allergy sufferers - between 20 and 40 years - coincides with the average age of the work force and the most productive period of an individual's life.

25 Both seasonal and perennial allergic conjunctivitis (ocular allergies) are characterized by itchy, red, swollen, and watery eyes. Allergic rhinitis (nasal allergies) manifests as a runny nose,

sneezing, congestion, and similar symptoms. It can be difficult for a physician to distinguish allergic conjunctivitis from allergic rhinoconjunctivitis because both allergic reactions can occur simultaneously or be triggered by the same types of stimuli. It is further difficult to distinguish acute allergic symptoms from late phase symptoms of allergic conjunctivitis, as each of these conditions can persist simultaneously or morph back and forth in any given individual. The signs and symptoms of allergic conjunctivitis and allergic rhinoconjunctivitis can significantly impact the quality of life of patients, from social interactions, productivity at work and school, to the ability to perform visual tasks such as working on a computer or reading.

Acute symptoms of allergic conjunctivitis are characterized by the clinical signs and symptoms of eye itching, redness, and swelling. Late phase or allergic inflammation reactions of allergic conjunctivitis include redness, lid swelling and tearing, and in some cases itching, as well as the predominance of congestion in the nose. Acute allergic symptoms are predominantly caused by the activation of mast cells, which when stimulated by an allergen (pollen, dust, dander) releases a host of substances that produce the signs and symptoms of allergic conjunctivitis (itching, redness, swelling, and tearing). Histamine is the primary mediator released and stimulates receptors on nerve endings and blood vessels to produce itching and redness. There are two histamine receptors that have been identified on the ocular surface. H1 receptors on nerve endings lead to itching, and H1 and H2 receptors on blood vessels lead to dilation of the blood vessels, leading to redness, and leakage of fluid from the vessels into the surrounding tissue producing swelling. Late phase inflammatory reactions are mediated by activation of inflammatory cells.

Like allergic conjunctivitis, allergic rhinoconjunctivitis is an allergen-induced, mast cell-mediated response. The reaction is triggered when airborne allergens bind to antibodies attached to the surface of mast cells in the eye and/or nose. Mast cells, in turn, release chemical mediators, which account for the immediate reaction in sensitized individuals exposed to allergen. Some of these mediators, such as histamine, directly affect blood vessels and nerves, leading to the signs and symptoms of allergic disease. Other released mediators cause the influx of white blood cells to the site, which leads to sustained symptoms in severe cases and particularly congestion in the nose.

Allergic conjunctivitis and rhinoconjunctivitis may also co-exist with other external ocular conditions and diseases, such as dry eye, or irritations caused by pollutants or other causes. This leads to a compromised tear film, which serves to protect the ocular surface from allergens.

5 Currently available treatments for eye allergy include: drops which can wash allergens off the ocular surface and act as a barrier for the eye (e.g. artificial tears), drugs which block histamine from binding to the histamine receptors (e.g. antihistamines), drugs that block the release of histamine and other substances from the mast cell (e.g. mast cell stabilizers), drugs with multiple modes of action (e.g. antihistamine/mast cell stabilizing agents), and drugs that can
10 actively constrict blood vessels thus reducing redness and swelling (e.g. vasoconstrictors). The criteria which may be considered in evaluating the appropriateness of an agent for a patient include: efficacy at onset of action, duration of action, how well it controls the individual signs and symptoms of allergic conjunctivitis, comfort of the formulation when instilled in the eye, and safety of the formulation when instilled in the eye. The comfort of an ophthalmic product
15 depends on the active pharmaceutical ingredient itself, as well as the nature of the formulation and the vehicle that makes up the product. Oral antihistamines have been shown to induce decreased tear production and lead to dryness of the ocular surface, which can exacerbate ocular discomfort and can make the eye susceptible to irritation by an ophthalmic product.

20 The currently available treatments which contain a single active agent, such as an antihistamine or a mast cell stabilizer, typically provide relief for only acute allergic conjunctivitis and don't address the signs and symptoms of the late phase inflammatory reactions (i.e., chronic, refractory, or persistent allergy).

25 Currently available treatments for allergic rhinoconjunctivitis include eyedrops, nasal sprays, and systemic oral agents. Currently approved anti-allergy eyedrops are indicated for ocular allergy and nasal sprays are targeted for nasal allergy. Systemic agents, while they have indications to treat both nasal and ocular symptoms, several well controlled clinical trials
30 conducted to ophthalmic standards have shown that systemic antihistamines are inferior to eyedrops in treating the ocular signs and symptoms (Spangler et al., Clin. Ther. 25(8), 2245-2267 (2003), are not in fact clinically effective on eye allergy, and actually have been shown by objective measures to reduce tear production on the eye by 50%, causing ocular dryness (Ousler

et al, *Ann Allergy Asthma Immunol.* Nov; 93(5):460-4 (2004). Further studies have shown that the combination of an eyedrop and nasal steroid is more effective than a systemic agent in treating the ocular and nasal signs and symptoms of allergy (Lanier et al. *Clin. Ther.* 24(7), 1161-1174 (2002)).

5 Cetirizine hydrochloride is a racemic selective H1 receptor inverse agonist which functions as an antihistamine. It is a major metabolite of hydroxyzine and a derivative of piperazine. The levorotary enantiomer of cetirizine is known as levocetirizine. Cetirizine hydrochloride is FDA approved for oral use and is used as a systemic antihistamine for the treatment of allergies, hay fever, angioedema, and urticaria. It has been historically difficult to
10 prepare cetirizine as an ophthalmic solution with satisfactory safety and stability profiles. Cetirizine has the disadvantage of forming aggregates in solution at low concentrations (typically less than 1% (w/v)), thereby decreasing the stability as an aqueous solution. Moreover, higher concentrations of cetirizine (1% and above) are strongly irritating and thus unsuitable for direct ocular or nasal administration. U.S. Patent No. 5,419,898 addresses these issues by using a
15 cyclodextrin compound to increase the solubility and stability of cetirizine for ophthalmic use. However, a cyclodextrin-free stable ophthalmic formulation containing cetirizine as the only active ingredient that is both comfortable in the eye and effective to mitigate the symptoms of allergic conjunctivitis has never been previously achieved.

 There thus exists a need to develop an effective, stable yet comfortable and safe cetirizine
20 formulations for ophthalmic administration for the treatment of allergic conjunctivitis (i.e., the acute phase, the late inflammatory phase, or both) and allergic rhinoconjunctivitis. Such formulations for administration directly to the eye would be advantageous over systemic oral formulations and nasal sprays due to faster action and avoidance of the side effects associated with systemic administration.

25

SUMMARY OF THE INVENTION

 The present invention provides comfortable topical ophthalmic formulations for the treatment of both acute and late phase signs of allergic conjunctivitis as well as rhinoconjunctivitis which contain a combination of ingredients which act synergistically to

relieve the signs and symptoms of allergic conjunctivitis and/or rhinoconjunctivitis, particularly ocular itching and/or nasal symptoms (e.g., itchy, running nose, sneezing, nasal/sinus congestion). In particular, the formulations described herein provide stable formulations comprising a low concentration of cetirizine suitable for ophthalmic use in a comfortable ophthalmic formulation when instilled in the eye.

The present invention is based on the surprising discovery that stable topical ophthalmic formulations comprising a low concentration of cetirizine can be prepared without the use of a cyclodextrin or other solubilizer compound, that is both comfortable when instilled in the eye and effective to mitigate the symptoms of allergic conjunctivitis and/or rhinoconjunctivitis, particularly ocular itching and/or nasal symptoms (e.g., itchy, running nose, sneezing, nasal/sinus congestion). The invention also provides methods for the treatment of allergic conjunctivitis and/or rhinoconjunctivitis in a subject in need of such treatment by administering a cetirizine formulation of the invention directly to the eye of the subject. Surprisingly, once a day dosing of the low concentration cetirizine formulations of the invention is effective to mitigate the symptoms of allergic conjunctivitis and/or rhinoconjunctivitis, particularly ocular itching and/or nasal symptoms (e.g., itchy, running nose, sneezing, nasal/sinus congestion) .

The invention also provides stable ophthalmic formulations of cetirizine in combination with one or more active ingredients including but not limited to a vasoconstrictor such as naphazoline or oxymetazoline, and/or a steroid such as fluticasone, or combinations thereof. The combination formulations of cetirizine are effective in mitigating the signs and symptoms of both acute and late phase allergic conjunctivitis, such as ocular itching, redness, chemosis, and lid swelling, and nasal symptoms, as well as allergic rhinoconjunctivitis.

More specifically, the combination formulations of the invention (e.g., cetirizine and fluticasone) provide a comprehensive treatment benefit for both acute and late phase reactions of allergic conjunctivitis, that cannot be achieved by the use of a single anti-allergic, or other active agent, alone. Antihistamines and mast cell stabilizers such as cetirizine do not effectively block all allergic and pro-inflammatory mediators from the mast cell. Cetirizine, and other antihistamines and mast cell stabilizers, effectively masks itching but has minimal effects on redness, tearing, swelling and inflammation. However, when cetirizine is combined with another

active agent which can halt the transcription and production of inflammatory mediators and down-regulate the production of anti-inflammatory mediator, such as a steroid (e.g., fluticasone), treatment of the signs and symptoms of acute and late phase allergic conjunctivitis ((i.e., the aggregate disease) is achieved. Likewise, such combination formulations provide a
5 comprehensive treatment benefit for rhinoconjunctivitis that cannot be achieved by the use of a single anti-allergic, or other active agent alone, for these same reasons.

In one particular embodiment, the cetirizine formulation of the invention comprises a stable ophthalmic formulation of cetirizine as the only active ingredient at a concentration of 0.01% to 1.0% (w/v), preferably 0.05% to 0.5% (w/v), or any specific value within said ranges.
10 Preferably, cetirizine is in the form of cetirizine hydrochloride or dihydrochloride. Surprisingly, the stable cetirizine formulation is achieved without the use of a cyclodextrin, or other solubilizing compound, which were described as being required in US Patent 5,419,898.

In another particular embodiment, the invention provides a stable ophthalmic formulation
15 of cetirizine in combination with fluticasone. Preferably, cetirizine is in the form of cetirizine hydrochloride or dihydrochloride. In certain embodiments, cetirizine is present in the formulation at a concentration of 0.05% to 1.0% (w/v), or any specific value within said range. For example, cetirizine is formulated at a concentration of 0.050% to 0.075%, 0.075% to 0.1%, 0.1% to 0.25%, 0.25% to 0.50%, 0.50% to 0.75%, or 0.75% to 1.0% (w/v), or any specific value
20 within said ranges). In particular embodiments, cetirizine is formulated at a concentration of 0.05%, 0.1%, 0.2%, 0.25%, 0.3%, 0.35%, 0.4%, 0.45%, 0.5%, 0.6%, 0.7%, 0.8%, 0.9%, or 1.0% (w/v). In certain embodiments, fluticasone is present in the formulation at a concentration of 0.001% to 1.0% (w/v), or any specific value within said range. Preferably, fluticasone is present in the formulation at a concentration of 0.001% and 0.2% (w/v), or any specific value within said
25 range. For example, fluticasone is formulated at a concentration of 0.001%, 0.005%, 0.01%, 0.015%, 0.025%, or 0.2% (w/v). In a particular embodiment, cetirizine is present in the formulation at a concentration of 0.1% (w/v) and fluticasone is present in the formulation at a concentration of 0.005% (w/v). In another particular embodiment, cetirizine is present in the formulation at a concentration of 0.25% (w/v) and fluticasone is present in the formulation at a
30 concentration of 0.01% (w/v). The stable cetirizine/fluticasone formulation is achieved without

the use of a cyclodextrin, or other solubilizing compound. The cetirizine alone, and combination formulations of the invention (e.g., cetirizine/fluticasone) are stable and comfortable upon instillation in the eye. Surprisingly, the cetirizine/fluticasone formulations of the invention do not increase intraocular pressure in the eye after repeated use (e.g., after 14 days). As such the cetirizine combination formulations of the invention are safe for ocular use.

In certain embodiments, the cetirizine alone and cetirizine combination formulations of the invention are formulated in a vehicle comprising 1% Polyethylene Glycol 400, NF; 0.2% Dibasic Sodium Phosphate, Anhydrous, USP; 0.25% Hypromellose, USP; 0.1% Polysorbate 80, NF; 1.2% to 1.8% Glycerin (or any specific value within said range), USP; 0.025% Edetate Disodium, USP; 0.01% Benzalkonium Chloride, NF (pH 7.0).

In some embodiments, the stable ophthalmic cetirizine formulations of the invention comprise a tear substitute. In particular embodiments, the tear substitute is hydroxypropylmethyl cellulose (Hypromellose or HPMC). According to some embodiments, the concentration of HPMC ranges from about 0.1% to about 2% w/v, or any specific value within said range.

According to some embodiments, the concentration of HPMC ranges from about 0.5% to about 1% w/v, or any specific value within said range. In a preferred embodiments, the concentration of HPMC ranges from about 0.1% to about 1.0% w/v, or any specific value within said range (e.g., 0.1-0.2%, 0.2-0.3%, 0.3-0.4%, 0.4-0.5%, 0.5-0.6%, 0.6-0.7%, 0.7-0.8%, 0.8-0.9%, 0.9-1.0%; about 0.2%, about 0.21%, about 0.22%, about 0.23%, about 0.24%, about 0.25%, about 0.26%, about 0.27%, about 0.28%, about 0.29%, about 0.30%, about 0.70%, about 0.71%, about 0.72%, about 0.73%, about 0.74%, about 0.75%, about 0.76%, about 0.77%, about 0.78%, about 0.79%, about 0.80%, about 0.81%, about 0.82%, about 0.83%, about 0.84%, about 0.85%, about 0.86%, about 0.87%, about 0.88%, about 0.89%, or about 0.90%).

In another particular embodiment the tear substitute is carboxymethyl cellulose (CMC). According to some embodiments, the concentration of CMC ranges from about 0.1% to about 2% w/v, or any specific value within said range. According to some embodiments, the concentration of CMC ranges from about 0.1% to about 1% w/v, or any specific value within said range. In a preferred embodiments, the concentration of CMC ranges from about 0.7% to about 0.9% w/v, or any specific value within said range (i.e., about 0.70%, about 0.71%, about

0.72%, about 0.73%, about 0.74%, about 0.75%, about 0.76%, about 0.77%, about 0.78%, about 0.79%, about 0.80%, about 0.81%, about 0.82%, about 0.83%, about 0.84%, about 0.85%, about 0.86%, about 0.87%, about 0.88%, about 0.89%, or about 0.90%).

5 In yet another particular embodiment, the stable ophthalmic cetirizine formulations of the invention comprise a polymeric, mucoadhesive vehicle. Examples of mucoadhesive vehicles suitable for use in the methods or formulations of the invention include but are not limited to aqueous polymeric suspensions comprising one or more polymeric suspending agents including without limitation dextrans, polyethylene glycol, polyvinylpyrrolidone, polysaccharide gels, Gelrite[®], cellulosic polymers, and carboxy-containing polymer systems. In a particular
10 embodiment, the polymeric suspending agent comprises a crosslinked carboxy-containing polymer (*e.g.*, polycarboxiphil). In another particular embodiment, the polymeric suspending agent comprises a polyethylene glycol (PEG). Examples of cross-linked carboxy-containing polymer systems suitable for use in the topical stable ophthalmic cetirizine formulations of the invention include but are not limited to Noveon AA-I, Carbopol[®], and/or DuraSite[®] (InSite
15 Vision).

Optionally, the formulations of the invention contain a preservative. In particular embodiments the preservative is benzalkonium chloride or a derivative thereof (*e.g.*, Polyquad[®]), or a stabilized oxychloro complex (*e.g.*, Purite[®]).

20 According to some embodiments, the ophthalmic formulations of the present invention has a viscosity that ranges from about 30 to about 150 centipoise (cpi), preferably about 50 to about 120 cpi, even more preferably about 60 to about 115 cpi (or any specific value within said ranges). According to preferred embodiments, the ophthalmic formulations of the present invention has a viscosity that ranges from about 60 to about 80 cpi, or any specific value within
25 said range (*i.e.*, about 60 cpi, about 61 cpi, about 62 cpi, about 63 cpi, about 64 cpi, about 65 cpi, about 66 cpi, about 67 cpi, about 68 cpi, about 69 cpi, about 70 cpi, about 71 cpi, about 72 cpi, about 73 cpi, about 74 cpi, about 75 cpi, about 76 cpi, about 77 cpi, about 78 cpi, about 79 cpi, or about 80 cpi).

The invention also provides methods of treating and preventing the symptoms of allergic conjunctivitis by administering a stable cetirizine formulation of the invention (i.e., cetirizine alone or in combination with an additional active agent such as a steroid (e.g., fluticasone) or a vasoconstrictor (e.g., naphazoline or oxymetazoline) directly to the eye of a subject in need of such treatment or prevention. Preferably, the formulation of the invention is administered once a day (q.d.). In certain embodiments, the methods of the invention (i.e., administration of a formulation of the invention directly to the eye) are also effective to treat nasal symptoms associated with allergic conjunctivitis. The invention also provides methods of treating and preventing the symptoms of allergic rhinoconjunctivitis by administering a stable cetirizine formulation of the invention (i.e., cetirizine alone or in combination with an additional active agent such as a steroid (e.g., fluticasone) or a vasoconstrictor (e.g., naphazoline or oxymetazoline) directly to the eye of a subject in need of such treatment or prevention. By providing a treatment option in eye drop form, the present invention will improve quality of life in patients with allergic rhinoconjunctivitis/rhinitis (See e.g., Berger et al, *Ann. Allergy Asthma Immunol.* Oct 95(4), 361-71 (2005).

The invention further provides kits comprising a pharmaceutical composition of cetirizine formulated for ophthalmic use and instructions for such use. Other features and advantages of the invention will become apparent from the following detailed description and claims.

BRIEF DESCRIPTION OF THE DRAWINGS

Figure IA is a line graph depicting the efficacy of a 0.1% cetirizine formulation reducing of ocular itching as compared to a vehicle control. The mean ocular itching score (scale of 0 to 4) is shown at 0, 3, 5, and 7 minutes after conjunctival challenge with allergen; Figure IB is a line graph depicting the efficacy of a 0.1% cetirizine formulation reducing conjunctival redness as compared to a vehicle control

Figure 2 is a line graph depicting the comfort profile of a 0.1% cetirizine formulation upon instillation in the eye as compared to a vehicle control. The comfort of the formulation is indicated on a subjective scale of 0 to 10 (0=very comfortable; 10=very uncomfortable). The

mean drop comfort score is shown at 0, 1, 2 minutes after addition of a drop of the cetirizine formulation of the invention.

Figures 3A and 3B depict a study design (screening and evaluation) for testing the efficacy of Fluticasone 0.001%, 0.005% and 0.01% as compared to vehicle in reducing ocular and nasal symptoms of ocular allergy in an allergic conjunctivitis model.

Figure 4 is a line graph comparing the efficacy of Fluticasone 0.001%, 0.005% and 0.01% as compared to vehicle in reducing ocular itching assessed on a scale of 0 (no itching) to 4 (severe itching) over time.

Figure 5 is a line graph comparing the efficacy of Fluticasone 0.001%, 0.005% and 0.01% as compared to vehicle in reducing conjunctival redness, assessed on a scale of 0 (no redness) to 4 (severe redness) over time.

Figure 6 is line graph comparing the efficacy of Fluticasone 0.001%, 0.005% and 0.01% as compared to vehicle in reducing lidswelling, assessed on a scale of 0 (no swelling) to 3 (severe swelling) over time.

Figure 7 is a line graph comparing the efficacy of Fluticasone 0.001%, 0.005% and 0.01% as compared to vehicle in reducing nasal congestion, assessed on a scale of 0 (no congestion) to 4 (severe congestion) over time.

Figure 8 is a bar graph summarizing the results shown in Figures 3-7.

Figure 9 is a line graph comparing the efficacy of Fluticasone 0.001%, 0.005% and 0.01% as compared to vehicle in reducing ciliary redness, assessed on a scale of 0 (no redness) to 4 (severe redness) over time.

Figure 10 is a line graph comparing the efficacy of Fluticasone 0.001%, 0.005% and 0.01% as compared to vehicle in reducing episcleral redness, assessed on a scale of 0 (no redness) to 4 (severe redness) over time.

Figure 11 is a line graph comparing the efficacy of Fluticasone 0.001%, 0.005% and 0.01% as compared to vehicle in reducing chemosis, assessed on a scale of 0 (none) to 4 (severe) over time.

Figure 12 is a line graph comparing the efficacy of Fluticasone 0.001%, 0.005% and 0.01% as compared to vehicle in reducing watery eyes, assessed on a scale of 0 (none) to 4 (severe) over time.

Figure 13 is a bar graph summarizing the results shown in Figures 9-11.

Figure 14 is a line graph comparing the efficacy of Fluticasone 0.001%, 0.005% and 0.01% as compared to vehicle in reducing rhinorrhea, assessed on a scale of 0 (none) to 4 (severe) over time.

5 Figure 15 is a line graph comparing the efficacy of Fluticasone 0.001%, 0.005% and 0.01% as compared to vehicle in reducing ear or palate pruritis, assessed on a scale of 0 (none) to 4 (severe) over time.

10 Figure 16 is a line graph comparing the efficacy of Fluticasone 0.001%, 0.005% and 0.01% as compared to vehicle in reducing nasal pruritis, assessed on a scale of 0 (none) to 4 (severe) over time.

Figure 17 is a line graph comparing the efficacy of Fluticasone 0.001%, 0.005% and 0.01% as compared to vehicle on total nasal score, assessed on a scale of 0 (no nasal symptoms) to 16 (multiple nasal symptoms) over time.

Figure 18 is a bar graph summarizing the results shown in Figures 14-17.

15 Figure 19 is a line graph comparing the efficacy of Fluticasone 0.001%, 0.005% and 0.01% as compared to vehicle on peak nasal inspiratory flow (PNIF).

Figure 20 a line graph comparing the drop comfort of Fluticasone 0.001%, 0.005% and 0.01% as compared to vehicle, assessed on a scale of 0 (extremely comfortable) to 10 (extremely uncomfortable) over time at Visit 2.

20 Figure 21 a line graph comparing the drop comfort of Fluticasone 0.001%, 0.005% and 0.01% as compared to vehicle, assessed on a scale of 0 (extremely comfortable) to 10 (extremely uncomfortable) over time at Visit 3.

Figure 22 is a chart summarizing the incidence of adverse events associated with instillation of Fluticasone 0.001%, 0.005% and 0.01% in the eye.

25 Figure 23 is a bar graph summarizing the effects of Fluticasone 0.001%, 0.005% and 0.01% as compared to vehicle on intraocular pressure.

Figure 24 is a bar graph summarizing the effects of a 0.1% cetirizine/0.005% fluticasone formulation (low dose) and a 0.25% cetirizine/0.01% fluticasone formulation (high dose) on conjunctival hyperemia, chemosis, discharge, and lid swelling after three days of dosing, as compared to 0.1% cetirizine alone, 0.005% fluticasone alone, a leading commercial

30

antihistamine for treating allergic conjunctivitis (Pataday[®]; olopatadine 0.2%), a commercially available steroid (Pred Forte[®]; prednisolone acetate 1%) and a vehicle control

5 Figure 25 is a bar graph summarizing the effects of a 0.1% cetirizine/0.005% fluticasone formulation (low dose) and a 0.25% cetirizine/0.01% fluticasone formulation (high dose) on conjunctival hyperemia, chemosis, discharge, and lid swelling after three days of dosing, as compared to 0.1% cetirizine alone, 0.005% fluticasone alone, and vehicle control.

10 Figure 26 is a bar graph summarizing the effects of a 0.1% cetirizine/0.005% fluticasone formulation (low dose) on conjunctival hyperemia, chemosis, discharge, and lid swelling after three days of dosing, as compared to 0.1% cetirizine alone, 0.005% fluticasone alone, and vehicle control.

15 Figure 27 is a bar graph summarizing the sum of clinical exam scores for a 0.1% cetirizine/0.005% fluticasone formulation (low dose) and a 0.25% cetirizine/0.01% fluticasone formulation (high dose), 0.1% cetirizine alone formulation, 0.005% fluticasone alone formulation, an olopatadine 0.2% formulation, a prednisolone acetate 1% formulation and a vehicle control.

20 Figure 28 is a bar graph summarizing the sum of clinical exam scores for a 0.1% cetirizine/0.005% fluticasone formulation (low dose) and a 0.25% cetirizine/0.01% fluticasone formulation (high dose), 0.1% cetirizine alone formulation, 0.005% fluticasone alone formulation, and a vehicle control.

25 Figure 29 is a line graph depicting the comfort profile of a 0.1% cetirizine/0.005% fluticasone formulation (low dose) and a 0.25% cetirizine/0.01% fluticasone formulation (high dose) upon instillation in the eye as compared to controls. The comfort of the formulation is indicated on a subjective scale of 0 to 10 (0=very comfortable; 10=very uncomfortable).

DETAILED DESCRIPTION OF THE INVENTION

25 The invention is based in part on the discovery that low concentrations of cetirizine (i.e., less than 1%) can be prepared as a stable ophthalmic formulation, without the use of a cyclodextrin or other solubilizing compound. Such formulations are comfortable and safe for ocular use and effective at reducing the symptoms of allergic conjunctivitis and/or allergic

rhinoconjunctivitis, particularly ocular itching and/or nasal symptoms (e.g., itchy, running nose, sneezing, nasal/sinus congestion).

5 The historical difficulty in preparing cetirizine as an ophthalmic solution with satisfactory safety and stability profiles is well recognized in the art due to the fact that cetirizine aggregates in solution at low concentrations, and is highly irritating to the ocular surface at high concentrations, being a strong acid. Without intending to be bound by any theory, it was believed necessary to reduce the possibility of salt formation and metal based degradation in order to arrive at a stable formulation. As such, the addition of counter ions or metal based buffers that could promote salt formation, precipitation, or metal based degradation were
10 minimized or excluded from the cetirizine formulations of the invention. Furthermore, it was discovered that the pH could be adjusted to approximately 7.0 with no adverse effects on stability, to improve the comfort of the formula.

15 The invention features novel topical ophthalmic formulations comprising an effective amount of cetirizine, or a pharmaceutically acceptable salt thereof, in a pharmaceutically acceptable carrier. Pharmaceutically acceptable cetirizine salts include cetirizine hydrochloride or cetirizine dihydrochloride. In particular embodiments, the invention provides stable ophthalmic formulations of cetirizine as the only active agent in the formulations. The invention also features ophthalmic formulations of cetirizine in combination with one or more additional active ingredients selected from oxymetazoline, naphazoline and fluticasone. Such combination
20 formulations are effective in further mitigating the acute and late phase signs and symptoms of allergic conjunctivitis, such as ocular itching, redness, chemosis, lid swelling and nasal symptoms. Such formulations are also effective in mitigating the signs and symptoms of rhinoconjunctivitis, such as runny nose, sneezing, nasal/sinus congestion and red, watery and/or itchy eyes.

25 The comfort, safety, efficacy, solubility, and stability of the ophthalmic formulations of the invention could not have been predicted by one skilled in the art. Many antihistamines have been developed over the years by various companies for different indications. However, not all of these can be formulated or are effective as an eyedrop. Likewise not all antihistamines have the same duration of action. For example the potent antihistamine levocabastine has a duration
30 of 2-4 hours; recently approved bepotastine (Bepreve®-ISTA), indicated for twice daily dosing,

has an 8 hour duration; olopatadine 0.1% (Patanol®) indicated for twice daily dosing, has an 8 hour duration; and olopatadine 0.2% (Pataday®), indicated for once daily dosing, has a 16 hour duration of action. Therefore the efficacy is not predictable. In one study (Berdy et al, 1990), a panel of antihistamines were screened yet only a few were suitable for the eye based on comfort, formulation, irritation, and efficacy. As evidenced by Berdy et al., one skilled in the art could not have predicted which of the antihistamines would be ideal for ocular use or for treating ocular allergy. The invention is based, in part, upon the surprising and unpredictable discovery that an antihistamine and a steroid, when combined, act synergistically to treat both the acute and late phase reactions of allergic conjunctivitis, as well as allergic rhinoconjunctivitis.

In some embodiment, the cetirizine formulations of the invention comprise one or more tear substitute components. The cetirizine component provides relief of the symptoms of allergic conjunctivitis, and the one or more tear substitute component provides ocular surface protection via enhancement of the tear film (as evident by increased tear film break up time), and can act to enhance dwell time on the ocular surface thus increasing duration of activity. An effective amount of such formulations may be used to treat and/or prevent signs and symptoms associated with acute and/or late phase allergic conjunctivitis and/or general eye irritation, and can also be used to treat another eye disorder if it contains a drug for that disorder. An effective amount of such formulations may also be used to treat and/or prevent signs and symptoms of allergic rhinoconjunctivitis. Such formulations provide a comfortable ophthalmic formulation when instilled in the eye and have enhanced efficacy and/or duration of action over formulations of cetirizine that are not combined with such other agents.

The superior efficacy of the combination cetirizine/tear substitute formulations is attributed to, among other things, the synergistic effect of the combination of ingredients in them. The combination of cetirizine and tear substitute, act synergistically to provide a longer dwell time of the cetirizine on the ocular surface, thus increasing duration and efficacy of action, and to prolong the integrity of the tear film thereby providing protection of the ocular surface (*e.g.*, by increasing the tear film break up time and/or the Ocular Protection Index). As such, the compositions of the invention are comfortable upon instillation into the eye, and may be used for relief of acute or chronic allergic conjunctivitis, and are particularly suitable for both intermittent and long term use.

Formulations

In the context of this patent all concentrations are given for the cetirizine free base. The concentration for the cetirizine salt (e.g. cetirizine hydrochloride or dihydrochloride) can be calculated by multiplying the free base concentration by 1.188. e.g. 0.1% cetirizine free base is equivalent to 0.1188% cetirizine hydrochloride salt ($0.1\% \times 1.188 = 0.1188\%$).

Preferably, the ophthalmic formulations according to the present invention are formulated as solutions, suspensions, ointments, gels, emulsions, oils, and other dosage forms for topical administration. Aqueous solutions are generally preferred, based on ease of formulation, as well as a patient's ability to easily administer such compositions by means of instilling one to two drops of the solutions in the affected eyes. However, the compositions may also be suspensions, viscous or semi-viscous gels, or other types of solid or semisolid compositions or sustained release devices or mechanisms that are placed in or around the eye. In one embodiment, the cetirizine formulations of the invention are aqueous formulations. The aqueous formulations of the invention are typically more than 50%, preferably more than 75%, and most preferably more than 90% by weight water. Preferably, the aqueous formulation does not contain a cyclodextrin or other solubilizer compound. Stable aqueous formulations of cetirizine are achieved by minimizing/excluding the addition of counter ions or metal based buffers that could promote salt formation, precipitation, or metal based degradation. In another embodiment, the cetirizine formulations are lyophilized formulations.

Active agents

Cetirizine is the primary active agent in the ophthalmic formulations of the present invention, and in certain embodiments, the only active agent in the formulations of the invention. In certain embodiments of the invention, cetirizine, or a pharmaceutically acceptable salt thereof, is formulated at a concentration of 0.01% to 1.0% (w/v). Preferably, cetirizine is in the form of cetirizine hydrochloride or dihydrochloride. In certain embodiments, cetirizine is formulated at a concentration of 0.05% to 0.075%, 0.075% to 0.1%, 0.1% to 0.25%, 0.25% to 0.50%, 0.50% to 0.75%, or 0.75% to 1.0% (w/v). In particular embodiments, cetirizine is formulated at a concentration of 0.05% to 1.0% (w/v), or any specific value within said range. For example, cetirizine is formulated at a concentration of 0.05%, 0.1%, 0.2%, 0.25%, 0.3%, 0.35%, 0.4%,

0.45%, 0.5%, 0.6%, 0.7%, 0.8%, 0.9%, or 1.0% (w/v). (w/v). In one embodiment, the cetirizine formulation of the invention comprises cetirizine hydrochloride or dihydrochloride as the only active ingredient at a concentration of 0.01% to 1.0% (w/v), preferably 0.05% to 0.5% (w/v), more preferably 0.1% to 0.25% (w/v) (or any specific value within said ranges).

5 Cetirizine may be formulated with other active agents as described herein. For example, cetirizine may be formulated with one or more additional anti-allergic agents. The term "anti-allergenic agent" refers to a molecule or composition that treats allergic conjunctivitis and/or rhinoconjunctivitis or reduces a symptom of allergic conjunctivitis and/or rhinoconjunctivitis. The term "allergic conjunctivitis" refers to any allergic disease of the eye, *e.g.*,
10 seasonal/perennial allergic conjunctivitis, vernal keratoconjunctivitis, giant papillary conjunctivitis, perennial allergic conjunctivitis and atopic keratoconjunctivitis. The signs and symptoms of ocular allergies include chemosis, eye itching, tearing, redness and swelling, and may also co-exist with nasal symptomatology. The term "allergic rhinoconjunctivitis" refers to a
15 combination of nasal and ocular symptoms characterized by inflammation of the lining of the tissue of the eyes and nose due to an allergy or infection, causing nasal discharge, mucus, sneezing, irritation, and red, water, itchy eyes. Non-limiting examples of anti-allergic agents include "antihistamines" or drugs which block histamine from binding to the histamine
20 receptors, "mast cell stabilizers" or drugs that block the release of histamine and other substances from the mast cell, "drugs with multiple modes of action" or drugs that are antiallergenic agents
25 having multiple modes of action (*e.g.* drugs that are antihistamines and mast cell stabilizers, drugs with antihistamine, mast cell stabilizing and anti-inflammatory activity, *etc.*), steroids, and nonsteroidal anti-inflammatory drugs or "NSAIDs."

 In certain embodiments, cetirizine is formulated with one or more additional active agents selected from a mast cell stabilizer such as nedocromil, iodoxamide, cromolyn, or
25 cromolyn sodium; a non-steroidal anti-inflammatory drug ("NSAID") such as diclofenac or ketorolac tromethamine, bromfenac, or nepafenac; a vasoconstrictor such as naphazoline, antolazine, tetrahydrozoline or oxymetazoline; a topical steroid such as fluticasone, beclomethasone, budesonide, diflorasone, triaminicinolone, clobetasol, difluprednate,
30 prednisolone, dexamethasone, halobetasol, or mometasone; an antihistamine such as antazoline, astemizole, azelastine, bepotastine, bilastine, brompheniramine, chlorpheniramine, clemastine,

desloratidine, dexbrompheniramine, diphenhydramine, doxylamine, ebastine, emedastine, epinastine, fexofenadine, hydroxyzine, ketotifen, levocabastine, levocetirizine, loratidine, mequitazine, mizolastine, olopatadine, oxatomide, phenindamine, pheniramine, pyrilamine, terfenidine, and triprolidine; or an alpha-adrenergic agonist such as epinephrine, fenoxazoline, indanazoline, naphazoline, oxedrine, phenylephrine, tefazoline, tetryzoline, tramazoline, tymazoline, oxymetazoline, or xylometazoline.

In certain embodiments, cetirizine is formulated with one or more additional active agents such as a vasoconstrictor (e.g., naphazoline or oxymetazoline), or a steroid (e.g., fluticasone).

Naphazoline (in the hydrochloride form) is the common name for 2-(1-naphthylmethyl)-2-imidazoline hydrochloride. It is a sympathomimetic agent with marked alpha adrenergic activity. It is a vasoconstrictor with a rapid action in reducing swelling when applied to mucous membrane. It acts on alpha-receptors in the arterioles of the conjunctiva to produce constriction, resulting in decreased congestion. Oxymetazoline is a selective alpha-1 agonist and partial alpha-2 agonist topical decongestant, used in the form of oxymetazoline hydrochloride in commercially available nasal sprays. Oxymetazoline has sympathomimetic properties, and thus constricts the blood vessels of the nose and sinuses via activation of alpha-2 adrenergic receptors. Fluticasone is a potent synthetic corticosteroid often prescribed as treatment for asthma and allergic rhinitis.

In certain embodiments, cetirizine is formulated at a concentration of from 0.05% to 0.50% (w/v), in combination with naphazoline at a concentration of from 0.01% to 0.5% (w/v), preferably 0.01% to 0.1% (w/v), preferably 0.05% to 0.1% (w/v), more preferably 0.09% to 0.1% (w/v). In particular embodiments, cetirizine is formulated at a concentration of 0.01%, 0.05%, 0.06%, 0.07%, 0.08%, 0.09%, 0.10%, 0.15%, 0.20%, 0.25%, 0.30%, 0.35%, 0.45%, or 0.50% (w/v) in combination with naphazoline at a concentration of 0.01%, 0.02%, 0.03%, 0.04%, 0.05%, 0.06% 0.07%, 0.08%, 0.09% or 0.10% (w/v).

In certain embodiments, cetirizine is formulated at a concentration of from 0.05% to 0.50% (w/v) in combination with oxymetazoline at a concentration of from 0.01% to about 0.2% (w/v), preferably 0.01% to 0.1% (w/v), more preferably 0.03% to 0.05% (w/v). In particular embodiments, cetirizine is formulated at a concentration of 0.05%, 0.06%, 0.07%, 0.08%,

0.09%, 0.10%, 0.15%, 0.20%, 0.25%, 0.30%, 0.35%, 0.45%, or 0.50% (w/v) in combination with oxymetazoline at a concentration of 0.01%, 0.02%, 0.03%, 0.04%, 0.05%, 0.06%, 0.07%, 0.09% or 0.10% (w/v).

5 In certain embodiments, cetirizine is formulated at a concentration of from 0.05% to 0.50% (w/v) in combination with fluticasone at a concentration of from 0.001% to 1.0% (w/v), preferably 0.001% to 0.2% (w/v), or any specific value within said ranges. In particular
embodiments, cetirizine is formulated at a concentration of 0.05%, 0.06%, 0.07%, 0.08%, 0.09%, 0.10%, 0.15%, 0.20%, 0.25%, 0.30%, 0.35%, 0.45%, or 0.50% (w/v) in combination
10 with fluticasone at a concentration of 0.001%, 0.002%, 0.003%, 0.004%, 0.005%, 0.01%, 0.015%, 0.05%, 0.1%, 0.2%, 0.5%, or 1% (w/v). In a particular embodiment, the cetirizine is present in the formulation at a concentration of 0.25% (w/v) and the fluticasone is present in the formulation at a concentration of 0.01% (w/v). In another particular embodiment, the cetirizine is present in the formulation at a concentration of 0.1% (w/v) and the fluticasone is present in the formulation at a concentration of 0.005% (w/v).

15 In certain embodiments, the viscosity of the cetirizine formulations of the invention (i.e. cetirizine alone or in combination with an additional active agent) ranges from 1-50 centipoise (cpi), or any specific value within said range. In a particular embodiment, the viscosity of the cetirizine formulations of the invention range from 5-30 cpi, preferably 10-20 cpi.

Excipients

20 In some embodiments, the cetirizine formulations of the invention comprise one or more pharmaceutically acceptable excipients. The term excipient as used herein broadly refers to a biologically inactive substance used in combination with the active agents of the formulation. An excipient can be used, for example, as a solubilizing agent, a stabilizing agent, a surfactant, a demulcent, a viscosity agent, a diluent, an inert carrier, a preservative, a binder, a disintegrant, a
25 coating agent, a flavoring agent, or a coloring agent. Preferably, at least one excipient is chosen to provide one or more beneficial physical properties to the formulation, such as increased stability and/or solubility of the active agent(s). A "pharmaceutically acceptable" excipient is one that has been approved by a state or federal regulatory agency for use in animals, and

preferably for use in humans, or is listed in the U.S. Pharmacopia, the European Pharmacopia or another generally recognized pharmacopia for use in animals, and preferably for use in humans.

Further examples of excipients include certain inert proteins such as albumins; hydrophilic polymers such as polyvinylpyrrolidone; amino acids such as aspartic acid (which
5 may alternatively be referred to as aspartate), glutamic acid (which may alternatively be referred to as glutamate), lysine, arginine, glycine, and histidine; fatty acids and phospholipids such as alkyl sulfonates and caprylate; surfactants such as sodium dodecyl sulphate and polysorbate; nonionic surfactants such as such as TWEEN[®], PLURONICS[®], or a polyethylene glycol (PEG) designated 200, 300, 400, or 600; a Carbowax designated 1000, 1500, 4000, 6000, and 10000;
10 carbohydrates such as glucose, sucrose, mannose, maltose, trehalose, and dextrans, including cyclodextrins; polyols such as mannitol and sorbitol; chelating agents such as EDTA; and salt-forming counter-ions such as sodium.

Examples of carriers that may be used in the formulations of the present invention include water, mixtures of water and water-miscible solvents, such as C₁- to C₇-alkanols, vegetable oils or mineral oils comprising from 0.5 to 5% non-toxic water-soluble polymers,
15 natural products, such as gelatin, alginates, pectins, tragacanth, karaya gum, xanthan gum, carrageenin, agar and acacia, starch derivatives, such as starch acetate and hydroxypropyl starch, and also other synthetic products, such as polyvinyl alcohol, polyvinylpyrrolidone, polyvinyl methyl ether, polyethylene oxide, preferably cross-linked polyacrylic acid, such as neutral
20 Carbopol, or mixtures of those polymers. The concentration of the carrier is, typically, from 1 to 100000 times the concentration of the active ingredient.

In a particular embodiment, the carrier is a polymeric, mucoadhesive vehicle. Examples of mucoadhesive vehicles suitable for use in the methods or formulations of the invention include but are not limited to aqueous polymeric suspensions comprising one or more polymeric
25 suspending agents including without limitation dextrans, polyethylene glycol, polyvinylpyrrolidone, polysaccharide gels, Gelrite[®], cellulosic polymers, and carboxy-containing polymer systems. In a particular embodiment, the polymeric suspending agent comprises a crosslinked carboxy-containing polymer (*e.g.*, polycarbophil). In another particular embodiment, the polymeric suspending agent comprises polyethylene glycol (PEG). Examples of cross-linked

carboxy-containing polymer systems suitable for use in the topical stable ophthalmic cetirizine formulations of the invention include but are not limited to Noveon AA-I, Carbopol[®], and/or DuraSite[®] (InSite Vision).

In particular embodiments, the cetirizine formulations of the invention comprise one or more excipients selected from among the following: a tear substitute, a tonicity enhancer, a preservative, a solubilizer, a viscosity enhancing agent, a demulcent, an emulsifier, a wetting agent, a sequestering agent, and a filler. The amount and type of excipient added is in accordance with the particular requirements of the formulation and is generally in the range of from about 0.0001% to 90% by weight.

Tear substitutes

The term "tear substitute" refers to molecules or compositions which lubricate, "wet," approximate the consistency of endogenous tears, aid in natural tear build-up, or otherwise provide temporary relief of dry eye signs or symptoms and conditions upon ocular administration. A variety of tear substitutes are known in the art and include, but are not limited to: monomeric polyols, such as, glycerol, propylene glycol, and ethylene glycol; polymeric polyols such as polyethylene glycol; cellulose esters such hydroxypropylmethyl cellulose, carboxymethyl cellulose sodium and hydroxy propylcellulose; dextrans such as dextran 70; water soluble proteins such as gelatin; vinyl polymers, such as polyvinyl alcohol, polyvinylpyrrolidone, and povidone; and carbomers, such as carbomer 934P, carbomer 941, carbomer 940 and carbomer 974P. Many such tear substitutes are commercially available, which include, but are not limited to cellulose esters such as Bion Tears[®], Celluvisc[®], Genteal[®], OccuCoat[®], Refresh[®], Systane[®], Teargen II[®], Tears Naturale[®], Tears Natural II[®], Tears Naturale Free[®], and TheraTears[®]; and polyvinyl alcohols such as Akwa Tears[®], HypoTears[®], Moisture Eyes[®], Murine Lubricating[®], and Visine Tears[®], Soothe[®]. Tear substitutes may also be comprised of paraffins, such as the commercially available Lacri-Lube[®] ointments. Other commercially available ointments that are used as tear substitutes include Lubrifresh PM[®], Moisture Eyes PM[®] and Refresh PM[®].

In one preferred embodiment of the invention, the tear substitute comprises hydroxypropylmethyl cellulose (Hypromellose or HPMC). According to some embodiments, the

concentration of HPMC ranges from about 0.1% to about 2% w/v, or any specific value within said range. According to some embodiments, the concentration of HPMC ranges from about 0.5% to about 1.5% w/v, or any specific value within said range. According to some
5 embodiments, the concentration of HPMC ranges from about 0.1% to about 1% w/v, or any specific value within said range. According to some embodiments, the concentration of HPMC ranges from about 0.6% to about 1% w/v, or any specific value within said range. In a preferred embodiment, the concentration of HPMC ranges from about 0.1% to about 1.0% w/v, or any specific value within said range (i.e., 0.1-0.2%, 0.2-0.3%, 0.3-0.4%, 0.4-0.5%, 0.5-0.6%, 0.6-0.7%, 0.7-0.8%, 0.8-0.9%, 0.9-1.0%; about 0.2%, about 0.21%, about 0.22%, about 0.23%,
10 about 0.24%, about 0.25%, about 0.26%, about 0.27%, about 0.28%, about 0.29%, about 0.30%, about 0.70%, about 0.71%, about 0.72%, about 0.73%, about 0.74%, about 0.75%, about 0.76%, about 0.77%, about 0.78%, about 0.79%, about 0.80%, about 0.81%, about 0.82%, about 0.83%, about 0.84%, about 0.85%, about 0.86%, about 0.87%, about 0.88%, about 0.89%, or about 0.90%).

15 For example, without limitation, a tear substitute which comprises hydroxypropyl methyl cellulose is GenTeal® lubricating eye drops. GenTeal® (CibaVision - Novartis) is a sterile lubricant eye drop containing hydroxypropylmethyl cellulose 3 mg/g and preserved with sodium perborate. Other examples of an HPMC-based tear are provided.

20 In another preferred embodiment, the tear substitute comprises carboxymethyl cellulose sodium. For example, without limitation, the tear substitute which comprises carboxymethyl cellulose sodium is Refresh® Tears. Refresh® Tears is a lubricating formulation similar to normal tears, containing a mild non-sensitizing preservative, stabilised oxychloro complex (Purite®), that ultimately changes into components of natural tears when used.

25 In a preferred embodiment, the tear substitute, or one or more components thereof, is an aqueous solution having a viscosity in a range which optimizes efficacy of supporting the tear film while minimizing blurring, lid caking, etc. Preferably, the viscosity of the tear substitute, or one or more components thereof, ranges from 1-150 centipoise (cpi), e.g., 5-150 cpi, 5-130 cpi, 30-130 cpi, 50-120 cpi, 60-115 cpi (or any specific value within said ranges). In a particular
30 embodiment, the viscosity of the tear substitute, or one or more components thereof, is about 70-90 cpi, or any specific value within said range (for example without limitation, 85 cpi).

Viscosity may be measured at a temperature of 20° C +/- 1° C using a Brookfield Cone and Plate Viscometer Model VDV-III Ultra⁺ with a CP40 or equivalent Spindle with a shear rate of approximately 22.50 +/- approximately 10 (1/sec), or a Brookfield Viscometer Model LVDV-E with a SC4-18 or equivalent Spindle with a shear rate of approximately 26 +/- approximately 10 (1/sec). Alternatively, viscosity may be measured at 25° C +/- 1° C using a Brookfield Cone and Plate Viscometer Model VDV-III Ultra⁺ with a CP40 or equivalent Spindle with a shear rate of approximately 22.50 +/- approximately 10 (1/sec), or a Brookfield Viscometer Model LVDV-E with a SC4-18 or equivalent Spindle with a shear rate of approximately 26 +/- approximately 10 (1/sec).

In some embodiments, the tear substitute, or one or more components thereof is buffered to a pH 5.0 to 9.0, preferably pH 5.5 to 7.5, more preferably pH 6.0 to 7.0 (or any specific value within said ranges), with a suitable salt (e.g., phosphate salts). In some embodiments, the tear substitute further comprises one or more ingredients, including without limitation, glycerol, propyleneglycerol, glycine, sodium borate, magnesium chloride, and zinc chloride.

Salts, buffers, and preservatives

The formulations of the present invention may also contain pharmaceutically acceptable salts, buffering agents, or preservatives. Examples of such salts include those prepared from the following acids: hydrochloric, hydrobromic, sulfuric, nitric, phosphoric, maleic, acetic, salicylic, citric, boric, formic, malonic, succinic, and the like. Such salts can also be prepared as alkaline metal or alkaline earth salts, such as sodium, potassium or calcium salts. Examples of buffering agents include phosphate, citrate, acetate, and 2-(N-morpholino)ethanesulfonic acid (MES).

For the adjustment of the pH, preferably to a physiological pH, buffers may especially be useful. The pH of the present solutions should be maintained within the range of 4.0 to 8.0, more preferably about 5.5 to 7.5, more preferably about 6.0 to 7.0. Suitable buffers may be added, such as boric acid, sodium borate, potassium citrate, citric acid, sodium bicarbonate, TRIS, and various mixed phosphate buffers (including combinations of Na₂HPO₄, NaH⁺PO₄ and KH₂PO₄) and mixtures thereof. Borate buffers are preferred. Generally, buffers will be used in amounts ranging from about 0.05 to 2.5 percent by weight, and preferably, from 0.1 to 1.5 percent.

In certain embodiments, the topical formulations additionally comprise a preservative. A preservative may typically be selected from a quaternary ammonium compound such as benzalkonium chloride, benzethonium chloride or the like. Benzalkonium chloride is better described as: N-benzyl-N—(Cg-Cis alkyD)-N,N-dimethylammonium chloride. Further examples of preservatives include antioxidants such as vitamin A, vitamin E, vitamin C, retinyl palmitate, and selenium; the amino acids cysteine and methionine; citric acid and sodium citrate; and synthetic preservatives such as thimerosal, and alkyl parabens, including for example, methyl paraben and propyl paraben. Other preservatives include octadecyldimethylbenzyl ammonium chloride, hexamethonium chloride, benzethonium chloride, phenol, catechol, resorcinol, cyclohexanol, 3-pentanol, m-cresol, phenylmercuric nitrate, phenylmercuric acetate or phenylmercuric borate, sodium perborate, sodium chlorite, alcohols, such as chlorobutanol, butyl or benzyl alcohol or phenyl ethanol, guanidine derivatives, such as chlorohexidine or polyhexamethylene biguanide, sodium perborate, Polyquad[®], Germal[®]!, sorbic acid and stabilized oxychloro complexes (e.g., Purite[®]). Preferred preservatives are quaternary ammonium compounds, in particular benzalkonium chloride or its derivative such as Polyquad (see U.S. Pat. No. 4,407,791), alkyl-mercury salts, parabens and stabilized oxychloro complexes (e.g., Purite[®]). Where appropriate, a sufficient amount of preservative is added to the ophthalmic composition to ensure protection against secondary contaminations during use caused by bacteria and fungi.

In particular embodiments, the cetirizine formulations of the invention comprise a preservative selected from among the following: benzalkonium chloride, 0.001% to 0.05%; benzethonium chloride, up to 0.02%; sorbic acid, 0.01% to 0.5%; polyhexamethylene biguanide, 0.1 ppm to 300 ppm; polyquaternium-1 (Omamer M) - 0.1 ppm to 200 ppm; hypochlorite, perchlorite or chlorite compounds, 500 ppm or less, preferably between 10 and 200 ppm); stabilized hydrogen peroxide solutions, a hydrogen peroxide source resulting in a weight % hydrogen peroxide of 0.0001 to 0.1% along with a suitable stabilizer; alkyl esters of p-hydroxybenzoic acid and mixtures thereof, preferably methyl paraben and propyl paraben, at 0.01% to 0.5%; chlorhexidine, 0.005% to 0.01%; chlorobutanol, up to 0.5%; and stabilized oxychloro complex (Purite[®]) 0.001% to 0.5%.

In another embodiment, the topical formulations of this invention do not include a preservative. Such formulations would be useful for patients who wear contact lenses, or those who use several topical ophthalmic drops and/or those with an already compromised ocular surface (e.g. dry eye) wherein limiting exposure to a preservative may be more desirable.

5 Viscosity enhancing agents and demulcents

In certain embodiments, viscosity enhancing agents may be added to the cetirizine formulations of the invention. Examples of such agents include polysaccharides, such as hyaluronic acid and its salts, chondroitin sulfate and its salts, dextrans, various polymers of the cellulose family, vinyl polymers, and acrylic acid polymers.

10 In certain embodiments, the cetirizine formulations of the invention comprise ophthalmic demulcents and/or viscosity enhancing polymers selected from one or more of the following: cellulose derivatives such as carboxymethylcellulose (0.01 to 5%) hydroxyethylcellulose (0.01% to 5%), hydroxypropyl methylcellulose or hypromellose (0.01% to 5%), and methylcellulose (0.02% to 5%); dextran 40 / 70 (0.01% to 1%); gelatin (0.01% to 0.1%); polyols such as glycerin
15 (0.01% to 5%), polyethylene glycol 300 (0.02% to 5%), polyethylene glycol 400 (0.02% to 5%), polysorbate 80 (0.02% to 3%), propylene glycol (0.02% to 3%), polyvinyl alcohol (0.02% to 5%), and povidone (0.02% to 3%); hyaluronic acid (0.01% to 2%); and chondroitin sulfate (0.01% to 2%).

20 Viscosity of the stable ophthalmic cetirizine formulations of the invention may be measured according to standard methods known in the art, such as use of a viscometer or rheometer. One of ordinary skill in the art will recognize that factors such as temperature and shear rate may effect viscosity measurement. In a particular embodiment, viscosity of the is measured at 20° C +/- 1° C using a Brookfield Cone and Plate Viscometer Model VDV-III Ultra+ with a CP40 or equivalent Spindle with a shear rate of approximately 22.50 +/-
25 approximately 10 (1/sec), or a Brookfield Viscometer Model LVDV-E with a SC4-18 or equivalent Spindle with a shear rate of approximately 26 +/- approximately 10 (1/sec). In another embodiment, viscosity of the ophthalmic formulations of the invention is measured at 25° C +/- T C using a Brookfield Cone and Plate Viscometer Model VDV-III Ultra+ with a CP40 or equivalent Spindle with a shear rate of approximately 22.50 +/- approximately 10

(1/sec), or a Brookfield Viscometer Model LVDV-E with a SC4-18 or equivalent Spindle with a shear rate of approximately 26 +/- approximately 10 (1/sec).

Tonicity enhancers

5 Tonicity is adjusted if needed typically by tonicity enhancing agents. Such agents may, for example be of ionic and/or non-ionic type. Examples of ionic tonicity enhancers are alkali metal or earth metal halides, such as, for example, CaCl₂, KBr, KCl, LiCl, NaI, NaBr or NaCl, Na₂SO₄ or boric acid. Non-ionic tonicity enhancing agents are, for example, urea, glycerol, sorbitol, mannitol, propylene glycol, or dextrose. The aqueous solutions of the present invention are typically adjusted with tonicity agents to approximate the osmotic pressure of normal
10 lachrymal fluids which is equivalent to a 0.9% solution of sodium chloride or a 2.5% solution of glycerol. An osmolality of about 225 to 400 mOsm/kg is preferred, more preferably 280 to 320 mOsm.

Solubilizing agents

15 The topical formulation may additionally require the presence of a solubilizer, in particular if one or more of the ingredients tends to form a suspension or an emulsion. Suitable solubilizers include, for example, tyloxapol, fatty acid glycerol polyethylene glycol esters, fatty acid polyethylene glycol esters, polyethylene glycols, glycerol ethers, polysorbate 20, polysorbate 80 or mixtures of those compounds. In a preferred embodiment, the solubilizer is a reaction product of castor oil and ethylene oxide, for example the commercial products
20 Cremophor EL® or Cremophor RH40®. Reaction products of castor oil and ethylene oxide have proved to be particularly good solubilizers that are tolerated extremely well by the eye. In another embodiment, the solubilizer is tyloxapol or a cyclodextrin. The concentration used depends especially on the concentration of the active ingredient. The amount added is typically sufficient to solubilize the active ingredient. For example, the concentration of the solubilizer is
25 from 0.1 to 5000 times the concentration of the active ingredient. Preferably, the solubilizer is not a cyclodextrin compound (for example alpha-, beta- or gamma-cyclodextrin, *e.g.* alkylated, hydroxyalkylated, carboxyalkylated or alkyloxycarbonyl-alkylated derivatives, or mono- or diglycosyl-alpha-, beta- or gamma-cyclodextrin, mono- or dimaltosyl-alpha-, beta- or gamma-cyclodextrin or panosyl-cyclodextrin).

Examples of formulations

In a preferred embodiment, the cetirizine formulation comprises cetirizine at 0.05% to 0.25% (w/v), glycerin at 0.1% to 5% (v/v) (e.g., 0.1% to 3% (v/v) or any specific value within said range), and water. In particular embodiments the cetirizine formulation of the invention
5 does not contain a cyclodextrin or other solubilizing compound. Optionally, the formulation also comprises a preservative such as benzalkonium chloride at 0.005% to 0.02% (w/v) or its derivative (e.g., Polyquad[®]), or a stabilized oxychloro complex such as Purite[®]. In a particular embodiment, the cetirizine formulation comprises cetirizine at 0.1% (w/v), glycerin at 1.2% to 3% (v/v), and water. In another particular embodiment, the cetirizine 0.1% (w/v), glycerin 1.2%
10 to 3% (v/v), and water formulation also comprises benzalkonium chloride at 0.01% (w/v) or a stabilized, oxychloro complex (e.g., Purite[®]). The pH of the formulation is between 5.0 and 7.5. For example, the pH of the formulation is 5, 5.5, 6.0, 6.5 or 7.0.

In a specific embodiment, the cetirizine formulation comprises cetirizine at 0.1% (w/v), glycerin at 2.125% (v/v), benzalkonium chloride at 0.01% (w/v), q.s. with water. In one
15 embodiment, the cetirizine formulation comprises cetirizine as the only active ingredient at 0.05% to 0.25% (w/v) and optionally one or more tear substitutes or a mucoadhesive, polymeric compound (e.g., Durasite[®]). Preferably, the cetirizine formulations do not contain a cyclodextrin or other solubilizing compound.

Where the formulation comprises one or more tear substitutes, the tear substitute
20 preferably contains hydroxypropylmethyl cellulose or carboxymethyl cellulose or both. In some embodiments, the hydroxypropylmethyl cellulose or carboxymethyl cellulose is present at a concentration of 0.5% to 1% (w/v) (or any specific value within said range) and the resulting viscosity of the solution is 60-80 cpi. In a particular embodiment, the hydroxypropylmethyl cellulose or carboxymethyl cellulose is present at a concentration of 0.7% to 0.9%. In another
25 particular embodiment, the hydroxypropylmethyl cellulose or carboxymethyl cellulose is present at a concentration of 0.1% to 0.7% and the resulting viscosity of the solution is 10-30 cpi. Optionally, the formulation also comprises a preservative, preferably benzalkonium chloride at a concentration of from 0.005% to 0.02% (w/v) (or any specific value within said range) or its derivative (e.g., Polyquad[®]), or a stabilized oxychloro complex (e.g., Purite[®]). The pH of the

formulation is between 5.0 and 7.5. For example, the pH of the formulation is 5, 5.5, 6.0, 6.5 or 7.0.

In another preferred embodiment, the cetirizine formulation comprises cetirizine at 0.05% to 0.25% (w/v), naphazoline at 0.01% to 0.2% (w/v), glycerin at 0.1% to 5% (v/v) (e.g., 0.1% to 3% (v/v) or any specific value within said range), and water. Preferably, the cetirizine/naphazoline formulation does not contain a cyclodextrin or other solubilizing compound. Optionally, the formulation also comprises benzalkonium chloride at 0.005% to 0.02% (w/v) or its derivative (e.g., Polyquad[®]), or a stabilized oxychloro complex such as Purite[®]. In a particular embodiment, the cetirizine formulation comprises cetirizine at 0.1% (w/v), naphazoline at 0.09% (w/v), glycerin at 1.2% to 3% (v/v), and water. In another particular embodiment, the cetirizine 0.1% (w/v), naphazoline 0.09% (w/v), glycerin at 1.2% to 3% (v/v), and water formulation also comprises benzalkonium chloride at 0.01% (w/v) or a stabilized oxychloro complex such as Purite[®]. The pH of the formulation is between 5.0 and 7.5. For example, the pH of the formulation is 5, 5.5, 6.0, 6.5 or 7.0.

In yet another preferred embodiment, the cetirizine formulation comprises cetirizine at 0.05% to 0.25% (w/v), naphazoline at 0.01% to 0.2% (w/v), and one or more tear substitutes or a mucoadhesive polymeric compound (e.g., Durasite[®]). In particular embodiments the cetirizine formulation does not contain a cyclodextrin or other solubilizing compound. Where the formulation comprises one or more tear substitutes, the tear substitute preferably contains hydroxypropylmethyl cellulose or carboxymethyl cellulose, or both. In some embodiments, the hydroxypropylmethyl cellulose or carboxymethyl cellulose is present at a concentration of 0.5% to 1% (w/v) (or any specific value within said range) and the resulting viscosity of the solution is 60-80 cpi. In a particular embodiment, the hydroxypropylmethyl cellulose or carboxymethyl cellulose is present at a concentration of 0.7% to 0.9%. Optionally, the formulation also comprises a preservative, preferably benzalkonium chloride at a concentration of from 0.005% to 0.02% (w/v) (or any specific value within said range) or stabilised oxychloro complex (Purite[®]). The pH of the formulation is between 5.0 and 7.5. For example, the pH of the formulation is 5, 5.5, 6.0, 6.5 or 7.0.

In yet another preferred embodiment, the cetirizine formulation comprises cetirizine at 0.05% to 0.25% (w/v), oxymetazoline at 0.01% to 0.1% (w/v), glycerin at 0.1% to 5% (v/v) (e.g.,

0.1% to 3% (v/v) or any specific value within said range), and water. Preferably, the cetirizine/oxymetazoline formulation does not contain a cyclodextrin or other solubilizing compound. Optionally, the formulation also comprises benzalkonium chloride at 0.005% to 0.02% (w/v) or its derivative (e.g., Polyquad[®]), or a stabilized, oxychloro complex (e.g., Purite[®]). In a particular embodiment, the cetirizine formulation comprises cetirizine at 0.1% (w/v), oxymetazoline at 0.05% (w/v), glycerin at 1.2% to 3% (v/v), and water. In another particular embodiment, the cetirizine 0.1% (w/v), oxymetazoline 0.05% (w/v), glycerin 1.2% to 3% (v/v), and water formulation also comprises benzalkonium chloride at 0.01% (w/v) or a stabilized, oxychloro complex (e.g., Purite[®]). In certain embodiments, the pH of the formulation is between 5.0 and 7.5. For example, the pH of the formulation is 5, 5.5, 6.0, 6.5 or 7.0.

In still another preferred embodiment, the cetirizine formulation comprises cetirizine at 0.05% to 0.25% (w/v), oxymetazoline at 0.01% to 0.1% (w/v), and one or more tear substitutes or a mucoadhesive, polymeric compound (e.g., Durasite[®]). Preferably, the cetirizine/oxymetazoline formulation does not contain a cyclodextrin or other solubilizing compound. Where the formulation comprises one or more tear substitutes, the tear substitute preferably contains hydroxypropylmethyl cellulose or carboxymethyl cellulose or both. In some embodiments, the hydroxypropylmethyl cellulose or carboxymethyl cellulose is present at a concentration of 0.5% to 1% (w/v) (or any specific value within said range) and the resulting viscosity of the solution is 60-80 cpi. In a particular embodiment, the hydroxypropylmethyl cellulose or carboxymethyl cellulose is present at a concentration of 0.7% to 0.9%. Optionally, the formulation also comprises a preservative, preferably benzalkonium chloride at a concentration of from 0.005% to 0.02% (w/v) (or any specific value within said range) or a stabilized oxychloro complex (Purite[®]). The pH of the formulation is between 5.0 and 7.5. For example, the pH of the formulation is 5, 5.5, 6.0, 6.5 or 7.0.

In still another preferred embodiment, the cetirizine formulation comprises cetirizine at 0.05% to 0.5% (w/v), fluticasone at 0.001% to 1.0% (w/v), glycerin at 0.1% to 5% (v/v) (e.g., 0.1% to 3% (v/v) or any specific value within said range), and water. Preferably, the cetirizine/fluticasone formulation does not contain a cyclodextrin or other solubilizing compound. Optionally, the formulation also comprises benzalkonium chloride at 0.005% to 0.02% (w/v) or its derivative (e.g., Polyquad[®]), or a stabilized, oxychloro complex (e.g.,

Purite[®]). In a particular embodiment, the cetirizine formulation comprises cetirizine at 0.1% (w/v), fluticasone at 0.005%, glycerin at 1.2% to 3% (v/v), and water. In another particular embodiment, the cetirizine formulation comprises cetirizine at 0.25% (w/v), fluticasone at 0.01% (w/v), glycerin at 1.2% to 3% (v/v), and water. Optionally, the cetirizine/fluticasone formulations also comprises benzalkonium chloride at 0.01% (w/v) or a stabilized, oxychloro complex (e.g., Purite[®]). The pH of the formulation is between 5.0 and 7.5. For example, the pH of the formulation is 5, 5.5, 6.0, 6.5 or 7.0.

In yet another preferred embodiment, the cetirizine formulation comprises cetirizine at 0.05% to 0.5% (w/v), fluticasone at 0.001% to 1.0% (w/v), preferably fluticasone 0.005%, and one or more tear substitutes or a mucoadhesive, polymeric compound (e.g., Durasite[®]). Preferably, the cetirizine/fluticasone formulation does not contain a cyclodextrin or other solubilizing compound. Where the formulation comprises one or more tear substitutes, the tear substitute preferably contains hydroxypropylmethyl cellulose or carboxymethyl cellulose or both. In some embodiments, the hydroxypropylmethyl cellulose or carboxymethyl cellulose is present at a concentration of 0.5% to 1% (w/v) (or any specific value within said range) and the resulting viscosity of the solution is 60-80 cpi. In a particular embodiment, the hydroxypropylmethyl cellulose or carboxymethyl cellulose is present at a concentration of 0.7% to 0.9%. Optionally, the formulation also comprises a preservative, preferably benzalkonium chloride at a concentration of from 0.005% to 0.02% (w/v) (or any specific value within said range) or stabilized oxychloro complex (Purite[®]). The pH of the formulation is between 5.0 and 7.5. For example, the pH of the formulation is 5, 5.5, 6.0, 6.5 or 7.0.

In still another preferred embodiment, the cetirizine formulation comprises 0.1% cetirizine, 0.005% fluticasone, 1% Polyethylene Glycol 400, NF, 0.2% Dibasic Sodium Phosphate, Anhydrous, USP, 0.25% Hypromellose, USP, 0.1% Polysorbate 80, NF, 1.8% Glycerin, USP, 0.025% Edetate Disodium, USP, and 0.01% Benzalkonium Chloride, NF (pH 7.0).

In yet another preferred embodiment, the cetirizine formulation comprises 0.25% cetirizine, 0.01% fluticasone, 1% Polyethylene Glycol 400, NF, 0.2% Dibasic Sodium Phosphate, Anhydrous, USP, 0.25% Hypromellose, USP; 0.1% Polysorbate 80, NF, 1.2%

Glycerin, USP, 0.025% Edetate Disodium, USP, and 0.01% Benzalkonium Chloride, NF (pH 7.0).

The formulations of the present invention provide for the chemical stability of the formulated cetirizine and other optional active agents (e.g., napahzoline, oxymetazoline, fluticasone, or combinations thereof) of the formulation, without the use of a cyclodextrin or other solubilizing compound. "Stability" and "stable" in this context refers to the resistance of the cetirizine and other optional active agents to chemical degradation under given manufacturing, preparation, transportation and storage conditions. The "stable" formulations of the invention also preferably retain at least 90%, 95%, 98%, 99%, or 99.5% of a starting or reference amount under given manufacturing, preparation, transportation, and/or storage conditions. The amount of cetirizine and other optional active agents can be determined using any art-recognized method, for example, as UV-Vis spectrophotometry and high pressure liquid chromatography (HPLC).

In certain embodiments, the cetirizine formulations are stable at temperatures ranging from about 20 to 30 °C for at least 1 week, at least 2 weeks, at least 3 weeks, at least 4 weeks, at least 5 weeks, at least 6 weeks, or at least 7 weeks. In other embodiments, the cetirizine formulations are stable at temperatures ranging from about 20 to 30 °C for at least 1 month, at least 2 months, at least 3 months, at least 4 months, at least 5 months, at least 6 months, at least 7 months, at least 8 months, at least 9 months, at least 10 months, at least 11 months, or at least 12 months. In one embodiment, the formulation is stable for at least 3 months at 20-25 °C.

In other embodiments, the cetirizine formulations are stable at temperatures ranging from about 2 to 8 °C for at least 1 month, at least 2 months, at least 4 months, at least 6 months, at least 8 months, at least 10 months, at least 12 months, at least 14 months, at least 16 months, at least 18 months, at least 20 months, at least 22 months, or at least 24 months. In one embodiment, the formulation is stable for at least 2 months at 2 to 8 °C.

In other embodiments, the cetirizine formulations are stable at temperatures of about -20 °C for at least 1 month, at least 2 months, at least 4 months, at least 6 months, at least 8 months, at least 10 months, at least 12 months, at least 14 months, at least 16 months, at least 18 months,

at least 20 months, at least 22 months, or at least 24 months. In one embodiment, the formulation is stable for at least 6-12 months at -20 °C.

In a particular embodiment, a cetirizine formulation of the invention is stable at temperatures of about 20-30 °C at concentrations up to 0.10% for at least 3 months. In another
5 embodiment, the formulation is stable at temperatures from about 2-8 °C at concentrations up to 0.10% for at least 6 months.

Methods of Use

The cetirizine formulations of the invention are useful for the treatment and prevention of the signs and symptoms of both the acute phase (i.e., seasonal) and late phase inflammatory
10 reactions (i.e., chronic, persistent or refractory) of allergic conjunctivitis, such as ocular itching, redness, and eyelid swelling, as well as associated nasal symptoms. The formulations of the invention are also useful for the treatment and prevention of the signs and symptoms of allergic rhinoconjunctivitis, such as itchy, running nose, sneezing, nasal/sinus congestion, and red, watery and/or itchy eyes.

The invention provides methods of treating or preventing allergic conjunctivitis and/or
15 allergic rhinoconjunctivitis in a subject in need thereof comprising topically administering to the eye surface of the subject a an ophthalmic formulation comprising an effective amount of cetirizine. In certain embodiments, the administration of cetirizine to the eye of a subject in need of treatment or prevention of allergic conjunctivitis and/or rhinoconjunctivitis is also effective to
20 mitigate or reduce one or more nasal symptoms associated with the either allergy (e.g., itchy, running nose, sneezing and/or nasal/sinus congestion). Topical administration of the ophthalmic formulations directly to the eye of a subject will significantly reduce nasal signs and symptoms via drainage from the ocular surface into the nasal cavity through the nasolacrimal duct (See e.g.,
25 Abelson et al., Clin. Ther. 25(3), 931-947 (2003); Spangler et al., Clin. Ther. 25(8), 2245-2267 (2003); and Crampton et al., Clin Ther. Nov; 24(11): 1800-8 (2002). Furthermore, significantly less active agent is required to treat the nasal symptoms when instilled through the eye of a subject as compared to administration through the nose of the subject. For example, each spray of Flonase® (commercially available nasal spray comprising fluticasone) delivers 50 micrograms of fluticasone to the nasal cavity to treat allergic rhinitis and allergic rhinoconjunctivitis. In

contrast, one drop of a 0.005% fluticasone ophthalmic formulation (i.e., 2.5 micrograms in a 500 microliter drop) has been shown to significantly reduce nasal symptoms associated with ocular allergy when topically administered directly to the eye (see Example 2 herein). As such, the methods of the present invention are more effective than the currently available treatment options for nasal symptoms of allergic conjunctivitis and allergic rhinoconjunctivitis.

The subject is preferably a human, but may be another mammal, for example a dog, a cat, a horse, a rabbit, a mouse, a rat, or a non-human primate.

The formulations of the present invention contain an amount of cetirizine, and optionally one or more additional active ingredients (for example without limitation a vasoconstrictor such as naphazoline or oxymetazoline, or a steroid such as fluticasone), that is effective for the intended use (i.e., to mitigate the signs and symptoms of allergic conjunctivitis and/or rhinoconjunctivitis). In certain embodiments, once a day administration of the formulations of the present invention is effective to mitigate the symptoms of allergic conjunctivitis and/or rhinoconjunctivitis. However, particular dosages are also selected based on a number of factors including the age, sex, species and condition of the subject. Effective amounts can also be extrapolated from dose-response curves derived from in vitro test systems or from animal models. The term "effective amount" means an amount of cetirizine that is sufficient to eliminate or reduce a symptom of allergic conjunctivitis and/or rhinoconjunctivitis. In certain embodiments, the effective amount is the amount sufficient for the treatment or prevention of allergic conjunctivitis and/or rhinoconjunctivitis. "Treatment" in this context refers to reducing or ameliorating at least one symptom of allergic conjunctivitis and/or rhinoconjunctivitis. "Prevention" in this context refers to a reduction in the frequency of, or a delay in the onset of, symptoms associated with allergic conjunctivitis and/or rhinoconjunctivitis, relative to a subject who does not receive the composition. The effective amount of cetirizine and other active agents in the formulation will depend on absorption, inactivation, and excretion rates of the drug as well as the delivery rate of the compound from the formulation. Particular dosages may also vary with the severity of the condition to be alleviated. It is to be further understood that for any particular subject, specific dosage regimens should be adjusted over time according to the individual need and the professional judgment of the person administering or supervising the

administration of the compositions. Typically, a dosing regiment will be determined using techniques known to one skilled in the art.

5 Examples of dosing regimens that can be used in the methods of the invention include, but are not limited to, once daily, twice daily, three times, and four times daily. In certain embodiments, the method comprises administering a cetirizine formulation of the invention to the eye of the subject once a day. In some embodiments, the administration is 2 to 4 times a day.

10 In certain embodiments, once a day administration (q.d.) is effective to mitigate the symptoms of ocular and/or nasal allergy. However, particular dosages may also be selected based on a number of factors including the age, sex, species and condition of the subject. Effective amounts can also be extrapolated from dose-response curves derived from in vitro test systems or from animal models.

15 The combined use of several active agents formulated into the compositions of the present invention may reduce the required dosage for any individual component because the onset and duration of effect of the different components may be complimentary. In such combined therapy, the different active agents may be delivered together or separately, and simultaneously or at different times within the day.

20 In a particular embodiment, a formulation comprising cetirizine as the only active agent in the formulation is administered to the eye of a subject in need of treatment or prevention of an allergic conjunctivitis and/or rhinoconjunctivitis once daily (q.d.). In certain embodiments, the combination formulation is administered two to four times a day.

In another particular embodiment, cetirizine is formulated with one or more of naphazoline, oxymetazoline or fluticasone, and administered to the eye of a subject in need of treatment or prevention of allergic conjunctivitis and/or rhinoconjunctivitis once daily (q.d.). In certain embodiments, the combination formulation is administered two to four times a day.

25 In a preferred embodiment, cetirizine is formulated with fluticasone and administered to the eye of a subject in need of treatment or prevention of allergic conjunctivitis and/or rhinoconjunctivitis. Surprisingly the combination formulations of cetirizine and fluticasone as described herein were more effective at relieving itching than could be predicted from the

efficacy of each component individually. Even more surprising was the finding that lower doses of cetirizine and fluticasone were more effective at relieving ocular itching and associated nasal symptoms of allergic conjunctivitis than higher doses of the individual components alone, or in combination. For example, as described in the Examples, a 0.1% cetirizine/0.005% fluticasone formulation (low dose) was more efficacious than 0.25% cetirizine/0.01% fluticasone formulation (high dose). Similarly, in a clinical study described herein, the efficacy of 0.005% fluticasone was more efficacious than the higher dose 0.01% fluticasone.

Packaging

The formulations of the present invention may be packaged as either a single dose product or a multi-dose product. The single dose product is sterile prior to opening of the package and all of the composition in the package is intended to be consumed in a single application to one or both eyes of a patient. The use of an antimicrobial preservative to maintain the sterility of the composition after the package is opened is generally unnecessary.

Multi-dose products are also sterile prior to opening of the package. However, because the container for the composition may be opened many times before all of the composition in the container is consumed, the multi-dose products must have sufficient antimicrobial activity to ensure that the compositions will not become contaminated by microbes as a result of the repeated opening and handling of the container. The level of antimicrobial activity required for this purpose is well known to those skilled in the art, and is specified in official publications, such as the United States Pharmacopoeia ("USP") and corresponding publications in other countries. Detailed descriptions of the specifications for preservation of ophthalmic pharmaceutical products against microbial contamination and the procedures for evaluating the preservative efficacy of specific formulations are provided in those publications. In the United States, preservative efficacy standards are generally referred to as the "USP PET" requirements. (The acronym "PET" stands for "preservative efficacy testing.")

The use of a single dose packaging arrangement eliminates the need for an antimicrobial preservative in the compositions, which is a significant advantage from a medical perspective, because conventional antimicrobial agents utilized to preserve ophthalmic compositions (e.g.,

benzalkonium chloride) may cause ocular irritation, particularly in patients suffering from dry eye conditions or pre-existing ocular irritation. However, the single dose packaging arrangements currently available, such as small volume plastic vials prepared by means of a process known as "form, fill and seal", have several disadvantages for manufacturers and consumers. The principal disadvantages of the single dose packaging systems are the much larger quantities of packaging materials required, which is both wasteful and costly, and the inconvenience for the consumer. Also, there is a risk that consumers will not discard the single dose containers following application of one or two drops to the eyes, as they are instructed to do, but instead will save the opened container and any composition remaining therein for later use. This improper use of single dose products creates a risk of microbial contamination of the single dose product and an associated risk of ocular infection if a contaminated composition is applied to the eyes.

While the formulations of this invention are preferably formulated as "ready for use" aqueous solutions, alternative formulations are contemplated within the scope of this invention. Thus, for example, the active ingredients, surfactants, salts, chelating agents, or other components of the ophthalmic solution, or mixtures thereof, can be lyophilized or otherwise provided as a dried powder or tablet ready for dissolution (e.g., in deionized, or distilled) water. Because of the self-preserving nature of the solution, sterile water is not required.

Kits

The present invention provides a pharmaceutical pack or kit comprising one or more containers filled with a liquid or lyophilized cetirizine formulation of the invention (i.e., a formulation comprising cetirizine alone or in combination with an additional active agent as described herein). In one embodiment, the formulation is an aqueous formulation of cetirizine. In one embodiment, the formulation is lyophilized. In preferred embodiments the liquid or lyophilized formulation is sterile. In one embodiment, the kit comprises a liquid or lyophilized formulation of the invention, in one or more containers, and one or more other prophylactic or therapeutic agents (e.g., cetirizine in combination with an additional active agent such as fluticasone, oxymetazoline or naphazoline) useful for the treatment of allergic conjunctivitis and/or allergic rhinoconjunctivitis. The one or more other prophylactic or therapeutic agents may be in the same container as the cetirizine or in one or more other containers. Preferably, the

cetirizine is formulated at a concentration of from about 0.05% (w/v) to about 1.0% (w/v) and is suitable for topical ocular administration. In certain embodiments, cetirizine is formulated with an additional active agents such as fluticasone, oxymetazoline or naphazoline, as described herein. In certain embodiments, the kit contains the cetirizine in unit dosage form.

5 In certain embodiments, the kit further comprises instructions for use in the treatment of allergic conjunctivitis and/or allergic rhinoconjunctivitis (e.g., using the cetirizine formulations of the invention alone or in combination with another prophylactic or therapeutic agent), as well as side effects and dosage information for one or more routes of administration. Optionally associated with such container(s) is a notice in the form prescribed by a governmental agency
10 regulating the manufacture, use or sale of pharmaceuticals or biological products, which notice reflects approval by the agency of manufacture, use or sale for human administration. While the instructional materials typically comprise written or printed materials they are not limited to such. Any medium capable of storing such instructions and communicating them to an end user is contemplated by this invention. Such media include, but are not limited to electronic storage
15 media (e.g., magnetic discs, tapes, cartridges, chips), optical media (e.g. CD ROM), and the like. Such media may include addresses to internet sites that provide such instructional materials.

 In another embodiment, this invention provides kits for the packaging and/or storage and/or use of the formulations described herein, as well as kits for the practice of the methods described herein. The kits can be designed to facilitate one or more aspects of shipping, use, and
20 storage.

 All publications and patents mentioned herein are hereby incorporated by reference in their entirety as if each individual publication or patent was specifically and individually indicated to be incorporated by reference.

EXAMPLES

25 The invention is further defined by reference to the following examples, which are not meant to limit the scope of the present invention. It will be apparent to those skilled in the art that many modifications, both to the materials and methods, may be practiced without departing from the purpose and interest of the invention.

Example 1: Cetirizine (0.1%) Prevents Ocular Itching Associated with Allergic Coniunctivitis

A placebo controlled, double-blind study was conducted to evaluate the efficacy of cetirizine 0.1% (N= 15) compared to vehicle (N= 16). Subjects underwent 2 screening visits (an allergen titration and confirmation) followed by a drug evaluation visit. At the drug evaluation visit, one drop of masked study medication was instilled in each eye and comfort assessments were taken. Sixteen hours later the subjects were challenged with allergen and allergic assessments were taken. The results are presented in Tables 1 and 2 and in Figures 1-2. The ocular itching score ranges from 0, no itching, to 4, severe itching. The comfort score ranges from 0, very comfortable, to 10, very uncomfortable (Note: The most uncomfortable commercially available allergy drop=4). The results demonstrate that a single drop of cetirizine (0.1%) ophthalmic solution (q.d.) was effective to prevent ocular itching associated with allergic conjunctivitis when administered 16 hours prior to conjunctival allergen challenge (CAC), but had little effect on reducing conjunctival redness (Figures 1A and 1B). Differences between cetirizine and vehicle groups were both clinically (>1 unit difference) and statistically significant (P<0.05). In addition, as shown in Table 2, and Figure 2, the cetirizine formulation was comfortable (i.e., well-tolerated) by the subjects.

Table 1 Mean Ocular Itching Scores (0-4 scale) following CAC 16 hrs after dosing

Statistic	Timepoint	Cetirizine 0.1% HCl (N=15)	Vehicle (N=16)	Mean Difference (cetirizine-vehicle)	p-value
Mean (SD)	Pre-CAC	0.00 (0.00)	0.00 (0.00)	0.00	1.0000
	3 min	1.67 (1.12)	2.36 (0.58)	-0.69	0.0191
	5 min	1.52 (1.12)	2.56 (0.60)	-1.04	0.0051
	7 min	1.45 (1.02)	2.47 (0.72)	-1.02	0.0031

Table 2 Mean Drop Comfort Scores (0-10 scale)

Statistic	Timepoint	Cetirizine 0.1% HCl (N=15)	Vehicle (N=16)	Mean Difference (cetirizine-vehicle)	p-value
Mean (SD)	Upon Instillation	0.47 (0.68)	0.72 (1.49)	-0.25	0.3908
	1 min	0.37 (0.49)	0.84 (1.80)	-0.47	0.1572
	2 min	0.47 (0.63)	0.81 (1.53)	-0.34	0.2467
	5 min	0.20 (0.41)	0.13 (0.34)	0.07	0.5981
	10 min	0.27 (0.46)	0.31 (0.70)	-0.04	0.7864

20

Example 2: Fluticasone Prevents Ocular and Nasal Symptoms Associated with Allergic Conjunctivitis

5 A placebo controlled, double-blind study was conducted to evaluate the efficacy of Fluticasone 0.001% (N= 16), Fluticasone 0.005% (N= 16), Fluticasone 0.01% (N=15) compared to vehicle alone (N=15). Subjects underwent 2 screening visits (allergen titration and confirmation) followed by 2 drug evaluation visits, as indicated in the study design shown in Figures 3A and 3B. At the drug evaluation visits, one drop of masked study medication was instilled in each eye and ocular allergic assessments were taken. Eight hours later the subjects were challenged with allergen and primary and secondary ocular and nasal endpoints were assessed, as well as safety of the formulations. The results are presented in Figures 4-23.

Primary Ocular Endpoints

Ocular itching, conjunctival redness, lid swelling, and nasal congestion were assessed in each subject during visit 4B.

15 Ocular itching was subjectively assessed on a scale of 0 (no itching) to 4 (severe itching). As shown in Figure 4, Fluticasone 0.001%, 0.005% and 0.01% were about equally effective in reducing ocular itching over a 7 minute time period as compared to vehicle alone.

20 Conjunctival redness was also subjectively assessed on a scale of 0 (no redness) to 4 (severe redness). As shown in Figure 5, Fluticasone 0.001%, 0.005% and 0.01% were about equally effective in reducing conjunctival redness over a 20 minute period as compared to vehicle alone.

Lid swelling was subjectively assessed on a scale of 0 (no lid swelling) to 3 (severe lid swelling). As shown in Figure 6, Fluticasone 0.001% and 0.005% were each more effective than Fluticasone 0.01% at reducing lid swelling over a 20 minute period as compared to vehicle alone.

Nasal Congestion was subjectively assessed on a scale of 0 (no congestion) to 4 (severe congestion). As shown in Figure 7, Fluticasone 0.001%, 0.005% and 0.01% were about equally effective in reducing nasal congestion over a 30 minute period as compared to vehicle alone.

5 A summary of the results of the primary ocular endpoint assessments is shown in Figure 8. As shown in Figure 8, the reduction in conjunctival redness by Fluticasone 0.005% and 0.01% and the reduction in lid swelling by Fluticasone 0.001% were each statistically significant ($p < 0.05$).

Secondary Ocular Endpoints

10 Ciliary Redness, episcleral redness, chemosis and watery eyes were assessed in each subject at visit 4B.

Ciliary redness was assessed on a scale of 0 (no redness) to 4 (severe redness). As shown in Figure 9, Fluticasone 0.001%, 0.005% and 0.01% were each significantly effective in reducing ciliary redness over a 20 minute period as compared to vehicle alone ($p < 0.05$ for each Fluticasone concentration).

15 Episcleral redness was assessed on a scale of 0 (no redness) to 4 (severe redness). As shown in Figure 10, Fluticasone 0.001%, 0.005% and 0.01% each reduce episcleral redness over a 20 minute period as compared to vehicle alone.

20 Chemosis was assessed on a scale of 0 (none) to 4 (extreme). As shown in Figure 11, Fluticasone 0.001%, 0.005% and 0.01% were each significantly effective in reducing chemosis over a 20 minute period.

Watery eyes were also subjectively assessed on a scale of 0 (not watery) to 4 (extremely watery). As shown in Figure 12, Fluticasone 0.001% and 0.05% were each more effective than Fluticasone 0.01% in reducing watery eyes over a 20 minute period, as compared to vehicle alone.

25 A summary of the secondary ocular endpoints assessed is shown in Figure 13. As shown in Figure 13, the reduction in ciliary redness by all three concentrations of Fluticasone, the

reduction in episcleral redness by Fluticasone 0.005%, and the reduction of watery eyes by Fluticasone 0.05% were each statistically significant ($p < 0.05$).

Secondary Nasal Endpoints

5 Rhinorrhea, ear or palate pruritis, nasal pruritis were assessed in each subject at visit 4B using a scale of 0 (none) to 4 (extreme) for each endpoint.

As shown in Figures 14 and 16, Fluticasone 0.001%, 0.005% and 0.01% each had a clinically significant effect in reducing rhinorrhea and nasal pruritis, respectively, over a 20 minute period as compared to vehicle alone. Shown in Figure 15, Fluticasone 0.001%, 0.005% and 0.01% were each had an effect in reducing ear and palate pruritis as compared to vehicle
10 alone.

Total nasal scores were assessed on a scale of 0-16. As shown in Figure 17, Fluticasone 0.001%, 0.005% and 0.01%, each surprisingly had a clinically significant effect on total nasal score when administered directly to the eye of each subject. A summary of the nasal endpoints assessed is shown in Figures 18 and 19.

15 Safety

Intraocular pressure, drop comfort and adverse events such as blurry vision, conjunctival hemorrhage, dry eye, site pain and/or irritation and headache, were assessed for each subject.

Drop comfort was subjectively assessed on a scale of 0 (extremely comfortable) to 10 (extremely uncomfortable) during visit 2 and visit 3. As shown in Figures 20 and 21,
20 Fluticasone 0.01 was highly uncomfortable upon instillation as compared to Fluticasone 0.001% and 0.005%, and as compared to vehicle alone. The comfort of Fluticasone 0.001% and 0.005% were comparable to the comfort of the vehicle control.

A summary of the total percentage of subjects who experienced adverse events such as blurry vision, conjunctival hemorrhage, dry eye, site pain and/or irritation, and headache, is
25 shown in Figure 22.

The effect of each concentration of Fluticasone on intraocular pressure (IOP) as compared to vehicle alone is shown in Figure 23.

The results demonstrate that a single drop of either Fluticasone 0.001%, 0.005% or 0.01% was effective to prevent both ocular and nasal symptoms associated with allergic conjunctivitis. However, when taking all primary and secondary endpoints into consideration, Fluticasone 0.005% was the most efficacious in relieving both ocular and nasal symptoms, and was shown to be more comfortable than Fluticasone 0.001% and Fluticasone 0.01%, with no adverse effect on intraocular pressure.

Example 3: An Evaluation of the Effects of Topical Cetirizine/Fluticasone Ophthalmic Formulations on the Signs of Allergic Conjunctivitis using the Murine Model of Ragweed-Induced Active Anaphylaxis

Seasonal allergic conjunctivitis (hay fever conjunctivitis) develops in a subset of atopic individuals (those with a genetic disposition of hypersensitivity to allergens). The signs and symptoms of the condition are elicited by airborne allergens (e.g. ragweed, tree and grass pollens, animal dander). Seasonal allergic conjunctivitis is the most common form of ocular allergic disease and may account for up to 90% of allergic disorders seen.

The most common and distressing ocular signs and symptoms associated with allergic conjunctivitis are itching and redness. Swelling, mucous discharge and excessive tearing are frequently involved. In allergic conjunctivitis, airborne allergens presumably dissolve in the tear film, traverse the conjunctiva, and then bind with IgE antibodies attached to the surface of the conjunctival mast cell to trigger an allergic response. This attachment results in mast cell degranulation and release of chemical mediators that lead to signs and symptoms of allergic disease. Some of these substances, e.g. histamines and prostaglandins, directly affect blood vessels and nerves, whereas others influence the migration of inflammatory cells such as neutrophils, eosinophils and macrophages, causing inflammation.

The major chemical mediator involved in producing ocular symptoms is histamine. Several types of histamine have been identified in the human conjunctiva. Stimulation of H1 receptors results mainly in itching while stimulation of H2 receptors results largely in

vasodilation (redness). However, studies with antihistamines known to be highly specific for H1 receptors have suggested that H1 receptors may also have a secondary effect on redness.

The purpose of this study was to investigate the potential of cetirizine/fluticasone combination formulations in preventing signs of allergic conjunctivitis in a murine active anaphylaxis model. In this model, mice are systemically sensitized to short ragweed allergen (SRW) and then challenged by instilling SRW in the eyes. Therapeutic treatment is given after sensitization but prior to topical challenge. Allergens present in the SRW preparation cross-link IgE antibodies bound to conjunctival mast cells causing degranulation and release of histamine and other allergic mediators, which in turn produce the characteristic signs and symptoms of allergic conjunctivitis.

Four test formulations, containing combination 0.1% Cetirizine/0.005% Fluticasone ("low dose"), combination 0.25% Cetirizine/0.01% Fluticasone ("high dose"), 0.1% Cetirizine or 0.005% Fluticasone, were compared with vehicle alone (1% Polyethylene Glycol 400, NF; 0.2% Dibasic Sodium Phosphate, Anhydrous, LJSF; 0.25% Hypromellose, USP; 0.1% Polysorbate 80, NF; 1.8% Glycerin, USP; 0.025% Edetate Disodium, USP; 0.01% Benzalkonium Chloride, NF (pH 7.0)) and two commercial positive controls, Pred Forte® (prednisolone acetate 1%) and Pataday® (olopatadine 0.2%).

Systemic sensitization to short ragweed allergen (SRW) was induced by injecting SRW plus alum adjuvant systemically into Balb/c mice (Day 1), and by administration of topical SRW eyedrops on days 19-21. Topical ocular drug treatment was administered daily on days 19-21 after SRW injection. After 3 days of treatment, the animals were assessed for signs of allergic conjunctivitis in response to challenge with topical SRW administration. Clinical assessments included conjunctival hyperemia, chemosis, discharge and lid swelling, each graded biomicroscopically on a 0-4 severity scale.

After 3 days of drug treatment, the animals treated with the combination 0.1% Cetirizine/0.005% Fluticasone demonstrated the least severity in three clinical signs (conjunctival hyperemia, chemosis, and lid swelling) as compared Cetirizine or Fluticasone alone or as compared to most other treatment groups. Cetirizine or Fluticasone alone produced no significant treatment effects.

The reduction in clinical signs in response to SRW challenge after 3 days of treatment with the combination 0.1% Cetirizine/0.005% Fluticasone was statistically significantly lower

than Fluticasone alone for hyperemia ($p \leq 0.001$), chemosis ($p \leq 0.01$), lid swelling ($p < 0.03$) and total clinical score ($p \leq 0.01$); and than Cetirizine alone for chemosis ($p < 0.05$). Borderline Additionally, statistical significance was almost achieved against Cetirizine alone for total clinical score ($p = 0.06$). Surprisingly, the reduction with the combination was more than could have been expected from the efficacy of the individual components.

Furthermore, the combination of 0.1% Cetirizine/0.005% Fluticasone performed better than either the steroid (Pred Forte®) or antihistamine (Pataday®), commercial products used as positive controls in this study. Additionally, the higher concentration of the combination (0.25% Cetirizine/0.01% Fluticasone) was minimally effective in this model under this dosing regimen and conditions.

The results of this study indicate that a substantial clinical benefit may be achieved with the combination of low dose Cetirizine/Fluticasone over its individual components, over the high dose combination and over existing lead commercial products.

Experimental Design:

Table 3: Schedule of Procedures

Procedure	Day 0	Day 19	Day 20	Day 21	Day 26
Ocular Exam	X			X	
SRW Injection	X				
Topical SRW		X	X	X	
Dosing		X	X	X	
Challenge				X	
Behavior Observations				X	
Photographs				X	
Euthanasia					X
Eye Enucleations					X

Sensitization

On Day 0, animals received injections containing a suspension of 50 µg of short ragweed allergen (SRW, Greer, Lenoir, NC, USA) in 25 µL alum (aluminum hydroxide gel). Additional sensitization was achieved by topical dosing with 1 mg SRW in 5 µl PBS on Days 19 and 20 after injection.

Dosing

On days 19 through 21, topical treatment was administered once daily. Mice were dosed topically to the central cornea using a calibrated micropipette, with a 5 µL drop of treatment in each eye. The dose groups are outlined in the table below:

Challenge

On day 21, twenty minutes after ocular treatment dosing, animals were challenged with topical doses of 1000 µg SRW suspension in 5 µl PBS in each eye. SRW was prepared fresh and used within 3 hours of mixing, and mixed well before administration to ensure homogeneity.

Table 4: Test/Control Articles

Group Number	Number of Animals	Test Article	Volume per Dose
1	8	0.1% Cetirizine/0.005% Fluticasone	5 µL
2	8	0.25% Cetirizine/0.01% Fluticasone	5 µL
3	8	0.1% Cetirizine	5 µL
4	8	0.005% Fluticasone	5 µL
5	8	Olopatadine HCl 0.2% (Pataday®)	5 µL
6	8	Pred. acetate 1% (Pred Forte®)	5 µL
7	8	Vehicle Control	5 µL

Experimental Procedures:

Ophthalmic exams were performed at baseline (study entry) according to the Ocular Irritation Grading Scale (Appendix 1) to verify that the eyes did not exhibit any signs of ocular irritation.

Ophthalmic exams were also performed on day 21, 15 minutes after the allergen challenge. Exams were performed under dissecting microscope, and included conjunctival hyperemia, chemosis, tear/discharge, and lid swelling, each graded on a 0-4 scale (0.5 units were allowed for any ocular score).

5 There were no abnormal ophthalmic findings in any animals used in the study and no unscheduled deaths during this study.

Tissue Collections/Preservation and Statistical Analysis

10 Immediately after euthanasia (CO₂ inhalation and cervical dislocation), eyes and surrounding lid tissue was collected and placed immediately in 4% paraformaldehyde for 24 hours, after which they were transferred to 70% ethanol for storage prior to paraffin embedding and sectioning for histology.

15 Both eyes of each animal were averaged and all animals within a group were averaged to obtain an average score for each treatment group for each measurement parameter. Statistically significant differences between groups were determined using the 2-tailed, 2-sample t-test.

RESULTS

Day 0 baseline exams ensured that all mice were free of any redness, swelling, and tearing.

20 After 3 days of drug treatment, the animals treated with the combination 0.1% Cetirizine/0.005% Fluticasone demonstrated the least severity in three of the four clinical signs (conjunctival hyperemia, chemosis, and lid swelling) as compared to Cetirizine or Fluticasone alone, and as compared to most other treatment groups. Total clinical score (sum of scores of all clinical signs in both eyes) was lowest in the 0.1% Cetirizine/0.005% Fluticasone combination group as compared to all other treatment groups. Cetirizine or Fluticasone alone produced no significant treatment effects.

25 The reduction in clinical signs in response to SRW challenge after 3 days of treatment with the combination 0.1% Cetirizine/0.005% Fluticasone was statistically significantly lower than Fluticasone alone for hyperemia ($p < 0.001$), chemosis ($p \leq 0.01$), lid swelling ($p < 0.03$) and total clinical score ($p < 0.01$); and than Cetirizine alone for chemosis ($p < 0.05$). Borderline significance was achieved against Cetirizine alone for total clinical score ($p = 0.06$).

Surprisingly, the high dose combination of 0.25% Cetirizine/0.01% Fluticasone was less effective than the low dose combination in this model for all clinical signs, with the exception of an effect on chemosis. The only statistically significant decrease in any clinical sign after high dose combination treatment was for chemosis as compared to Fluticasone alone ($p < 0.05$)

5 Under these treatment conditions (3 days of once-daily dosing), neither of the positive control test articles, commercially available Pred Forte (prednisolone acetate 1%), a steroid, or Pataday (olopatadine 0.2%), the leading anti-histamine, produced significant treatment effects, with the exception of a decrease in chemosis produced by olopatadine, comparable to the effect seen with the combination 0.1% Cetirizine/0.005% Fluticasone. This chemosis effect was
 10 statistically significantly different from Fluticasone alone ($p < 0.05$)

The results are summarized in Table 5 below and in Figures 24-28

Table 5 Summary of Results

Treatment Group	Conjunctival Hyperemia		Chemosis		Discharge		Lid Edema		Total Clinical Score	
	Average	SEM	Avg	SEM	Avg	SEM	Avg	SEM	Avg	SEM
0.1% Cetirizine/ 0.005% Fluticasone	1.00	0.11	1.22	0.11	1.38	0.12	1.56	0.09	10.31	0.66
0.25% Cetirizine/ 0.01% Fluticasone	1.53	0.14	1.28	0.15	1.41	0.18	1.69	0.27	11.63	1.09
0.1% Cetirizine	1.34	0.17	1.59	0.14	1.66	0.21	1.78	0.15	12.75	1.00
0.005% Fluticasone	1.78	0.15	1.66	0.09	1.34	0.15	1.97	0.14	13.50	0.80
Olopatadine HCl 0.2% (Pataday®)	1.47	0.25	1.19	0.19	1.53	0.15	1.63	0.16	11.63	1.34
Pred acetate 1% (Pred Forte®)	1.61	0.14	1.50	0.12	1.79	0.26	1.93	0.28	12.86	1.43
Vehicle Control	1.53	0.20	1.38	0.13	1.56	0.24	1.94	0.18	12.81	1.19

Conclusion:

15 The low dose combination of 0.1% Cetirizine/0.005% Fluticasone was the most effective at preventing signs of allergic conjunctivitis in the murine ragweed sensitization model. Neither component of the combination used alone, at the same concentrations, produced a substantial treatment effect. The low-dose combination, assessed after 3 days of treatment and 15 minutes
 20 after ragweed challenge, reduced conjunctival hyperemia, chemosis, and lid swelling, and resulted in the lowest clinical summary score of any of the treatment arms, including the cetirizine or fluticasone alone, and commercial ophthalmics Pataday® and Pred Forte®

Surprisingly, the higher concentration of the combination (0.25% Cetirizine/0.01% Fluticasone) was minimally effective in this model under this dosing regimen and conditions. These results indicate that the 0.1% Cetirizine/0.005% Fluticasone formulation has excellent potential for the prevention and treatment of allergic conjunctivitis and that a substantial clinical benefit might be achieved with the combination of Cetirizine/Fluticasone over either medication used alone.

In summary, the results consistently favored 0.1% cetirizine/0.005% fluticasone combination (low dose) over both the individual components alone as well as the high dose combination (0.25% cetirizine/0.01% fluticasone), which is surprising because one skilled in the art might expect the higher dose formulation to work at least equally well if not better than the low dose formulation. The low dose combination also worked better than would be expected from the results of the individual components, thus showed a synergistic effect between the cetirizine and fluticasone

Additionally, the low dose combination worked better than well known, leading ocular antihistamines and ocular steroids – these results confirm the effectiveness of the specific combination of cetirizine/fluticasone at the preferred low dose concentrations.

Lastly, the low dose combination was more efficacious than its comparison arms across all endpoints, including total ocular composite score.

Example 4: Comfort Profile of Cetirizine/Fluticasone Formulation

The purpose of this study was to assess the comfort of a 0.1% cetirizine/0.005% fluticasone (low dose) formulation and a 0.25% cetirizine/0.01% fluticasone (high dose) formulation upon instillation in the human eye (N=5). The low dose and high dose combinations were each formulated in 1% Polyethylene Glycol 400, NF; 0.2% Dibasic Sodium Phosphate, Anhydrous, USP; 0.25% Hypromellose, USP; 0.1% Polysorbate 80, NF; 1.8% Glycerin, USP; 0.025% Edetate Disodium, USP; 0.01% Benzalkonium Chloride, NF, as reflected in Tables 6 and 6 below:

Table 6: 0.005% Fluticasone Propionate / 0.1% Cetrizine Ophthalmic Suspension

Concentration	Ingredient	Purpose
0.005%	Fluticasone Propionate, USP	Active, Steroid
1%	Polyethylene Glycol 400, NF	Carrier
0.2%	Dibasic Sodium Phosphate, Anhydrous, USP	Buffer
0.1188%	Cetirizine Dihydrochloride, Ph Eur	Active, Antihistamine
0.25%	Hypromellose, USP	Viscosity agent
0.1%	Polysorbate 80, NF	Surfactant
1.8%	Glycerin, USP	Tonicity Agent
0.025%	Edetate Disodium, USP	Chelating Agent
0.01%	Benzalkonium Chloride, NF	Preservative
q.s.	Sterile Purified Water	Vehicle

Table 7: 0.01% Fluticasone Propionate / 0.25% Cetrizine Ophthalmic Suspension

Concentration	Ingredient	Purpose
0.01%	Fluticasone Propionate, USP	Active, Steroid
2%	Polyethylene Glycol 400, NF	Carrier
0.2%	Dibasic Sodium Phosphate, Anhydrous, USP	Buffer
0.297%	Cetirizine Dihydrochloride, Ph Eur	Active, Antihistamine
0.25%	Hypromellose, USP	Viscosity agent
0.1%	Polysorbate 80, NF	Surfactant
1.2%	Glycerin, USP	Tonicity Agent
0.025%	Edetate Disodium, USP	Chelating Agent
0.01%	Benzalkonium Chloride, NF	Preservative
q.s.	Sterile Purified Water	Vehicle

5 Each of the formulations in Tables 5 and 6 had a pH 7.0 and an osmolality of 300 mOsm/kg

One drop of masked study medication was instilled in each eye and subjects were asked to assess the comfort of the drop on a subjective scale of 0 to 10 (0=comfortable, 10=very uncomfortable (Note: The most uncomfortable commercially available allergy drop=4). The results are shown in Figure 29. Both the low dose and high dose formulations were well tolerated (average comfort score <3) and were found to be more comfortable than the formulation comprising 0.005% fluticasone alone as the only active agent, which had an osmolality of 900 mOsm/kg (average comfort score ~3, See Figures 20-21, Example 2).

15

Example 5: Clinical Efficacy of Cetirizine/Fluticasone Formulations

A placebo controlled, double-blind study will be conducted to evaluate the efficacy of cetirizine 0.1%/fluticasone 0.005% formulation (low dose) formulation compared to the individual treatment arms (i.e., cetirizine alone and fluticasone alone) and a vehicle control.

5 Subjects will undergo 2 screening visits (an allergen titration and confirmation) followed by a drug evaluation visit. At the drug evaluation visit, one drop of masked study medication will be instilled in both eyes and comfort assessments will be taken. Sixteen hours later subjects will be challenged with allergen (conjunctival allergen challenge; "CAC") and allergic assessments will be taken. Subjects will be asked to subjectively rate their ocular itching on a scale of 0 to 4
10 (0=little to no itching, 4=extreme itching). Conjunctival redness (post- CAC) will also be evaluated. Subjects will be further asked to keep a diary to evaluate ocular itching and conjunctival redness over a 2 week period. Intraocular pressure ("IOP") measurements and any adverse events will be measured/collected over 14 days dosing.

15 Based on the surprising results of the *in vivo* animal study described in Example 3 above, it is anticipated that the low dose cetirizine/fluticasone formulation will be more efficacious than both the individual components (i.e., cetirizine alone and fluticasone alone) and the vehicle control in reducing ocular itching and conjunctival redness (post-CAC). Based on the clinical efficacy of the 0.1% cetirizine alone formulation (see Example 1), it is anticipated that the low
20 0.1% cetirizine/0.005% fluticasone formulation will be even more efficacious in reducing the signs and symptoms of allergic conjunctivitis for at least 16 hours or more, as compared to the cetirizine alone, and will have better efficacy at treating the late phase allergic inflammation response.

Example 6: Stability of 0.10% Cetirizine Formulation and Combined Cetirizine/Fluticasone Formulations

25 Tables 8-9 below show that a 0.1% formulation of cetirizine was stable for at least three months both at room temperature (Table 6) and at higher temperatures (Table 7).

Tables 10-11 below show that a 0.1% cetirizine/0.005% fluticasone formulation (in 1% Polyethylene Glycol 400, NF; 0.2% Dibasic Sodium Phosphate, Anhydrous, USP; 0.25% Hypromellose, USP; 0.1% Polysorbate 80, NF; 1.8% Glycerin, USP; 0.025% Edetate Disodium,

USP; 0.01% Benzalkonium Chloride, NF (pH 7.0); i.e., the formulation listed in Table 5) was stable for at least one month at both room temperature (Table 8) and at higher temperature (Table 9) when stored upright.

5 Tables 12 and 13 show that a 0.25% cetirizine/0.01% fluticasone formulation (in 1% Polyethylene Glycol 400, NF; 0.2% Dibasic Sodium Phosphate, Anhydrous, USP; 0.25% Hypromellose, USP; 0.1% Polysorbate 80, NF; 1.8% Glycerin, USP; 0.025% Edetate Disodium, USP; 0.01% Benzalkonium Chloride, NF (pH 7.0); i.e., the formulation listed in Table 6) was stable for at least one month at room temperature (Table 10) and at a higher temperature (Table 11) when stored upright.

10 Cetirizine and fluticasone concentrations were quantified by high pressure liquid chromatography (HPLC). Impurities are shown as "relative retention time" or RRT in the table, which relates the unknown peak to the elution time of the parent peak, cetirizine (or fluticasone). At no time did the total impurities exceed 1%. Sterility, particulate matter, and preservative efficacy were determined only at the initial time point because these should remain unchanged provided that the sealed container is not compromised.

15 The data herein demonstrates cetirizine and cetirizine/fluticasone formulations that are stable without the inclusion of a cyclodextrin or other solubilizing compound. Without intending to be bound by any theory, the stability was achieved by minimizing/excluding the addition of counter ions or metal based buffers that could promote salt formation, precipitation, or metal based degradation.

20

Table 8 : Cetirizine 0.10%/Benzalkonium Chloride 0.01% (w/v) Ophthalmic Solution Stability Testing: 25°C / 60% RH (QA 10/13/2008)

Lot #: 04262008@18

Test	Limits / Specification	1 Month			2 Month			3 Month		
		Initial	July 9, 2008	August 11, 2008	September 10, 2008	Initial	July 9, 2008	August 11, 2008	September 10, 2008	
Appearance (Contents)	Clear and colourless to slightly yellow solution	June 9, 2008 Conforms: Clear, Colorless Solution	Conforms: Clear, Colorless Solution	Conforms: Clear, Colorless Solution	Conforms: Clear, Colorless Solution	Conforms: Clear, Colorless Solution	Conforms: Clear, Colorless Solution	Conforms: Clear, Colorless Solution	Conforms: Clear, Colorless Solution	
Appearance (Container Integrity)	No leakage observed, container intact	Conforms: No leakage, container intact	Conforms: No leakage, container intact	Conforms: No leakage, container intact	Conforms: No leakage, container intact	Conforms: No leakage, container intact	Conforms: No leakage, container intact	Conforms: No leakage, container intact	Conforms: No leakage, container intact	
Assay: Cetirizine Label Claim: 0.10% (w/v) (equivalent to Cetirizine dihydrochloride 0.1188%)	NLT 90.0% and NMT 110.0% of Label Claim (LC)	99.2% LC	99.5% LC	99.7% LC	99.4% LC	99.2% LC	99.5% LC	99.7% LC	99.4% LC	
Assay of Ketotifen Impurities (Total, Ketotifen impurities, Cetirizine impurities)	Absence of Active Report individual $\geq 0.05\%$ Report Total	Not Detected	Not Detected	Not Detected	Not Detected	RRT @ 0.93: 0.06% RRT @ 1.1: 0.15% Total: 0.2%	RRT @ 0.90: 0.06% RRT @ 1.60: 0.06% RRT @ 2.11: 0.06% Total: 0.2%	RRT @ 0.67: 0.07% RRT @ 0.91: 0.06% RRT @ 1.10: 0.05% RRT @ 1.11: 0.09% RRT @ 2.33: 0.06% Total: 0.30%	Not Detected	
Assay: Benzalkonium Chloride Label Claim: 0.01% (w/v)	NLT 85.0% and NMT 115% of Label Claim	99.4% LC	94.6% LC	100.0% LC	94.7% LC	99.4% LC	94.6% LC	100.0% LC	94.7% LC	
pH	5.5 ± 0.5	5.7	6.0	6.0	5.9	5.7	6.0	6.0	5.9	
Osmolality	Report	253 mOsm/Kg.H ₂ O	253 mOsm/Kg.H ₂ O	253 mOsm/Kg.H ₂ O	252 mOsm/Kg.H ₂ O	253 mOsm/Kg.H ₂ O	253 mOsm/Kg.H ₂ O	253 mOsm/Kg.H ₂ O	252 mOsm/Kg.H ₂ O	
Sterility	Meets USP Criteria	Pass	Pass	Pass	Pass	Pass	Pass	Pass	Pass	
Particulate Matter	Number of particles with diameter of $\geq 10 \mu\text{m}$: NMT 50/mL $\geq 25 \mu\text{m}$: NMT 5/mL $\geq 50 \mu\text{m}$: NMT 2/mL	Pass	Pass	Pass	Pass	Pass	Pass	Pass	Pass	
Antimicrobial Preservative Efficacy	Report	Pass	Pass	Pass	Pass	Pass	Pass	Pass	Pass	

Table 9 Cetirizine O 10%/Benzalkonium Chloride 0.01% (w/v) Ophthalmic Solution Stability Testing 40°C / 75% RH (QA 10/13/2008)

(Lot #: 04262008@18)

Test	Limits / Specification	Initial June 9, 2008	1 Month July 9, 2008	2 Month August 11, 2008	3 Month September 10, 2008
Appearance (Contents)	Clear and colorless to slightly yellow solution	Conforms Clear, Colorless Solution	Conforms Clear, Colorless Solution	Conforms Clear, Colorless Solution	Conforms Clear, Colorless Solution
Appearance (Container Integrity)	No leakage observed container intact	Conforms No leakage, container intact	Conforms No leakage, container intact	Conforms No leakage, container intact	Conforms No leakage, container intact
Assay Cetirizine Label Claim 0.10% (w/v) (equivalent to Cetirizine dihydrochloride 0.188%)	NLT 99.0% and NMT 110.0% of Label Claim (LC)	99.2% LC	99.6% LC	100.1% LC	99.4% LC
Assay of Ketorfen Impurities (Total, Ketorfen impurities, Cetirizine impurities)	Absence of Active Report individual $\geq 0.05\%$ Report Total	Not Detected RRT @ 0.93 0.06% RRT @ 1.1 0.15% Total 0.2%	Not Detected RRT @ 0.90 0.06% RRT @ 2.11 0.06% Total 0.1%	Not Detected RRT @ 0.67 0.34% RRT @ 0.78 0.05% RRT @ 0.91 0.06% RRT @ 1.10 0.05% RRT @ 1.11 0.09% RRT @ 2.33 0.06% Total 0.70%	Not Detected RRT @ 0.63 0.44% RRT @ 0.92 0.05% RRT @ 1.10 0.09% Total 0.6%
Assay Benzalkonium Chloride Label Claim 0.01% (w/v)	NLT 85.0% and NMT 115% of Label Claim	99.4% LC	92.9% LC	99.1% LC	96.8% LC
pH	5.5 \pm 0.5	5.7	6.0	5.9	5.7
Osmolality	Report	253 mOsm/Kg H ₂ O	254 mOsm/Kg H ₂ O	254 mOsm/Kg H ₂ O	255 mOsm/Kg H ₂ O
Sterility	Meets USP Criteria	Pass			
Particulate Matter	Number of particles with diameter of $\geq 10 \mu\text{m}$ NMT 50/mL $\geq 25 \mu\text{m}$ NMT 5/mL $\geq 50 \mu\text{m}$ NMT 2/mL	Pass			
Antimicrobial Preservative Efficacy	Report	Pass			

Table 10 0.005% Fluticasone Propionate / 0.1% Cetrizine Ophthalmic Suspension Stability Testing 25°C / 40% RH
(Lot Number Ora091202 V1)

Test Date Pulled	Specification	Initial		1 Week		2 Week		1 Month	
		12/15/09 Inverted Orientation	12/21/09 Inverted Orientation	12/28/09 Inverted Orientation	01/04/10 Upright Orientation	01/13/10 Upright Orientation			
Appearance (Solution)	Report Results	Clear, Colorless, no ppt	Clear, Colorless, no ppt	Clear, Colorless, no ppt	NT	Slightly Turbid Solution			
Appearance (Container)	No leakage observed, container intact	NT	No leakage observed, container intact	No leakage observed, container intact	NT	No leakage observed, container intact			
Fluticasone Propionate Assay	90% - 110% Label Claim	95.1% LC	98.6% LC	89.4% LC*	102.4% LC	99.6% LC			
Fluticasone Related Substances	Report individual %AUC, Report total, % AUC	RRT 0.19 0.75% AUC RRT 0.36 0.35% AUC Total 1.07% AUC	RRT 0.19 0.50% AUC RRT 0.36 0.40% AUC RRT 0.66 0.24% AUC RRT 0.93 0.07% AUC Total 1.21%	RRT 0.09 0.06% AUC RRT 0.10 0.14% AUC RRT 0.12 0.72% AUC RRT 0.27 0.49% AUC RRT 0.33 0.18% AUC RRT 0.52 0.05% AUC RRT 0.61 0.29% AUC RRT 0.76 0.23% AUC RRT 0.88 0.27% AUC Total 2.43%	RRT 0.07 0.25% AUC RRT 0.09 0.06% AUC RRT 0.10 0.16% AUC RRT 0.12 0.53% AUC RRT 0.27 0.46% AUC RRT 0.33 0.14% AUC Total 1.6%	RRT 0.12 0.39% AUC RRT 0.14 0.63% AUC RRT 0.29 0.41% AUC RRT 0.34 0.10% AUC Total 1.53% AUC			
Cetrizine Assay	90% - 110% Label Claim	98.6% LC	97.2% LC	98.0% LC	NT	96.5% LC			
Cetrizine Related Substances	Report individual %AUC, Report total, % AUC	RRT 0.96 0.5% AUC RRT 1.13 0.08% AUC Total 0.13%	RRT 0.96 0.05% AUC RRT 1.13 0.18% AUC Total 0.23%	RRT 0.96 0.05% AUC RRT 1.13 0.19% AUC Total 0.24%	NT	RRT 1.13 0.53% AUC Total 0.53% AUC			
Benzalkonium chloride Assay	50% - 150% Label Claim	99.5% LC	NT	NT	NT	101.0% LC			

Test	1 Week	2 Week	1 Month
Date Pulled	12/21/09	12/28/09	01/13/10
Disodium Edetate	Inverted Orientation 95.8% LC	Inverted Orientation NT	Upright Orientation 91.2% LC
pH	7.0	7.0	7.0
Osmolality	290 mOsm/Kg	291 mOsm/Kg	290 mOsm/Kg

RH= relative humidity, LC= label claim, AUC= area under curve, NT= not tested

*The low assay values were attributed to the inverted orientation in which the stability samples were stored. Samples stored in the upright orientation were tested at the 2-week time point and subsequent time points, as reflected in the data shown.

Table 11 0.005% Fluticasone Propionate / 0.1% Cetirizine Ophthalmic Suspension Stability Testing 4°C / NMT 25% RH (Lot Number Ora091202 VI)

Test	1 Week	2 Week	1 Month
Date Pulled	12/21/09	12/28/09	01/13/10
Appearance (Solution)	Clear, Colorless, no ppt	Clear, Colorless, no ppt	Slightly turbid solution
Appearance (Container)	No leakage observed, container intact	No leakage observed, Container intact	No leakage observed, container intact
Fluticasone Propionate Assay	82.2% LC*	58.4% LC*	101.4% LC
Fluticasone Related Substances	RRT 0.19 0.75% AUC RRT 0.36 0.35% AUC Total 1.07% AUC	RRT 0.09 0.66% AUC RRT 0.10 0.59% AUC RRT 0.12 0.72% AUC RRT 0.28 0.72% AUC RRT 0.33 1.12% AUC RRT 0.45 0.20% AUC RRT 0.49 0.11% AUC RRT 0.53 0.14% AUC RRT 0.60 0.14% AUC RRT 0.76 0.31% AUC RRT 0.88 0.49% AUC Total 5.20% AUC	RRT 0.07 0.26% AUC RRT 0.09 0.52% AUC RRT 0.10 0.13% AUC RRT 0.12 0.35% AUC RRT 0.27 0.43% AUC RRT 0.33 0.19% AUC Total 2.23% AUC

Test	Specification	Initial	1 Week	2 Week	2 Week	1 Month
Date Pulled		12/15/09	12/21/09	12/28/09	01/04/10	01/13/10
		Inverted Orientation	Inverted Orientation	Inverted Orientation	Upright Orientation	Upright Orientation
Cetirizine Assay	90% - 110% Label Claim	98.6% LC	97.2% LC	97.9% LC	NT	96.8% LC
Cetirizine Related Substances	Report individual %AUC, Report total, % AUC	RRT 0.96, 0.5% AUC RRT 1.13: 0.08% AUC Total: 0.13%	RRT 1.13: 0.47% AUC Total: 0.47%	RRT 1.13: 0.48% AUC Total: 0.48%	NT	RRT 1.13: 0.82% AUC Total: 0.82% AUC
Benzalkonium chloride Assay	50% - 150% Label Claim	99.5% LC	NT	NT	NT	101.3% LC
Disodium Edetate	70% - 120% Label Claim	95.8% LC	NT	NT	NT	91.0% LC
pH	6.5 - 7.8	7.1	7.0	7.0	NT	7.0
Osmolality	Report results	291 mOsm/Kg	292 mOsm/Kg	293 mOsm/Kg	NT	291 mOsm/Kg

RH= relative humidity, LC= label claim, AUC= area under curve, NT= not tested.

*The low assay values were attributed to the inverted orientation in which the stability samples were stored. Samples stored in the upright orientation were tested at the 2-week time point and subsequent time points, as reflected in the data shown

Table 12: 0.01% Fluticasone Propionate / 0.25% Cetirizine Ophthalmic Suspension Stability Testing, 25°C / 40% RH
(Lot Number: Ora091 130. VI)

Test	Specification	Initial	1 Week	2 Week	2 Week	1 Month
Date Pulled		12/15/09	12/21/09	12/28/09	01/04/10	01/13/10
		Inverted Orientation	Inverted Orientation	Inverted Orientation	Upright Orientation	Upright Orientation
Appearance (Solution)	Report Results	Clear, Colorless, no ppt.	Clear, colorless, no ppt	Clear, colorless, no ppt	NT	Slightly turbid solution
Appearance (Container)	No leakage observed, container intact	NT	No leakage observed, container intact	No leakage observed, container intact	NT	No leakage observed, container intact
Fluticasone Propionate Assay	90% - 110% Label Claim	96.9% LC	98.9% LC	79.0% LC*	99.6% LC	99.2% LC
Fluticasone Related	Report individual	RRT 0.18:	RRT 0.19: 0.61% AUC	RRT 0.06: 0.36% AUC	RRT 0.06:	RRT 0.11: 0.46% AUC

Test	Date Pulled	Specification	Initial		1 Week		2 Week		1 Month	
			12/15/09 Inverted Orientation	12/21/09 Inverted Orientation	12/28/09 Inverted Orientation	01/04/10 Upright Orientation	01/13/10 Upright Orientation			
Substances		%AUC, Report total, % AUC	0.82% AUC RRT 0.35 0.40% AUC Total 1.22%	RRT 0.35 0.47% AUC RRT 0.67 0.43% AUC Total 1.51%	RRT 0.09 0.38% AUC RRT 0.12 0.82% AUC RRT 0.27 0.67% AUC RRT 0.33 0.20% AUC RRT 0.44 0.31% AUC RRT 0.51 0.42% AUC RRT 0.60 0.27% AUC RRT 0.76 1.04% AUC RRT 0.88 1.48% AUC Total 6.14%	0.49% AUC RRT 0.09 0.38% AUC RRT 0.12 0.66% AUC RRT 0.27 0.53% AUC RRT 0.36 0.20% AUC RRT 0.52 0.09% AUC Total 2.35%	RRT 0.13 0.74% AUC RRT 0.29 0.50% AUC Total 1.17% AUC			
Cetirizine Assay		90% - 110% Label Claim	99.3% LC	97.3% LC	98.7% LC	NT	97.2% LC			
Cetirizine Related Substances		Report individual %AUC, Report total, % AUC	RRT 0.96, 0.05% AUC RRT 1.13 0.14% AUC Total 0.19%	RRT 0.96 0.05% AUC RRT 1.13 0.31% AUC Total 0.36%	RRT 0.96 0.05% AUC RRT 1.13 0.32% AUC Total 0.37%	NT	RRT 1.13 0.75% AUC Total 0.75% AUC			
Benzalkonium chloride Assay		50% - 150% Label Claim	96.7% LC	NT	NT	NT	100.6% LC			
Disodium Edetate		70% - 120% Label Claim	92.9% LC	NT	NT	NT	89.7% LC			
pH		6.5-7.8	7.1	7.1	7.1	NT	7.1			
Osmolality		Report results	272 mOsm/Kg	273 mOsm/Kg	274 mosm/Kg	NT	273 mOsm/Kg			

RH= relative humidity, LC= label claim, AUC= area under curve, NT= not tested

*The low assay values were attributed to the inverted orientation in which the stability samples were stored. Samples stored in the upright orientation were tested at the 2-week time point and subsequent time points, as reflected in the data shown

Table 13 0.01% Fluticasone Propionate / 0.25% Cetirizine Ophthalmic Suspension Stability Testing 40°C / NMT 25% RH
(Lot Number Ora091130 V1)

Test	Specification		1 Week		2 Week		2 Week		1 Month	
	Date Pulled		12/15/09 Inverted Orientation	12/21/09 Inverted Orientation	12/28/09 Inverted Orientation	01/04/10 Upright Orientation	01/13/10 Upright Orientation			
Appearance (Solution)		Report Results	Clear, Colorless, no ppt	Clear, colorless, no ppt	Clear, colorless, no ppt	NT	Slightly turbid solution			
Appearance (Container)		No leakage observed, container intact	NT	No leakage observed, container intact	No leakage observed, container intact	NT	No leakage observed, container intact			
Fluticasone Propionate Assay		90% - 110% Label Claim	96.9% LC	98.5% LC	51.4% LC*	100.4% LC	98.9% LC			
Fluticasone Related Substances		Report individual %AUC Report total, % AUC	RRT 0.18 0.82% AUC RRT 0.35 0.40% AUC Total 1.22%	RRT 0.19 0.47% AUC RRT 0.35 0.49% AUC RRT 0.66 0.38% AUC Total 1.34%	RRT 0.09 1.09% AUC RRT 0.10 0.43% AUC RRT 0.12 0.73% AUC RRT 0.27 0.97% AUC RRT 0.32 0.56% AUC RRT 0.44 0.24% AUC RRT 0.51 0.67% AUC RRT 0.60 0.30% AUC RRT 0.76 0.99% AUC RRT 0.88 1.32% AUC Total 7.54%	RRT 0.06 0.44% AUC RRT 0.09 0.93% AUC RRT 0.12 0.53% AUC RRT 0.27 0.52% AUC RRT 0.31 0.07% AUC RRT 0.36 0.17% AUC Total 2.66%	RRT 0.11 0.94% AUC RRT 0.13 0.71% AUC RRT 0.28 0.08% AUC Total 1.73% AUC			
Cetirizine Assay		90% - 110% Label Claim	99.3% LC	97.1% LC	98.6% LC	NT	96.7% LC			
Cetirizine Related Substances		Report individual %AUC, Report total, % AUC	RRT 0.96 0.05% AUC RRT 1.13 0.14% AUC Total 0.19%	RRT 0.46 0.08% AUC RRT 1.13 0.69% AUC Total 0.77%	RRT 0.46 0.08% AUC RRT 1.13 0.70% AUC Total 0.78%	NT	RRT 1.13 0.96% AUC Total 0.96% AUC			
Benzalkonium chloride Assay		50% - 150% Label Claim	96.7% LC	NT	NT	NT	98.7% LC			
Sodium Edetate		70% - 120% Label Claim	92.9% LC	NT	NT	NT	90.4% LC			
pH		6.5 - 7.8	7.1	7.1	7.1	NT	7.0			
Osmolality		Report results	272 mOsm/Kg	273 mOsm/Kg	272 mOsm/Kg	NT	274 mOsm/Kg			

RH= relative humidity, LC= label claim, AUC= area under curve, NT= not tested

*The low assay values were attributed to the inverted orientation in which the stability samples were stored. Samples stored in the upright orientation were tested at the 2-week time point and subsequent time points, as reflected in the data shown.

EQUIVALENTS

Those skilled in the art will recognize, or be able to ascertain using no more than routine experimentation, many equivalents to the specific embodiments of the invention described herein. Such equivalents are intended to be encompassed by the following claims.

5

We claim:

1. A topical ophthalmic formulation comprising an effective amount of cetirizine, or a pharmaceutically acceptable salt thereof, wherein cetirizine is the only active agent in the formulation and is present at a concentration of between 0.05% and 0.24% (w/v),
5 and wherein the formulation does not contain a cyclodextrin or other solubilizing compound.

2. The ophthalmic formulation of claim 1, wherein the cetirizine is present as cetirizine hydrochloride or dihydrochloride.

10

3. The ophthalmic formulation of claim I, wherein the concentration of cetirizine is 0.1%.

15

4. The ophthalmic formulation of claim 1, further comprising glycerin.

5. The ophthalmic formulation of claim 4, wherein the glycerin is at a concentration of 0.1% to 3% (v/v).

20

6. The ophthalmic formulation of claim 1, further comprising a preservative.

7. The ophthalmic formulation of claim 6, wherein the preservative is benzalkonium chloride or a derivative thereof, or a stabilized, oxychloro complex.

25

8. The ophthalmic formulation of claim 7, wherein the preservative is benzalkonium chloride present in amount ranging from 0.005% to 0.02% (v/v).

9. The ophthalmic formulation of claim 1, wherein the composition does not comprise a preservative.

30

10. The ophthalmic formulation of claim 1, further comprising a steroid or a vasoconstrictor.

11. The ophthalmic formulation of claim 10, wherein the steroid is fluticasone and the vasoconstrictor is naphazoline or oxymetazoline.

5 12. The ophthalmic formulation of claim 11, wherein fluticasone and is present in the formulation at a concentration of 0.001% to 0.2% (w/v).

13. The ophthalmic formulation of claim 12, wherein the concentration of fluticasone is 0.005% (w/v).

10 14. The ophthalmic formulation of claim 1, wherein the pH of the composition is 5 to 7.0.

15 15. The ophthalmic formulation of claim 1, wherein the formulation is an aqueous formulation, an ointment, an oil, a suspension, an emulsion, or incorporated in a drug delivery device.

16. The ophthalmic formulation of claim 15, wherein the formulation is in an aqueous formulation.

20 17. A topical ophthalmic formulation comprising 0.1% cetirizine (w/v), 0.005% fluticasone (w/v), 1% Polyethylene Glycol 400, NF, 0.2% Dibasic Sodium Phosphate, Anhydrous, USP, 0.25% Hypromellose, USP, 0.1% Polysorbate 80, NF, 1.8% Glycerin, USP, 0.025% Edetate Disodium, USP, 0.01% Benzalkonium Chloride, NF, wherein the formulation has a pH 7.0.

25 18. A method for treating allergic conjunctivitis by topically administering to the eye of a subject in need of such treatment an ophthalmic formulation comprising an effective amount of cetirizine, or a pharmaceutically acceptable salt thereof, wherein cetirizine is the only active ingredient in the formulation and is present at a concentration
30 of between 0.05% and 0.24% (w/v), and wherein the formulation does not contain a cyclodextrin or other solubilizing compound.

19. A method for treating allergic rhinoconjunctivitis by topically administering to the eye of a subject in need of such treatment an ophthalmic formulation comprising an effective amount of cetirizine, or a pharmaceutically acceptable salt thereof, wherein cetirizine is the only active ingredient in the formulation and is present at a concentration of between 0.05% and 0.24% (w/v), and wherein the formulation does not contain a cyclodextrin or other solubilizing compound.

20. The method of claim 18 or 19, wherein the ophthalmic formulation comprises an additional active agent selected from the group consisting of naphazoline, oxymetazoline, or fluticasone.

21. The method of claim 20, wherein the additional active agent is fluticasone and is present in the formulation at a concentration of 0.001% to 1.0% (w/v).

22. The ophthalmic formulation of claim 21, wherein the concentration of fluticasone is 0.005% (w/v).

23. The method of claim 18 or 19, wherein the ophthalmic formulation is administered once daily.

Allergy Human POC Study #1 Results (Ocular Itching 16 Hours Post-Dose)

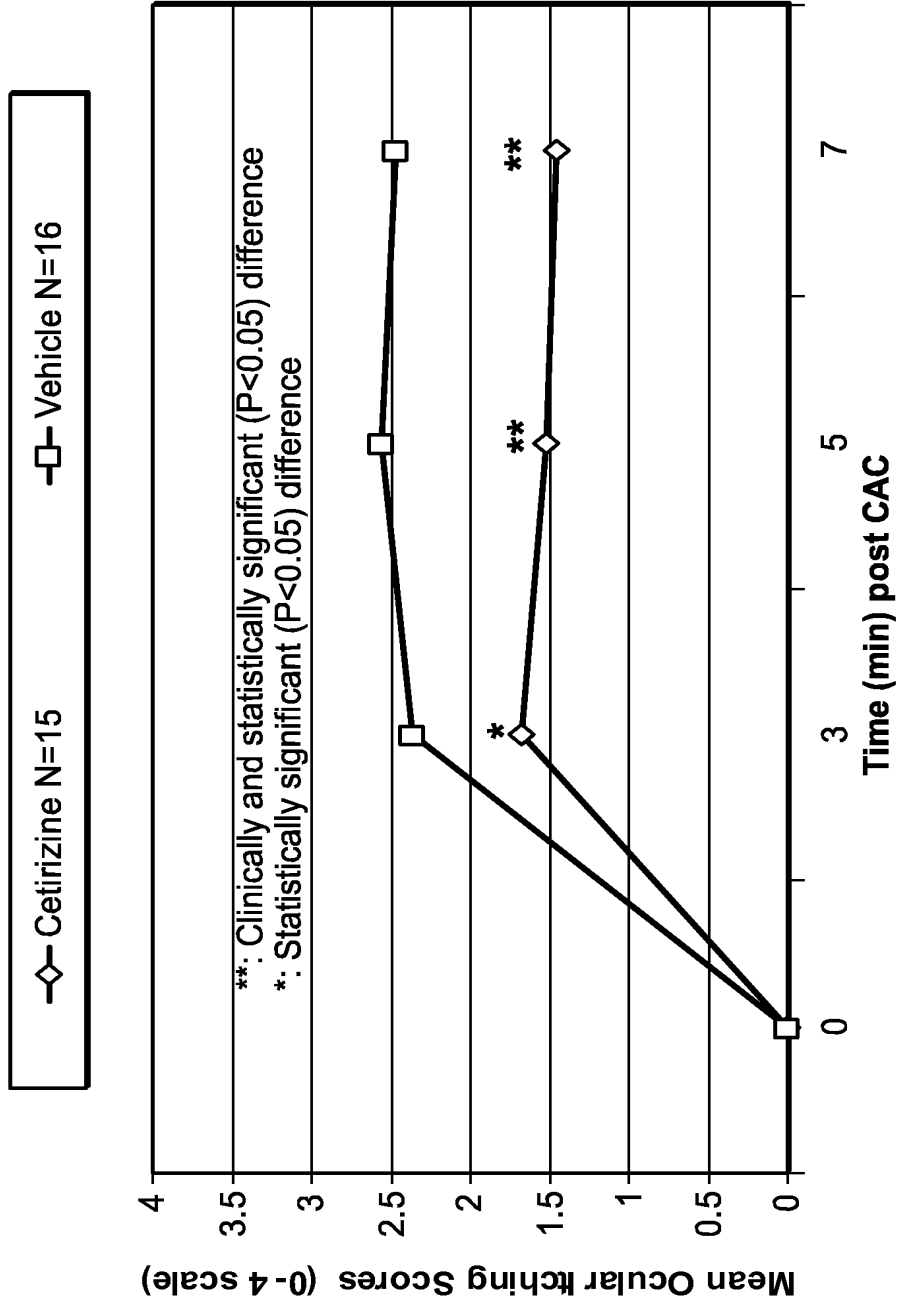

FIG. 1A

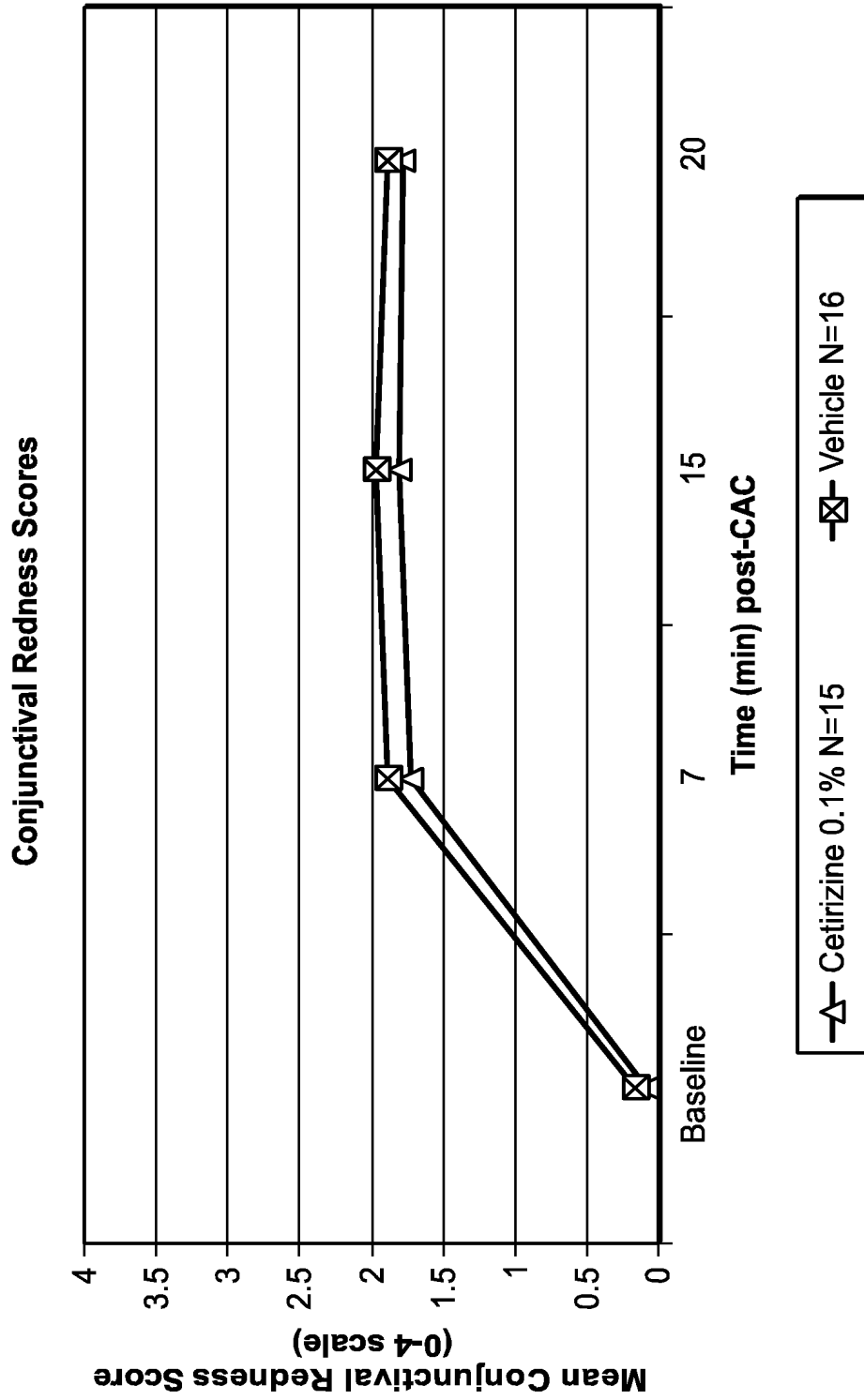
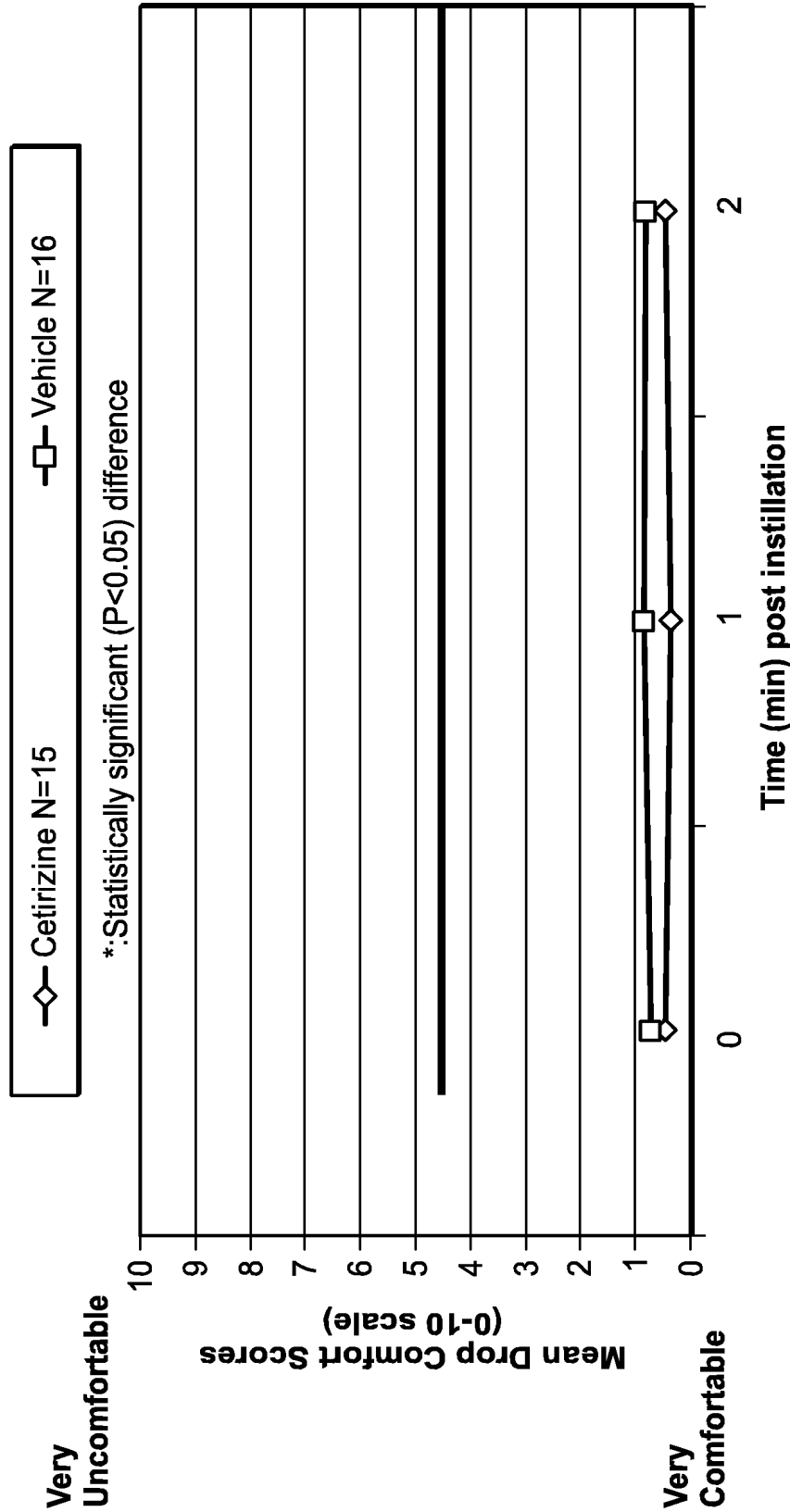

FIG. 1B

Allergy Human POC Study #1 Results (Drop Comfort)



Note: Most Uncomfortable Commercially Available Allergy Drop=4

FIG. 2

Study Design: Screening

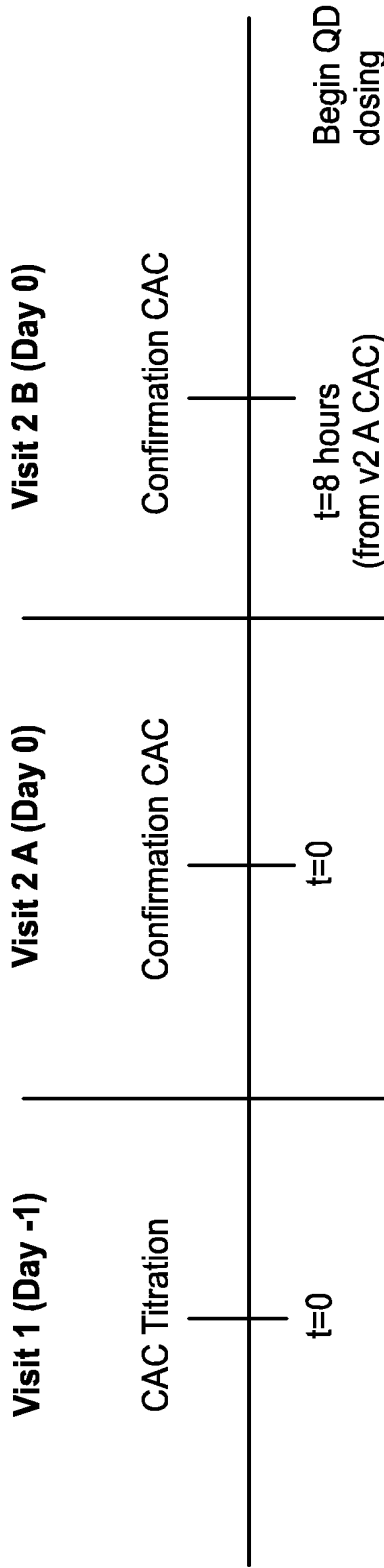

Ocular allergic assessments: Itching: 3, 5, and 7 minutes post-CAC
 Redness, Chemosis, Lid Swelling, Watery Eyes, Rhinorrhea, Nasal Pruritis, & Ear or palate Pruritis : 7, 15, and 20 minutes post-CAC
 Peak Nasal Inspiratory Flow: 9 and 30 minutes post-CAC

Only subjects who experienced a score of ≥ 2 for ocular itching, conjunctival redness and nasal congestion at Visit 1 and a score of ≥ 2 for ocular itching and conjunctival redness in 2 out of 3 time point and ≥ 2 for nasal congestion in at least 2 out of 4 time points at Visit 2B were scheduled for Visit 3

FIG. 3A

Study Design: Efficacy Evaluation

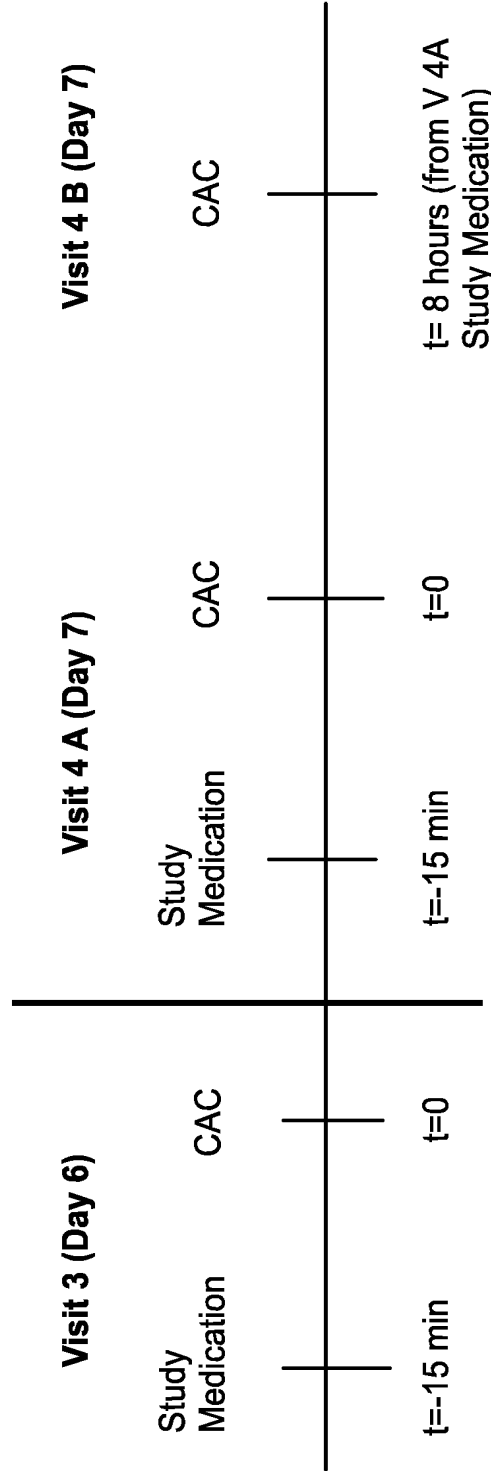

Ocular allergic assessments: Itching: 3, 5, and 7 minutes post-CAC Redness, Chemosis, Lid Swelling, Watery Eyes, Rhinorrhea, Nasal Pruritis, & Ear or palate Pruritis : 7, 15, and 20 minutes post-CAC
 Peak Nasal Inspiratory Flow: 9 and 30 minutes post-CAC

FIG. 3B

6/31

Primary: Ocular Itching (Visit 4B)

—□— FI 0.001% (N=16) —△— FI 0.005% (N=16) —*— FI 0.01% (N=15) —*— Vehicle (N=15)

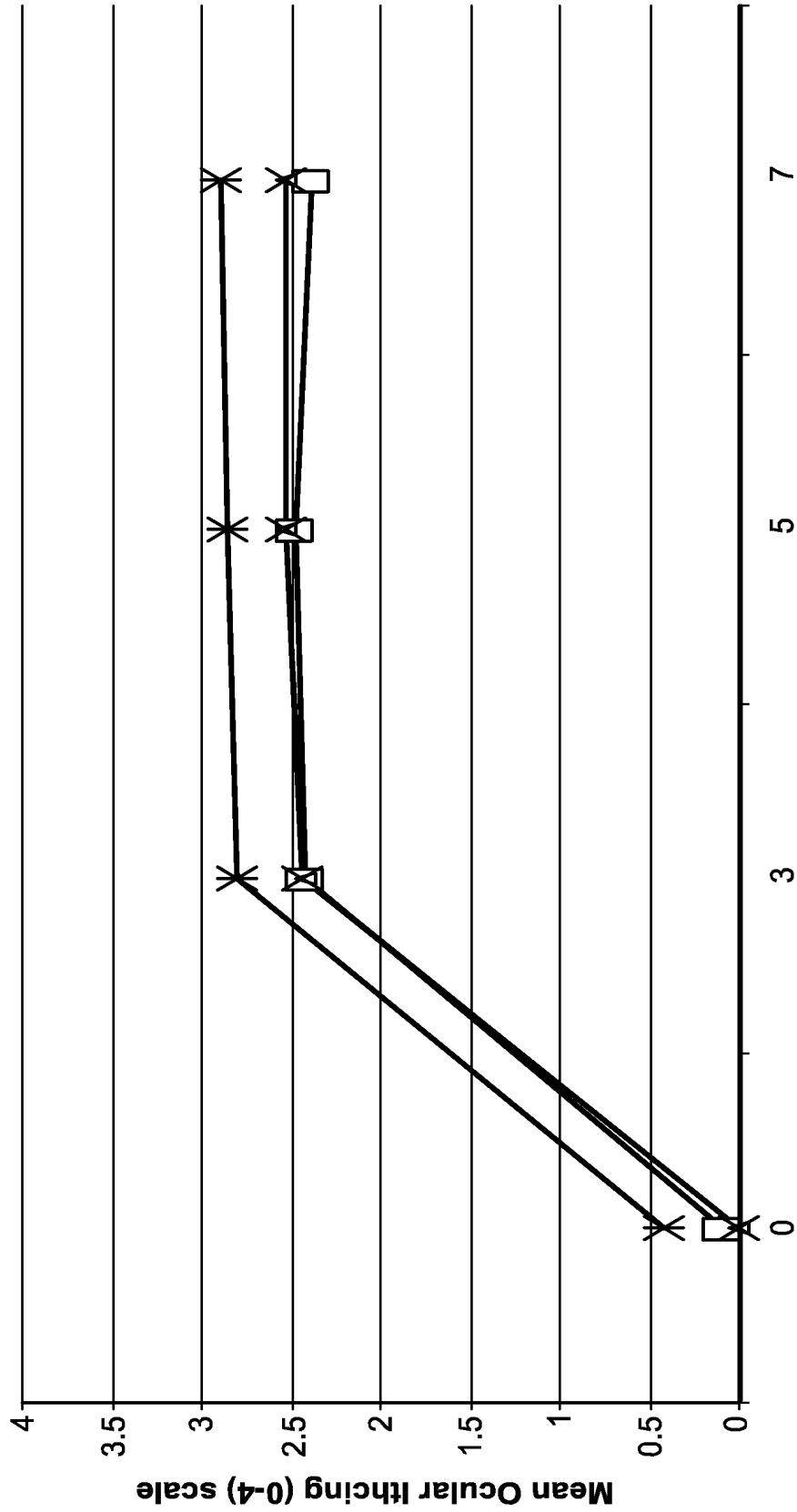

FIG. 4

7/31

Primary: Conjunctival Redness (Visit 4B)

—□— FI 0.001% (N=16) —△— FI 0.005% (N=16) —*— FI 0.01% (N=15) —*— Vehicle (N=15)

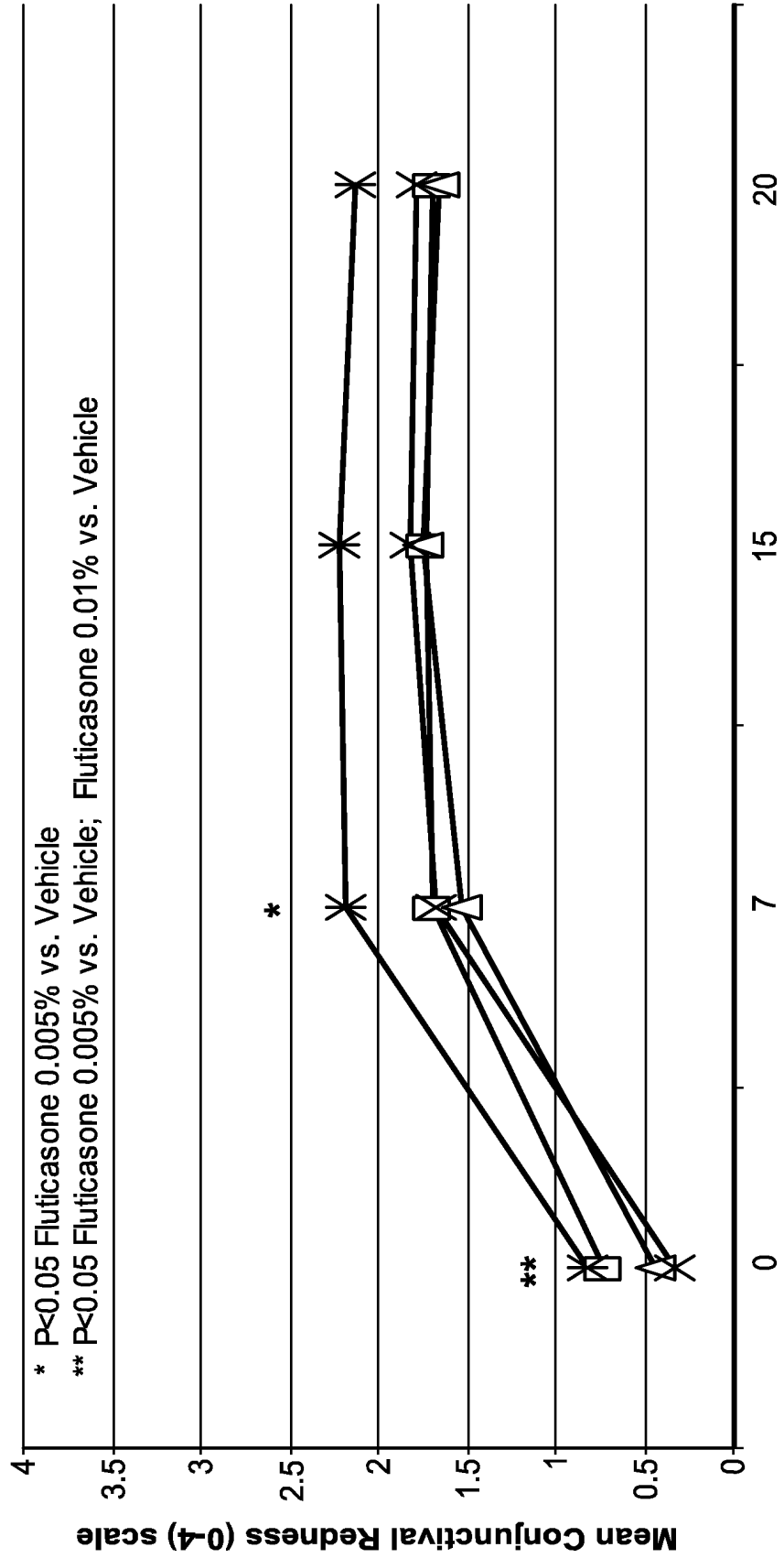

FIG. 5

Primary: Lid Swelling (Visit 4B)

—□— FI 0.001% (N=16) —△— FI 0.005% (N=16) —*— FI 0.01% (N=15) —*— Vehicle (N=15)

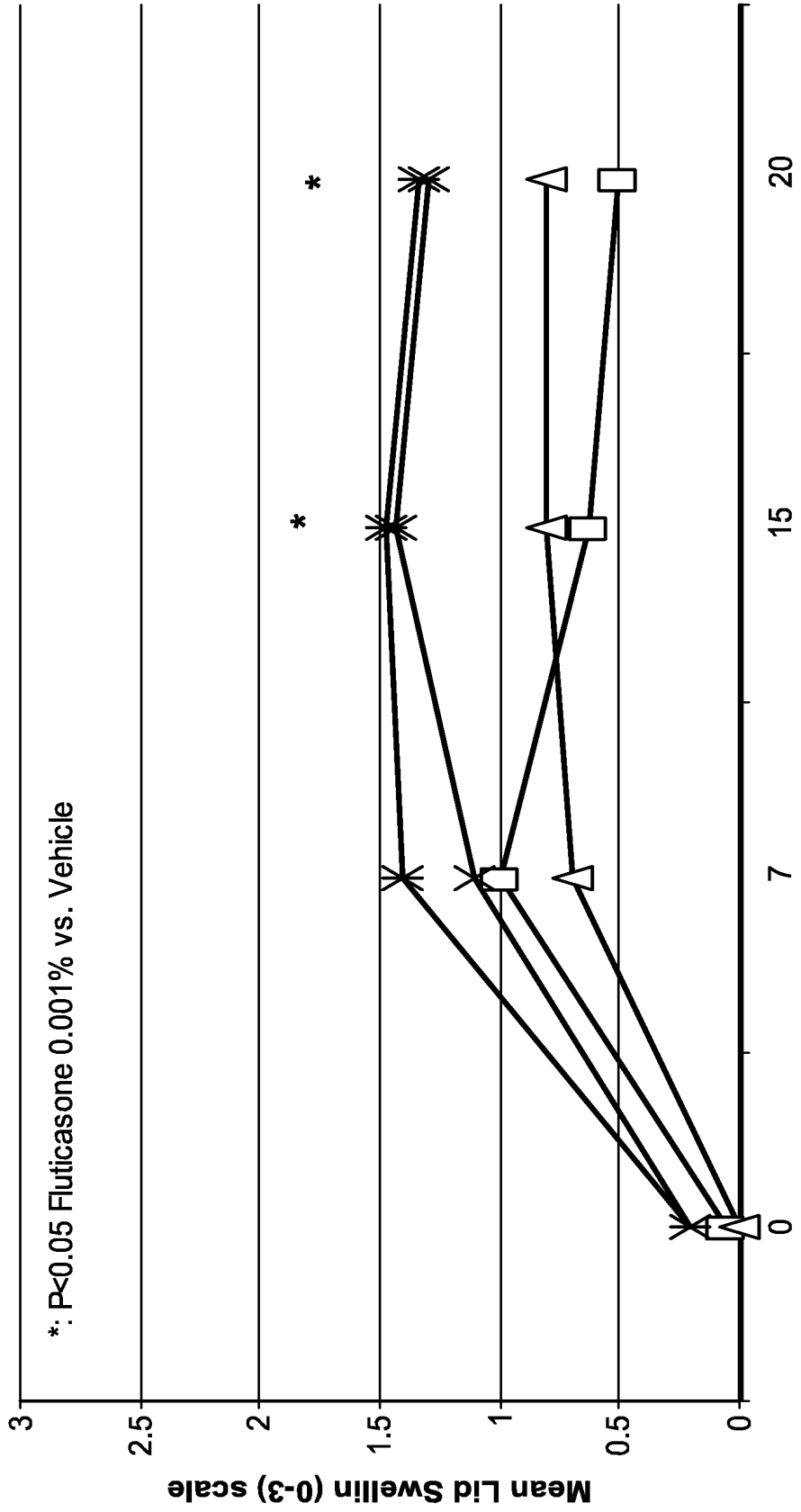

FIG. 6

9/31

Primary: Nasal Congestion (Visit 4B)

—□— FI 0.001% (N=16) —△— FI 0.005% (N=16) —*— FI 0.01% (N=15) —*— Vehicle (N=15)

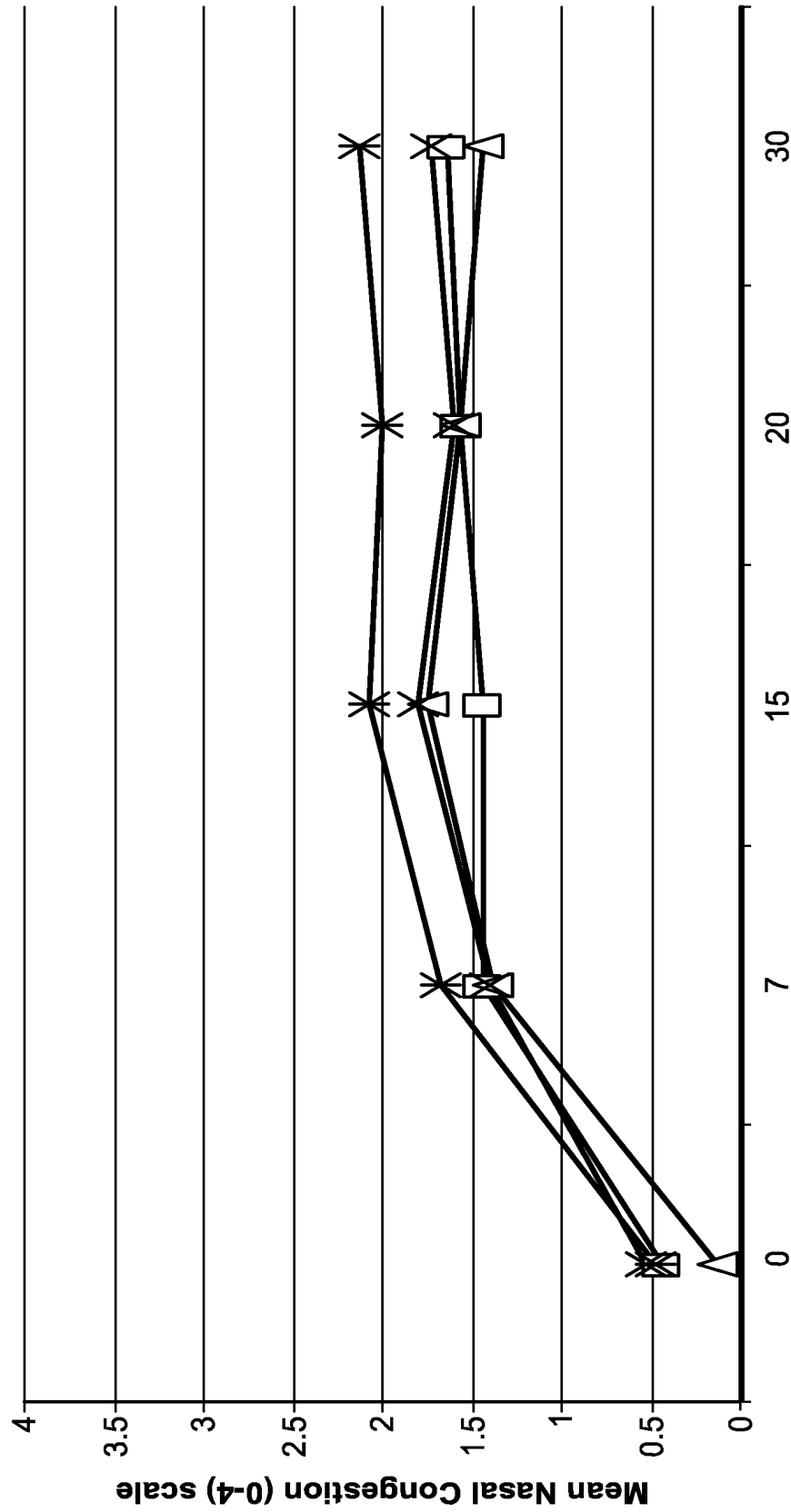

FIG. 7

10/31

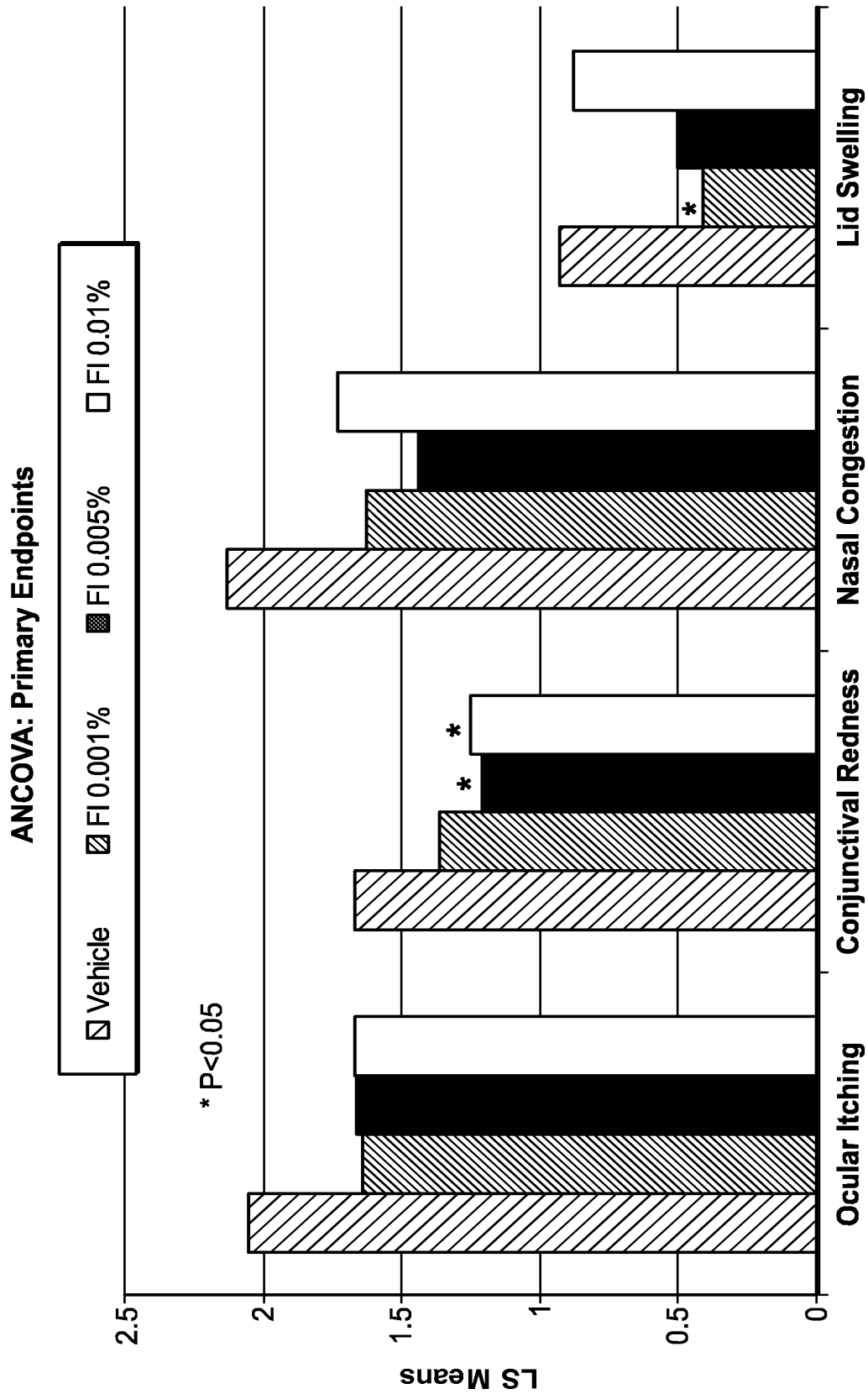

FIG. 8

11/31

Secondary: Ciliary Redness (Visit 4B)

—□— FI 0.001% (N=16) —△— FI 0.005% (N=16) —*— FI 0.01% (N=15) —*— Vehicle (N=15)

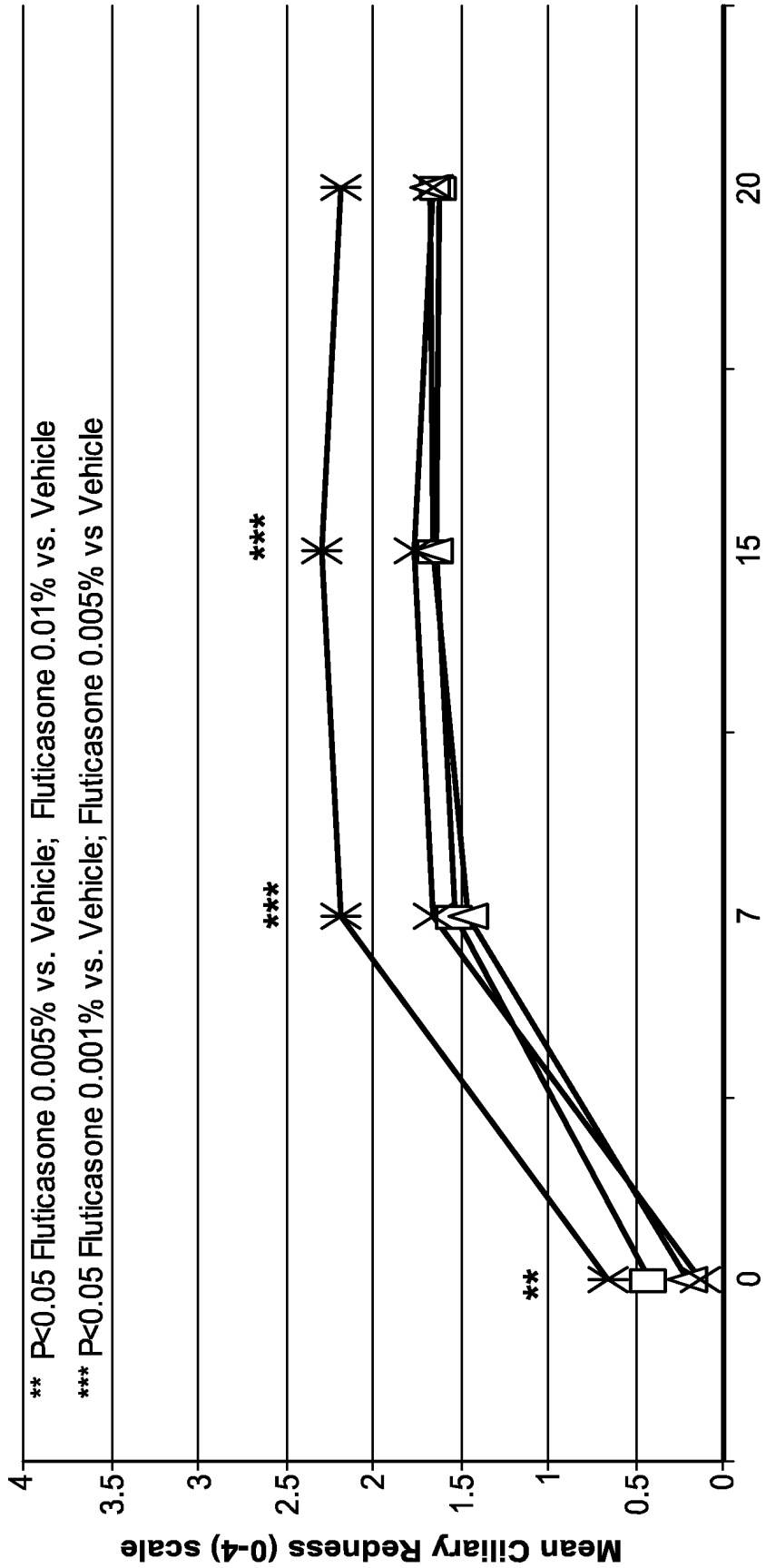

FIG. 9

12/31

Secondary: Episcleral Redness (Visit 4B)

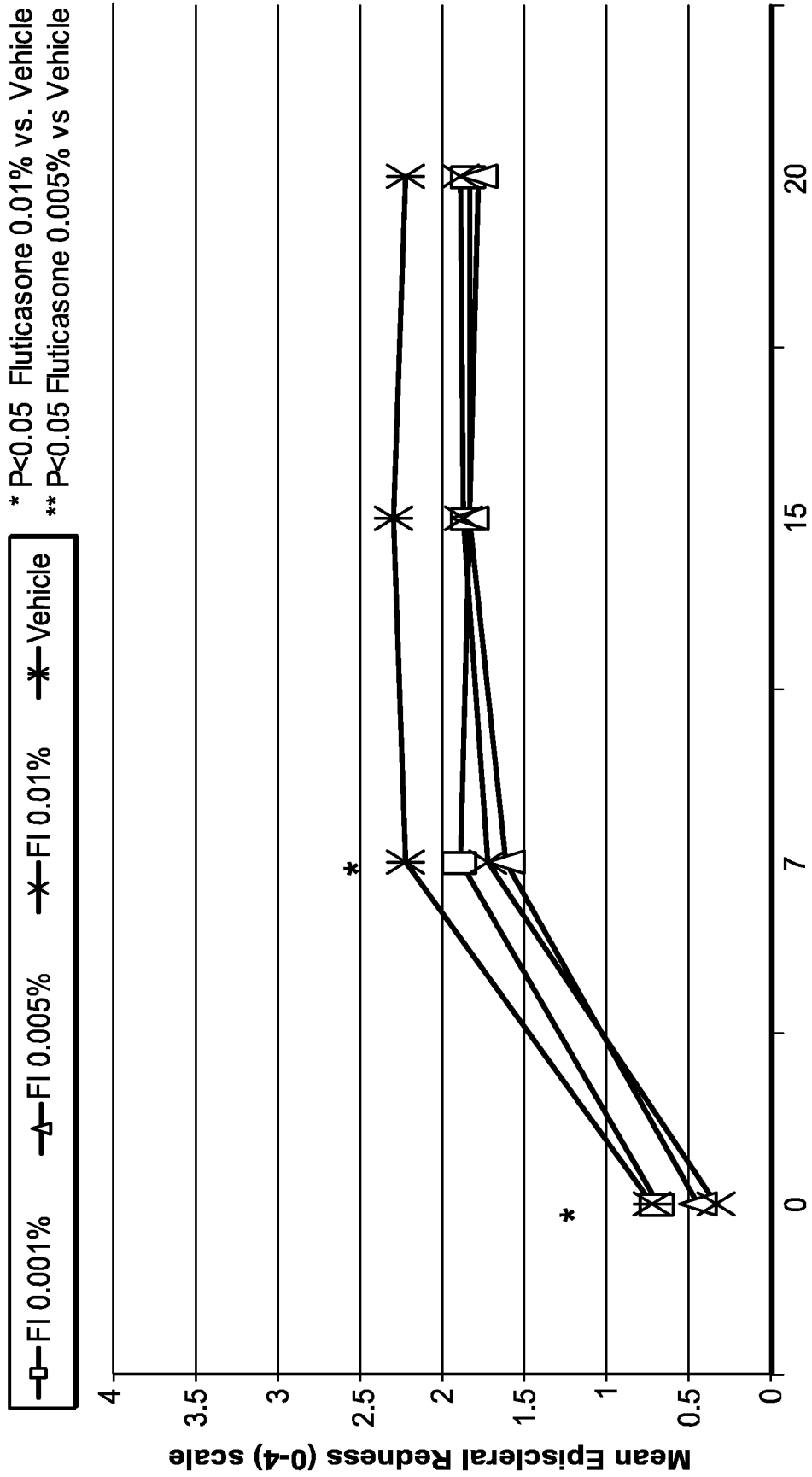

FIG. 10

Secondary: Chemosis (Visit 4B)

—□— FI 0.001% (N=16) —△— FI 0.005% (N=16) —✱— FI 0.01% (N=15) —✱— Vehicle (N=15)

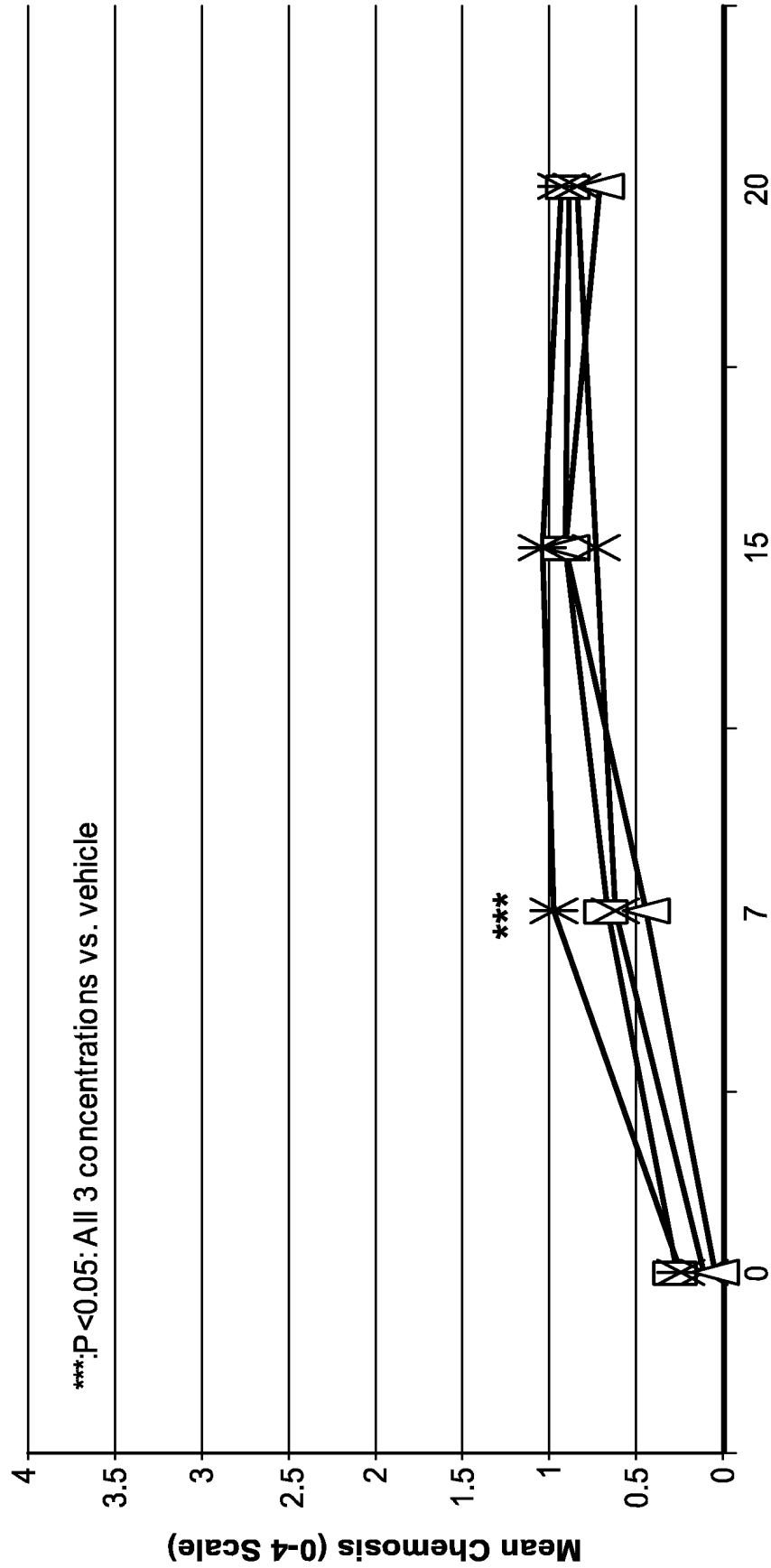

FIG. 11

Secondary: Watery Eyes (Visit 4B)

—□— FI 0.001% (N=16) —△— FI 0.005% (N=16) —×— FI 0.01% (N=15) —*— Vehicle (N=15)

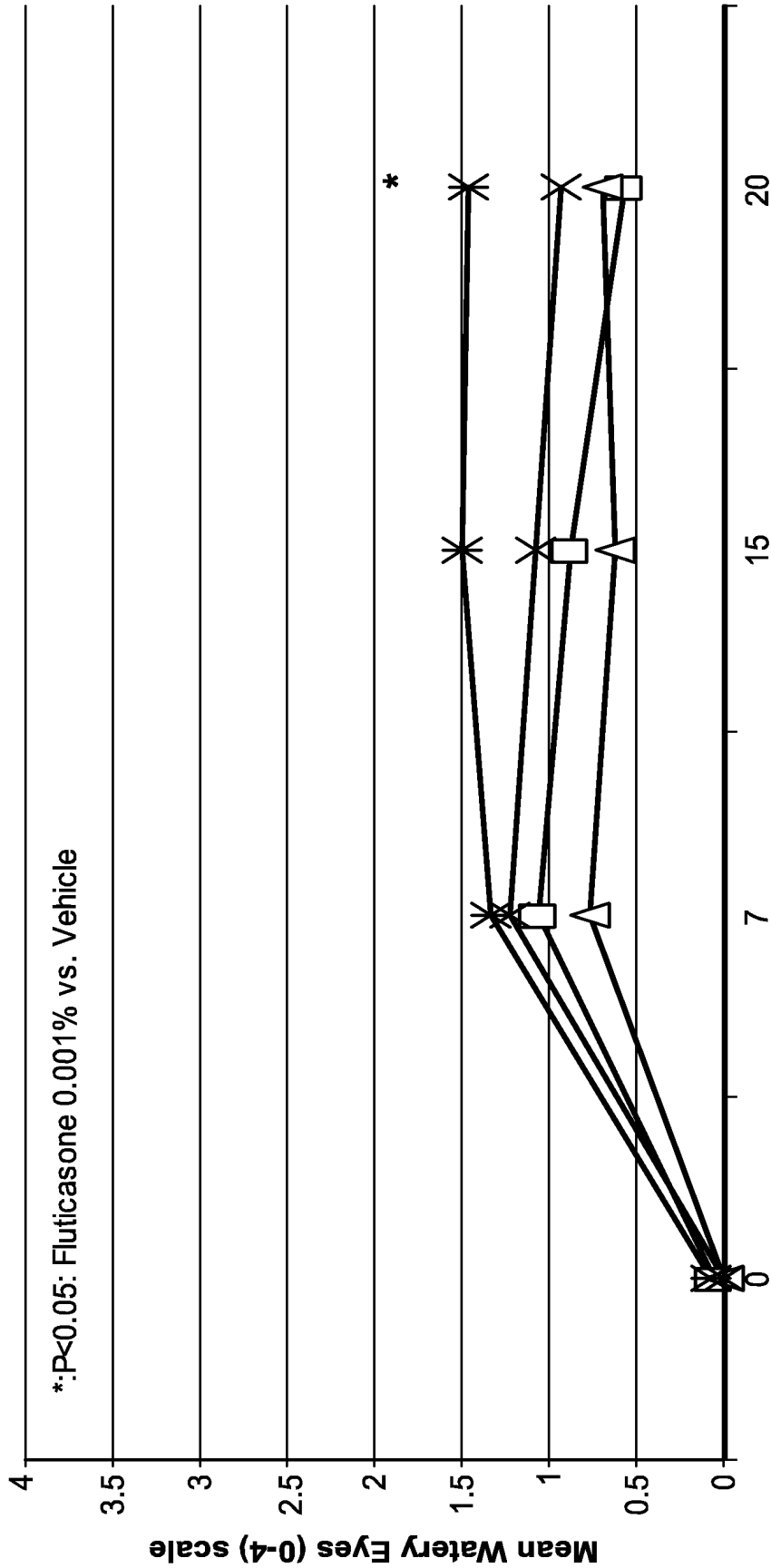
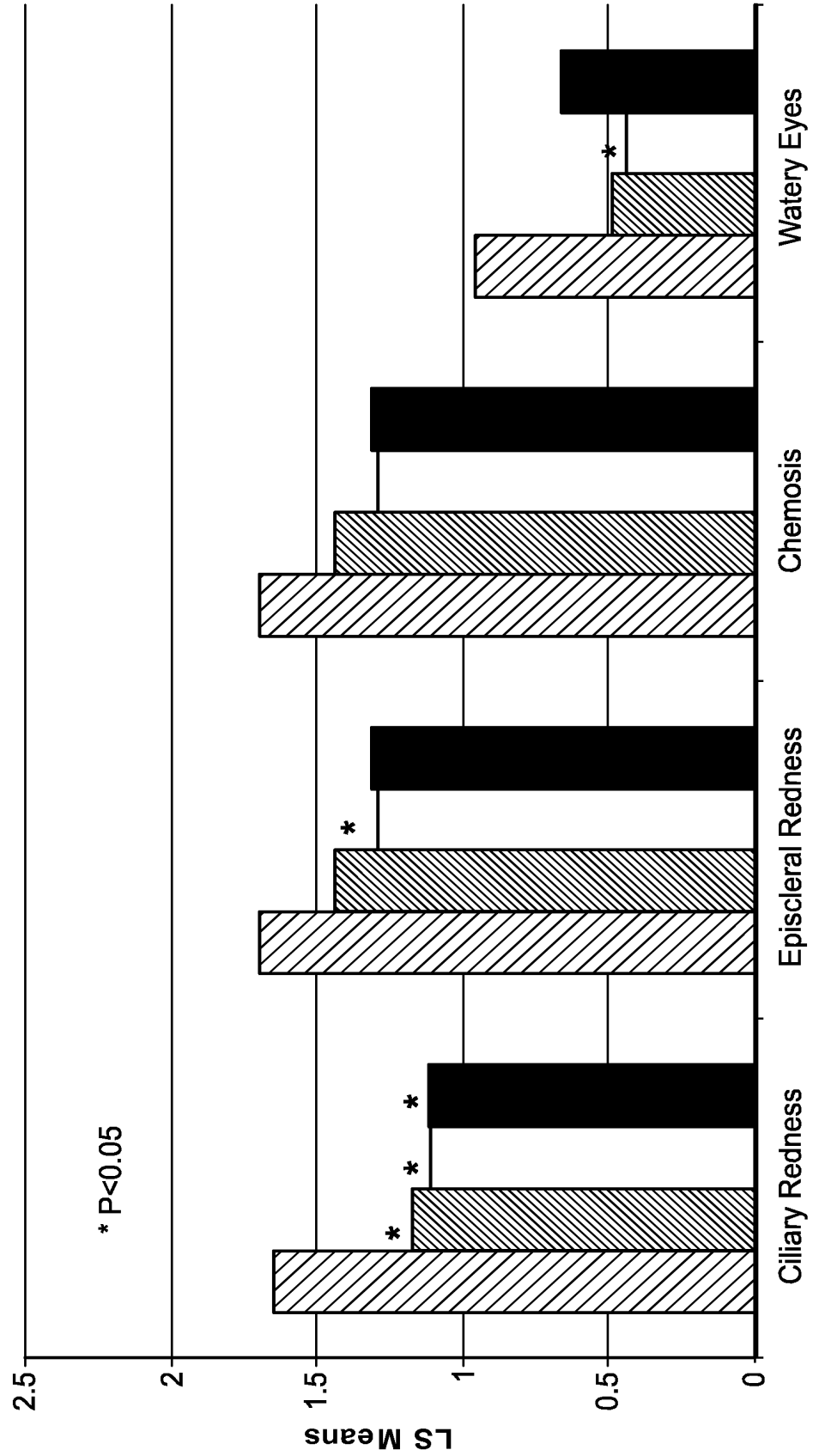

FIG. 12

ANCOVA Secondary Ocular Endpoints



* P<0.05

FIG. 13

Rhinorrhoea (Visit 4B)

—□— Fl 0.001% (N=16) —△— Fl 0.005% (N=16) —*— Fl 0.01% (N=15) —*— Vehicle (N=15)

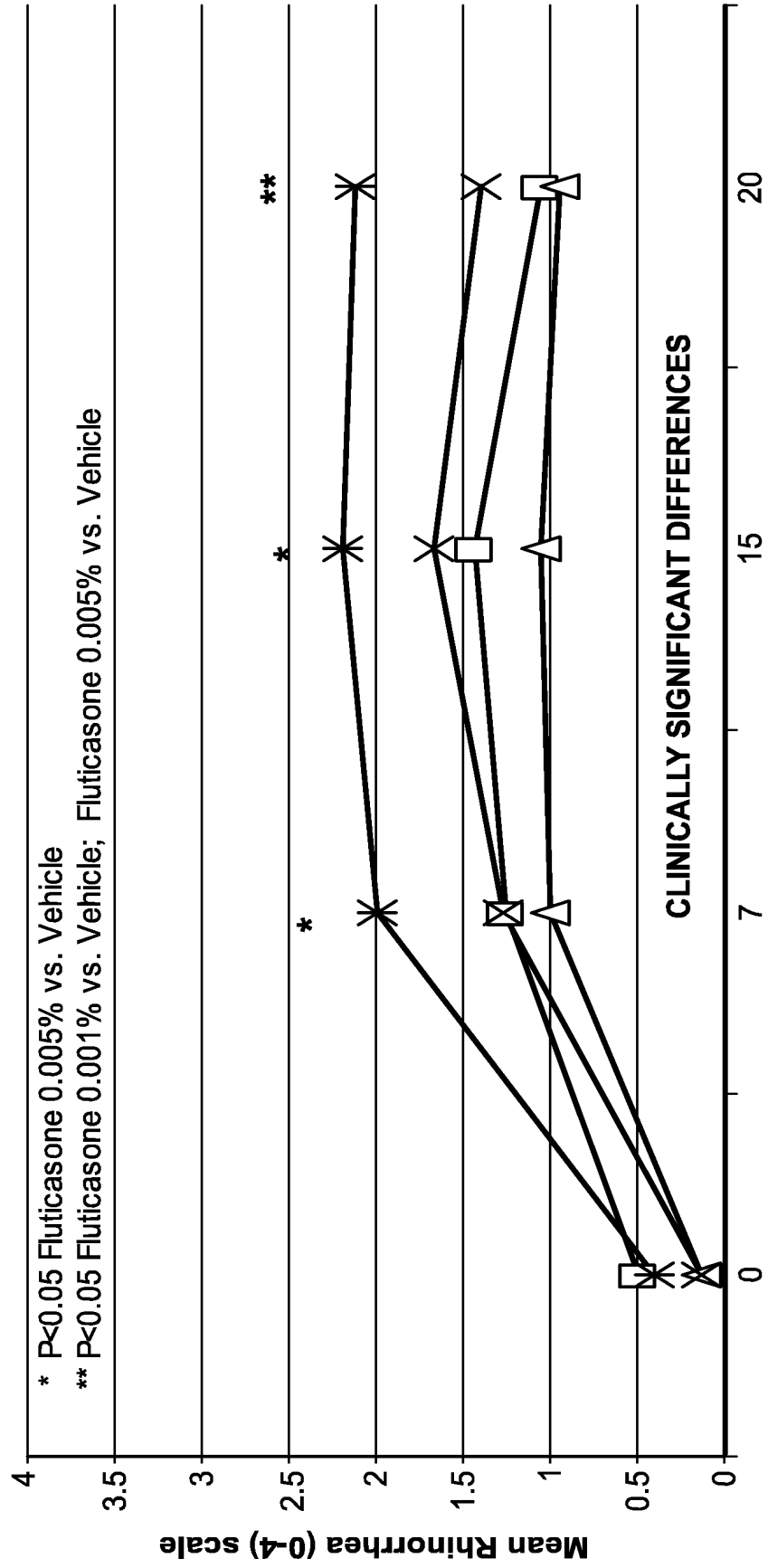

FIG. 14

17/31

Ear or Palate Pruritis (Visit 4B)

-□- FI 0.001% (N=16) -Δ- FI 0.005% (N=16) -✱- FI 0.01% (N=15) -✱- Vehicle (N=15)

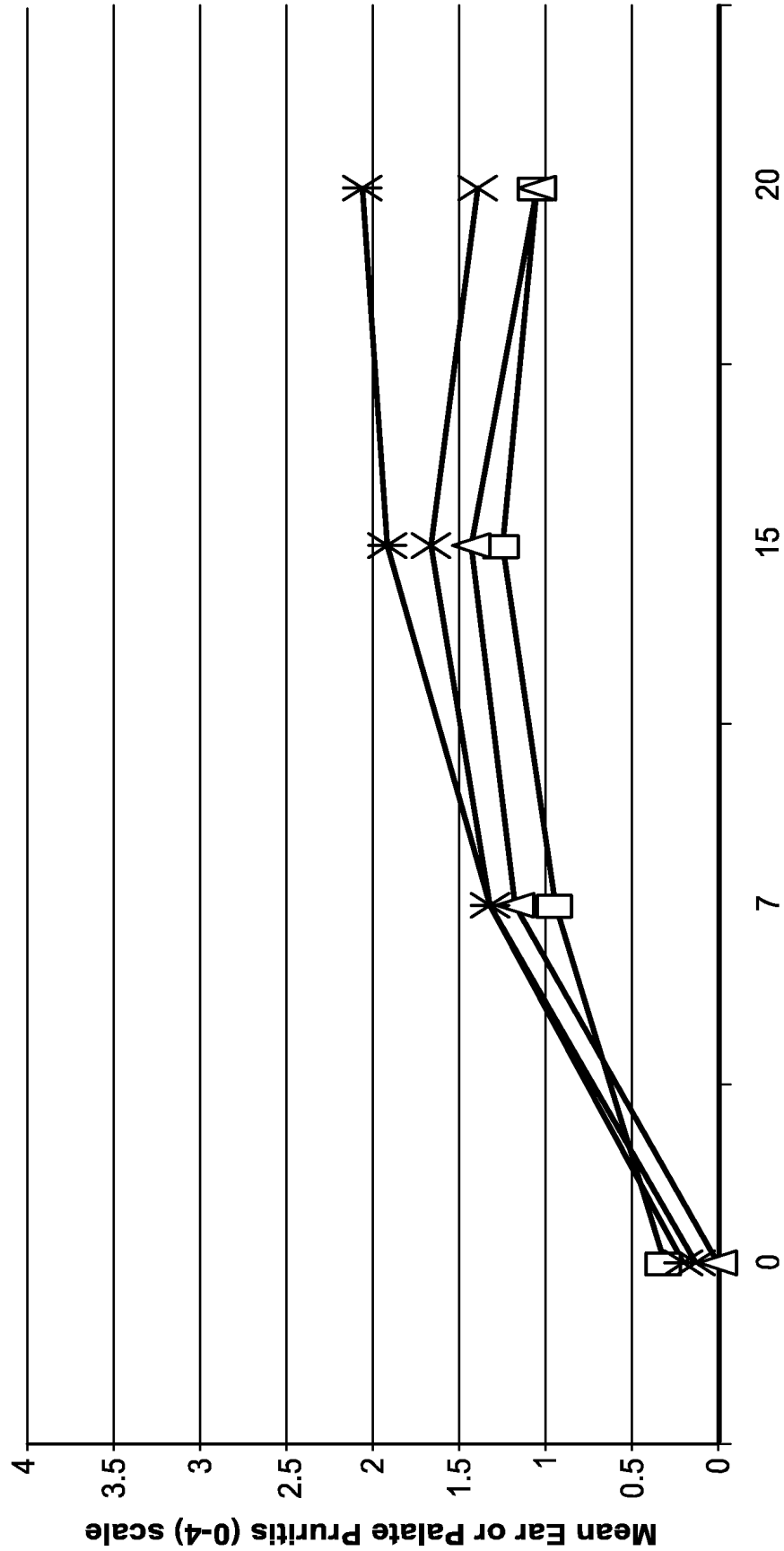
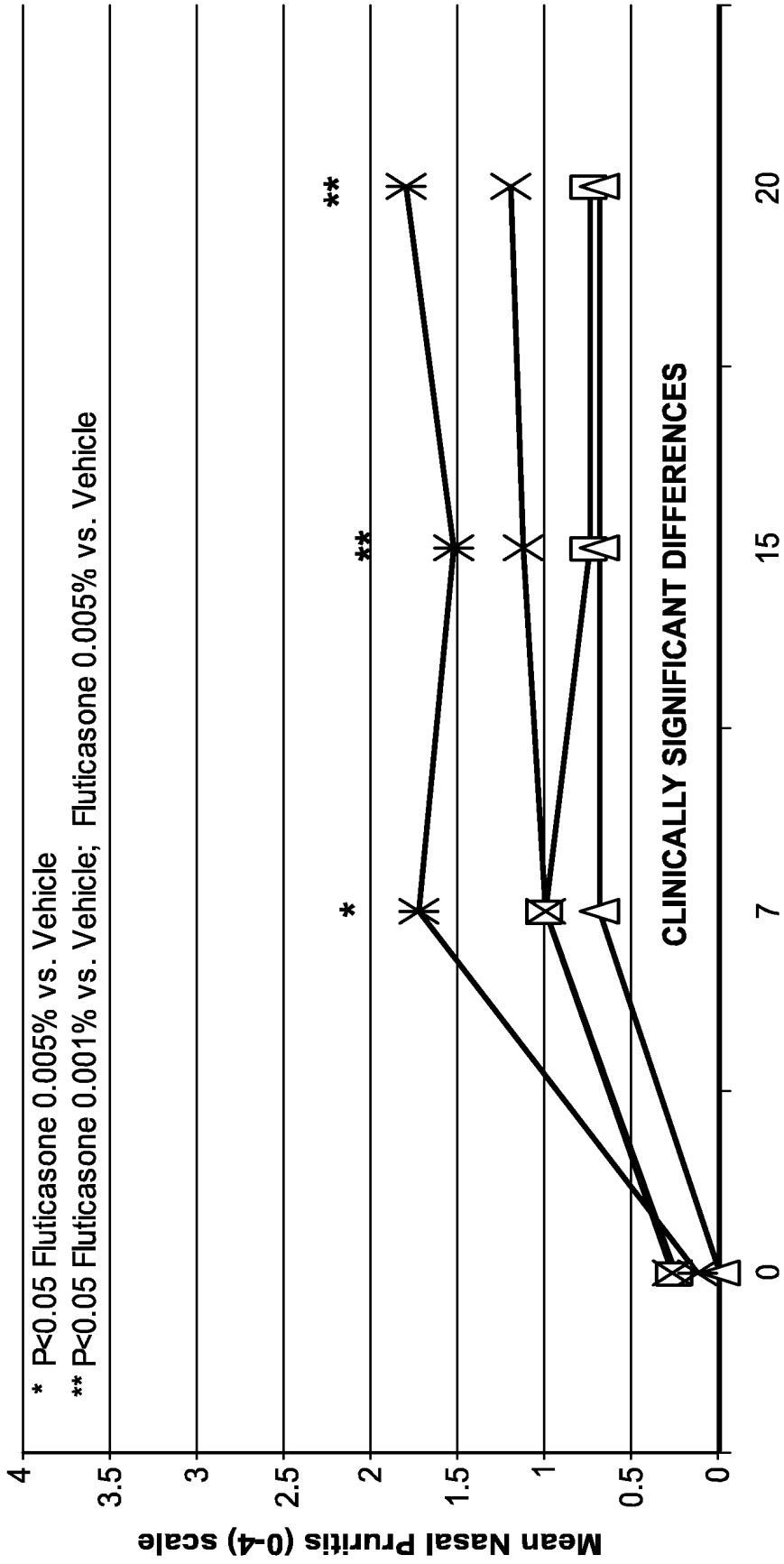

FIG. 15

Nasal Pruritis (Visit 4B)

—□— Fl 0.001% (N=16) —△— Fl 0.005% (N=16) —✕— Fl 0.01% (N=15) —✱— Vehicle (N=15)



* P<0.05 Fluticasone 0.005% vs. Vehicle

** P<0.05 Fluticasone 0.001% vs. Vehicle; Fluticasone 0.005% vs. Vehicle

CLINICALLY SIGNIFICANT DIFFERENCES

FIG. 16

Total Nasal Score (Visit 4B)

—□— FI 0.001% (N=16) —△— FI 0.005% (N=16) —×— FI 0.01% (N=15) —*— Vehicle (N=15)

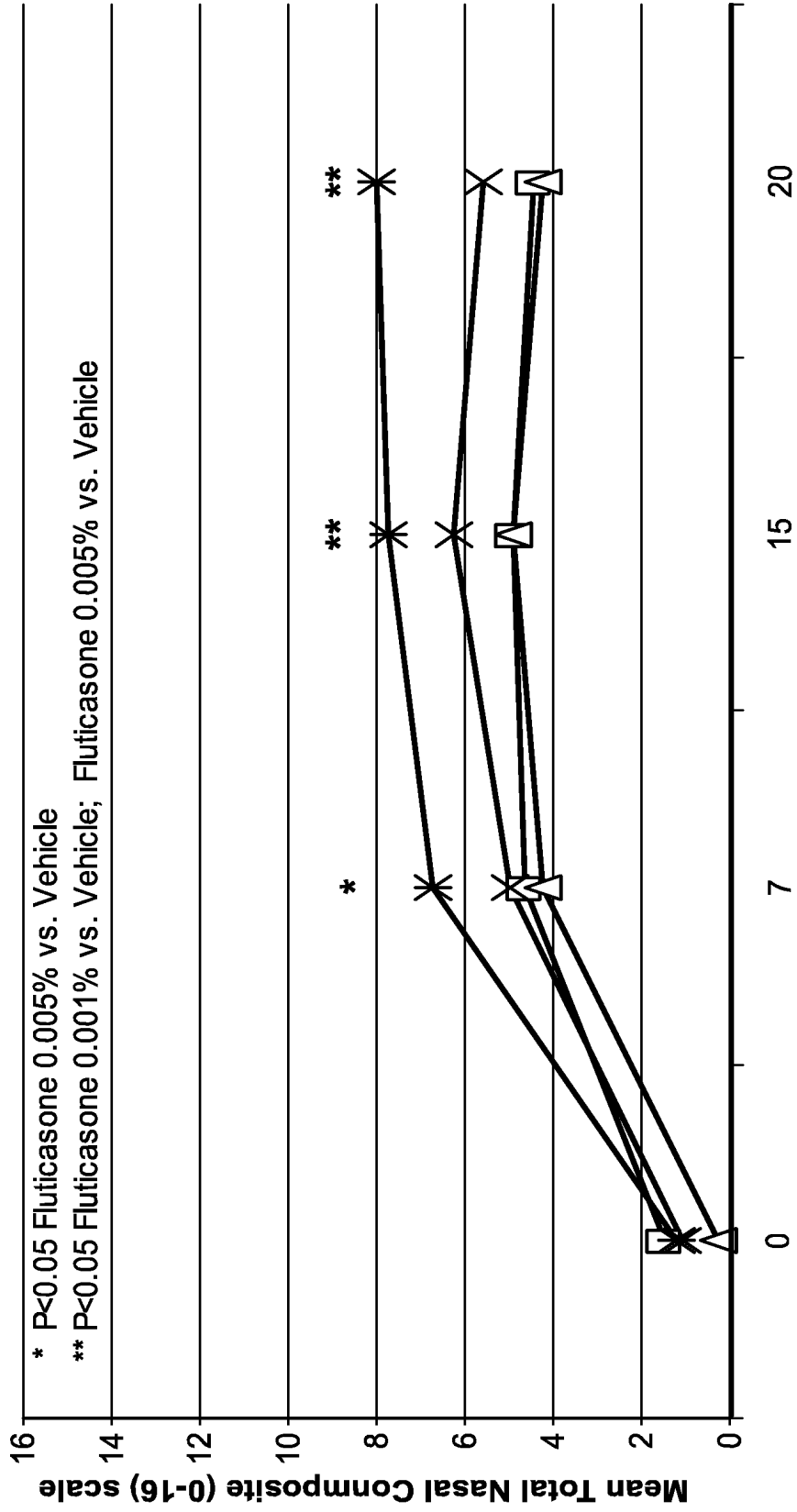

FIG. 17

20/31

ANCOVA Nasal

Vehicle (N=15) FI 0.001% (N=16) FI 0.005% (N=16) FI 0.01% (N=15)

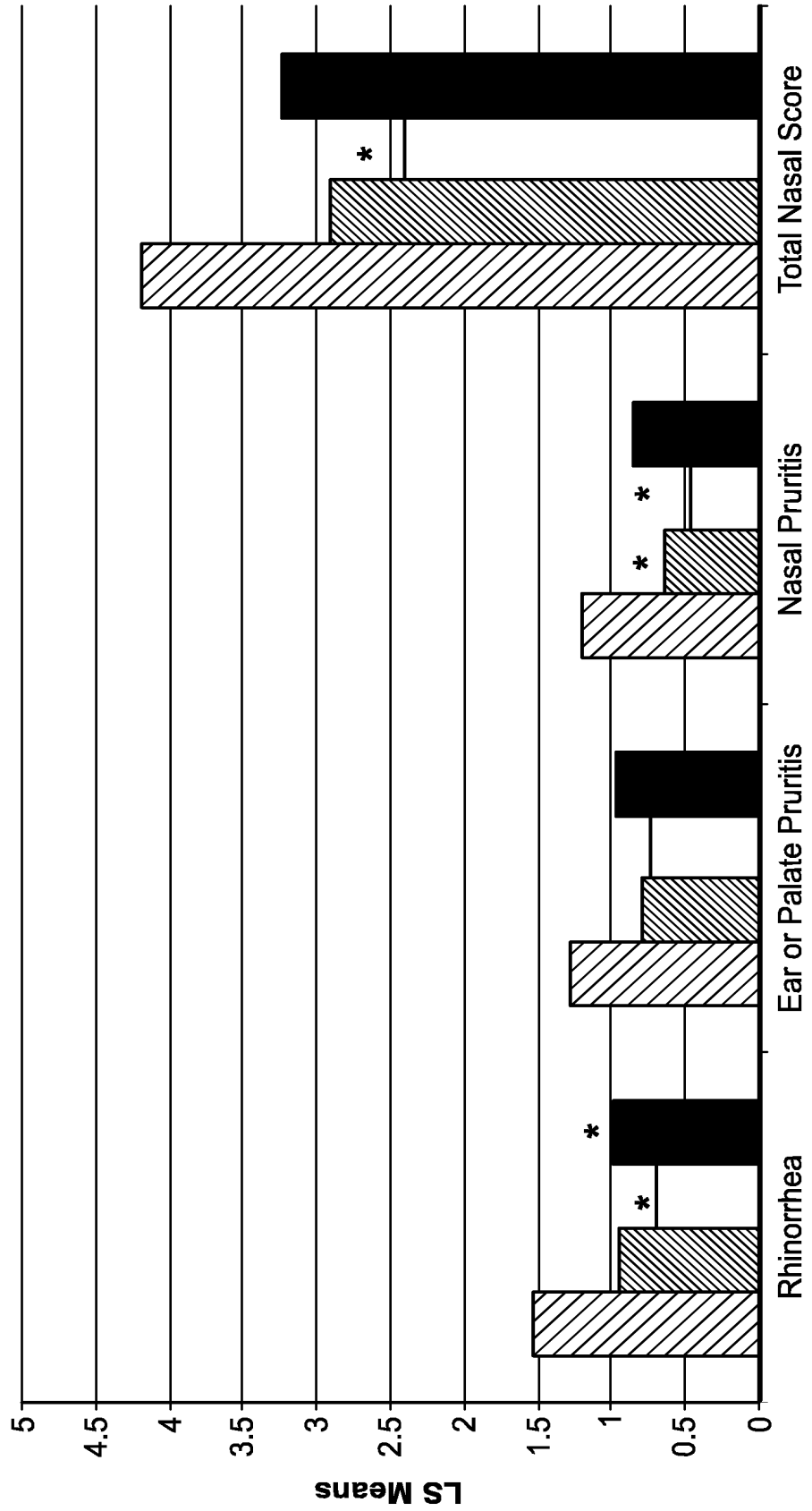

FIG. 18

Secondary: PNIF Visit 4B

—◇— FI 0.001% (N=16) —□— FI 0.005% (N=16) —△— FI 0.01% (N=15) —✕— Vehicle (N=15)

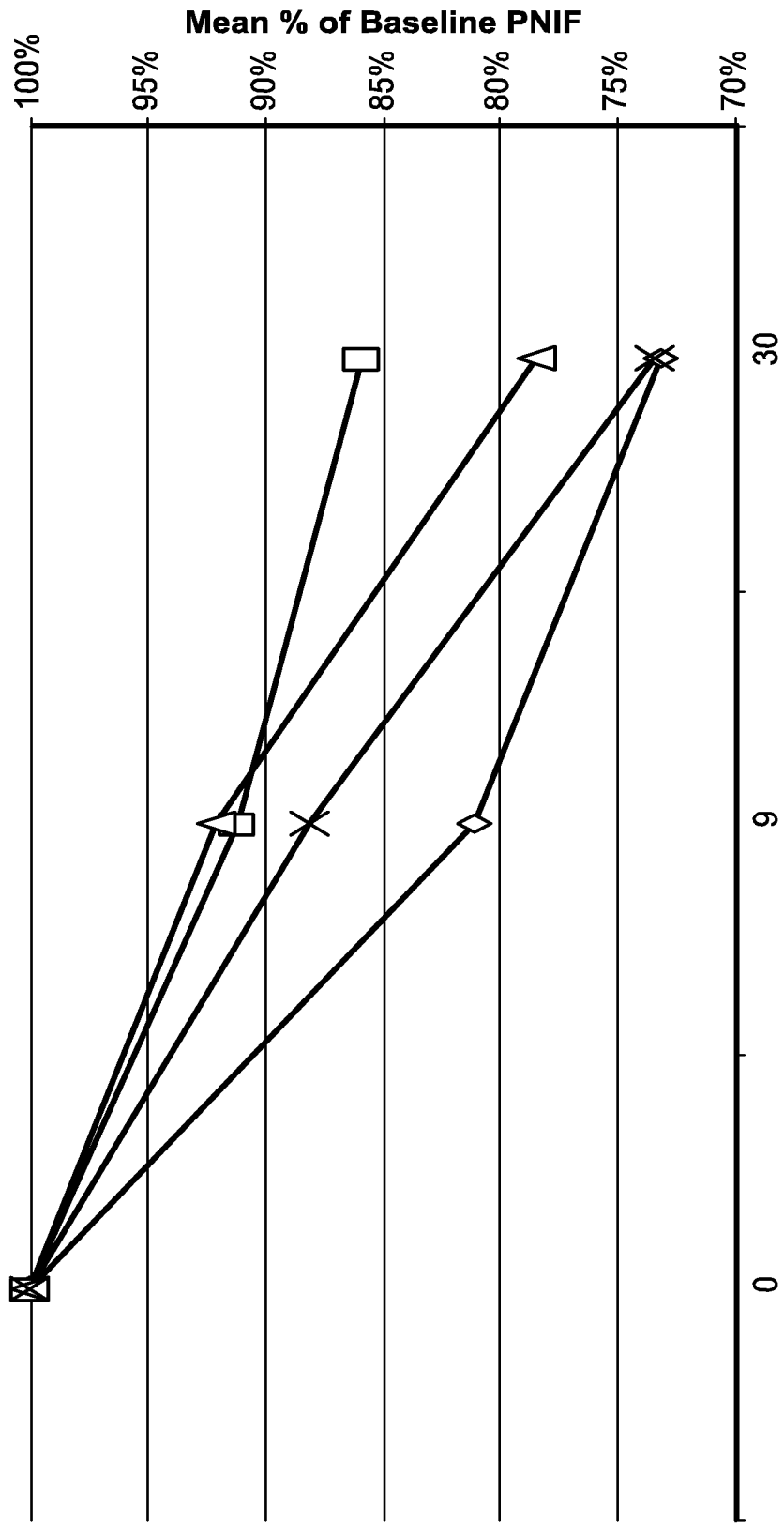

FIG. 19

Visit 2 Drop Comfort Score

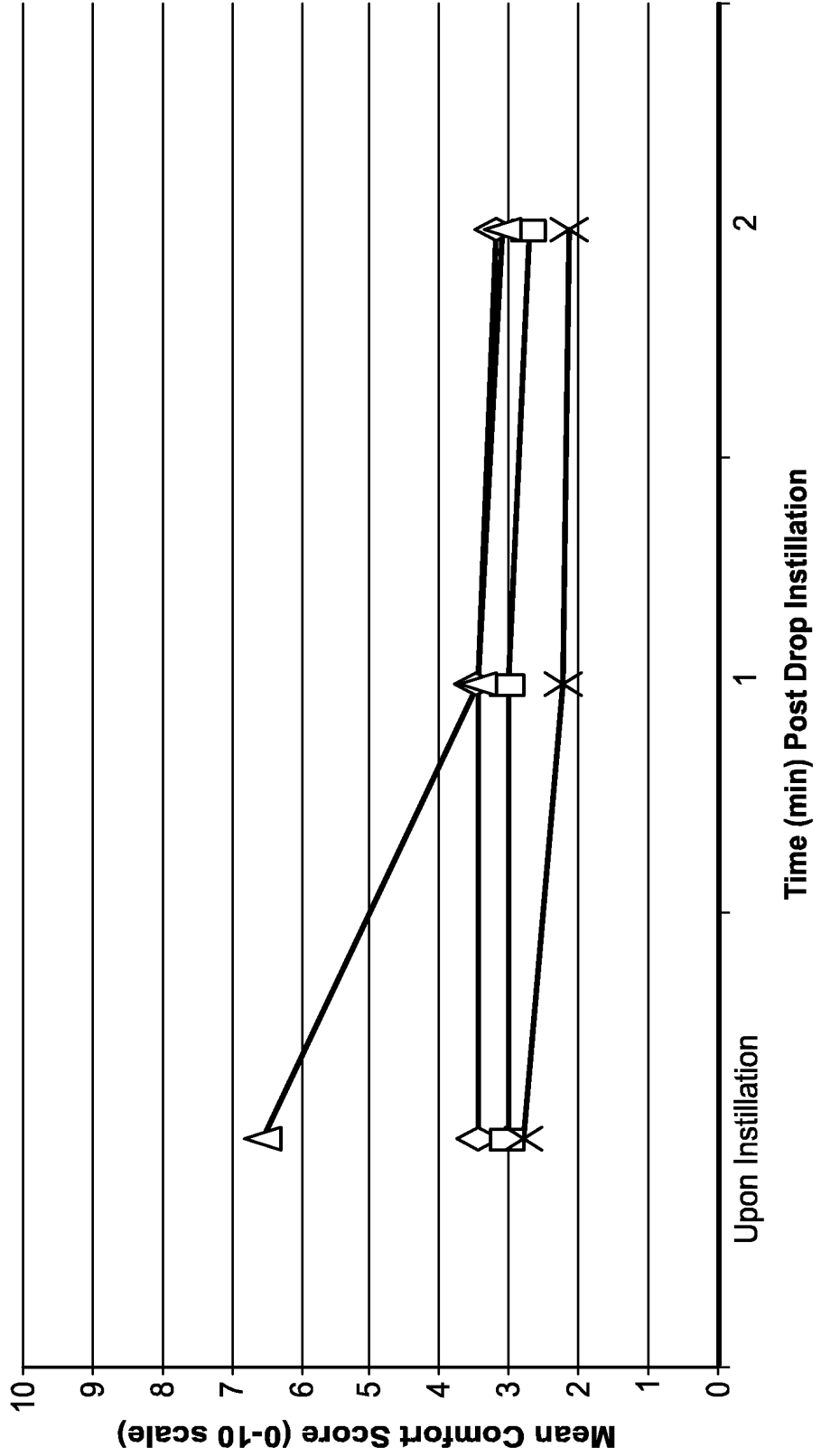
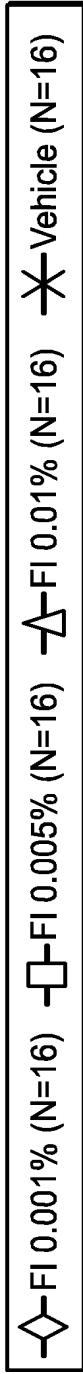

FIG. 20

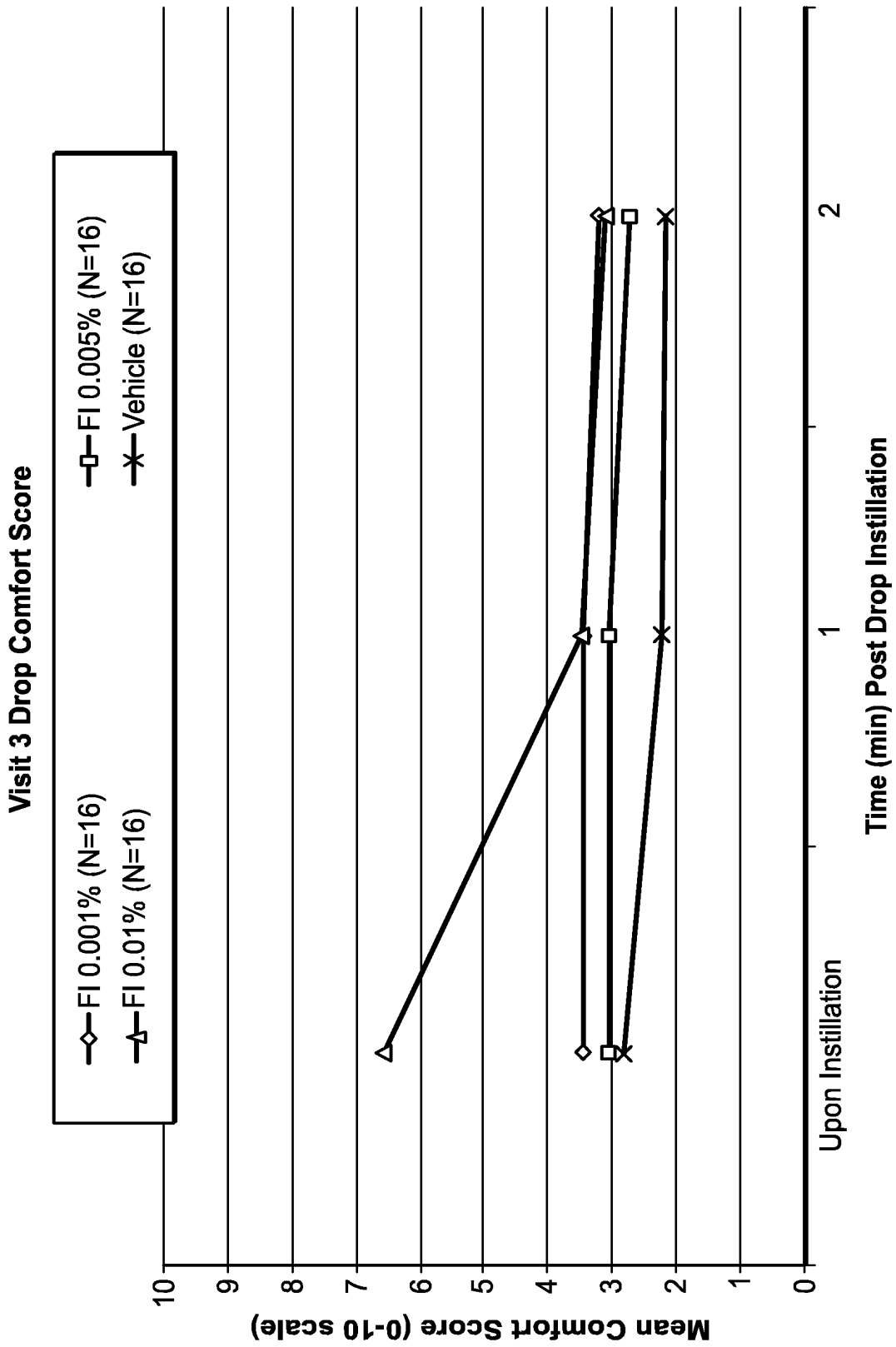

FIG. 21

24/31

SAFETY- ADVERSE EVENTS

- Fluticasone 0.001%- 1 Event- 6.3% of Subjects
 - Vision blurred
- Fluticasone 0.005%- 2 Events- 12.5% of Subjects
 - Conjunctival hemorrhage
 - Dry eye
- Fluticasone 0.01%- 5 Events- 18.8% of Subjects
 - 3 Instillation site pain
 - 1 Instillation site irritation
 - 1 Headache
- Vehicle- 1 Event- 6.3% of Subjects
 - 1 Gastroenteritis Viral

FIG. 22

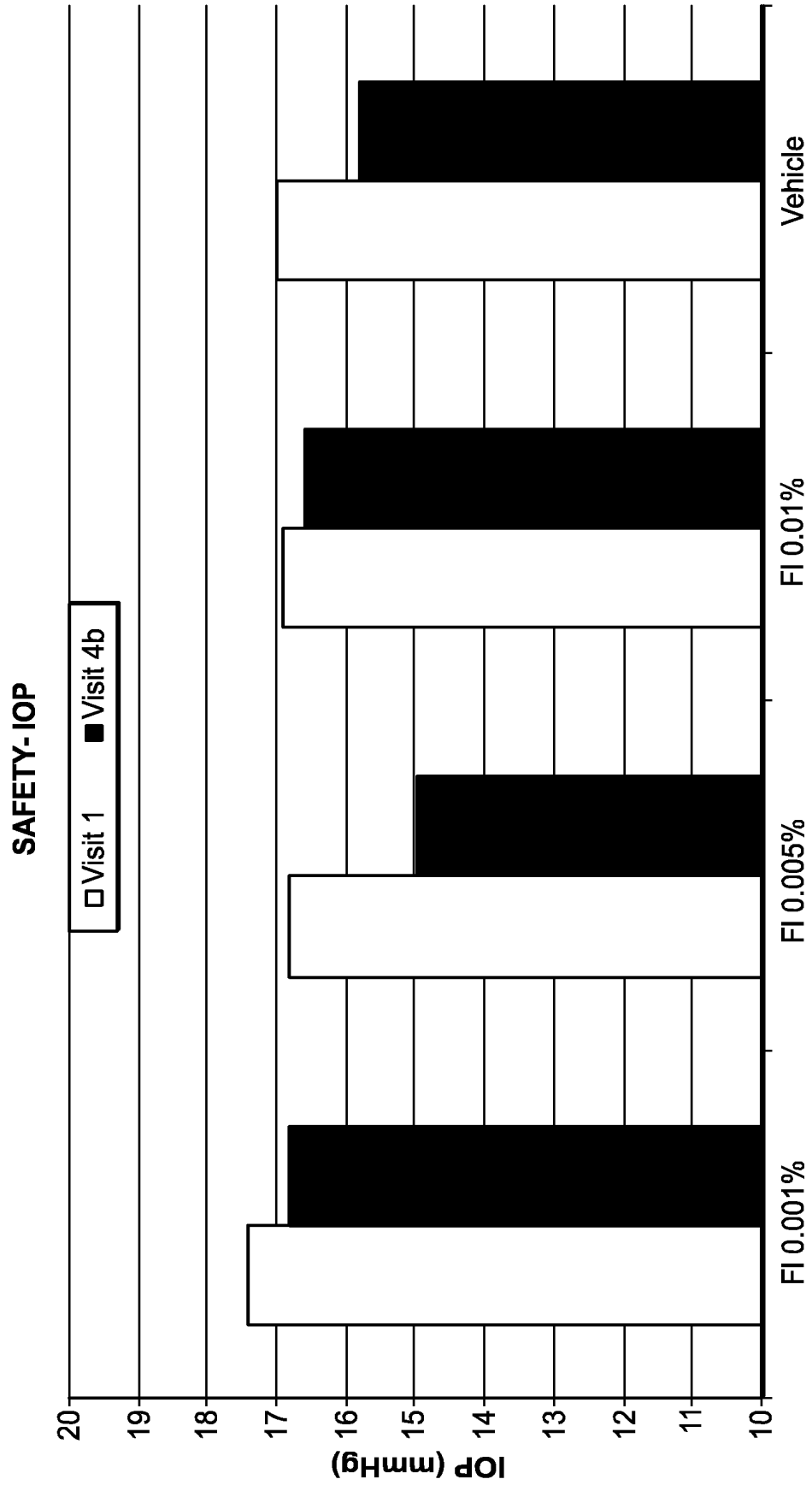

FIG. 23

- ▨ Conjunctival Hyperemia
- ▩ Chemosis
- Discharge
- Lid Swelling

Clinical Signs After 3 Days of Dosing

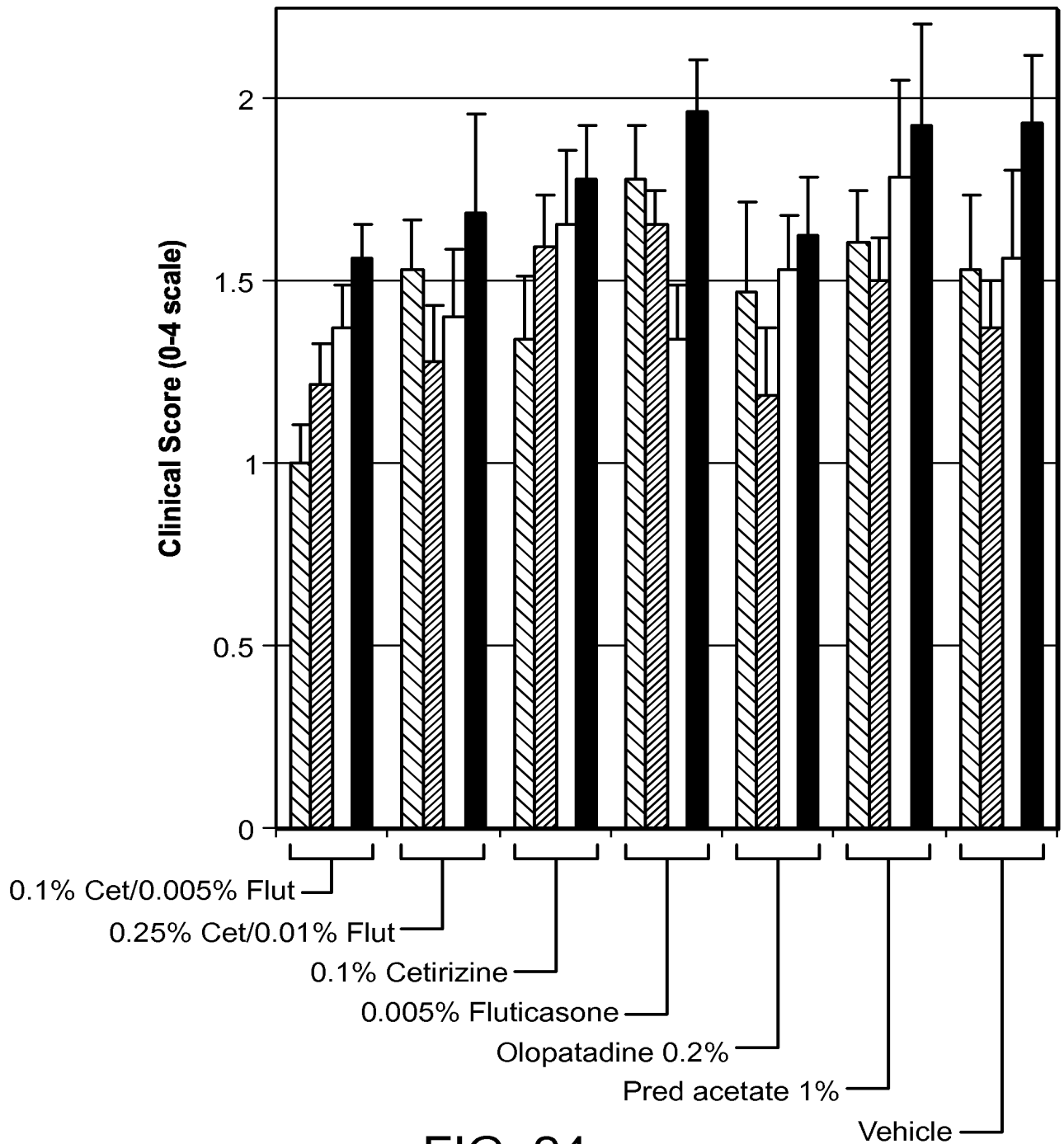

FIG. 24

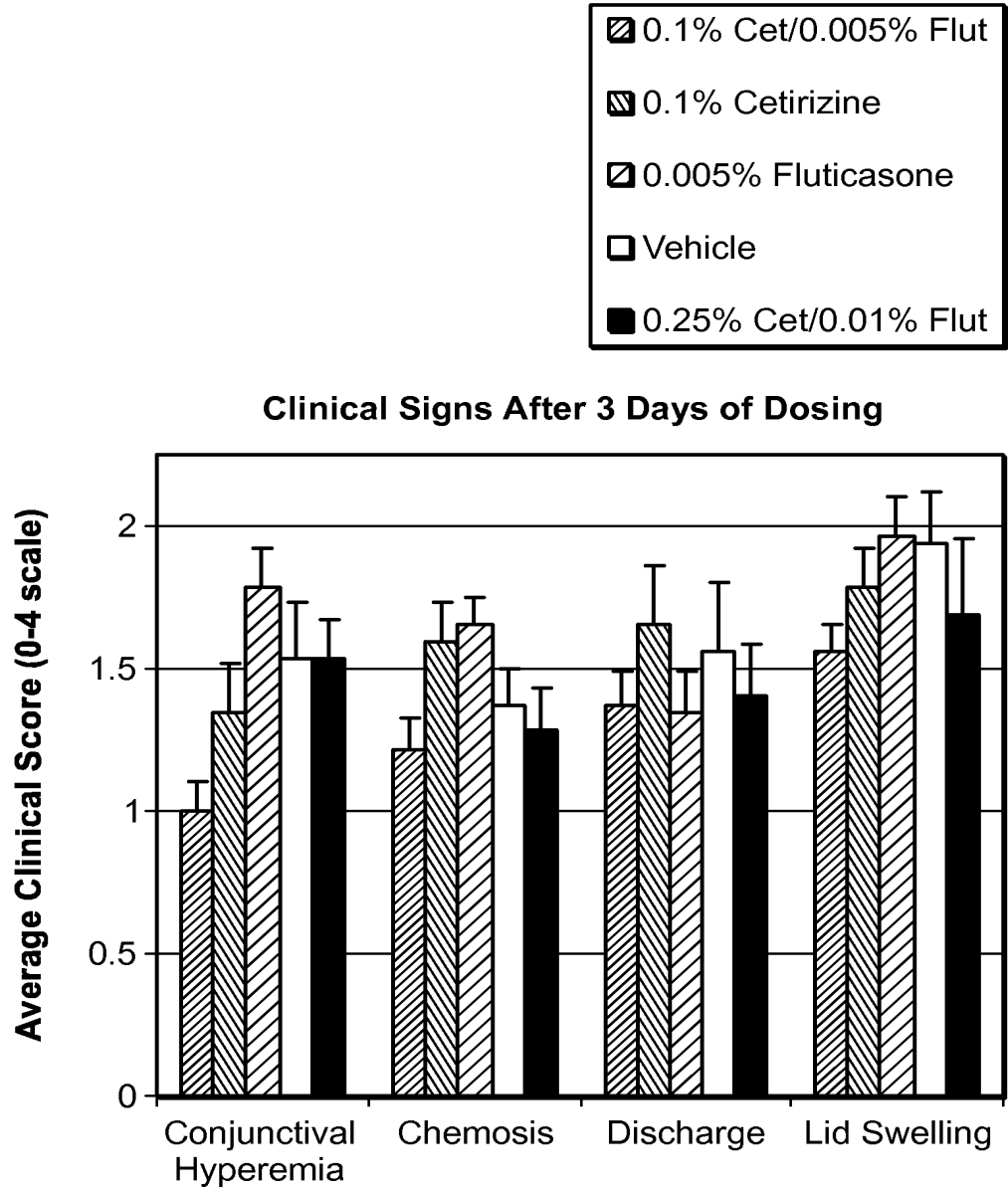

FIG. 25

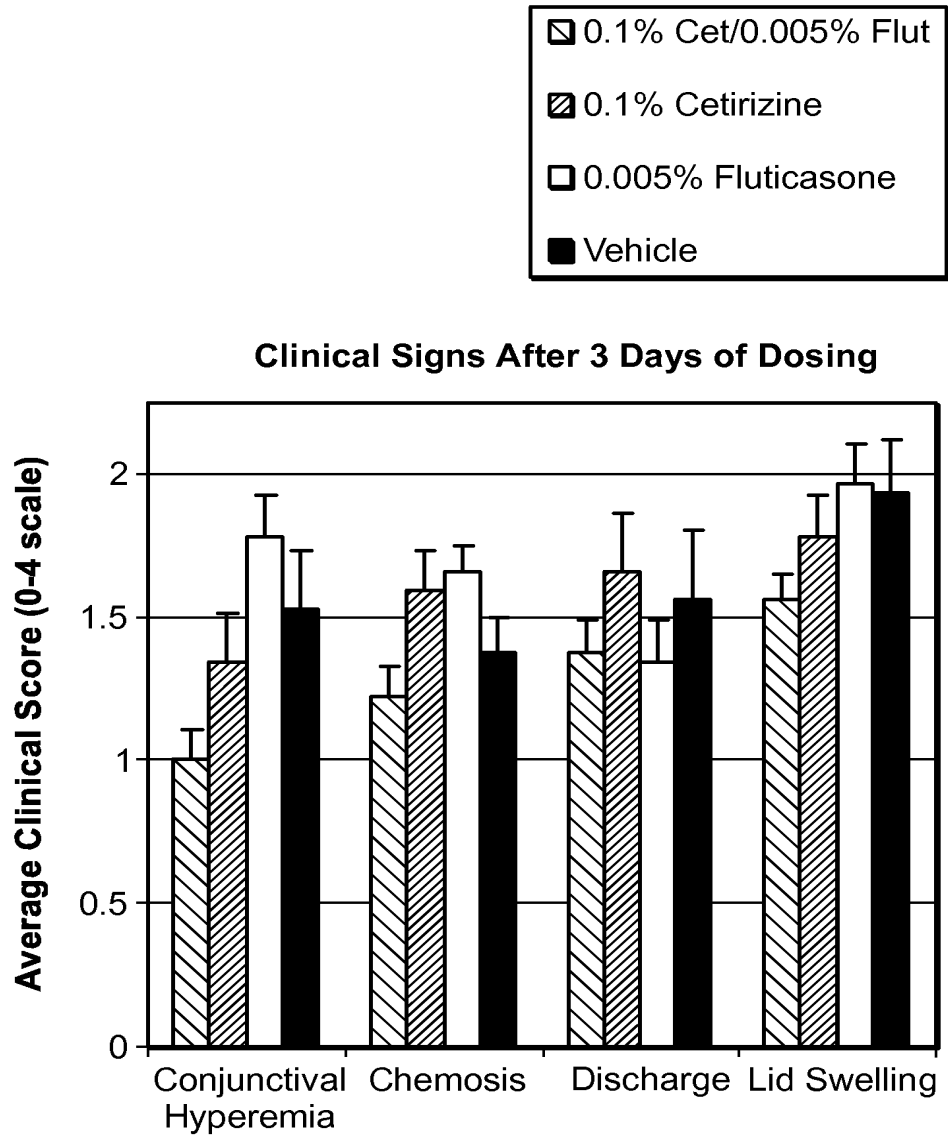

FIG. 26

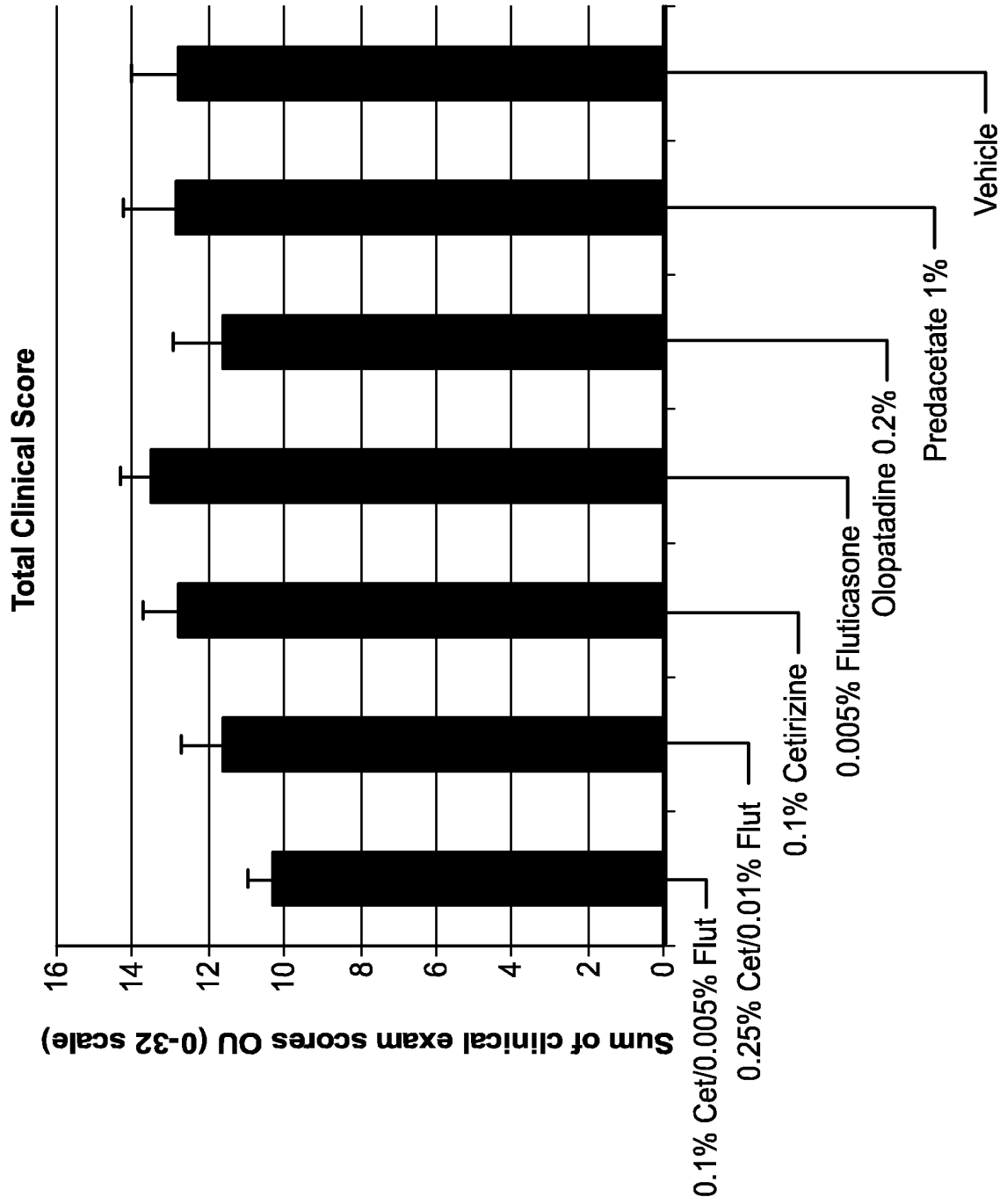

FIG. 27

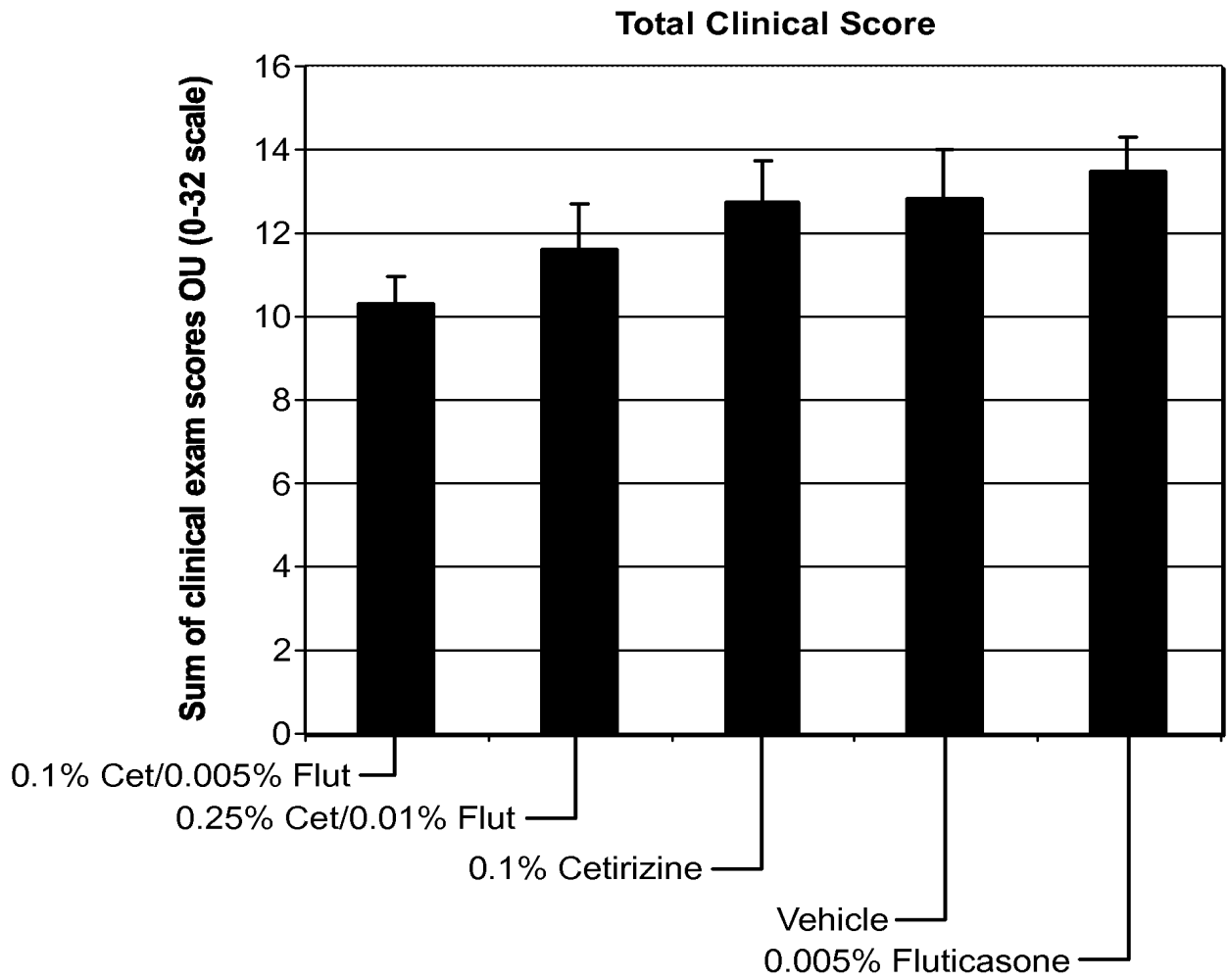

FIG. 28

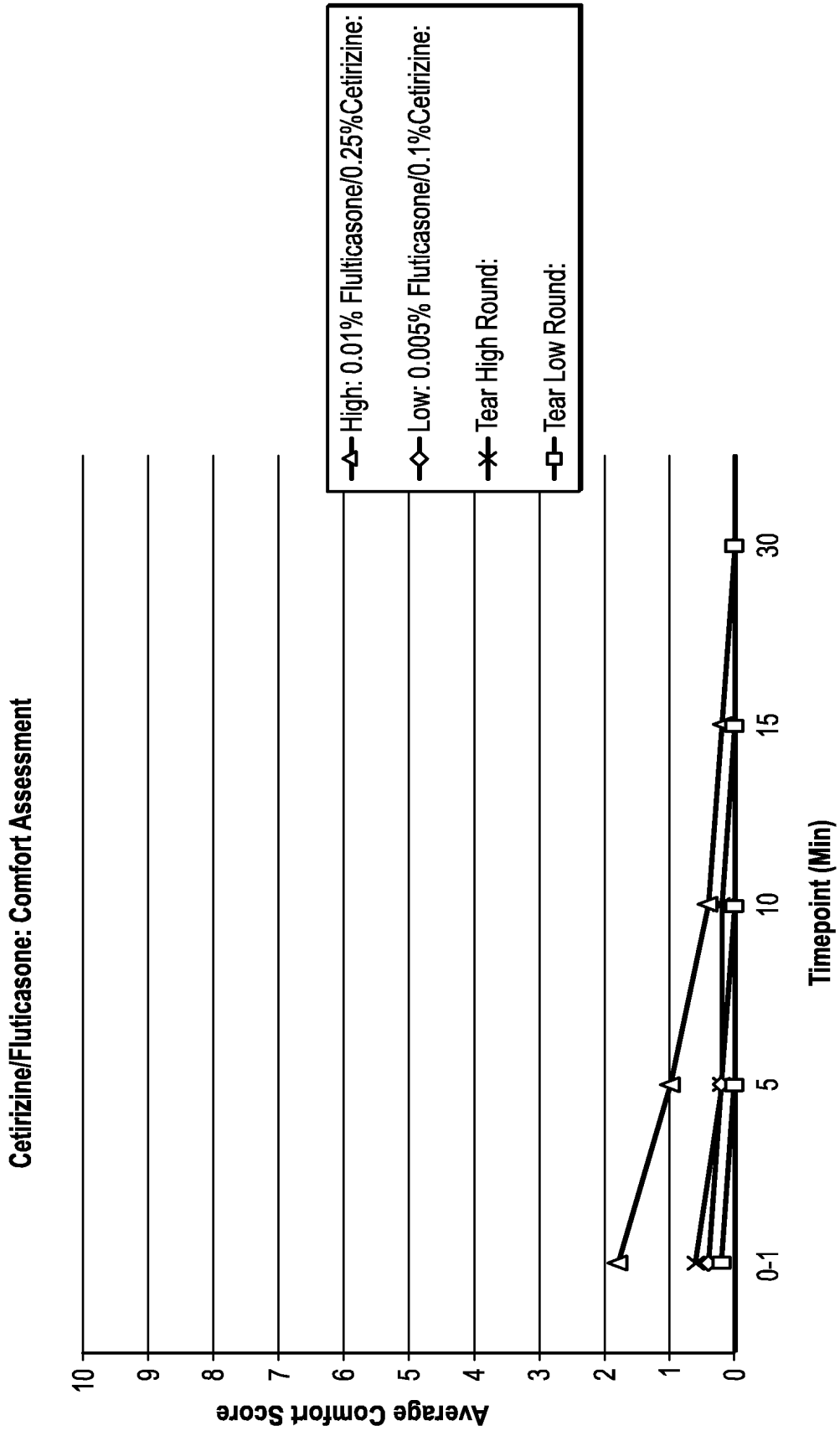

FIG. 29

INTERNATIONAL SEARCH REPORT

International application No.
PCT/US 10/27295

A. CLASSIFICATION OF SUBJECT MATTER
 IPC(8) - A61 K 31/4965 (201 0.01)
 USPC - 514/255.04
 According to International Patent Classification (IPC) or to both national classification and IPC

B. FIELDS SEARCHED
 Minimum documentation searched (classification system followed by classification symbols)
 USPC - 514/255.04

Documentation searched other than minimum documentation to the extent that such documents are included in the fields searched
 USPC - 424/78.15, 424/400; 521/32; 544/396; 510/201 (see search terms below)

Electronic data base consulted during the international search (name of data base and, where practicable, search terms used)
 PubWEST(USPT,PGPB,EPAB,JPAB); Google: ophthalmic; admixtures; eye; ocular; ceftriaxone; zyrtec; hydrochloride; dihydrochloride; glycerol; glycerine; glycerol; benzalkonium chloride; oxychloro complex; Hypromellose; Polysorbate 80; Dibasic Sodium Phosphate; Edetate Disodium; steroid; fluticasone; pH

C DOCUMENTS CONSIDERED TO BE RELEVANT

Category*	Citation of document, with indication, where appropriate, of the relevant passages	Relevant to claim No
X ----- Y	US 5,419,898 A (Ikejiri et al.) 30 May 1995 (30.05 1995) col 1, ln 31-47; col 2, ln 55-68; col 3, ln 25-28; col 3, ln 46 to col 4, ln 28; col 6, ln 17 to col 7, ln 13	1-9, 14-16, 18-19 ----- 10-13, 17, 20-23
Y	US 2007/0020330 A1 (Dang et al.) 25 January 2007 (25.01.2007) Abstract; para [0010], [0016], [0025], [0062]-[0063], [0088], [0090], [0092], [0116], [1199], [1209], [1275]	10-13, 17, 20-23
Y	US 2006/0183698 A1 (Abelson) 17 August 2006 (17.08.2006) Abstract; para [0004]-[0005], [0067]	17

D Further documents are listed in the continuation of Box C **D**

<ul style="list-style-type: none"> Special categories of cited documents <p>"A" document defining the general state of the art which is not considered to be of particular relevance</p> <p>"E" earlier application or patent but published on or after the international filing date</p> <p>"L" document which may throw doubts on priority claim(s) or which is cited to establish the publication date of another citation or other special reason (as specified)</p> <p>"O" document referring to an oral disclosure, use, exhibition or other means</p> <p>"P" document published prior to the international filing date but later than the priority date claimed</p>	<p>"T" later document published after the international filing date or priority date and not in conflict with the application but cited to understand the principle or theory underlying the invention</p> <p>"X" document of particular relevance, the claimed invention cannot be considered novel or cannot be considered to involve an inventive step when the document is taken alone</p> <p>"Y" document of particular relevance, the claimed invention cannot be considered to involve an inventive step when the document is combined with one or more other such documents, such combination being obvious to a person skilled in the art</p> <p>"&" document member of the same patent family</p>
---	---

Date of the actual completion of the international search 4 April 2010 (04.04.2010)	Date of mailing of the international search report 12 MAY 2010
--	--

Name and mailing address of the ISA/US Mail Stop PCT, Attn: ISA/US, Commissioner for Patents P.O. Box 1450, Alexandria, Virginia 22313-1450 Facsimile No. 571-273-3201	Authorized officer Lee W. Young PCT Helpdesk- 571-272-4300 PCT OSP 571-272-7774
---	--



Office de la Propriété
Intellectuelle
du Canada

Un organisme
d'Industrie Canada

Canadian
Intellectual Property
Office

An agency of
Industry Canada

CA 2391076 C 2008/06/17

(11)(21) **2 391 076**

(12) **BREVET CANADIEN
CANADIAN PATENT**

(13) **C**

(86) Date de dépôt PCT/PCT Filing Date: 2000/10/14

(87) Date publication PCT/PCT Publication Date: 2001/05/25

(45) Date de délivrance/Issue Date: 2008/06/17

(85) Entrée phase nationale/National Entry: 2002/05/10

(86) N° demande PCT/PCT Application No.: EP 2000/010122

(87) N° publication PCT/PCT Publication No.: 2001/035962

(30) Priorité/Priority: 1999/11/12 (DE199 54 516.2)

(51) Cl.Int./Int.Cl. *A61K 31/55* (2006.01),
A61K 9/08 (2006.01), *A61P 11/02* (2006.01),
A61P 37/08 (2006.01)

(72) Inventeurs/Inventors:
TRACH, VOLKER, DE;
DUSCHLER, GEROLD, DE

(73) Propriétaire/Owner:
BOEHRINGER INGELHEIM INTERNATIONAL GMBH,
DE

(74) Agent: FETHERSTONHAUGH & CO.

(54) Titre : SOLUTIONS CONTENANT DE L'EPINASTINE

(54) Title: SOLUTIONS CONTAINING EPINASTIN

(57) Abrégé/Abstract:

The invention relates to topically administered aqueous solutions containing epinastin, optionally in the form of its racemate or its enantiomers and optionally in the form of the pharmacologically acceptable acid addition salts thereof.



Abstract

The invention relates to topically administered aqueous solutions containing epinastin, optionally in the form of its racemate or its enantiomers and optionally in the form of the pharmacologically acceptable acid addition salts thereof.

5

71741J.202

Case 1/1112-Prio-Dr.Wy

BOEHRINGER INGELHEIM INTERNATIONAL GMBH

5 **Solutions containing epinastin**

10 The invention relates to topically administered aqueous solutions containing epinastin, optionally in the form of its racemates, its enantiomers and optionally in the form of the pharmacologically acceptable acid addition salts thereof.

Background of the Invention

15 Allergic reactions of the eye (hereinafter referred to as ocular allergic reactions) signifies a series of differently defined syndromes. The following are examples of ocular allergic reactions, e.g.: seasonal allergic conjunctivitis, perennial allergic conjunctivitis, giant cell conjunctivitis, vernal keratoconjunctivitis or atopic keratoconjunctivitis. Examples of allergic reactions of the nose (hereinafter referred to as nasal allergic reactions) include seasonal allergic rhinitis and perennial allergic rhinitis, for example.

25 The immunological mechanism on which ocular and nasal allergic reactions are based comprises *inter alia* inflammatory processes caused by histamine. The allergic reactions produced by the release of histamine occur at an early stage of the ocular and nasal allergic reactions mentioned above.

30 Moreover, ocular and nasal allergic reactions may be due to the release of other mast cell mediators as well as toxic eosinophilic granule proteins and enzymes. The influx of neutrophils and eosinophils into the tissue of the ocular conjunctiva and the nasal mucous membrane leads to a late phase reaction, hereinafter referred to as LPR.

35

25771-736

- 2 -

LPR normally occurs within a period of 3-6 hours after the initial histamine-mediated allergic reaction. LPR is also characterised by the occurrence of vasodilation and chemosis and by the swelling of the conjunctiva and the nasal mucous
5 membrane.

Whereas histamine-produced allergic reactions can be counteracted by administering antihistamines, the influx of neutrophils and eosinophils into the tissue of the ocular conjunctiva and the nasal mucous membrane remains unaffected
10 by administering pure antihistamines.

Problem of the Invention

The problem of the present invention is therefore to provide topically administerable solutions which inhibit the influx of neutrophils and eosinophils into the tissue of
15 the ocular conjunctiva and the nasal mucous membrane, thereby reducing or preventing the occurrence of LPR and are therefore characterised by a longer lasting duration of activity.

According to one aspect of the present invention,
20 there is provided use of a solution consisting of:
a) epinastine, an enantiomer thereof, a racemate of the enantiomers thereof, or a pharmacologically acceptable acid addition salt thereof, in a concentration of
0.0005 to 0.1 wt.%; b) water or a physiological saline
25 solution as solvent; c) a buffer for adjusting the pH to a value from 6.5 to 7.2; and d) a preservative, in preparing a medicament for topical application to conjunctiva or nasal mucosa for treating late phase reaction in allergic rhinitis or conjunctivitis.

30 According to another aspect of the present invention, there is provided use of a solution consisting

25771-736

- 2a -

of: a) epinastine, an enantiomer thereof, a racemate of the enantiomers thereof, or a pharmacologically acceptable acid addition salt thereof, in a concentration of 0.0005 to 0.1 wt.%; b) water or a physiological saline solution as solvent; c) a buffer for adjusting the pH to a value from 6.5 to 7.2; and d) a preservative; and e) one or more components selected from the group consisting of: chelating agents, viscosity agents penetration promoters, antioxidants, and physiologically acceptable agents for adjusting the tonicity of the solution, in preparing a medicament for topical application to conjunctiva or nasal mucosa for treating late phase reaction in allergic rhinitis or conjunctivitis.

According to still another aspect of the present invention, there is provided use of a solution consisting of: a) epinastine, an enantiomer thereof, a racemate of the enantiomers thereof, or a pharmacologically acceptable acid addition salt thereof, in a concentration of 0.0005 to 0.1 wt.%; b) water or a physiological saline solution as solvent; c) a buffer for adjusting the pH to a value from 6.5 to 7.2; and d) a preservative, for topical application to conjunctiva or nasal mucosa for treating late phase reaction in allergic rhinitis or conjunctivitis.

According to yet another aspect of the present invention, there is provided use of a solution consisting of: a) epinastine, an enantiomer thereof, a racemate of the enantiomers thereof, or a pharmacologically acceptable acid addition salt thereof, in a concentration of 0.0005 to 0.1 wt.%; b) water or a physiological saline solution as solvent; c) a buffer for adjusting the pH to a value from 6.5 to 7.2; and d) a preservative; and e) one or more components selected from the group consisting of: chelating agents, viscosity agents penetration promoters,

25771-736

- 2b -

antioxidants, and physiologically acceptable agents for adjusting the tonicity of the solution, for topical application to conjunctiva or nasal mucosa for treating late phase reaction in allergic rhinitis or conjunctivitis.

5 According to a further aspect of the present invention, there is provided a solution consisting of: a) epinastine, an enantiomer thereof, a racemate of the enantiomers thereof, or a pharmacologically acceptable acid addition salt thereof, in a concentration of
10 0.0005 to 0.1 wt.%; b) water or a physiological saline solution as solvent; c) a buffer for adjusting the pH to a value from 6.5 to 7.2; and d) a preservative, for topical application to conjunctiva or nasal mucosa for treating late phase reaction in allergic rhinitis or conjunctivitis.

15 According to yet a further aspect of the present invention, there is provided a solution consisting of: a) epinastine, an enantiomer thereof, a racemate of the enantiomers thereof, or a pharmacologically acceptable acid addition salt thereof, in a concentration of
20 0.0005 to 0.1 wt.%; b) water or a physiological saline solution as solvent; c) a buffer for adjusting the pH to a value from 6.5 to 7.2; and d) a preservative; and e) one or more components selected from the group consisting of: chelating agents, viscosity agents penetration promoters,
25 antioxidants, and physiologically acceptable agents for adjusting the tonicity of the solution, for topical application to conjunctiva or nasal mucosa for treating late phase reaction in allergic rhinitis or conjunctivitis.

More Detailed Description of the Invention

30 It has been found, surprisingly, that topically administerable aqueous solutions containing epinastin, optionally in the form of its racemate, its enantiomers and

25771-736

- 2c -

possibly in the form of the pharmacologically acceptable acid addition salts thereof, may be used to solve the problem on which the invention is based, since they inhibit the influx of neutrophils and eosinophils into the tissue of the ocular conjunctiva and nasal mucous membrane, thereby reducing or preventing the occurrence of LPR and are accordingly characterised by a longer lasting duration of activity.

The compound epinastin (3-amino-9,13b-dihydro-1H-dibenz-[c,f]imidazol[1,5-a]azepine) and the acid addition salts

thereof are described for the first time in German Patent Application P 30 08 944.2.

5 The effect of the topically administered solutions containing epinastin as inhibitors of the influx of eosinophils and neutrophils was demonstrated using the so-called passive ocular anaphylaxis model in rats.

Description of Experiment:

10 72 hours after the rats have been sensitised by injecting antiserum into the eyelids of the test animals, a fresh provocation was induced in them by intravenous administration of ovalbumin. Some of the experimental animals were pretreated by the administration of solution
15 containing epinastin according to the invention into the conjunctival sac 15 minutes before the ovalbumin is administered. Two hours after the administration of ovalbumin the experimental animals were killed and the conjunctiva was investigated for its content of
20 eosinophils and neutrophils and the mast cell granulation was determined.

Results:

25 The animals pretreated with epinastin solution according to the invention (0.05-0.5%) had a significantly lower content of eosinophils in their conjunctiva. The animals pretreated with epinastin solution according to the invention had a significantly lower content of lymphocytes in their conjunctiva ($p < 0.01$). In the animals pretreated
30 with epinastin solution according to the invention, a roughly 35% inhibition of mast cell degranulation was determined ($p < 0.01$).

35 Consequently, the invention relates to topically administered aqueous solutions containing epinastin, optionally in the form of its racemate, its enantiomers

and optionally in the form of the pharmacologically acceptable addition salts thereof, in a concentration of 0.005 to 0.5, preferably 0.02 to 0.1, most preferably 0.03 to 0.07 mg/ml of solution.

5

The above-mentioned topically administered aqueous solutions containing epinastin hydrochloride are preferred according to the invention.

- 10 Suitable aqueous solvents are physiologically acceptable aqueous solvents, physiologically acceptable saline solutions being particularly preferred.

According to the invention, topically administered
15 solutions are preferably prepared which typically contain 0.005 to 0.5, preferably 0.02 to 0.1, most preferably 0.03 to 0.07 mg/ml of epinastin, optionally in the form of its racemate, its enantiomers and optionally in the form of the pharmacologically acceptable acid addition salts
20 thereof, as well as physiological saline solutions as the main carriers. The pH of the solutions according to the invention should preferably be maintained within the range from 6.5 - 7.2 by means of a suitable buffer system. The preparations may also contain conventional,
25 pharmaceutically acceptable excipients, preservatives, stabilisers and/or penetration promoters.

The preferred carrier which may be used in the solutions according to the invention is purified water and
30 preferably a physiological saline solution.

Without restricting the subject matter of the invention to the following, the excipients which may be used according to the invention include viscosity agents such as
35 polyvinyl alcohol, povidone, hydroxypropylmethylcellulose,

poloxamers, carboxymethylcellulose, carbomers and hydroxyethylcellulose.

Without restricting the subject matter of the invention to
5 the following, the preferred preservatives which may be used in the solutions according to the invention include benzalkonium chloride, chlorobutanol, thimerosal, phenyl mercury acetate and phenyl mercury nitrate.

10 The penetration promoters may be, for example, surfactants, specific organic solvents such as dimethylsulphoxide and other sulphoxides, dimethylacetamide and pyrrolidone, specific amides of heterocyclic amines, glycols such as propyleneglycol,
15 propylene carbonate, oleic acid, alkylamines and derivatives thereof, various cationic, anionic, non-ionogenic and amphoteric surfactants and the like.

Substances may be added as necessary or as desired in
20 order to adjust the tonicity of the solution. Such substances include salts and especially sodium chloride, potassium chloride, mannitol and glycerol or other suitable physiologically acceptable agents for adjusting tonicity, without restricting the invention to the above.

25 Various buffers and substances may be used to adjust the pH, provided that the preparation obtained is physiologically acceptable. These buffers might include acetate buffer, citrate buffer, phosphate buffer and
30 borate buffer.

Similarly, physiologically acceptable antioxidants which may be used according to the invention include sodium metabisulphite, sodium thiosulphate, acetylcysteine,
35 butylated hydroxyanisole and butylated hydroxytoluene, without restricting the invention to this list.

Other carrier components which may be incorporated in the solutions according to the invention are chelating agents. The preferred chelating agent is disodium edetate
5 (Na-EDTA), although other chelating agents may also be used instead of or in conjunction with disodium edetate.

The above-mentioned topically administered aqueous solutions according to the invention may be applied either
10 to the conjunctiva or to the nasal mucous membrane. Solutions for ophthalmic use are of equal importance to solutions for nasal application for the purposes of the present invention.

15 The invention relates not only to the solutions according to the invention mentioned hereinbefore but also to the use of the above-mentioned topically administered aqueous solutions for inhibiting the influx of neutrophils and eosinophils into the tissue of the ocular conjunctiva or
20 the tissue of the nasal mucous membrane.

The present invention also relates to the use of epinastin, optionally in the form of its racemate, its enantiomers and optionally in the form of the
25 pharmacologically acceptable acid addition salts thereof, for producing the topically administered aqueous solutions according to the invention for treating disorders of the ocular conjunctiva or the nasal mucous membranes in which there is therapeutic value in inhibiting the influx of
30 neutrophils and eosinophils into the tissue of the ocular conjunctiva or the nasal mucous membrane in allergic reactions.

The above-mentioned use for inhibiting LPR is preferred,
35 whilst it is particularly preferable to use the preparation to treat the diseases listed at the beginning.

The Examples shown in Table 1 illustrate the invention without restricting it.

Table 1:							
	Solution 1	Solution 2	Solution 3	Solution 4	Solution 5	Solution 6	Solution 7
	0.05% [g/100ml]	0.01% [g/100ml]	0.05% [g/100mg]	0.10% [g/100ml]	0.01% [g/100ml]	0.05% [g/100ml]	0.10% [g/100ml]
Epinastin-hydrochloride	0.0500	0.0100	0.0500	0.1000	0.0100	0.0500	0.1000
Na-EDTA	0.0500	0.0500	0.0500	0.0500	-	-	-
Sodium chloride	0.5000	0.5000	0.5000	0.5000	0.5000	0.5000	0.5000
Sodium dihydrogen phosphate dihydrate	0.7800	0.7800	0.7800	0.7800	0.4100	0.4100	0.4100
Benzalkonium chloride	0.0101	0.0101	0.0101	0.0101	0.0101	0.0101	0.0101
Sodium hydroxide	0.0001	0.0001	0.0001	0.0001	-	-	-
Sodium dihydrogen phosphate dihydrate	-	-	-	-	0.6500	0.6500	0.6500
Hydroxyethylcellulose	-	-	-	-	0.1000	0.1000	0.1000
Water	99.4198	99.4598	99.4198	99.3698	99.0749	99.0349	99.9849
	100.8100	100.8100	100.8100	100.8100	100.7550	100.7550	100.7550

25771-736

- 9 -

CLAIMS:

1. Use of a solution consisting of:
 - a) epinastine, an enantiomer thereof, a racemate of the enantiomers thereof, or a pharmacologically acceptable acid addition salt thereof, in a concentration of 5 0.0005 to 0.1 wt.%;
 - b) water or a physiological saline solution as solvent;
 - c) a buffer for adjusting the pH to a value from 10 6.5 to 7.2; and
 - d) a preservative,

in preparing a medicament for topical application to conjunctiva or nasal mucosa for treating late phase reaction in allergic rhinitis or conjunctivitis.
- 15 2. A use according to claim 1, wherein the buffer is adjusted to the range of pH from 6.5 to 7.2 by addition of sodium hydroxide.
3. A use according to claim 1 or 2, wherein component a) is epinastine hydrochloride.
- 20 4. A use according to claim 3, wherein the concentration of epinastine hydrochloride is 0.05 to 0.1 wt.%.
5. A use according to claim 3, wherein the concentration of epinastine hydrochloride is 25 0.005 to 0.5 mg/ml.
6. A use according to any one of claims 1 to 5, wherein the preservative is selected from the group

25771-736

- 10 -

consisting of benzalkonium chloride, chlorobutanol, thimerosal, phenyl mercury acetate and phenyl mercury nitrate.

7. A use according to any one of claims 1 to 6, wherein the buffer is selected from the group consisting of acetate buffer, citrate buffer, phosphate buffer and borate buffer.

8. Use of a solution consisting of:

a) epinastine, an enantiomer thereof, a racemate of the enantiomers thereof, or a pharmacologically acceptable acid addition salt thereof, in a concentration of 0.0005 to 0.1 wt.%;

b) water or a physiological saline solution as solvent;

c) a buffer for adjusting the pH to a value from 6.5 to 7.2; and

d) a preservative; and

e) one or more components selected from the group consisting of: chelating agents, viscosity agents, penetration promoters, antioxidants, and physiologically acceptable agents for adjusting the tonicity of the solution,

in preparing a medicament for topical application to conjunctiva or nasal mucosa for treating late phase reaction in allergic rhinitis or conjunctivitis.

9. A use according to claim 8, wherein the buffer is adjusted to the range of pH from 6.5 to 7.2 by addition of sodium hydroxide.

25771-736

- 11 -

10. A use according to claim 8 or 9, wherein component a) is epinastine hydrochloride.
11. A use according to claim 10, wherein the concentration of epinastine hydrochloride is
5 0.05 to 0.1 wt.%.
12. A use according to claim 10, wherein the concentration of epinastine hydrochloride is
0.005 to 0.5 mg/ml.
13. A use according to any one of claims 8 to 12,
10 wherein the preservative is selected from the group consisting of benzalkonium chloride, chlorobutanol, thimerosal, phenyl mercury acetate and phenyl mercury nitrate.
14. A use according to any one of claims 8 to 13,
15 wherein the buffer is selected from the group consisting of acetate buffer, citrate buffer, phosphate buffer and borate buffer.
15. A use according to any one of claims 8 to 14,
20 wherein the viscosity agents are one or more viscosity agents selected from the group consisting of polyvinyl alcohol, povidone, hydroxypropylmethyl cellulose, poloxamers, carboxymethylcellulose, carbomer and hydroxyethyl cellulose.
16. A use according to any one of claims 8 to 15,
25 wherein the penetration promoters are one or more penetration promoters selected from the group consisting of dimethylsulphoxide, dimethylacetamide, pyrrolidone, propyleneglycol, propylene carbonate and oleic acid.
17. A use according to any one of claims 8 to 16,
30 wherein the agents for adjusting tonicity are one or more

25771-736

- 12 -

agents selected from the group consisting of sodium chloride, potassium chloride, mannitol and glycerol.

18. A use according to any one of claims 8 to 17, wherein the antioxidants are one or more antioxidants
5 selected from the group consisting of sodium metabisulphite, sodium thiosulphate, acetylcysteine, butylated hydroxyanisole and butylated hydroxytoluene.

19. A use according to any one of claims 8 to 18, wherein the chelating agents are the chelating agent
10 disodium edentate.

20. A use according to any one of claims 9 to 11, wherein b) is water, d) is benzalkonium chloride and e) is sodium chloride, sodium hydrogen phosphate dihydrate and hydroxyethyl cellulose.

15 21. A use according to any one of claims 9 to 11, wherein b) is water, c) is sodium hydroxide, d) is benzalkonium chloride and e) is sodium chloride, sodium hydrogen phosphate dihydrate, hydroxyethyl cellulose, and sodium-EDTA.

20 22. Use of a solution consisting of:

a) epinastine, an enantiomer thereof, a racemate of the enantiomers thereof, or a pharmacologically acceptable acid addition salt thereof, in a concentration of 0.0005 to 0.1 wt.%;

25 b) water or a physiological saline solution as solvent;

c) a buffer for adjusting the pH to a value from 6.5 to 7.2; and

d) a preservative,

25771-736

- 13 -

for topical application to conjunctiva or nasal mucosa for treating late phase reaction in allergic rhinitis or conjunctivitis.

23. A use according to claim 22, wherein the buffer is
5 adjusted to the range of pH from 6.5 to 7.2 by addition of sodium hydroxide.

24. A use according to claim 22 or 23, wherein component a) is epinastine hydrochloride.

25. A use according to claim 24, wherein the
10 concentration of epinastine hydrochloride is 0.05 to 0.1 wt.%.

26. A use according to claim 24, wherein the concentration of epinastine hydrochloride is 0.005 to 0.5 mg/ml.

15 27. A use according to any one of claims 22 to 26, wherein the preservative is selected from the group consisting of benzalkonium chloride, chlorobutanol, thimerosal, phenyl mercury acetate and phenyl mercury nitrate.

20 28. A use according to any one of claims 22 to 27, wherein the buffer is selected from the group consisting of acetate buffer, citrate buffer, phosphate buffer and borate buffer.

29. Use of a solution consisting of:

25 a) epinastine, an enantiomer thereof, a racemate of the enantiomers thereof, or a pharmacologically acceptable acid addition salt thereof, in a concentration of 0.0005 to 0.1 wt.%;

25771-736

- 14 -

b) water or a physiological saline solution as solvent;

c) a buffer for adjusting the pH to a value from 6.5 to 7.2; and

5 d) a preservative; and

e) one or more components selected from the group consisting of: chelating agents, viscosity agents penetration promoters, antioxidants, and physiologically acceptable agents for adjusting the tonicity of the
10 solution,

for topical application to conjunctiva or nasal mucosa for treating late phase reaction in allergic rhinitis or conjunctivitis.

30. A use according to claim 29, wherein the buffer is
15 adjusted to the range of pH from 6.5 to 7.2 by addition of sodium hydroxide.

31. A use according to claim 29 or 30, wherein component a) is epinastine hydrochloride.

32. A use according to claim 31, wherein the
20 concentration of epinastine hydrochloride is 0.05 to 0.1 wt.%.

33. A use according to claim 31, wherein the concentration of epinastine hydrochloride is 0.005 to 0.5 mg/ml.

25 34. A use according to any one of claims 29 to 33, wherein the preservative is selected from the group consisting of benzalkonium chloride, chlorobutanol, thimerosal, phenyl mercury acetate and phenyl mercury nitrate.

25771-736

- 15 -

35. A use according to any one of claims 29 to 34, wherein the buffer is selected from the group consisting of acetate buffer, citrate buffer, phosphate buffer and borate buffer.
- 5 36. A use according to any one of claims 29 to 35, wherein the viscosity agents are one or more viscosity agents selected from the group consisting of polyvinyl alcohol, povidone, hydroxypropylmethyl cellulose, poloxamers, carboxymethylcellulose, carbomer and
10 hydroxyethyl cellulose.
37. A use according to any one of claims 29 to 36, wherein the penetration promoters are one or more penetration promoters selected from the group consisting of dimethylsulphoxide, dimethylacetamide, pyrrolidone,
15 propyleneglycol, propylene carbonate and oleic acid.
38. A use according to any one of claims 29 to 37, wherein the agents for adjusting tonicity are one or more agents selected from the group consisting of sodium chloride, potassium chloride, mannitol and glycerol.
- 20 39. A use according to any one of claims 29 to 38, wherein the antioxidants are one or more antioxidants selected from the group consisting of sodium metabisulphite, sodium thiosulphate, acetylcysteine, butylated hydroxyanisole and butylated hydroxytoluene.
- 25 40. A use according to any one of claims 29 to 39, wherein the chelating agents are the chelating agent disodium edentate.
41. A use according to any one of claims 31 to 33, wherein b) is water, d) is benzalkonium chloride and e) is

25771-736

- 16 -

sodium chloride, sodium hydrogen phosphate dihydrate and hydroxyethyl cellulose.

42. A use according to any one of claims 31 to 33, wherein b) is water, c) is sodium hydroxide, d) is benzalkonium chloride and e) is sodium chloride, sodium hydrogen phosphate dihydrate, hydroxyethyl cellulose, and sodium-EDTA.

43. A solution consisting of:

a) epinastine, an enantiomer thereof, a racemate of the enantiomers thereof, or a pharmacologically acceptable acid addition salt thereof, in a concentration of 0.0005 to 0.1 wt.%;

b) water or a physiological saline solution as solvent;

c) a buffer for adjusting the pH to a value from 6.5 to 7.2; and

d) a preservative,

for topical application to conjunctiva or nasal mucosa for treating late phase reaction in allergic rhinitis or conjunctivitis.

44. A solution according to claim 43, wherein the buffer is adjusted to the range of pH from 6.5 to 7.2 by addition of sodium hydroxide.

45. A solution according to claim 43 or 44, wherein component a) is epinastine hydrochloride.

46. A solution according to claim 45, wherein the concentration of epinastine hydrochloride is 0.05 to 0.1 wt.%.

25771-736

- 17 -

47. A solution according to claim 45, wherein the concentration of epinastine hydrochloride is 0.005 to 0.5 mg/ml.

48. A solution according to any one of
5 claims 43 to 47, wherein the preservative is selected from the group consisting of benzalkonium chloride, chlorobutanol, thimerosal, phenyl mercury acetate and phenyl mercury nitrate.

49. A solution according to any one of
10 claims 43 to 48, wherein the buffer is selected from the group consisting of acetate buffer, citrate buffer, phosphate buffer and borate buffer.

50. A solution consisting of:

a) epinastine, an enantiomer thereof, a racemate
15 of the enantiomers thereof, or a pharmacologically acceptable acid addition salt thereof, in a concentration of 0.0005 to 0.1 wt.%;

b) water or a physiological saline solution as solvent;

20 c) a buffer for adjusting the pH to a value from 6.5 to 7.2; and

d) a preservative; and

e) one or more components selected from the group consisting of: chelating agents, viscosity agents
25 penetration promoters, antioxidants, and physiologically acceptable agents for adjusting the tonicity of the solution,

25771-736

- 18 -

for topical application to conjunctiva or nasal mucosa for treating late phase reaction in allergic rhinitis or conjunctivitis.

51. A solution according to claim 50, wherein the
5 buffer is adjusted to the range of pH from 6.5 to 7.2 by addition of sodium hydroxide.
52. A solution according to claim 50 or 51, wherein component a) is epinastine hydrochloride.
53. A solution according to claim 52, wherein the
10 concentration of epinastine hydrochloride is 0.05 to 0.1 wt.%.
54. A solution according to claim 52, wherein the concentration of epinastine hydrochloride is 0.005 to 0.5 mg/ml.
- 15 55. A solution according to any one of claims 50 to 54, wherein the preservative is selected from the group consisting of benzalkonium chloride, chlorobutanol, thimerosal, phenyl mercury acetate and phenyl mercury nitrate.
- 20 56. A solution according to any one of claims 50 to 55, wherein the buffer is selected from the group consisting of acetate buffer, citrate buffer, phosphate buffer and borate buffer.
- 25 57. A solution according to any one of claims 50 to 56, wherein the viscosity agents are one or more viscosity agents selected from the group consisting of polyvinyl alcohol, povidone, hydroxypropylmethyl cellulose, poloxamers, carboxymethylcellulose, carbomer and hydroxyethyl cellulose.

25771-736

- 19 -

58. A solution according to any one of claims 50 to 57, wherein the penetration promoters are one or more penetration promoters selected from the group consisting of dimethylsulphoxide, dimethylacetamide, 5 pyrrolidone, propyleneglycol, propylene carbonate and oleic acid.

59. A solution according to any one of claims 50 to 58, wherein the agents for adjusting tonicity are one or more agents selected from the group consisting of 10 sodium chloride, potassium chloride, mannitol and glycerol.

60. A solution according to any one of claims 50 to 59, wherein the antioxidants are one or more antioxidants selected from the group consisting of sodium metabisulphite, sodium thiosulphate, acetylcysteine, 15 butylated hydroxyanisole and butylated hydroxytoluene.

61. A solution according to any one of claims 50 to 60, wherein the chelating agents are the chelating agent disodium edentate.

62. A solution according to any one of 20 claims 52 to 54, wherein b) is water, d) is benzalkonium chloride and e) is sodium chloride, sodium hydrogen phosphate dihydrate and hydroxyethyl cellulose.

63. A solution according to any one of claims 52 to 54, wherein b) is water, c) is sodium 25 hydroxide, d) is benzalkonium chloride and e) is sodium chloride, sodium hydrogen phosphate dihydrate, hydroxyethyl cellulose, and sodium-EDTA.

FETHERSTONHAUGH & CO.
OTTAWA, CANADA

PATENT AGENTS



Europäisches Patentamt
European Patent Office
Office européen des brevets



(11) **EP 1 004 309 A1**

(12) **EUROPEAN PATENT APPLICATION**
published in accordance with Art. 158(3) EPC

(43) Date of publication:
31.05.2000 Bulletin 2000/22

(51) Int. Cl.⁷: **A61K 31/55**
// C07D495/14

(21) Application number: **98921787.2**

(86) International application number:
PCT/JP98/02275

(22) Date of filing: **22.05.1998**

(87) International publication number:
WO 98/53828 (03.12.1998 Gazette 1998/48)

(84) Designated Contracting States:
DE ES FR GB IT

(30) Priority: **27.05.1997 JP 13706197**
27.05.1997 JP 15447497

(71) Applicants:
• **Senju Pharmaceutical Co., Ltd.**
Osaka-shi, Osaka 541-0046 (JP)
• **YOSHITOMI PHARMACEUTICAL INDUSTRIES,**
LTD.
Osaka-shi Osaka 541-0046 (JP)

(72) Inventors:
• **TERAI, Tadashi**
Kobe-shi, Hyogo 658-0081 (JP)

• **YASUEDA, Shinichi**
Takarazuka-shi, Hyogo 665-0861 (JP)
• **OGAWA, Takahiro**
Nishinomiya-shi, Hyogo 662-0865 (JP)
• **OTORI, Akira**
Kobe-shi, Hyogo 673-0003 (JP)

(74) Representative:
von Kreisler, Alek, Dipl.-Chem. et al
Patentanwälte,
von Kreisler-Selting-Werner,
Bahnhofsvorplatz 1 (Deichmannhaus)
50667 Köln (DE)

(54) **ISRAPAFANT-CONTAINING WATER-BASE PREPARATIONS**

(57)

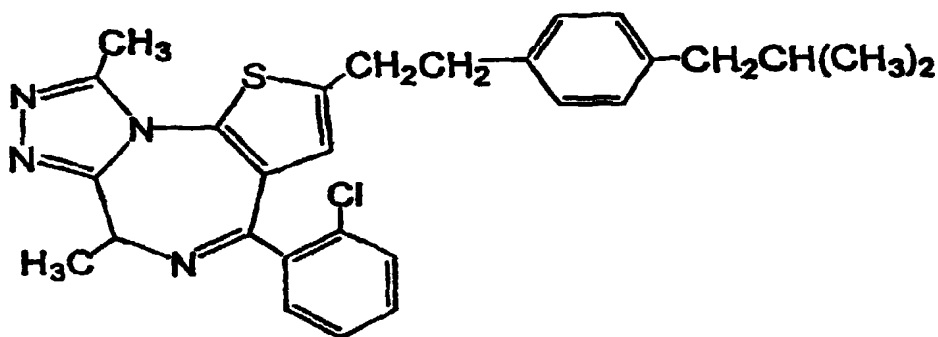

(I)

EP 1 004 309 A1

Water-base preparations comprising an aqueous solution or suspension of israpafant represented by structural formula (I) and providing eye drops and nose drugs exhibiting excellent therapeutic effects against allergic conjunctivitis and rhinitis by local administration.

Description

Technical Field

5 [0001] The present invention relates to an aqueous agent containing israpafant. More particularly, the present invention relates to an aqueous solution obtained by dissolving israpafant in water at a high concentration and a suspension obtained by dispersing israpafant stably in water. These aqueous agents are utilized as an eye drop or nasal drop particularly effective for allergic conjunctivitis, allergic rhinitis and the like.

10 Background Art

[0002] 4-(2-Chlorophenyl)-2-[2-(4-isobutylphenyl)ethyl]-6,9-dimethyl-6H-thieno[3,2-f][1,2,4]triazolo[4,3-a][1,4]diazepine (general name israpafant) disclosed in JP-B-5-55510 and having the formula (I)

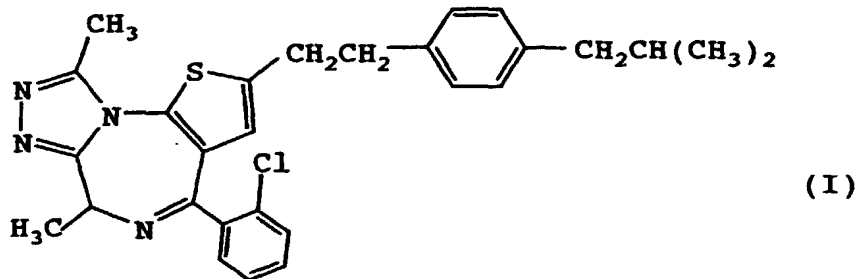

is known to show superior antagonistic action against platelet activating factor (PAF). Therefore, it is considered to be extremely useful for many diseases induced by PAF, such as inflammatory diseases, allergic diseases, anaphylactic shock, septic shock, vascular diseases such as DIC and the like, cardiac diseases, asthma, pulmonary edema, adult respiratory diseases, ulcer and the like.

30 [0003] In addition, DE 42 01 147 A1 discloses that a compound having a PAF antagonistic action and having the formula

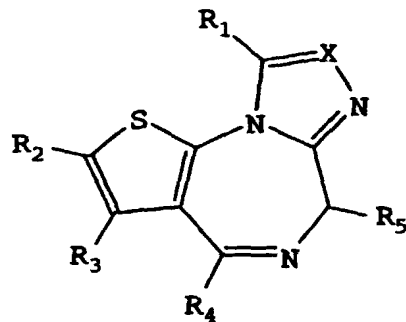

is useful for allergic conjunctivitis and further for allergic rhinitis, and recites some formulation examples of oral suspension containing this compound.

[0004] However, there is no disclosure of an aqueous preparation obtained by dissolving israpafant in water.

50 [0005] That is, israpafant is crystal or crystalline powder hardly soluble in water and easily dissolved in organic solvent such as dimethylformamide, methanol and the like. Nevertheless, the use of an organic solvent as a carrier of a preparation is inappropriate and, since in particular, an eye drop, a nasal drop and the like are locally administered to a site sensitive to irritation, the use of an organic solvent as a carrier to give an israpafant preparation should be avoided. As mentioned earlier, israpafant is hardly dissolved in water. Specifically, its solubility in water at 25°C is less than 0.01 w/v%, and the solubility in buffer (pH 4, 5, 6, 7, 8 and 9) is below detection limit (50 ng/ml) by HPLC, at such low concentration the efficacy of israpafant cannot be exerted in any way.

55 [0006] While to be mentioned later, when an israpafant suspension was orally administered to a guinea pig suffering from allergic conjunctivitis, no effect was observed in the test by the present inventors.

[0007] Therefore, there is a demand for an israpafant preparation which is effective for allergic conjunctivitis and further for allergic rhinitis.

Disclosure of the Invention

5

[0008] It is therefore an object of the present invention to provide an aqueous agent containing israpafant, which is particularly effective against allergic conjunctivitis, allergic rhinitis and the like.

[0009] In particular, an object of the present invention is to provide an aqueous preparation obtained by dissolving israpafant at a high concentration, namely, at a concentration at which its efficacy can be fully exerted, and a suspension preparation which is less irritative and which is capable of fully exerting the efficacy of israpafant.

[0010] Another object of the present invention is to provide an aqueous solution of israpafant, which is obtained by dissolving israpafant at a high concentration, and a method for producing a suspension.

[0011] The present inventors have conducted intensive studies in an attempt to achieve the above-mentioned problems, and found that israpafant can be dissolved in water at a high concentration in the presence of a surfactant and that this aqueous solution can be used as an eye drop and a nasal drop, which resulted in the completion of the present invention.

[0012] The present inventors have further found that administration of israpafant as an aqueous suspension to a local site of the eye or nose is effective for allergic conjunctivitis, allergic rhinitis, vernal conjunctivitis, conjunctival allergy caused by contact lens (giant papillary conjunctivitis), phlyctenular conjunctivitis, contact blepharocconjunctivitis, Sjögren's syndrome, multiple corneal infiltration, keratitis disciformis, stromal keratitis, endothelium keratitis, episcleritis, scleritis, uveitis, retinal vasculitis, papillary vasculitis, optic neuritis, eosinophilic granuloma, rejection associated with keratoplasty, eye itching, sneeze, nose itching, hypersensitivity of the nose, nose vestibule eczema, anterior rhinitis sicca, nasal obstruction and the like, and further that, since israpafant is a compound hardly soluble in water, it can be prepared into a stable aqueous eye drop or nasal drop suspension, which is free of agglomeration or caking of suspended particles, which resulted in the completion of the present invention.

[0013] Accordingly, the present invention provides the following.

(1) An aqueous agent containing israpafant, which is expressed by the formula (I):

30

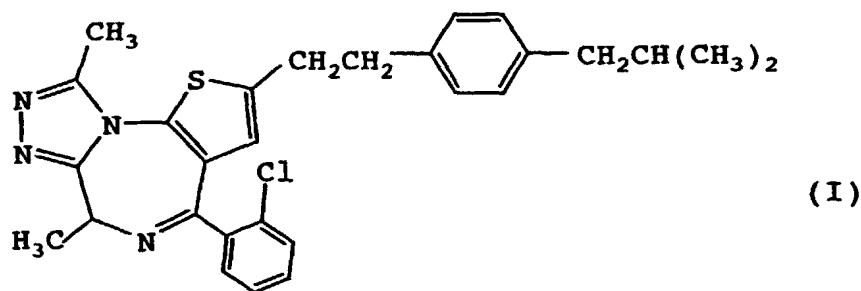

35

40

(2) The aqueous agent of (1) above, wherein the israpafant (I) has a concentration of not less than 0.01 w/v%.

(3) The aqueous agent of (2) above, wherein the aqueous agent is an eye drop or nasal drop.

(4) The aqueous agent of (3) above, wherein the eye drop or nasal drop is an aqueous solution containing israpafant (I).

(5) The aqueous agent of (4) above, wherein the israpafant (I) has a concentration of 0.01 - 0.1 w/v%.

(6) The aqueous agent of (5) above, further comprising a surfactant.

(7) The aqueous agent of (6) above, wherein the surfactant has a concentration of 0.5 - 10 w/v%.

(8) The aqueous agent of (7) above, wherein the surfactant is at least one member selected from the group consisting of a cationic surfactant, an anionic surfactant and a nonionic surfactant.

(9) The aqueous agent of (3) above, wherein the eye drop or nasal drop is a suspension containing israpafant (I).

(10) The aqueous agent of (9) above, wherein the israpafant has a concentration of 0.01 - 2 w/v%.

(11) The aqueous agent of (10) above, further comprising a suspending agent.

(12) The aqueous agent of (11) above, wherein the suspending agent is at least one member selected from a surfactant and a water soluble polymer.

(13) The aqueous agent of (12) above, wherein the surfactant has a concentration of 0.0001 - 0.1 w/v%.

(14) The aqueous agent of (13) above, wherein the surfactant is at least one surfactant selected from a nonionic

55

surfactant and an anionic surfactant.

(15) The aqueous agent of (12) above, wherein the water soluble polymer has a concentration of 0.00001 - 0.5 w/v%.

(16) The aqueous agent of (15) above, wherein the water soluble polymer is a water soluble cellulose derivative.

(17) The aqueous agent of (16) above, wherein the water soluble cellulose derivative is at least one cellulose derivative selected from hydroxypropylmethylcellulose, carboxymethylcellulose and methylcellulose.

(18) The aqueous agent of (17) above, wherein the agent contains israpafant (I) in a proportion of 0.1 - 1 w/v% and hydroxypropyl methylcellulose in the weight ratio to israpafant (I) of 0.001 - 0.01:1.

(19) A method for producing an aqueous solution of israpafant, comprising dissolving israpafant of the formula (I):

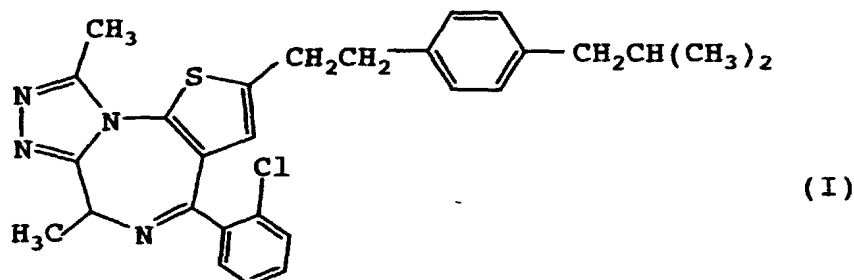

in water in the presence of a surfactant.

(20) A method for producing a suspension of israpafant, comprising suspending israpafant of the formula (I):

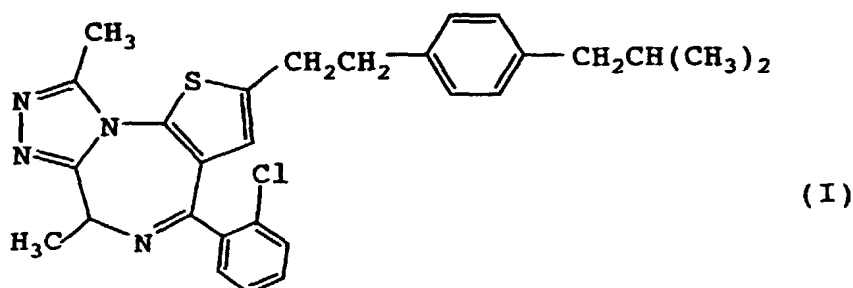

in water in the presence of a suspending agent.

[0014] Israpafant which is used as the active ingredient of the aqueous agent of the present invention is a compound expressed by the formula (I)

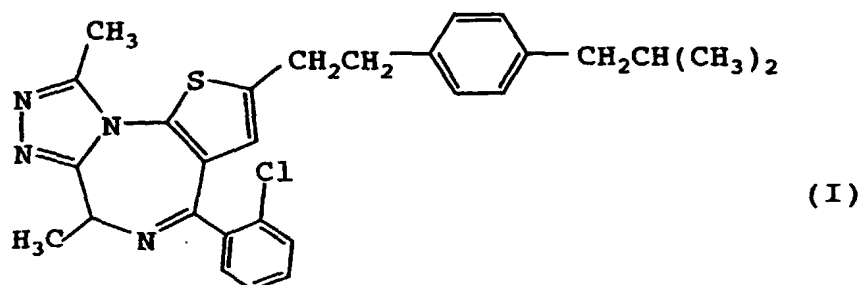

The concentration of israpafant (I) in the aqueous agent is appropriately determined, with preference given to not less than 0.01 w/v%. The aqueous agent of the present invention is preferably used as an eye drop or a nasal drop.

[0015] The aqueous israpafant solution of the present invention can be produced by dissolving israpafant in water in the presence of a surfactant.

[0016] Examples of the surfactant include cationic surfactants, anionic surfactants, nonionic surfactants and the like.

5 **[0017]** Examples of the cationic surfactant include benzalkonium salt such as benzalkonium chloride (BAK) and the like.

[0018] Examples of the anionic surfactant include sodium alkylsulfonate such as sodium dodecylsulfate (SDS), sodium pentanesulfonate, sodium octanesulfonate and the like.

10 **[0019]** The nonionic surfactant preferably has an HLB of 10 - 18 and a molecular weight of 500 - 4000, with preference given to ether nonionic surfactants and ester nonionic surfactants. Examples thereof include polyoxyethylene sorbitane fatty acid esters such as polysorbate 80 and the like, polyoxyethylene hydrogenated castor oil such as polyoxyethylene hydrogenated castor oil 60 (HCO 60) and the like, polyoxyethylene alkylphenyl formaldehyde condensate such as tyloxapol and the like, polyoxyethylene polyoxypropylene block copolymer such as poloxamer and the like, sucrose fatty acid ester and the like.

15 **[0020]** The above-mentioned surfactant can be used alone or in combination. In particular, since anionic surfactants cause irritation to the eye, when an aqueous solution containing an anionic surfactant is used as an eye drop, a nonionic surfactant is preferably used concurrently to reduce irritation.

[0021] The concentration of israpafant in the aqueous solution is not less than 0.01 w/v%, preferably 0.01 - 0.1 w/v%. When the concentration of israpafant is within the above-mentioned range, the local administration of an eye drop, a nasal drop and the like leads to exhibition of useful efficacy and preparation of an aqueous solution causing less irritation.

[0022] When dissolving israpafant in water in the above-mentioned range, the surfactant is preferably contained in 0.5 - 10 w/v% of the aqueous solution, more preferably 0.5 - 4 w/v%.

25 **[0023]** The proportion of the surfactant relative to israpafant is preferably 30 - 80 parts by weight, more preferably 45 - 60 parts by weight, of a cationic surfactant, 3 - 10 parts by weight, more preferably 4 - 7 parts by weight, of an anionic surfactant, and 50 - 200 parts by weight, more preferably 70 - 160 parts by weight, of a nonionic surfactant, per part by weight of israpafant.

[0024] Examples of the suspending agent to be used when preparing israpafant into an aqueous suspension in the present invention include a nonionic surfactant, an anionic surfactant, a water soluble polymer and the like, which can be used alone or in combination.

30 **[0025]** The nonionic surfactant preferably has an HLB of 10 - 18 and a molecular weight of 500 - 4000, with preference given to an ether type nonionic surfactant and an ester type nonionic surfactant.

[0026] Specific examples include polyoxyethylene sorbitane fatty acid esters such as polysorbate 80 and the like, polyoxyethylene hydrogenated castor oil such as polyoxyethylene hydrogenated castor oil 60 (HCO 60) and the like, polyoxyethylene alkylphenyl formaldehyde condensate such as tyloxapol and the like, polyoxyethylene polyoxypropylene block copolymer such as poloxamer and the like, sucrose fatty acid ester and the like. In addition, an anionic surfactant such as sodium lauryl sulfate (SDS) and the like can be used.

40 **[0027]** Preferable examples of the water soluble polymer include water soluble cellulose derivatives such as hydroxypropylmethylcellulose (HPMC), carboxymethylcellulose (CMC), methylcellulose (MC) and the like, carboxyvinyl polymer, macrogol, sodium chondroitin sulfate, polyvinylpyrrolidone such as polyvinylpyrrolidone K25 (PVP K25), polyvinylpyrrolidone K30 (PVP K30), polyvinylpyrrolidone K90 (PVP K90) and the like, polyvinyl alcohol and the like.

[0028] The concentration of israpafant in a suspension is generally 0.01 - 2 w/v%, preferably 0.1 - 1 w/v%. When the concentration of israpafant is within the above-mentioned range, useful efficacy for local administration can be exerted and a stable suspension can be prepared.

45 **[0029]** The suspending agent is contained in a proportion of 0.00001 - 0.5 w/v% in a suspension. The surfactant and water soluble polymer to be used as suspending agents can be used alone or in combination.

[0030] The concentration of each ingredient of the suspending agent is preferably 0.0001 - 0.1 w/v%, more preferably 0.001 - 0.1 w/v% and most preferably 0.005 - 0.1 w/v% in the case of a surfactant, and preferably 0.00001 - 0.5 w/v%, more preferably 0.0001 - 0.1 w/v% in the case of a water soluble polymer.

50 **[0031]** The proportion of israpafant and the surfactant is preferably 0.01 - 1 part by weight of a surfactant per part by weight of israpafant. The proportion of israpafant and the water soluble polymer is preferably 0.0001 - 1 part by weight, more preferably 0.0005 - 0.1 part by weight, and most preferably 0.001 - 0.01 part by weight, of a water soluble polymer per part by weight of israpafant. Particularly, when HPMC is used, a weight ratio of 0.001 - 0.01 parts by weight per part by weight of israpafant is preferable. When the concentration of the suspending agent is within the above-mentioned range, a stable suspension having fine dispersibility can be prepared.

55 **[0032]** The aqueous agent of the present invention can contain, where necessary, other anti-allergic agents, such as histamine release inhibitor, histamine receptor antagonist, leukotriene release inhibitor, leukotriene receptor antagonist, PAF release inhibitor, PAF receptor antagonist, IgE antibody production inhibitor, cytokine release inhibitor,

cytokine receptor inhibitor and the like.

[0033] When the aqueous agent of the present invention is used as an eye drop or nasal drop, known additives typically used for an eye drop or a nasal drop can be used. Examples of such additive include isotonicizing agent, buffer, chelating agent, preservative and the like.

[0034] Examples of isotonicity agent include inorganic salt such as sodium chloride, boric acid, potassium chloride and the like, and polyhydric alcohol such as glycerol, mannitol, sorbitol and the like.

[0035] The buffer may be, for example, borate buffer, phosphate buffer, acetate buffer, citrate buffer, Tris buffer, amino acid such as glutamine and ϵ -aminocaproic acid, and the like.

[0036] Examples of chelating agent include disodium edetate, citric acid and the like. Examples of preservative include quaternary ammonium salt such as benzalkonium chloride, benzetonium chloride and the like, p-aminobenzoate such as methyl p-aminobenzoate, ethyl p-aminobenzoate, propyl p-aminobenzoate, butyl p-aminobenzoate and the like, sorbic acid, chlorobutanol, disodium edetate, boric acid and the like.

[0037] The amounts of these additives are subject to no particular limitation, but an isotonicity agent is generally added in 0.5 - 6.5 w/v% of the aqueous agent, a buffer is generally added in 0.01 - 2 w/v% of the aqueous agent, a chelating agent is generally added in 0.001 - 1 w/v% of the aqueous agent, and a preservative is generally added in 0.001 - 2 w/v% of the aqueous agent.

[0038] The method for preparing an aqueous solution is subject to no particular limitation, and an aqueous solution can be obtained by various known methods. For example, a buffer, an isotonicity agent, a preservative and the like are added to sterile purified water for dissolution. Thereto are added a surfactant and then israpafant, and they are dissolved, where necessary, the solution may be heated to about 70°C. After cooling, a pH adjusting agent (hydrochloric acid, sodium hydroxide and the like) is added to adjust the pH to a desired value.

[0039] Alternatively, israpafant may be dissolved in a 0.5 - 10 w/v% cationic surfactant or anionic surfactant, and a buffer, an isotonicizing agent, a preservative and the like are added and dissolved, whereafter the mixture is lyophilized, which lyophilization product is dissolved when in use in an injectable distilled water and the like, or israpafant, a buffer, an isotonicity agent, a preservative and the like are mixed in a mortar and the like, sealed in a vial and the like and dissolved when in use in a liquid for dissolution containing a surfactant.

[0040] The method for preparing a dispersion is not particularly limited and can be a method conventionally known. For example, a suspending agent, a buffer, an isotonicity agent and a preservative are added to sterile purified water and dissolved, during which the mixture may be heated. To this solution is added israpafant, which is uniformly suspended in various homogenizers, mixers, mills or by ultrasonication. Then, pH is adjusted using a pH adjusting agent (hydrochloric acid, sodium hydroxide and the like) to give an aqueous dispersion.

[0041] When the aqueous agent of the present invention thus prepared is used as an eye drop or nasal drop for the treatment of, for example, allergic conjunctivitis, allergic rhinitis, vernal conjunctivitis, conjunctival allergy caused by contact lens (giant papillary conjunctivitis), phlyctenular conjunctivitis, contact blepharocconjunctivitis, Sjögren's syndrome, multiple corneal infiltration, keratitis disciformis, stromal keratitis, endothelium keratitis, episcleritis, scleritis, uveitis, retinal vasculitis, papillary vasculitis, optic neuritis, eosinophilic granuloma, rejection associated with keratoplasty, eye itching, sneeze, nose itching, hypersensitivity of the nose, nose vestibule eczema, anterior rhinitis sicca, nasal obstruction and the like, it is preferably administered 2 - 6 times a day by 20 - 50 μ l per dose.

[0042] It is also possible to concurrently use the inventive agent with other anti-allergic, anti-inflammatory and/or anti-bacterial eye drop, nasal drop and the like.

Brief Description of the Drawings

[0043]

Fig. 1 is a photograph (biological morphology) showing the standard for grouping of guinea pigs for the evaluation of suppressive effect (early phase reaction) against promotion of conjunctival vascular permeability in Experimental Example 2; Fig. 2 shows conjunctival dye-leakage at 30 minutes after the second challenge for the evaluation of suppressive effect against promotion of conjunctival vascular permeability in Experimental Example 2; Fig. 3 shows scores of conjunctivitis at 20 minutes after the second challenge for the evaluation of suppressive effect against immediate allergic conjunctivitis in Experimental Example 2; and Fig. 4 shows number of conjunctival eosinophil infiltration at 6 hours after the second challenge for the evaluation of suppressive effect against conjunctival eosinophil infiltration in Experimental Example 2.

Best Mode of Embodying the Invention

[0044] The present invention is explained in detail in the following by way of Examples and Experimental Examples, to which the present invention is not limited.

[0045] The dissolution test of israpafant is shown in the following.

Experimental Example 1

5 [0046] Israpafant (manufactured by Yoshitomi Pharmaceutical Industries, Ltd.) was suspended in 0.1% acetate buffer (pH 4, 5, 6), phosphate buffer (pH 6, 7, 8) and borate buffer (pH 8, 9) in a concentration of 0.1% (w/v%, hereinafter the same). Each suspension was filled in a glass ampoule by 5 ml and shaken at 25°C overnight (ca. 15 hours). After passing through a 0.45 µm membrane filter, the solubility of israpafant was measured by HPLC.

10 [0047] In 0.1% phosphate buffer (pH 7) were dissolved the additives shown in Table 2 in a proportion of 0.5% (0.5% and 4% in the sole case of polysorbate). In the same manner as above, israpafant was suspended and dissolved, after which the solubility of israpafant was measured by HPLC.

Quantitative Determination of israpafant - by HPLC

15 **HPLC conditions**

[0048]

column: YMC AM-302 (4.6×150 mm)
 20 mobile phase: acetonitrile:0.1M ammonium acetate-87:13
 detection: UV 244 nm
 column temperature:35°C
 flow rate: 0.7 ml/min
 25 internal standard:1,3,5-triphenylbenzene

[0049] The solubility of the above-mentioned israpafant in each buffer is shown in Table 1, and the solubility in an aqueous solution containing various additives is shown in Table 2.

30 Table 1

buffer	pH of buffer	solubility (µg/ml)
acetate buffer	pH 4	0.0
acetate buffer	pH 5	0.0
35 acetate buffer	pH 6	0.0
phosphate buffer	pH 6	0.0
phosphate buffer	pH 7	0.0
40 phosphate buffer	pH 8	0.0
borate buffer	pH 8	0.0
borate buffer	pH 9	0.0

45

50

55

Table 2

additive	solubility (µg/ml)
<u>surfactant</u>	
polysorbate 80	66.9
polysorbate 80 (4% aq. solution)	581.1
HCO60	47.3
BAK	99.0
SDS	1057.0
Tyloxapol	29.5
<u>water soluble polymer</u>	
HPMC	0.6
PVP(K30)	0.0
PVA(EG40)	0.4
CMC Na	0.0
chondroitin sulfate	0.0
PEG-1000	0.0
PEG-4000	0.0
<u>cyclodextrin</u>	
α-CD	0.0
β-CD	0.0
γ-CD	0.0
2HP-β-CD	0.0
<u>Others</u>	
caffeine	0.0
propylene glycol	0.0
2-pyrrolidone	0.0

[0050] Each symbol in Table 2 is as follows.

- HCO60:polyoxyethylene hydrogenated castor oil 60
- BAK:benzalkonium chloride
- SDS:sodium dodecylsulfate
- HPMC:hydroxypropylmethylcellulose
- PVP:polyvinylpyrrolidone
- PVA:polyvinyl alcohol
- CMC Na:sodium carboxymethylcellulose
- PEG:polyethylene glycol
- CD:cyclodextrin

[0051] The solubility of israpafant in each buffer was below detection limit (50 ng/ml) by HPLC. Israpafant did not dissolve in an aqueous solution containing a water soluble polymer or cyclodextrin. However, it dissolved well in an aqueous surfactant solution. Particularly, israpafant dissolved extremely well in a 4% aqueous polysorbate solution and a 0.5% aqueous sodium dodecylsulfate solution.

[0052] The effect of the eye drop of the present invention against allergic conjunctivitis, which is an ocular inflammation, is shown in the following.

Experimental Example 2

1. Object

5 **[0053]** The suppressive effect of israpafant against guinea pig active sensitization allergic conjunctivitis was studied.

[0054] In allergic conjunctivitis, an early phase reaction that occurs 10 - 20 minutes after antigen challenge and late phase reaction that occurs 4-10 hours later have been clinically confirmed. In the former, histamine, leukotriene, PAF and the like liberated from mast cells are involved and conjunctivitis signs of itching, chemosis, injection and tearing are observed. In the latter, chemical mediators such as histamine, leukotriene, PAF and the like, and cytokine such as interleukin 3, interleukin 5 and the like are also involved, wherein edema and foreign body sensation are observed. It is said that eosinophils and lymphocytes infiltrate into conjunctiva and cause epithelial disorders at cornea and conjunctiva due to injurious proteins in eosinophil granules.

15 **[0055]** For investigation of usefulness of israpafant against allergic conjunctivitis, its suppressive effect against allergic conjunctivitis by guinea pig active sensitization was studied.

[0056] In this model with regard to the early phase reaction, promotion of conjunctival vascular permeability and signs of conjunctivitis were the index of evaluation, and for the late phase reaction, eosinophil infiltration into conjunctiva was the index of evaluation.

20 2. Animals used

[0057] Male Hartley guinea pigs weighing about 300 g purchased from Japan SLC. Ltd. were used. These animals had free access to a solid feed (γ ray irradiated feed LRC4, ORIENTAL YEAST CO., LTD.) and tap water, and were bred in a breeding chamber set to a temperature $23 \pm 2^\circ\text{C}$ and humidity $55 \pm 15\%$.

25

3. Test drug

[0058] Israpafant (manufactured by Yoshitomi Pharmaceutical Industries, Ltd.) was suspended in a vehicle (pH 5) shown below at a concentration of 1% to give an eye drop suspension. In addition, a suspension of israpafant in 0.5% CMC at 10 mg/ml was prepared for oral administration. As a control, physiological saline was used.

30

Polysorbate 80	0.1 g
sodium dihydrogenphosphate • 2H ₂ O	0.1 g
sodium chloride	0.9 g
distilled water	100 ml in total

35

40

4. Test method

1) Suppressive effect (early phase reaction) against promotion of conjunctival vascular permeability

45 **[0059]** Guinea pigs were sensitized with a dispersion of 10 μg ovalbumin (OA) and 30 mg aluminum hydroxide gel by peritoneal administration. At 14 days after the sensitization, a 2.5% OA antigen solution was instilled into the both eyes by 10 μl to induce allergic conjunctivitis (first challenge). At 20 minutes after the last challenge, conjunctivitis signs were observed and the animals were grouped in such a manner that the severity of the condition was equalized from the degrees of chemosis, conjunctival injection and tearing.

50 **[0060]** The evaluation of a drug included the following steps. At 24 hours from the first challenge, 10 mg/kg Evans' blue was intravenously administered, and a 2.5% OA antigen solution was instilled into the both eyes by 10 μl to again induce conjunctivitis (the second challenge). Thirty minutes later, conjunctival dye-leakage part was excised, the parts of the both eyes were combined and the amount of the leaked dye was measured. The drug was instilled into the both eyes by 10 μl at 3, 2, 1 hour before the second challenge in the case of administration by instillation. In the case of an oral administration, 10 mg/kg was administered once at 1 hour before the second challenge. For suppression of histamine reaction, 1 mg/kg of mepyramine was intravenously administered one minute before.

55

2) Suppressive effect (early phase reaction) against immediate allergic conjunctivitis signs

[0061] In the same manner as in 1), sensitization and induction by the first challenge and the second challenge were performed. Twenty minutes later, conjunctivitis signs were observed, and chemosis was scored 0 - 6 points [see Fig. 1, A:0, B:2 (weak), C:4 (moderate), D:6 (strong)], conjunctival injection was scored 0 - 4 points (0: no injection, 1: very mild injection in the eye lid or bulbar conjunctiva, 2: mild injection in the eye lid or bulbar conjunctiva, 3: strong injection in the eye lid or bulbar conjunctiva, 4: strong injection in a wide area of the eye lid and bulbar conjunctiva), and tearing was scored 0 - 4 points (0: no tearing, 1: extremely small amount of tearing, 2: tearing, 3: a small amount of secretion, 4: a large amount of secretion), wherein evaluation followed the total scores. The drug was administered by instillation (10 µl) into one eye at 2, 4, 8 hours after the first challenge and 3, 2, 1 hour before the second challenge.

3) Suppressive effect (early phase reaction) against eosinophil infiltration into conjunctiva

[0062] In the same manner as in 1), sensitization and induction by first challenge and second challenge were performed.

[0063] The drug was evaluated by removing the eye ball at 6 hours after the second challenge, preparing an optical microscopic specimen according to a conventional method, staining eosinophils by Luna staining, and counting and averaging the number of eosinophils infiltrated into conjunctiva with regard to each of 6 visible areas (one visible area being 0.04 mm²) of the vicinity of conjunctival lymphoid tissue. The drug was administered in the same manner as in 1).

test group

[0064]

- physiological saline (control group)
- 1.0% israpafant (instillation group)
- 10 mg/kg israpafant p.o. (oral group)
- 1 mg/kg mepyramine i.v. (intravenous injection group)
- 1.0% israpafant + 1 mg/kg mepyramine i.v. (concurrent instillation group)
- 10 mg/kg israpafant p.o.+1 mg/kg mepyramine i.v. (concurrent instillation group)

5. Results and discussion

1) Suppressive effect (early phase reaction) against promotion of conjunctival vascular permeability

[0065] Conjunctival dye-leakage at 30 minutes after the second challenge is shown in Fig. 2. In Fig. 2, each column shows mean± standard error (n=7 - 8). Significant difference from control group at *;p<0.05, **;p<0.01 (Dunnett's test). Significant difference from mepyramine group at #;p<0.05 (Student's test).

[0066] The dye-leakage (µg/two eye balls) of the control group instilled with physiological saline was 34.5 µg but that of the israpafant instillation group and oral administration group was 24.7 µg and 25.3 µg, respectively. Thus, they did not show a significant suppressive effect. The dye-leakage of the mepyramine administration group was 17.5 µg, thus showing significant suppression of promotion of vascular permeability. In contrast, concurrent instillation group and oral concurrent group showed less (11.0 µg and 10.1 µg, respectively) dye-leakage than the single administration group, thus significantly suppressing promotion of vascular permeability.

[0067] From the above results, it was suggested that israpafant was useful against early phase reaction when used concurrently with an antihistamic agent, because PAF is involved in the early phase reaction of allergic conjunctivitis.

2) Suppressive effect (early phase reaction) against immediate allergic conjunctivitis signs

[0068] The total score of conjunctivitis signs at 20 minutes after the second challenge is shown in Fig. 3. In Fig. 3, each column means mean ±standard error (n=8). Significant difference from control group at *;p<0.05 (Wilcoxon test).

[0069] When compared to the total score of the physiological saline instilled control group, 1% israpafant instillation group showed significant decrease in the total score.

[0070] From the above results, it was suggested that israpafant alleviated the conjunctivitis signs of immediate type allergy.

3) Suppressive effect (late phase reaction) against eosinophil infiltration into conjunctiva

[0071] The conjunctival eosinophil infiltration count at 6 hours after the second challenge is shown in Fig. 4. In Fig. 4, each column means mean±standard error (n=16). Significant difference from control group at *; p<0.05 (Dunnett's test).

[0072] The eosinophil infiltration count (cell/0.04 mm²) of the control group was 95.3, but it was 71.8 in the israpafant instillation group, showing significant suppression of eosinophil infiltration. In contrast, the oral group showed no suppressive effect. In addition, the mepyramine group, the concurrent instillation group and concurrent oral administration group showed suppressive effect, but the effect of each group was almost the same, and no effect from the concurrent use of israpafant was found.

[0073] From the above results, it was suggested that israpafant was useful against late phase reaction in view of significant suppression of eosinophil infiltration by single instillation. However, no effect was found by oral administration.

15 **Experimental Example 3**

1. Object

[0074] The effect was studied when used as an eye drop of israpafant against rat PAF conjunctivitis.

2. Animal used

[0075] Male Wistar rats weighing about 130 g purchased from Clea Japan, Inc. were used. They were bred at temperature 23±2°C and humidity 55±15%.

3. Test drug

[0076] Israpafant was suspended at 0.03, 0.1, 0.3 and 1.0%. Physiological saline was used for the control group.

[0077] The formulation of the vehicle for an israpafant eye drop was as shown below, wherein the pH of the eye drop at each concentration was 7.0.

sodium dihydrogenphosphate • 2H ₂ O	0.1 g
sodium chloride	0.9 g
polysorbate 80	0.1 g
distilled water	100 ml in total

4. Test method

[0078] PAF diluted to 4 µg/ml was administered to the upper subconjunctiva of the rat by 25 µl and at the same time, 0.5% Evans' blue (0.5 ml) was intravenously administered. Thirty minutes later, the dye-leakage part of the conjunctiva was excised and the dye was extracted with formamide, after which absorbance (625 nm) was measured. The test drug was administered by instillation (5 µl) to the eye at 1, 2 hours before subconjunctival induction of PAF.

5. Results and Discussion

[0079] The dye-leakage of each group is shown in Table 3.

Table 3

drug	concentration (%)	dose (µg)	n	amount of dye leakage (µg/site)	inhibition (%)
physiological saline	-	-	8	40.03±2.57	-
israpafant	0.03	3	8	32.29±3.31	19.1
	0.1	10	8	28.17±1.42*	29.6
	0.3	30	7	23.37±2.56*	41.6
	1.0	100	7	18.74±2.20*	53.2

Each value represents the mean±standard error.
Significant difference from physiological saline at *; p<0.01 (Dunnett's test).

[0080] The dye-leakage of the control group was 40.0 µg/site but israpafant showed a concentration-dependent suppressive effect, wherein the suppressive percentage at 0.03% - 1.0% concentration was 19.1%, 29.6%, 41.6% and 53.2%, showing significant difference at a concentration of 0.1% or greater. From the above results, israpafant showed a concentration-dependent suppressive effect against promotion of vascular permeability at conjunctival local site by PAF, demonstrating good penetration into a tissue of the present preparation.

Experimental Example 4

1. Object

[0081] The stability of israpafant suspension was studied.

2. Drug and reagent

[0082] Polysorbate 80 used met the standard of the Japan Pharmacopoeia.

3. Test method

[0083] The following israpafant suspension formulation was prepared. Polysorbate 80 was used as the suspending agent, phosphate buffer (pH 7) was used as the buffer, and sodium chloride was used as the isotonicizing agent. The suspension was filled in glass ampoules by 5 ml and stored at 25, 40 and 60°C. The suspension was sampled with time (3 days later, one week later, 2 weeks later) and israpafant content was quantitatively determined by HPLC.

israpafant	0.1 g
polysorbate 80	0.1 g
sodium dihydrogenphosphate • 2H ₂ O	0.1 g
sodium chloride	0.9 g
distilled water	100 ml in total

Quantitative Determination of israpafant - by HPLC

HPLC conditions

[0084]

column: YMCAM-302 (4.6×150 mm)

EP 1 004 309 A1

mobile phase: acetonitrile:0.1M ammonium acetate=87:13
 detection: UV 244 nm
 column temperature:35°C
 flow rate: 0.7 ml/min
 5 internal standard:1,3,5-triphenyl benzene

4. Results and Discussion

[0085] The results are shown in Table 4.

Table 4

temperature (°C)	residual content (%)			
	initial	3 days later	1 week later	2 weeks later
25	100.0 (pH 6.97)	-	-	101.4 (pH 6.94)
40		-	-	99.7 (pH 6.94)
60		97.3 (pH 6.96)	97.3 (pH 6.97)	100.3 (pH 6.96)
80		99.3 (pH 6.97)	-	-

[0086] As is evident from the Table, the 0.1% israpafant suspension after storage at 60°C for 2 weeks showed an israpafant residual content of 100.3%. The residual content after storage at 80°C for 3 days was 99.3%, demonstrating the stability of the 0.1% israpafant dispersion.

Example 1 (Formulation Example of eye drop)

[0087] Using the following ingredients, sodium dodecylsulfate, polysorbate 80, sodium dihydrogenphosphate dihydrate, boric acid and benzalkonium chloride were dissolved in sterile purified water. Using a pH adjusting agent, the pH was adjusted to about 7. Israpafant was added and the mixture was heated to about 70°C to allow dissolution. After cooling, the pH adjusting agent was used again to adjust the pH 7 to give an eye drop.

israpafant	0.1 g
sodium dodecylsulfate	0.65 g
polysorbate 80	3.25 g
sodium dihydrogenphosphate dihydrate	0.1 g
boric acid	1.6 g
benzalkonium chloride	0.005 g
sodium hydroxide	q.s.
sterile purified water	amount to make the total amount 100 ml
pH	7.0

Example 2 (Formulation Example of nasal drop)

[0088] Using the following ingredients and in the same manner as in Example 1, a nasal drop was obtained.

israpafant	0.05 g
------------	--------

EP 1 004 309 A1

(continued)

5

polysorbate 80	4.0 g
sodium dihydrogenphosphate dihydrate	0.1 g
sodium chloride	0.9 g
benzalkonium chloride	0.01 g
sodium hydroxide	q.s.
sterile purified water	amount to make the total amount 100 ml
pH	8.0

10

Example 3 (Formulation Example of eye drop)

15

[0089] Using the following ingredients and in the same manner as in Example 1, an eye drop was obtained.

20

israpafant	0.05 g
sodium octanesulfonate	0.5 g
polysorbate 80	3.35 g
sodium dihydrogenphosphate dihydrate	0.1 g
sodium chloride	0.9 g
benzalkonium chloride	0.005 g
sodium hydroxide	q.s.
sterile purified water	amount to make the total amount 100 ml
pH	7.0

25

30

Example 4 (Formulation Example of eye drop)

[0090] Using the following ingredients and in the same manner as in Example 1, an eye drop was obtained.

40

israpafant	0.05 g
sodium pentanesulfonate	0.5 g
polysorbate 80	4.15 g
sodium dihydrogenphosphate dihydrate	0.1 g
conc. glycerol	2.6 g
benzalkonium chloride	0.005 g
sodium hydroxide	q.s.
sterile purified water	amount to make the total amount 100 ml
pH	7.0

45

50

55

Example 5 (Formulation Example of eye drop)

[0091] Using the following ingredients and in the same manner as in Example 1, an eye drop was obtained.

EP 1 004 309 A1

5

israpafant	0.1 g
SDS	0.65 g
polysorbate 80	3.25 g
sodium acetate	0.1 g
sodium chloride	0.9 g
methyl p-hydroxybenzoate	0.026 g
propyl p-hydroxybenzoate	0.014 g
hydrochloric acid	q.s.
sterile purified water	amount to make the total amount 100 ml
pH	5.0

10

15

20 **Example 6**

[0092]

25

israpafant	0.1 g
polysorbate 80	0.1 g
monosodium phosphate dihydrate	0.1 g
sodium chloride	0.9 g
benzalkonium chloride	0.005 g
sodium hydroxide	appropriate amount
sterile purified water	amount to make the total amount 100 ml
pH	7.0

30

35

40 **Example 7**

[0093]

45

israpafant	1.0 g
HPMC	0.001 g
sodium dihydrogenphosphate dihydrate	0.1 g
sodium chloride	0.9 g
benzalkonium chloride	0.005 g
sodium hydroxide	appropriate amount
sterile purified water	amount to make the total amount 100 ml
pH	7.0

50

55

Example 8

[0094]

5

israpafant	0.1 g
HCO-60	0.1 g
sodium dihydrogenphosphate dihydrate	0.1 g
sodium chloride	0.9 g
benzalkonium chloride	0.005 g
sodium hydroxide	appropriate amount
sterile purified water	amount to make the total amount 100 ml
pH	7.0

10

15

20 Example 9

[0095]

25

israpafant	1.0 g
HPMC	0.01 g
sodium dihydrogenphosphate dihydrate	0.1 g
sodium chloride	0.9 g
methyl p-hydroxybenzoate	0.026 g
propyl p-hydroxybenzoate	0.014 g
sodium hydroxide	appropriate amount
sterile purified water	amount to make the total amount 100 ml
pH	5.0

30

35

40

Example 10

[0096]

45

israpafant	1.0 g
HPMC	0.01 g
boric acid	1.6 g
benzalkonium chloride	0.005 g
sodium hydroxide	appropriate amount
sterile purified water	amount to make the total amount 100 ml
pH	7.0

50

55

EP 1 004 309 A1

Example 11

[0097]

5

israpafant	0.1 g
tyloxapol	0.1 g
sodium dihydrogenphosphate dihydrate	0.1 g
sodium chloride	0.9 g
benzalkonium chloride	0.005 g
sodium hydroxide	appropriate amount
sterile purified water	amount to make the total amount 100 ml
pH	7.0

10

15

20 Example 12

[0098]

25

israpafant	0.1 g
SDS	0.001 g
sodium dihydrogenphosphate dihydrate	0.1 g
boric acid	1.6 g
benzalkonium chloride	0.005 g
sodium hydroxide	appropriate amount
sterile purified water	amount to make the total amount 100 ml
pH	7.0

30

35

40 Example 13

[0099]

45

israpafant	1.0 g
methylcellulose	0.001 g
sodium dihydrogenphosphate dihydrate	0.1 g
sodium chloride	0.9 g
benzalkonium chloride	0.005 g
sodium hydroxide	appropriate amount
sterile purified water	amount to make the total amount 100 ml
pH	7.0

50

55

Example 14

[0100]

5

10

15

20

israpafant	0.1 g
methylcellulose	0.1 g
sodium acetate	0.1 g
conc. glycerol	2.6 g
methyl p-hydroxybenzoate	0.026 g
propyl p-hydroxybenzoate	0.014 g
chlorobutanol	0.2 g
sodium hydroxide	appropriate amount
sterile purified water	amount to make the total amount 100 ml
pH	5.0

Example 15

25 [0101]

30

35

40

israpafant	0.1 g
sucrose fatty acid ester	0.05 g
sodium dihydrogenphosphate dihydrate	0.1 g
sodium chloride	0.9 g
benzalkonium chloride	0.005 g
sodium hydroxide	appropriate amount
sterile purified water	amount to make the total amount 100 ml
pH	7.0

Example 16

[0102]

45

50

55

israpafant	0.1 g
polysorbate 80	0.005 g
PVP K30	0.2 g
sodium dihydrogenphosphate dihydrate	0.1 g
sodium chloride	0.9 g
benzalkonium chloride	0.005 g
sodium hydroxide	appropriate amount

(continued)

sterile purified water	amount to make the total amount 100 ml
pH	7.0

5

Example 17**[0103]**

10

israpafant	1.0 g
HPMC(2910)	0.004 g
sodium dihydrogenphosphate dihydrate	0.1 g
sodium chloride	0.9 g
benzalkonium chloride	0.005 g
sodium hydroxide	appropriate amount
sterile purified water	amount to make the total amount 100 ml
pH	7.0

15

20

25 Industrial Applicability

[0104] The aqueous agent of the present invention shows superior therapeutic effect when locally administered as an eye drop or a nasal drop for allergic conjunctivitis, allergic rhinitis, venal conjunctivitis, conjunctival allergy caused by contact lens (giant papillary conjunctivitis), phlyctenular conjunctivitis, contact blepharoconjunctivitis, Sjögren's syndrome, multiple corneal infiltration, keratitis disciformis, stromal keratitis, endothelium keratitis, episcleritis, scleritis, uveitis, retinal vasculitis, papillary vasulitis, optic neuritis, eosinophilic granuloma, rejection associated with keratoplasty, eye itching, sneeze, nose itching, hypersensitivity of the nose, nose vestibule eczema, anterior rhinitis sicca, nasal obstruction and the like.

30

[0105] This application is based on patent application Nos. 137061/1997 and 154474/1997 filed in Japan, the contents of which are hereby incorporated by reference.

35

Claims

1. An aqueous agent containing israpafant, which is expressed by the formula (I):

40

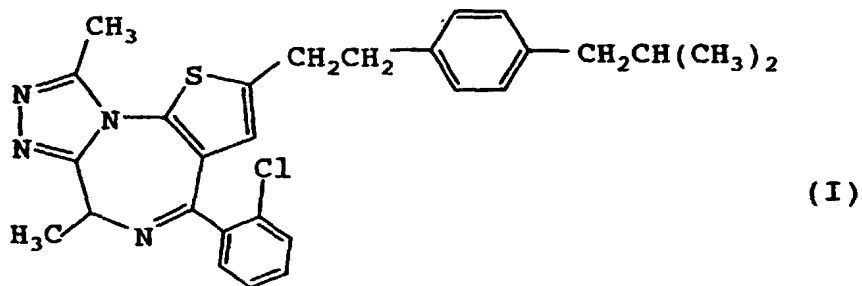

45

50

2. The aqueous agent of claim 1, wherein the israpafant (I) has a concentration of not less than 0.01 w/v%.

55

3. The aqueous agent of claim 2, wherein the aqueous agent is an eye drop or nasal drop.

4. The aqueous agent of claim 3, wherein the eye drop or nasal drop is an aqueous solution containing israpafant (I).
5. The aqueous agent of claim 4, wherein the israpafant (I) has a concentration of 0.01 - 0.1 w/v%.
- 5 6. The aqueous agent of claim 5, further comprising a surfactant.
7. The aqueous agent of claim 6, wherein the surfactant has a concentration of 0.5 - 10 w/v%.
8. The aqueous agent of claim 7, wherein the surfactant is at least one member selected from the group consisting of
10 a cationic surfactant, an anionic surfactant and a nonionic surfactant.
9. The aqueous agent of claim 3, wherein the eye drop or nasal drop is a suspension containing israpafant (I).
10. The aqueous agent of claim 9, wherein the israpafant has a concentration of 0.01 - 2 w/v%.
- 15 11. The aqueous agent of claim 10, further comprising a suspending agent.
12. The aqueous agent of claim 11, wherein the suspending agent is at least one member selected from a surfactant
and a water soluble polymer.
- 20 13. The aqueous agent of claim 12, wherein the surfactant has a concentration of 0.0001 - 0.1 w/v%.
14. The aqueous agent of claim 13, wherein the surfactant is at least one member selected from a nonionic surfactant
and an anionic surfactant.
- 25 15. The aqueous agent of claim 12, wherein the water soluble polymer has a concentration of 0.00001 - 0.5 w/v%.
16. The aqueous agent of claim 15, wherein the water soluble polymer is a water soluble cellulose derivative.
- 30 17. The aqueous agent of claim 16, wherein the water soluble cellulose derivative is at least one cellulose derivative
selected from hydroxypropylmethylcellulose, carboxymethylcellulose and methylcellulose.
18. The aqueous agent of claim 17, wherein the agent comprises israpafant (I) in a proportion of 0.1 - 1 w/v% and
hydroxypropylmethylcellulose in the weight ratio to israpafant (I) of 0.001 - 0.01:1.
- 35 19. A method for producing an aqueous solution of israpafant, comprising dissolving israpafant of the formula (I):

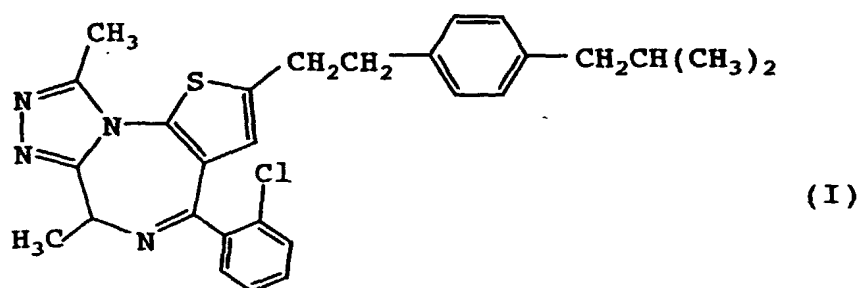

50 in water in the presence of a surfactant.

20. A method for producing a suspension of israpafant, comprising suspending israpafant of the formula (I):

55

5

10

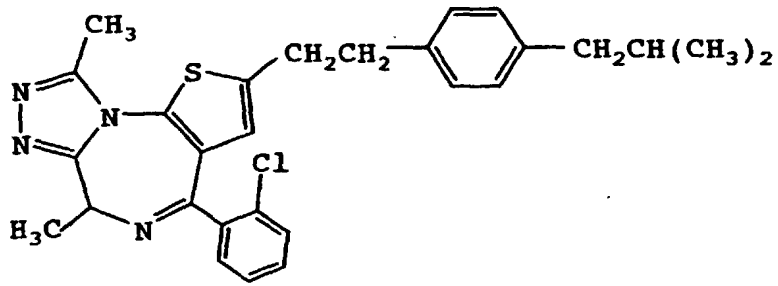

(I)

15

in water in the presence of a suspending agent.

20

25

30

35

40

45

50

55

FIG. 1

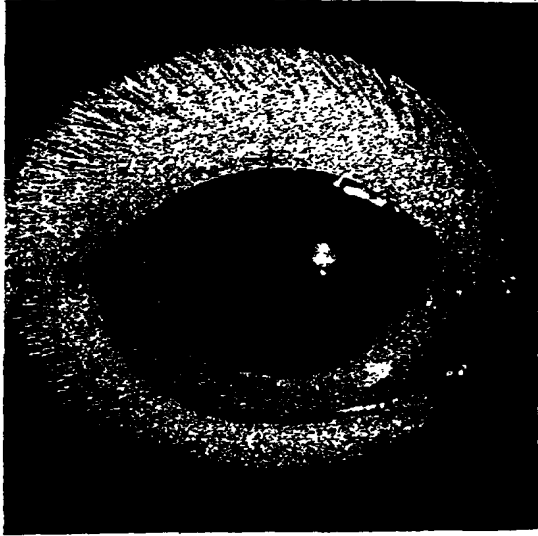

A

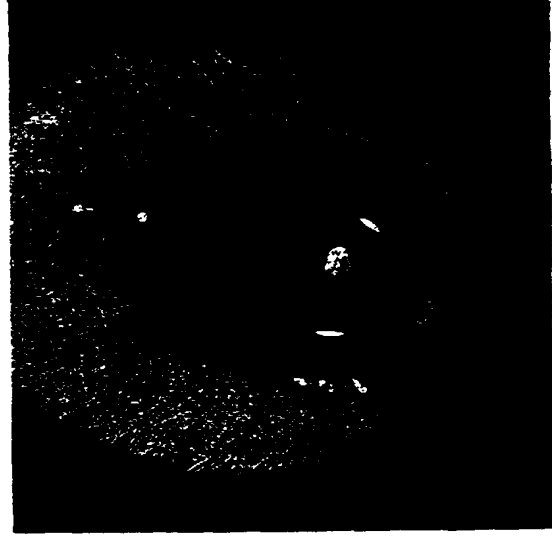

B

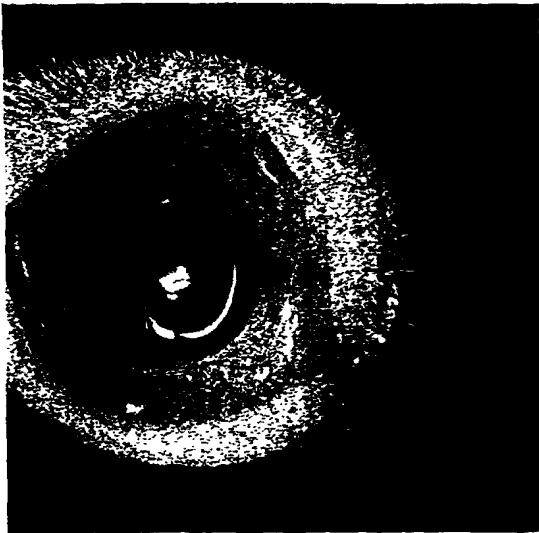

C



D

FIG.2

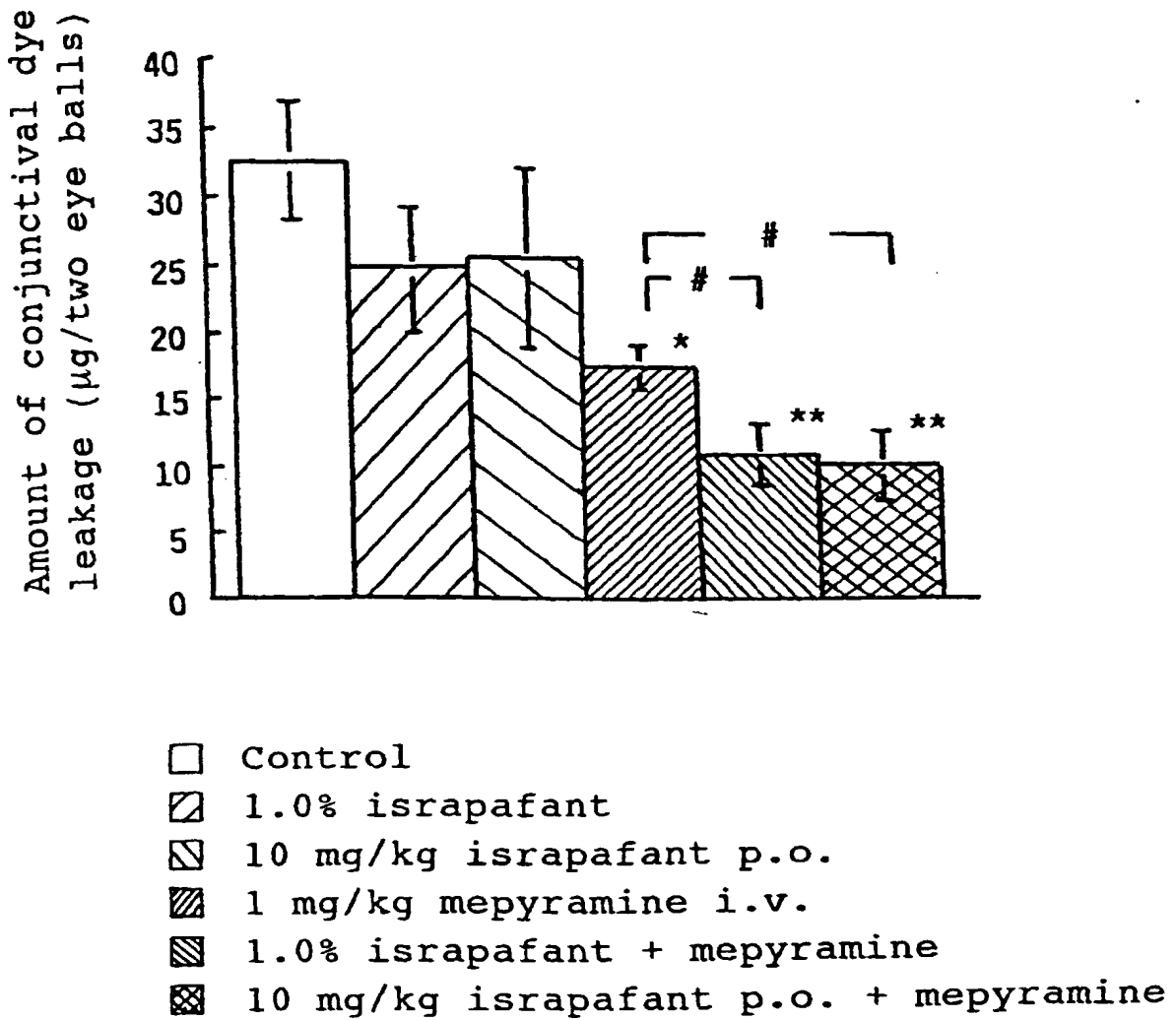

FIG.3

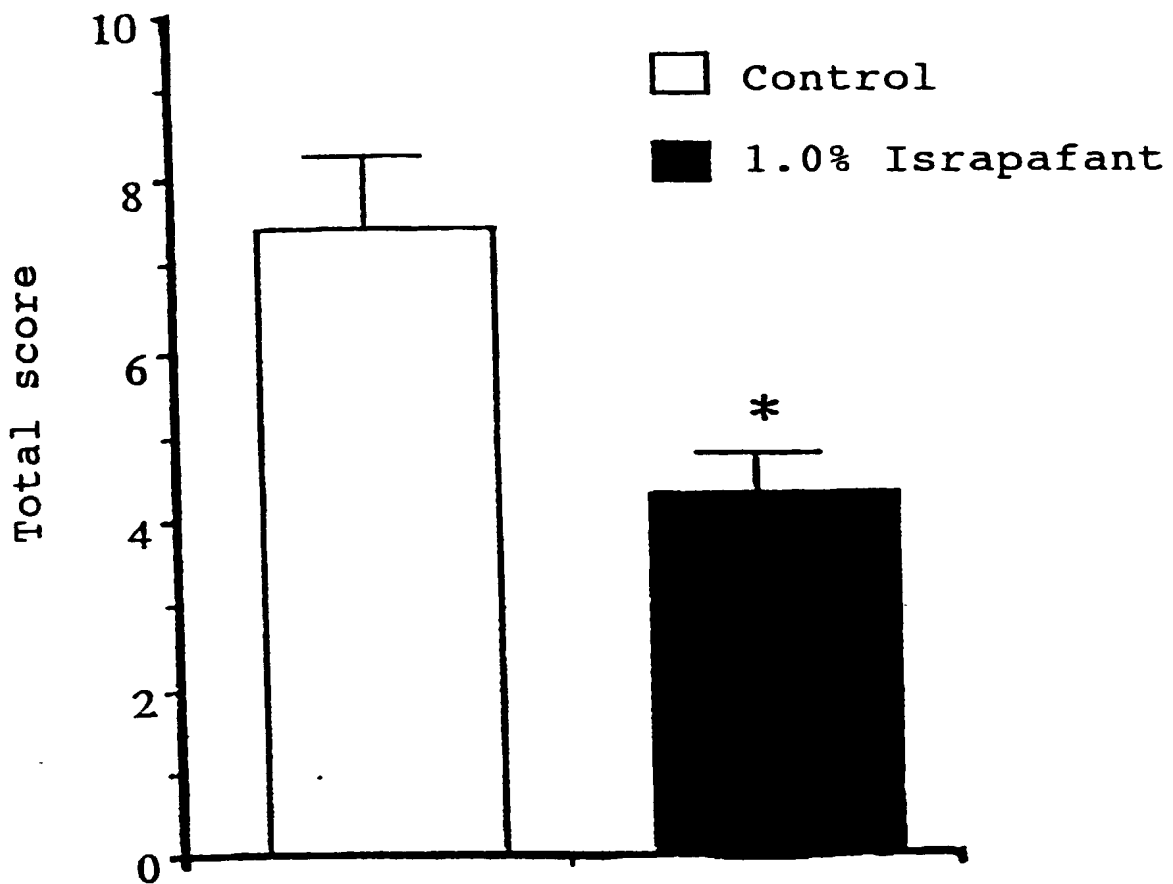
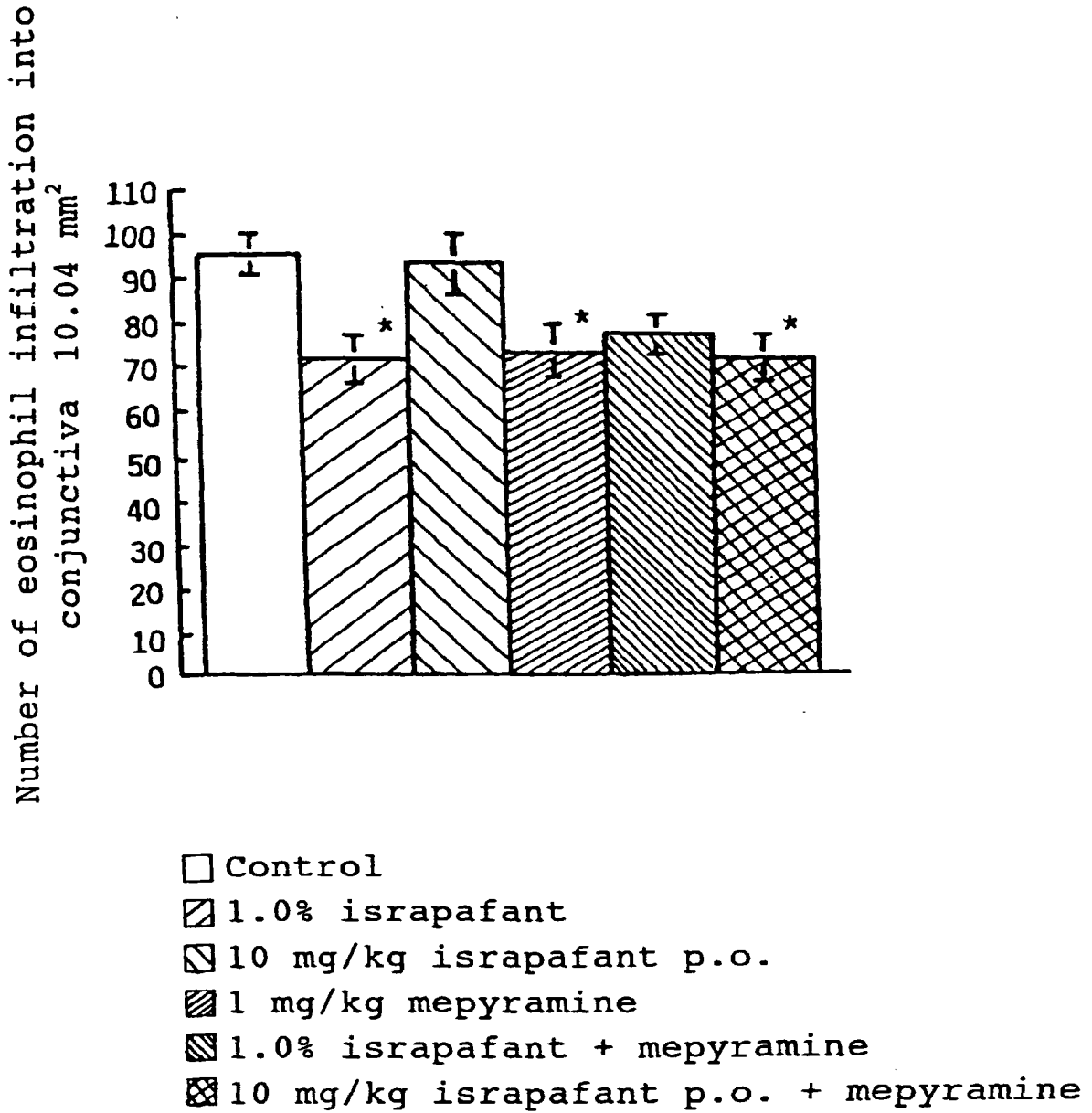

FIG.4



INTERNATIONAL SEARCH REPORT

International application No.

PCT/JP98/02275

A. CLASSIFICATION OF SUBJECT MATTER Int.Cl ⁶ A61K31/55 // C07D495/14		
According to International Patent Classification (IPC) or to both national classification and IPC		
B. FIELDS SEARCHED		
Minimum documentation searched (classification system followed by classification symbols) Int.Cl ⁶ A61K31/40-31/405, 31/55-31/57, C07D495/14		
Documentation searched other than minimum documentation to the extent that such documents are included in the fields searched Jitsuyo Shinan Koho 1926-1998 Toroku Jitsuyo Shinan Koho 1994-1998 Kokai Jitsuyo Shinan Koho 1971-1998		
Electronic data base consulted during the international search (name of data base and, where practicable, search terms used) CA (STN), REG (STN)		
C. DOCUMENTS CONSIDERED TO BE RELEVANT		
Category*	Citation of document, with indication, where appropriate, of the relevant passages	Relevant to claim No.
X Y	JP, 4-108732, A (Yu Mizushima), April 9, 1992 (09. 04. 92), Claims ; page 1, lower right column, lines 2 to 16 ; page 2, upper left column, lines 4, 5 ; page 3, upper right column, lines 15 to 18, Example 1 (Family: none)	1, 2 3-20
Y	JP, 5-55510, B2 (Yoshitomi Pharmaceutical Industries, Ltd.), August 17, 1993 (17. 08. 93), Claims ; page 16, right column, lines 12 to 25 ; Example 13 & EP, 268242, A1	1-20
Y	JP, 5-155770, A (Fujisawa Pharmaceutical Co., Ltd.), June 22, 1993 (22. 06. 93), Claims 1 to 4 ; page 4, right column, lines 20, 21 ; page 7, left column, line 43 to right column, line 9 & EP, 484936, A1	1-3, 9-14, 20
<input checked="" type="checkbox"/> Further documents are listed in the continuation of Box C. <input type="checkbox"/> See patent family annex.		
* Special categories of cited documents: "A" document defining the general state of the art which is not considered to be of particular relevance "E" earlier document but published on or after the international filing date "L" document which may throw doubts on priority claim(s) or which is cited to establish the publication date of another citation or other special reason (as specified) "O" document referring to an oral disclosure, use, exhibition or other means "P" document published prior to the international filing date but later than the priority date claimed		"I" later document published after the international filing date or priority date and not in conflict with the application but cited to understand the principle or theory underlying the invention "X" document of particular relevance; the claimed invention cannot be considered novel or cannot be considered to involve an inventive step when the document is taken alone "Y" document of particular relevance; the claimed invention cannot be considered to involve an inventive step when the document is combined with one or more other such documents, such combination being obvious to a person skilled in the art "&" document member of the same patent family
Date of the actual completion of the international search August 14, 1998 (14. 08. 98)		Date of mailing of the international search report August 25, 1998 (25. 08. 98)
Name and mailing address of the ISA/ Japanese Patent Office		Authorized officer
Facsimile No.		Telephone No.

Form PCT/ISA/210 (second sheet) (July 1992)

INTERNATIONAL SEARCH REPORT

International application No.
PCT/JP98/02275

C(Continuation). DOCUMENTS CONSIDERED TO BE RELEVANT		
Category*	Citation of document, with indication, where appropriate, of the relevant passages	Relevant to claim No.
Y	JP, 8-217678, A (Senju Pharmaceutical Co., Ltd.), August 27, 1996 (27. 08. 96), Claims ; page 2, right column, lines 14 to 20 ; page 3, left column, lines 6 to 29 (Family: none)	1-3, 9-12, 15-18, 20
Y	JP, 7-277980, A (SYNTHELABO), October 24, 1995 (24. 10. 95), Claims ; page 2, left column, line 42 to right column, line 12 ; page 4, right column, lines 14 to 16 & EP, 669131, A1	1-8, 19

Form PCT/ISA/210 (continuation of second sheet) (July 1992)

(19)



(11)

EP 1 231 920 B1

(12)

EUROPÄISCHE PATENTSCHRIFT

(45) Veröffentlichungstag und Bekanntmachung des Hinweises auf die Patenterteilung:
07.02.2007 Patentblatt 2007/06

(51) Int Cl.:
A61K 31/55 (2006.01) **A61K 9/08** (2006.01)
A61P 11/02 (2006.01) **A61P 27/14** (2006.01)
A61P 27/02 (2006.01)

(21) Anmeldenummer: **00972763.7**

(86) Internationale Anmeldenummer:
PCT/EP2000/010122

(22) Anmeldetag: **14.10.2000**

(87) Internationale Veröffentlichungsnummer:
WO 2001/035962 (25.05.2001 Gazette 2001/21)

(54) **VERWENDUNG VON EPINASTIN ZUR BEHANDLUNG VON ALLERGISCHER RHINITIS/ KONJUNKTIVITIS**

USE OF EPINASTIN FOR THE TREATMENT OF ALLERGIC RHINITIS/CONJUNCTIVITIS

UTILISATION DE L'EPINASTINE POUR LE TRAITEMENT DE LA RHINITE/CONJONCTIVITE ALLERGIQUE

(84) Benannte Vertragsstaaten:
AT BE CH CY DE DK ES FI FR GB GR IE IT LI LU MC NL PT SE
Benannte Erstreckungsstaaten:
LT LV RO SI

(73) Patentinhaber: **Boehringer Ingelheim International GmbH**
55216 Ingelheim (DE)

(30) Priorität: **12.11.1999 DE 19954516**

(72) Erfinder:
• **TRACH, Volker**
88400 Biberach an der Riss (DE)
• **DUSCHLER, Gerold**
89584 Ehingen (DE)

(43) Veröffentlichungstag der Anmeldung:
21.08.2002 Patentblatt 2002/34

(56) Entgegenhaltungen:
EP-A- 0 903 151 **WO-A-97/17971**

EP 1 231 920 B1

Anmerkung: Innerhalb von neun Monaten nach der Bekanntmachung des Hinweises auf die Erteilung des europäischen Patents kann jedermann beim Europäischen Patentamt gegen das erteilte europäische Patent Einspruch einlegen. Der Einspruch ist schriftlich einzureichen und zu begründen. Er gilt erst als eingelegt, wenn die Einspruchsgebühr entrichtet worden ist. (Art. 99(1) Europäisches Patentübereinkommen).

Beschreibung

[0001] Die Erfindung betrifft die Verwendung topisch applizierbarer wässriger Lösungen enthaltend Epinastin, gegebenenfalls in Form seines Racemats, seiner Enantiomere, sowie gegebenenfalls in Form seiner pharmakologisch unbedenklichen Säureadditionssalze.

Hintergrund der Erfindung

[0002] Unter allergischen Reaktionen des Auges (im folgenden okulare allergische Reaktionen) sind eine Reihe unterschiedlich definierter Krankheitsbilder zu verstehen. Als okulare allergische Reaktionen seien beispielsweise genannt: saisonale allergische Konjunktivitis, perenniale allergische Konjunktivitis, Riesenzellen-Konjunktivitis, vemale Keratokonjunktivitis oder auch atopische Keratokonjunktivitis. Als Beispiele für allergische Reaktionen der Nase (im folgenden nasale allergische Reaktionen) seien beispielsweise die saisonale allergische Rhinitis sowie die perenniale allergische Rhinitis erwähnt.

[0003] Der immunologische Mechanismus, der okularen und nasalen allergischen Reaktionen zugrundeliegt umfaßt u.a. Histamin-bedingte Entzündungsprozesse. Die durch die Freisetzung von Histamin bedingten allergischen Reaktionen treten bereits im Frühstadium der eingangs genannten okularen und nasalen allergischen Reaktionen auf. Ferner können okularen und nasalen allergischen Reaktionen ursächlich die Freisetzung weiterer Mastzellen-Mediatoren sowie toxischer eosinophiler Granula-Proteine und Enzyme zugrunde liegen. Der Zustrom von Neutrophilen und Eosinophilen in das Gewebe der Bindehaut des Auges sowie der Nasenschleimhaut führt dabei zu einer späteren Reaktion (Late-Phase-Reaktion, im folgenden LPR). LPR tritt üblicherweise in einem Zeitraum von 3-6 Stunden nach der anfänglichen Histamin-vermittelten allergischen Reaktion auf. LPR ist unter anderem durch das Auftreten von Vasodilatation und Chemosis sowie durch Anschwellen der Conjunctiva (Bindehaut des Auges) sowie der Nasenschleimhaut gekennzeichnet.

[0004] Während durch Applikation von Antihistaminika den Histamin-bedingten allergischen Reaktionen entgegenwirkt werden kann, bleibt der Zustrom von Neutrophilen und Eosinophilen in das Gewebe der Bindehaut des Auges sowie der Nasenschleimhaut durch Gabe von reinen Antihistaminika unbeeinflusst.

Aufgabe der Erfindung

[0005] Es ist daher Aufgabe der vorliegenden Erfindung, die Verwendung topisch applizierbarer Lösungen bereitzustellen, die den Zustrom von Neutrophilen und Eosinophilen in das Gewebe der Bindehaut des Auges sowie der Nasenschleimhaut hemmen, das Auftreten von LPR bei allergischer Rhinitis und Konjunktivitis dadurch vermindern oder verhindern und dementsprechend durch eine länger anhaltende Wirkdauer gekennzeichnet sind.

Detailliertere Beschreibung der Erfindung

[0006] Überraschenderweise wurde gefunden, daß topisch applizierbare wässrige Lösungen enthaltend Epinastin, gegebenenfalls in Form seines Racemats, seiner Enantiomere, sowie gegebenenfalls in Form seiner pharmakologisch unbedenklichen Säureadditionssalze, zur Lösung der der Erfindung zugrunde liegenden Aufgabe Verwendung finden können, da sie den Zustrom von Neutrophilen und Eosinophilen in das Gewebe der Bindehaut des Auges sowie der Nasenschleimhaut hemmen, das Auftreten von LPR bei allergischer Rhinitis und Konjunktivitis dadurch vermindern oder verhindern und dementsprechend durch eine länger anhaltende Wirkdauer gekennzeichnet sind.

[0007] Die Verbindung Epinastin (3-Amino-9,13b-dihydro-1H-dibenz-[c,f]imidazol[1,5-a]-azepin) sowie dessen Säureadditionssalze sind erstmals in der deutschen Patentanmeldung P 30 08 944.2 beschrieben.

[0008] Die Wirkung der topische applizierbaren Epinastin-haltigen Lösungen als Inhibitoren des Eosinophilen und Neutrophilen Zustroms wurde anhand des sogenannten "Passive-Ocular-Anaphylaxis"-Modells in Ratten demonstriert.

Versuchsbeschreibung:

[0009] 72 Stunden nach Sensibilisierung der Ratten durch Injektion von Antiserum in die Augenlider der Testtiere wurde in diesen durch i.v.-Gabe von Ovalbumin eine erneute Provokation induziert. Ein Teil der Versuchstiere wurde 15 Minuten vor der Ovalbumingabe durch Applikation von erfindungsgemäßer Epinastin-haltiger Lösung in den Bindehautsack vorbehandelt. Zwei Stunden nach der Ovalbumingabe wurden die Versuchstiere getötet und die Bindehaut auf den Gehalt an Eosinophilen und Neutrophilen untersucht sowie die Mastzellengranulation bestimmt.

Ergebnis:

[0010] Die mit erfindungsgemäßer Epinastin-Lösung (0,05-0,5%) vorbehandelten Tiere wiesen in der Bindehaut einen deutlich geringeren Gehalt an Eosinophilen auf.

5 Die mit erfindungsgemäßer Epinastin-Lösung vorbehandelten Tiere wiesen in der Bindehaut einen deutlich geringeren Gehalt an Lymphocyten auf ($p < 0.01$).

[0011] In den mit erfindungsgemäßer Epinastin-Lösung vorbehandelten Tieren wurde eine etwa 35%-ige Inhibition der Mastzellen Degranulation bestimmt ($p < 0.01$).

10 **[0012]** Die Erfindung betrifft folglich die Verwendung topisch applizierbarer wässriger Lösungen enthaltend Epinastin, gegebenenfalls in Form seines Racemats, seiner Enantiomere, sowie gegebenenfalls in Form seiner pharmakologisch unbedenklichen Säureadditionssalze, in einer Konzentration von 0,005 bis 0,5, bevorzugt 0,02 bis 0,1 besonders bevorzugt 0,03 bis 0,07 mg/ml Lösung.

[0013] Erfindungsgemäß bevorzugt ist die Verwendung vorstehend genannter topisch applizierbarer wässriger Lösungen enthaltend Epinastin-Hydrochlorid.

15 **[0014]** Geeignete wässrige Lösemittel sind physiologisch verträgliche wässrige Lösemittel, besonders bevorzugt sind physiologisch verträgliche Kochsalzlösungen.

20 **[0015]** Erfindungsgemäß werden vorzugsweise topisch applizierbare Lösungen hergestellt, die typischerweise 0,005 bis 0,5, bevorzugt 0,02 bis 0,1 besonders bevorzugt 0,03 bis 0,07 mg/ml Epinastin, gegebenenfalls in Form seines Racemats, seiner Enantiomere, sowie gegebenenfalls in Form seiner pharmakologisch unbedenklichen Säureadditionssalze, sowie physiologische Kochsalzlösungen als Hauptträger enthalten. Der pH-Wert der erfindungsgemäßen Lösungen sollte mit einem geeigneten Puffersystem vorzugsweise im Bereich von 6,5 - 7,2 gehalten werden. Die Präparate können ferner herkömmliche, pharmazeutisch verträgliche Hilfsstoffe, Konservierungsmittel, Stabilisatoren und/oder Penetrationsverstärker enthalten.

25 **[0016]** Der bevorzugte Träger, der in den erfindungsgemäßen Lösungen verwendet werden kann, ist gereinigtes Wasser und vorzugsweise eine physiologische Kochsalzlösung.

[0017] Zu den erfindungsgemäß einsetzbaren Hilfsstoffen gehören, ohne den Gegenstand der Erfindung auf selbige zu beschränken, Viskositätsmittel wie Polyvinylalkohol, Povidone, Hydroxypropylmethylcellulose, Poloxamere, Carboxymethylcellulose, Carbomer und Hydroxyethylcellulose.

30 **[0018]** Zu bevorzugten Konservierungsmitteln, die in den erfindungsgemäßen Lösungen verwendet werden können, gehören, ohne den Gegenstand der Erfindung auf selbige zu beschränken, Benzalkoniumchlorid, Chlorbutanol, Thimerosal, Phenylquecksilberacetat und Phenylquecksilbernitrat.

35 **[0019]** Bei den Penetrationsverstärkern kann es sich beispielsweise um oberflächenaktive Mittel, um bestimmte organische Lösemittel wie Dimethylsulfoxid und andere Sulfoxide, Dimethylacetamid und Pyrrolidon, um bestimmte Amide von heterocyclischen Aminen, um Glykole wie Propylenglykol, um Propylencarbonat, um Ölsäure, um Alkylamine und Derivate davon, um verschiedene kationische, anionische, nicht-ionogene und amphotere oberflächenaktive Mittel und um dergleichen handeln.

[0020] Mittel zur Einstellung der tonischen Beschaffenheit können je nach Bedarf oder Zweckmäßigkeit zugesetzt werden. Hierzu gehören, ohne die Erfindung auf selbige zu beschränken, Salze und insbesondere Natriumchlorid, Kaliumchlorid, Mannit und Glycerin oder andere geeignete, physiologisch verträgliche Mittel zur Einstellung der Tonizität.

40 **[0021]** Verschiedene Puffer und Mittel zur Einstellung des pH-Werts können verwendet werden, sofern das erhaltene Präparat physiologisch verträglich ist. Zu entsprechenden Puffern gehören Acetatpuffer, Citratpuffer, Phosphatpuffer und Boratpuffer.

45 **[0022]** In ähnlicher Weise gehören zu physiologisch verträglichen Antioxidationsmitteln zur erfindungsgemäßen Verwendung, ohne die Erfindung auf selbige zu beschränken, Natriummetabisulfit, Natriumthiosulfat, Acetylcystein, butyliertes Hydroxyanisol und butyliertes Hydroxytoluol.

[0023] Weitere Trägerkomponenten, die den erfindungsgemäßen Lösungen einverleibt werden können, sind chelatbildende Mittel. Das bevorzugte chelatbildende Mittel ist Dinatriumedetat (Na-EDTA), wengleich auch andere chelatbildenden Mittel anstelle von oder in Verbindung mit Dinatriumedetat eingesetzt werden können.

50 **[0024]** Die vorstehend genannten topisch applizierbaren wässrigen Lösungen, können entweder auf die Bindehaut oder auf die Nasenschleimhaut aufgebracht werden. Lösungen zur opthalmischen Anwendung sind dabei für die vorliegende Erfindung von gleichrangiger Bedeutung wie nasal zu applizierende Lösungen.

[0025] Die vorliegende Erfindung zielt auf die Verwendung der vorstehend genannten topisch applizierbaren wässrigen Lösungen zur Hemmung des Zustroms von Neutrophilen und Eosinophilen in das Gewebe der Bindehaut des Auges oder Gewebe der Nasenschleimhaut.

55 **[0026]** Die vorliegende Erfindung zielt ferner auf die Verwendung von Epinastin, gegebenenfalls in Form seines Racemats, seiner Enantiomere, sowie gegebenenfalls in Form seiner pharmakologisch unbedenklichen Säureadditionssalze, zur Herstellung der erfindungsgemäßen topisch applizierbaren wässrigen Lösungen zur Behandlung von Störungen der Bindehaut des Auges oder der Nasenschleimhaut, in denen die Hemmung des Zustrom von Neutrophilen und

EP 1 231 920 B1

Eosinophilen in das Gewebe der Bindehaut des Auges oder der Nasenschleimhaut bei allergischen Reaktionen einen therapeutischen Nutzen beinhaltet.

[0027] Bevorzugt ist die vorstehend genannte Verwendung zur Hemmung von LPR, besonders bevorzugt zur Behandlung der einleitend genannten Erkrankungen.

5 **[0028]** Die in Tabelle 1 aufgeführten Beispiele erläutern die Erfindung ohne sie auf selbige zu beschränken.

10

15

20

25

30

35

40

45

50

55

55 50 45 40 35 30 25 20 15 10 5

Tabelle 1:

	Lösung 1 0.05% [g/100ml]	Lösung 2 0.01% [g/100ml]	Lösung 3 0.05% [g/100ml]	Lösung 4 0.10% [g/100ml]	Lösung 5 0.01% [g/100ml]	Lösung 6 0.05% [g/100ml]	Lösung 7 0.10% [g/100ml]
Epinastin-Hydrochlorid	0.0500	0.0100	0.0500	0.1000	0.0100	0.0500	0.1000
Na-EDTA	0.0500	0.0500	0.0500	0.0500	-	-	-
Natriumchlorid	0.5000	0.5000	0.5000	0.5000	0.5000	0.5000	0.5000
Natriumdihydrogenphosphat-Dihydrat	0.7800	0.7800	0.7800	0.7800	0.4100	0.4100	0.4100
Benzalkoniumchlorid	0.0101	0.0101	0.0101	0.0101	0.0101	0.0101	0.0101
Natriumhydroxid	0.0001	0.0001	0.0001	0.0001	-	-	-
Natriumdihydrogenphosphat-Dihydrat	-	-	-	-	0.6500	0.6500	0.6500
Hydroxyethylcellulose	-	-	-	-	0.1000	0.1000	0.1000
Wasser	99.4198	99.4598	99.4198	99.3698	99.0749	99.0349	99.9849
	100.8100	100.8100	100.8100	100.8100	100.7550	100.7550	100.7550

5

EP 1 231 920 B1

Patentansprüche

1. Verwendung einer Lösung bestehend aus:

- 5 a) Epinastin als aktivem Wirkstoff, gegebenenfalls in Form seines Racemats, seiner Enantiomere, sowie gegebenenfalls in Form seiner pharmakologisch unbedenklichen Säureadditionssalze, in einer Konzentration von 0,0005 bis 0,1 Gew.%,
 b) Wasser oder eine physiologische Kochsalzlösung als Lösungsmittel,
 10 c) einen Puffer zum Einstellen eines pH-Werts von 6,5 bis 7,2, gegebenenfalls durch Zugabe von Natriumhydroxid,
 d) einem Konservierungsmittel, und optional
 e) chelatbildende Mittel,
 15 f) Viskositätsmittel,
 g) Penetrationsverstärkern,
 h) Antioxidationsmitteln,
 i) und/oder physiologisch verträgliche Mittel zum Einstellen der Tonizität der Lösung.

zur Herstellung eines Medikaments zur topischen Applikation auf die Bindehaut oder Nasenschleimhaut zur Behandlung der späteren Reaktion (late phase reaction) bei allergischer Rhinitis oder Konjunktivitis.

2. Verwendung gemäß Anspruch 1, **dadurch gekennzeichnet, dass** der Wirkstoff Epinastin-Hydrochlorid ist.

3. Verwendung gemäß Anspruch 1 oder 2, **dadurch gekennzeichnet, dass** das Viskositätsmittel ausgewählt ist aus der Gruppe Polyvinylalkohol, Povidone, Hydroxypropylmethylcellulose, Poloxamere, Carboxymethylcellulose, Carboxymer und Hydroxyethylcellulose.

4. Verwendung gemäß einem oder mehreren der Ansprüche 1 bis 3, **dadurch gekennzeichnet, dass** das Konservierungsmittel ausgewählt ist aus der Gruppe Benzalkoniumchlorid, Chlorbutanol, Thimerosal, Phenylquecksilberacetat und Phenylquecksilbernitrat

5. Verwendung gemäß einem oder mehreren der Ansprüche 1 bis 4, **dadurch gekennzeichnet, dass** das Penetrationsverstärker ausgewählt ist aus der Gruppe Dimethylsulfoxid, Dimethylacetamid, Pyrrolidon, Propylenglykol, Propylencarbonat und Ölsäure.

6. Verwendung gemäß einem oder mehreren der Ansprüche 1 bis 5, **dadurch gekennzeichnet, dass** das Mittel zum Einstellen der Tonizität ausgewählt ist aus der Gruppe Natriumchlorid, Kaliumchlorid, Mannit und Glycerin.

7. Verwendung gemäß einem oder mehreren der Ansprüche 1 bis 6, **dadurch gekennzeichnet, dass** der Puffer ausgewählt ist aus der Gruppe Acetatpuffer, Citratpuffer, Phosphatpuffer und Boratpuffer.

8. Verwendung gemäß einem oder mehreren der Ansprüche 1 bis 7, **dadurch gekennzeichnet, dass** das Antioxidationsmittel ausgewählt ist aus der Gruppe Natriummetabisulfit, Natriumthiosulfat, Acetylcystein, butyliertes Hydroxyanisol und butyliertes Hydroxytoluol

9. Verwendung gemäß einem oder mehreren der Ansprüche 1 bis 8, **dadurch gekennzeichnet, dass** das chelatbildende Mittel Dinatriumedetat ist.

10. Verwendung gemäß einem oder mehreren der Ansprüche 1 bis 9, **dadurch gekennzeichnet, dass** Epinastinhydrochlorid als Wirkstoff in einer Menge von 0,05 bis 0,1 Gew.% verwendet wird.

11. Verwendung gemäß einem oder mehreren der Ansprüche 1 bis 9, **dadurch gekennzeichnet, daß** Epinastinhydrochlorid, als Wirkstoff in einer Menge von 0,005 bis 0,5 mg/ml verwendet wird.

55 12. Verwendung gemäß einem oder mehreren der Ansprüche 1 bis 10, **dadurch gekennzeichnet, dass** die Lösung aus Wasser als Lösungsmittel, Epinastin-Hydrochlorid, Natriumchlorid, Natriumhydrogenphosphat-dihydrat, Benzalkoniumchlorid, Hydroxyethylcellulose und optional Natrium-EDTA und Natriumhydroxid besteht.

Claims

1. Use of a solution consisting of:

- 5 a) epinastine as an active substance, optionally in the form of its racemate, its enantiomers, and optionally in the form of the pharmacologically acceptable acid addition salts thereof, in a concentration of 0.0005 to 0.1 wt.%,
 b) water or a physiological saline solution as solvent,
 c) a buffer for adjusting the pH to a value from 6.5 to 7.2, optionally by the addition of sodium hydroxide,
 d) a preservative,
 10 and optionally
 e) chelating agents,
 f) viscosity agents,
 g) penetration promoters,
 h) antioxidants,
 15 i) and/or physiologically acceptable agents for adjusting the tonicity of the solution,

for preparing a medicament for topical application to the conjunctiva or nasal mucosa for treating late phase reaction in allergic rhinitis or conjunctivitis.

- 20 2. Use according to claim 1, **characterised in that** the active substance is epinastine hydrochloride.
3. Use according to claim 1 or 2, **characterised in that** the viscosity agent is selected from among polyvinyl alcohol, povidone, hydroxypropylmethyl cellulose, poloxamers, carboxymethylcellulose, carbomer and hydroxyethyl cellulose.
- 25 4. Use according to one or more of claims 1 to 3, **characterised in that** the preservative is selected from among benalkonium chloride, chlorobutanol, thimerosal, phenyl mercury acetate and phenyl mercury nitrate.
- 30 5. Use according to one or more of claims 1 to 4, **characterised in that** the penetration promoter is selected from among dimethylsulphoxide, dimethylacetamide, pyrrolidone, propyleneglycol, propylene carbonate and oleic acid.
6. Use according to one or more of claims 1 to 5, **characterised in that** the agent for adjusting tonicity is selected from among sodium chloride, potassium chloride, mannitol and glycerol.
- 35 7. Use according to one or more of claims 1 to 6, **characterised in that** the buffer is selected from among acetate buffer, citrate buffer, phosphate buffer and borate buffer.
8. Use according to one or more of claims 1 to 7, **characterised in that** the antioxidant is selected from among sodium metabisulphite, sodium thiosulphate, acetylcysteine, butylated hydroxyanisole and butylated hydroxytoluene.
- 40 9. Use according to one or more of claims 1 to 8, **characterised in that** the chelating agent is disodium edentate.
10. Use according to one or more of claims 1 to 9, **characterised in that** the epinastine hydrochloride is used as active substance in an amount of from 0.05 to 0.1 wt.%.
- 45 11. Use according to one or more of claims 1 to 9, **characterised in that** the epinastine hydrochloride is used as active substance in an amount of from 0.005 to 0.5 mg/ml.
- 50 12. Use according to one or more of claims 1 to 11, **characterised in that** the solution consists of water as solvent, epinastine hydrochloride, sodium chloride, sodium hydrogen phosphate dehydrate, benzalkonium chloride, hydroxyethylcellulose and optionally sodium-EDTA and sodium hydroxide.

Revendications

1. Utilisation d'une solution consistant en:

- a) de l'epinastine comme principe actif, éventuellement sous forme de son racémate, de ses énantiomères,

EP 1 231 920 B1

ainsi éventuellement que sous forme de ses sels d'addition d'acide pharmacologiquement acceptables, en une concentration de 0.0005 en 0.1 % en masse,

b) de l'eau ou une solution physiologique de chlorure de sodium comme solvant,

c) un tampon pour l'ajustement d'un pH 6.5 à 7.2, éventuellement par addition d'hydroxyde de sodium,

d) un conservateur,

et éventuellement

e) des agents chélatants,

f) des agents de viscosité,

g) des renforcateurs de pénétration,

h) des antioxydants,

i) et/ou des agents physiologiquement acceptables pour l'ajustement de la tonicité de la solution,

pour la production d'un médicament pour l'application topique sur la conjonctive ou la muqueuse nasale pour le traitement de la réaction ultérieure (late phase reaction) dans le cas de la rhinite allergique ou de la conjonctivite.

2. Utilisation selon la revendication 1 **caractérisée en ce que** le principe actif est le chlorhydrate d'epinastine.
3. Utilisation selon la revendication 1 ou 2 **caractérisée en ce que** l'agent de viscosité est choisi dans le groupe poly (alcool vinylique), Povidone, hydroxypropylméthylcellulose, poloxamères, carboxyméthylcellulose, carbomère et hydroxyéthylcellulose.
4. Utilisation selon une ou plusieurs des revendications 1 à 3 **caractérisée en ce que** le conservateur est choisi dans le groupe chlorure de benzalkonium, chlorobutanol, thimérosal, acétate de phénylmercure et nitrate de phénylmercure.
5. Utilisation selon une ou plusieurs des revendications 1 à 4 **caractérisée en ce que** le renforcateur de pénétration est choisi dans le groupe diméthylsulfoxyde, diméthylacétamide, pyrrolidone, propylèneglycol, carbonate de propylène et acide oléique.
6. Utilisation selon une ou plusieurs des revendications 1 à 5 **caractérisée en ce que** l'agent pour l'ajustement de la tonicité est choisi dans le groupe chlorure de sodium, chlorure de potassium, mannitol et glycérine.
7. Utilisation selon une ou plusieurs des revendications 1 à 6 **caractérisée en ce que** le tampon est choisi dans le groupe tampon acétate, tampon citrate, tampon phosphate et tampon borate.
8. Utilisation selon une ou plusieurs des revendications 1 à 7 **caractérisée en ce que** l'antioxydant est choisi dans le groupe métabisulfite de sodium, thiosulfate de sodium, acétylcystéine, hydroxyamisole butylé et hydroxytoluène butylé.
9. Utilisation selon une ou plusieurs des revendications 1 à 8 **caractérisée en ce que** l'agent chélatant est l'édétate de disodium.
10. Utilisation selon une ou plusieurs des revendications 1 à 9 **caractérisée en ce que** le chlorhydrate d'epinastine est utilisé comme principe actif en une quantité de 0.05 à 0.1 % en masse.
11. Utilisation selon une ou plusieurs des revendications 1 à 9 **caractérisée en ce que** le chlorhydrate d'epinastine est utilisé comme principe actif en une quantité de 0.005 à 0.5 mg/ml.
12. Utilisation selon une ou plusieurs des revendications 1 à 11 **caractérisée en ce que** la solution consiste en eau comme solvant chlorhydrate d'epinastine, chlorure de sodium, hydrogénophosphate de sodium dihydraté, chlorure de benzalkonium, hydroxyéthylcellulose est éventuellement EDTA de sodium et hydroxyde de sodium.



(11) **EP 1 994 931 A1**

(12) **EUROPEAN PATENT APPLICATION**
published in accordance with Art. 158(3) EPC

(43) Date of publication:
26.11.2008 Bulletin 2008/48

(21) Application number: **07737656.4**

(22) Date of filing: **02.03.2007**

(51) Int Cl.:
A61K 31/55 (2006.01) A61P 27/02 (2006.01)
A61P 27/16 (2006.01) A61P 37/08 (2006.01)
C07D 487/04 (2006.01)

(86) International application number:
PCT/JP2007/054008

(87) International publication number:
WO 2007/100079 (07.09.2007 Gazette 2007/36)

(84) Designated Contracting States:
AT BE BG CH CY CZ DE DK EE ES FI FR GB GR
HU IE IS IT LI LT LU LV MC MT NL PL PT RO SE
SI SK TR

(30) Priority: **02.03.2006 JP 2006055706**
02.03.2006 JP 2006055711

(71) Applicant: **Meiji Seika Kaisha Ltd.**
Tokyo 104-8002 (JP)

(72) Inventors:
• **SHISHIKURA, Takashi**
Tokyo 104-8002 (JP)

- **INABA, Tsuneyoshi**
Yokohama-shi, Kanagawa 222-8567 (JP)
- **HOSHINA, Yukari**
Yokohama-shi, Kanagawa 222-8567 (JP)
- **AKABANE, Hiroto**
Yokohama-shi, Kanagawa 222-8567 (JP)
- **UCHIDA, Mitsuhiro**
Yokohama-shi, Kanagawa 222-8567 (JP)

(74) Representative: **Gillard, Richard Edward et al**
Elkington and Fife LLP
Prospect House
8 Pembroke Road
Sevenoaks
Kent TN13 1XR (GB)

(54) **PROPHYLACTIC OR THERAPEUTIC AGENT FOR ALLERGIC OPHTHALMIC DISEASE OR ALLERGIC NASAL DISEASE COMPRISING TRICYCLIC TRIAZOLOBENZOAZEPINE DERIVATIVE**

(57) The present invention provides a pharmaceutical composition for use in the prophylaxis or treatment of allergic ophthalmic diseases or allergic nasal diseases, which comprises 7,8-dimethoxy-4(5H),10-dioxo-1H-1,2,3-triazolo[4,5-c][1] benzazepine, 2-(1-isopropoxy-carbonyloxy-2-methylpropyl)-7,8-dimethoxy-4(5 H),10-dioxo-2H-1,2,3-triazolo[4,5-c][1] benzazepine or a phar-

maceutically acceptable salt thereof. The pharmaceutical composition according to the present invention has few side effects, exerts strong prophylactic and therapeutic effects in the late phase exhibiting pharmaceutical resistance to conventional instillations, and can be used appropriately for topical applications.

EP 1 994 931 A1

Description**CROSS-REFERENCE TO RELATED APPLICATIONS**

5 **[0001]** This application is based upon and claims the benefit of priority from the prior Japanese Patent Applications No. 055706/2006 (filing date: March 2, 2006) and No. 055711/2006 (filing date March 2, 2006), the entire contents of which are incorporated herein by reference.

BACKGROUND OF THE INVENTION

10

Field of the invention

[0002] The present invention provides a prophylactic or therapeutic agent for allergic ophthalmic diseases or allergic nasal diseases, comprising a tricyclic triazolobenzazepine derivative. More particularly, the present invention provides a pharmaceutical composition for use in the prophylaxis or treatment of allergic ophthalmic diseases or allergic nasal diseases, comprising 7,8-dimethoxy-4(5H),10-dioxo-1H-1,2,3-triazolo[4,5-c][1]benzazepine, a prodrug thereof, or a pharmaceutically acceptable salt thereof.

Background Art

20

[0003] Allergic ophthalmic diseases are symptoms related to eyes and their peripheral tissues based on an allergic reaction induced by various stimulations such as an immunoreaction. Specific examples thereof include seasonal allergic conjunctivitis, chronic allergic conjunctivitis, vernal conjunctivitis, atopic keratoconjunctivitis, and giant papillary conjunctivitis. Among them, the pathologic condition of the allergic conjunctivitis is mainly an inflammatory disease of conjunctiva/cornea based on type I allergic reaction. The type I allergic reaction is biphasic reaction comprising early phase (immediate-type reaction) and late phase (delay-type reaction).

25

[0004] The early phase appears 15 to 30 min after the exposure of antigen and disappears 1 to 2 hr after that. The late phase appears 6 to 12 hr after the disappearance of the early phase and continues for 24 to 48 hr (see Hansen I. et al.: Mediators of inflammation in the early and the late phase of allergic rhinitis. *Curr. Opin. Allergy Clin. Immunol.* 4; 159-163, 2004). In the early phase, symptoms such as itching, dacryorrhea, hyperemia, and conjunctiva and palpebral edema appear through the action of chemical transmitters such as histamine released from mast cells. On the other hand, the late phase is a persistent inflammation reaction induced by the invasion of inflammatory cells such as T cells and eosinophils, cytokines/chemokines produced therefrom, and toxic proteins released from the eosinophils. The late phase is considered to participate in increased severity and procrastination of the pathologic condition (see Azuma Kozue, Ohno Shigeaki: *Arerugisei Ketsumaku Shikkan Gaisetsu (Outline of allergic conjunctival diseases)* "NEW MOOK Ganka (Ophthalmology); *Arerugisei Gan Shikkan (Allergic ophthalmic diseases)* 6," edited by Ohno Shigeaki et al., KANEHARA & Co., LTD., 1-5, 2003).

30

[0005] For the early phase, cromoglycate, an inhibitor of histamine release, and antihistamines are effective (see King H.C.: *Pharmacotherapy of allergic rhinitis*. in "Allergy in ENT Practice The basic guide 2nd" ed. by King H.C. et al. Thieme Medical Publisher, Inc. 178-204, 2005). On the other hand, the late phase is induced, for example, by cytokines/chemokines and toxic proteins in addition to histamine (see Kramer M.F. et al.,: *Nasal IL-16 and MIP-1a in late-phase allergic response*. *Allergy and Asthma Proc.* 22; 127-132, 2001; Economides A and Kaliner M.A.: Chapter 5 Allergic rhinitis. in "Current Review of Rhinitis" ed by Kaliner M.A. Current Medicine, Inc. 35-51, 2002). These play a main role in the inflammation in the late phase. In this connection, there is a report that even levocabastine, which is the most potent antihistamine agent, cannot inhibit the late phase (see Hingorani M. and Lightman S.: *Ocular Allergy* in "Allergy and Allergic Diseases" ed by A.B.Kay Blackwell Science, Inc. 1645-1670, 1997).

40

[0006] Steroids have a potent cytokine/chemokines production inhibitory activity and a very potent effect against the late phase (see Ciprandi G.B et al.,: *Deflazacort protects against late-phase but early-phase reactions induced by the allergen-specific conjunctival provocation test*. *Allergy* 48; 421-430, 1993). The steroids, however, has a risk of side effects such as cause increased ocular pressure and onset of glaucoma. Accordingly, short-term use thereof is recommended. Further, a check on the side effect by ocular specialist physicians should also be periodically carried out (see Takamura Etsuko: *Arerugisei Ketsumaku Shikkan No Meno Kayumi No Sein To Chiryō (Cause and treatment of ocular itching in allergic conjunctivitis)*. *Allergology* 19; 444-449, 2005; Barney N.P. and Graziano F.M.: *Allergic and immunological diseases of eye*, in *Middleton's Allergy principles & practice* 6th edition ed. by Adkinson N.F. et al. Mosby, Inc. 1599-1617, 2003). Accordingly, there are many restrictions in the use of steroids in allergic ophthalmic diseases, and, thus, the use of the steroids is troublesome.

50

55

Thus, the development of pharmaceutical preparations for treating and preventing allergic ophthalmic diseases, which is also effective in late phase and has no side effect, has been still desired.

[0007] Allergic nasal diseases are symptoms related to nose and its surrounding tissues based on an allergic reaction caused by various stimulations such as an immunoreaction. Specific examples thereof include seasonal allergic rhinitis, perennial allergic rhinitis, and allergic sinusitis. The clinical condition of the allergic rhinitis is also based on a type-I allergic reaction.

5 **[0008]** In the early phase of the type-I allergic reaction, for example, sneezing, itching, rhinorrhea, and edema of nasal mucosa appear due to chemical mediators such as histamine released from mast cells. Also in the early phase, as in the case of ophthalmic diseases, cromoglycate, an inhibitor of histamine release, and antihistamines are effective. In the late phase, however, in addition to histamine, cytokines/chemokines and toxic proteins produced by infiltrated inflammatory cells, such as T cells and eosinophils, induce the above symptoms. Accordingly, it is reported that any

10 satisfactory effect cannot be attained by merely blocking the action of histamine (see Bensch G.W. et al.,: Evaluation of cytokines in nasal secretions after nasal antigen challenge: lack of influence of antihistamines. *Ann. Allergy Asthma Immunol.* 88; 457-462, 2002). The late phase is considered to participate in increased severity and procrastination of the pathologic condition, and, in fact, internal medicines of antihistamine agents are widely used as basic prescribed medicines for rhinitis. It is reported that additional administration of a nasal drop of an antihistamine agent to a patient

15 suffering from rhinitis, however, does not improve the effect (see Bereger W.E. et al.: Efficacy of azelastine nasal spray in patients with an unsatisfactory response to loratadine. *Ann. Allergy Asthma Immunol.* 91; 205-211, 2003; LaForce C.F. et al.,: Efficacy of azelastine nasal spray in seasonal allergic rhinitis patients who remain symptomatic after treatment with fexofenadine. *Ann. Allergy Asthma Immunol.* 93; 154-159, 2004). This supports the fact that the symptom induced by inflammatory cells invaded in the late phase cannot be suppressed by the antihistamine agent without difficulties.

20 **[0009]** Steroids have a potent cytokine/chemokine production inhibitory activity and exhibit a highly potent effect against the late phase in an allergic reaction of an allergic rhinitis (see Drain K.L. and Li J.T.C.: chapter 17 Corticosteroids and their use in rhinitis. in "Current Review of Rhinitis" ed. by Kaliner M.A. Current Medicine, Inc. 163-173, 2002). Regarding the clinical effect in the rhinitis as well, steroids have been confirmed to surpass antihistamine agents (see Schleimer R.P. et al.,: glucocorticoids in "Middleton's Allergy Principles & Practice Sixth edition" ed by Adkinson Jr. N.F. et al Mosby, Inc. 870-913, 2003). The steroids, however, sometimes induce local side effects in noses such as nasal

25 bleeding, local stimulation, and drying (see the above-described Drain K.L. and Li J.T.C.: chapter 17 Corticosteroids and their use in rhinitis. in "Current Review of Rhinitis" ed by Kaliner M.A. Current Medicine, Inc. 163-173, 2002). In patients who suffers from an allergic disease complicated by other allergic diseases such as asthma and atopic eczema and already use steroids, in some cases, the addition of a nasal steroid sometimes causes excessive exposure to the steroid and increases a risk of the systemic side effect (inhibition in hypothalamus-hypophysis-adrenal system and inhibition of the growth in early adolescence). For these reasons, there are many restrictions in the use of steroids in allergic nasal diseases.

Accordingly, the development of pharmaceutical preparations for treating and preventing allergic nasal diseases, which are also effective in the late phase, is less likely to cause side effect and, have still been desired in the art.

35 **[0010]** 7,8-Dimethoxy-4(5H),10-dioxo-1H-1,2,3-triazolo[4,5-c][1] benzazepine (hereinafter referred to as "compound A") is a compound having the following structure and is known to have antiallergic activity (see WO 95/18130 (Japanese Patent No. 3290664 and U.S. Patent No. 5686442).

[0011]

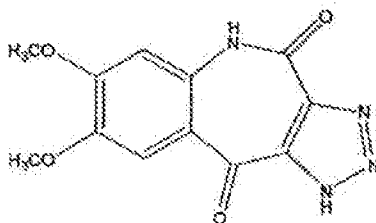

50 (Compound A)

55 **[0012]** This document (the above-described WO 95/18130), however, relates to effective ingredients in oral preparations (tablets and capsules) for preventing allergic diseases. In fact, pharmacological test examples show only the prophylactic effect on the inhibition of an allergic reaction by the oral administration of tricyclic benzazepine derivatives containing compound A. Specifically, the document discloses the prophylactic effect on the inhibition of an allergic reaction in the skin of the foot by orally administering a tricyclic benzazepine derivative before the onset of the allergic

reaction. Further, the document describes that the onset inhibitory effect (inhibition ratio) is about 50%.

[0013] As described above, cromoglycate, which inhibits the release of histamine, is effective in the early phase of the allergic reaction. The following fact, however, should be noted. The cromoglycate, when administered before exposure to an antigen, is effective, but on the other hand, after the induction of the allergic reaction, the effect disappears. Accordingly, the cromoglycate has been regarded as having such a property that the onset of action is slow and the action is moderate. On the other hand, the clinical judgment is such that, since the treatment is started in a symptomatic state, a satisfactory clinical effect cannot be expected by mere prophylactic effect without difficulties. Thus, the development of therapeutic effect, upon the administration of a medicament after the onset of the allergic reaction, is very important.

[0014] 2-(1-isopropoxycarbonyloxy-2-methylpropyl)-7,8-dimethoxy-4(5H),10-dioxo-2H-1,2,3-triazolo[4,5-c][1]benzazepine (hereinafter often referred to as "compound B") is a prodrug of compound A and has the following structure. It is known that compound B, after passage through mucous membranes of digestive tracts, is converted to compound A in vivo and develops antiallergic action as its drug efficacy. It has been demonstrated that compound B, as compared with compound A, can improve the absorption upon oral administration by a factor of seven (see WO 99/16770 (Japanese Patent No. 3188482 and U.S. Patent No. 6372735).

[0015]

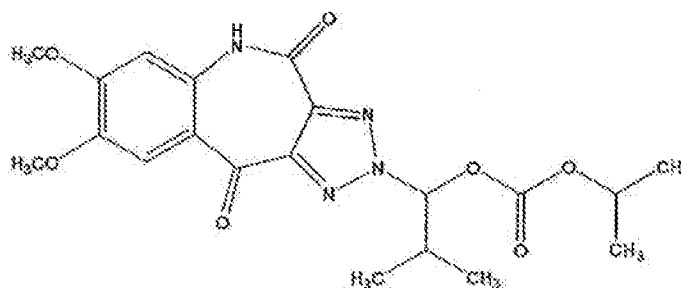

(Compound B)

[0016] This document (the above-described WO 99/16770), however, also relates to active ingredients of oral preparations for preventing allergic diseases, and only oral preparations such as tablets and fine subitlaes are disclosed as formulation examples. Further, pharmacological test examples disclosed in the document also relate to oral preparations.

[0017] In general, it cannot be necessarily said that, even when an active ingredient is absorbed into the living body through mucous membranes, for example, in digestive tracts and exhibits an excellent effect, an excellent effect favorably comparable with the oral administration can be attained in parenteral administration. For example, when a parenteral preparation is topically administered to mucous membranes in target organs of allergic diseases, the contemplated active ingredient acts directly on the affected part. Accordingly, a lot of consideration should be placed on the dose and dosage form. Further, the possibility of side effects caused by direct action is also not negligible. In general, these matters should be studied separately from the finding in the oral administration.

SUMMARY OF THE INVENTION

[0018] The present inventors have now made a search for pharmaceutical preparations which are effective in preventing and treating allergic ophthalmic diseases or allergic nasal diseases and do not develop significant side effects. As a result, it has been found that the late phase could be substantially completely inhibited by topically administering compound A to an eye or a nose before the onset of allergic reaction (that is, for prophylactic purposes). It has also been found that the late phase can also be potently inhibited by topically administering compound A to an eye or a nose during the progression of allergic inflammation (that is, for therapeutic purposes). Further, it has been found that compound B, which is converted to compound A in vivo, has the same effect as compound A and thus is usable. The present invention is based on these finding.

[0019] Accordingly, an object of the present invention is to provide a pharmaceutical preparation, which is effective in preventing and treating allergic ophthalmic diseases or allergic nasal diseases and, at the same time, develops few side effects and is suitable for topical administration.

[0020] According to the present invention, there is provided a pharmaceutical composition for use in the prophylaxis

or treatment of allergic ophthalmic diseases or allergic nasal diseases, which comprises 7,8-dimethoxy-4(5H),10-dioxo-1H-1,2,3-triazolo[4,5-c][1]benzazepine (compound A), a prodrug thereof, or a pharmaceutically acceptable salt thereof.

[0021] According to the present invention, there is also provided a pharmaceutical composition for use in the prophylaxis or treatment of allergic ophthalmic diseases or allergic nasal diseases, which comprises 2-(1-isopropoxycarbonyloxy-2-methylpropyl)-7,8-dimethoxy-4(5H),10-dioxo-2H-1,2,3-triazolo[4,5-c][1] benzazepine (compound B) or a pharmaceutically acceptable salt thereof. Compound B is a prodrug of compound A.

[0022] In a preferred embodiment of the present invention, the prophylactic or therapeutic pharmaceutical composition is administered as ocular instillation. In another preferred embodiment of the present invention, the prophylactic or therapeutic pharmaceutical composition is administered as nasal drops.

[0023] In a more preferred embodiment of the present invention, the prophylactic or therapeutic pharmaceutical composition further comprises a pharmaceutically acceptable carrier.

[0024] According to the present invention, there is further provided a method for the prophylaxis or treatment of allergic ophthalmic diseases or allergic nasal diseases, which comprises administering a prophylactically or therapeutically effective amount of 7,8-dimethoxy-4(5H),10-dioxo-1H-1,2,3-triazolo[4,5-c][1]benzazepine, a prodrug thereof, or a pharmaceutically acceptable salt thereof to a mammal.

[0025] In another embodiment of the present invention, there is provided a method for the prophylaxis or treatment of allergic ophthalmic diseases or allergic nasal diseases, which comprises administering a prophylactically or therapeutically effective amount of 2-(1-isopropoxycarbonyloxy-2-methylpropyl)-7,8-dimethoxy-4(5H),10-dioxo-2H-1,2,3-triazolo[4,5-c][1]benzazepine or a pharmaceutically acceptable salt thereof to a mammal.

[0026] According to the present invention, there is also provided use of 7,8-dimethoxy-4(5H),10-dioxo-1H-1,2,3-triazolo[4,5-c][1]benzazepine, a prodrug thereof, or a pharmaceutically acceptable salt thereof, for the preparation of an agent for use in the prophylaxis or treatment of allergic ophthalmic diseases or allergic nasal diseases.

[0027] According to another aspect of the present invention, there is provided use of 2-(1-isopropoxycarbonyloxy-2-methylpropyl)-7,8-dimethoxy-4(5H),10-dioxo-2H-1,2,3-triazolo[4,5-c][1]benzazepine or a pharmaceutically acceptable salt thereof, for the preparation of a prophylactic or therapeutic agent for allergic ophthalmic diseases or allergic nasal diseases.

[0028] Further, the present invention can be regarded as follows: (1) a prophylactic or therapeutic agent for allergic ophthalmic diseases or allergic nasal diseases, comprising 7,8-dimethoxy-4(5H),10-dioxo-1H-1,2,3-triazolo[4,5-c][1]benzazepine, or a pharmaceutically acceptable salt thereof; (2) a prophylactic or therapeutic agent for allergic ophthalmic diseases or allergic nasal diseases, comprising 2-(1-isopropoxycarbonyloxy-2-methylpropyl)-7,8-dimethoxy-4(5H),10-dioxo-2H-1,2,3-triazolo[4,5-c][1]benzazepine or a pharmaceutically acceptable salt thereof; (3) the prophylactic or therapeutic agent for allergic ophthalmic diseases according to the above item (1) or (2), which is administered as ocular instillation; (4) the prophylactic or therapeutic agent for allergic nasal diseases according to the above item (1) or (2), which is administered as nasal drops.

[0029] The pharmaceutical composition for use in the prophylaxis or treatment of allergic ophthalmic diseases or allergic nasal diseases according to the present invention has few side effects and has potent prophylactic effect and therapeutic effect in late phase where the resistant to therapy against existing eye drops or nasal drops develops.

DETAILED DESCRIPTION OF THE INVENTION

Compound

[0030] Compound A (7,8-dimethoxy-4(5H),10-dioxo-1H-1,2,3-triazolo[4,5-c][1]benzazepine) as an active ingredient in the present invention is a conventional compound and can be produced, for example, by the description on a production process of the compound and the description of Example 43 in the above-described WO 95/18130.

[0031] The active ingredient in the present invention may be a prodrug of compound A or a pharmaceutically acceptable salt of the compound or a prodrug thereof. The prodrug of compound A is of such a type that a 1,2,3-triazole group in compound A has been modified, and can be produced according to the above-described WO 99/16770.

[0032] A prodrug, which is preferred in the present invention, is compound B (2-(1-isopropoxycarbonyloxy-2-methylpropyl)-7,8-dimethoxy-4(5H),10-dioxo-2H-1,2,3-triazolo[4,5-c][1]benzazepine) and can be produced, for example, by the description described in Example 20 of the above-described WO 99/16770.

[0033] In the present invention, compound A or compound B as the active ingredient may be converted to a pharmaceutically acceptable salt thereof which may be used as the active ingredient. Pharmaceutically acceptable salts of compound A or compound B include medically acceptable nontoxic salts. Suitable nontoxic salts include alkali metal or alkaline earth metal salts such as sodium, potassium or calcium salts; hydrohalogenic acid salts such as hydrofluoride salts, hydrochloride salts, hydrobromide salts, or hydroiodide salts; inorganic acid salts such as nitric acid salts, perchloric acid salts, sulfuric acid salts, or phosphoric acid salts; lower alkylsulfonic acid salts such as methanesulfonic acid salts, trifluoromethanesulfonic acid salts, or ethanesulfonic acid salts ("lower alkyl" is preferably C1-3 alkyl); arylsulfonic acid

salts such as benzenesulfonic acid salts or p-toluenesulfonic acid salts; organic acid salts such as fumaric acid salts, succinic acid salts, citric acid salts, tartaric acid salts, oxalic acid salts, or maleic acid salts; and amino acid salts such as glutamic acid salts or aspartic acid salts.

5 Pharmaceutical composition

[0034] As demonstrated in working examples, topical administration (instillation) of compound A as an active ingredient in the present invention to an experimental animal actually showed prophylactic and therapeutic effects against allergic ophthalmic diseases, particularly allergic conjunctivitis. This effect is significantly superior to existing medicaments and can also inhibit late phase allergic reaction (Test Examples 1 and 2). Further, when compound A and compound B were administered as ocular instillation, the concentration of compound A and compound B could be maintained topically for a longer period of time at a higher concentration than that in the oral administration (Test Example 3). Topical administration (rhinenchysis) of compound A to an experimental animal actually showed prophylactic and therapeutic effects on allergic nasal diseases, particularly allergic rhinitis. This effect was significantly superior to existing medicaments (Test Examples 4-1, 4-2 and 5). When compound A and compound B were administered as nasal drops and oral administration, the rhinenchysis could realize a higher inhibitory effect at a lower dose (particularly Test Examples 4-2 and 4-3).

WO 99/16770 shows that compound B is a prodrug of compound A.

[0035] Further, from the viewpoint of safety, as compared with the oral administration, in the topical administration (instillation/rhinenchysis), the expose to the whole body is lower, and a potent action is developed at a much lower dose, suggesting that the systemic side effect could be significantly reduced. Further, the results of topical irritation tests show that the safety of compound A and compound B is high. Specifically, toxicity against epithelial cells of cornea in human eyes was studied. As a result, for the 24-hr cell survival rate, any toxicity was not observed in the concentration range of 100 nM to 0.3 mM. This concentration is not less than 60 times higher than the maximum eye tissue concentration 1.29 $\mu\text{g/g}$ (4.7 μM) in the case of instillation of a 0.1% liquid at which compound A develops a satisfactory effect. Even when a severe eye irritation test using rabbits in which instillation is carried out six times per day at 30 min intervals for two days, is carried out, the results are such that, for 3% compound A and % compound B, only slight reddening of the conjunctiva was observed and, for 0.5% compound A, irritation was not observed at all, indicating that these compounds are highly safe medicaments.

[0036] Accordingly, the active ingredient in the present invention develops an excellent prophylactic or therapeutic effect on allergic ophthalmic diseases or allergic nasal diseases, preferably upon topical application. As described above, according to the present invention, there is provided a pharmaceutical composition for use in the prophylaxis or treatment of allergic ophthalmic diseases or allergic nasal diseases, comprising compound A, a prodrug thereof, or a pharmaceutically acceptable salt thereof, or compound B, or a pharmaceutically acceptable salt thereof.

[0037] Allergic ophthalmic diseases include, for example, seasonal allergic conjunctivitis, chronic allergic conjunctivitis, vernal conjunctivitis, atopic keratoconjunctivitis, and giant papillary conjunctivitis.

[0038] Allergic nasal diseases include, for example, seasonal allergic rhinitis, chronic allergic rhinitis, allergic sinusitis, and pollinosis.

[0039] The pharmaceutical composition for use in the prophylaxis or treatment of allergic ophthalmic diseases according to the present invention may be any pharmaceutical composition so far as it can be topically administered, for example, to ocular-mucous membranes. The pharmaceutical composition according to the present invention is preferably administered as ocular instillation. The topical administration, particularly instillation, can advantageously highly inhibit an inflammatory reaction in a conjunctiva which is a target organ in allergic ophthalmic diseases. Accordingly, the pharmaceutical composition according to the present invention is preferably used in an eye drop form.

[0040] When the pharmaceutical composition for use in the prophylaxis or treatment of allergic ophthalmic diseases is administered as ocular instillation, the pharmaceutical composition can be formulated into an eye drop according to a conventional method by mixing the pharmaceutical composition with pharmaceutically acceptable carriers, excipients, and diluents which are already known per se.

In the present invention, the pharmaceutically acceptable carrier, the excipient and the diluent are sometimes collectively referred to as a pharmaceutically acceptable carrier.

[0041] When the composition for use in the prophylaxis or treatment of allergic ophthalmic diseases according to the present invention is used as an eye drop, the pharmaceutical composition may be provided in any form which is commonly used as the eye drop. For example, the eye drop may be provided in the form of aqueous eye drops such as aqueous eye drop liquids, aqueous suspension eye drop liquids, viscous eye drop liquids, and solubilized eye drop liquids, and nonaqueous eye drops such as nonaqueous eye drop liquids and nonaqueous suspension liquids. In the present invention, aqueous eye drop liquids are more preferred.

[0042] When the pharmaceutical composition for use in the prophylaxis or treatment of allergic ophthalmic diseases is formulated, for example, into aqueous eye drop liquids, various additives commonly used in aqueous eye drop liquids

may be properly incorporated in the aqueous eye drop liquids. Additives include buffering agents, tonicity adjusting agents, antiseptics, preservatives, solubilizers (stabilizers), pH adjustors, thickeners, and chelating agents.

[0043] The pharmaceutical composition for use in the prophylaxis or treatment of allergic nasal diseases according to the present invention may be any pharmaceutical composition so far as it can be topically administered, for example, to nasal mucosa. The pharmaceutical composition according to the present invention is preferably administered as nasal drops. The topical administration, particularly rhinenchysis, can advantageously highly inhibit an inflammatory reaction in a nasal mucosa which is a target organ in allergic nasal diseases. Accordingly, the pharmaceutical composition according to the present invention is preferably used in a nasal drop form.

[0044] When the pharmaceutical composition for use in the prophylaxis or treatment of allergic nasal diseases is administered as nasal drops, the pharmaceutical composition can be formulated into a nasal drop according to a conventional method by mixing the pharmaceutical composition with pharmaceutically acceptable carriers, excipients, and diluents which are already known per se.

[0045] When the composition for use in the prophylaxis or treatment of allergic nasal diseases according to the present invention is used as a nasal drop, the pharmaceutical composition may be provided in any form which is commonly used as the nasal drop. For example, the nasal drop may be provided in the form of nasal drops such as aqueous nasal drop liquids, aqueous suspension nasal drop liquids, nonaqueous nasal drop liquids, nonaqueous suspension nasal drop liquids, or gel nasal drop liquids.

[0046] When the pharmaceutical composition for use in the prophylaxis or treatment of allergic nasal diseases is formulated, for example, into nasal drops, various additives commonly used in nasal drops may be properly incorporated in the nasal drop. Additives include buffering agents, tonicity adjusting agents, preservatives, solubilizers (stabilizers), pH adjustors, thickeners, and chelating agents.

[0047] Buffering agents usable in the present invention include, for example, borate buffering agents, phosphate buffering agents, citrate buffering agents, tartrate buffering agents, and acetate buffering agents.

[0048] Tonicity adjusting agents include, for example, salts such as sodium chloride, saccharides such as sorbitol, mannitol, and glucose, polyhydric alcohols such as glycerin, polyethyleneglycol, and propylene glycol.

[0049] Antiseptics include, for example, benzalkonium chloride, benzethonium chloride, and paraoxybenzoic acid esters such as methyl p-oxybenzoate and ethyl p-oxybenzoate.

[0050] Preservatives include p-hydroxybenzoic esters and benzalkonium chloride.

[0051] pH adjustors include, for example, sodium hydroxide, ammonium hydroxide, hydrochloric acid, acetic acid, and phosphoric acid.

[0052] Thickeners include, for example, methylcellulose, carboxymethylcellulose, hydroxypropyl methylcellulose, polyvinyl alcohol, polyvinylpyrrolidone, and polyacrylic acid and its salt. They may be used in a combination of two or more.

[0053] When the pharmaceutical composition for use in the prophylaxis or treatment of allergic ophthalmic diseases is used as an ophthalmic ointment, purified lanolin, vaseline, plastibase, and liquid paraffin may be properly used as bases for the ophthalmic ointment.

[0054] In the pharmaceutical composition for use in the prophylaxis or treatment of allergic ophthalmic diseases or allergic nasal diseases, the active ingredient according to the present invention may be properly used in combination with other ophthalmological chemical agents, for example, chlorpheniramine maleate, naphazoline hydrochloride, sodium azulene sulfonate, lysozyme chloride, and glycyrrhetic acid, or chemical agents for treating nasal diseases, so far as the contemplated object can be attained.

[0055] The dose of the pharmaceutical composition according to the present invention may be properly varied depending upon the amount of the active ingredient contained in the pharmaceutical composition. For preventing or treating allergic ophthalmic diseases or allergic nasal diseases as the target disease, a prophylactically or therapeutically effective amount of the active ingredient is administered to a patient.

The expression "prophylactically or therapeutically effective amount" means such an amount that a prophylactic or therapeutic effect can be attained in a patient suffering from the target allergic ophthalmic disease or allergic nasal disease. In general, the effective amount can be appropriately determined in consideration of particular conditions, for example, the age, weight, sex, type of disease, and severity of condition of patients.

[0056] In the present invention, when compound A is used, the amount of compound A used may be any amount, so far as the contemplated effect can be attained, and may vary depending, for example, upon the symptom and age. The amount of compound A is preferably 0.001 to 3% by weight, more preferably 0.01 to 1% by weight. For ophthalmic administration (instillation), compound A may be administered, for example, by eye dropping twice to four times per day by one to a few drops at a time. When the level of severity is higher, compound A may be administered, for example, as ocular instillation a few times per day. The instillation dose is typically about 30 μ L. For rhinenchysis, compound A may be administered, for example, by nasal dropping or by spray from a spray bottle filled with compound A at a dose of 10 to 200 μ L at a time, once to four times per day.

[0057] In the present invention, when compound B is used, the amount of compound B used may be any amount, so

far as the contemplated effect can be attained, and may vary depending, for example, upon the symptom and age. The amount of compound B is preferably 0.001 to 3% by weight, more preferably 0.01 to 1% by weight. For instillation, compound B may be administered, for example, by eye dropping twice to four times per day by one to a few drops at a time. When the level of severity is higher, compound B may be administered, for example, as ocular instillation a few times per day. The instillation dose is typically about 30 µL. For rhinorrhysis, compound B may be administered, for example, by nasal dropping or by spray from a spray bottle filled with compound B at a dose of 10 to 200 µL at a time, once to four times per day.

[0058] The pharmaceutical composition for use in the prophylaxis or treatment of allergic ophthalmic diseases or allergic nasal diseases may fall within a pH range which is commonly used as eye drops or nasal drops, and is preferably in the range of 4.0 to 8.0.

EXAMPLES

[0059] The present invention is further illustrated by the following Examples that are not intended as a limitation of the invention.

Test Example 1: Prophylactic effect on allergic conjunctivitis

Test Example 1-1: Prophylactic effect of compound A on allergic conjunctivitis

[0060] Male SD rats were prepared. Bordetella pertussis (4×10^{10}) and 1 mg of dinitrophenylated ovalbumin (hereinafter often abbreviated to "DNP-OA") were subcutaneously administered into the footpad of the rats. After 8 to 10 days from the administration, a 3% DNP-OA solution was administered to the right eye of the rats to induce an allergic reaction. In some experiments, in order to confirm dye leakage and location of edema, a dye was injected, and, in the anatomy, the coincidence of dye leakage with the location of edema was confirmed. Evans Blue (a dye) (25 mg/kg) was intravenously administered six hr after the induction of the allergic reaction.

[0061] After 9 hr from the induction of the allergic reaction, the eyeballs of the rats were harvested. Further, lenses, hydatoids, and the contents of the vitreous body were removed from the eyeballs, and the weight of the tissues was measured. Furthermore, the dye leakage amount in the harvested eye tissue was measured. For dye measurement, the eye tissue was immersed in 0.15 mL of 1 N KOH and was lysed at 37°C for two or three days. A 0.6 N phosphoric acid/acetic acid mixed liquid (0.9 mL) was added to the lysed tissue, and the mixture was centrifuged at 1750 g for 15 min. The absorbance (630 nm) of Evans Blue in the supernatant was measured with Multiskan JX (manufactured by Labsystem Ltd.). The amount of the dye was regarded as a dye leakage amount.

[0062] Compound A was dissolved in 0.15 M sodium hydrogencarbonate, and the solution was adjusted to pH 7.2. For the control group, 0.15 M sodium hydrogencarbonate adjusted to pH 7.2 was administered. For a negative control group (a nonsensitization group), a 3% DNP-OA solution was administered to the right eye of the nonsensitized rats, and the solvent was used into the same manner as in the control group.

The medicament or the solvent was administered to the right eye (5 µL/eye) 15 min before the induction of the allergic reaction. Compound A was administered at concentrations of 0.01%, 0.1%, and 1% for studies of dose response.

[0063] The results are shown as in Table 1.

In the table, the inhibition ratio was calculated by the following equation.

$$\text{Inhibition (\%)} = 100 \times \{(B - A) - (C - A)\} \div (B - A)$$

wherein A represents a negative control group (a nonsensitized group); B represents a control group; and C represents a medicament administered group.

[0064]

Table 1: Prophylactic effect of compound A on allergic conjunctivitis (studies on dose response)

Medicament	Dose/rat	Medicament concentration	Inhibition ratio(%)	
			Increase in tissue weight	Increase in dye leakage amount
Compound A	0.05 µg/rat	0.01%	67.0% **	74.4% **
Compound A	0.5 µg/rat	0.1%	89.0% **	83.9% **

(continued)

Medicament	Dose/rat	Medicament concentration	Inhibition ratio(%)	
			Increase in tissue weight	Increase in dye leakage amount
Compound A	5 µg/rat	1%	83.7% **	87.6% **
**: p < 0.01 compared to control group (Dunnett's multiple comparison test) (tissue weight for nonsensitized group: 76.4 ± 2.5 mg, tissue weight for control group: 114.2 ± 4.7 mg, n = 8) (dye leakage amount for nonsensitized group: 2.96 ± 0.17 mg, dye leakage amount for control group: 6.91 ± 0.47 mg, n = 8)				

[0065] As shown in the results, it was confirmed that the dye leakage amount substantially correlated with the tissue weight, the dye leakage site and the edema could be visually observed to be concentrated on the conjunctiva. In the anatomy, the leakage of the dye was concentrated in the conjunctiva, and, based on this fact, it was determined that the allergic reaction is mainly induced in the conjunctiva. The weight of the eye tissue, which has induced the allergic reaction, increases by edema mainly developed in the conjunctiva. Accordingly, in the following tests, the effect of the medicament will be examined using an increase in eye tissue weight as an index of the late phase.

Test Example 1-2: Comparison of prophylactic effect on allergic conjunctivitis between compound A and existing medicaments

[0066] A comparison test for prophylactic effect on allergic conjunctivitis was carried out between compound A and existing medicaments. For comparison, the following existing medicaments for allergic conjunctivitis (commercially available eye drops) were used.

- 1) Mast cell stabilizer (histamine release inhibitor): Cromoglycate (cromoglycate sodium, manufactured by Astellas Pharma Inc.)
- 2) Antihistamine agent: Ketotifen (ketotifen fumarate, manufactured by Novartis) and Levocabastine (levocabastine hydrochloride, manufactured by Santen Pharmaceutical Co., Ltd.)
- 3) Steroid: Betamethazone (betamethazone sodium phosphate, manufactured by Shionogi & Co., Ltd.) and Fluorometholone (fluorometholone, manufactured by Santen Pharmaceutical Co., Ltd.)

[0067] Compound A and existing medicaments were administered at concentrations shown in Table 2, and the prophylactic effect on the allergic conjunctivitis was confirmed in the same manner as in Test Example 1-1.

[0068] The results were as shown in Table 2.

[0069]

Table 2: Comparison of prophylactic effect on allergic conjunctivitis between compound A and existing medicaments

Medicament	Medicament concentration	Inhibition ratio
		Increase in tissue weight
Compound A	0.1%	99.1% **
Levocabastine	0.025%	11.1%
Ketotifen	0.05%	13.4%
Cromoglycate	2%	14.7%
Betamethazone	0.1%	79.6% **
Fluorometholone	0.1%	59.4% *
*, **; compared to control group p < 0.05, 0.01 (Dunnett's multiple comparison test)		

[0070] As shown in the results, existing medicaments for allergic conjunctivitis (commercially available eye drops) except for steroid did not inhibited late phase allergic reaction.

Test Example 2: Therapeutic effect of compound A on allergic conjunctivitis (studies on dose response)

[0071] In clinical practice, in most cases, a medicament is generally administered after the onset of a symptom. Accordingly, a test was carried out on therapeutic effect of compound A on allergic conjunctivitis.

As can be seen from the results of Test Example 1-2, existing eye drops for allergic conjunctivitis except for steroid did not inhibit the late phase allergic reaction. Accordingly, for the therapeutic effect (effect on the medicament administration after the onset), the results only for Betamethasone which had exhibited prophylactic effect in Test Example 1-2 were evaluated for comparison.

[0072] Compound A, Betamethasone, control group, and negative control group were administered at the same concentration as in Test Example 1-1, and the concentration of Betamethasone was as shown in Table 3.

The test was carried out in the same manner as in Test Example 1-1, except that, three hr after the induction of the allergic reaction, for compound A, Betamethasone, control group, and negative control group were administered, the test solution was administered at a dose of 5 μ L/eye to the right eye.

[0073] The results were as shown in Table 3.

[0074]

Table 3: Therapeutic effect of compound A on allergic conjunctivitis

Medicament		Tissue weight increase
Compound A	0.01%	70.3% **
Compound A	0.1%	99.9% **
Compound A	1%	103.7% **
Betamethasone	0.1%	74.8% **
**; p < 0.01 compared to control group (Dunnett's multiple comparison test)		

[0075] As shown in Table 3, compound A and Betamethasone had potent therapeutic effect on allergic conjunctivitis.

Test Example 3: Change in concentration of administered compound A and compound B in the eye tissueTest Example 3-1: Change in concentration of ophthalmically administered compound A and compound B in the eye tissue

[0076] A test solution (0.1% or 1%) of compound A in an isotonic borate buffer solution adjusted to pH 7.4 and a test solution (0.1%) of compound B in an isotonic borate buffer solution were provided, and 50 μ L of each test solution was administered as ocular instillation to male rabbits.

The concentration of compound A in the eye tissue after instillation was measured as follows. At the outset, the tissue or blood was removed from the test animals and was cryopreserved. Purified water (0.1 mL) was added to a sufficient quantity of the cryopreserved tissue and the like followed by homogenization. Thereafter, 0.5 mL of 0.1% phosphoric acid, 0.05 mL of an internal standard solution (a predetermined internal standard substance (10.1 μ L/mL) described in WO 95/18130), 0.05 mL of acetonitrile, and 0.05 mL of purified water were added thereto. An extraction solvent (25% chloroform/diethyl ether) (8 mL) was added, and the mixture was shaken and centrifuged. Thereafter, 7 mL of the organic layer was evaporated to dryness under the negative pressure, and the residue was dissolved in 0.3 mL of a mobile phase to give an analyte. A liquid prepared by mixing and dissolving 0.55 g of tetraoxyl ammonium bromide into 450 mL of acetonitrile, 450 mL of 10 mM phosphate buffer solution, and 100 mL of methanol was used as the mobile phase. The concentration of compound A was measured by injecting 0.025 mL of the analyte into high-performance liquid chromatography (HPLC) (measurement conditions: fluorescence excitation 270 nm, emission 466 nm).

The concentration of only compound A in the eye tissue was measured because compound B is a prodrug of compound A.

[0077] The results were as shown in Table 4.

[0078]

5
10
15
20
25
30
35
40
45
50
55

Table 4: Change in concentration of compound A in the eye tissue

Concentration in the eye tissue (µg/g)	Administered medicament and its concentration		Time after instillation (hr)					
	Medicament	Concentration (%)	0.25	1	2	4	8	24
Compound A	0.1 %	1.29±0.71	0.05±0.01	0.15±0.11	0.04±0.07	0.07±0.08	0	
Compound A	1 %	6.09±2.20	1.15±0.83	1.26±0.94	1.38±0.54	0.66±0.42	0.06±0.06	
Compound B	0.1 %	0.82±0.31	0.11±0.04	0.30±0.93	0.04±0.01	0.07±0.07	0.01±0.01	

In the table, the numerals are average ± standard error.

Test Example 3-2: Change in concentration of orally administered compound B in the blood and the eye tissue

[0079] Compound B was suspended in 1% hydroxymethylcellulose to regulate the concentration of compound to 0.2 mg/mL. This test solution was orally administered to male rats at a dose of 5 mL/kg (dose: 1 mg/kg (200 µg/rat)). The concentration profile of compound A after the oral administration in blood and the eye tissue was measured.

[0080] The results were as shown in Table 5.

[0081]

Table 5: Change in concentration of compound A in the blood and the eye tissue after oral administration of compound B

Concentration in tissue	Time after oral administration (hr)			
	0.5	2	8	24
Blood concentration (µg/mL)	0.027	0.018	0.001	0
Eye tissue concentration (µg/g)	0.002	0.0015	N.D.	N.D.

In the table, numerals are mean. N.D.: Not detected

[0082] As can be seen from the results shown in Tables 4 and 5, as compared with the case where compound B was orally administered, the ophthalmic administration of compound A and compound B could maintain the concentration of compound A in the eye tissue at a far higher concentration for a far longer period of time (8 hr or more).

Formulation Example: Prophylactic or therapeutic agent for allergic ophthalmic diseases

[0083] General methods for producing pharmaceutical preparations as prophylactic or therapeutic agents of allergic ophthalmic diseases and production example of the pharmaceutical preparations according to the present invention will be described.

Compound A or compound B and a tonicity adjusting agent were added to sterilized purified water. If necessary, for example, a preservative, a buffering agent, a stabilizer, and a thickener were added to and dissolved in the solvent. Specific formulation examples are shown below.

Production Example 1: Solution formulation for topical ophthalmologic administration

[0084]

Table 6:

Ingredients	Concentration (w/v%)
Compound A	0.1
Boric acid	0.0006
Sodium chloride (tonicity adjusting agent)	q.s.
Benzalconium chloride	0.005
Hydrochloric acid (pH adjustor)	q.s. pH 7.0
Purified water	q.s.

Production Example 2: Suspension formulation for topical ophthalmologic administration

[0085]

Table 7:

Ingredients	Concentration (w/v%)
Compound B	0.1
Hydroxypropylmethylcellulose	q.s.

(continued)

Ingredients	Concentration (w/v%)
Boric acid	0.0006
Polysorbate 80	0.01
Benzalconium chloride	0.005
Hydrochloric acid (pH adjustor)	q.s. pH 7.0
Purified water	q.s.

10 Test Example 4: Prophylactic effect on allergic rhinitis

Test Example 4-1: Prophylactic effect of compound A on allergic rhinitis (studies on dose response)

15 **[0086]** Male Sprague Dawley rats (n = 6) were prepared. Bordetella pertussis (4×10^{10}) and 1 mg of dinitrophenylated ovalbumin (hereinafter referred to as "DNP-OA") were subcutaneously administered into the footpad of the rats. After nine days from the administration, 15 μ L of a 13.3% DNP-OA solution was administered into both nasal cavities to induce an allergic reaction. After six hr from the antigen administration, Evans Blue (a dye) (50 mg/kg) was intravenously administered.

20 **[0087]** After nine hr from the induction of the allergic reaction, the nasal septal mucosa of the rats was harvested, and the weight of the tissue was measured. The tissue of the nasal septal mucosa was lysed with 1 N KOH, and the leakage amount of the dye was determined as an index of vascular permeability in the late phase of the allergic rhinitis.

25 **[0088]** Compound A was dissolved in physiological saline. For the control group not subjected to any medicament treatment, the physiological saline used in the solvent for compound A was used. The negative control group which had not induced the allergy was regarded as a saline group. In this case, physiological saline was administered instead of the antigen. Compound A and the control group (physiological saline) (each 5 μ L) were administered as nasal drops into both nasal cavities, immediately before the induction of the allergic reaction. Compound A was administered at concentrations of 0.01%, 0.1%, and 1% to study the dose response.

30 **[0089]** The results were as shown in Table 8.
In the table, the inhibition ratio was calculated by the following equation.

$$\text{Inhibition (\%)} = 100 \times \{(B - A) - (C - A)\} \div (B - A)$$

35 wherein A represents a negative control group (a nonsensitized group); B represents a control group; and C represents a medicament administered group.

[0090]

40 Table 8: Prophylactic effect of compound A on allergic rhinitis

Medicament	Dose/rat	Medicament concentration	Increase in dye leakage amount
			Inhibition ratio
Compound A	1 μ g/rat	0.01%	52.9% **
Compound A	10 μ g/rat	0.1%	111.7% **
Compound A	100 μ g/rat	1%	123.1% **
**; p < 0.01 compared to control group (Dunnett's multiple comparison test)			

50 The medicament was administered immediately before the antigen administration (start of allergy).

[0091] The results show that, when compound A is prophylactically administered as nasal drops, compound A is effective against allergic rhinitis dose-dependently.

55 Test Example 4-2: Comparison between compound A and existing medicaments on prophylactic effect on allergic rhinitis

[0092] A test on comparison between compound A and existing medicaments for prophylactic effect on allergic rhinitis. For comparison, existing medicaments for allergic rhinitis (commercially available nasal drops) were used.

[0093]

1) Mast cell stabilizer (histamine release inhibitor): Cromoglycate (cromoglycate sodium, manufactured by Astellas Pharma Inc.) and Amlexanox (manufactured by Takeda Chemical Industries, Ltd.)

2) Antihistamine agent: Ketotifen (ketotifen fumarate, manufactured by Novartis) and Levocabastine (levocabastine hydrochloride, manufactured by NIPPON SHINYAKU CO., LTD.)

3) Steroid: Fluticasone propionate (fluticasone propionate, manufactured by Glaxo SmithKline K.K.)

[0094] Compound A and existing medicaments were administered at concentrations shown in Table 9 immediately before the antigen administration (start of allergy), and the prophylactic effect on the allergic conjunctivitis was confirmed in the same manner as in Test Example 4-1.

[0095] The results were as shown in Table 9.

[0096]

Table 9: Comparison between compound A and existing medicaments for prophylactic effect on allergic rhinitis

Medicament	Dose/rat	Medicament concentration	Increase in dye leakage amount
			Inhibition ratio
Compound A	10 μ g/rat	0.1%	95.7% **
Cromoglycate	200 μ g/rat	2%	2.9%
Amlexanox	25 μ g/rat	0.25%	81.1% **
Levocabastine	2.5 μ g/rat	0.025%	22.7%
Ketotifen	5.5 μ g/rat	0.055%	49.4%
Fluticasone	5.1 μ g/rat	0.051%	106.0% **

**; p < 0.01 compared to control group (Dunnett's multiple comparison test)

[0097] As can be seen from the results, compound A, Amlexanox, and Ketotifen had prophylactic effect on allergic rhinitis.

Test Example 4-3: Prophylactic effect of compound B against allergic rhinitis where compound B was orally administered

[0098] The prophylactic effect of compound B on allergic rhinitis in the same manner as in Test Example 4-1, except that compound B was suspended in hydroxypropylmethylcellulose and the suspension was orally administered. The medicament was administered 15 min before the administration of the antigen (start of allergy).

[0099] The results were as shown in Table 10.

[0100]

Table 10:

Medicament	Dose/rat	Dose (mg/kg)	Increase in dye leakage amount
			Inhibition ratio
Compound B	200 μ g/rat	1 mg/kg	46.3% **
Compound B	1000 μ g/rat	5 mg/ μ kg	81.9% **

**; Compared to control group p < 0.01 (Dunnett's multiple comparison test)

[0101] As can be seen from Tables 9 and 10, when compound B is assumed to be converted as it is to compound A in vivo, it can be said that the rhinorrhysis exhibited a higher inhibition ratio at a lower dose. Accordingly, it could be expected that, when compound A is formulated into nasal drops, more reliable drug efficacy can be provided at a concentration of not less than 0.1% and, further, a reduction in total exposure can reduce systemic side effect.

Test Example 5: Therapeutic effect of compound A on allergic rhinitis

[0102] In clinical practice, it is important that the effect can be attained also in such a state that a symptom is developed. Accordingly, a test was carried out on the therapeutic effect of compound A on allergic rhinitis. For comparison, Amlexanox and Ketotifen, which were effective on prophylactic effect in Test Example 3-2, were also evaluated.

In the same manner as in Test Example 4-1, the allergic reaction was induced, and the vascular permeability in the late phase of the allergic rhinitis was measured. In this case, however, for the evaluation of the therapeutic effect, compound A, Amlexanox, and Ketotifen were administered one hr after the induction of the allergic reaction. Since greenie was leaked, the dose was doubled (10 µL) so that the dispersion of the medicament within the nasal cavities is not inhibited, and the concentration of the medicament was regulated with physiological saline to the half of the concentration in the experiment on prophylactic effect to render the dose per individual identical.

[0103] The results were as shown in Table 11.

[0104]

Table 11: Therapeutic effect of compound A on allergic rhinitis

Medicament	Dose/rat	Medicament concentration	Dye leakage amount increase
			Inhibition ratio
Compound A	10 µg/rat	0.05%	93.8% **
Amlexanox	25 µg/rat	0.125%	25.0%
Ketotifen	5.5 µg/rat	0.0275%	48.6%

p < 0.01 compared to control group (Dunnett's multiple comparison test)

The medicament was administered one hr after the administration of the antigen.

[0105] From the results, the administration of compound A as nasal drops exhibited therapeutic effect on the allergic rhinitis.

Formulation Example: Prophylactic or therapeutic agent for allergic nasal diseases

[0106] General methods for producing prophylactic or therapeutic agents for allergic nasal diseases and production examples of the prophylactic or therapeutic agents for allergic nasal diseases according to the present invention will be described.

Compound A or compound B and a tonicity adjusting agent are added to sterilized purified water. If necessary, for example, a preservative, a buffering agent, a stabilizer, and a thickening agent were added to and dissolved in a solvent. Specific formulation examples will be described below.

Production Example 3: Topical solution formulation for nasal diseases

[0107]

Table 12:

Ingredient	Concentration (w/v%)
Compound A	0.1
Boric acid	0.0006
Sodium chloride (tonicity adjusting agents)	q.s.
Benzalconium chloride	0.005
Hydrochloric acid (pH adjustor)	q.s. pH 7.0
Purified water	q.s.

Production Example 4: Topical suspension formulation for nasal diseases

[0108]

Table 13:

Ingredients	Concentration (w/v%)
Compound B	0.1
Hydroxypropylmethylcellulose	q.s.
Boric acid	0.0006
Polysorbate 80	0.01
Benzalconium chloride	0.005
Hydrochloric acid (pH adjustor)	q.s. pH 7.0
Purified water	q.s.

Claims

1. A pharmaceutical composition for use in the prophylaxis or treatment of allergic ophthalmic diseases or allergic nasal diseases, which comprises 7,8-dimethoxy-4(5H),10-dioxo-1H-1,2,3-triazolo[4,5-c][1]benzazepine, a prodrug thereof, or a pharmaceutically acceptable salt thereof.
2. The pharmaceutical composition according to Claim 1, which comprises 2-(1-isopropoxycarbonyloxy-2-methylpropyl)-7,8-dimethoxy-4(5H),10-dioxo-2H-1,2,3-triazolo[4,5-c][1]benzazepine, or a pharmaceutically acceptable salt thereof.
3. The pharmaceutical composition according to Claim 1 or 2, which is administered as ocular instillation.
4. The pharmaceutical composition according to Claim 1 or 2, which is administered as nasal drops.
5. The pharmaceutical composition according to any one of Claims 1 to 4, which further comprises a pharmaceutically acceptable carrier.
6. A method for the prophylaxis or treatment of allergic ophthalmic diseases or allergic nasal diseases, which comprises administering a prophylactically or therapeutically effective amount of 7,8-dimethoxy-4(5H),10-dioxo-1H-1,2,3-triazolo[4,5-c][1]benzazepine, a prodrug thereof, or a pharmaceutically acceptable salt thereof to a mammal.
7. The method according to Claim 6, wherein the compound to be administered is 2-(1-isopropoxycarbonyloxy-2-methylpropyl)-7,8-dimethoxy-4(5H),10-dioxo-2H-1,2,3-triazolo[4,5-c][1]benzazepine or a pharmaceutically acceptable salt thereof.
8. The method according to Claim 6 or 7, wherein the compound is administered by instillation.
9. The method according to Claim 6 or 7, wherein the compound is administered as nasal drops.
10. The method according to any one of Claims 6 to 9, comprising administering an effective amount of a compound together with a pharmaceutically acceptable carrier.
11. Use of 7,8-dimethoxy-4(5H),10-dioxo-1H-1,2,3-triazolo[4,5-c][1]benzazepine, a prodrug thereof, or a pharmaceutically acceptable salt thereof, for the preparation of an agent for use in the prophylaxis or treatment allergic ophthalmic diseases or allergic nasal diseases.
12. The use according to Claim 11, wherein the compound is 2-(1-isopropoxycarbonyloxy-2-methylpropyl)-7,8-dimethoxy-4(5H),10-dioxo-2H-1,2,3-triazolo[4,5-c][1]benzazepine, or a pharmaceutically acceptable salt thereof.
13. The use according to Claim 11 or 12, wherein the agent is in form of an ocular instillation.
14. The use according to Claim 11 or 12, wherein the agent is in form of nasal drops.
15. The use according to any one of Claims 11 to 14, wherein the agent further comprise a pharmaceutically acceptable carrier.

INTERNATIONAL SEARCH REPORT

International application No.
PCT/JP2007/054008

<p>A. CLASSIFICATION OF SUBJECT MATTER A61K31/55(2006.01)1, A61P27/02(2006.01)1, A61P27/16(2006.01)1, A61P37/08(2006.01)1, C07D487/04(2006.01)1</p> <p>According to International Patent Classification (IPC) or to both national classification and IPC</p>																										
<p>B. FIELDS SEARCHED Minimum documentation searched (classification system followed by classification symbols) A61K31/55, A61P27/02, A61P27/16, A61P37/08, C07D487/04</p> <p>Documentation searched other than minimum documentation to the extent that such documents are included in the fields searched Jitsuyo Shinan Koho 1922-1996 Jitsuyo Shinan Toroku Koho 1996-2007 Kokai Jitsuyo Shinan Koho 1971-2007 Toroku Jitsuyo Shinan Koho 1994-2007</p> <p>Electronic data base consulted during the international search (name of data base and, where practicable, search terms used) Caplus (STN)</p>																										
<p>C. DOCUMENTS CONSIDERED TO BE RELEVANT</p> <table border="1"> <thead> <tr> <th>Category*</th> <th>Citation of document, with indication, where appropriate, of the relevant passages</th> <th>Relevant to claim No.</th> </tr> </thead> <tbody> <tr> <td>X</td> <td>WO 2004/113343 A1 (Meiji Seika Kaisha, Ltd.), 29 December, 2004 (29.12.04), Claims; Par. No. [0011] & EP 1642900 A1</td> <td>1-5, 11-15</td> </tr> <tr> <td>X</td> <td>WO 2003/055886 A1 (Meiji Seika Kaisha, Ltd.), 10 July, 2003 (10.07.03), Claims; page 4, the last line to page 5, line 3 & US 2005/130955 A1 & US 2005/0020579 A1 & EP 1466914 A1 & EP 1469000 A1 & CA 2471651 A & CN 1617872 A & WO 2003/055886 A1</td> <td>1-5, 11-15</td> </tr> <tr> <td>X</td> <td>WO 99/16770 A1 (Meiji Seika Kaisha, Ltd.), 08 April, 1999 (08.04.99), Claims; page 38, lines 14 to 18 & EP 1026167 A1 & CA 2305307 A</td> <td>1-5, 11-15</td> </tr> </tbody> </table> <p><input checked="" type="checkbox"/> Further documents are listed in the continuation of Box C. <input type="checkbox"/> See patent family annex.</p> <table border="1"> <tr> <td>* Special categories of cited documents:</td> <td>"T" later document published after the international filing date or priority date and not in conflict with the application but cited to understand the principle or theory underlying the invention</td> </tr> <tr> <td>"A" document defining the general state of the art which is not considered to be of particular relevance</td> <td>"X" document of particular relevance; the claimed invention cannot be considered novel or cannot be considered to involve an inventive step when the document is taken alone</td> </tr> <tr> <td>"B" earlier application or patent but published on or after the international filing date</td> <td>"Y" document of particular relevance; the claimed invention cannot be considered to involve an inventive step when the document is combined with one or more other such documents, such combination being obvious to a person skilled in the art</td> </tr> <tr> <td>"C" document which may throw doubts on priority claim(s) or which is cited to establish the publication date of another citation or other special reason (as specified)</td> <td>"Z" document member of the same patent family</td> </tr> <tr> <td>"G" document referring to an oral disclosure, use, exhibition or other means</td> <td></td> </tr> <tr> <td>"P" document published prior to the international filing date but later than the priority date claimed</td> <td></td> </tr> </table>			Category*	Citation of document, with indication, where appropriate, of the relevant passages	Relevant to claim No.	X	WO 2004/113343 A1 (Meiji Seika Kaisha, Ltd.), 29 December, 2004 (29.12.04), Claims; Par. No. [0011] & EP 1642900 A1	1-5, 11-15	X	WO 2003/055886 A1 (Meiji Seika Kaisha, Ltd.), 10 July, 2003 (10.07.03), Claims; page 4, the last line to page 5, line 3 & US 2005/130955 A1 & US 2005/0020579 A1 & EP 1466914 A1 & EP 1469000 A1 & CA 2471651 A & CN 1617872 A & WO 2003/055886 A1	1-5, 11-15	X	WO 99/16770 A1 (Meiji Seika Kaisha, Ltd.), 08 April, 1999 (08.04.99), Claims; page 38, lines 14 to 18 & EP 1026167 A1 & CA 2305307 A	1-5, 11-15	* Special categories of cited documents:	"T" later document published after the international filing date or priority date and not in conflict with the application but cited to understand the principle or theory underlying the invention	"A" document defining the general state of the art which is not considered to be of particular relevance	"X" document of particular relevance; the claimed invention cannot be considered novel or cannot be considered to involve an inventive step when the document is taken alone	"B" earlier application or patent but published on or after the international filing date	"Y" document of particular relevance; the claimed invention cannot be considered to involve an inventive step when the document is combined with one or more other such documents, such combination being obvious to a person skilled in the art	"C" document which may throw doubts on priority claim(s) or which is cited to establish the publication date of another citation or other special reason (as specified)	"Z" document member of the same patent family	"G" document referring to an oral disclosure, use, exhibition or other means		"P" document published prior to the international filing date but later than the priority date claimed	
Category*	Citation of document, with indication, where appropriate, of the relevant passages	Relevant to claim No.																								
X	WO 2004/113343 A1 (Meiji Seika Kaisha, Ltd.), 29 December, 2004 (29.12.04), Claims; Par. No. [0011] & EP 1642900 A1	1-5, 11-15																								
X	WO 2003/055886 A1 (Meiji Seika Kaisha, Ltd.), 10 July, 2003 (10.07.03), Claims; page 4, the last line to page 5, line 3 & US 2005/130955 A1 & US 2005/0020579 A1 & EP 1466914 A1 & EP 1469000 A1 & CA 2471651 A & CN 1617872 A & WO 2003/055886 A1	1-5, 11-15																								
X	WO 99/16770 A1 (Meiji Seika Kaisha, Ltd.), 08 April, 1999 (08.04.99), Claims; page 38, lines 14 to 18 & EP 1026167 A1 & CA 2305307 A	1-5, 11-15																								
* Special categories of cited documents:	"T" later document published after the international filing date or priority date and not in conflict with the application but cited to understand the principle or theory underlying the invention																									
"A" document defining the general state of the art which is not considered to be of particular relevance	"X" document of particular relevance; the claimed invention cannot be considered novel or cannot be considered to involve an inventive step when the document is taken alone																									
"B" earlier application or patent but published on or after the international filing date	"Y" document of particular relevance; the claimed invention cannot be considered to involve an inventive step when the document is combined with one or more other such documents, such combination being obvious to a person skilled in the art																									
"C" document which may throw doubts on priority claim(s) or which is cited to establish the publication date of another citation or other special reason (as specified)	"Z" document member of the same patent family																									
"G" document referring to an oral disclosure, use, exhibition or other means																										
"P" document published prior to the international filing date but later than the priority date claimed																										
Date of the actual completion of the international search 21 May, 2007 (21.05.07)	Date of mailing of the international search report 29 May, 2007 (29.05.07)																									
Name and mailing address of the ISA/ Japanese Patent Office	Authorized officer																									
Facsimile No.	Telephone No.																									

INTERNATIONAL SEARCH REPORT

International application No.

PCT/JP2007/054008

C (Continuation). DOCUMENTS CONSIDERED TO BE RELEVANT		
Category*	Citation of document, with indication, where appropriate, of the relevant passages	Relevant to claim No
Y	WO 97/00258 A1 (Meiji Seika Kaisha, Ltd.), 03 January, 1997 (03.01.97), Claims; page 26, lines 13 to 21 & US 6093714 A & EP 834512 A1 & CN 1190971 A	1-5, 11-15
X	WO 95/18130 A1 (Meiji Seika Kaisha, Ltd.), 06 July, 1995 (06.07.95), Claims; page 84, line 15 to page 85, line 14 & US 5686442 A & US 5840895 A & EP 686636 A1	1-5, 11-15

Form PCT/ISA/210 (continuation of second sheet) (April 2003)

INTERNATIONAL SEARCH REPORT

International application No.

PCT/JP2007/054008

Box No. II Observations where certain claims were found unsearchable (Continuation of item 2 of first sheet)

This international search report has not been established in respect of certain claims under Article 17(2)(a) for the following reasons:

1. Claims Nos.: 6-10
because they relate to subject matter not required to be searched by this Authority, namely:
It pertains to methods for treatment of the human body by therapy.
2. Claims Nos.:
because they relate to parts of the international application that do not comply with the prescribed requirements to such an extent that no meaningful international search can be carried out, specifically.
3. Claims Nos.:
because they are dependent claims and are not drafted in accordance with the second and third sentences of Rule 6.4(a).

Box No. III Observations where unity of invention is lacking (Continuation of item 3 of first sheet)

This International Searching Authority found multiple inventions in this international application, as follows:

1. As all required additional search fees were timely paid by the applicant, this international search report covers all searchable claims.
2. As all searchable claims could be searched without effort justifying an additional fee, this Authority did not invite payment of any additional fee.
3. As only some of the required additional search fees were timely paid by the applicant, this international search report covers only those claims for which fees were paid, specifically claims Nos.:
4. No required additional search fees were timely paid by the applicant. Consequently, this international search report is restricted to the invention first mentioned in the claims; it is covered by claims Nos.:

- Remark on Protest**
- the The additional search fees were accompanied by the applicant's protest and, where applicable, payment of a protest fee.
- The additional search fees were accompanied by the applicant's protest but the applicable protest fee was not paid within the time limit specified in the invitation.
- No protest accompanied the payment of additional search fees.

Form PCT/ISA/210 (continuation of first sheet (2)) (April 2005)

REFERENCES CITED IN THE DESCRIPTION

This list of references cited by the applicant is for the reader's convenience only. It does not form part of the European patent document. Even though great care has been taken in compiling the references, errors or omissions cannot be excluded and the EPO disclaims all liability in this regard.

Patent documents cited in the description

- * JP 2006055706 A [0001]
- * JP 2006055711 A [0001]
- * WO 9518130 A [0010] [0012] [0030] [0076]
- * JP 3290664 B [0010]
- * US 5686442 A [0010]
- * WO 9916770 A [0014] [0016] [0031] [0032] [0034]
- * JP 3188482 B [0014]
- * US 6372735 B [0014]

Non-patent literature cited in the description

- * HANSEN I. et al. Mediators of inflammation in the early and the late phase of allergic rhinitis. *Curr. Opin. Allergy Clin. Immunol.*, 2004, vol. 4, 159-163 [0004]
- * AZUMA KOZUE ; OHNO SHIGEAKI. Arerugisei Ketsumaku Shikkan Gaisetsu. *NEW MOOK Ganka* [0004]
- * Arerugisei Gan Shikkan. KANEHARA & Co., LTD, 2003, 1-5 [0004]
- * KING H.C. et al. Allergy in ENT Practice The basic guide 2nd. Thieme Medical Publisher, Inc, 2005, 178-204 [0005]
- * KRAMER M.F. et al. Nasal IL-16 and MIP-1a in late-phase allergic response. *Allergy and Asthma Proc.*, 2001, vol. 22, 127-132 [0005]
- * ECONOMIDES A ; KALINER M.A. Current Review of Rhinitis. Current Medicine, Inc, 2002, 35-51 [0005]
- * HINGORANI M. ; LIGHTMAN S. Ocular Allergy in "Allergy and Allergic Diseases. Blackwell Science, Inc, 1997, 1645-1670 [0005]
- * CIPRANDI G.B et al. Deflazacort protects against late-phase but early-phase reactions induced by the allergen-specific conjunctival provocation test. *Allergy*, 1993, vol. 48, 421-430 [0006]
- * TAKAMURA ETSUKO. Arerugisei Ketsumaku Shikkan No Meno Kayumi No Seilin To Chiryō. *Allergology*, 2005, vol. 19, 444-449 [0006]
- * Allergic and immunological diseases of eye. BARNEY N.P. ; GRAZIANO F.M. et al. Middleton's Allergy principles & practice. Mosby, Inc, 2003, 1599-1617 [0006]
- * BENSCH G.W. et al. Evaluation of cytokines in nasal secretions after nasal antigen challenge: lack of influence of antihistamines. *Ann. Allergy Asthma Immunol.*, 2002, vol. 88, 457-462 [0008]
- * BEREGER W.E. et al. Efficacy of azelastine nasal spray in patients with an unsatisfactory response to loratadine. *Ann. Allergy Asthma Immunol.*, 2003, vol. 91, 205-211 [0008]
- * LAFORCE C.F. et al. Efficacy of azelastine nasal spray in seasonal allergic rhinitis patients who remain symptomatic after treatment with fexofenadine. *Ann. Allergy Asthma Immunol.*, 2004, vol. 93, 154-159 [0008]
- * DRAIN K.L. ; LI J.T.C. Corticosteroids and their use in rhinitis. in "Current Review of Rhinitis. Current Medicine, Inc, 2002, 163-173 [0009]
- * SCHLEIMER R.P. et al. Middleton's Allergy Principles & Practice Sixth edition. *glucocorticoids*, 2003, 870-913 [0009]
- * Corticosteroids and their use in rhinitis. DRAIN K.L. ; LI J.T.C. Current Review of Rhinitis. Current Medicine, Inc, 2002, 163-173 [0009]

PATENT COOPERATION TREATY

PCT

INTERNATIONAL SEARCH REPORT

(PCT Article 18 and Rules 43 and 44)

Applicant's or agent's file reference 3988 - WO - F	FOR FURTHER ACTION		see Form PCT/ISA/220 as well as, where applicable, item 5 below.
International application No. PCT/US2012/038663	International filing date (day/month/year) 18/05/2012	(Earliest) Priority Date (day/month/year) 19/05/2011	
Applicant ALCON RESEARCH, LTD.			

This international search report has been prepared by this International Searching Authority and is transmitted to the applicant according to Article 18. A copy is being transmitted to the International Bureau.

This international search report consists of a total of 4 sheets.

It is also accompanied by a copy of each prior art document cited in this report.

1. **Basis of the report**

a. With regard to the **language**, the international search was carried out on the basis of:

- the international application in the language in which it was filed
- a translation of the international application into _____, which is the language of a translation furnished for the purposes of international search (Rules 12.3(a) and 23.1(b))

b. This international search report has been established taking into account the **rectification of an obvious mistake** authorized by or notified to this Authority under Rule 91 (Rule 43.6bis(a)).

c. With regard to any **nucleotide and/or amino acid sequence** disclosed in the international application, see Box No. I.

2. **Certain claims were found unsearchable** (See Box No. II)

3. **Unity of invention is lacking** (see Box No. III)

4. With regard to the **title**,

- the text is approved as submitted by the applicant
- the text has been established by this Authority to read as follows:

5. With regard to the **abstract**,

- the text is approved as submitted by the applicant
- the text has been established, according to Rule 38.2, by this Authority as it appears in Box No. IV. The applicant may, within one month from the date of mailing of this international search report, submit comments to this Authority

6. With regard to the **drawings**,

a. the figure of the **drawings** to be published with the abstract is Figure No. 1

- as suggested by the applicant
- as selected by this Authority, because the applicant failed to suggest a figure
- as selected by this Authority, because this figure better characterizes the invention

b. none of the figures is to be published with the abstract

INTERNATIONAL SEARCH REPORT

International application No

PCT/US2012/038663

A. CLASSIFICATION OF SUBJECT MATTER

INV. A61K31/335 A61K9/00 A61P27/14
ADD.

According to International Patent Classification (IPC) or to both national classification and IPC

B. FIELDS SEARCHED

Minimum documentation searched (classification system followed by classification symbols)
A61K A61P

Documentation searched other than minimum documentation to the extent that such documents are included in the fields searched

Electronic data base consulted during the international search (name of data base and, where practicable, search terms used)

EPO-Internal, BIOSIS, CHEM ABS Data, EMBASE, WPI Data

C. DOCUMENTS CONSIDERED TO BE RELEVANT

Category*	Citation of document, with indication, where appropriate, of the relevant passages	Relevant to claim No.
X	WO 2009/003199 A1 (CYDEX PHARMACEUTICALS INC [US]; PIPKIN JAMES D [US]; ZIMMERER RUPERT O) 31 December 2008 (2008-12-31) the whole document page 1, line 2 - line 7 page 4, line 11 - line 26 page 5, line 14 - line 27 page 8, line 18 - line 26 page 57, line 10 - line 15 page 66, line 22 - line 33 page 71, line 27 - page 73, line 10 page 78, line 31 - page 80, line 32 example 20	1-25
X	WO 96/39147 A2 (ALCON LAB INC [US]) 12 December 1996 (1996-12-12) the whole document claims 1-2	1,2,24, 25



Further documents are listed in the continuation of Box C.



See patent family annex.

* Special categories of cited documents :

"A" document defining the general state of the art which is not considered to be of particular relevance

"E" earlier application or patent but published on or after the international filing date

"L" document which may throw doubts on priority claim(s) or which is cited to establish the publication date of another citation or other special reason (as specified)

"O" document referring to an oral disclosure, use, exhibition or other means

"P" document published prior to the international filing date but later than the priority date claimed

"T" later document published after the international filing date or priority date and not in conflict with the application but cited to understand the principle or theory underlying the invention

"X" document of particular relevance; the claimed invention cannot be considered novel or cannot be considered to involve an inventive step when the document is taken alone

"Y" document of particular relevance; the claimed invention cannot be considered to involve an inventive step when the document is combined with one or more other such documents, such combination being obvious to a person skilled in the art

"&" document member of the same patent family

Date of the actual completion of the international search

18 July 2012

Date of mailing of the international search report

25/07/2012

Name and mailing address of the ISA/

European Patent Office, P.B. 5818 Patentlaan 2
NL - 2280 HV Rijswijk
Tel. (+31-70) 340-2040,
Fax: (+31-70) 340-3016

Authorized officer

Economou, Dimitrios

1

INTERNATIONAL SEARCH REPORT

International application No

PCT/US2012/038663

C(Continuation). DOCUMENTS CONSIDERED TO BE RELEVANT

Category*	Citation of document, with indication, where appropriate, of the relevant passages	Relevant to claim No.
X	WO 01/54687 A1 (ALCON UNIVERSAL LTD [CH]; YANNI JOHN M [US]) 2 August 2001 (2001-08-02) the whole document claims 1-2	1,2,9, 24,25
X	----- WO 2008/015695 A2 (SUN PHARMACEUTICAL IND LTD [IN]; BHOWMICK SUBHAS BALARAM [IN]; LADDHA) 7 February 2008 (2008-02-07) the whole document examples A-M examples 1-7 -----	1-25

INTERNATIONAL SEARCH REPORT

International application No

Information on patent family members

PCT/US2012/038663

Patent document cited in search report		Publication date	Patent family member(s)	Publication date
WO 2009003199	A1	31-12-2008	CN 101795565 A	04-08-2010
			EP 2173169 A1	14-04-2010
			JP 2010531898 A	30-09-2010
			WO 2009003199 A1	31-12-2008
WO 9639147	A2	12-12-1996	AT 220906 T	15-08-2002
			AU 698854 B2	12-11-1998
			AU 5726196 A	24-12-1996
			CA 2195094 A1	12-12-1996
			CN 1161000 A	01-10-1997
			DE 10299034 I1	23-01-2003
			DE 69622527 D1	29-08-2002
			DE 69622527 T2	05-12-2002
			DK 799044 T3	14-10-2002
			EP 0799044 A2	08-10-1997
			ES 2179198 T3	16-01-2003
			FI 970489 A	05-02-1997
			JP 3068858 B2	24-07-2000
			JP H09510235 A	14-10-1997
			LU 90969 I2	02-12-2002
			NL 300101 I1	02-12-2002
			NO 970517 A	03-04-1997
			PT 799044 E	29-11-2002
TW 438588 B	07-06-2001			
US 5641805 A	24-06-1997			
WO 9639147 A2	12-12-1996			
WO 0154687	A1	02-08-2001	AT 291913 T	15-04-2005
			AU 776789 B2	23-09-2004
			AU 3455601 A	07-08-2001
			CA 2395866 A1	02-08-2001
			DE 60109742 D1	04-05-2005
			DE 60109742 T2	18-08-2005
			EP 1250133 A1	23-10-2002
			ES 2236180 T3	16-07-2005
			JP 2003520813 A	08-07-2003
			JP 2011132259 A	07-07-2011
			PT 1250133 E	31-05-2005
			US 2001056093 A1	27-12-2001
			WO 0154687 A1	02-08-2001
WO 2008015695	A2	07-02-2008	NONE	

PATENT COOPERATION TREATY

From the
INTERNATIONAL SEARCHING AUTHORITY

PCT

To:

see form PCT/ISA/220

**WRITTEN OPINION OF THE
INTERNATIONAL SEARCHING AUTHORITY
(PCT Rule 43bis.1)**

Date of mailing
(day/month/year) see form PCT/ISA/210 (second sheet)

Applicant's or agent's file reference
see form PCT/ISA/220

FOR FURTHER ACTION
See paragraph 2 below

International application No. PCT/US2012/038663	International filing date (day/month/year) 18.05.2012	Priority date (day/month/year) 19.05.2011
--	--	--

International Patent Classification (IPC) or both national classification and IPC
INV. A61K31/335 A61K9/00 A61P27/14

Applicant
ALCON RESEARCH, LTD.

1. This opinion contains indications relating to the following items:

- Box No. I Basis of the opinion
- Box No. II Priority
- Box No. III Non-establishment of opinion with regard to novelty, inventive step and industrial applicability
- Box No. IV Lack of unity of invention
- Box No. V Reasoned statement under Rule 43bis.1(a)(i) with regard to novelty, inventive step and industrial applicability; citations and explanations supporting such statement
- Box No. VI Certain documents cited
- Box No. VII Certain defects in the international application
- Box No. VIII Certain observations on the international application

2. **FURTHER ACTION**

If a demand for international preliminary examination is made, this opinion will usually be considered to be a written opinion of the International Preliminary Examining Authority ("IPEA") except that this does not apply where the applicant chooses an Authority other than this one to be the IPEA and the chosen IPEA has notified the International Bureau under Rule 66.1bis(b) that written opinions of this International Searching Authority will not be so considered.

If this opinion is, as provided above, considered to be a written opinion of the IPEA, the applicant is invited to submit to the IPEA a written reply together, where appropriate, with amendments, before the expiration of 3 months from the date of mailing of Form PCT/ISA/220 or before the expiration of 22 months from the priority date, whichever expires later.

For further options, see Form PCT/ISA/220.

3. For further details, see notes to Form PCT/ISA/220.

Name and mailing address of the ISA:



European Patent Office
D-80298 Munich
Tel. +49 89 2399 - 0
Fax: +49 89 2399 - 4465

Date of completion of
this opinion

see form
PCT/ISA/210

Authorized Officer

Economou, Dimitrios
Telephone No. +49 89 2399-0



**WRITTEN OPINION OF THE
INTERNATIONAL SEARCHING AUTHORITY**

International application No.
PCT/US2012/038663

Box No. I Basis of the opinion

1. With regard to the **language**, this opinion has been established on the basis of:
 - the international application in the language in which it was filed
 - a translation of the international application into , which is the language of a translation furnished for the purposes of international search (Rules 12.3(a) and 23.1 (b)).
2. This opinion has been established taking into account the **rectification of an obvious mistake** authorized by or notified to this Authority under Rule 91 (Rule 43bis.1(a))
3. With regard to any **nucleotide and/or amino acid sequence** disclosed in the international application, this opinion has been established on the basis of a sequence listing filed or furnished:
 - a. (means)
 - on paper
 - in electronic form
 - b. (time)
 - in the international application as filed
 - together with the international application in electronic form
 - subsequently to this Authority for the purposes of search
4. In addition, in the case that more than one version or copy of a sequence listing has been filed or furnished, the required statements that the information in the subsequent or additional copies is identical to that in the application as filed or does not go beyond the application as filed, as appropriate, were furnished.
5. Additional comments:

Box No. II Priority

1. The validity of the priority claim has not been considered because the International Searching Authority does not have in its possession a copy of the earlier application whose priority has been claimed or, where required, a translation of that earlier application. This opinion has nevertheless been established on the assumption that the relevant date (Rules 43bis.1 and 64.1) is the claimed priority date.
2. This opinion has been established as if no priority had been claimed due to the fact that the priority claim has been found invalid (Rules 43bis.1 and 64.1). Thus for the purposes of this opinion, the international filing date indicated above is considered to be the relevant date.
3. Additional observations, if necessary:

Box No. V Reasoned statement under Rule 43bis.1(a)(i) with regard to novelty, inventive step or industrial applicability; citations and explanations supporting such statement

1. Statement

Novelty (N)	Yes: Claims	<u>4-23</u>
	No: Claims	<u>1-3, 24, 25</u>
Inventive step (IS)	Yes: Claims	
	No: Claims	<u>1-25</u>
Industrial applicability (IA)	Yes: Claims	<u>1-25</u>
	No: Claims	

2. Citations and explanations

see separate sheet

Box No. VII Certain defects in the international application

The following defects in the form or contents of the international application have been noted:

see separate sheet

Box No. VIII Certain observations on the international application

The following observations on the clarity of the claims, description, and drawings or on the question whether the claims are fully supported by the description, are made:

see separate sheet

Re Item V

Reasoned statement with regard to novelty, inventive step or industrial applicability; citations and explanations supporting such statement

1). Claims 24-25 relate to subject-matter considered by this Authority to be covered by the provisions of Rule 39.1(iv) / 67.1(iv) PCT.

The patentability can be dependent upon the formulation of the claims. The EPO, for example, does not recognise as patentable claims to the use of a compound in medical treatment, but may allow claims to a product, in particular substances or compositions for use in a first or further medical treatment.

2). Reference is made to the following documents:

Reference is made to the following documents:

D1=WO 2009/003199

D2=WO 96/39147

D3=WO 01/54687

D4=WO 2008/015695

All of the documents **D1-D3** disclose compositions comprising at least 0.7% olopatadin for the treatment of allergic eye diseases. Hence the subject-matter of claims 1-2 and 24-25 is not novel

D1 discloses compositions comprising at least 0.7% olopatadin for the treatment of allergic eye diseases (see example 20). Example 20 discloses also the composition in the presence of SBE-gamma-CD. Hence the subject-matter of claim 3 is also not novel.

The closest prior art is **D1** which discloses high concentrations of olopatadine in aqueous solution suitable for ophthalmic administration (see example 20). Said document refers also to the additional compounds which appear to routinely used in the technical field (e.g PVP, PEG, boric acid, polyols, HPMC, preservatives; see the passages mentioned in the ISR).

Additionally, from **D4** the use of PEG, HPMC, PVP, BAK for solubilization of olopatadine have been mentioned in examples A-M in which however, the highest amount of olopatadine has reached 0.665 % but with an insufficient physical stability. Compositions comprising 0.527 % olopatadine are mentioned in example 1 which comprise HP-beta-cyclodextrin, HPMC and benzalkonium chloride. Hence, as it appears from **D1** or **D4**, cyclodextrins, PVP, HPMC, PEG are obvious in the technical field and therefore the subject-matter of the present application does not appear to involve an inventive step.

Re Item VII

Certain defects in the international application

As it appears from the description tailoring of the compositions of the present application appears to be a challenge for the person skilled in the art. The compositions must be stable, must comprise olopatadine in high concentrations (at least 0.67 %), thus exhibiting consistent efficacy against late phase symptoms of allergic conjunctivitis and must have sufficient antimicrobial activity to provide desired levels of preservation efficacy.

As it is evident from **table B** cyclodextrin can significantly enhance the solubility of olopatadine in aqueous solutions. However, must be present in a concentration of at least 1.5 % since amounts of 1 % HP-beta-cyclodextrin do not solubilize at least 0.67 % of olopatadine. From **table C** however, can be seen that 1.5% HP-beta-cyclodextrin significantly inhibits the ability of a preservative to provide desired preservation to an aqueous solution. From **table E** it is evident that formulations having high concentrations of olopatadine show desirable preservation by combining PVP with a relatively low amount of HP-beta-cyclodextrin by using BAK and boric acid as preservatives. **Tables F** and **G** show that formulations comprising SBE-beta-CD do not provide desired levels of preservation.

The only compositions which appear to possess the above mentioned properties are probably the compositions mentioned on **table J** of the description. These compositions comprise however, specific components, in particular amounts. Claims which are roughly similar to the compositions of table J are claims 20-23. For the invention as defined in any of the other claims the description does not comprise at least a way of how the skilled person would carry out the invention, since it appears the desired ef-

fects cannot be achieved without undue burden. Hence, the present application does not fulfil the requirements of art. 5 PCT as regards subject-matter as defined in claims 1-19 and 24-25.

Re Item VIII

Certain observations on the international application

It is clear from the description from page 3, line 19 to page 4, line 2 that the following features are essential to the definition of the invention:

- a cyclodextrin
- a lactam polymer
- a polyether
- a pH of 5.5 to 8
- an osmolality of 200 to 450 (units mentioned on page 14, lines 16-20)
- a preservative and a borate and/or polyol.

Since independent claims 1, 9, 16 and 20 do not contain this feature it does not meet the requirement following from Article 6 PCT taken in combination with Rule 6.3(b) PCT that any independent claim must contain all the technical features essential to the definition of the invention.

Electronic Acknowledgement Receipt

EFS ID:	13583779
Application Number:	13475607
International Application Number:	
Confirmation Number:	4130
Title of Invention:	HIGH CONCENTRATION OLOPATADINE OPHTHALMIC COMPOSITION
First Named Inventor/Applicant Name:	Daniel A. Gamache
Customer Number:	26356
Filer:	Scott Chapple/Barbara McKenzie
Filer Authorized By:	Scott Chapple
Attorney Docket Number:	3988 US
Receipt Date:	24-AUG-2012
Filing Date:	18-MAY-2012
Time Stamp:	15:21:52
Application Type:	Utility under 35 USC 111(a)

Payment information:

Submitted with Payment	no
------------------------	----

File Listing:

Document Number	Document Description	File Name	File Size(Bytes)/ Message Digest	Multi Part /.zip	Pages (if appl.)
1	Information Disclosure Statement (IDS) Form (SB08)	3988_US_IDS-sb8a_082412.pdf	615892 <small>5e7481cba9300b0390abe5d18c53f0d1135d275f6</small>	no	11

Warnings:

Information:

2	Foreign Reference	EP_00862414_B1.pdf	73586 c65a66583ec7cfd863e3e11bebdcf5992bf7c80a	no	12
Warnings:					
Information:					
3	Foreign Reference	EP_00998304_B1.pdf	249613 7699967467632f4d1f20240f346bc9b04ea722e4	no	26
Warnings:					
Information:					
4	Foreign Reference	GB_2169508_A.pdf	386343 21ff02847e5a60395d19b013b119bec1faad4443	no	5
Warnings:					
Information:					
5	Foreign Reference	JP_2001-158750.pdf	2094287 2337d41a011e072354c1fd52999c7f25ded4b5	no	33
Warnings:					
Information:					
6	Foreign Reference	WO_1988_008709_A1.pdf	551841 724b5421ee11bd89399e8f43bfd160eeede b8cec	no	14
Warnings:					
Information:					
7	Foreign Reference	WO_1990_004971_A1.pdf	1322593 26da2d0a2b7b5f6baa0e4c9e5c6f857cd7056a9a	no	37
Warnings:					
Information:					
8	Foreign Reference	WO_1991_009523_A1.pdf	1286576 402fbf746ce4112319a71d1f1c1928c4beaa2260	no	27
Warnings:					
Information:					
9	Foreign Reference	WO_1996_039147_A2.pdf	658700 b08b2ee27e632e286ffbd2e1561638a4554f2468	no	19
Warnings:					
Information:					
10	Foreign Reference	WO_2001_054687_A1.pdf	504250 72a89001c3962b7acda3f06dd071944aaa3c04c1	no	13
Warnings:					
Information:					

11	Foreign Reference	WO_2003_013481_A1.pdf	877245	no	20
			8224ff750c1435b42e90326185a38d436a4c5688		
Warnings:					
Information:					
12	Foreign Reference	WO_2006_011044_A1.pdf	283135	no	25
			f5a57bc4b713162e71a6e88afc802110778ee656		
Warnings:					
Information:					
13	Foreign Reference	WO_2008_015695_A2.pdf	1157262	no	27
			2bc8c05098bb70e7a10c2355fd7d34773a6f21db		
Warnings:					
Information:					
14	Foreign Reference	WO_2009_003199_A1.pdf	1497934	no	161
			97d9dadedb8a09720bf68e12d09dc010845cd012		
Warnings:					
Information:					
15	Foreign Reference	WO_2010_107689_A1.pdf	1442471	no	95
			447d9e34e9fa5dcaaebe95a3d9b79fae1fdb871f		
Warnings:					
Information:					
16	Foreign Reference	CA_239176.pdf	882542	no	24
			37807990ef2220f09db245a2ae044fe8cbed075		
Warnings:					
Information:					
17	Foreign Reference	EP_1004309_A1.pdf	233324	no	27
			66a27b37c9ccf9dba3a37ace2e9971469456ee44		
Warnings:					
Information:					
18	Foreign Reference	EP_01231920_B1.pdf	80361	no	8
			3fafba1e067d52c52a81bbd8e0c3439bfb3712c1		
Warnings:					
Information:					
19	Foreign Reference	EP_1994931_A1.pdf	1353235	no	20
			1486d56eb9c8ba809f5885c29566002e54519b84		
Warnings:					
Information:					

20	Non Patent Literature	Chigbu_2009_CLAE_260-272.pdf	1530852 fc488fa60b24c43f90998c0eae9576f7424c08cc	no	13
Warnings:					
Information:					
21	Non Patent Literature	Chigbu_2009_CLAE_3-15.pdf	9015832 fb00edc5454da76b3fc00afb8092c34c9c4fd45	no	13
Warnings:					
Information:					
22	Non Patent Literature	Ciprandi_1995_JACI_612-621.pdf	815611 14b2b67da888915e82722428a20af919ff152467	no	10
Warnings:					
Information:					
23	Non Patent Literature	DuBuske_1996_JACI_S307-S318.pdf	1254673 d97db8297000dd8228c685287ce94d1c5553c1b	no	12
Warnings:					
Information:					
24	Non Patent Literature	Fukuda_2009_JACI_827-833.pdf	844404 e2ee8b13f9a3879278ab8d8ac03a40ffedd59034	no	10
Warnings:					
Information:					
25	Non Patent Literature	PCT-US2012-038663_SearchReport.pdf	221913 c3a90b45130326095a45e30610f576e522d361d0	no	4
Warnings:					
Information:					
26	Non Patent Literature	PCT-US2012-038663_WrittenOpinion.pdf	290683 a7b1ec42c23e02b8c644fa799c20246a402ad8b7	no	6
Warnings:					
Information:					
27	Non Patent Literature	Izushi_2002_EJP_79-82.pdf	356603 f13224b4380e12268725a656f90d6103935523ac	no	4
Warnings:					
Information:					
28	Non Patent Literature	Leonardi_2003_CT_2539-2552.pdf	759945 f2bf624a5331bc880ae593e0b4d90ac12d8f1ac6	no	14
Warnings:					
Information:					

29	Non Patent Literature	Ozaki_2003_GACEO_394-402.pdf	898816 8fe6f149f7c469d08b64ef014fd711711aea3ce0	no	10
Warnings:					
Information:					
30	Non Patent Literature	Ueta_LettertoEditor_2007_JACI_476-478.pdf	332944 4512981bc86b31d395384a4e9953e7831e696310	no	4
Warnings:					
Information:					
31	Non Patent Literature	Vogelson_2004_AAP_69-75.pdf	635120 082c55b4296484105b458e0acc4b0d76fcc7be4e	no	7
Warnings:					
Information:					
32	Non Patent Literature	Yanni_1996_JOPT.pdf	663910 f88dce36098510add5a1011a4f561d99eb563408	no	12
Warnings:					
Information:					
Total Files Size (in bytes):			33172496		

This Acknowledgement Receipt evidences receipt on the noted date by the USPTO of the indicated documents, characterized by the applicant, and including page counts, where applicable. It serves as evidence of receipt similar to a Post Card, as described in MPEP 503.

New Applications Under 35 U.S.C. 111

If a new application is being filed and the application includes the necessary components for a filing date (see 37 CFR 1.53(b)-(d) and MPEP 506), a Filing Receipt (37 CFR 1.54) will be issued in due course and the date shown on this Acknowledgement Receipt will establish the filing date of the application.

National Stage of an International Application under 35 U.S.C. 371

If a timely submission to enter the national stage of an international application is compliant with the conditions of 35 U.S.C. 371 and other applicable requirements a Form PCT/DO/EO/903 indicating acceptance of the application as a national stage submission under 35 U.S.C. 371 will be issued in addition to the Filing Receipt, in due course.

New International Application Filed with the USPTO as a Receiving Office

If a new international application is being filed and the international application includes the necessary components for an international filing date (see PCT Article 11 and MPEP 1810), a Notification of the International Application Number and of the International Filing Date (Form PCT/RO/105) will be issued in due course, subject to prescriptions concerning national security, and the date shown on this Acknowledgement Receipt will establish the international filing date of the application.



UNITED STATES PATENT AND TRADEMARK OFFICE

UNITED STATES DEPARTMENT OF COMMERCE
United States Patent and Trademark Office
Address: COMMISSIONER FOR PATENTS
P.O. Box 1450
Alexandria, Virginia 22313-1450
www.uspto.gov

Table with 4 columns: APPLICATION NUMBER (13/475,607), FILING OR 371(C) DATE (05/18/2012), FIRST NAMED APPLICANT (Daniel A. Gamache), ATTY. DOCKET NO./TITLE (3988 US)

CONFIRMATION NO. 4130

PUBLICATION NOTICE



26356
ALCON
IP LEGAL, TB4-8
6201 SOUTH FREEWAY
FORT WORTH, TX 76134

Title:HIGH CONCENTRATION OLOPATADINE OPHTHALMIC COMPOSITION

Publication No.US-2012-0295967-A1

Publication Date:11/22/2012

NOTICE OF PUBLICATION OF APPLICATION

The above-identified application will be electronically published as a patent application publication pursuant to 37 CFR 1.211, et seq. The patent application publication number and publication date are set forth above.

The publication may be accessed through the USPTO's publically available Searchable Databases via the Internet at www.uspto.gov. The direct link to access the publication is currently http://www.uspto.gov/patft/.

The publication process established by the Office does not provide for mailing a copy of the publication to applicant. A copy of the publication may be obtained from the Office upon payment of the appropriate fee set forth in 37 CFR 1.19(a)(1). Orders for copies of patent application publications are handled by the USPTO's Office of Public Records. The Office of Public Records can be reached by telephone at (703) 308-9726 or (800) 972-6382, by facsimile at (703) 305-8759, by mail addressed to the United States Patent and Trademark Office, Office of Public Records, Alexandria, VA 22313-1450 or via the Internet.

In addition, information on the status of the application, including the mailing date of Office actions and the dates of receipt of correspondence filed in the Office, may also be accessed via the Internet through the Patent Electronic Business Center at www.uspto.gov using the public side of the Patent Application Information and Retrieval (PAIR) system. The direct link to access this status information is currently http://pair.uspto.gov/. Prior to publication, such status information is confidential and may only be obtained by applicant using the private side of PAIR.

Further assistance in electronically accessing the publication, or about PAIR, is available by calling the Patent Electronic Business Center at 1-866-217-9197.

Office of Data Management, Application Assistance Unit (571) 272-4000, or (571) 272-4200, or 1-888-786-0101



UNITED STATES PATENT AND TRADEMARK OFFICE

UNITED STATES DEPARTMENT OF COMMERCE
United States Patent and Trademark Office
Address: COMMISSIONER FOR PATENTS
P.O. Box 1450
Alexandria, Virginia 22313-1450
www.uspto.gov

Table with columns: APPLICATION NO., FILING DATE, FIRST NAMED INVENTOR, ATTORNEY DOCKET NO., CONFIRMATION NO.
Row 1: 13/475,607, 05/18/2012, Daniel A. Gamache, 3988 US, 4130
Row 2: 26356, 7590, 04/18/2013, ALCON IP LEGAL, TB4-8, 6201 SOUTH FREEWAY, FORT WORTH, TX 76134, EXAMINER TRAN, MY CHAU T, ART UNIT 1629, PAPER NUMBER, NOTIFICATION DATE 04/18/2013, DELIVERY MODE ELECTRONIC

Please find below and/or attached an Office communication concerning this application or proceeding.

The time period for reply, if any, is set in the attached communication.

Notice of the Office communication was sent electronically on above-indicated "Notification Date" to the following e-mail address(es):

patent.docketing@alcon.com

Office Action Summary

Application No.
13/475,607

Applicant(s)
GAMACHE ET AL.

Examiner
MY-CHAU T. TRAN

Art Unit
1629

AIA (First Inventor to File)
Status
No

-- The MAILING DATE of this communication appears on the cover sheet with the correspondence address --

Period for Reply

A SHORTENED STATUTORY PERIOD FOR REPLY IS SET TO EXPIRE 1 MONTH(S) OR THIRTY (30) DAYS, WHICHEVER IS LONGER, FROM THE MAILING DATE OF THIS COMMUNICATION.

- Extensions of time may be available under the provisions of 37 CFR 1.136(a). In no event, however, may a reply be timely filed after SIX (6) MONTHS from the mailing date of this communication.
- If NO period for reply is specified above, the maximum statutory period will apply and will expire SIX (6) MONTHS from the mailing date of this communication.
- Failure to reply within the set or extended period for reply will, by statute, cause the application to become ABANDONED (35 U.S.C. § 133). Any reply received by the Office later than three months after the mailing date of this communication, even if timely filed, may reduce any earned patent term adjustment. See 37 CFR 1.704(b).

Status

- 1) Responsive to communication(s) filed on 23 November 2012.
 A declaration(s)/affidavit(s) under **37 CFR 1.130(b)** was/were filed on _____.
- 2a) This action is **FINAL**. 2b) This action is non-final.
- 3) An election was made by the applicant in response to a restriction requirement set forth during the interview on _____; the restriction requirement and election have been incorporated into this action.
- 4) Since this application is in condition for allowance except for formal matters, prosecution as to the merits is closed in accordance with the practice under *Ex parte Quayle*, 1935 C.D. 11, 453 O.G. 213.

Disposition of Claims

- 5) Claim(s) 1-25 is/are pending in the application.
5a) Of the above claim(s) _____ is/are withdrawn from consideration.
- 6) Claim(s) _____ is/are allowed.
- 7) Claim(s) _____ is/are rejected.
- 8) Claim(s) _____ is/are objected to.
- 9) Claim(s) 1-25 are subject to restriction and/or election requirement.

* If any claims have been determined allowable, you may be eligible to benefit from the **Patent Prosecution Highway** program at a participating intellectual property office for the corresponding application. For more information, please see http://www.uspto.gov/patents/init_events/pph/index.jsp or send an inquiry to PPHfeedback@uspto.gov.

Application Papers

- 10) The specification is objected to by the Examiner.
- 11) The drawing(s) filed on _____ is/are: a) accepted or b) objected to by the Examiner.
Applicant may not request that any objection to the drawing(s) be held in abeyance. See 37 CFR 1.85(a).
Replacement drawing sheet(s) including the correction is required if the drawing(s) is objected to. See 37 CFR 1.121(d).

Priority under 35 U.S.C. § 119

- 12) Acknowledgment is made of a claim for foreign priority under 35 U.S.C. § 119(a)-(d) or (f).

Certified copies:

- a) All b) Some * c) None of the:
- Certified copies of the priority documents have been received.
 - Certified copies of the priority documents have been received in Application No. _____.
 - Copies of the certified copies of the priority documents have been received in this National Stage application from the International Bureau (PCT Rule 17.2(a)).
- * See the attached detailed Office action for a list of the certified copies not received.

Interim copies:

- a) All b) Some c) None of the: Interim copies of the priority documents have been received.

Attachment(s)

- 1) Notice of References Cited (PTO-892)
- 2) Information Disclosure Statement(s) (PTO/SB/08)
Paper No(s)/Mail Date _____
- 3) Interview Summary (PTO-413)
Paper No(s)/Mail Date. _____
- 4) Other: _____

Art Unit: 1629

DETAILED ACTION

Application and Claims Status

1. Claims 1-25 are currently pending and are under consideration in this Office Action.

Election/Restrictions

2. This application contains claims directed to the following patentably distinct species of the claimed invention.

(A) *A single specific ophthalmic composition* - Applicants are required to elect a single ophthalmic composition to be examined in their claimed invention to the treatment of a condition associated with an ocular allergic conjunctivitis. Applicants should identify the active agent(s) and the excipient(s)/diluent(s)/vehicle(s)/carrier(s) by ***name and amount*** for the elected single ophthalmic composition. For example, the ophthalmic composition includes the chemical compounds claimed in instant claims 1-23, or the chemical compounds disclosed in the instant specification on the following pages 5-14.

Applicant is required under 35 U.S.C. 121 to elect a single disclosed species for prosecution on the merits to which the claims shall be restricted if no generic claim is finally held to be allowable.

Each of the species identified above is directed to patentably distinct species, wherein each of the species is materially and/or functionally different for the others. Further, it is a significant burden to examine more than a single species of each of the species categories as set forth above because the art is divergent and not necessarily coextensive. Art related to a given species that is

Art Unit: 1629

materially and/or functionally different from the others would not necessarily disclose or make obvious each of the species.

Applicant is advised that a reply to this requirement must include an identification of the species that is elected consonant with this requirement, and a listing of all claims readable thereon, including any claims subsequently added. An argument that a claim is allowable or that all claims are generic is considered nonresponsive unless accompanied by an election.

Upon the allowance of a generic claim, applicant will be entitled to consideration of claims to additional species which are written in dependent form or otherwise include all the limitations of an allowed generic claim as provided by 37 CFR § 1.141. If claims are added after the election, Applicant must indicate which are readable upon the elected species. See MPEP § 809.02(a).

Should applicant traverse on the ground that the species are not patentably distinct, applicant should submit evidence or identify such evidence now of record showing the species to be obvious variants or clearly admit on the record that this is the case. In either instance, if the examiner finds one of the inventions unpatentable over the prior art, the evidence or admission may be used in a rejection under 35 U.S.C. 103(a) of the other invention.

3. Because the above restriction/election requirement is complex, a telephone call to Applicant to request an oral election was not made. See MPEP § 812.01.

4. Applicant is reminded that upon the cancellation of claims to a non-elected invention, the inventorship must be amended in compliance with 37 CFR 1.48(b) if one or more of the

Art Unit: 1629

currently named inventors is no longer an inventor of at least one claim remaining in the application. Any amendment of inventorship must be accompanied by a request under 37 CFR 1.48(b) and by the fee required under 37 CFR 1.17(i).

Conclusion

If Applicants should amend the claims, a complete and responsive reply will clearly identify where support can be found in the disclosure for each amendment. Applicants should point to the page and line numbers of the application corresponding to each amendment, and provide any statements that might help to identify support for the claimed invention (e.g., if the amendment is not supported *in ipsius verbis*, clarification on the record may be helpful). Should Applicants present new claims, Applicants should clearly identify where support can be found in the disclosure.

Any inquiry concerning this communication or earlier communications from the examiner should be directed to MY-CHAU T. TRAN whose telephone number is 571-272-0810. The examiner can normally be reached on Monday - Friday: 8:00 - 4:30.

If attempts to reach the examiner by telephone are unsuccessful, the examiner's supervisor, Jeffrey S. Lundgren can be reached on 571-272-5541. The fax phone number for the organization where this application or proceeding is assigned is 571-273-8300.

Art Unit: 1629

Information regarding the status of an application may be obtained from the Patent Application Information Retrieval (PAIR) system. Status information for published applications may be obtained from either Private PAIR or Public PAIR. Status information for unpublished applications is available through Private PAIR only. For more information about the PAIR system, see <http://pair-direct.uspto.gov>. Should you have questions on access to the Private PAIR system, contact the Electronic Business Center (EBC) at 866-217-9197 (toll-free). If you would like assistance from a USPTO Customer Service Representative or access to the automated information system, call 800-786-9199 (IN USA OR CANADA) or 571-272-1000.

/MY-CHAU T. TRAN/
Primary Examiner, Art Unit 1629

April 15, 2013

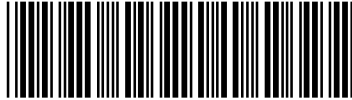
Index of Claims 	Application/Control No. 13475607	Applicant(s)/Patent Under Reexamination GAMACHE ET AL.
	Examiner MY-CHAU T TRAN	Art Unit 1629

✓	Rejected
=	Allowed

-	Cancelled
÷	Restricted

N	Non-Elected
I	Interference

A	Appeal
O	Objected

Claims renumbered in the same order as presented by applicant
 CPA
 T.D.
 R.1.47

CLAIM		DATE							
Final	Original	03/28/2013							
	1	÷							
	2	÷							
	3	÷							
	4	÷							
	5	÷							
	6	÷							
	7	÷							
	8	÷							
	9	÷							
	10	÷							
	11	÷							
	12	÷							
	13	÷							
	14	÷							
	15	÷							
	16	÷							
	17	÷							
	18	÷							
	19	÷							
	20	÷							
	21	÷							
	22	÷							
	23	÷							
	24	÷							
	25	÷							

INFORMATION DISCLOSURE STATEMENT BY APPLICANT (Not for submission under 37 CFR 1.99)	Application Number		13475607
	Filing Date		2012-05-18
	First Named Inventor	Daniel A. Gamache	
	Art Unit		1629
	Examiner Name		
	Attorney Docket Number		3988 US

U.S.PATENTS						Remove
Examiner Initial*	Cite No	Patent Number	Kind Code ¹	Issue Date	Name of Patentee or Applicant of cited Document	Pages,Columns,Lines where Relevant Passages or Relevant Figures Appear
/MCT/	1	3767788		1973-10-23	Rankin	
	2	3843782		1974-10-22	Kreznoski et al.	
	3	3856919		1974-12-24	Rankin	
	4	3931319		1976-01-06	Green et al.	
	5	3947573		1976-03-30	Rankin	
	6	4027020		1977-05-31	Green et al.	
	7	4120949		1978-10-17	Bapatla et al.	
↓ /MCT/	8	4283393		1981-08-11	Field et al.	

ALL REFERENCES CONSIDERED EXCEPT WHERE LINED THROUGH. /MCT/

**INFORMATION DISCLOSURE
STATEMENT BY APPLICANT**
(Not for submission under 37 CFR 1.99)

Application Number	13475607
Filing Date	2012-05-18
First Named Inventor	Daniel A. Gamache
Art Unit	1629
Examiner Name	
Attorney Docket Number	3988 US

/MCT/	9	4407791		1983-10-04	Stark	
	10	4470965		1984-09-11	Wolf et al.	
	11	4525346		1985-06-25	Stark	
	12	4836986		1989-06-06	Ogunbiyi et al.	
	13	4923693		1990-05-08	Michalos	
	14	5037647		1991-08-06	Chowhan et al.	
	15	5068225		1991-11-26	Pennell et al.	
	16	5116863		1992-05-26	Oshima et al.	
	17	5134127		1992-07-28	Stella et al.	
	18	5141961		1992-08-25	Coapman	
/MCT/	19	5300287		1994-04-05	Park	

**INFORMATION DISCLOSURE
STATEMENT BY APPLICANT**
(Not for submission under 37 CFR 1.99)

Application Number		13475607
Filing Date		2012-05-18
First Named Inventor	Daniel A. Gamache	
Art Unit		1629
Examiner Name		
Attorney Docket Number		3988 US

/MCT/	20	5376645		1994-12-27	Stella et al.	
	21	5472954		1995-12-05	Loftsson	
	22	5591426		1997-01-07	Dabrowski et al.	
	23	5597559		1997-01-28	Olejniak et al.	
	24	5624962		1997-04-29	Takeuchi et al.	
	25	5888493		1999-03-30	Sawaya	
	26	6153746		2000-11-28	Shah et al.	
	27	6511949		2003-01-28	Nitta et al.	
	28	6828356		2004-12-07	Su et al.	
	29	7074424		2006-07-11	Avila et al.	
↓ /MCT/	30	7147844		2006-12-12	Hamano et al.	

**INFORMATION DISCLOSURE
STATEMENT BY APPLICANT**
(Not for submission under 37 CFR 1.99)

Application Number	13475607
Filing Date	2012-05-18
First Named Inventor	Daniel A. Gamache
Art Unit	1629
Examiner Name	
Attorney Docket Number	3988 US

/MCT/	31	7429602		2008-09-30	Trach et al.	
/MCT/	32	7635773		2009-12-22	Antle	

If you wish to add additional U.S. Patent citation information please click the Add button.

Add

U.S.PATENT APPLICATION PUBLICATIONS

Remove

Examiner Initial*	Cite No	Publication Number	Kind Code ¹	Publication Date	Name of Patentee or Applicant of cited Document	Pages, Columns, Lines where Relevant Passages or Relevant Figures Appear
/MCT/	1	20020006443		2002-01-17	Curatolo et al.	
	2	20020150616		2002-10-17	Vandecruys	
	3	20030170309		2003-09-11	Babcock et al.	
	4	20050004074		2005-01-06	Lyons et al.	
	5	20050191270		2005-09-01	Gruening et al.	
	6	20050244472		2005-11-03	Hughes et al.	
/MCT/	7	20060210645		2006-09-21	Du Mee et al.	

ALL REFERENCES CONSIDERED EXCEPT WHERE LINED THROUGH. /MCT/

**INFORMATION DISCLOSURE
STATEMENT BY APPLICANT**
(Not for submission under 37 CFR 1.99)

Application Number	13475607
Filing Date	2012-05-18
First Named Inventor	Daniel A. Gamache
Art Unit	1629
Examiner Name	
Attorney Docket Number	3988 US

/MCT/	8	20070020336		2007-01-25	Loftsson et al.	
	9	20080132444		2008-06-05	Li et al.	
	10	20090118262		2009-05-07	Rohrs et al.	
	11	20090232763		2009-09-17	Kabra et al.	
	12	20090239842		2009-09-24	Trach et al.	
	13	20100240625		2010-09-23	Abelson et al.	
	14	20100249062		2010-09-30	Matsumura et al.	
/MCT/	15	20100324031		2010-12-23	Kabra	

If you wish to add additional U.S. Published Application citation information please click the Add button. [Add](#)

FOREIGN PATENT DOCUMENTS

[Remove](#)

Examiner Initial*	Cite No	Foreign Document Number ³	Country Code ²	Kind Code ⁴	Publication Date	Name of Patentee or Applicant of cited Document	Pages, Columns, Lines where Relevant Passages or Relevant Figures Appear	T ⁵
/MCT/	1	0862414	EP		2001-12-05	Novartis AG		<input type="checkbox"/>

ALL REFERENCES CONSIDERED EXCEPT WHERE LINED THROUGH. /MCT/

**INFORMATION DISCLOSURE
STATEMENT BY APPLICANT**
(Not for submission under 37 CFR 1.99)

Application Number	13475607
Filing Date	2012-05-18
First Named Inventor	Daniel A. Gamache
Art Unit	1629
Examiner Name	
Attorney Docket Number	3988 US

/MCT/	2	0998304	EP		2003-08-20	Janssen Pharmaceutica N.V.	<input type="checkbox"/>
/MCT/	3	2169508	GB		1986-07-16	Smith and Nephew Associated Companies plc	<input type="checkbox"/>
/MCT/	4	2001-158750	JP		2001-06-12	Lion Corp.	<input checked="" type="checkbox"/>
/MCT/	5	88/08709	WO		1988-11-17	MDR Group, Inc.	<input type="checkbox"/>
/MCT/	6	90/04971	WO		1990-05-17	M.D.R. Group, Inc.	<input type="checkbox"/>
/MCT/	7	91/09523	WO		1991-07-11	Allergan Inc.	<input type="checkbox"/>
/MCT/	8	96/39147	WO		1996-12-12	Alcon Laboratories, Inc.	<input type="checkbox"/>
/MCT/	9	01/54687	WO		2001-08-02	Alcon Universal Ltd.	<input type="checkbox"/>
/MCT/	10	2003/013481	WO		2003-02-20	Khamar et al.	<input type="checkbox"/>
/MCT/	11	2006/011044	WO		2006-02-02	Pfizer Products Inc.	<input type="checkbox"/>
/MCT/	12	2008/015695	WO		2008-02-07	Sun Pharmaceutical Ind. Ltd.	<input type="checkbox"/>

**INFORMATION DISCLOSURE
STATEMENT BY APPLICANT**
(Not for submission under 37 CFR 1.99)

Application Number	13475607
Filing Date	2012-05-18
First Named Inventor	Daniel A. Gamache
Art Unit	1629
Examiner Name	
Attorney Docket Number	3988 US

/MCT/	13	2009/003199	WO		2008-12-31	Cydex Pharmaceuticals, Inc.	<input type="checkbox"/>
/MCT/	14	2010/107689	WO		2010-09-23	Aciex Therapeutics, Inc.	<input type="checkbox"/>
/MCT/	15	2 391 076	CA		2001-05-25	Boehringer Ingelheim International GmbH	<input type="checkbox"/>
/MCT/	16	1 004 309	EP		2000-05-31	Senju Pharmaceutical Co., Ltd.	<input type="checkbox"/>
/MCT/	17	1 231 920	EP		2007-02-07	Boehringer Ingelheim International GmbH	<input type="checkbox"/>
/MCT/	18	1 994 931	EP		2008-11-26	Meiji Seika Kaisha Ltd.	<input type="checkbox"/>

If you wish to add additional Foreign Patent Document citation information please click the Add button **Add**

NON-PATENT LITERATURE DOCUMENTS

Remove

Examiner Initials*	Cite No	Include name of the author (in CAPITAL LETTERS), title of the article (when appropriate), title of the item (book, magazine, journal, serial, symposium, catalog, etc), date, pages(s), volume-issue number(s), publisher, city and/or country where published.	T ⁵
/MCT/	1	CHIGBU, "The management of allergic eye disease in primary eye care", Contact Lens & Anterior Eye, 32, pgs 260-272, 2009	<input type="checkbox"/>
/MCT/	2	CHIGBU, "The pathophysiology of ocular allergy: A review", Contact Lens & Anterior Eye, 32, pgs. 3-15, 2009	<input type="checkbox"/>
/MCT/	3	CIPRANDI et al., "Cetirizine reduces inflammatory cell recruitment and ICAM-1 (or CD54) expression on conjunctival epithelium in both early- and late-phase reactions after allergen-specific challenge", J Allergy Clin Immunol, vol. 95, no. 2, pgs 612-621, Feb. 1995	<input type="checkbox"/>

ALL REFERENCES CONSIDERED EXCEPT WHERE LINED THROUGH. /MCT/

**INFORMATION DISCLOSURE
STATEMENT BY APPLICANT**
(Not for submission under 37 CFR 1.99)

Application Number	13475607
Filing Date	2012-05-18
First Named Inventor	Daniel A. Gamache
Art Unit	1629
Examiner Name	
Attorney Docket Number	3988 US

/MCT/	4	DU BUSKE, "Clinical comparison of histamine H1-receptor antagonist drugs", J Allergy Clin Immunol, vol. 98, no. 6, part 3, pgs. S307-S318, Dec. 1996	<input type="checkbox"/>
/MCT/	5	FUKUDA et al., "Critical role of IgE-dependent mast cell activation in a murine model of allergic conjunctivitis", J Allergy Clin Immunol, vol. 124, no. 4, 827-833.e2, Oct. 2009	<input type="checkbox"/>
/MCT/	6	International Search Report for corresponding PCT/US2012/038663 with mailing date July 25, 2012	<input type="checkbox"/>
/MCT/	7	International Written Opinion for corresponding PCT/US2012/038663 with mailing date July 25, 2012	<input type="checkbox"/>
/MCT/	8	IZUSHI et al., "The role of histamine H1 receptors in late-phase reaction of allergic conjunctivitis", European Journal of Pharmacology, 440:79-82, 2002	<input type="checkbox"/>
/MCT/	9	LEONARDI and ABELSON, "Double-Masked, Randomized, Placebo-Controlled Clinical Study of the Mast Cell-Stabilizing Effects of Treatment with Olopatadine in the Conjunctival Allergen Challenge Model in Humans", Clinical Therapeutics, vol. 25, no. 10, pgs. 2539-2552, 2003	<input type="checkbox"/>
/MCT/	10	OZAKI et al., "Mast-cell activation augments the late phase reaction in experimental immune-mediated blepharoconjunctivitis", Graefe's Arch Clin Exp Ophthalmol, 241:394-402, 2003	<input type="checkbox"/>
/MCT/	11	UETA et al., letter to editor, "Development of eosinophilic conjunctival inflammation at late-phase reaction in mast cell-deficient mice", J Allergy Clin Immunol, pgs 476-478, Aug. 2007	<input type="checkbox"/>
/MCT/	12	VOGELSON et al., "Preclinical and Clinical Antiallergic Effect of Olopatadine 0.2% Solution 24 Hours after Topical Ocular Administration", Allergy and Asthma Proc., Vol. 25, No. 1, pgs 69-75, Jan-Feb 2004	<input type="checkbox"/>
/MCT/	13	YANNI et al., "The In Vitro and In Vivo Ocular Pharmacology of Olopatadine (AL-4943A), an Effective Anti-Allergic/Antihistaminic Agent", Journal of Ocular Pharmacology and Therapeutics, Vol. 12, No. 4, 1996	<input type="checkbox"/>

If you wish to add additional non-patent literature document citation information please click the Add button **Add**

ALL REFERENCES CONSIDERED EXCEPT WHERE LINED THROUGH. /MCT/

**INFORMATION DISCLOSURE
STATEMENT BY APPLICANT**
(Not for submission under 37 CFR 1.99)

Application Number	13475607	
Filing Date	2012-05-18	
First Named Inventor	Daniel A. Gamache	
Art Unit	1629	
Examiner Name		
Attorney Docket Number	3988 US	

EXAMINER SIGNATURE

Examiner Signature	/My Chau Tran/	Date Considered	03/29/2013
--------------------	----------------	-----------------	------------

*EXAMINER: Initial if reference considered, whether or not citation is in conformance with MPEP 609. Draw line through a citation if not in conformance and not considered. Include copy of this form with next communication to applicant.

¹ See Kind Codes of USPTO Patent Documents at www.USPTO.GOV or MPEP 901.04. ² Enter office that issued the document, by the two-letter code (WIPO Standard ST.3). ³ For Japanese patent documents, the indication of the year of the reign of the Emperor must precede the serial number of the patent document. ⁴ Kind of document by the appropriate symbols as indicated on the document under WIPO Standard ST.16 if possible. ⁵ Applicant is to place a check mark here if English language translation is attached.

IN THE UNITED STATES PATENT AND TRADEMARK OFFICE

In re Application of : Gamache, Daniel A. et al.
Serial No. : 13/475,607
Filed : May 18, 2012
Confirmation No. : 4130
Examiner : Tran, My Chau T.
Group Art Unit : 1629
For : High Concentration Olopatadine Ophthalmic Composition

RESPONSE TO ELECTION/RESTRICTION REQUIREMENT DATED APRIL 18, 2013

Mail Stop Amendment
Commissioner for Patents
P.O. Box 1450
Alexandria, VA 22313-1450

Sir:

This paper is submitted in response to the Election/Restriction Requirement dated April 18, 2013 for which the one-month date for response is May 18, 2013.

Applicant believes that no extension of time is required for this response. However, should such request or fee be deficient or absent, consider this paragraph such a request and authorization to deduct said fees from Alcon Research, Ltd. Deposit Account No. **010682**.

REMARKS**A. Status of the Claims**

This application was originally filed with claims 1-25. A listing of the claims is provided below.

B. Election Requirement under 35 U.S.C. §121 and/or 372

An Election Requirement was issued under 35 U.S.C. §121 and/or §372. The Election Requirement provides no guidance as to which claims contain species from which Applicants are required to elect. Applicants suggest that such an Election Requirement is improper as is further discussed below. The Election Requirement does suggest that applicants need to elect a single composition for prosecution on the merits and needs to identify ingredients and concentrations of those ingredients within the composition. In an attempt to comply with this Election Requirement, Applicants elect, with traverse, the composition described in the table below:

Ingredients	w/v%
Olopatadine (Olopatadine HCl)	0.7
Polyether (PEG)	4.0
Lactam Polymer (PVP)	4.0
Viscosity Agent (HEC)	0.1 (if used w/ HPMC or other viscosity agent) 0.3 (if used w/o HPMC or other viscosity agent)
Viscosity Agent (HPMC)	0.15 (if used w/ HEC or other viscosity agent) 0.35 (if used w/o HEC or other viscosity agent)
Chelating agent (Disodium EDTA)	0.005
Borate (Boric Acid)	0.3

cyclodextrin derivative	1.5
Polyol (Mannitol)	0.3
Polyol (Propylene Glycol)	1.0
Tonicity Agent (Sodium Chloride)	0.35
Preservative (BAK)	0.01
pH adjusting agents (NaOH or HCl)	sufficient to achieve pH = 7.0
purified water	Q.S. 100

All of claims 1-25 read on the elected species

C. Traverse

As suggested, the Election Requirement provides no guidance as to which claims contain species from which Applicants are required to elect. An indication of which claims include which species is required for issuance of an election restriction requirement. Section 803 of the MPEP reads as follows:

There are two criteria for a proper requirement for restriction between patentably distinct inventions:

- (A) The inventions must be independent... or distinct as claimed; and
- (B) There * > would < be a serious burden on the examiner if restriction is > not < required. (emphasis added)

Further, section 806.01 of the MPEP reads as follows:

In passing upon questions of double patenting and restriction, it is the claimed subject matter that is considered and such claimed subject matter must be compared in order to determine the question of distinctness or independence. (emphasis added)

Further yet, 37 C.F.R. 1.146 reads:

In the first action on an application containing a generic claim to a generic invention (genus) and claims to more than one patentably distinct species embraced thereby, the examiner may require the applicant in the reply to that action to elect a species of his or her invention to which his or her claim will be restricted if no claim to the genus is found to be allowable... (emphasis added)

These sections of the MPEP make clear that Election/Restriction Requirements are to be based upon the claims of an application and should indicate where different species are within the claims. The Election Requirement for the present application has failed to do that. As such, Applicants request that the requirement be withdrawn.

In an effort to expedite prosecution, Applicants have provided an election of a reasonably specific composition within this Response. While Applicants have made a good faith effort to comply with the request of the Election Requirement, Applicants make no acquiescence in the Election/Restriction requirement and specifically maintain the right to amend claims as necessary or desired during further prosecution of the present application.

Applicants believe the claims of the present application are in condition for allowance and request that allowance of the claim be considered. The Examiner is invited to contact the undersigned attorney at 817-615-5288 with any questions, comments or suggestions relating to the instant application.

Respectfully submitted,

ALCON RESEARCH, LTD.

By: 

Scott A. Chapple
Registration No. 46,287

May 15, 2013

Date

Address for Correspondence:
Scott A. Chapple, IP Legal
Alcon Research, Ltd.
6201 South Freeway, Mail Code TB4-8
Fort Worth, Texas 76134-2099
Phone: 817-615-5288
Atty Docket No.: 3988 US

What Is Claimed Is:

Claim 1 (original): An ophthalmic composition for treatment of ocular allergic conjunctivitis, the composition comprising:

5 at least 0.67 w/v % olopatadine; and
 water.

Claim 2 (original): A composition as in claim 1 wherein the concentration of olopatadine is at least 0.7 w/v% and is dissolved in solution.

10 Claim 3 (original): A composition as in claim 1 further comprising a γ -cyclodextrin derivative, a β -cyclodextrin derivative or both to aid in the solubility of the olopatadine.

15 Claim 4 (original): A composition as in claim 1 further comprising a lactam polymer to aid in the solubility of the olopatadine.

Claim 5 (original): A composition as in claim 4 wherein the lactam polymer is polyvinylpyrrolidone.

20 Claim 6 (original): A composition as in claims 1 further comprising a polyether.

25 Claim 7 (original): A composition as in claim 6 wherein the polyether is polyethylene glycol.

Claim 8 (original): A composition as in claim 1 wherein the composition is disposed in an eyedropper, has a pH of 5.5 to 8.0 and an osmolality of 200 to 450.

30 Claim 9 (original): An ophthalmic composition for treatment of ocular allergic conjunctivitis, the composition comprising:

 at least 0.67 w/v % olopatadine dissolved in solution;
 PEG having a molecular weight of 300 to 500;
35 polyvinylpyrrolidone; and

cyclodextrin derivative selected from β -cyclodextrin derivative, γ -cyclodextrin or both.

5 Claim 10 (original): A composition as in claim 9 further comprising a preservative selected from a polymeric quaternary ammonium compound and benzalkonium chloride.

10 Claim 11 (original): A composition as in claim 10 wherein the cyclodextrin derivative is hydroxypropyl- β -cyclodextrin or sulfoalkyl ether β -cyclodextrin.

15 Claim 12 (original): A composition as in claim 11 wherein the β -cyclodextrin derivative is hydroxypropyl- β -cyclodextrin when the preservative is the benzalkonium chloride and the β -cyclodextrin derivative is sulfoalkyl ether β -cyclodextrin when the preservative is the polymeric quaternary ammonium compound.

20 Claim 13 (original): A composition as in claim 10 wherein the preservative is benzalkonium chloride and the cyclodextrin derivative is hydroxypropyl- γ -cyclodextrin.

25 Claim 14 (original): A composition as in claim 9 further comprising borate.

30 Claim 15 (original): A composition as in claim 14 further comprising polyol.

35 Claim 16 (original): An ophthalmic composition for treatment of ocular allergic conjunctivitis, the composition comprising:

at least 0.67 w/v % but no greater than 1.0 w/v% olopatadine dissolved in solution;

PEG having a molecular weight of 300 to 500 wherein the concentration of the PEG in solution is from about 2.0 w/v % to about 6.0 w/v%;

a lactam polymer wherein the lactam polymer is polyvinylpyrrolidone and the concentration of the polyvinylpyrrolidone in solution is from about 2.0 w/v % to about 6.0 w/v%; and

a β -cyclodextrin derivative or a γ -cyclodextrin derivative selected from SAE- β -cyclodextrin, HP- γ -cyclodextrin and HP- β -cyclodextrin wherein the

concentration of the β -cyclodextrin derivative or the γ -cyclodextrin derivative is at least 0.5 w/v% but no greater than 2.0 w/v%.

5 Claim 17 (original): A composition as in claims 16 further comprising borate at a concentration of at least about 0.18 w/v % but less than about 0.5 w/v%.

Claim 18 (original): A composition as in claim 17 further comprising polyol.

10 Claim 19 (original): A composition as in claim 18 wherein the polyol include polyethylene glycol at a concentration of at least 0.4 w/v% but no greater than 2.2 w/v%.

Claim 20 (original): An ophthalmic composition for treatment of ocular allergic conjunctivitis, the composition comprising:

15 at least 0.67 w/v % but no greater than 1.0 w/v% olopatadine dissolved in solution;

PEG having a molecular weight of 300 to 500 wherein the concentration of the PEG in solution is from about 2.0 w/v % to about 6.0 w/v%;

20 a lactam polymer wherein the lactam polymer is polyvinylpyrrolidone and the concentration of the polyvinylpyrrolidone in solution is from about 2.0 w/v % to about 6.0 w/v%; and

hydroxypropyl- γ -cyclodextrin in the composition at a concentration of at least 0.5 w/v% but no greater than 2.0 w/v%.

25 Claim 21 (original): A composition as in claims 20 further comprising borate at a concentration of at least about 0.18 w/v % but less than about 0.5 w/v%.

Claim 22 (original): A composition as in claim 21 further comprising polyol.

30 Claim 23 (original): A composition as in claim 22 wherein the polyol include polyethylene glycol at a concentration of at least 0.4 w/v% but no greater than 2.2 w/v%.

35 Claim 24 (original): A method of treating ocular allergy symptoms, the method comprising:

topically applying the composition of claim 20 to an eye of a human.

Claim 25 (original): A method as in claim 24 wherein the step of topically applying the composition includes dispensing an eyedrop from an eyedropper.

5

Electronic Acknowledgement Receipt

EFS ID:	15781172
Application Number:	13475607
International Application Number:	
Confirmation Number:	4130
Title of Invention:	HIGH CONCENTRATION OLOPATADINE OPHTHALMIC COMPOSITION
First Named Inventor/Applicant Name:	Daniel A. Gamache
Customer Number:	26356
Filer:	Scott Chapple/Barbara McKenzie
Filer Authorized By:	Scott Chapple
Attorney Docket Number:	3988 US
Receipt Date:	15-MAY-2013
Filing Date:	18-MAY-2012
Time Stamp:	12:13:12
Application Type:	Utility under 35 USC 111(a)

Payment information:

Submitted with Payment	no
------------------------	----

File Listing:

Document Number	Document Description	File Name	File Size(Bytes)/ Message Digest	Multi Part /.zip	Pages (if appl.)
1		PAT903988-US- NP_2013-05-15_RESP.pdf	321445 <small>8cd8be30b3304a3b91b08d914b255147963e2fcc</small>	yes	9

Multipart Description/PDF files in .zip description			
Document Description		Start	End
Response to Election / Restriction Filed		1	5
Claims		6	9

Warnings:

Information:

Total Files Size (in bytes):	321445
-------------------------------------	--------

This Acknowledgement Receipt evidences receipt on the noted date by the USPTO of the indicated documents, characterized by the applicant, and including page counts, where applicable. It serves as evidence of receipt similar to a Post Card, as described in MPEP 503.

New Applications Under 35 U.S.C. 111

If a new application is being filed and the application includes the necessary components for a filing date (see 37 CFR 1.53(b)-(d) and MPEP 506), a Filing Receipt (37 CFR 1.54) will be issued in due course and the date shown on this Acknowledgement Receipt will establish the filing date of the application.

National Stage of an International Application under 35 U.S.C. 371

If a timely submission to enter the national stage of an international application is compliant with the conditions of 35 U.S.C. 371 and other applicable requirements a Form PCT/DO/EO/903 indicating acceptance of the application as a national stage submission under 35 U.S.C. 371 will be issued in addition to the Filing Receipt, in due course.

New International Application Filed with the USPTO as a Receiving Office

If a new international application is being filed and the international application includes the necessary components for an international filing date (see PCT Article 11 and MPEP 1810), a Notification of the International Application Number and of the International Filing Date (Form PCT/RO/105) will be issued in due course, subject to prescriptions concerning national security, and the date shown on this Acknowledgement Receipt will establish the international filing date of the application.

Under the Paperwork Reduction Act of 1995, no persons are required to respond to a collection of information unless it displays a valid OMB control number.

PATENT APPLICATION FEE DETERMINATION RECORD Substitute for Form PTO-875	Application or Docket Number 13/475,607	Filing Date 05/18/2012	<input type="checkbox"/> To be Mailed
---	---	----------------------------------	---------------------------------------

ENTITY: LARGE SMALL MICRO

APPLICATION AS FILED – PART I

	(Column 1)	(Column 2)		(Column 2)
FOR	NUMBER FILED	NUMBER EXTRA	RATE (\$)	FEE (\$)
<input type="checkbox"/> BASIC FEE (37 CFR 1.16(a), (b), or (c))	N/A	N/A	N/A	
<input type="checkbox"/> SEARCH FEE (37 CFR 1.16(k), (l), or (m))	N/A	N/A	N/A	
<input type="checkbox"/> EXAMINATION FEE (37 CFR 1.16(o), (p), or (q))	N/A	N/A	N/A	
TOTAL CLAIMS (37 CFR 1.16(i))	minus 20 =	*	X \$ =	
INDEPENDENT CLAIMS (37 CFR 1.16(h))	minus 3 =	*	X \$ =	
<input type="checkbox"/> APPLICATION SIZE FEE (37 CFR 1.16(s))	If the specification and drawings exceed 100 sheets of paper, the application size fee due is \$310 (\$155 for small entity) for each additional 50 sheets or fraction thereof. See 35 U.S.C. 41(a)(1)(G) and 37 CFR 1.16(s).			
<input type="checkbox"/> MULTIPLE DEPENDENT CLAIM PRESENT (37 CFR 1.16(j))				
* If the difference in column 1 is less than zero, enter "0" in column 2.			TOTAL	

APPLICATION AS AMENDED – PART II

	(Column 1)	(Column 2)	(Column 3)		(Column 3)	
AMENDMENT	05/15/2013	CLAIMS REMAINING AFTER AMENDMENT	HIGHEST NUMBER PREVIOUSLY PAID FOR	PRESENT EXTRA	RATE (\$)	ADDITIONAL FEE (\$)
	Total (37 CFR 1.16(i))	* 25	Minus	** 25	= 0	X \$80 = 0
	Independent (37 CFR 1.16(h))	* 4	Minus	***4	= 0	X \$420 = 0
	<input type="checkbox"/> Application Size Fee (37 CFR 1.16(s))					
	<input type="checkbox"/> FIRST PRESENTATION OF MULTIPLE DEPENDENT CLAIM (37 CFR 1.16(j))					
					TOTAL ADD'L FEE	0

	(Column 1)	(Column 2)	(Column 3)		(Column 3)	
AMENDMENT		CLAIMS REMAINING AFTER AMENDMENT	HIGHEST NUMBER PREVIOUSLY PAID FOR	PRESENT EXTRA	RATE (\$)	ADDITIONAL FEE (\$)
	Total (37 CFR 1.16(i))	*	Minus	**	=	X \$ =
	Independent (37 CFR 1.16(h))	*	Minus	***	=	X \$ =
	<input type="checkbox"/> Application Size Fee (37 CFR 1.16(s))					
	<input type="checkbox"/> FIRST PRESENTATION OF MULTIPLE DEPENDENT CLAIM (37 CFR 1.16(j))					
					TOTAL ADD'L FEE	

* If the entry in column 1 is less than the entry in column 2, write "0" in column 3.
 ** If the "Highest Number Previously Paid For" IN THIS SPACE is less than 20, enter "20".
 *** If the "Highest Number Previously Paid For" IN THIS SPACE is less than 3, enter "3".
 The "Highest Number Previously Paid For" (Total or Independent) is the highest number found in the appropriate box in column 1.

LIE
/RUTH LLOYD/

This collection of information is required by 37 CFR 1.16. The information is required to obtain or retain a benefit by the public which is to file (and by the USPTO to process) an application. Confidentiality is governed by 35 U.S.C. 122 and 37 CFR 1.14. This collection is estimated to take 12 minutes to complete, including gathering, preparing, and submitting the completed application form to the USPTO. Time will vary depending upon the individual case. Any comments on the amount of time you require to complete this form and/or suggestions for reducing this burden, should be sent to the Chief Information Officer, U.S. Patent and Trademark Office, U.S. Department of Commerce, P.O. Box 1450, Alexandria, VA 22313-1450. DO NOT SEND FEES OR COMPLETED FORMS TO THIS ADDRESS. **SEND TO: Commissioner for Patents, P.O. Box 1450, Alexandria, VA 22313-1450.**

If you need assistance in completing the form, call 1-800-PTO-9199 and select option 2.



UNITED STATES PATENT AND TRADEMARK OFFICE

UNITED STATES DEPARTMENT OF COMMERCE
United States Patent and Trademark Office
Address: COMMISSIONER FOR PATENTS
P.O. Box 1450
Alexandria, Virginia 22313-1450
www.uspto.gov

Table with columns: APPLICATION NO., FILING DATE, FIRST NAMED INVENTOR, ATTORNEY DOCKET NO., CONFIRMATION NO., EXAMINER, ART UNIT, PAPER NUMBER, NOTIFICATION DATE, DELIVERY MODE. Includes application details for Daniel A. Gamache and examiner information for TRAN, MY CHAU T.

Please find below and/or attached an Office communication concerning this application or proceeding.

The time period for reply, if any, is set in the attached communication.

Notice of the Office communication was sent electronically on above-indicated "Notification Date" to the following e-mail address(es):

patent.docketing@alcon.com

Office Action Summary

Application No.
13/475,607

Applicant(s)
GAMACHE ET AL.

Examiner
MY-CHAU T. TRAN

Art Unit
1629

AIA (First Inventor to File)
Status
No

-- The MAILING DATE of this communication appears on the cover sheet with the correspondence address --

Period for Reply

A SHORTENED STATUTORY PERIOD FOR REPLY IS SET TO EXPIRE 3 MONTH(S) OR THIRTY (30) DAYS, WHICHEVER IS LONGER, FROM THE MAILING DATE OF THIS COMMUNICATION.

- Extensions of time may be available under the provisions of 37 CFR 1.136(a). In no event, however, may a reply be timely filed after SIX (6) MONTHS from the mailing date of this communication.
- If NO period for reply is specified above, the maximum statutory period will apply and will expire SIX (6) MONTHS from the mailing date of this communication.
- Failure to reply within the set or extended period for reply will, by statute, cause the application to become ABANDONED (35 U.S.C. § 133). Any reply received by the Office later than three months after the mailing date of this communication, even if timely filed, may reduce any earned patent term adjustment. See 37 CFR 1.704(b).

Status

- 1) Responsive to communication(s) filed on 05/15/2013.
 A declaration(s)/affidavit(s) under **37 CFR 1.130(b)** was/were filed on _____.
- 2a) This action is **FINAL**. 2b) This action is non-final.
- 3) An election was made by the applicant in response to a restriction requirement set forth during the interview on _____; the restriction requirement and election have been incorporated into this action.
- 4) Since this application is in condition for allowance except for formal matters, prosecution as to the merits is closed in accordance with the practice under *Ex parte Quayle*, 1935 C.D. 11, 453 O.G. 213.

Disposition of Claims

- 5) Claim(s) 1-25 is/are pending in the application.
 5a) Of the above claim(s) 11 and 12 is/are withdrawn from consideration.
- 6) Claim(s) 16,17 and 20-25 is/are allowed.
- 7) Claim(s) 1-10,14,15,18 and 19 is/are rejected.
- 8) Claim(s) 13 is/are objected to.
- 9) Claim(s) _____ are subject to restriction and/or election requirement.

* If any claims have been determined allowable, you may be eligible to benefit from the **Patent Prosecution Highway** program at a participating intellectual property office for the corresponding application. For more information, please see http://www.uspto.gov/patents/init_events/pph/index.jsp or send an inquiry to PPHfeedback@uspto.gov.

Application Papers

- 10) The specification is objected to by the Examiner.
- 11) The drawing(s) filed on 05/18/2012 is/are: a) accepted or b) objected to by the Examiner.
 Applicant may not request that any objection to the drawing(s) be held in abeyance. See 37 CFR 1.85(a).
 Replacement drawing sheet(s) including the correction is required if the drawing(s) is objected to. See 37 CFR 1.121(d).

Priority under 35 U.S.C. § 119

- 12) Acknowledgment is made of a claim for foreign priority under 35 U.S.C. § 119(a)-(d) or (f).

Certified copies:

- a) All b) Some * c) None of the:
- Certified copies of the priority documents have been received.
 - Certified copies of the priority documents have been received in Application No. _____.
 - Copies of the certified copies of the priority documents have been received in this National Stage application from the International Bureau (PCT Rule 17.2(a)).

* See the attached detailed Office action for a list of the certified copies not received.

Attachment(s)

- Notice of References Cited (PTO-892)
- Information Disclosure Statement(s) (PTO/SB/08)
Paper No(s)/Mail Date _____
- Interview Summary (PTO-413)
Paper No(s)/Mail Date. _____
- Other: _____

Art Unit: 1629

DETAILED ACTION***Application and Claims Status***

1. The present application is being examined under the pre-AIA first to invent provisions.
2. Applicant's amendment and response filed 05/15/2013 are acknowledged and entered.
3. Claims 1-25 were pending. No claims were amended, added, and/or cancelled.

Therefore, claims 1-25 are currently pending.

Election/Restrictions

4. Applicant's election with traverse of the species of ophthalmic composition in the reply filed on 05/15/2013 is acknowledged. Applicants election is as follows: "*Applicants elect, with traverse, the composition described in the table below:*"

Ingredients	w/v%
Olopatadine (Olopatadine HCl)	0.7
Polyether (PEG)	4.0
Lactam Polymer (FVP)	4.0
Viscosity Agent (HEC)	0.1 (if used w/ HPMC or other viscosity agent) 0.3 (if used w/o HPMC or other viscosity agent)
Viscosity Agent (HPMC)	0.15 (if used w/ HEC or other viscosity agent) 0.35 (if used w/o HEC or other viscosity agent)
Chelating agent (Disodium-EDTA)	0.008
Borate (Boric Acid)	0.3

Art Unit: 1629

cyclodextrin derivative	1.5
Polyol (Mannitol)	0.3
Polyol (Propylene Glycol)	1.0
Tonicity Agent (Sodium Chloride)	0.35
Preservative (BAK)	0.01
pH adjusting agents (NaOH or HCl)	sufficient to achieve pH = 7.0
purified water	Q.S. 100

The traversal is on the ground that “*Election/Restriction Requirements are to be based upon the claims of an application and should indicate where different species are within the claims. The Election Requirement for the present application has failed to do that*”, in which applicant specifically cites MPEP § 803 and 806.01. This is not found persuasive because 1) as clearly stated in the previous Office Action, this is a species election regarding the various claimed species of ophthalmic composition wherein each claimed ophthalmic composition have distinct formulation. See especially instant claims 1, 9, 16, and 20. Each distinct formulation has different concentration of active agent and/or different type of excipients, diluents, vehicles, and/or carriers that result in distinct claimed ophthalmic composition. Moreover, applicants have not provided any evidence and/or clearly state on record that each of the claimed ophthalmic composition does not have distinct formulation. 2) The MPEP citations provided by applicant does not specifically relates to the species election that is require by the previous Office Action. Applicants should read MPEP § 806.04(b), 806.04(e), 806.04(f), and 806.04(h) that are specifically related to the species election requirement. Thus, the instant application meets the species election requirement.

The requirement is still deemed proper and is therefore made FINAL.

Art Unit: 1629

5. Claims 11 and 12 are withdrawn from further consideration pursuant to 37 CFR 1.142(b), as being drawn to *nonelected species*, there being no allowable generic or linking claim.

Applicant timely traversed the restriction (election) requirement in the reply filed on 05/15/2013.

Accordingly, claims 1-10 and 13-25 are under consideration in this Office Action.

Priority

6. This instant application claims benefits to two provisional application, which are 61/487,789 filed 05/19/2011 and 61/548,957 filed 10/19/2011, under 35 U.S.C. 119(e).

Claim Rejections - 35 USC § 112

7. The following is a quotation of 35 U.S.C. 112(d):

(d) REFERENCE IN DEPENDENT FORMS.—Subject to subsection (e), a claim in dependent form shall contain a reference to a claim previously set forth and then specify a further limitation of the subject matter claimed. A claim in dependent form shall be construed to incorporate by reference all the limitations of the claim to which it refers.

The following is a quotation of 35 U.S.C. 112 (pre-AIA), fourth paragraph:

Subject to the [fifth paragraph of 35 U.S.C. 112 (pre-AIA)], a claim in dependent form shall contain a reference to a claim previously set forth and then specify a further limitation of the subject matter claimed. A claim in dependent form shall be construed to incorporate by reference all the limitations of the claim to which it refers.

8. Claims 18 and 19 are rejected under 35 U.S.C. 112(d) or pre-AIA 35 U.S.C. 112, 4th paragraph, as being of improper dependent form for failing to further limit the subject matter of the claim upon which it depends, or for failing to include all the limitations of the claim upon which it depends. Here, instant claim 18 recites the limitation of “*further comprising polyol*”. Instant claim 19 recites the limitation of “*wherein the polyol include polyethylene glycol at a concentration of at least 0.4 w/v% but no greater than 2.2 w/v%*”. Instant claim 16 for which

Art Unit: 1629

claims 18 and 19 depend recites the limitation of “*PEG having a molecular weight of 300 to 500 wherein the concentration of the PEG in solution is from about 2.0 w/v % to about 6.0 w/v%*”.

The acronym of PEG is defined in the instant specification as polyethylene glycol (see pg. 2, lines 26-27). Consequently, claims 18 and 19 do not further limit the subject matter of instant claim 16. Applicant may cancel the claim(s), amend the claim(s) to place the claim(s) in proper dependent form, rewrite the claim(s) in independent form, or present a sufficient showing that the dependent claim(s) complies with the statutory requirements.

Claim Rejections - 35 USC § 102

9. The following is a quotation of the appropriate paragraphs of pre-AIA 35 U.S.C. 102 that form the basis for the rejections under this section made in this Office action:

A person shall be entitled to a patent unless –

(e) the invention was described in (1) an application for patent, published under section 122(b), by another filed in the United States before the invention by the applicant for patent or (2) a patent granted on an application for patent by another filed in the United States before the invention by the applicant for patent, except that an international application filed under the treaty defined in section 351(a) shall have the effects for purposes of this subsection of an application filed in the United States only if the international application designated the United States and was published under Article 21(2) of such treaty in the English language.

10. Claims 1, 2, and 4-8 are rejected under pre-AIA 35 U.S.C. 102(e) as being anticipated by Schneider et al. (US Patent Application Publication 2011/0082145 A1; *Filing Date 10/01/2010*).

For ***claims 1, 2, and 4-8***, Schneider et al. disclose formulations of olopatadine and their use for treating and/or preventing allergic or inflammatory disorders of the eye, ear, skin, and nose (see e.g. Abstract; sections: [0002], [0009], and [0018]). In one embodiment, the pharmaceutical aqueous solution composition is an ophthalmic formulation to be administered to the eye of a patient for the treatment of ocular disorder that includes allergic and/or inflammatory

Art Unit: 1629

conditions of the eye (refers to instant claimed limitation of ophthalmic composition and eyedropper) (see e.g. sections: [0018] and [0048]-[0050]). The solution composition comprises olopatadine and ophthalmologically acceptable preservatives, surfactants, viscosity enhancers, penetration enhancers, buffers, tonicity agents, and water to form an aqueous, sterile ophthalmic solution, suspension, or emulsion (refers to instant claimed limitation of olopatadine and water) (see e.g. sections: [0040]-[0041], [0044]-[0045], [0048]-[0049], and [0051]-[0053]). The concentration of olopatadine is at least 0.05 % w/v, i.e. the concentration lower limit is 0.05 % w/v without any upper limit (refers to instant claimed limitation of at least 0.67 w/v % olopatadine and instant claim 2) (see e.g. section [0045]). The type of lubricants and/or viscosity agents include polyethylene glycols (PEGs) and polyvinylpyrrolidones (PVPs) (refers to instant claims 4-7) (see e.g. section [0052]). The solution composition comprises an osmolality of about 150-450 mOsm and a pH of about 3.0 to about 8.5 (refers to instant claim 8) (see e.g. sections: [0053]-[0054]).

Therefore, the solution composition of Schneider et al. does anticipate the instant claimed invention.

Claim Rejections - 35 USC § 103

11. The following is a quotation of pre-AIA 35 U.S.C. 103(a) which forms the basis for all obviousness rejections set forth in this Office action:

(a) A patent may not be obtained though the invention is not identically disclosed or described as set forth in section 102 of this title, if the differences between the subject matter sought to be patented and the prior art are such that the subject matter as a whole would have been obvious at the time the invention was made to a person having ordinary skill in the art to which said subject matter pertains. Patentability shall not be negated by the manner in which the invention was made.

Art Unit: 1629

12. Claims 1-8 are rejected under pre-AIA 35 U.S.C. 103(a) as being unpatentable over Schneider et al. (US Patent Application Publication 2011/0082145 A1; *Filing Date 10/01/2010*) and Abelson et al. (US Patent Application Publication 2004/0198828 A1).

For *claims 1, 2, and 4-8*, Schneider et al. disclose formulations of olopatadine and their use for treating and/or preventing allergic or inflammatory disorders of the eye, ear, skin, and nose (see e.g. Abstract; sections: [0002], [0009], and [0018]). In one embodiment, the pharmaceutical aqueous solution composition is an ophthalmic formulation to be administered to the eye of a patient for the treatment of ocular disorder that includes allergic and/or inflammatory conditions of the eye (refers to instant claimed limitation of ophthalmic composition and eyedropper) (see e.g. sections: [0018] and [0048]-[0050]). The solution composition comprises olopatadine and ophthalmologically acceptable preservatives, surfactants, viscosity enhancers, penetration enhancers, buffers, tonicity agents, and water to form an aqueous, sterile ophthalmic solution, suspension, or emulsion (refers to instant claimed limitation of olopatadine and water) (see e.g. sections: [0040]-[0041], [0044]-[0045], [0048]-[0049], and [0051]-[0053]). The concentration of olopatadine is at least 0.05 % w/v, i.e. the concentration lower limit is 0.05 % w/v without any upper limit (refers to instant claimed limitation of at least 0.67 w/v % olopatadine and instant claim 2) (see e.g. section [0045]). The type of lubricants and/or viscosity agents include polyethylene glycols (PEGs) and polyvinylpyrrolidones (PVPs) (refers to instant claims 4-7) (see e.g. section [0052]). The solution composition comprises an osmolality of about 150-450 mOsm and a pH of about 3.0 to about 8.5 (refers to instant claim 8) (see e.g. sections: [0053]-[0054]).

The teachings of Schneider et al. differ from the presently claimed invention as follows:

Art Unit: 1629

For *claim 3*, Schneider et al. fail to disclose a solubilizer such as cyclodextrins and its derivatives.

However, Abelson et al. teach the limitations that are deficient in Schneider et al. as follows:

For *claim 3*, Abelson et al. disclose pharmaceutical compositions for the treatment of ocular allergies (see e.g. Abstract; sections: [0004], [0006], and [0019]). The pharmaceutical compositions comprises long-acting anti-histamine agent such as olopatadine and a variety of carriers such as water and polyvinylpyrrolidone (see e.g. sections: [0022] and [0035]). The pharmaceutical compositions for ocular administration include other type of ingredients that meet the prerequisites for ocular tolerability such as tonicity enhancers, preservatives, solubilizers, non-toxic excipients, demulcents, sequestering agents and pH adjusting agents (see e.g. sections: [0037]-[0047]). The type of solubilizers includes a cyclodextrin such as alpha-, beta- or gamma-cyclodextrin, e.g. alkylated, hydroxyalkylated, carboxyalkylated or alkyloxycarbonylalkylated derivatives, or mono- or diglycosyl-alpha-, beta or gamma-cyclodextrin, mono- or dimaltosyl-alpha-, beta or gamma-cyclodextrin or panosyl-cyclodextrin (see e.g. section [0042]).

It would have been obvious to a person of ordinary skill in the art at the time the invention was made to disclose a solubilizer such as cyclodextrins and its derivatives as taught by Abelson et al. in the composition of Schneider et al. One of ordinary skill in the art would have been motivated to disclose a solubilizer such as cyclodextrins and its derivatives in the composition of Schneider et al. for the advantage of providing a solution form of the active ingredient in order to provide better penetration to a target site of action and better dosage consistency (Abelson: section [0042]; Schneider: section [0007]). Additionally, both Schneider

Art Unit: 1629

et al. and Abelson et al. disclose that the pharmaceutical composition is an ophthalmic formulation to be administered to the eye of a patient for the treatment of ocular allergies (Schneider: section [0048]; Abelson: section [0037]). Furthermore, one of ordinary skill in the art would have a reasonable expectation of success in the combination of Schneider et al. and Abelson et al. because it is art recognize that it is more desirable for the active ingredients of a pharmaceutical composition to be in a solution form (Schneider: section [0007]).

Therefore, the combine teachings of Schneider et al. and Abelson et al. do render the invention of the instant claims *prima facie* obvious.

13. Claims 9, 10, 14, and 15 are rejected under pre-AIA 35 U.S.C. 103(a) as being unpatentable over Schneider et al. (US Patent Application Publication 2011/0082145 A1; *Filing Date 10/01/2010*) and Abelson et al. (US Patent Application Publication 2004/0198828 A1).

For **claims 9, 10, 14 and 15**, Schneider et al. disclose formulations of olopatadine and their use for treating and/or preventing allergic or inflammatory disorders of the eye, ear, skin, and nose (see e.g. Abstract; sections: [0002], [0009], and [0018]). In one embodiment, the pharmaceutical aqueous solution composition is an ophthalmic formulation to be administered to the eye of a patient for the treatment of ocular disorder that includes allergic and/or inflammatory conditions of the eye (refers to instant claimed limitation of ophthalmic composition and eyedropper) (see e.g. sections: [0018] and [0048]-[0050]). The solution composition comprises olopatadine and ophthalmologically acceptable preservatives, surfactants, viscosity enhancers, penetration enhancers, buffers, tonicity agents, and water to form an aqueous, sterile ophthalmic solution, suspension, or emulsion (refers to instant claimed limitation of olopatadine dissolved in

Art Unit: 1629

solution) (see e.g. sections: [0040]-[0041], [0044]-[0045], [0048]-[0049], and [0051]-[0053]).

The concentration of olopatadine is at least 0.05 % w/v, i.e. the concentration lower limit is 0.05

% w/v without any upper limit (refers to instant claimed limitation of at least 0.67 w/v %

olopatadine) (see e.g. section [0045]). The type of lubricants and/or viscosity agents include

polyethylene glycols (PEGs) and polyvinylpyrrolidones (PVPs) (refers to instant claimed

limitation of PEG and polyvinylpyrrolidone) (see e.g. section [0052]). The type of preservative

includes benzalkonium chloride (refers to instant claim 10) (see e.g. sections: [0051]-[0052]).

The type of buffering agents includes borates (refers to instant claim 14), and the type of

tonicity-adjusting agents includes mannitol (refers to instant claim 15) (see e.g. section [0052]).

The solution composition comprises an osmolality of about 150-450 mOsm and a pH of about

3.0 to about 8.5 (see e.g. sections: [0053]-[0054]).

The teachings of Schneider et al. differ from the presently claimed invention as follows:

For *claim 9*, Schneider et al. fail to disclose (a) a solubilizer such as cyclodextrins and its derivatives; and (b) the type of PEG having a molecular weight of 300 to 500.

However, Abelson et al. teach the limitations that are deficient in Schneider et al. as follows:

For *claim 9*, Abelson et al. disclose pharmaceutical compositions for the treatment of ocular allergies (see e.g. Abstract; sections: [0004], [0006], and [0019]). The pharmaceutical compositions comprises long-acting anti-histamine agent such as olopatadine and a variety of carriers such as water and polyvinylpyrrolidone (see e.g. sections: [0022] and [0035]). The pharmaceutical compositions for ocular administration include other type of ingredients that meet the prerequisites for ocular tolerability such as tonicity enhancers, preservatives, solubilizers, non-toxic excipients, demulcents, sequestering agents and pH adjusting agents (see

Art Unit: 1629

e.g. sections: [0037]-[0047]). The type of solubilizers includes a cyclodextrin such as alpha-, beta- or gamma-cyclodextrin, e.g. alkylated, hydroxyalkylated, carboxyalkylated or alkyloxycarbonylalkylated derivatives, or mono- or diglycosyl-alpha-, beta or gamma-cyclodextrin, mono- or dimaltosyl-alpha-, beta or gamma-cyclodextrin or panosyl-cyclodextrin (see e.g. section [0042]). The type of buffers includes borate (see e.g. section [0038]). The type of tonicity enhancers includes mannitol (see e.g. section [0039]). The type of preservative includes benzalkonium chloride (see e.g. section [0039]). The type of non-toxic excipients includes polyethylene glycols that are designated 200, 300, 400, and 600 (see e.g. section [0044]).

(a) It would have been obvious to a person of ordinary skill in the art at the time the invention was made to disclose a solubilizer such as cyclodextrins and its derivatives as taught by Abelson et al. in the composition of Schneider et al. One of ordinary skill in the art would have been motivated to disclose a solubilizer such as cyclodextrins and its derivatives in the composition of Schneider et al. for the advantage of providing a solution form of the active ingredient in order to provide better penetration to a target site of action and better dosage consistency (Abelson: section [0042]; Schneider: section [0007]). Additionally, both Schneider et al. and Abelson et al. disclose that the pharmaceutical composition is an ophthalmic formulation to be administered to the eye of a patient for the treatment of ocular allergies (Schneider: section [0048]; Abelson: section [0037]). Furthermore, one of ordinary skill in the art would have a reasonable expectation of success in the combination of Schneider et al. and Abelson et al. because it is art recognize that it is more desirable for the active ingredients of a pharmaceutical composition to be in a solution form (Schneider: section [0007]).

Art Unit: 1629

(b) It would have been obvious to a person of ordinary skill in the art at the time the invention was made to disclose the type of PEG having a molecular weight of 300 to 500 in the composition of Schneider et al. One of ordinary skill in the art would have been motivated to disclose the type of PEG having a molecular weight of 300 to 500 in the composition of Schneider et al. since the type of non-toxic excipients would be a choice of experimental design and is considered within the purview of the cited prior art. Moreover, one of ordinary skill in the art would have a reasonable expectation of success in the combination of Schneider et al. and Abelson et al. because the pharmaceutical composition of both Schneider et al. and Abelson et al. include pharmaceutical carriers that is specific for an ophthalmic formulation (Schneider: section [0048]; Abelson: section [0037]).

Therefore, the combine teachings of Schneider et al. and Abelson et al. do render the invention of the instant claims *prima facie* obvious.

Allowable Subject Matter

14. Claim 13 is objected to as being dependent upon a rejected base claim, but would be allowable if rewritten in independent form including all of the limitations of the base claim and any intervening claims.

15. Claims 16-17 and 20-25 are allowable.

16. The following is a statement of reasons for the indication of allowable subject matter:

Art Unit: 1629

- A.** The instant claims 16-17 are allowable for the reason that the cited prior arts do not teach or fairly suggest the presently claimed composition comprising ‘*at least 0.67 w/v % but no greater than 1.0 w/v% olopatadine dissolved in solution; PEG having a molecular weight of 300 to 500 wherein the concentration of the PEG in solution is from about 2.0 w/v % to about 6.0 w/v%; a lactam polymer wherein the lactam polymer is polyvinylpyrrolidone and the concentration of the polyvinylpyrrolidone in solution is from about 2.0 w/v % to about 6.0 w/v%; and the concentration of the β -cyclodextrin derivative or the γ -cyclodextrin derivative is at least 0.5 w/v% but no greater than 2.0 w/v%’.*
- B.** The instant claims 20-25 are allowable for the reason that the cited prior arts do not teach or fairly suggest the presently claimed composition and method of using the claimed composition wherein the claimed composition comprises ‘*at least 0.67 w/v % but no greater than 1.0 w/v% olopatadine dissolved in solution; PEG having a molecular weight of 300 to 500 wherein the concentration of the PEG in solution is from about 2.0 w/v % to about 6.0 w/v%; a lactam polymer wherein the lactam polymer is polyvinylpyrrolidone and the concentration of the polyvinylpyrrolidone in solution is from about 2.0 w/v % to about 6.0 w/v%; and hydroxypropyl- γ -cyclodextrin in the composition at a concentration of at least 0.5 w/v% but no greater than 2.0 w/v%’.*

Art Unit: 1629

Conclusion

Any inquiry concerning this communication or earlier communications from the examiner should be directed to MY-CHAU T. TRAN whose telephone number is 571-272-0810. The examiner can normally be reached on Monday - Friday: 8:00 - 4:30.

If attempts to reach the examiner by telephone are unsuccessful, the examiner's supervisor, Jeffrey S. Lundgren can be reached on 571-272-5541. The fax phone number for the organization where this application or proceeding is assigned is 571-273-8300.

Information regarding the status of an application may be obtained from the Patent Application Information Retrieval (PAIR) system. Status information for published applications may be obtained from either Private PAIR or Public PAIR. Status information for unpublished applications is available through Private PAIR only. For more information about the PAIR system, see <http://pair-direct.uspto.gov>. Should you have questions on access to the Private PAIR system, contact the Electronic Business Center (EBC) at 866-217-9197 (toll-free). If you would like assistance from a USPTO Customer Service Representative or access to the automated information system, call 800-786-9199 (IN USA OR CANADA) or 571-272-1000.

/MY-CHAU T. TRAN/
Primary Examiner, Art Unit 1629

October 8, 2013

Notice of References Cited	Application/Control No. 13/475,607	Applicant(s)/Patent Under Reexamination GAMACHE ET AL.	
	Examiner MY-CHAU T. TRAN	Art Unit 1629	Page 1 of 1

U.S. PATENT DOCUMENTS

*	Document Number Country Code-Number-Kind Code	Date MM-YYYY	Name	Classification
*	A US-5,641,805	06-1997	Hayakawa et al.	514/450
*	B US-6,995,186 B2	02-2006	Castillo et al.	514/450
*	C US-2004/0198828 A1	10-2004	Abelson et al.	514/571
*	D US-2011/0082145 A1	04-2011	Schneider et al.	514/235.2
*	E US-2012/0015953 A1	01-2012	Beauregard et al.	514/250
	F US-			
	G US-			
	H US-			
	I US-			
	J US-			
	K US-			
	L US-			
	M US-			

FOREIGN PATENT DOCUMENTS

*	Document Number Country Code-Number-Kind Code	Date MM-YYYY	Country	Name	Classification
	N				
	O				
	P				
	Q				
	R				
	S				
	T				

NON-PATENT DOCUMENTS

*	Document Number Country Code-Number-Kind Code	Date MM-YYYY	Country	Name	Classification
	Include as applicable: Author, Title Date, Publisher, Edition or Volume, Pertinent Pages)				
	U				
	V				
	W				
	X				

*A copy of this reference is not being furnished with this Office action. (See MPEP § 707.05(a).)
Dates in MM-YYYY format are publication dates. Classifications may be US or foreign.

WEST Search History for Application 13475607

Creation Date: 2013100613:37

Prior Art Searches

Query	DB	Op.	Plur.	Thes.	Date
("20020006443" "20020150616" "20030170309" "20050004074" "20050191270" "20050244472" "20060210645" "20070020336" "20080132444" "20090118262" "20090232763" "20090239842" "20100240625" "20100249062" "20100324031" "3767788" "3843782" "3856919" "3931319" "3947573" "4027020" "4120949" "4283393" "4407791" "4470965" "4525346" "4836986" "4923693" "5037647" "5068225" "5116863" "5134127" "5141961" "5300287" "5376645" "5472954" "5591426" "5597559" "5624962" "5888493" "6153746" "6511949" "6828356" "7074424" "7147844" "7429602" "7635773").PN.	PGPB, USPT, USOC	ADJ	YES	ASSIGNEE	10-02-2013
olopatadine and ("20020006443" "20020150616" "20030170309" "20050004074" "20050191270" "20050244472" "20060210645" "20070020336" "20080132444" "20090118262" "20090232763" "20090239842" "20100240625" "20100249062" "20100324031" "3767788" "3843782" "3856919" "3931319" "3947573" "4027020" "4120949" "4283393" "4407791" "4470965" "4525346" "4836986" "4923693" "5037647" "5068225" "5116863" "5134127" "5141961" "5300287" "5376645" "5472954" "5591426" "5597559" "5624962" "5888493" "6153746" "6511949" "6828356" "7074424" "7147844" "7429602" "7635773").PN.)	PGPB, USPT, USOC	ADJ	YES	ASSIGNEE	10-02-2013
GAMACHE-DANIEL-A\$.in.	PGPB, USPT, USOC, EPAB, JPAB, DWPI, TDBD, FPRS	ADJ	YES	ASSIGNEE	10-02-2013
ALANI-LAMAN\$.in.	PGPB, USPT, USOC,	ADJ	YES	ASSIGNEE	10-02-2013

	EPAB, JPAB, DWPI, TDBD, FPRS				
GHOSH-MALAY\$.in.	PGPB, USPT, USOC, EPAB, JPAB, DWPI, TDBD, FPRS	ADJ	YES	ASSIGNEE	10-02-2013
GALAN-FRANCISCO-JAVIER\$.in.	PGPB, USPT, USOC, EPAB, JPAB, DWPI, TDBD, FPRS	ADJ	YES	ASSIGNEE	10-02-2013
PERDIGUER-NURIA-CARRERAS\$.in.	PGPB, USPT, USOC, EPAB, JPAB, DWPI, TDBD, FPRS	ADJ	YES	ASSIGNEE	10-02-2013
SINGH-ONKAR-N\$.in.	PGPB, USPT, USOC, EPAB, JPAB, DWPI, TDBD, FPRS	ADJ	YES	ASSIGNEE	10-02-2013
(GAMACHE-DANIEL-A\$.in.) and (ALANI-LAMAN\$.in.) and (GHOSH-MALAY\$.in.) and (GALAN-FRANCISCO-JAVIER\$.in.) and (PERDIGUER-NURIA-CARRERAS\$.in.) and (SINGH-ONKAR-N\$.in.)	PGPB, USPT, USOC, EPAB, JPAB, DWPI, TDBD, FPRS	ADJ	YES	ASSIGNEE	10-02-2013
(GAMACHE-DANIEL-A\$.in.) and	PGPB,	ADJ	YES	ASSIGNEE	10-02-2013

(ALANI-LAMAN\$.in.) and (GHOSH-MALAY\$.in.) and (GALAN-FRANCISCO-JAVIER\$.in.) and (PERDIGUER-NURIA-CARRERAS\$.in.)	USPT, USOC, EPAB, JPAB, DWPI, TDBD, FPRS				
(GAMACHE-DANIEL-A\$.in.) and (ALANI-LAMAN\$.in.) and (GHOSH-MALAY\$.in.) and (GALAN-FRANCISCO-JAVIER\$.in.)	PGPB, USPT, USOC, EPAB, JPAB, DWPI, TDBD, FPRS	ADJ	YES	ASSIGNEE	10-02-2013
(GAMACHE-DANIEL-A\$.in.) and (ALANI-LAMAN\$.in.) and (GHOSH-MALAY\$.in.) and (GALAN-FRANCISCO-JAVIER\$.in.) and (SINGH-ONKAR-N\$.in.)	PGPB, USPT, USOC, EPAB, JPAB, DWPI, TDBD, FPRS	ADJ	YES	ASSIGNEE	10-02-2013
olopatadine.clm. and (GAMACHE-DANIEL-A\$.in.)	PGPB, USPT, USOC, EPAB, JPAB, DWPI, TDBD, FPRS	ADJ	YES	ASSIGNEE	10-02-2013
olopatadine.clm. and (ALANI-LAMAN\$.in.)	PGPB, USPT, USOC, EPAB, JPAB, DWPI, TDBD, FPRS	ADJ	YES	ASSIGNEE	10-02-2013
olopatadine.clm. and (GHOSH-MALAY\$.in.)	PGPB, USPT, USOC, EPAB, JPAB, DWPI, TDBD, FPRS	ADJ	YES	ASSIGNEE	10-02-2013

olopatadine.clm. and (GALAN-FRANCISCO-JAVIER\$.in.)	PGPB, USPT, USOC, EPAB, JPAB, DWPI, TDBD, FPRS	ADJ	YES	ASSIGNEE	10-02-2013
olopatadine.clm. and (PERDIGUER-NURIA-CARRERAS\$.in.)	PGPB, USPT, USOC, EPAB, JPAB, DWPI, TDBD, FPRS	ADJ	YES	ASSIGNEE	10-02-2013
olopatadine.clm. and (SINGH-ONKAR-N\$.in.)	PGPB, USPT, USOC, EPAB, JPAB, DWPI, TDBD, FPRS	ADJ	YES	ASSIGNEE	10-02-2013
ALCON RESEARCH\$.as.	PGPB, USPT, USOC, EPAB, JPAB, DWPI, TDBD, FPRS	ADJ	YES	ASSIGNEE	10-02-2013
olopatadine.clm. and (ALCON RESEARCH\$.as.)	PGPB, USPT, USOC, EPAB, JPAB, DWPI, TDBD, FPRS	ADJ	YES	ASSIGNEE	10-02-2013
(ophthalmic (formulation or composition)).clm. and (olopatadine.clm. and GAMACHE-DANIEL-A\$.in.)	PGPB, USPT, USOC, EPAB, JPAB, DWPI, TDBD,	ADJ	YES	ASSIGNEE	10-02-2013

	FPRS				
(ophthalmic (formulation or composition)).clm. and (olopatadine.clm. and SINGH-ONKAR-N\$.in.)	PGPB, USPT, USOC, EPAB, JPAB, DWPI, TDBD, FPRS	ADJ	YES	ASSIGNEE	10-02-2013
(ophthalmic (formulation or composition)).clm. and (olopatadine.clm. and ALCON RESEARCH\$.as.)	PGPB, USPT, USOC, EPAB, JPAB, DWPI, TDBD, FPRS	ADJ	YES	ASSIGNEE	10-02-2013
(514/449 514/450)! [CCLS]	PGPB, USPT, USOC	ADJ	YES	ASSIGNEE	10-02-2013
olopatadine and ((514/449 514/450)! [CCLS])	PGPB, USPT, USOC	ADJ	YES	ASSIGNEE	10-02-2013
(ophthalmic (formulation or composition)) and (olopatadine and (514/449 514/450)! [CCLS])	PGPB, USPT, USOC	ADJ	YES	ASSIGNEE	10-02-2013
cyclodextrin and ((ophthalmic (formulation or composition)) and olopatadine and (514/449 514/450)! [CCLS])	PGPB, USPT, USOC	ADJ	YES	ASSIGNEE	10-02-2013
lactam and ((ophthalmic (formulation or composition)) and olopatadine and (514/449 514/450)! [CCLS])	PGPB, USPT, USOC	ADJ	YES	ASSIGNEE	10-02-2013
polyether and ((ophthalmic (formulation or composition)) and olopatadine and (514/449 514/450)! [CCLS])	PGPB, USPT, USOC	ADJ	YES	ASSIGNEE	10-02-2013
(polyethylene glycol) and ((ophthalmic (formulation or composition)) and olopatadine and (514/449 514/450)! [CCLS])	PGPB, USPT, USOC	ADJ	YES	ASSIGNEE	10-02-2013
(ophthalmic (formulation or composition)) and olopatadine	EPAB, JPAB, DWPI, TDBD, FPRS	ADJ	YES	ASSIGNEE	10-02-2013

cyclodextrin and ((ophthalmic (formulation or composition)) and olopatadine)	EPAB, JPAB, DWPI, TDBD, FPRS	ADJ	YES	ASSIGNEE	10-02-2013
lactam and ((ophthalmic (formulation or composition)) and olopatadine)	EPAB, JPAB, DWPI, TDBD, FPRS	ADJ	YES	ASSIGNEE	10-02-2013
lactam and (cyclodextrin and (ophthalmic (formulation or composition)) and olopatadine)	EPAB, JPAB, DWPI, TDBD, FPRS	ADJ	YES	ASSIGNEE	10-02-2013
(polyethylene glycol) and ((ophthalmic (formulation or composition)) and olopatadine)	EPAB, JPAB, DWPI, TDBD, FPRS	ADJ	YES	ASSIGNEE	10-02-2013
(polyethylene glycol) and (cyclodextrin and (ophthalmic (formulation or composition)) and olopatadine)	EPAB, JPAB, DWPI, TDBD, FPRS	ADJ	YES	ASSIGNEE	10-02-2013
(ophthalmic (formulation or composition)) and olopatadine	PGPB, USPT, USOC	ADJ	YES	ASSIGNEE	10-02-2013
((ophthalmic (formulation or composition)) and olopatadine) not @AY>2011	PGPB, USPT, USOC	ADJ	YES	ASSIGNEE	10-02-2013
cyclodextrin and ((ophthalmic (formulation or composition)) and olopatadine not @AY>2011)	PGPB, USPT, USOC	ADJ	YES	ASSIGNEE	10-02-2013
lactam and (cyclodextrin and (ophthalmic (formulation or composition)) and olopatadine not @AY>2011)	PGPB, USPT, USOC	ADJ	YES	ASSIGNEE	10-02-2013
(polyethylene glycol) and (cyclodextrin and (ophthalmic (formulation or composition)) and olopatadine not @AY>2011)	PGPB, USPT, USOC	ADJ	YES	ASSIGNEE	10-02-2013
lactam and ((polyethylene glycol) and cyclodextrin and (ophthalmic (formulation or composition)) and olopatadine not @AY>2011)	PGPB, USPT, USOC	ADJ	YES	ASSIGNEE	10-02-2013

(olopatadine same ((mass ratio) or dos\$4 or concentrat\$3 or ((weight or WT) same (percent or (per cent) or "%")))) and ((ophthalmic (formulation or composition)) and olopatadine)	PGPB, USPT, USOC	ADJ	YES	ASSIGNEE	10-03-2013
(olopatadine same (percent or (per cent) or "%")) and ((ophthalmic (formulation or composition)) and olopatadine)	PGPB, USPT, USOC	ADJ	YES	ASSIGNEE	10-03-2013
cyclodextrin and ((olopatadine same (percent or (per cent) or "%")) and (ophthalmic (formulation or composition)) and olopatadine)	PGPB, USPT, USOC	ADJ	YES	ASSIGNEE	10-03-2013
(polyethylene glycol) and ((olopatadine same (percent or (per cent) or "%")) and (ophthalmic (formulation or composition)) and olopatadine)	PGPB, USPT, USOC	ADJ	YES	ASSIGNEE	10-03-2013
(polyvinylpyrrolidone) and ((polyethylene glycol) and (olopatadine same (percent or (per cent) or "%")) and (ophthalmic (formulation or composition)) and olopatadine)	PGPB, USPT, USOC	ADJ	YES	ASSIGNEE	10-03-2013

STN Express Query Summary

ALL L# QUERIES AND ANSWER SETS ARE DELETED AT LOGOFF

LOGOFF? (Y)/N/HOLD:y

(FILE 'HOME' ENTERED AT 20:53:34 ON 01 OCT 2013)

FILE 'CAPLUS' ENTERED AT 20:55:31 ON 01 OCT 2013

L1 1 SEA FILE=CAPLUS SPE=ON ABB=ON PLU=ON US20120295967/PN

L2 1 SEA FILE=CAPLUS SPE=ON ABB=ON PLU=ON US2012-475607/AP

L3 1 DUP REMOVE L1 L2 (1 DUPLICATE REMOVED)

D IBIB ABS HITSTR

FILE 'REGISTRY' ENTERED AT 20:56:54 ON 01 OCT 2013

FILE 'CAPLUS' ENTERED AT 20:57:03 ON 01 OCT 2013

L4 TRA PLU=ON L3 1 RN : 6 TERMS

FILE 'REGISTRY' ENTERED AT 20:57:08 ON 01 OCT 2013

L5 6 SEA FILE=REGISTRY SPE=ON ABB=ON PLU=ON L4

D L5 1-6

DISPLAY SET NOTICE

FILE 'REGISTRY' ENTERED AT 20:58:08 ON 01 OCT 2013

L6 STR 140462-76-6

L7 120 SEA FILE=REGISTRY FAM FUL L6

DISPLAY SET NOTICE

FILE 'REGISTRY' ENTERED AT 20:58:52 ON 01 OCT 2013

L8 STR 113806-05-6

L9 120 SEA FILE=REGISTRY FAM FUL L8

E OLOPATADINE/CN

L10 1 SEA FILE=REGISTRY SPE=ON ABB=ON PLU=ON OLOPATADINE/CN

D L10

L11 1 SEA FILE=REGISTRY SPE=ON ABB=ON PLU=ON OLOPATADINE/CN

D

L12 STRUCTURE UPLOADED

STRUCTURE: C:\Users\mtran7\Documents\STN Express 8.4\Queries\Olopatadine.str

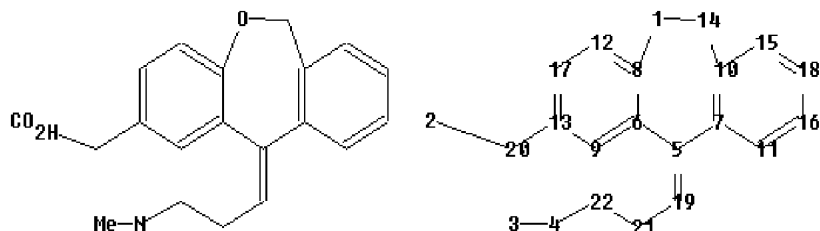

chain nodes :

2 3 4 19 20 21 22

ring nodes :

1 5 6 7 8 9 10 11 12 13 14 15 16 17 18

chain bonds :

2-20 3-4 4-22 5-19 13-20 19-21 21-22

ring bonds :

1-8 1-14 5-6 5-7 6-8 6-9 7-10 7-11 8-12 9-13 10-14 10-15 11-16 12-17
13-17 15-18 16-18

exact/norm bonds :

1-8 1-14 4-22 5-6 5-7 10-14

exact bonds :

2-20 3-4 5-19 13-20 19-21 21-22

normalized bonds :

6-8 6-9 7-10 7-11 8-12 9-13 10-15 11-16 12-17 13-17 15-18 16-18

Match level :

1:Atom 2:CLASS 3:CLASS 4:CLASS 5:Atom 6:Atom 7:Atom 8:Atom 9:Atom 10:Atom
11:Atom 12:Atom 13:Atom 14:Atom 15:Atom 16:Atom 17:Atom 18:Atom 19:CLASS
20:CLASS 21:CLASS 22:CLASS

D

L13 140 SEA FILE=REGISTRY SSS FUL L12

FILE 'HCAPLUS, CAPLUS, BIOSIS, EMBASE, MEDLINE' ENTERED AT 21:03:16 ON 01

OCT 2013

L14 576550 SEA FILE=MFE SPE=ON ABB=ON PLU=ON L5

L15 2316 SEA FILE=MFE SPE=ON ABB=ON PLU=ON L7

L16 2316 SEA FILE=MFE SPE=ON ABB=ON PLU=ON L9

L17 1831 SEA FILE=MFE SPE=ON ABB=ON PLU=ON L11

L18 2322 SEA FILE=MFE SPE=ON ABB=ON PLU=ON L13

L19 1831 SEA FILE=MFE SPE=ON ABB=ON PLU=ON L14 AND L15 AND L16 AND
L17 AND L18

L20 1067 DUP REMOVE L19 (764 DUPLICATES REMOVED)

L*** DEL 368 S L14 AND L15 AND L16 AND L17 AND L18

L*** DEL 215 S L14 AND L15 AND L16 AND L17 AND L18

L*** DEL 136 S L14 AND L15 AND L16 AND L17 AND L18

L*** DEL 744 S L14 AND L15 AND L16 AND L17 AND L18

L*** DEL 215 S L14 AND L15 AND L16 AND L17 AND L18

L21 105 SEA FILE=MFE SPE=ON ABB=ON PLU=ON (OCULAR ALLERGY) AND L20

L22 104 SEA FILE=MFE SPE=ON ABB=ON PLU=ON OLOPATADINE AND L21

L23 1 SEA FILE=MFE SPE=ON ABB=ON PLU=ON (POLYETHER OR (POLYETHYLEN
E GLYCOL) OR PEG) AND L22

D IBIB ABS HITSTR L23

L24 0 SEA FILE=MFE SPE=ON ABB=ON PLU=ON (OPHTHALMIC COMPOSITION)
AND L22

L25 28 SEA FILE=MFE SPE=ON ABB=ON PLU=ON (OPHTHALMIC) AND L22

D IBIB ABS HITSTR L25 1-28

L*** DEL 368 S L14 AND L15 AND L16 AND L17 AND L18

L*** DEL 215 S L14 AND L15 AND L16 AND L17 AND L18

L*** DEL 136 S L14 AND L15 AND L16 AND L17 AND L18

L*** DEL 744 S L14 AND L15 AND L16 AND L17 AND L18

L*** DEL 215 S L14 AND L15 AND L16 AND L17 AND L18

L26 1032 SEA FILE=MFE SPE=ON ABB=ON PLU=ON OLOPATADINE AND L20

L27 37 SEA FILE=MFE SPE=ON ABB=ON PLU=ON (POLYETHER OR (POLYETHYLEN
E GLYCOL) OR PEG) AND L26

L28 20 SEA FILE=MFE SPE=ON ABB=ON PLU=ON (OPHTHALMIC) AND L27

D IBIB ABS HITSTR L28 1-20

E GAMACHE DANIEL/AU

L29 223 SEA FILE=MFE SPE=ON ABB=ON PLU=ON ("GAMACHE DANIEL"/AU OR
"GAMACHE DANIEL A"/AU OR "GAMACHE DANIEL A DR"/AU OR "GAMACHE
DANIEL ANDRE"/AU)

E ALANI LAMAN/AU

L30 65 SEA FILE=MFE SPE=ON ABB=ON PLU=ON ("ALANI LAMAN"/AU OR "ALANI LAMAN A"/AU OR "ALANI LAMAN L"/AU OR "ALANI LAMAN LYNN"/AU)

E GHOSH MALAY/AU

L31 194 SEA FILE=MFE SPE=ON ABB=ON PLU=ON ("GHOSH MALAY"/AU OR "GHOSH MALAY K"/AU OR "GHOSH MALAY KUMAR"/AU)

E GALAN FRANCISCO/AU

L32 42 SEA FILE=MFE SPE=ON ABB=ON PLU=ON ("GALAN FRANCISCO"/AU OR "GALAN FRANCISCO JAVIER"/AU OR "GALAN FRANCISCO M"/AU)

E PERDIGUER NURIA/AU

L33 5 SEA FILE=MFE SPE=ON ABB=ON PLU=ON ("PERDIGUER NURIA"/AU OR "PERDIGUER NURIA CARRERAS"/AU)

E SINGH ONKAR/AU

L34 481 SEA FILE=MFE SPE=ON ABB=ON PLU=ON "SINGH ONKAR"/AU OR ("SINGH ONKAR N"/AU OR "SINGH ONKAR NATH"/AU)

L35 2 SEA FILE=MFE SPE=ON ABB=ON PLU=ON L29 AND L30 AND L31 AND L32 AND L33 AND L34

D IBIB ABS HITSTR L35 1-2

FILE 'ADISINSIGHT, BIOSIS, CAPLUS, DRUGU, EMBASE, MEDLINE' ENTERED AT 21:36:57 ON 01 OCT 2013

L36 328447 SEA FILE=MFE SPE=ON ABB=ON PLU=ON L5

L37 1786 SEA FILE=MFE SPE=ON ABB=ON PLU=ON L7

L38 1786 SEA FILE=MFE SPE=ON ABB=ON PLU=ON L9

L39 1508 SEA FILE=MFE SPE=ON ABB=ON PLU=ON L11

L40 1789 SEA FILE=MFE SPE=ON ABB=ON PLU=ON L13

L41 1508 SEA FILE=MFE SPE=ON ABB=ON PLU=ON L36 AND L37 AND L38 AND L39

L42 1508 SEA FILE=MFE SPE=ON ABB=ON PLU=ON L36 AND L37 AND L38 AND L39 AND L40

L43 1472 SEA FILE=MFE SPE=ON ABB=ON PLU=ON OLOPATADINE AND L42

L44 37 SEA FILE=MFE SPE=ON ABB=ON PLU=ON (POLYETHER OR (POLYETHYLEN E GLYCOL) OR PEG) AND L43

L45 37 DUP REMOVE L44 (0 DUPLICATES REMOVED)

L46 20 SEA FILE=MFE SPE=ON ABB=ON PLU=ON (OPHTHALMIC) AND L44
D IBIB ABS IND L46 1-20

Session Began October 01, 2013 at 11:48 PM

Task Began October 01, 2013 11:48 PM

Explore substances by ID: olopatadine (ID 1)

Answer Type: Substances
Result Count: 1

Retrieve reference information in 1 substance (ID 2)

From ID: 1
Answer Type: References
Result Count: 505

Refine by research topic (ID 3)

Research Topic: ophthalmic
From ID: 2
Answer Type: References
Result Count: 184

Refine by research topic (ID 4)

Research Topic: PEG
From ID: 3
Answer Type: References
Result Count: 19

Full text accessed for solutions from PCT Int. Appl. Pages: 29pp. 2008

Detailed display

From ID: 4
Type: Self-preserved aqueous pharmaceutical compositions comprising borate/polyol and zinc system

Detailed display

From ID: 4
Type: Medicament comprising an active substance combination for the treatment of allergy symptoms

Copyright © 2013 American Chemical Society. All Rights Reserved.

Copyright © 1994-2013 Sun Microsystems, Inc. All Rights Reserved. (Java runtime environment)

Copyright © 2013, Yahoo! Inc. All Rights Reserved. (YUI Base, Fonts, Reset CSS)

Copyright © 200-2013, The Dojo Foundation. All Rights Reserved

Copyright © 2013, Exadel, Inc. All Rights Reserved. (JBoss RichFaces)

Copyright © 2002 InfoChem GmbH. All Rights Reserved. (InfoChem's reaction classification program CLASSIFY)

The following copyright notice applies to Raphael only: Permission is hereby granted, free of charge, to any person obtaining a copy of this software and associated documentation files (the 'Software'), to deal in the Software without restriction, including without limitation the rights to use, copy, modify, merge, publish, distribute, sublicense, and/or sell copies of the Software, and to permit persons to whom the Software is furnished to do so, subject to the following conditions: The above copyright notice and this permission notice shall be included in all copies or substantial portions of the Software. THE SOFTWARE IS PROVIDED 'AS IS', WITHOUT WARRANTY OF ANY KIND, EXPRESS OR IMPLIED, INCLUDING BUT NOT LIMITED TO THE WARRANTIES OF MERCHANTABILITY, FITNESS FOR A PARTICULAR PURPOSE AND NONINFRINGEMENT. IN NO EVENT SHALL THE AUTHORS OR COPYRIGHT HOLDERS BE LIABLE FOR ANY CLAIM, DAMAGES OR OTHER LIABILITY, WHETHER IN AN ACTION OF CONTRACT, TORT OR OTHERWISE, ARISING FROM, OUT OF OR IN CONNECTION WITH THE SOFTWARE OR THE USE OR OTHER DEALINGS IN THE SOFTWARE.

The following copyright notice applies to Google Closure Templates only. Copyright 2009 Google Inc. Licensed under the Apache License, Version 2.0 (the 'License'); you may not use this file except in compliance with the License. You may obtain a copy of the License at <http://www.apache.org/licenses/LICENSE-2.0> Unless required by applicable law or agreed to in writing, software distributed under the License is distributed on an 'AS IS' BASIS, WITHOUT WARRANTIES OR CONDITIONS OF ANY KIND, either express or implied. See the License for the specific language governing permissions and limitations under the License.

Copyright (c) 2010, 2012 Adobe Systems Incorporated, All Rights Reserved, (Source Sans Pro) Licensed under the SIL Open Font License, Version 1.1 (available at: <http://scripts.sil.org/OFL>)

Copyright 2005-2013 The Dojo Foundation (Dojo Toolkit) Licensed under the Apache License, Version 2.0 (the "License"); you may not use this file except in compliance with the License. You may obtain a copy of the License at: <http://www.apache.org/licenses/LICENSE-2.0> Unless required by applicable law or agreed to in writing, software distributed under the License is distributed on an "AS IS" BASIS, WITHOUT WARRANTIES OR CONDITIONS OF ANY KIND, either express or implied. See the License for the specific language governing permissions and limitations under the License.

Copyright (c) 2008 Dmitry Baranovskiy (Raphael) Licensed under the MIT License (available at: <http://opensource.org/licenses/MIT>) Permission is hereby granted, free of charge, to any person obtaining a copy of this software and associated documentation files (the "Software"), to deal in the Software without restriction, including without limitation the rights to use, copy, modify, merge, publish, distribute, sublicense, and/or sell copies of the Software, and to permit persons to whom the Software is furnished to do so, subject to the following conditions: The above copyright notice and this permission notice shall be included in all copies or substantial portions of the Software. THE SOFTWARE IS PROVIDED "AS IS", WITHOUT WARRANTY OF ANY KIND, EXPRESS OR IMPLIED, INCLUDING BUT NOT LIMITED TO THE WARRANTIES OF MERCHANTABILITY, FITNESS FOR A PARTICULAR PURPOSE AND NONINFRINGEMENT. IN NO EVENT SHALL THE AUTHORS OR COPYRIGHT HOLDERS BE LIABLE FOR ANY CLAIM, DAMAGES OR OTHER LIABILITY, WHETHER IN AN ACTION OF CONTRACT, TORT OR OTHERWISE, ARISING FROM, OUT OF OR IN CONNECTION WITH THE SOFTWARE OR THE USE OR OTHER DEALINGS IN THE SOFTWARE.

CAPLUSSM: Copyright © 2013 American Chemical Society. All Rights Reserved. (The U.K. patent material in this product/service is U.K. Crown copyright and is made available with permission.

Copyright © Crown Copyright. The French (FR) patent material in this product/service is made available from Institut National de la Propriété Industrielle (INPI).)

CAS REGISTRYSM: Copyright © 2013 American Chemical Society. All Rights Reserved. (Some records contain information from GenBank®. See also: Benson D.A., Karsch-Mizrahi I., Lipman D.J., Ostel J., Rapp B.A., Wheeler D.L. Genbank. Nucl. Acids Res. 28(1):15-18 (2000). Property values tagged with IC are from the ZIC/VINITI data file provided by InfoChem.) CAS Registry is a service mark of the American Chemical Society. GenBank is a registered trademark of the U.S. Library of Medicine.

CASREACT® : Copyright © 2013 American Chemical Society. All Rights Reserved. CASREACT contains reactions from CAS and from: ZIC/VINITI database (1974-1999) provided by InfoChem; INPI data prior to 1986; Biotransformations database compiled under the direction of Professor Dr. Klaus Kieslich; organic reactions, portions copyright 1996-2006 John Wiley & Sons, Ltd., John Wiley and Sons, Inc., Organic Reactions Inc., and Organic Syntheses Inc. Reproduced under license. All Rights Reserved.

CHEMCATS® : Copyright © 2013 American Chemical Society. All Rights Reserved. Chemical supplier information is supplied on an "as is" basis. Full information regarding substance availability, price, etc., is provided when you request supplier information.

CHEMLIST® : Copyright © 2013 American Chemical Society. All Rights Reserved.

MEDLINE® : is produced by the U.S. National Library of Medicine. MEDLINE is a registered trademark of the U.S. National Library of Medicine.

Search Notes 	Application/Control No. 13475607	Applicant(s)/Patent Under Reexamination GAMACHE ET AL.
	Examiner MY-CHAU T TRAN	Art Unit 1629

CPC- SEARCHED		
Symbol	Date	Examiner

CPC COMBINATION SETS - SEARCHED		
Symbol	Date	Examiner

US CLASSIFICATION SEARCHED			
Class	Subclass	Date	Examiner
514	449, 450	10/02/2013	MCT

SEARCH NOTES		
Search Notes	Date	Examiner
PALM Inventors; WEST - see printout; STN - see printout; SciFinder - see printout	10/01/2013	MCT
Reviewed for ODP the following Patent(s) and/or Application(s): 13/183,194	10/01/2013	MCT

INTERFERENCE SEARCH			
US Class/ CPC Symbol	US Subclass / CPC Group	Date	Examiner

--	--

Index of Claims 	Application/Control No. 13475607	Applicant(s)/Patent Under Reexamination GAMACHE ET AL.
	Examiner MY-CHAU T TRAN	Art Unit 1629

✓	Rejected
=	Allowed

-	Cancelled
÷	Restricted

N	Non-Elected
I	Interference

A	Appeal
O	Objected

Claims renumbered in the same order as presented by applicant
 CPA
 T.D.
 R.1.47

CLAIM		DATE							
Final	Original	03/28/2013	10/01/2013						
	1	÷	✓						
	2	÷	✓						
	3	÷	✓						
	4	÷	✓						
	5	÷	✓						
	6	÷	✓						
	7	÷	✓						
	8	÷	✓						
	9	÷	✓						
	10	÷	✓						
	11	÷	N						
	12	÷	N						
	13	÷	✓						
	14	÷	✓						
	15	÷	✓						
	16	÷	=						
	17	÷	=						
	18	÷	=						
	19	÷	=						
	20	÷	=						
	21	÷	=						
	22	÷	=						
	23	÷	=						
	24	÷	=						
	25	÷	=						

INFORMATION DISCLOSURE STATEMENT BY APPLICANT (Not for submission under 37 CFR 1.99)	Application Number		13475607	
	Filing Date		2012-05-18	
	First Named Inventor	Daniel A. Gamache		
	Art Unit		1629	
	Examiner Name	My Chau T Tran		
	Attorney Docket Number		PAT903988-US-NP	

U.S.PATENTS						Remove
Examiner Initial*	Cite No	Patent Number	Kind Code ¹	Issue Date	Name of Patentee or Applicant of cited Document	Pages,Columns,Lines where Relevant Passages or Relevant Figures Appear
	1					

If you wish to add additional U.S. Patent citation information please click the Add button. Add

U.S.PATENT APPLICATION PUBLICATIONS						Remove
Examiner Initial*	Cite No	Publication Number	Kind Code ¹	Publication Date	Name of Patentee or Applicant of cited Document	Pages,Columns,Lines where Relevant Passages or Relevant Figures Appear
	1					

If you wish to add additional U.S. Published Application citation information please click the Add button. Add

FOREIGN PATENT DOCUMENTS								Remove
Examiner Initial*	Cite No	Foreign Document Number ³	Country Code ² j	Kind Code ⁴	Publication Date	Name of Patentee or Applicant of cited Document	Pages,Columns,Lines where Relevant Passages or Relevant Figures Appear	T ⁵
	1							<input type="checkbox"/>

If you wish to add additional Foreign Patent Document citation information please click the Add button Add

NON-PATENT LITERATURE DOCUMENTS				Remove
Examiner Initials*	Cite No	Include name of the author (in CAPITAL LETTERS), title of the article (when appropriate), title of the item (book, magazine, journal, serial, symposium, catalog, etc), date, pages(s), volume-issue number(s), publisher, city and/or country where published.		T ⁵

INFORMATION DISCLOSURE STATEMENT BY APPLICANT (Not for submission under 37 CFR 1.99)	Application Number		13475607
	Filing Date		2012-05-18
	First Named Inventor	Daniel A. Gamache	
	Art Unit		1629
	Examiner Name	My Chau T Tran	
	Attorney Docket Number		PAT903988-US-NP

	1	International Preliminary Report on Patentability for corresponding PCT/US2012/038663 with mailing date November 28, 2013	<input type="checkbox"/>
--	---	---	--------------------------

If you wish to add additional non-patent literature document citation information please click the Add button **Add**

EXAMINER SIGNATURE

Examiner Signature		Date Considered	
--------------------	--	-----------------	--

*EXAMINER: Initial if reference considered, whether or not citation is in conformance with MPEP 609. Draw line through a citation if not in conformance and not considered. Include copy of this form with next communication to applicant.

¹ See Kind Codes of USPTO Patent Documents at www.USPTO.GOV or MPEP 901.04. ² Enter office that issued the document, by the two-letter code (WIPO Standard ST.3). ³ For Japanese patent documents, the indication of the year of the reign of the Emperor must precede the serial number of the patent document. ⁴ Kind of document by the appropriate symbols as indicated on the document under WIPO Standard ST.16 if possible. ⁵ Applicant is to place a check mark here if English language translation is attached.

INFORMATION DISCLOSURE STATEMENT BY APPLICANT (Not for submission under 37 CFR 1.99)	Application Number	13475607
	Filing Date	2012-05-18
	First Named Inventor	Daniel A. Gamache
	Art Unit	1629
	Examiner Name	My Chau T Tran
	Attorney Docket Number	PAT903988-US-NP

CERTIFICATION STATEMENT

Please see 37 CFR 1.97 and 1.98 to make the appropriate selection(s):

That each item of information contained in the information disclosure statement was first cited in any communication from a foreign patent office in a counterpart foreign application not more than three months prior to the filing of the information disclosure statement. See 37 CFR 1.97(e)(1).

OR

That no item of information contained in the information disclosure statement was cited in a communication from a foreign patent office in a counterpart foreign application, and, to the knowledge of the person signing the certification after making reasonable inquiry, no item of information contained in the information disclosure statement was known to any individual designated in 37 CFR 1.56(c) more than three months prior to the filing of the information disclosure statement. See 37 CFR 1.97(e)(2).

- See attached certification statement.
- Fee set forth in 37 CFR 1.17 (p) has been submitted herewith.
- None

SIGNATURE

A signature of the applicant or representative is required in accordance with CFR 1.33, 10.18. Please see CFR 1.4(d) for the form of the signature.

Signature	/Scott A. Chapple, 46,287/	Date (YYYY-MM-DD)	2013-12-16
Name/Print	Scott A. Chapple	Registration Number	46,287

This collection of information is required by 37 CFR 1.97 and 1.98. The information is required to obtain or retain a benefit by the public which is to file (and by the USPTO to process) an application. Confidentiality is governed by 35 U.S.C. 122 and 37 CFR 1.14. This collection is estimated to take 1 hour to complete, including gathering, preparing and submitting the completed application form to the USPTO. Time will vary depending upon the individual case. Any comments on the amount of time you require to complete this form and/or suggestions for reducing this burden, should be sent to the Chief Information Officer, U.S. Patent and Trademark Office, U.S. Department of Commerce, P.O. Box 1450, Alexandria, VA 22313-1450. **DO NOT SEND FEES OR COMPLETED FORMS TO THIS ADDRESS. SEND TO: Commissioner for Patents, P.O. Box 1450, Alexandria, VA 22313-1450.**

Privacy Act Statement

The Privacy Act of 1974 (P.L. 93-579) requires that you be given certain information in connection with your submission of the attached form related to a patent application or patent. Accordingly, pursuant to the requirements of the Act, please be advised that: (1) the general authority for the collection of this information is 35 U.S.C. 2(b)(2); (2) furnishing of the information solicited is voluntary; and (3) the principal purpose for which the information is used by the U.S. Patent and Trademark Office is to process and/or examine your submission related to a patent application or patent. If you do not furnish the requested information, the U.S. Patent and Trademark Office may not be able to process and/or examine your submission, which may result in termination of proceedings or abandonment of the application or expiration of the patent.

The information provided by you in this form will be subject to the following routine uses:

1. The information on this form will be treated confidentially to the extent allowed under the Freedom of Information Act (5 U.S.C. 552) and the Privacy Act (5 U.S.C. 552a). Records from this system of records may be disclosed to the Department of Justice to determine whether the Freedom of Information Act requires disclosure of these records.
2. A record from this system of records may be disclosed, as a routine use, in the course of presenting evidence to a court, magistrate, or administrative tribunal, including disclosures to opposing counsel in the course of settlement negotiations.
3. A record in this system of records may be disclosed, as a routine use, to a Member of Congress submitting a request involving an individual, to whom the record pertains, when the individual has requested assistance from the Member with respect to the subject matter of the record.
4. A record in this system of records may be disclosed, as a routine use, to a contractor of the Agency having need for the information in order to perform a contract. Recipients of information shall be required to comply with the requirements of the Privacy Act of 1974, as amended, pursuant to 5 U.S.C. 552a(m).
5. A record related to an International Application filed under the Patent Cooperation Treaty in this system of records may be disclosed, as a routine use, to the International Bureau of the World Intellectual Property Organization, pursuant to the Patent Cooperation Treaty.
6. A record in this system of records may be disclosed, as a routine use, to another federal agency for purposes of National Security review (35 U.S.C. 181) and for review pursuant to the Atomic Energy Act (42 U.S.C. 218(c)).
7. A record from this system of records may be disclosed, as a routine use, to the Administrator, General Services, or his/her designee, during an inspection of records conducted by GSA as part of that agency's responsibility to recommend improvements in records management practices and programs, under authority of 44 U.S.C. 2904 and 2906. Such disclosure shall be made in accordance with the GSA regulations governing inspection of records for this purpose, and any other relevant (i.e., GSA or Commerce) directive. Such disclosure shall not be used to make determinations about individuals.
8. A record from this system of records may be disclosed, as a routine use, to the public after either publication of the application pursuant to 35 U.S.C. 122(b) or issuance of a patent pursuant to 35 U.S.C. 151. Further, a record may be disclosed, subject to the limitations of 37 CFR 1.14, as a routine use, to the public if the record was filed in an application which became abandoned or in which the proceedings were terminated and which application is referenced by either a published application, an application open to public inspections or an issued patent.
9. A record from this system of records may be disclosed, as a routine use, to a Federal, State, or local law enforcement agency, if the USPTO becomes aware of a violation or potential violation of law or regulation.

ADVANCE E-MAIL

From the INTERNATIONAL BUREAU

PCT

NOTIFICATION CONCERNING
TRANSMITTAL OF COPY OF INTERNATIONAL
PRELIMINARY REPORT ON PATENTABILITY
(CHAPTER I OF THE PATENT COOPERATION
TREATY)

(PCT Rule 44bis.1(c))

To:

SCOTT A. CHAPPLE
Alcon Research, Ltd.
IP Legal, Mail Code TB4-8
6201 South Freeway
Fort Worth, Texas 76134-2099
ETATS-UNIS D'AMERIQUE

Date of mailing (<i>day/month/year</i>) 28 November 2013 (28.11.2013)		
Applicant's or agent's file reference 3988-WO-F		IMPORTANT NOTICE
International application No. PCT/US2012/038663	International filing date (<i>day/month/year</i>) 18 May 2012 (18.05.2012)	Priority date (<i>day/month/year</i>) 19 May 2011 (19.05.2011)
Applicant ALCON RESEARCH, LTD. et al		

The International Bureau transmits herewith a copy of the international preliminary report on patentability (Chapter I of the Patent Cooperation Treaty)

<p>The International Bureau of WIPO 34, chemin des Colombettes 1211 Geneva 20, Switzerland</p> <p>Facsimile No. +41 22 338 82 70</p>	<p>Authorized officer</p> <p style="text-align: center;">Simin Baharlou</p> <p>e-mail: pt09.pct@wipo.int</p>
--	---

PATENT COOPERATION TREATY

PCT

INTERNATIONAL PRELIMINARY REPORT ON PATENTABILITY

(Chapter I of the Patent Cooperation Treaty)

(PCT Rule 44bis)

Applicant's or agent's file reference 3988-WO-F	FOR FURTHER ACTION		See item 4 below
International application No. PCT/US2012/038663	International filing date (<i>day/month/year</i>) 18 May 2012 (18.05.2012)	Priority date (<i>day/month/year</i>) 19 May 2011 (19.05.2011)	
International Patent Classification (8th edition unless older edition indicated) See relevant information in Form PCT/ISA/237			
Applicant ALCON RESEARCH, LTD.			

<p>1. This international preliminary report on patentability (Chapter I) is issued by the International Bureau on behalf of the International Searching Authority under Rule 44 bis.1(a).</p> <p>2. This REPORT consists of a total of 7 sheets, including this cover sheet.</p> <p>In the attached sheets, any reference to the written opinion of the International Searching Authority should be read as a reference to the international preliminary report on patentability (Chapter I) instead.</p>																								
<p>3. This report contains indications relating to the following items:</p> <table border="0"> <tr> <td><input checked="" type="checkbox"/></td> <td>Box No. I</td> <td>Basis of the report</td> </tr> <tr> <td><input checked="" type="checkbox"/></td> <td>Box No. II</td> <td>Priority</td> </tr> <tr> <td><input type="checkbox"/></td> <td>Box No. III</td> <td>Non-establishment of opinion with regard to novelty, inventive step and industrial applicability</td> </tr> <tr> <td><input type="checkbox"/></td> <td>Box No. IV</td> <td>Lack of unity of invention</td> </tr> <tr> <td><input checked="" type="checkbox"/></td> <td>Box No. V</td> <td>Reasoned statement under Article 35(2) with regard to novelty, inventive step or industrial applicability; citations and explanations supporting such statement</td> </tr> <tr> <td><input type="checkbox"/></td> <td>Box No. VI</td> <td>Certain documents cited</td> </tr> <tr> <td><input checked="" type="checkbox"/></td> <td>Box No. VII</td> <td>Certain defects in the international application</td> </tr> <tr> <td><input checked="" type="checkbox"/></td> <td>Box No. VIII</td> <td>Certain observations on the international application</td> </tr> </table> <p>4. The International Bureau will communicate this report to designated Offices in accordance with Rules 44bis.3(c) and 93bis.1 but not, except where the applicant makes an express request under Article 23(2), before the expiration of 30 months from the priority date (Rule 44bis .2).</p>	<input checked="" type="checkbox"/>	Box No. I	Basis of the report	<input checked="" type="checkbox"/>	Box No. II	Priority	<input type="checkbox"/>	Box No. III	Non-establishment of opinion with regard to novelty, inventive step and industrial applicability	<input type="checkbox"/>	Box No. IV	Lack of unity of invention	<input checked="" type="checkbox"/>	Box No. V	Reasoned statement under Article 35(2) with regard to novelty, inventive step or industrial applicability; citations and explanations supporting such statement	<input type="checkbox"/>	Box No. VI	Certain documents cited	<input checked="" type="checkbox"/>	Box No. VII	Certain defects in the international application	<input checked="" type="checkbox"/>	Box No. VIII	Certain observations on the international application
<input checked="" type="checkbox"/>	Box No. I	Basis of the report																						
<input checked="" type="checkbox"/>	Box No. II	Priority																						
<input type="checkbox"/>	Box No. III	Non-establishment of opinion with regard to novelty, inventive step and industrial applicability																						
<input type="checkbox"/>	Box No. IV	Lack of unity of invention																						
<input checked="" type="checkbox"/>	Box No. V	Reasoned statement under Article 35(2) with regard to novelty, inventive step or industrial applicability; citations and explanations supporting such statement																						
<input type="checkbox"/>	Box No. VI	Certain documents cited																						
<input checked="" type="checkbox"/>	Box No. VII	Certain defects in the international application																						
<input checked="" type="checkbox"/>	Box No. VIII	Certain observations on the international application																						

	Date of issuance of this report 19 November 2013 (19.11.2013)
The International Bureau of WIPO 34, chemin des Colombettes 1211 Geneva 20, Switzerland	Authorized officer Simin Baharlou
Facsimile No. +41 22 338 82 70	e-mail: pt09.pct@wipo.int

Form PCT/IB/373 (January 2004)

PATENT COOPERATION TREATY

From the
INTERNATIONAL SEARCHING AUTHORITY

PCT

**WRITTEN OPINION OF THE
INTERNATIONAL SEARCHING AUTHORITY
(PCT Rule 43bis.1)**

To:

see form PCT/ISA/220

Date of mailing
(day/month/year) see form PCT/ISA/210 (second sheet)

Applicant's or agent's file reference
see form PCT/ISA/220

FOR FURTHER ACTION
See paragraph 2 below

International application No.
PCT/US2012/038663

International filing date (day/month/year)
18.05.2012

Priority date (day/month/year)
19.05.2011

International Patent Classification (IPC) or both national classification and IPC
INV. A61K31/335 A61K9/00 A61P27/14

Applicant
ALCON RESEARCH, LTD.

1. This opinion contains indications relating to the following items:

- Box No. I Basis of the opinion
- Box No. II Priority
- Box No. III Non-establishment of opinion with regard to novelty, inventive step and industrial applicability
- Box No. IV Lack of unity of invention
- Box No. V Reasoned statement under Rule 43bis.1(a)(i) with regard to novelty, inventive step and industrial applicability; citations and explanations supporting such statement
- Box No. VI Certain documents cited
- Box No. VII Certain defects in the international application
- Box No. VIII Certain observations on the international application

2. **FURTHER ACTION**

If a demand for international preliminary examination is made, this opinion will usually be considered to be a written opinion of the International Preliminary Examining Authority ("IPEA") except that this does not apply where the applicant chooses an Authority other than this one to be the IPEA and the chosen IPEA has notified the International Bureau under Rule 66.1bis(b) that written opinions of this International Searching Authority will not be so considered.

If this opinion is, as provided above, considered to be a written opinion of the IPEA, the applicant is invited to submit to the IPEA a written reply together, where appropriate, with amendments, before the expiration of 3 months from the date of mailing of Form PCT/ISA/220 or before the expiration of 22 months from the priority date, whichever expires later.

For further options, see Form PCT/ISA/220.

3. For further details, see notes to Form PCT/ISA/220.

Name and mailing address of the ISA:

 European Patent Office
D-80298 Munich
Tel. +49 89 2399 - 0
Fax: +49 89 2399 - 4465

Date of completion of this opinion

see form
PCT/ISA/210

Authorized Officer

Economou, Dimitrios

Telephone No. +49 89 2399-0



Box No. I Basis of the opinion

1. With regard to the **language**, this opinion has been established on the basis of:
 - the international application in the language in which it was filed
 - a translation of the international application into , which is the language of a translation furnished for the purposes of international search (Rules 12.3(a) and 23.1 (b)).
2. This opinion has been established taking into account the **rectification of an obvious mistake** authorized by or notified to this Authority under Rule 91 (Rule 43bis.1(a))
3. With regard to any **nucleotide and/or amino acid sequence** disclosed in the international application, this opinion has been established on the basis of a sequence listing filed or furnished:
 - a. (means)
 - on paper
 - in electronic form
 - b. (time)
 - in the international application as filed
 - together with the international application in electronic form
 - subsequently to this Authority for the purposes of search
4. In addition, in the case that more than one version or copy of a sequence listing has been filed or furnished, the required statements that the information in the subsequent or additional copies is identical to that in the application as filed or does not go beyond the application as filed, as appropriate, were furnished.
5. Additional comments:

Box No. II Priority

1. The validity of the priority claim has not been considered because the International Searching Authority does not have in its possession a copy of the earlier application whose priority has been claimed or, where required, a translation of that earlier application. This opinion has nevertheless been established on the assumption that the relevant date (Rules 43bis.1 and 64.1) is the claimed priority date.
2. This opinion has been established as if no priority had been claimed due to the fact that the priority claim has been found invalid (Rules 43bis.1 and 64.1). Thus for the purposes of this opinion, the international filing date indicated above is considered to be the relevant date.
3. Additional observations, if necessary:

Box No. V Reasoned statement under Rule 43bis.1(a)(i) with regard to novelty, inventive step or industrial applicability; citations and explanations supporting such statement

1. Statement

Novelty (N)	Yes: Claims	<u>4-23</u>
	No: Claims	<u>1-3, 24, 25</u>
Inventive step (IS)	Yes: Claims	
	No: Claims	<u>1-25</u>
Industrial applicability (IA)	Yes: Claims	<u>1-25</u>
	No: Claims	

2. Citations and explanations

see separate sheet

Box No. VII Certain defects in the international application

The following defects in the form or contents of the international application have been noted:

see separate sheet

Box No. VIII Certain observations on the international application

The following observations on the clarity of the claims, description, and drawings or on the question whether the claims are fully supported by the description, are made:

see separate sheet

Re Item V

Reasoned statement with regard to novelty, inventive step or industrial applicability; citations and explanations supporting such statement

1). Claims 24-25 relate to subject-matter considered by this Authority to be covered by the provisions of Rule 39.1(iv) / 67.1(iv) PCT.

The patentability can be dependent upon the formulation of the claims. The EPO, for example, does not recognise as patentable claims to the use of a compound in medical treatment, but may allow claims to a product, in particular substances or compositions for use in a first or further medical treatment.

2). Reference is made to the following documents:

Reference is made to the following documents:

D1=WO 2009/003199

D2=WO 96/39147

D3=WO 01/54687

D4=WO 2008/015695

All of the documents **D1-D3** disclose compositions comprising at least 0.7% olopatadin for the treatment of allergic eye diseases. Hence the subject-matter of claims 1-2 and 24-25 is not novel

D1 discloses compositions comprising at least 0.7% olopatadin for the treatment of allergic eye diseases (see example 20). Example 20 discloses also the composition in the presence of SBE-gamma-CD. Hence the subject-matter of claim 3 is also not novel.

The closest prior art is **D1** which discloses high concentrations of olopatadine in aqueous solution suitable for ophthalmic administration (see example 20). Said document refers also to the additional compounds which appear to routinely used in the technical field (e.g PVP, PEG, boric acid, polyols, HPMC, preservatives; see the passages mentioned in the ISR).

Additionally, from **D4** the use of PEG, HPMC, PVP, BAK for solubilization of olopatadine have been mentioned in examples A-M in which however, the highest amount of olopatadine has reached 0.665 % but with an insufficient physical stability. Compositions comprising 0.527 % olopatadine are mentioned in example 1 which comprise HP-beta-cyclodextrin, HPMC and benzalkonium chloride. Hence, as it appears from **D1** or **D4**, cyclodextrins, PVP, HPMC, PEG are obvious in the technical field and therefore the subject-matter of the present application does not appear to involve an inventive step.

Re Item VII

Certain defects in the international application

As it appears from the description tailoring of the compositions of the present application appears to be a challenge for the person skilled in the art. The compositions must be stable, must comprise olopatadine in high concentrations (at least 0.67 %), thus exhibiting consistent efficacy against late phase symptoms of allergic conjunctivitis and must have sufficient antimicrobial activity to provide desired levels of preservation efficacy.

As it is evident from **table B** cyclodextrin can significantly enhance the solubility of olopatadine in aqueous solutions. However, must be present in a concentration of at least 1.5 % since amounts of 1 % HP-beta-cyclodextrin do not solubilize at least 0.67 % of olopatadine. From **table C** however, can be seen that 1.5% HP-beta-cyclodextrin significantly inhibits the ability of a preservative to provide desired preservation to an aqueous solution. From **table E** it is evident that formulations having high concentrations of olopatadine show desirable preservation by combining PVP with a relatively low amount of HP-beta-cyclodextrin by using BAK and boric acid as preservatives. **Tables F** and **G** show that formulations comprising SBE-beta-CD do not provide desired levels of preservation.

The only compositions which appear to possess the above mentioned properties are probably the compositions mentioned on **table J** of the description. These compositions comprise however, specific components, in particular amounts. Claims which are roughly similar to the compositions of table J are claims 20-23. For the invention as defined in any of the other claims the description does not comprise at least a way of how the skilled person would carry out the invention, since it appears the desired ef-

fects cannot be achieved without undue burden. Hence, the present application does not fulfil the requirements of art. 5 PCT as regards subject-matter as defined in claims 1-19 and 24-25.

Re Item VIII

Certain observations on the international application

It is clear from the description from page 3, line 19 to page 4, line 2 that the following features are essential to the definition of the invention:

- a cyclodextrin
- a lactam polymer
- a polyether
- a pH of 5.5 to 8
- an osmolality of 200 to 450 (units mentioned on page 14, lines 16-20)
- a preservative and a borate and/or polyol.

Since independent claims 1, 9, 16 and 20 do not contain this feature it does not meet the requirement following from Article 6 PCT taken in combination with Rule 6.3(b) PCT that any independent claim must contain all the technical features essential to the definition of the invention.

Electronic Acknowledgement Receipt

EFS ID:	17679057
Application Number:	13475607
International Application Number:	
Confirmation Number:	4130
Title of Invention:	HIGH CONCENTRATION OLOPATADINE OPHTHALMIC COMPOSITION
First Named Inventor/Applicant Name:	Daniel A. Gamache
Customer Number:	26356
Filer:	Scott Chapple/Candy Sanders
Filer Authorized By:	Scott Chapple
Attorney Docket Number:	3988 US
Receipt Date:	17-DEC-2013
Filing Date:	18-MAY-2012
Time Stamp:	11:37:25
Application Type:	Utility under 35 USC 111(a)

Payment information:

Submitted with Payment	no
------------------------	----

File Listing:

Document Number	Document Description	File Name	File Size(Bytes)/ Message Digest	Multi Part /.zip	Pages (if appl.)
1	Information Disclosure Statement (IDS) Form (SB08)	PAT903988-US-NP_2013-12-17_IDS_fillable_.pdf	612158 <small>2aa7fda1f965fa2060ab481fcfb2d34b76efc79</small>	no	4

Warnings:

Information:

A U.S. Patent Number Citation or a U.S. Publication Number Citation is required in the Information Disclosure Statement (IDS) form for autoloading of data into USPTO systems. You may remove the form to add the required data in order to correct the Informational Message if you are citing U.S. References. If you chose not to include U.S. References, the image of the form will be processed and be made available within the Image File Wrapper (IFW) system. However, no data will be extracted from this form. Any additional data such as Foreign Patent Documents or Non Patent Literature will be manually reviewed and keyed into USPTO systems.

2	Other Reference-Patent/App/Search documents	PAT903988_REF_PCT-US2012-038663_IPRP__.pdf	283145 <small>77754228e4dd35e5aa36d74d7e166fa4d56dd167</small>	no	8
---	---	--	---	----	---

Warnings:

Information:

Total Files Size (in bytes):	895303
-------------------------------------	--------

This Acknowledgement Receipt evidences receipt on the noted date by the USPTO of the indicated documents, characterized by the applicant, and including page counts, where applicable. It serves as evidence of receipt similar to a Post Card, as described in MPEP 503.

New Applications Under 35 U.S.C. 111

If a new application is being filed and the application includes the necessary components for a filing date (see 37 CFR 1.53(b)-(d) and MPEP 506), a Filing Receipt (37 CFR 1.54) will be issued in due course and the date shown on this Acknowledgement Receipt will establish the filing date of the application.

National Stage of an International Application under 35 U.S.C. 371

If a timely submission to enter the national stage of an international application is compliant with the conditions of 35 U.S.C. 371 and other applicable requirements a Form PCT/DO/EO/903 indicating acceptance of the application as a national stage submission under 35 U.S.C. 371 will be issued in addition to the Filing Receipt, in due course.

New International Application Filed with the USPTO as a Receiving Office

If a new international application is being filed and the international application includes the necessary components for an international filing date (see PCT Article 11 and MPEP 1810), a Notification of the International Application Number and of the International Filing Date (Form PCT/RO/105) will be issued in due course, subject to prescriptions concerning national security, and the date shown on this Acknowledgement Receipt will establish the international filing date of the application.

IN THE UNITED STATES PATENT AND TRADEMARK OFFICE

In re Application of : Gamache, Daniel et al.
Serial No. : 13/475,607
Filed : May 18, 2013
Confirmation No. : 4130
Examiner : Tran, My Chau T
Group Art Unit : 1629
For : High Concentration Olopatadine Ophthalmic Composition

AMENDMENT AND RESPONSE

Mail Stop Amendment
Commissioner for Patents
P.O. Box 1450
Alexandria, VA 22313-1450

Dear Sir or Madam:

This paper is submitted in response to the Office Action dated October 17, 2013, for which the three-month date for response is January 17, 2013.

A request for a one-month extension of time to respond is included herewith along with the required fee. This one-month extension will bring the due date to February 17, 2013. If any request or fee is deficient or absent, consider this paragraph such a request and authorization to deduct said fees from Alcon Research, Ltd., Deposit Account No. **010682**.

Allowance of the application is respectfully requested.

Amendments to the Claims are reflected in the listing of claims that begins on page 2 of this paper.

Remarks begin on page 7 of this paper.

AMENDMENTS TO THE CLAIMS

This listing of claims will replace all prior versions and listings of claims in the application:

Claims 1-8 (cancelled)

Claim 9 (currently amended): An aqueous ophthalmic solution composition for treatment of ocular allergic conjunctivitis, the solution composition comprising:

at least 0.67 w/v % olopatadine dissolved in the solution;

PEG having a molecular weight of 300 to 500;

polyvinylpyrrolidone; ~~and~~

hydroxypropyl- γ -cyclodextrin;

benzalkonium chloride; and

water. ~~cyclodextrin derivative selected from β -cyclodextrin derivative, γ -cyclodextrin or both.~~

Claims 10-13 (cancelled)

Claim 14 (currently amended): A solution composition as in claim 9 further comprising borate.

Claim 15 (currently amended): A solution composition as in claim 14 further comprising a polyol ~~polyol~~.

Claim 16 (currently amended): An aqueous ophthalmic solution composition for treatment of ocular allergic conjunctivitis, the solution composition comprising:

at least 0.67 w/v % but no greater than 1.0 w/v% olopatadine dissolved in the solution;

2.0 w/v % to 6.0 w/v% PEG having a molecular weight of 300 to 500 ~~wherein the concentration of the PEG in solution is from about 2.0 w/v % to about 6.0 w/v%~~;

~~a lactam polymer wherein the lactam polymer is polyvinylpyrrolidone and the concentration of the polyvinylpyrrolidone in solution is from about 2.0 w/v % to about 6.0 w/v%~~ polyvinylpyrrolidone; ~~and~~

at least 0.5 w/v% but no greater than 2.0 w/v% cyclodextrin a ~~β-cyclodextrin derivative or a γ-cyclodextrin derivative~~ selected from the group consisting of SAE-β-cyclodextrin, HP-γ-cyclodextrin, HP-β-cyclodextrin and combinations thereof, and HP β cyclodextrin wherein the concentration of the ~~cyclodextrin β-cyclodextrin derivative or the γ-cyclodextrin derivative~~ is at least 0.5 w/v% but no greater than 2.0 w/v%; and
water.

Claim 17 (currently amended): A solution composition as in claim 16 further comprising borate at a concentration of at least ~~about~~ 0.18 w/v % but less than ~~about~~ 0.5 w/v%.

Claim 18 (currently amended): A solution composition as in claim 17 further comprising a polyol ~~polyol~~.

Claim 19 (currently amended): A solution composition as in claim 18 wherein the polyol is propylene glycol ~~include polyethylene glycol~~ at a concentration of at least 0.4 w/v% but no greater than 2.2 w/v%.

Claim 20 (currently amended): An aqueous ophthalmic solution composition for treatment of ocular allergic conjunctivitis, the solution composition comprising:

at least 0.67 w/v % but no greater than 1.0 w/v% olopatadine dissolved in the solution;

2.0 w/v % to 6.0 w/v% PEG having a molecular weight of 300 to 500 ~~wherein the concentration of the PEG in solution is from about 2.0 w/v % to about 6.0 w/v%;~~

a ~~lactam polymer wherein the lactam polymer is polyvinylpyrrolidone and the concentration of the polyvinylpyrrolidone in solution is from about 2.0 w/v % to about 6.0 w/v%~~ polyvinylpyrrolidone; and

at least 0.5 w/v% but no greater than 2.0 w/v% hydroxypropyl-γ-cyclodextrin ~~in the composition at a concentration of at least 0.5 w/v% but no greater than 2.0 w/v%; and~~

water.

Claim 21 (currently amended): A solution composition as in claim 20 further comprising borate at a concentration of at least ~~about~~ 0.18 w/v % but less than ~~about~~ 0.5 w/v%.

Claim 22 (currently amended): A solution composition as in claim 21 further comprising a polyol ~~polyol~~.

Claim 23 (currently amended) A solution composition as in claim 22 wherein the polyol is propylene glycol ~~include polyethylene glycol~~ at a concentration of at least 0.4 w/v% but no greater than 2.2 w/v%.

Claim 24 (currently amended): A method of treating at least one ocular allergy symptom ~~symptoms~~ in humans, the method comprising:

topically applying to an eye of a human an amount of the solution composition of claim 20 ~~claim 16~~ sufficient to treat the at least one ocular allergy symptom to an eye of a human.

Claim 25 (currently amended): A method as in claim 24 wherein the step of topically applying the solution composition includes dispensing at least one drop of the solution to the eye ~~an eyedrop from an eyedropper~~.

Claim 26 (new): A method as in claim 25 wherein the at least one ocular allergy symptom includes ocular itching.

Claim 27 (new): A solution as in claim 9 further comprising hydroxypropylmethyl cellulose.

Claim 28 (new): A solution as in claim 16 further comprising at least 0.15 w/v% but no greater than 1.0 w/v% hydroxypropylmethyl cellulose.

Claim 29 (new): A solution as in claim 20 further comprising at least 0.15 w/v% but no greater than 1.0 w/v% hydroxypropylmethyl cellulose.

Claim 30 (new): A solution as in claim 15 wherein the polyol is mannitol.

Claim 31 (new): A solution as in claim 18 wherein the polyol is mannitol solution at a concentration that is at least 0.05 w/v% but no greater than 0.5 w/v%.

Claim 32 (new): A solution as in claim 22 wherein the polyol is mannitol at a concentration that is at least 0.05 w/v% but no greater than 0.5 w/v%.

Claim 33 (new): An aqueous ophthalmic solution for treatment of ocular allergic conjunctivitis, the solution comprising:

at least 0.67 w/v % but no greater than 1.0 w/v% olopatadine dissolved in the solution;

2.0 w/v % to 6.0 w/v% PEG having a molecular weight of 300 to 500;

2.0 w/v % to 6.0 w/v% polyvinylpyrrolidone;

at least 0.5 w/v% but no greater than 2.0 w/v% hydroxypropyl- γ -cyclodextrin;

greater than 0.003 w/v% but less than 0.03 w/v% benzalkonium chloride; and

water;

wherein the pH of the solution is 6.0 to 7.8 and the osmolality of the solution is 200 to 400mOsm/kg.

Claim 34 (new): A solution as in claim 33 further comprising at least 0.15 w/v% but no greater than 1.0 w/v% hydroxypropylmethyl cellulose

Claim 35 (new): A solution as in claim 34 wherein:

i) the concentration of PEG is at least 3.0 w/v% but no greater than 5.0 w/v%;

ii) the concentration of polyvinylpyrrolidone is at least 3.0 w/v% but no greater than 5.0 w/v%; and

iii) the concentration of hydroxypropyl methylcellulose is at least 0.3 w/v% but no greater than 0.5 w/v%.

Claim 36 (new): A solution as in claim 35 further comprising:

at least 0.18 w/v% but less than 0.4 w/v% boric acid; and

at least 0.05 w/v% but no greater than 0.5 w/v% mannitol.

Claim 37 (new): A method of treating ocular allergy symptoms in humans, the method comprising:

topically applying to an eye of a human an amount of the solution of claim 35 sufficient to treat ocular allergy symptoms.

Claim 38 (new): A method as in claim 37 wherein the step of topically applying the solution includes dispensing at least one drop of the solution to the eye.

Claim 39 (new): A method as in claim 38 wherein the ocular allergy symptoms include ocular itching.

REMARKS

The Office Action of October 17, 2013 rejected claims 1-10, 14, 15, 18 and 19, objected to claim 13, but indicated that claim as being allowable if rewritten in independent format. The Office Action also allowed claims 16-17 and 20-25. Applicants thank Examiner Tran for the indication of allowed and allowable subject matter. By this Amendment, Applicants have amended the claims to leave only allowed and allowable subject matter pending. Specifically, Applicants have cancelled claims 1-8 and 10-13, have amended claims 9, 16, 19, 20, 21 and 23 and added new claims 26-30. Applicants respectfully request that the claims of the present application be formally allowed.

I. Election/Restriction Requirement

The Office Action deemed the Election Requirement issued for the present application to be proper and withdrew claims 11 and 12 based upon that Requirement. Without acquiescing in the Requirement, Applicants have canceled claims 11 and 12.

II. Claim Rejections under 35 USC 112

The Office Action rejected claims 18 and 19 suggesting that those claims do not further limit the claim upon which they depend. In particular, the Office Action suggests that PEG is a polyol and that the recitation of the inclusion of a polyol in the composition in claims 18 and 19 is not further limiting. Applicants believe this rejection was made because claim 19 inadvertently recited polyethylene glycol (PEG) as a polyol. However, because of the definition of polyol in the specification of the present application, it is clear that PEG would not be considered a polyol for purposes of the present application. Specifically, the specification, at page 11, lines 21-24, reads:

As used herein, the term 'polyol' includes any compound having at least one hydroxyl group on each of two adjacent carbon atoms that are not in trans configuration relative to each other.

PEG does not fall into this definition. Further, claim 19 has been amended to recite the polyol as propylene glycol. Propylene glycol does fall within the definition of polyol in the present

application. As such, Applicants respectfully request that the rejection of claims 18 and 19 be withdrawn.

In the event that Examiner Tran still believes that the term “polyol” raises an issue with respect to the claims, Applicants respectfully request that Examiner Tran phone the undersigned so that such issue can be expeditiously resolved.

III. Claim Rejections under 35 USC 102/103

The Office Action rejected claims 1-10, 14, and 15 under 35 USC 102 or 35 USC 103 as being anticipated by or obvious and unpatentable over one or both of the following references: US Patent Application Publication 2011/0082145; U.S. Patent Application Publication 2004/0198828. However, the Office Action only objected to claim 13, but indicated the claim allowable if rewritten in independent format. Further, the Office Action allowed claims 16-17 and 20-25. Without acquiescing in the rejection of claims 1-10, 14 and 15 Applicants have amended the claims to leave only allowed or allowable subject matter still pending. Specifically, Applicants have canceled claim 1-8, have rewritten independent claim 9 to include the subject matter of claim 13 such that claim 9 and its dependents are allowable and have left the allowed claims pending. Applicants have also amended the claims to be in a more desired format. In the event that Examiner Tran believes that any of the claim amendments raises an issue with respect to the allowability of the claims, Applicants respectfully request that Examiner Tran phone the undersigned so that such issue can be expeditiously resolved.

I. New Claims

Applicants have added new claims 26-38. These claims are drawn to preferred embodiments of the present application. These claims are narrower in scope than the currently allowed and allowable claims. As such, Applicants respectfully request that these new claims be entered and allowed. In the event that Examiner Tran believes that any of the new claims raise an issue with respect the allowability of the present application, Applicants respectfully request that Examiner Tran phone the undersigned so that such issue can be expeditiously resolved.

U.S. Serial No.: 13/475,607
Filed: May 18, 2013
Page 9

In view of the above, Applicants respectfully request formal allowance of the present application.

U.S. Serial No.: 13/475,607
Filed: May 18, 2013
Page 10

CONCLUSION:

Applicants respectfully request allowance of the claims of the present application. Should the Examiner have any questions regarding this Amendment, please feel free to contact the undersigned attorney at the phone number listed below.

Respectfully submitted,

ALCON RESEARCH, LTD.

February 17, 2014
Date

/Scott A. Chapple, Reg. 46,287/
Scott A. Chapple
Reg. No. 46,287

Address for Correspondence:
Alcon Research, Ltd.
Scott A. Chapple, IP Legal
6201 S. Freeway, Mail Code TB4-8
Fort Worth, TX 76134-2099
Phone: 817-551-8793

Attorney Docket: PAT903988-US-NP

INFORMATION DISCLOSURE STATEMENT BY APPLICANT (Not for submission under 37 CFR 1.99)	Application Number		13475607	
	Filing Date		2012-05-18	
	First Named Inventor	Daniel A. Gamache		
	Art Unit		1629	
	Examiner Name	Tran, My Chau T.		
	Attorney Docket Number		PAT903988-US-NP	

U.S.PATENTS						Remove
Examiner Initial*	Cite No	Patent Number	Kind Code ¹	Issue Date	Name of Patentee or Applicant of cited Document	Pages,Columns,Lines where Relevant Passages or Relevant Figures Appear
	1	5874414		1999-02-23	Cydex, Inc.	
	2	6280745	B1	2001-08-28	Alliance Pharmaceutical Corp.	
	3	6407079	B1	2002-06-18	Janssen Pharmaceutica N.V.	

If you wish to add additional U.S. Patent citation information please click the Add button. Add

U.S.PATENT APPLICATION PUBLICATIONS						Remove
Examiner Initial*	Cite No	Publication Number	Kind Code ¹	Publication Date	Name of Patentee or Applicant of cited Document	Pages,Columns,Lines where Relevant Passages or Relevant Figures Appear
	1					

If you wish to add additional U.S. Published Application citation information please click the Add button. Add

FOREIGN PATENT DOCUMENTS								Remove
Examiner Initial*	Cite No	Foreign Document Number ³	Country Code ² j	Kind Code ⁴	Publication Date	Name of Patentee or Applicant of cited Document	Pages,Columns,Lines where Relevant Passages or Relevant Figures Appear	T ⁵
	1							<input type="checkbox"/>

INFORMATION DISCLOSURE STATEMENT BY APPLICANT (Not for submission under 37 CFR 1.99)	Application Number	13475607
	Filing Date	2012-05-18
	First Named Inventor	Daniel A. Gamache
	Art Unit	1629
	Examiner Name	Tran, My Chau T.
	Attorney Docket Number	PAT903988-US-NP

If you wish to add additional Foreign Patent Document citation information please click the Add button **Add**

NON-PATENT LITERATURE DOCUMENTS **Remove**

Examiner Initials*	Cite No	Include name of the author (in CAPITAL LETTERS), title of the article (when appropriate), title of the item (book, magazine, journal, serial, symposium, catalog, etc), date, pages(s), volume-issue number(s), publisher, city and/or country where published.	T ⁵
	1		<input type="checkbox"/>

If you wish to add additional non-patent literature document citation information please click the Add button **Add**

EXAMINER SIGNATURE

Examiner Signature	Date Considered
--------------------	-----------------

*EXAMINER: Initial if reference considered, whether or not citation is in conformance with MPEP 609. Draw line through a citation if not in conformance and not considered. Include copy of this form with next communication to applicant.

¹ See Kind Codes of USPTO Patent Documents at www.USPTO.GOV or MPEP 901.04. ² Enter office that issued the document, by the two-letter code (WIPO Standard ST.3). ³ For Japanese patent documents, the indication of the year of the reign of the Emperor must precede the serial number of the patent document. ⁴ Kind of document by the appropriate symbols as indicated on the document under WIPO Standard ST.16 if possible. ⁵ Applicant is to place a check mark here if English language translation is attached.

**INFORMATION DISCLOSURE
STATEMENT BY APPLICANT**
(Not for submission under 37 CFR 1.99)

Application Number	13475607		
Filing Date	2012-05-18		
First Named Inventor	Daniel A. Gamache		
Art Unit	1629		
Examiner Name	Tran, My Chau T.		
Attorney Docket Number	PAT903988-US-NP		

CERTIFICATION STATEMENT

Please see 37 CFR 1.97 and 1.98 to make the appropriate selection(s):

That each item of information contained in the information disclosure statement was first cited in any communication from a foreign patent office in a counterpart foreign application not more than three months prior to the filing of the information disclosure statement. See 37 CFR 1.97(e)(1).

OR

That no item of information contained in the information disclosure statement was cited in a communication from a foreign patent office in a counterpart foreign application, and, to the knowledge of the person signing the certification after making reasonable inquiry, no item of information contained in the information disclosure statement was known to any individual designated in 37 CFR 1.56(c) more than three months prior to the filing of the information disclosure statement. See 37 CFR 1.97(e)(2).

See attached certification statement.

The fee set forth in 37 CFR 1.17 (p) has been submitted herewith.

A certification statement is not submitted herewith.

SIGNATURE

A signature of the applicant or representative is required in accordance with CFR 1.33, 10.18. Please see CFR 1.4(d) for the form of the signature.

Signature	/Scott A. Chapple, 46,287/	Date (YYYY-MM-DD)	2014-02-17
Name/Print	Scott A. Chapple	Registration Number	46,287

This collection of information is required by 37 CFR 1.97 and 1.98. The information is required to obtain or retain a benefit by the public which is to file (and by the USPTO to process) an application. Confidentiality is governed by 35 U.S.C. 122 and 37 CFR 1.14. This collection is estimated to take 1 hour to complete, including gathering, preparing and submitting the completed application form to the USPTO. Time will vary depending upon the individual case. Any comments on the amount of time you require to complete this form and/or suggestions for reducing this burden, should be sent to the Chief Information Officer, U.S. Patent and Trademark Office, U.S. Department of Commerce, P.O. Box 1450, Alexandria, VA 22313-1450. **DO NOT SEND FEES OR COMPLETED FORMS TO THIS ADDRESS. SEND TO: Commissioner for Patents, P.O. Box 1450, Alexandria, VA 22313-1450.**

Privacy Act Statement

The Privacy Act of 1974 (P.L. 93-579) requires that you be given certain information in connection with your submission of the attached form related to a patent application or patent. Accordingly, pursuant to the requirements of the Act, please be advised that: (1) the general authority for the collection of this information is 35 U.S.C. 2(b)(2); (2) furnishing of the information solicited is voluntary; and (3) the principal purpose for which the information is used by the U.S. Patent and Trademark Office is to process and/or examine your submission related to a patent application or patent. If you do not furnish the requested information, the U.S. Patent and Trademark Office may not be able to process and/or examine your submission, which may result in termination of proceedings or abandonment of the application or expiration of the patent.

The information provided by you in this form will be subject to the following routine uses:

1. The information on this form will be treated confidentially to the extent allowed under the Freedom of Information Act (5 U.S.C. 552) and the Privacy Act (5 U.S.C. 552a). Records from this system of records may be disclosed to the Department of Justice to determine whether the Freedom of Information Act requires disclosure of these records.
2. A record from this system of records may be disclosed, as a routine use, in the course of presenting evidence to a court, magistrate, or administrative tribunal, including disclosures to opposing counsel in the course of settlement negotiations.
3. A record in this system of records may be disclosed, as a routine use, to a Member of Congress submitting a request involving an individual, to whom the record pertains, when the individual has requested assistance from the Member with respect to the subject matter of the record.
4. A record in this system of records may be disclosed, as a routine use, to a contractor of the Agency having need for the information in order to perform a contract. Recipients of information shall be required to comply with the requirements of the Privacy Act of 1974, as amended, pursuant to 5 U.S.C. 552a(m).
5. A record related to an International Application filed under the Patent Cooperation Treaty in this system of records may be disclosed, as a routine use, to the International Bureau of the World Intellectual Property Organization, pursuant to the Patent Cooperation Treaty.
6. A record in this system of records may be disclosed, as a routine use, to another federal agency for purposes of National Security review (35 U.S.C. 181) and for review pursuant to the Atomic Energy Act (42 U.S.C. 218(c)).
7. A record from this system of records may be disclosed, as a routine use, to the Administrator, General Services, or his/her designee, during an inspection of records conducted by GSA as part of that agency's responsibility to recommend improvements in records management practices and programs, under authority of 44 U.S.C. 2904 and 2906. Such disclosure shall be made in accordance with the GSA regulations governing inspection of records for this purpose, and any other relevant (i.e., GSA or Commerce) directive. Such disclosure shall not be used to make determinations about individuals.
8. A record from this system of records may be disclosed, as a routine use, to the public after either publication of the application pursuant to 35 U.S.C. 122(b) or issuance of a patent pursuant to 35 U.S.C. 151. Further, a record may be disclosed, subject to the limitations of 37 CFR 1.14, as a routine use, to the public if the record was filed in an application which became abandoned or in which the proceedings were terminated and which application is referenced by either a published application, an application open to public inspections or an issued patent.
9. A record from this system of records may be disclosed, as a routine use, to a Federal, State, or local law enforcement agency, if the USPTO becomes aware of a violation or potential violation of law or regulation.

Electronic Patent Application Fee Transmittal

Application Number:	13475607
Filing Date:	18-May-2012
Title of Invention:	HIGH CONCENTRATION OLOPATADINE OPHTHALMIC COMPOSITION
First Named Inventor/Applicant Name:	Daniel A. Gamache
Filer:	Scott Chapple/Barbara McKenzie
Attorney Docket Number:	PAT903988-US-NP

Filed as Large Entity

Utility under 35 USC 111(a) Filing Fees

Description	Fee Code	Quantity	Amount	Sub-Total in USD(\$)
Basic Filing:				
Pages:				
Claims:				
Claims in Excess of 20	1202	13	80	1040
Independent claims in excess of 3	1201	1	420	420

Miscellaneous-Filing:

Petition:

Patent-Appeals-and-Interference:

Post-Allowance-and-Post-Issuance:

Description	Fee Code	Quantity	Amount	Sub-Total in USD(\$)
Extension-of-Time:				
Extension - 1 month with \$0 paid	1251	1	200	200
Miscellaneous:				
Total in USD (\$)				1660

Electronic Acknowledgement Receipt

EFS ID:	18218732
Application Number:	13475607
International Application Number:	
Confirmation Number:	4130
Title of Invention:	HIGH CONCENTRATION OLOPATADINE OPHTHALMIC COMPOSITION
First Named Inventor/Applicant Name:	Daniel A. Gamache
Customer Number:	26356
Filer:	Scott Chapple/Barbara McKenzie
Filer Authorized By:	Scott Chapple
Attorney Docket Number:	PAT903988-US-NP
Receipt Date:	17-FEB-2014
Filing Date:	18-MAY-2012
Time Stamp:	16:07:15
Application Type:	Utility under 35 USC 111(a)

Payment information:

Submitted with Payment	yes
Payment Type	Deposit Account
Payment was successfully received in RAM	\$1660
RAM confirmation Number	10223
Deposit Account	010682
Authorized User	

The Director of the USPTO is hereby authorized to charge indicated fees and credit any overpayment as follows:

Charge any Additional Fees required under 37 C.F.R. Section 1.16 (National application filing, search, and examination fees)

Charge any Additional Fees required under 37 C.F.R. Section 1.17 (Patent application and reexamination processing fees)

Charge any Additional Fees required under 37 C.F.R. Section 1.19 (Document supply fees)

Charge any Additional Fees required under 37 C.F.R. Section 1.20 (Post Issuance fees)

Charge any Additional Fees required under 37 C.F.R. Section 1.21 (Miscellaneous fees and charges)

File Listing:

Document Number	Document Description	File Name	File Size(Bytes)/ Message Digest	Multi Part /.zip	Pages (if appl.)
1		PAT903988-US- NP_2014-02-17_RESP.pdf	121551 aa238d79ab55ee9617aea038f208dcd053b a2d26	yes	10
Multipart Description/PDF files in .zip description					
	Document Description		Start		End
	Amendment/Req. Reconsideration-After Non-Final Reject		1		1
	Claims		2		6
	Applicant Arguments/Remarks Made in an Amendment		7		10
Warnings:					
Information:					
2	Information Disclosure Statement (IDS) Form (SB08)	PAT903988-US- NP_2014-02-17_IDS_fillable.pdf	612225 805dc976f333db145c95686594decaee82a 6b0d7	no	4
Warnings:					
Information:					
3	Fee Worksheet (SB06)	fee-info.pdf	33874 d22c43c7f04e55996bbb32668f2a0df853b5 42d2	no	2
Warnings:					
Information:					
Total Files Size (in bytes):			767650		

This Acknowledgement Receipt evidences receipt on the noted date by the USPTO of the indicated documents, characterized by the applicant, and including page counts, where applicable. It serves as evidence of receipt similar to a Post Card, as described in MPEP 503.

New Applications Under 35 U.S.C. 111

If a new application is being filed and the application includes the necessary components for a filing date (see 37 CFR 1.53(b)-(d) and MPEP 506), a Filing Receipt (37 CFR 1.54) will be issued in due course and the date shown on this Acknowledgement Receipt will establish the filing date of the application.

National Stage of an International Application under 35 U.S.C. 371

If a timely submission to enter the national stage of an international application is compliant with the conditions of 35 U.S.C. 371 and other applicable requirements a Form PCT/DO/EO/903 indicating acceptance of the application as a national stage submission under 35 U.S.C. 371 will be issued in addition to the Filing Receipt, in due course.

New International Application Filed with the USPTO as a Receiving Office

If a new international application is being filed and the international application includes the necessary components for an international filing date (see PCT Article 11 and MPEP 1810), a Notification of the International Application Number and of the International Filing Date (Form PCT/RO/105) will be issued in due course, subject to prescriptions concerning national security, and the date shown on this Acknowledgement Receipt will establish the international filing date of the application.

Electronic Patent Application Fee Transmittal

Application Number:	13475607
Filing Date:	18-May-2012
Title of Invention:	HIGH CONCENTRATION OLOPATADINE OPHTHALMIC COMPOSITION
First Named Inventor/Applicant Name:	Daniel A. Gamache
Filer:	Scott Chapple/Barbara McKenzie
Attorney Docket Number:	PAT903988-US-NP

Filed as Large Entity

Utility under 35 USC 111(a) Filing Fees

Description	Fee Code	Quantity	Amount	Sub-Total in USD(\$)
Basic Filing:				
Pages:				
Claims:				
Miscellaneous-Filing:				
Petition:				
Patent-Appeals-and-Interference:				
Post-Allowance-and-Post-Issuance:				
Extension-of-Time:				

Description	Fee Code	Quantity	Amount	Sub-Total in USD(\$)
Miscellaneous:				
Submission- Information Disclosure Stmt	1806	1	180	180
Total in USD (\$)				180

Electronic Acknowledgement Receipt

EFS ID:	18218799
Application Number:	13475607
International Application Number:	
Confirmation Number:	4130
Title of Invention:	HIGH CONCENTRATION OLOPATADINE OPHTHALMIC COMPOSITION
First Named Inventor/Applicant Name:	Daniel A. Gamache
Customer Number:	26356
Filer:	Scott Chapple/Barbara McKenzie
Filer Authorized By:	Scott Chapple
Attorney Docket Number:	PAT903988-US-NP
Receipt Date:	17-FEB-2014
Filing Date:	18-MAY-2012
Time Stamp:	16:13:53
Application Type:	Utility under 35 USC 111(a)

Payment information:

Submitted with Payment	yes
Payment Type	Deposit Account
Payment was successfully received in RAM	\$180
RAM confirmation Number	10275
Deposit Account	010682
Authorized User	

The Director of the USPTO is hereby authorized to charge indicated fees and credit any overpayment as follows:

Charge any Additional Fees required under 37 C.F.R. Section 1.16 (National application filing, search, and examination fees)

Charge any Additional Fees required under 37 C.F.R. Section 1.17 (Patent application and reexamination processing fees)

Charge any Additional Fees required under 37 C.F.R. Section 1.19 (Document supply fees)

Charge any Additional Fees required under 37 C.F.R. Section 1.20 (Post Issuance fees)

Charge any Additional Fees required under 37 C.F.R. Section 1.21 (Miscellaneous fees and charges)

File Listing:

Document Number	Document Description	File Name	File Size(Bytes)/ Message Digest	Multi Part /.zip	Pages (if appl.)
1	Fee Worksheet (SB06)	fee-info.pdf	30596 99cd88e0e6071b4fde3de8d97a5db913db1246f1	no	2

Warnings:

Information:

Total Files Size (in bytes):

30596

This Acknowledgement Receipt evidences receipt on the noted date by the USPTO of the indicated documents, characterized by the applicant, and including page counts, where applicable. It serves as evidence of receipt similar to a Post Card, as described in MPEP 503.

New Applications Under 35 U.S.C. 111

If a new application is being filed and the application includes the necessary components for a filing date (see 37 CFR 1.53(b)-(d) and MPEP 506), a Filing Receipt (37 CFR 1.54) will be issued in due course and the date shown on this Acknowledgement Receipt will establish the filing date of the application.

National Stage of an International Application under 35 U.S.C. 371

If a timely submission to enter the national stage of an international application is compliant with the conditions of 35 U.S.C. 371 and other applicable requirements a Form PCT/DO/EO/903 indicating acceptance of the application as a national stage submission under 35 U.S.C. 371 will be issued in addition to the Filing Receipt, in due course.

New International Application Filed with the USPTO as a Receiving Office

If a new international application is being filed and the international application includes the necessary components for an international filing date (see PCT Article 11 and MPEP 1810), a Notification of the International Application Number and of the International Filing Date (Form PCT/RO/105) will be issued in due course, subject to prescriptions concerning national security, and the date shown on this Acknowledgement Receipt will establish the international filing date of the application.

Under the Paperwork Reduction Act of 1995, no persons are required to respond to a collection of information unless it displays a valid OMB control number.

PATENT APPLICATION FEE DETERMINATION RECORD Substitute for Form PTO-875	Application or Docket Number 13/475,607	Filing Date 05/18/2012	<input type="checkbox"/> To be Mailed
---	---	----------------------------------	---------------------------------------

ENTITY: LARGE SMALL MICRO

APPLICATION AS FILED – PART I

FOR	NUMBER FILED	NUMBER EXTRA	RATE (\$)	FEE (\$)
<input type="checkbox"/> BASIC FEE <small>(37 CFR 1.16(a), (b), or (c))</small>	N/A	N/A	N/A	
<input type="checkbox"/> SEARCH FEE <small>(37 CFR 1.16(k), (l), or (m))</small>	N/A	N/A	N/A	
<input type="checkbox"/> EXAMINATION FEE <small>(37 CFR 1.16(o), (p), or (q))</small>	N/A	N/A	N/A	
TOTAL CLAIMS <small>(37 CFR 1.16(i))</small>	minus 20 =	*	X \$ =	
INDEPENDENT CLAIMS <small>(37 CFR 1.16(h))</small>	minus 3 =	*	X \$ =	
<input type="checkbox"/> APPLICATION SIZE FEE <small>(37 CFR 1.16(s))</small>	If the specification and drawings exceed 100 sheets of paper, the application size fee due is \$310 (\$155 for small entity) for each additional 50 sheets or fraction thereof. See 35 U.S.C. 41(a)(1)(G) and 37 CFR 1.16(s).			
<input type="checkbox"/> MULTIPLE DEPENDENT CLAIM PRESENT <small>(37 CFR 1.16(j))</small>				
* If the difference in column 1 is less than zero, enter "0" in column 2.			TOTAL	

APPLICATION AS AMENDED – PART II

	(Column 1)	(Column 2)	(Column 3)	PRESENT EXTRA	RATE (\$)	ADDITIONAL FEE (\$)
AMENDMENT	02/17/2014	CLAIMS REMAINING AFTER AMENDMENT	HIGHEST NUMBER PREVIOUSLY PAID FOR			
	Total <small>(37 CFR 1.16(i))</small>	* 27	Minus	** 25 = 2	X \$80 =	160
	Independent <small>(37 CFR 1.16(h))</small>	* 4	Minus	***4 = 0	X \$420 =	0
	<input type="checkbox"/> Application Size Fee <small>(37 CFR 1.16(s))</small>					
<input type="checkbox"/> FIRST PRESENTATION OF MULTIPLE DEPENDENT CLAIM <small>(37 CFR 1.16(j))</small>						
					TOTAL ADD'L FEE	160

	(Column 1)	(Column 2)	(Column 3)	PRESENT EXTRA	RATE (\$)	ADDITIONAL FEE (\$)
AMENDMENT		CLAIMS REMAINING AFTER AMENDMENT	HIGHEST NUMBER PREVIOUSLY PAID FOR			
	Total <small>(37 CFR 1.16(i))</small>	*	Minus	** =	X \$ =	
	Independent <small>(37 CFR 1.16(h))</small>	*	Minus	*** =	X \$ =	
	<input type="checkbox"/> Application Size Fee <small>(37 CFR 1.16(s))</small>					
<input type="checkbox"/> FIRST PRESENTATION OF MULTIPLE DEPENDENT CLAIM <small>(37 CFR 1.16(j))</small>						
					TOTAL ADD'L FEE	

* If the entry in column 1 is less than the entry in column 2, write "0" in column 3.
 ** If the "Highest Number Previously Paid For" IN THIS SPACE is less than 20, enter "20".
 *** If the "Highest Number Previously Paid For" IN THIS SPACE is less than 3, enter "3".

The "Highest Number Previously Paid For" (Total or Independent) is the highest number found in the appropriate box in column 1.

LIE
/DEBORAH POLLARD/

This collection of information is required by 37 CFR 1.16. The information is required to obtain or retain a benefit by the public which is to file (and by the USPTO to process) an application. Confidentiality is governed by 35 U.S.C. 122 and 37 CFR 1.14. This collection is estimated to take 12 minutes to complete, including gathering, preparing, and submitting the completed application form to the USPTO. Time will vary depending upon the individual case. Any comments on the amount of time you require to complete this form and/or suggestions for reducing this burden, should be sent to the Chief Information Officer, U.S. Patent and Trademark Office, U.S. Department of Commerce, P.O. Box 1450, Alexandria, VA 22313-1450. DO NOT SEND FEES OR COMPLETED FORMS TO THIS ADDRESS. **SEND TO: Commissioner for Patents, P.O. Box 1450, Alexandria, VA 22313-1450.**

If you need assistance in completing the form, call 1-800-PTO-9199 and select option 2.



NOTICE OF ALLOWANCE AND FEE(S) DUE

26356 7590 05/08/2014
ALCON
IP LEGAL
6201 SOUTH FREEWAY
FORT WORTH, TX 76134

Table with 2 columns: EXAMINER (TRAN, MY CHAU T), ART UNIT (1629), PAPER NUMBER (4130)

DATE MAILED: 05/08/2014

Table with 5 columns: APPLICATION NO., FILING DATE, FIRST NAMED INVENTOR, ATTORNEY DOCKET NO., CONFIRMATION NO.

13/475,607 05/18/2012 Daniel A. Gamache PAT903988-US-NP 4130

TITLE OF INVENTION: HIGH CONCENTRATION OLOPATADINE OPHTHALMIC COMPOSITION

Table with 7 columns: APPLN. TYPE, ENTITY STATUS, ISSUE FEE DUE, PUBLICATION FEE DUE, PREV. PAID ISSUE FEE, TOTAL FEE(S) DUE, DATE DUE

nonprovisional UNDISCOUNTED \$960 \$0 \$0 \$960 08/08/2014

THE APPLICATION IDENTIFIED ABOVE HAS BEEN EXAMINED AND IS ALLOWED FOR ISSUANCE AS A PATENT. PROSECUTION ON THE MERITS IS CLOSED. THIS NOTICE OF ALLOWANCE IS NOT A GRANT OF PATENT RIGHTS. THIS APPLICATION IS SUBJECT TO WITHDRAWAL FROM ISSUE AT THE INITIATIVE OF THE OFFICE OR UPON PETITION BY THE APPLICANT. SEE 37 CFR 1.313 AND MPEP 1308.

THE ISSUE FEE AND PUBLICATION FEE (IF REQUIRED) MUST BE PAID WITHIN THREE MONTHS FROM THE MAILING DATE OF THIS NOTICE OR THIS APPLICATION SHALL BE REGARDED AS ABANDONED. THIS STATUTORY PERIOD CANNOT BE EXTENDED. SEE 35 U.S.C. 151. THE ISSUE FEE DUE INDICATED ABOVE DOES NOT REFLECT A CREDIT FOR ANY PREVIOUSLY PAID ISSUE FEE IN THIS APPLICATION. IF AN ISSUE FEE HAS PREVIOUSLY BEEN PAID IN THIS APPLICATION (AS SHOWN ABOVE), THE RETURN OF PART B OF THIS FORM WILL BE CONSIDERED A REQUEST TO REAPPLY THE PREVIOUSLY PAID ISSUE FEE TOWARD THE ISSUE FEE NOW DUE.

HOW TO REPLY TO THIS NOTICE:

I. Review the ENTITY STATUS shown above. If the ENTITY STATUS is shown as SMALL or MICRO, verify whether entitlement to that entity status still applies.

If the ENTITY STATUS is the same as shown above, pay the TOTAL FEE(S) DUE shown above.

If the ENTITY STATUS is changed from that shown above, on PART B - FEE(S) TRANSMITTAL, complete section number 5 titled "Change in Entity Status (from status indicated above)".

For purposes of this notice, small entity fees are 1/2 the amount of undiscounted fees, and micro entity fees are 1/2 the amount of small entity fees.

II. PART B - FEE(S) TRANSMITTAL, or its equivalent, must be completed and returned to the United States Patent and Trademark Office (USPTO) with your ISSUE FEE and PUBLICATION FEE (if required). If you are charging the fee(s) to your deposit account, section "4b" of Part B - Fee(s) Transmittal should be completed and an extra copy of the form should be submitted. If an equivalent of Part B is filed, a request to reapply a previously paid issue fee must be clearly made, and delays in processing may occur due to the difficulty in recognizing the paper as an equivalent of Part B.

III. All communications regarding this application must give the application number. Please direct all communications prior to issuance to Mail Stop ISSUE FEE unless advised to the contrary.

IMPORTANT REMINDER: Utility patents issuing on applications filed on or after Dec. 12, 1980 may require payment of maintenance fees. It is patentee's responsibility to ensure timely payment of maintenance fees when due.

PART B - FEE(S) TRANSMITTAL

**Complete and send this form, together with applicable fee(s), to: Mail Mail Stop ISSUE FEE
 Commissioner for Patents
 P.O. Box 1450
 Alexandria, Virginia 22313-1450
 or Fax (571)-273-2885**

INSTRUCTIONS: This form should be used for transmitting the ISSUE FEE and PUBLICATION FEE (if required). Blocks 1 through 5 should be completed where appropriate. All further correspondence including the Patent, advance orders and notification of maintenance fees will be mailed to the current correspondence address as indicated unless corrected below or directed otherwise in Block 1, by (a) specifying a new correspondence address; and/or (b) indicating a separate "FEE ADDRESS" for maintenance fee notifications.

Note: A certificate of mailing can only be used for domestic mailings of the Fee(s) Transmittal. This certificate cannot be used for any other accompanying papers. Each additional paper, such as an assignment or formal drawing, must have its own certificate of mailing or transmission.

CURRENT CORRESPONDENCE ADDRESS (Note: Use Block 1 for any change of address)

26356 7590 05/08/2014
ALCON
IP LEGAL
6201 SOUTH FREEWAY
FORT WORTH, TX 76134

Certificate of Mailing or Transmission

I hereby certify that this Fee(s) Transmittal is being deposited with the United States Postal Service with sufficient postage for first class mail in an envelope addressed to the Mail Stop ISSUE FEE address above, or being facsimile transmitted to the USPTO (571) 273-2885, on the date indicated below.

(Depositor's name)
(Signature)
(Date)

APPLICATION NO.	FILING DATE	FIRST NAMED INVENTOR	ATTORNEY DOCKET NO.	CONFIRMATION NO.
13/475,607	05/18/2012	Daniel A. Gamache	PAT903988-US-NP	4130

TITLE OF INVENTION: HIGH CONCENTRATION OLOPATADINE OPHTHALMIC COMPOSITION

APPLN. TYPE	ENTITY STATUS	ISSUE FEE DUE	PUBLICATION FEE DUE	PREV. PAID ISSUE FEE	TOTAL FEE(S) DUE	DATE DUE
nonprovisional	UNDISCOUNTED	\$960	\$0	\$0	\$960	08/08/2014

EXAMINER	ART UNIT	CLASS-SUBCLASS
TRAN, MY CHAU T	1629	514-450000

<p>1. Change of correspondence address or indication of "Fee Address" (37 CFR 1.363).</p> <p><input type="checkbox"/> Change of correspondence address (or Change of Correspondence Address form PTO/SB/122) attached.</p> <p><input type="checkbox"/> "Fee Address" indication (or "Fee Address" Indication form PTO/SB/47; Rev 03-02 or more recent) attached. Use of a Customer Number is required.</p>	<p>2. For printing on the patent front page, list</p> <p>(1) The names of up to 3 registered patent attorneys or agents OR, alternatively, _____ 1</p> <p>(2) The name of a single firm (having as a member a registered attorney or agent) and the names of up to 2 registered patent attorneys or agents. If no name is listed, no name will be printed. _____ 2</p> <p>_____ 3</p>
---	---

3. ASSIGNEE NAME AND RESIDENCE DATA TO BE PRINTED ON THE PATENT (print or type)

PLEASE NOTE: Unless an assignee is identified below, no assignee data will appear on the patent. If an assignee is identified below, the document has been filed for recordation as set forth in 37 CFR 3.11. Completion of this form is NOT a substitute for filing an assignment.

(A) NAME OF ASSIGNEE _____ (B) RESIDENCE: (CITY and STATE OR COUNTRY) _____

Please check the appropriate assignee category or categories (will not be printed on the patent) : Individual Corporation or other private group entity Government

<p>4a. The following fee(s) are submitted:</p> <p><input type="checkbox"/> Issue Fee</p> <p><input type="checkbox"/> Publication Fee (No small entity discount permitted)</p> <p><input type="checkbox"/> Advance Order - # of Copies _____</p>	<p>4b. Payment of Fee(s): (Please first reapply any previously paid issue fee shown above)</p> <p><input type="checkbox"/> A check is enclosed.</p> <p><input type="checkbox"/> Payment by credit card. Form PTO-2038 is attached.</p> <p><input type="checkbox"/> The Director is hereby authorized to charge the required fee(s), any deficiency, or credits any overpayment, to Deposit Account Number _____ (enclose an extra copy of this form).</p>
---	--

5. Change in Entity Status (from status indicated above)

Applicant certifying micro entity status. See 37 CFR 1.29

Applicant asserting small entity status. See 37 CFR 1.27

Applicant changing to regular undiscouted fee status.

NOTE: Absent a valid certification of Micro Entity Status (see forms PTO/SB/15A and 15B), issue fee payment in the micro entity amount will not be accepted at the risk of application abandonment.

NOTE: If the application was previously under micro entity status, checking this box will be taken to be a notification of loss of entitlement to micro entity status.

NOTE: Checking this box will be taken to be a notification of loss of entitlement to small or micro entity status, as applicable.

NOTE: This form must be signed in accordance with 37 CFR 1.31 and 1.33. See 37 CFR 1.4 for signature requirements and certifications.

Authorized Signature _____ Date _____

Typed or printed name _____ Registration No. _____



UNITED STATES PATENT AND TRADEMARK OFFICE

UNITED STATES DEPARTMENT OF COMMERCE
United States Patent and Trademark Office
Address: COMMISSIONER FOR PATENTS
P.O. Box 1450
Alexandria, Virginia 22313-1450
www.uspto.gov

Table with 5 columns: APPLICATION NO., FILING DATE, FIRST NAMED INVENTOR, ATTORNEY DOCKET NO., CONFIRMATION NO.
13/475,607 05/18/2012 Daniel A. Gamache PAT903988-US-NP 4130

26356 7590 05/08/2014
ALCON
IP LEGAL
6201 SOUTH FREEWAY
FORT WORTH, TX 76134

Table with 1 column: EXAMINER
TRAN, MY CHAU T

Table with 2 columns: ART UNIT, PAPER NUMBER
1629

DATE MAILED: 05/08/2014

Determination of Patent Term Adjustment under 35 U.S.C. 154 (b)

(Applications filed on or after May 29, 2000)

The Office has discontinued providing a Patent Term Adjustment (PTA) calculation with the Notice of Allowance.

Section 1(h)(2) of the AIA Technical Corrections Act amended 35 U.S.C. 154(b)(3)(B)(i) to eliminate the requirement that the Office provide a patent term adjustment determination with the notice of allowance. See Revisions to Patent Term Adjustment, 78 Fed. Reg. 19416, 19417 (Apr. 1, 2013). Therefore, the Office is no longer providing an initial patent term adjustment determination with the notice of allowance. The Office will continue to provide a patent term adjustment determination with the Issue Notification Letter that is mailed to applicant approximately three weeks prior to the issue date of the patent, and will include the patent term adjustment on the patent. Any request for reconsideration of the patent term adjustment determination (or reinstatement of patent term adjustment) should follow the process outlined in 37 CFR 1.705.

Any questions regarding the Patent Term Extension or Adjustment determination should be directed to the Office of Patent Legal Administration at (571)-272-7702. Questions relating to issue and publication fee payments should be directed to the Customer Service Center of the Office of Patent Publication at 1-(888)-786-0101 or (571)-272-4200.

OMB Clearance and PRA Burden Statement for PTOL-85 Part B

The Paperwork Reduction Act (PRA) of 1995 requires Federal agencies to obtain Office of Management and Budget approval before requesting most types of information from the public. When OMB approves an agency request to collect information from the public, OMB (i) provides a valid OMB Control Number and expiration date for the agency to display on the instrument that will be used to collect the information and (ii) requires the agency to inform the public about the OMB Control Number's legal significance in accordance with 5 CFR 1320.5(b).

The information collected by PTOL-85 Part B is required by 37 CFR 1.311. The information is required to obtain or retain a benefit by the public which is to file (and by the USPTO to process) an application. Confidentiality is governed by 35 U.S.C. 122 and 37 CFR 1.14. This collection is estimated to take 12 minutes to complete, including gathering, preparing, and submitting the completed application form to the USPTO. Time will vary depending upon the individual case. Any comments on the amount of time you require to complete this form and/or suggestions for reducing this burden, should be sent to the Chief Information Officer, U.S. Patent and Trademark Office, U.S. Department of Commerce, P.O. Box 1450, Alexandria, Virginia 22313-1450. DO NOT SEND FEES OR COMPLETED FORMS TO THIS ADDRESS. SEND TO: Commissioner for Patents, P.O. Box 1450, Alexandria, Virginia 22313-1450. Under the Paperwork Reduction Act of 1995, no persons are required to respond to a collection of information unless it displays a valid OMB control number.

Privacy Act Statement

The Privacy Act of 1974 (P.L. 93-579) requires that you be given certain information in connection with your submission of the attached form related to a patent application or patent. Accordingly, pursuant to the requirements of the Act, please be advised that: (1) the general authority for the collection of this information is 35 U.S.C. 2(b)(2); (2) furnishing of the information solicited is voluntary; and (3) the principal purpose for which the information is used by the U.S. Patent and Trademark Office is to process and/or examine your submission related to a patent application or patent. If you do not furnish the requested information, the U.S. Patent and Trademark Office may not be able to process and/or examine your submission, which may result in termination of proceedings or abandonment of the application or expiration of the patent.

The information provided by you in this form will be subject to the following routine uses:

1. The information on this form will be treated confidentially to the extent allowed under the Freedom of Information Act (5 U.S.C. 552) and the Privacy Act (5 U.S.C. 552a). Records from this system of records may be disclosed to the Department of Justice to determine whether disclosure of these records is required by the Freedom of Information Act.
2. A record from this system of records may be disclosed, as a routine use, in the course of presenting evidence to a court, magistrate, or administrative tribunal, including disclosures to opposing counsel in the course of settlement negotiations.
3. A record in this system of records may be disclosed, as a routine use, to a Member of Congress submitting a request involving an individual, to whom the record pertains, when the individual has requested assistance from the Member with respect to the subject matter of the record.
4. A record in this system of records may be disclosed, as a routine use, to a contractor of the Agency having need for the information in order to perform a contract. Recipients of information shall be required to comply with the requirements of the Privacy Act of 1974, as amended, pursuant to 5 U.S.C. 552a(m).
5. A record related to an International Application filed under the Patent Cooperation Treaty in this system of records may be disclosed, as a routine use, to the International Bureau of the World Intellectual Property Organization, pursuant to the Patent Cooperation Treaty.
6. A record in this system of records may be disclosed, as a routine use, to another federal agency for purposes of National Security review (35 U.S.C. 181) and for review pursuant to the Atomic Energy Act (42 U.S.C. 218(c)).
7. A record from this system of records may be disclosed, as a routine use, to the Administrator, General Services, or his/her designee, during an inspection of records conducted by GSA as part of that agency's responsibility to recommend improvements in records management practices and programs, under authority of 44 U.S.C. 2904 and 2906. Such disclosure shall be made in accordance with the GSA regulations governing inspection of records for this purpose, and any other relevant (i.e., GSA or Commerce) directive. Such disclosure shall not be used to make determinations about individuals.
8. A record from this system of records may be disclosed, as a routine use, to the public after either publication of the application pursuant to 35 U.S.C. 122(b) or issuance of a patent pursuant to 35 U.S.C. 151. Further, a record may be disclosed, subject to the limitations of 37 CFR 1.14, as a routine use, to the public if the record was filed in an application which became abandoned or in which the proceedings were terminated and which application is referenced by either a published application, an application open to public inspection or an issued patent.
9. A record from this system of records may be disclosed, as a routine use, to a Federal, State, or local law enforcement agency, if the USPTO becomes aware of a violation or potential violation of law or regulation.

Notice of Allowability	Application No. 13/475,607	Applicant(s) GAMACHE ET AL.	
	Examiner MY-CHAU T. TRAN	Art Unit 1629	AIA (First Inventor to File) Status No

-- The MAILING DATE of this communication appears on the cover sheet with the correspondence address--

All claims being allowable, PROSECUTION ON THE MERITS IS (OR REMAINS) CLOSED in this application. If not included herewith (or previously mailed), a Notice of Allowance (PTOL-85) or other appropriate communication will be mailed in due course. **THIS NOTICE OF ALLOWABILITY IS NOT A GRANT OF PATENT RIGHTS.** This application is subject to withdrawal from issue at the initiative of the Office or upon petition by the applicant. See 37 CFR 1.313 and MPEP 1308.

1. This communication is responsive to 02/17/2014.
 A declaration(s)/affidavit(s) under **37 CFR 1.130(b)** was/were filed on _____.
2. An election was made by the applicant in response to a restriction requirement set forth during the interview on _____; the restriction requirement and election have been incorporated into this action.
3. The allowed claim(s) is/are 9 and 14-39. As a result of the allowed claim(s), you may be eligible to benefit from the **Patent Prosecution Highway** program at a participating intellectual property office for the corresponding application. For more information, please see http://www.uspto.gov/patents/init_events/pph/index.jsp or send an inquiry to PPHfeedback@uspto.gov.
4. Acknowledgment is made of a claim for foreign priority under 35 U.S.C. § 119(a)-(d) or (f).

Certified copies:

- a) All b) Some *c) None of the:
1. Certified copies of the priority documents have been received.
 2. Certified copies of the priority documents have been received in Application No. _____.
 3. Copies of the certified copies of the priority documents have been received in this national stage application from the International Bureau (PCT Rule 17.2(a)).

* Certified copies not received: _____.

Applicant has THREE MONTHS FROM THE "MAILING DATE" of this communication to file a reply complying with the requirements noted below. Failure to timely comply will result in ABANDONMENT of this application.

THIS THREE-MONTH PERIOD IS NOT EXTENDABLE.

5. CORRECTED DRAWINGS (as "replacement sheets") must be submitted.
 including changes required by the attached Examiner's Amendment / Comment or in the Office action of Paper No./Mail Date _____.
Identifying indicia such as the application number (see 37 CFR 1.84(c)) should be written on the drawings in the front (not the back) of each sheet. Replacement sheet(s) should be labeled as such in the header according to 37 CFR 1.121(d).
6. DEPOSIT OF and/or INFORMATION about the deposit of BIOLOGICAL MATERIAL must be submitted. Note the attached Examiner's comment regarding REQUIREMENT FOR THE DEPOSIT OF BIOLOGICAL MATERIAL.

Attachment(s)

- | | |
|---|---|
| <ol style="list-style-type: none"> 1. <input type="checkbox"/> Notice of References Cited (PTO-892) 2. <input checked="" type="checkbox"/> Information Disclosure Statements (PTO/SB/08),
Paper No./Mail Date <u>12/17/2013 & 2/17/2014</u> 3. <input type="checkbox"/> Examiner's Comment Regarding Requirement for Deposit of Biological Material 4. <input type="checkbox"/> Interview Summary (PTO-413),
Paper No./Mail Date _____. | <ol style="list-style-type: none"> 5. <input type="checkbox"/> Examiner's Amendment/Comment 6. <input type="checkbox"/> Examiner's Statement of Reasons for Allowance 7. <input type="checkbox"/> Other _____. |
|---|---|

/MY-CHAU T TRAN/
Primary Examiner, Art Unit 1629

WEST Search History for Application 13475607

Creation Date: 2014050110:56

Interference Searches

Query	DB	Op.	Plur.	Thes.	Date
(514/449 514/450)! [CCLS]	UPAD	ADJ	YES	ASSIGNEE	05-01-2014
olopatadine and ((514/449 514/450)! [CCLS])	UPAD	ADJ	YES	ASSIGNEE	05-01-2014
(olopatadine same ((mass ratio) or dos \$ 4 or concentrat \$ 3 or ((weight or WT) same (percent or (per cent) or "%")))) and cyclodextrin	UPAD	ADJ	YES	ASSIGNEE	05-01-2014

Prior Art Searches

Query	DB	Op.	Plur.	Thes.	Date
("20020006443" "20020150616" "20030170309" "20050004074" "20050191270" "20050244472" "20060210645" "20070020336" "20080132444" "20090118262" "20090232763" "20090239842" "20100240625" "20100249062" "20100324031" "3767788" "3843782" "3856919" "3931319" "3947573" "4027020" "4120949" "4283393" "4407791" "4470965" "4525346" "4836986" "4923693" "5037647" "5068225" "5116863" "5134127" "5141961" "5300287" "5376645" "5472954" "5591426" "5597559" "5624962" "5888493" "6153746" "6511949" "6828356" "7074424" "7147844" "7429602" "7635773").PN.	PGPB, USPT, USOC	ADJ	YES	ASSIGNEE	04-28-2014
olopatadine and ("20020006443" "20020150616" "20030170309" "20050004074" "20050191270" "20050244472" "20060210645" "20070020336" "20080132444" "20090118262" "20090232763" "20090239842" "20100240625" "20100249062" "20100324031" "3767788" "3843782" "3856919" "3931319" "3947573" "4027020" "4120949" "4283393" "4407791" "4470965" "4525346" "4836986" "4923693" "5037647" "5068225" "5116863" "5134127" "5141961" "5300287" "5376645" "5472954" "5591426" "5597559" "5624962" "5888493" "6153746" "6511949" "6828356" "7074424" "7147844" "7429602" "7635773").PN.)	PGPB, USPT, USOC	ADJ	YES	ASSIGNEE	04-28-2014

GAMACHE-DANIEL-A\$.in.	PGPB, USPT, USOC, EPAB, JPAB, DWPI, TDBD, FPRS	ADJ	YES	ASSIGNEE	04-28-2014
ALANI-LAMAN\$.in.	PGPB, USPT, USOC, EPAB, JPAB, DWPI, TDBD, FPRS	ADJ	YES	ASSIGNEE	04-28-2014
GHOSH-MALAY\$.in.	PGPB, USPT, USOC, EPAB, JPAB, DWPI, TDBD, FPRS	ADJ	YES	ASSIGNEE	04-28-2014
GALAN-FRANCISCO-JAVIER\$.in.	PGPB, USPT, USOC, EPAB, JPAB, DWPI, TDBD, FPRS	ADJ	YES	ASSIGNEE	04-28-2014
PERDIGUER-NURIA-CARRERAS\$.in.	PGPB, USPT, USOC, EPAB, JPAB, DWPI, TDBD, FPRS	ADJ	YES	ASSIGNEE	04-28-2014
SINGH-ONKAR-N\$.in.	PGPB, USPT, USOC, EPAB, JPAB, DWPI, TDBD,	ADJ	YES	ASSIGNEE	04-28-2014

	FPRS				
(GAMACHE-DANIEL-A\$.in.) and (ALANI-LAMAN\$.in.) and (GHOSH-MALAY\$.in.) and (GALAN-FRANCISCO-JAVIER\$.in.) and (PERDIGUER-NURIA-CARRERAS\$.in.) and (SINGH-ONKAR-N\$.in.)	PGPB, USPT, USOC, EPAB, JPAB, DWPI, TDBD, FPRS	ADJ	YES	ASSIGNEE	04-28-2014
(GAMACHE-DANIEL-A\$.in.) and (ALANI-LAMAN\$.in.) and (GHOSH-MALAY\$.in.) and (GALAN-FRANCISCO-JAVIER\$.in.) and (PERDIGUER-NURIA-CARRERAS\$.in.)	PGPB, USPT, USOC, EPAB, JPAB, DWPI, TDBD, FPRS	ADJ	YES	ASSIGNEE	04-28-2014
(GAMACHE-DANIEL-A\$.in.) and (ALANI-LAMAN\$.in.) and (GHOSH-MALAY\$.in.) and (GALAN-FRANCISCO-JAVIER\$.in.)	PGPB, USPT, USOC, EPAB, JPAB, DWPI, TDBD, FPRS	ADJ	YES	ASSIGNEE	04-28-2014
(GAMACHE-DANIEL-A\$.in.) and (ALANI-LAMAN\$.in.) and (GHOSH-MALAY\$.in.) and (GALAN-FRANCISCO-JAVIER\$.in.) and (SINGH-ONKAR-N\$.in.)	PGPB, USPT, USOC, EPAB, JPAB, DWPI, TDBD, FPRS	ADJ	YES	ASSIGNEE	04-28-2014
olopatadine.clm. and (GAMACHE-DANIEL-A\$.in.)	PGPB, USPT, USOC, EPAB, JPAB, DWPI, TDBD, FPRS	ADJ	YES	ASSIGNEE	04-28-2014
olopatadine.clm. and (ALANI-LAMAN\$.in.)	PGPB, USPT, USOC, EPAB, JPAB,	ADJ	YES	ASSIGNEE	04-28-2014

	DWPI, TDBD, FPRS				
olopatadine.clm. and (GHOSH-MALAY\$.in.)	PGPB, USPT, USOC, EPAB, JPAB, DWPI, TDBD, FPRS	ADJ	YES	ASSIGNEE	04-28-2014
olopatadine.clm. and (GALAN-FRANCISCO-JAVIER\$.in.)	PGPB, USPT, USOC, EPAB, JPAB, DWPI, TDBD, FPRS	ADJ	YES	ASSIGNEE	04-28-2014
olopatadine.clm. and (PERDIGUER-NURIA-CARRERAS\$.in.)	PGPB, USPT, USOC, EPAB, JPAB, DWPI, TDBD, FPRS	ADJ	YES	ASSIGNEE	04-28-2014
olopatadine.clm. and (SINGH-ONKAR-N\$.in.)	PGPB, USPT, USOC, EPAB, JPAB, DWPI, TDBD, FPRS	ADJ	YES	ASSIGNEE	04-28-2014
ALCON RESEARCH\$.as.	PGPB, USPT, USOC, EPAB, JPAB, DWPI, TDBD, FPRS	ADJ	YES	ASSIGNEE	04-28-2014
olopatadine.clm. and (ALCON RESEARCH\$.as.)	PGPB, USPT, USOC,	ADJ	YES	ASSIGNEE	04-28-2014

	EPAB, JPAB, DWPI, TDBD, FPRS				
(ophthalmic (formulation or composition)).clm. and (olopatadine.clm. and GAMACHE-DANIEL-A\$.in.)	PGPB, USPT, USOC, EPAB, JPAB, DWPI, TDBD, FPRS	ADJ	YES	ASSIGNEE	04-28-2014
(ophthalmic (formulation or composition)).clm. and (olopatadine.clm. and SINGH-ONKAR-N\$.in.)	PGPB, USPT, USOC, EPAB, JPAB, DWPI, TDBD, FPRS	ADJ	YES	ASSIGNEE	04-28-2014
(ophthalmic (formulation or composition)).clm. and (olopatadine.clm. and ALCON RESEARCH\$.as.)	PGPB, USPT, USOC, EPAB, JPAB, DWPI, TDBD, FPRS	ADJ	YES	ASSIGNEE	04-28-2014
(514/449 514/450)! [CCLS]	PGPB, USPT, USOC	ADJ	YES	ASSIGNEE	04-28-2014
olopatadine and ((514/449 514/450)! [CCLS])	PGPB, USPT, USOC	ADJ	YES	ASSIGNEE	04-28-2014
(ophthalmic (formulation or composition)) and (olopatadine and (514/449 514/450)! [CCLS])	PGPB, USPT, USOC	ADJ	YES	ASSIGNEE	04-28-2014
cyclodextrin and ((ophthalmic (formulation or composition)) and olopatadine and (514/449 514/450)! [CCLS])	PGPB, USPT, USOC	ADJ	YES	ASSIGNEE	04-28-2014
lactam and ((ophthalmic (formulation or composition)) and olopatadine and (514/449 514/450)! [CCLS])	PGPB, USPT, USOC	ADJ	YES	ASSIGNEE	04-28-2014

polyether and ((ophthalmic (formulation or composition)) and olopatadine and (514/449 514/450)! [CCLS])	PGPB, USPT, USOC	ADJ	YES	ASSIGNEE	04-28-2014
(polyethylene glycol) and ((ophthalmic (formulation or composition)) and olopatadine and (514/449 514/450)! [CCLS])	PGPB, USPT, USOC	ADJ	YES	ASSIGNEE	04-28-2014
(ophthalmic (formulation or composition)) and olopatadine	EPAB, JPAB, DWPI, TDBD, FPRS	ADJ	YES	ASSIGNEE	04-28-2014
cyclodextrin and ((ophthalmic (formulation or composition)) and olopatadine)	EPAB, JPAB, DWPI, TDBD, FPRS	ADJ	YES	ASSIGNEE	04-28-2014
lactam and ((ophthalmic (formulation or composition)) and olopatadine)	EPAB, JPAB, DWPI, TDBD, FPRS	ADJ	YES	ASSIGNEE	04-28-2014
lactam and (cyclodextrin and (ophthalmic (formulation or composition)) and olopatadine)	EPAB, JPAB, DWPI, TDBD, FPRS	ADJ	YES	ASSIGNEE	04-28-2014
(polyethylene glycol) and ((ophthalmic (formulation or composition)) and olopatadine)	EPAB, JPAB, DWPI, TDBD, FPRS	ADJ	YES	ASSIGNEE	04-28-2014
(polyethylene glycol) and (cyclodextrin and (ophthalmic (formulation or composition)) and olopatadine)	EPAB, JPAB, DWPI, TDBD, FPRS	ADJ	YES	ASSIGNEE	04-28-2014
(ophthalmic (formulation or composition)) and olopatadine	PGPB, USPT, USOC	ADJ	YES	ASSIGNEE	04-28-2014
((ophthalmic (formulation or composition)) and olopatadine) not @AY>2011	PGPB, USPT, USOC	ADJ	YES	ASSIGNEE	04-28-2014
cyclodextrin and ((ophthalmic (formulation or composition)) and olopatadine not @AY>2011)	PGPB, USPT,	ADJ	YES	ASSIGNEE	04-28-2014

	USOC				
lactam and (cyclodextrin and (ophthalmic (formulation or composition)) and olopatadine not @AY>2011)	PGPB, USPT, USOC	ADJ	YES	ASSIGNEE	04-28-2014
(polyethylene glycol) and (cyclodextrin and (ophthalmic (formulation or composition)) and olopatadine not @AY>2011)	PGPB, USPT, USOC	ADJ	YES	ASSIGNEE	04-28-2014
lactam and ((polyethylene glycol) and cyclodextrin and (ophthalmic (formulation or composition)) and olopatadine not @AY>2011)	PGPB, USPT, USOC	ADJ	YES	ASSIGNEE	04-28-2014
(olopatadine same ((mass ratio) or dos\$4 or concentrat\$3 or ((weight or WT) same (percent or (per cent) or "%"))) and ((ophthalmic (formulation or composition)) and olopatadine)	PGPB, USPT, USOC	ADJ	YES	ASSIGNEE	04-28-2014
(olopatadine same (percent or (per cent) or "%")) and ((ophthalmic (formulation or composition)) and olopatadine)	PGPB, USPT, USOC	ADJ	YES	ASSIGNEE	04-28-2014
cyclodextrin and ((olopatadine same (percent or (per cent) or "%")) and (ophthalmic (formulation or composition)) and olopatadine)	PGPB, USPT, USOC	ADJ	YES	ASSIGNEE	04-28-2014
(polyethylene glycol) and ((olopatadine same (percent or (per cent) or "%")) and (ophthalmic (formulation or composition)) and olopatadine)	PGPB, USPT, USOC	ADJ	YES	ASSIGNEE	04-28-2014
(polyvinylpyrrolidone) and ((polyethylene glycol) and (olopatadine same (percent or (per cent) or "%")) and (ophthalmic (formulation or composition)) and olopatadine)	PGPB, USPT, USOC	ADJ	YES	ASSIGNEE	04-28-2014
((polyvinylpyrrolidone) and (polyethylene glycol) and (olopatadine same (percent or (per cent) or "%")) and (ophthalmic (formulation or composition)) and olopatadine) and @pd > 20131003	PGPB, USPT, USOC	ADJ	YES	ASSIGNEE	04-28-2014
("5874414" "6280745" "6407079").PN.	USPT	ADJ	YES	ASSIGNEE	04-28-2014
((ophthalmic (formulation or composition)) and olopatadine) and ("5874414" "6280745" "6407079").PN.)	USPT	ADJ	YES	ASSIGNEE	04-28-2014
(hydroxypropylmethyl cellulose) and ((ophthalmic (formulation or composition)) and olopatadine)	PGPB, USPT, USOC	ADJ	YES	ASSIGNEE	04-28-2014
(propylene glycol) and ((hydroxypropylmethyl cellulose) and (ophthalmic (formulation or composition)) and olopatadine)	PGPB, USPT, USOC	ADJ	YES	ASSIGNEE	04-28-2014

mannitol and ((propylene glycol) and (hydroxypropylmethyl cellulose) and (ophthalmic (formulation or composition)) and olopatadine)	PGPB, USPT, USOC	ADJ	YES	ASSIGNEE	04-28-2014
(polyethylene glycol) and (mannitol and (propylene glycol) and (hydroxypropylmethyl cellulose) and (ophthalmic (formulation or composition)) and olopatadine)	PGPB, USPT, USOC	ADJ	YES	ASSIGNEE	04-28-2014
(polyvinylpyrrolidone) and ((polyethylene glycol) and mannitol and (propylene glycol) and (hydroxypropylmethyl cellulose) and (ophthalmic (formulation or composition)) and olopatadine)	PGPB, USPT, USOC	ADJ	YES	ASSIGNEE	04-28-2014
cyclodextrin and ((polyvinylpyrrolidone) and (polyethylene glycol) and mannitol and (propylene glycol) and (hydroxypropylmethyl cellulose) and (ophthalmic (formulation or composition)) and olopatadine)	PGPB, USPT, USOC	ADJ	YES	ASSIGNEE	04-28-2014
(olopatadine same ((mass ratio) or dos\$4 or concentrat\$3 or ((weight or WT) same (percent or (per cent) or "%")))) and (cyclodextrin and (polyvinylpyrrolidone) and (polyethylene glycol) and mannitol and (propylene glycol) and (hydroxypropylmethyl cellulose) and (ophthalmic (formulation or composition)) and olopatadine)	PGPB, USPT, USOC	ADJ	YES	ASSIGNEE	04-28-2014
(olopatadine same ((mass ratio) or dos\$4 or concentrat\$3 or ((weight or WT) same (percent or (per cent) or "%")))) and cyclodextrin	PGPB, USPT, USOC	ADJ	YES	ASSIGNEE	04-28-2014
(polyvinylpyrrolidone) and ((olopatadine same ((mass ratio) or dos\$4 or concentrat\$3 or ((weight or WT) same (percent or (per cent) or "%")))) and cyclodextrin)	PGPB, USPT, USOC	ADJ	YES	ASSIGNEE	04-28-2014
(propylene glycol) and ((polyvinylpyrrolidone) and (olopatadine same ((mass ratio) or dos\$4 or concentrat\$3 or ((weight or WT) same (percent or (per cent) or "%")))) and cyclodextrin)	PGPB, USPT, USOC	ADJ	YES	ASSIGNEE	04-28-2014
mannitol and ((propylene glycol) and (polyvinylpyrrolidone) and (olopatadine same ((mass ratio) or dos\$4 or concentrat\$3 or ((weight or WT) same (percent or (per cent) or "%")))) and cyclodextrin)	PGPB, USPT, USOC	ADJ	YES	ASSIGNEE	04-28-2014
(benzalkonium chloride) and (mannitol and (propylene glycol) and (polyvinylpyrrolidone) and (olopatadine same ((mass ratio) or dos\$4 or concentrat\$3 or ((weight or WT) same (percent or (per cent) or "%")))) and cyclodextrin)	PGPB, USPT, USOC	ADJ	YES	ASSIGNEE	04-28-2014

<p>(ocular allergy) and ((benzalkonium chloride) and mannitol and (propylene glycol) and (polyvinylpyrrolidone) and (olopatadine same ((mass ratio) or dos\$4 or concentrat\$3 or ((weight or WT) same (percent or (per cent) or "%")))) and cyclodextrin)</p>	<p>PGPB, USPT, USOC</p>	<p>ADJ</p>	<p>YES</p>	<p>ASSIGNEE</p>	<p>05-01-2014</p>
---	---------------------------------	------------	------------	-----------------	-------------------

INFORMATION DISCLOSURE STATEMENT BY APPLICANT (Not for submission under 37 CFR 1.99)	Application Number	13475607
	Filing Date	2012-05-18
	First Named Inventor	Daniel A. Gamache
	Art Unit	1629
	Examiner Name	My Chau T Tran
	Attorney Docket Number	PAT903988-US-NP

U.S. PATENTS						Remove
Examiner Initial*	Cite No	Patent Number	Kind Code ¹	Issue Date	Name of Patentee or Applicant of cited Document	Pages, Columns, Lines where Relevant Passages or Relevant Figures Appear
	1					

If you wish to add additional U.S. Patent citation information please click the Add button.

Add

U.S. PATENT APPLICATION PUBLICATIONS						Remove
Examiner Initial*	Cite No	Publication Number	Kind Code ¹	Publication Date	Name of Patentee or Applicant of cited Document	Pages, Columns, Lines where Relevant Passages or Relevant Figures Appear
	1					

If you wish to add additional U.S. Published Application citation information please click the Add button.

Add

FOREIGN PATENT DOCUMENTS								Remove
Examiner Initial*	Cite No	Foreign Document Number ³	Country Code ² j	Kind Code ⁴	Publication Date	Name of Patentee or Applicant of cited Document	Pages, Columns, Lines where Relevant Passages or Relevant Figures Appear	T ⁵
	1							<input type="checkbox"/>

If you wish to add additional Foreign Patent Document citation information please click the Add button

Add

NON-PATENT LITERATURE DOCUMENTS				Remove
Examiner Initials*	Cite No	Include name of the author (in CAPITAL LETTERS), title of the article (when appropriate), title of the item (book, magazine, journal, serial, symposium, catalog, etc), date, pages(s), volume-issue number(s), publisher, city and/or country where published.		T ⁵

ALL REFERENCES CONSIDERED EXCEPT WHERE LINED THROUGH. /MCT/

INFORMATION DISCLOSURE STATEMENT BY APPLICANT (Not for submission under 37 CFR 1.99)	Application Number		13475607
	Filing Date		2012-05-18
	First Named Inventor	Daniel A. Gamache	
	Art Unit		1629
	Examiner Name	My Chau T Tran	
	Attorney Docket Number		PAT903988-US-NP

/MCT/	1	International Preliminary Report on Patentability for corresponding PCT/US2012/038663 with mailing date November 28, 2013	<input type="checkbox"/>
-------	---	---	--------------------------

If you wish to add additional non-patent literature document citation information please click the Add button **Add**

EXAMINER SIGNATURE

Examiner Signature	/My-Chau Tran/	Date Considered	04/28/2014
--------------------	----------------	-----------------	------------

*EXAMINER: Initial if reference considered, whether or not citation is in conformance with MPEP 609. Draw line through a citation if not in conformance and not considered. Include copy of this form with next communication to applicant.

¹ See Kind Codes of USPTO Patent Documents at www.USPTO.GOV or MPEP 901.04. ² Enter office that issued the document, by the two-letter code (WIPO Standard ST.3). ³ For Japanese patent documents, the indication of the year of the reign of the Emperor must precede the serial number of the patent document. ⁴ Kind of document by the appropriate symbols as indicated on the document under WIPO Standard ST.16 if possible. ⁵ Applicant is to place a check mark here if English language translation is attached.

Issue Classification 	Application/Control No. 13475607	Applicant(s)/Patent Under Reexamination GAMACHE ET AL.	
	Examiner MY-CHAU T TRAN	Art Unit 1629	

CPC						
Symbol					Type	Version
A61K		47		48969	I	2013-01-01
C08B		37		0015	I	2013-01-01
C08L		5		16	I	2013-01-01
A61K		31		335	F	2013-01-01
A61K		47		32	A	2013-01-01
A61K		9		08	I	2013-01-01
A61K		9		0048	I	2013-01-01

CPC Combination Sets				
Symbol	Type	Set	Ranking	Version

NONE		Total Claims Allowed:	
		27	
(Assistant Examiner)	(Date)	O.G. Print Claim(s)	O.G. Print Figure
/MY-CHAU T TRAN/ Primary Examiner.Art Unit 1629	05/01/2014	9	NONE
(Primary Examiner)	(Date)		

Issue Classification 	Application/Control No. 13475607	Applicant(s)/Patent Under Reexamination GAMACHE ET AL.
	Examiner MY-CHAU T TRAN	Art Unit 1629

US ORIGINAL CLASSIFICATION				INTERNATIONAL CLASSIFICATION									
CLASS		SUBCLASS		CLAIMED				NON-CLAIMED					
514		450		A	6	1	K	31 / 335 (2006.01.01)					
CROSS REFERENCE(S)													
CLASS	SUBCLASS (ONE SUBCLASS PER BLOCK)												
514	449												

NONE		Total Claims Allowed:	
(Assistant Examiner)		27	
(Date)			
/MY-CHAU T TRAN/ Primary Examiner.Art Unit 1629		O.G. Print Claim(s)	O.G. Print Figure
(Primary Examiner)		9	NONE
(Date)		05/01/2014	

Issue Classification 	Application/Control No. 13475607	Applicant(s)/Patent Under Reexamination GAMACHE ET AL.
	Examiner MY-CHAU T TRAN	Art Unit 1629

<input checked="" type="checkbox"/> Claims renumbered in the same order as presented by applicant <input type="checkbox"/> CPA <input type="checkbox"/> T.D. <input type="checkbox"/> R.1.47															
Final	Original	Final	Original	Final	Original	Final	Original	Final	Original	Final	Original	Final	Original	Final	Original
	1	5	17	21	33										
	2	6	18	22	34										
	3	7	19	23	35										
	4	8	20	24	36										
	5	9	21	25	37										
	6	10	22	26	38										
	7	11	23	27	39										
	8	12	24												
1	9	13	25												
	10	14	26												
	11	15	27												
	12	16	28												
	13	17	29												
2	14	18	30												
3	15	19	31												
4	16	20	32												

NONE		Total Claims Allowed:	
		27	
(Assistant Examiner)	(Date)	O.G. Print Claim(s)	O.G. Print Figure
/MY-CHAU T TRAN/ Primary Examiner.Art Unit 1629	05/01/2014	9	NONE
(Primary Examiner)	(Date)		

Index of Claims 	Application/Control No. 13475607	Applicant(s)/Patent Under Reexamination GAMACHE ET AL.
	Examiner MY-CHAU T TRAN	Art Unit 1629

✓	Rejected
=	Allowed

-	Cancelled
÷	Restricted

N	Non-Elected
I	Interference

A	Appeal
O	Objected

Claims renumbered in the same order as presented by applicant
 CPA
 T.D.
 R.1.47

CLAIM		DATE							
Final	Original	03/28/2013	10/01/2013	05/01/2014					
	1	÷	✓	-					
	2	÷	✓	-					
	3	÷	✓	-					
	4	÷	✓	-					
	5	÷	✓	-					
	6	÷	✓	-					
	7	÷	✓	-					
	8	÷	✓	-					
1	9	÷	✓	=					
	10	÷	✓	-					
	11	÷	N	-					
	12	÷	N	-					
	13	÷	✓	-					
2	14	÷	✓	=					
3	15	÷	✓	=					
4	16	÷	=	=					
5	17	÷	=	=					
6	18	÷	=	=					
7	19	÷	=	=					
8	20	÷	=	=					
9	21	÷	=	=					
10	22	÷	=	=					
11	23	÷	=	=					
12	24	÷	=	=					
13	25	÷	=	=					
14	26			=					
15	27			=					
16	28			=					
17	29			=					
18	30			=					
19	31			=					
20	32			=					
21	33			=					
22	34			=					
23	35			=					
24	36			=					

<i>Index of Claims</i> 	Application/Control No. 13475607	Applicant(s)/Patent Under Reexamination GAMACHE ET AL.
	Examiner MY-CHAU T TRAN	Art Unit 1629

✓	Rejected
=	Allowed

-	Cancelled
÷	Restricted

N	Non-Elected
I	Interference

A	Appeal
O	Objected

Claims renumbered in the same order as presented by applicant
 CPA
 T.D.
 R.1.47

CLAIM		DATE							
Final	Original	03/28/2013	10/01/2013	05/01/2014					
25	37			=					
26	38			=					
27	39			=					

INFORMATION DISCLOSURE STATEMENT BY APPLICANT (Not for submission under 37 CFR 1.99)	Application Number	13475607
	Filing Date	2012-05-18
	First Named Inventor	Daniel A. Gamache
	Art Unit	1629
	Examiner Name	Tran, My Chau T.
	Attorney Docket Number	PAT903988-US-NP

U.S.PATENTS						Remove
Examiner Initial*	Cite No	Patent Number	Kind Code ¹	Issue Date	Name of Patentee or Applicant of cited Document	Pages,Columns,Lines where Relevant Passages or Relevant Figures Appear
/MCT/	1	5874414		1999-02-23	Cydex, Inc.	
/MCT/	2	6280745	B1	2001-08-28	Alliance Pharmaceutical Corp.	
/MCT/	3	6407079	B1	2002-06-18	Janssen Pharmaceutica N.V.	

If you wish to add additional U.S. Patent citation information please click the Add button.

Add

U.S.PATENT APPLICATION PUBLICATIONS						Remove
Examiner Initial*	Cite No	Publication Number	Kind Code ¹	Publication Date	Name of Patentee or Applicant of cited Document	Pages,Columns,Lines where Relevant Passages or Relevant Figures Appear
	1					

If you wish to add additional U.S. Published Application citation information please click the Add button.

Add

FOREIGN PATENT DOCUMENTS								Remove
Examiner Initial*	Cite No	Foreign Document Number ³	Country Code ² j	Kind Code ⁴	Publication Date	Name of Patentee or Applicant of cited Document	Pages,Columns,Lines where Relevant Passages or Relevant Figures Appear	T ⁵
	1							<input type="checkbox"/>

ALL REFERENCES CONSIDERED EXCEPT WHERE LINED THROUGH. /MCT/

INFORMATION DISCLOSURE STATEMENT BY APPLICANT (Not for submission under 37 CFR 1.99)	Application Number	13475607
	Filing Date	2012-05-18
	First Named Inventor	Daniel A. Gamache
	Art Unit	1629
	Examiner Name	Tran, My Chau T.
	Attorney Docket Number	PAT903988-US-NP

If you wish to add additional Foreign Patent Document citation information please click the Add button **Add**

NON-PATENT LITERATURE DOCUMENTS **Remove**

Examiner Initials*	Cite No	Include name of the author (in CAPITAL LETTERS), title of the article (when appropriate), title of the item (book, magazine, journal, serial, symposium, catalog, etc), date, pages(s), volume-issue number(s), publisher, city and/or country where published.	T ⁵
	1		<input type="checkbox"/>

If you wish to add additional non-patent literature document citation information please click the Add button **Add**

EXAMINER SIGNATURE

Examiner Signature	/My-Chau Tran/	Date Considered	04/28/2014
--------------------	----------------	-----------------	------------

*EXAMINER: Initial if reference considered, whether or not citation is in conformance with MPEP 609. Draw line through a citation if not in conformance and not considered. Include copy of this form with next communication to applicant.

¹ See Kind Codes of USPTO Patent Documents at www.USPTO.GOV or MPEP 901.04. ² Enter office that issued the document, by the two-letter code (WIPO Standard ST.3). ³ For Japanese patent documents, the indication of the year of the reign of the Emperor must precede the serial number of the patent document. ⁴ Kind of document by the appropriate symbols as indicated on the document under WIPO Standard ST.16 if possible. ⁵ Applicant is to place a check mark here if English language translation is attached.

UNITED STATES PATENT AND TRADEMARK OFFICE

UNITED STATES DEPARTMENT OF COMMERCE
United States Patent and Trademark Office
 Address: COMMISSIONER FOR PATENTS
 P.O. Box 1450
 Alexandria, Virginia 22313-1450
 www.uspto.gov

BIB DATA SHEET
CONFIRMATION NO. 4130

SERIAL NUMBER	FILING or 371(c) DATE	CLASS	GROUP ART UNIT	ATTORNEY DOCKET NO.	
13/475,607	05/18/2012	514	1629	PAT903988-US-NP	
APPLICANTS INVENTORS Daniel A. Gamache, Arlington, TX; Laman Alani, Fort Worth, TX; Malay Ghosh, Fort Worth, TX; Francisco Javier Galán, Barcelona, SPAIN; Núria Carreras Perdiguier, Barcelona, SPAIN; Onkar N. Singh, Arlington, TX;					
** CONTINUING DATA ***** This appln claims benefit of 61/487,789 05/19/2011 and claims benefit of 61/548,957 10/19/2011					
** FOREIGN APPLICATIONS *****					
** IF REQUIRED, FOREIGN FILING LICENSE GRANTED ** 06/01/2012					
Foreign Priority claimed <input type="checkbox"/> Yes <input checked="" type="checkbox"/> No 35 USC 119(a-d) conditions met <input type="checkbox"/> Yes <input checked="" type="checkbox"/> No Verified and Acknowledged <u>/MY-CHAU T TRAN/</u> Examiner's Signature	<input type="checkbox"/> Met after Allowance Initials	STATE OR COUNTRY TX	SHEETS DRAWINGS 5	TOTAL CLAIMS 25	INDEPENDENT CLAIMS 4
ADDRESS ALCON IP LEGAL 6201 SOUTH FREEWAY FORT WORTH, TX 76134 UNITED STATES					
TITLE HIGH CONCENTRATION OLOPATADINE OPHTHALMIC COMPOSITION					
FILING FEE RECEIVED 3390	FEES: Authority has been given in Paper No. _____ to charge/credit DEPOSIT ACCOUNT No. _____ for following:		<input type="checkbox"/> All Fees <input type="checkbox"/> 1.16 Fees (Filing) <input type="checkbox"/> 1.17 Fees (Processing Ext. of time) <input type="checkbox"/> 1.18 Fees (Issue) <input type="checkbox"/> Other _____ <input type="checkbox"/> Credit		

Search Notes 	Application/Control No. 13475607	Applicant(s)/Patent Under Reexamination GAMACHE ET AL.
	Examiner MY-CHAU T TRAN	Art Unit 1629

CPC- SEARCHED		
Symbol	Date	Examiner

CPC COMBINATION SETS - SEARCHED		
Symbol	Date	Examiner

US CLASSIFICATION SEARCHED			
Class	Subclass	Date	Examiner
514	449, 450	10/02/2013	MCT
UPDATED	UPDATED - see printout	04/28/2014	MCT

SEARCH NOTES		
Search Notes	Date	Examiner
PALM Inventors; WEST - see printout; STN - see printout; SciFinder - see printout	10/01/2013	MCT
Reviewed for ODP the following Patent(s) and/or Application(s): 13/183,194	10/01/2013	MCT
UPDATED - see printout	04/28/2014	MCT

INTERFERENCE SEARCH			
US Class/ CPC Symbol	US Subclass / CPC Group	Date	Examiner
514	449, 450; see printout	05/01/2014	MCT

--	--



UNITED STATES PATENT AND TRADEMARK OFFICE

UNITED STATES DEPARTMENT OF COMMERCE
United States Patent and Trademark Office
Address: COMMISSIONER FOR PATENTS
P.O. Box 1450
Alexandria, Virginia 22313-1450
www.uspto.gov

Table with columns: APPLICATION NO., FILING DATE, FIRST NAMED INVENTOR, ATTORNEY DOCKET NO., CONFIRMATION NO.
Row 1: 13/475,607, 05/18/2012, Daniel A. Gamache, PAT903988-US-NP, 4130
Row 2: 26356, 7590, 05/23/2014, ALCON IP LEGAL, 6201 SOUTH FREEWAY FORT WORTH, TX 76134, EXAMINER TRAN, MY CHAU T, ART UNIT 1629, PAPER NUMBER, NOTIFICATION DATE 05/23/2014, DELIVERY MODE ELECTRONIC

Please find below and/or attached an Office communication concerning this application or proceeding.

The time period for reply, if any, is set in the attached communication.

Notice of the Office communication was sent electronically on above-indicated "Notification Date" to the following e-mail address(es):

patent.docketing@alcon.com

Supplemental Notice of Allowability	Application No. 13/475,607	Applicant(s) GAMACHE ET AL.	
	Examiner MY-CHAU T. TRAN	Art Unit 1629	AIA (First Inventor to File) Status No

-- The MAILING DATE of this communication appears on the cover sheet with the correspondence address--

All claims being allowable, PROSECUTION ON THE MERITS IS (OR REMAINS) CLOSED in this application. If not included herewith (or previously mailed), a Notice of Allowance (PTOL-85) or other appropriate communication will be mailed in due course. **THIS NOTICE OF ALLOWABILITY IS NOT A GRANT OF PATENT RIGHTS.** This application is subject to withdrawal from issue at the initiative of the Office or upon petition by the applicant. See 37 CFR 1.313 and MPEP 1308.

1. This communication is responsive to 05/15/2014.
 A declaration(s)/affidavit(s) under **37 CFR 1.130(b)** was/were filed on _____.
2. An election was made by the applicant in response to a restriction requirement set forth during the interview on _____; the restriction requirement and election have been incorporated into this action.
3. The allowed claim(s) is/are 9 and 14-39. As a result of the allowed claim(s), you may be eligible to benefit from the **Patent Prosecution Highway** program at a participating intellectual property office for the corresponding application. For more information, please see http://www.uspto.gov/patents/init_events/oph/index.jsp or send an inquiry to PPHfeedback@uspto.gov.
4. Acknowledgment is made of a claim for foreign priority under 35 U.S.C. § 119(a)-(d) or (f).

Certified copies:

- a) All b) Some *c) None of the:
1. Certified copies of the priority documents have been received.
 2. Certified copies of the priority documents have been received in Application No. _____.
 3. Copies of the certified copies of the priority documents have been received in this national stage application from the International Bureau (PCT Rule 17.2(a)).

* Certified copies not received: _____.

Applicant has THREE MONTHS FROM THE "MAILING DATE" of this communication to file a reply complying with the requirements noted below. Failure to timely comply will result in ABANDONMENT of this application.
THIS THREE-MONTH PERIOD IS NOT EXTENDABLE.

5. CORRECTED DRAWINGS (as "replacement sheets") must be submitted.
 including changes required by the attached Examiner's Amendment / Comment or in the Office action of Paper No./Mail Date _____.
Identifying indicia such as the application number (see 37 CFR 1.84(c)) should be written on the drawings in the front (not the back) of each sheet. Replacement sheet(s) should be labeled as such in the header according to 37 CFR 1.121(d).
6. DEPOSIT OF and/or INFORMATION about the deposit of BIOLOGICAL MATERIAL must be submitted. Note the attached Examiner's comment regarding REQUIREMENT FOR THE DEPOSIT OF BIOLOGICAL MATERIAL.

Attachment(s)

- | | |
|--|---|
| <ol style="list-style-type: none"> 1. <input checked="" type="checkbox"/> Notice of References Cited (PTO-892) 2. <input type="checkbox"/> Information Disclosure Statements (PTO/SB/08),
Paper No./Mail Date _____ 3. <input type="checkbox"/> Examiner's Comment Regarding Requirement for Deposit of Biological Material 4. <input checked="" type="checkbox"/> Interview Summary (PTO-413),
Paper No./Mail Date <u>20140516</u>. | <ol style="list-style-type: none"> 5. <input type="checkbox"/> Examiner's Amendment/Comment 6. <input type="checkbox"/> Examiner's Statement of Reasons for Allowance 7. <input type="checkbox"/> Other _____. |
|--|---|

/MY-CHAU T TRAN/
Primary Examiner, Art Unit 1629

Applicant-Initiated Interview Summary	Application No. 13/475,607	Applicant(s) GAMACHE ET AL.	
	Examiner MY-CHAU T. TRAN	Art Unit 1629	

All participants (applicant, applicant's representative, PTO personnel):

- (1) SCOTT CHAPPLE. (3) _____.
- (2) MY-CHAU T. TRAN. (4) _____.

Date of Interview: 15 May 2014.

Type: Telephonic Video Conference
 Personal [copy given to: applicant applicant's representative]

Exhibit shown or demonstration conducted: Yes No.
If Yes, brief description: _____.

Issues Discussed 101 112 102 103 Others
(For each of the checked box(es) above, please describe below the issue and detailed description of the discussion)

Claim(s) discussed: NONE.

Identification of prior art discussed: US PATENT 5,874,418.

Substance of Interview

(For each issue discussed, provide a detailed description and indicate if agreement was reached. Some topics may include: identification or clarification of a reference or a portion thereof, claim interpretation, proposed amendments, arguments of any applied references etc...)

Mr. Chapple called the examiner on 05/14/2014 and left a message request a phone interview regarding the IDS filed on 02/17/2014. The examiner called Mr. Chapple back on 05/15/2014 and discussed the IDS filed on 02/17/2014, which the examiner have considered and mailed on 05/08/2014. Mr. Chapple informed the examiner that there is a typographical error made in one of the cited US Patents wherein US Patent 5,874,414 should be US Patent 5,874,418. The examiner inform Mr. Chapple that the US Patent 5,874,418 will be considered and cited in the PTO-892, however, if applicant want to remove/delete US Patent 5,874,414, applicant will need to file a Certificate of Correction after issuance of the application .

Applicant recordation instructions: The formal written reply to the last Office action must include the substance of the interview. (See MPEP section 713.04). If a reply to the last Office action has already been filed, applicant is given a non-extendable period of the longer of one month or thirty days from this interview date, or the mailing date of this interview summary form, whichever is later, to file a statement of the substance of the interview

Examiner recordation instructions: Examiners must summarize the substance of any interview of record. A complete and proper recordation of the substance of an interview should include the items listed in MPEP 713.04 for complete and proper recordation including the identification of the general thrust of each argument or issue discussed, a general indication of any other pertinent matters discussed regarding patentability and the general results or outcome of the interview, to include an indication as to whether or not agreement was reached on the issues raised.

Attachment

/MY-CHAU T TRAN/
Primary Examiner, Art Unit 1629

Summary of Record of Interview Requirements

Manual of Patent Examining Procedure (MPEP), Section 713.04, Substance of Interview Must be Made of Record

A complete written statement as to the substance of any face-to-face, video conference, or telephone interview with regard to an application must be made of record in the application whether or not an agreement with the examiner was reached at the interview.

Title 37 Code of Federal Regulations (CFR) § 1.133 Interviews

Paragraph (b)

In every instance where reconsideration is requested in view of an interview with an examiner, a complete written statement of the reasons presented at the interview as warranting favorable action must be filed by the applicant. An interview does not remove the necessity for reply to Office action as specified in §§ 1.111, 1.135. (35 U.S.C. 132)

37 CFR §1.2 Business to be transacted in writing.

All business with the Patent or Trademark Office should be transacted in writing. The personal attendance of applicants or their attorneys or agents at the Patent and Trademark Office is unnecessary. The action of the Patent and Trademark Office will be based exclusively on the written record in the Office. No attention will be paid to any alleged oral promise, stipulation, or understanding in relation to which there is disagreement or doubt.

The action of the Patent and Trademark Office cannot be based exclusively on the written record in the Office if that record is itself incomplete through the failure to record the substance of interviews.

It is the responsibility of the applicant or the attorney or agent to make the substance of an interview of record in the application file, unless the examiner indicates he or she will do so. It is the examiner's responsibility to see that such a record is made and to correct material inaccuracies which bear directly on the question of patentability.

Examiners must complete an Interview Summary Form for each interview held where a matter of substance has been discussed during the interview by checking the appropriate boxes and filling in the blanks. Discussions regarding only procedural matters, directed solely to restriction requirements for which interview recordation is otherwise provided for in Section 812.01 of the Manual of Patent Examining Procedure, or pointing out typographical errors or unreadable script in Office actions or the like, are excluded from the interview recordation procedures below. Where the substance of an interview is completely recorded in an Examiners Amendment, no separate Interview Summary Record is required.

The Interview Summary Form shall be given an appropriate Paper No., placed in the right hand portion of the file, and listed on the "Contents" section of the file wrapper. In a personal interview, a duplicate of the Form is given to the applicant (or attorney or agent) at the conclusion of the interview. In the case of a telephone or video-conference interview, the copy is mailed to the applicant's correspondence address either with or prior to the next official communication. If additional correspondence from the examiner is not likely before an allowance or if other circumstances dictate, the Form should be mailed promptly after the interview rather than with the next official communication.

The Form provides for recordation of the following information:

- Application Number (Series Code and Serial Number)
- Name of applicant
- Name of examiner
- Date of interview
- Type of interview (telephonic, video-conference, or personal)
- Name of participant(s) (applicant, attorney or agent, examiner, other PTO personnel, etc.)
- An indication whether or not an exhibit was shown or a demonstration conducted
- An identification of the specific prior art discussed
- An indication whether an agreement was reached and if so, a description of the general nature of the agreement (may be by attachment of a copy of amendments or claims agreed as being allowable). Note: Agreement as to allowability is tentative and does not restrict further action by the examiner to the contrary.
- The signature of the examiner who conducted the interview (if Form is not an attachment to a signed Office action)

It is desirable that the examiner orally remind the applicant of his or her obligation to record the substance of the interview of each case. It should be noted, however, that the Interview Summary Form will not normally be considered a complete and proper recordation of the interview unless it includes, or is supplemented by the applicant or the examiner to include, all of the applicable items required below concerning the substance of the interview.

A complete and proper recordation of the substance of any interview should include at least the following applicable items:

- 1) A brief description of the nature of any exhibit shown or any demonstration conducted,
- 2) an identification of the claims discussed,
- 3) an identification of the specific prior art discussed,
- 4) an identification of the principal proposed amendments of a substantive nature discussed, unless these are already described on the Interview Summary Form completed by the Examiner,
- 5) a brief identification of the general thrust of the principal arguments presented to the examiner,
(The identification of arguments need not be lengthy or elaborate. A verbatim or highly detailed description of the arguments is not required. The identification of the arguments is sufficient if the general nature or thrust of the principal arguments made to the examiner can be understood in the context of the application file. Of course, the applicant may desire to emphasize and fully describe those arguments which he or she feels were or might be persuasive to the examiner.)
- 6) a general indication of any other pertinent matters discussed, and
- 7) if appropriate, the general results or outcome of the interview unless already described in the Interview Summary Form completed by the examiner.

Examiners are expected to carefully review the applicant's record of the substance of an interview. If the record is not complete and accurate, the examiner will give the applicant an extendable one month time period to correct the record.

Examiner to Check for Accuracy

If the claims are allowable for other reasons of record, the examiner should send a letter setting forth the examiner's version of the statement attributed to him or her. If the record is complete and accurate, the examiner should place the indication, "Interview Record OK" on the paper recording the substance of the interview along with the date and the examiner's initials.

Notice of References Cited	Application/Control No. 13/475,607	Applicant(s)/Patent Under Reexamination GAMACHE ET AL.	
	Examiner MY-CHAU T. TRAN	Art Unit 1629	Page 1 of 1

U.S. PATENT DOCUMENTS

*	Document Number Country Code-Number-Kind Code	Date MM-YYYY	Name	Classification
*	A US-5,874,418	02-1999	Stella et al.	514/58
	B US-			
	C US-			
	D US-			
	E US-			
	F US-			
	G US-			
	H US-			
	I US-			
	J US-			
	K US-			
	L US-			
	M US-			

FOREIGN PATENT DOCUMENTS

*	Document Number Country Code-Number-Kind Code	Date MM-YYYY	Country	Name	Classification
	N				
	O				
	P				
	Q				
	R				
	S				
	T				

NON-PATENT DOCUMENTS

*	Document Number Country Code-Number-Kind Code	Date MM-YYYY	Country	Name	Classification
	Include as applicable: Author, Title Date, Publisher, Edition or Volume, Pertinent Pages)				
	U				
	V				
	W				
	X				

*A copy of this reference is not being furnished with this Office action. (See MPEP § 707.05(a).)
Dates in MM-YYYY format are publication dates. Classifications may be US or foreign.

WEST Search History for Application 13475607

Creation Date: 2014051613:43

Interference Searches

Query	DB	Op.	Plur.	Thes.	Date
((olopatadine same ((mass ratio) or dos \$ 4 or concentrat \$ 3 or ((weight or WT) same (percent or (per cent) or "%")))) and cyclodextrin) and @ pd > 20140501	UPAD	ADJ	YES	ASSIGNEE	05-16-2014
(514/449 514/450)! [CCLS]	UPAD	ADJ	YES	ASSIGNEE	05-16-2014
olopatadine and ((514/449 514/450)! [CCLS])	UPAD	ADJ	YES	ASSIGNEE	05-16-2014
(olopatadine same ((mass ratio) or dos \$ 4 or concentrat \$ 3 or ((weight or WT) same (percent or (per cent) or "%")))) and cyclodextrin	UPAD	ADJ	YES	ASSIGNEE	05-16-2014

Prior Art Searches

Query	DB	Op.	Plur.	Thes.	Date
("20020006443" "20020150616" "20030170309" "20050004074" "20050191270" "20050244472" "20060210645" "20070020336" "20080132444" "20090118262" "20090232763" "20090239842" "20100240625" "20100249062" "20100324031" "3767788" "3843782" "3856919" "3931319" "3947573" "4027020" "4120949" "4283393" "4407791" "4470965" "4525346" "4836986" "4923693" "5037647" "5068225" "5116863" "5134127" "5141961" "5300287" "5376645" "5472954" "5591426" "5597559" "5624962" "5888493" "6153746" "6511949" "6828356" "7074424" "7147844" "7429602" "7635773").PN.	PGPB, USPT, USOC	ADJ	YES	ASSIGNEE	05-16-2014
olopatadine and ("20020006443" "20020150616" "20030170309" "20050004074" "20050191270" "20050244472" "20060210645" "20070020336" "20080132444" "20090118262" "20090232763" "20090239842" "20100240625" "20100249062" "20100324031" "3767788" "3843782" "3856919" "3931319" "3947573" "4027020" "4120949" "4283393" "4407791" "4470965" "4525346" "4836986" "4923693"	PGPB, USPT, USOC	ADJ	YES	ASSIGNEE	05-16-2014

<p>"5037647" "5068225" "5116863" "5134127" "5141961" "5300287" "5376645" "5472954" "5591426" "5597559" "5624962" "5888493" "6153746" "6511949" "6828356" "7074424" "7147844" "7429602" "7635773").PN.)</p>					
GAMACHE-DANIEL-A\$.in.	PGPB, USPT, USOC, EPAB, JPAB, DWPI, TDBD, FPRS	ADJ	YES	ASSIGNEE	05-16-2014
ALANI-LAMAN\$.in.	PGPB, USPT, USOC, EPAB, JPAB, DWPI, TDBD, FPRS	ADJ	YES	ASSIGNEE	05-16-2014
GHOSH-MALAY\$.in.	PGPB, USPT, USOC, EPAB, JPAB, DWPI, TDBD, FPRS	ADJ	YES	ASSIGNEE	05-16-2014
GALAN-FRANCISCO-JAVIER\$.in.	PGPB, USPT, USOC, EPAB, JPAB, DWPI, TDBD, FPRS	ADJ	YES	ASSIGNEE	05-16-2014
PERDIGUER-NURIA-CARRERAS\$.in.	PGPB, USPT, USOC, EPAB, JPAB, DWPI, TDBD, FPRS	ADJ	YES	ASSIGNEE	05-16-2014
SINGH-ONKAR-N\$.in.	PGPB,	ADJ	YES	ASSIGNEE	05-16-2014

	USPT, USOC, EPAB, JPAB, DWPI, TDBD, FPRS				
(GAMACHE-DANIEL-A\$.in.) and (ALANI-LAMAN\$.in.) and (GHOSH-MALAY\$.in.) and (GALAN-FRANCISCO-JAVIER\$.in.) and (PERDIGUER-NURIA-CARRERAS\$.in.) and (SINGH-ONKAR-N\$.in.)	PGPB, USPT, USOC, EPAB, JPAB, DWPI, TDBD, FPRS	ADJ	YES	ASSIGNEE	05-16-2014
(GAMACHE-DANIEL-A\$.in.) and (ALANI-LAMAN\$.in.) and (GHOSH-MALAY\$.in.) and (GALAN-FRANCISCO-JAVIER\$.in.) and (PERDIGUER-NURIA-CARRERAS\$.in.)	PGPB, USPT, USOC, EPAB, JPAB, DWPI, TDBD, FPRS	ADJ	YES	ASSIGNEE	05-16-2014
(GAMACHE-DANIEL-A\$.in.) and (ALANI-LAMAN\$.in.) and (GHOSH-MALAY\$.in.) and (GALAN-FRANCISCO-JAVIER\$.in.)	PGPB, USPT, USOC, EPAB, JPAB, DWPI, TDBD, FPRS	ADJ	YES	ASSIGNEE	05-16-2014
(GAMACHE-DANIEL-A\$.in.) and (ALANI-LAMAN\$.in.) and (GHOSH-MALAY\$.in.) and (GALAN-FRANCISCO-JAVIER\$.in.) and (SINGH-ONKAR-N\$.in.)	PGPB, USPT, USOC, EPAB, JPAB, DWPI, TDBD, FPRS	ADJ	YES	ASSIGNEE	05-16-2014
olopatadine.clm. and (GAMACHE-DANIEL-A\$.in.)	PGPB, USPT, USOC, EPAB, JPAB, DWPI, TDBD, FPRS	ADJ	YES	ASSIGNEE	05-16-2014

olopatadine.clm. and (ALANI-LAMAN\$.in.)	PGPB, USPT, USOC, EPAB, JPAB, DWPI, TDBD, FPRS	ADJ	YES	ASSIGNEE	05-16-2014
olopatadine.clm. and (GHOSH-MALAY\$.in.)	PGPB, USPT, USOC, EPAB, JPAB, DWPI, TDBD, FPRS	ADJ	YES	ASSIGNEE	05-16-2014
olopatadine.clm. and (GALAN-FRANCISCO-JAVIER\$.in.)	PGPB, USPT, USOC, EPAB, JPAB, DWPI, TDBD, FPRS	ADJ	YES	ASSIGNEE	05-16-2014
olopatadine.clm. and (PERDIGUER-NURIA-CARRERAS\$.in.)	PGPB, USPT, USOC, EPAB, JPAB, DWPI, TDBD, FPRS	ADJ	YES	ASSIGNEE	05-16-2014
olopatadine.clm. and (SINGH-ONKAR-N\$.in.)	PGPB, USPT, USOC, EPAB, JPAB, DWPI, TDBD, FPRS	ADJ	YES	ASSIGNEE	05-16-2014
ALCON RESEARCH\$.as.	PGPB, USPT, USOC, EPAB, JPAB, DWPI, TDBD,	ADJ	YES	ASSIGNEE	05-16-2014

	FPRS				
olopatadine.clm. and (ALCON RESEARCH\$.as.)	PGPB, USPT, USOC, EPAB, JPAB, DWPI, TDBD, FPRS	ADJ	YES	ASSIGNEE	05-16-2014
(ophthalmic (formulation or composition)).clm. and (olopatadine.clm. and GAMACHE-DANIEL-A\$.in.)	PGPB, USPT, USOC, EPAB, JPAB, DWPI, TDBD, FPRS	ADJ	YES	ASSIGNEE	05-16-2014
(ophthalmic (formulation or composition)).clm. and (olopatadine.clm. and SINGH-ONKAR-N\$.in.)	PGPB, USPT, USOC, EPAB, JPAB, DWPI, TDBD, FPRS	ADJ	YES	ASSIGNEE	05-16-2014
(ophthalmic (formulation or composition)).clm. and (olopatadine.clm. and ALCON RESEARCH\$.as.)	PGPB, USPT, USOC, EPAB, JPAB, DWPI, TDBD, FPRS	ADJ	YES	ASSIGNEE	05-16-2014
(514/449 514/450)! [CCLS]	PGPB, USPT, USOC	ADJ	YES	ASSIGNEE	05-16-2014
olopatadine and ((514/449 514/450)! [CCLS])	PGPB, USPT, USOC	ADJ	YES	ASSIGNEE	05-16-2014
(ophthalmic (formulation or composition)) and (olopatadine and (514/449 514/450)! [CCLS])	PGPB, USPT, USOC	ADJ	YES	ASSIGNEE	05-16-2014
cyclodextrin and ((ophthalmic (formulation or composition)) and olopatadine and (514/449 514/450)! [CCLS])	PGPB, USPT, USOC	ADJ	YES	ASSIGNEE	05-16-2014

lactam and ((ophthalmic (formulation or composition)) and olopatadine and (514/449 514/450)! [CCLS])	PGPB, USPT, USOC	ADJ	YES	ASSIGNEE	05-16-2014
polyether and ((ophthalmic (formulation or composition)) and olopatadine and (514/449 514/450)! [CCLS])	PGPB, USPT, USOC	ADJ	YES	ASSIGNEE	05-16-2014
(polyethylene glycol) and ((ophthalmic (formulation or composition)) and olopatadine and (514/449 514/450)! [CCLS])	PGPB, USPT, USOC	ADJ	YES	ASSIGNEE	05-16-2014
((ophthalmic (formulation or composition)) and olopatadine	EPAB, JPAB, DWPI, TDBD, FPRS	ADJ	YES	ASSIGNEE	05-16-2014
cyclodextrin and ((ophthalmic (formulation or composition)) and olopatadine)	EPAB, JPAB, DWPI, TDBD, FPRS	ADJ	YES	ASSIGNEE	05-16-2014
lactam and ((ophthalmic (formulation or composition)) and olopatadine)	EPAB, JPAB, DWPI, TDBD, FPRS	ADJ	YES	ASSIGNEE	05-16-2014
lactam and (cyclodextrin and (ophthalmic (formulation or composition)) and olopatadine)	EPAB, JPAB, DWPI, TDBD, FPRS	ADJ	YES	ASSIGNEE	05-16-2014
(polyethylene glycol) and ((ophthalmic (formulation or composition)) and olopatadine)	EPAB, JPAB, DWPI, TDBD, FPRS	ADJ	YES	ASSIGNEE	05-16-2014
(polyethylene glycol) and (cyclodextrin and (ophthalmic (formulation or composition)) and olopatadine)	EPAB, JPAB, DWPI, TDBD, FPRS	ADJ	YES	ASSIGNEE	05-16-2014
((ophthalmic (formulation or composition)) and olopatadine	PGPB, USPT, USOC	ADJ	YES	ASSIGNEE	05-16-2014
((ophthalmic (formulation or composition)) and olopatadine) not @AY>2011	PGPB, USPT,	ADJ	YES	ASSIGNEE	05-16-2014

	USOC				
cyclodextrin and ((ophthalmic (formulation or composition)) and olopatadine not @AY>2011)	PGPB, USPT, USOC	ADJ	YES	ASSIGNEE	05-16-2014
lactam and (cyclodextrin and (ophthalmic (formulation or composition)) and olopatadine not @AY>2011)	PGPB, USPT, USOC	ADJ	YES	ASSIGNEE	05-16-2014
(polyethylene glycol) and (cyclodextrin and (ophthalmic (formulation or composition)) and olopatadine not @AY>2011)	PGPB, USPT, USOC	ADJ	YES	ASSIGNEE	05-16-2014
lactam and ((polyethylene glycol) and cyclodextrin and (ophthalmic (formulation or composition)) and olopatadine not @AY>2011)	PGPB, USPT, USOC	ADJ	YES	ASSIGNEE	05-16-2014
(olopatadine same ((mass ratio) or dos\$4 or concentrat\$3 or ((weight or WT) same (percent or (per cent) or "%"))) and ((ophthalmic (formulation or composition)) and olopatadine)	PGPB, USPT, USOC	ADJ	YES	ASSIGNEE	05-16-2014
(olopatadine same (percent or (per cent) or "%") and ((ophthalmic (formulation or composition)) and olopatadine)	PGPB, USPT, USOC	ADJ	YES	ASSIGNEE	05-16-2014
cyclodextrin and ((olopatadine same (percent or (per cent) or "%") and (ophthalmic (formulation or composition)) and olopatadine)	PGPB, USPT, USOC	ADJ	YES	ASSIGNEE	05-16-2014
(polyethylene glycol) and ((olopatadine same (percent or (per cent) or "%") and (ophthalmic (formulation or composition)) and olopatadine)	PGPB, USPT, USOC	ADJ	YES	ASSIGNEE	05-16-2014
(polyvinylpyrrolidone) and ((polyethylene glycol) and (olopatadine same (percent or (per cent) or "%") and (ophthalmic (formulation or composition)) and olopatadine)	PGPB, USPT, USOC	ADJ	YES	ASSIGNEE	05-16-2014
("5874414" "6280745" "6407079").PN.	USPT	ADJ	YES	ASSIGNEE	05-16-2014
((ophthalmic (formulation or composition)) and olopatadine) and ("5874414" "6280745" "6407079").PN.)	USPT	ADJ	YES	ASSIGNEE	05-16-2014
(hydroxypropylmethyl cellulose) and ((ophthalmic (formulation or composition)) and olopatadine)	PGPB, USPT, USOC	ADJ	YES	ASSIGNEE	05-16-2014
(propylene glycol) and ((hydroxypropylmethyl cellulose) and (ophthalmic (formulation or composition)) and olopatadine)	PGPB, USPT, USOC	ADJ	YES	ASSIGNEE	05-16-2014
		ADJ	YES	ASSIGNEE	05-16-2014

mannitol and ((propylene glycol) and (hydroxypropylmethyl cellulose) and (ophthalmic (formulation or composition)) and olopatadine)	PGPB, USPT, USOC				
(polyethylene glycol) and (mannitol and (propylene glycol) and (hydroxypropylmethyl cellulose) and (ophthalmic (formulation or composition)) and olopatadine)	PGPB, USPT, USOC	ADJ	YES	ASSIGNEE	05-16-2014
(polyvinylpyrrolidone) and ((polyethylene glycol) and mannitol and (propylene glycol) and (hydroxypropylmethyl cellulose) and (ophthalmic (formulation or composition)) and olopatadine)	PGPB, USPT, USOC	ADJ	YES	ASSIGNEE	05-16-2014
cyclodextrin and ((polyvinylpyrrolidone) and (polyethylene glycol) and mannitol and (propylene glycol) and (hydroxypropylmethyl cellulose) and (ophthalmic (formulation or composition)) and olopatadine)	PGPB, USPT, USOC	ADJ	YES	ASSIGNEE	05-16-2014
(olopatadine same ((mass ratio) or dos\$4 or concentrat\$3 or ((weight or WT) same (percent or (per cent) or "%")))) and (cyclodextrin and (polyvinylpyrrolidone) and (polyethylene glycol) and mannitol and (propylene glycol) and (hydroxypropylmethyl cellulose) and (ophthalmic (formulation or composition)) and olopatadine)	PGPB, USPT, USOC	ADJ	YES	ASSIGNEE	05-16-2014
(olopatadine same ((mass ratio) or dos\$4 or concentrat\$3 or ((weight or WT) same (percent or (per cent) or "%")))) and cyclodextrin	PGPB, USPT, USOC	ADJ	YES	ASSIGNEE	05-16-2014
(polyvinylpyrrolidone) and ((olopatadine same ((mass ratio) or dos\$4 or concentrat\$3 or ((weight or WT) same (percent or (per cent) or "%")))) and cyclodextrin)	PGPB, USPT, USOC	ADJ	YES	ASSIGNEE	05-16-2014
(propylene glycol) and ((polyvinylpyrrolidone) and (olopatadine same ((mass ratio) or dos\$4 or concentrat\$3 or ((weight or WT) same (percent or (per cent) or "%")))) and cyclodextrin)	PGPB, USPT, USOC	ADJ	YES	ASSIGNEE	05-16-2014
mannitol and ((propylene glycol) and (polyvinylpyrrolidone) and (olopatadine same ((mass ratio) or dos\$4 or concentrat\$3 or ((weight or WT) same (percent or (per cent) or "%")))) and cyclodextrin)	PGPB, USPT, USOC	ADJ	YES	ASSIGNEE	05-16-2014
(benzalkonium chloride) and (mannitol and (propylene glycol) and (polyvinylpyrrolidone) and (olopatadine same ((mass ratio) or dos\$4 or concentrat\$3 or ((weight or WT) same (percent or (per cent) or "%")))) and cyclodextrin)	PGPB, USPT, USOC	ADJ	YES	ASSIGNEE	05-16-2014

((ocular allergy) and ((benzalkonium chloride) and mannitol and (propylene glycol) and (polyvinylpyrrolidone) and (olopatadine same ((mass ratio) or dos\$4 or concentrat\$3 or ((weight or WT) same (percent or (per cent) or "%")))) and cyclodextrin)	PGPB, USPT, USOC	ADJ	YES	ASSIGNEE	05-16-2014
("5874414" "6280745" "6407079" "5874418").PN.	USPT	ADJ	YES	ASSIGNEE	05-16-2014
((ophthalmic (formulation or composition)) and olopatadine) and ("5874414" "6280745" "6407079" "5874418").PN.)	USPT	ADJ	YES	ASSIGNEE	05-16-2014
cyclodextrin and ("5874414" "6280745" "6407079" "5874418").PN.)	USPT	ADJ	YES	ASSIGNEE	05-16-2014
(ophthalmic (formulation or composition)) and (cyclodextrin and ("5874414" "6280745" "6407079" "5874418").PN.)	USPT	ADJ	YES	ASSIGNEE	05-16-2014
((ocular allergy) and (benzalkonium chloride) and mannitol and (propylene glycol) and (polyvinylpyrrolidone) and (olopatadine same ((mass ratio) or dos\$4 or concentrat\$3 or ((weight or WT) same (percent or (per cent) or "%")))) and cyclodextrin) and @pd>20140501	PGPB, USPT, USOC	ADJ	YES	ASSIGNEE	05-16-2014

PART B - FEE(S) TRANSMITTAL

Complete and send this form, together with applicable fee(s), to: **Mail** Mail Stop ISSUE FEE
 Commissioner for Patents
 P.O. Box 1450
 Alexandria, Virginia 22313-1450
 or **Fax** (571)-273-2885

INSTRUCTIONS: This form should be used for transmitting the ISSUE FEE and PUBLICATION FEE (if required). Blocks 1 through 5 should be completed where appropriate. All further correspondence including the Patent, advance orders and notification of maintenance fees will be mailed to the current correspondence address as indicated unless corrected below or directed otherwise in Block 1, by (a) specifying a new correspondence address; and/or (b) indicating a separate "FEE ADDRESS" for maintenance fee notifications.

Note: A certificate of mailing can only be used for domestic mailings of the Fee(s) Transmittal. This certificate cannot be used for any other accompanying papers. Each additional paper, such as an assignment or formal drawing, must have its own certificate of mailing or transmission.

CURRENT CORRESPONDENCE ADDRESS (Note: Use Block 1 for any change of address)

26356 7590 05/08/2014
 ALCON
 IP LEGAL
 6201 SOUTH FREEWAY
 FORT WORTH, TX 76134

Certificate of Mailing or Transmission
 I hereby certify that this Fee(s) Transmittal is being deposited with the United States Postal Service with sufficient postage for first class mail in an envelope addressed to the Mail Stop ISSUE FEE address above, or being facsimile transmitted to the USPTO (571) 273-2885, on the date indicated below.

(Depositor's name)
(Signature)
(Date)

APPLICATION NO.	FILING DATE	FIRST NAMED INVENTOR	ATTORNEY DOCKET NO.	CONFIRMATION NO.
13/475,607	05/18/2012	Daniel A. Gamache	PAT903988-US-NP	4130

TITLE OF INVENTION: HIGH CONCENTRATION OLOPATADINE OPHTHALMIC COMPOSITION

APPLN. TYPE	ENTITY STATUS	ISSUE FEE DUE	PUBLICATION FEE DUE	PREV. PAID ISSUE FEE	TOTAL FEE(S) DUE	DATE DUE
nonprovisional	UNDISCOUNTED	\$960	\$0	\$0	\$960	08/08/2014

EXAMINER	ART UNIT	CLASS-SUBCLASS
TRAN, MY CHAU T	1629	514-450000

1. Change of correspondence address or indication of "Fee Address" (37 CFR 1.363).

Change of correspondence address (or Change of Correspondence Address form PTO/SB/122) attached.

"Fee Address" indication (or "Fee Address" Indication form PTO/SB/47; Rev 03-02 or more recent) attached. Use of a Customer Number is required.

2. For printing on the patent front page, list

(1) The names of up to 3 registered patent attorneys or agents OR, alternatively,

(2) The name of a single firm (having as a member a registered attorney or agent) and the names of up to 2 registered patent attorneys or agents. If no name is listed, no name will be printed.

1. Scott A. Chapple

2. _____

3. _____

3. ASSIGNEE NAME AND RESIDENCE DATA TO BE PRINTED ON THE PATENT (print or type)

PLEASE NOTE: Unless an assignee is identified below, no assignee data will appear on the patent. If an assignee is identified below, the document has been filed for recordation as set forth in 37 CFR 3.11. Completion of this form is NOT a substitute for filing an assignment.

(A) NAME OF ASSIGNEE: Alcon Research, Ltd.

(B) RESIDENCE: (CITY and STATE OR COUNTRY) Fort Worth, Texas

Please check the appropriate assignee category or categories (will not be printed on the patent): Individual Corporation or other private group entity Government

4a. The following fee(s) are submitted:

Issue Fee

Publication Fee (No small entity discount permitted)

Advance Order - # of Copies _____

4b. Payment of Fee(s): (Please first reapply any previously paid issue fee shown above)

A check is enclosed.

Payment by credit card. Form PTO-2038 is attached.

The Director is hereby authorized to charge the required fee(s), any deficiency, or credits any overpayment, to Deposit Account Number 010682 (enclose an extra copy of this form).

5. Change in Entity Status (from status indicated above)

Applicant certifying micro entity status. See 37 CFR 1.29

Applicant asserting small entity status. See 37 CFR 1.27

Applicant changing to regular undiscounted fee status.

NOTE: Absent a valid certification of Micro Entity Status (see forms PTO/SB/15A and 15B), issue fee payment in the micro entity amount will not be accepted at the risk of application abandonment.

NOTE: If the application was previously under micro entity status, checking this box will be taken to be a notification of loss of entitlement to micro entity status.

NOTE: Checking this box will be taken to be a notification of loss of entitlement to small or micro entity status, as applicable.

NOTE: This form must be signed in accordance with 37 CFR 1.31 and 1.33. See 37 CFR 1.4 for signature requirements and certifications.

Authorized Signature: [Signature] Date: 13 June 2014

Typed or printed name: Scott A. Chapple Registration No. 46,287

Electronic Patent Application Fee Transmittal

Application Number:	13475607
Filing Date:	18-May-2012
Title of Invention:	HIGH CONCENTRATION OLOPATADINE OPHTHALMIC COMPOSITION
First Named Inventor/Applicant Name:	Daniel A. Gamache
Filer:	Scott Chapple/Candy Sanders
Attorney Docket Number:	PAT903988-US-NP

Filed as Large Entity

Utility under 35 USC 111(a) Filing Fees

Description	Fee Code	Quantity	Amount	Sub-Total in USD(\$)
Basic Filing:				
Pages:				
Claims:				
Miscellaneous-Filing:				
Publ. Fee- Early, Voluntary, or Normal	1504	1	0	0

Petition:

Patent-Appeals-and-Interference:

Post-Allowance-and-Post-Issuance:

Description	Fee Code	Quantity	Amount	Sub-Total in USD(\$)
Utility Appl Issue Fee	1501	1	960	960
Publ. Fee- Early, Voluntary, or Normal	1504	1	0	0
Extension-of-Time:				
Miscellaneous:				
Total in USD (\$)				960

Electronic Acknowledgement Receipt

EFS ID:	19301240
Application Number:	13475607
International Application Number:	
Confirmation Number:	4130
Title of Invention:	HIGH CONCENTRATION OLOPATADINE OPHTHALMIC COMPOSITION
First Named Inventor/Applicant Name:	Daniel A. Gamache
Customer Number:	26356
Filer:	Scott Chapple/Candy Sanders
Filer Authorized By:	Scott Chapple
Attorney Docket Number:	PAT903988-US-NP
Receipt Date:	13-JUN-2014
Filing Date:	18-MAY-2012
Time Stamp:	15:15:09
Application Type:	Utility under 35 USC 111(a)

Payment information:

Submitted with Payment	yes
Payment Type	Deposit Account
Payment was successfully received in RAM	\$960
RAM confirmation Number	1672
Deposit Account	010682
Authorized User	

The Director of the USPTO is hereby authorized to charge indicated fees and credit any overpayment as follows:

Charge any Additional Fees required under 37 C.F.R. Section 1.16 (National application filing, search, and examination fees)

Charge any Additional Fees required under 37 C.F.R. Section 1.17 (Patent application and reexamination processing fees)

Charge any Additional Fees required under 37 C.F.R. Section 1.19 (Document supply fees)

Charge any Additional Fees required under 37 C.F.R. Section 1.20 (Post Issuance fees)

Charge any Additional Fees required under 37 C.F.R. Section 1.21 (Miscellaneous fees and charges)

File Listing:

Document Number	Document Description	File Name	File Size(Bytes)/ Message Digest	Multi Part /.zip	Pages (if appl.)
1	Issue Fee Payment (PTO-85B)	PAT903988-US- NP_2014-06-13_SUB_Issue_Fee _.pdf	130327 dd7d451005eb36f56dd9d4c6c8d1e825ca8 98930	no	1

Warnings:

Information:

2	Fee Worksheet (SB06)	fee-info.pdf	33615 655b5ae6fafbe2db6cb8c45a3f934ba99c07 d24e	no	2
---	----------------------	--------------	---	----	---

Warnings:

Information:

Total Files Size (in bytes): 163942

This Acknowledgement Receipt evidences receipt on the noted date by the USPTO of the indicated documents, characterized by the applicant, and including page counts, where applicable. It serves as evidence of receipt similar to a Post Card, as described in MPEP 503.

New Applications Under 35 U.S.C. 111

If a new application is being filed and the application includes the necessary components for a filing date (see 37 CFR 1.53(b)-(d) and MPEP 506), a Filing Receipt (37 CFR 1.54) will be issued in due course and the date shown on this Acknowledgement Receipt will establish the filing date of the application.

National Stage of an International Application under 35 U.S.C. 371

If a timely submission to enter the national stage of an international application is compliant with the conditions of 35 U.S.C. 371 and other applicable requirements a Form PCT/DO/EO/903 indicating acceptance of the application as a national stage submission under 35 U.S.C. 371 will be issued in addition to the Filing Receipt, in due course.

New International Application Filed with the USPTO as a Receiving Office

If a new international application is being filed and the international application includes the necessary components for an international filing date (see PCT Article 11 and MPEP 1810), a Notification of the International Application Number and of the International Filing Date (Form PCT/RO/105) will be issued in due course, subject to prescriptions concerning national security, and the date shown on this Acknowledgement Receipt will establish the international filing date of the application.

INFORMATION DISCLOSURE STATEMENT BY APPLICANT (Not for submission under 37 CFR 1.99)	Application Number		13475607
	Filing Date		2012-05-18
	First Named Inventor	Daniel A. Gamache	
	Art Unit		1629
	Examiner Name	Tran, My Chau T.	
	Attorney Docket Number		PAT903988-US-NP

U.S. PATENTS							Remove
Examiner Initial* <small>(Change(s) applied to document,</small>	Cite No	Patent Number	Kind Code ¹	Issue Date	Name of Patentee or Applicant of cited Document	Pages, Columns, Lines where Relevant Passages or Relevant Figures Appear	
N.B.H. 6/16/2014 /MCT/	1	5874414		1999-02-23	Cydex, Inc. Haseloff et al.		
/MCT/	2	6280745	B1	2001-08-28	Flore et al. Alliance Pharmaceutical Corp.		
/MCT/	3	6407079	B1	2002-06-18	Muller et al. Janssen Pharmaceutica N.V.		

If you wish to add additional U.S. Patent citation information please click the Add button.

Add

U.S. PATENT APPLICATION PUBLICATIONS							Remove
Examiner Initial*	Cite No	Publication Number	Kind Code ¹	Publication Date	Name of Patentee or Applicant of cited Document	Pages, Columns, Lines where Relevant Passages or Relevant Figures Appear	
	1						

If you wish to add additional U.S. Published Application citation information please click the Add button.

Add

FOREIGN PATENT DOCUMENTS								Remove
Examiner Initial*	Cite No	Foreign Document Number ³	Country Code ²	Kind Code ⁴	Publication Date	Name of Patentee or Applicant of cited Document	Pages, Columns, Lines where Relevant Passages or Relevant Figures Appear	T ⁵
	1							<input type="checkbox"/>

ALL REFERENCES CONSIDERED EXCEPT WHERE LINED THROUGH. /MCT/



APPLICATION NO.	ISSUE DATE	PATENT NO.	ATTORNEY DOCKET NO.	CONFIRMATION NO.
13/475,607	07/29/2014	8791154	PAT903988-US-NP	4130

26356 7590 07/09/2014
ALCON
IP LEGAL
6201 SOUTH FREEWAY
FORT WORTH, TX 76134

ISSUE NOTIFICATION

The projected patent number and issue date are specified above.

Determination of Patent Term Adjustment under 35 U.S.C. 154 (b) (application filed on or after May 29, 2000)

The Patent Term Adjustment is 1 day(s). Any patent to issue from the above-identified application will include an indication of the adjustment on the front page.

If a Continued Prosecution Application (CPA) was filed in the above-identified application, the filing date that determines Patent Term Adjustment is the filing date of the most recent CPA.

Applicant will be able to obtain more detailed information by accessing the Patent Application Information Retrieval (PAIR) WEB site (<http://pair.uspto.gov>).

Any questions regarding the Patent Term Extension or Adjustment determination should be directed to the Office of Patent Legal Administration at (571)-272-7702. Questions relating to issue and publication fee payments should be directed to the Application Assistance Unit (AAU) of the Office of Data Management (ODM) at (571)-272-4200.

APPLICANT(s) (Please see PAIR WEB site <http://pair.uspto.gov> for additional applicants):

Daniel A. Gamache, Arlington, TX;
Laman Alani, Fort Worth, TX;
Malay Ghosh, Fort Worth, TX;
Francisco Javier Galán, Barcelona, SPAIN;
Núria Carreras Perdiguier, Barcelona, SPAIN;
Onkar N. Singh, Arlington, TX;

The United States represents the largest, most dynamic marketplace in the world and is an unparalleled location for business investment, innovation, and commercialization of new technologies. The USA offers tremendous resources and advantages for those who invest and manufacture goods here. Through SelectUSA, our nation works to encourage and facilitate business investment. To learn more about why the USA is the best country in the world to develop technology, manufacture products, and grow your business, visit SelectUSA.gov.

IN THE UNITED STATES PATENT AND TRADEMARK OFFICE

In re Application of: Daniel A. Gamache, *et al.*

Serial No: 13/475,607

Group Art Unit: 1629

Confirmation No: 4130

Filed: May 18, 2012

Patent No: 8,791,154 B2

Issue Date: July 29, 2014

Examiner: Tran, My Chau T.

For: HIGH CONCENTRATION OLOPATADINE OPHTHALMIC COMPOSITION

REQUEST FOR CERTIFICATE OF CORRECTION
PURSUANT TO 37 C.F.R. § 1.323

COMMISSIONER FOR PATENTS
P.O. Box 1450
Alexandria, VA 22313-1450

Dear Sir:

Patentee respectfully requests that the enclosed Certificate of Correction on Form PTO/SB/44 be issued correcting an error in the above-referenced patent. The exact location where the error occurred in the patent is listed on the enclosed certificate.

The error that appears in this patent is Applicants' error. Payment of the fee due is enclosed herewith. If any fees are inadvertently omitted or if any additional fees are required

U.S. Serial No. 13/475,607
Filed: July 29, 2014

or have been overpaid, please appropriately charge or credit those fees to Deposit Account
No. 010682 of Alcon Research, Ltd.

Respectfully submitted,

August 13, 2014
Dated

/Scott A. Chapple, 46, 287/
Scott A. Chapple
Reg. No. 46,287

Address for Correspondence:

Scott A. Chapple
IP Legal, Mail Code TB4-8
Alcon Research, Ltd.
6201 South Freeway
Fort Worth, TX 76134-2099
Phone: (817) 551-8793

Attorney Docket: PAT903988-US-NP

**UNITED STATES PATENT AND TRADEMARK OFFICE
CERTIFICATE OF CORRECTION**Page 1 of 1

PATENT NO. : 8,791,154 B2

APPLICATION NO.: 13/475,607

ISSUE DATE : July 29, 2014

INVENTOR(S) : Daniel A. Gamache, et al.

It is certified that an error appears or errors appear in the above-identified patent and that said Letters Patent is hereby corrected as shown below:

On Page 1, Section (56), under References Cited, please remove --5,874,414 A 2/1999 Haseloff et al.--.

MAILING ADDRESS OF SENDER (Please do not use customer number below):

Alcon Research, Ltd.
IP Legal
6201 South Freeway

This collection of information is required by 37 CFR 1.322, 1.323, and 1.324. The information is required to obtain or retain a benefit by the public which is to file (and by the USPTO to process) an application. Confidentiality is governed by 35 U.S.C. 122 and 37 CFR 1.14. This collection is estimated to take 1.0 hour to complete, including gathering, preparing, and submitting the completed application form to the USPTO. Time will vary depending upon the individual case. Any comments on the amount of time you require to complete this form and/or suggestions for reducing this burden, should be sent to the Chief Information Officer, U.S. Patent and Trademark Office, U.S. Department of Commerce, P.O. Box 1450, Alexandria, VA 22313-1450. DO NOT SEND FEES OR COMPLETED FORMS TO THIS ADDRESS. **SEND TO: Attention Certificate of Corrections Branch, Commissioner for Patents, P.O. Box 1450, Alexandria, VA 22313-1450.**

If you need assistance in completing the form, call 1-800-PTO-9199 and select option 2.

Privacy Act Statement

The **Privacy Act of 1974 (P.L. 93-579)** requires that you be given certain information in connection with your submission of the attached form related to a patent application or patent. Accordingly, pursuant to the requirements of the Act, please be advised that: (1) the general authority for the collection of this information is 35 U.S.C. 2(b)(2); (2) furnishing of the information solicited is voluntary; and (3) the principal purpose for which the information is used by the U.S. Patent and Trademark Office is to process and/or examine your submission related to a patent application or patent. If you do not furnish the requested information, the U.S. Patent and Trademark Office may not be able to process and/or examine your submission, which may result in termination of proceedings or abandonment of the application or expiration of the patent.

The information provided by you in this form will be subject to the following routine uses:

1. The information on this form will be treated confidentially to the extent allowed under the Freedom of Information Act (5 U.S.C. 552) and the Privacy Act (5 U.S.C. 552a). Records from this system of records may be disclosed to the Department of Justice to determine whether disclosure of these records is required by the Freedom of Information Act.
2. A record from this system of records may be disclosed, as a routine use, in the course of presenting evidence to a court, magistrate, or administrative tribunal, including disclosures to opposing counsel in the course of settlement negotiations.
3. A record in this system of records may be disclosed, as a routine use, to a Member of Congress submitting a request involving an individual, to whom the record pertains, when the individual has requested assistance from the Member with respect to the subject matter of the record.
4. A record in this system of records may be disclosed, as a routine use, to a contractor of the Agency having need for the information in order to perform a contract. Recipients of information shall be required to comply with the requirements of the Privacy Act of 1974, as amended, pursuant to 5 U.S.C. 552a(m).
5. A record related to an International Application filed under the Patent Cooperation Treaty in this system of records may be disclosed, as a routine use, to the International Bureau of the World Intellectual Property Organization, pursuant to the Patent Cooperation Treaty.
6. A record in this system of records may be disclosed, as a routine use, to another federal agency for purposes of National Security review (35 U.S.C. 181) and for review pursuant to the Atomic Energy Act (42 U.S.C. 218(c)).
7. A record from this system of records may be disclosed, as a routine use, to the Administrator, General Services, or his/her designee, during an inspection of records conducted by GSA as part of that agency's responsibility to recommend improvements in records management practices and programs, under authority of 44 U.S.C. 2904 and 2906. Such disclosure shall be made in accordance with the GSA regulations governing inspection of records for this purpose, and any other relevant (*i.e.*, GSA or Commerce) directive. Such disclosure shall not be used to make determinations about individuals.
8. A record from this system of records may be disclosed, as a routine use, to the public after either publication of the application pursuant to 35 U.S.C. 122(b) or issuance of a patent pursuant to 35 U.S.C. 151. Further, a record may be disclosed, subject to the limitations of 37 CFR 1.14, as a routine use, to the public if the record was filed in an application which became abandoned or in which the proceedings were terminated and which application is referenced by either a published application, an application open to public inspection or an issued patent.
9. A record from this system of records may be disclosed, as a routine use, to a Federal, State, or local law enforcement agency, if the USPTO becomes aware of a violation or potential violation of law or regulation.

Electronic Patent Application Fee Transmittal

Application Number:	13475607
Filing Date:	18-May-2012
Title of Invention:	HIGH CONCENTRATION OLOPATADINE OPHTHALMIC COMPOSITION
First Named Inventor/Applicant Name:	Daniel A. Gamache
Filer:	Scott Chapple/Candy Sanders
Attorney Docket Number:	PAT903988-US-NP

Filed as Large Entity

Utility under 35 USC 111(a) Filing Fees

Description	Fee Code	Quantity	Amount	Sub-Total in USD(\$)
Basic Filing:				
Pages:				
Claims:				
Miscellaneous-Filing:				
Petition:				
Patent-Appeals-and-Interference:				
Post-Allowance-and-Post-Issuance:				
Certificate of Correction	1811	1	100	100

Extension-of-Time:

Description	Fee Code	Quantity	Amount	Sub-Total in USD(\$)
Miscellaneous:				
Total in USD (\$)				100

Electronic Acknowledgement Receipt

EFS ID:	19851582
Application Number:	13475607
International Application Number:	
Confirmation Number:	4130
Title of Invention:	HIGH CONCENTRATION OLOPATADINE OPHTHALMIC COMPOSITION
First Named Inventor/Applicant Name:	Daniel A. Gamache
Customer Number:	26356
Filer:	Scott Chapple/Candy Sanders
Filer Authorized By:	Scott Chapple
Attorney Docket Number:	PAT903988-US-NP
Receipt Date:	13-AUG-2014
Filing Date:	18-MAY-2012
Time Stamp:	11:41:07
Application Type:	Utility under 35 USC 111(a)

Payment information:

Submitted with Payment	yes
Payment Type	Deposit Account
Payment was successfully received in RAM	\$100
RAM confirmation Number	7810
Deposit Account	010682
Authorized User	

The Director of the USPTO is hereby authorized to charge indicated fees and credit any overpayment as follows:

Charge any Additional Fees required under 37 C.F.R. Section 1.16 (National application filing, search, and examination fees)

Charge any Additional Fees required under 37 C.F.R. Section 1.17 (Patent application and reexamination processing fees)

Charge any Additional Fees required under 37 C.F.R. Section 1.19 (Document supply fees)

Charge any Additional Fees required under 37 C.F.R. Section 1.20 (Post Issuance fees)

Charge any Additional Fees required under 37 C.F.R. Section 1.21 (Miscellaneous fees and charges)

File Listing:

Document Number	Document Description	File Name	File Size(Bytes)/ Message Digest	Multi Part /.zip	Pages (if appl.)
1	Request for Certificate of Correction	PAT903988-US- NP_2014-08-13_SUB_Request_ for_Certificate_of_Correction_ .pdf	82690 2f7ac6500cc9958906ec6ccee06f73b298877c8	no	2

Warnings:

Information:

2	Request for Certificate of Correction	PAT903988-US- NP_2014-08-13_SUB_Form_PT O- SB-44_Certificate_of_Correctio n_Fillable_.pdf	164668 01a6d8c4bc0d8a267f4a86165e7e5b09e477a6b3	no	2
---	---------------------------------------	---	--	----	---

Warnings:

Information:

3	Fee Worksheet (SB06)	fee-info.pdf	30063 fb8a624b30ac1ecbbb5ec7047498360507df89ed	no	2
---	----------------------	--------------	---	----	---

Warnings:

Information:

Total Files Size (in bytes):

277421

This Acknowledgement Receipt evidences receipt on the noted date by the USPTO of the indicated documents, characterized by the applicant, and including page counts, where applicable. It serves as evidence of receipt similar to a Post Card, as described in MPEP 503.

New Applications Under 35 U.S.C. 111

If a new application is being filed and the application includes the necessary components for a filing date (see 37 CFR 1.53(b)-(d) and MPEP 506), a Filing Receipt (37 CFR 1.54) will be issued in due course and the date shown on this Acknowledgement Receipt will establish the filing date of the application.

National Stage of an International Application under 35 U.S.C. 371

If a timely submission to enter the national stage of an international application is compliant with the conditions of 35 U.S.C. 371 and other applicable requirements a Form PCT/DO/EO/903 indicating acceptance of the application as a national stage submission under 35 U.S.C. 371 will be issued in addition to the Filing Receipt, in due course.

New International Application Filed with the USPTO as a Receiving Office

If a new international application is being filed and the international application includes the necessary components for an international filing date (see PCT Article 11 and MPEP 1810), a Notification of the International Application Number and of the International Filing Date (Form PCT/RO/105) will be issued in due course, subject to prescriptions concerning national security, and the date shown on this Acknowledgement Receipt will establish the international filing date of the application.

UNITED STATES PATENT AND TRADEMARK OFFICE
CERTIFICATE OF CORRECTION

PATENT NO. : 8,791,154 B2
APPLICATION NO. : 13/475607
DATED : July 29, 2014
INVENTOR(S) : Daniel A. Gamache et al.

Page 1 of 1

It is certified that error appears in the above-identified patent and that said Letters Patent is hereby corrected as shown below:

On the Title Page:

Item (56), under References Cited, please remove --5,874,414 A 2/1999 Haseloff et al.--.

Signed and Sealed this
Fourteenth Day of October, 2014



Michelle K. Lee
Deputy Director of the United States Patent and Trademark Office

AO 120 (Rev. 08/10)

TO: Mail Stop 8 Director of the U.S. Patent and Trademark Office P.O. Box 1450 Alexandria, VA 22313-1450	REPORT ON THE FILING OR DETERMINATION OF AN ACTION REGARDING A PATENT OR TRADEMARK
---	---

In Compliance with 35 U.S.C. § 290 and/or 15 U.S.C. § 1116 you are hereby advised that a court action has been filed in the U.S. District Court _____ for the District of Delaware _____ on the following

Trademarks or Patents. (the patent action involves 35 U.S.C. § 292.):

DOCKET NO.	DATE FILED 3/28/2016	U.S. DISTRICT COURT for the District of Delaware
PLAINTIFF Alcon Research, Ltd.		DEFENDANT Lupin Ltd. and Lupin Pharmaceuticals, Inc.
PATENT OR TRADEMARK NO.	DATE OF PATENT OR TRADEMARK	HOLDER OF PATENT OR TRADEMARK
1 8,791,154 B2	7/29/2014	Alcon Research, Ltd.
2		
3		
4		
5		

In the above—entitled case, the following patent(s)/ trademark(s) have been included:

DATE INCLUDED	INCLUDED BY <input type="checkbox"/> Amendment <input type="checkbox"/> Answer <input type="checkbox"/> Cross Bill <input type="checkbox"/> Other Pleading	
PATENT OR TRADEMARK NO.	DATE OF PATENT OR TRADEMARK	HOLDER OF PATENT OR TRADEMARK
1		
2		
3		
4		
5		

In the above—entitled case, the following decision has been rendered or judgement issued:

DECISION/JUDGEMENT

CLERK	(BY) DEPUTY CLERK	DATE
-------	-------------------	------

Copy 1—Upon initiation of action, mail this copy to Director Copy 3—Upon termination of action, mail this copy to Director
 Copy 2—Upon filing document adding patent(s), mail this copy to Director Copy 4—Case file copy



UNITED STATES PATENT AND TRADEMARK OFFICE

UNITED STATES DEPARTMENT OF COMMERCE
United States Patent and Trademark Office
Address: COMMISSIONER FOR PATENTS
P.O. Box 1450
Alexandria, Virginia 22313-1450
www.uspto.gov

APPLICATION NUMBER	PATENT NUMBER	GROUP ART UNIT	FILE WRAPPER LOCATION
13/475,607	8791154	1629	9200



Correspondence Address/Fee Address Change

The following fields have been set to Customer Number 1095 on 04/13/2016

- Correspondence Address
- Maintenance Fee Address

The address of record for Customer Number 1095 is:

**1095
NOVARTIS PHARMACEUTICAL CORPORATION
INTELLECTUAL PROPERTY DEPARTMENT
ONE HEALTH PLAZA 433/2
EAST HANOVER, NJ 07936-1080**

UNITED STATES PATENT AND TRADEMARK OFFICE

BEFORE THE PATENT TRIAL AND APPEAL BOARD

ARGENTUM PHARMACEUTICALS LLC,
Petitioner,

v.

ALCON RESEARCH, LTD.,
Patent Owner.

Case IPR2016-00544
Patent 8,791,154 B2

Before JENNIFER MEYER CHAGNON, CHRISTOPHER M. KAISER,
and CHRISTOPHER G. PAULRAJ, *Administrative Patent Judges*.

KAISER, *Administrative Patent Judge*.

DECISION
Institution of *Inter Partes* Review
37 C.F.R. § 42.108

INTRODUCTION

A. Background

Argentum Pharmaceuticals LLC (“Petitioner”) filed a Petition (Paper 1, “Pet.”) requesting *inter partes* review of claims 1–4, 8, 12, 13, 21, and 22 of U.S. Patent No. 8,791,154 B2 (Ex. 1001, “the ’154 patent”). Alcon Research, Ltd. (“Patent Owner”) did not file a Preliminary Response.

We have authority to determine whether to institute an *inter partes* review. 35 U.S.C. § 314(b); 37 C.F.R. § 42.4(a). The standard for instituting an *inter partes* review is set forth in 35 U.S.C. § 314(a), which provides that an *inter partes* review may not be instituted unless “there is a reasonable likelihood that the petitioner would prevail with respect to at least 1 of the claims challenged in the petition.”

After considering the Petition and the evidence currently of record, we determine that Petitioner has demonstrated that there is a reasonable likelihood that it would prevail with respect to at least one of the claims challenged in the Petition. Accordingly, we institute *inter partes* review.

B. Related Matters

The parties note that the ’154 patent is the subject of *Alcon Research, Ltd. v. Watson Laboratories, Inc.*, Case No. 1-15-cv-01159-SLR (D. Del.). Pet. 1; Paper 6, 2.

C. The Asserted Grounds of Unpatentability

Petitioner contends that claims 1–4, 8, 12, 13, 21, and 22 of the ’154 patent are unpatentable based on the following grounds (Pet. 17–60):¹

¹ Petitioner also relies on declarations from Erning Xia, Ph.D., and Leonard Bielory, M.D. Ex. 1002 (“the Xia Declaration” or “Xia Decl.”); Ex. 1003 (“the Bielory Declaration” or “Bielory Decl.”).

Statutory Ground	Basis	Challenged Claims
§ 103 _u	Bhowmick, ² Yanni, ³ and Castillo ⁴	1–4, 8, 12, 13, 21, and 22
§ 103	Schneider, ⁵ Hayakawa, ⁶ Bhowmick, and Castillo	1–4, 8, 12, 13, 21, and 22

D. The '154 Patent

The '154 patent relates to “an ophthalmic composition containing a relatively high concentration of olopatadine.” Ex. 1001, at [57]. This “invention is directed to an ophthalmic composition for treatment of allergic conjunctivitis.” *Id.* at 2:41–42. The '154 patent describes the claimed compositions as including “at least 0.67 w/v % olopatadine, preferably dissolved in solution.” *Id.* at 2:42–45. The claimed compositions also are described as “typically includ[ing] a cyclodextrin, and more particularly, a γ -cyclodextrin derivative and/or a β -cyclodextrin derivative to aid in solubilizing the olopatadine.” *Id.* at 2:45–48. In addition, the '154 patent describes other ingredients to assist in solubilization of the olopatadine, including “a lactam polymer (e.g., polyvinylpyrrolidone (PVP))” and “a

² Bhowmick et al., WO 2008/015695 A2, published Feb. 7, 2008 (Ex. 1004, “Bhowmick”).

³ J.M. Yanni et al., *The In Vitro and In Vivo Ocular Pharmacology of Olopatadine (AL-4943A), an Effective Anti-Allergic/Antihistaminic Agent*, 12 J. OCULAR PHARMACOLOGY & THERAPEUTICS 389, 389–400 (1996) (Ex. 1005, “Yanni”).

⁴ Castillo et al., U.S. Patent No. 6,995,186 B2, issued Feb. 7, 2006 (Ex. 1006, “Castillo”).

⁵ Schneider et al., US 2011/0082145 A1, published Apr. 7, 2011 (Ex. 1007, “Schneider”).

⁶ Hayakawa et al., U.S. Patent No. 5,641,805, issued June 24, 1997 (Ex. 1008, “Hayakawa”).

polyether (e.g., polyethylene glycol (PEG)).” *Id.* at 2:52–57. The claimed compositions also are described as including “a preservative” such as “benzalkonium chloride,” as well as “borate and/or polyol to aid in achieving desired preservation.” *Id.* at 2:60–67. In addition to the claimed compositions, the ’154 patent also describes “a method of treating ocular allergy symptoms” by “topically applying [the claimed compositions] to an eye of a human,” preferably by “dispensing an eyedrop from an eyedropper.” *Id.* at 3:1–6.

E. Illustrative Claims

Of the challenged claims in the ’154 patent, claims 1, 4, 8, and 21 are independent. Ex. 1001, 26:28–28:13. Independent claims 1 and 4 and dependent claim 12 are illustrative. They recite:

1. An aqueous ophthalmic solution for treatment of ocular allergic conjunctivitis, the solution comprising:
 - at least 0.67 w/v % olopatadine dissolved in the solution;
 - PEG having a molecular weight of 300 to 500;
 - polyvinylpyrrolidone;
 - hydroxypropyl- γ -cyclodextrin;
 - benzalkonium chloride; and
 - water.

Ex. 1001, 26:28–35.

4. An aqueous ophthalmic solution for treatment of ocular allergic conjunctivitis, the solution comprising:

at least 0.67 w/v % but no greater than 1.0 w/v %
olopatadine dissolved in the solution;

2.0 w/v % to 6.0 w/v % PEG having a molecular weight
of 300 to 500;

2.0 w/v % to 6.0 w/v % polyvinylpyrrolidone;

at least 0.5 w/v % but no greater than 2.0 w/v %
cyclodextrin derivative selected from the group
consisting of SAE- β -cyclodextrin, HP- γ -cyclodextrin,
HP- β -cyclodextrin and combinations thereof; and

water.

Ex. 1001, 26:39–50.

12. A method of treating at least one ocular allergy symptom in humans, the method comprising:

topically applying to an eye of a human an amount of the
solution of claim 4 sufficient to treat the at least one
ocular allergy symptom.

Ex. 1001, 27:7–11.

ANALYSIS

A. Claim Construction

In an *inter partes* review, we construe claim terms in an unexpired patent according to their broadest reasonable construction in light of the specification of the patent in which they appear. 37 C.F.R. § 42.100(b); *see Cuozzo Speed Techs. LLC v. Lee*, No. 15–446, 2016 WL 3369425, at *12 (U.S. June 20, 2016) (upholding the use of the broadest reasonable interpretation standard). Claim terms also are given their ordinary and customary meaning, as would be understood by one of ordinary skill in the

art in the context of the entire disclosure. *In re Translogic Tech., Inc.*, 504 F.3d 1249, 1257 (Fed. Cir. 2007).

1. *Preambles*

Petitioner argues that the preambles of claims 1, 4, 8, and 21 should be interpreted as non-limiting. Pet. 13–14. But Petitioner also provides argument and identifies evidence sufficient on the present record to show that these preambles are taught or suggested by the prior art on which Petitioner relies. *Id.* at 32–37, 39, 50, 52, 54, 56. Accordingly, we need not decide whether the preambles are limiting in order to determine whether to institute trial. *See Vivid Techs., Inc. v. Am. Sci. & Eng'g, Inc.*, 200 F.3d 795, 803 (Fed. Cir. 1999) (“only those terms need be construed that are in controversy, and only to the extent necessary to resolve the controversy”).

2. *“Solution comprising . . . at least 0.67 w/v % olopatadine . . . dissolved in the solution”*

Petitioner proposes that the phrase “solution comprising . . . at least 0.67 w/v % olopatadine . . . dissolved in the solution” be interpreted to include solutions in which at least 0.67 w/v % olopatadine is dissolved in the solution and additional olopatadine may be present in an undissolved form. Pet. 14–15. This phrase does not need construction at this time. First, there is at this time no evidence of record that the prior art on which Petitioner relies is limited to solutions in which some amount of olopatadine is present in an undissolved form. Second, Petitioner’s proposed construction does not attribute any new meaning to the phrase beyond that granted by the use of the term “comprising,” which permits the presence of items not recited in the language of the claim. *Genentech, Inc. v. Chiron Corp.*, 112 F.3d 495, 501 (Fed. Cir. 1997) (holding that “comprising” is a term of art meaning that the

named elements are essential, but other elements may be added and still form a construct within the scope of the claim).

3. “w/v %”

Petitioner argues that “w/v %” should be interpreted as “the mass of the component in grams per 100 milliliters of solution multiplied by 100,” which Petitioner describes as “the standard used in the formulations and topical eye pharmaceutical industries.” Pet. 15 (citing Ex. 1002 ¶ 21). Based on the evidence currently of record, we agree with Petitioner that this is the appropriate interpretation of “w/v %.” Accordingly, we construe “w/v %” of a component as “the mass of the component in grams per 100 milliliters of solution multiplied by 100.”

B. Asserted Obviousness over Bhowmick, Yanni, and Castillo

Petitioner argues that claims 1–4, 8, 12, 13, 21, and 22 would have been obvious over the combination of Bhowmick, Yanni, and Castillo.

1. Bhowmick

Bhowmick relates to “an aqueous topical solution comprising a therapeutically effective amount of olopatadine.” Ex. 1004, at [57]. It teaches that such solutions are “indicated for the treatment of signs and symptoms of allergic conjunctivitis.” *Id.* at 1:18–19. Bhowmick also teaches various means of “enhanc[ing] the physical stability of” its olopatadine solutions, including cyclodextrin derivatives, such as “the hydroxypropyl derivatives of alpha-, beta-, and gamma-cyclodextrin” and “sulfoalkyl ether cyclodextrin.” *Id.* at 4:16–5:12. When discussing the use of hydroxypropyl- β -cyclodextrin to stabilize olopatadine solutions “for ophthalmic administration,” Bhowmick teaches using “about 1.0% to about 5%” of the cyclodextrin derivative. *Id.* at 6:5–6. More broadly, Bhowmick

teaches including between about 1.65 and about 50 times as much hydroxypropyl- β -cyclodextrin as olopatadine by weight. *Id.* at 6:18–20. Bhowmick teaches the use of other stabilizers, including hydroxypropyl methylcellulose in “concentrations ranging from about 0.001% to about 5%.” *Id.* at 7:10–13. In addition, Bhowmick teaches adding other compounds, such as benzalkonium chloride as a preservative “in an amount ranging from about 0.005% to about 1%w/v,” and sodium borate as a buffering agent. *Id.* at 7:20–22, 8:14–21. Bhowmick teaches that its solution “is intended to be administered as . . . eye drops,” that its solution has an osmolality “between 150 [and] 450 mOsm,” and that its solution has a pH of “4 to 8, preferably pH of 6.5 to 7.5.” *Id.* at 8:10–12, 8:22–24.

2. *Yanni*

Yanni teaches that olopatadine “is an anti-allergic agent” and reports results of *in vitro* and *in vivo* studies of olopatadine using “human conjunctival mast cell preparations” as well as “guinea pigs.” Ex. 1005, 389. Yanni teaches using solutions containing 0.001 to 1.0 w/v % olopatadine. *Id.* at 395.

3. *Castillo*

Castillo relates to “[t]opical formulations of olopatadine for treatment of allergic or inflammatory disorders of the eye.” Ex. 1006, at [57]; *see id.* at 2:13–15. Castillo teaches aqueous solutions with 0.17 to 0.62 w/v % of olopatadine and “an amount of polyvinylpyrrolidone . . . sufficient to enhance the physical stability of the formulations.” *Id.* at [57]; *see id.* at 2:17–27, 2:66–3:2. The polyvinylpyrrolidone concentration in Castillo is taught as 0.1 to 3%. *Id.* at 3:22–25. Castillo also teaches the presence of other substances in the solutions, including polyols as tonicity-adjusting

agents, benzalkonium chloride as a preservative, borates as buffering agents, and 400-molecular-weight polyethylene glycol at a concentration of 2 w/v %. *Id.* at 3:64–67, 4:2–3, Table 5.

4. *Analysis of Obviousness over Bhowmick, Yanni, and Castillo*

Petitioner argues that Bhowmick, Yanni, and Castillo teach or suggest all the limitations of each of claims 1–4, 8, 12, 13, 21, and 22 of the '154 patent and that a person of ordinary skill in the art would have had a reason to combine the teachings of the three references. Pet. 17–41. After reviewing the Petition and the evidence cited therein, we conclude that Petitioner has made a sufficient showing regarding each of these matters to establish a reasonable likelihood of prevailing on its assertion that the challenged claims are obvious over the combination of Bhowmick, Yanni, and Castillo.

a. Claim 1

Claim 1 recites “[polyethylene glycol] having a molecular weight of 300 to 500,” “polyvinylpyrrolidone,” and “benzalkonium chloride” as components of its “aqueous ophthalmic solution.” Ex. 1001, 26:28–35. Petitioner has made a sufficient showing that each of these is taught or suggested by Castillo. Pet. 33–34 (citing Ex. 1006, 2:23–27, 3:66–67, Table 5). Claim 1 also recites “hydroxypropyl- γ -cyclodextrin” and “water.” Ex. 1001, 26:28–35. Petitioner has made a sufficient showing that each of these is taught or suggested by Bhowmick. *Id.* (citing Ex. 1004, at [57], 4:16–17, 5:3–5, 5:12–18). Finally, claim 1 recites “at least 0.67 w/v % olopatadine dissolved in the solution.” Petitioner has made a sufficient showing that this limitation is taught or suggested by Yanni. Pet. 33 (citing Ex. 1005, 395). Yanni teaches olopatadine concentrations from 0.001 to

IPR2016-00544
Patent 8,791,154 B2

1.0 w/v %. Ex. 1005, 395. A prima facie case of obviousness exists in situations where, as here, the claimed ranges overlap the ranges disclosed by the prior art. See *In re Geisler*, 116 F.3d 1465, 1469 (Fed. Cir. 1997); *In re Woodruff*, 919 F.2d 1575, 1578 (Fed. Cir. 1990). There is as yet no evidence of record to overcome this prima facie case of obviousness.

The fact that the prior art contains individual teachings of each of the limitations of claim 1 would not be sufficient to establish obviousness if a person of ordinary skill in the art would not have had a reason to combine the prior-art teachings in question. There must be “some articulated reasoning with some rational underpinning” to combine the known elements in the manner required in the claim at issue. *KSR Int’l Co. v. Teleflex Inc.*, 550 U.S. 398, 418 (2007). “[I]f a technique has been used to improve one device, and a person of ordinary skill in the art would recognize that it would improve similar devices in the same way, using the technique is obvious unless its actual application is beyond his or her skill.” *Id.* at 417. Here, Petitioner has identified evidence of record suggesting that the compounds added to the ophthalmic solutions of Bhowmick and Castillo to stabilize, preserve, buffer, and adjust the tonicity of those solutions would perform the same functions in ophthalmic solutions using the higher amount of olopatadine taught by Yanni. Pet. 23 (citing Ex. 1007 ¶ 7; Ex. 1003 ¶ 36; Ex. 1006, 2:19–22), 25 (citing Ex. 1004, at [57], 7:20–22).

Because Petitioner has made a sufficient showing both that Bhowmick, Yanni, and Castillo teach or suggest all the limitations of claim 1 and that a person of ordinary skill in the art would have had a reason to combine the teachings of Bhowmick, Yanni, and Castillo, we determine that

Petitioner has established a reasonable likelihood of prevailing in showing the obviousness of claim 1 over this combination of references.

b. Claim 2

Claim 2 depends from claim 1 and adds the requirement that the aqueous ophthalmic solution contain borate. Ex. 1001, 26:36. Petitioner argues that this new limitation is taught or suggested by both Bhowmick and Castillo. Pet. 34 (citing Ex. 1004, 8:14–21; Ex. 1006, 4:2–4). Bhowmick teaches the inclusion of “buffering agents includ[ing] . . . sodium borate,” while Castillo teaches “buffering agents includ[ing] . . . borates.” Ex. 1004, 8:16–20; Ex. 1006, 4:2–3. Petitioner thus has established a reasonable likelihood of prevailing in showing the obviousness of claim 2 over Bhowmick, Yanni, and Castillo.

c. Claim 3

Claim 3 depends from claim 2 and requires that the aqueous ophthalmic solution contain “a polyol.” Ex. 1001, 26:37. Petitioner argues that this limitation is taught or suggested by Castillo. Pet. 34 (citing Ex. 1006, 3:64–65). The ’154 patent lists examples of polyols, including mannitol, glycerin, and sorbitol, among others. Ex. 1001, 7:65–8:1. Castillo teaches the inclusion of “tonicity-adjusting agents includ[ing] mannitol, . . . glycerin, [and] sorbitol.” Ex. 1006, 3:64–65. Petitioner thus has established a reasonable likelihood of prevailing in showing the obviousness of claim 3 over Bhowmick, Yanni, and Castillo.

d. Claim 4

Claim 4 is similar to claim 1, but it narrows the scope of claim 1 by reciting limits on the concentration of the recited compounds in the ophthalmic solution. Petitioner argues that Yanni teaches or suggests the

recited “at least 0.67 w/v % but no greater than 1.0 w/v % olopatadine dissolved in the solution.” Pet. 35 (citing Ex. 1005, 391–392, 394–396, Tables 2, 3). As noted above, Yanni teaches olopatadine concentrations between 0.001 and 1.0 w/v %, which overlaps the claimed range. Ex. 1005, 395. Accordingly, Petitioner has made a sufficient showing that this limitation is taught or suggested by the prior art.

Petitioner argues that Castillo teaches or suggests the recited “2.0 w/v % to 6.0 w/v % [polyethylene glycol] having a molecular weight of 300 to 500.” Pet. 35 (citing Ex. 1006, Table 5). The cited portion of Castillo teaches 2 w/w % of “Polyethylene Glycol (400).” Ex. 1006, Table 5. Castillo does not explain how to convert its “w/w %” into the “w/v %” of the claims of the ’154 patent. There is evidence in the record that suggests that Castillo’s 2 w/w % equates to 2.06 to 2.10 w/v % when converted into the units used in the ’154 patent. Pet. 27 (citing Ex. 1003 ¶¶ 43–44). This evidence is, for the moment at least, not contradicted by any evidence of record. Accordingly, Petitioner has made a sufficient showing that this limitation is taught or suggested by the prior art.

Petitioner argues that Castillo teaches or suggests the recited “2.0 w/v % to 6.0 w/v % polyvinylpyrrolidone.” Pet. 35 (citing Ex. 1006, 2:66–3:2, 3:22–25). Castillo teaches polyvinylpyrrolidone concentrations between 0.1 and 3 percent. Ex. 1006, 3:22–25. Although the cited portion of Castillo does not say whether the type of percentage intended is w/v %, another portion of Castillo makes clear that “all component amounts are presented on a % (w/v) basis.” *Id.* at 2:32–34. Accordingly, Petitioner has made a sufficient showing that this limitation is taught or suggested by the prior art.

Claim 4 also broadens the scope of claim 1 by allowing a “cyclodextrin derivative selected from the group consisting of [sulfoalkyl ether]- β -cyclodextrin, [hydroxypropyl]- γ -cyclodextrin, [hydroxypropyl]- β -cyclodextrin and combinations thereof,” rather than restricting the choice to claim 1’s “hydroxypropyl- γ -cyclodextrin.”

Ex. 1001, 26:39–50. As discussed above, Petitioner has made a sufficient showing that Bhowmick teaches or suggests hydroxypropyl- γ -cyclodextrin. Pet. 33 (citing Ex. 1004, 4:16–17, 5:3–5, 5:12–18). Petitioner also has made a sufficient showing that Bhowmick teaches or suggests the other compounds recited. Pet. 35–36 (citing Ex. 1004, 5:10–18, 6:1–8). As for the requirement that the cyclodextrin derivative be present at a concentration of “at least 0.5 w/v % but no greater than 2.0 w/v %,” Petitioner argues that Bhowmick teaches this. Pet. 35–36 (citing Ex. 1004, 6:5–6, 6:18–21). Bhowmick teaches a concentration of hydroxypropyl- β -cyclodextrin “in the range from about 1.0% to about 5%.” Ex. 1004, 6:5–6. The surrounding portions of Bhowmick make clear that these percentages are intended to be w/v %. *See* Ex. 1004, 6:1–4 (stating that preferable hydroxypropyl- β -cyclodextrin concentration ranges “from about 0.1% to about 20%w/v of the composition, and more preferably . . . from about 1.0% to about 10% w/v of the composition”): Accordingly, Petitioner has made a sufficient showing that this limitation is taught or suggested by the prior art.

As discussed above with respect to claim 1, Petitioner has made a sufficient showing that a person of ordinary skill in the art would have had a reason to combine the teachings of Bhowmick, Yanni, and Castillo. Accordingly, we determine that Petitioner has established a reasonable

likelihood of prevailing in showing the obviousness of claim 4 over this combination of references.

e. Claim 8

Claim 8 is identical to claim 4, except that it limits the cyclodextrin derivative to hydroxypropyl- γ -cyclodextrin, rather than allowing other possible cyclodextrin derivatives as claim 4 does. Ex. 1001, 26:58–67. As discussed above with respect to claims 1 and 4, Petitioner has made a sufficient showing that Bhowmick teaches the use of hydroxypropyl- γ -cyclodextrin. Pet. 33 (citing Ex. 1004, 4:16–17, 5:3–5, 5:12–18). We note that, with respect to the limitation on the amount of hydroxypropyl- γ -cyclodextrin that may be present, Ex. 1001, 26:65–66 (“at least 0.5 w/v % but no greater than 2.0 w/v % hydroxypropyl- γ -cyclodextrin”), Bhowmick presents an overlapping range of compositions only for hydroxypropyl- β -cyclodextrin. Ex. 1004, 6:1–6. But Petitioner directs us to evidence of record suggesting that a person of ordinary skill in the art would have understood that hydroxypropyl- β -cyclodextrin and hydroxypropyl- γ -cyclodextrin were interchangeable in identical quantities. Pet. 27–28 (citing Ex. 1001, 5:30–47; Ex. 1002 ¶¶ 38–40, 60; Ex. 1045 ¶¶ 18, 163). There is as yet no evidence of record contradicting this evidence. Accordingly, we determine that Petitioner has established a reasonable likelihood of prevailing in showing the obviousness of claim 8 over Bhowmick, Yanni, and Castillo.

f. Claim 12

Claim 12 depends from claim 4 and recites a “method of treating at least one ocular allergy symptom in humans, the method comprising: topically applying to an eye of a human an amount of the solution of claim 4

sufficient to treat the at least one ocular allergy symptom.” Ex. 1001, 27:7–11. Petitioner directs us to evidence of record that Bhowmick teaches treating “symptoms of allergic conjunctivitis.” Pet. 38 (citing Ex. 1004, 1:16–19). Petitioner also directs us to evidence of record that Castillo teaches using a topical olopatadine solution to treat “allergic . . . disorders of the eye.” *Id.* at 38–39 (citing Ex. 1006, 2:13–19). Although Petitioner does not explicitly argue that the combination of Bhowmick, Yanni, and Castillo teaches or suggests that the eyes whose allergic disorders would be treated were human eyes, Petitioner does implicitly argue that this limitation is satisfied by citing to *Alcon Research, Ltd. v. Apotex Inc.* Pet. 32 (citing 687 F.3d 1362, 1369 (Fed. Cir. 2012)). In *Alcon*, the Federal Circuit held that, even though the prior-art references relied upon “d[id] not expressly disclose that olopatadine would be safe for use in human eyes,” a person of ordinary skill in the art “would have [had] a reasonable expectation of success for adapting [the prior-art olopatadine] formulation for the same use in a human eye.” 687 F.3d at 1369. Accordingly, we determine that Petitioner has established a reasonable likelihood of prevailing in showing the obviousness of claim 12 over Bhowmick, Yanni, and Castillo.

g. Claim 13

Claim 13 depends from claim 12 and recites a “method as in claim 12 wherein the step of topically applying the solution includes dispensing at least one drop of the solution to the eye.” Ex. 1001, 27:12–14. Petitioner has made a sufficient showing that Bhowmick and Castillo each teach administering olopatadine solutions as eye drops. Pet. 39 (citing Ex. 1004, 8:10–11; Ex. 1006, 4:16–19). Petitioner thus has established a reasonable

likelihood of prevailing in showing the obviousness of claim 13 over Bhowmick, Yanni, and Castillo.

h. Claim 21

Claim 21 is similar to claim 8, discussed above, but it includes two additional limitations not present in claim 8. Ex. 1001, 27:32–28:10. First, claim 21 requires “greater than 0.003 w/v % but less than 0.03 w/v % benzalkonium chloride.” *Id.* at 28:6–7. Petitioner has made a sufficient showing that this limitation is taught or suggested by Bhowmick. Pet. 40 (citing Ex. 1004, 7:20–22). Bhowmick discloses the use of benzalkonium chloride “in an amount ranging from about 0.005% to about 1 %w/v.” Ex. 1004, 7:20–22. This range overlaps with the claimed range.

Second, claim 21 requires that “the pH of the solution [be] 6.0 to 7.8 and the osmolality of the solution [be] 200 to 400 mOsm/kg.” Ex. 1001, 28:9–10. Petitioner argues that the pH portion of this limitation is taught or suggested by Bhowmick, while the osmolality portion is taught or suggested by both Bhowmick and Castillo. Pet. 41 (citing Ex. 1004, 8:11–12, 8:22–24; Ex. 1006, 4:16–19). With respect to pH, Bhowmick discloses a solution with “a pH 4 to 8, preferably . . . 6.5 to 7.5, and most preferably . . . 6.8 to 7.2.” Ex. 1004, 8:22–24. With respect to osmolality, Bhowmick discloses a solution with an osmolality of “150 to 450 mOsm, and more preferably between 250 [and] 350 mOsm,” and Castillo discloses an osmolality of “150–450 mOsm, preferably 250–350 mOsm.” Ex. 1004, 8:11–12; Ex. 1006, 4:17–19. We note that claim 21 recites its osmolality requirement in units of mOsm/kg, while Bhowmick and Castillo disclose osmolality in units of mOsm. Ex. 1001, 28:9–10; Ex. 1004, 8:11–12; Ex. 1006, 4:17–19. Petitioner directs us to evidence of record that a person of ordinary skill in

the art would interpret Bhowmick's and Castillo's osmolality values as being reported in mOsm/kg rather than in mOsm, making them comparable to those of claim 21. Pet. 28–29 (citing Ex. 1002 ¶ 51). There is as yet no evidence of record contradicting this evidence. Accordingly, Petitioner has established a reasonable likelihood of prevailing in showing the obviousness of claim 21 over Bhowmick, Yanni, and Castillo.

i. Claim 22

Claim 22 depends from claim 21 and adds a limitation requiring “at least 0.15 w/v % but no greater than 1.0 w/v % hydroxypropylmethyl cellulose.” Ex. 1001, 28:11–13. Petitioner argues that this limitation is taught or suggested by Bhowmick. Pet. 41 (citing Ex. 1004, 7:10–13). Bhowmick discloses the use of “hydroxypropyl methylcellulose” in “concentrations ranging from about 0.001% to about 5%, and more preferably in concentrations ranging from about 0.01% to about 1% w/v.” Ex. 1004, 7:10–13. Given that these disclosed ranges overlap the range recited in claim 22, Petitioner has established a reasonable likelihood of prevailing in showing the obviousness of claim 22 over Bhowmick, Yanni, and Castillo.

C. Asserted Obviousness over Schneider, Hayakawa, Bhowmick, and Castillo

Petitioner argues that claims 1–4, 8, 12, 13, 21, and 22 would have been obvious over the combination of Schneider, Hayakawa, Bhowmick, and Castillo.

1. Schneider

Schneider relates to “solution compositions comprising olopatadine.” Ex. 1007, at [57]. In particular, Schneider “relates to formulations of

olopatadine and their use for treating and/or preventing allergic or inflammatory disorders of the eye, nose, skin, and ear.” *Id.* It teaches that, “[i]n general, it is more desirable for active ingredients to be in solution rather than suspension in a pharmaceutical composition.” *Id.* ¶ 7. Schneider’s products are “pharmaceutical aqueous solution compositions,” *id.* ¶ 9, that “are used to treat . . . allergic conjunctivitis,” *id.* ¶ 48. The amount of olopatadine in Schneider is taught as “about . . . 0.60% w/v, or higher.” *Id.* ¶ 45. In addition to olopatadine, Schneider teaches adding several other compounds to its ophthalmic solutions, including sodium borate as a buffer, *id.* ¶ 44, water, *id.* ¶ 49, benzalkonium chloride as a preservative, *id.* ¶ 51, polyethylene glycol and polyvinylpyrrolidone “as lubricants or as viscosity agents,” *id.* ¶ 52, and dextrose, mannitol, sorbitol, propylene glycol, or glycerol as tonicity agents, *id.* ¶ 53. Schneider teaches a composition pH between 6.0 and 7.5. *Id.* ¶ 44. It also teaches osmolality “about 150–450 mOsm, preferably 250–350 mOsm.” *Id.* ¶ 53.

2. Hayakawa

Hayakawa relates to “[t]opical ophthalmic formulations” containing olopatadine.⁷ Ex. 1008, at [57]. Olopatadine is disclosed as having “human

⁷ Hayakawa uses “Compound A” or “11-(3-dimethylaminopropylidene)-6,11-dihydrodibenz[b,e]oxepin-2-acetic acid” to refer to either individual isomer or to a mixture of both isomers of 11-(3-dimethylaminopropylidene)-6,11-dihydrodibenz[b,e]oxepin-2-acetic acid. Ex. 1008, 3:10–15. This compound, in the hydrochloride salt of its *Z* isomer, is identified as olopatadine in Yanni. Ex. 1005, 389. Schneider identifies this compound, not in its hydrochloride salt, but still in its *Z* isomer, as olopatadine. Ex. 1007 ¶ 3. There is as yet no evidence in the record contradicting the identification of the compound disclosed in Hayakawa as olopatadine. Accordingly, we use the term “olopatadine” when referring to the compound that Hayakawa discloses.

conjunctival mast cell stabilizing activity” and “significant antihistaminic activity.” *Id.* at 3:18–22. Accordingly, Hayakawa notes that olopatadine has both “a prophylactic effect” and “a therapeutic effect.” *Id.* at 3:22–23. Hayakawa discloses using olopatadine in concentrations ranging from “0.0001 to 5 w/v %,” *id.* at 6:43–44, with histamine inhibition increasing as the dose of olopatadine increases, *id.* at Table 1.

3. *Analysis of Obviousness over Schneider, Hayakawa, Bhowmick, and Castillo*

Petitioner argues that Schneider, Hayakawa, Bhowmick, and Castillo teach or suggest all the limitations of each of claims 1–4, 8, 12, 13, 21, and 22 of the ’154 patent and that a person of ordinary skill in the art would have had a reason to combine the teachings of the four references. Pet. 42–58. After reviewing the Petition and the evidence cited therein, we conclude that Petitioner has made a sufficient showing regarding each of these matters to establish a reasonable likelihood of prevailing on its assertion that the challenged claims are obvious over the combination of Schneider, Hayakawa, Bhowmick, and Castillo.

a. Claim 1

Claim 1 recites “[polyethylene glycol] having a molecular weight of 300 to 500,” “polyvinylpyrrolidone,” “benzalkonium chloride,” and “water” as components of its “aqueous ophthalmic solution.” Ex. 1001, 26:28–35. Petitioner has made a sufficient showing that each of these is taught or suggested by Schneider.⁸ Pet. 51 (citing Ex. 1007 ¶¶ 49, 51, 52). Claim 1

⁸ As discussed above, Petitioner also has made a sufficient showing that “[polyethylene glycol] having a molecular weight of 300 to 500” is taught or suggested by Castillo. Pet. 33–34 (citing Ex. 1006, Table 5).

also recites “hydroxypropyl- γ -cyclodextrin.” Ex. 1001, 26:28–35.

Petitioner has made a sufficient showing that this is taught or suggested by Bhowmick. Pet. 51 (citing Ex. 1004, 4:16–17, 5:3–5, 5:12–18). Finally, claim 1 recites “at least 0.67 w/v % olopatadine dissolved in the solution.” Petitioner has made a sufficient showing that this limitation is taught or suggested at least by Hayakawa. Pet. 50 (citing Ex. 1008, 6:40–49).

Hayakawa teaches olopatadine concentrations from 0.0001 to 5.0 w/v %. Ex. 1008, 6:43–44. A prima facie case of obviousness exists in situations where, as here, the claimed ranges overlap the ranges disclosed by the prior art. *See Geisler*, 116 F.3d at 1469; *Woodruff*, 919 F.2d at 1578. There is as yet no evidence of record to overcome this prima facie case of obviousness.

The fact that the prior art contains individual teachings of each of the limitations of claim 1 would be not be sufficient to establish obviousness if a person of ordinary skill in the art would not have had a reason to combine the prior-art teachings in question. There must be “some articulated reasoning with some rational underpinning” to combine the known elements in the manner required in the claim at issue. *KSR*, 550 U.S. at 418. “[I]f a technique has been used to improve one device, and a person of ordinary skill in the art would recognize that it would improve similar devices in the same way, using the technique is obvious unless its actual application is beyond his or her skill.” *Id.* at 417. Here, as discussed above, Petitioner has identified evidence of record suggesting that the compounds added to the ophthalmic solutions of Schneider, Bhowmick, and Castillo to stabilize, preserve, buffer, and adjust the tonicity of those solutions would perform the same functions in ophthalmic solutions using higher amounts of olopatadine, such as those amounts taught by Hayakawa. Pet. 46–47 (citing Ex. 1002

¶¶ 64–74; Ex. 1007 ¶ 7; Ex. 1008, 3:18–23, Table 1); *see also* Pet. 23 (citing Ex. 1003 ¶ 36; Ex. 1006, 2:19–22; Ex. 1007 ¶ 7); Pet. 25 (citing Ex. 1004, at [57], 7:20–22).

Because Petitioner has made a sufficient showing both that Schneider, Hayakawa, Bhowmick, and Castillo teach or suggest all the limitations of claim 1 and that a person of ordinary skill in the art would have had a reason to combine the teachings of Schneider, Hayakawa, Bhowmick, and Castillo, we determine that Petitioner has established a reasonable likelihood of prevailing in showing the obviousness of claim 1 over this combination of references.

b. Claim 2

Claim 2 depends from claim 1 and requires that the aqueous ophthalmic solution contain borate. Ex. 1001, 26:36. Petitioner argues that this new limitation is taught or suggested by Schneider. Pet. 51 (citing Ex. 1007 ¶ 44). Schneider teaches using “sodium borate or boric acid” as a “buffer system.” Ex. 1007 ¶ 44. Petitioner thus has established a reasonable likelihood of prevailing in showing the obviousness of claim 2 over Schneider, Hayakawa, Bhowmick, and Castillo.

c. Claim 3

Claim 3 depends from claim 2 and adds the requirement that the aqueous ophthalmic solution contain “a polyol.” Ex. 1001, 26:37. Petitioner argues that this limitation is taught or suggested by Schneider. Pet. 51 (citing Ex. 1007 ¶ 53). The ’154 patent lists examples of polyols, including mannitol, glycerin, and sorbitol, among others. Ex. 1001, 7:65–8:1. Schneider teaches the inclusion of “tonicity agents” such as “mannitol [and] sorbitol,” among others. Ex. 1007 ¶ 53. Petitioner thus has established a

reasonable likelihood of prevailing in showing the obviousness of claim 3 over Schneider, Hayakawa, Bhowmick, and Castillo.

d. Claim 4

Claim 4 is similar to claim 1, but it narrows the scope of claim 1 by reciting limits on the concentration of the recited compounds in the ophthalmic solution. Petitioner argues that at least Hayakawa teaches or suggests the recited “at least 0.67 w/v % but no greater than 1.0 w/v % olopatadine dissolved in the solution.” Pet. 52 (citing Ex. 1008, 6:40–49). As noted above, Hayakawa teaches olopatadine concentrations between 0.0001 and 5.0 w/v %, which overlaps the claimed range. Ex. 1008, 6:43–44. Accordingly, Petitioner has made a sufficient showing that this limitation is taught or suggested by the prior art.

Petitioner argues that Castillo teaches or suggests the recited “2.0 w/v % to 6.0 w/v % [polyethylene glycol] having a molecular weight of 300 to 500.” Pet. 52 (citing Ex. 1006, Table 5). The cited portion of Castillo teaches 2 w/w % of “Polyethylenc Glycol (400).” Ex. 1006, Table 5. As discussed above, Castillo does not explain how to convert its “w/w %” into the “w/v %” of the claims of the ’154 patent. There is evidence in the record that suggests that Castillo’s 2 w/w % equates to 2.06 to 2.10 w/v % when converted into the units used in the ’154 patent. Pet. 27 (citing Ex. 1003 ¶¶ 43–44). This evidence is, for the moment at least, not contradicted by any evidence of record. Accordingly, Petitioner has made a sufficient showing that this limitation is taught or suggested by the prior art.

Petitioner argues that Castillo teaches or suggests the recited “2.0 w/v % to 6.0 w/v % polyvinylpyrrolidone.” Pet. 52–53 (citing Ex. 1006, 3:22–25). Castillo teaches polyvinylpyrrolidone concentrations between 0.1

and 3 percent. Ex. 1006, 3:22–25. Although the cited portion of Castillo does not say whether the type of percentage intended is w/v %, another portion of Castillo makes clear that “all component amounts are presented on a % (w/v) basis.” *Id.* at 2:32–34. Accordingly, Petitioner has made a sufficient showing that this limitation is taught or suggested by the prior art.

Claim 4 also broadens the scope of claim 1 by allowing a “cyclodextrin derivative selected from the group consisting of [sulfoalkyl ether]- β -cyclodextrin, [hydroxypropyl]- γ -cyclodextrin, [hydroxypropyl]- β -cyclodextrin and combinations thereof,” rather than restricting the choice to claim 1’s “hydroxypropyl- γ -cyclodextrin.” Ex. 1001, 26:39–50. As discussed above, Petitioner has made a sufficient showing that Bhowmick teaches or suggests hydroxypropyl- γ -cyclodextrin. Pet. 51 (citing Ex. 1004, 4:16–17, 5:3–5, 5:12–18). Petitioner also has made a sufficient showing that Bhowmick teaches or suggests the other compounds recited. Pet. 53 (citing Ex. 1004, 5:10–18, 6:1–8). As for the requirement that the cyclodextrin derivative be present at a concentration of “at least 0.5 w/v % but no greater than 2.0 w/v %,” Petitioner argues that Bhowmick teaches this. Pet. 53 (citing Ex. 1004, 6:5–6, 6:18–21). Bhowmick teaches a concentration of hydroxypropyl- β -cyclodextrin “in the range from about 1.0% to about 5%.” Ex. 1004, 6:5–6. The surrounding portions of Bhowmick make clear that these percentages are intended to be w/v %. *See* Ex. 1004, 6:1–4 (stating that preferable hydroxypropyl- β -cyclodextrin concentration ranges “from about 0.1% to about 20%w/v of the composition, and more preferably . . . from about 1.0% to about 10% w/v of the composition”). Accordingly, Petitioner has made a sufficient showing that this limitation is taught or suggested by the prior art.

As discussed above with respect to claim 1, Petitioner has made a sufficient showing that a person of ordinary skill in the art would have had a reason to combine the teachings of Schneider, Hayakawa, Bhowmick, and Castillo. Accordingly, we determine that Petitioner has established a reasonable likelihood of prevailing in showing the obviousness of claim 4 over this combination of references.

e. Claim 8

Claim 8 is identical to claim 4, except that it limits the cyclodextrin derivative to hydroxypropyl- γ -cyclodextrin, rather than allowing other possible cyclodextrin derivatives as claim 4 does. Ex. 1001, 26:58–67. As discussed above with respect to claims 1 and 4, Petitioner has made a sufficient showing that Bhowmick teaches the use of hydroxypropyl- γ -cyclodextrin. Pet. 51 (citing Ex. 1004, 4:16–17, 5:3–5, 5:12–18). We note that, with respect to the limitation on the amount of hydroxypropyl- γ -cyclodextrin that may be present, Ex. 1001, 26:65–66 (“at least 0.5 w/v % but no greater than 2.0 w/v % hydroxypropyl- γ -cyclodextrin”), Bhowmick presents an overlapping range of compositions only for hydroxypropyl- β -cyclodextrin. Ex. 1004, 6:1–6. But Petitioner directs us to evidence of record suggesting that a person of ordinary skill in the art would have understood that hydroxypropyl- β -cyclodextrin and hydroxypropyl- γ -cyclodextrin were interchangeable in identical quantities. Pet. 27–28 (citing Ex. 1001, 5:30–47; Ex. 1002 ¶¶ 38–40, 60; Ex. 1045 ¶¶ 18, 163). There is as yet no evidence of record contradicting this evidence. Accordingly, we determine that Petitioner has established a reasonable likelihood of prevailing in showing the obviousness of claim 8 over Schneider, Hayakawa, Bhowmick, and Castillo.

f. Claim 12

Claim 12 depends from claim 4 and recites a “method of treating at least one ocular allergy symptom in humans, the method comprising: topically applying to an eye of a human an amount of the solution of claim 4 sufficient to treat the at least one ocular allergy symptom.” Ex. 1001, 27:7–11. Petitioner argues that Schneider teaches treating “allergic conjunctivitis.” Pet. 55–56 (citing Ex. 1007 ¶ 50). Petitioner also argues that Schneider teaches administering olopatadine “topically to the eye.” *Id.* (citing Ex. 1007 ¶ 50). Although Petitioner does not explicitly argue that the combination of Schneider, Hayakawa, Bhowmick, and Castillo teaches or suggests that the eyes whose allergic disorders would be treated were human eyes, Petitioner does implicitly argue that this limitation is satisfied by citing to *Alcon*. Pet. 32 (citing 687 F.3d at 1369). In *Alcon*, the Federal Circuit held that, even though the prior-art references relied upon “d[id] not expressly disclose that olopatadine would be safe for use in human eyes,” a person of ordinary skill in the art “would have [had] a reasonable expectation of success for adapting [the prior-art olopatadine] formulation for the same use in a human eye.” 687 F.3d at 1369. Accordingly, we determine that Petitioner has established a reasonable likelihood of prevailing in showing the obviousness of claim 12 over Schneider, Hayakawa, Bhowmick, and Castillo.

g. Claim 13

Claim 13 depends from claim 12 and recites a “method as in claim 12 wherein the step of topically applying the solution includes dispensing at least one drop of the solution to the eye.” Ex. 1001, 27:12–14. Petitioner has made a sufficient showing that Schneider teaches or suggests

administering olopatadine solutions as eye drops. Pet. 56 (citing Ex. 1007 ¶ 50). Petitioner thus has established a reasonable likelihood of prevailing in showing the obviousness of claim 13 over Schneider, Hayakawa, Bhowmick, and Castillo.

h. Claim 21

Claim 21 is similar to claim 8, discussed above, but it includes two additional limitations not present in claim 8. Ex. 1001, 27:32–28:10. First, claim 21 requires “greater than 0.003 w/v % but less than 0.03 w/v % benzalkonium chloride.” *Id.* at 28:6–7. Petitioner has made a sufficient showing that this limitation is taught or suggested by Schneider. Pet. 57 (citing Ex. 1007 ¶ 51). Schneider discloses the use of benzalkonium chloride “at a level of from 0.001 to 5.0% w/v.” Ex. 1007 ¶ 51. This range overlaps with the claimed range.

Second, claim 21 requires that “the pH of the solution [be] 6.0 to 7.8 and the osmolality of the solution [be] 200 to 400 mOsm/kg.” Ex. 1001, 28:9–10. Petitioner argues that this limitation is taught or suggested by Schneider. Pet. 57–58 (citing Ex. 1007 ¶¶ 44, 53). With respect to pH, Schneider discloses a solution with “a target pH within the range of pH 6.0–7.5.” Ex. 1007 ¶ 44. With respect to osmolality, Schneider discloses a solution with an osmolality of “generally about 150–450 mOsm, preferably 250–350 mOsm.” *Id.* ¶ 53. We note that claim 21 recites its osmolality requirement in units of mOsm/kg, while Schneider discloses osmolality in units of mOsm. Ex. 1001, 28:9–10; Ex. 1007 ¶ 53. Petitioner directs us to evidence of record that a person of ordinary skill in the art would interpret Schneider’s osmolality values as being reported in mOsm/kg rather than in mOsm, making them comparable to those of claim 21. Pet. 28–29 (citing

Ex. 1002 ¶ 51). There is as yet no evidence of record contradicting this evidence. Accordingly, Petitioner has established a reasonable likelihood of prevailing in showing the obviousness of claim 21 over Schneider, Hayakawa, Bhowmick, and Castillo.

i. Claim 22

Claim 22 depends from claim 21 and adds a limitation requiring “at least 0.15 w/v % but no greater than 1.0 w/v % hydroxypropylmethyl cellulose.” Ex. 1001, 28:11–13. Petitioner argues that this limitation is taught or suggested by Bhowmick. Pet. 58 (citing Ex. 1004, 7:10–13). Bhowmick discloses the use of “hydroxypropyl methylcellulose” in “concentrations ranging from about 0.001% to about 5%, and more preferably in concentrations ranging from about 0.01% to about 1% w/v.” Ex. 1004, 7:10–13. Given that these disclosed ranges overlap the range recited in claim 22, Petitioner has established a reasonable likelihood of prevailing in showing the obviousness of claim 22 over Schneider, Hayakawa, Bhowmick, and Castillo.

CONCLUSION

Upon consideration of the Petition and the evidence before us, we determine that Petitioner has demonstrated a reasonable likelihood that it would prevail in showing that the claims it challenges are unpatentable on the following grounds:

Claims 1–4, 8, 12, 13, 21, and 22 as obvious over the combination of Bhowmick, Yanni, and Castillo; and

Claims 1–4, 8, 12, 13, 21, and 22 as obvious over the combination of Schneider, Hayakawa, Bhowmick, and Castillo.

Accordingly, we institute *inter partes* review of these claims on these grounds. The Board has not made a final determination on the patentability of any challenged claim.

ORDER

It is hereby

ORDERED that, pursuant to 35 U.S.C. § 314, an *inter partes* review is hereby instituted to determine:

whether claims 1–4, 8, 12, 13, 21, and 22 are obvious over the combination of Bhowmick, Yanni, and Castillo; and

whether claims 1–4, 8, 12, 13, 21, and 22 are obvious over the combination of Schneider, Hayakawa, Bhowmick, and Castillo; and

FURTHER ORDERED that, pursuant to 35 U.S.C. § 314(c) and 37 C.F.R. § 42.4, notice is hereby given of the institution of a trial commencing on the entry date of this decision.

IPR2016-00544
Patent 8,791,154 B2

PETITIONER:

Michael R. Houston
Joseph P. Meara
FOLEY & LARDNER LLP
jmeara-pgp@foley.com

PATENT OWNER:

David M. Krinsky
Thomas S. Fletcher
WILLIAMS & CONNOLLY LLP
dkrinsky@wc.com
tfletcher@wc.com
pazeo-IPR@wc.com

UNITED STATES PATENT AND TRADEMARK OFFICE

BEFORE THE PATENT TRIAL AND APPEAL BOARD

APOTEX INC. and APOTEX CORP.,
Petitioner,

v.

ALCON RESEARCH, LTD.,
Patent Owner.

Case IPR2016-01640
Patent 8,791,154 B2

Before JENNIFER MEYER CHAGNON, CHRISTOPHER M. KAISER,
and CHRISTOPHER G. PAULRAJ, *Administrative Patent Judges*.

KAISER, *Administrative Patent Judge*.

DECISION
Institution of *Inter Partes* Review
37 C.F.R. § 42.108

INTRODUCTION

A. Background

Apotex Inc. and Apotex Corp. (“Petitioner”) filed a Petition (Paper 2, “Pet.”) requesting *inter partes* review of claims 1–4, 8, 12, 13, 21, and 22 of U.S. Patent No. 8,791,154 B2 (Ex. 1001, “the ’154 patent”). Alcon Research, Ltd. (“Patent Owner”) waived its opportunity to file a Preliminary Response. Paper 7, 2. Petitioner also moved for joinder with IPR2016-00544, an ongoing *inter partes* review that we instituted on July 18, 2016. Paper 3. Patent Owner does not oppose the motion for joinder. Paper 7, 2.

We have authority to determine whether to institute an *inter partes* review. 35 U.S.C. § 314(b); 37 C.F.R. § 42.4(a). The standard for instituting an *inter partes* review is set forth in 35 U.S.C. § 314(a), which provides that an *inter partes* review may not be instituted unless “there is a reasonable likelihood that the petitioner would prevail with respect to at least 1 of the claims challenged in the petition.” Petitioner may be joined as a party to a previously instituted *inter partes* review if Petitioner “properly files a petition . . . that [we] . . . determine[] warrants the institution of an *inter partes* review.” 35 U.S.C. § 315(c); 37 C.F.R. § 42.4(a).

After considering the Petition and the evidence currently of record, we determine that Petitioner has demonstrated that there is a reasonable likelihood that it would prevail with respect to at least one of the claims challenged in the Petition. Accordingly, we institute *inter partes* review. Because Petitioner has filed a Petition that warrants institution, we join Petitioner as a party to IPR2016-00544, and we terminate the present proceeding.

B. Related Matters

The parties note that the '154 patent is the subject of *Alcon Research, Ltd. v. Watson Laboratories, Inc.*, Case No. 1-15-cv-01159-SLR (D. Del.), as well as *Alcon Research, Ltd. v. Lupin Ltd.*, Case No. 1-16-cv-00195 (D. Del.). Pet. 1–2; Paper 6, 2.

C. The Asserted Grounds of Unpatentability

Petitioner contends that claims 1–4, 8, 12, 13, 21, and 22 of the '154 patent are unpatentable based on the following grounds (Pet. 18–59):¹

Statutory Ground	Basis	Challenged Claims
§ 103	Bhowmick, ² Yanni, ³ and Castillo ⁴	1–4, 8, 12, 13, 21, and 22
§ 103	Schneider, ⁵ Hayakawa, ⁶ Bhowmick, and Castillo	1–4, 8, 12, 13, 21, and 22

¹ Petitioner also relies on declarations from Erning Xia, Ph.D. (Ex. 1002) and Leonard Bielory, M.D (Ex. 1003).

² Bhowmick et al., WO 2008/015695 A2, published Feb. 7, 2008 (Ex. 1004, “Bhowmick”).

³ J.M. Yanni et al., *The In Vitro and In Vivo Ocular Pharmacology of Olopatadine (AL-4943A), an Effective Anti-Allergic/Antihistaminic Agent*, 12 J. OCULAR PHARMACOLOGY & THERAPEUTICS 389, 389–400 (1996) (Ex. 1005, “Yanni”).

⁴ Castillo et al., U.S. Patent No. 6,995,186 B2, issued Feb. 7, 2006 (Ex. 1006, “Castillo”).

⁵ Schneider et al., US 2011/0082145 A1, published Apr. 7, 2011 (Ex. 1007, “Schneider”).

⁶ Hayakawa et al., U.S. Patent No. 5,641,805, issued June 24, 1997 (Ex. 1008, “Hayakawa”).

These are identical to the grounds of unpatentability asserted in IPR2016-00544.

D. The '154 Patent

The '154 patent relates to “an ophthalmic composition containing a relatively high concentration of olopatadine.” Ex. 1001, at [57]. This “invention is directed to an ophthalmic composition for treatment of allergic conjunctivitis.” *Id.* at 2:41–42. The '154 patent describes the claimed compositions as including “at least 0.67 w/v % olopatadine, preferably dissolved in solution.” *Id.* at 2:42–45. The claimed compositions also are described as “typically includ[ing] a cyclodextrin, and more particularly, a γ -cyclodextrin derivative and/or a β -cyclodextrin derivative to aid in solubilizing the olopatadine.” *Id.* at 2:45–48. In addition, the '154 patent describes other ingredients to assist in solubilization of the olopatadine, including “a lactam polymer (e.g., polyvinylpyrrolidone (PVP))” and “a polyether (e.g., polyethylene glycol (PEG)).” *Id.* at 2:52–57. The claimed compositions also are described as including “a preservative” such as “benzalkonium chloride,” as well as “borate and/or polyol to aid in achieving desired preservation.” *Id.* at 2:60–67. In addition to the claimed compositions, the '154 patent also describes “a method of treating ocular allergy symptoms” by “topically applying [the claimed compositions] to an eye of a human,” preferably by “dispensing an eyedrop from an eyedropper.” *Id.* at 3:1–6.

E. Illustrative Claims

Of the challenged claims in the '154 patent, claims 1, 4, 8, and 21 are independent. Ex. 1001, 26:28–28:13. Independent claims 1 and 4 and dependent claim 12 are illustrative. They recite:

1. An aqueous ophthalmic solution for treatment of ocular allergic conjunctivitis, the solution comprising:
 - at least 0.67 w/v % olopatadine dissolved in the solution;
 - PEG having a molecular weight of 300 to 500;
 - polyvinylpyrrolidone;
 - hydroxypropyl- γ -cyclodextrin;
 - benzalkonium chloride; and
 - water.

Ex. 1001, 26:28–35.

4. An aqueous ophthalmic solution for treatment of ocular allergic conjunctivitis, the solution comprising:
 - at least 0.67 w/v % but no greater than 1.0 w/v % olopatadine dissolved in the solution;
 - 2.0 w/v % to 6.0 w/v % PEG having a molecular weight of 300 to 500;
 - 2.0 w/v % to 6.0 w/v % polyvinylpyrrolidone;
 - at least 0.5 w/v % but no greater than 2.0 w/v % cyclodextrin derivative selected from the group consisting of SAE- β -cyclodextrin, HP- γ -cyclodextrin, HP- β -cyclodextrin and combinations thereof; and
 - water.

Ex. 1001, 26:39–50.

12. A method of treating at least one ocular allergy symptom in humans, the method comprising:
 - topically applying to an eye of a human an amount of the solution of claim 4 sufficient to treat the at least one ocular allergy symptom.

Ex. 1001, 27:7–11.

ANALYSIS

Because the asserted grounds of unpatentability, the arguments, and the supporting evidence here are identical to those in IPR2016-00544, we adopt the analysis explained in our Decision to Institute in that case. *See Argentum Pharm. LLC v. Alcon Research, Ltd.*, Case IPR2016-00544, slip op. at 5–27 (PTAB July 18, 2016) (Paper 8). Consistent with that analysis, we determine that Petitioner has shown a reasonable likelihood of prevailing in showing the obviousness of each of the challenged claims over the combinations of Bhowmick, Yanni, and Castillo and of Schneider, Hayakawa, Bhowmick, and Castillo. Accordingly, we institute *inter partes* review. *See* 35 U.S.C. § 314(a) (permitting institution of *inter partes* review if “there is a reasonable likelihood that the petitioner would prevail with respect to at least 1 of the claims challenged in the petition”).

In addition, Petitioner moves for joinder as a party to IPR2016-00544. Paper 3. Because Petitioner has filed a Petition that we have “determine[d] warrants the institution of an *inter partes* review,” the requirements of 35 U.S.C. § 315(c) are met. Therefore, we must consider whether to exercise our discretion to join Apotex Inc. and Apotex Corp. as Petitioners to IPR2016-00544.

Apotex Inc. and Apotex Corp., together with the parties to IPR2016-00544, filed a Joint Stipulation explaining the agreement between and among them regarding the prosecution of the consolidated proceedings should joinder be granted. Paper 7. Apotex Inc. and Apotex Corp. agree not to file any papers, objections, or discovery requests separately from those filed jointly with Argentum Pharmaceuticals, the current Petitioner in IPR2016-00544. *Id.* at 2. Apotex Inc., Apotex Corp., and Argentum

IPR2016-01640
Patent 8,791,154 B2

Pharmaceuticals agree to identify a single questioning or defending attorney for each deposition, and Apotex Inc. and Apotex Corp. agree not to participate in any oral hearing in the consolidated proceedings. *Id.* at 2–3. Moreover, Apotex Inc. and Apotex Corp. agree to proceed on the evidence and arguments advanced by Argentum Pharmaceuticals and that the presence of Apotex Inc. and Apotex Corp. shall not be the basis for alteration of the schedule or page limits currently in place in IPR2016-00544. *Id.* at 3–4.

Given these concessions by Apotex Inc. and Apotex Corp., we exercise our discretion and join Apotex Inc. and Apotex Corp. as Petitioners to IPR2016-00544. We also conclude that there is no need to maintain separate proceedings. Accordingly, we consolidate the present trial with IPR2016-00544, and we terminate the trial in the present case. *See* 37 C.F.R. § 42.72 (permitting termination of trial following consolidation of trial with another proceeding).

CONCLUSION

Upon consideration of the Petition and the evidence before us, we determine that Petitioner has demonstrated a reasonable likelihood that it would prevail in showing that the claims it challenges are unpatentable on the following grounds:

Claims 1–4, 8, 12, 13, 21, and 22 as obvious over the combination of Bhowmick, Yanni, and Castillo; and

Claims 1–4, 8, 12, 13, 21, and 22 as obvious over the combination of Schneider, Hayakawa, Bhowmick, and Castillo.

IPR2016-01640
Patent 8,791,154 B2

Accordingly, we institute *inter partes* review of these claims on these grounds. The Board has not made a final determination on the patentability of any challenged claim.

We also join Petitioner as a party to IPR2016-00544, consolidate the present trial with IPR2016-00544, and terminate the present trial. The caption for IPR2016-00544 is modified to reflect the joinder of Apotex Inc. and Apotex Corp. as Petitioners in accordance with the example attached as the last page of the present Decision.

ORDER

It is hereby

ORDERED that, pursuant to 35 U.S.C. § 314, an *inter partes* review is hereby instituted to determine:

whether claims 1–4, 8, 12, 13, 21, and 22 are obvious over the combination of Bhowmick, Yanni, and Castillo; and

whether claims 1–4, 8, 12, 13, 21, and 22 are obvious over the combination of Schneider, Hayakawa, Bhowmick, and Castillo;

FURTHER ORDERED that, pursuant to 35 U.S.C. § 314(c) and 37 C.F.R. § 42.4, notice is hereby given of the institution of a trial commencing on the entry date of this decision;

FURTHER ORDERED that Petitioner is joined as a party to IPR2016-00544;

FURTHER ORDERED that the trial in this case is consolidated with IPR2016-00544;

FURTHER ORDERED that, pursuant to 37 C.F.R. § 42.72, the trial in this case is terminated;

IPR2016-01640
Patent 8,791,154 B2

FURTHER ORDERED that all further filings shall be made only in IPR2016-00544;

FURTHER ORDERED that the asserted grounds of unpatentability on which trial was instituted in IPR2016-00544 are unchanged;

FURTHER ORDERED that the current Scheduling Order for IPR2016-00544 shall continue to govern IPR2016-00544;

FURTHER ORDERED that Apotex Inc. and Apotex Corp. shall abide by the Joint Stipulation with respect to consolidated filings, discovery, and objections;

FURTHER ORDERED that all filings by Apotex Inc. and Apotex Corp. in IPR2016-00544 shall be consolidated with the filings of the other Petitioner, unless the filing involves an issue unique to Apotex Inc. and Apotex Corp. or states a point of disagreement related to the consolidated filing, and, in such circumstances, Apotex Inc. and Apotex Corp. shall seek authorization from the Board to file a separate paper;

FURTHER ORDERED that all page limits set forth in 37 C.F.R. § 42.24 will apply to all consolidated filings;

FURTHER ORDERED that Apotex Inc. and Apotex Corp. shall be bound by any discovery agreements, including deposition arrangements, between the existing parties to IPR2016-00544;

FURTHER ORDERED that Patent Owner shall not be required to provide any additional discovery or deposition time as a result of joinder;

FURTHER ORDERED that Petitioners shall resolve any disputes between them and shall contact the Board only if such matters cannot be resolved;

IPR2016-01640
Patent 8,791,154 B2

FURTHER ORDERED that the case caption in IPR2016-00544 shall be changed to reflect the joinder of Apotex Inc. and Apotex Corp. as Petitioners in accordance with the attached example; and

FURTHER ORDERED that a copy of this Decision shall be entered into the file of IPR2016-00544.

IPR2016-01640
Patent 8,791,154 B2

PETITIONER:

Michael R. Houston
Joseph P. Meara
FOLEY & LARDNER LLP
jmeara-pgp@foley.com

Teresa Stanek Rea
Deborah H. Yellin
Vincent J. Galluzzo
CROWELL & MORING LLP
trea@crowell.com
dyellin@crowell.com
vgalluzzo@crowell.com

PATENT OWNER:

David M. Krinsky
Thomas S. Fletcher
WILLIAMS & CONNOLLY LLP
dkrinsky@wc.com
tfletcher@wc.com
pazeo-IPR@wc.com

UNITED STATES PATENT AND TRADEMARK OFFICE

BEFORE THE PATENT TRIAL AND APPEAL BOARD

ARGENTUM PHARMACEUTICALS LLC,
APOTEX INC., and APOTEX CORP.,
Petitioners,

v.

ALCON RESEARCH, LTD.,
Patent Owner.

Case IPR2016-00544¹
Patent 8,791,154 B2

¹ Petitioner Apotex Inc. and Apotex Corp. from IPR2016-01640 has been joined as a Petitioner to this proceeding.

UNITED STATES PATENT AND TRADEMARK OFFICE

BEFORE THE PATENT TRIAL AND APPEAL BOARD

ARGENTUM PHARMACEUTICALS LLC,
APOTEX INC., and APOTEX CORP.,
Petitioner,

v.

ALCON RESEARCH, LTD.,
Patent Owner.

Case IPR2016-00544¹
Patent 8,791,154 B2

Before JENNIFER MEYER CHAGNON, CHRISTOPHER M. KAISER,
and CHRISTOPHER G. PAULRAJ, *Administrative Patent Judges*.

KAISER, *Administrative Patent Judge*.

ORDER
Termination of the Proceedings
35 U.S.C. § 317(a) and 37 C.F.R. § 42.72

¹ Petitioner Apotex Inc. and Apotex Corp. from IPR2016-01640 has been joined as a Petitioner to this proceeding.

On November 30, 2016, the parties filed a Joint Motion to Terminate this proceeding pursuant to 35 U.S.C. § 317(a). Paper 27. In addition, pursuant to 35 U.S.C. § 317(b) and 37 C.F.R. § 42.74(c), the parties filed true and correct copies of two separate Settlement and License Agreements. Ex. 2004; Ex. 2005. The Agreements were accompanied by joint requests to treat the Agreements as business confidential information, to be kept separate from the publicly available patent files. Paper 28; Paper 29.

Under 35 U.S.C. § 317(a), “[a]n inter partes review instituted under this chapter shall be terminated with respect to any petitioner upon the joint request of the petitioner and patent owner, unless the Office has decided the merits of the proceeding before the request for termination is filed.” In this case, the Board instituted trial on July 18, 2016, and Apotex Inc. and Apotex Corp. were joined as Petitioners on October 5, 2016. Paper 8; Paper 25. So far, Patent Owner has not filed its Patent Owner Response, and the Board has not decided the merits of the proceeding.

Under 37 C.F.R. § 42.72, “[t]he Board may terminate a trial without rendering a final written decision, where appropriate, including . . . pursuant to a joint request under 35 U.S.C. [§] 317(a).” After reviewing the Joint Motion to Terminate and the Agreements, we determine that it is appropriate to terminate the proceeding without rendering a final written decision. Therefore, the Joint Motion to Terminate is GRANTED.

IPR2016-00544
Patent 8,791,154 B2

Accordingly, it is

ORDERED that the Joint Motion to Terminate is GRANTED and this proceeding is hereby TERMINATED; and

FURTHER ORDERED that the Joint Requests that Settlement Agreements Be Treated as Business Confidential Information and Kept Separate are GRANTED, and the Settlement and License Agreements will be kept separate from the patent files.

IPR2016-00544
Patent 8,791,154 B2

PETITIONER:

Michael R. Houston
Joseph P. Meara
FOLEY & LARDNER LLP
jmeara-pgp@foley.com

Teresa Stanek Rea
Deborah H. Yellin
Vincent J. Galluzzo
CROWELL & MORING LLP
trea@crowell.com
dyellin@crowell.com
vgalluzzo@crowell.com

PATENT OWNER:

David M. Krinsky
Thomas S. Fletcher
Adam L. Perlman
Thomas H. L. Selby
Christopher J. Mandernach
WILLIAMS & CONNOLLY LLP
dkrinsky@wc.com
tfletcher@wc.com
aperlman@wc.com
tselby@wc.com
cmandernach@wc.com

AO 120 (Rev. 08/10)

TO: Mail Stop 8 Director of the U.S. Patent and Trademark Office P.O. Box 1450 Alexandria, VA 22313-1450	REPORT ON THE FILING OR DETERMINATION OF AN ACTION REGARDING A PATENT OR TRADEMARK
---	--

In Compliance with 35 U.S.C. § 290 and/or 15 U.S.C. § 1116 you are hereby advised that a court action has been filed in the U.S. District Court _____ for the District of Delaware _____ on the following

Trademarks or Patents. (the patent action involves 35 U.S.C. § 292.);

DOCKET NO. <i>16-906-SVR</i>	DATE FILED 10/6/2016	U.S. DISTRICT COURT for the District of Delaware
PLAINTIFF Alcon Research, Ltd.		DEFENDANT Apotex Inc. and Apotex Corp.
PATENT OR TRADEMARK NO.	DATE OF PATENT OR TRADEMARK	HOLDER OF PATENT OR TRADEMARK
1 8,791,154 B2	7/29/2014	Alcon Research, Ltd.
2		
3		
4		
5		

In the above—entitled case, the following patent(s)/ trademark(s) have been included:

DATE INCLUDED	INCLUDED BY <input type="checkbox"/> Amendment <input type="checkbox"/> Answer <input type="checkbox"/> Cross Bill <input type="checkbox"/> Other Pleading		
PATENT OR TRADEMARK NO.	DATE OF PATENT OR TRADEMARK	HOLDER OF PATENT OR TRADEMARK	
1			
2			
3			
4			
5			

In the above—entitled case, the following decision has been rendered or judgement issued:

DECISION/JUDGEMENT <div style="font-size: 1.2em; font-family: cursive;"> Notice of Dismissal filed on 11/30/16. </div>

CLERK <i>John A. Cerino</i>	(BY) DEPUTY CLERK <i>L Scarpato</i>	DATE 11/30/16
--------------------------------	--	------------------

Copy 1—Upon initiation of action, mail this copy to Director Copy 3—Upon termination of action, mail this copy to Director
 Copy 2—Upon filing document adding patent(s), mail this copy to Director Copy 4—Case file copy

AO 120 (Rev. 08/10)

TO: Mail Stop 8 Director of the U.S. Patent and Trademark Office P.O. Box 1450 Alexandria, VA 22313-1450	REPORT ON THE FILING OR DETERMINATION OF AN ACTION REGARDING A PATENT OR TRADEMARK
---	---

In Compliance with 35 U.S.C. § 290 and/or 15 U.S.C. § 1116 you are hereby advised that a court action has been filed in the U.S. District Court _____ for the District of Delaware _____ on the following

Trademarks or Patents. (the patent action involves 35 U.S.C. § 292.):

DOCKET NO.	DATE FILED 10/6/2016	U.S. DISTRICT COURT for the District of Delaware
PLAINTIFF Alcon Research, Ltd.		DEFENDANT Apotex Inc. and Apotex Corp.
PATENT OR TRADEMARK NO.	DATE OF PATENT OR TRADEMARK	HOLDER OF PATENT OR TRADEMARK
1 8,791,154 B2	7/29/2014	Alcon Research, Ltd.
2		
3		
4		
5		

In the above—entitled case, the following patent(s)/ trademark(s) have been included:

DATE INCLUDED	INCLUDED BY <input type="checkbox"/> Amendment <input type="checkbox"/> Answer <input type="checkbox"/> Cross Bill <input type="checkbox"/> Other Pleading	
PATENT OR TRADEMARK NO.	DATE OF PATENT OR TRADEMARK	HOLDER OF PATENT OR TRADEMARK
1		
2		
3		
4		
5		

In the above—entitled case, the following decision has been rendered or judgement issued:

DECISION/JUDGEMENT

CLERK	(BY) DEPUTY CLERK	DATE
-------	-------------------	------

Copy 1—Upon initiation of action, mail this copy to Director Copy 3—Upon termination of action, mail this copy to Director
 Copy 2—Upon filing document adding patent(s), mail this copy to Director Copy 4—Case file copy

AO 120 (Rev. 08/10)

TO: Mail Stop 8 Director of the U.S. Patent and Trademark Office P.O. Box 1450 Alexandria, VA 22313-1450	REPORT ON THE FILING OR DETERMINATION OF AN ACTION REGARDING A PATENT OR TRADEMARK
---	---

In Compliance with 35 U.S.C. § 290 and/or 15 U.S.C. § 1116 you are hereby advised that a court action has been filed in the U.S. District Court _____ for the District of Delaware _____ on the following

Trademarks or Patents. (the patent action involves 35 U.S.C. § 292.):

DOCKET NO.	DATE FILED 10/6/2016	U.S. DISTRICT COURT for the District of Delaware
PLAINTIFF Alcon Research, Ltd.		DEFENDANT Apotex Inc. and Apotex Corp.
PATENT OR TRADEMARK NO.	DATE OF PATENT OR TRADEMARK	HOLDER OF PATENT OR TRADEMARK
1 8,791,154 B2	7/29/2014	Alcon Research, Ltd.
2		
3		
4		
5		

In the above—entitled case, the following patent(s)/ trademark(s) have been included:

DATE INCLUDED	INCLUDED BY <input type="checkbox"/> Amendment <input type="checkbox"/> Answer <input type="checkbox"/> Cross Bill <input type="checkbox"/> Other Pleading	
PATENT OR TRADEMARK NO.	DATE OF PATENT OR TRADEMARK	HOLDER OF PATENT OR TRADEMARK
1		
2		
3		
4		
5		

In the above—entitled case, the following decision has been rendered or judgement issued:

DECISION/JUDGEMENT

CLERK	(BY) DEPUTY CLERK	DATE
-------	-------------------	------

Copy 1—Upon initiation of action, mail this copy to Director Copy 3—Upon termination of action, mail this copy to Director
 Copy 2—Upon filing document adding patent(s), mail this copy to Director Copy 4—Case file copy

AO 120 (Rev. 08/10)

TO: Mail Stop 8 Director of the U.S. Patent and Trademark Office P.O. Box 1450 Alexandria, VA 22313-1450	REPORT ON THE FILING OR DETERMINATION OF AN ACTION REGARDING A PATENT OR TRADEMARK
--	---

In Compliance with 35 U.S.C. § 290 and/or 15 U.S.C. § 1116 you are hereby advised that a court action has been filed in the U.S. District Court _____ for the District of Delaware _____ on the following

Trademarks or Patents. (the patent action involves 35 U.S.C. § 292.);

DOCKET NO.	DATE FILED 8/31/2017	U.S. DISTRICT COURT for the District of Delaware
PLAINTIFF ALCON RESEARCH, LTD.		DEFENDANT CIPLA LIMITED and CIPLA USA, INC.
PATENT OR TRADEMARK NO.	DATE OF PATENT OR TRADEMARK	HOLDER OF PATENT OR TRADEMARK
1 8,791,154 B2	7/29/2014	Alcon Research, Ltd.
2 9,533,053 B2	1/3/2017	Alcon Research, Ltd.
3		
4		
5		

In the above—entitled case, the following patent(s)/ trademark(s) have been included:

DATE INCLUDED	INCLUDED BY <input type="checkbox"/> Amendment <input type="checkbox"/> Answer <input type="checkbox"/> Cross Bill <input type="checkbox"/> Other Pleading	
PATENT OR TRADEMARK NO.	DATE OF PATENT OR TRADEMARK	HOLDER OF PATENT OR TRADEMARK
1		
2		
3		
4		
5		

In the above—entitled case, the following decision has been rendered or judgement issued:

DECISION/JUDGEMENT

CLERK	(BY) DEPUTY CLERK	DATE
-------	-------------------	------

Copy 1—Upon initiation of action, mail this copy to Director Copy 3—Upon termination of action, mail this copy to Director
 Copy 2—Upon filing document adding patent(s), mail this copy to Director Copy 4—Case file copy

AO 120 (Rev. 08/10)

TO: Mail Stop 8 Director of the U.S. Patent and Trademark Office P.O. Box 1450 Alexandria, VA 22313-1450	REPORT ON THE FILING OR DETERMINATION OF AN ACTION REGARDING A PATENT OR TRADEMARK
--	---

In Compliance with 35 U.S.C. § 290 and/or 15 U.S.C. § 1116 you are hereby advised that a court action has been filed in the U.S. District Court _____ for the District of Delaware _____ on the following

Trademarks or Patents. (the patent action involves 35 U.S.C. § 292.);

DOCKET NO.	DATE FILED 8/31/2017	U.S. DISTRICT COURT for the District of Delaware
PLAINTIFF ALCON RESEARCH, LTD.		DEFENDANT CIPLA LIMITED and CIPLA USA, INC.
PATENT OR TRADEMARK NO.	DATE OF PATENT OR TRADEMARK	HOLDER OF PATENT OR TRADEMARK
1 8,791,154 B2	7/29/2014	Alcon Research, Ltd.
2 9,533,053 B2	1/3/2017	Alcon Research, Ltd.
3		
4		
5		

In the above—entitled case, the following patent(s)/ trademark(s) have been included:

DATE INCLUDED	INCLUDED BY <input type="checkbox"/> Amendment <input type="checkbox"/> Answer <input type="checkbox"/> Cross Bill <input type="checkbox"/> Other Pleading	
PATENT OR TRADEMARK NO.	DATE OF PATENT OR TRADEMARK	HOLDER OF PATENT OR TRADEMARK
1		
2		
3		
4		
5		

In the above—entitled case, the following decision has been rendered or judgement issued:

DECISION/JUDGEMENT

CLERK	(BY) DEPUTY CLERK	DATE
-------	-------------------	------

Copy 1—Upon initiation of action, mail this copy to Director Copy 3—Upon termination of action, mail this copy to Director
 Copy 2—Upon filing document adding patent(s), mail this copy to Director Copy 4—Case file copy