



US007237117B2

(12) **United States Patent**
Weiss

(10) **Patent No.:** **US 7,237,117 B2**
(45) **Date of Patent:** **Jun. 26, 2007**

- (54) **UNIVERSAL SECURE REGISTRY**
- (75) Inventor: **Kenneth P. Weiss**, 59 Sargent St.,
Newton, MA (US) 02158
- (73) Assignee: **Kenneth P. Weiss**, Newton, MA (US)
- (*) Notice: Subject to any disclaimer, the term of this
patent is extended or adjusted under 35
U.S.C. 154(b) by 814 days.
- (21) Appl. No.: **09/810,703**
- (22) Filed: **Mar. 16, 2001**

6,253,202	B1 *	6/2001	Gilmour	707/9
6,253,203	B1 *	6/2001	O'Flaherty et al.	707/9
6,260,039	B1 *	7/2001	Schneck et al.	707/10
6,308,203	B1 *	10/2001	Itabashi et al.	709/217
6,393,421	B1 *	5/2002	Paglin	707/9
6,516,315	B1 *	2/2003	Gupta	707/9
6,546,005	B1 *	4/2003	Berkley et al.	370/353
6,581,059	B1 *	6/2003	Barrett et al.	707/9
6,640,211	B1 *	10/2003	Holden	705/1
6,658,400	B2 *	12/2003	Perell et al.	707/1
6,845,448	B1 *	1/2005	Chaganti et al.	713/166
6,941,271	B1 *	9/2005	Soong	705/3
2001/0032100	A1 *	10/2001	Mahmud et al.	705/2
2002/0046061	A1 *	4/2002	Wright et al.	705/3
2004/0117215	A1 *	6/2004	Marchosky	705/3

(65) **Prior Publication Data**
US 2002/0178364 A1 Nov. 28, 2002

* cited by examiner

- (51) **Int. Cl.**
H04K 1/00 (2006.01)
H04L 9/00 (2006.01)
- (52) **U.S. Cl.** **713/182**; 707/1; 707/3;
707/9; 726/2; 726/4; 726/5; 726/17; 726/18;
726/21
- (58) **Field of Classification Search** 713/182,
713/200-202; 707/1, 2, 9, 10, 3; 705/2,
705/3, 77, 78, 79; 709/9; 726/2, 4, 5, 17,
726/18, 21
See application file for complete search history.

Primary Examiner—Kim Vu
Assistant Examiner—Beemnet W Dada
(74) *Attorney, Agent, or Firm*—Lowrie, Lando & Anastasi,
LLP.

- (56) **References Cited**
U.S. PATENT DOCUMENTS
5,058,161 A * 10/1991 Weiss 380/270
5,168,520 A * 12/1992 Weiss 713/184
5,657,388 A * 8/1997 Weiss 713/185
5,664,109 A * 9/1997 Johnson et al. 705/2
5,813,006 A * 9/1998 Polnerow et al. 707/10
5,915,023 A * 6/1999 Bernstein 705/75
6,073,106 A * 6/2000 Rozen et al. 705/3

(57) **ABSTRACT**
A secure registry system and method for the use thereof are provided which permits secure access to a database containing selected data on a plurality of entities, at least portions of which database has restricted access. Mechanisms are provided for controlling access to restricted access portions of the database are provided, such access being determined by at least one of the identity of the requesting entity and the entity's status. A multicharacter public code may be provided which the system can map to provide permit delivery of items, complete telephone calls and perform other functions for entities. The system may also be utilized to locate an individual based on limited biological data. Organizations utilizing the system may have custom software facilitating their access and use of the system.

12 Claims, 14 Drawing Sheets

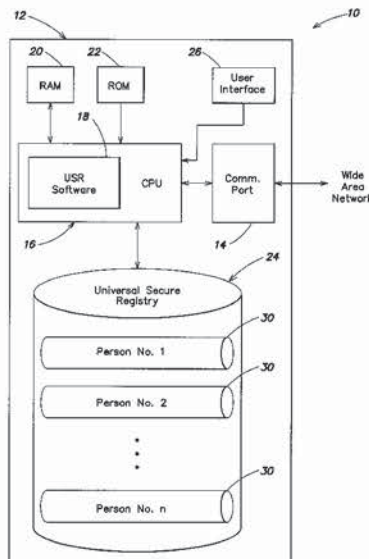

APPENDIX 1104

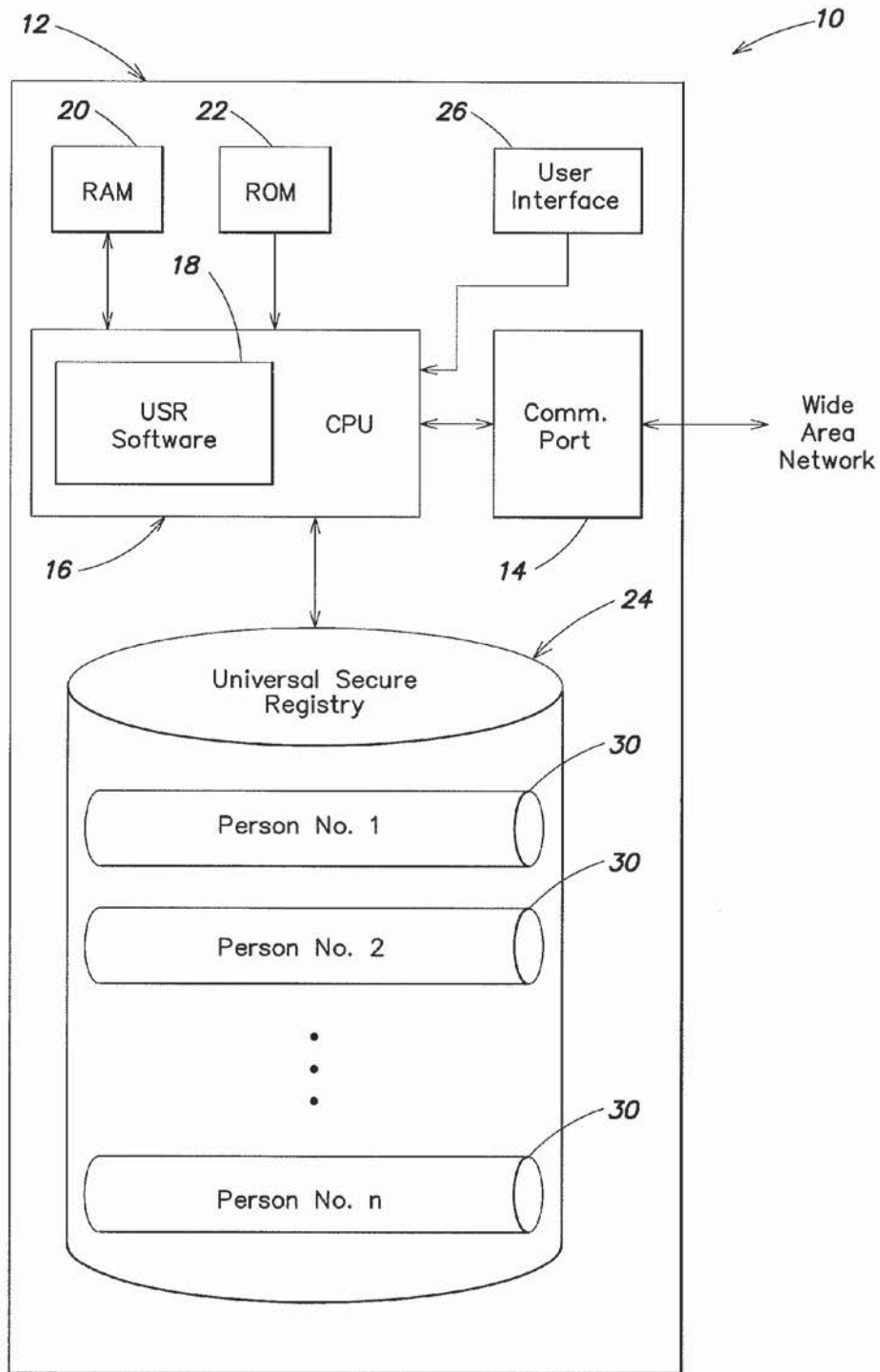

FIG. 1

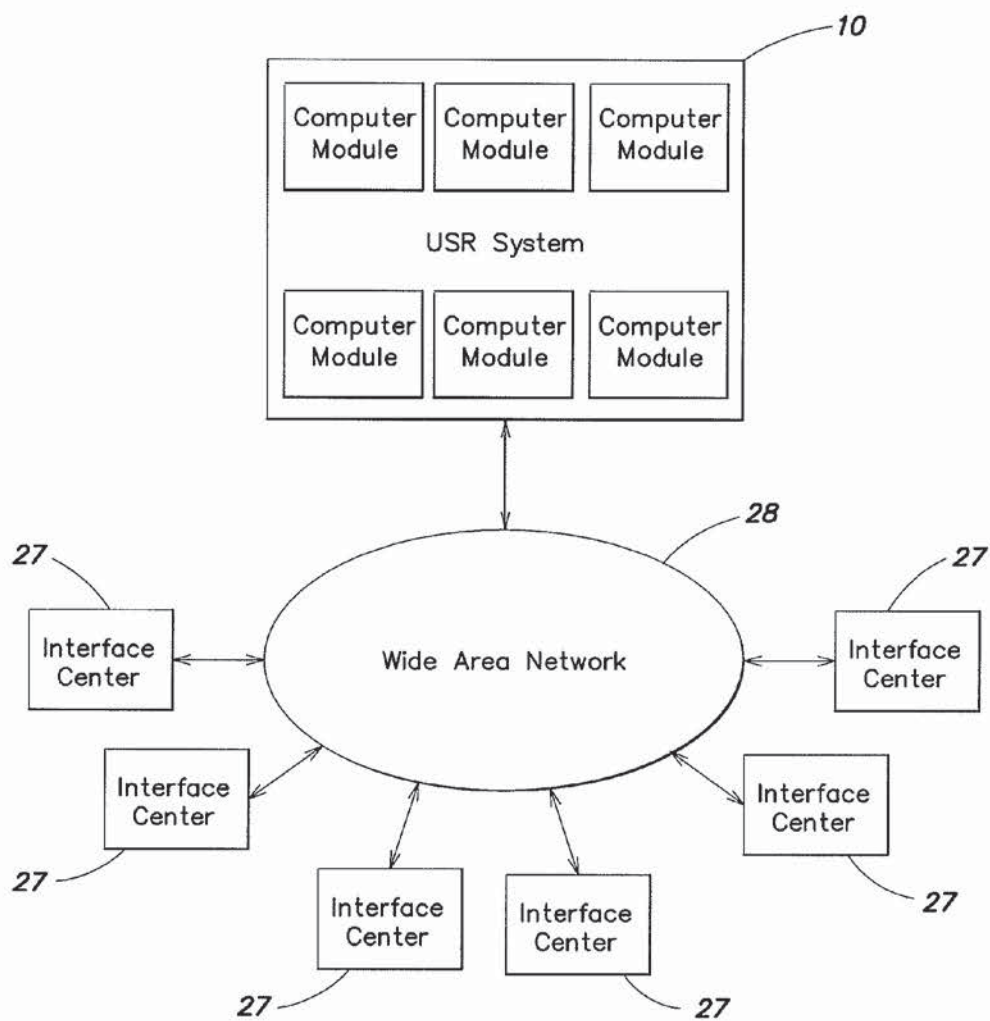

FIG. 2

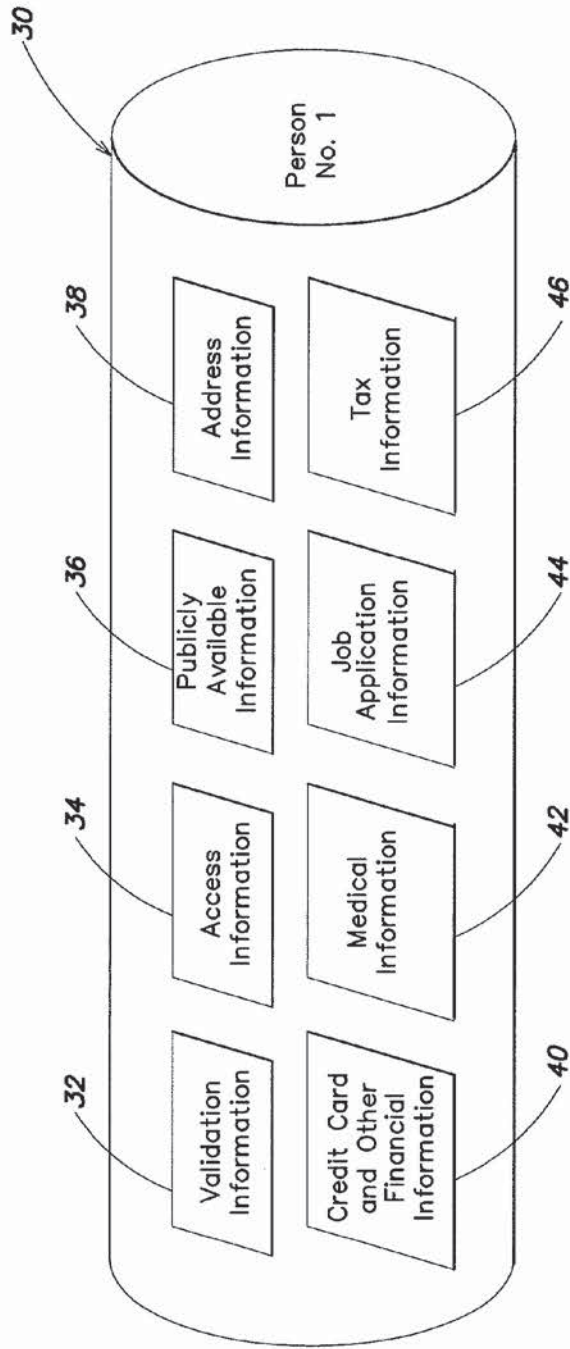

FIG. 3

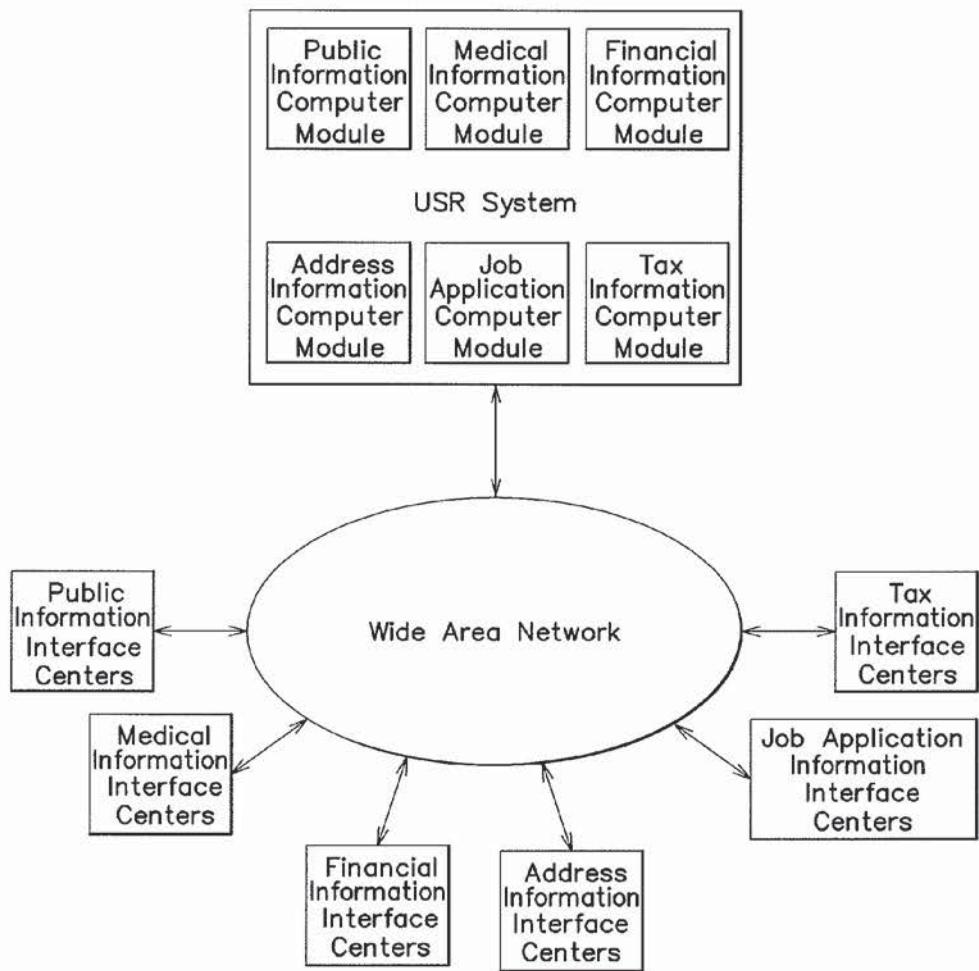

FIG. 4

Explore Litigation Insights

Docket Alarm provides insights to develop a more informed litigation strategy and the peace of mind of knowing you're on top of things.

Real-Time Litigation Alerts



Keep your litigation team up-to-date with **real-time alerts** and advanced team management tools built for the enterprise, all while greatly reducing PACER spend.

Our comprehensive service means we can handle Federal, State, and Administrative courts across the country.

Advanced Docket Research



With over 230 million records, Docket Alarm's cloud-native docket research platform finds what other services can't. Coverage includes Federal, State, plus PTAB, TTAB, ITC and NLRB decisions, all in one place.

Identify arguments that have been successful in the past with full text, pinpoint searching. Link to case law cited within any court document via Fastcase.

Analytics At Your Fingertips



Learn what happened the last time a particular judge, opposing counsel or company faced cases similar to yours.

Advanced out-of-the-box PTAB and TTAB analytics are always at your fingertips.

API

Docket Alarm offers a powerful API (application programming interface) to developers that want to integrate case filings into their apps.

LAW FIRMS

Build custom dashboards for your attorneys and clients with live data direct from the court.

Automate many repetitive legal tasks like conflict checks, document management, and marketing.

FINANCIAL INSTITUTIONS

Litigation and bankruptcy checks for companies and debtors.

E-DISCOVERY AND LEGAL VENDORS

Sync your system to PACER to automate legal marketing.