

(19) **United States**

(12) **Patent Application Publication**
Seeger et al.

(10) **Pub. No.: US 2002/0075389 A1**

(43) **Pub. Date: Jun. 20, 2002**

(54) **APPARATUS AND METHOD FOR CAPTURING A DIGITAL IMAGE**

Publication Classification

(75) Inventors: **Mauritius Seeger, Royston (GB);
Stuart A. Taylor, Cambridge (GB)**

(51) **Int. Cl.⁷ H04N 5/228**
(52) **U.S. Cl. 348/222**

Correspondence Address:
**John E. Beck
Xerox Corporation
Xerox Square-20A
Rochester, NY 14644 (US)**

(57) **ABSTRACT**

A camera apparatus obtains a sharp, high-resolution image of an object which is difficult to focus in a single image at a fixed focus, such as the imaging of a document using a document camera held at an oblique angle to the document. The apparatus composites an image of an object from plural image segments of the object acquired at different focusing distances. High quality regions (i.e. sharply focused and/or high resolution) are extracted from each image to form the segments for compositing.

(73) Assignee: **Xerox Corporation**

(21) Appl. No.: **09/737,965**

(22) Filed: **Dec. 18, 2000**

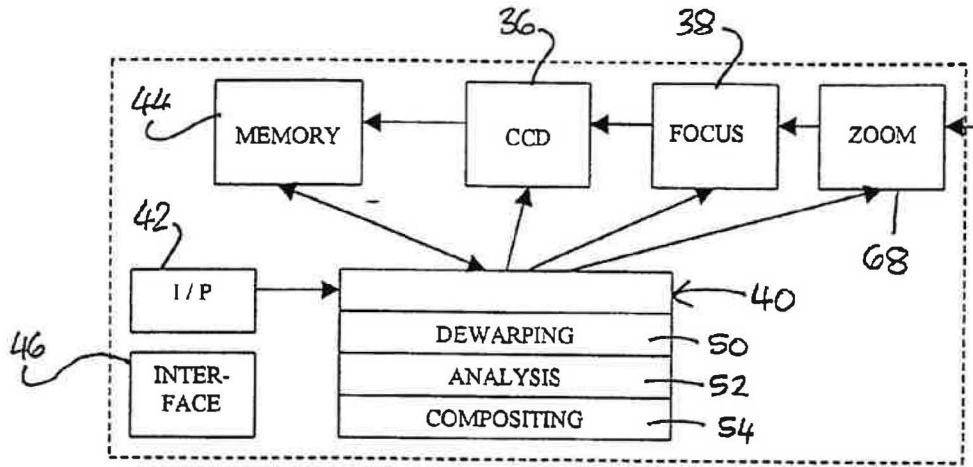

exocad GmbH, et al.
Exhibit 1011

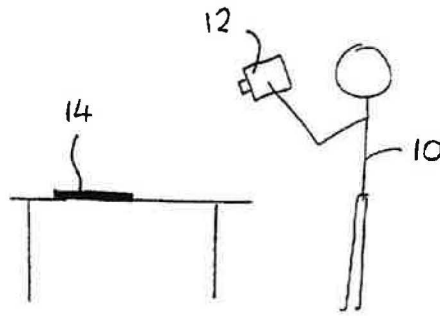

FIG. 1

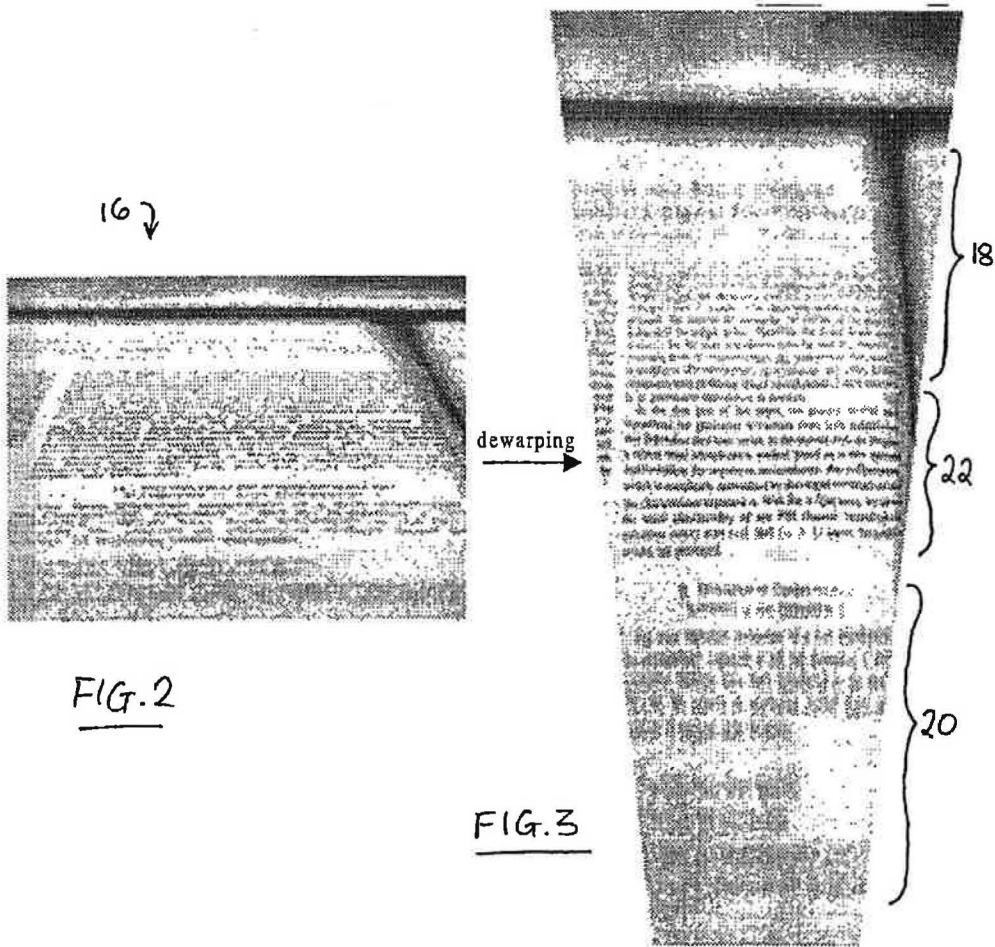
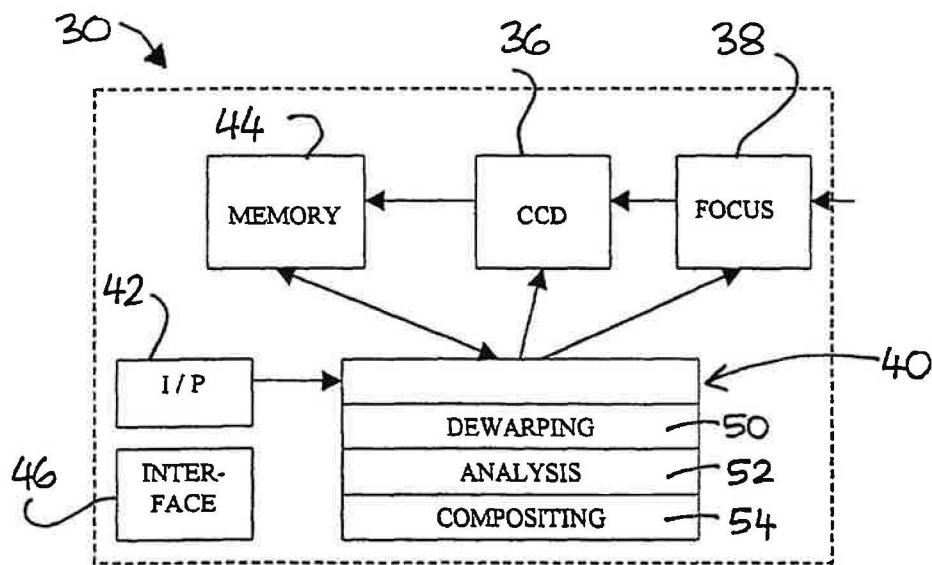
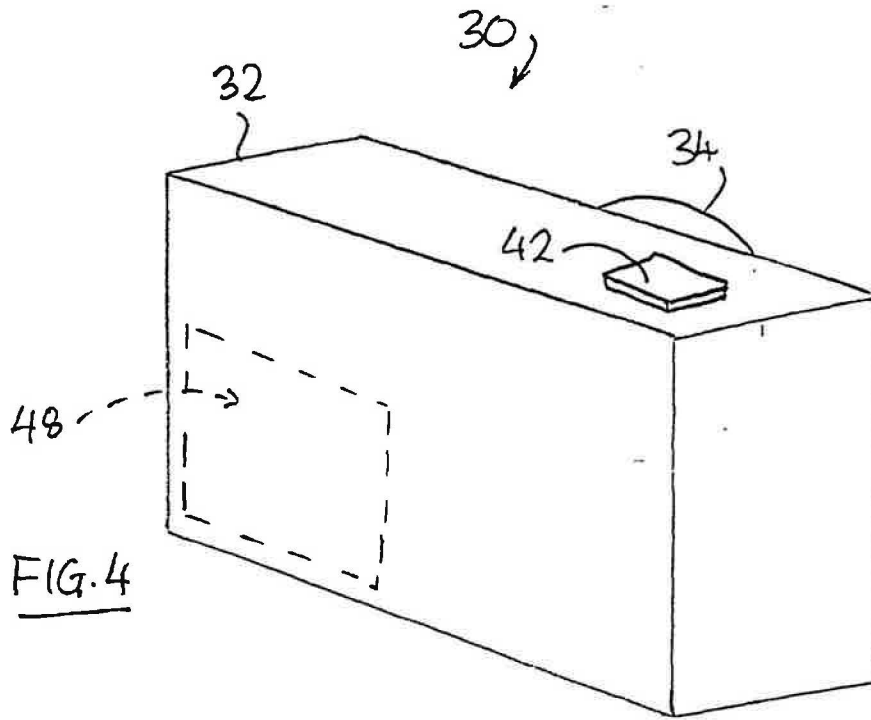

FIG. 2

FIG. 3



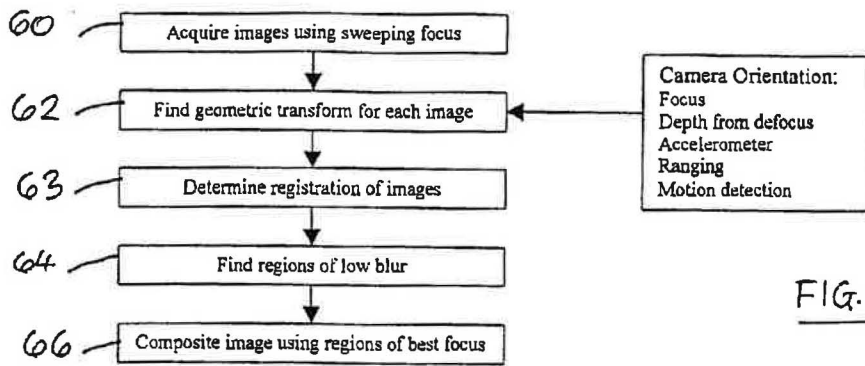

FIG. 6

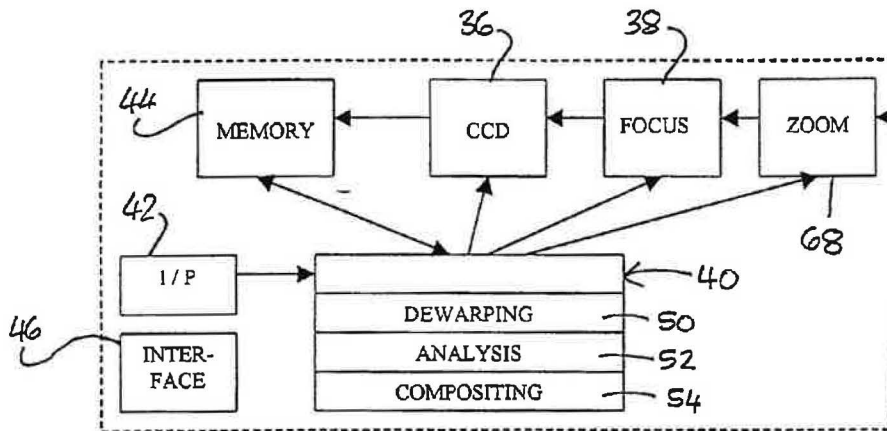

FIG. 7

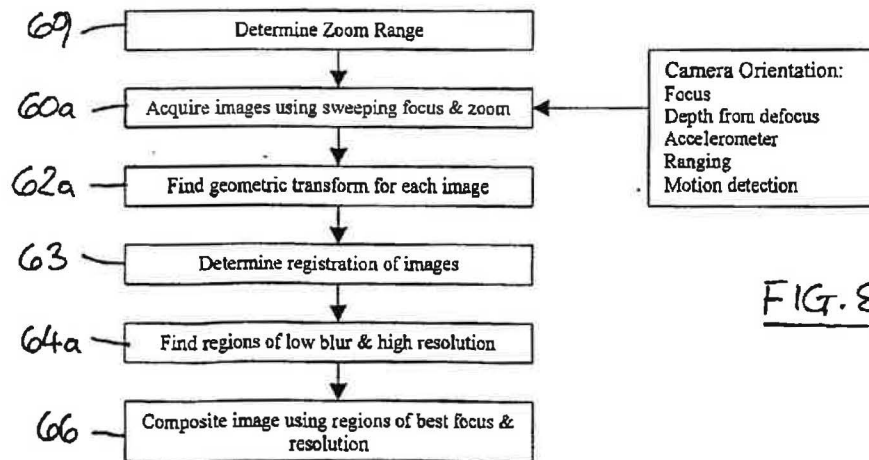
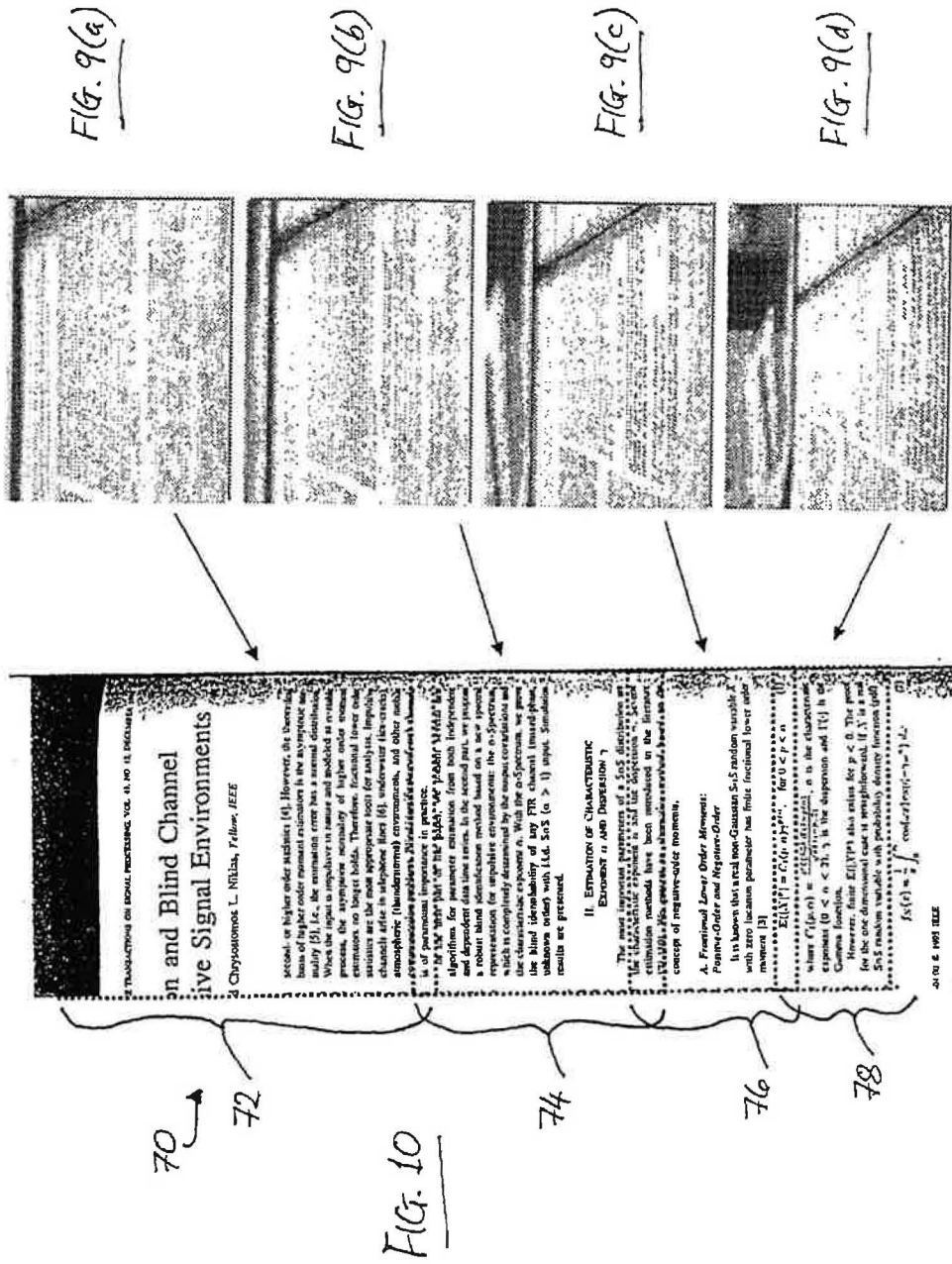

FIG. 8



Explore Litigation Insights

Docket Alarm provides insights to develop a more informed litigation strategy and the peace of mind of knowing you're on top of things.

Real-Time Litigation Alerts



Keep your litigation team up-to-date with **real-time alerts** and advanced team management tools built for the enterprise, all while greatly reducing PACER spend.

Our comprehensive service means we can handle Federal, State, and Administrative courts across the country.

Advanced Docket Research



With over 230 million records, Docket Alarm's cloud-native docket research platform finds what other services can't. Coverage includes Federal, State, plus PTAB, TTAB, ITC and NLRB decisions, all in one place.

Identify arguments that have been successful in the past with full text, pinpoint searching. Link to case law cited within any court document via Fastcase.

Analytics At Your Fingertips



Learn what happened the last time a particular judge, opposing counsel or company faced cases similar to yours.

Advanced out-of-the-box PTAB and TTAB analytics are always at your fingertips.

API

Docket Alarm offers a powerful API (application programming interface) to developers that want to integrate case filings into their apps.

LAW FIRMS

Build custom dashboards for your attorneys and clients with live data direct from the court.

Automate many repetitive legal tasks like conflict checks, document management, and marketing.

FINANCIAL INSTITUTIONS

Litigation and bankruptcy checks for companies and debtors.

E-DISCOVERY AND LEGAL VENDORS

Sync your system to PACER to automate legal marketing.