



US006347122B1

(12) **United States Patent**
Chen et al.

(10) **Patent No.:** **US 6,347,122 B1**
(45) **Date of Patent:** **Feb. 12, 2002**

(54) **OPTIMAL COMPLEMENT PUNCTURED CONVOLUTIONAL CODES FOR USE IN DIGITAL AUDIO BROADCASTING AND OTHER APPLICATIONS**

(75) Inventors: **Brian Chen**, Somerville, MA (US);
Carl-Erik Wilhelm Sundberg, Chatham, NJ (US)

(73) Assignee: **Agere Systems Guardian Corp.**, Orlando, FL (US)

(*) Notice: Subject to any disclaimer, the term of this patent is extended or adjusted under 35 U.S.C. 154(b) by 0 days.

(21) Appl. No.: **09/006,570**

(22) Filed: **Jan. 13, 1998**

(51) Int. Cl.⁷ **H04L 5/12**

(52) U.S. Cl. **375/262; 375/219; 375/265; 375/270; 375/296**

(58) **Field of Search** **375/262, 340, 375/265, 270, 296, 216; 371/43.1; 714/786, 774, 755, 790, 792**

(56) **References Cited**

U.S. PATENT DOCUMENTS

5,844,922 A	*	12/1998	Wolf et al.	371/43.1
5,909,454 A	*	6/1999	Schmidt	371/43.1
5,910,182 A	*	6/1999	Dent et al.	714/786
5,949,796 A	*	9/1999	Kumar	370/529
6,005,894 A	*	12/1999	Kumar	375/270

OTHER PUBLICATIONS

1. B.W. Kroeger and A.J. Vigil, "Improved IBOC DAB Technology for AM and FM Broadcasting," SBE Engineering Conference, pp. 1-10, 1996.
2. B.W. Kroeger and D. Cammarata, "Robust Modem and Coding Techniques for FM Hybrid IBOC DAB," IEEE Transactions on Broadcasting, vol. 43, No. 4, pp. 412-420, Dec. 1997.

3. B.W. Kroeger and P.J. Peyla, "Compatibility of FM Hybrid In-Band On-Channel (IBOC) System for Digital Audio Broadcast," IEEE Transactions on Broadcasting, vol. 43, No. 4, pp. 421-430, Dec. 1997.

4. Y. Yasuda, K. Kashiki and Y. Hirata, "High-rate punctured convolutional codes for soft decision Viterbi decoding," IEEE Transactions on Communications, vol. 32, Mar. 1984.

5. S. Kallel, "Complementary Punctured Convolutional Codes and Their Applications," IEEE Transactions on Communications, vol. 43, No. 6, pp. 2005-2009, Jun. 1995.

6. J. Hagenauer et al., "The Performance of Rate-Compatible Punctured Convolutional Codes for Digital Mobile Radio," IEEE Transactions on Communications, vol. 38, No. 7, pp. 966-980, Jul. 1990.

(List continued on next page.)

Primary Examiner—Stephen Chin

Assistant Examiner—Shuwang Liu

(74) *Attorney, Agent, or Firm*—Ryan, Mason & Lewis, LLP

(57) **ABSTRACT**

The invention provides optimal complementary punctured convolutional codes for coding information bits in a communication system. In an illustrative embodiment, an optimal pair of complementary punctured codes is selected from a set of potential code pairs. The set of potential code pairs includes all non-catastrophic complementary punctured code pairs which combine to produce to a specified full-bandwidth code, and thus includes both equivalent and non-equivalent complementary codes. The optimal code pair may be selected, for example, as the pair of equivalent or non-equivalent codes which has the best free Hamming distance and minimum information error weight of all the pairs in the set. In addition, the invention provides both rate-compatible and rate-incompatible codes suitable for use in providing unequal error protection (UEP) for different classes of information bits. The invention further provides optimal bit assignment techniques for use in digital audio broadcasting or other applications in which digital information is transmitted on subcarriers in both an upper and a lower sideband of an analog carrier.

45 Claims, 3 Drawing Sheets

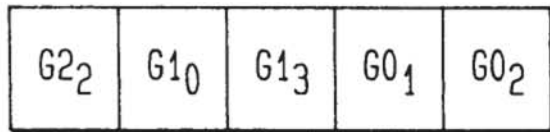

LOWER SIDEBAND

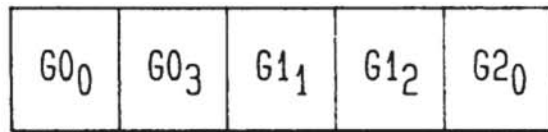

UPPER SIDEBAND

OTHER PUBLICATIONS

7. J. Hagenauer, "Rate Compatible Punctured Convolutional Codes (RCPC Codes) and their Applications," IEEE Transactions on Communications, vol. 36, No. 4, pp. 389-400, Apr. 1988.

8. R.V. Cox et al., "Sub-band Speech Coding and Matched Convolutional Channel Coding for Mobile Radio Chan-

nels," IEEE Transactions on Acoustics, Speech and Signal Processing, vol. 39, No. 8, pp. 1717-1731, Aug. 1991.

9. A.R. Calderbank and N. Seshadri, "Multilevel Codes for Unequal Error Protection," IEEE Transactions on Information Theory, vol. 39, No. 4, pp. 1234-1248, Jul. 1993.

* cited by examiner

FIG. 1
(PRIOR ART)

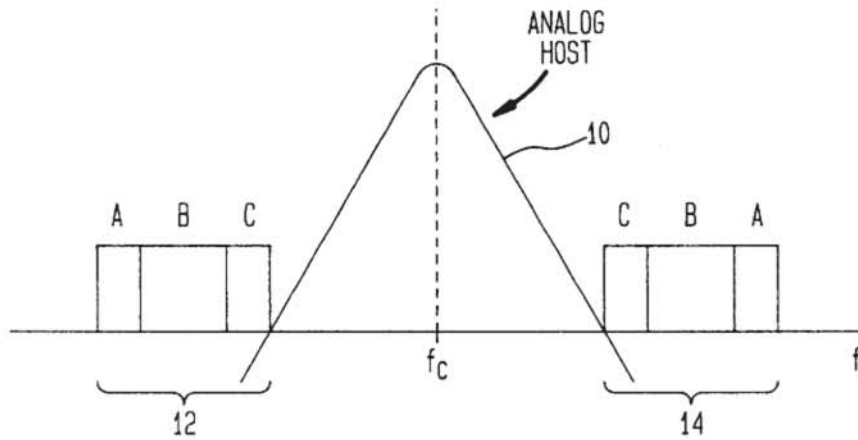

FIG. 2

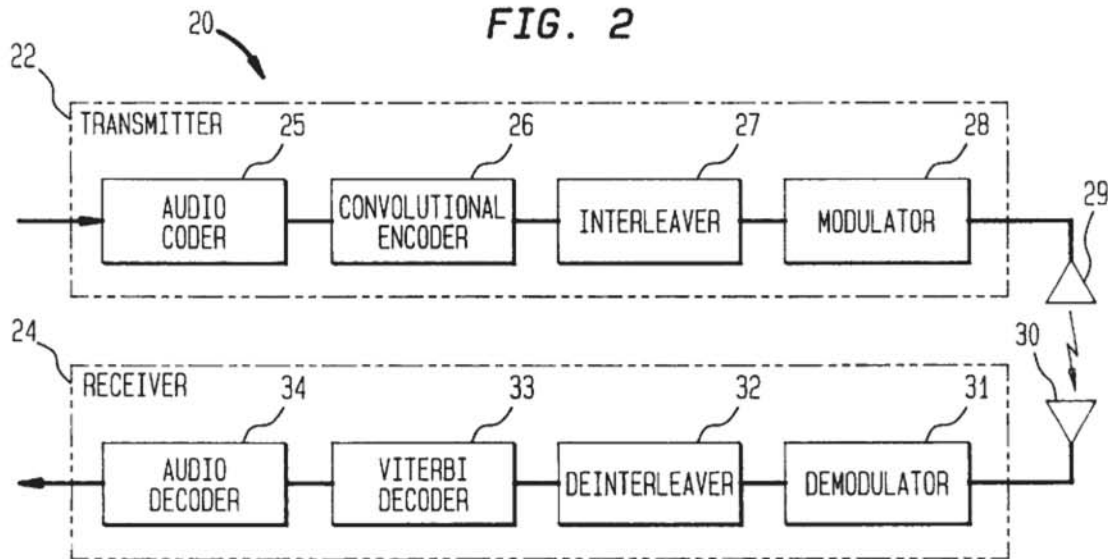
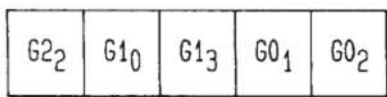
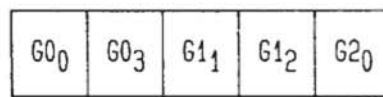

FIG. 3A



LOWER SIDEBAND

FIG. 3B



UPPER SIDEBAND

FIG. 4

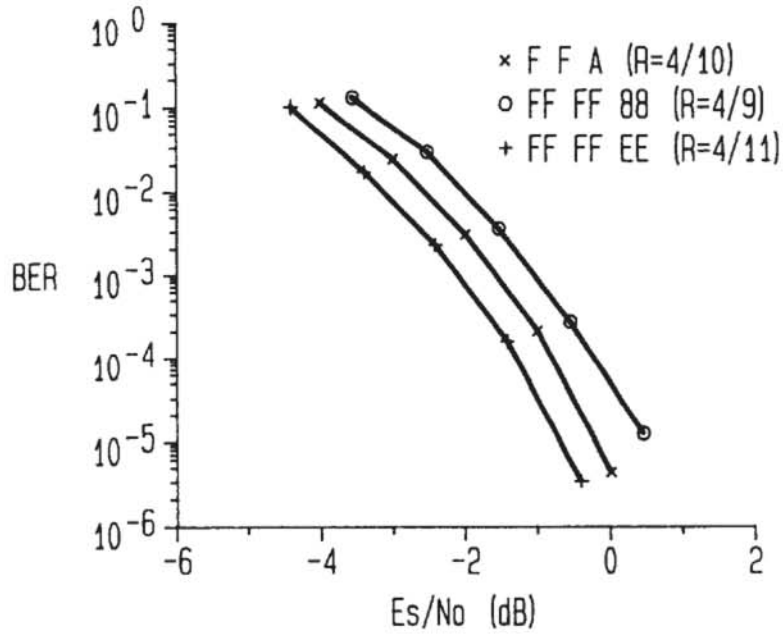

FIG. 5

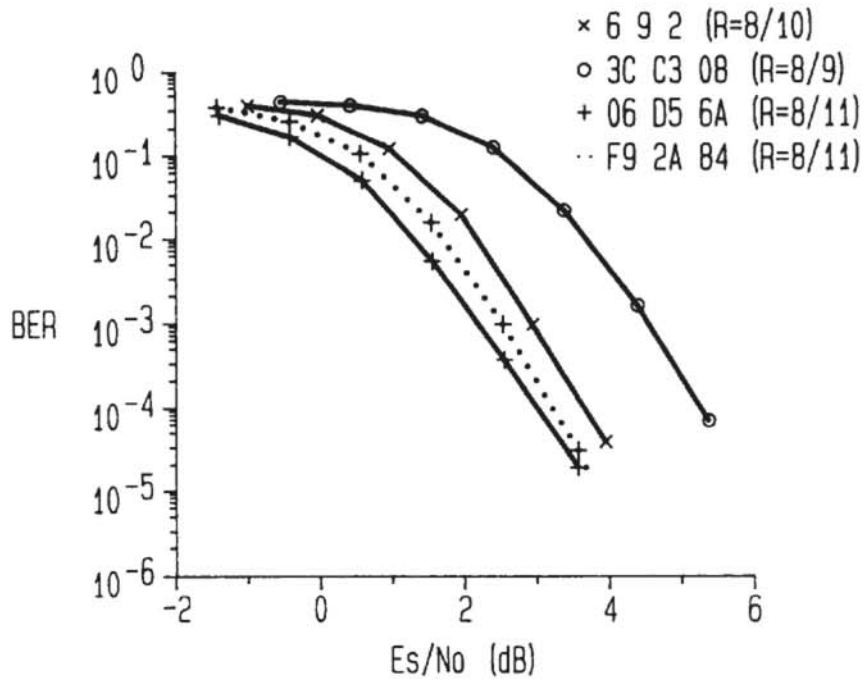

FIG. 6

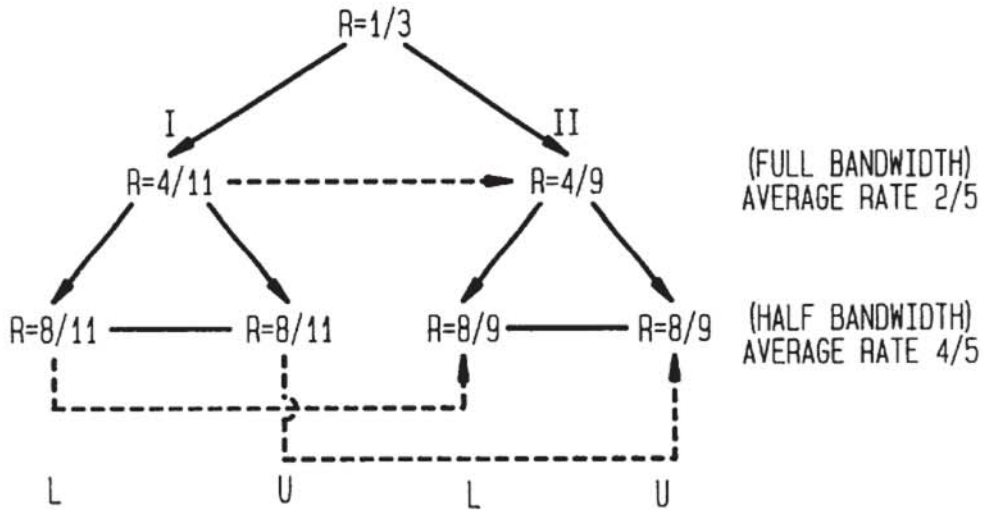
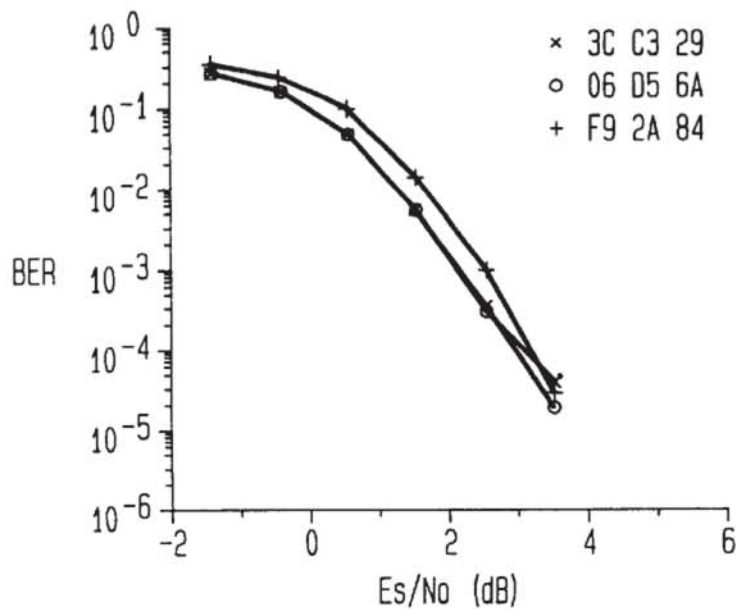

FIG. 7



Explore Litigation Insights

Docket Alarm provides insights to develop a more informed litigation strategy and the peace of mind of knowing you're on top of things.

Real-Time Litigation Alerts



Keep your litigation team up-to-date with **real-time alerts** and advanced team management tools built for the enterprise, all while greatly reducing PACER spend.

Our comprehensive service means we can handle Federal, State, and Administrative courts across the country.

Advanced Docket Research



With over 230 million records, Docket Alarm's cloud-native docket research platform finds what other services can't. Coverage includes Federal, State, plus PTAB, TTAB, ITC and NLRB decisions, all in one place.

Identify arguments that have been successful in the past with full text, pinpoint searching. Link to case law cited within any court document via Fastcase.

Analytics At Your Fingertips



Learn what happened the last time a particular judge, opposing counsel or company faced cases similar to yours.

Advanced out-of-the-box PTAB and TTAB analytics are always at your fingertips.

API

Docket Alarm offers a powerful API (application programming interface) to developers that want to integrate case filings into their apps.

LAW FIRMS

Build custom dashboards for your attorneys and clients with live data direct from the court.

Automate many repetitive legal tasks like conflict checks, document management, and marketing.

FINANCIAL INSTITUTIONS

Litigation and bankruptcy checks for companies and debtors.

E-DISCOVERY AND LEGAL VENDORS

Sync your system to PACER to automate legal marketing.