



US007260835B2

(12) **United States Patent**
Bajkar

(10) **Patent No.:** **US 7,260,835 B2**
(45) **Date of Patent:** **Aug. 21, 2007**

(54) **BLUETOOTH™ BASED SECURITY SYSTEM**

(75) Inventor: **Sundee M. Bajkar**, Sunnyvale, CA (US)

(73) Assignee: **Intel Corporation**, Santa Clara, CA (US)

(*) Notice: Subject to any disclaimer, the term of this patent is extended or adjusted under 35 U.S.C. 154(b) by 693 days.

(21) Appl. No.: **09/883,403**

(22) Filed: **Jun. 19, 2001**

(65) **Prior Publication Data**

US 2002/0194500 A1 Dec. 19, 2002

(51) **Int. Cl.**

H04L 9/00 (2006.01)
G06F 15/16 (2006.01)
G06F 21/20 (2006.01)

(52) **U.S. Cl.** **726/4; 726/1; 726/14**

(58) **Field of Classification Search** 713/200–202; 705/56; 340/568.1, 571, 426.18, 426.19
See application file for complete search history.

(56) **References Cited**

U.S. PATENT DOCUMENTS

5,963,134	A *	10/1999	Bowers et al.	340/572.1
6,317,028	B1 *	11/2001	Valiulis	340/10.1
6,418,533	B2 *	7/2002	Angelo et al.	713/202
6,433,685	B1 *	8/2002	Struble et al.	340/571
6,574,455	B2 *	6/2003	Jakobsson et al.	455/41.2
6,609,656	B1 *	8/2003	Elledge	235/382
6,647,497	B1 *	11/2003	Cromer et al.	713/200
6,771,933	B1 *	8/2004	Eng et al.	455/41.2
6,772,331	B1 *	8/2004	Hind et al.	713/151
6,778,809	B2 *	8/2004	Morimoto	455/11.1
6,785,542	B1 *	8/2004	Blight et al.	455/426.1

2003/0051052	A1 *	3/2003	Shteyn et al.	709/245
2003/0092383	A1 *	5/2003	Moles et al.	455/41
2003/0095524	A1 *	5/2003	Stephens et al.	370/338
2004/0109441	A1 *	6/2004	Hur et al.	370/352
2005/0057370	A1 *	3/2005	Warrior et al.	340/870.01
2005/0076242	A1 *	4/2005	Breuer	713/201
2005/0283645	A1 *	12/2005	Turner et al.	714/4
2006/0236364	A1 *	10/2006	Suni et al.	726/1

OTHER PUBLICATIONS

Gehmann, "Bluetooth Security White Paper", Apr. 19, 2004, Bluetooth SIG Security Expert Group, p. 1-46.*
Miller, "Mapping Salutation Architecture APIs to Bluetooth Service Discovery Layer", Jul. 1, 1999, Bluetooth Special Interest Group, p. 1-26.*
Johansson et al, "JUMP Mode—A Dynamic Window-Based Scheduling Framework for Bluetooth Scatternets", Oct. 2001, ACM, p. 204-211.*

* cited by examiner

Primary Examiner—Christopher Revak

(74) *Attorney, Agent, or Firm*—Cyndi M. Wheeler

(57) **ABSTRACT**

A Bluetooth based security system utilized to provide ad-hoc security services to secured assets. Such a Bluetooth based security system comprises a secured device (SD) equipped with Bluetooth (BT) technology; a plurality of Bluetooth Access Points (BTAPs) located at designated points to establish a BT link with the secured device (SD); and a security server (SS) connected to all BTAPs and arranged to provide access control and security services for the secured device (SD), wherein the security server (SS) obtains attribute information of the secured device (SD), including an unique device identification (ID) and a last known location of the secured device (SD), activates a lock with the secured device (SD), and sends location information of a designated BTAP and an unlock code to the secured device (SD), via the designated BTAP.

30 Claims, 6 Drawing Sheets

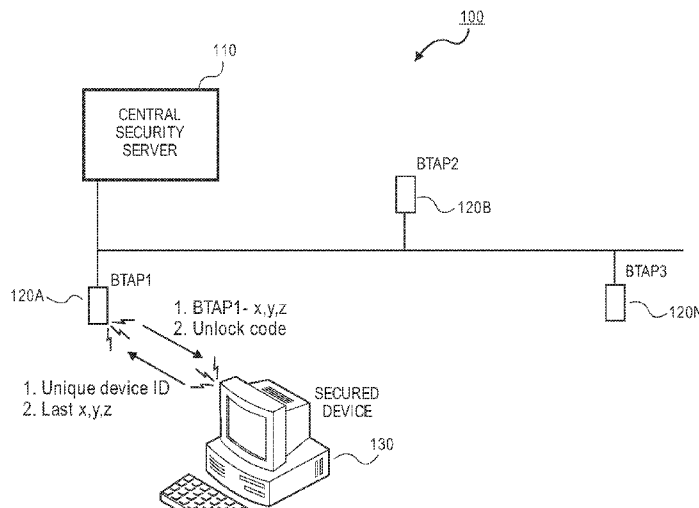

FIG. 1

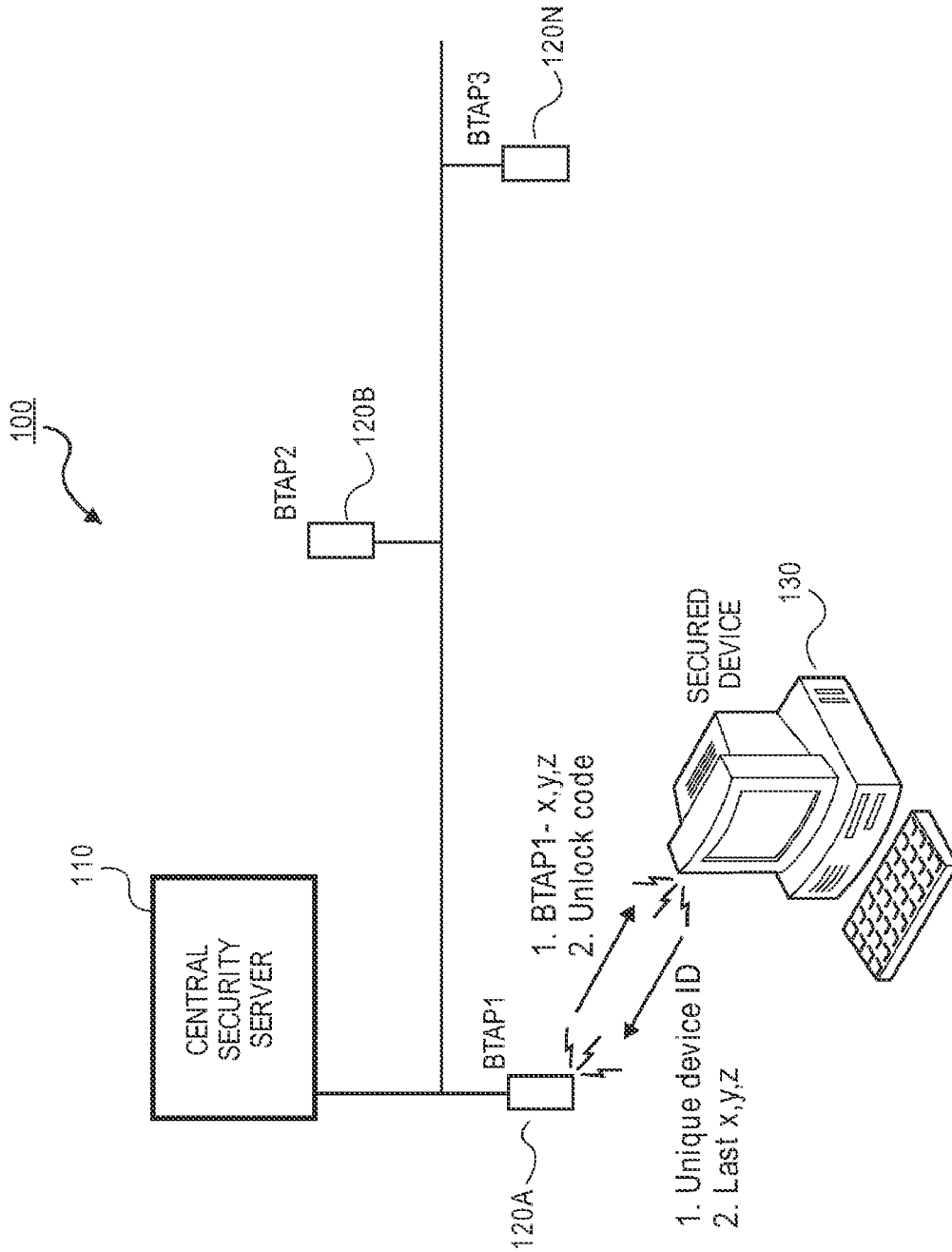

FIG. 2

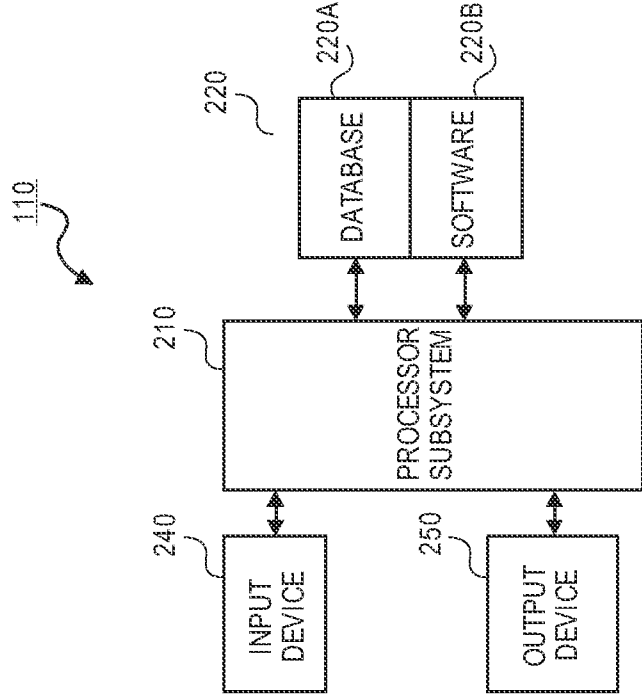

FIG. 3

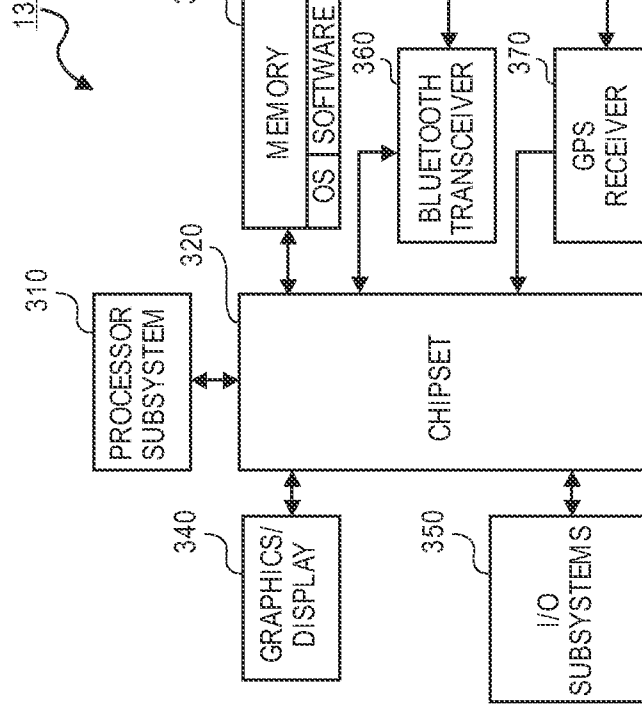

FIG. 4

360

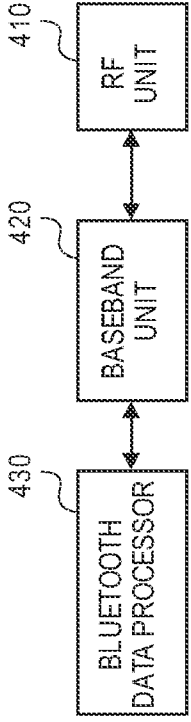

FIG. 5

370

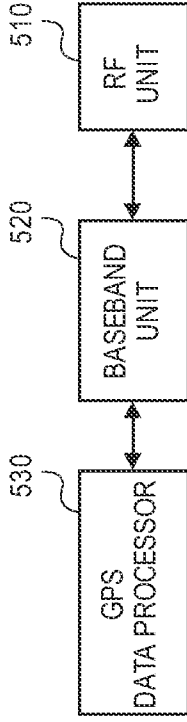

FIG. 6

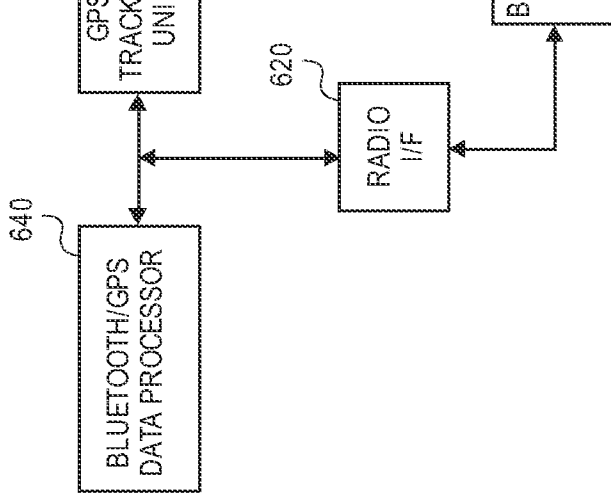

FIG. 7

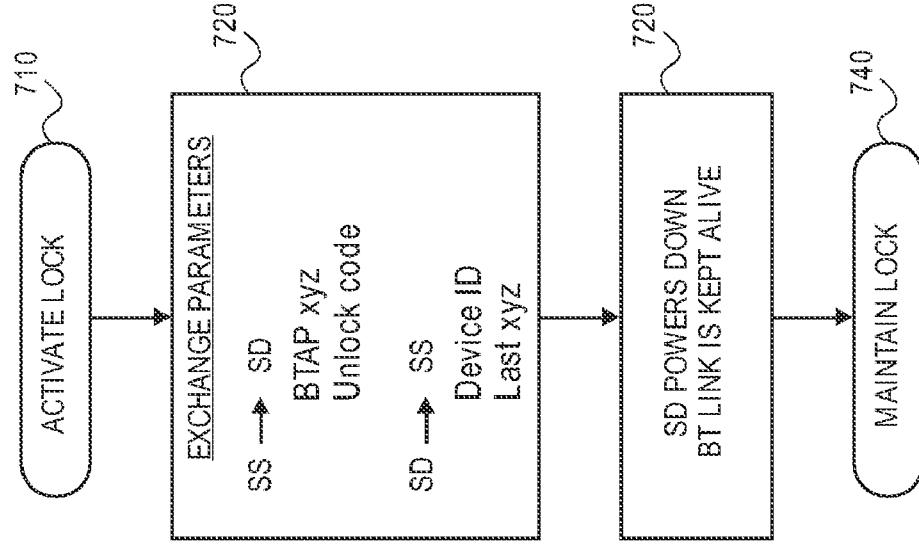
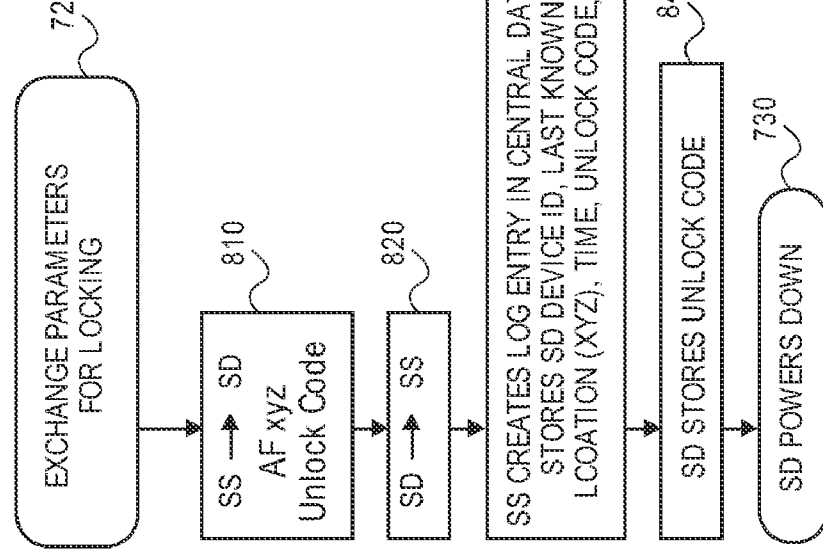

FIG. 8



Explore Litigation Insights

Docket Alarm provides insights to develop a more informed litigation strategy and the peace of mind of knowing you're on top of things.

Real-Time Litigation Alerts



Keep your litigation team up-to-date with **real-time alerts** and advanced team management tools built for the enterprise, all while greatly reducing PACER spend.

Our comprehensive service means we can handle Federal, State, and Administrative courts across the country.

Advanced Docket Research



With over 230 million records, Docket Alarm's cloud-native docket research platform finds what other services can't. Coverage includes Federal, State, plus PTAB, TTAB, ITC and NLRB decisions, all in one place.

Identify arguments that have been successful in the past with full text, pinpoint searching. Link to case law cited within any court document via Fastcase.

Analytics At Your Fingertips



Learn what happened the last time a particular judge, opposing counsel or company faced cases similar to yours.

Advanced out-of-the-box PTAB and TTAB analytics are always at your fingertips.

API

Docket Alarm offers a powerful API (application programming interface) to developers that want to integrate case filings into their apps.

LAW FIRMS

Build custom dashboards for your attorneys and clients with live data direct from the court.

Automate many repetitive legal tasks like conflict checks, document management, and marketing.

FINANCIAL INSTITUTIONS

Litigation and bankruptcy checks for companies and debtors.

E-DISCOVERY AND LEGAL VENDORS

Sync your system to PACER to automate legal marketing.