



US006531845B2

(12) **United States Patent**
Kerai et al.

(10) **Patent No.:** **US 6,531,845 B2**
(45) **Date of Patent:** **Mar. 11, 2003**

(54) **BATTERY CHARGING**

(75) Inventors: **Kanji Kerai**, London (GB); **Kalle Tuulos**, Turku (FI)

(73) Assignee: **Nokia Mobile Phones Limited**, Espoo (FI)

(*) Notice: Subject to any disclaimer, the term of this patent is extended or adjusted under 35 U.S.C. 154(b) by 0 days.

(21) Appl. No.: **09/864,273**

(22) Filed: **May 25, 2001**

(65) **Prior Publication Data**

US 2002/0005707 A1 Jan. 17, 2002

(30) **Foreign Application Priority Data**

May 26, 2000 (GB) 0012946

(51) **Int. Cl.**⁷ **H02J 7/00**

(52) **U.S. Cl.** **320/107**

(58) **Field of Search** 320/106, 107, 320/110

(56) **References Cited**

U.S. PATENT DOCUMENTS

5,371,453 A 12/1994 Fernandez 320/136
5,592,528 A 1/1997 Nelson et al. 324/538
5,814,969 A * 9/1998 Banyas 320/112
6,087,804 A * 7/2000 Suda 320/106

6,118,251 A * 9/2000 Atwater 320/131
6,184,652 B1 2/2001 Yang 320/110
6,184,660 B1 * 2/2001 Hatular 320/139
6,211,649 B1 4/2001 Matsuda 320/115

FOREIGN PATENT DOCUMENTS

EP 1085400 3/2000 G06F/1/26
GB 2 286 732 8/1995
GB 2 293 283 3/1996
JP 200020175 1/2000 G06F/1/26
JP 200020176 1/2000 G06F/1/26
JP 200029544 1/2000 G05F/1/00
JP 2000139032 5/2000 H02J/7/00
JP 2000165513 6/2000 H04M/1/72

* cited by examiner

Primary Examiner—Edward H. Tso

Assistant Examiner—Pia Tibbits

(74) *Attorney, Agent, or Firm*—Antonelli, Terry, Stout & Kraus, LLP

(57) **ABSTRACT**

A battery charging circuit is described in which power is derived from a communications port such as a USB interface (22) and is supplied to a rechargeable battery of a communications device. The communications device, which may be a mobile radio telephone, can be charged from the power supply or internal battery of a laptop computer equipped with a USB port and connected thereto with a suitable cable thereby avoiding the need for a user to carry a dedicated battery charger for the radio telephone.

44 Claims, 6 Drawing Sheets

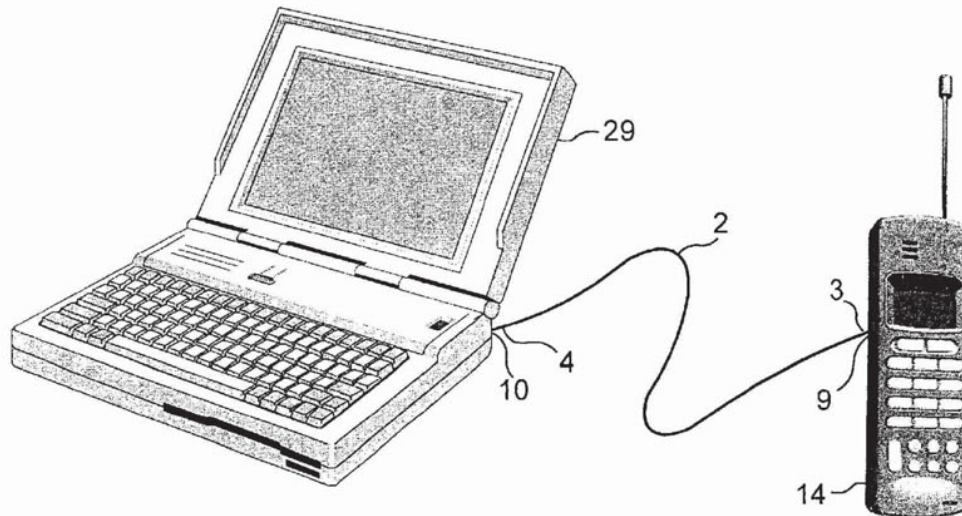

PA_0000290

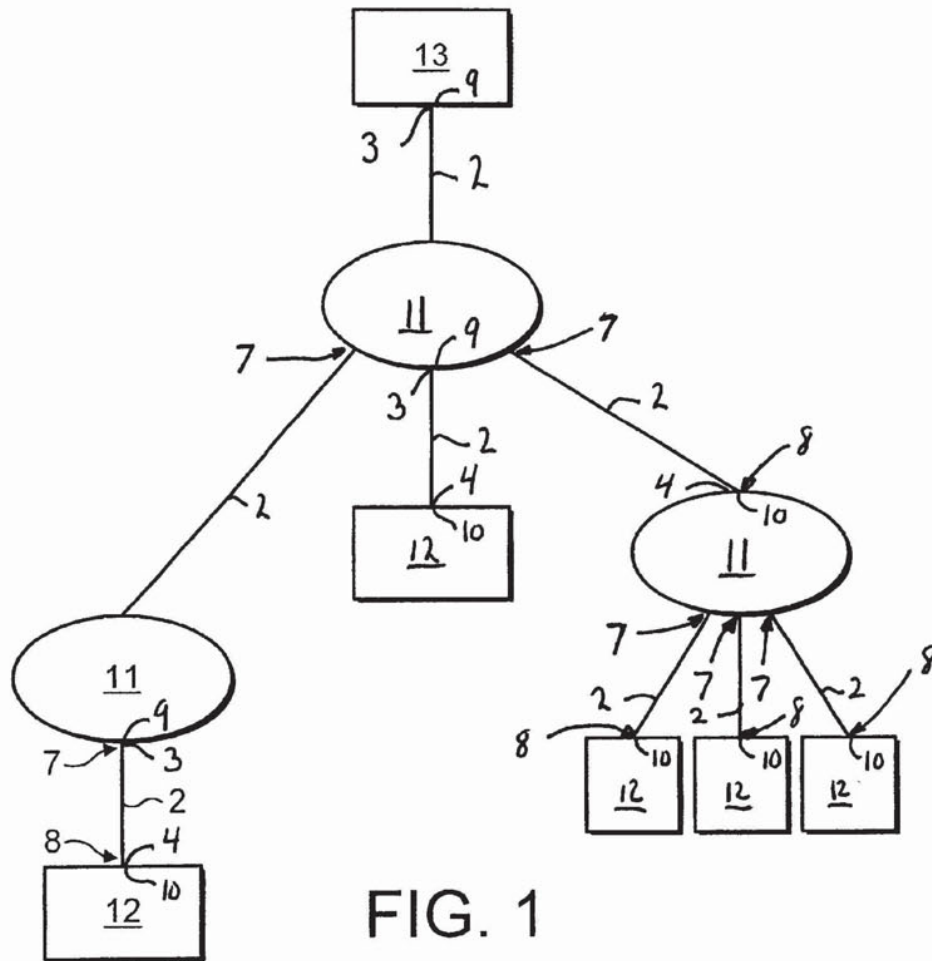

FIG. 1

(PRIOR ART)

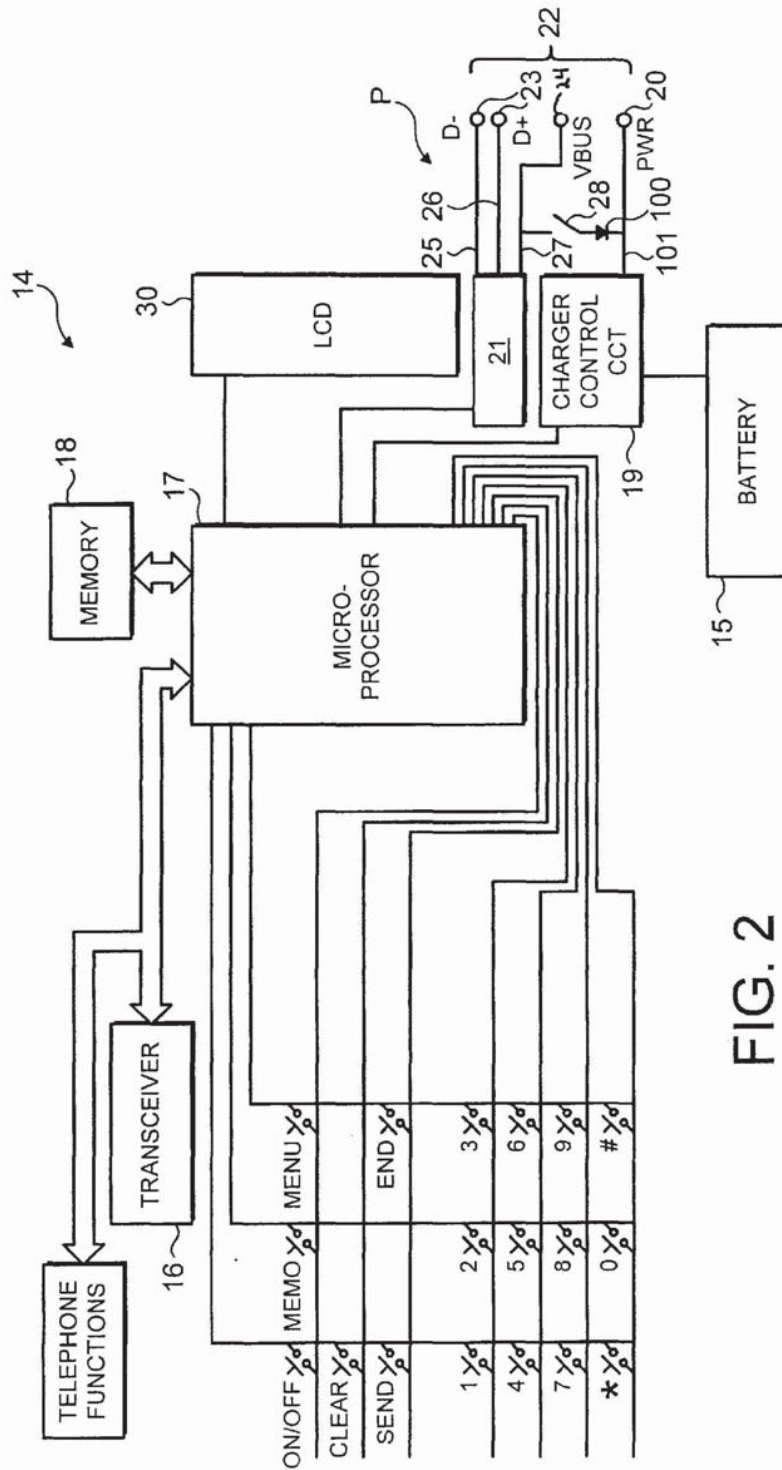

FIG. 2

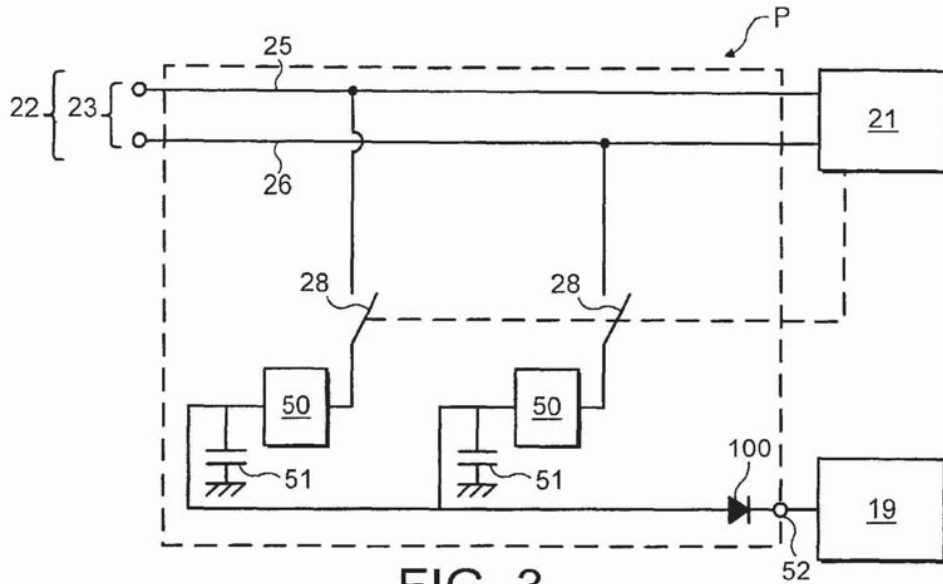

FIG. 3

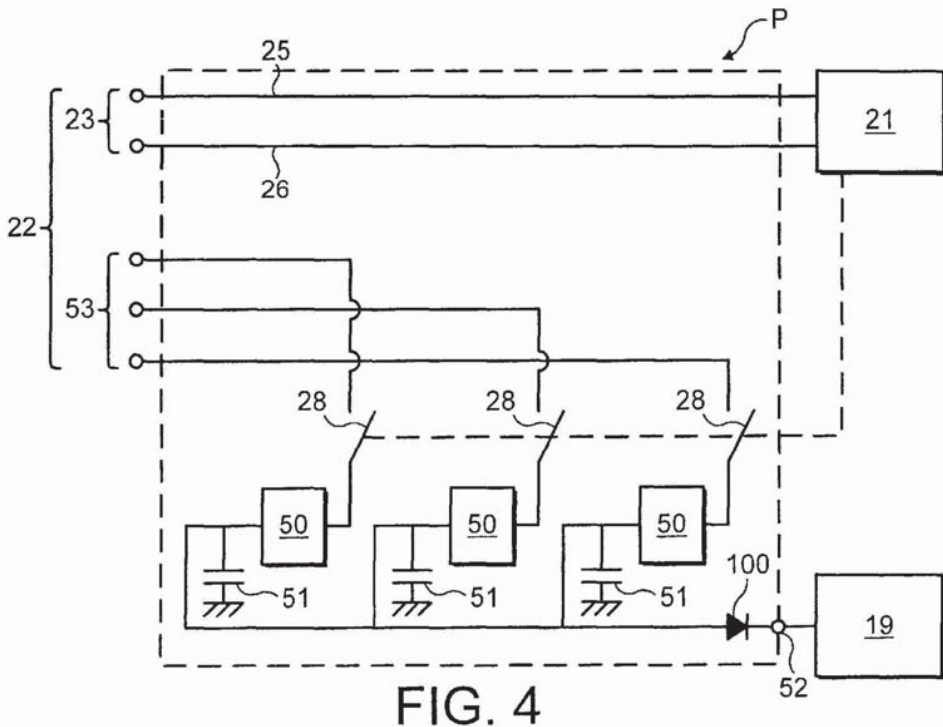

FIG. 4

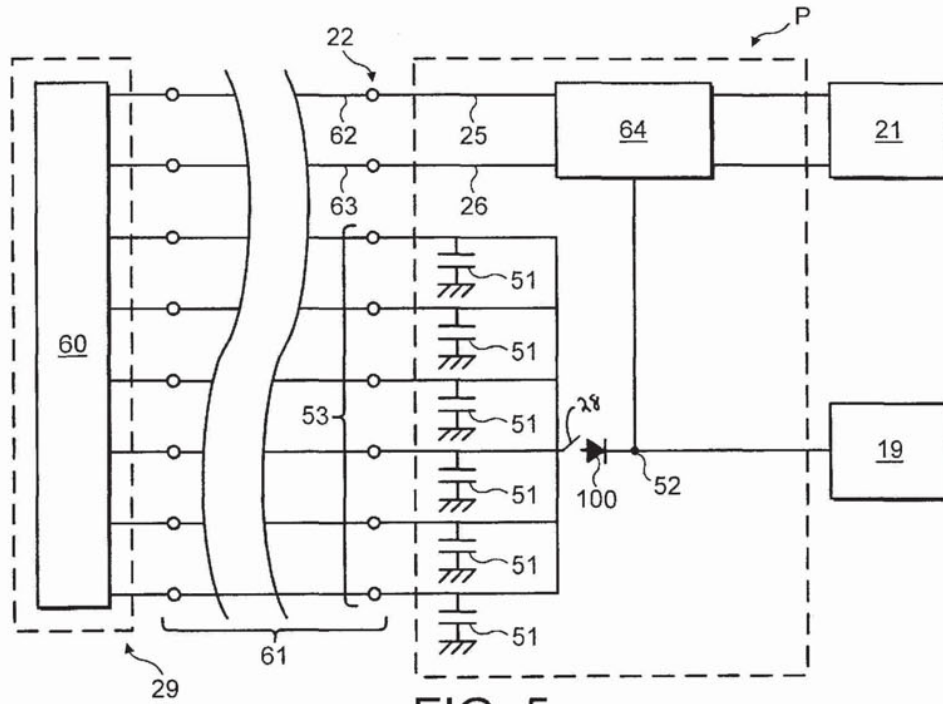

FIG. 5

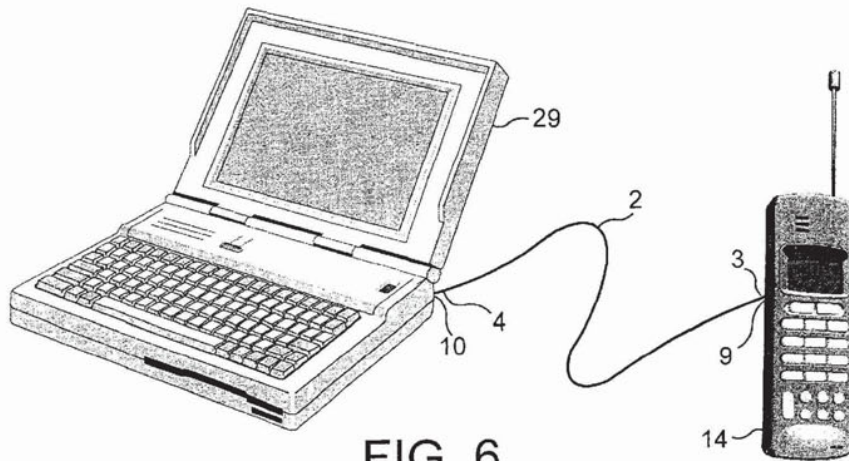

FIG. 6

Explore Litigation Insights

Docket Alarm provides insights to develop a more informed litigation strategy and the peace of mind of knowing you're on top of things.

Real-Time Litigation Alerts



Keep your litigation team up-to-date with **real-time alerts** and advanced team management tools built for the enterprise, all while greatly reducing PACER spend.

Our comprehensive service means we can handle Federal, State, and Administrative courts across the country.

Advanced Docket Research



With over 230 million records, Docket Alarm's cloud-native docket research platform finds what other services can't. Coverage includes Federal, State, plus PTAB, TTAB, ITC and NLRB decisions, all in one place.

Identify arguments that have been successful in the past with full text, pinpoint searching. Link to case law cited within any court document via Fastcase.

Analytics At Your Fingertips



Learn what happened the last time a particular judge, opposing counsel or company faced cases similar to yours.

Advanced out-of-the-box PTAB and TTAB analytics are always at your fingertips.

API

Docket Alarm offers a powerful API (application programming interface) to developers that want to integrate case filings into their apps.

LAW FIRMS

Build custom dashboards for your attorneys and clients with live data direct from the court.

Automate many repetitive legal tasks like conflict checks, document management, and marketing.

FINANCIAL INSTITUTIONS

Litigation and bankruptcy checks for companies and debtors.

E-DISCOVERY AND LEGAL VENDORS

Sync your system to PACER to automate legal marketing.